

Operator Manual



CROWN

PE



WARNING

It's the law, you must be trained and certified to operate this truck.

(OSHA § 1910.178, Rev. 1999)

You or others around you can be seriously injured or even killed if you don't use this truck correctly.

Read and obey all warnings and instructions in this Manual* and on the truck.

Head, arms, hands, legs or feet outside the operator area can be pinned or crushed whenever the truck is moving. Stay within the operator area and **stop the truck completely before getting off.**

However, falls from docks can cause serious injury or even death.

Immediately exit and move away from the truck in these emergencies.

Inspect your truck before starting work, make sure it is in good working order.

* Additional copies of this Operator Manual and all Truck Labels can be obtained from Crown Equipment Corporation, New Bremen, Ohio 45869 U.S.A.

All rights reserved under International and Pan American copyright conventions
Copyright 2006 Crown Equipment Corp.

You Must be Trained



IT'S THE LAW, YOU MUST BE TRAINED AND CERTIFIED

Federal law states that only properly trained operators are permitted to operate a powered industrial truck and that your employer must train you and certify that you are qualified to operate this powered industrial truck. (OSHA §1910.178, Rev. 1999)

Do not operate this truck in your work place until you have been trained and certified by your employer.



You could be killed or seriously injured if you are not adequately trained for lift truck operation!

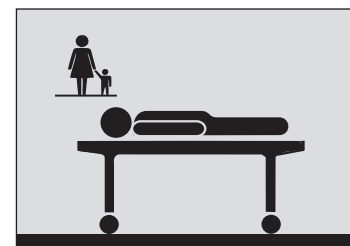

Protect Yourself

! Know the Hazards

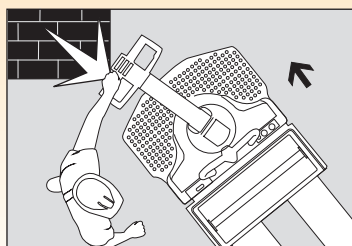
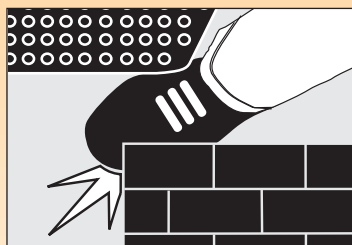
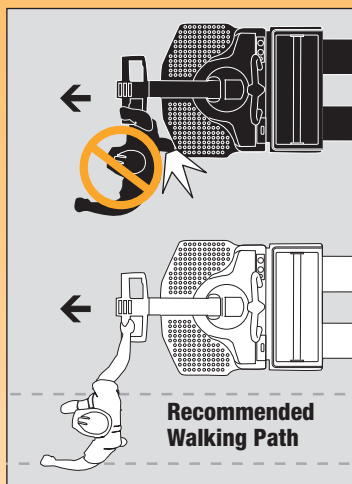

DRIVE CAREFULLY

- When walking, keep to the side of the truck while traveling power unit first. Make certain the truck won't hit the back of your leg or foot. Don't let the truck run over your foot.
- If traveling forks first, keep both hands on the control handle and be careful when changing direction of travel. Keep your feet clear of the truck.
- When riding, keep your hands on the controls and feet on the platform. Keep your body within the operator area.
- While riding, never stick a foot or any part of your body outside the truck, no matter how slow the truck is moving. This truck weighs about 1360 kg or 3000 pounds, even without a load. You cannot stop or slow it down with your foot, hand or any part of your body. A foot or hand caught between the truck and a fixed object will be crushed or even cut off.
- Stay away from the edge of docks and ramps. Make sure dockboards are secure. Check that trailer wheels are chocked. You could be seriously injured or even killed in a fall from a dock or dockboard.
- Keep your truck under control at all times. Drive at a speed that allows you to stop safely. Be even more careful on slippery or uneven surfaces. Do not drive over objects on the floor.
- Perform all truck movements smoothly and at a speed that will give you time to react in an emergency.

! Know the Hazards

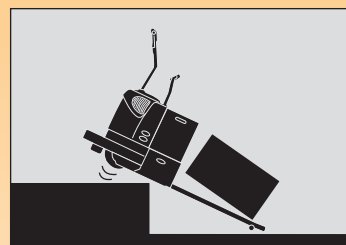

LOOK WHERE YOU'RE DRIVING

- You could be pinned or crushed by objects intruding or poking into the operator area.
- Always be alert to the area around you and watch where you are driving.

AVOID FALLS

Falls from docks are very serious accidents, you can be crushed or even killed. Immediately exit and move away from the truck in these emergencies.

Note: This is not like sit-down rider trucks, where it is recommended that the operator stay with the truck.

The best way to prevent injury is to know where you are at all times and follow the rules of safe truck operation.

Be extremely careful when working around docks, dockboards and trailers.

USE YOUR TRUCK SAFELY

- Keep your hands and feet away from all moving parts such as forks or wheels.
- Never allow passengers on the truck. There is no safe place for them.
- Before you leave your truck:
 - Come to a complete stop.
 - Lower the forks to the floor.
 - Shut the truck off with the key or disconnect the battery.
 - Make certain coast is off.

Warning	1
You Must be Trained	2
Protect Yourself	3
Contents	5
What's in it for You?	6
Your Walkie/Rider Pallet Truck	7
Lift Truck Parts	9
Capacity Plate	11
Display	13
Power On & Off	15
Braking	16
Steering & Travel	17
Power Steering optional	18
Traveling	19
Raising & Lowering	21
Coast Controls optional	22
QuickPick™ Walkalong Control optional	25
Additional Options	27
Daily Safety Check	29
Be a Safe Driver	31
Battery Maintenance	35
Warning Labels	38

WHAT'S IN IT FOR YOU?

The better you understand your truck and how to use it, the better and safer operator you can be. Here are some guides to using this manual.

Power On & Off



KEY SWITCH
Turn the truck on by turning the key clockwise to ON. Check that all display lights are working. Turn the truck off by turning the key counterclockwise to OFF.
Always turn the key off and make certain coast is off when leaving the truck.



POWER DISCONNECT
Pull up on the battery connector to disconnect the battery and cut all power.
Always disconnect the battery any time the truck isn't working right. The key switch does not cut all power to the truck.
Don't use the truck if it's not working right. Report the problem to your supervisor.

Steering & Travel

STEERING
You control steering by moving the control handle from side to side.
For example: This picture shows the directions the truck can turn when the control handle is moved to the approximate position shown.

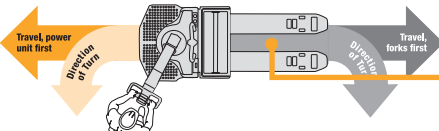

Know the Hazards

POWER UNIT SWING
Be careful turning while traveling forks first. The power unit will swing wide in the opposite direction. Make sure you have clearance, and watch out for people in the area.

SLOW DOWN FOR SPILLS OR WET FLOORS
Powder or liquid spills can cause slippery floors. Slow down or you could lose control of steering. Be careful and allow for a longer stopping distance. Don't run over objects on the floor.

15 Power On & Off
Steering &

QUICK LOCATORS

In addition to the "Contents" page you can use page headings to find topics. Some pages also have a picture of the truck in the corner showing features or functions covered on that page.

HOW-TO-DRAWINGS

On many pages you will find pictures as well as text to help you understand how to use your truck safely and productively.

"KNOW THE HAZARDS"

Watch for and read these special blocks. You will find information about possible safety hazards and how to avoid them.

Your Walkie/Rider Pallet Truck

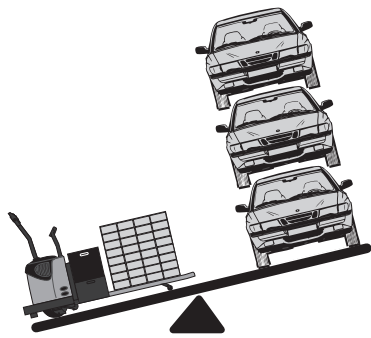

WALKIE/RIDER PALLET TRUCKS

As a rider your pallet truck is designed to move loads over long distances. You can also use it as a walkalong truck and pick stock with it.

YOUR PALLET TRUCK IS NOT AN AUTOMOBILE

With a load it may weigh more than 3 automobiles.

- You don't steer the same.
- You don't brake the same.
- You don't accelerate the same.

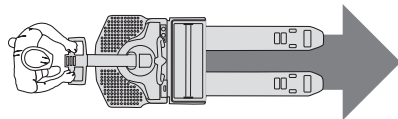

HOW TO DRIVE YOUR TRUCK WHILE WALKING

Forks First

When traveling forks first, use both hands to operate the control handle.

Watch your feet if you change direction of travel.

Power Unit First

When traveling power unit first, stay to one side of the truck and slightly ahead of the power unit. Use the hand closest to the truck to operate the control handle.

Watch your feet.

Stay out of the path of the truck.

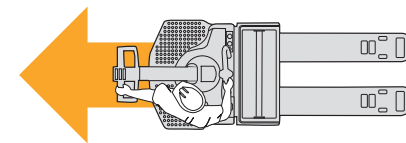
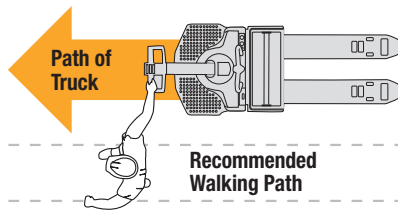

HOW TO DRIVE YOUR TRUCK WHILE RIDING

Keep both feet on the platform. Place one hand on the control handle and the other on the grab bar. Keep your entire body within the operator area.

GIVE YOUR BODY A BREAK

Take advantage of stop time. Get off the truck and flex your arms and legs. Staying alert will help you be a better and safer driver.



BUILT TO STANDARDS

This truck was designed and built to current industry and government standards and guidelines. For more information see the following:

- American National Standards Institute (ANSI / ITSDf) B56.1 (Download free from www.itsdf.org)
- Occupational Safety and Health Act (OSHA) §1910.178 Rev. 1999
- Underwriters Laboratory (UL) 583
- National Fire Prevention Association (NFPA) 505

Lift Truck Parts

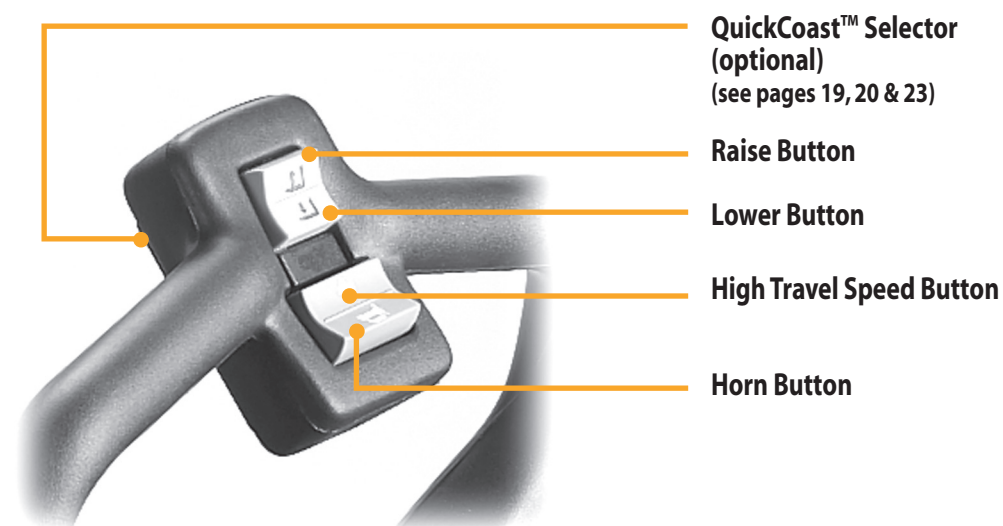
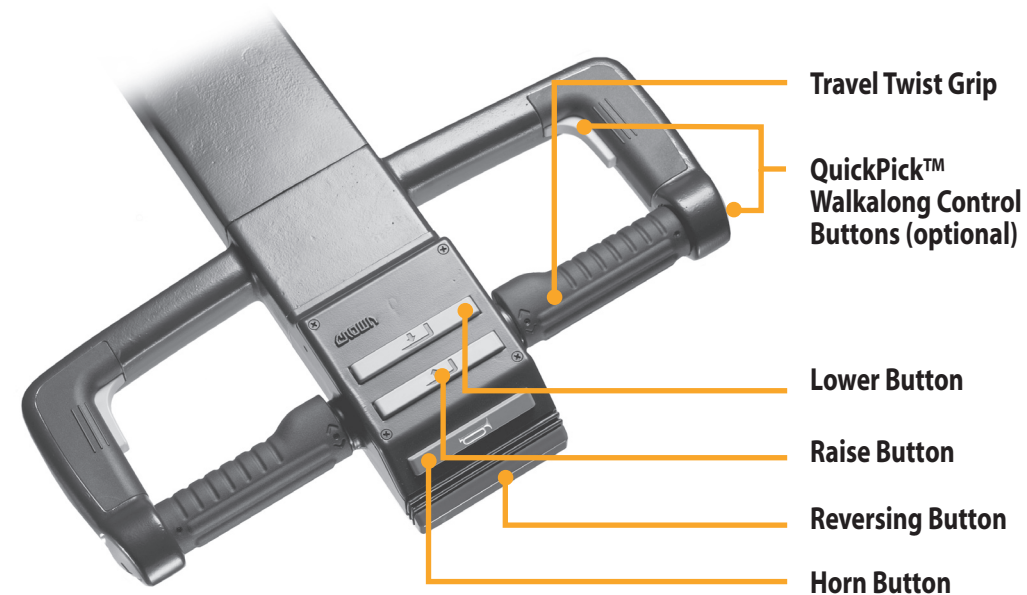
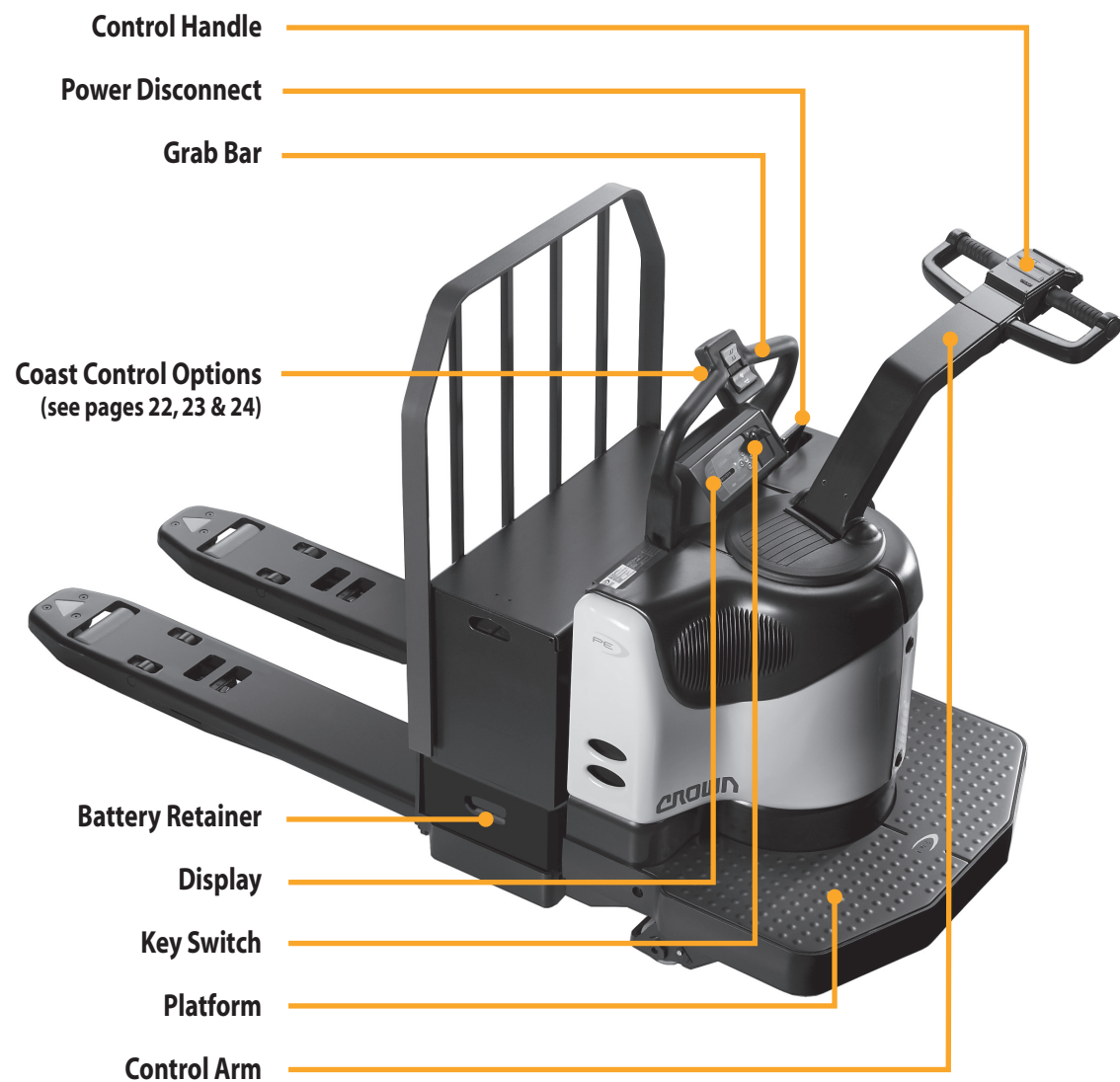

Capacity Plate

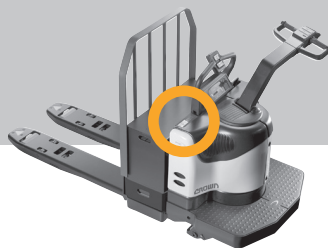

CAPACITY PLATE INFORMATION

The capacity plate is on the top of the power unit cover. It contains:

- Capacity information
- Truck type (a fire safety rating)
- Truck weight (does not include load)
- Grade rating
- Battery information
- Truck information

SAMPLE CAPACITY PLATE

The information shown on this sample plate does not apply to your truck.

WHAT IS YOUR TRUCK CAPACITY?

Capacity is the maximum load that can be lifted or transported with your truck. See the capacity plate on your truck. Make certain you use the correct units of measure.

	Units of measure: kg/mm (lb/in)	Truck Data Number		Max. Grade	
	Capacity with Equally Distributed Load	1234567890123456	2003		%
	2720(6000)	Battery Weight		Hour Rate	
	Truck Weight with Max. Battery	Min 440(975)	Max 680(1500)		
	1460(3224)	Model Number		D.C. Voltage	
	Truck Weight Less Battery ± 5%	PW4000XX		24	
	780(1724)	Battery Type	Load Tire Tread Width	Max. AMP Hr.	
	Serial Number	E	330(12.9)		
	A1234567				
	Truck Type				
	E				
	This truck as released conforms to the mandatory requirements of ANSI/ITSDF B56.1 Crown Equipment Corporation New Bremen, Ohio 45869 USA 705-A				

Note: ANSI/ITSDF B56.1 requires that all data be shown first in Metric units and then USA units.

! Know the Hazards

KNOW YOUR LOAD

Do not exceed the capacity shown on your truck's capacity plate. Make certain you use the correct units of measure. Be careful when handling long, high or wide loads. Do not handle unstable loads.

TRUCK TYPE

Some truck types are not permitted in areas where there are fire hazards. Watch for marked areas. *For example: You must not drive a type E or ES truck into an area restricted to EE or EX trucks.*

TRUCK WEIGHT

Dockboards, elevators and some floors have limited capacity. Check your capacity plate for the weight of your truck. Remember to add the weight of the battery and the load you have on the forks.

Display

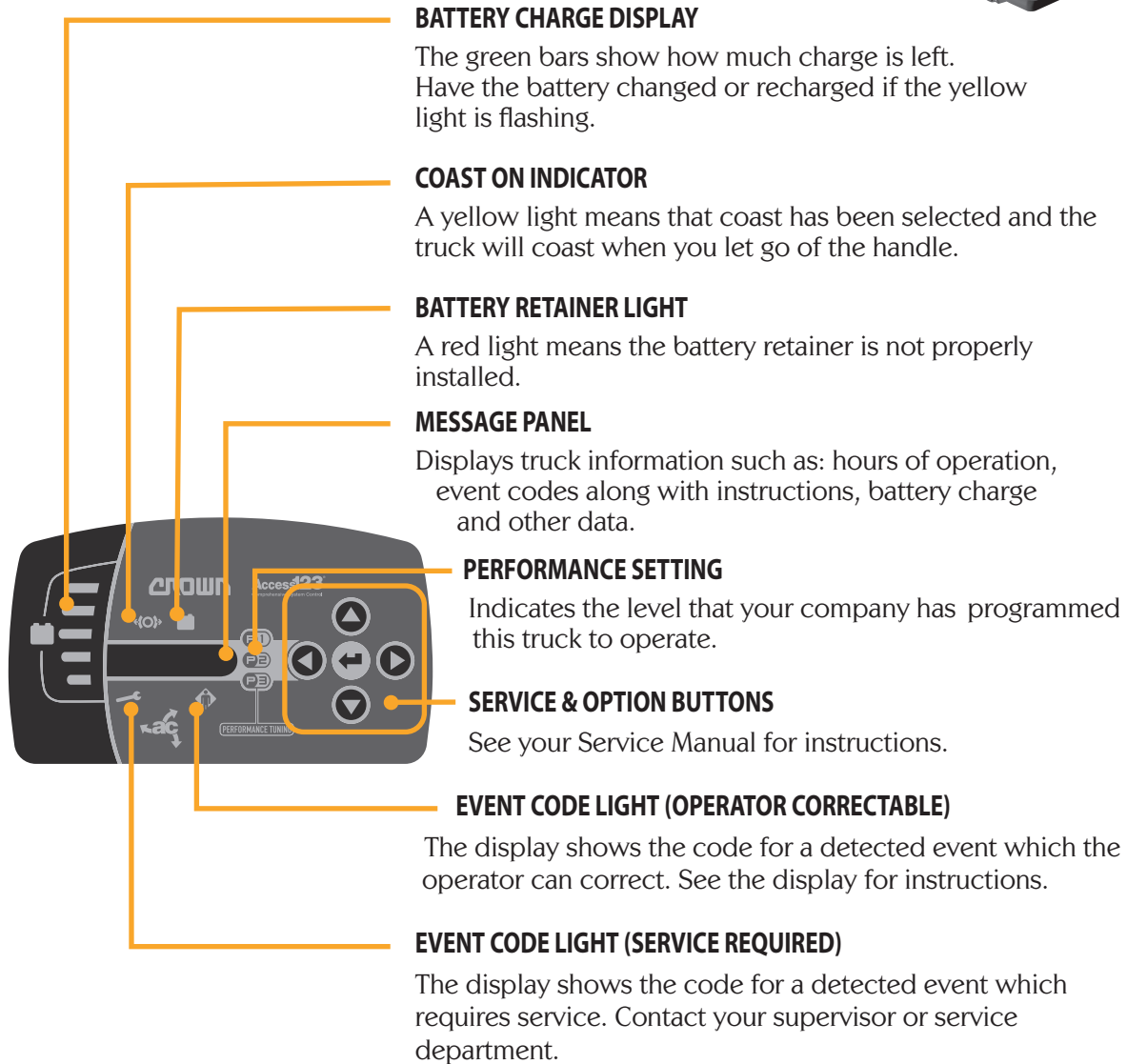
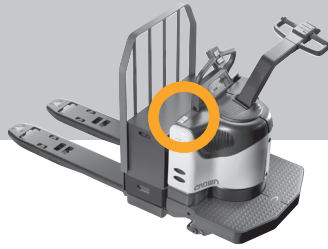

This page
left blank
intentionally

Power On & Off

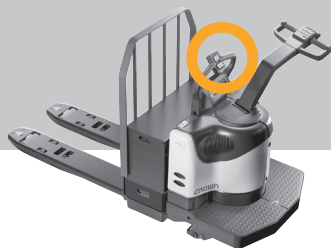

KEY SWITCH

Turn the truck on by turning the key clockwise to ON. Check that all display lights are working.

Turn the truck off by turning the key counterclockwise to OFF.

Always turn the key off and make certain coast is off when leaving the truck.



POWER DISCONNECT

Pull up on the battery connector to disconnect the battery and cut all power.

Always disconnect the battery any time the truck isn't working right. The key switch does not cut all power to the truck.

Don't use the truck if it's not working right. Report the problem to your supervisor.

Braking

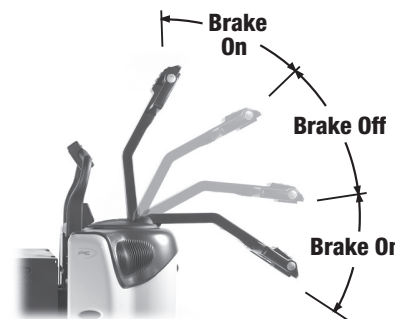

BRAKING

To apply the brake, move the control handle either down or up to one of the braking positions.

Braking is different if you use the coast feature (see pages 22, 23 & 24).

Always check the braking and the position of the coast selector before you start driving.

! Know the Hazards

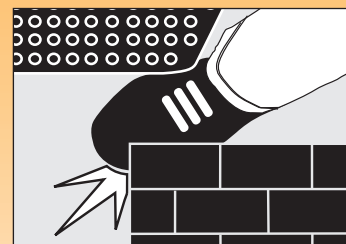

WATCH YOUR FEET

While riding, keep your feet on the platform at all times. This truck can weigh 1360 kg or 3000 pounds unloaded. You cannot stop or even slow it down with your foot, or any part of your body, no matter how slow the truck is moving. A foot or hand caught between the truck and a wall, or any fixed object, will be crushed or even cut off.



MAKE SURE YOUR BRAKE WORKS

Test the brake on your truck at the start of each shift. Know the distance it takes to stop before you start working.

If at any time the stopping distance is too long for you to stop safely, don't drive the truck. Report any problem to your supervisor.

Steering & Travel

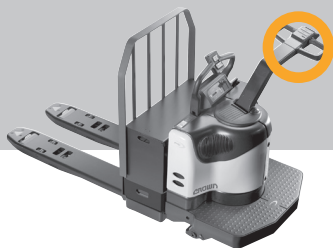

STEERING

You control steering by moving the control handle from side to side.
For example: This picture shows the directions the truck can turn when the control handle is moved to the approximate position shown.

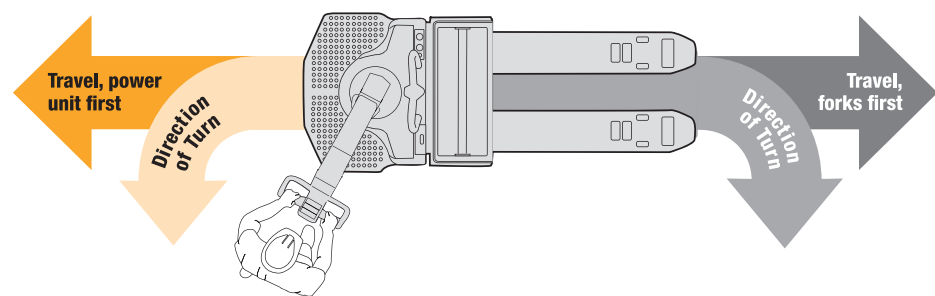

! Know the Hazards

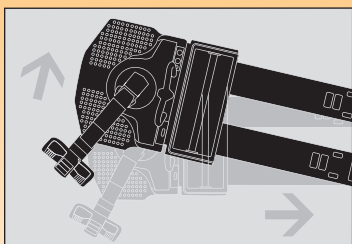

POWER UNIT SWING

Be careful turning while traveling forks first. The power unit will swing wide in the opposite direction. Make sure you have clearance, and watch out for people in the area.



SLOW DOWN FOR SPILLS OR WET FLOORS

Powder or liquid spills can cause slippery floors. Slow down or you could lose control of steering and braking. Be careful and allow for a longer stopping distance. Don't run over objects on the floor.

Power Steering optional

POWER STEERING OPTION

This option makes it easier for you to move the steering handle from side to side.

After you turn the key to ON, the display will show the following instructions:

1. Steer to Center.

Move the steering handle through the center position.

Note: Travel speed will be limited until the handle is centered.

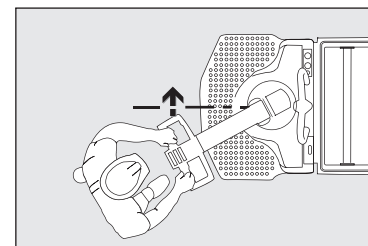

2. Cycle Reversing Button.

Press the Reversing Button.

The truck is ready for operation.



! Know the Hazards

SIMILAR LOOKING TRUCKS CAN BE DIFFERENT

If you ever drive a different truck, even one that looks just like yours, be careful. It may not have the same options.

Traveling

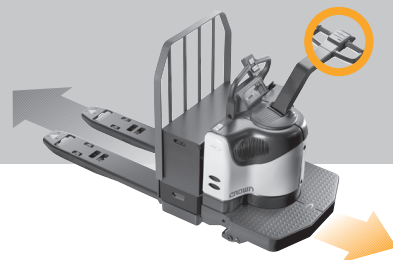

TRAVEL

Rotate the top of the twist grip in the direction you want to travel.

The farther you rotate the grip from the neutral position, the faster the truck will travel.

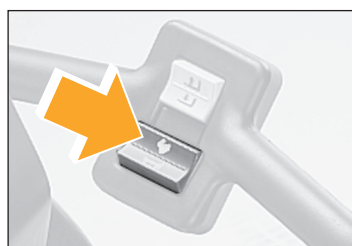

ONE TOUCH HIGH TRAVEL SPEED

For high travel speed while riding the truck, rotate the twist grip, then press and release the high travel speed button on the grab bar. Rotate the twist grip to the maximum travel speed position.

When the twist grip is returned to neutral, the speed control will reset to standard operation.

HIGH TRAVEL SPEED WITHOUT ONE TOUCH

Rotate the twist grip, then push and hold the high travel speed button on the grab bar. Rotate the twist grip to the maximum travel speed position.

When the twist grip is returned to neutral, the speed control will reset to standard operation.



REVERSING BUTTON

If you accidentally hit the reversing button while working in close quarters, the truck will move in the direction of the forks.

Be careful. The reversing button cannot prevent all injuries.

! Know the Hazards

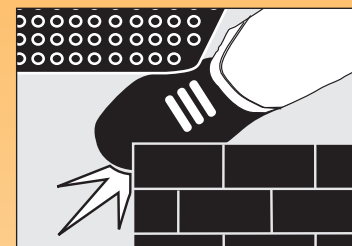

WATCH YOUR FEET AND HANDS

- While riding, keep your feet on the platform and hands on the controls at all times. This truck weighs about 1360 kg or 3000 pounds, even without a load. You cannot stop or even slow it down with your foot, hand or any part of your body, no matter how slow the truck is moving. A foot or hand caught between the truck and a wall, post or any fixed object will be crushed or even cut off.

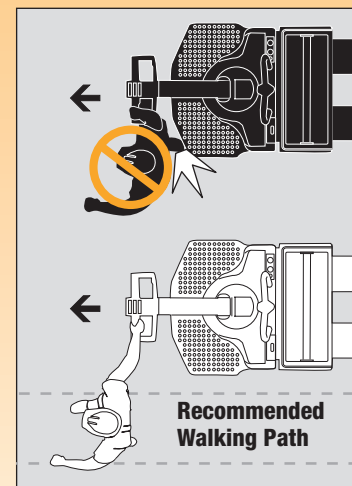

- When walking and traveling power unit first, protect your legs and feet by staying to the side and keeping out of the path of the truck.

LOOK WHERE YOU'RE GOING

Driver distractions can cause accidents resulting in injury or even death.

- Don't use cell phones or similar devices while operating the truck.
- Travel in the direction where you have the best visibility.
- Always be alert to the area around you and watch where you are driving. You could be pinned or crushed by driving into walls or racks or other fixed objects.
- You could also be seriously injured by objects intruding or poking into the operator area.

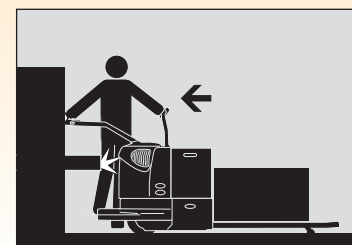

Raising & Lowering

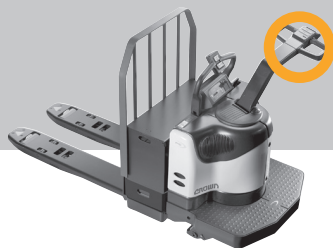

RAISE

Push either raise button until the forks are at the desired height.

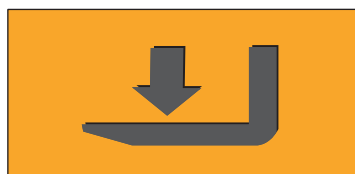

LOWER

Push either lower button until the forks are at the desired height.

Coast Controls optional

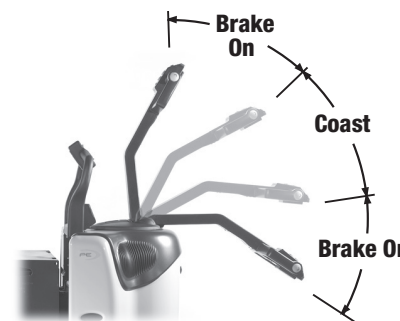

COAST, A WALKALONG CONTROL OPTION

You can use one of two optional coast controls to make it easier to pick loads while walking short distances with the truck. This feature allows the truck to coast when you let go of the control handle. However you can apply the brake by moving the control handle to one of the brake positions.

Be even more careful when using coast. Make sure you understand the possible hazards. Don't place yourself or others at risk.

High travel speed is not available while coast is engaged.

OPTION 1, MANUAL COAST SELECTOR

COAST ON

Move the control handle to the coast position and shift the coast selector lever toward the control arm.

With coast on, the truck will coast when you let go of the control handle. You must move the handle to a brake position to apply the brake.



COAST OFF

Move the control handle down and shift the coast selector away from the control arm.

When coast is disabled, braking will return to standard operation (see page 16).

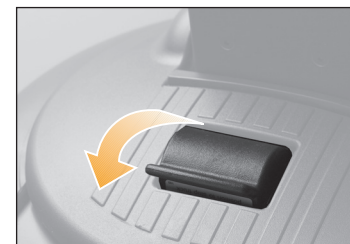

Coast Controls optional (continued)

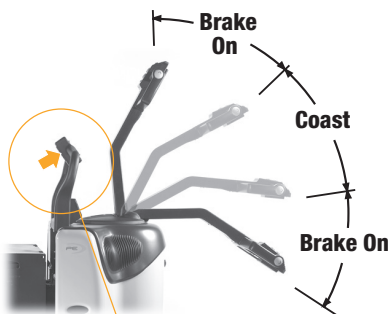
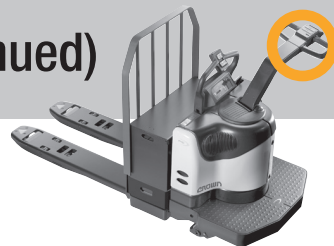

OPTION 2, Electronic QuickCoast™ SELECTOR

COAST ON

Move the control handle to the coast position and press the coast selector button on the back of the grab bar, opposite the raise/lower switches. The “no-brake” symbol on the display will light and a single “beep” will sound to warn that the truck is in the coast mode.

With coast on, the truck will coast when you let go of the control handle. You must move the handle to a brake position to apply the brake. A “beep” will continue to sound as long as the handle is in the brake position.

COAST OFF

To turn coast off, either press the high travel speed button on the grab bar, turn the key switch to OFF, or disconnect the battery. The “no-brake” symbol will go out, and the control handle will return to vertical.

If you accidentally hit the reversing button when the handle is in the coast position, coast is also disabled.

When coast is disabled, braking will return to standard operation (see page 16).



WARNING

Truck will coast if handle stays in drive position when released.

Move control handle to brake position to stop truck.

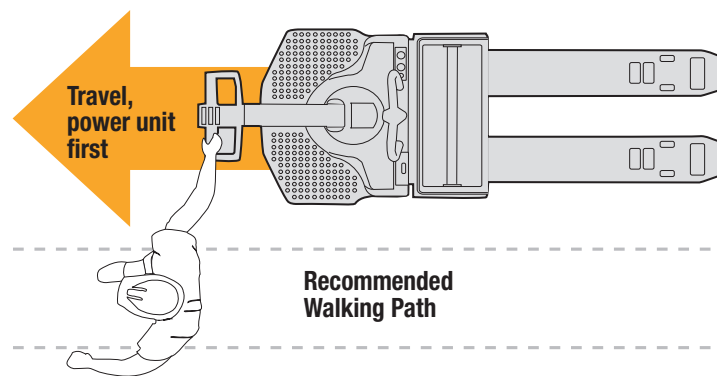

WHEN USING COAST

- Travel power unit first only.
- Don't get in the path of the truck and watch your feet.
- Stay to the side of the truck. Keep your arm extended to give maximum clearance between you and the truck.

Know the Hazards

WARNING

Truck will coast if handle stays in drive position when released.

Move control handle to brake position to stop truck.



USING COAST REQUIRES EVEN MORE CAUTION

- Automatic braking is disabled when Coast is activated. Handle must be manually moved to a brake position.
- Floors must be level and free of obstacles.
- Never allow the truck to coast into a cross aisle.
- Do not use coast in pedestrian walkways.
- Watch out for people and other trucks.
- Do not walk in the path of a coasting truck. Stay to the side of the truck with your arm extended and keep your feet clear.
- Use coast while traveling power unit first only.
- Always turn coast off when you finish a coast operation, or whenever you leave your vehicle.
- For QuickCoast equipped trucks, when you turn coast off or turn the truck off, make certain your body is not in the path of the control handle as it returns to vertical.

QuickPick™ Walkalong Control optional

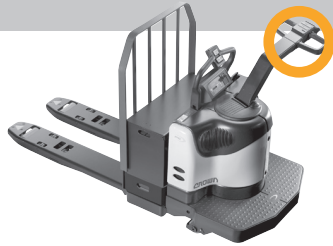

QUICKPICK™ WALKALONG CONTROL OPTION

You can use this option, usually along with the coast option (see pages 22, 23 & 24), to make it even easier to pick loads.

Use these options when picking items located close to each other in an aisle, usually within 4 bays or about 11 meters (36 feet).

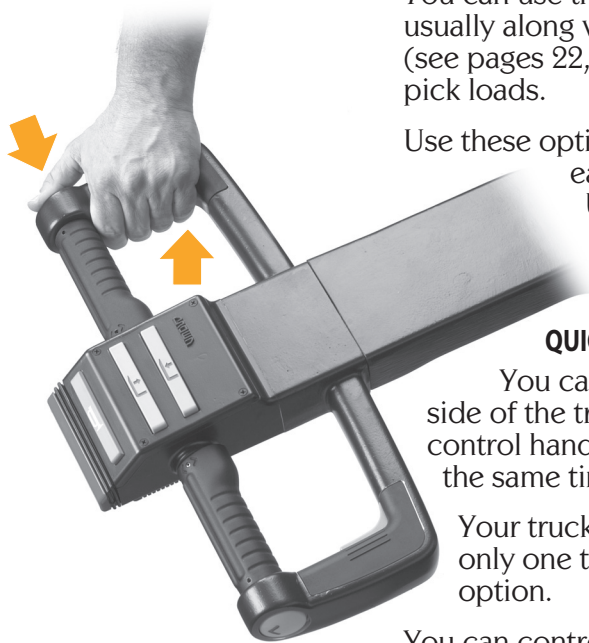

QUICKPICK WALKALONG CONTROL BUTTONS

You can use the QuickPick controls from either side of the truck. Place your hand on the end of the control handle closest to you. Press both buttons at the same time.

Your truck will travel power unit first. You have only one travel speed while using the QuickPick option.

You can control travel speed by releasing and pressing the control buttons occasionally.

Use the twist grips anytime you need better control of travel speed or steering.

Know the Hazards

USE THE QUICKPICK™ WALKALONG CONTROL CAREFULLY

- Don't let the truck speed exceed your walking speed.
- Limit use of the QuickPick controls to moving the truck between picks in clear aisles.
- Use the twist grips if you need better control of travel speed or steering.
- Use only on level surfaces.
- Watch out for people and other trucks.

Additional Options

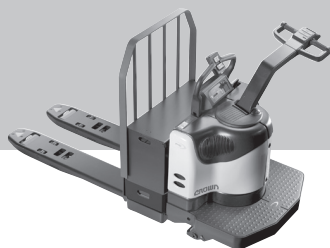

LOAD BACKREST OPTION

Your company may have ordered a load backrest if you must handle loads that are unstable or not secured.

Don't place your hand or arm over the backrest. It could be pinned or crushed by the load.

There are three types of backrest.



PIVOTING TYPE

Lift up on the handle and swing the backrest forward if you need to service the battery. When you return the backrest to the upright position, make sure the handle is all the way down and the backrest can't swing forward.

LIFT-OFF TYPE

You can remove or install this backrest as required.
Note: Use a hoist if the backrest is heavy.

BOLT-ON TYPE

Need not be removed to change the battery.

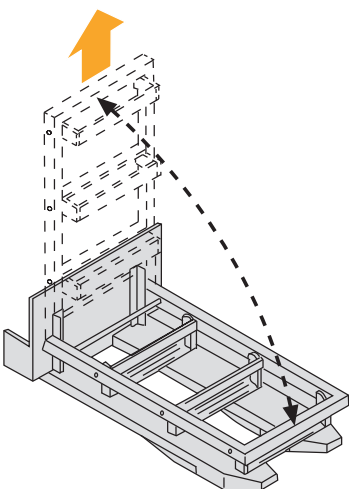

SKID ADAPTOR OPTION

Lift the skid adaptor until you can move it forward and lower it to the forks.

Make certain the skid adaptor is secure when you return it to the upright position.



WORK ASSIST™ TUBE OPTION

This feature provides a location for attaching work assist options such as: lights, fan, clipboard etc.

While traveling, be sure that the work assist tube will clear doorways and other surrounding obstructions.

The work assist tube does not have a gripping surface, nor is it located to serve as a handhold. Always keep one hand on the grab bar while riding.

Make certain any options fastened to the work assist tube do not interfere with operation of the control handle.

! Know the Hazards

WARNING

Watch For Obstructions

Make certain this tube will clear doorways and any surrounding obstructions.

This Tube Not A Handhold

Keep your hands in the proper operating position while riding.

Handle Must Move Freely

Do not add any device that will interfere with movement of the control handle.

478-A

PROTECT YOUR HANDS AND ARMS

Loads can shift and fall against the backrest. Keep your hands and arms on the power unit side of the backrest.

Do not use the work assist tube as a handhold. Keep one hand on the grab bar while riding.

WATCH FOR OTHER WORK ASSIST HAZARDS

Make certain the work assist tube will clear all doorways, lighting, racks and other surrounding obstructions.

Be sure any additions to the work assist tube will not interfere with control handle movement.

SIMILAR LOOKING TRUCKS CAN BE DIFFERENT

If you ever drive a different truck, even one that looks just like yours, be careful. It may not have the same options.

Daily Safety Check

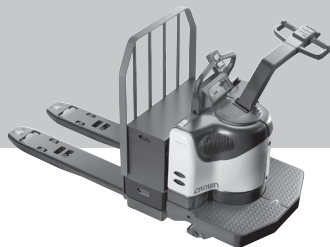

CHECK YOUR TRUCK BEFORE STARTING WORK

You must make sure your truck is safe to use.

1. Walk around your truck and check it over.

- Check to make sure the battery is charged, water level is OK and vent caps are in place. Don't use an open flame to check the battery.
- Make certain the battery retainers on both sides of the truck are properly installed.
- See that all wheels are in good condition.
- Clean the twist grips and grab bar.
- Check that both forks are secure and not bent, cracked or badly worn.
- Look under the truck for signs of hydraulic leaks.
- Test the horn.
- Make sure the power disconnect works.
- Check that all controls work smoothly.
- See that the load backrest is in place and fastened if your truck has that option.

2. Test drive your truck in an uncongested area.

- Test raise and lower operation.
- Check the steering.
- Drive the truck slowly in both directions. Check the reversing button.
- Check braking distance in forward and reverse. Load size and floor conditions can affect these distances.
- Drive through the full speed range in both forward and reverse.
- Know the distance it takes to stop before you start working. If the braking distance is too long to stop safely, don't drive the truck.
- Check Coast, QuickPick™ controls, and any other options your truck may have.

If anything doesn't look, work or feel right, don't drive the truck. Report the problem to your supervisor.

You can get checklist forms from your Crown dealer (part no. OF-3772). Used properly, this checklist can alert service people to needed repairs.

Be a Safe Driver

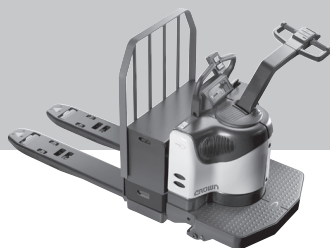

The most important component is you.



MAKE SURE YOU ARE READY TO DRIVE

- Do not use this truck unless you are trained and certified.
- Be certain you understand how your truck works and the hazards that go with it. Don't drive the truck if you have any doubts.
- Know the capacity of your truck. Make certain you use the correct units of measure.
- Some trucks are not allowed in areas where there are fire hazards. Be certain your truck is the correct fire safety type for the area.
- Make sure your hands and shoes are clean and dry, and your clothing is proper for the job.

MAKE SURE YOUR TRUCK IS READY

- Inspect your truck before using it (see pages 29 and 30). If it's not working right, or something is broken, report the problem to your supervisor. Don't use the truck.
- In an open area, test the braking. Check at a slow travel speed first, then a faster one. Know the distance it takes to stop before you start work.

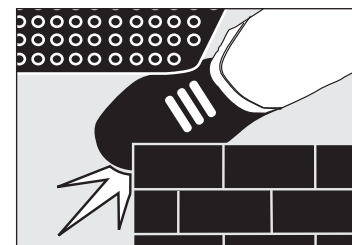

WHEN RIDING

- Never stick a foot or any part of your body outside the operator area, no matter how slow the truck is moving. You cannot stop 1360 kg (3000 pounds) with any part of your body. A foot or hand caught between the truck and a fixed object will be crushed or even cut off.
- Keep your hands on the controls and feet on the platform.
- Stop your truck completely before getting off.

WHEN WALKING

- Stay to the side of the truck when traveling power unit first. Make sure the truck won't hit your leg or run over your foot.
- When traveling forks first, keep both hands on the control. Be careful when changing direction. Keep your feet clear of the truck.

DRIVE CAUTIOUSLY, BE ALERT

- Look where you are going. Don't let your hands or feet get pinned or crushed.
- Travel in the direction that gives you the best view. Slow down in congested areas.
- Slow down for wet or slippery floors. Don't run over things.
- Look where you are going before you change direction of travel.
- See that you have room to drive and turn. Watch out for power unit swing. Slow down when making turns.
- Avoid sudden movement of controls. Learn to use them smoothly at a moderate, even rate.
- Be extra careful if you must use your truck in an area where there is a risk of falling objects.

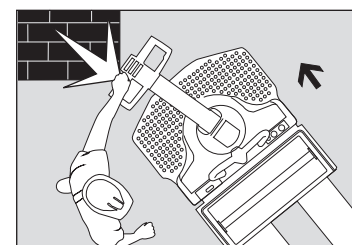

Continued next page...

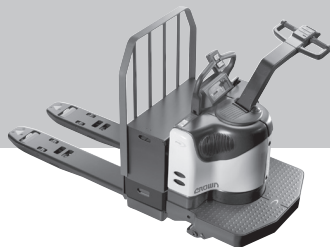

WATCH OUT FOR OTHER PEOPLE

- Slow down. Yield or stop for pedestrians. Use your horn when you come to a crosswalk or intersection.
- Be careful that you don't pin or crush someone. *For example: Never drive your truck toward anyone standing in front of a fixed object.*
- Never allow passengers on your truck.
- Keep others away from your truck while you're working. Don't ever allow anyone to ride on the load or forks.
- Don't let anyone use your truck unless they are trained and certified.
- Don't use the coast option if there are people in the aisle.

WHEN LEAVING YOUR TRUCK

- Lower the forks. Turn the truck off or disconnect the battery.
- Avoid parking on inclines. But if you must, block the wheels of your truck.
- Make sure coast is off.



AVOID FALLS

- Stay away from the edge of docks and ramps.
- Check that bridgeplates and dockboards are secure. Be certain that either the trailer wheels are chocked or the trailer is locked to the dock. Check capacities. Be sure your truck, with load, isn't too heavy for where you are driving.
- Make sure the load you are moving is stable. Center the load. Be even more careful with long, high or wide loads. They can be less stable.
- Don't drive onto an elevator unless you are authorized. Check the capacity or load limit and make sure there are no people present. Enter load first and set the brake.

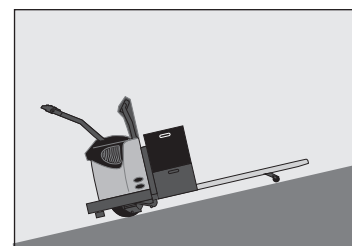

Forks pointed upgrade

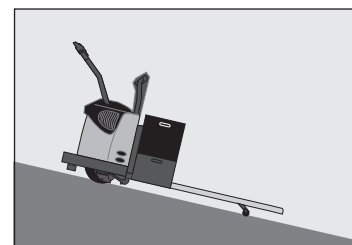

Forks pointed downgrade

BE CAREFUL TRAVELING ON RAMPS AND GRADES

When Riding

- With a load, drive with the forks pointed upgrade.
- Without a load, drive with forks downgrade.

When Walking

- Stay out of the path of the truck.
- With or without a load, drive with the forks pointed downgrade.
- If a load requires that you travel with the forks upgrade, be even more careful. Operate the controls from the side of the truck.

Slow down and don't turn on ramps or grades.

Battery Maintenance

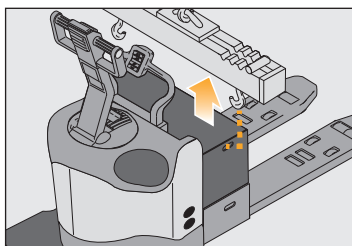
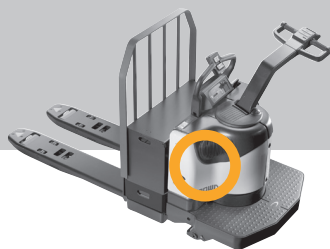

WHEN YOU INSTALL OR CHANGE BATTERIES

- Turn the truck OFF. Be sure the coast selector is off and the brake is applied.
- Make certain you use the correct size and weight battery. Never operate a truck that has an underweight or undersize battery installed.
- Never let anything metal touch the top of the cells. You could cause sparks or do damage to the battery. Use an insulator (such as plywood) when necessary.
- Use an approved spreader bar to place a battery in, or remove it from, the battery compartment or a stand. Make sure you adjust the spreader bar hooks to fit the battery.

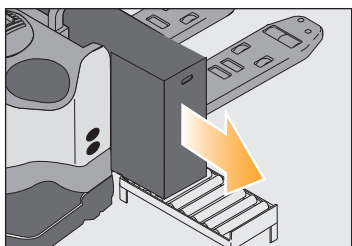

USING A ROLLER STAND

- If you use a roller stand to install or remove a battery make sure the roller stand is the same height as the rollers in the truck's battery compartment. Also make sure the roller stand is at least as long as your battery.

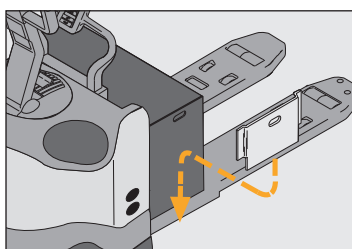

AFTER INSTALLING YOUR BATTERY

- Replace the battery retainers. Make certain the retainers on both sides of the truck are in place.
- Connect the battery. Turn the truck ON and check truck operation.

Note: DELAY ON LIFT

When the battery is connected to the truck, there is approximately a 10 second delay before lift is available.

! Know the Hazards

! DANGER



Batteries produce explosive gas.
Do not smoke, use open flame, or create an arc or sparks near this battery. Ventilate well in enclosed areas and when charging.

Batteries contain **Sulfuric Acid** which causes severe burns. Do not get in eyes, on skin, or clothing. In case of contact, flush immediately. Get medical attention if your eyes are affected.

107

TRUCK BATTERIES CAN BE DANGEROUS

Your truck battery produces fumes that can explode. It also contains acid that could burn or disfigure you.

- Do not try to install, remove, charge or service your truck battery unless you are trained and authorized.
- Never smoke or use an open flame around batteries.
- Your company should provide an area where it is safe to work on batteries. Use that area for all battery work.
- Use protective equipment such as gloves, eye shields, aprons etc.

BATTERY RETAINERS MUST BE IN PLACE

The battery could slide out if all retainers are not in place. Check that both retainers are installed before operating your truck.

COAST SELECTOR MUST BE OFF

Be sure the coast selector is off and the brake is on before removing or installing a battery.

Continued next page...



EACH WARNING LABEL ON YOUR TRUCK IS IMPORTANT
Read and obey all of them to protect yourself and others.

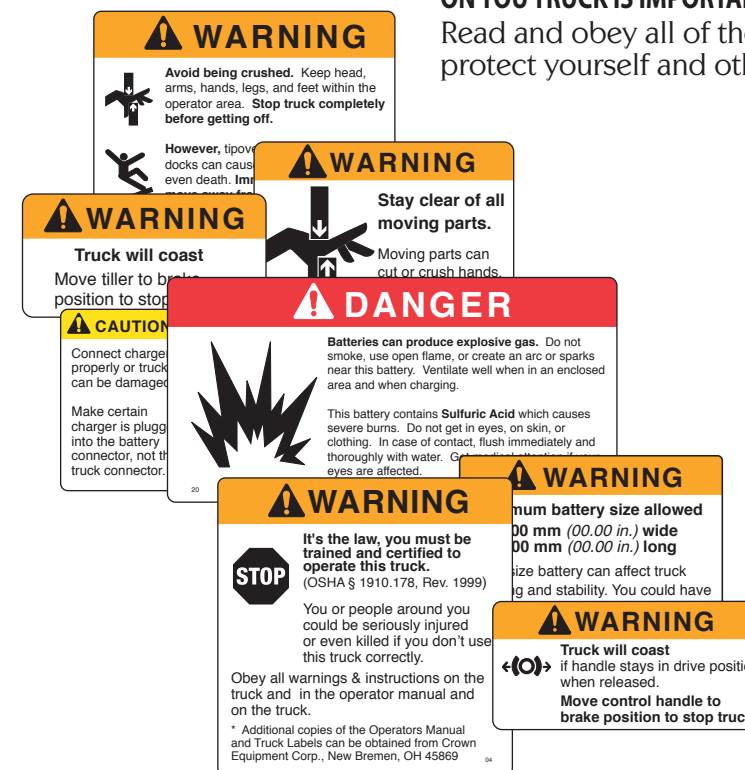

Know the Hazards



BEFORE CHARGING YOUR TRUCK BATTERY

- Turn the truck OFF. Be sure the coast selector is off and the brake is applied.
- Charge the battery only in areas designated for that use.
- See that the battery cells are filled to the proper level. Never use an open flame to check the battery.
- Make certain the charger is the same voltage and amperage as your battery.
- Read the battery charger instructions.
- Be sure the charger is turned OFF before connecting the battery to the charger. Otherwise you might create a spark which could cause the battery to explode.

BATTERY SIZE IS IMPORTANT

Make certain you use the correct size, type and weight of battery. Never operate a truck that has an underweight or undersize battery installed.

WARNING

Minimum battery size allowed
000 mm (00.00 in.) wide
000 mm (00.00 in.) long

Undersize battery can affect truck handling and stability. You could have an accident.
Use U.L. classified Type E battery.



4500 SERIES



*This operator manual has
information for all models of
series PE 4500 plus some
options and accessories.*

*Some of the illustrations and
information may not apply
to your truck.*



The most important component is you.



New Bremen, Ohio 45869 USA © 2009

PF14692 Rev. 6/14

Printed in U.S.A.