

2003 Buick LeSabre Owner Manual

Seats and Restraint Systems	1-1	Driving Your Vehicle	4-1
Front Seats	1-2	Your Driving, the Road, and Your Vehicle	4-2
Safety Belts	1-6	Towing	4-31
Child Restraints	1-27	Service and Appearance Care	5-1
Air Bag Systems	1-46	Service	5-3
Restraint System Check	1-54	Fuel	5-4
Features and Controls	2-1	Checking Things Under the Hood	5-10
Keys	2-3	Headlamp Aiming	5-47
Doors and Locks	2-9	Bulb Replacement	5-52
Windows	2-16	Windshield Wiper Blade Replacement	5-57
Theft-Deterrent Systems	2-18	Tires	5-58
Starting and Operating Your Vehicle	2-21	Appearance Care	5-77
Mirrors	2-33	Vehicle Identification	5-85
OnStar [®] System	2-37	Electrical System	5-85
HomeLink [®] Transmitter	2-38	Capacities and Specifications	5-93
Storage Areas	2-42	Normal Maintenance Replacement Parts	5-94
Sunroof	2-43	Maintenance Schedule	6-1
Vehicle Personalization	2-44	Maintenance Schedule	6-2
Instrument Panel	3-1	Customer Assistance Information	7-1
Instrument Panel Overview	3-4	Customer Assistance Information	7-2
Climate Controls	3-24	Reporting Safety Defects	7-9
Warning Lights, Gages and Indicators	3-32	Index	1
Driver Information Center (DIC)	3-45		
Audio System(s)	3-55		



GENERAL MOTORS, GM, the GM Emblem, BUICK, the BUICK Emblem and the name LESABRE are registered trademarks of General Motors Corporation.

This manual includes the latest information at the time it was printed. We reserve the right to make changes after that time without further notice. For vehicles first sold in Canada, substitute the name "General Motors of Canada Limited" for Buick Motor Division whenever it appears in this manual.

Please keep this manual in your vehicle, so it will be there if you ever need it when you're on the road. If you sell the vehicle, please leave this manual in it so the new owner can use it.

Canadian Owners

You can obtain a French copy of this manual from your dealer or from:

Helm, Incorporated
P.O. Box 07130
Detroit, MI 48207

How to Use This Manual

Many people read their owner's manual from beginning to end when they first receive their new vehicle. If you do this, it will help you learn about the features and controls for your vehicle. In this manual, you will find that pictures and words work together to explain things.

Index

A good place to look for what you need is the Index in back of the manual. It is an alphabetical list of what is in the manual, and the page number where you will find it.

Safety Warnings and Symbols

You will find a number of safety cautions in this book. We use a box and the word CAUTION to tell you about things that could hurt you if you were to ignore the warning.

 **CAUTION:**

These mean there is something that could hurt you or other people.

In the caution area, we tell you what the hazard is. Then we tell you what to do to help avoid or reduce the hazard. Please read these cautions. If you don't, you or others could be hurt.

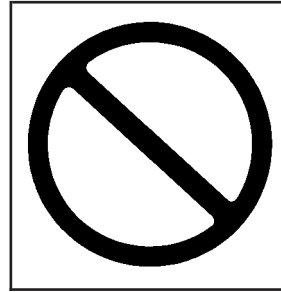

You will also find a circle with a slash through it in this book. This safety symbol means “Don’t,” “Don’t do this” or “Don’t let this happen.”

Vehicle Damage Warnings

Also, in this book you will find these notices:

Notice: These mean there is something that could damage your vehicle.

A notice will tell you about something that can damage your vehicle. Many times, this damage would not be covered by your warranty, and it could be costly. But the notice will tell you what to do to help avoid the damage.

When you read other manuals, you might see CAUTION and NOTICE warnings in different colors or in different words.

You'll also see warning labels on your vehicle. They use the same words, CAUTION or NOTICE.

































Vehicle Symbols

Your vehicle has components and labels that use symbols instead of text. Symbols, used on your vehicle, are shown along with the text describing the operation or information relating to a specific component, control, message, gage or indicator.

If you need help figuring out a specific name of a component, gage or indicator, reference the following topics:

- Seats and Restraint Systems in Section 1
- Features and Controls in Section 2
- Instrument Panel Overview in Section 3
- Climate Controls in Section 3
- Warning Lights, Gages and Indicators in Section 3
- Audio System(s) in Section 3
- Engine Compartment Overview in Section 5

These are some examples of vehicle symbols you may find on your vehicle:

CAUTION POSSIBLE INJURY		LATCH BOTH LAP AND SHOULDER BELTS TO PROTECT OCCUPANT DO NOT TWIST SAFETY BELT WHEN ATTACHING	 	MASTER LIGHTING SWITCH		ENGINE COOLANT TEMP		FUSE BOX ACCESS			
PROTECT EYES BY SHIELDING		FASTEN SEAT BELTS		AIR BAG		TURN SIGNALS		BATTERY CHARGING SYSTEM		ENGINE COOLANT FAN	
CAUSTIC BATTERY ACID COULD CAUSE BURNS		MOVE SEAT FULLY REARWARD SECURE CHILD SEAT		DO NOT INSTALL A REAR-FACING CHILD RESTRAINT IN THIS SEATING POSITION		PARKING LAMPS		BRAKE		FUEL	
AVOID SPARKS OR FLAMES		PULL BELT OUT COMPLETELY THEN SECURE CHILD SEAT		DO NOT INSTALL A FORWARD-FACING CHILD RESTRAINT IN THIS SEATING POSITION		HAZARD WARNING FLASHER		COOLANT		OWNER'S MANUAL	
SPARK OR FLAME COULD EXPLODE BATTERY		POWER WINDOW		DOOR LOCK UNLOCK		DAYTIME RUNNING LAMPS		ENGINE OIL PRESSURE		SERVICE	
						FOG LAMPS		ANTI-LOCK BRAKES		SERVICE MANUAL	

 **NOTES**

Section 1 Seats and Restraint Systems

Front Seats	1-2	Child Restraint Systems	1-33
Manual Seats	1-2	Where to Put the Restraint	1-36
Power Seats	1-2	Top Strap	1-37
Manual Lumbar	1-3	Top Strap Anchor Location	1-38
Power Lumbar	1-3	Lower Anchorages and Top Tethers for Children (LATCH System)	1-38
Heated Seats	1-4	Securing a Child Restraint Designed for the LATCH System	1-40
Reclining Seatbacks	1-4	Securing a Child Restraint in a Rear Seat Position	1-41
Head Restraints	1-6	Securing a Child Restraint in the Right Front Seat Position	1-43
Safety Belts	1-6	Air Bag Systems	1-46
Safety Belts: They Are for Everyone	1-6	Where Are the Air Bags?	1-49
Questions and Answers About Safety Belts	1-11	When Should an Air Bag Inflate?	1-50
How to Wear Safety Belts Properly	1-11	What Makes an Air Bag Inflate?	1-51
Driver Position	1-12	How Does an Air Bag Restrain?	1-52
Safety Belt Use During Pregnancy	1-18	What Will You See After an Air Bag Inflates?	1-52
Right Front Passenger Position	1-19	Servicing Your Air Bag-Equipped Vehicle	1-54
Center Front Passenger Position	1-19	Restraint System Check	1-54
Rear Seat Passengers	1-21	Checking Your Restraint Systems	1-54
Rear Safety Belt Comfort Guides for Children and Small Adults	1-24	Replacing Restraint System Parts After a Crash	1-55
Safety Belt Extender	1-26		
Child Restraints	1-27		
Older Children	1-27		
Infants and Young Children	1-29		

Front Seats

Manual Seats

CAUTION:

You can lose control of the vehicle if you try to adjust a manual driver's seat while the vehicle is moving. The sudden movement could startle and confuse you, or make you push a pedal when you don't want to. Adjust the driver's seat only when the vehicle is not moving.

Pull up on the control bar located under the front of the seat to unlock it. Slide the seat to where you want it and release the bar. Try to move the seat with your body to make sure the seat is locked into place.

Power Seats

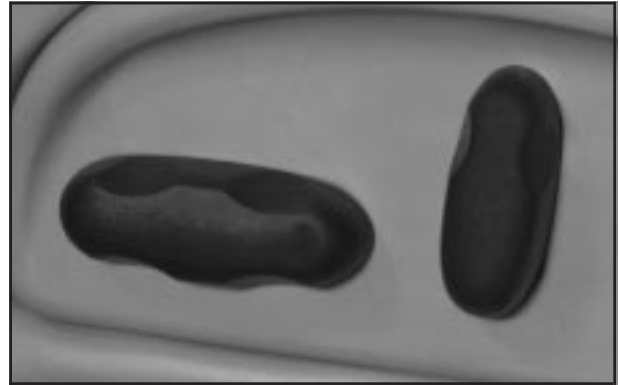

If your vehicle has this feature, the controls for the power seats are located on the outboard side of each front seat.

To adjust the power seats, do the following:

Horizontal Control: Raise or lower the front of the seat cushion by pressing the forward edge of the control up or down.

Raise or lower the rear of the seat cushion by pressing the rear edge of the control up or down.

Move the seat forward or rearward by pressing the control toward the front or rear of the vehicle.

Move the seat higher or lower by holding the whole control up or down.

Vertical Control (Option): Move the seatback into a reclined position by pressing the top of the control backward.

Move the seatback forward by pressing the top of the control forward.

Manual Lumbar



The knob that controls this feature is located on the outboard side of each front seat. Turn the knob toward the front of the vehicle to increase lumbar support. Turn the knob toward the rear of the vehicle to decrease lumbar support.

If you have the independent front cushion moved down as far as it will go, you may feel the lumbar support higher in your back. Readjust the location of the cushion until you are comfortable. You may also want to adjust the seatback for maximum comfort.

Power Lumbar



If your vehicle has this feature, the power lumbar control is located on the outboard side of each front seat. Use the power seat control first to get the proper position. Then continue with the lumbar adjustment.

To reshape the lower seatback, press the lumbar control forward to increase support and rearward to decrease support. Press the control up or down to raise or lower the support mechanism.

Keep in mind that as your seating position changes, as it may during long trips, so should the position of your lumbar support. Adjust the seat as needed.

If you have the independent front cushion moved down as far as it will go, you may feel the lumbar support higher in your back. Readjust the location of the cushion until you are comfortable. You may also want to adjust the seatback for maximum comfort.

Heated Seats

If your vehicle has this feature, press this button to turn on the heating element in the seat.



The heated seat buttons are located on the driver's and front passenger's door panel.

When the heated seat button is first pressed, the high setting is activated. Press the button again for the low setting. The third press of the button turns the feature off.

The low setting warms the seatback and cushion until the seat nears body temperature. The high setting heats the seat to a slightly higher temperature.

The heated seats can only be used when the ignition is turned on. When the ignition is turned off, the heating element is also turned off.

Reclining Seatbacks



If your vehicle has power seats, the vertical control described previously in this section reclines the front seatbacks.

If your vehicle has the manual recliner, lift the lever on the outboard side of the seat and move the seatback to the desired position. Release the lever to lock the seatback. Pull up on the lever without pushing on the seatback and the seatback will go to an upright position.



But don't have a seatback reclined if your vehicle is moving.

⚠ CAUTION:

Sitting in a reclined position when your vehicle is in motion can be dangerous. Even if you buckle up, your safety belts can't do their job when you're reclined like this.

The shoulder belt can't do its job. In a crash, you could go into it, receiving neck or other injuries.

The lap belt can't do its job either. In a crash the belt could go up over your abdomen. The belt forces would be there, not at your pelvic bones. This could cause serious internal injuries.

For proper protection when the vehicle is in motion, have the seatback upright. Then sit well back in the seat and wear your safety belt properly.

Head Restraints



Adjust your head restraint so that the top of the restraint is closest to the top of your head. This position reduces the chance of a neck injury in a crash.

Safety Belts

Safety Belts: They Are for Everyone

This part of the manual tells you how to use safety belts properly. It also tells you some things you should not do with safety belts.

CAUTION:

Don't let anyone ride where he or she can't wear a safety belt properly. If you are in a crash and you're not wearing a safety belt, your injuries can be much worse. You can hit things inside the vehicle or be ejected from it. You can be seriously injured or killed. In the same crash, you might not be, if you are buckled up. Always fasten your safety belt, and check that your passengers' belts are fastened properly too.

⚠ CAUTION:

It is extremely dangerous to ride in a cargo area, inside or outside of a vehicle. In a collision, people riding in these areas are more likely to be seriously injured or killed. Do not allow people to ride in any area of your vehicle that is not equipped with seats and safety belts. Be sure everyone in your vehicle is in a seat and using a safety belt properly.



Your vehicle has a light that comes on as a reminder to buckle up. See *Safety Belt Reminder Light* on page 3-36.

In most states and in all Canadian provinces, the law says to wear safety belts. Here's why: *They work.*

You never know if you'll be in a crash. If you do have a crash, you don't know if it will be a bad one.

A few crashes are mild, and some crashes can be so serious that even buckled up, a person wouldn't survive. But most crashes are in between. In many of them, people who buckle up can survive and sometimes walk away. Without belts they could have been badly hurt or killed.

After more than 30 years of safety belts in vehicles, the facts are clear. In most crashes buckling up does matter... a lot!

Why Safety Belts Work

When you ride in or on anything, you go as fast as it goes.

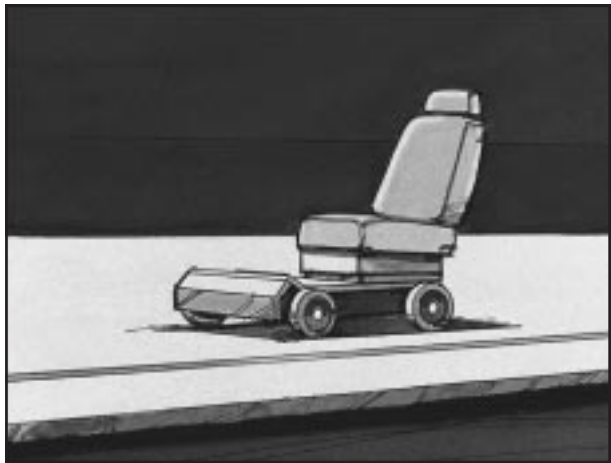

Take the simplest vehicle. Suppose it's just a seat on wheels.



Put someone on it.

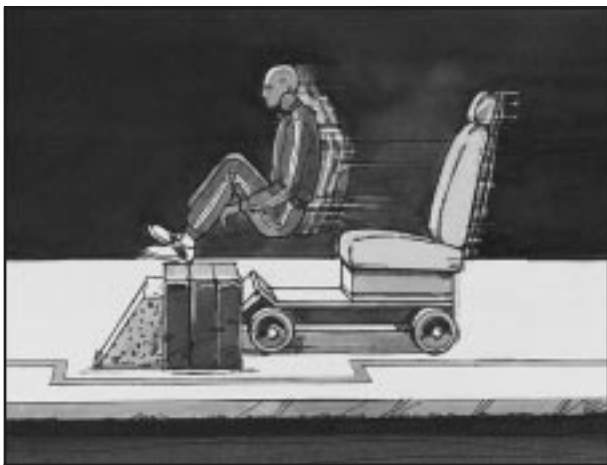

Get it up to speed. Then stop the vehicle. The rider doesn't stop.



The person keeps going until stopped by something. In a real vehicle, it could be the windshield...



or the instrument panel...



or the safety belts!

With safety belts, you slow down as the vehicle does. You get more time to stop. You stop over more distance, and your strongest bones take the forces. That's why safety belts make such good sense.

Questions and Answers About Safety Belts

Q: Won't I be trapped in the vehicle after an accident if I'm wearing a safety belt?

A: You *could* be – whether you're wearing a safety belt or not. But you can unbuckle a safety belt, even if you're upside down. And your chance of being conscious during and after an accident, so you *can* unbuckle and get out, is *much* greater if you are belted.

Q: If my vehicle has air bags, why should I have to wear safety belts?

A: Air bags are in many vehicles today and will be in most of them in the future. But they are supplemental systems only; so they work *with* safety belts – not instead of them. Every air bag system ever offered for sale has required the use of safety belts. Even if you're in a vehicle that has air bags, you still have to buckle up to get the most protection. That's true not only in frontal collisions, but especially in side and other collisions.

Q: If I'm a good driver, and I never drive far from home, why should I wear safety belts?

A: You may be an excellent driver, but if you're in an accident – even one that isn't your fault – you and your passengers can be hurt. Being a good driver doesn't protect you from things beyond your control, such as bad drivers.

Most accidents occur within 25 miles (40 km) of home. And the greatest number of serious injuries and deaths occur at speeds of less than 40 mph (65 km/h).

Safety belts are for everyone.

How to Wear Safety Belts Properly

This part is only for people of adult size.

Be aware that there are special things to know about safety belts and children. And there are different rules for smaller children and babies. If a child will be riding in your vehicle, see *Older Children on page 1-27* or *Infants and Young Children on page 1-29*. Follow those rules for everyone's protection.

First, you'll want to know which restraint systems your vehicle has.

We'll start with the driver position.

Driver Position

This part describes the driver's restraint system.

Lap-Shoulder Belt

The driver has a lap-shoulder belt. Here's how to wear it properly.

1. Close and lock the door.
2. Adjust the seat so you can sit up straight. To see how, see "Seats" in the Index.



3. Pick up the latch plate and pull the belt across you. Don't let it get twisted.

The lap-shoulder belt may lock if you pull the belt across you very quickly. If this happens, let the belt go back slightly to unlock it. Then pull the belt across you more slowly.

4. Push the latch plate into the buckle until it clicks. Pull up on the latch plate to make sure it is secure. If the belt isn't long enough, see *Safety Belt Extender on page 1-26*.

Make sure the release button on the buckle is positioned so you would be able to unbuckle the safety belt quickly if you ever had to.

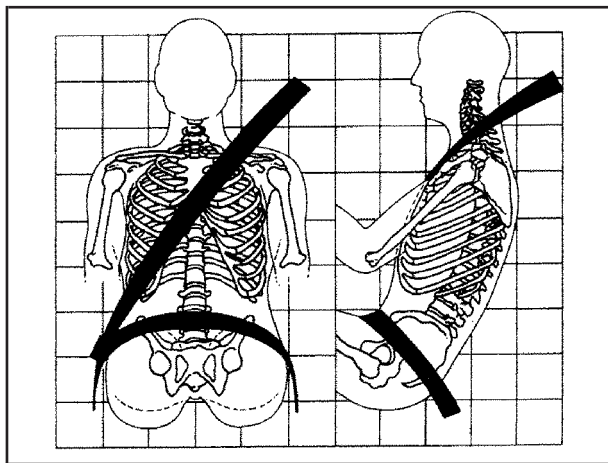

The lap part of the belt should be worn low and snug on the hips, just touching the thighs. In a crash, this applies force to the strong pelvic bones. And you'd be less likely to slide under the lap belt. If you slid under it, the belt would apply force at your abdomen. This could cause serious or even fatal injuries. The shoulder belt should go over the shoulder and across the chest. These parts of the body are best able to take belt restraining forces.

The safety belt locks if there's a sudden stop or crash, or if you pull the belt very quickly out of the retractor.

Q: What's wrong with this?

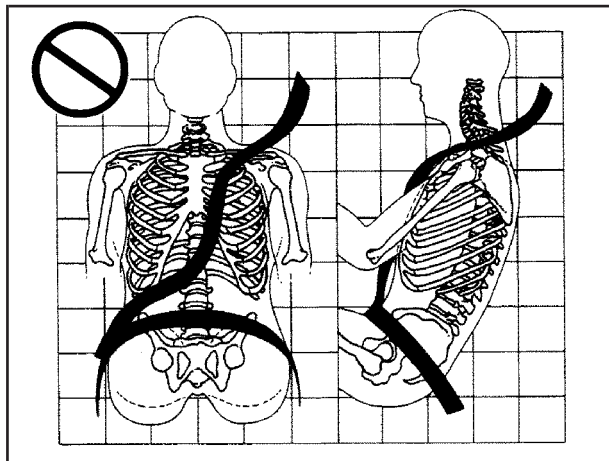

A: The shoulder belt is too loose. It won't give nearly as much protection this way.

⚠ CAUTION:

You can be seriously hurt if your shoulder belt is too loose. In a crash, you would move forward too much, which could increase injury. The shoulder belt should fit against your body.

Q: What's wrong with this?

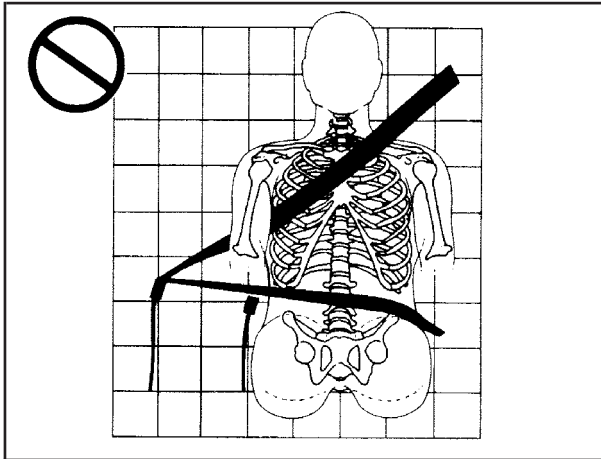

A: The belt is buckled in the wrong place.

⚠ CAUTION:

You can be seriously injured if your belt is buckled in the wrong place like this. In a crash, the belt would go up over your abdomen. The belt forces would be there, not at the pelvic bones. This could cause serious internal injuries. Always buckle your belt into the buckle nearest you.

Q: What's wrong with this?

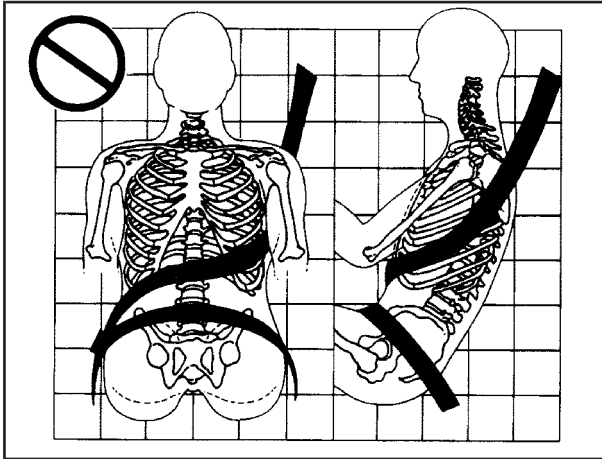

A: The shoulder belt is worn under the arm. It should be worn over the shoulder at all times.

⚠ CAUTION:

You can be seriously injured if you wear the shoulder belt under your arm. In a crash, your body would move too far forward, which would increase the chance of head and neck injury. Also, the belt would apply too much force to the ribs, which aren't as strong as shoulder bones. You could also severely injure internal organs like your liver or spleen.

Q: What's wrong with this?

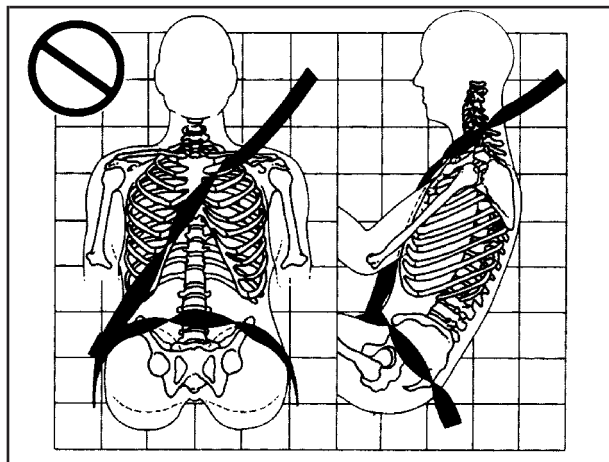

A: The belt is twisted across the body.

⚠ CAUTION:

You can be seriously injured by a twisted belt. In a crash, you wouldn't have the full width of the belt to spread impact forces. If a belt is twisted, make it straight so it can work properly, or ask your dealer to fix it.



To unlatch the belt, just push the button on the buckle. The belt should go back out of the way.

Before you close the door, be sure the belt is out of the way. If you slam the door on it, you can damage both the belt and your vehicle.

Safety Belt Use During Pregnancy

Safety belts work for everyone, including pregnant women. Like all occupants, they are more likely to be seriously injured if they don't wear safety belts.



A pregnant woman should wear a lap-shoulder belt, and the lap portion should be worn as low as possible, below the rounding, throughout the pregnancy.

The best way to protect the fetus is to protect the mother. When a safety belt is worn properly, it's more likely that the fetus won't be hurt in a crash. For pregnant women, as for anyone, the key to making safety belts effective is wearing them properly.

Right Front Passenger Position

To learn how to wear the right front passenger's safety belt properly, see *Driver Position on page 1-12*.

The right front passenger's safety belt works the same way as the driver's safety belt – except for one thing. If you ever pull the lap portion of the belt out all the way, you will engage the child restraint locking feature. If this happens, just let the belt go back all the way and start again.

If your vehicle has a center passenger position, be sure to use the correct buckle when buckling your lap-shoulder belt. If you find that the latch plate will not go fully into the buckle, see if you are using the buckle for the center passenger position.

Center Front Passenger Position

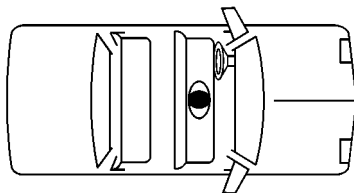

Lap Belt

If your vehicle has a front bench seat, someone can sit in the center position.



When you sit in the center front seating position, you have a lap safety belt, which has no retractor. To make the belt longer, tilt the latch plate and pull it along the belt.



To make the belt shorter, pull its free end as shown until the belt is snug.

Buckle, position and release it the same way as the lap part of a lap-shoulder belt. If the belt isn't long enough, see *Safety Belt Extender on page 1-26*.

Make sure the release button on the buckle is positioned so you would be able to unbuckle the safety belt quickly if you ever had to.

Rear Seat Passengers

It's very important for rear seat passengers to buckle up! Accident statistics show that unbelted people in the rear seat are hurt more often in crashes than those who are wearing safety belts.

Rear passengers who aren't safety belted can be thrown out of the vehicle in a crash. And they can strike others in the vehicle who are wearing safety belts.

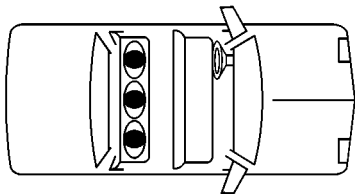

Lap-Shoulder Belt

All rear seating positions have lap-shoulder belts. Here's how to wear one properly.



1. Pick up the latch plate and pull the belt across you. Don't let it get twisted.
The shoulder belt may lock if you pull the belt across you very quickly. If this happens, let the belt go back slightly to unlock it. Then pull the belt across you more slowly.
2. Push the latch plate into the buckle until it clicks.



If the belt stops before it reaches the buckle, tilt the latch plate and keep pulling until you can buckle it.

Pull up on the latch plate to make sure it is secure.

If the belt is not long enough, see *Safety Belt Extender* on page 1-26.

Make sure the release button on the buckle is positioned so you would be able to unbuckle the safety belt quickly if you ever had to.



3. To make the lap part tight, pull down on the buckle end of the belt as you pull up on the shoulder part.

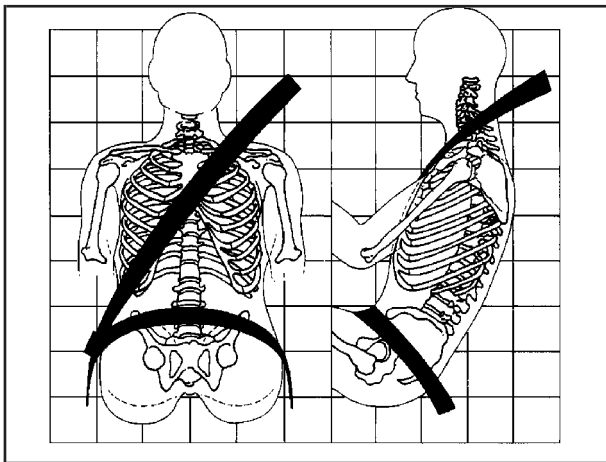

The lap part of the belt should be worn low and snug on the hips, just touching the thighs. In a crash this applies force to the strong pelvic bones. And you'd be less likely to slide under the lap belt. If you slid under it, the belt would apply force at your abdomen. This could cause serious or even fatal injuries. The shoulder belt should go over the shoulder and across the chest. These parts of the body are best able to take belt restraining forces.

The safety belt locks if there's a sudden stop or a crash, or if you pull the belt very quickly out of the retractor.

CAUTION:

You can be seriously hurt if your shoulder belt is too loose. In a crash, you would move forward too much, which could increase injury. The shoulder belt should fit against your body.



To unlatch the belt, just push the button on the buckle.

Rear Safety Belt Comfort Guides for Children and Small Adults

Your vehicle may have this feature already. If it doesn't, you can get it from any GM dealer.

Rear shoulder belt comfort guides provide added safety belt comfort for older children who have outgrown booster seats and for small adults. When installed on a shoulder belt, the comfort guide better positions the belt away from the neck and head.

There is one guide available for each outside passenger position in the rear seat. To provide added safety belt comfort for children who have outgrown child restraints and booster seats and for smaller adults, the comfort guides may be installed on the shoulder belts. Here's how to install a comfort guide and use the safety belt:



1. Remove the guide from its storage pocket on the side of the seatback.



2. Slide the guide under and past the belt. The elastic cord must be under the belt. Then, place the guide over the belt, and insert the two edges of the belt into the slots of the guide.



3. Be sure that the belt is not twisted and it lies flat. The elastic cord must be under the belt and the guide on top.



Safety Belt Extender

If the vehicle's safety belt will fasten around you, you should use it.

But if a safety belt isn't long enough to fasten, your dealer will order you an extender. It's free. When you go in to order it, take the heaviest coat you will wear, so the extender will be long enough for you. The extender will be just for you, and just for the seat in your vehicle that you choose. Don't let someone else use it, and use it only for the seat it is made to fit. To wear it, just attach it to the regular safety belt.

4. Buckle, position and release the safety belt as described in *Rear Seat Passengers* on page 1-21. Make sure that the shoulder belt crosses the shoulder.

To remove and store the comfort guides, squeeze the belt edges together so that you can take them out of the guides. Slide the guide into its storage pocket on the side of the seatback.

Child Restraints

Older Children



Older children who have outgrown booster seats should wear the vehicle's safety belts.

Q: What is the proper way to wear safety belts?

A: If possible, an older child should wear a lap-shoulder belt and get the additional restraint a shoulder belt can provide. The shoulder belt should not cross the face or neck. The lap belt should fit snugly below the hips, just touching the top of the thighs. It should never be worn over the abdomen, which could cause severe or even fatal internal injuries in a crash.

Accident statistics show that children are safer if they are restrained in the rear seat.

In a crash, children who are not buckled up can strike other people who are buckled up, or can be thrown out of the vehicle. Older children need to use safety belts properly.



Q: What if a child is wearing a lap-shoulder belt, but the child is so small that the shoulder belt is very close to the child's face or neck?

A: If the child is sitting in a seat next to a window, move the child toward the center of the vehicle. If the child is sitting in the center rear seat passenger position, move the child toward the safety belt buckle. In either case, be sure that the shoulder belt still is on the child's shoulder, so that in a crash the child's upper body would have the restraint that belts provide.

If the child is so small that the shoulder belt is still very close to the child's face or neck, you might want to place the child in a seat that has a lap belt, if your vehicle has one.

⚠ CAUTION:

Never do this.

Here two children are wearing the same belt. The belt can't properly spread the impact forces. In a crash, the two children can be crushed together and seriously injured. A belt must be used by only one person at a time.



⚠ CAUTION:

Never do this.

Here a child is sitting in a seat that has a lap-shoulder belt, but the shoulder part is behind the child. If the child wears the belt in this way, in a crash the child might slide under the belt. The belt's force would then be applied right on the child's abdomen. That could cause serious or fatal injuries.

Wherever the child sits, the lap portion of the belt should be worn low and snug on the hips, just touching the child's thighs. This applies belt force to the child's pelvic bones in a crash.

Infants and Young Children

Everyone in a vehicle needs protection! This includes infants and all other children. Neither the distance traveled nor the age and size of the traveler changes the need, for everyone, to use safety restraints. In fact, the law in every state in the United States and in every Canadian province says children up to some age must be restrained while in a vehicle.

Every time infants and young children ride in vehicles, they should have the protection provided by appropriate restraints. Young children should not use the vehicle's adult safety belts alone, unless there is no other choice. Instead, they need to use a child restraint.



⚠ CAUTION:

People should never hold a baby in their arms while riding in a vehicle. A baby doesn't weigh much -- until a crash. During a crash a baby will become so heavy it is not possible to hold it. For example, in a crash at only 25 mph (40 km/h), a 12-lb. (5.5 kg) baby will suddenly become a 240-lb. (110 kg) force on a person's arms. A baby should be secured in an appropriate restraint.



⚠ CAUTION:

Children who are up against, or very close to, any air bag when it inflates can be seriously injured or killed. Air bags plus lap-shoulder belts offer outstanding protection for adults

CAUTION: (Continued)

CAUTION: (Continued)

and older children, but not for young children and infants. Neither the vehicle's safety belt system nor its air bag system is designed for them. Young children and infants need the protection that a child restraint system can provide.

Q: What are the different types of add-on child restraints?

A: Add-on child restraints, which are purchased by the vehicle's owner, are available in four basic types. Selection of a particular restraint should take into consideration not only the child's weight, height and age but also whether or not the restraint will be compatible with the motor vehicle in which it will be used.

For most basic types of child restraints, there are many different models available. When purchasing a child restraint, be sure it is designed to be used in a motor vehicle. If it is, the restraint will have a label saying that it meets federal motor vehicle safety standards.

The restraint manufacturer's instructions that come with the restraint state the weight and height limitations for a particular child restraint. In addition, there are many kinds of restraints available for children with special needs.

 **CAUTION:**

Newborn infants need complete support, including support for the head and neck. This is necessary because a newborn infant's neck is weak and its head weighs so much compared with the rest of its body. In a crash, an infant in a rear-facing seat settles into the restraint, so the crash forces can be distributed across the strongest part of an infant's body, the back and shoulders. Infants always should be secured in appropriate infant restraints.

 **CAUTION:**

The body structure of a young child is quite unlike that of an adult or older child, for whom the safety belts are designed. A young child's hip bones are still so small that the vehicle's regular safety belt may not remain low on the hip bones, as it should. Instead, it may settle up around the child's abdomen. In a crash, the belt would apply force on a body area that's unprotected by any bony structure. This alone could cause serious or fatal injuries. Young children always should be secured in appropriate child restraints.

Child Restraint Systems

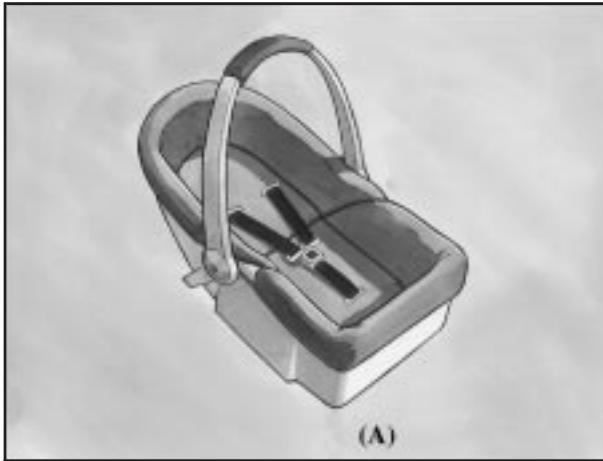

An infant car bed (A), a special bed made for use in a motor vehicle, is an infant restraint system designed to restrain or position a child on a continuous flat surface. Make sure that the infant's head rests toward the center of the vehicle.

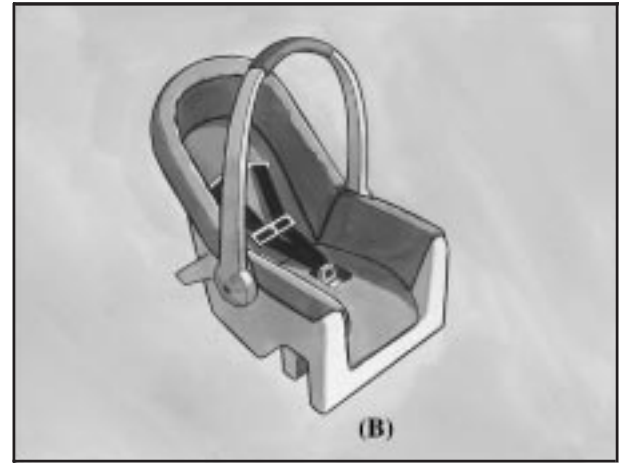

A rear-facing infant seat (B) provides restraint with the seating surface against the back of the infant. The harness system holds the infant in place and, in a crash, acts to keep the infant positioned in the restraint.

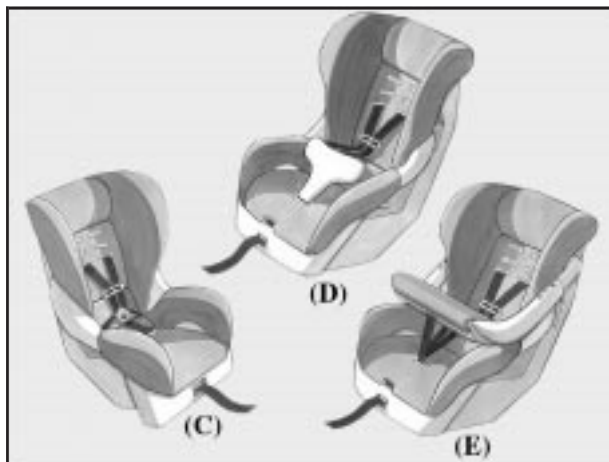

A forward-facing child seat (C-E) provides restraint for the child's body with the harness and also sometimes with surfaces such as T-shaped or shelf-like shields.

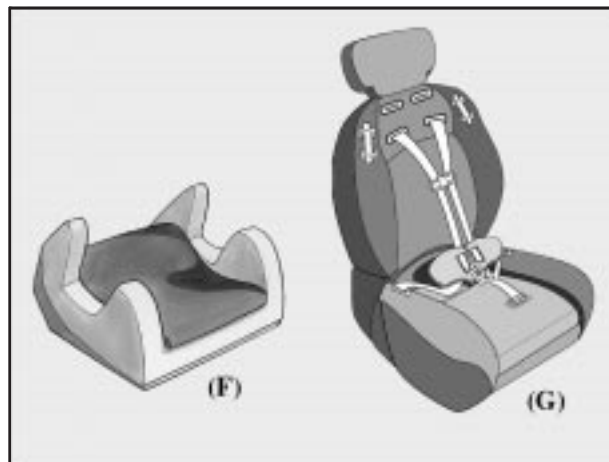

A booster seat (F-G) is a child restraint designed to improve the fit of the vehicle's safety belt system. Some booster seats have a shoulder belt positioner, and some high-back booster seats have a five-point harness. A booster seat can also help a child to see out the window.

Q: How do child restraints work?

A: A child restraint system is any device designed for use in a motor vehicle to restrain, seat, or position children. A built-in child restraint system is a permanent part of the motor vehicle. An add-on child restraint system is a portable one, which is purchased by the vehicle's owner.

For many years, add-on child restraints have used the adult belt system in the vehicle. To help reduce the chance of injury, the child also has to be secured within the restraint. The vehicle's belt system secures the add-on child restraint in the vehicle, and the add-on child restraint's harness system holds the child in place within the restraint.

One system, the three-point harness, has straps that come down over each of the infant's shoulders and buckle together at the crotch. The five-point harness system has two shoulder straps, two hip straps and a crotch strap. A shield may take the place of hip straps. A T-shaped shield has shoulder straps that are attached to a flat pad which rests low against the child's body. A shelf- or armrest-type shield has straps that are attached to a wide, shelf-like shield that swings up or to the side.

When choosing a child restraint, be sure the child restraint is designed to be used in a vehicle. If it is, it will have a label saying that it meets federal motor vehicle safety standards.

Then follow the instructions for the restraint. You may find these instructions on the restraint itself or in a booklet, or both. These restraints use the belt system in your vehicle, but the child also has to be secured within the restraint to help reduce the chance of personal injury. When securing an add-on child restraint, refer to the instructions that come with the restraint which may be on the restraint itself or in a booklet, or both, and to this manual. The child restraint instructions are important, so if they are not available, obtain a replacement copy from the manufacturer.

Where to Put the Restraint

Accident statistics show that children are safer if they are restrained in the rear rather than the front seat. We, therefore, recommend that child restraints be secured in a rear seat, including an infant riding in a rear-facing infant seat, a child riding in a forward-facing child seat and an older child riding in a booster seat. *Never* put a rear-facing child restraint in the front passenger seat. Here's why:

CAUTION:

A child in a rear-facing child restraint can be seriously injured or killed if the right front passenger's air bag inflates. This is because the back of the rear-facing child restraint would be very close to the inflating air bag. Always secure a rear-facing child restraint in a rear seat.

You may secure a forward-facing child restraint in the right front seat, but before you do, always move the front passenger seat as far back as it will go. It's better to secure the child restraint in a rear seat.

CAUTION:

A child in a child restraint in the center front seat can be badly injured or killed by the right front passenger's air bag if it inflates. Never secure a child restraint in the center front seat. It is always better to secure a child restraint in the rear seat.

If you secure a forward-facing child restraint in the right front passenger seat, move the front passenger seat as far back as it will go. It is better to secure the child restraint in a rear seat.

Wherever you install it, be sure to secure the child restraint properly.

Keep in mind that an unsecured child restraint can move around in a collision or sudden stop and injure people in the vehicle. Be sure to properly secure any child restraint in your vehicle – even when no child is in it.

Top Strap

Some child restraints have a top strap, or “top tether.” It can help restrain the child restraint during a collision. For it to work, a top strap must be properly anchored to the vehicle. Some top strap-equipped child restraints are designed for use with or without the top strap being anchored. Others require the top strap always to be anchored. Be sure to read and follow the instructions for your child restraint. If yours requires that the top strap be anchored, don’t use the restraint unless it is anchored properly.

If the child restraint does not have a top strap, one can be obtained, in kit form, for many child restraints. Ask the child restraint manufacturer whether or not a kit is available.

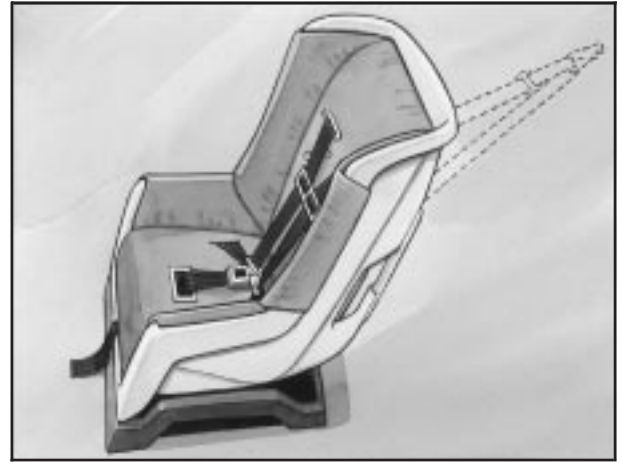

In Canada, the law requires that forward-facing child restraints have a top strap, and that the strap be anchored. In the United States, some child restraints also have a top strap. If your child restraint has a top strap, it should be anchored.

Anchor the top strap to an anchor point specified in *Top Strap Anchor Location* on page 1-38. Be sure to use an anchor point located on the same side of the vehicle as the seating position where the child restraint will be placed.

Once you have the top strap anchored, you'll be ready to secure the child restraint itself. Tighten the top strap when and as the child restraint manufacturer's instructions say.

Top Strap Anchor Location

Your vehicle has top strap anchors already installed for the rear seating positions. You'll find them behind the rear seat on the filler panel.

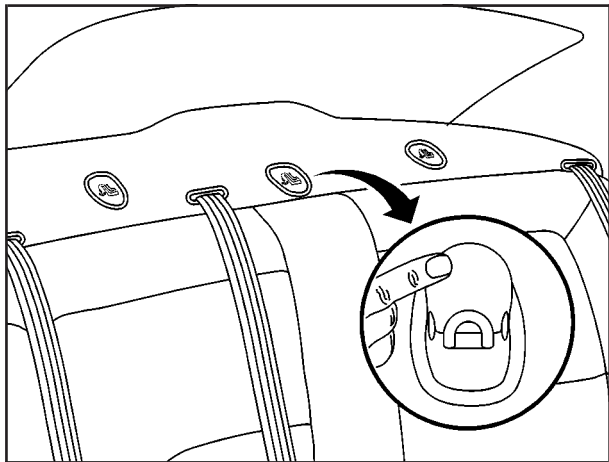

In order to get to a bracket, you'll have to open the trim cover.

Lower Anchorages and Top Tethers for Children (LATCH System)

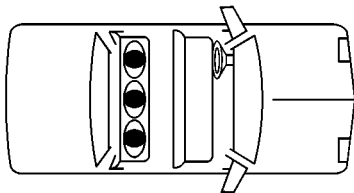

Your vehicle has the LATCH system. You'll find anchors (A) in all three rear seat positions.



To assist you in locating the lower anchors for this child restraint system, each seating position with the LATCH system will have a label sewn into the seatback at each anchor point.

In order to use the system, you need either a forward-facing child restraint that has attaching points (B) at its base and a top tether anchor (C), or a rear-facing child restraint that has attaching points (B), as shown here.

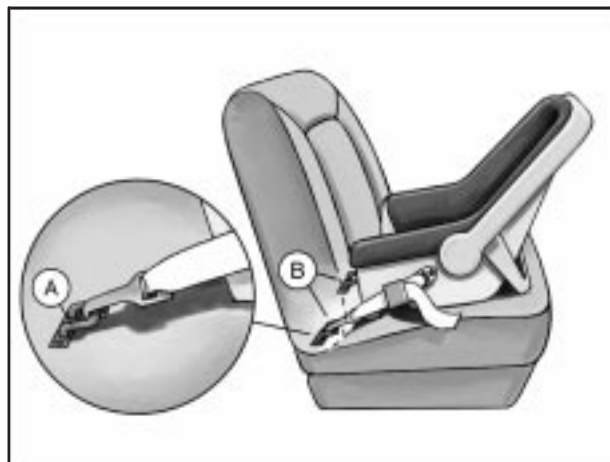
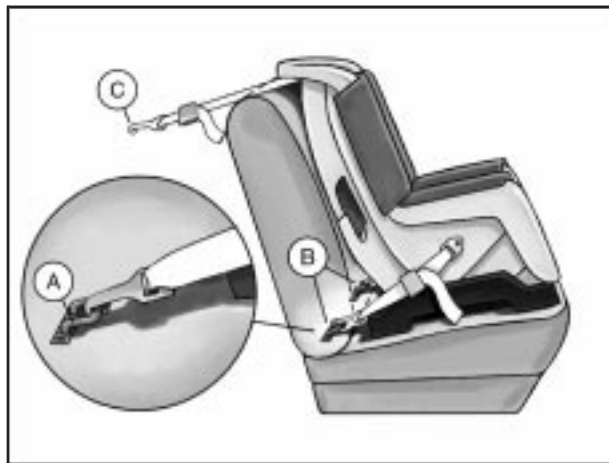

With this system, use the LATCH system instead of the vehicle's safety belts to secure a child restraint.

 **CAUTION:**

If a LATCH-type child restraint isn't attached to its anchorage points, the restraint won't be able to protect the child correctly. In a crash, the child could be seriously injured or killed. Make sure that a LATCH-type child restraint is properly installed using the anchorage points, or use the vehicle's safety belts to secure the restraint. See "Securing a Child Restraint Designed for the LATCH System" or "Securing a Child Restraint in a Rear Seat Position" in the Index for information on how to secure a child restraint in your vehicle.

Securing a Child Restraint Designed for the LATCH System

1. Find the anchors for the seating position you want to use, where the bottom of the seatback meets the back of the seat cushion.
2. Put the child restraint on the seat.
3. Attach the anchor points on the child restraint to the anchors in the vehicle. The child restraint instructions will show you how.
4. If the child restraint is forward-facing, attach the top strap to the top strap anchor. See *Top Strap on page 1-37*. Tighten the top strap according to the child restraint instructions.
5. Push and pull the child restraint in different directions to be sure it is secure.

To remove the child restraint, simply unhook the top strap from the top tether anchor and then disconnect the anchor points.

Securing a Child Restraint in a Rear Seat Position

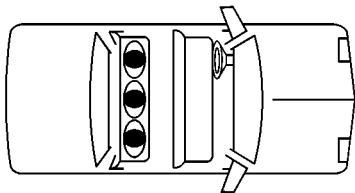

If your child restraint is equipped with the LATCH system, see *Lower Anchorages and Top Tethers for Children (LATCH System)* on page 1-38.

CAUTION:

A child in a child restraint in the center front seat can be badly injured or killed by the right front passenger's air bag if it inflates. Never secure a child restraint in the center front seat. It is always better to secure a child restraint in the rear seat.

CAUTION: (Continued)

CAUTION: (Continued)

If you secure a forward-facing child restraint in the right front passenger seat, move the front passenger seat as far back as it will go. It is better to secure the child restraint in a rear seat.

You'll be using the lap-shoulder belt. See the earlier part about the top strap if the child restraint has one. Be sure to follow the instructions that came with the child restraint. Secure the child in the child restraint when and as the instructions say.

1. Put the restraint on the seat.
2. Pick up the latch plate, and run the lap and shoulder portions of the vehicle's safety belt through or around the restraint. The child restraint instructions will show you how.



Tilt the latch plate to adjust the belt if needed.



3. Buckle the belt. Make sure the release button is positioned so you would be able to unbuckle the safety belt quickly if you ever had to.



Securing a Child Restraint in the Right Front Seat Position

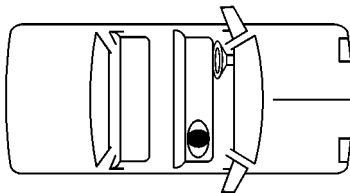

Your vehicle has a right front passenger air bag. *Never* put a rear facing child restraint in this seat. Here's why:

CAUTION:

A child in a rear-facing child restraint can be seriously injured or killed if the right front passenger's air bag inflates. This is because the back of the rear-facing child restraint would be very close to the inflating air bag. Always secure a rear-facing child restraint in a rear seat.

4. To tighten the belt, pull up on the shoulder belt while you push down on the child restraint. If you're using a forward-facing child restraint, you may find it helpful to use your knee to push down on the child restraint as you tighten the belt.
5. Push and pull the child restraint in different directions to be sure it is secure.

To remove the child restraint, just unbuckle the vehicle's safety belt and let it go back all the way. The safety belt will move freely again and be ready to work for an adult or larger child passenger.

Although a rear seat is a safer place, you can secure a forward-facing child restraint in the right front seat.

You'll be using the lap-shoulder belt. See *Top Strap on page 1-37* if the child restraint has one. Be sure to follow the instructions that came with the child restraint. Secure the child in the child restraint when and as the instructions say.

1. Because your vehicle has a right front passenger air bag, always move the seat as far back as it will go before securing a forward-facing child restraint. See *Power Seats on page 1-2*.
2. Put the restraint on the seat.
3. Pick up the latch plate, and run the lap and shoulder portions of the vehicle's safety belt through or around the restraint. The child restraint instructions will show you how.



4. Buckle the belt. Make sure the release button is positioned so you would be able to unbuckle the safety belt quickly if you ever had to.



5. Pull the rest of the lap belt all the way out of the retractor to set the lock.



6. To tighten the belt, feed the lap belt back into the retractor while you push down on the child restraint. You may find it helpful to use your knee to push down on the child restraint as you tighten the belt.
7. Push and pull the child restraint in different directions to be sure it is secure.

To remove the child restraint, just unbuckle the vehicle's safety belt and let it go back all the way. The safety belt will move freely again and be ready to work for an adult or larger child passenger.

Air Bag Systems

This part explains the frontal and side impact air bag systems.

Your vehicle has a frontal air bag for the driver and a frontal air bag for the right front passenger. Your vehicle may also have a side impact air bag for the driver, and another side impact air bag for the right front passenger.

If your vehicle has a side impact air bag for the driver and/or right front passenger, the words AIR BAG will appear on the air bag covering on the side of the seatback closest to the door.

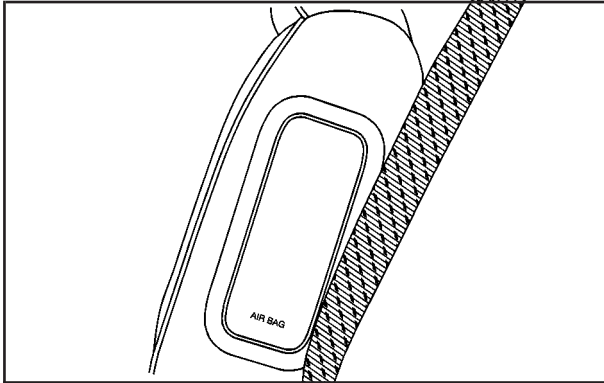

Frontal air bags are designed to help reduce the risk of injury from the force of an inflating frontal air bag. But these air bags must inflate very quickly to do their job and comply with federal regulations.

Here are the most important things to know about the air bag systems:

CAUTION:

You can be severely injured or killed in a crash if you aren't wearing your safety belt – even if you have air bags. Wearing your safety belt during a crash helps reduce your chance of hitting things inside the vehicle or being ejected from it. Air bags are designed to work with safety belts but don't replace them.

CAUTION: (Continued)

CAUTION: (Continued)

Frontal air bags for the driver and right front passenger are designed to deploy only in moderate to severe frontal and near frontal crashes. They aren't designed to inflate at all in rollover, rear or low-speed frontal crashes, or in many side crashes. And, for some unrestrained occupants, frontal air bags may provide less protection in frontal crashes than more forceful air bags have provided in the past.

The side impact air bags for the driver and right front passenger are designed to inflate only in moderate to severe crashes where something hits the side of your vehicle. They aren't designed to inflate in frontal, in rollover or in rear crashes.

Everyone in your vehicle should wear a safety belt properly – whether or not there's an air bag for that person.

CAUTION:

Both frontal and side impact air bags inflate with great force, faster than the blink of an eye. If you're too close to an inflating air bag, as you would be if you were leaning forward, it could seriously injure you. Safety belts help keep you in position for air bag inflation before and during a crash. Always wear your safety belt, even with frontal air bags. The driver should sit as far back as possible while still maintaining control of the vehicle. Front occupants should not lean on or sleep against the door.

 **CAUTION:**

Anyone who is up against, or very close to, any air bag when it inflates can be seriously injured or killed. Air bags plus lap-shoulder belts offer the best protection for adults, but not for young children and infants. Neither the vehicle's safety belt system nor its air bag system is designed for them. Young children and infants need the protection that a child restraint system can provide. Always secure children properly in your vehicle. To read how, see the part of this manual called "Older Children" or "Infants and Young Children."

**AIR
BAG**

There is an air bag readiness light on the instrument panel, which shows AIR BAG.

The system checks the air bag electrical system for malfunctions. The light tells you if there is an electrical problem. See *Air Bag Readiness Light* on page 3-36.

Where Are the Air Bags?



The driver's frontal air bag is in the middle of the steering wheel.



The right front passenger's frontal air bag is in the instrument panel on the passenger's side.

If your vehicle has one, the driver's side impact air bag is in the side of the driver's seatback closest to the door.



If your vehicle has one, the right front passenger's side impact air bag is in the side of the passenger's seatback closest to the door.

CAUTION:

If something is between an occupant and an air bag, the bag might not inflate properly or it might force the object into that person causing severe injury or even death. The path of an inflating air bag must be kept clear. Don't put anything between an occupant and an air bag, and don't attach or put anything on the steering wheel hub or on or near any other air bag covering. Don't let seat covers block the inflation path of a side impact air bag.

When Should an Air Bag Inflate?

The driver's and right front passenger's frontal air bags are designed to inflate in moderate to severe frontal or near-frontal crashes. But they are designed to inflate only if the impact speed is above the system's designed "threshold level."

In addition, your vehicle has “dual stage” frontal air bags, which adjust the amount of restraint according to crash severity. For moderate frontal impacts, these air bags inflate at a level less than full deployment. For more severe frontal impacts, full deployment occurs. If the front of your vehicle goes straight into a wall that does not move or deform, the threshold level for the reduced deployment is about 10 to 16 mph (18 to 26 km/h), and the threshold level for a full deployment is about 18 to 24 mph (29 to 38.5 km/h). The threshold level can vary, however, with specific vehicle design, so that it can be somewhat above or below this range.

If your vehicle strikes something that will move or deform, such as a parked car, the threshold level will be higher. The driver’s and right front passenger’s frontal air bags are not designed to inflate in rollovers, rear impacts, or in many side impacts because inflation would not help the occupant.

Your vehicle may or may not have a side impact air bag. See *Air Bag Systems on page 1-46*. Side impact air bags are designed to inflate in moderate to severe side crashes. A side impact air bag will inflate if the crash severity is above the system’s designed “threshold level.” The threshold level can vary with specific vehicle design. Side impact air bags are not designed to inflate in frontal or near-frontal impacts, rollovers or rear impacts, because inflation would not help the occupant. A side impact air bag will only deploy on the side of the vehicle that is struck.

In any particular crash, no one can say whether an air bag should have inflated simply because of the damage to a vehicle or because of what the repair costs were. For frontal air bags, inflation is determined by the angle of the impact and how quickly the vehicle slows down in frontal and near-frontal impacts. For side impact air bags, inflation is determined by the location and severity of the impact.

What Makes an Air Bag Inflate?

In an impact of sufficient severity, the air bag sensing system detects that the vehicle is in a crash. For both frontal and side impact air bags, the sensing system triggers a release of gas from the inflator, which inflates the air bag. The inflator, the air bag and related hardware are all part of the air bag modules. Frontal air bag modules are located inside the steering wheel and instrument panel. For vehicles with side impact air bags, the air bag modules are located in the seatback closest to the driver’s and/or right front passenger’s door.

How Does an Air Bag Restrain?

In moderate to severe frontal or near frontal collisions, even belted occupants can contact the steering wheel or the instrument panel. In moderate to severe side collisions, even belted occupants can contact the inside of the vehicle. The air bag supplements the protection provided by safety belts. Air bags distribute the force of the impact more evenly over the occupant's upper body, stopping the occupant more gradually. But the frontal air bags would not help you in many types of collisions, including rollovers, rear impacts, and many side impacts, primarily because an occupant's motion is not toward the air bag. Side impact air bags would not help you in many types of collisions, including frontal or near frontal collisions, rollovers, and rear impacts, primarily because an occupant's motion is not toward those air bags. Air bags should never be regarded as anything more than a supplement to safety belts, and then only in moderate to severe frontal or near-frontal collisions for the driver's and right front passenger's frontal air bags, and only in moderate to severe side collisions for vehicles with a driver's and right front passenger's side impact air bag.

What Will You See After an Air Bag Inflates?

After the air bag inflates, it quickly deflates, so quickly that some people may not even realize the air bag inflated. Some components of the air bag module will be hot for a short time. These components include the steering wheel hub for the driver's frontal air bag and the instrument panel for the right front passenger's frontal air bag. For vehicles with side impact air bags, the side of the seatback closest to the driver's and/or right front passenger's door will be hot. The parts of the bag that come into contact with you may be warm, but not too hot to touch. There will be some smoke and dust coming from the vents in the deflated air bags. Air bag inflation doesn't prevent the driver from seeing or being able to steer the vehicle, nor does it stop people from leaving the vehicle.

 **CAUTION:**

When an air bag inflates, there is dust in the air. This dust could cause breathing problems for people with a history of asthma or other breathing trouble. To avoid this, everyone in the vehicle should get out as soon as it is safe to do so. If you have breathing problems but can't get out of the vehicle after an air bag inflates, then get fresh air by opening a window or a door. If you experience breathing problems following an air bag deployment, you should seek medical attention.

Your vehicle has a feature that will automatically unlock the doors and turn the interior lamps on when the air bags inflate (if battery power is available). You can lock the doors again and turn the interior lamps off by using the door lock and interior lamp controls.

In many crashes severe enough to inflate an air bag, windshields are broken by vehicle deformation. Additional windshield breakage may also occur from the right front passenger air bag.

- Air bags are designed to inflate only once. After an air bag inflates, you'll need some new parts for your air bag system. If you don't get them, the air bag system won't be there to help protect you in another crash. A new system will include air bag modules and possibly other parts. The service manual for your vehicle covers the need to replace other parts.
- Your vehicle is equipped with an electronic frontal sensor, which helps the sensing system distinguish between a moderate frontal impact and a more severe frontal impact. Your vehicle is also equipped with a crash sensing and diagnostic module, which records information about the frontal air bag system. The module records information about the readiness of the system, when the system commands air bag inflation and driver's safety belt usage at deployment. The module also records speed, engine rpm, brake and throttle data.
- Let only qualified technicians work on your air bag systems. Improper service can mean that an air bag system won't work properly. See your dealer for service.

Notice: If you damage the covering for the driver's or the right front passenger's air bag, or the air bag covering on the driver's and right front passenger's seatback, the bag may not work properly. You may have to replace the air bag module in the steering wheel, both the air bag module and the instrument panel for the right front passenger's air bag, or both the air bag module and seatback for the driver's and right front passenger's side impact air bag. Do not open or break the air bag coverings.

Servicing Your Air Bag-Equipped Vehicle

Air bags affect how your vehicle should be serviced. There are parts of the air bag systems in several places around your vehicle. Your dealer and the service manual have information about servicing your vehicle and the air bag systems. To purchase a service manual, see *Service Publications Ordering Information on page 7-10*.

CAUTION:

For up to 10 seconds after the ignition key is turned off and the battery is disconnected, an air bag can still inflate during improper service. You can be injured if you are close to an air bag when it inflates. Avoid yellow connectors. They are probably part of the air bag system. Be sure to follow proper service procedures, and make sure the person performing work for you is qualified to do so.

The air bag systems do not need regular maintenance.

Restraint System Check

Checking Your Restraint Systems

Now and then, make sure the safety belt reminder light and all your belts, buckles, latch plates, retractors and anchorages are working properly. Look for any other loose or damaged safety belt system parts. If you see anything that might keep a safety belt system from doing its job, have it repaired.

Torn or frayed safety belts may not protect you in a crash. They can rip apart under impact forces. If a belt is torn or frayed, get a new one right away.

Also look for any opened or broken air bag covers, and have them repaired or replaced. (The air bag system does not need regular maintenance.)

Replacing Restraint System Parts After a Crash

CAUTION:

A crash can damage the restraint systems in your vehicle. A damaged restraint system may not properly protect the person using it, resulting in serious injury or even death in a crash. To help make sure your restraint systems are working properly after a crash, have them inspected and any necessary replacements made as soon as possible.

If you've had a crash, do you need new belts or LATCH system parts?

After a very minor collision, nothing may be necessary. But if the belts were stretched, as they would be if worn during a more severe crash, then you need new parts.

If the LATCH system was being used during a more severe crash, you may need new LATCH system parts.

If belts are cut or damaged, replace them. Collision damage also may mean you will need to have LATCH system, safety belt or seat parts repaired or replaced. New parts and repairs may be necessary even if the belt or LATCH system wasn't being used at the time of the collision.

If your seat adjuster won't work after a crash, the special part of the safety belt that goes through the seat to the adjuster may need to be replaced.

If an air bag inflates, you'll need to replace air bag system parts. See the part about the air bag system earlier in this manual.

 **NOTES**



Section 2 Features and Controls

Keys	2-3	Starting and Operating Your Vehicle	2-21
Remote Keyless Entry System	2-5	New Vehicle Break-In	2-21
Remote Keyless Entry System Operation	2-5	Ignition Positions	2-22
Doors and Locks	2-9	Starting Your Engine	2-23
Door Locks	2-9	Engine Coolant Heater	2-24
Central Door Unlocking System	2-10	Automatic Transaxle Operation	2-25
Power Door Locks	2-10	Parking Brake	2-27
Door Ajar Reminder	2-11	Shifting Into Park (P)	2-28
Delayed Locking	2-11	Shifting Out of Park (P)	2-30
Programmable Automatic		Parking Over Things That Burn	2-31
Door Locks	2-11	Engine Exhaust	2-31
Rear Door Security Locks	2-13	Running Your Engine While You	
Lockout Protection	2-13	Are Parked	2-32
Leaving Your Vehicle	2-13	Mirrors	2-33
Trunk	2-14	Manual Rearview Mirror	2-33
Windows	2-16	Automatic Dimming Rearview Mirror	2-33
Power Windows	2-17	Automatic Dimming Rearview Mirror	
Sun Visors	2-17	with Compass	2-33
Theft-Deterrent Systems	2-18	Outside Power Mirrors	2-35
Content Theft-Deterrent	2-18	Outside Curb View Assist Mirror	2-36
PASS-Key® III	2-19	Outside Convex Mirror	2-36
PASS-Key® III Operation	2-20	Outside Automatic Dimming	
		Heated Mirror	2-36

Section 2 Features and Controls

OnStar® System	2-37	Sunroof	2-43
HomeLink® Transmitter	2-38	Vehicle Personalization	2-44
Programming the HomeLink® Transmitter	2-39	Memory Seat and Mirrors	2-44
Storage Areas	2-42		
Glove Box	2-42		
Center Console Storage Area	2-42		
Convenience Net	2-43		

Keys

CAUTION:

Leaving children in a vehicle with the ignition key is dangerous for many reasons. A child or others could be badly injured or even killed.

They could operate the power windows or other controls or even make the vehicle move.

Do not leave the keys in a vehicle with children.



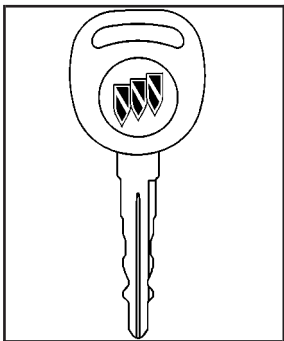

There is a master key that works in all of the lock cylinders (driver's door, trunk, ignition, and glove box).

Your vehicle has the PASS-Key[®] III vehicle theft system. Both the master and VALET key have a transponder in the key head that matches a decoder in the vehicle's steering column. If a replacement key or any additional key is needed, you must purchase this key from your dealer. The key will have PK3[®] stamped on it. Keep the bar code tag that came with the original keys. Give this tag to your dealer if you need a new key made.

Any new PASS-Key[®] III key must be programmed before it will start your vehicle. See *PASS-Key[®] III* on page 2-19 for more information on programming your new key.

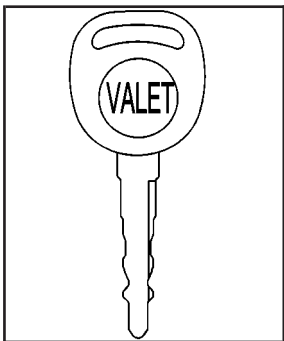

There is also a VALET key which only operates the driver's door and the ignition.

If your vehicle is equipped with the OnStar[®] System with an active subscription and you lock your keys inside the vehicle, OnStar[®] may be able to send a command to unlock your vehicle. See *OnStar[®] System* on page 2-37 for more information.

Notice: Your vehicle has a number of features that can help prevent theft. You can have a lot of trouble getting into your vehicle if you ever lock your keys inside. You may even have to damage your vehicle to get in. So be sure you have spare keys.

Remote Keyless Entry System

Your keyless entry system operates on a radio frequency subject to Federal Communications Commission (FCC) Rules and with Industry Canada.

This device complies with Part 15 of the FCC Rules. Operation is subject to the following two conditions:

1. This device may not cause interference, and
2. This device must accept any interference received, including interference that may cause undesired operation of the device.

This device complies with RSS-210 of Industry Canada. Operation is subject to the following two conditions:

1. This device may not cause interference, and
2. This device must accept any interference received, including interference that may cause undesired operation of the device.

Changes or modifications to this system by other than an authorized service facility could void authorization to use this equipment.

At times you may notice a decrease in range. This is normal for any remote keyless entry system. If the transmitter does not work or if you have to stand closer to your vehicle for the transmitter to work, try this:

- Check the distance. You may be too far from your vehicle. You may need to stand closer during rainy or snowy weather.
- Check the location. Other vehicles or objects may be blocking the signal. Take a few steps to the left or right, hold the transmitter higher, and try again.
- Check to determine if battery replacement is necessary. See “Battery Replacement” under *Remote Keyless Entry System Operation on page 2-5*.
- If you are still having trouble, see your dealer or a qualified technician for service.

Remote Keyless Entry System Operation

With this feature, you can lock and unlock your doors or unlock your trunk from about 3 feet (1 m) up to 30 feet (9 m) away using the remote keyless entry transmitter supplied with your vehicle.

If your vehicle is equipped with the DIC, the numbers on the back of your transmitter correspond to DRIVER #1 and DRIVER #2 on the DIC. For more information see *Driver Information Center (DIC) on page 3-45*.





 **(Unlock):** When this button is pressed, the driver's door will unlock and the exterior lights will flash twice.

If the unlock button is pressed again within five seconds, all doors will unlock, the exterior lamps will flash twice and the horn may sound. See "Security Feedback" later in this section for more information.

Pressing the unlock button will also illuminate the interior lamps. See "Entry Lighting" under *Interior Lamps on page 3-17*.

 **(Lock):** When this button is pressed, all doors will lock, the exterior lamps will flash once and the horn may sound.

 **(Trunk):** The trunk will unlock if this button is pressed when the ignition is in OFF. It will also work when the ignition is on, but only while the transaxle is in PARK (P) or NEUTRAL (N).

 **(Instant Alarm):** When this button is pressed, the horn will sound and the headlamps and taillamps will flash for up to 30 seconds. This can be turned off by pressing the instant alarm button again or by turning the ignition on. If your vehicle is equipped with the content theft-deterrent feature, you may also turn off the instant alarm by unlocking the vehicle with a key.

Personalization Features

The following list of features, if available on your vehicle, can be programmed to each driver's preference.

- **Automatic Door Locks:** This feature programs your door locks to automatically lock or unlock when shifting in and out of PARK (P).
- **Security Feedback:** This feature provides feedback to the driver when the vehicle receives a command from the remote keyless entry transmitter.

- **Delayed Locking:** This feature lets the driver delay the actual locking of the vehicle. When all doors have been closed, the doors will lock automatically after five seconds.
- **Perimeter Lighting:** When the button with the unlock symbol on the remote keyless entry transmitter is pressed, the daytime running lamps (DRL), parking lamps and back-up lamps will turn on.

For more detailed information and programming instructions, refer to *DIC Vehicle Personalization on page 3-50* for each individual feature listed above.

Security Feedback

This feature provides feedback when the vehicle receives a command from the remote keyless entry transmitter. Feedback is only provided if all doors are closed, the ignition is off and the Retained Accessory Power (RAP) is inactive. One of the following modes may be selected for each transmitter:

Mode 1: No feedback when locking or unlocking vehicle.

Mode 2: Parking lamps, back-up lamps and the DRL exterior lamps will flash twice when unlocking the vehicle and flash once when locking the vehicle.

Mode 3: Horn chirps when all doors are unlocked (second time the button is pressed) and when locking the vehicle.

Mode 4: Parking lamps, back-up lamps and the DRL exterior lamps will flash twice each time the button with the unlock symbol is pressed; the horn chirps when all doors are unlocked. Parking lamps and the DRL exterior lamps flash once and the horn chirps when locking the vehicle.

The exterior lamps will not flash if the manual parking lamps are on.

If your vehicle is equipped with the DIC, you must program this feature using it. See *Driver Information Center (DIC) on page 3-45*.

If your vehicle is not equipped with the DIC, do the following to change to another mode:

1. Close all the doors and turn the ignition on. Keep all doors closed throughout this procedure.
2. Press and hold LOCK on the driver's power door lock switch throughout this procedure. All the doors will lock.
3. Press the trunk button on the transmitter. The security feedback will remain in its current mode. The horn will chirp as feedback.

4. Press the trunk button again. Each time the trunk button is pressed, the security feedback will advance to the next mode, and the horn will chirp.
5. Release the power door lock switch. The security feedback will remain in the most current mode selected.

This procedure only changes the mode for the transmitter used to change this setting.

To verify the mode selected, remove the key from the ignition and close all of the doors after you've exited the vehicle. Press the lock button on the transmitter to be verified and confirm the appropriate feedback. Repeat with the unlock button.

Matching Transmitter(s) to Your Vehicle

Each remote keyless entry transmitter is coded to prevent another transmitter from unlocking your vehicle. If a transmitter is lost or stolen, a replacement can be purchased through your dealer. Remember to bring any remaining transmitters with you when you go to

your dealer. When the dealer matches the replacement transmitter to your vehicle, any remaining transmitters must also be matched. Once your dealer has coded the new transmitter, the lost transmitter will not unlock your vehicle. Each vehicle can have a maximum of four transmitters matched to it.

See your dealer to have additional transmitters matched to your vehicle.

Battery Replacement

Under normal use, the battery in your remote keyless entry transmitter should last about four years.

You can tell the battery is weak if the transmitter won't work at the normal range in any location. If you have to get close to your vehicle before the transmitter works, it's probably time to change the battery.

Notice: When replacing the battery, use care not to touch any of the circuitry. Static from your body transferred to these surfaces may damage the transmitter.



To replace the battery, do the following:

1. Insert a coin, or similar object, into the notch near the key ring. Turn it counterclockwise to separate the two halves of the transmitter.
2. Once the transmitter is separated, use a pencil eraser to remove the old battery. Do not use a metal object.
3. Remove and replace the battery as the instructions inside the cover indicate. Use one Duracell® battery, type DL-2032, or a similar type.
4. Snap the transmitter back together tightly to be sure no moisture can enter.
5. Check the operation of the transmitter.

Doors and Locks

Door Locks

⚠ CAUTION:

Unlocked doors can be dangerous.

- **Passengers — especially children — can easily open the doors and fall out of a moving vehicle. When a door is locked, the handle will not open it. You increase the chance of being thrown out of the vehicle in a crash if the doors are not locked. So, wear safety belts properly and lock the doors whenever you drive.**
- **Young children who get into unlocked vehicles may be unable to get out. A child can be overcome by extreme heat and can suffer permanent injuries or even death from heat stroke. Always lock your vehicle whenever you leave it.**
- **Outsiders can easily enter through an unlocked door when you slow down or stop your vehicle. Locking your doors can help prevent this from happening.**

There are several ways to lock and unlock your vehicle.

If your vehicle has a content theft-deterrent system, unlock the doors only with the key or remote keyless entry system. This will avoid setting off the alarm.

To unlock the door from the outside, use your door key or remote keyless entry transmitter. Turning the door key toward the front of the vehicle will lock the door. Turning the door key toward the rear of the vehicle will unlock it.

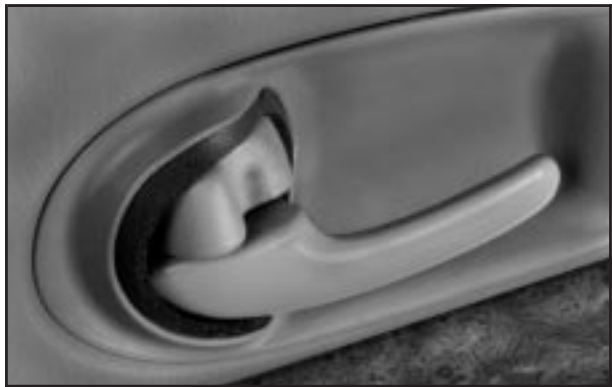

To unlock the door from the inside, move the manual door lock, located above the door handle, rearward. To lock the door, move the manual door lock forward.

Central Door Unlocking System

If your vehicle has a theft-deterrent system, all doors will unlock if the key is held in the outside key cylinder unlock position for more than two seconds. The doors will also unlock if the key is turned to the unlock position twice in three seconds.

Power Door Locks

With power door locks, you can lock or unlock all the doors on your vehicle.



The power door lock switches are located on the driver's and front passenger's door panels.

Door Ajar Reminder

If your vehicle is equipped with the Driver Information Center (DIC), and a door is not fully closed, the DIC will display a DOOR AJAR message. See *Driver Information Center (DIC)* on page 3-45.

Delayed Locking

This feature lets the driver delay the actual locking of the vehicle. When the driver's power door lock switch or remote keyless entry lock button is pressed with the key removed from the ignition, and the driver's door open, a chime will sound three times to signal that the delayed locking system is active. When all doors have been closed, the doors will lock automatically after five seconds. If any door is opened before this, the five-second timer will reset itself once all the doors have been closed again.

Pressing the driver's or passenger's power door lock switch or the remote keyless entry transmitter button again will override this feature.

Personal Choice Programming

The delayed locking feature can be turned on or off.

If your vehicle is equipped with the DIC, you must use it to program this feature. See *Driver Information Center (DIC)* on page 3-45.

To turn the feature on, do the following:

1. Close all the doors and turn the ignition on. Keep all doors closed throughout this procedure.
2. Press and hold LOCK on the driver's power door lock switch throughout this procedure. All the doors will lock.
3. Press the unlock button on the transmitter. The lock delay is still off and all doors will remain locked.
4. Press the unlock button on the transmitter again. Lock delay is now active and all doors will unlock.
5. Release the power door lock switch.

To turn this feature off, repeat the previous procedure.

This procedure only changes the mode for the transmitter used to change this setting.

Programmable Automatic Door Locks

Close the doors and turn on the ignition. Every time you move the shift lever out of PARK (P), all of the doors will lock. And, every time you stop and move the shift lever into PARK (P), the doors will unlock. If someone needs to get out while you're not in PARK (P), have that person use the manual door lock control or power door lock switch. When the door is closed again, it will not lock automatically. If you need to lock the doors before shifting out of PARK (P), use the manual door lock control or power door lock switch.

Personalization Programming

You can program the automatic door locks feature to change to the following modes:

Mode 0: No automatic door lock or unlock.

Mode 1: All doors automatically lock when shifted out of PARK (P). No automatic door unlock.

Mode 2: All doors automatically lock when shifted out of PARK (P). Only the driver's door automatically unlocks when shifted into PARK (P).

Mode 3: All doors automatically lock when shifted out of PARK (P). All doors automatically unlock when shifted into PARK (P).

If your vehicle is equipped with the DIC, you must use it to program this feature. See *Driver Information Center (DIC) on page 3-45*.

If your vehicle is not equipped with the DIC, use the following procedure to change modes:

1. Close all the doors and turn the ignition on. Keep all doors closed throughout this procedure.
2. Press and hold LOCK on the driver's power door lock switch throughout this procedure. All the doors will lock.

3. Press the button with the lock symbol on the remote keyless entry transmitter. The automatic door locks will remain in the current mode.
4. Press the button with the lock symbol on the transmitter again. Each time this button is pressed, the mode will advance by one, going from 3 to 0 to 1, etc.

The door locks will cycle according to the mode entered while customizing the memory door locks. (Mode 0 has no feedback.)

5. Release the power door lock switch. The automatic door locks will remain in the most recent mode selected.

This procedure only changes the mode for the transmitter used to change this setting.

Rear Door Security Locks

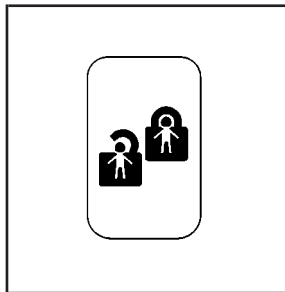

Your vehicle is equipped with rear door security locks that prevent passengers from opening the rear doors of your vehicle from the inside.

To use one of these locks, do the following:

1. Open the rear door you want to lock.
2. Move the lever located on the inside door edge, all the way to the lock symbol.
3. Close the door.
4. Do the same thing to the other rear door lock.

The rear doors of your vehicle cannot be opened from the inside when this feature is in use.

To open a rear door when the security lock is on, do the following:

1. Unlock the door.
2. Open the door from the outside.

If you don't cancel the security lock feature, adults or older children who ride in the rear seat won't be able to open the rear door from the inside. You should let adults and older children know how these security locks work, and how to cancel the locks.

To cancel the rear door lock, do the following:

1. Unlock and open the door from the outside.
2. Move the lever all the way to the unlock symbol.
3. Do the same for the other rear door.

The rear door locks will now work normally.

Lockout Protection

The power door locks will not work if the key is in the ignition and a door is open. You can override this feature by holding the driver's side power door lock switch for more than three seconds.

Leaving Your Vehicle

If you are leaving the vehicle, take your keys, open your door and set the locks from the inside. Then get out and close the door. Or, press the lock button on the remote keyless entry transmitter after shutting the doors.

If your vehicle has a theft-deterrent system, see *Content Theft-Deterrent* on page 2-18.

Trunk

CAUTION:

It can be dangerous to drive with the trunk lid open because carbon monoxide (CO) gas can come into your vehicle. You can't see or smell CO. It can cause unconsciousness and even death. If you must drive with the trunk lid open or if electrical wiring or other cable connections must pass through the seal between the body and the trunk lid:

- Make sure all other windows are shut.
- Turn the fan on your heating or cooling system to its highest speed and select the control setting that will force outside air into your vehicle. See "Climate Control System" in the Index.
- If you have air outlets on or under the instrument panel, open them all the way.

See "Engine Exhaust" in the Index.

Trunk Lock Release

To unlock the trunk from the outside, insert the master key and turn it clockwise.

Remote Trunk Release Lockout



The TRUNK release button is located on the driver's door trim map pocket.

Push this button to open the trunk. The transaxle must be in PARK (P) or NEUTRAL (N) for the remote trunk release button to work.

To lock the trunk from inside your vehicle, insert the master key and turn it clockwise to LOCK. The VALET key will not work in this procedure.

Trunk Security Override

The remote keyless entry transmitter will unlock the trunk even if the trunk release lockout switch is in LOCK.

Emergency Trunk Release Handle

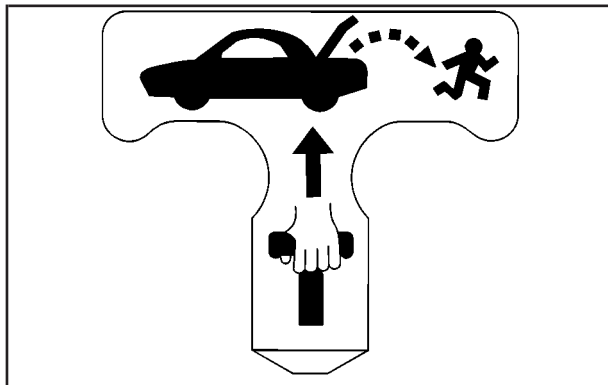

Notice: The emergency trunk release handle is not designed to be used to tie down the trunk lid or as an anchor point when securing items in the trunk. Improper use of the emergency trunk release handle could damage it.

There is a glow-in-the-dark emergency trunk release handle located near the trunk latch. This handle will glow following exposure to light. Pull the release handle up to open the trunk from the inside.

Windows

CAUTION:

Leaving children in a vehicle with the windows closed is dangerous. A child can be overcome by the extreme heat and can suffer permanent injuries or even death from heat stroke. Never leave a child alone in a vehicle, especially with the windows closed in warm or hot weather.



Power Windows



The power window controls located on the driver's door armrest operate each of the windows while the ignition is on or while Retained Accessory Power (RAP) is active. In addition, each passenger door has a control for its own window. See "Retained Accessory Power (RAP)" under *Ignition Positions* on page 2-22 for more information.

Express-Down Window

The driver's and front passenger's windows have an express-down feature. Pull the AUTO control back all the way; release it and the window will lower

automatically. To stop the window from lowering, pull the AUTO control again. To partially open the window, pull the AUTO control back slightly. To raise the window, push and hold the AUTO control forward.

Window Lock Out

Press the LOCK button on the driver's door armrest to disable all passenger window controls. The driver's window controls will still be operable. If you have a Driver Information Center (DIC), you can also set the control to only lock out the rear window controls. See *Driver Information Center (DIC)* on page 3-45.

Press the LOCK button again to allow passengers to use their window controls.

Sun Visors

Lighted Visor Vanity Mirror

When you open the cover to the passenger's visor vanity mirror, the lamp will turn on.

Your vehicle may also have a lighted driver's visor vanity mirror.

Dual Sun Visor

If your vehicle has this feature, each visor has two parts, so that both the windshield and door glass can be shaded at the same time. To use the dual sun visors, flip the first visor down and turn it toward the window. Then, flip the second visor down toward the windshield.

Theft-Deterrent Systems

Vehicle theft is big business, especially in some cities. Although your vehicle has a number of theft-deterrent features, we know that nothing we put on it can make it impossible to steal.

Content Theft-Deterrent



SECURITY

Your vehicle may have a content theft-deterrent alarm system. With this system, the SECURITY light will flash as you open the door (if your ignition is off).

This light reminds you to activate the content theft-deterrent system when leaving your vehicle.

To activate the system, do the following:

1. Open the door.
2. Lock the door with the power door lock switch or with the remote keyless entry transmitter. The SECURITY light should come on and stay on.
3. Close all doors. The SECURITY light should go off after about 30 seconds. The alarm is not armed until the SECURITY light goes off.

If a door is opened without the key or remote keyless entry transmitter, the alarm will go off. Your vehicle's lamps will flash and the horn will sound for 30 seconds. The lamps and horn will then turn off to save battery power.

Remember, the content theft-deterrent system won't activate if you lock the doors with a key or use the manual door lock. It activates only if you use a power door lock switch with a door open, or with the remote keyless entry transmitter. You should also remember that you can start your vehicle with the correct ignition key if the alarm has been set off.

Here's how to avoid setting off the alarm by accident:

- If you don't want to activate the theft-deterrent system, the vehicle should be locked with the door key *after* the doors are closed.
- Always unlock a door with a key, or use the remote keyless entry transmitter. Unlocking a door any other way will set off the alarm.

If you set off the alarm by accident, unlock the driver's door with your key. You can also turn off the alarm by pressing the unlock button on the remote keyless entry transmitter. The alarm won't stop if you try to unlock a door any other way.

Testing the Alarm

The alarm can be tested by following these steps:

1. From inside the vehicle, roll down the driver's window and open the driver's door.
2. Activate the system by locking the doors with the power door lock switch while the door is open, or with the remote keyless entry transmitter.
3. Get out of the car, close the door and wait for the SECURITY light to go out.
4. Then reach in through the window, unlock the door with the manual door lock and open the door. This should set off the alarm.

If the alarm does not sound when it should, but the vehicle's lamps flash, check to see if the horn works. The horn fuse may be blown. To replace the fuse, see *Fuses and Circuit Breakers on page 5-86*.

If the alarm does not sound or the vehicle's lamps do not flash, the vehicle should be serviced by an authorized service center.

PASS-Key® III

Your PASS-Key® III system operates on a radio frequency subject to Federal Communications Commission (FCC) Rules and with Industry Canada.

This device complies with Part 15 of the FCC Rules. Operation is subject to the following two conditions: (1) this device may not cause harmful interference, and (2) this device must accept any interference received, including interference that may cause undesired operation.

This device complies with RSS-210 of Industry Canada. Operation is subject to the following two conditions: (1) this device may not cause interference, and (2) this device must accept any interference received, including interference that may cause undesired operation of the device.

Changes or modifications to this system by other than an authorized service facility could void authorization to use this equipment.

PASS-Key® III uses a radio frequency transponder in the key that matches a decoder in your vehicle.

PASS-Key® III Operation

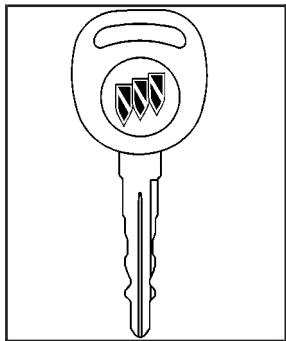

Your vehicle is equipped with the PASS-Key® III (Personalized Automotive Security System) theft-deterrent system. PASS-Key® III is a passive theft-deterrent system. This means you don't have to do anything different to arm or disarm the system. It works when you insert or remove the key from the ignition.

When the PASS-Key® III system senses that someone is using the wrong key, it shuts down the vehicle's starter and fuel systems. The starter will not work and fuel will stop being delivered to the engine. Anyone using a trial-and-error method to start the vehicle will be discouraged because of the high number of electrical key codes.

When trying to start the vehicle, if the engine does not start and the SECURITY light comes on, the key may have a damaged transponder. Turn the ignition off and try again.

If the engine still does not start, and the key appears to be undamaged, try another ignition key. At this time, you may also want to check the fuse. See *Fuses and Circuit Breakers on page 5-86*. If the engine still does not start with the other key, your vehicle needs service. If your vehicle does start, the first key may be faulty. See your dealer who can service the PASS-Key® III to have a new key made.

It is possible for the PASS-Key® III decoder to learn the transponder value of a new or replacement key. Up to 10 additional keys may be programmed for the vehicle. This procedure is for programming additional keys only.

Canadian Owners: If you lose or damage your keys, only a GM dealer can service PASS-Key® III to have new keys made. To program additional keys you will need two current driver's keys. You must add a step to the following procedure. After Step 2, repeat Steps 1 and 2 with the second current driver's key. Then continue with Step 3.

To program the new key, do the following:

1. Verify that the new key has PK3® stamped on it.
2. Insert the current driver's key in the ignition and start the engine. If the engine will not start, see your dealer for service.
3. After the engine has started, turn the key to OFF, and remove the key.

4. Insert the key to be programmed and turn it to RUN within 10 seconds of removing the previous key.
5. The SECURITY telltale light will turn off once the key has been programmed. It may not be apparent that the SECURITY light went on due to how quickly the key is programmed.
6. Repeat Steps 1 through 4 if additional keys are to be programmed.

If you are ever driving and the SECURITY light comes on and stays on, you will be able to restart your engine if you turn it off. Your PASS-Key® III system, however, is not working properly and must be serviced by your dealer. Your vehicle is not protected by the PASS-Key® III system at this time.

If you lose or damage a PASS-Key® III key, see your dealer to have a new key made.

Starting and Operating Your Vehicle

New Vehicle Break-In

Notice: Your vehicle doesn't need an elaborate "break-in." But it will perform better in the long run if you follow these guidelines:

- Don't drive at any one speed — fast or slow — for the first 500 miles (805 km). Don't make full-throttle starts.
- Avoid making hard stops for the first 200 miles (322 km) or so. During this time your new brake linings aren't yet broken in. Hard stops with new linings can mean premature wear and earlier replacement. Follow this breaking-in guideline every time you get new brake linings.
- Don't tow a trailer during break-in. See "Towing a Trailer" in the Index for more information.

Ignition Positions

With the key in the ignition switch, you can turn it to five different positions.

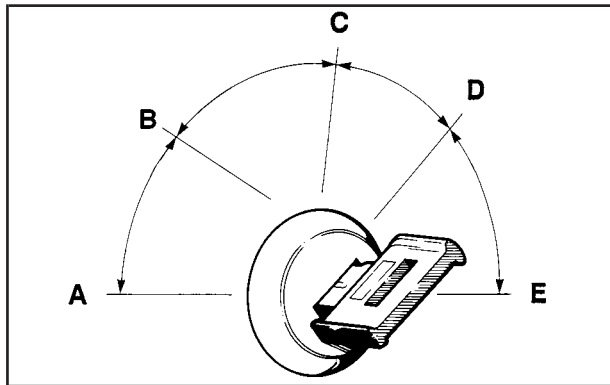

(A) ACCESSORY: This position lets you use your electrical accessories such as power windows, power sunroof (if equipped), radio and the windshield wipers. To use, push in the ignition key and turn it toward you. Your steering wheel will remain locked, just as it was before you inserted the key.

(B) LOCK: This is the only position in which you can remove the key. This position locks your ignition, steering wheel and transaxle. It's a theft-deterrent feature.

Notice: If your key seems stuck in LOCK and you can't turn it, be sure you are using the correct key; if so, is it all the way in? If it is, then turn the steering wheel left and right while you turn the key hard. Turn the key only with your hand. Using a tool to force it could break the key or the ignition switch. If none of these works, then your vehicle needs service.

(C) OFF: This position lets you turn off the engine but still turn the steering wheel. It doesn't lock the steering wheel like LOCK and it doesn't send any electrical power to the accessories. The instrument panel cluster will remain powered in LOCK to illuminate the gear shift indicator. The cluster will also activate the parking brake light when the parking brake is set. Use OFF if you must have your vehicle in motion while the engine is not running.

(D) RUN: This is the position the switch returns to after you start your engine and release the switch. This is also the position for normal driving. Even when the engine is not running, you can use RUN to operate your electrical accessories and to display some instrument panel warning lights.

(E) START: This position starts your engine. When the engine starts, release the key. The ignition switch will return to RUN for normal driving.

Key Reminder Warning

If you leave your key in OFF, you will hear a warning chime when you open the driver's door.

Always leave your key in LOCK while the engine is off. If you leave it in any other position, you will drain your battery power.

Retained Accessory Power (RAP)

After you turn the ignition off and remove the key, you will still have power to such accessories as the power windows, audio steering wheel controls (if equipped), clock, sunroof (if equipped) and the radio for up to 10 minutes. The instrument panel cluster lights will stay on for a few seconds, then will go out. Once you open a door, the power will shut off.

Starting Your Engine

Move your shift lever to PARK (P) or NEUTRAL (N). Your engine won't start in any other position – that's a safety feature. To restart when you're already moving, use NEUTRAL (N) only.

Notice: Don't try to shift to PARK (P) if your vehicle is moving. If you do, you could damage the transaxle. Shift to PARK (P) only when your vehicle is stopped.

1. With your foot off the accelerator pedal, turn your ignition key to START. When the engine starts, let go of the key. The idle speed will go down as your engine gets warm.

Notice: Holding your key in START for longer than 15 seconds at a time will cause your battery to be drained much sooner. And the excessive heat can damage your starter motor. Wait about 15 seconds between each try to help avoid draining your battery or damaging your starter.

2. If it doesn't start within 10 seconds, hold your key in START for about 10 seconds at a time until your engine starts. Wait about 15 seconds between each try.
3. If your engine still won't start (or starts but then stops), it could be flooded with too much gasoline. Try pushing your accelerator pedal all the way to the floor and holding it there as you hold the key in START for about three seconds. If the vehicle starts briefly but then stops again, do the same thing. This time keep the pedal down for five or six seconds to clear the extra gasoline from the engine. After waiting about 15 seconds, repeat the normal starting procedure.

Notice: Your engine is designed to work with the electronics in your vehicle. If you add electrical parts or accessories, you could change the way the engine operates. Before adding electrical equipment, check with your dealer. If you don't, your engine might not perform properly.

Engine Coolant Heater

If your vehicle has this feature, in very cold weather, 0°F (-18°C) or colder, the engine coolant heater can help. You'll get easier starting and better fuel economy during engine warm-up. Usually, the coolant heater should be plugged in a minimum of four hours prior to starting your vehicle. At temperatures above 32°F (0°C), use of the coolant heater is not required.

To Use the Engine Coolant Heater

1. Turn off the engine.
2. Open the hood and unwrap the electrical cord.
The engine coolant heater cord is located on the passenger's side of the vehicle, above the headlamp assembly.

3. Plug it into a normal, grounded 110-volt AC outlet.

CAUTION:

Plugging the cord into an ungrounded outlet could cause an electrical shock. Also, the wrong kind of extension cord could overheat and cause a fire. You could be seriously injured. Plug the cord into a properly grounded three-prong 110-volt AC outlet. If the cord won't reach, use a heavy-duty three-prong extension cord rated for at least 15 amps.

4. Before starting the engine, be sure to unplug and store the cord as it was before to keep it away from moving engine parts. If you don't, it could be damaged.

How long should you keep the coolant heater plugged in? The answer depends on the outside temperature, the kind of oil you have, and some other things. Instead of trying to list everything here, we ask that you contact your dealer in the area where you'll be parking your vehicle. The dealer can give you the best advice for that particular area.

Automatic Transaxle Operation

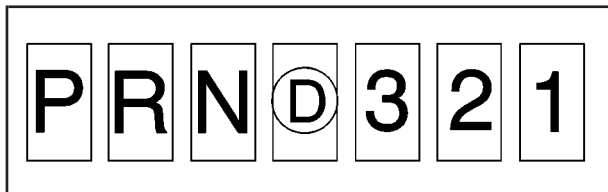

Your automatic transaxle has a shift lever located on the steering column.

PARK (P): This position locks your front wheels. It's the best position to use when you start your engine because your vehicle can't move easily.

CAUTION:

It is dangerous to get out of your vehicle if the shift lever is not fully in PARK (P) with the parking brake firmly set. Your vehicle can roll.

CAUTION: (Continued)

CAUTION: (Continued)

Do not leave your vehicle when the engine is running unless you have to. If you have left the engine running, the vehicle can move suddenly. You or others could be injured. To be sure your vehicle will not move, even when you are on fairly level ground, always set your parking brake and move the shift lever to PARK (P). See “Shifting Into Park (P)” in the Index. If you are pulling a trailer, see “Towing a Trailer” in the Index.

Ensure the shift lever is fully in PARK (P) before starting the engine. Your vehicle has an automatic transaxle shift lock control system. You have to fully apply your regular brakes before you can shift from PARK (P) when the ignition is in RUN. If you cannot shift out of PARK (P), ease pressure on the shift lever and push the shift lever all the way into PARK (P) as you maintain brake application. Then move the shift lever into the gear you wish. See *Shifting Out of Park (P) on page 2-30*.

REVERSE (R): Use this gear to back up.

Notice: Shifting to REVERSE (R) while your vehicle is moving forward could damage your transaxle. Shift to REVERSE (R) only after your vehicle is stopped.

To rock your vehicle back and forth to get out of snow, ice or sand without damaging your transaxle, see *If You Are Stuck: In Sand, Mud, Ice or Snow* on page 4-30.

NEUTRAL (N): In this position, your engine doesn't connect with the wheels. To restart when you're already moving, use NEUTRAL (N) only. Also, use NEUTRAL (N) when your vehicle is being towed.

 **CAUTION:**

Shifting into a drive gear while your engine is “racing” (running at high speed) is dangerous. Unless your foot is firmly on the brake pedal, your vehicle could move very rapidly. You could lose control and hit people or objects. Do not shift into a drive gear while your engine is racing.

Notice: Damage to your transaxle caused by shifting into a drive gear with the engine running at high speed isn't covered by your warranty.

AUTOMATIC OVERDRIVE (D): This position is for normal driving. If you need more power for passing, and you're:

- Going less than about 35 mph (55 km/h), push your accelerator pedal about halfway down.
- Going about 35 mph (55 km/h) or more, push the accelerator all the way down.

You'll shift down to the next gear and have more power.

THIRD (3): This position is also used for normal driving, however, it offers more power and lower fuel economy than AUTOMATIC OVERDRIVE (D).

Here are some times you might choose THIRD (3) instead of AUTOMATIC OVERDRIVE (D):

- When driving on hilly, winding roads.
- When towing a trailer, so there is less shifting between gears.
- When going down a steep hill.

SECOND (2): This position gives you more power but lower fuel economy than THIRD (3). You can use SECOND (2) on hills. It can help control your speed as you go down steep mountain roads, but then you would also want to use your brakes off and on.

Notice: Don't drive in SECOND (2) for more than 5 miles (8 km), or at speeds over 55 mph (90 km/h), or you can damage your transaxle. Use AUTOMATIC OVERDRIVE (Ⓓ) or THIRD (3) as much as possible.

Don't shift into SECOND (2) unless you are going slower than 65 mph (105 km/h), or you can damage your engine.

FIRST (1): This position gives you even more power but lower fuel economy than SECOND (2). You can use it on very steep hills, or in deep snow or mud. If the shift lever is put in FIRST (1), the transaxle won't shift into first gear until the vehicle is going slowly enough.

Notice: If your front wheels won't turn, don't try to drive. This might happen if you were stuck in very deep sand or mud or were up against a solid object. You could damage your transaxle. Also, if you stop when going uphill, don't hold your vehicle there with only the accelerator pedal. This could overheat and damage the transaxle. Use your brakes to hold your vehicle in position on a hill.

Parking Brake



This vehicle has a PUSH TO RELEASE parking brake pedal. To set the parking brake, hold the regular brake pedal down with your right foot. Push down the parking brake pedal with your left foot.

If the ignition is in RUN or OFF, the brake system warning light will turn on while the parking brake is set. The parking brake uses the brakes on the rear wheels.

To release the parking brake, hold the regular brake pedal down and push the parking brake pedal with your left foot. When you lift your left foot, the parking brake pedal will follow it to the released position.

If you try to drive approximately 20 feet (6.1 m) with the parking brake on, the brake light stays on and a chime sounds until you release the parking brake.

Notice: Driving with the parking brake on can cause your rear brakes to overheat. You may have to replace them, and you could also damage other parts of your vehicle.

If you are towing a trailer and are parking on any hill, see *Towing a Trailer on page 4-35*. That section explains what to do first to keep the trailer from moving.

Shifting Into Park (P)

CAUTION:

It can be dangerous to get out of your vehicle if the shift lever is not fully in PARK (P) with the parking brake firmly set. Your vehicle can roll. If you have left the engine running, the vehicle can move suddenly. You or others could be injured. To be sure your vehicle will not move, even when you are on fairly level ground, use the steps that follow. If you are pulling a trailer, see “Towing a Trailer” in the Index.

1. Hold the brake pedal down with your right foot and set the parking brake.

2. Move the shift lever into PARK (P) like this:

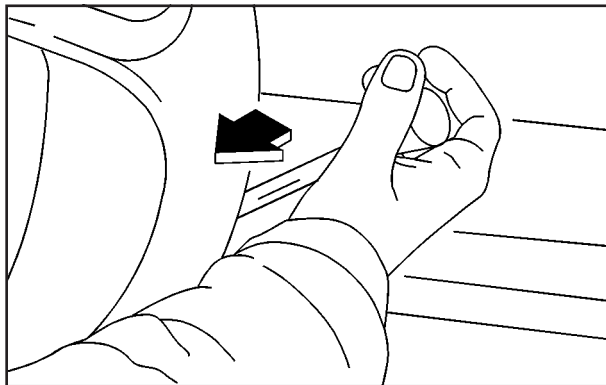

- Pull the lever toward you.

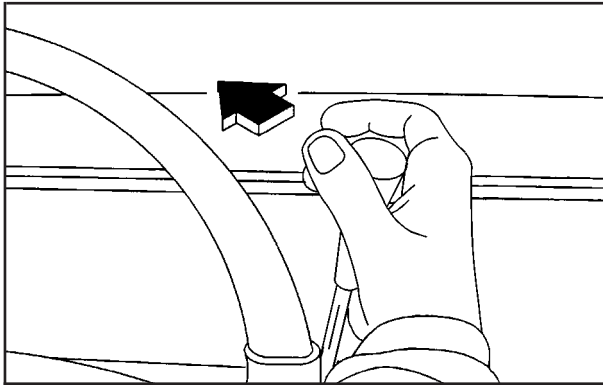

- Move the lever up as far as it will go.
3. Turn the ignition key to LOCK.
 4. Remove the key and take it with you. If you can leave your vehicle with the ignition key in your hand, your vehicle is in PARK (P).

Leaving Your Vehicle With the Engine Running

CAUTION:

It can be dangerous to leave your vehicle with the engine running. Your vehicle could move suddenly if the shift lever is not fully in PARK (P) with the parking brake firmly set. And, if you leave the vehicle with the engine running, it could overheat and even catch fire. You or others could be injured. Do not leave your vehicle with the engine running.

If you have to leave your vehicle with the engine running, be sure your vehicle is in PARK (P) and your parking brake is firmly set before you leave it. After you've moved the shift lever into PARK (P), hold the regular brake pedal down. Then, see if you can move the shift lever away from PARK (P) without first pulling it toward you. If you can, it means that the shift lever wasn't fully locked into PARK (P).

Torque Lock

If you are parking on a hill and you don't shift your transaxle into PARK (P) properly, the weight of the vehicle may put too much force on the parking pawl in the transaxle. You may find it difficult to pull the shift lever out of PARK (P). This is called "torque lock." To prevent torque lock, set the parking brake and then shift into PARK (P) properly before you leave the driver's seat. To find out how, see *Shifting Into Park (P) on page 2-28*.

When you are ready to drive, move the shift lever out of PARK (P) *before* you release the parking brake.

If torque lock does occur, you may need to have another vehicle push yours a little uphill to take some of the pressure from the parking pawl in the transaxle, so you can pull the shift lever out of PARK (P).

Shifting Out of Park (P)

Your vehicle has an automatic transaxle shift lock control system. You have to fully apply your regular brake before you can shift from PARK (P) when the ignition is in RUN. See *Automatic Transaxle Operation on page 2-25*.

If you cannot shift out of PARK (P), ease pressure on the shift lever then push the shift lever all the way into PARK (P) as you maintain brake application. Then move the shift lever into the gear you want.

If you ever hold the brake pedal down but still can't shift out of PARK (P), try this:

1. Turn the key to OFF. Open and close the driver's door to turn off the RAP feature.
2. Apply and hold the brake until the end of Step 4.
3. Shift to NEUTRAL (N).
4. Start the vehicle and then shift to the drive gear you want.
5. Have the vehicle fixed as soon as you can.

Parking Over Things That Burn

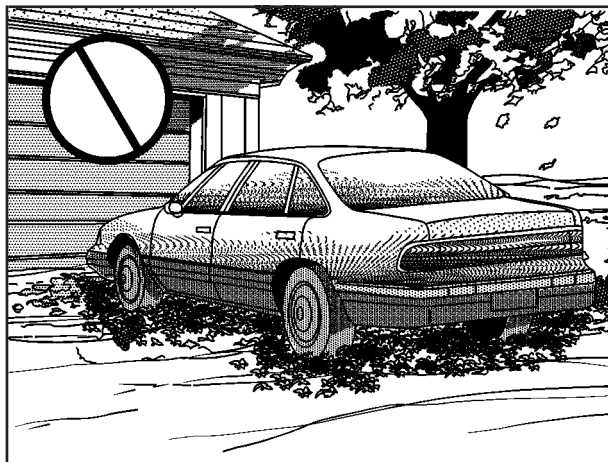

CAUTION:

Things that can burn could touch hot exhaust parts under your vehicle and ignite. Do not park over papers, leaves, dry grass or other things that can burn.

Engine Exhaust

CAUTION:

Engine exhaust can kill. It contains the gas carbon monoxide (CO), which you can not see or smell. It can cause unconsciousness and death.

You might have exhaust coming in if:

- Your exhaust system sounds strange or different.
- Your vehicle gets rusty underneath.
- Your vehicle was damaged in a collision.
- Your vehicle was damaged when driving over high points on the road or over road debris.
- Repairs were not done correctly.
- Your vehicle or exhaust system had been modified improperly.

If you ever suspect exhaust is coming into your vehicle:

- Drive it only with all the windows down to blow out any CO; and
- Have your vehicle fixed immediately.

Running Your Engine While You Are Parked

It's better not to park with the engine running. But if you ever have to, here are some things to know.

CAUTION:

Idling the engine with the climate control system off could allow dangerous exhaust into your vehicle. See the earlier Caution under “Engine Exhaust.”

Also, idling in a closed-in place can let deadly carbon monoxide (CO) into your vehicle even if the climate control fan is at the highest setting. One place this can happen is a garage. Exhaust — with CO — can come in easily. NEVER park in a garage with the engine running.

Another closed-in place can be a blizzard. See “Winter Driving” in the Index.

CAUTION:

It can be dangerous to get out of your vehicle if the shift lever is not fully in PARK (P) with the parking brake firmly set. Your vehicle can roll. Do not leave your vehicle when the engine is running unless you have to. If you have left the engine running, the vehicle can move suddenly. You or others could be injured. To be sure your vehicle will not move, even when you are on fairly level ground, always set your parking brake and move the shift lever to PARK (P).

Follow the proper steps to be sure your vehicle won't move. See *Shifting Into Park (P)* on page 2-28.

If you are parking on a hill and if you're pulling a trailer, also see *Towing a Trailer* on page 4-35.

Mirrors

Manual Rearview Mirror

When you are sitting in a comfortable driving position, adjust the mirror so you can see clearly behind your vehicle. Grip the mirror in the center to move it up or down and side to side. The day/night adjustment allows you to adjust the mirror to avoid glare from any headlamps behind you. Push the tab away from you for daytime use; pull it toward you for night use.

Automatic Dimming Rearview Mirror

Your vehicle may have an automatic dimming rearview mirror. Your vehicle's mirror may also contain OnStar[®] controls. See *OnStar[®] System on page 2-37* for more information.

At night, when the glare is too high, the mirror will gradually darken to reduce glare. This change may take a few seconds. The mirror will return to its clear daytime state when the glare is reduced.

Mirror Operation

AUTO: Press this button to turn on the automatic dimming feature.

OFF: Press this button to turn off the automatic dimming feature.

 **(On/Off):** For mirrors equipped with OnStar[®] controls, press this button to turn on the automatic dimming feature. To turn off automatic dimming, press this button again.

The indicator light will be illuminated when this feature is active.

Automatic Dimming Rearview Mirror with Compass

Your vehicle may have an automatic dimming rearview mirror with a compass. Your vehicle's mirror may also contain OnStar[®] controls. See *OnStar[®] System on page 2-37* for more information.

The mirror also includes an eight-point compass display in the upper right corner of the mirror face.

When cleaning the mirror, use a paper towel or similar material dampened with glass cleaner. Do not spray glass cleaner directly on the mirror as that may cause the liquid cleaner to enter the mirror housing.

Mirror Operation

MIRROR: Press this button to turn on the automatic dimming feature. Press it again to turn off the automatic dimming feature.

 **(On/Off):** For mirrors equipped with OnStar® controls, press and hold this button for several seconds to turn on the automatic dimming feature. Press and hold it again to turn the automatic dimming feature off.

The green indicator light will come on when this feature is active. The automatic dimming feature will be active each time the vehicle is started.

Compass Operation

COMPASS: Press this button once to turn the compass on or off.

 **(On/Off):** For mirrors equipped with OnStar® controls, press this button once to turn the compass on or off.

When the ignition and the compass feature are on, the compass will show two character boxes for approximately two seconds. After two seconds, the mirror will display the compass heading.

Compass Calibration

When on, the compass automatically calibrates as the vehicle is driven. If, after two seconds, the display does not show a compass heading (N for North, for

example), there may be a strong magnetic field interfering with the compass. Such interference may be caused by a magnetic antenna mount, magnetic note pad holder or a similar magnetic item. If the letter C should ever appear in the compass window, the compass may need calibration.

The mirror can be calibrated by driving the vehicle in circles at 5 mph (8 km/h) or less until the display reads a direction.

Mirrors equipped with OnStar® controls can be placed in calibration mode by pressing and holding the on/off button until a C is shown in the compass display.

Compass Variance

Compass variance is the difference between earth's magnetic north and true geographic north. The mirror is set in zone eight upon leaving the factory. It will be necessary to adjust the compass to compensate for compass variance if you live outside zone eight. Under certain circumstances, as during a long distance cross-country trip, it will be necessary to adjust for compass variance. If not adjusted to account for compass variance, your compass could give false readings.

To adjust for compass variance, do the following:

1. Find your current location and variance zone number on the following zone map.

2. Press and hold COMPASS (or the on/off button for mirrors equipped with OnStar® controls) until a zone number appears in the display.

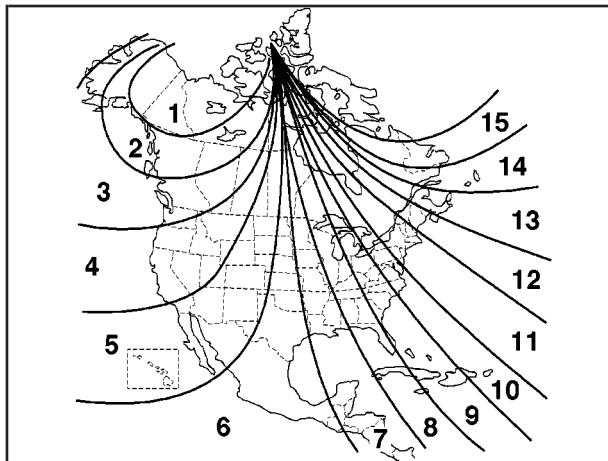

3. Once a zone number appears in the display, press the COMPASS button (or the on/off button for mirrors equipped with OnStar® controls) quickly until the correct zone number appears in the display. Stop pressing the button and the mirror will return to normal operation. If C appears in the compass window, the compass may need calibration. See “Compass Calibration” explained previously.

Outside Power Mirrors



The controls for the outside power mirrors are located on the driver's door armrest.

Press the left or right side of the L/R selector switch located beneath the control pad to choose the left or right mirror.

To adjust the mirror, press one of the four arrows located on the control pad to move the mirror in the direction you want it to go. When finished adjusting the mirrors, leave the L/R selector switch in the center position, to prevent unwanted mirror movement in case the control pad is accidentally bumped while driving. Adjust each outside mirror so that you can see a little of your vehicle, and the area behind your vehicle.

The mirrors may also have an arrow that flashes when the turn signal is used. See *Turn Signal/Multifunction Lever on page 3-7*.

Outside Curb View Assist Mirror

If you have the Memory Seat and Mirrors feature, the passenger's outside rearview mirror includes a tilt-down feature that operates when the shift lever is in REVERSE (R). This feature assists the driver, improving rear obstacle detection. When the vehicle is shifted out of REVERSE (R), the passenger mirror will return to its original position after a five-second delay. This delay prevents movement of the mirror if multiple gear transitions (REVERSE (R) to AUTOMATIC OVERDRIVE (Ⓧ) to REVERSE (R)) occur during a parallel parking maneuver. This feature can be programmed on or off through the personal choice selection menu. See *DIC Vehicle Personalization on page 3-50* for programming instructions.

Outside Convex Mirror

Your passenger's side mirror is convex. A convex mirror's surface is curved so you can see more from the driver's seat.

CAUTION:

A convex mirror can make things (like other vehicles) look farther away than they really are. If you cut too sharply into the right lane, you could hit a vehicle on your right. Check your inside mirror or glance over your shoulder before changing lanes.

Outside Automatic Dimming Heated Mirror

If you have this feature, the outside driver's mirror will adjust for the glare of headlamps behind you. This feature is controlled using the on and off settings on the automatic dimming rearview mirror. See *Automatic Dimming Rearview Mirror on page 2-33*.

When you operate the rear window defogger, the heated driver's and passenger's outside rearview mirrors are warmed to help clear them of ice and snow. See "Rear Window Defogger" under *Climate Control System on page 3-24* or *Dual Automatic Climate Control System on page 3-26* for more information.

OnStar® System



Your vehicle may have this feature. OnStar® uses global positioning system (GPS) satellite technology, wireless communications, and state of the art call centers to provide you with a wide range of safety, security, information and convenience services.

A complete OnStar® user's guide and the terms and conditions of the OnStar® Subscription Service Agreement are included in your OnStar®-equipped vehicle's glove box literature. For more information, visit www.onstar.com, contact OnStar® at 1-888-4-ONSTAR (1-888-466-7827), or press the blue OnStar® button to speak to an OnStar® advisor 24 hours a day, 7 days a week.

A completed Subscription Service Agreement is required prior to delivery of OnStar® services and prepaid calling minutes are also required for OnStar® Personal Calling and OnStar® Virtual Advisor use. Terms and conditions of the Subscription Service Agreement can be found at www.onstar.com.

OnStar® Services

One of the following plans is normally included for a specific duration with each vehicle equipped with OnStar®. You can upgrade or extend your OnStar® service plan to meet your needs.

Safe and Sound Plan

- Automatic Notification of Air Bag Deployment
- Emergency Services
- Roadside Assistance
- Stolen Vehicle Assistance
- AccidentAssist
- Remote Door Unlock
- Remote Diagnostics
- Online Concierge

Directions and Connections Plan

- All Safe and Sound Plan services
- Route Support
- RideAssist
- Information and Convenience Services

Luxury and Leisure Plan

- All Directions and Connections Plan services
- Personal Concierge

OnStar® Personal Calling

With OnStar® Personal Calling, you have a safer way to stay connected while driving. It's a hands-free wireless phone that's integrated into your vehicle. You can place calls nationwide using voice-activated dialing with no contracts and no additional roaming charges. To find out more about OnStar® Personal Calling, refer to the OnStar® owner's guide in your vehicle's glove box, or call OnStar® at 1-888-4-ONSTAR (1-888-466-7827).

OnStar® Virtual Advisor

With OnStar® Virtual Advisor you can listen to your favorite news, entertainment and information topics, such as traffic and weather reports, stock quotes and sports scores. You listen to your e-mail through your vehicle's speakers, and reply with your hands on the wheel and your eyes on the road.

HomeLink® Transmitter



HomeLink®, a combined universal transmitter and receiver, provides a way to replace up to three hand-held transmitters used to activate devices such as gate operators, garage door openers, entry door locks, security systems and home lighting. Additional HomeLink® information can be found on the internet at www.homelink.com or by calling 1-800-355-3515.

If your vehicle is equipped with the HomeLink[®] Transmitter, it complies with Part 15 of the FCC Rules. Operation is subject to the following two conditions:
(1) this device may not cause harmful interference, and
(2) this device must accept any interference received, including interference that may cause undesired operation.

This device complies with RSS-210 of Industry Canada. Operation is subject to the following two conditions:
(1) this device may not cause interference, and (2) this device must accept any interference, including interference that may cause undesired operation of the device.

Changes and modifications to this system by other than an authorized service facility could void authorization to use this equipment.

Programming the HomeLink[®] Transmitter

Do not use the HomeLink[®] Transmitter with any garage door opener that does not have the “stop and reverse” feature. This includes any garage door opener model manufactured before April 1, 1982. If you have a newer garage door opener with rolling codes, please be sure to follow steps 6 through 8 to complete the programming of your HomeLink[®] Transmitter.

Read the instructions completely before attempting to program the HomeLink[®] Transmitter. Because of the steps involved, it may be helpful to have another person available to assist you in programming the transmitter.

Keep the original transmitter for use in other vehicles as well as for future HomeLink[®] programming. It is also recommended that upon the sale of the vehicle, the programmed HomeLink[®] buttons should be erased for security purposes. Refer to “Erasing HomeLink[®] Buttons” or, for assistance, contact HomeLink[®] on the internet at: www.homelink.com or by calling 1-800-355-3515.

Be sure that people and objects are clear of the garage door or gate operator you are programming. When programming a garage door, it is advised to park outside of the garage.

It is recommended that a new battery be installed in your hand-held transmitter for quicker and more accurate transmission of the radio frequency.

Your vehicle's engine should be turned off while programming the transmitter. Follow these steps to program up to three channels:

1. Press and hold down the two outside buttons, releasing only when the indicator light begins to flash, after 20 seconds. Do not hold down the buttons for longer than 30 seconds and do not repeat this step to program a second and/or third transmitter to the remaining two HomeLink[®] buttons.

2. Position the end of your hand-held transmitter about 1 to 3 inches (3 to 8 cm) away from the HomeLink® buttons while keeping the indicator light in view.

3. Simultaneously press and hold both the desired button on HomeLink® and the hand-held transmitter button. Do not release the buttons until Step 4 has been completed.

Some entry gates and garage door openers may require you to substitute Step 3 with the procedure noted in “Gate Operator and Canadian Programming” later in this section.

4. The indicator light will flash slowly at first and then rapidly after HomeLink® successfully receives the frequency signal from the hand-held transmitter. Release both buttons.

5. Press and hold the newly-trained HomeLink® button and observe the indicator light.

If the indicator light stays on constantly, programming is complete and your device should activate when the HomeLink® button is pressed and released.

To program the remaining two HomeLink® buttons, begin with Step 2 under “Programming HomeLink®.” Do not repeat Step 1 as this will erase all of the programmed channels.

If the indicator light blinks rapidly for two seconds and then turns to a constant light, continue with Steps 6 through 8 following to complete the programming of a rolling-code equipped device (most commonly, a garage door opener).

6. Locate in the garage, the garage door opener receiver (motor-head unit). Locate the “Learn” or “Smart” button. This can usually be found where the hanging antenna wire is attached to the motor-head unit.

7. Firmly press and release the “Learn” or “Smart” button. The name and color of the button may vary by manufacturer.

You will have 30 seconds to start Step 8.

8. Return to the vehicle. Firmly press and hold the programmed HomeLink® button for two seconds, then release. Repeat the press/hold/release sequence a second time, and depending on the brand of the garage door opener (or other rolling code device), repeat this sequence a third time to complete the programming.

HomeLink® should now activate your rolling-code equipped device.

To program the remaining two HomeLink® buttons, begin with Step 2 of “Programming HomeLink®.” Do not repeat Step 1.

Gate Operator and Canadian Programming

Canadian radio-frequency laws require transmitter signals to “time out” or quit after several seconds of transmission. This may not be long enough for HomeLink® to pick up the signal during programming. Similarly, some U.S. gate operators are manufactured to “time out” in the same manner.

If you live in Canada, or you are having difficulty programming a gate operator by using the “Programming HomeLink®” procedures (regardless of where you live), replace Step 3 under “Programming HomeLink®” with the following:

Continue to press and hold the HomeLink® button while you press and release every two seconds (cycle) your hand-held transmitter until the frequency signal has been successfully accepted by HomeLink®. The indicator light will flash slowly at first and then rapidly. Proceed with Step 4 under “Programming HomeLink®” to complete.

Using HomeLink®

Press and hold the appropriate HomeLink® button for at least half of a second. The indicator light will come on while the signal is being transmitted.

Erasing HomeLink® Buttons

To erase programming from the three buttons do the following:

1. Press and hold down the two outside buttons until the indicator light begins to flash, after 20 seconds.
2. Release both buttons. Do not hold for longer than 30 seconds.

HomeLink® is now in the train (learning) mode and can be programmed at any time beginning with Step 2 under “Programming HomeLink®.”

Individual buttons can not be erased, but they can be reprogrammed. See “Reprogramming a Single HomeLink® Button” next.

Reprogramming a Single HomeLink® Button

To program a device to HomeLink® using a HomeLink® button previously trained, follow these steps:

1. Press and hold the desired HomeLink® button. Do not release the button.
2. The indicator light will begin to flash after 20 seconds. While still holding the HomeLink® button, proceed with Step 2 under “Programming HomeLink®.”

Resetting Defaults

To reset HomeLink® to default settings do the following:

1. Hold down the two outside buttons for about 20 seconds until the indicator light begins to flash.
2. Continue to hold both buttons until the HomeLink® indicator light turns off.
3. Release both buttons.

For questions or comments, contact HomeLink® at 1-800-355-3515, or on the internet at www.homelink.com.

Storage Areas

Glove Box

Use the door key to lock and unlock the glove box. To open, lift the latch release on the left side of the glove box door.

Center Console Storage Area

Your vehicle has a center console with two storage compartments and cupholders. The cupholders have removable liners to hold beverage containers of different sizes. To access the cupholders and the front storage area, push the doors covering them back into the console. In the front storage area you will find a place to store a cellular phone, as well as a built-in writing surface. Underneath this tray is a CD storage area and another door which can be opened to retrieve items which may fall into the space between the console and the sliding door. To access the CD storage area, place your finger in the oval in the top tray and lift up.

To access the rear storage area, press the lift latch at the front edge of the armrest and pull up. Inside are areas which can be used to store a variety of items. The back of the console may contain either additional cupholders or air vents for the rear seat passengers.

You will also find two accessory power outlets located inside the rear storage area. These outlets can be used for accessories requiring power, such as a cellular phone. See *Accessory Power Outlets on page 3-22*.

Convenience Net

Your vehicle may have a convenience net. You'll see it just inside the back wall of the trunk.

Put small loads, like grocery bags, behind the net. It can help keep them from falling over during sharp turns or quick starts and stops. For heavier loads, store them in the trunk as far forward as you can.

You can unhook the net so that it will lie flat when you're not using it.

Sunroof

Your vehicle may be equipped with a sunroof. The sunroof has both manual and express features for opening the glass panel and sunshade.



The switch for the sunroof is located on the headliner between the sun visors.

The sunroof switch has four positions that control the sunroof movement.

The switch will work only when the ignition is on or when the RAP is active. See "Retained Accessory Power (RAP)" under *Ignition Positions on page 2-22*.

Open: Press and hold the switch rearward to the first position to open the glass panel and sunshade. The sunshade can also be opened manually.

Comfort Stop: Press and release the switch rearward to the second position to express open the glass panel to the comfort stop position. The comfort stop position is designed to help reduce noise and make passengers more comfortable.

Express Open: When the glass panel is express opening, pressing the switch in any direction will stop it in a partially-opened position. The glass panel may be fully opened by pressing the switch rearward again. If you press and hold the switch in the express open position for more than one and a half seconds, the express open operation will be overridden and the sunroof will operate manually.

Close: To close the glass panel, press and hold the switch forward. As the glass panel reaches the closed position, it will open slightly toward the vent position and then drop down to the closed position to provide a better seal. The sunshade must be closed manually.

Vent: Once the sunroof is closed, it can be opened to the vent position by pushing the switch upward. To close the glass panel, pull the switch downward. The sunshade must be opened and closed manually for vent operation.

Vehicle Personalization

Memory Seat and Mirrors



If your vehicle has this feature, the controls are located on the driver's door panel, and are used to program and recall memory settings for the driver's seating, outside mirror positions and climate controls. See *Climate Control System on page 3-24* for more information.

To save your seat and mirror positions into memory, use the following procedure:

1. First identify the DRIVER # on the Driver Information Center (DIC) by pressing the MEMORY button 1 or 2 or by pressing the unlock button on the remote keyless entry transmitter. See *Driver Information Center (DIC) on page 3-45*.

2. Adjust the driver's seat and lumbar position to a safe and comfortable driving position. Adjust both outside mirrors to suit you. See *Outside Power Mirrors on page 2-35*.
3. Press and hold the MEMORY button (1 or 2) corresponding with your DRIVER # displayed on the DIC for longer than three seconds. You will hear two beeps confirming that the seat and mirror positions have been entered into memory.

To set the seat and mirror positions for a second driver, follow the previous steps, but start by pressing the unlock button on the transmitter that displays the other DRIVER # on the DIC. Be sure to use the MEMORY button which corresponds to the DRIVER # identified by the second transmitter.

To recall your memory positions, your vehicle must be in PARK (P). Push and release the MEMORY button corresponding to the desired driving position. The seat and mirrors will move to the position previously stored for the identified driver. You will hear one beep.

To store the exit position for an easy exit, use the following procedure:

1. First identify the DRIVER # by pressing the MEMORY button 1 or 2 or by pressing the unlock button on the transmitter.
2. Adjust the driver's seat to the desired exit position.

3. Press and hold the EXIT button for longer than three seconds. You will hear two beeps confirming that the seat exit position has been entered into memory.

To set the exit position for a second driver, follow the previous steps, but start by pressing the unlock button on the transmitter that displays the other DRIVER # on the DIC. Be sure to use the MEMORY button which corresponds to the DRIVER # identified by the other transmitter.

To recall the exit position, your vehicle must be in PARK (P). Push and release the EXIT button and the seat will move to the exit position previously stored for the current identified driver. You will hear one beep. If an exit position has not been stored for the current identified driver, the seat will move all the way back.

To stop recall movement of the seat at any time, press the driver's power seat control located on the outboard side of the front seat.

Mirrors and lumbar positions will not be stored or recalled for the exit position.

If you would like your stored driving or exit position to be recalled when unlocking your vehicle with the transmitter, see *DIC Vehicle Personalization on page 3-50*.

Section 3 Instrument Panel

Instrument Panel Overview	3-4	Air Bag Readiness Light	3-36
Hazard Warning Flashers	3-6	Battery Warning Light	3-37
Other Warning Devices	3-6	Brake System Warning Light	3-37
Horn	3-7	Anti-Lock Brake System Warning Light	3-38
Tilt Wheel	3-7	Traction Control System (TCS) Warning Light ...	3-39
Turn Signal/Multifunction Lever	3-7	Engine Coolant Temperature Gage	3-40
Exterior Lamps	3-14	Malfunction Indicator Lamp	3-40
Interior Lamps	3-17	Oil Pressure Light	3-43
Head-Up Display (HUD)	3-20	Security Light	3-44
Accessory Power Outlets	3-22	Cruise Control Light	3-44
Ashtrays and Cigarette Lighter	3-23	Service Vehicle Soon Light	3-44
Climate Controls	3-24	Fuel Gage	3-45
Climate Control System	3-24	Driver Information Center (DIC)	3-45
Dual Automatic Climate Control System	3-26	DIC Controls and Displays	3-46
Outlet Adjustment	3-30	DIC Warnings and Messages	3-49
Steering Wheel Climate Controls	3-31	DIC Vehicle Personalization	3-50
Climate Controls Personalization	3-31	Audio System(s)	3-55
Warning Lights, Gages and Indicators	3-32	Setting the Time	3-55
Instrument Panel Cluster	3-33	Radio with CD	3-56
Speedometer and Odometer	3-35	Radio with Cassette and CD	3-62
Tachometer	3-35	Trunk-Mounted CD Changer	3-73
Safety Belt Reminder Light	3-36	Personal Choice Radio Controls	3-77

Section 3 Instrument Panel

Theft-Deterrent Feature	3-77	Care of Your CD Player	3-80
Audio Steering Wheel Controls	3-78	Diversity Antenna System	3-81
Understanding Radio Reception	3-78	XM™ Satellite Radio Antenna System	
Care of Your Cassette Tape Player	3-79	(United States Only)	3-81
Care of Your CDs	3-80	Chime Level Adjustment	3-81

Instrument Panel Overview

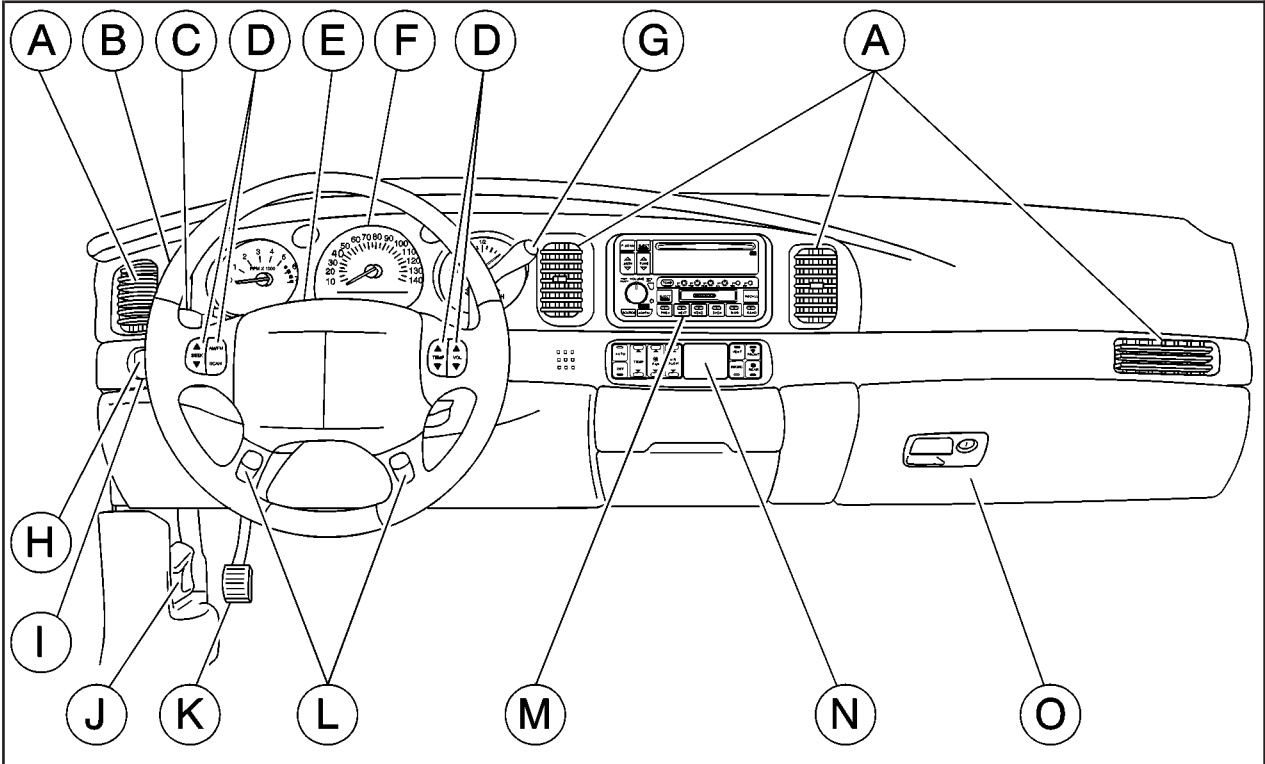

The main components of your instrument panel are the following:

- A. Air Outlets
- B. Driver Information Center (DIC) Buttons (If Equipped)
- C. Turn Signal/Multifunction Lever
- D. Steering Wheel Controls (If Equipped)
- E. Hazard Warning Flashers
- F. Instrument Panel Cluster
- G. Traction Control Button (If Equipped)
- H. Exterior Lamp Buttons
- I. Head-Up Display (HUD) Controls (If Equipped)
- J. Hood Release
- K. Parking Brake
- L. Cruise Controls
- M. Audio System
- N. Climate Controls
- O. Glove Box

Hazard Warning Flashers

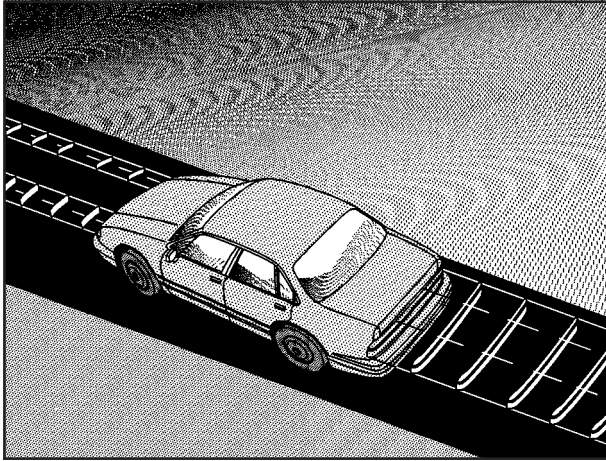

Your hazard warning flashers let you warn others. They also let police know you have a problem. Your front and rear turn signal lamps will flash on and off.



The hazard warning flasher button is located on top of the steering column.

Your hazard warning flashers work no matter what position your key is in, and even if the key isn't in.

Press the button to make the front and rear turn signal lamps flash on and off. To turn the flashers off, press the button again.

When the hazard warning flashers are on, your turn signals won't work.

Other Warning Devices

If you carry reflective triangles, you can set one up at the side of the road about 300 feet (100 m) behind your vehicle.

Horn

Press the center area of the steering wheel to sound the horn.

Tilt Wheel

A tilt wheel allows you to adjust the steering wheel before you drive. You can also raise it to the highest level to give your legs more room when you exit and enter the vehicle.

The lever that allows you to tilt the steering wheel is located on the left side of the steering column.



To tilt the wheel, hold the wheel and pull the lever toward you. Then move the wheel to a comfortable position and release the lever to lock the wheel in place.

Turn Signal/Multifunction Lever



The lever on the left side of the steering column includes the following:

- Turn and Lane-Change Signals
- Headlamp High/Low-Beam Changer
- Flash-To-Pass
- Windshield Wipers
- Windshield Washer

For more information on exterior lamps, see *Exterior Lamps* on page 3-14.

Turn and Lane-Change Signals

To signal a turn, move the lever on the left side of the steering wheel all the way up or down. The lever returns automatically when the turn is complete.

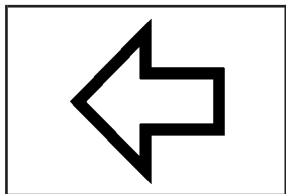

An arrow on the instrument panel cluster will flash in the direction of the turn or lane change.

If your vehicle is equipped with the Head-Up Display (HUD), an arrow will also appear in the display area to indicate the direction of the turn or lane change.

See *Head-Up Display (HUD)* on page 3-20 for more information.

You may also have an arrow in the outside mirror that flashes when the turn signal is used. See *Outside Power Mirrors* on page 2-35 for more information.

Raise or lower the lever until the arrow starts to flash to signal a lane change. Hold it there until the lane change is complete.

If the arrows flash very fast as you signal a turn or a lane change, a signal bulb may be burned out and other drivers won't see your turn signal.

If a bulb is burned out, replace it to help avoid an accident. If the arrows don't go on at all when you signal a turn, check the fuse. See *Fuses and Circuit Breakers* on page 5-86.

Turn Signal On Chime

If your turn signal is left on for more than 0.8 miles (1.3 km), a chime will sound at each flash of the turn signal. To turn off the chime, move the turn signal lever to the off position.

Headlamp High/Low-Beam Changer

To change the headlamps from low beam to high beam or high beam to low beam, pull the turn signal lever toward you and release it.

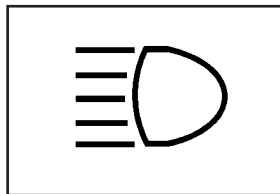

When the high beams are on, this light located on the instrument panel cluster will also be on.

If your vehicle is equipped with the Head-Up Display (HUD), this symbol will also appear in the display area to indicate the high beams are on. See *Head-Up Display (HUD)* on page 3-20 for more information.

Flash-To-Pass

This feature lets you use the high-beam headlamps to signal the driver in front of you that you want to pass. It works even if your headlamps are off.

Pull the turn signal lever toward you briefly to flash-to-pass.

If the headlamps are off or on low beam, the high-beam headlamps will turn on. They'll stay on as long as you hold the lever toward you and the high-beam indicator on the instrument panel cluster will come on.

Windshield Wipers



The windshield wipers are controlled by turning the band marked WIPER.

If your windshield wipers are on for more than six seconds while you are driving, the low-beam headlamps, instrument panel cluster backlighting and taillamps will turn on. For more information see "Wiper Activated Headlamps" under *Exterior Lamps on page 3-14*.

Off: Turn the band to OFF to turn the wipers off.

MIST: For a single wiping cycle, turn the band to MIST. Hold it there until the wipers start, then let go. The wipers will stop after one cycle. If you want more cycles, hold the band on MIST longer.

LO (Low Speed): Turn the band to LO for steady wiping at a slow speed.

HI (High Speed): Turn the band to HI for steady wiping at a high speed.

The wiper speed may be set for a long or short delay between wipes. Turn the band to choose the delay time. The closer to LO, the shorter the delay.

Heavy snow or ice can overload your wiper motor. A circuit breaker will stop the motor until it cools. Clear away snow or ice to prevent an overload.

Keep in mind that damaged wiper blades may prevent you from seeing well enough to drive safely. To avoid damage, be sure to clear ice and snow from the wiper blades before using them. If your blades do become damaged, get new blades or blade inserts.

Rainsense™ II Wipers

If your vehicle has this feature, the moisture sensor is mounted on the interior of the windshield below the rearview mirror and is used to automatically operate the wipers. This system operates by monitoring the amount of moisture build-up on the windshield. Wipes occur as needed to clear the windshield depending

on the driving conditions and the sensitivity setting. In light rain or snow, fewer wipes will occur. In heavy rain or snow, wipes will occur more frequently. The system will operate in the delay, low speed and high speed modes. If the system is left on for long periods of time, occasional wipes may occur without any moisture on the windshield. This is normal and indicates that the Rainsense™ system is active.

The Rainsense™ system is activated by turning the wiper control band to one of the five sensitivity levels within the delay area. The delay position closest to OFF/MIST is the lowest sensitivity setting, level one. The highest sensitivity setting, level five, is closest to the LO position. A single wipe will occur each time you turn the wiper control band to a higher sensitivity level to indicate that the sensitivity level has been increased.

Notice: The wipers must be turned off when going through a car wash to avoid damage.

The MIST and wash cycles operate as normal and are not affected by the Rainsense™ function. The system can be overridden at any time by manually changing the wiper control to LO or HI speed.

Notice: Do not place stickers or other items on the exterior glass surface directly in front of the rainsensor. Doing this could cause the rainsensor to malfunction.

Windshield Washer

At the top of the turn signal/multifunction lever, there's a paddle with the word PUSH on it. To spray washer fluid on the windshield, push the paddle. The wipers will clear the window and either stop or return to your preset speed. For more washer cycles, push and hold the paddle.

CAUTION:

In freezing weather, don't use your washer until the windshield is warmed. Otherwise the washer fluid can form ice on the windshield, blocking your vision.

Ice build up can block washer nozzles. Remove ice for proper operation.

See *Windshield Washer Fluid* on page 5-36 for more information.

Cruise Control



The switches to operate cruise control are located on the steering wheel.

With cruise control, you can maintain a speed of about 25 mph (40 km/h) or more without keeping your foot on the accelerator. This is helpful on long trips.

Cruise control does not work at speeds below about 25 mph (40 km/h).

When you apply your brakes, the cruise control shuts off.

CAUTION:

- Cruise control can be dangerous where you can't drive safely at a steady speed. So, don't use your cruise control on winding roads or in heavy traffic.
- Cruise control can be dangerous on slippery roads. On such roads, fast changes in tire traction can cause needless wheel spinning, and you could lose control. Don't use cruise control on slippery roads.

If your vehicle is in cruise control when the optional traction control system begins to limit wheel spin, the cruise control will automatically disengage. See *Traction Control System (TCS) on page 4-9*. When road conditions allow you to safely use it again, you may turn the cruise control back on.

Setting Cruise Control

CAUTION:

If you leave your cruise control on when you're not using cruise, you might hit a button and go into cruise when you don't want to. You could be startled and even lose control. Keep the cruise control switch off until you want to use cruise control.

1. Press the ON/OFF switch to turn cruise control on. An indicator light will come on in the switch to show that cruise control is on.
2. Get up to the speed you want.
3. Press the SET/COAST switch and the CRUISE light on the instrument panel cluster will illuminate.
4. Take your foot off the accelerator pedal.

Resuming a Set Speed

Suppose you set your cruise control at a desired speed and then you apply the brake. This, of course, shuts off the cruise control. But you don't need to reset it.

Once you're going about 25 mph (40 km/h) or more, you can briefly press the RESUME/ACCEL (resume/accelerate) switch to return to your desired preset speed.

You'll go right back up to your chosen speed and stay there. If you press and hold the RESUME/ACCEL switch, the vehicle will keep going faster until you release the switch or apply the brake. So unless you want to go faster, don't press and hold the RESUME/ACCEL switch.

Increasing Speed While Using Cruise Control

There are two ways to go to a higher speed:

- Use the accelerator pedal to get to the higher speed. Press the SET/COAST switch, then release it and the accelerator pedal. You'll now cruise at the higher speed.
- Press the RESUME/ACCEL switch. Hold it there until you get up to the speed you want, and then release it. (To increase your speed in very small amounts, briefly press the RESUME/ACCEL switch and then release it. Each time you do this, your vehicle will go about 1 mph (1.6 km/h) faster.)

The accelerate feature will only work after you have set the cruise control speed by pressing the SET/COAST switch.

Reducing Speed While Using Cruise Control

There are two ways to reduce your speed while using cruise control:

- Press the SET/COAST switch until you reach the lower speed you want, then release it.
- To slow down in very small amounts, push the SET/COAST switch briefly. Each time you do this, you'll go about 1 mph (1.6 km/h) slower.

Passing Another Vehicle While Using Cruise Control

Use the accelerator pedal to increase your speed. When you take your foot off the pedal, your vehicle will slow down to the cruise control speed you set earlier.

Using Cruise Control on Hills

How well your cruise control will work on hills depends upon your speed, load and the steepness of the hills. When going up steep hills, you may have to step on the accelerator pedal to maintain your speed. When going downhill, you may have to brake or shift to a lower gear to keep your speed down. Applying the brake or shifting into a lower gear will take your vehicle out of cruise control. If you need to apply the brake or shift to a lower gear due to the grade of the downhill slope, you may not want to attempt to use your cruise control feature.

Ending Cruise Control

There are two ways to turn off the cruise control:

- Step lightly on the brake pedal; or
- press ON/OFF.

Erasing Speed Memory

When you turn off the cruise control or the ignition, your cruise control set speed memory is erased.

Exterior Lamps

The exterior lamp control buttons are located to the left of the steering column.



 **(Parking Lamps):** Press this button to turn on the parking lamps, together with the following:

- Sidemarkers Lamps
- Taillamps
- License Plate Lamps
- Instrument Panel Lights

 **(Headlamps):** Press this button to turn on the headlamps, together with the previously listed lamps and lights.

Wiper Activated Headlamps

This feature turns on the low-beam headlamps, instrument panel cluster backlighting and taillamps when the Twilight Sentinel[®] is in day mode and after the windshield wipers have been in use for approximately six seconds.

To operate the wiper activated headlamps, the Twilight Sentinel[®] must be on. If the wiper activated headlamps are on and the ignition switch is turned to RUN, the wiper activated headlamps will continue. When you turn the key to OFF, the wiper activated headlamps will immediately turn off. The wiper activated headlamps will also turn off if you turn off the Twilight Sentinel[®] or the windshield wipers.

Headlamps On Reminder

If you leave the exterior lamp buttons for the headlamps or parking lamps on, remove the key from the ignition and open the driver's door, you will hear a continuous warning chime. The chime will turn off when the lamps are turned off.

Daytime Running Lamps

Daytime Running Lamps (DRL) can make it easier for others to see the front of your vehicle during the day. DRL can be helpful in many different driving conditions, but they can be especially helpful in the short periods after dawn and before sunset. Fully functional daytime running lamps are required on all vehicles first sold in Canada.

A light sensor on top of the instrument panel monitors the exterior light level for the operation of DRL and Twilight Sentinel[®], so be sure it isn't covered.

The DRL system will make your high-beam headlamps turn on at reduced brightness in daylight when the following conditions are met:

- The ignition is on,
- the exterior lamp button for the headlamps is off and
- the transaxle is not in PARK (P).

When the DRL are on, only your high-beam headlamps will be on. The parking lamps, taillamps, sidemarker and other lamps won't be on.

When it is dark enough outside, your low-beam headlamps will come on. The other lamps that turn on with your headlamps will also turn on. When it is bright enough outside, the regular lamps will go off, and your high-beam headlamps change to the reduced brightness of DRL.

To turn off all exterior lighting at night when you are parked, turn off the headlamps and move the Twilight Sentinel[®] lever all the way toward OFF. The exterior lamps will turn back on automatically when you move the transaxle out of PARK (P).

As with any vehicle, you should turn on the regular headlamp system when you need it.

Cornering Lamps

If your vehicle has this feature, the cornering lamps come on when the headlamps or parking lamps are on and you signal a turn with the multifunction lever. They provide more light for cornering.

Twilight Sentinel®

Twilight Sentinel® turns your headlamps on and off by sensing how dark it is outside.



The lever for this feature is located to the left of the steering column.

To operate it, leave the exterior lamp button off.

If you slide the lever all the way to MAX, your headlamps will remain on for about three minutes after you turn off your engine. As you slide the lever toward OFF, the headlamps will turn off more quickly. You can change this delay time from only a few seconds to three minutes.

The exterior lamps can be completely shut off while the vehicle is in PARK (P) by sliding the Twilight Sentinel® lever all the way to OFF. To turn the exterior lamps back on, slide the lever toward MAX again, or shift out of PARK (P).

Park Lamp Override Feature

If the Twilight Sentinel® lighting is active, it can be disabled by turning on the manual parking lamps. The lighting will be disabled until the ignition is moved from RUN or until the outside light level becomes daylight. The outside light level changing to daylight will cause the Twilight Sentinel® feature to deactivate. The wiper-activated headlamps will override the twilight disable feature.

Light Sensor



Your Twilight Sentinel® and DRL work with the light sensor located on top of the instrument panel.

Don't cover it up. If you do, the sensor will read "dark" and the Twilight Sentinel® lighting will turn on.

Exterior Lighting Battery Saver

If the exterior lamp button has been left on, the exterior lamps will turn off approximately 10 minutes after the ignition is turned to LOCK and any door has been opened. This protects against draining the battery in case you have accidentally left the headlamps or parking lamps on. If you need to leave the lamps on for more than 10 minutes, use the manual control to turn the lamps back on after the ignition is turned to LOCK and any door is opened. To delay the lamps from turning off, see “Twilight Sentinel[®]” under *Exterior Lamps* on page 3-14.

Interior Lamps

Instrument Panel Brightness



The lever for this feature is located to the left of the steering column.

The brightness of the instrument panel lights can be adjusted by sliding the INTERIOR lever from LO to HI.

The instrument panel lights will be on only while the parking lamps are on. The interior courtesy lamps can be turned on by sliding the INTERIOR lever all the way to HI.

Courtesy Lamps

If it is dark enough outside, when any door is opened, several lamps go on. They make it easy for you to enter and leave the vehicle. You can also turn these lamps on by sliding the INTERIOR lever all the way to the top.

Entry Lighting

If it is dark enough outside when you press the unlock button on the remote keyless entry transmitter, the interior courtesy lamps will turn on and stay on for approximately 40 seconds. The lamps will turn off immediately by pressing the lock button on the remote keyless entry transmitter, turning the ignition key to RUN or activating the power door locks.

Delayed Entry Lighting

If it is dark enough outside when you open the door, the interior lamps will turn on. When you close the door with the ignition off, the interior lamps will stay on for up to 25 seconds or until the ignition is turned to an on position. When the lamps turn off as a result of the 25 second timer or the ignition switch being turned on, the lighting will deactivate via the theater dimming effect. Locking the doors will override the delayed entry lighting feature and the lamps will turn off right away.

Theater Dimming

This feature allows for a three to five-second fade out of the courtesy lamps instead of immediate turn off.

Delayed Exit Lighting

If it is dark enough outside when you remove the key from the ignition, the interior lamps will turn on and stay on for approximately 25 seconds. This will give you time to find the door pull handle or lock switches. Once the key is inserted into the ignition the exit lighting will be cancelled and the lighting will fade out.

Perimeter Lighting

If it is dark enough outside when the unlock button on the remote keyless entry transmitter is pressed, the DRL, parking lamps and back-up lamps will come on.

Personal Choice Programming

This feature can be programmed in the on or off mode for each transmitter.

If your vehicle is equipped with the Driver Information Center (DIC), you must use it to program this feature. See *Driver Information Center (DIC) on page 3-45*.

To turn the feature off, do the following:

1. Close all the doors and turn the ignition on. Keep all doors closed throughout this procedure.
2. Press and hold LOCK on the power door lock switch throughout this procedure. All the doors will lock.
3. Press the instant alarm on the transmitter. Perimeter lighting remains on at this time and the horn will chirp two times.

4. Press the instant alarm on the transmitter again. Perimeter lighting is disabled and the horn will chirp one time.
5. Release the door lock switch. The perimeter lighting feature is now off.

To turn the feature on, do the following:

1. Close all the doors and turn the ignition on. Keep all doors closed throughout this procedure.
2. Press and hold LOCK on the power door lock switch throughout this procedure. All the doors will lock.
3. Press the instant alarm on the transmitter. Perimeter lighting now remains off at this time and the horn will chirp one time.
4. Press the instant alarm on the transmitter again. Perimeter lighting is now enabled and the horn will chirp two times.
5. Release the door lock switch. The perimeter lighting feature is now on.

This procedure only changes the mode for the transmitter used to change this setting.

Front Reading Lamps



The front reading lamps, located on the headliner, are turned on or off by pressing one of the buttons located near each lamp.

Inadvertent Power Battery Saver

This feature is designed to protect your vehicle's battery against drainage from the interior lamps, trunk lamp, glove box lamp, cigarette lighters or garage door opener. When the ignition is turned off, the power to these features will automatically turn off after 10 minutes. Power will be restored for an additional 10 minutes if any door is opened, the trunk is opened or the courtesy lamp switch is turned on. To restore power back to the cigarette lighters the ignition must be turned back to RUN.

Battery Load Management

The battery load management feature is designed to monitor the vehicle's electrical load and determine when the battery is in a heavy discharge condition. During times of high electrical loading, the engine may idle at a higher rpm setting than normal to make sure the battery charges. High electrical loads may occur when several of the following are on: headlamps, high beams, rear window defogger, fan at high speed, heated seats (if equipped) and engine cooling fans.

If your vehicle's battery remains in a heavy discharge condition for a long period of time, the fan, rear defogger, heated seats and heated mirrors will be disabled and the DIC will display BATTERY SAVER ACTIVE. This can happen either under long periods of idling or low speed driving with high electrical loading, or in the event of a charging system fault.

Head-Up Display (HUD)

CAUTION:

If the HUD image is too bright, or too high in your field of view, it may take you more time to see things you need to see when it's dark outside. Be sure to keep the HUD image dim and placed low in your field of view.

If your vehicle is equipped with the Head-Up Display (HUD), you can see some of the driver information that appears on your instrument panel cluster.

The information may be displayed in English or metric units and appears as a reflection in the windshield. The HUD consists of the following information:

- Speedometer Reading
- Turn Signal Indicators
- High-Beam Headlamp Indicator
- Check Gages Message

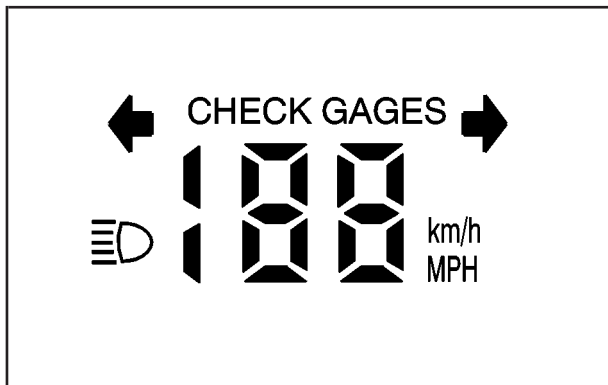

The HUD shows these images when they are lighted on the instrument panel cluster.

Be sure to continue scanning your displays, controls and driving environment just as you would in a vehicle without HUD. If you never look at your instrument panel cluster, you may not see something important, such as a warning light.

Notice: Although the HUD image appears to be near the front of the vehicle, do not use it as a parking aid. The HUD was not designed for that purpose. If you try to use it as such, you may misjudge the distance and damage your vehicle.



The HUD controls are located on the instrument panel to the left of the steering wheel.

1. Start your engine and slide the HUD dimmer lever all the way up.
The brightness of the HUD image is determined by an internal photo-cell, and where you have the HUD dimmer control set.
2. Adjust the seat to your driving position. Press the image height adjuster switch to raise the image as far as possible.

3. Now press the image height adjuster switch to position the image as low as possible, while still keeping it in full view.
4. Slide the dimmer lever downward until the HUD image is no brighter than necessary.

To turn the HUD display off, slide the dimmer lever all the way down.

If the sun comes out and the sky becomes cloudy, you may need to adjust the HUD brightness using the dimmer lever. Polarized sunglasses could make the HUD image harder to see.

To change the display from English to metric units, push the ENG/MET button located to the left of the steering column.

Clean the inside of the windshield as necessary to remove any dirt or film that reduces the sharpness or clarity of the HUD image.

To clean the HUD lens, spray household glass cleaner on a soft, clean cloth. Gently wipe and dry the HUD lens. Do not spray cleaner directly on the lens to avoid cleaner leaking inside the unit.

If the ignition is on and you can't see the HUD image, check to see if:

- Something is covering the HUD unit.
- The HUD dimmer lever is adjusted properly.
- The HUD image is adjusted to the proper height.
- A fuse is blown. See *Fuses and Circuit Breakers on page 5-86*.

Keep in mind that your windshield is part of the HUD system. If you ever have your windshield replaced, be sure to get one that is designed for HUD or your HUD image may look blurred or out of focus.

Accessory Power Outlets

The accessory power outlets can be used to plug in electrical equipment such as a cellular telephone or CB radio.

Your vehicle may have up to three power outlets depending on the type of front seat you have. If your vehicle has front bucket seats with a center console, you will find two outlets inside the rear storage compartment. (An extra power outlet can be found in the ashtray.)

Your vehicle may have a small cap that must be pulled down to access the accessory power outlet. If it does, when not using the outlet be sure to cover it with the protective cap.

The accessory power outlets will only operate when the ignition key is in RUN and for 10 minutes after turning the ignition off. If you would like the outlets to operate regardless of ignition position, and for extended periods of time, see "Engine Compartment Fuse Block" under *Fuses and Circuit Breakers on page 5-86* or contact your dealer.

Notice: When using an accessory power outlet, maximum electrical load must not exceed 15 amps. Always turn off any electrical equipment when not in use. Leaving electrical equipment on for extended periods will drain your battery.

Certain electrical accessories may not be compatible to the accessory power outlets and could result in blown vehicle or adapter fuses. If you experience a problem see your dealer for additional information on the accessory power outlets.

Notice: Adding some electrical equipment to your vehicle can damage it or keep other things from working as they should. This wouldn't be covered by your warranty. Check with your dealer before adding electrical equipment, and never use anything that exceeds the amperage rating.

When adding electrical equipment, be sure to follow the proper installation instructions included with the equipment.

Notice: Power outlets are designed for accessory plugs only. Do not hang any type of accessory or accessory bracket from the plug. Improper use of the power outlet can cause damage not covered by your warranty.

Ashtrays and Cigarette Lighter

Pull down the front center tray to reveal the front ashtray, cigarette lighter and accessory power outlet. The front center and rear ashtrays may be removed for cleaning. Hold the sides of the ashtray and then pull the ashtray up and out.

Notice: Don't put papers or other flammable items into your ashtrays. Hot cigarettes or other smoking materials could ignite them, causing a damaging fire.

To use a lighter, push the center all the way in and let it go. When it is ready, the center will pop back out by itself. Pull out the entire unit to use it.

Notice: Don't hold a cigarette lighter in with your hand while it is heating. If you do, it won't be able to back away from the heating element when it's ready. That can make it overheat, damaging the lighter and the heating element.

The cigarette lighter will only operate when the ignition key is in RUN and for 10 minutes after turning the ignition off. If you would like the lighter to operate regardless of ignition position, and for extended periods of time, see "Engine Compartment Fuse Block" under *Fuses and Circuit Breakers on page 5-86* or see your dealer.

Climate Controls

Climate Control System

With this system you can control the heating, cooling, and ventilation for your vehicle.

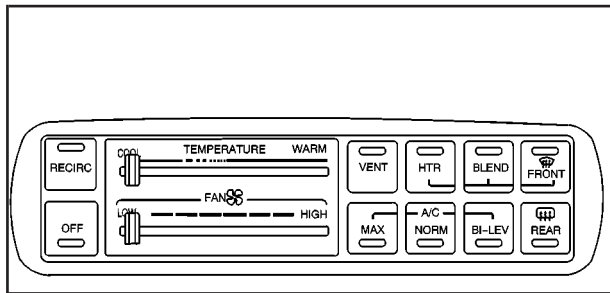

TEMPERATURE: This lever is used to adjust the temperature of the air coming through the system. Moving the lever between COOL and WARM will change the temperature of the air coming through your outlets.

FAN: Move this lever to select the speed of the fan. Moving the lever between LOW and HIGH will decrease or increase the fan speed. The fan will be off when the system is off.

To change the current mode, select one of the following:

RECIRC (Recirculation): This mode keeps outside air from coming in the vehicle. It can be used to prevent outside air and odors from entering your vehicle or to help heat or cool the air inside your vehicle more quickly. Press this button to turn the recirculation mode on or off. When the button is pressed, an indicator light will come on. You may not use RECIRC with FRONT defrost or BLEND.

VENT: This mode directs air to the instrument panel outlets.

HTR (Heater): This mode directs most of the air to the floor outlets with some air directed to the outboard outlets (for the side windows) and some air directed to the windshield.

BLEND: This mode splits the airflow between the windshield and the floor outlets. The air conditioning compressor will be operating.

OFF: The ventilation system always allows fresh air to flow through your vehicle when it is moving. The system will try to keep the air at a previously chosen temperature. When the system is off, the blower fan is also off.

MAX (Maximum Air Conditioning): This mode directs airflow through the instrument panel outlets. The amount of outside air entering your vehicle is limited.

Also in this mode, the RECIRC function is activated to create the maximum cooling effect in the vehicle. If RECIRC was activated before selecting MAX, the light in the RECIRC button will go off. If RECIRC is selected after MAX, the light in the RECIRC button will not come on.

NORM (Normal Air Conditioning): This mode cools the outside air entering your vehicle and directs it through the instrument panel outlets.

BI-LEV (Bi-Level Air Conditioning): This mode directs approximately half of the air to the instrument panel outlets, and then directs most of the remaining air to the floor outlets. Some air may be directed toward the windshield. Cooler air is directed to the upper outlets and warmer air to the floor outlets. The air conditioning compressor is on in this mode.

On hot days, open the windows to let hot inside air escape; then close them. This helps to reduce the time it takes for your vehicle to cool down. It also helps the system to operate more efficiently.

For quick cool down on hot days, do the following:

1. Select the vent mode.
2. Select the recirculation mode.
3. Select MAX.
4. Select the coolest temperature.
5. Select the highest fan speed.

Using these settings together for long periods of time may cause the air inside of your vehicle to become too dry. To prevent this from happening, after the air in your vehicle has cooled, turn the recirculation mode off.

The air conditioning system removes moisture from the air, so you may sometimes notice a small amount of water dripping underneath your vehicle while idling or after turning off the engine. This is normal.

Sensors

The solar sensor on your vehicle monitors the solar radiation and the air inside of your vehicle, then uses the information to maintain the selected temperature by initiating needed adjustments to the temperature, the fan speed and the air delivery system. The system may also supply cooler air to the side of the vehicle facing the sun. The recirculation mode will also be activated, as necessary. Do not cover the solar sensor located in the center of the instrument panel, near the windshield, or the system will not work properly.

Defogging and Defrosting

Fog on the inside of windows is a result of high humidity (moisture) condensing on the cool window glass. This can be minimized if the climate control system is used properly. This mode allows you to clear fog or frost from your windshield.

 **FRONT (Defrost):** Pressing this button directs most of the air to the windshield and the outboard outlets (for the side windows), with some air directed to the floor outlets. In this mode, the system will automatically turn off recirculation and run the air conditioning compressor, unless the outside temperature is at or below freezing. Recirculation cannot be selected while in the FRONT defrost mode. Do not drive the vehicle until all the windows are clear.

Rear Window Defogger

The rear window defogger uses a warming grid to remove fog or frost from the rear window.

 **REAR:** Press this button to turn the rear window defogger on or off. Be sure to clear as much snow from the rear window as possible.

At speeds above 35 mph (55 km/h), the defogger will operate continuously until you press the REAR button again. After 10 minutes of driving below 35 mph (55 km/h), the defogger will turn off automatically. If you need additional warming time, push the button again. The system will then operate for five minutes before going off by itself.

If your vehicle has heated outside rearview mirrors, the mirrors will heat to help clear fog or frost from the surface of the mirror when the rear window defogger button is pressed.

Notice: Don't use a razor blade or something else sharp on the inside of the rear window. If you do, you could cut or damage the defogger and the repairs would not be covered by your warranty. Do not attach a temporary vehicle license, tape, a decal or anything similar to the defogger grid.

Dual Automatic Climate Control System

With this system you can control the heating, cooling and ventilation for your vehicle.



Automatic Operation

AUTO (Automatic): Press the AUTO button for automatic control of the inside temperature, the air delivery mode and the fan speed.

1. Press the AUTO button.
2. Adjust the temperature to 75° F (24° C).

Choosing the coldest or warmest temperature setting will not cause the system to heat or cool any faster. If you set the system at the warmest temperature setting, the system will remain in manual mode at that temperature and it will not go into automatic mode.

In cold weather, the system will start at reduced fan speeds to avoid blowing cold air into your vehicle until warmer air is available. The system will start out blowing air at the floor but may change modes automatically as the vehicle warms up to maintain the chosen temperature setting. The length of time needed for warm up will depend on the outside temperature and the length of time that has elapsed since your vehicle was last driven.

3. Wait for the system to regulate. This may take from 10 to 30 minutes. Then adjust the temperature, if necessary.

Do not cover the solar sensor located in the center of the instrument panel, near the windshield. For more information on the solar sensor, see "Sensors" later in this section.

Manual Operation

Pressing the FAN or AIR FLOW buttons cancels automatic operation and places the system in manual mode. Press the AUTO button to return to automatic operation.

TEMP (Temperature): To manually adjust the temperature inside the vehicle, push the TEMP arrow. Push the TEMP up arrow for warmer temperature settings and the TEMP down arrow for cooler temperature settings. The setting will be shown on the display. The display will return to the outside temperature after a few seconds.

 **FAN:** Pressing the FAN button will display and hold the current fan speed while in manual mode. If you want the fan to run at a lower speed, push the down arrow on the FAN button. If you want to increase the fan speed, push the up arrow on the FAN button.

AIR FLOW: Pressing the AIR FLOW button will display and hold the current setting while in manual mode.

Use the up and down arrows on the AIR FLOW button to cycle through the available modes.

WINDSHIELD-FLOOR: This mode directs most of the airflow to the windshield with some airflow to the outboard outlets (for the side windows) and the floor outlets.

MID: This mode directs airflow through the instrument panel outlets.

MID-FLOOR: This mode directs airflow through both the floor and the instrument panel outlets. There is also a small amount of air directed to the windshield and the outboard outlets (for the side windows).

FLOOR: This mode directs most of the airflow to the floor outlets with some directed to the outboard outlets (for the side windows) and the windshield.

OFF: Press the OFF button once to turn off the passenger climate control, if it has been activated. Pressing the OFF button a second time will turn off the main system. The outside temperature will be shown on the display when the system is off.

VENT (Flow-Through Ventilation): Pressing the VENT button allows outside air to flow through your vehicle without the air conditioning compressor working. To turn off the VENT selection, push the VENT button again.

Selecting the VENT and AUTO buttons at the same time allows the system to control the airflow automatically without using the air conditioning compressor or the recirculation mode.

RECIRC (Recirculation): Press this button to limit the amount of outside air coming into the vehicle. It can be used to prevent outside air and odors from entering your vehicle or to help heat or cool the air inside your vehicle more quickly. Press this button to turn the recirculation mode on or off. When the button is pressed, an indicator light will come on. The recirculation mode cannot be used with the FRONT defrost or VENT mode.

On hot days, open the windows to let hot air escape; then close them. This helps to reduce the time it takes for your vehicle to cool down. It also helps the system to operate more efficiently.

For quick cool down on hot days, press the AUTO button and the system will automatically enter recirculation mode and the temperature will be at the full cold position for maximum cooling.

Using these settings together for long periods of time may cause the air inside of your vehicle to become too dry. To prevent this from happening, after the air in your vehicle has cooled, turn the recirculation mode off.

The air conditioning system removes moisture from the air, so you may sometimes notice a small amount of water dripping underneath your vehicle while idling or after turning off the engine. This is normal.

Sensors

The solar sensor on your vehicle monitors the solar radiation and the air inside of your vehicle, then uses the information to maintain the selected temperature by initiating needed adjustments to the temperature, the fan speed and the air delivery system. The system may also supply cooler air to the side of the vehicle facing the sun. The recirculation mode will also be activated, as necessary. Do not cover the solar sensor located in the center of the instrument panel, near the windshield, or the system will not work properly.

Defogging and Defrosting

Fog on the inside of windows is a result of high humidity (moisture) condensing on the cool window glass. This can be minimized if the climate control system is used properly.

 **FRONT:** Press the FRONT button to defrost the windshield by directing airflow toward the windshield and outboard outlets (for the side windows). To turn off FRONT, press the AUTO or AIR FLOW buttons.

If the AIR FLOW up button is pressed while in the FRONT defrost mode, the system will direct the air toward the instrument panel outlets. If the AIR FLOW down button is pressed while in the FRONT defrost mode, the system will direct the air toward the floor, and the FRONT defrost mode will cancel. Do not drive the vehicle until all the windows are clear.

Rear Window Defogger

The rear window defogger uses a warming grid to remove fog or frost from the rear window.

 **REAR:** Press this button to turn the rear window defogger on or off. Be sure to clear as much snow from the rear window as possible.

At speeds above 35 mph (55 km/h), the defogger will operate continuously until you press the REAR button again. After 10 minutes of driving below 35 mph (55 km/h), the defogger will turn off automatically. If you need additional warming time, push the button again. The system will then operate for five minutes before going off by itself.

If your vehicle has heated outside rearview mirrors, the mirrors will heat to help clear fog or frost from the surface of the mirror when the rear window defogger button is pressed.

Notice: Don't use a razor blade or something else sharp on the inside of the rear window. If you do, you could cut or damage the defogger and the repairs would not be covered by your warranty. Do not attach a temporary vehicle license, tape, a decal or anything similar to the defogger grid.

Passenger Temperature Control

If your vehicle has this feature, then the driver and the front-seat passenger can select separate temperature settings. This feature allows the passenger to select a temperature that is 5° F (3° C) warmer or cooler than the driver's selected temperature. The control is located on the passenger's door armrest.



Press the red button for a warmer temperature or the blue button for a cooler temperature. Press the OFF button on the main system once to turn off the passenger's temperature control. Press the OFF button twice to turn off the entire climate control system.

Outlet Adjustment



Use the levers located in the middle of the front outlets to change the direction of the airflow.



In vehicles equipped with rear seat outlets, you can adjust the direction of the airflow using the lever in the center of each outlet. Use the thumbwheel located between the outlets to turn them on and off.

Operation Tips

- Clear away any ice, snow or leaves from the air inlets at the base of the windshield that may block the flow of air into your vehicle.
- Use of non-GM approved hood deflectors may adversely affect the performance of the system.
- Keep the path under the front seats clear of objects to help circulate the air inside of your vehicle more effectively.

Steering Wheel Climate Controls



If your vehicle has this feature, you can control the temperature function by using the switch located on your steering wheel.

△ TEMP ▽ (Temperature): Press the up or down arrow on this switch to increase or decrease the temperature.

Climate Controls Personalization

If your vehicle is equipped with this feature, up to two drivers are able to store and recall climate control settings for the temperature, the fan speed and the direction of the airflow.

Memory buttons 1 and 2 are located on the driver's door panel and correspond to the numbers 1 or 2 found on the back of each remote keyless entry transmitter.

To store settings, do the following:

1. Select the desired temperature, fan speed and airflow mode. If desired, a separate temperature setting may also be selected for the front seat passenger. For information on how to do this, see *Dual Automatic Climate Control System on page 3-26*.
2. Locate memory buttons 1 and 2 on the driver's door panel.
3. Press the memory button on the door panel that corresponds to the number on the back of the transmitter you are programming, until you hear two beeps. The beeps confirm that your selection has been saved and can now be recalled. For more information on the memory feature, see *Memory Seat and Mirrors on page 2-44*.

Follow these steps each time you want to change the stored settings.

To recall the climate control settings last stored on your transmitter, press the unlock button on your remote keyless entry transmitter and put the ignition in ACCESSORY or RUN. The settings will be recalled.

Warning Lights, Gages and Indicators

This part describes the warning lights and gages that may be on your vehicle. The pictures will help you locate them.

Warning lights and gages can signal that something is wrong before it becomes serious enough to cause an expensive repair or replacement. Paying attention to your warning lights and gages could also save you or others from injury.

Warning lights come on when there may be or is a problem with one of your vehicle's functions. As you will see in the details on the next few pages, some warning lights come on briefly when you start the engine just to let you know they're working. If you are familiar with this section, you should not be alarmed when this happens.

Gages can indicate when there may be or is a problem with one of your vehicle's functions. Often gages and warning lights work together to let you know when there's a problem with your vehicle.

When one of the warning lights comes on and stays on when you are driving, or when one of the gages shows there may be a problem, check the section that tells you what to do about it. Please follow this manual's advice. Waiting to do repairs can be costly – and even dangerous. So please get to know your warning lights and gages. They're a big help.

Your vehicle may also have a DIC that works along with the warning lights and gages. See *Driver Information Center (DIC) on page 3-45*.

The volume of your vehicle's warning chimes can be adjusted. For information see *Chime Level Adjustment on page 3-81*.

Instrument Panel Cluster

Your instrument panel cluster is designed to let you know at a glance how your vehicle is running. You'll know how fast you're going, how much fuel you're using, and many other things you'll need to drive safely and economically.

Your vehicle is equipped with one of these instrument panel clusters, which includes indicator warning lights and gauges that are explained on the following pages.

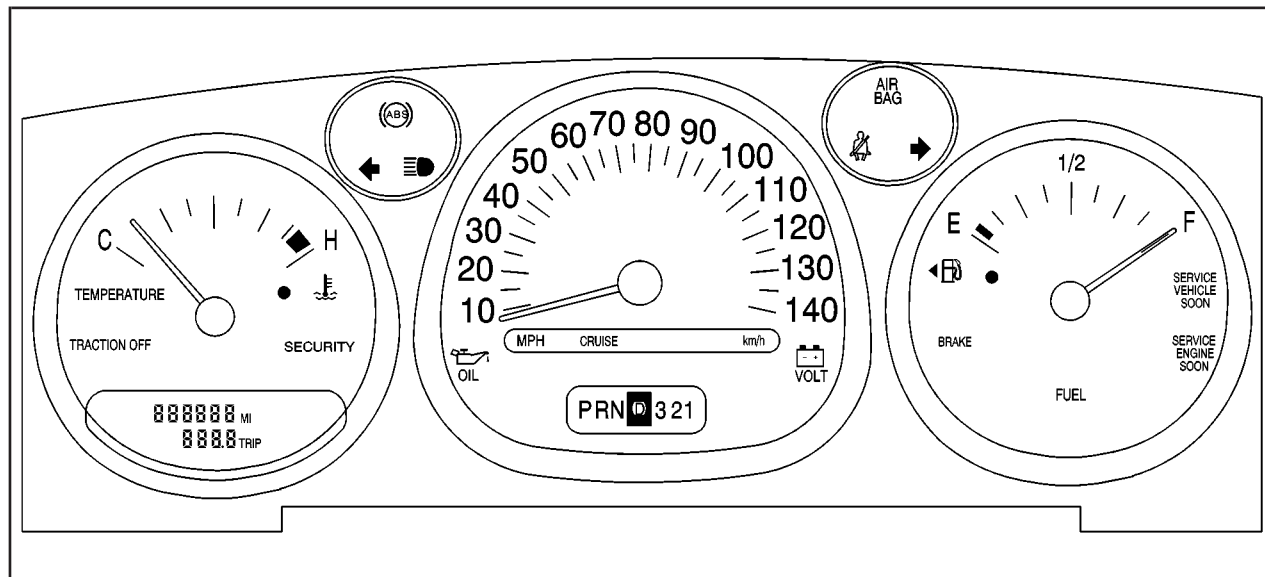

Standard Cluster (United States version shown, Canada similar)

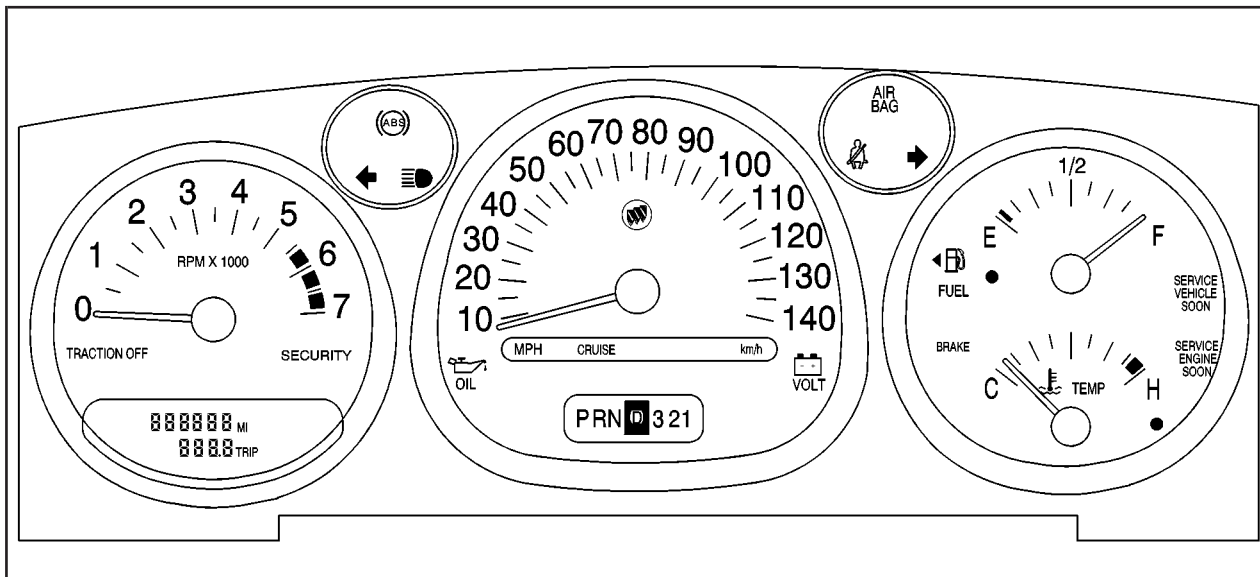

Cluster With Tachometer (United States version shown, Canada similar)

Speedometer and Odometer

Your speedometer lets you see your speed in both miles per hour (mph) and kilometers per hour (km/h). Your odometer shows how far your vehicle has been driven, in either miles or kilometers. Press The ENG/MET button which is located to the left of the speedometer to change from mph to km/h.

Your vehicle has a tamper resistant odometer.

You may wonder what happens if your vehicle needs a new odometer installed. If the new one can be set to the mileage total of the old odometer, then it must be. But if it can't, then it's set at zero and a label must be put on the driver's door to show the old mileage reading when the new odometer was installed.

Trip Odometer

A trip odometer can tell you how far you have driven since you last set it to zero. To reset it, push the TRIP RESET button. If your vehicle is equipped with a DIC, see *Driver Information Center (DIC) on page 3-45* for information on resetting the trip odometer.

Tachometer

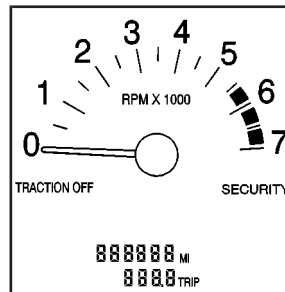

If your vehicle has this feature, the tachometer tells you how fast the engine is running. It displays engine speed in thousands of revolutions per minute (rpm).

Notice: Do not operate the engine with the tachometer in the shaded warning area, or engine damage may occur.

Safety Belt Reminder Light

When the key is turned to RUN or START, a chime will come on for several seconds to remind people to fasten their safety belts.



The safety belt light will also come on and stay on for several seconds, then flash for several more.

If the driver's belt is already buckled, neither the chime nor the light will come on.

Air Bag Readiness Light

There is an air bag readiness light on the instrument panel, which shows AIR BAG. The system checks the air bag's electrical system for malfunctions. The light tells you if there is an electrical problem. The system check includes the air bag sensors, the air bag modules, the wiring and the crash sensing and diagnostic module. For more information on the air bag system, see *Air Bag Systems on page 1-46*.

AIR
BAG

This light will come on when you start your vehicle, and it will flash for a few seconds. Then the light should go out. This means the system is ready.

If the air bag readiness light stays on after you start the vehicle or comes on when you are driving, your air bag system may not work properly. Have your vehicle serviced right away.

CAUTION:

If the air bag readiness light stays on after you start your vehicle, it means the air bag system may not be working properly. The air bags in your vehicle may not inflate in a crash, or they could even inflate without a crash. To help avoid injury to yourself or others, have your vehicle serviced right away if the air bag readiness light stays on after you start your vehicle.

The air bag readiness light should flash for a few seconds when you turn the ignition key to RUN. If the light doesn't come on then, have it fixed so it will be ready to warn you if there is a problem.

Battery Warning Light

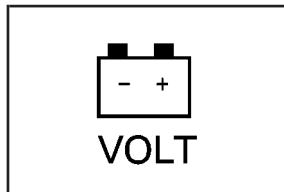

When you turn the key to RUN, this light will turn on briefly to show that the generator and battery charging systems are working.

If the light stays on, a chime will sound indicating that the vehicle needs service. You should take your vehicle to the dealer as soon as possible. To save the battery until you get there, turn off all accessories and set the climate control system to OFF.

Brake System Warning Light

Your vehicle's hydraulic brake system is divided into two parts. If one part isn't working, the other part can still work and stop you. For good braking, though, you need both parts working well.

If the warning light comes on, there is a brake problem. Have your brake system inspected right away.

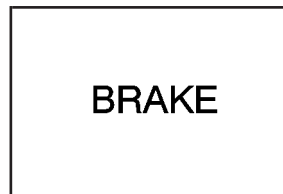

United States

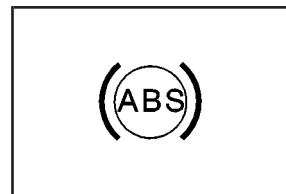

Canada

This light should come on when you turn the key to RUN. If it doesn't come on then, have it fixed so it will be ready to warn you if there's a problem.

When the ignition is on, the brake system warning light will also come on when you set your parking brake. The light will stay on if your parking brake doesn't release fully. If you try to drive off with the parking brake set, a chime will also come on until you release the parking brake. If the light stays on after your parking brake is fully released, it means you have a brake problem.

If the light comes on while you are driving, pull off the road and stop carefully. You may notice that the pedal is harder to push. Or, the pedal may go closer to the floor. It may take longer to stop. If the light is still on, have the vehicle towed for service. See *Towing Your Vehicle* on page 4-31.

CAUTION:

Your brake system may not be working properly if the brake system warning light is on. Driving with the brake system warning light on can lead to an accident. If the light is still on after you've pulled off the road and stopped carefully, have the vehicle towed for service.

Anti-Lock Brake System Warning Light

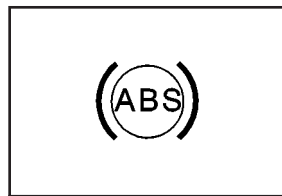

With the anti-lock brake system, the light(s) will come on when your engine is started and may stay on for several seconds. That's normal.

If the light stays on, turn the ignition to OFF. Or, if the light comes on when you're driving, stop as soon as possible and turn the ignition off. Then start the engine again to reset the system. If the light still stays on, or comes on again while you're driving, your vehicle needs service. If the regular brake system warning light isn't on, you still have brakes, but you don't have anti-lock brakes. If the regular brake system warning light is also on, you don't have anti-lock brakes and there's a problem with your regular brakes. See *Brake System Warning Light* on page 3-37.

The anti-lock brake system warning light will come on briefly when you turn the ignition key to RUN. This is normal. If the light doesn't come on then, have it fixed so it will be ready to warn you if there is a problem.

Traction Control System (TCS) Warning Light

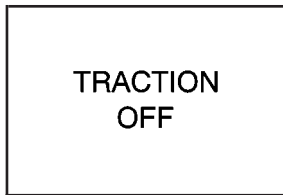

For vehicles equipped with the traction control system, this warning light should come on briefly when the engine is started.

If the warning light doesn't come on then, have it fixed so it will be ready to warn you if there's a problem. If it stays on, or comes on when you're driving, there may be a problem with your traction control system and your vehicle may need service. When this warning light is on, the system will not limit wheel spin. Adjust your driving accordingly.

The traction control system warning light may come on for the following reasons:

- If you turn the system off by pressing the button located on the end of the gearshift lever, the warning light will come on and stay on. To turn the system back on, press the button again. The warning light should go off. See *Traction Control System (TCS)* on page 4-9 for more information.
- If there's a brake system problem that is specifically related to traction control, the traction control system will turn off and the warning light will come on. If your brakes begin to overheat, the traction control system will turn off and the warning light will come on until your brakes cool down.
- If the traction control system is affected by an engine-related problem, the system will turn off and the warning light will come on.

If the traction control system warning light comes on and stays on for an extended period of time when the system is turned on, your vehicle needs service.

Engine Coolant Temperature Gage

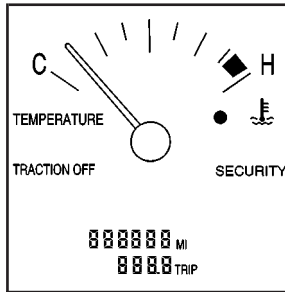

Standard version
shown, uplevel similar

This gage shows the engine coolant temperature. If the pointer moves into the shaded area, the engine is too hot.

A temperature indicator light will turn on and a chime will sound.

If you have been operating your vehicle under normal driving conditions, and the temperature indicator light comes on, you should pull off the road, stop your vehicle and turn off the engine as soon as possible.

Malfunction Indicator Lamp

Service Engine Soon Light

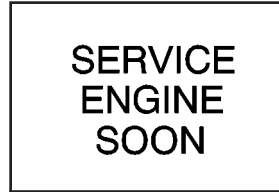

Your vehicle is equipped with a computer which monitors operation of the fuel, ignition and emission control systems.

This system is called OBD II (On-Board Diagnostics-Second Generation) and is intended to assure that emissions are at acceptable levels for the life of the vehicle, helping to produce a cleaner environment. The SERVICE ENGINE SOON light comes on to indicate that there is a problem and service is required. Malfunctions often will be indicated by the system before any problem is apparent. This may prevent more serious damage to your vehicle. This system is also designed to assist your service technician in correctly diagnosing any malfunction.

Notice: If you keep driving your vehicle with this light on, after a while, your emission controls may not work as well, your fuel economy may not be as good and your engine may not run as smoothly. This could lead to costly repairs that may not be covered by your warranty.

Notice: Modifications made to the engine, transaxle, exhaust, intake or fuel system of your vehicle or the replacement of the original tires with other than those of the same Tire Performance Criteria (TPC) can affect your vehicle's emission controls and may cause this light to come on. Modifications to these systems could lead to costly repairs not covered by your warranty. This may also result in a failure to pass a required Emission Inspection/Maintenance test.

This light should come on, as a check to show you it is working, when the ignition is on and the engine is not running. If the light doesn't come on, have it repaired. This light will also come on during a malfunction in one of two ways:

- **Light Flashing** — A misfire condition has been detected. A misfire increases vehicle emissions and may damage the emission control system on your vehicle. Diagnosis and service may be required.
- **Light On Steady** — An emission control system malfunction has been detected on your vehicle. Diagnosis and service may be required.

If the Light Is Flashing

The following may prevent more serious damage to your vehicle:

- Reducing vehicle speed.
- Avoiding hard accelerations.
- Avoiding steep uphill grades.
- If you are towing a trailer, reduce the amount of cargo being hauled as soon as it is possible.

If the light stops flashing and remains on steady, see “If the Light Is On Steady” following.

If the light continues to flash, when it is safe to do so, *stop the vehicle*. Find a safe place to park your vehicle. Turn the key off, wait at least 10 seconds and restart the engine. If the light remains on steady, see “If the Light Is On Steady” following. If the light is still flashing, follow the previous steps, and see your dealer for service as soon as possible.

If the Light Is On Steady

You may be able to correct the emission system malfunction by considering the following:

Did you recently put fuel into your vehicle?

If so, reinstall the fuel cap, making sure to fully install the cap. See *Filling Your Tank on page 5-7*. The diagnostic system can determine if the fuel cap has been left off or improperly installed. A loose or missing fuel cap will allow fuel to evaporate into the atmosphere. A few driving trips with the cap properly installed should turn the light off.

Did you just drive through a deep puddle of water?

If so, your electrical system may be wet. The condition will usually be corrected when the electrical system dries out. A few driving trips should turn the light off.

Have you recently changed brands of fuel?

If so, be sure to fuel your vehicle with quality fuel. See *Gasoline Octane on page 5-4*. Poor fuel quality will cause your engine not to run as efficiently as designed. You may notice this as stalling after start-up, stalling when you put the vehicle into gear, misfiring, hesitation on acceleration or stumbling on acceleration. (These conditions may go away once the engine is warmed up.) This will be detected by the system and cause the light to turn on.

If you experience one or more of these conditions, change the fuel brand you use. It will require at least one full tank of the proper fuel to turn the light off.

If none of the above steps have made the light turn off, your dealer can check the vehicle. Your dealer has the proper test equipment and diagnostic tools to fix any mechanical or electrical problems that may have developed.

Emissions Inspection and Maintenance Programs

Some state/provincial and local governments have or may begin programs to inspect the emission control equipment on your vehicle. Failure to pass this inspection could prevent you from getting a vehicle registration.

Here are some things you need to know in order to help your vehicle pass an inspection:

Your vehicle will not pass this inspection if the SERVICE ENGINE SOON light is on or not working properly.

Your vehicle will not pass this inspection if the OBD (on-board diagnostic) system determines that critical emission control systems have not been completely diagnosed by the system. The vehicle would be considered not ready for inspection. This can happen if you have recently replaced your battery or if your battery has run down. The diagnostic system is designed to evaluate critical emission control systems during normal driving. This may take several days of routine driving. If you have done this and your vehicle still does not pass the inspection for lack of OBD system readiness, your GM dealer can prepare the vehicle for inspection.

Oil Pressure Light

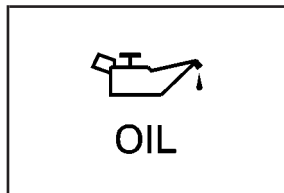

If your vehicle has the standard instrument panel cluster, this light will come on if there is a problem with your vehicle's engine oil pressure.

If your vehicle has the optional gage cluster, you can read your oil pressure directly from the Driver Information Center (DIC). See *DIC Controls and Displays on page 3-46*.

The oil pressure light will come on briefly when you turn your key to RUN. That's just a check to be sure the light works. This is normal and doesn't show a problem. If it doesn't come on and then go off, be sure to have it fixed so it will be there to warn you if there is a problem.

When this light *comes* on and *stays* on, and a chime sounds, it means oil isn't going through the engine properly. The oil could be low, or there might be some other oil problem. See your dealer for service.

CAUTION:

Don't keep driving if the oil pressure is low. If you do, your engine can become so hot that it catches fire. You or others could be burned. Check your oil as soon as possible and have your vehicle serviced.

Notice: Damage to your engine from neglected oil problems can be costly and is not covered by your warranty.

Security Light

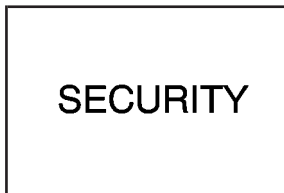

Your vehicle may have a content theft-deterrent alarm system. With this system, the SECURITY light will flash as you open the door (if your ignition is off).

For more information see *Content Theft-Deterrent on page 2-18*.

Cruise Control Light



The CRUISE light comes on when you set the vehicle's cruise control. See "Cruise Control" under *Turn Signal/Multifunction Lever on page 3-7*.

Service Vehicle Soon Light



This light will come on and stay on if your vehicle has certain non-emission related problems.

These problems may not be obvious and may affect vehicle performance or durability. Consult a qualified dealership for necessary repairs to maintain top vehicle performance.

This light will come on briefly when the ignition is turned on to show that it is working properly.

Fuel Gage

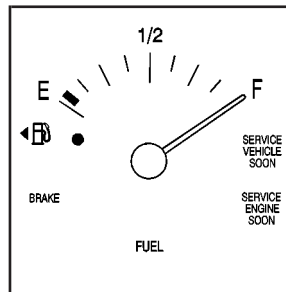

United States

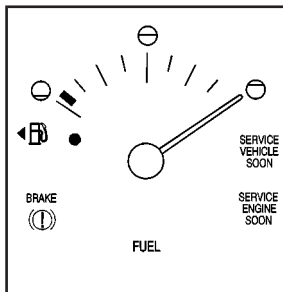

Canada

The fuel gage shows about how much fuel is in your tank. It works only when the ignition is on. When the indicator moves to the edge of the low fuel warning band, the low fuel warning light will come on and a chime will sound. You still have a little fuel left, but you need to get more fuel right away.

Here are some things that some owners ask about. None of these show a problem with your fuel gage:

- At the service station, the gas pump shuts off before the gage reads full.
- It takes more (or less) fuel to fill up than the gage indicated. For example, the gage may have indicated half full, but it took more (or less) than half the tank's capacity to fill it.
- The gage moves up a little when you turn a corner, speed up or make a hard stop.
- The gage doesn't go back to empty when you turn off the ignition.

Driver Information Center (DIC)

Your vehicle may be equipped with a Driver Information Center (DIC). The DIC will display information about how your vehicle is functioning, as well as warning messages if a system problem is detected. This feature also allows two different drivers to store and recall their own personal choice settings. See "DIC Controls and Displays" following for more information.

DIC Controls and Displays

When you turn the ignition on, the DIC will display your DRIVER NUMBER. You can have your dealer program your name to appear on this display line. See your dealer for more information.

The system will then perform a status check and display any messages if a problem is detected. If there are no problems detected, the display will return to the mode selected by that driver the last time the ignition was turned off.

If a problem is detected, a diagnostic message will appear in the display. The following pages will show the messages you may see on the DIC display.

The message center is continuously updated with the vehicle's performance status.



The following buttons are on the DIC control panel which is located to the left of the steering column:

ODO/TRIP (Odometer/Trip): When this button is pressed, the display will show the total mileage, and Trip 1 or Trip 2 miles. Trip 1 and Trip 2 will display the miles traveled since the last reset. To reset the trip odometer, press the ODO/TRIP button until the preferred trip number (1 or 2) is shown in the DIC display, then press the RESET button. The trip odometer will now accumulate miles until the next reset.

FUEL INFO (Information): Press this button to display fuel information.

Press the FUEL INFO button until the display shows FUEL ECONOMY AVERAGE. Average fuel economy is viewed as a long term approximation of your overall driving conditions. To learn the average fuel economy from a new starting point, press the RESET button while the average fuel economy is displayed in the DIC.

Press the FUEL INFO button until the display shows FUEL ECONOMY INST. Instantaneous fuel economy varies with your driving conditions, such as acceleration, braking and the grade of the road being traveled. The RESET button does not function in this mode.

Press the FUEL INFO button until the display shows FUEL RANGE. The fuel range will calculate the remaining distance you can drive without refueling. This calculation is based on the average fuel economy for the last 25 miles (40.25 km) driven, and the fuel remaining in the fuel tank. The RESET button does not function in this mode.

GAGE INFO (Information): Use this button to display oil pressure, oil life, coolant temperature, tire pressure and battery information.

Press the GAGE INFO button until OIL PRESSURE appears in the display. If there are no problems detected with the oil pressure, the display will show OIL PRESSURE NORMAL. If a low oil pressure condition is detected, the display will show OIL PRESSURE LOW. If you see the OIL PRESSURE LOW message, your vehicle could be low on oil or the oil is not going through the engine properly. See your dealer for service.

Press the GAGE INFO button until COOLANT TEMP appears in the display. If there are no problems detected with the temperature, COOLANT TEMP NORMAL will appear in the display. If the temperature is too high, COOLANT TEMP HOT will appear in the display. If you see the COOLANT TEMP HOT message, the engine is overheated. You should pull off the road, stop your vehicle and turn off your engine as soon as possible. This manual explains what to do. See *Engine Overheating on page 5-26*.

Press the GAGE INFO button until the display shows BATTERY STATE. If the voltage is normal the display will show BATTERY STATE NORMAL. If the voltage drops below 10.5 volts, the display will show BATTERY STATE LOW. If the voltage is above 16.2 volts, the display will show BATTERY STATE HIGH. If the display shows the high or low message, you need to have your battery and charging system checked.

Press the GAGE INFO button until OIL LIFE INDEX appears in the display. The OIL LIFE INDEX NORMAL display will show an estimate of the oil's remaining useful life. When the oil life index is less than 10 percent, the display will show OIL LIFE INDEX CHANGE OIL. When you have the oil changed according to the maintenance schedule (see *Part A: Scheduled Maintenance Services on page 6-4*), you will have to reset the oil life monitor. To reset the Oil Life System, see *Engine Oil on page 5-13*.

Press the GAGE INFO button until TIRE PRESSURE appears in the display. TIRE PRESSURE NORMAL is displayed when the check tire pressure system believes your vehicle's tire pressures are normal. If a potential tire pressure problem is detected, the display will show CHECK TIRE PRESSURE.

If you see the CHECK TIRE PRESSURE message, you should stop as soon as you can and check all your tires for damage. If a tire is flat, see *If a Tire Goes Flat on page 5-66*. Also check the tire pressure in all four tires as soon as you can. See *Inflation -- Tire Pressure on page 5-58* and *Check Tire Pressure System on page 5-59*. There are times when you will have to reset (calibrate) the Check Tire Pressure System. See *Check Tire Pressure System on page 5-59*.

RESET: This button, used along with other buttons, will reset system functions.

ENG/MET (English/Metric): Use this button to change the display between English and metric units.

DIC messages can be displayed in one of three languages: English, French or Spanish. The language of the display is set by pressing both the FUEL INFO and RESET buttons for five seconds. As the buttons are held, each language will be displayed for three seconds. Release the FUEL INFO and RESET buttons when the desired language is displayed. All DIC messages will now be in the selected language. Language selection can also be done through the DIC Personal Choice Programming. See "Language Selection" later in this section.

DIC Warnings and Messages

Other messages or warnings may appear in the DIC display. For Canadian drivers, in addition to the DIC message your DIC will display EXP with a number after it which reflects the following messages:

EXP (Export ID)	Warning Message
20	TURN SIGNAL STILL ON?
24	TRUNK AJAR
25	WINDSHIELD WASHER FLUID LOW
27	BATTERY SAVER ACTIVE
36	ENGINE OIL LOW – CHECK LEVEL
40	THEFT ATTEMPT DETECTED
54	SERVICE STABILITY SYSTEM
55	STABILITY SYSTEM ACTIVE
61	GAS CAP LOOSE – CHECK CAP
81	CHANGE ENGINE OIL SOON
91	TRACTION CONTROL SYSTEM ACTIVE
102	CHECK CHARGE SYSTEM
139	DOOR AJAR
144	CHECK TIRE PRESSURES
The EXP codes are used to make translation from English to other languages easier.	
Pressing any of the DIC control buttons will remove the messages or warnings from the DIC display.	

SERVICE STABILITY SYSTEM – 54: If you ever see the SERVICE STABILITY SYSTEM message, it means there may be a problem with your stability enhancement system. If you see this message, try to reset the system (stop; turn off the engine; then start the engine again). If the SERVICE STABILITY SYSTEM message still comes on, it means there is a problem. You should see your dealer for service. Reduce your speed and drive accordingly.

STABILITY SYSTEM ACTIVE – 55: You may see the STABILITY SYSTEM ACTIVE message on the Driver Information Center. It means that an advanced, computer-controlled system has come on to help your vehicle continue to go in the direction in which you're steering. This stability enhancement system activates when the computer senses that your vehicle is just starting to spin, as it might if you hit a patch of ice or other slippery spot on the road. When the system is on, you may hear a noise or feel a vibration in the brake pedal. This is normal.

When the STABILITY SYSTEM ACTIVE message is on, you should continue to steer in the direction you want to go. The system is designed to help you in bad weather or other difficult driving situations by making the most of whatever road conditions will permit. If the STABILITY SYSTEM ACTIVE message comes on, you'll know that something has caused your vehicle to start to spin, so you should consider slowing down.

DIC Vehicle Personalization

The DIC can be used to program the following personal choice features available with your vehicle:

- Automatic Door Locks
- Window Lock Out
- Security Feedback
- Delayed Locking
- Perimeter Lighting
- Memory Seats
- Outside Curb View Assist Mirror
- Driver ID
- Language Selection

The personal choice settings displayed on the DIC are determined by the transmitter used to enter the vehicle. Each remote keyless entry transmitter was pre-programmed to belong to DRIVER 1 or DRIVER 2 and is numbered on the back. After the unlock button on a remote keyless entry transmitter is pressed and the ignition is in RUN, the DIC will display the identified driver and recall the settings previously programmed for that driver. The settings can also be recalled by briefly pressing one of the MEMORY buttons located on the driver's door.

If you unlock the vehicle using your door key instead of your transmitter, the DIC will not change drivers and will recall the information from the last transmitter used or the last driver using the memory seat controls. If this happens and you were not the last driver of the vehicle, simply press your correct driver number on the memory seat controls or press the unlock button on your remote keyless entry transmitter.

Use the following steps for personalization programming instructions.

1. Turn the ignition on and keep the transaxle in PARK (P).
2. Inform the DIC which driver you are by pressing the unlock button on your remote keyless entry transmitter or the appropriate memory seat control.
3. Press and hold the ENG/MET button for five seconds. WELCOME TO BUICK OPTION FEATURE will appear in the display.
4. The first choice to be made will be DRIVER ID 1 or 2. Press the ENG/MET button to toggle between your selections within a display and RESET to choose the current selection and move on to the next personal choice feature.

If you would like to exit the selection mode without moving through each of the personal choice features, simply press a different button on the DIC or turn off the ignition. Whatever personal choices you made will still be retained, even without passing through each of the features. In order for your personal choices to save, you must press RESET after making your selections.

If you happen to move past a selection you would like to make a personal choice for, press the unlock button on your remote keyless entry transmitter or press the appropriate driver number on the seat control. This will return you to the beginning of the option feature programming mode.

Automatic Door Locks

The door lock modes when shifting in and out of PARK (P), can be changed through the DIC. You can change these modes by different selections of the following DIC displays:

- AUTO DOOR LOCKS – OFF/ON
- UNLOCK – OFF/ON
- UNLOCK – KEY OFF/PARK
- DOOR TO UNLOCK – DRIVER/ALL

If you choose OFF for AUTO DOOR LOCKS, your door locks will operate normally with no automatic feature.

If you choose ON for AUTO DOOR LOCKS, ON for UNLOCK and KEY OFF, your doors will lock every time you shift out of PARK (P), and the doors will unlock every time you stop and turn the ignition to OFF.

If you choose ON for AUTO DOOR LOCKS, ON for UNLOCK and PARK, your doors will lock every time you shift out of PARK (P), and the doors will unlock every time you stop and shift into PARK (P).

If you choose ON for AUTO DOOR LOCKS, and OFF for UNLOCK, your doors will lock every time you shift out of PARK (P), and there will be no automatic door unlock when shifting back into PARK (P).

If you choose ON for UNLOCK and DRIVER for DOOR TO UNLOCK, only the driver's door will automatically unlock when shifting into PARK or turning the key to OFF.

If you choose ON for UNLOCK and ALL for DOOR TO UNLOCK, all doors will automatically unlock when shifting into PARK or turning the key to OFF.

To change modes, do the following:

1. Move the arrow on the display between the selections by pressing the ENG/MET button.
2. Once you have made your selection, press the RESET button and your choice will be retained in memory.

See *Programmable Automatic Door Locks* on page 2-11 for more information about this feature.

Window Lock Out

The number of passenger windows locked out by the window LOCK switch can be programmed through the DIC.

If you choose R + PASS, all three passenger window switches will be inactive when the window LOCK switch is enabled.

If you choose REAR, only the two rear passenger window switches will be locked out when the window LOCK switch is enabled.

To change modes, do the following:

1. Move the arrow on the display between R + PASS and REAR by pressing the ENG/MET button.
2. Once you have made your selection, press the RESET button. Your choice will be retained in memory.

For more information on this feature, see “Window Lock Out” under *Power Windows on page 2-17*.

Security Feedback

By choosing different combinations of these selections, you can choose the type of transmitter activated feedback when locking and unlocking your vehicle with your transmitter. Each time you make a selection by pressing the ENG/MET button, press the RESET button to record your choice.

- KEYLESS FEEDBACK – OFF/ON
- LIGHTS FEEDBACK – OFF/ON
- HORN FEEDBACK – OFF/ON

If you choose ON for KEYLESS FEEDBACK you will also need to choose LIGHTS and/or HORN FEEDBACK.

You can select the following modes:

- If you choose OFF for KEYLESS FEEDBACK, you will receive no security feedback when locking or unlocking your vehicle.
- If you choose ON for KEYLESS FEEDBACK and ON for LIGHTS FEEDBACK, the exterior lamps will flash twice when unlocking your vehicle and once when locking your vehicle.

- If you choose ON for KEYLESS FEEDBACK and ON for HORN FEEDBACK, your horn will chirp when all doors are unlocked and when locking your vehicle.
- If you choose ON for KEYLESS, LIGHTS and HORN FEEDBACK, your exterior lamps will flash twice at the first unlock button press, your exterior lamps will flash twice and the horn will chirp once at the second unlock button press, and the exterior lamps will flash and the horn will chirp once when locking your vehicle.

For more information on this feature, see “Security Feedback” under *Remote Keyless Entry System Operation on page 2-5*.

Delayed Locking

This feature, which delays the actual locking of the vehicle, can be made active or inactive through the DIC. When DELAYED LOCKING – OFF/ON appears on the display, use the ENG/MET button to toggle the arrow between OFF and ON. When you have made your choice, press the RESET button to record your selection.

For more information on this feature, see *Delayed Locking on page 2-11*.

Perimeter Lighting

Press the unlock button on the remote keyless entry transmitter to turn on the DRL (high-beams at reduced intensity), parking lamps and back-up lamps if it is dark enough according to the Twilight Sentinel®.

You can control activation of this feature by choosing OFF or ON when the PERIMETER LIGHTS choice is displayed on the DIC. Make your choice by pressing the ENG/MET button and record your choice by pressing the RESET button. You will then be prompted to choose a TIMEOUT period. See “Exterior Lights” following for more information.

For more information on this feature, see “Perimeter Lighting” under *Interior Lamps on page 3-17*.

Exterior Lights

The EXTERIOR LIGHTS/TIMEOUT feature can be changed to a desired setting by using the ENG/MET to toggle from 5 to 30 seconds. Each toggle will increase the time by five seconds. Once the desired timeout is displayed, press RESET to record your choice and move on to the next personal choice feature.

Memory Seats

If your vehicle has this feature, the memory seat and mirror positions will be recalled for the identified driver when the remote keyless entry transmitter is used to enter the vehicle.

You can program this feature to be active by choosing ON when the SEAT RECALL choice appears, or inactive by choosing OFF when the SEAT RECALL choice appears on the DIC. Make your choices by pressing the ENG/MET button and store them to memory by pressing the RESET button.

You can also program this feature to recall your memory seat position or the exit seat position.

MEMORY: Choose ON when the SEAT RECALL choice appears, and then choose MEMORY when the RECALL POSITION choice appears.

EXIT: Choose ON when the SEAT RECALL choice appears, and then choose EXIT when the RECALL POSITION choice appears. The seat will move when you enter the vehicle after unlocking it with a remote keyless entry transmitter. This will allow for easy entry.

For more information on this feature, see *Memory Seat and Mirrors on page 2-44*.

Outside Curb View Assist Mirror

If your vehicle has the outside curb view assist mirror, which tips the passenger mirror down while the vehicle is in REVERSE (R), it can be made active or inactive through the DIC. When TILT

MIRRORS – OFF/ON appears on the display, use the ENG/MET button to toggle the arrow between OFF and ON. When you have made your choice, press the RESET button to record your selection. For more information on this feature, see *Outside Curb View Assist Mirror on page 2-36*.

Driver ID

This feature displays the DRIVER ID, as identified by the DIC. If this feature is ON, the DRIVER ID will be displayed every time the ignition is turned on. If the DRIVER ID is OFF, the DRIVER ID can be displayed by pressing either a button on the remote keyless entry transmitter or a memory seat button.

Language Selection

After DRIVER ID has been selected, “Language English” will be displayed. Pressing the RESET button selects English as the DIC language and ends programming. If you prefer the language to be French or Spanish, press the ENG/MET button when “Language English” appears on the display. Hold the ENG/MET button until the desired language is displayed, then press the RESET button to select that language.

Audio System(s)

Notice: Before you add any sound equipment to your vehicle – like a tape player, CB radio, mobile telephone or two-way radio – be sure you can add what you want. If you can, it's very important to do it properly. Added sound equipment may interfere with the operation of your vehicle's engine, radio or other systems, and even damage them. Your vehicle's systems may interfere with the operation of sound equipment that has been added improperly.

So, before adding sound equipment, check with your dealer and be sure to check federal rules covering mobile radio and telephone units.

Your audio system has been designed to operate easily and to give years of listening pleasure. You will get the most enjoyment out of it if you acquaint yourself with it first. Figure out which radio you have in your vehicle, find out what your audio system can do and how to operate all of its controls to be sure you're getting the most out of the advanced engineering that went into it.

Your vehicle has a feature called Retained Accessory Power (RAP). With RAP, you can play your audio system even after the ignition is turned off. See "Retained Accessory Power (RAP)" under *Ignition Positions* on page 2-22.

Setting the Time

Press and hold H until the correct hour appears on the display. AM will also appear for morning hours. Press and hold M until the correct minute appears on the display. The time may be set with the ignition on or off.

To synchronize the time with an FM station broadcasting Radio Data System (RDS) information, press and hold H and M at the same time until TIME UPDATED appears on the display. If the time is not available from the station, NO UPDATE will appear on the display instead.

Radio with CD



Playing the Radio

PWR (Power): Push this knob to turn the system on and off.

VOL (Volume): Turn this knob to increase or to decrease the volume.

DISP (Display): Press this button to switch the display between the radio station frequency and the time. The time can be displayed with the ignition on or off.

SCV (Speed-Compensated Volume): With SCV, your audio system adjusts automatically to make up for road and wind noise as you drive. To get to SCV, push the TUNE/AUDIO button repeatedly until SPEED VOL is displayed. Turn the TUNE/AUDIO button to select OFF, MIN, MED, or MAX. Each higher choice allows for more volume compensation at faster vehicle speeds. Then, as you drive, SCV automatically increases the volume, as necessary, to overcome noise at any speed. The volume level should always sound the same to you as you drive. If you don't want to use SCV, select OFF.

Finding a Station

BAND: Press this button to switch between FM1, FM2, and AM. The display will show your selection.

TUNE: Turn this knob to choose a radio station.

◀ SEEK ▶ : Press the right or the left arrow to go to the next or to the previous station and stay there.

To scan stations, press and hold one of the SEEK arrows for two seconds until SCAN appears on the display. The radio will go to a station, play for a few seconds, then go on to the next station. Press one of the SEEK arrows again to stop scanning.

To scan preset stations, press and hold one of the SEEK arrows for more than four seconds until PSCAN and the preset number appear on the display. You will hear a double beep. The radio will go to the first preset station stored on your pushbuttons, play for a few seconds, then go on to the next preset station. Press one of the SEEK arrows again to stop scanning presets.

The radio will seek and scan only to stations that are in the selected band and only to those with a strong signal.

Setting Preset Stations

The six numbered pushbuttons let you return to your favorite stations. You can set up to 18 stations (six FM1, six FM2 and six AM) by performing the following steps:

1. Turn the radio on.
2. Press BAND to select FM1, FM2, or AM.
3. Tune in the desired station.
4. Press EQ to select the EQ setting. It will be stored with the preset station.
5. Press and hold one of the six numbered pushbuttons. When you hear the radio produce one beep, release the pushbutton. Whenever you press that numbered pushbutton, the station you set will return.
6. Repeat the steps for each pushbutton.

Setting the Tone (Bass/Treble)

AUDIO: Push and release AUDIO until BASS, MID, or TREBLE appears on the display. Then turn the AUDIO knob to increase or to decrease. If a station is weak or noisy, you may want to decrease the treble.

To adjust bass, midrange or treble to the middle position, select BASS, MID, or TREBLE. Then push and hold AUDIO for more than two seconds until you hear a beep. BASS and a zero, MID and a zero or TREBLE and a zero will appear on the display.

To adjust both tone controls and both speaker controls to the middle position, end out of audio mode by waiting five seconds without making any changes. Then push and hold AUDIO for more than two seconds until you hear a beep. ALL CENTERED will appear on the display.

Adjusting the Speakers (Balance/Fade)

AUDIO: To adjust the balance between the right and the left speakers, push and release AUDIO until BAL appears on the display. Then turn the AUDIO knob to move the sound toward the right or the left speakers. A bar graph with indicators will show how the sound is balanced between the right and the left speakers.

To adjust the fade between the front and the rear speakers, push and release AUDIO until FADE appears on the display. Then turn the AUDIO knob to move the sound toward the front or the rear speakers. A bar graph with indicators will show how the sound is balanced between the front and rear speakers.

To adjust balance or fade to the middle position, select BAL or FADE. Then push and hold AUDIO for more than two seconds until you hear a beep. The indicator will be centered on the display.

To adjust both tone controls and both speaker controls to the middle position, end out of audio mode by waiting five seconds without making any changes. Then press and hold AUDIO for more than two seconds until you hear a beep. ALL CENTERED will appear on the display.

EQ (Equalizer): Press this button to choose bass, mid and treble equalization settings designed for different program types.

Using RDS

Your audio system is equipped with a Radio Data System (RDS). RDS features are available for use only on FM stations that broadcast RDS information. Using this system, the radio can do the following:

With RDS, your radio can do the following:

- Seek to stations broadcasting the selected type of programming
- Receive announcements concerning local and national emergencies
- Display messages from radio stations
- Seek to stations with traffic announcements

This system relies upon receiving specific information from these stations and will only work when the information is available. In rare cases, a radio station may broadcast incorrect information that will cause the radio features to work improperly. If this happens, contact the radio station.

While you are tuned to an RDS station, the station name or the call letters will appear on the display, instead of the frequency. RDS stations may also provide the time of day, a program type (PTY) for current programming, and the name of the program being broadcast.

Finding a PTY Station

To select and find a desired PTY perform the following:

1. Press P-TYP. The PTY symbol will be displayed on the screen.
2. Select a category by turning the AUDIO knob.
3. Once the desired category is displayed, press either SEEK arrow to select the category and take you to the category's first station.
4. If you want to go to another station within that category and P-TYPE is displayed, press either SEEK arrow once. If the category is not displayed, press either SEEK arrow twice to display the category and then to go to another station.
5. If PTY times out and is no longer on the display, go back to Step 1.

SCAN: You can also scan through the channels within a category by performing the following:

1. Press P-TYP. The PTY symbol will be displayed on the screen.
2. Select a category by turning the AUDIO knob.
3. Once the desired category is displayed, press and hold either SEEK arrow, and the radio will begin scanning within your chosen category.
4. Press and hold either SEEK arrow again to stop at a particular station.

BAND (Alternate Frequency): Alternate frequency allows the radio to switch to a stronger station with the same program type. Press and hold BAND for two seconds to turn alternate frequency on. AF ON will appear on the display. The radio may switch to stronger stations. Press and hold BAND again for two seconds to turn alternate frequency off. AF OFF will appear on the display. The radio will not switch to other stations. When you turn the ignition off and then on again, the alternate frequency feature will remain in the last chosen position.

RDS Messages

ALERT!: Alert warns of local or national emergencies. When an alert announcement comes on the current radio station, ALERT! will appear on the display. You will hear the announcement, even if the volume is muted or a compact disc is playing. If a compact disc is playing, play will stop during the announcement. You will not be able to turn off alert announcements.

ALERT! will not be affected by tests of the emergency broadcast system. This feature is not supported by all RDS stations.

INFO (Information): If the current station has a message, INFO will appear on the display. Press this button to see the message. The message may display the artist and song title, call in phone numbers, etc.

If the whole message is not displayed, parts of it will appear every three seconds. To scroll through the message at your own speed, press the INFO button repeatedly. A new group of words will appear on the display with each press. Once the complete message has been displayed, INFO will disappear from the display until another new message is received. The old message can be displayed by pressing the INFO button until a new message is received or a different station is tuned to.

TRAF (Traffic): If TRAF appears on the display, the tuned station broadcasts traffic announcements and when a traffic announcement comes on the tuned radio station you will hear it.

If the current tuned station does not broadcast traffic announcements, press this button and the radio will seek to a station that does. When the radio finds a station that broadcasts traffic announcements, it will stop and TRAF will be displayed. When a traffic announcement comes on the tuned radio station you will hear it. If no station is found, NO TRAFFIC will appear on the display.

If TRAF is on the display you can press the TRAF button to turn off the traffic announcements.

Your radio will play the traffic announcement even if the volume is muted or interrupt the play of a CD if the last tuned station broadcasts traffic announcements.

Radio Messages

CAL (CALIBRATE): Your audio system has been calibrated for your vehicle from the factory. If this message appears on the display it means that your radio has not been configured properly for your vehicle and must be returned to the dealership for service.

Playing a Compact Disc

Insert a disc partway into the slot, label side up. The player will pull it in. The disc should begin playing. If you want to insert a CD while the ignition or the radio is off, first press the eject button or DISP.

If you turn off the ignition or radio with a disc in the player, it will stay in the player. When you turn on the ignition or system, the disc will start playing where it stopped, if it was the last selected audio source.

The integral CD player can play the smaller 8 cm single discs with an adapter ring. Full-size compact discs and the smaller discs are loaded in the same manner.

If playing a CD-R the sound quality may be reduced due to CD-R quality, the method of recording, the quality of the music that has been recorded, and the way the CD-R has been handled. You may experience an increase in skipping, difficulty in finding tracks, and/or difficulty in loading and ejecting. If these problems occur try a known good CD.

Do not add paper labels to discs, they could get caught in the CD player.

Do not play 3 inch discs without a standard adapter disc.



If an error appears on the display, see “Compact Disc Errors” later in this section.

1  **(Reverse):** Press and hold this pushbutton to quickly reverse within a track. Release it to play the passage. You will hear sound at a reduced level.

2  **(Forward):** Press and hold this pushbutton to quickly advance within a track. Release it to play the passage. You will hear sound at a reduced level.

4 RDM (Random): Press this pushbutton to hear the tracks in random, rather than sequential, order. Press RDM again to turn off random play.

DISP (Display): Press this button to see which track is playing. Press it again within five seconds to see how long it has been playing. To change what is normally shown on the display (track or elapsed time), press this button until you see the display you want, then hold the button until the display flashes.

 **SEEK**  : Press the left arrow to go to the start of the current track if more than eight seconds have played. If you hold the button or press it more than once, the player will continue moving back through the disc.

Press the right arrow to go to the next track. If you hold the button or press it more than once, the player will continue moving forward through the disc.

To scan CD tracks, press and hold one of the SEEK arrows for two seconds until SCAN appears on the display. You will hear a beep. The disc will go to the next track, play for a few seconds, then go on to the next track. The sound will mute and SCAN and the track number will appear on the display while scanning. The disc will only scan forward. Press one of the SEEK arrows again to stop scanning.

BAND: Press this button to listen to the radio when a CD is playing.

CD: Press this button to change to playing a CD when listening to the radio.

 **(Eject):** Press this button to eject a CD.

Compact Disc Messages

CHECK CD: If this message appears on the radio display, it could be due to one of the following reasons:

- You're driving on a very rough road. When the road is smoother, the disc should play.
- The disc is dirty, scratched, wet, or upside down.
- The air is very humid. If so, wait about an hour and try again.
- There may have been a problem while burning the CD.
- The label may be caught in the CD player.

If the CD is not playing correctly, for any other reason, try a known good CD.

If any error occurs repeatedly or if an error can not be corrected, contact your dealer. If your radio displays an error number, write it down and provide it to your dealer when reporting the problem.

Radio with Cassette and CD



Radio Data System (RDS)

Your audio system is equipped with a Radio Data System (RDS). RDS features are available for use only on FM stations that broadcast RDS information.

With RDS, your radio can do the following:

- Seek to stations broadcasting the selected type of programming
- Receive announcements concerning local and national emergencies
- Display messages from radio stations
- Seek to stations with traffic announcements

This system relies upon receiving specific information from these stations and will only work when the information is available. In rare cases, a radio station may broadcast incorrect information that will cause the radio features to work improperly. If this happens, contact the radio station.

While you are tuned to an RDS station, the station name or the call letters will appear on the display instead of the frequency. RDS stations may also provide the time of day, a program type (PTY) for current programming, and the name of the program being broadcast.

XM™ Radio Satellite Service (USA Only)

XM™ is a continental U.S. based satellite radio service that offers 100 coast to coast channels including music, news, sports, talk, and children's programming. XM™ provides digital quality audio and text information, including song title and artist name. A service fee is required in order to receive the XM™ service. For more information, contact XM™ at www.xmradio.com or call 1-800-852-XXM (9696).

Playing the Radio

PWR (Power): Push this knob to turn the system on and off.

VOL (Volume): Turn this knob to increase or to decrease the volume.

SCV (Speed-Compensated Volume): With SCV, your audio system adjusts automatically to make up for road and wind noise as you drive. To get to SCV, press the TUNE/AUDIO knob repeatedly until SPEED VOL is displayed. Turn the TUNE/AUDIO knob to select OFF, MIN, MED or MAX. Each higher choice allows for more volume compensation at faster vehicle speeds. Then, as you drive, SCV automatically increases the volume, as necessary, to overcome noise at any speed. The volume level should always sound the same to you as you drive. If you don't want to use SCV, select OFF.

DISP (Display): Press this button to display the time when the ignition is turned off.

For XM™ (USA only, if equipped), press this button while in XM™ mode to retrieve four different categories of information related to the current song or channel: Artist, Song Title, Category or PTY, Channel Number/Channel Name.

To change the default on the display, press this button until you see the display you want, then hold the button until the display flashes. The selected display will now be the default.

Finding a Station

BAND: Press this button to switch between FM1, FM2, or AM, XM1 or XM2 (USA only, if equipped). The display will show your selection.

TUNE: Turn this knob to choose a radio station.

◀ SEEK ▶ : Press the right or the left arrow to go to the next or to the previous station and stay there.

To scan stations, press and hold one of the SEEK arrows for two seconds until SCAN appears on the display. The radio will go to a station, play for a few seconds, then go on to the next station. Press one of the SEEK arrows again to stop scanning.

To scan preset stations, press and hold one of the SEEK arrows for more than four seconds until SCAN and the preset number appear on the display. You will hear a double beep. The radio will go to the first preset station stored on your pushbuttons, play for a few seconds, then go on to the next preset station. Press one of the SEEK arrows again to stop scanning presets.

The radio will seek and scan only to the stations that are in the selected band and only to those with a strong signal.

Setting Preset Stations

The six numbered pushbuttons let you return to your favorite stations. You can set up to 30 stations (six FM1, six FM2, and six AM, six XM1 and six XM2 (USA only, if equipped)), by performing the following steps:

1. Turn the radio on.
2. Press BAND to select FM1, FM2, or AM, XM1 or XM2.
3. Tune in the desired station.
4. Press EQ to select the EQ setting. It will be stored with the preset station.
5. Press and hold one of the six numbered pushbuttons. When you hear the radio produce one beep, release the pushbutton. Whenever you press that numbered pushbutton, the station you set will return.
6. Repeat the steps for each pushbutton.

Setting the Tone (Bass/Treble)

AUDIO: Push and release AUDIO until BASS, MID, or TREBLE appears on the display. Then turn the AUDIO knob to increase or to decrease. If a station is weak or noisy, you may want to decrease the treble.

To adjust bass, midrange or treble to the middle position, select BASS, MID, or TREBLE. Then push and hold AUDIO for more than two seconds until you hear a beep. BASS and a zero, MID and a zero or TREBLE and a zero will appear on the display.

To adjust both tone controls and both speaker controls to the middle position, end out of audio mode by waiting five seconds without making any changes. Then push and hold AUDIO for more than two seconds until you hear a beep. ALL CENTERED will appear on the display.

EQ (Equalizer): Press this button to choose bass, mid and treble equalization settings designed for different program types.

Adjusting the Speakers (Balance/Fade)

AUDIO: To adjust the balance between the right and the left speakers, push and release AUDIO until BAL appears on the display. Then turn the AUDIO knob to move the sound toward the right or the left speakers. A bar graph with indicators will show how the sound is balanced.

To adjust the fade between the front and the rear speakers, push and release AUDIO until FADE appears on the display. Then turn the AUDIO knob to move the sound toward the front or the rear speakers. A bar graph with indicators will show how the sound is balanced.

To adjust balance or fade to the middle position, select BAL or FADE. Then push and hold AUDIO for more than two seconds until you hear a beep. The indicator will be centered on the display.

To adjust both tone controls and both speaker controls to the middle position, end out of audio mode by waiting five seconds without making any changes. Then press and hold AUDIO for more than two seconds until you hear a beep. ALL CENTERED will appear on the display.

Finding a PTY Station (RDS and XM™)

To select and find a desired PTY perform the following:

1. Press P-TYP. The P-TYPE symbol will be displayed on the screen.
2. Select a category by turning the AUDIO knob.
3. Once the desired category is displayed, press either SEEK arrow to select the category and take you to the category's first station.
4. If you want to go to another station within that category and the category is displayed, press either SEEK arrow once. If the category is not displayed, press either SEEK arrow twice to display the category and then to go to another station.
5. If PTY times out and is no longer on the display, go back to Step 1.

SCAN: You can also scan through the stations within a category by performing the following:

1. Press P-TYP. The PTY symbol will be displayed on the screen.
2. Select a category by turning the AUDIO knob.
3. Once the desired category is displayed, press and hold either SEEK arrow, and the radio will begin scanning within your chosen category.
4. Press and hold either SEEK arrow again to stop at a particular station.

If both P-TYP and TRAF are on, the radio will search for stations with the selected PTY and traffic announcements.

BAND (Alternate Frequency): Alternate frequency allows the radio to switch to a stronger station with the same program type. Press and hold BAND for two seconds to turn alternate frequency on. AF ON will appear on the display. The radio may switch to stronger stations. Press and hold BAND again for two seconds to turn alternate frequency off. AF OFF will appear on the display. The radio will not switch to other stations. When you turn the ignition off and then on again, the alternate frequency feature will automatically be turned on.

This function does not apply for XM™ Satellite Radio Service.

RDS Messages

ALERT!: Alert warns of local or national emergencies. When an alert announcement comes on the current radio station, ALERT! will appear on the display. You will hear the announcement, even if the volume is muted or a cassette tape or compact disc is playing. If a cassette tape or compact disc is being used, play will stop during the announcement. You will not be able to turn off alert announcements.

ALERT! will not be affected by tests of the emergency broadcast system. This feature is not supported by all RDS stations.

INFO (Information): If the current station has a message, INFO will appear on the display. Press this button to see the message. The message may display the artist and song title, call in phone numbers, etc.

If the whole message is not displayed, parts of it will appear every three seconds. To scroll through the message at your own speed, press the INFO button repeatedly. A new group of words will appear on the display with each press. Once the complete message has been displayed, INFO will disappear from the display until another new message is received. The old message can be displayed by pressing the INFO button until a new message is received or a different station is tuned to.

TRAF (Traffic): If TRAF appears on the display, the tuned station broadcasts traffic announcements. To receive the traffic announcement from the tuned station, press this button. Brackets will be displayed around TRAF and when a traffic announcement comes on the tuned radio station you will hear it.

If the current tuned station does not broadcast traffic announcements, press this button and the radio will seek to a station that does. When the radio finds a

station that broadcasts traffic announcements, it will stop and brackets will be displayed around TRAF. When a traffic announcement comes on the tuned radio station you will hear it. If no station is found, NO TRAFFIC will appear on the display.

If the brackets are on the display and TRAF is not, you can then press the TRAF button to remove the brackets or use the TUNE knob or the SEEK arrows to go to a station that supports traffic announcements. If no station is found, NO TRAFFIC will appear on the display.

Your radio will play the traffic announcements even if the volume is muted or interrupt the play of a cassette tape or CD if the last tuned station broadcasts traffic announcements.

This function does not apply to XM™ Satellite Radio Service.

Radio Messages

CAL (CALIBRATE): Your audio system has been calibrated for your vehicle from the factory. If this message appears on the display it means that your radio has not been configured properly for your vehicle and must be returned to the dealership for service.

XM™ Radio Messages

Radio Display Message	Condition	Action Required
XL (Explicit Language Channels)	XL on the radio display, after the channel name, indicates content with explicit language.	These channels, or any others, can be blocked at a customer's request, by calling 1-800-852-XM XM (9696).
Updating	Updating encryption code	The encryption code in your receiver is being updated, and no action is required. This process should take no longer than 30 seconds.
No Signal	Loss of signal	Your system is functioning correctly, but you are in a location that is blocking the XM signal. When you move into an open area, the signal should return.
Loading XM	Acquiring channel audio (after 4 second delay)	Your radio system is acquiring and processing audio and text data. No action is needed. This message should disappear shortly.
CH Off Air	Channel not in service	This channel is not currently in service. Tune to another channel.
CH Unavail	Channel no longer available	This previously assigned channel is no longer assigned. Tune to another station. If this station was one of your presets, you may need to choose another station for that preset button.
No Info	Artist Name/Feature not available	No artist information is available at this time on this channel. Your system is working properly.
No Info	Song/Program Title not available	No song title information is available at this time on this channel. Your system is working properly.

XM™ Radio Messages (cont'd)

Radio Display Message	Condition	Action Required
No Info	Category Name not available	No category information is available at this time on this channel. Your system is working properly.
No Info	No Text/Informational message available	No text or informational messages are available at this time on this channel. Your system is working properly.
Not Found	No channel available for the chosen category	There are no channels available for the category you selected. Your system is working properly.
XM Locked	Theft lock active	The XM receiver in your vehicle may have previously been in another vehicle. For security purposes, XM receivers cannot be swapped between vehicles. If you receive this message after having your vehicle serviced, check with the servicing facility.
Radio ID	Radio ID label (channel 0)	If you tune to channel 0, you will see this message alternating with your XM Radio 8 digit radio ID label. This label is needed to activate your service.
Unknown	Radio ID not known (should only be if hardware failure)	If you receive this message when you tune to channel 0, you may have a receiver fault. Consult with your dealer.
Chk XMRCvr	Hardware failure	If this message does not clear within a short period of time, your receiver may have a fault. Consult with your retail location.

Playing a Cassette Tape

The longer side with the tape visible should face to the right. If the ignition and the radio are on, the tape can be inserted and will begin playing. If you hear nothing or hear a garbled sound, the tape may not be in squarely. Press the eject button to remove the tape and start over.

While the tape is playing, use the VOLUME and AUDIO controls just as you do for the radio. The display will show an arrow to show which side of the tape is playing.

If you want to insert a tape while the ignition or radio is off, first press the eject button or DISP. Cassette tape adapter kits for portable compact disc players will work in your cassette tape player.

Your tape bias is set automatically.

If an error appears on the display, see “Cassette Tape Messages” later in this section.

1  **(Reverse):** Press this pushbutton to reverse the tape rapidly. The radio will play while the tape reverses. Press it again to return to playing speed.

2  **(Forward):** Press this pushbutton to advance quickly to another part of the tape. The radio will play while the tape advances. Press this pushbutton again to return to playing speed.

6 SIDE: Press this pushbutton to play the other side of the tape.

◀ SEEK ▶ : Your tape must have at least three seconds of silence between each selection for seek to work. Press the left or the right arrow to go to the previous or to the next selection on the tape. SEEK and a negative or positive number will be displayed. Pressing the left or right arrow multiple times will increase the number of selections to be searched up to -5 or +5. If -5 or +5 is shown on the display the cassette tape player will fast forward or rewind through the four selections and stop at the fifth selection.

To scan cassette tape selections, press and hold one of the SEEK arrows for two seconds until SCN appears on the display. You will hear a beep. The tape will go to the next selection, play for a few seconds, then go on to the next selection. The cassette tape will only scan forward. Press one of the SEEK arrows again to stop scanning.

BAND: Press this button to listen to the radio when a cassette tape or CD is playing.

CD TAPE: Press this button to play a cassette tape or a CD when listening to the radio.

 **(Eject):** Press this button to eject a tape.

Cassette Tape Messages

If an error message appears while trying to play a cassette tape, it could be for one of the following reasons:

- **TIGHT TAPE:** The tape is tight and the player can't turn the tape hubs. Remove the tape. Hold the tape with the open end down and try to turn the right hub counterclockwise with a pencil. Turn the tape over and repeat. If the hubs do not turn easily, your tape may be damaged and should not be used in the player. Try a new tape to make sure your player is working properly.
- **BROKEN TAPE:** The tape is broken. Try a new tape.

CLEAN PLAYER: If this message appears on the display, the cassette tape player needs to be cleaned. It will still play tapes, but you should clean it as soon as possible to prevent damage to the tapes and player. See *Care of Your Cassette Tape Player on page 3-79*.

If any error occurs repeatedly or if an error can not be corrected, contact your dealership. If your radio displays an error number, write it down and provide it to your dealership when reporting the problem.

CD Adapter Kits

It is possible to use a portable CD player adapter kit with your cassette tape player after activating the bypass feature on your tape player.

To activate the bypass feature, use the following steps:

1. Turn the ignition on.
2. Turn the radio off.
3. Insert the adapter into the cassette slot.
4. Press and hold the CD TAPE button until READY is displayed.

The override feature will remain active until the eject button is pressed.

Playing a Compact Disc

Insert a disc partway into the slot, label side up. The player will pull it in. The disc should begin playing. If you want to insert a CD while the ignition or the radio is off, first press the eject button or DISP.

If you turn off the ignition or radio with a disc in the player, it will stay in the player. When you turn on the ignition or system, the disc will start playing where it stopped, if it was the last selected audio source.

The integral CD player can play the smaller 8 cm single discs with an adapter ring. Full-size compact discs and the smaller discs are loaded in the same manner.

If playing a CD-R the sound quality may be reduced due to CD-R quality, the method of recording, the quality of the music that has been recorded, and the way the CD-R has been handled. You may experience an increase in skipping, difficulty in finding tracks, and/or difficulty in loading and ejecting. If these problems occur try a known good CD.

Do not add paper labels to discs, they could get caught in the CD player.

Do not play 3 inch discs without a standard adapter disc.

If an error appears on the display, see “Compact Disc Errors” later in this section.

1  **(Reverse):** Press and hold this pushbutton to quickly reverse within a track. You will hear sound.

2  **(Forward):** Press and hold this pushbutton to quickly advance within a track. You will hear sound.

4 RDM (Random): Press this pushbutton to hear the tracks in random, rather than sequential, order. Press RDM again to turn off random play.

DISP (Display): Press this button to see which track is playing. Press it again within five seconds to see how long it has been playing. To change the default on

the display (track or elapsed time), press this button until you see the display you want, then hold the button until the display flashes. The selected display will now be the default.

◀ SEEK ▶ : Press the left SEEK arrow to go to the start of the current track if more than eight seconds have played. If you hold the button or press it more than once, the player will continue moving back through the disc.

Press the right SEEK arrow to go to the next track. If you hold the button or press it more than once, the player will continue moving forward through the disc.

To scan CD tracks, press and hold one of the SEEK arrows for two seconds until SCAN appears on the display. You will hear a beep. The disc will go to the next track, play for a few seconds, then go on to the next track. The disc will only scan forward. Press one of the SEEK arrows again to stop scanning.

BAND: Press this button to listen to the radio when a cassette tape or CD is playing.

CD TAPE: Press this button to change to playing a cassette tape or a CD when listening to the radio.

 **(Eject):** Press this button to eject a CD.

Compact Disc Messages

CHECK CD: If this message appears on the radio display, it could be due to one of the following reasons:

- You're driving on a very rough road. When the road becomes smoother, the disc should play.
- The disc is dirty, scratched, wet or upside down.
- The air is very humid. If so, wait about an hour and try again.
- There may have been a problem while burning the CD.
- The label may be caught in the CD player.

If the CD is not playing correctly, for any other reason, try a known good CD.

If any error occurs repeatedly or if an error can't be corrected, contact your dealer. If your radio displays an error number, write it down and provide it to your dealer when reporting the problem.

Trunk-Mounted CD Changer



With the optional compact disc changer, you can play up to 12 discs continuously. Normal size discs may be played using the trays supplied in the magazine.

Notice: Place large objects in the trunk appropriately so that they will not come into contact with the CD changer. Damage could result that wouldn't be covered by your warranty.

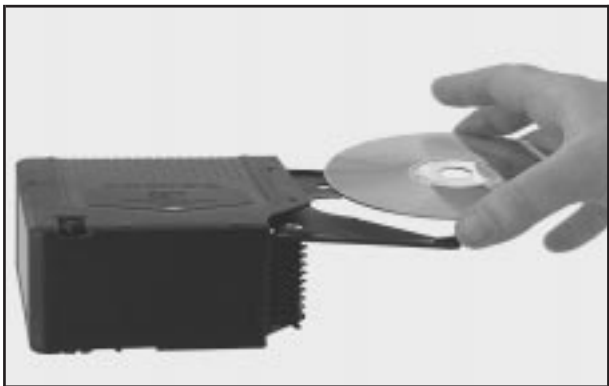

You must first load the magazine with discs before you can play a compact disc. Each of the 12 trays holds one disc. Slide the button on the top of the magazine and gently pull out one of the trays. Load the trays from top to bottom, placing a disc on the tray label side up. If you load a disc with the label side down, the disc will not play and an error will occur. Gently push the tray back into the magazine slot until it locks into place. Repeat this procedure for loading up to 12 discs in the magazine.



Once you have loaded the discs in the magazine, slide open the door of the compact disc (CD) changer. Push the magazine into the changer in the direction of the arrow marked on top of the magazine.



Close the door by sliding it all the way to the right. When the door is closed, the changer will begin checking for discs in the magazine. This will continue for up to one and a half minutes depending on the number of discs loaded.

To eject the magazine from the player, slide the CD changer door all the way open (to the left). The magazine will automatically eject. Remember to keep the door closed whenever possible to keep dirt and dust from getting inside the changer.

Whenever a CD magazine with discs is loaded in the changer and the door is closed, the CD changer stack symbol will appear on the radio display. If the CD changer is checking the magazine for CDs, the CD changer stack symbol will flash on the display until the changer is ready to play. When a CD begins playing, the disc and track number will be displayed. The disc numbers are listed on the front of the magazine.

All of the CD functions are controlled by the radio buttons except for ejecting the magazine.

Playing a Compact Disc

If an error appears on the display, see "Compact Disc Errors" later in this section.

1 ◀◀ (**Reverse**): Press and hold this pushbutton to quickly reverse within a track. As the CD reverses, elapsed time will be displayed to help you find the correct passage.

2 ▶▶ (**Forward**): Press and hold this pushbutton to quickly advance within a track. As the CD advances, elapsed time will be displayed to help you find the correct passage.

4 RDM (Random): Press this pushbutton to enter the random play mode. RAND will appear on the display. While in this mode, tracks and discs will be played in random, rather than sequential, order. Press this pushbutton again to turn off the random feature and return to normal operation.

6 SIDE: Press this pushbutton to select the next disc in the magazine. Each time you press SIDE, the disc number on the radio display will go to that of the next available CD.

DISP (Display): Press this button to see how long the current track has been playing. Press this button again to display the disc and track number. To change what is normally shown on the display (track or elapsed time), press this button until you see the display you want, then hold this button until the display flashes and a chime is heard. While elapsed time is showing, CD TIME will appear on the display.

◀ SEEK ▶ : Press the left arrow while playing a CD to go back to the start of the current track if more than eight seconds have played. If you press it more than once, the player will continue moving backward through the disc.

Press the right arrow and it will go to the next track on the disc. If you press it more than once, the player will continue moving forward through the disc.

When you press the left SEEK arrow for two seconds you will hear a beep. The disc will play the first few seconds of each track on each disc. DISC SCAN will appear on the display. Press the left SEEK arrow again to stop scanning.

BAND: Press this button to return to listening to the radio while a CD is playing.

CD or CD TAPE: Press this button to play a CD if you have a magazine loaded in the changer when listening to the radio. You can also press this button to switch between a cassette tape, CD or the CD changer if all three are loaded.

Compact Disc Errors

E (Error): If this message and a number appear on the display, an error has occurred.

If the error occurred while trying to play a CD in the compact disc player or changer, the following conditions may have caused the error:

- **E30:** You're driving on a very rough road. When the road becomes smoother, the disc should play.
- **E30:** The disc is dirty, scratched, wet or upside down.
- **E30:** The air is very humid. If so, wait about an hour and try again.

- **E34:** The CD changer door is open. Completely close the door to restore normal operation.
- **E35:** An empty magazine is inserted in the CD changer. Try the magazine again with a disc loaded on one of the trays.

If any error occurs repeatedly or if an error cannot be corrected, contact your dealership. If your radio displays an error number other than the error codes listed previously, write it down and provide it to your dealership when reporting the problem.

Personal Choice Radio Controls

If your vehicle has this feature it will enable two drivers to store and recall personal settings for radio presets, last tuned station, volume, tone, and audio source (radio, cassette, or CD).

The memory buttons 1 and 2 for this feature are located on the driver's door panel and correspond to the numbers 1 and 2 found on the back of each remote keyless entry transmitter.

To recall audio sources, press the unlock button on the remote keyless entry transmitter and turn the ignition on. The source last listened to will be recalled for the identified driver 1 or 2.

To program this feature, do the following:

1. Set all radio preferences. For more information see "Setting Preset Stations" and "Setting the Tone" listed for your particular radio.
2. Locate the memory buttons on the driver's door panel.
3. Press one of the memory buttons 1 or 2 until you hear two beeps. The beeps confirm that your selection has been saved and can now be recalled.

Follow these steps each time you want to change the stored settings.

Theft-Deterrent Feature

THEFTLOCK[®] is designed to discourage theft of your radio. It works by using a secret code to disable all radio functions whenever battery power is removed and the radio is placed in a different vehicle. This feature requires no user input to be activated. It is automatically armed when it is put into the vehicle for the first time.

When the ignition is turned off, the blinking red light indicates that THEFTLOCK[®] is armed.

If THEFTLOCK[®] is activated, your radio will not operate if stolen. The radio will display LOCKED and a red LED indicator light will come on above the key symbol to indicate a locked condition. If this occurs, the radio will need to be returned to the dealer.

Audio Steering Wheel Controls

If your vehicle has this feature, you can control certain radio functions using the buttons on your steering wheel.

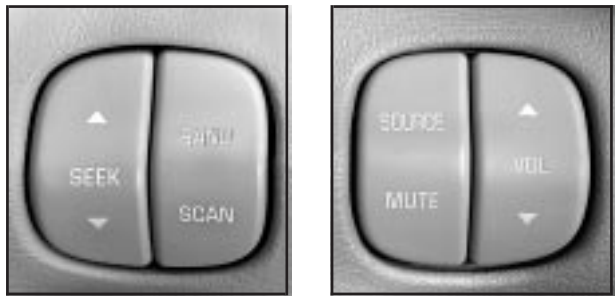

▲ **SEEK** ▼ : Press the up arrow to seek to the next station and the down arrow to seek to the previous station. The sound will mute while seeking. When playing a cassette tape or a compact disc, press the up arrow to hear the next selection.

BAND: Press this button to choose FM1, FM2, or AM, XM1 or XM2 (USA only, if your radio is equipped with XM™ Satellite Radio Service).

SCAN: Press this button to scan your radio preset stations. The radio will scan to the first preset station stored on your pushbuttons, play for a few seconds, then go on to the next preset station. The radio will scan preset stations with a strong signal only. Press this button again to stop scanning.

SOURCE: Press this button to play a cassette tape or compact disc when listening to the radio. If a cassette tape and a compact disc are both loaded, the system will go to the tape play first.

MUTE: Press this button to silence the system. Press it again to turn on the sound.

▲ **VOL (Volume)** ▼ : Press the up or down arrow to increase or decrease volume.

Understanding Radio Reception

AM

The range for most AM stations is greater than for FM, especially at night. The longer range, however, can cause stations to interfere with each other. AM can pick up noise from things like storms and power lines. Try reducing the treble to reduce this noise if you ever get it.

FM Stereo

FM stereo will give you the best sound, but FM signals will reach only about 10 to 40 miles (16 to 65 km). Tall buildings or hills can interfere with FM signals, causing the sound to come and go.

XM™ Satellite Radio Service (USA Only)

XM™ Satellite Radio gives you digital radio reception from coast to coast. Just as with FM, tall buildings or hills can interfere with satellite radio signals, causing the sound to come and go. Your radio may display NO SIGNAL to indicate interference.

Care of Your Cassette Tape Player

A tape player that is not cleaned regularly can cause reduced sound quality, ruined cassettes or a damaged mechanism. Cassette tapes should be stored in their cases away from contaminants, direct sunlight and extreme heat. If they aren't, they may not operate properly or may cause failure of the tape player.

Your tape player should be cleaned regularly after every 50 hours of use. Your radio may display CLEAN PLAYER to indicate that you have used your tape player for 50 hours without resetting the tape clean timer. If this message appears on the display, your cassette tape player needs to be cleaned. It will still play tapes, but you should clean it as soon as possible to prevent damage to your tapes and player. If you notice a reduction in sound quality, try a known good cassette to see if the tape or the tape player is at fault. If this other cassette has no improvement in sound quality, clean the tape player.

For best results, use a scrubbing action, non-abrasive cleaning cassette with pads which scrub the tape head as the hubs of the cleaner cassette turn. The recommended cleaning cassette is available through your dealership.

The cut tape detection feature of your cassette tape player may identify the cleaning cassette tape as a damaged tape, in error. If the cleaning cassette ejects, insert the cassette at least three times to ensure thorough cleaning.

You may also choose a non-scrubbing action, wet-type cleaner which uses a cassette with a fabric belt to clean the tape head. This type of cleaning cassette will not eject on its own. A non-scrubbing action cleaner may not clean as thoroughly as the scrubbing type cleaner. The use of a non-scrubbing action, dry-type cleaning cassette is not recommended.

After you clean the player, press and hold the eject button for five seconds to reset the CLEAN PLAYER indicator. The radio will display --- to show the indicator was reset.

Cassettes are subject to wear and the sound quality may degrade over time. Always make sure the cassette tape is in good condition before you have your tape player serviced.

Care of Your CDs

Handle discs carefully. Store them in their original cases or other protective cases and away from direct sunlight and dust. If the surface of a disc is soiled, dampen a clean, soft cloth in a mild, neutral detergent solution and clean it, wiping from the center to the edge.

Be sure never to touch the side without writing when handling discs. Pick up discs by grasping the outer edges or the edge of the hole and the outer edge.

Care of Your CD Player

The use of CD lens cleaner discs is not advised, due to the risk of contaminating the lens of the CD optics with lubricants internal to the CD mechanism.

Diversity Antenna System

Your AM-FM antennas are located in the windshield and rear window. Be sure that the inside surfaces of the windshield and rear window are not scratched and that the lines on the glass are not damaged. If the inside surfaces are damaged, they could interfere with radio reception. Also, for proper radio reception, the antenna connectors at the top-center of the front and rear windows need to be properly attached to the posts on the glass.

Notice: Do not apply aftermarket glass tinting with metallic film. The metallic film in some tinting materials will interfere with or distort the incoming radio reception. Any damage caused to your backglass antenna due to metallic tinting materials will not be covered by your warranty.

Notice: Do not try to clear frost or other material from the inside of the rear window with a razor blade or anything else that is sharp. This may damage the rear defogger grid and affect your radio's ability to pick up stations clearly. The repairs wouldn't be covered by your warranty.

If, when you turn on your rear window defogger, you hear static on your radio station, it could mean that a defogger grid line has been damaged. If this is true, the grid line must be repaired.

If you choose to add an aftermarket cellular telephone to your vehicle, and the antenna needs to be attached to the glass, be sure that you do not damage the grid lines for the AM-FM antennas or place the cellular telephone antenna over the grid lines.

XM™ Satellite Radio Antenna System (United States Only)

Your XM™ Satellite Radio antenna is located on the roof of your vehicle. Keep this antenna clear of snow and ice build up for clear radio reception.

The performance of your XM system may be affected if your sunroof is open.

Chime Level Adjustment

The volume level of the vehicle's chimes can be controlled by the radio. To change the volume level, press and hold pushbutton 6 with the ignition on and the radio power off. The chime volume level will change from the normal level to loud, and LOUD will be displayed on the radio. To change back to the default or normal setting, press and hold pushbutton 6 again. The chime level will change from the loud level to normal, and NORMAL will be displayed.

 **NOTES**

Section 4 Driving Your Vehicle

Your Driving, the Road, and Your Vehicle	4-2	Freeway Driving	4-21
Defensive Driving	4-2	Before Leaving on a Long Trip	4-22
Drunken Driving	4-2	Highway Hypnosis	4-23
Control of a Vehicle	4-5	Hill and Mountain Roads	4-24
Braking	4-6	Winter Driving	4-25
Traction Control System (TCS)	4-9	If You Are Stuck: In Sand, Mud, Ice or Snow	4-30
Steering	4-10	Towing	4-31
Off-Road Recovery	4-13	Towing Your Vehicle	4-31
Passing	4-13	Recreational Vehicle Towing	4-32
Loss of Control	4-15	Loading Your Vehicle	4-33
Driving at Night	4-16	Towing a Trailer	4-35
Driving in Rain and on Wet Roads	4-17		
City Driving	4-20		

Your Driving, the Road, and Your Vehicle

Defensive Driving

The best advice anyone can give about driving is: Drive defensively.

Please start with a very important safety device in your vehicle: Buckle up. See *Safety Belts: They Are for Everyone on page 1-6*.

Defensive driving really means “be ready for anything.” On city streets, rural roads or freeways, it means “always expect the unexpected.”

Assume that pedestrians or other drivers are going to be careless and make mistakes. Anticipate what they might do. Be ready for their mistakes.

Rear-end collisions are about the most preventable of accidents. Yet they are common. Allow enough following distance. It's the best defensive driving maneuver, in both city and rural driving. You never know when the vehicle in front of you is going to brake or turn suddenly.

Defensive driving requires that a driver concentrate on the driving task. Anything that distracts from the driving task — such as concentrating on a cellular telephone call, reading, or reaching for something on the floor — makes proper defensive driving more difficult and can even cause a collision, with resulting injury. Ask a passenger to help do things like this, or pull off the road in a safe place to do them yourself. These simple defensive driving techniques could save your life.

Drunken Driving

Death and injury associated with drinking and driving is a national tragedy. It's the number one contributor to the highway death toll, claiming thousands of victims every year.

Alcohol affects four things that anyone needs to drive a vehicle:

- Judgment
- Muscular Coordination
- Vision
- Attentiveness.

Police records show that almost half of all motor vehicle-related deaths involve alcohol. In most cases, these deaths are the result of someone who was drinking and driving. In recent years, more than 16,000 annual motor vehicle-related deaths have been associated with the use of alcohol, with more than 300,000 people injured.

Many adults — by some estimates, nearly half the adult population — choose never to drink alcohol, so they never drive after drinking. For persons under 21, it's against the law in every U.S. state to drink alcohol. There are good medical, psychological and developmental reasons for these laws.

The obvious way to eliminate the leading highway safety problem is for people never to drink alcohol and then drive. But what if people do? How much is “too much” if someone plans to drive? It's a lot less than many might think. Although it depends on each person and situation, here is some general information on the problem.

The Blood Alcohol Concentration (BAC) of someone who is drinking depends upon four things:

- The amount of alcohol consumed
- The drinker's body weight
- The amount of food that is consumed before and during drinking
- The length of time it has taken the drinker to consume the alcohol.

According to the American Medical Association, a 180 lb (82 kg) person who drinks three 12 ounce (355 ml) bottles of beer in an hour will end up with a BAC of about 0.06 percent. The person would reach the same BAC by drinking three 4 ounce (120 ml) glasses of wine or three mixed drinks if each had 1-1/2 ounces (45 ml) of liquors like whiskey, gin or vodka.



It's the amount of alcohol that counts. For example, if the same person drank three double martinis (3 ounces or 90 ml of liquor each) within an hour, the person's BAC would be close to 0.12 percent. A person who consumes food just before or during drinking will have a somewhat lower BAC level.

There is a gender difference, too. Women generally have a lower relative percentage of body water than men. Since alcohol is carried in body water, this means that a woman generally will reach a higher BAC level than a man of her same body weight will when each has the same number of drinks.

The law in an increasing number of U.S. states, and throughout Canada, sets the legal limit at 0.08 percent. In some other countries, the limit is even lower. For example, it is 0.05 percent in both France and Germany. The BAC limit for all commercial drivers in the United States is 0.04 percent.

The BAC will be over 0.10 percent after three to six drinks (in one hour). Of course, as we've seen, it depends on how much alcohol is in the drinks, and how quickly the person drinks them.

But the ability to drive is affected well below a BAC of 0.10 percent. Research shows that the driving skills of many people are impaired at a BAC approaching 0.05 percent, and that the effects are worse at night.

All drivers are impaired at BAC levels above 0.05 percent. Statistics show that the chance of being in a collision increases sharply for drivers who have a BAC of 0.05 percent or above. A driver with a BAC level of 0.06 percent has doubled his or her chance of having a collision. At a BAC level of 0.10 percent, the chance of this driver having a collision is 12 times greater; at a level of 0.15 percent, the chance is 25 times greater!

The body takes about an hour to rid itself of the alcohol in one drink. No amount of coffee or number of cold showers will speed that up. "I'll be careful" isn't the right answer. What if there's an emergency, a need to take sudden action, as when a child darts into the street? A person with even a moderate BAC might not be able to react quickly enough to avoid the collision.

There's something else about drinking and driving that many people don't know. Medical research shows that alcohol in a person's system can make crash injuries worse, especially injuries to the brain, spinal cord or heart. This means that when anyone who has been drinking — driver or passenger — is in a crash, that person's chance of being killed or permanently disabled is higher than if the person had not been drinking.

⚠ CAUTION:

Drinking and then driving is very dangerous. Your reflexes, perceptions, attentiveness and judgment can be affected by even a small amount of alcohol. You can have a serious — or even fatal — collision if you drive after drinking. Please don't drink and drive or ride with a driver who has been drinking. Ride home in a cab; or if you're with a group, designate a driver who will not drink.

Control of a Vehicle

You have three systems that make your vehicle go where you want it to go. They are the brakes, the steering and the accelerator. All three systems have to do their work at the places where the tires meet the road.

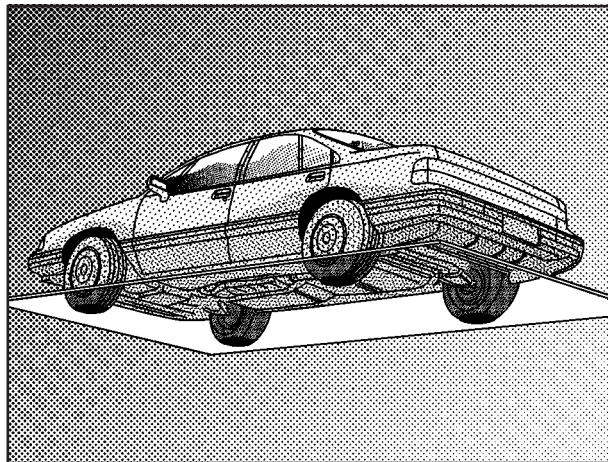

Sometimes, as when you're driving on snow or ice, it's easy to ask more of those control systems than the tires and road can provide. That means you can lose control of your vehicle. Also see *Traction Control System (TCS)* on page 4-9.

Braking

Braking action involves *perception time* and *reaction time*.

First, you have to decide to push on the brake pedal. That's *perception time*. Then you have to bring up your foot and do it. That's *reaction time*.

Average *reaction time* is about 3/4 of a second. But that's only an average. It might be less with one driver and as long as two or three seconds or more with another. Age, physical condition, alertness, coordination and eyesight all play a part. So do alcohol, drugs and frustration. But even in 3/4 of a second, a vehicle moving at 60 mph (100 km/h) travels 66 feet (20 m). That could be a lot of distance in an emergency, so keeping enough space between your vehicle and others is important.

And, of course, actual stopping distances vary greatly with the surface of the road (whether it's pavement or gravel); the condition of the road (wet, dry, icy); tire tread; the condition of your brakes; the weight of the vehicle and the amount of brake force applied.

Avoid needless heavy braking. Some people drive in spurts — heavy acceleration followed by heavy braking — rather than keeping pace with traffic. This is a mistake. Your brakes may not have time to cool between hard stops. Your brakes will wear out much faster if you do a lot of heavy braking. If you keep pace with the traffic and allow realistic following distances, you will eliminate a lot of unnecessary braking. That means better braking and longer brake life.

If your engine ever stops while you're driving, brake normally but don't pump your brakes. If you do, the pedal may get harder to push down. If your engine stops, you will still have some power brake assist. But you will use it when you brake. Once the power assist is used up, it may take longer to stop and the brake pedal will be harder to push.

Anti-lock Brake System (ABS)

Your vehicle has anti-lock brakes. ABS is an advanced electronic braking system that will help prevent a braking skid.

When you start your engine, or when you begin to drive away, your anti-lock brake system will check itself. You may hear a momentary motor or clicking noise while this test is going on, and you may even notice that your brake pedal moves or pulses a little. This is normal.

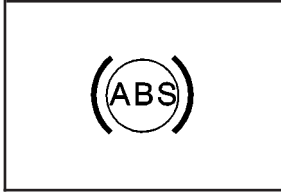

If there's a problem with the anti-lock brake system, this warning light will stay on. See *Anti-Lock Brake System Warning Light* on page 3-38.



Let's say the road is wet and you're driving safely. Suddenly, an animal jumps out in front of you. You slam on the brakes and continue braking. Here's what happens with ABS:

A computer senses that wheels are slowing down. If one of the wheels is about to stop rolling, the computer will separately work the brakes at each front wheel and at both rear wheels.

The anti-lock system can change the brake pressure faster than any driver could. The computer is programmed to make the most of available tire and road conditions. This can help you steer around the obstacle while braking hard.



As you brake, your computer keeps receiving updates on wheel speed and controls braking pressure accordingly.

Remember: Anti-lock doesn't change the time you need to get your foot up to the brake pedal or always decrease stopping distance. If you get too close to the vehicle in front of you, you won't have time to apply your brakes if that vehicle suddenly slows or stops. Always leave enough room up ahead to stop, even though you have anti-lock brakes.

Using Anti-Lock

Don't pump the brakes. Just hold the brake pedal down firmly and let anti-lock work for you. You may feel a slight brake pedal pulsation or notice some noise, but this is normal.

Braking in Emergencies

With anti-lock, you can steer and brake at the same time. In many emergencies, steering can help you more than even the very best braking.

Traction Control System (TCS)

Your vehicle may have a traction control system that limits wheel spin. This is especially useful in slippery road conditions. The system operates only if it senses that one or both of the front wheels are spinning or beginning to lose traction. When this happens, the system works the front brakes and reduces engine power to limit wheel spin.

You may feel or hear the system working, but this is normal.

If your vehicle is in cruise control when the traction control system begins to limit wheel spin, the cruise control will automatically disengage. When road conditions allow you to safely use it again, you may reengage the cruise control. See “Cruise Control” under *Turn Signal/Multifunction Lever on page 3-7*.

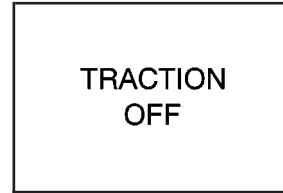

This light should come on briefly when you start the engine. If it stays on or comes on while you are driving, there's a problem with your traction control system.

See *Traction Control System (TCS) Warning Light on page 3-39*. When this warning light is on, the system will not limit wheel spin. Adjust your driving accordingly.

The traction control system automatically comes on whenever you start your vehicle. To limit wheel spin, especially in slippery road conditions, you should always leave the system on. But you can turn the traction control system off if you ever need to. You should turn the system off if your vehicle ever gets stuck in sand, mud or snow and rocking the vehicle is required. See “Rocking Your Vehicle To Get It Out” under *If You Are Stuck: In Sand, Mud, Ice or Snow on page 4-30*.



To turn the system off, press the TRACTION OFF button located at the end of the shift lever on the right side of the steering wheel.

The traction control system warning light will come on and stay on. If the system is limiting wheel spin when you press the button, the warning light will come on – but the system won't turn off right away. It will wait until there's no longer a current need to limit wheel spin.

You can turn the system back on at any time by pressing the button again. The traction control system warning light should go off.

Steering

Power Steering

If you lose power steering assist because the engine stops or the system is not functioning, you can steer but it will take much more effort.

Steering Tips

Driving on Curves

It's important to take curves at a reasonable speed.

A lot of the “driver lost control” accidents mentioned on the news happen on curves. Here's why:

Experienced driver or beginner, each of us is subject to the same laws of physics when driving on curves.

The traction of the tires against the road surface makes it possible for the vehicle to change its path when you turn the front wheels. If there's no traction, inertia will keep the vehicle going in the same direction. If you've ever tried to steer a vehicle on wet ice, you'll understand this.

The traction you can get in a curve depends on the condition of your tires and the road surface, the angle at which the curve is banked, and your speed. While you're in a curve, speed is the one factor you can control.

Suppose you're steering through a sharp curve. Then you suddenly accelerate. Both control systems — steering and acceleration — have to do their work where the tires meet the road. Adding the sudden acceleration can demand too much of those places. You can lose control. See *Traction Control System (TCS)* on page 4-9.

What should you do if this ever happens? Ease up on the accelerator pedal, steer the vehicle the way you want it to go, and slow down.

If you have Stabilitrak[®], you may see the STABILITY SYSTEM ACTIVE message on the Driver Information Center. See “Stability System Active Message” under *DIC Warnings and Messages* on page 3-49.

Speed limit signs near curves warn that you should adjust your speed. Of course, the posted speeds are based on good weather and road conditions. Under less favorable conditions you'll want to go slower.

If you need to reduce your speed as you approach a curve, do it before you enter the curve, while your front wheels are straight ahead.

Try to adjust your speed so you can “drive” through the curve. Maintain a reasonable, steady speed. Wait to accelerate until you are out of the curve, and then accelerate gently into the straightaway.

Steering in Emergencies

There are times when steering can be more effective than braking. For example, you come over a hill and find a truck stopped in your lane, or a car suddenly pulls out from nowhere, or a child darts out from between parked cars and stops right in front of you. You can avoid these problems by braking — if you can stop in time. But sometimes you can't; there isn't room. That's the time for evasive action — steering around the problem.

Your vehicle can perform very well in emergencies like these. First apply your brakes.

See *Braking on page 4-6*. It is better to remove as much speed as you can from a possible collision. Then steer around the problem, to the left or right depending on the space available.

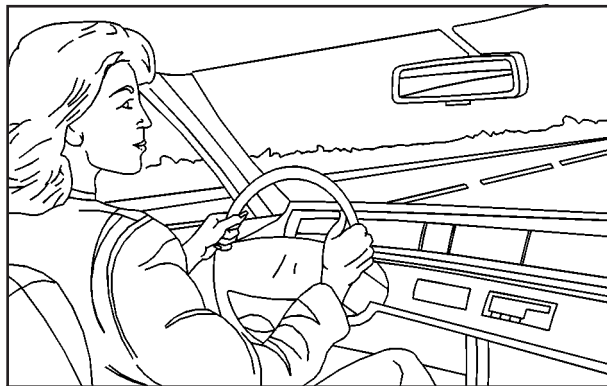

An emergency like this requires close attention and a quick decision. If you are holding the steering wheel at the recommended 9 and 3 o'clock positions, you can turn it a full 180 degrees very quickly without removing either hand. But you have to act fast, steer quickly, and just as quickly straighten the wheel once you have avoided the object.

The fact that such emergency situations are always possible is a good reason to practice defensive driving at all times and wear safety belts properly.

Off-Road Recovery

You may find that your right wheels have dropped off the edge of a road onto the shoulder while you're driving.

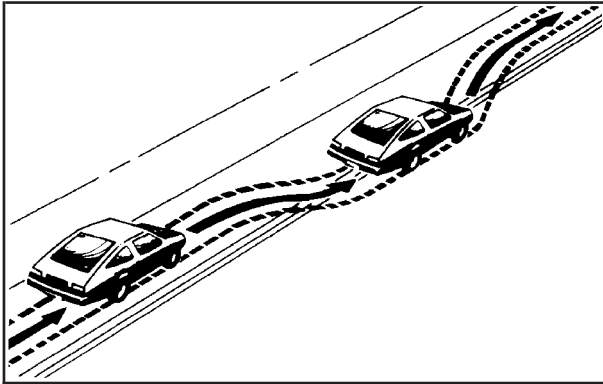

If the level of the shoulder is only slightly below the pavement, recovery should be fairly easy. Ease off the accelerator and then, if there is nothing in the way, steer so that your vehicle straddles the edge of the pavement. You can turn the steering wheel up to one-quarter turn until the right front tire contacts the pavement edge. Then turn your steering wheel to go straight down the roadway.

Passing

The driver of a vehicle about to pass another on a two-lane highway waits for just the right moment, accelerates, moves around the vehicle ahead, then goes back into the right lane again. A simple maneuver?

Not necessarily! Passing another vehicle on a two-lane highway is a potentially dangerous move, since the passing vehicle occupies the same lane as oncoming traffic for several seconds. A miscalculation, an error in judgment, or a brief surrender to frustration or anger can suddenly put the passing driver face to face with the worst of all traffic accidents — the head-on collision.

So here are some tips for passing:

- “Drive ahead.” Look down the road, to the sides and to crossroads for situations that might affect your passing patterns. If you have any doubt whatsoever about making a successful pass, wait for a better time.
- Watch for traffic signs, pavement markings and lines. If you can see a sign up ahead that might indicate a turn or an intersection, delay your pass. A broken center line usually indicates it's all right to pass (providing the road ahead is clear). Never cross a solid line on your side of the lane or a double solid line, even if the road seems empty of approaching traffic.

- Do not get too close to the vehicle you want to pass while you're awaiting an opportunity. For one thing, following too closely reduces your area of vision, especially if you're following a larger vehicle. Also, you won't have adequate space if the vehicle ahead suddenly slows or stops. Keep back a reasonable distance.
- When it looks like a chance to pass is coming up, start to accelerate but stay in the right lane and don't get too close. Time your move so you will be increasing speed as the time comes to move into the other lane. If the way is clear to pass, you will have a "running start" that more than makes up for the distance you would lose by dropping back. And if something happens to cause you to cancel your pass, you need only slow down and drop back again and wait for another opportunity.
- If other vehicles are lined up to pass a slow vehicle, wait your turn. But take care that someone isn't trying to pass you as you pull out to pass the slow vehicle. Remember to glance over your shoulder and check the blind spot.
- Check your mirrors, glance over your shoulder, and start your left lane change signal before moving out of the right lane to pass. When you are far enough ahead of the passed vehicle to see its front in your inside mirror, activate your right lane change signal and move back into the right lane. (Remember that your right outside mirror is convex. The vehicle you just passed may seem to be farther away from you than it really is.)
- Try not to pass more than one vehicle at a time on two-lane roads. Reconsider before passing the next vehicle.
- Don't overtake a slowly moving vehicle too rapidly. Even though the brake lamps are not flashing, it may be slowing down or starting to turn.
- If you're being passed, make it easy for the following driver to get ahead of you. Perhaps you can ease a little to the right.

Loss of Control

Let's review what driving experts say about what happens when the three control systems (brakes, steering and acceleration) don't have enough friction where the tires meet the road to do what the driver has asked.

In any emergency, don't give up. Keep trying to steer and constantly seek an escape route or area of less danger.

Skidding

In a skid, a driver can lose control of the vehicle. Defensive drivers avoid most skids by taking reasonable care suited to existing conditions, and by not "overdriving" those conditions. But skids are always possible.

The three types of skids correspond to your vehicle's three control systems. In the braking skid, your wheels aren't rolling. In the steering or cornering skid, too much speed or steering in a curve causes tires to slip and lose cornering force. And in the acceleration skid, too much throttle causes the driving wheels to spin.

A cornering skid is best handled by easing your foot off the accelerator pedal.

If you have the traction control system, remember: It helps avoid only the acceleration skid. If you do not have traction control, or if the system is off, then an acceleration skid is also best handled by easing your foot off the accelerator pedal.

If your vehicle starts to slide, ease your foot off the accelerator pedal and quickly steer the way you want the vehicle to go. If you start steering quickly enough, your vehicle may straighten out. Always be ready for a second skid if it occurs.

If you have Stabilitrak[®], you may see the STABILITY SYSTEM ACTIVE message on the Driver Information Center. See "Stability System Active Message" under *DIC Warnings and Messages on page 3-49*.

Of course, traction is reduced when water, snow, ice, gravel or other material is on the road. For safety, you'll want to slow down and adjust your driving to these conditions. It is important to slow down on slippery surfaces because stopping distance will be longer and vehicle control more limited.

While driving on a surface with reduced traction, try your best to avoid sudden steering, acceleration or braking (including engine braking by shifting to a lower gear). Any sudden changes could cause the tires to slide. You may not realize the surface is slippery until your vehicle is skidding. Learn to recognize warning clues — such as enough water, ice or packed snow on the road to make a "mirrored surface" — and slow down when you have any doubt.

Remember: Any anti-lock brake system (ABS) helps avoid only the braking skid.

Driving at Night

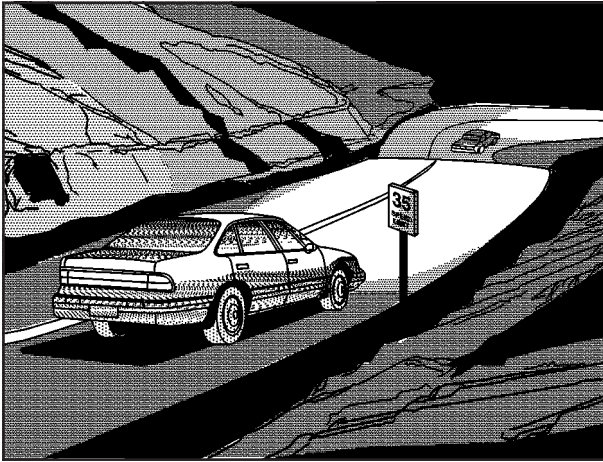

Night driving is more dangerous than day driving. One reason is that some drivers are likely to be impaired — by alcohol or drugs, with night vision problems, or by fatigue.

Here are some tips on night driving.

- Drive defensively.
- Don't drink and drive.

- Adjust your inside rearview mirror to reduce the glare from headlamps behind you.
- Since you can't see as well, you may need to slow down and keep more space between you and other vehicles.
- Slow down, especially on higher speed roads. Your headlamps can light up only so much road ahead.
- In remote areas, watch for animals.
- If you're tired, pull off the road in a safe place and rest.

No one can see as well at night as in the daytime. But as we get older these differences increase. A 50-year-old driver may require at least twice as much light to see the same thing at night as a 20-year-old.

What you do in the daytime can also affect your night vision. For example, if you spend the day in bright sunshine you are wise to wear sunglasses. Your eyes will have less trouble adjusting to night. But if you're driving, don't wear sunglasses at night. They may cut down on glare from headlamps, but they also make a lot of things invisible.

You can be temporarily blinded by approaching headlamps. It can take a second or two, or even several seconds, for your eyes to readjust to the dark. When you are faced with severe glare (as from a driver who doesn't lower the high beams, or a vehicle with misaimed headlamps), slow down a little. Avoid staring directly into the approaching headlamps.

Keep your windshield and all the glass on your vehicle clean — inside and out. Glare at night is made much worse by dirt on the glass. Even the inside of the glass can build up a film caused by dust. Dirty glass makes lights dazzle and flash more than clean glass would, making the pupils of your eyes contract repeatedly.

Remember that your headlamps light up far less of a roadway when you are in a turn or curve. Keep your eyes moving; that way, it's easier to pick out dimly lighted objects. Just as your headlamps should be checked regularly for proper aim, so should your eyes be examined regularly. Some drivers suffer from night blindness — the inability to see in dim light — and aren't even aware of it.

Driving in Rain and on Wet Roads

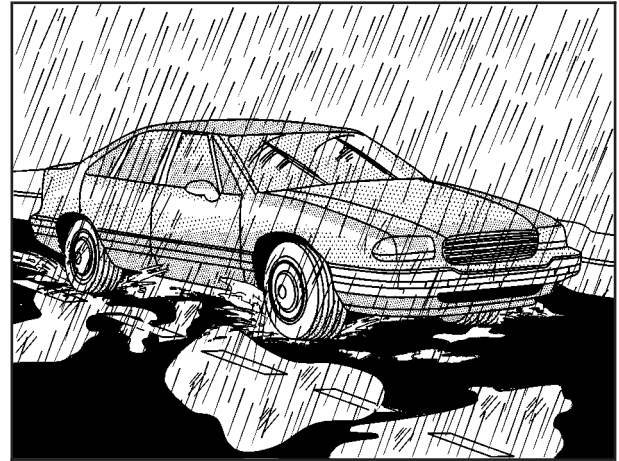

Rain and wet roads can mean driving trouble. On a wet road, you can't stop, accelerate or turn as well because your tire-to-road traction isn't as good as on dry roads. And, if your tires don't have much tread left, you'll get even less traction. It's always wise to go slower and be cautious if rain starts to fall while you are driving. The surface may get wet suddenly when your reflexes are tuned for driving on dry pavement.

The heavier the rain, the harder it is to see. Even if your windshield wiper blades are in good shape, a heavy rain can make it harder to see road signs and traffic signals, pavement markings, the edge of the road and even people walking.

It's wise to keep your windshield wiping equipment in good shape and keep your windshield washer tank filled with washer fluid. Replace your windshield wiper inserts when they show signs of streaking or missing areas on the windshield, or when strips of rubber start to separate from the inserts.

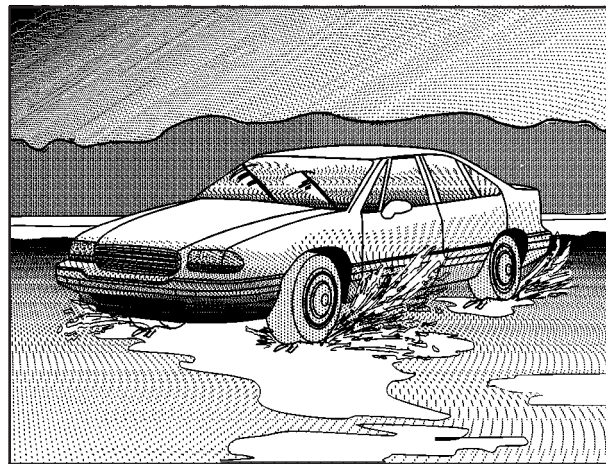

Driving too fast through large water puddles or even going through some car washes can cause problems, too. The water may affect your brakes. Try to avoid puddles. But if you can't, try to slow down before you hit them.

CAUTION:

Wet brakes can cause accidents. They won't work as well in a quick stop and may cause pulling to one side. You could lose control of the vehicle.

After driving through a large puddle of water or a car wash, apply your brake pedal lightly until your brakes work normally.

Hydroplaning

Hydroplaning is dangerous. So much water can build up under your tires that they can actually ride on the water. This can happen if the road is wet enough and you're going fast enough. When your vehicle is hydroplaning, it has little or no contact with the road.

Hydroplaning doesn't happen often. But it can if your tires do not have much tread or if the pressure in one or more is low. It can happen if a lot of water is standing on the road. If you can see reflections from trees, telephone poles or other vehicles, and raindrops "dimple" the water's surface, there could be hydroplaning.

Hydroplaning usually happens at higher speeds. There just isn't a hard and fast rule about hydroplaning. The best advice is to slow down when it is raining.

Driving Through Deep Standing Water

Notice: If you drive too quickly through deep puddles or standing water, water can come in through your engine's air intake and badly damage your engine. Never drive through water that is slightly lower than the underbody of your vehicle. If you can't avoid deep puddles or standing water, drive through them very slowly.

Driving Through Flowing Water

CAUTION:

Flowing or rushing water creates strong forces. If you try to drive through flowing water, as you might at a low water crossing, your vehicle can be carried away. As little as six inches of flowing water can carry away a smaller vehicle. If this happens, you and other vehicle occupants could drown. Don't ignore police warning signs, and otherwise be very cautious about trying to drive through flowing water.

Some Other Rainy Weather Tips

- Besides slowing down, allow some extra following distance. And be especially careful when you pass another vehicle. Allow yourself more clear room ahead, and be prepared to have your view restricted by road spray.
- Have good tires with proper tread depth. See *Tires on page 5-58*.

City Driving



One of the biggest problems with city streets is the amount of traffic on them. You'll want to watch out for what the other drivers are doing and pay attention to traffic signals.

Here are ways to increase your safety in city driving:

- Know the best way to get to where you are going. Get a city map and plan your trip into an unknown part of the city just as you would for a cross-country trip.
- Try to use the freeways that rim and crisscross most large cities. You'll save time and energy. See the next part, "Freeway Driving."
- Treat a green light as a warning signal. A traffic light is there because the corner is busy enough to need it. When a light turns green, and just before you start to move, check both ways for vehicles that have not cleared the intersection or may be running the red light.

Freeway Driving



Mile for mile, freeways (also called thruways, parkways, expressways, turnpikes or superhighways) are the safest of all roads. But they have their own special rules.

The most important advice on freeway driving is: Keep up with traffic and keep to the right. Drive at the same speed most of the other drivers are driving. Too-fast or too-slow driving breaks a smooth traffic flow. Treat the left lane on a freeway as a passing lane.

At the entrance, there is usually a ramp that leads to the freeway. If you have a clear view of the freeway as you drive along the entrance ramp, you should begin to check traffic. Try to determine where you expect to blend with the flow. Try to merge into the gap at close to the prevailing speed. Switch on your turn signal, check your mirrors and glance over your shoulder as often as necessary. Try to blend smoothly with the traffic flow.

Once you are on the freeway, adjust your speed to the posted limit or to the prevailing rate if it's slower. Stay in the right lane unless you want to pass.

Before changing lanes, check your mirrors. Then use your turn signal.

Just before you leave the lane, glance quickly over your shoulder to make sure there isn't another vehicle in your "blind" spot.

Once you are moving on the freeway, make certain you allow a reasonable following distance.

Expect to move slightly slower at night.

When you want to leave the freeway, move to the proper lane well in advance. If you miss your exit, do not, under any circumstances, stop and back up. Drive on to the next exit.

The exit ramp can be curved, sometimes quite sharply. The exit speed is usually posted. Reduce your speed according to your speedometer, not to your sense of motion. After driving for any distance at higher speeds, you may tend to think you are going slower than you actually are.

Before Leaving on a Long Trip

Make sure you're ready. Try to be well rested. If you must start when you're not fresh — such as after a day's work — don't plan to make too many miles that first part of the journey. Wear comfortable clothing and shoes you can easily drive in.

Is your vehicle ready for a long trip? If you keep it serviced and maintained, it's ready to go. If it needs service, have it done before starting out. Of course, you'll find experienced and able service experts in GM dealerships all across North America. They'll be ready and willing to help if you need it.

Here are some things you can check before a trip:

- *Windshield Washer Fluid:* Is the reservoir full? Are all windows clean inside and outside?
- *Wiper Blades:* Are they in good shape?
- *Fuel, Engine Oil, Other Fluids:* Have you checked all levels?
- *Lamps:* Are they all working? Are the lenses clean?
- *Tires:* They are vitally important to a safe, trouble-free trip. Is the tread good enough for long-distance driving? Are the tires all inflated to the recommended pressure?
- *Weather Forecasts:* What's the weather outlook along your route? Should you delay your trip a short time to avoid a major storm system?
- *Maps:* Do you have up-to-date maps?

Highway Hypnosis

Is there actually such a condition as “highway hypnosis”? Or is it just plain falling asleep at the wheel? Call it highway hypnosis, lack of awareness, or whatever.

There is something about an easy stretch of road with the same scenery, along with the hum of the tires on the road, the drone of the engine, and the rush of the wind against the vehicle that can make you sleepy. Don't let it happen to you! If it does, your vehicle can leave the road in *less than a second*, and you could crash and be injured.

What can you do about highway hypnosis? First, be aware that it can happen.

Then here are some tips:

- Make sure your vehicle is well ventilated, with a comfortably cool interior.
- Keep your eyes moving. Scan the road ahead and to the sides. Check your rearview mirrors and your instruments frequently.
- If you get sleepy, pull off the road into a rest, service or parking area and take a nap, get some exercise, or both. For safety, treat drowsiness on the highway as an emergency.

Hill and Mountain Roads



Driving on steep hills or mountains is different from driving in flat or rolling terrain.

If you drive regularly in steep country, or if you're planning to visit there, here are some tips that can make your trips safer and more enjoyable.

- Keep your vehicle in good shape. Check all fluid levels and also the brakes, tires, cooling system and transaxle. These parts can work hard on mountain roads.
- Know how to go down hills. The most important thing to know is this: let your engine do some of the slowing down. Shift to a lower gear when you go down a steep or long hill.

CAUTION:

If you don't shift down, your brakes could get so hot that they wouldn't work well. You would then have poor braking or even none going down a hill. You could crash. Shift down to let your engine assist your brakes on a steep downhill slope.

CAUTION:

Coasting downhill in **NEUTRAL (N)** or with the ignition off is dangerous. Your brakes will have to do all the work of slowing down. They could get so hot that they wouldn't work well. You would then have poor braking or even none going down a hill. You could crash. Always have your engine running and your vehicle in gear when you go downhill.

- Know how to go uphill. Drive in the highest gear possible.
- Stay in your own lane when driving on two-lane roads in hills or mountains. Don't swing wide or cut across the center of the road. Drive at speeds that let you stay in your own lane.
- As you go over the top of a hill, be alert. There could be something in your lane, like a stalled car or an accident.
- You may see highway signs on mountains that warn of special problems. Examples are long grades, passing or no-passing zones, a falling rocks area or winding roads. Be alert to these and take appropriate action.

Winter Driving



Here are some tips for winter driving:

- Have your vehicle in good shape for winter.
- You may want to put winter emergency supplies in your trunk.



Include an ice scraper, a small brush or broom, a supply of windshield washer fluid, a rag, some winter outer clothing, a small shovel, a flashlight, a red cloth and a couple of reflective warning triangles. And, if you will be driving under severe conditions, include a small bag of sand, a piece of old carpet or a couple of burlap bags to help provide traction. Be sure you properly secure these items in your vehicle.

Driving on Snow or Ice

Most of the time, those places where your tires meet the road probably have good traction.

However, if there is snow or ice between your tires and the road, you can have a very slippery situation. You'll have a lot less traction or "grip" and will need to be very careful.

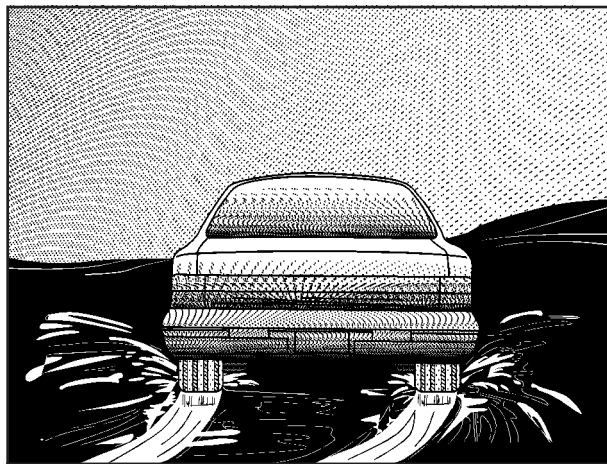

What's the worst time for this? "Wet ice." Very cold snow or ice can be slick and hard to drive on. But wet ice can be even more trouble because it may offer

the least traction of all. You can get wet ice when it's about freezing (32°F; 0°C) and freezing rain begins to fall. Try to avoid driving on wet ice until salt and sand crews can get there.

Whatever the condition – smooth ice, packed, blowing or loose snow – drive with caution.

If you have traction control, keep the system on. It will improve your ability to accelerate when driving on a slippery road. Even though your vehicle has a traction control system you'll want to slow down and adjust your driving to the road conditions. See *Traction Control System (TCS) on page 4-9*.

If you don't have a traction control system, accelerate gently. Try not to break the fragile traction. If you accelerate too fast, the drive wheels will spin and polish the surface under the tires even more.

Your anti-lock brakes improve your vehicle's stability when you make a hard stop on a slippery road. Even though you have the anti-lock braking system, you'll want to begin stopping sooner than you would on dry pavement. See *Braking on page 4-6*.

- Allow greater following distance on any slippery road.
- Watch for slippery spots. The road might be fine until you hit a spot that's covered with ice. On an otherwise clear road, ice patches may appear in shaded areas where the sun can't reach: around clumps of trees, behind buildings or under bridges. Sometimes the surface of a curve or an overpass may remain icy when the surrounding roads are clear. If you see a patch of ice ahead of you, brake before you are on it. Try not to brake while you're actually on the ice, and avoid sudden steering maneuvers.

If You're Caught in a Blizzard

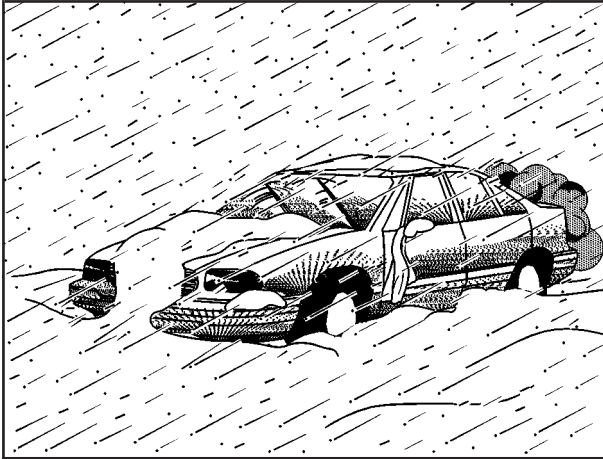

If you are stopped by heavy snow, you could be in a serious situation. You should probably stay with your vehicle unless you know for sure that you are near help and you can hike through the snow.

Here are some things to do to summon help and keep yourself and your passengers safe:

- Turn on your hazard flashers.
- Tie a red cloth to your vehicle to alert police that you've been stopped by the snow.
- Put on extra clothing or wrap a blanket around you. If you have no blankets or extra clothing, make body insulators from newspapers, burlap bags, rags, floor mats – anything you can wrap around yourself or tuck under your clothing to keep warm.

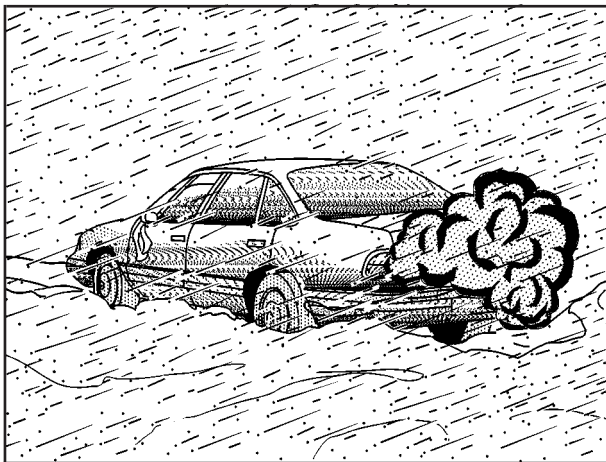

You can run the engine to keep warm, but be careful.

⚠ CAUTION:

Snow can trap exhaust gases under your vehicle. This can cause deadly CO (carbon monoxide) gas to get inside. CO could overcome you and kill you. You can't see it or smell it, so you might not know it is in your vehicle. Clear away snow from around the base of your vehicle, especially any that is blocking your exhaust pipe. And check around again from time to time to be sure snow doesn't collect there.

Open a window just a little on the side of the vehicle that's away from the wind. This will help keep CO out.

Run your engine only as long as you must. This saves fuel. When you run the engine, make it go a little faster than just idle. That is, push the accelerator slightly. This uses less fuel for the heat that you get and it keeps the battery charged. You will need a well-charged battery to restart the vehicle, and possibly for signaling later on with your headlamps. Let the heater run for a while.

Then, shut the engine off and close the window almost all the way to preserve the heat. Start the engine again and repeat this only when you feel really uncomfortable from the cold. But do it as little as possible. Preserve the fuel as long as you can. To help keep warm, you can get out of the vehicle and do some fairly vigorous exercises every half hour or so until help comes.

If You Are Stuck: In Sand, Mud, Ice or Snow

In order to free your vehicle when it is stuck, you will need to spin the wheels, but you don't want to spin your wheels too fast. The method known as "rocking" can help you get out when you're stuck, but you must use caution.

CAUTION:

If you let your tires spin at high speed, they can explode, and you or others could be injured. And, the transaxle or other parts of the vehicle can overheat. That could cause an engine compartment fire or other damage. When you're stuck, spin the wheels as little as possible. Don't spin the wheels above 35 mph (55 km/h) as shown on the speedometer.

Notice: Spinning your wheels can destroy parts of your vehicle as well as the tires. If you spin the wheels too fast while shifting your transaxle back and forth, you can destroy your transaxle. See “Rocking Your Vehicle To Get It Out.”

For information about using tire chains on your vehicle, see *Tire Chains* on page 5-66.

Rocking Your Vehicle To Get It Out

First, turn your steering wheel left and right. That will clear the area around your front wheels. If your vehicle has traction control, you should turn the system off. See *Traction Control System (TCS)* on page 4-9. Then shift back and forth between REVERSE (R) and a forward gear, spinning the wheels as little as possible. Release the accelerator pedal while you shift, and press lightly on the accelerator pedal when the transaxle is in gear. By slowly spinning your wheels in the forward

and reverse directions, you will cause a rocking motion that may free your vehicle. If that doesn't get you out after a few tries, you may need to be towed out. If you do need to be towed out, see “Towing Your Vehicle” following.

Towing

Towing Your Vehicle

Consult your dealer or a professional towing service if you need to have your disabled vehicle towed. See *Roadside Assistance Program* on page 7-6.

If you want to tow your vehicle behind another vehicle for recreational purposes (such as behind a motorhome), see “Recreational Vehicle Towing” following.

Recreational Vehicle Towing

Recreational vehicle towing means towing your vehicle behind another vehicle – such as behind a motorhome. The two most common types of recreational vehicle towing are known as “dinghy towing” (towing your vehicle with all four wheels on the ground) and “dolly towing” (towing your vehicle with two wheels on the ground and two wheels up on a device known as a “dolly”).

With the proper preparation and equipment, many vehicles can be towed in these ways. See “Dinghy Towing” and “Dolly Towing,” following.

Here are some important things to consider before you do recreational vehicle towing:

- What’s the towing capacity of the towing vehicle? Be sure you read the tow vehicle manufacturer’s recommendations.
- How far will you tow? Some vehicles have restrictions on how far and how long they can tow.

- Do you have the proper towing equipment? See your dealer or trailering professional for additional advice and equipment recommendations.
- Is your vehicle ready to be towed? Just as you would prepare your vehicle for a long trip, you’ll want to make sure your vehicle is prepared to be towed. See *Before Leaving on a Long Trip* on page 4-22.

Dinghy Towing

Notice: Towing your vehicle with all four wheels on the ground will damage drivetrain components.

Your vehicle was not designed to be towed with all four wheels on the ground. If your vehicle must be towed, you should use a dolly. See “Dolly Towing” that follows for more information.

Dolly Towing

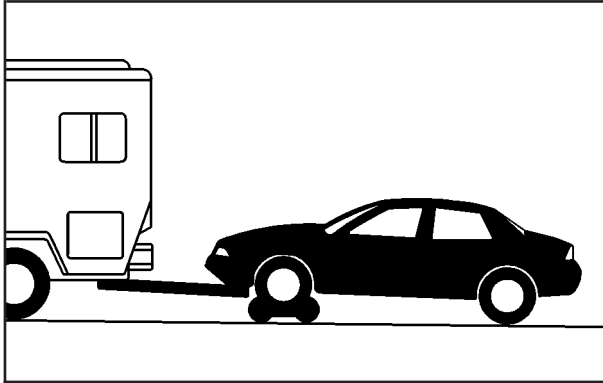

Your vehicle can be towed using a dolly. To tow your vehicle using a dolly, follow these steps:

1. Put the front wheels on the dolly.
2. Put the vehicle in PARK (P).
3. Set the parking brake and then remove the key.
4. Clamp the steering wheel in a straight-ahead position.
5. Release the parking brake.

Loading Your Vehicle

GM TIRE-LOADING INFORMATION

OCCUPANTS				VEHICLE CAPACITY	
FRT.	CTR.	RR.	TOTAL	KG	LB
<input type="checkbox"/>	<input type="checkbox"/>	<input type="checkbox"/>	<input type="checkbox"/>		
MAX. LOADING @ GVWR SAME AS VEHICLE CAPACITY WEIGHT					
MODEL: _____					
TIRE SIZE		SPEED RATING		COLD TIRE PRESSURE	
FRT					
RR					
CPA					
TIRES ARE HOT, ADD 28KPA(4PSI)					
SEE OWNER'S MANUAL FOR MORE INFORMATION					

EXAMPLE

Two labels on your vehicle show how much weight it may properly carry. The Tire-Loading Information label found on the rear edge of the driver's door tells you the proper size, speed rating and recommended inflation pressures for the tires on your vehicle. It also gives you important information about the number of people that can be in your vehicle and the total weight that you can carry. This weight is called the Vehicle Capacity Weight and includes the weight of all occupants, cargo and all nonfactory-installed options.

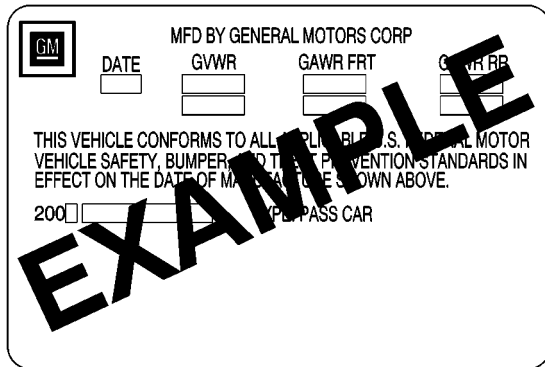

The other label is the Certification label, found on the rear edge of the driver's door. It tells you the gross weight capacity of your vehicle, called the Gross Vehicle Weight Rating (GVWR). The GVWR includes the weight of the vehicle, all occupants, fuel and cargo. Never exceed the GVWR for your vehicle, or the Gross Axle Weight Rating (GAWR) for either the front or rear axle.

And, if you do have a heavy load, you should spread it out. Don't carry more than 176 lbs (80 kg) in your trunk.

CAUTION:

Do not load your vehicle any heavier than the GVWR, or either the maximum front or rear GAWR. If you do, parts on your vehicle can break, and it can change the way your vehicle handles. These could cause you to lose control and crash. Also, overloading can shorten the life of your vehicle.

Notice: Your warranty does not cover parts or components that fail because of overloading.

If you put things inside your vehicle – like suitcases, tools, packages, or anything else – they will go as fast as the vehicle goes. If you have to stop or turn quickly, or if there is a crash, they'll keep going.

CAUTION:

Things you put inside your vehicle can strike and injure people in a sudden stop or turn, or in a crash.

- Put things in the trunk of your vehicle. In a trunk, put them as far forward as you can. Try to spread the weight evenly.
- Never stack heavier things, like suitcases, inside the vehicle so that some of them are above the tops of the seats.
- Don't leave an unsecured child restraint in your vehicle.
- When you carry something inside the vehicle, secure it whenever you can.

Automatic Level Control

This feature keeps the rear of your vehicle level as the load changes. It is automatic – you do not need to adjust anything.

Towing a Trailer

CAUTION:

If you do not use the correct equipment and drive properly, you can lose control when you pull a trailer. For example, if the trailer is too heavy, the brakes may not work well — or even at all. You and your passengers could be seriously injured. You may also damage your vehicle; the resulting repairs would not be covered by your warranty. Pull a trailer only if you have followed all the steps in this section. Ask your dealer for advice and information about towing a trailer with your vehicle.

Your vehicle can tow a trailer if it is equipped with the proper trailer towing equipment. To identify what the vehicle trailering capacity is for your vehicle, you should read the information in “Weight of the Trailer” that appears later in this section. But trailering is different than just driving your vehicle by itself. Trailering means changes in handling, durability and fuel economy. Successful, safe trailering takes correct equipment, and it has to be used properly.

That's the reason for this part. In it are many time-tested, important trailering tips and safety rules. Many of these are important for your safety and that of your passengers. So please read this section carefully before you pull a trailer.

Load-pulling components such as the engine, transaxle, wheel assemblies and tires are forced to work harder against the drag of the added weight. The engine is required to operate at relatively higher speeds and under greater loads, generating extra heat. What's more, the trailer adds considerably to wind resistance, increasing the pulling requirements.

If You Do Decide To Pull A Trailer

If you do, here are some important points:

- There are many different laws, including speed limit restrictions, having to do with trailering. Make sure your rig will be legal, not only where you live but also where you'll be driving. A good source for this information can be state or provincial police.
- Consider using a sway control. You can ask a hitch dealer about sway controls.

- Don't tow a trailer at all during the first 1,000 miles (1 600 km) your new vehicle is driven. Your engine, axle or other parts could be damaged.
- Then, during the first 500 miles (800 km) that you tow a trailer, don't drive over 50 mph (80 km/h) and don't make starts at full throttle. This helps your engine and other parts of your vehicle wear in at the heavier loads.
- Obey speed limit restrictions when towing a trailer. Don't drive faster than the maximum posted speed for trailers, or no more than 55 mph (90 km/h), to save wear on your vehicle's parts.

Three important considerations have to do with weight:

- the weight of the trailer,
- the weight of the trailer tongue
- and the total weight on your vehicle's tires.

Weight of the Trailer

How heavy can a trailer safely be?

It should never weigh more than 1,000 lbs (450 kg). But even that can be too heavy.

It depends on how you plan to use your rig. For example, speed, altitude, road grades, outside temperature and how much your vehicle is used to pull a trailer are all important. And, it can also depend on any special equipment that you have on your vehicle.

You can ask your dealer for our trailering information or advice, or you can write us at:

Buick Customer Assistance Center
P.O. Box 33136
Detroit, MI 48232-5136

In Canada, write to:

General Motors of Canada Limited
Customer Communication Centre, 163-005
1908 Colonel Sam Drive
Oshawa, Ontario L1H 8P7

Weight of the Trailer Tongue

The tongue load (A) of any trailer is an important weight to measure because it affects the total or gross weight of your vehicle. The Gross Vehicle Weight (GVW) includes the curb weight of the vehicle, any cargo you may carry in it, and the people who will be riding in the vehicle. And if you tow a trailer, you must add the tongue load to the GVW because your vehicle will be carrying that weight, too. See *Loading Your Vehicle on page 4-33* for more information about your vehicle's maximum load capacity.

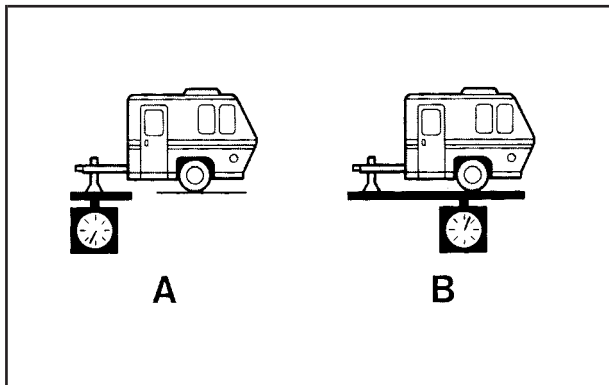

If you're using a weight-carrying hitch or a weight-distributing hitch, the trailer tongue (A) should weigh 10 to 15 percent of the total loaded trailer weight (B).

After you've loaded your trailer, weigh the trailer and then the tongue, separately, to see if the weights are proper. If they aren't, you may be able to get them right simply by moving some items around in the trailer.

Total Weight on Your Vehicle's Tires

Be sure your vehicle's tires are inflated to the upper limit for cold tires. You'll find these numbers on the Tire-Loading Information label located at the rear edge of the driver's door or see *Loading Your Vehicle on page 4-33*. Then be sure you don't go over the GVW limit for your vehicle, including the weight of the trailer tongue.

Hitches

It's important to have the correct hitch equipment. Crosswinds, large trucks going by and rough roads are a few reasons why you'll need the right hitch. Here are some rules to follow:

- The rear bumper on your vehicle is not intended for hitches. Do not attach rental hitches or other bumper-type hitches to it. Use only a frame-mounted hitch that does not attach to the bumper.
- Will you have to make any holes in the body of your vehicle when you install a trailer hitch? If you do, then be sure to seal the holes later when you remove the hitch. If you don't seal them, deadly carbon monoxide (CO) from your exhaust can get into your vehicle. See *Engine Exhaust on page 2-31*. Dirt and water can also enter the vehicle.

Safety Chains

You should always attach chains between your vehicle and your trailer. Cross the safety chains under the tongue of the trailer so that the tongue will not drop to the road if it becomes separated from the hitch. Instructions about safety chains may be provided by the hitch manufacturer or by the trailer manufacturer. Follow the manufacturer's recommendation for attaching safety chains and do not attach them to the bumper. Always leave just enough slack so you can turn with your rig. And, never allow safety chains to drag on the ground.

Trailer Brakes

Does your trailer have its own brakes? Be sure to read and follow the instructions for the trailer brakes so you'll be able to install, adjust and maintain them properly.

Because you have anti-lock brakes, do not try to tap into your vehicle's brake system. If you do, both brake systems won't work well, or at all.

Trailer Wiring Harness

All of the electrical circuits required for your trailer lighting system can be accessed at the driver's side rear lamp connector. This connector is located under the carpet on the rear corner of the trunk compartment.

Driving with a Trailer

Towing a trailer requires a certain amount of experience. Before setting out for the open road, you'll want to get to know your rig. Acquaint yourself with the feel of handling and braking with the added weight of the trailer. And always keep in mind that the vehicle you are driving is now a good deal longer and not nearly as responsive as your vehicle is by itself.

Before you start, check the trailer hitch and platform (and attachments), safety chains, electrical connector, lamps, tires and mirror adjustment. If the trailer has electric brakes, start your vehicle and trailer moving and then apply the trailer brake controller by hand to be sure the brakes are working. This lets you check your electrical connection at the same time.

During your trip, check occasionally to be sure that the load is secure, and that the lamps and any trailer brakes are still working.

Following Distance

Stay at least twice as far behind the vehicle ahead as you would when driving your vehicle without a trailer. This can help you avoid situations that require heavy braking and sudden turns.

Passing

You'll need more passing distance up ahead when you're towing a trailer. And, because you're a good deal longer, you'll need to go much farther beyond the passed vehicle before you can return to your lane.

Backing Up

Hold the bottom of the steering wheel with one hand. Then, to move the trailer to the left, just move that hand to the left. To move the trailer to the right, move your hand to the right. Always back up slowly and, if possible, have someone guide you.

Making Turns

Notice: Making very sharp turns while trailering could cause the trailer to come in contact with the vehicle. Your vehicle could be damaged. Avoid making very sharp turns while trailering.

When you're turning with a trailer, make wider turns than normal. Do this so your trailer won't strike soft shoulders, curbs, road signs, trees or other objects. Avoid jerky or sudden maneuvers. Signal well in advance.

Turn Signals When Towing a Trailer

When you tow a trailer, your vehicle may need a different turn signal flasher and/or extra wiring. Check with your dealer. The arrows on your instrument panel will flash whenever you signal a turn or lane change. Properly hooked up, the trailer lamps will also flash, telling other drivers you're about to turn, change lanes or stop.

When towing a trailer, the arrows on your instrument panel will flash for turns even if the bulbs on the trailer are burned out. Thus, you may think drivers behind you are seeing your signal when they are not. It's important to check occasionally to be sure the trailer bulbs are still working.

Your vehicle has bulb warning lights. When you plug a trailer lighting system into your vehicle's lighting system, its bulb warning lights may not let you know if one of your lamps goes out. So, when you have a trailer lighting system plugged in, be sure to check your vehicle and trailer lamps from time to time to be sure they're all working. Once you disconnect the trailer lamps, the bulb warning lights again can tell you if one of your vehicle lamps is out.

Driving On Grades

Reduce speed and shift to a lower gear *before* you start down a long or steep downgrade. If you don't shift down, you might have to use your brakes so much that they would get hot and no longer work well.

On a long uphill grade, shift down to THIRD (3) and reduce your speed to around 45 mph (70 km/h) to reduce the possibility of engine and transaxle overheating.

Parking on Hills

CAUTION:

You really should not park your vehicle, with a trailer attached, on a hill. If something goes wrong, your rig could start to move. People can be injured, and both your vehicle and the trailer can be damaged.

But if you ever have to park your rig on a hill, here's how to do it:

1. Apply your regular brakes, but don't shift into PARK (P) yet.
2. Have someone place chocks under the trailer wheels.
3. When the wheel chocks are in place, release the regular brakes until the chocks absorb the load.
4. Reapply the regular brakes. Then apply your parking brake, and then shift to PARK (P).
5. Release the regular brakes.

When You Are Ready to Leave After Parking on a Hill

1. Apply your regular brakes and hold the pedal down while you:
 - start your engine,
 - shift into a gear, and
 - release the parking brake.
2. Let up on the brake pedal.
3. Drive slowly until the trailer is clear of the chocks.
4. Stop and have someone pick up and store the chocks.

Maintenance When Trailer Towing

Your vehicle will need service more often when you're pulling a trailer. See the Maintenance Schedule for more on this. Things that are especially important in trailer operation are automatic transaxle fluid (don't overfill), engine oil, drive belt, cooling system and brake system. Each of these is covered in this manual, and the Index will help you find them quickly. If you're trailering, it's a good idea to review this information before you start your trip.

Check periodically to see that all hitch nuts and bolts are tight.

Engine Cooling When Trailer Towing

Your cooling system may temporarily overheat during severe operating conditions. See *Engine Overheating on page 5-26*.

Section 5 Service and Appearance Care

Service	5-3	Windshield Washer Fluid	5-36
Doing Your Own Service Work	5-3	Brakes	5-37
Adding Equipment to the Outside of Your Vehicle	5-4	Battery	5-40
Jump Starting	5-42	Headlamp Aiming	5-47
Fuel	5-4	Headlamp Horizontal Aiming	5-49
Gasoline Octane	5-4	Headlamp Vertical Aiming	5-50
Gasoline Specifications	5-5	Bulb Replacement	5-52
California Fuel	5-5	Halogen Bulbs	5-52
Additives	5-6	Headlamps	5-52
Fuels in Foreign Countries	5-6	Front Turn Signal Lamps	5-53
Filling Your Tank	5-7	Taillamps, Turn Signal, and Stoplamps	5-53
Filling a Portable Fuel Container	5-9	Taillamps and Back-Up Lamps	5-55
Checking Things Under the Hood	5-10	Replacement Bulbs	5-56
Hood Release	5-11	Windshield Wiper Blade Replacement	5-57
Engine Compartment Overview	5-12	Tires	5-58
Engine Oil	5-13	Inflation -- Tire Pressure	5-58
Engine Air Cleaner/Filter	5-18	Check Tire Pressure System	5-59
Automatic Transaxle Fluid	5-21	Tire Inspection and Rotation	5-60
Engine Coolant	5-23	When It Is Time for New Tires	5-62
Radiator Pressure Cap	5-26	Buying New Tires	5-62
Engine Overheating	5-26	Uniform Tire Quality Grading	5-63
Cooling System	5-28	Wheel Alignment and Tire Balance	5-64
Power Steering Fluid	5-35		

Section 5 Service and Appearance Care

Wheel Replacement	5-65	Vehicle Identification	5-85
Tire Chains	5-66	Vehicle Identification Number (VIN)	5-85
If a Tire Goes Flat	5-66	Service Parts Identification Label	5-85
Changing a Flat Tire	5-67	Electrical System	5-85
Compact Spare Tire	5-76	Add-On Electrical Equipment	5-85
Appearance Care	5-77	Power Windows and Other Power Options	5-86
Cleaning the Inside of Your Vehicle	5-77	Fuses and Circuit Breakers	5-86
Care of Safety Belts	5-80	Removing the Rear Seat Cushion	5-89
Weatherstrips	5-80	Capacities and Specifications	5-93
Cleaning the Outside of Your Vehicle	5-80	Normal Maintenance Replacement Parts	5-94
Sheet Metal Damage	5-82	Normal Maintenance Replacement Parts	5-94
Finish Damage	5-83		
Underbody Maintenance	5-83		
Chemical Paint Spotting	5-83		
Vehicle Care/Appearance Materials	5-84		

Service

Your dealer knows your vehicle best and wants you to be happy with it. We hope you will go to your dealer for all your service needs. You will get genuine GM parts and GM-trained and supported service people.

We hope you will want to keep your GM vehicle all GM. Genuine GM parts have one of these marks:



ACDelco®



GM Parts



GM
Goodwrench

Doing Your Own Service Work

If you want to do some of your own service work, you'll want to use the proper service manual. It tells you much more about how to service your vehicle than this manual can. To order the proper service manual, see *Service Publications Ordering Information on page 7-10*.

Your vehicle has an air bag system. Before attempting to do your own service work, see *Servicing Your Air Bag-Equipped Vehicle on page 1-54*.

You should keep a record with all parts receipts and list the mileage and the date of any service work you perform. See *Part E: Maintenance Record on page 6-24*.

CAUTION:

You can be injured and your vehicle could be damaged if you try to do service work on a vehicle without knowing enough about it.

- Be sure you have sufficient knowledge, experience, the proper replacement parts and tools before you attempt any vehicle maintenance task.

CAUTION: (Continued)

CAUTION: (Continued)

- **Be sure to use the proper nuts, bolts and other fasteners. “English” and “metric” fasteners can be easily confused. If you use the wrong fasteners, parts can later break or fall off. You could be hurt.**

Adding Equipment to the Outside of Your Vehicle

Things you might add to the outside of your vehicle can affect the airflow around it. This may cause wind noise and affect windshield washer performance. Check with your dealer before adding equipment to the outside of your vehicle.

Fuel

Use of the recommended fuel is an important part of the proper maintenance of your vehicle.

Gasoline Octane

Use regular unleaded gasoline with a posted octane of 87 or higher. If the octane is less than 87, you may get a heavy knocking noise when you drive. If this occurs, use a gasoline rated at 87 octane or higher as soon as possible. Otherwise, you might damage your engine. A little pinging noise when you accelerate or drive uphill is considered normal. This does not indicate a problem exists or that a higher-octane fuel is necessary. If you are using 87 octane or higher-octane fuel and hear heavy knocking, your engine needs service.

Gasoline Specifications

It is recommended that gasoline meet specifications which were developed by the American Automobile Manufacturers Association and endorsed by the Canadian Vehicle Manufacturers Association for better vehicle performance and engine protection. Gasoline meeting these specifications could provide improved driveability and emission control system performance compared to other gasoline.



Canada Only

In Canada, look for the “Auto Makers’ Choice” label on the pump.

California Fuel

If your vehicle is certified to meet California Emission Standards (see the underhood emission control label), it is designed to operate on fuels that meet California specifications. If this fuel is not available in states adopting California emissions standards, your vehicle will operate satisfactorily on fuels meeting federal specifications, but emission control system performance may be affected. The malfunction indicator lamp may turn on (see *Malfunction Indicator Lamp on page 3-40*) and your vehicle may fail a smog-check test. If this occurs, return to your authorized GM dealer for diagnosis. If it is determined that the condition is caused by the type of fuel used, repairs may not be covered by your warranty.

Additives

To provide cleaner air, all gasolines in the United States are now required to contain additives that will help prevent engine and fuel system deposits from forming, allowing your emission control system to work properly. You should not have to add anything to your fuel. Gasolines containing oxygenates, such as ethers and ethanol, and reformulated gasolines may be available in your area to contribute to clean air. General Motors recommends that you use these gasolines, particularly if they comply with the specifications described earlier.

Notice: Your vehicle was not designed for fuel that contains methanol. Do not use fuel containing methanol. It can corrode metal parts in your fuel system and also damage the plastic and rubber parts. That damage would not be covered under your warranty.

Some gasolines that are not reformulated for low emissions may contain an octane-enhancing additive called methylcyclopentadienyl manganese

tricarbonyl (MMT); ask the attendant where you buy gasoline whether the fuel contains MMT. General Motors does not recommend the use of such gasolines. Fuels containing MMT can reduce the life of spark plugs and the performance of the emission control system may be affected. The malfunction indicator lamp may turn on. If this occurs, return to your authorized GM dealer for service.

Fuels in Foreign Countries

If you plan on driving in another country outside the United States or Canada, the proper fuel may be hard to find. Never use leaded gasoline or any other fuel not recommended in the previous text on fuel. Costly repairs caused by use of improper fuel would not be covered by your warranty.

To check the fuel availability, ask an auto club, or contact a major oil company that does business in the country where you will be driving.

Filling Your Tank

CAUTION:

Fuel vapor is highly flammable. It burns violently, and that can cause very bad injuries. Don't smoke if you're near fuel or refueling your vehicle. Keep sparks, flames and smoking materials away from fuel.



The fuel cap is behind a hinged fuel door on the driver's side of the vehicle.



While refueling, hang the tethered fuel cap from the hook on the fuel door.

To remove the fuel cap, turn it slowly to the left (counterclockwise). The fuel cap has a spring in it; if you let go of the cap too soon, it will spring back to the right.

⚠ CAUTION:

If you get fuel on yourself and then something ignites it, you could be badly burned. Fuel can spray out on you if you open the fuel cap too quickly. This spray can happen if your tank is nearly full, and is more likely in hot weather. Open the fuel cap slowly and wait for any “hiss” noise to stop. Then unscrew the cap all the way.

Be careful not to spill fuel. Clean fuel from painted surfaces as soon as possible. See *Cleaning the Outside of Your Vehicle* on page 5-80.

When you put the fuel cap back on, turn it to the right (clockwise) until you hear a clicking sound. Make sure you fully install the cap. The diagnostic system can determine if the fuel cap has been left off or improperly installed. This would allow fuel to evaporate into the atmosphere. See *Malfunction Indicator Lamp* on page 3-40.

The GAS CAP LOOSE-CHECK CAP message will be displayed on the Driver Information Center (DIC) (if equipped) if the fuel cap is not properly installed.

Notice: If you need a new fuel cap, be sure to get the right type. Your dealer can get one for you. If you get the wrong type, it may not fit properly. This may cause your malfunction indicator lamp to light and may damage your fuel tank and emissions system. See “Malfunction Indicator Lamp” in the Index.

Filling a Portable Fuel Container

CAUTION:

Never fill a portable fuel container while it is in your vehicle. Static electricity discharge from the container can ignite the gasoline vapor. You can be badly burned and your vehicle damaged if this occurs. To help avoid injury to you and others:

- Dispense gasoline only into approved containers.
- Do not fill a container while it is inside a vehicle, in a vehicle's trunk, pickup bed or on any surface other than the ground.
- Bring the fill nozzle in contact with the inside of the fill opening before operating the nozzle. Contact should be maintained until the filling is complete.
- Don't smoke while pumping gasoline.

Checking Things Under the Hood

CAUTION:

An electric fan under the hood can start up and injure you even when the engine is not running. Keep hands, clothing and tools away from any underhood electric fan.

CAUTION:

Things that burn can get on hot engine parts and start a fire. These include liquids like fuel, oil, coolant, brake fluid, windshield washer and other fluids, and plastic or rubber. You or others could be burned. Be careful not to drop or spill things that will burn onto a hot engine.

Hood Release

To open the hood, do the following:



1. Pull the hood release handle inside the vehicle. It is located next to the parking brake pedal near the floor.



2. Then go to the front of the vehicle and pull up on the secondary hood release. The hood latch is located under the hood, near the center, and at the front edge of the grille.
3. Lift up on the latch as you lift up on the hood. Before closing the hood, be sure all the filler caps are on properly. Then just pull the hood down and close it firmly.

Engine Compartment Overview

When you open the hood on the engine, you'll see the following:

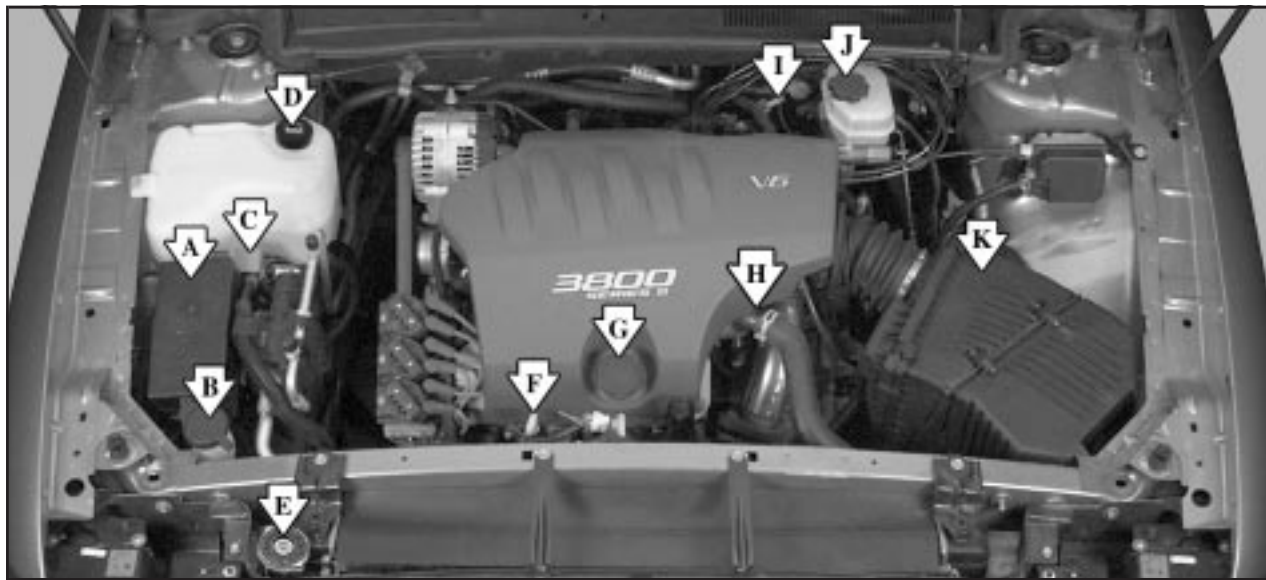

- A. Engine Compartment Fuse Block
- B. Windshield Washer Fluid Reservoir
- C. Remote Positive Terminal
- D. Engine Coolant Recovery Tank
- E. Radiator Pressure Cap
- F. Engine Oil Dipstick
- G. Engine Oil Fill Cap
- H. Automatic Transaxle Fluid Dipstick
 - I. Brake Master Cylinder Reservoir
 - J. Engine Air Cleaner/Filter

Engine Oil

**ENGINE OIL LOW
CHECK LEVEL**

If the ENGINE OIL LOW —CHECK LEVEL DIC message appears on the instrument cluster, it means you need to check your engine oil level right away. For more information, see *DIC Warnings and Messages on page 3-49*.

You should check your engine oil level regularly; this is an added reminder.

Checking Engine Oil

It's a good idea to check your engine oil every time you get fuel. In order to get an accurate reading, the oil must be warm and the vehicle must be on level ground.



The engine oil dipstick is located right behind the engine fans and in front of the engine oil filler cap. The top of the dipstick is a round yellow loop. See *Engine Compartment Overview on page 5-12* for more information on location.

Turn off the engine and give the oil several minutes to drain back into the oil pan. If you don't, the oil dipstick might not show the actual level.

Pull out the dipstick and clean it with a paper towel or cloth, then push it back in all the way. Remove it again, keeping the tip down, and check the level.

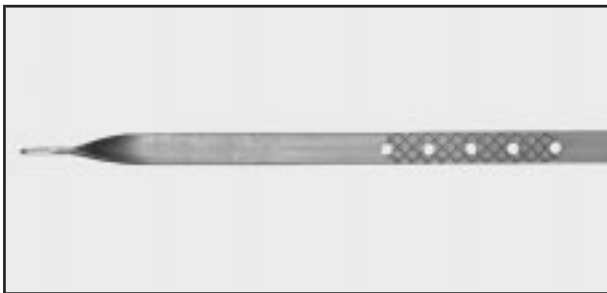

The engine oil fill cap is located near the engine oil dipstick. See *Engine Compartment Overview* on page 5-12 for more information on location.

When to Add Engine Oil

If the oil is at or below the cross-hatched area at the tip of the dipstick, then you'll need to add at least one quart of oil. But you must use the right kind. This part explains what kind of oil to use. For engine oil crankcase capacity, see *Capacities and Specifications* on page 5-93.

Notice: Don't add too much oil. If your engine has so much oil that the oil level gets above the cross-hatched area that shows the proper operating range, your engine could be damaged.

Be sure to fill it enough to put the level somewhere in the proper operating range in the cross-hatched area. Push the dipstick all the way back in when you're through.

What Kind of Engine Oil to Use

Oils recommended for your vehicle can be identified by looking for the starburst symbol.

This symbol indicates that the oil has been certified by the American Petroleum Institute (API). Do not use any oil which does not carry this starburst symbol.



If you choose to perform the engine oil change service yourself, be sure the oil you use has the starburst symbol on the front of the oil container. If you have your oil changed for you, be sure the oil put into your engine is American Petroleum Institute certified for gasoline engines.

You should also use the proper viscosity oil for your vehicle, as shown in the viscosity chart.

SAE 10W-30 is the viscosity grade recommended for your vehicle. However, you can use SAE 5W-30 if it's going to be colder than 60°F (16°C) before your next oil change. When it is very cold, colder than 0°F (-18°C), you should use an SAE 5W-30 oil. These numbers on an oil container show its viscosity, or thickness. Do not use other viscosity grade oils, such as SAE 10W-40 or SAE 20W-50 under any conditions.

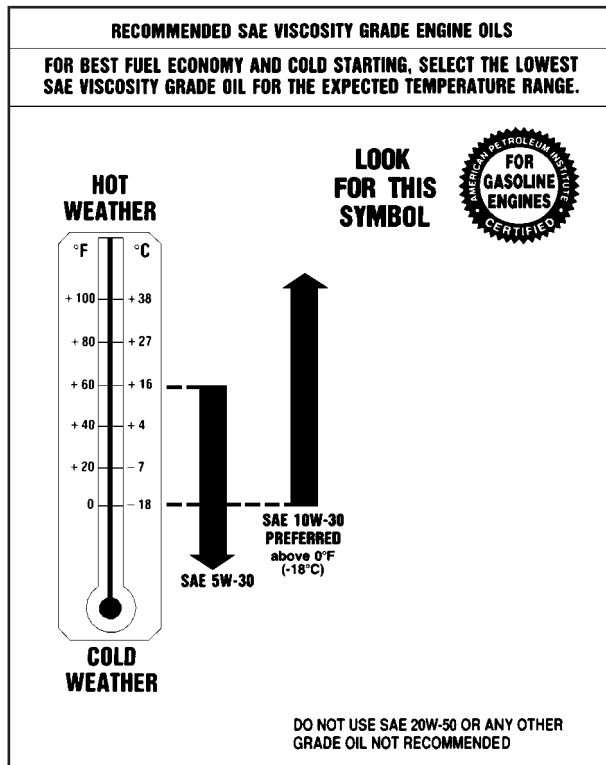

Notice: Use only engine oil with the American Petroleum Institute Certified For Gasoline Engines starburst symbol. Failure to use the recommended oil can result in engine damage not covered by your warranty.

GM Goodwrench® oil meets all the requirements for your vehicle.

If you are in an area of extreme cold, where the temperature falls below -20°F (-29°C), it is recommended that you use either an SAE 5W-30 synthetic oil or an SAE 0W-30 oil. Both will provide easier cold starting and better protection for your engine at extremely low temperatures.

Engine Oil Additives

Don't add anything to your oil. The recommended oils with the starburst symbol are all you will need for good performance and engine protection.

When to Change Engine Oil (Vehicles Without the GM Oil Life System)

If any one of these is true for you, use the short trip/city maintenance schedule:

- Most trips are less than 5 miles (8 km). This is particularly important when outside temperatures are below freezing.
- Most trips include extensive idling (such as frequent driving in stop-and-go traffic).

- You frequently tow a trailer or use a carrier on top of your vehicle.
- The vehicle is used for delivery service, police, taxi or other commercial application.

Driving under these conditions causes engine oil to break down sooner. If any one of these is true for your vehicle, then you need to change your oil and filter every 3,000 miles (5 000 km) or 3 months — whichever occurs first.

If none of them is true, use the long trip/highway maintenance schedule. Change the oil and filter every 7,500 miles (12 500 km) or 12 months — whichever occurs first. Driving a vehicle with a fully warmed engine under highway conditions will cause engine oil to break down slower.

When to Change Engine Oil (Vehicles with the GM Oil Life System)

If so equipped, your vehicle has a computer system that lets you know when to change the engine oil and filter. This is based on engine revolutions and engine temperature, and not on mileage. Based on driving conditions, the mileage at which an oil change will be indicated can vary considerably. For the oil life system to work properly, you must reset the system every time the oil is changed.

When the system has calculated that oil life has been diminished, it will indicate that an oil change is necessary. A CHANGE ENGINE OIL SOON message will come on. Change your oil as soon as possible within the next two times you stop for fuel. It is possible that, if you are driving under the best conditions, the oil life system may not indicate that an oil change is necessary for over a year. However, your engine oil and filter must be changed at least once a year and at this time the system must be reset. Your dealer has GM-trained service people who will perform this work using genuine GM parts and reset the system. It is also important to check your oil regularly and keep it at the proper level.

If the system is ever reset accidentally, you must change your oil at 3,000 miles (5 000 km) since your last oil change. Remember to reset the oil life system whenever the oil is changed.

How to Reset the Oil Life System

The GM Oil Life System calculates when to change your engine oil and filter based on vehicle use. Anytime your oil is changed, reset the system so it can calculate when the next oil change is required. If a situation occurs where you change your oil prior to a CHANGE ENGINE OIL SOON message being turned on, reset the system.

To reset the Oil Life System, do the following:

1. Display the OIL LIFE INDEX on the DIC.
2. Press and hold the RESET button on the DIC for more than five seconds. The oil life will change to 100%.

What to Do with Used Oil

Used engine oil contains certain elements that may be unhealthy for your skin and could even cause cancer. Don't let used oil stay on your skin for very long. Clean your skin and nails with soap and water, or a good hand cleaner. Wash or properly dispose of clothing or rags containing used engine oil. See the manufacturer's warnings about the use and disposal of oil products.

Used oil can be a threat to the environment. If you change your own oil, be sure to drain all the oil from the filter before disposal. Never dispose of oil by putting it in the trash, pouring it on the ground, into sewers, or into streams or bodies of water. Instead, recycle it by taking it to a place that collects used oil. If you have a problem properly disposing of your used oil, ask your dealer, a service station or a local recycling center for help.

Engine Air Cleaner/Filter

See *Engine Compartment Overview* on page 5-12 for the location of the engine air cleaner/filter.

When to Inspect the Engine Air Cleaner/Filter

Inspect the air cleaner/filter every 15,000 miles (25 000 km) and replace every 30,000 miles (50 000 km). If you are driving in dusty/dirty conditions, inspect the filter at each engine oil change.

How to Inspect the Engine Air Cleaner/Filter

To inspect the air cleaner/filter remove the filter from the vehicle and lightly shake the filter to release loose dust and dirt. If the filter remains “caked” with dirt, a new filter is required.

To inspect or replace the engine air cleaner/filter do the following:



1. Lift the latches on the engine air cleaner/filter housing cover.



2. Remove the air intake hose that is snapped over the throttle body by pulling the hose upward and away from the throttle body which is located near the top of the engine.



3. Disconnect the electrical connector from the air intake hose. This will allow you to lift the rear portion of the engine air cleaner/filter housing.
4. After detaching the hose from the throttle body, pull back the entire rear portion of the engine air cleaner/filter housing by pulling upward and rearward.



5. Inspect or replace the engine air cleaner/filter.
6. Reinstall the rear section of the engine air cleaner/filter housing.
7. Reconnect the electrical connector.
8. Reattach the air intake hose by snapping it back onto the throttle body.
9. Refasten the latches to the engine air cleaner/filter housing cover.

⚠ CAUTION:

Operating the engine with the air cleaner/filter off can cause you or others to be burned. The air cleaner not only cleans the air, it helps to stop flame if the engine backfires. If it isn't there and the engine backfires, you could be burned. Don't drive with it off, and be careful working on the engine with the air cleaner/filter off.

Notice: If the air cleaner/filter is off, a backfire can cause a damaging engine fire. And, dirt can easily get into your engine, which will damage it. Always have the air cleaner/filter in place when you're driving.

Automatic Transaxle Fluid

When to Check and Change

A good time to check your automatic transaxle fluid level is when the engine oil is changed.

Change both the fluid and filter every 50,000 miles (83 000 km) if the vehicle is mainly driven under one or more of these conditions:

- In heavy city traffic where the outside temperature regularly reaches 90°F (32°C) or higher.
- In hilly or mountainous terrain.
- When doing frequent trailer towing.
- Uses such as found in taxi, police or delivery service.

If you do not use your vehicle under any of these conditions, change the fluid and filter at 100,000 miles (166 000 km).

See *Part A: Scheduled Maintenance Services on page 6-4*.

How to Check

Because this operation can be a little difficult, you may choose to have this done at the dealership service department.

If you do it yourself, be sure to follow all the instructions here, or you could get a false reading on the dipstick.

Notice: Too much or too little fluid can damage your transaxle. Too much can mean that some of the fluid could come out and fall on hot engine or exhaust system parts, starting a fire. Too little fluid could cause the transaxle to overheat. Be sure to get an accurate reading if you check your transaxle fluid.

Wait at least 30 minutes before checking the transaxle fluid level if you have been driving:

- When outside temperatures are above 90°F (32°C).
- At high speed for quite a while.
- In heavy traffic – especially in hot weather.
- While pulling a trailer.

To get the right reading, the fluid should be at normal operating temperature, which is 180°F to 200°F (82°C to 93°C).

Get the vehicle warmed up by driving about 15 miles (24 km) when outside temperatures are above 50°F (10°C). If it's colder than 50°F (10°C), you may have to drive longer.

Checking the Fluid Level

Prepare your vehicle as follows:

- Park your vehicle on a level place. Keep the engine running.
- With the parking brake applied, place the shift lever in PARK (P).
- With your foot on the brake pedal, move the shift lever through each gear range, pausing for about three seconds in each range. Then, position the shift lever in PARK (P).
- Let the engine run at idle for three to five minutes.

Then, without shutting off the engine, follow these steps:



The transaxle fluid dipstick top is a round, red loop and is located next to the brake master cylinder behind the engine block. See *Engine Compartment Overview* on page 5-12 for more information on location.

1. Pull out the dipstick and wipe it with a clean rag or paper towel.
2. Push it back in all the way, wait three seconds and then pull it back out again.



3. Check both sides of the dipstick, and read the lower level. The fluid level must be in the cross-hatched area.
4. If the fluid level is in the acceptable range, push the dipstick back in all the way.

How to Add Fluid

Refer to the Maintenance Schedule to determine what kind of transaxle fluid to use. See *Part D: Recommended Fluids and Lubricants* on page 6-23.

If the fluid level is low, add only enough of the proper fluid to bring the level into the cross-hatched area on the dipstick.

1. Pull out the dipstick.
2. Using a long-neck funnel, add enough fluid at the dipstick hole to bring it to the proper level.

It doesn't take much fluid, generally less than one pint (0.5 L). *Don't overfill.*

Notice: We recommend you use only fluid labeled DEXRON®-III, because fluid with that label is made especially for your automatic transaxle. Damage caused by fluid other than DEXRON®-III is not covered by your new vehicle warranty.

3. After adding fluid, recheck the fluid level as described under "How to Check," earlier in this section.
4. When the correct fluid level is obtained, push the dipstick back in all the way.

Engine Coolant

The cooling system in your vehicle is filled with DEX-COOL® engine coolant. This coolant is designed to remain in your vehicle for 5 years or 150,000 miles (240 000 km), whichever occurs first, if you add only DEX-COOL® extended life coolant.

The following explains your cooling system and how to add coolant when it is low. If you have a problem with engine overheating, see *Engine Overheating* on page 5-26.

A 50/50 mixture of clean, drinkable water and DEX-COOL[®] coolant will:

- Give freezing protection down to -34°F (-37°C).
- Give boiling protection up to 265°F (129°C).
- Protect against rust and corrosion.
- Help keep the proper engine temperature.
- Let the warning lights and gages work as they should.

Notice: When adding coolant, it is important that you use only DEX-COOL[®] (silicate-free) coolant. If coolant other than DEX-COOL[®] is added to the system, premature engine, heater core or radiator corrosion may result. In addition, the engine coolant will require change sooner — at 30,000 miles (50,000 km) or 24 months, whichever occurs first. Damage caused by the use of coolant other than DEX-COOL[®] is not covered by your new vehicle warranty.

What to Use

Use a mixture of one-half *clean, drinkable water* and one-half DEX-COOL[®] coolant which won't damage aluminum parts. If you use this coolant mixture, you don't need to add anything else.

CAUTION:

Adding only plain water to your cooling system can be dangerous. Plain water, or some other liquid such as alcohol, can boil before the proper coolant mixture will. Your vehicle's coolant warning system is set for the proper coolant mixture. With plain water or the wrong mixture, your engine could get too hot but you wouldn't get the overheat warning. Your engine could catch fire and you or others could be burned. Use a 50/50 mixture of clean, drinkable water and DEX-COOL[®] coolant.

Notice: If you use an improper coolant mixture, your engine could overheat and be badly damaged. The repair cost wouldn't be covered by your warranty. Too much water in the mixture can freeze and crack the engine, radiator, heater core and other parts.

If you have to add coolant more than four times a year, have your dealer check your cooling system.

Notice: If you use the proper coolant, you don't have to add extra inhibitors or additives which claim to improve the system. These can be harmful.

Checking Coolant



The engine coolant recovery tank is located in the engine compartment on the passenger's side of the vehicle. See *Engine Compartment Overview on page 5-12* for more information on location.

The vehicle must be on a level surface. When your engine is cold, the coolant level should be at FULL COLD or a little higher. When your engine is warm, the level should be up to FULL HOT or a little higher.

Adding Coolant

If you need more coolant, add the proper DEX-COOL[®] coolant mixture *at the coolant recovery tank*, but be careful not to spill it.

CAUTION:

Turning the radiator pressure cap when the engine and radiator are hot can allow steam and scalding liquids to blow out and burn you badly. With the coolant recovery tank, you will almost never have to add coolant at the radiator. Never turn the radiator pressure cap — even a little — when the engine and radiator are hot.

CAUTION:

You can be burned if you spill coolant on hot engine parts. Coolant contains ethylene glycol, and it will burn if the engine parts are hot enough. Don't spill coolant on a hot engine.

Occasionally check the coolant level in the radiator. For information on how to add coolant to the radiator, see *Cooling System on page 5-28*.

Radiator Pressure Cap

Notice: Your radiator cap is a pressure-type cap and must be tightly installed to prevent coolant loss and possible engine damage from overheating. Be sure the arrows on the cap line up with the overflow tube on the radiator filler neck.

See *Engine Compartment Overview* on page 5-12 for more information on location.

Engine Overheating

You will find a warning light about a hot engine as well as an engine coolant temperature gage on your vehicle's instrument panel cluster.

If Steam Is Coming From Your Engine



 **CAUTION:**

Steam from an overheated engine can burn you badly, even if you just open the hood. Stay away from the engine if you see or hear steam coming from it. Just turn it off and get everyone away from the vehicle until it cools down. Wait until there is no sign of steam or coolant before you open the hood.

If you keep driving when your engine is overheated, the liquids in it can catch fire. You or others could be badly burned. Stop your engine if it overheats, and get out of the vehicle until the engine is cool.

***Notice:* If your engine catches fire because you keep driving with no coolant, your vehicle can be badly damaged. The costly repairs would not be covered by your warranty.**

If No Steam Is Coming From Your Engine

If you get an engine overheat warning but see or hear no steam, the problem may not be too serious. Sometimes the engine can get a little too hot when you:

- Climb a long hill on a hot day.
- Stop after high-speed driving.
- Idle for long periods in traffic.
- Tow a trailer.

If you get the overheat warning with no sign of steam, try this for a minute or so:

1. In heavy traffic, let the engine idle in NEUTRAL (N) while stopped. If it is safe to do so, pull off the road, shift to PARK (P) or NEUTRAL (N) and let the engine idle.
2. Turn on your heater to full hot at the highest fan speed and open the window as necessary.

If you no longer have the overheat warning, you can drive. Just to be safe, drive slower for about 10 minutes. If the warning doesn't come back on, you can drive normally.

If the warning continues and you have not stopped, pull over, stop, and park your vehicle right away.

If there's still no sign of steam, you can idle the engine for three minutes while you're parked. If you still have the warning, *turn off the engine and get everyone out of the vehicle* until it cools down.

You may decide not to lift the hood but to get service help right away.

Cooling System

When you decide it's safe to lift the hood, here's what you'll see:

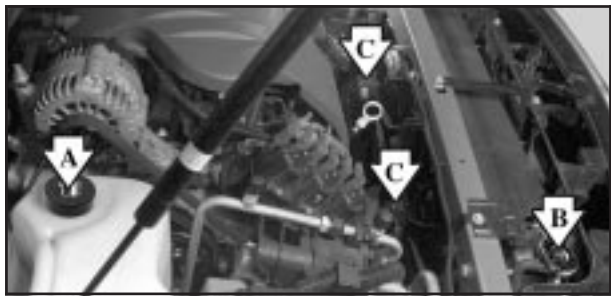

- A. Coolant Recovery Tank
- B. Radiator Pressure Cap
- C. Electric Engine Cooling Fans

CAUTION:

An electric engine cooling fan under the hood can start up even when the engine is not running and can injure you. Keep hands, clothing and tools away from any underhood electric fan.

If the coolant inside the coolant recovery tank is boiling, don't do anything else until it cools down. The vehicle should be parked on a level surface.



See *Engine Compartment Overview* on page 5-12 for more information on location.

The coolant level should be at or above the FULL COLD mark when the engine is cold. The coolant level should be at the FULL HOT mark under normal operating conditions. If it isn't, you may have a leak at the pressure cap or in the radiator hoses, heater hoses, radiator, water pump or somewhere else in the cooling system.

 **CAUTION:**

Heater and radiator hoses, and other engine parts, can be very hot. Don't touch them. If you do, you can be burned.

Don't run the engine if there is a leak. If you run the engine, it could lose all coolant. That could cause an engine fire, and you could be burned. Get any leak fixed before you drive the vehicle.

If there seems to be no leak, with the engine on, check to see if the electric engine cooling fans are running. If the engine is overheating, both fans should be running. If they aren't, your vehicle needs service.

Notice: Engine damage from running your engine without coolant isn't covered by your warranty.

Notice: When adding coolant, it is important that you use only DEX-COOL[®] (silicate-free) coolant. If coolant other than DEX-COOL[®] is added to the system, premature engine, heater core or radiator corrosion may result. In addition, the engine coolant will require change sooner — at 30,000 miles (50 000 km) or 24 months, whichever occurs first. Damage caused by the use of coolant other than DEX-COOL[®] is not covered by your new vehicle warranty.

How to Add Coolant to the Coolant Recovery Tank

CAUTION:

Adding only plain water to your cooling system can be dangerous. Plain water, or some other liquid such as alcohol, can boil before the proper coolant mixture will. Your vehicle's coolant warning system is set for the proper coolant mixture. With plain water or the wrong mixture, your engine could get too hot but you wouldn't get the overheat warning. Your engine could catch fire and you or others could be burned. Use a 50/50 mixture of clean, drinkable water and DEX-COOL[®] coolant.

Notice: In cold weather, water can freeze and crack the engine, radiator, heater core and other parts. Use the recommended coolant and the proper coolant mixture.



If you haven't found a problem yet, but the coolant level isn't at the FULL COLD mark, add a 50/50 mixture of *clean, drinkable water* and DEX-COOL[®] engine coolant at the coolant recovery tank. See *Engine Coolant* on page 5-23 for more information.

CAUTION:

You can be burned if you spill coolant on hot engine parts. Coolant contains ethylene glycol and it will burn if the engine parts are hot enough. Don't spill coolant on a hot engine.

When the coolant in the coolant recovery tank is at the FULL COLD mark, start your vehicle.

If the overheat warning continues, there's one more thing you can try. You can add the proper coolant mixture directly to the radiator, but be sure the cooling system is cool before you do it.

CAUTION:

Steam and scalding liquids from a hot cooling system can blow out and burn you badly. They are under pressure, and if you turn the radiator pressure cap — even a little — they can come out at high speed. Never turn the cap when the cooling system, including the radiator pressure cap, is hot. Wait for the cooling system and radiator pressure cap to cool if you ever have to turn the pressure cap.



How to Add Coolant to the Radiator



1. You can remove the radiator pressure cap when the cooling system, including the radiator pressure cap and upper radiator hose, is no longer hot. Turn the pressure cap slowly counterclockwise until it first stops. (Don't press down while turning the pressure cap.)

If you hear a hiss, wait for that to stop. A hiss means there is still some pressure left.



2. Then keep turning the pressure cap, but now push down as you turn it. Remove the pressure cap.
3. Remove the 3800 Series II V6 engine cover shield to access the bleed valve.

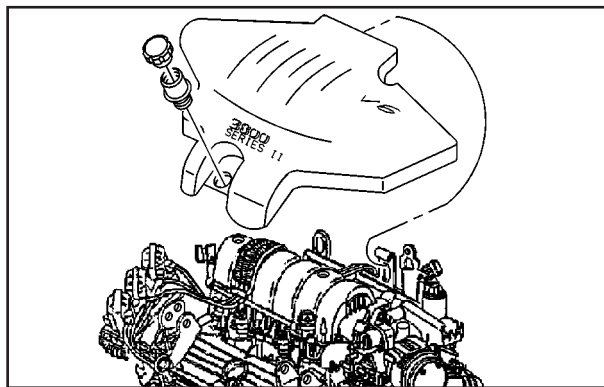

- 3.1. Clean the area around the engine oil fill tube and cap before removing. Twist the oil fill tube, with cap attached, counterclockwise and remove it.
- 3.2. If you have the supercharged engine, remove the nut in the center of the cover shield.
- 3.3. Lift the engine cover shield at the front, slide the catch tab out of the engine bracket and remove the cover shield.
- 3.4. Put the oil fill tube, with cap attached, in the valve cover oil fill hole until you're ready to replace the cover shield.



4. After the engine cools, open the coolant air bleed valve. There is one bleed valve. It is located on the thermostat housing.



5. Fill the radiator with the proper DEX-COOL[®] coolant mixture, up to the base of the filler neck. See *Engine Coolant on page 5-23* for more information about the proper coolant mixture.
If you see a stream of coolant coming from an air bleed valve, close the valve. Otherwise, close the valve after the radiator is filled.
6. Rinse or wipe any spilled coolant from the engine and the compartment.
7. Replace the 3800 Series II V6 engine cover shield.
 - 7.1. Remove the oil fill tube, with cap attached, from the valve cover.
 - 7.2. Insert the catch tab on the cover shield under the bracket on the engine.
 - 7.3. Place the hole in the cover shield over the hole in the valve cover. Install oil fill tube and cap by twisting clockwise.
 - 7.4. If you have the supercharged engine, install the nut in the center of the cover shield.



8. Then fill the coolant recovery tank to the FULL COLD mark.

9. Put the cap back on the coolant recovery tank, but leave the radiator pressure cap off.



10. Start the engine and let it run until you can feel the upper radiator hose getting hot. Watch out for the engine cooling fans.

11. By this time, the coolant level inside the radiator filler neck may be lower. If the level is lower, add more of the proper DEX-COOL® coolant mixture through the filler neck until the level reaches the base of the filler neck.



12. Then replace the pressure cap. At any time during this procedure if coolant begins to flow out of the filler neck, reinstall the pressure cap. Be sure the arrow on the pressure cap lines up like this.

Power Steering Fluid

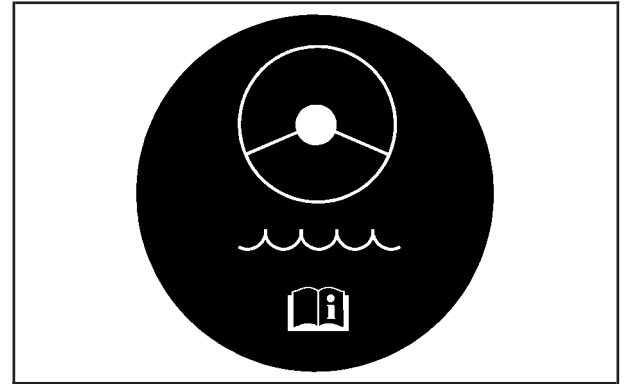

The power steering fluid reservoir is located below the generator and behind the accessory drive belt in the rear of the engine compartment on the passenger's side of the vehicle.

When to Check Power Steering Fluid

It is not necessary to regularly check power steering fluid unless you suspect there is a leak in the system or you hear an unusual noise. A fluid loss in this system could indicate a problem. Have the system inspected and repaired.

How to Check Power Steering Fluid

Turn the key off, let the engine compartment cool down, wipe the cap and the top of the reservoir clean, then unscrew the cap and wipe the dipstick with a clean rag. Replace the cap and completely tighten it. Then remove the cap again and look at the fluid level on the dipstick.

The level should be at the FULL COLD mark. If necessary, add only enough fluid to bring the level up to the mark.

What to Use

To determine what kind of fluid to use, see *Part D: Recommended Fluids and Lubricants on page 6-23*. Always use the proper fluid. Failure to use the proper fluid can cause leaks and damage hoses and seals.

Windshield Washer Fluid

What to Use

When you need windshield washer fluid, be sure to read the manufacturer's instructions before use. If you will be operating your vehicle in an area where the temperature may fall below freezing, use a fluid that has sufficient protection against freezing. See *Engine Compartment Overview on page 5-12* for reservoir location.

Adding Washer Fluid

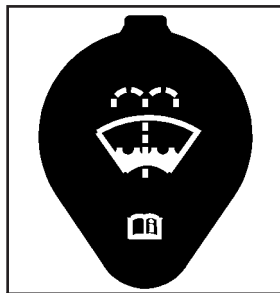

Open the cap with the washer symbol on it. Add washer fluid until the tank is full.

Notice:

- When using concentrated washer fluid, follow the manufacturer's instructions for adding water.
- Don't mix water with ready-to-use washer fluid. Water can cause the solution to freeze and damage your washer fluid tank and other parts of the washer system. Also, water doesn't clean as well as washer fluid.
- Fill your washer fluid tank only three-quarters full when it's very cold. This allows for expansion if freezing occurs, which could damage the tank if it is completely full.
- Don't use engine coolant (antifreeze) in your windshield washer. It can damage your washer system and paint.

Brakes

Brake Fluid

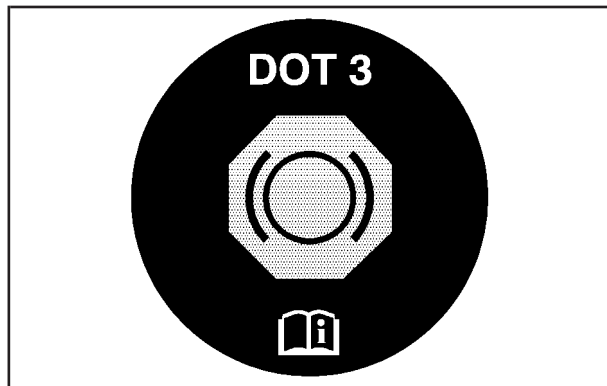

Your master cylinder reservoir is filled with DOT-3 brake fluid. See *Engine Compartment Overview on page 5-12* for the location of the reservoir.

There are only two reasons why the brake fluid level in the reservoir might go down. The first is that the brake fluid goes down to an acceptable level during normal brake lining wear. When new linings are put in, the fluid level goes back up.

The other reason is that fluid is leaking out of the brake system. If it is, you should have your brake system fixed, since a leak means that sooner or later your brakes won't work well, or won't work at all.

So, it isn't a good idea to "top off" your brake fluid. Adding brake fluid won't correct a leak. If you add fluid when your linings are worn, then you'll have too much fluid when you get new brake linings. You should add (or remove) brake fluid, as necessary, only when work is done on the brake hydraulic system.

CAUTION:

If you have too much brake fluid, it can spill on the engine. The fluid will burn if the engine is hot enough. You or others could be burned, and your vehicle could be damaged. Add brake fluid only when work is done on the brake hydraulic system.

When your brake fluid falls to a low level, your brake warning light will come on. A chime will sound if you try to drive with this warning light on. See *Brake System Warning Light on page 3-37*.

What to Add

When you do need brake fluid, use only DOT-3 brake fluid. Refer to *Part D: Recommended Fluids and Lubricants on page 6-23*. Use new brake fluid from a sealed container only.

Always clean the brake fluid reservoir cap and the area around the cap before removing it. This will help keep dirt from entering the reservoir.

CAUTION:

With the wrong kind of fluid in your brake system, your brakes may not work well, or they may not even work at all. This could cause a crash. Always use the proper brake fluid.

Notice:

- **Using the wrong fluid can badly damage brake system parts. For example, just a few drops of mineral-based oil, such as engine oil, in your brake system can damage brake system parts so badly that they'll have to be replaced. Don't let someone put in the wrong kind of fluid.**

- **If you spill brake fluid on your vehicle's painted surfaces, the paint finish can be damaged. Be careful not to spill brake fluid on your vehicle. If you do, wash it off immediately. See "Appearance Care" in the Index.**

Brake Wear

Your vehicle has four-wheel disc brakes.

Disc brake pads have built-in wear indicators that make a high-pitched warning sound when the brake pads are worn and new pads are needed. The sound may come and go or be heard all the time your vehicle is moving (except when you are pushing on the brake pedal firmly).

CAUTION:

The brake wear warning sound means that soon your brakes won't work well. That could lead to an accident. When you hear the brake wear warning sound, have your vehicle serviced.

Notice: Continuing to drive with worn-out brake pads could result in costly brake repair.

Some driving conditions or climates may cause a brake squeal when the brakes are first applied or lightly applied. This does not mean something is wrong with your brakes.

Properly torqued wheel nuts are necessary to help prevent brake pulsation. When tires are rotated, inspect brake pads for wear and evenly tighten wheel nuts in the proper sequence to GM torque specifications.

Brake linings should always be replaced as complete axle sets.

See *Brake System Inspection* on page 6-22.

Brake Pedal Travel

See your dealer if the brake pedal does not return to normal height, or if there is a rapid increase in pedal travel. This could be a sign of brake trouble.

Brake Adjustment

Every time you apply the brakes, with or without the vehicle moving, your brakes adjust for wear.

Replacing Brake System Parts

The braking system on a vehicle is complex. Its many parts have to be of top quality and work well together if the vehicle is to have really good braking. Your vehicle was designed and tested with top-quality GM brake parts. When you replace parts of your braking system — for example, when your brake linings wear down and you need new ones put in — be sure you get new approved GM replacement parts. If you don't, your brakes may no longer work properly. For example, if someone puts in brake linings that are wrong for your vehicle, the balance between your front and rear brakes can change — for the worse. The braking performance you've come to expect can change in many other ways if someone puts in the wrong replacement brake parts.

Battery

Your new vehicle comes with a maintenance free ACDelco® battery. When it's time for a new battery, get one that has the replacement number shown on the original battery's label. We recommend an ACDelco® battery.

Warning: Battery posts, terminals and related accessories contain lead and lead compounds, chemicals known to the State of California to cause cancer and reproductive harm. Wash hands after handling.

The battery is located under the rear seat cushion. To access the battery, see *Removing the Rear Seat Cushion on page 5-89*. You don't need to access the battery to jump start your vehicle. See *Jump Starting on page 5-42*.

CAUTION:

A battery that isn't properly vented can let sulfuric acid fumes into the area under the rear seat cushion. These fumes can damage your rear seat safety belt systems. You may not be able to see this damage, and the safety belts might not provide the protection needed in a crash. If a replacement battery is ever needed, it must be vented in the same manner as the original battery. Always make sure that the vent hose is properly reattached before reinstalling the seat cushion.

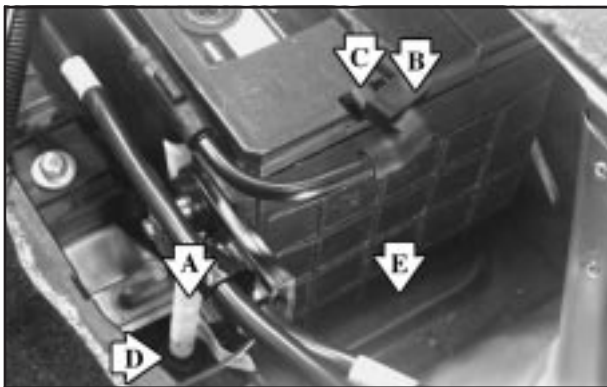

To be sure the vent hose (A) is properly attached, the vent hose connectors (B) must be securely reattached to the vent outlets (C) on each side of the battery, and the vent assembly grommet (D) must be secured to the floor pan (E).

Vehicle Storage

If you're not going to drive your vehicle for 25 days or more, remove the black, negative (-) cable from the battery. This will help keep your battery from running down.

CAUTION:

Batteries have acid that can burn you and gas that can explode. You can be badly hurt if you aren't careful. See "Jump Starting" next for tips on working around a battery without getting hurt.

Contact your dealer to learn how to prepare your vehicle for longer storage periods.

Also, for your audio system, see *Theft-Deterrent Feature* on page 3-77.

Jump Starting

If your vehicle's battery has run down, you may want to use another vehicle and some jumper cables to start your vehicle. Be sure to use the steps below to do it safely.

CAUTION:

Batteries can hurt you. They can be dangerous because:

- They contain acid that can burn you.
- They contain gas that can explode or ignite.
- They contain enough electricity to burn you.

If you don't follow these steps exactly, some or all of these things can hurt you.

Notice: Ignoring these steps could result in costly damage to your vehicle that wouldn't be covered by your warranty.

Trying to start your vehicle by pushing or pulling it won't work, and it could damage your vehicle.

1. Check the other vehicle. It must have a 12-volt battery with a negative ground system.

Notice: If the other system isn't a 12-volt system with a negative ground, both vehicles can be damaged.

2. Get the vehicles close enough so the jumper cables can reach, but be sure the vehicles aren't touching each other. If they are, it could cause a ground connection you don't want. You wouldn't be able to start your vehicle, and the bad grounding could damage the electrical systems.

To avoid the possibility of the vehicles rolling, set the parking brake firmly on both vehicles involved in the jump start procedure. Put an automatic transaxle in PARK (P) or a manual transmission in NEUTRAL (N) before setting the parking brake.

Notice: If you leave your radio on, it could be badly damaged. The repairs wouldn't be covered by your warranty.

3. Turn off the ignition on both vehicles. Unplug unnecessary accessories plugged into the cigarette lighter or in the accessory power outlet(s). Turn off the radio and all lamps that aren't needed. This will avoid sparks and help save both batteries. And it could save your radio!
4. Open the hood on the other vehicle and locate the positive (+) and negative (-) terminal locations on that vehicle.

Open the hood on your vehicle and find the remote positive (+) terminal, located in the engine compartment on the passenger side of the vehicle. See *Engine Compartment Overview on page 5-12* for more information on location.



Access the remote positive (+) terminal by removing the cover.

You will not see the battery of your vehicle under the hood. It is located under the rear passenger's seat. You will not need to access the battery for jump starting. The remote positive (+) terminal is for that purpose.

⚠ CAUTION:

An electric fan can start up even when the engine is not running and can injure you. Keep hands, clothing and tools away from any underhood electric fan.

 **CAUTION:**

Using a match near a battery can cause battery gas to explode. People have been hurt doing this, and some have been blinded. Use a flashlight if you need more light.

Be sure the battery has enough water. You don't need to add water to the ACDelco® battery installed in your new vehicle. But if a battery has filler caps, be sure the right amount of fluid is there. If it is low, add water to take care of that first. If you don't, explosive gas could be present.

Battery fluid contains acid that can burn you. Don't get it on you. If you accidentally get it in your eyes or on your skin, flush the place with water and get medical help immediately.

 **CAUTION:**

Fans or other moving engine parts can injure you badly. Keep your hands away from moving parts once the engine is running.

5. Check that the jumper cables don't have loose or missing insulation. If they do, you could get a shock. The vehicles could be damaged too.

Before you connect the cables, here are some basic things you should know. Positive (+) will go to positive (+) or to a remote positive (+) terminal if the vehicle has one. Negative (-) will go to a heavy, unpainted metal engine part or to a remote negative (-) terminal if the vehicle has one.

Don't connect positive (+) to negative (-) or you'll get a short that would damage the battery and maybe other parts too. And don't connect the negative (-) cable to the negative (-) terminal on the dead battery because this can cause sparks.



6. Connect the red positive (+) cable to the positive (+) terminal of the dead battery. Use a remote positive (+) terminal if the vehicle has one.



8. Now connect the black negative (-) cable to the negative (-) terminal of the good battery. Use a remote negative (-) terminal if the vehicle has one.



7. Don't let the other end touch metal. Connect it to the positive (+) terminal of the good battery. Use a remote positive (+) terminal if the vehicle has one.

Don't let the other end touch anything until the next step. The other end of the negative (-) cable *doesn't* go to the dead battery. It goes to a heavy, unpainted metal engine part or to a remote negative (-) terminal on the vehicle with the dead battery.



9. Connect the other end of the negative (-) cable at least 18 inches (45 cm) away from the dead battery, but not near engine parts that move. The electrical connection is just as good there, and the chance of sparks getting back to the battery is much less.

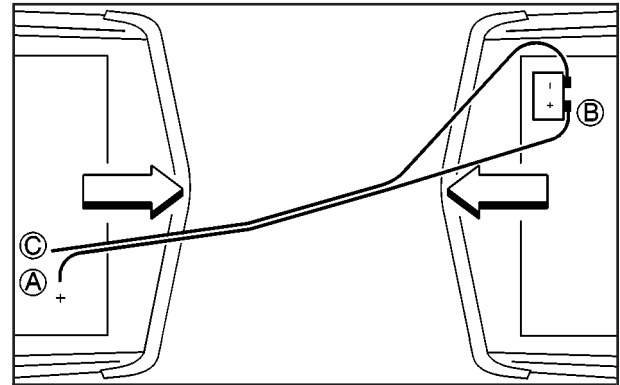

Jumper Cable Removal

- A. Dead Battery or Remote Positive (+) Terminal
- B. Good Battery or Remote Positive (+) and Remote Negative (-) Terminals
- C. Heavy, Unpainted Metal Engine Part or Remote Negative (-) Terminal

10. Now start the vehicle with the good battery and run the engine for a while.
11. Try to start the vehicle that had the dead battery. If it won't start after a few tries, it probably needs service.

Notice: Damage to your vehicle may result from electrical shorting if jumper cables are removed incorrectly. To prevent electrical shorting, take care that the cables don't touch each other or any other metal. The repairs wouldn't be covered by your warranty.

To disconnect the jumper cables from both vehicles, do the following:

1. Disconnect the black negative (-) cable from the vehicle that had the dead battery.
2. Disconnect the black negative (-) cable from the vehicle with the good battery.
3. Disconnect the red positive (+) cable from the vehicle with the good battery.
4. Disconnect the red positive (+) cable from the other vehicle.
5. Return the positive (+) remote terminal cover to its original position.

Headlamp Aiming

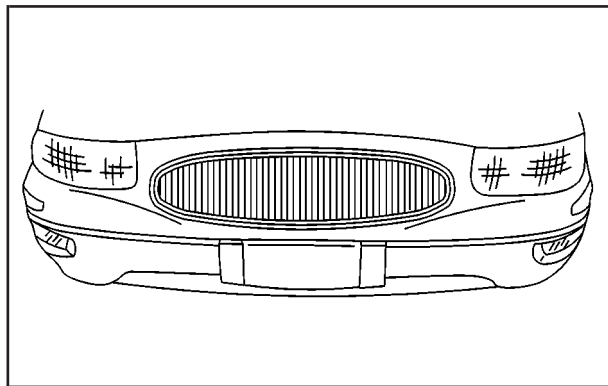

Your vehicle has a visual optical headlamp aiming system equipped with horizontal aim indicators. The aim has been preset at the factory and should need no further adjustment. This is true even though your horizontal aim indicators may not fall exactly on the "0" (zero) marks on their scales.

If your vehicle is damaged in an accident, the headlamp aim may be affected. Aim adjustment to the low beam may be necessary if it is difficult to see lane markers (for horizontal aim), or if oncoming drivers flash their high beams at you (for vertical aim). If you believe your headlamps need to be re-aimed, we recommend that you take your vehicle to your dealer for service. However, it is possible for you to re-aim your headlamps as described in the following procedure.

Notice: To make sure your headlamps are aimed properly, read all the instructions before beginning. Failure to follow these instructions could cause damage to headlamp parts.

The vehicle should be properly prepared as follows:

- The vehicle should be placed so the headlamps are 25 ft. (7.6 m) from a light colored wall or other flat surface.
- The vehicle must have all four tires on a perfectly level surface which is level all the way to the wall or other flat surface.

- The vehicle should be placed so it is perpendicular to the wall or other flat surface.
- The vehicle should not have any snow, ice or mud attached to it.
- The vehicle should be fully assembled and all other work stopped while headlamp aiming is being done.
- The vehicle should be normally loaded with a full tank of fuel and one person or 160 lbs (75 kg) on the driver's seat.
- Tires should be properly inflated.

Headlamp aiming is done with the vehicle low beam lamps. The high beam lamps will be correctly aimed if the low beam lamps are aimed properly.

The headlamp aiming devices are under the hood near the headlamps.

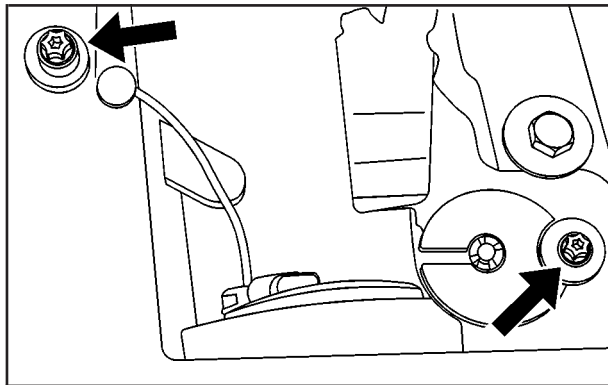

If you believe your headlamps need horizontal (left/right) adjustment, follow the horizontal aiming procedure. If you believe your headlamps need only vertical (up/down) adjustment, follow only the vertical aiming procedure.

Adjustment screws can be turned with an E8 Torx[®] socket or T15 Torx[®] screwdriver.

Headlamp Horizontal Aiming

Turn the horizontal aiming screw (A) until the indicator (B) is lined up with zero.

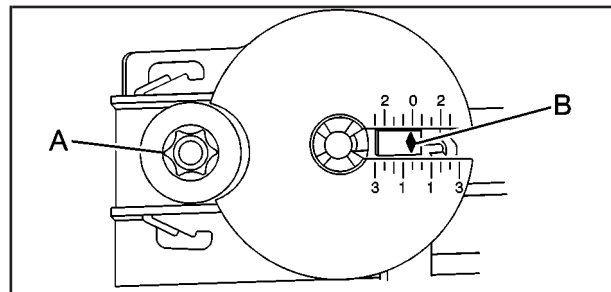

Once the horizontal aim is adjusted, then adjust the vertical aim.

Headlamp Vertical Aiming

Notice: Horizontal aiming must be performed before making any adjustments to the vertical aim. Adjusting the vertical aim first will result in an incorrect headlamp aim.

1. Find the aim dot on the lens of the low beam lamps.

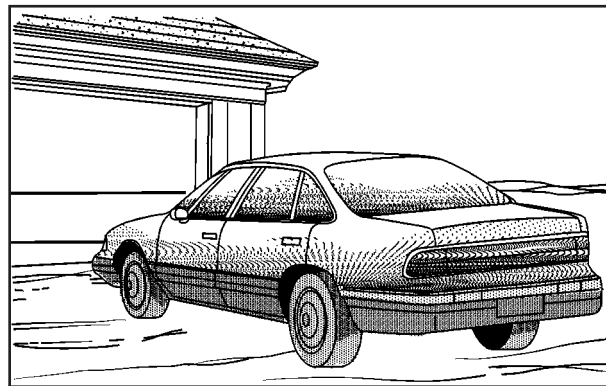
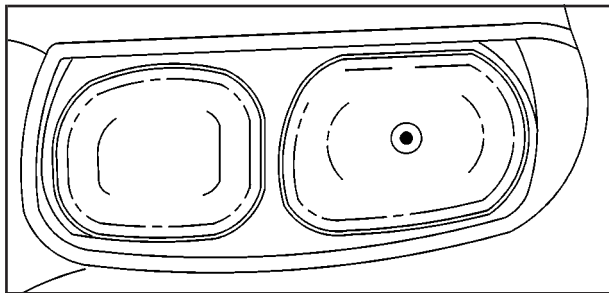

4. Turn on the low-beam headlamps and place a piece of cardboard or equivalent in front of the headlamp not being aimed. This should allow only the beam of light from the headlamp being aimed to be seen on the flat surface.

2. Measure the distance from the ground to the aim dot on each lamp; if left low beam, subtract two inches. Record this distance.
3. At the wall or other flat surface, measure from the ground upward the recorded distance from Step 2 and draw or tape a horizontal line the width of the vehicle.

Notice: Do not cover a headlamp to improve beam cut-off when aiming. Covering a headlamp may cause excessive heat build-up which may cause damage to the headlamp.

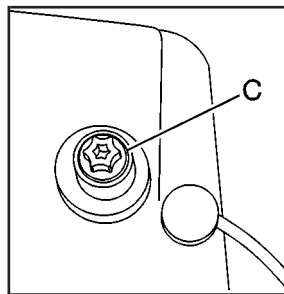
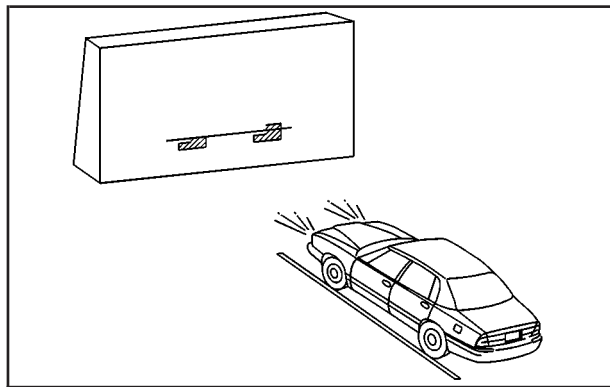

5. Turn the vertical aiming screw (C) until the headlamp beam is aimed to the horizontal tape line.

The top edge of the cut-off should be positioned at the bottom edge of the horizontal tape line.

6. Repeat Steps 4 and 5 for the opposite headlamp.

Bulb Replacement

For the type of bulb to use, see *Replacement Bulbs* on page 5-56.

For any bulb changing procedure not listed in this section, contact your dealer.

Halogen Bulbs

CAUTION:

Halogen bulbs have pressurized gas inside and can burst if you drop or scratch the bulb. You or others could be injured. Be sure to read and follow the instructions on the bulb package.

Headlamps



1. Remove the two bolts retaining the headlamp assembly.
2. Slide the headlamp outward until the pins are loose.
3. Remove the headlamp assembly to access the bulbs.

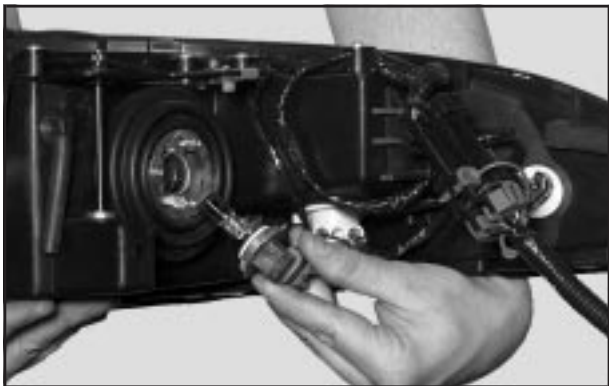

4. Turn the bulb retainer counterclockwise to remove it from the bulb assembly.
5. Pull the old bulb straight out from the retainer. Push the new bulb straight into the retainer.
6. Reverse Steps 1 through 4 to reinstall the headlamp assembly.

Front Turn Signal Lamps

Once the headlamp assembly has been removed from the vehicle, the front turn signal bulbs can be accessed.

1. Reach down into the space provided by the removal of the headlamp assembly and, while pushing in the tab on the bulb assembly, turn the assembly counterclockwise and remove it.
2. Remove the old bulb by pulling it straight out of the retainer.
3. Install the new bulb and turn the bulb assembly back into place.

Taillamps, Turn Signal, and Stoplamps

1. Open the trunk. Turn the screws located just inside of the trunk counterclockwise and remove them.
2. Remove the plastic trim piece from the trunk.
3. Pull the carpet away from the rear area to access the turn signal bulb assembly.
4. Loosen and remove the bolts that hold the assembly in place.



5. Pull out the bulb assembly.



6. Turn the bulb socket one-quarter turn counterclockwise, while pressing it firmly.

7. Pull the bulb socket straight out of the assembly.
8. Remove the old bulb by pulling it straight out.
9. Replace with a new bulb by pushing the bulb straight into the socket until the bulb clicks into place.
10. Turn the bulb socket one-quarter turn into the assembly to lock it back into place.
11. Reverse Steps 1 through 5 to reinstall the bulb assembly.

Taillamps and Back-Up Lamps



1. Open the trunk. Loosen and remove the seven fasteners that hold the taillamp assembly in place. The assembly for both sides is one piece. The entire piece must be removed to replace any bulbs.



2. Pull out the assembly.



Replacement Bulbs

Exterior Lamp	Bulb Number
Front	
Low Beam Headlamps	9006
High Beam Headlamps	9005
Front Turn Signals	3157
Rear	
Trunk Mounted Back-Up Lamps	3057
Trunk Mounted Taillamps	194
Tail/Stop/Turn Signal Lamps	3357
For any bulb not listed here contact your dealer.	

3. Push in the tab and turn the bulb socket counterclockwise to remove it.
4. Remove the bulb by pulling it straight out.
5. Replace the bulb and reverse the steps to install the assembly.

Windshield Wiper Blade Replacement

Windshield wiper blades should be inspected at least twice a year for wear or cracking. See “Wiper Blade Check” under *Part B: Owner Checks and Services on page 6-17* for more information.

Replacement blades come in different types and are removed in different ways.

To replace the wiper blade assembly, do the following:

1. Lift the windshield wiper arm away from the windshield.



2. Push the tab on the wiper blade assembly and pull the assembly down enough to release it from the “U” hooked end of the wiper arm. Slide the assembly away from the arm.
3. Remove the blade.
4. To reinstall the wiper blade assembly, slide it over the wiper arm to engage the “U” hooked end on the wiper blade assembly. Pull up on the assembly to lock it into place.

For the proper windshield wiper blade replacement length and type, see *Normal Maintenance Replacement Parts on page 5-94*.

Tires

Your new vehicle comes with high-quality tires made by a leading tire manufacturer. If you ever have questions about your tire warranty and where to obtain service, see your Buick Warranty booklet for details.

CAUTION:

Poorly maintained and improperly used tires are dangerous.

- **Overloading your tires can cause overheating as a result of too much friction. You could have an air-out and a serious accident. See “Loading Your Vehicle” in the Index.**
- **Underinflated tires pose the same danger as overloaded tires. The resulting accident could cause serious injury. Check all tires frequently to maintain the recommended pressure. Tire pressure should be checked when your tires are cold.**

CAUTION: (Continued)

CAUTION: (Continued)

- **Overinflated tires are more likely to be cut, punctured or broken by a sudden impact — such as when you hit a pothole. Keep tires at the recommended pressure.**
- **Worn, old tires can cause accidents. If your tread is badly worn, or if your tires have been damaged, replace them.**

Inflation -- Tire Pressure

The Tire-Loading Information label, which is on the rear edge of the driver's door, shows the correct inflation pressures for your tires when they're cold. "Cold" means your vehicle has been sitting for at least three hours or driven no more than 1 mile (1.6 km).

Notice: Don't let anyone tell you that underinflation or overinflation is all right. It's not. If your tires don't have enough air (underinflation), you can get the following:

- Too much flexing
- Too much heat
- Tire overloading
- Bad wear
- Bad handling
- Bad fuel economy

If your tires have too much air (overinflation), you can get the following:

- Unusual wear
- Bad handling
- Rough ride
- Needless damage from road hazards

When to Check

Check your tires once a month or more.

Don't forget your compact spare tire. It should be at 60 psi (420 kPa).

How to Check

Use a good quality pocket-type gage to check tire pressure. You can't tell if your tires are properly inflated simply by looking at them. Radial tires may look properly inflated even when they're underinflated.

Be sure to put the valve caps back on the valve stems. They help prevent leaks by keeping out dirt and moisture.

Check Tire Pressure System

If your vehicle has the check tire pressure system, it can alert you to a large change in the pressure of one tire. The system won't alert you before you drive that a tire is low or flat. You must begin driving before the system will work properly.

The CHECK TIRE PRESSURE message will appear on the Driver Information Center (DIC) if pressure difference (low pressure) is detected in one tire. The check tire pressure system may not alert you if:

- more than one tire is low,
- the vehicle is moving faster than 65 mph (105 km/h),
- the system is not yet calibrated,
- the tire treadwear is uneven,
- the compact spare tire is installed,
- tire chains are being used, or
- the vehicle is being driven on a rough or frozen road.

If the anti-lock brake system warning light comes on, the check tire pressure system may not be working properly. See your dealer for service. Also, see *Anti-Lock Brake System Warning Light on page 3-38*.

The check tire pressure system detects differences in tire rotation speeds that are caused by changes in tire pressure. The system can alert you about a low tire – but it doesn't replace normal tire maintenance. See *Tires on page 5-58*.

When the CHECK TIRE PRESSURE message appears on the Driver Information Center, you should stop as soon as you can and check all your tires for damage. If a tire is flat, see *If a Tire Goes Flat on page 5-66*. Also check the tire pressure in all four tires as soon as you can. See *Inflation -- Tire Pressure on page 5-58*.

Any time you adjust a tire's pressure or have one or more tires repaired or replaced, you'll need to reset (calibrate) the check tire pressure system. You'll also need to reset the system whenever you rotate the tires, buy new tires and install or remove the compact spare.

Don't reset the check tire pressure system without first correcting the cause of the problem and checking and adjusting the pressure in all four tires. If you reset the system when the tire pressures are incorrect, the check tire pressure system will not work properly and may not alert you when a tire is low or high.

To reset (calibrate) the system:

1. Turn the ignition switch to RUN.
2. Press the GAGE INFO button on the DIC until TIRE PRESSURE appears on the display.
3. Press and hold the DIC RESET button for about five seconds. After five seconds, the display will show TIRE PRESSURE RESET. If TIRE PRESSURE RESET does not appear in the display after about five seconds retry the process. If it does not work after two tries, see your dealer for service. After you release the DIC RESET button, TIRE PRESSURE NORMAL will appear in the display.

The system completes the calibration process during driving. Calibration time can take 45 to 90 minutes, depending on your driving habits. After the system has been calibrated, the system will alert the driver that a tire is low, up to a maximum speed of 65 mph (105 km/h).

Tire Inspection and Rotation

Tires should be rotated every 6,000 to 8,000 miles (10 000 to 13 000 km).

Any time you notice unusual wear rotate your tires as soon as possible and check wheel alignment. Also check for damaged tires or wheels. See *When It Is Time for New Tires on page 5-62* and *Wheel Replacement on page 5-65* for more information.

The purpose of regular rotation is to achieve more uniform wear for all tires on the vehicle. The first rotation is the most important. See “Part A: Scheduled Maintenance Services,” in Section 6, for scheduled rotation intervals.

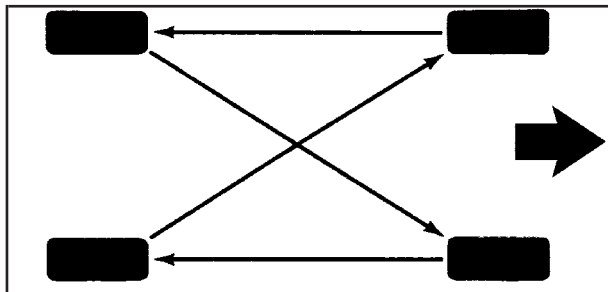

When rotating your tires, always use the correct rotation pattern shown here.

Don't include the compact spare tire in your tire rotation.

After the tires have been rotated, adjust the front and rear inflation pressures as shown on the Tire-Loading Information label.

Reset the check tire pressure system, if equipped. See *Check Tire Pressure System on page 5-59*.

Make certain that all wheel nuts are properly tightened. See “Wheel Nut Torque” under *Capacities and Specifications on page 5-93*.

CAUTION:

Rust or dirt on a wheel, or on the parts to which it is fastened, can make wheel nuts become loose after a time. The wheel could come off and cause an accident. When you change a wheel, remove any rust or dirt from places where the wheel attaches to the vehicle. In an emergency, you can use a cloth or a paper towel to do this; but be sure to use a scraper or wire brush later, if you need to, to get all the rust or dirt off. See “Changing a Flat Tire” in the Index.

When It Is Time for New Tires

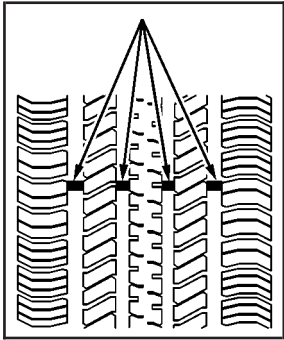

One way to tell when it's time for new tires is to check the treadwear indicators, which will appear when your tires have only 1/16 inch (1.6 mm) or less of tread remaining.

You need a new tire if any of the following statements are true:

- You can see the indicators at three or more places around the tire.
- You can see cord or fabric showing through the tire's rubber.
- The tread or sidewall is cracked, cut or snagged deep enough to show cord or fabric.

- The tire has a bump, bulge or split.
- The tire has a puncture, cut or other damage that can't be repaired well because of the size or location of the damage.

Buying New Tires

To find out what kind and size of tires you need, look at the Tire-Loading Information label.

The tires installed on your vehicle when it was new had a Tire Performance Criteria Specification (TPC Spec) number on each tire's sidewall. When you get new tires, get ones with that same TPC Spec number. That way your vehicle will continue to have tires that are designed to give proper endurance, handling, speed rating, traction, ride and other things during normal service on your vehicle. If your tires have an all-season tread design, the TPC number will be followed by an "MS" (for mud and snow).

If you ever replace your tires with those not having a TPC Spec number, make sure they are the same size, load range, speed rating and construction type (bias, bias-belted or radial) as your original tires.

 **CAUTION:**

Mixing tires could cause you to lose control while driving. If you mix tires of different sizes or types (radial and bias-belted tires), the vehicle may not handle properly, and you could have a crash. Using tires of different sizes may also cause damage to your vehicle. Be sure to use the same size and type tires on all wheels. It's all right to drive with your compact spare temporarily, it was developed for use on your vehicle. See "Compact Spare Tire" in the index.

 **CAUTION:**

If you use bias-ply tires on your vehicle, the wheel rim flanges could develop cracks after many miles of driving. A tire and/or wheel could fail suddenly, causing a crash. Use only radial-ply tires with the wheels on your vehicle.

Uniform Tire Quality Grading

Quality grades can be found where applicable on the tire sidewall between tread shoulder and maximum section width. For example:

Treadwear 200 Traction AA Temperature A

The following information relates to the system developed by the United States National Highway Traffic Safety Administration, which grades tires by treadwear, traction and temperature performance. (This applies only to vehicles sold in the United States.) The grades are molded on the sidewalls of most passenger car tires. The Uniform Tire Quality Grading system does not apply to deep tread, winter-type snow tires, space-saver or temporary use spare tires, tires with nominal rim diameters of 10 to 12 inches (25 to 30 cm), or to some limited-production tires.

While the tires available on General Motors passenger cars and light trucks may vary with respect to these grades, they must also conform to federal safety requirements and additional General Motors Tire Performance Criteria (TPC) standards.

Treadwear

The treadwear grade is a comparative rating based on the wear rate of the tire when tested under controlled conditions on a specified government test course. For example, a tire graded 150 would wear one and a half (1.5) times as well on the government course as a tire graded 100. The relative performance of tires depends upon the actual conditions of their use, however, and may depart significantly from the norm due to variations in driving habits, service practices and differences in road characteristics and climate.

Traction – AA, A, B, C

The traction grades, from highest to lowest, are AA, A, B, and C. Those grades represent the tire's ability to stop on wet pavement as measured under controlled conditions on specified government test surfaces of asphalt and concrete. A tire marked C may have poor traction performance. Warning: The traction grade assigned to this tire is based on straight-ahead braking traction tests, and does not include acceleration, cornering, hydroplaning, or peak traction characteristics.

Temperature – A, B, C

The temperature grades are A (the highest), B, and C, representing the tire's resistance to the generation of heat and its ability to dissipate heat when tested under controlled conditions on a specified indoor

laboratory test wheel. Sustained high temperature can cause the material of the tire to degenerate and reduce tire life, and excessive temperature can lead to sudden tire failure. The grade C corresponds to a level of performance which all passenger car tires must meet under the Federal Motor Vehicle Safety Standard No. 109. Grades B and A represent higher levels of performance on the laboratory test wheel than the minimum required by law.

Warning: The temperature grade for this tire is established for a tire that is properly inflated and not overloaded. Excessive speed, underinflation, or excessive loading, either separately or in combination, can cause heat buildup and possible tire failure.

Wheel Alignment and Tire Balance

The wheels on your vehicle were aligned and balanced carefully at the factory to give you the longest tire life and best overall performance.

Scheduled wheel alignment and wheel balancing are not needed. However, if you notice unusual tire wear or your vehicle pulling one way or the other, the alignment may need to be reset. If you notice your vehicle vibrating when driving on a smooth road, your wheels may need to be rebalanced.

Wheel Replacement

Replace any wheel that is bent, cracked or badly rusted or corroded. If wheel nuts keep coming loose, the wheel, wheel bolts and wheel nuts should be replaced. If the wheel leaks air, replace it (except some aluminum wheels, which can sometimes be repaired). See your dealer if any of these conditions exist.

Your dealer will know the kind of wheel you need.

Each new wheel should have the same load-carrying capacity, diameter, width, offset and be mounted the same way as the one it replaces.

If you need to replace any of your wheels, wheel bolts or wheel nuts, replace them only with new GM original equipment parts. This way, you will be sure to have the right wheel, wheel bolts and wheel nuts for your vehicle.

CAUTION:

Using the wrong replacement wheels, wheel bolts or wheel nuts on your vehicle can be dangerous. It could affect the braking and handling of your vehicle, make your tires lose air and make you lose control. You could have a collision in which you or others could be injured. Always use the correct wheel, wheel bolts and wheel nuts for replacement.

Notice: The wrong wheel can also cause problems with bearing life, brake cooling, speedometer or odometer calibration, headlamp aim, bumper height, vehicle ground clearance and tire or tire chain clearance to the body and chassis.

See *Changing a Flat Tire* on page 5-67 for more information.

Used Replacement Wheels

CAUTION:

Putting a used wheel on your vehicle is dangerous. You can't know how it's been used or how far it's been driven. It could fail suddenly and cause a crash. If you have to replace a wheel, use a new GM original equipment wheel.

Tire Chains

Notice: Use tire chains only where legal and only when you must. Use only SAE Class "S" type chains that are the proper size for your tires. Install them on the front tires and tighten them as tightly as possible with the ends securely fastened. Drive slowly and follow the chain manufacturer's instructions. If you can hear the chains contacting your vehicle, stop and retighten them. If the contact continues, slow down until it stops. Driving too fast or spinning the wheels with chains on will damage your vehicle.

If a Tire Goes Flat

It's unusual for a tire to "blowout" while you're driving, especially if you maintain your tires properly. If air goes out of a tire, it's much more likely to leak out slowly. But if you should ever have a "blowout," here are a few tips about what to expect and what to do:

If a front tire fails, the flat tire will create a drag that pulls the vehicle toward that side. Take your foot off the accelerator pedal and grip the steering wheel firmly. Steer to maintain lane position, and then gently brake to a stop well out of the traffic lane.

A rear blowout, particularly on a curve, acts much like a skid and may require the same correction you'd use in a skid. In any rear blowout, remove your foot from the accelerator pedal. Get the vehicle under control by steering the way you want the vehicle to go. It may be very bumpy and noisy, but you can still steer. Gently brake to a stop, well off the road if possible.

 **CAUTION:**

Lifting a vehicle and getting under it to do maintenance or repairs is dangerous without the appropriate safety equipment and training. The jack provided with your vehicle is designed only for changing a flat tire. If it is used for anything else, you or others could be badly injured or killed if the vehicle slips off the jack. Use the jack provided with your vehicle only for changing a flat tire.

If a tire goes flat, the next part shows how to use your jacking equipment to change a flat tire safely.

Changing a Flat Tire

If a tire goes flat, avoid further tire and wheel damage by driving slowly to a level place. Turn on your hazard warning flashers.

 **CAUTION:**

Changing a tire can cause an injury. The vehicle can slip off the jack and roll over you or other people. You and they could be badly injured. Find a level place to change your tire. To help prevent the vehicle from moving:

1. Set the parking brake firmly.
2. Put the shift lever in PARK (P).
3. Turn off the engine.

To be even more certain the vehicle won't move, you can put blocks at the front and rear of the tire farthest away from the one being changed. That would be the tire on the other side of the vehicle, at the opposite end.

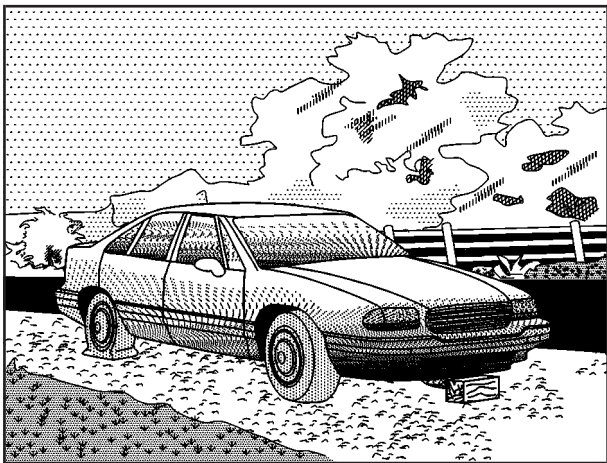

The following steps will tell you how to use the jack and change a tire.

Removing the Spare Tire and Tools



The equipment you'll need is located in the trunk.

1. Pull the carpeting from the floor of the trunk.
2. Lift and remove the cover.
3. Remove the compact spare tire. See *Compact Spare Tire* on page 5-76 for more information about the compact spare.
4. Unscrew the wing nuts to remove the container that holds the wrench and jack.
5. Remove the wheel wrench, jack and the spare tire from the trunk.

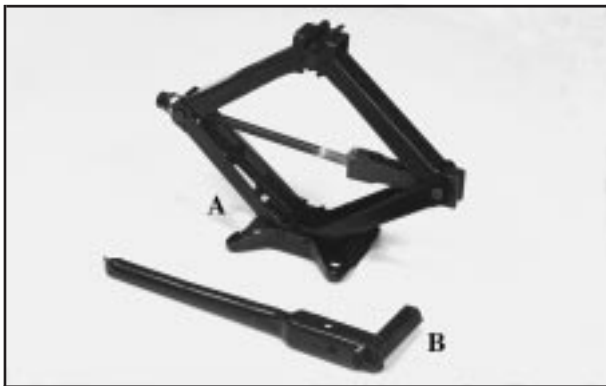

The tools you'll be using include the jack (A) and the wheel wrench (B).

Removing the Wheel Covers and Wheel Nut Caps

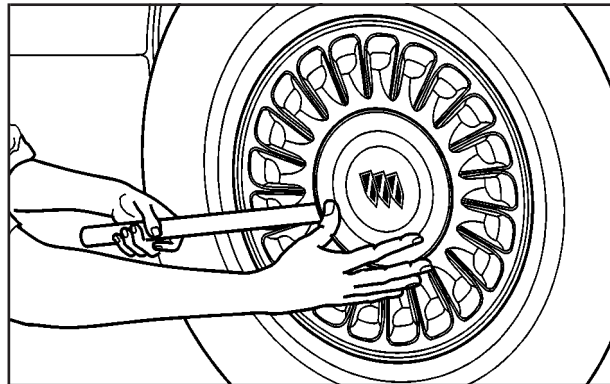

If your vehicle has an aluminum wheel with a center cover that hides the wheel nuts, remove the center cover by using the flat end of the wheel wrench to pry it off.

If your vehicle has a wheel cover, remove it by using the flat end of the wheel wrench. Pry along the edge of the wheel cover until it comes off.

When reinstalling the wheel cover, carefully line up the tire valve stem and the notch in the wheel cover.

Removing the Flat Tire and Installing the Spare Tire



1. Use the wheel wrench to loosen the wheel nuts, but don't remove them yet.
2. The jack has a bolt at the end. Attach the wheel wrench to the bolt to create a jack handle.

3. Turn the wheel wrench counterclockwise to lower the jack head until it fits under the vehicle.

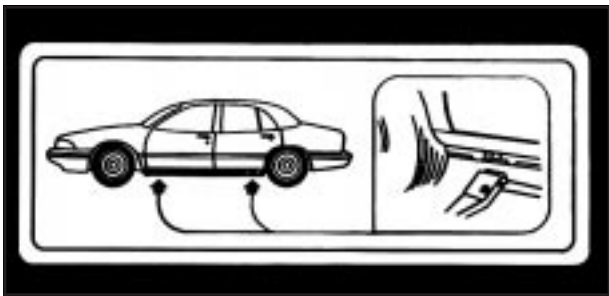

- Put the jack into a notch in the frame which is located near each wheel well. The front notch is eight inches (20 cm) back from the front wheel well. The rear notch is three inches (8 cm) forward from the rear wheel well. The notches are accessible through openings in the plastic trim at the bottom of the vehicle.

Position the jack and raise the jack head until it fits firmly on the ridge in the vehicle's frame nearest the flat tire. Do not raise the vehicle yet. Put the compact spare tire near you.

⚠ CAUTION:

Getting under a vehicle when it is jacked up is dangerous. If the vehicle slips off the jack you could be badly injured or killed. Never get under a vehicle when it is supported only by a jack.

⚠ CAUTION:

Raising your vehicle with the jack improperly positioned can damage the vehicle and even make the vehicle fall. To help avoid personal injury and vehicle damage, be sure to fit the jack lift head into the proper location before raising the vehicle.



5. Raise the vehicle by turning the wheel wrench clockwise in the jack. Raise the vehicle far enough so there's enough room for the spare tire to fit under the wheel well.
6. Remove all the wheel nuts and take off the flat tire.

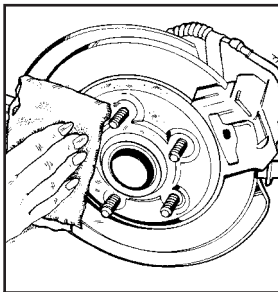

7. Remove any rust or dirt from the wheel bolts, mounting surfaces and spare wheel.

⚠ CAUTION:

Rust or dirt on the wheel, or on the parts to which it is fastened, can make the wheel nuts become loose after a time. The wheel could come off and cause an accident. When you change a wheel, remove any rust or dirt from the places where the wheel attaches to the vehicle. In an emergency, you can use a cloth or a paper towel to do this; but be sure to use a scraper or wire brush later, if you need to, to get all the rust or dirt off.

⚠ CAUTION:

Never use oil or grease on studs or nuts. If you do, the nuts might come loose. Your wheel could fall off, causing a serious accident.

8. Place the compact spare tire on the wheel-mounting surface.



9. Reinstall the wheel nuts with the rounded end of the nuts toward the wheel. Make sure each wheel stud is centered in each wheel hole while tightening the nuts. Tighten each nut by hand until the wheel is held against the hub.

10. Lower the vehicle by turning the wheel wrench counterclockwise on the jack. Lower the jack completely.

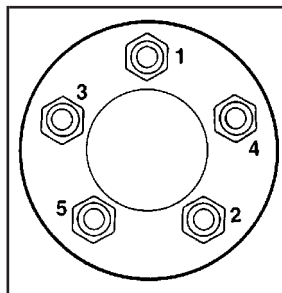

11. Tighten the wheel nuts firmly in a crisscross sequence.

⚠ CAUTION:

Incorrect wheel nuts or improperly tightened wheel nuts can cause the wheel to come loose and even come off. This could lead to an accident. Be sure to use the correct wheel nuts. If you have to replace them, be sure to get new GM original equipment wheel nuts. Stop somewhere as soon as you can and have the nuts tightened with a torque wrench to the proper torque specification. See “Capacities and Specifications” in the Index for wheel nut torque specification.

Notice: Improperly tightened wheel nuts can lead to brake pulsation and rotor damage. To avoid expensive brake repairs, evenly tighten the wheel nuts in the proper sequence and to the proper torque specification. See “Capacities and Specifications” in the index for the wheel nut torque specification.

Notice: Wheel covers won't fit on your compact spare. If you try to put a wheel cover on your compact spare, you could damage the cover or the spare.

Storing the Flat Tire and Tools

CAUTION:

Storing a jack, a tire, or other equipment in the passenger compartment of the vehicle could cause injury. In a sudden stop or collision, loose equipment could strike someone. Store all these in the proper place.

After you've put the compact spare tire on your vehicle, you'll need to store the flat tire in your trunk. Use the following procedure to secure the flat tire in the trunk.

Store the flat tire as far forward in the trunk as possible. Store the jack and wheel wrench in their compartment in the trunk.



Storing the Spare Tire and Tools

CAUTION:

Storing a jack, a tire, or other equipment in the passenger compartment of the vehicle could cause injury. In a sudden stop or collision, loose equipment could strike someone. Store all these in the proper place.

Store the compact spare tire and tools as shown in the diagram.

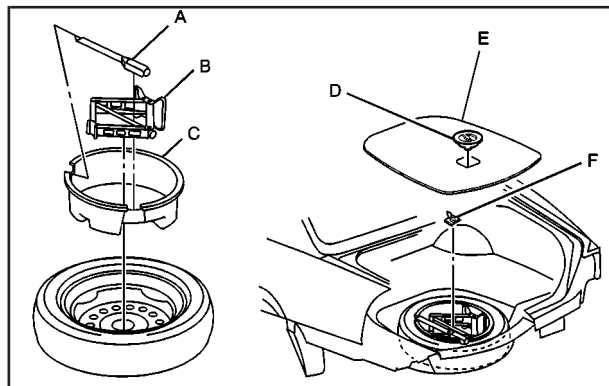

A. Wrench

B. Jack

C. Jack Container

D. Retainer

E. Spare Tire Cover

F. Retainer

The compact spare tire is for temporary use only. Replace the compact spare tire with a full-size tire as soon as you can. See "Compact Spare Tire" following for more information.

Compact Spare Tire

Although the compact spare tire was fully inflated when your vehicle was new, it can lose air after a time. Check the inflation pressure regularly. It should be 60 psi (420 kPa).

After installing the compact spare on your vehicle, you should stop as soon as possible and make sure your spare tire is correctly inflated. The compact spare is made to perform well at speeds up to 65 mph (105 km/h) for distances up to 3,000 miles (5 000 km), so you can finish your trip and have your full-size tire repaired or replaced where you want. You must calibrate the Check Tire Pressure System after installing or removing the compact spare. See *Check Tire Pressure System on page 5-59*. Of course, it's best to replace your spare with a full-size tire as soon as you can. Your spare will last longer and be in good shape in case you need it again.

Notice: When the compact spare is installed, don't take your vehicle through an automatic car wash with guide rails. The compact spare can get caught on the rails. That can damage the tire and wheel, and maybe other parts of your vehicle.

Don't use your compact spare on other vehicles.

And don't mix your compact spare tire or wheel with other wheels or tires. They won't fit. Keep your compact spare tire and its wheel together.

Notice: Tire chains won't fit your compact spare. Using them can damage your vehicle and can damage the chains too. Don't use tire chains on your compact spare.

Appearance Care

Remember, cleaning products can be hazardous. Some are toxic. Others can burst into flames if you strike a match or get them on a hot part of the vehicle. Some are dangerous if you breathe their fumes in a closed space. When you use anything from a container to clean your vehicle, be sure to follow the manufacturer's warnings and instructions. And always open your doors or windows when you are cleaning the inside.

Never use these to clean your vehicle:

- Gasoline
- Benzene
- Naphtha
- Carbon Tetrachloride
- Acetone
- Paint Thinner
- Turpentine
- Lacquer Thinner
- Nail Polish Remover

They can all be hazardous — some more than others — and they can all damage your vehicle, too.

Do not use any of these unless this manual says you can. In many uses, these will damage your vehicle:

- Alcohol
- Laundry Soap
- Bleach
- Reducing Agents

Cleaning the Inside of Your Vehicle

Use a vacuum cleaner often to get rid of dust and loose dirt. Wipe vinyl, leather, plastic and painted surfaces with a clean, damp cloth.

Cleaning Fabric/Carpet

Your dealer has cleaners for the cleaning of fabric and carpet. They will clean normal spots and stains very well.

You can get GM-approved cleaning products from your dealer. See *Vehicle Care/Appearance Materials on page 5-84*.

Here are some cleaning tips:

- Always read the instructions on the cleaner label.
- Clean up stains as soon as you can — before they set.
- Carefully scrape off any excess stain.
- Use a clean cloth or sponge, and change to a clean area often. A soft brush may be used if stains are stubborn.
- If a ring forms on fabric after spot cleaning, clean the entire area immediately or it will set.

Using Cleaner on Fabric

1. Vacuum and brush the area to remove any loose dirt.
2. Always clean a whole trim panel or section. Mask surrounding trim along stitch or welt lines.
3. Follow the directions on the container label.
4. Apply cleaner with a clean sponge. Do not saturate the material and do not rub it roughly.
5. As soon as you have cleaned the section, use a sponge to remove any excess cleaner.
6. Wipe cleaned area with a clean, water-dampened towel or cloth.
7. Wipe with a clean cloth and let dry.

Special Fabric Cleaning Problems

Stains caused by such things as catsup, coffee (black), egg, fruit, fruit juice, milk, soft drinks, vomit, urine and blood can be removed as follows:

1. Carefully scrape off excess stain, then sponge the soiled area with cool water.
2. If a stain remains, follow the cleaning instructions described earlier.
3. If an odor lingers after cleaning vomit or urine, treat the area with a water and baking soda solution: 1 teaspoon (5 ml) of baking soda to 1 cup (250 ml) of lukewarm water.
4. Let dry.

Stains caused by candy, ice cream, mayonnaise, chili sauce and unknown stains can be removed as follows:

1. Carefully scrape off excess stain.
2. Clean with cool water and allow to dry completely.
3. If a stain remains, follow the cleaner instructions described earlier.

Cleaning Vinyl

Use warm water and a clean cloth.

- Rub with a clean, damp cloth to remove dirt. You may have to do this more than once.
- Things like tar, asphalt and shoe polish will stain if you do not get them off quickly. Use a clean cloth and vinyl cleaner. See your dealer for this product.

Cleaning Leather

Use a soft cloth with lukewarm water and a mild soap or saddle soap and wipe dry with a soft cloth. Then, let the leather dry naturally. Do not use heat to dry.

- For stubborn stains, use a leather cleaner.
- *Never* use oils, varnishes, solvent-based or abrasive cleaners, furniture polish or shoe polish on leather.
- Soiled or stained leather should be cleaned immediately. If dirt is allowed to work into the finish, it can harm the leather.

Cleaning the Top of the Instrument Panel

Use only mild soap and water to clean the top surfaces of the instrument panel. Sprays containing silicones or waxes may cause annoying reflections in the windshield and even make it difficult to see through the windshield under certain conditions.

Cleaning Interior Plastic Components

Use only a mild soap and water solution on a soft cloth or sponge. Commercial cleaners may affect the surface finish.

Cleaning Glass Surfaces

Glass should be cleaned often. GM Glass Cleaner or a liquid household glass cleaner will remove normal tobacco smoke and dust films on interior glass. See *Vehicle Care/Appearance Materials* on page 5-84.

Notice: Don't use abrasive cleaners on glass, because they may cause scratches. Avoid placing decals on the inside rear window, since they may have to be scraped off later. If abrasive cleaners are used on the inside of the rear window, an electric defogger element may be damaged. Any temporary license should not be attached across the defogger grid.

Care of Safety Belts

Keep belts clean and dry.

CAUTION:

Do not bleach or dye safety belts. If you do, it may severely weaken them. In a crash, they might not be able to provide adequate protection. Clean safety belts only with mild soap and lukewarm water.

Weatherstrips

Silicone grease on weatherstrips will make them last longer, seal better, and not stick or squeak. Apply silicone grease with a clean cloth at least every six months. During very cold, damp weather more frequent application may be required. See *Part D: Recommended Fluids and Lubricants on page 6-23*.

Cleaning the Outside of Your Vehicle

The paint finish on your vehicle provides beauty, depth of color, gloss retention and durability.

Washing Your Vehicle

The best way to preserve your vehicle's finish is to keep it clean by washing it often with lukewarm or cold water.

Don't wash your vehicle in the direct rays of the sun. Use a car washing soap. Don't use strong soaps or chemical detergents. Be sure to rinse the vehicle well, removing all soap residue completely. You can get GM-approved cleaning products from your dealer. See *Vehicle Care/Appearance Materials on page 5-84*. Don't use cleaning agents that are petroleum based, or that contain acid or abrasives. All cleaning agents should be flushed promptly and not allowed to dry on the surface, or they could stain. Dry the finish with a soft, clean chamois or an all-cotton towel to avoid surface scratches and water spotting.

High pressure car washes may cause water to enter your vehicle.

Cleaning Exterior Lamps/Lenses

Use only lukewarm or cold water, a soft cloth and a car washing soap to clean exterior lamps and lenses. Follow instructions under “Washing Your Vehicle.”

Finish Care

Occasional waxing or mild polishing of your vehicle by hand may be necessary to remove residue from the paint finish. You can get GM-approved cleaning products from your dealer. See *Vehicle Care/Appearance Materials* on page 5-84.

If your vehicle has a “basecoat/clearcoat” paint finish. The clearcoat gives more depth and gloss to the colored basecoat. Always use waxes and polishes that are non-abrasive and made for a basecoat/clearcoat paint finish.

Notice: Machine compounding or aggressive polishing on a basecoat/clearcoat paint finish may dull the finish or leave swirl marks.

Foreign materials such as calcium chloride and other salts, ice melting agents, road oil and tar, tree sap, bird droppings, chemicals from industrial chimneys, etc., can damage your vehicle’s finish if they remain on painted surfaces. Wash the vehicle as soon as possible. If necessary, use non-abrasive cleaners that are marked safe for painted surfaces to remove foreign matter.

Exterior painted surfaces are subject to aging, weather and chemical fallout that can take their toll over a period of years. You can help to keep the paint finish looking new by keeping your vehicle garaged or covered whenever possible.

Cleaning Windshield and Wiper Blades

If the windshield is not clear after using the windshield washer, or if the wiper blade chatters when running, wax, sap or other material may be on the blade or windshield.

Clean the outside of the windshield with a full-strength glass cleaning liquid. The windshield is clean if beads do not form when you rinse it with water.

Grime from the windshield will stick to the wiper blades and affect their performance. Clean the blade by wiping vigorously with a cloth soaked in full-strength windshield washer solvent. Then rinse the blade with water.

Check the wiper blades and clean them as necessary; replace blades that look worn.

Cleaning Aluminum or Chrome-Plated Wheels

Your vehicle may be equipped with either aluminum or chrome-plated wheels.

Keep your wheels clean using a soft clean cloth with mild soap and water. Rinse with clean water. After rinsing thoroughly, dry with a soft clean towel. A wax may then be applied.

The surface of these wheels is similar to the painted surface of your vehicle. Don't use strong soaps, chemicals, abrasive polishes, abrasive cleaners, cleaners with acid, or abrasive cleaning brushes on them because you could damage the surface. Do not use chrome polish on aluminum wheels.

Use chrome polish only on chrome-plated wheels, but avoid any painted surface of the wheel, and buff off immediately after application.

Don't take your vehicle through an automatic car wash that has silicone carbide tire cleaning brushes. These brushes can also damage the surface of these wheels.

Cleaning Tires

To clean your tires, use a stiff brush with tire cleaner.

Notice: When applying a tire dressing, always take care to wipe off any overspray or splash from all painted surfaces on the body or wheels of the vehicle. Petroleum-based products may damage the paint finish and tires.

Sheet Metal Damage

If your vehicle is damaged and requires sheet metal repair or replacement, make sure the body repair shop applies anti-corrosion material to parts repaired or replaced to restore corrosion protection.

Original manufacturer replacement parts will provide the corrosion protection while maintaining the warranty.

Finish Damage

Any stone chips, fractures or deep scratches in the finish should be repaired right away. Bare metal will corrode quickly and may develop into major repair expense.

Minor chips and scratches can be repaired with touch-up materials available from your dealer. Larger areas of finish damage can be corrected in your dealer's body and paint shop.

Underbody Maintenance

Chemicals used for ice and snow removal and dust control can collect on the underbody. If these are not removed, corrosion and rust can develop on the underbody parts such as fuel lines, frame, floor pan and exhaust system even though they have corrosion protection.

At least every spring, flush these materials from the underbody with plain water. Clean any areas where mud and debris can collect. Dirt packed in close areas of the frame should be loosened before being flushed. Your dealer or an underbody car washing system can do this for you.

Chemical Paint Spotting

Some weather and atmospheric conditions can create a chemical fallout. Airborne pollutants can fall upon and attack painted surfaces on your vehicle. This damage can take two forms: blotchy, ring-shaped discolorations, and small, irregular dark spots etched into the paint surface.

Although no defect in the paint job causes this, GM will repair, at no charge to the owner, the surfaces of new vehicles damaged by this fallout condition within 12 months or 12,000 miles (20 000 km) of purchase, whichever occurs first.

Vehicle Care/Appearance Materials

See your GM dealer for more information on purchasing the following products.

Vehicle Care/Appearance Materials

Description	Usage
Polishing Cloth Wax-Treated	Interior and exterior polishing cloth.
Tar and Road Oil Remover	Removes tar, road oil and asphalt.
Chrome Cleaner and Polish	Use on chrome or stainless steel.
White Sidewall Tire Cleaner	Removes soil and black marks from whitewalls.
Vinyl Cleaner	Cleans vinyl tops, upholstery and convertible tops.
Glass Cleaner	Removes dirt, grime, smoke and fingerprints.
Chrome and Wire Wheel Cleaner	Removes dirt and grime from chrome wheels and wire wheel covers.
Finish Enhancer	Removes dust, fingerprints, and surface contaminants. Spray on wipe off.

Vehicle Care/Appearance Materials (cont'd)

Description	Usage
Swirl Remover Polish	Removes swirl marks, fine scratches and other light surface contamination.
Cleaner Wax	Removes light scratches and protects finish.
Foaming Tire Shine Low Gloss	Cleans, shines and protects in one easy step, no wiping necessary.
Wash Wax Concentrate	Medium foaming shampoo. Cleans and lightly waxes. Biodegradable and phosphate free.
Spot Lifter	Quickly and easily removes spots and stains from carpets, vinyl and cloth upholstery.
Odor Eliminator	Odorless spray odor eliminator used on fabrics, vinyl, leather and carpet.
See your General Motors parts department for these products. See <i>Part D: Recommended Fluids and Lubricants on page 6-23.</i>	

Vehicle Identification

Vehicle Identification Number (VIN)



This is the legal identifier for your vehicle. It appears on a plate in the front corner of the instrument panel, on the driver's side. You can see it if you look through the windshield from outside your vehicle. The VIN also appears on the Vehicle Certification and Service Parts labels and the certificates of title and registration.

Engine Identification

The 8th character in your VIN is the engine code. This code will help you identify your engine, specifications and replacement parts.

Service Parts Identification Label

You'll find this label on your spare tire cover. It's very helpful if you ever need to order parts. On this label is:

- your VIN,
- the model designation,
- paint information and
- a list of all production options and special equipment.

Be sure that this label is not removed from the vehicle.

Electrical System

Add-On Electrical Equipment

Notice: Don't add anything electrical to your vehicle unless you check with your dealer first. Some electrical equipment can damage your vehicle and the damage wouldn't be covered by your warranty. Some add-on electrical equipment can keep other components from working as they should.

Your vehicle has an air bag system. Before attempting to add anything electrical to your vehicle, see *Servicing Your Air Bag-Equipped Vehicle on page 1-54.*

Power Windows and Other Power Options

Circuit breakers in the rear fuse block protect the power windows and other power accessories. When the current load is too heavy, the circuit breaker opens and closes, protecting the circuit until the problem is fixed or goes away.

Fuses and Circuit Breakers

The wiring circuits in your vehicle are protected from short circuits by a combination of fuses and circuit breakers. This greatly reduces the chance of fires caused by electrical problems.

Look at the silver-colored band inside the fuse. If the band is broken or melted, replace the fuse. Be sure you replace a bad fuse with a new one of the identical size and rating.

You will find a fuse puller clipped in both of the fuse blocks. Snap the wide end of the fuse puller at the side indentations and pull the fuse out.

The MaxiFuses are located in two fuse blocks, one located in the engine compartment on the passenger's side and the other under the rear seat on the driver's side. If a MaxiFuse should blow, have your vehicle serviced by your dealer immediately.

Engine Compartment Fuse Block



The engine compartment fuse block is located near the front on the passenger's side of the vehicle. See *Engine Compartment Overview* on page 5-12 for more information on location.

Lift the cover to gain access. On some vehicles, there may be an additional cover that you will need to lift to gain access to the fuses.

Fuse 22 or 23 can be moved to the outer position to provide continuous power to the auxiliary outlets or cigarette lighter when the ignition is not on. See your dealer for additional assistance, if needed.

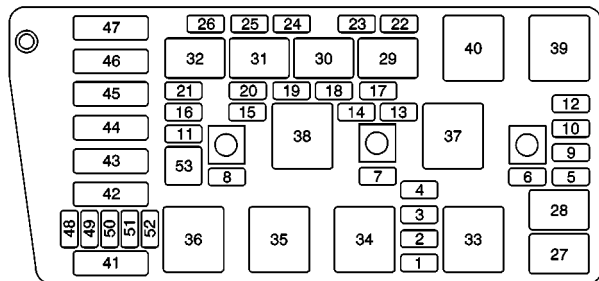

Fuses

Fuses	Usage
1	Not Used
2	Accessory
3	Windshield Wipers
4	Not Used
5	Left Low-Beam Headlamp
6	Right Low-Beam Headlamp
7	Instrument Panel

Fuses

8	Powertrain Control Module Battery
9	Right High-Beam Headlamp
10	Left High-Beam Headlamp
11	Ignition 1
12	Not Used
13	Transaxle
14	Cruise Control
15	Direct Ignition System
16	Injector Bank #2
17	Not Used
18	Not Used
19	Powertrain Control Module Ignition
20	Oxygen Sensor
21	Injector Bank #1
22	Auxiliary Power
23	Cigarette Lighter
24	Fog Lamps/Daytime Running Lamps
25	Horn
26	Air Conditioner Clutch

Relays	Usage
27	High-Beam Headlamp
28	Low-Beam Headlamp
29	Fog Lamps
30	Daytime Running Lamps
31	Horn
32	Air Conditioner Clutch
33	HVAC Solenoid
34	Accessory
35	Not Used
36	Starter 1
37	Cooling Fan 1
38	Ignition 1
39	Cooling Fan Series/Parallel
40	Cooling Fan 2

Circuit Breakers	Usage
41	Starter

Fuses	Usage
42	Not Used
43	Empty
44	ABS
45	Not Used
46	Cooling Fan 1
47	Cooling Fan 2
48	Spare
49	Spare
50	Spare
51	Spare
52	Spare
53	Fuse Puller

Removing the Rear Seat Cushion

Notice: The battery and main fuse blocks are located under the rear seat cushion. The battery's ground terminal and some relay wires are exposed. To help avoid damage to the battery and wires, be careful when removing or reinstalling the seat cushion. Do not remove covers from covered parts. Do not store anything under the seat, as objects could touch exposed wires and cause a short.

To remove the rear seat cushion, do the following:

1. Pull up on the front of the cushion to release the front hooks.
2. Pull the cushion up and out toward the front of the vehicle.

To reinstall the rear seat cushion, do the following:

CAUTION:

A safety belt that isn't properly routed through the seat cushion or is twisted won't provide the protection needed in a crash. If the safety belt hasn't been routed through the seat cushion at all, it won't be there to work for the next passenger. The person sitting in that position could be badly injured. After reinstalling the seat cushion, always check to be sure that the safety belts are properly routed and are not twisted.

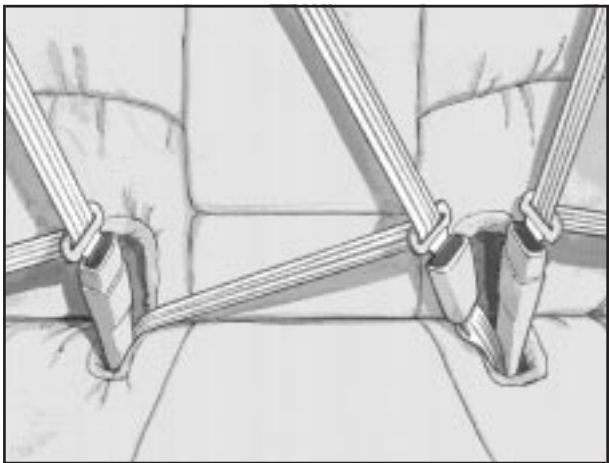

1. Buckle the center passenger position safety belt, then route the safety belts through the proper slots in the seat cushion. Don't let the safety belts get twisted.

2. Slide the rear of the cushion up and under the seatback so the rear-locating guides hook into the wire loops on the back frame.
3. With the seat cushion lowered, push rearward and then press down on the seat cushion until the spring locks on both ends engage.
4. Check to make sure the safety belts are properly routed and that no portion of any safety belt is trapped under the seat. Also make sure the seat cushion is secured.

Rear Underseat Fuse Block



The rear fuse block is located beneath the rear seat on the driver's side. The rear seat cushion must be removed to access the fuse block. See *Removing the Rear Seat Cushion* on page 5-89.

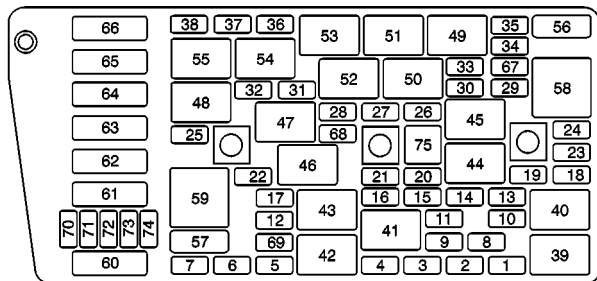

Fuses	Usage
1	Fuel Pump
2	HVAC Blower
3	Memory
4	Assembly Line Diagnostic Link
5	Not Used
6	Compact Disc (CD)
7	Driver's Door Module
8	Air Bag System (SIR)
9	Not Used
10	Right Parking Lamp
11	Vent Solenoid
12	Ignition 1
13	Left Parking Lamp

Fuses	Usage
14	Dimmer
15	Satellite Digital Radio
16	Left Front Heated Seat
17	Not Used
18	Rear Door Module
19	Stoplamp
20	Park/Reverse
21	Audio
22	Retained Accessory Power (RAP)
23	Not Used
24	Not Used
25	Passenger Door Module
26	Body
27	Interior Lamps
28	Not Used
29	Ignition Switch
30	Instrument Panel
31	Right Front Heated Seat
32	Not Used
33	HVAC
34	Ignition 3 Rear
35	Anti-Lock Brake System (ABS)
36	Turn Signal/Hazard
37	HVAC Battery
38	Dimmer

Relays	Usage
39	Fuel Pump
40	Parking Lamp
41	Ignition 1
42	Rear Fog Lamp
43	Not Used
44	Park
45	Reverse
46	Retained Accessory Power (RAP)
47	Fuel Tank Door Lock
48	Not Used
49	Ignition 3
50	Fuel Tank Door Release
51	Interior Lamps
52	Trunk Release
53	Front Courtesy Lamps
54	Not Used
55	Electronic Level Control (ELC)

**Circuit
Breakers**

	Usage
56	Power Seats
57	Power Windows

Relays	Usage
58	Cigar
59	Rear Defogger

Fuses	Usage
60	Not Used
61	Rear Defog
62	Not Used
63	Audio Amplifier
64	Electronic Level Control (ELC)
65	Cigar
66	Not Used
67	Not Used
68	Not Used
69	Spare
70	Spare
71	Spare
72	Spare
73	Spare
74	Spare
75	Fuse Puller

Capacities and Specifications

The following approximate capacities are given in English and metric conversions. Please refer to *Part D: Recommended Fluids and Lubricants* on page 6-23 for more information.

Capacities

Application	Capacities	
	English	Metric
Wheel Nut Torque	100 lb-ft	140 N•m
Automatic Transaxle	7.4 quarts	7.0 L
Engine Cooling System	10.0 quarts	9.5 L
Engine Oil with Filter	4.5 quarts	4.3 L
Fuel Tank	18.5 gallons	70.0 L
Air Conditioning Refrigerant R134a	2.2 lbs	1.0 kg

All capacities are approximate. When adding, be sure to fill to the appropriate level, as recommended in this manual. Recheck fluid level after filling.

Engine Specifications

Engine	VIN Code	Transmission	Spark Plug Gap	Firing Order
3.8L V6	K	Automatic	0.060 inch (1.52 mm)	1-6-5-4-3-2

Normal Maintenance Replacement Parts

Normal Maintenance Replacement Parts

Part	Number
Engine Air Cleaner/Filter	A1096C*
Passenger Compartment Air Filter	GM Part # 25654414
Engine Oil Filter	PF-47*
Fuel Filter	GF-627*
Transaxle Filter	GM Part # 24206433
PCV Valve	GM Part # 17113515
Spark Plugs	41-101*
Windshield Wiper Blades Length Type	22 inches (56.0 cm) Shepherd's Hook
*ACDelco® part number	

Section 6 Maintenance Schedule

Maintenance Schedule	6-2	At Least Twice a Year	6-18
Introduction	6-2	At Least Once a Year	6-18
Your Vehicle and the Environment	6-2	Part C: Periodic Maintenance Inspections	6-21
Maintenance Requirements	6-2	Steering, Suspension and Front Drive Axle	
How This Section is Organized	6-3	Boot and Seal Inspection	6-21
Part A: Scheduled Maintenance Services	6-4	Exhaust System Inspection	6-21
Using Your Maintenance Schedule	6-4	Fuel System Inspection	6-22
Selecting the Right Schedule	6-5	Engine Cooling System Inspection	6-22
Short Trip/City Scheduled Maintenance	6-6	Throttle System Inspection	6-22
Long Trip/Highway Scheduled Maintenance	6-13	Brake System Inspection	6-22
Part B: Owner Checks and Services	6-17	Part D: Recommended Fluids and	
At Each Fuel Fill	6-17	Lubricants	6-23
At Least Once a Month	6-17	Part E: Maintenance Record	6-24

Maintenance Schedule

Introduction

Important: Keep engine oil at the proper level and change as recommended.



Have you purchased the GM Protection Plan? The Plan supplements your new vehicle warranties. See your Warranty and Owner Assistance booklet or your dealer for details.

Your Vehicle and the Environment

Proper vehicle maintenance not only helps to keep your vehicle in good working condition, but also helps the environment. Improper vehicle maintenance can even affect the quality of the air we breathe. Improper fluid levels or the wrong tire inflation can increase the level of emissions from your vehicle. To help protect our environment, and to keep your vehicle in good condition, be sure to maintain your vehicle properly.

Maintenance Requirements

Maintenance intervals, checks, inspections and recommended fluids and lubricants as prescribed in this manual are necessary to keep your vehicle in good working condition. Any damage caused by failure to follow scheduled maintenance may not be covered by warranty.

How This Section is Organized

This maintenance schedule is divided into five parts:

“Part A: Scheduled Maintenance Services” explains what to have done and how often. Some of these services can be complex, so unless you are technically qualified and have the necessary equipment, you should let your GM dealer’s service department do these jobs.

Your GM dealer has GM-trained and supported service people that will perform the work using genuine GM parts.

CAUTION:

Performing maintenance work on a vehicle can be dangerous. In trying to do some jobs, you can be seriously injured. Do your own maintenance work only if you have the required know-how and the proper tools and equipment for the job. If you have any doubt, have a qualified technician do the work.

If you want to get the service information, see *Service Publications Ordering Information* on page 7-10.

“Part B: Owner Checks and Services” tells you what should be checked and when. It also explains what you can easily do to help keep your vehicle in good condition.

“Part C: Periodic Maintenance Inspections” explains important inspections that your dealer’s service department can perform for you.

“Part D: Recommended Fluids and Lubricants” lists some recommended products necessary to help keep your vehicle properly maintained. These products, or their equivalents, should be used whether you do the work yourself or have it done.

“Part E: Maintenance Record” is a place for you to record and keep track of the maintenance performed on your vehicle. Keep your maintenance receipts. They may be needed to qualify your vehicle for warranty repairs.

Part A: Scheduled Maintenance Services

In this part are scheduled maintenance services which are to be performed at the mileage intervals specified.

Using Your Maintenance Schedule

We at General Motors want to keep your vehicle in good working condition. But we don't know exactly how you'll drive it. You may drive short distances only a few times a week. Or you may drive long distances all the time in very hot, dusty weather. You may use your vehicle in making deliveries. Or you may drive it to work, to do errands or in many other ways.

Because of the different ways people use their vehicles, maintenance needs may vary. You may need more frequent checks and replacements. So please read the following and note how you drive. If you have questions on how to keep your vehicle in good condition, see your dealer.

This part tells you the maintenance services you should have done and when to schedule them.

When you go to your dealer for your service needs, you'll know that GM-trained and supported service people will perform the work using genuine GM parts.

The proper fluids and lubricants to use are listed in Part D. Make sure whoever services your vehicle uses these. All parts should be replaced and all necessary repairs done before you or anyone else drives the vehicle.

These schedules are for vehicles that:

- carry passengers and cargo within recommended limits. You will find these on your vehicle's Tire-Loading Information label. See *Loading Your Vehicle on page 4-33*.
- are driven on reasonable road surfaces within legal driving limits.
- use the recommended fuel. See *Gasoline Octane on page 5-4*.

Selecting the Right Schedule

First you'll need to decide which of the two schedules is right for your vehicle. Here's how to decide which schedule to follow:

Short Trip/City Definition

Follow the Short Trip/City Scheduled Maintenance if any one of these conditions is true for your vehicle:

- Most trips are less than 5 miles (8 km). This is particularly important when outside temperatures are below freezing.
- Most trips include extensive idling (such as frequent driving in stop-and-go traffic).
- You frequently tow a trailer or use a carrier on top of your vehicle.
- If the vehicle is used for delivery service, police, taxi or other commercial application.

One of the reasons you should follow this schedule if you operate your vehicle under any of these conditions is that these conditions cause engine oil to break down sooner.

Short Trip/City Intervals

Every 3,000 Miles (5 000 km): Engine Oil and Filter Change (or 3 months, whichever occurs first).

Every 6,000 Miles (10 000 km): Tire Rotation.

Every 15,000 Miles (25 000 km): Engine Air Cleaner Filter Inspection.

Every 30,000 Miles (50 000 km): Engine Air Cleaner Filter Replacement.

Every 50,000 Miles (83 000 km): Automatic Transaxle Service (severe conditions only).

Every 100,000 Miles (166 000 km): Spark Plug Wire Inspection. Spark Plug Replacement. Automatic Transaxle Service (normal conditions).

Every 150 000 Miles (240 000 km): Cooling System Service (or every 60 months, whichever occurs first). Engine Accessory Drive Belt Inspection.

These intervals only summarize maintenance services. Be sure to follow the complete scheduled maintenance on the following pages.

Long Trip/Highway Definition

Follow this scheduled maintenance *only* if none of the conditions from the Short Trip/City Scheduled Maintenance are true. Do not use this schedule if the vehicle is used for trailer towing, driven in a dusty area or used off paved roads. Use the Short Trip/City schedule for these conditions

Driving a vehicle with a fully warmed engine under highway conditions will cause engine oil to break down slower.

Long Trip/Highway Intervals

Every 7,500 Miles (12 500 km): Engine Oil and Filter Change (or every 12 months, whichever occurs first). Tire Rotation.

Every 15,000 Miles (25 000 km): Engine Air Cleaner Filter Inspection.

Every 30,000 Miles (50 000 km): Engine Air Cleaner Filter Replacement.

Every 50,000 Miles (83 000 km): Automatic Transaxle Service (severe conditions only).

Every 100,000 Miles (166 000 km): Spark Plug Wire Inspection. Spark Plug Replacement. Automatic Transaxle Service (normal conditions.)

Every 150,000 Miles (240 000 km): Cooling System Service (or every 60 months, whichever occurs first). Engine Accessory Drive Belt Inspection.

These intervals only summarize maintenance services. Be sure to follow the complete scheduled maintenance on the following pages.

Short Trip/City Scheduled Maintenance

The services shown in this schedule up to 100,000 miles (166 000 km) should be repeated after 100,000 miles (166 000 km) at the same intervals for the life of this vehicle. The services shown at 150,000 miles (240 000 km) should be repeated at the same interval after 150,000 miles (240 000 km) for the life of this vehicle.

See *Part B: Owner Checks and Services on page 6-17* and *Part C: Periodic Maintenance Inspections on page 6-21.*

Footnotes

† The U.S. Environmental Protection Agency or the California Air Resources Board has determined that the failure to perform this maintenance item will not nullify the emission warranty or limit recall liability prior to the completion of the vehicle's useful life. We, however, urge that all recommended maintenance services be performed at the indicated intervals and the maintenance be recorded.

* If your vehicle has the GM Oil Life System, a computer system lets you know when to change the oil and filter. This is based on engine revolutions and engine temperature, and not on mileage. Based on driving conditions, the mileage at which an oil change will be indicated can vary considerably. For the oil life system to work properly, you must reset the system every time the oil is changed.

When the system has calculated that oil life has been diminished, it will indicate that an oil change is necessary. A CHANGE ENGINE OIL SOON message will come on. Change your oil as soon as possible within the next two times you stop for fuel. It is possible that, if you are driving under the best conditions, the oil life system may not indicate that an oil change is necessary for over a year. However, your engine oil and filter must be changed at least once a year and at this time the system must be reset. It is also important to check your oil regularly and keep it at the proper level.

If the system is ever reset accidentally, you must change your oil at 3,000 miles (5 000 km) since your last oil change. Remember to reset the oil life system whenever the oil is changed. See Engine Oil on page 5-13 for information on resetting the system.

Whenever the tires are rotated, the Check Tire Pressure System (if equipped) must be reset.

+ A good time to check your brakes is during tire rotation. See Brake System Inspection on page 6-22.

3,000 Miles (5 000 km)

- Change engine oil and filter (or every 3 months, whichever occurs first). An Emission Control Service. (See footnote *.)

6,000 Miles (10 000 km)

- Change engine oil and filter (or every 3 months, whichever occurs first). An Emission Control Service. (See footnote *.)
- Rotate tires. See *Tire Inspection and Rotation* on page 5-60 for proper rotation pattern and additional information. (See footnote .) (See footnote +.)

9,000 Miles (15 000 km)

- Change engine oil and filter (or every 3 months, whichever occurs first). An Emission Control Service. (See footnote *.)

12,000 Miles (20 000 km)

- Change engine oil and filter (or every 3 months, whichever occurs first). *An Emission Control Service. (See footnote *.)*
- Rotate tires. See *Tire Inspection and Rotation on page 5-60* for proper rotation pattern and additional information. *(See footnote .) (See footnote +.)*

15,000 Miles (25 000 km)

- Change engine oil and filter (or every 3 months, whichever occurs first). *An Emission Control Service. (See footnote *.)*
- Inspect engine air cleaner filter. If necessary, replace the filter. If vehicle is driven in dusty/dirty conditions, inspect filter at every engine oil change. See *Engine Air Cleaner/Filter on page 5-18* for more information. *An Emission Control Service. (See footnote †.)*

18,000 Miles (30 000 km)

- Change engine oil and filter (or every 3 months, whichever occurs first). *An Emission Control Service. (See footnote *.)*
- Rotate tires. See *Tire Inspection and Rotation on page 5-60* for proper rotation pattern and additional information. *(See footnote .) (See footnote +.)*

21,000 Miles (35 000 km)

- Change engine oil and filter (or every 3 months, whichever occurs first). *An Emission Control Service. (See footnote *.)*

24,000 Miles (40 000 km)

- Change engine oil and filter (or every 3 months, whichever occurs first). *An Emission Control Service. (See footnote *.)*
- Rotate tires. See *Tire Inspection and Rotation on page 5-60* for proper rotation pattern and additional information. *(See footnote .) (See footnote +.)*

27,000 Miles (45 000 km)

- Change engine oil and filter (or every 3 months, whichever occurs first). *An Emission Control Service. (See footnote *.)*

30,000 Miles (50 000 km)

- Change engine oil and filter (or every 3 months, whichever occurs first). *An Emission Control Service. (See footnote *.)*
- Replace engine air cleaner filter. See *Engine Air Cleaner/Filter on page 5-18* for more information. *An Emission Control Service.*
- Rotate tires. See *Tire Inspection and Rotation on page 5-60* for proper rotation pattern and additional information. *(See footnote .) (See footnote +.)*

33,000 Miles (55 000 km)

- ❑ Change engine oil and filter (or every 3 months, whichever occurs first). *An Emission Control Service. (See footnote *.)*

36,000 Miles (60 000 km)

- ❑ Change engine oil and filter (or every 3 months, whichever occurs first). *An Emission Control Service. (See footnote *.)*
- ❑ Rotate tires. See *Tire Inspection and Rotation on page 5-60* for proper rotation pattern and additional information. *(See footnote .) (See footnote +.)*

39,000 Miles (65 000 km)

- ❑ Change engine oil and filter (or every 3 months, whichever occurs first). *An Emission Control Service. (See footnote *.)*

42,000 Miles (70 000 km)

- ❑ Change engine oil and filter (or every 3 months, whichever occurs first). *An Emission Control Service. (See footnote *.)*
- ❑ Rotate tires. See *Tire Inspection and Rotation on page 5-60* for proper rotation pattern and additional information. *(See footnote .) (See footnote +.)*

45,000 Miles (75 000 km)

- ❑ Change engine oil and filter (or every 3 months, whichever occurs first). *An Emission Control Service. (See footnote *.)*
- ❑ Inspect engine air cleaner filter. If necessary, replace the filter. If vehicle is driven in dusty/dirty conditions, inspect filter at every engine oil change. See *Engine Air Cleaner/Filter on page 5-18* for more information. *An Emission Control Service. (See footnote †.)*

48,000 Miles (80 000 km)

- ❑ Change engine oil and filter (or every 3 months, whichever occurs first). *An Emission Control Service. (See footnote *.)*
- ❑ Rotate tires. See *Tire Inspection and Rotation on page 5-60* for proper rotation pattern and additional information. *(See footnote .) (See footnote +.)*

50,000 Miles (83 000 km)

- ❑ Change automatic transaxle fluid and filter if the vehicle is mainly driven under one or more of these conditions:
 - In heavy city traffic where the outside temperature regularly reaches 90°F (32°C) or higher.
 - In hilly or mountainous terrain.
 - When doing frequent trailer towing.
 - Uses such as found in taxi, police or delivery service.

If you do not use your vehicle under any of these conditions, change the fluid and filter at 100,000 miles (166 000 km).

51,000 Miles (85 000 km)

- ❑ Change engine oil and filter (or every 3 months, whichever occurs first). *An Emission Control Service. (See footnote *.)*

54,000 Miles (90 000 km)

- ❑ Change engine oil and filter (or every 3 months, whichever occurs first). *An Emission Control Service. (See footnote *.)*
- ❑ Rotate tires. See *Tire Inspection and Rotation on page 5-60* for proper rotation pattern and additional information. *(See footnote .) (See footnote +.)*

57,000 Miles (95 000 km)

- ❑ Change engine oil and filter (or every 3 months, whichever occurs first). *An Emission Control Service. (See footnote *.)*

60,000 Miles (100 000 km)

- ❑ Change engine oil and filter (or every 3 months, whichever occurs first). *An Emission Control Service. (See footnote *.)*
- ❑ Replace engine air cleaner filter. See *Engine Air Cleaner/Filter on page 5-18* for more information. *An Emission Control Service.*
- ❑ Rotate tires. See *Tire Inspection and Rotation on page 5-60* for proper rotation pattern and additional information. *(See footnote .) (See footnote +.)*

63,000 Miles (105 000 km)

- ❑ Change engine oil and filter (or every 3 months, whichever occurs first). *An Emission Control Service. (See footnote *.)*

66,000 Miles (110 000 km)

- ❑ Change engine oil and filter (or every 3 months, whichever occurs first). *An Emission Control Service. (See footnote *.)*
- ❑ Rotate tires. See *Tire Inspection and Rotation on page 5-60* for proper rotation pattern and additional information. *(See footnote .) (See footnote +.)*

69,000 Miles (115 000 km)

- ❑ Change engine oil and filter (or every 3 months, whichever occurs first). *An Emission Control Service.* (See footnote *.)

72,000 Miles (120 000 km)

- ❑ Change engine oil and filter (or every 3 months, whichever occurs first). *An Emission Control Service.* (See footnote *.)
- ❑ Rotate tires. See *Tire Inspection and Rotation on page 5-60* for proper rotation pattern and additional information. (See footnote .) (See footnote +.)

75,000 Miles (125 000 km)

- ❑ Change engine oil and filter (or every 3 months, whichever occurs first). *An Emission Control Service.* (See footnote *.)
- ❑ Inspect engine air cleaner filter. If necessary, replace the filter. If vehicle is driven in dusty/dirty conditions, inspect filter at every engine oil change. See *Engine Air Cleaner/Filter on page 5-18* for more information. *An Emission Control Service.* (See footnote †.)

78,000 Miles (130 000 km)

- ❑ Change engine oil and filter (or every 3 months, whichever occurs first). *An Emission Control Service.* (See footnote *.)
- ❑ Rotate tires. See *Tire Inspection and Rotation on page 5-60* for proper rotation pattern and additional information. (See footnote .) (See footnote +.)

81,000 Miles (135 000 km)

- ❑ Change engine oil and filter (or every 3 months, whichever occurs first). *An Emission Control Service.* (See footnote *.)

84,000 Miles (140 000 km)

- ❑ Change engine oil and filter (or every 3 months, whichever occurs first). *An Emission Control Service.* (See footnote *.)
- ❑ Rotate tires. See *Tire Inspection and Rotation on page 5-60* for proper rotation pattern and additional information. (See footnote .) (See footnote +.)

87,000 Miles (145 000 km)

- ❑ Change engine oil and filter (or every 3 months, whichever occurs first). *An Emission Control Service.* (See footnote *.)

90,000 Miles (150 000 km)

- ❑ Change engine oil and filter (or every 3 months, whichever occurs first). *An Emission Control Service.* (See footnote *.)
- ❑ Replace engine air cleaner filter. See *Engine Air Cleaner/Filter* on page 5-18 for more information. *An Emission Control Service.*
- ❑ Rotate tires. See *Tire Inspection and Rotation* on page 5-60 for proper rotation pattern and additional information. (See footnote .) (See footnote +.)

93,000 Miles (155 000 km)

- ❑ Change engine oil and filter (or every 3 months, whichever occurs first). *An Emission Control Service.* (See footnote *.)

96,000 Miles (160 000 km)

- ❑ Change engine oil and filter (or every 3 months, whichever occurs first.) *An Emission Control Service.* (See footnote *.)
- ❑ Rotate tires. See *Tire Inspection and Rotation* on page 5-60 for proper rotation pattern and additional information. (See footnote .) (See footnote +.)

99,000 Miles (165 000 km)

- ❑ Change engine oil and filter (or every 3 months, whichever occurs first). *An Emission Control Service.* (See footnote *.)

100,000 Miles (166 000 km)

- ❑ Inspect spark plug wires. *An Emission Control Service.*
- ❑ Replace spark plugs. *An Emission Control Service.*
- ❑ Change automatic transaxle fluid and filter if the vehicle is mainly driven under one or more of these conditions:
 - In heavy city traffic where the outside temperature regularly reaches 90°F (32°C) or higher.
 - In hilly or mountainous terrain.
 - When doing frequent trailer towing.
 - Uses such as found in taxi, police or delivery service.
- ❑ If you haven't used your vehicle under severe service conditions listed previously and, therefore, haven't changed your automatic transaxle fluid, change both the fluid and filter.

150,000 Miles (240 000 km)

- ❑ Drain, flush and refill cooling system (or every 60 months since last service, whichever occurs first). See *Engine Coolant* on page 5-23 for what to use. Inspect hoses. Clean radiator, condenser, pressure cap and neck. Pressure test cooling system and pressure cap. *An Emission Control Service.*
- ❑ Inspect engine accessory drive belt. *An Emission Control Service.*

Long Trip/Highway Scheduled Maintenance

The services shown in this schedule up to 100,000 miles (166 000 km) should be repeated after 100,000 miles (166 000 km) at the same intervals for the life of this vehicle. The services shown at 150,000 miles (240 000 km) should be repeated at the same interval after 150,000 miles (240 000 km) for the life of this vehicle.

See *Part B: Owner Checks and Services on page 6-17* and *Part C: Periodic Maintenance Inspections on page 6-21*.

Footnotes

† *The U.S. Environmental Protection Agency or the California Air Resources Board has determined that the failure to perform this maintenance item will not nullify the emission warranty or limit recall liability prior to the completion of the vehicle's useful life. We, however, urge that all recommended maintenance services be performed at the indicated intervals and the maintenance be recorded.*

** If your vehicle has the GM Oil Life System, a computer system lets you know when to change the engine oil and filter. This is based on engine revolutions and engine temperature, and not on mileage. Based on driving conditions, the mileage at which an oil change will be indicated can vary considerably. For the oil life system to work properly, you must reset the system every time the oil is changed.*

When the system has calculated that oil life has been diminished, it will indicate that an oil change is necessary. A CHANGE ENGINE OIL SOON message will come on. Change your oil as soon as possible within the next two times you stop for fuel. It is possible that, if you are driving under the best conditions, the oil life system may not indicate that an oil change is necessary for over a year. However, your engine oil and filter must be changed at least once a year and at this time the system must be reset. It is also important to check your oil regularly and keep it at the proper level.

If the system is ever reset accidentally, you must change your oil at 3,000 miles (5 000 km) since your last oil change. Remember to reset the oil life system whenever the oil is changed. See Engine Oil on page 5-13 for information on resetting the system.

Whenever the tires are rotated, the Check Tire Pressure System (if equipped) must be reset.

+ A good time to check your brakes is during tire rotation. See Brake System Inspection on page 6-22.

7,500 Miles (12 500 km)

- Change engine oil and filter (or every 12 months, whichever occurs first). *An Emission Control Service.* (See footnote *.)
- Rotate tires. See *Tire Inspection and Rotation* on page 5-60 for proper rotation pattern and additional information. (See footnote .) (See footnote +.)

15,000 Miles (25 000 km)

- Change engine oil and filter (or every 12 months, whichever occurs first). *An Emission Control Service.* (See footnote *.)
- Inspect engine air cleaner filter. See *Engine Air Cleaner/Filter* on page 5-18 for more information. *An Emission Control Service.* (See footnote †.)
- Rotate tires. See *Tire Inspection and Rotation* on page 5-60 for proper rotation pattern and additional information. (See footnote .) (See footnote +.)

22,500 Miles (37 500 km)

- Change engine oil and filter (or every 12 months, whichever occurs first). *An Emission Control Service.* (See footnote *.)
- Rotate tires. See *Tire Inspection and Rotation* on page 5-60 for proper rotation pattern and additional information. (See footnote .) (See footnote +.)

30,000 Miles (50 000 km)

- Change engine oil and filter (or every 12 months, whichever occurs first). *An Emission Control Service.* (See footnote *.)
- Rotate tires. See *Tire Inspection and Rotation* on page 5-60 for proper rotation pattern and additional information. (See footnote .) (See footnote +.)
- Replace engine air cleaner filter. See *Engine Air Cleaner/Filter* on page 5-18 for more information. *An Emission Control Service.*

37,500 Miles (62 500 km)

- Change engine oil and filter (or every 12 months, whichever occurs first). *An Emission Control Service.* (See footnote *.)
- Rotate tires. See *Tire Inspection and Rotation* on page 5-60 for proper rotation pattern and additional information. (See footnote .) (See footnote +.)

45,000 Miles (75 000 km)

- Change engine oil and filter (or every 12 months, whichever occurs first). *An Emission Control Service.* (See footnote *.)
- Inspect engine air cleaner filter. See *Engine Air Cleaner/Filter* on page 5-18 for more information. *An Emission Control Service.* (See footnote †.)
- Rotate tires. See *Tire Inspection and Rotation* on page 5-60 for proper rotation pattern and additional information. (See footnote .) (See footnote +.)

50,000 Miles (83 000 km)

- Change automatic transaxle fluid and filter if the vehicle is mainly driven under one or more of these conditions:
 - In heavy city traffic where the outside temperature regularly reaches 90°F (32°C) or higher.
 - In hilly or mountainous terrain.
 - When doing frequent trailer towing.
 - Uses such as found in taxi, police or delivery service.

If you do not use your vehicle under any of these conditions, change the fluid and filter at 100,000 miles (166 000 km).

52,500 Miles (87 500 km)

- Change engine oil and filter (or every 12 months, whichever occurs first). *An Emission Control Service. (See footnote *.)*
- Rotate tires. See *Tire Inspection and Rotation on page 5-60* for proper rotation pattern and additional information. *(See footnote .) (See footnote +.)*

60,000 Miles (100 000 km)

- Change engine oil and filter (or every 12 months, whichever occurs first). *An Emission Control Service. (See footnote *.)*
- Rotate tires. See *Tire Inspection and Rotation on page 5-60* for proper rotation pattern and additional information. *(See footnote .) (See footnote +.)*
- Replace engine air cleaner filter. See *Engine Air Cleaner/Filter on page 5-18* for more information. *An Emission Control Service.*

67,500 Miles (112 500 km)

- Change engine oil and filter (or every 12 months, whichever occurs first). *An Emission Control Service. (See footnote *.)*
- Rotate tires. See *Tire Inspection and Rotation on page 5-60* for proper rotation pattern and additional information. *(See footnote .) (See footnote +.)*

75,000 Miles (125 000 km)

- Change engine oil and filter (or every 12 months, whichever occurs first). *An Emission Control Service. (See footnote *.)*
- Inspect engine air cleaner filter. See *Engine Air Cleaner/Filter on page 5-18* for more information. *An Emission Control Service. (See footnote †.)*
- Rotate tires. See *Tire Inspection and Rotation on page 5-60* for proper rotation pattern and additional information. *(See footnote .) (See footnote +.)*

82,500 Miles (137 500 km)

- ❑ Change engine oil and filter (or every 12 months, whichever occurs first). *An Emission Control Service. (See footnote *.)*
- ❑ Rotate tires. See *Tire Inspection and Rotation on page 5-60* for proper rotation pattern and additional information. *(See footnote .) (See footnote +.)*

90,000 Miles (150 000 km)

- ❑ Change engine oil and filter (or every 12 months, whichever occurs first). *An Emission Control Service. (See footnote *.)*
- ❑ Replace engine air cleaner filter. See *Engine Air Cleaner/Filter on page 5-18* for more information. *An Emission Control Service.*
- ❑ Rotate tires. See *Tire Inspection and Rotation on page 5-60* for proper rotation pattern and additional information. *(See footnote .) (See footnote +.)*

97,500 Miles (162 500 km)

- ❑ Change engine oil and filter (or every 12 months, whichever occurs first). *An Emission Control Service. (See footnote *.)*
- ❑ Rotate tires. See *Tire Inspection and Rotation on page 5-60* for proper rotation pattern and additional information. *(See footnote .) (See footnote +.)*

100,000 Miles (166 000 km)

- ❑ Inspect spark plug wires. *An Emission Control Service.*
- ❑ Replace spark plugs. *An Emission Control Service.*
- ❑ Change automatic transaxle fluid and filter if the vehicle is mainly driven under one or more of these conditions:
 - In heavy city traffic where the outside temperature regularly reaches 90°F (32°C) or higher.
 - In hilly or mountainous terrain.
 - When doing frequent trailer towing.
 - Uses such as found in taxi, police or delivery service.
- ❑ If you haven't used your vehicle under severe service conditions listed previously and, therefore, haven't changed your automatic transaxle fluid, change both the fluid and filter

150,000 Miles (240 000 km)

- ❑ Drain, flush and refill cooling system (or every 60 months since last service, whichever occurs first). See *Engine Coolant on page 5-23* for what to use. Inspect hoses. Clean radiator, condenser, pressure cap and neck. Pressure test the cooling system and pressure cap. *An Emission Control Service.*
- ❑ Inspect engine accessory drive belt. *An Emission Control Service.*

Part B: Owner Checks and Services

Listed in this part are owner checks and services which should be performed at the intervals specified to help ensure the safety, dependability and emission control performance of your vehicle.

Be sure any necessary repairs are completed at once. Whenever any fluids or lubricants are added to your vehicle, make sure they are the proper ones, as shown in Part D.

At Each Fuel Fill

It is important for you or a service station attendant to perform these underhood checks at each fuel fill.

Engine Oil Level Check

Check the engine oil level and add the proper oil if necessary. See *Engine Oil on page 5-13* for further details.

Engine Coolant Level Check

Check the engine coolant level and add DEX-COOL[®] coolant mixture if necessary. See *Engine Coolant on page 5-23* for further details.

Windshield Washer Fluid Level Check

Check the windshield washer fluid level in the windshield washer tank and add the proper fluid if necessary. See *Windshield Washer Fluid on page 5-36* for further details.

At Least Once a Month

Tire Inflation Check

Visually inspect your tires and make sure tires are inflated to the correct pressures. Don't forget to check your spare tire. See *Tires on page 5-58* for further details.

Cassette Tape Player Service

Clean cassette tape player. Cleaning should be done every 50 hours of tape play. See *Audio System(s) on page 3-55* for further details.

At Least Twice a Year

Restraint System Check

Make sure the safety belt reminder light and all your belts, buckles, latch plates, retractors and anchorages are working properly. Look for any other loose or damaged safety belt system parts. If you see anything that might keep a safety belt system from doing its job, have it repaired. Have any torn or frayed safety belts replaced.

Also look for any opened or broken air bag coverings, and have them repaired or replaced. (The air bag system does not need regular maintenance.)

Wiper Blade Check

Inspect wiper blades for wear or cracking. Replace blade inserts that appear worn or damaged or that streak or miss areas of the windshield. Also see “Windshield Wiper and Wiper Blades” under *Cleaning the Outside of Your Vehicle on page 5-80*.

Weatherstrip Lubrication

Silicone grease on weatherstrips will make them last longer, seal better, and not stick or squeak. Apply silicone grease with a clean cloth. During very cold, damp weather more frequent application may be required. See *Part D: Recommended Fluids and Lubricants on page 6-23*.

Automatic Transaxle Check

Check the transaxle fluid level; add if needed. See *Automatic Transaxle Fluid on page 5-21*. A fluid loss may indicate a problem. Check the system and repair if needed.

At Least Once a Year

Key Lock Cylinders Service

Lubricate the key lock cylinders with the lubricant specified in Part D.

Body Lubrication Service

Lubricate all body door hinges. Also lubricate all hinges and latches, including those for the hood, glove box door and console door. Part D tells you what to use. More frequent lubrication may be required when exposed to a corrosive environment.

Starter Switch Check

CAUTION:

When you are doing this check, the vehicle could move suddenly. If it does, you or others could be injured. Follow the steps below.

1. Before you start, be sure you have enough room around the vehicle.
2. Firmly apply both the parking brake and the regular brake. See *Parking Brake on page 2-27* if necessary.
Do not use the accelerator pedal, and be ready to turn off the engine immediately if it starts.
3. Try to start the engine in each gear. The starter should work only in PARK (P) or NEUTRAL (N). If the starter works in any other position, your vehicle needs service.

Automatic Transaxle Shift Lock Control System Check

CAUTION:

When you are doing this check, the vehicle could move suddenly. If it does, you or others could be injured. Follow the steps below.

1. Before you start, be sure you have enough room around the vehicle. It should be parked on a level surface.
2. Firmly apply the parking brake. See *Parking Brake on page 2-27* if necessary.
Be ready to apply the regular brake immediately if the vehicle begins to move.
3. With the engine off, turn the key to the RUN position, but don't start the engine. Without applying the regular brake, try to move the shift lever out of PARK (P) with normal effort. If the shift lever moves out of PARK (P), your vehicle needs service.

Ignition Transaxle Lock Check

While parked, and with the parking brake set, try to turn the ignition key to LOCK in each shift lever position.

- The key should turn to LOCK only when the shift lever is in PARK (P).
- The key should come out only in LOCK.

Parking Brake and Automatic Transaxle Park (P) Mechanism Check

CAUTION:

When you are doing this check, your vehicle could begin to move. You or others could be injured and property could be damaged. Make sure there is room in front of your vehicle in case it begins to roll. Be ready to apply the regular brake at once should the vehicle begin to move.

Park on a fairly steep hill, with the vehicle facing downhill. Keeping your foot on the regular brake, set the parking brake.

- To check the parking brake's holding ability: With the engine running and transaxle in NEUTRAL (N), slowly remove foot pressure from the regular brake pedal. Do this until the vehicle is held by the parking brake only.
- To check the PARK (P) mechanism's holding ability: With the engine running, shift to PARK (P). Then release the parking brake followed by the regular brake.

Underbody Flushing Service

At least every spring, use plain water to flush any corrosive materials from the underbody. Take care to clean thoroughly any areas where mud and other debris can collect.

Part C: Periodic Maintenance Inspections

Listed in this part are inspections and services which should be performed at least twice a year (for instance, each spring and fall). *You should let your dealer's service department do these jobs. Make sure any necessary repairs are completed at once.*

Proper procedures to perform these services may be found in a service manual. See *Service Publications Ordering Information on page 7-10.*

Steering, Suspension and Front Drive Axle Boot and Seal Inspection

Inspect the front and rear suspension and steering system for damaged, loose or missing parts, signs of wear or lack of lubrication. Inspect the power steering lines and hoses for proper hook-up, binding, leaks, cracks, chafing, etc. Clean and then inspect the drive axle boot seals for damage, tears or leakage. Replace seals if necessary.

Exhaust System Inspection

Inspect the complete exhaust system. Inspect the body near the exhaust system. Look for broken, damaged, missing or out-of-position parts as well as open seams, holes, loose connections or other conditions which could cause a heat build-up in the floor pan or could let exhaust fumes into the vehicle. See *Engine Exhaust on page 2-31.*

Fuel System Inspection

Inspect the complete fuel system for damage or leaks.

Engine Cooling System Inspection

Inspect the hoses and have them replaced if they are cracked, swollen or deteriorated. Inspect all pipes, fittings and clamps; replace as needed. Clean the outside of the radiator and air conditioning condenser. To help ensure proper operation, a pressure test of the cooling system and pressure cap is recommended at least once a year.

Throttle System Inspection

Inspect the throttle system for interference or binding, and for damaged or missing parts. Replace parts as needed. Replace any components that have high effort or excessive wear. Do not lubricate accelerator and cruise control cables.

Brake System Inspection

Inspect the complete system. Inspect brake lines and hoses for proper hook-up, binding, leaks, cracks, chafing, etc. Inspect disc brake pads for wear and rotors for surface condition. Inspect other brake parts, including calipers, parking brake, etc. You may need to have your brakes inspected more often if your driving habits or conditions result in frequent braking.

Part D: Recommended Fluids and Lubricants

Fluids and lubricants identified below by name, part number or specification may be obtained from your dealer.

Usage	Fluid/Lubricant
Engine Oil	Engine oil with the American Petroleum Institute Certified for Gasoline Engines starburst symbol of the proper viscosity. To determine the preferred viscosity for your vehicle's engine, see <i>Engine Oil on page 5-13</i> .
Engine Coolant	50/50 mixture of clean, drinkable water and use only DEX-COOL [®] Coolant. See <i>Engine Coolant on page 5-23</i> .
Hydraulic Brake System	Delco Supreme 11 Brake Fluid or equivalent DOT-3 brake fluid.
Windshield Washer Solvent	GM Optikleen [®] Washer Solvent or equivalent.
Parking Brake Cable Guides	Chassis Lubricant (GM Part No. U.S. 12377985, in Canada 88901242, or equivalent) or lubricant meeting requirements of NLGI #2, Category LB or GC-LB.

Usage	Fluid/Lubricant
Power Steering System	GM Power Steering Fluid (GM Part No. U.S. 1052884, in Canada 993294, or equivalent).
Automatic Transaxle	DEXRON [®] -III Automatic Transmission Fluid.
Key Lock Cylinders	Multi-Purpose Lubricant, Superlube (GM Part No. U.S. 12346241, in Canada 10953474, or equivalent).
Hood Latch Assembly, Secondary Latch, Pivots, Spring Anchor and Release Pawl	Lubriplate Lubricant Aerosol (GM Part No. U.S. 12346293, in Canada 992723, or equivalent) or lubricant meeting requirements of NLGI #2, Category LB or GC-LB.
Hood and Door Hinges	Multi-Purpose Lubricant, Superlube (GM Part No. U.S. 12346241, in Canada 10953474, or equivalent).
Fuel Door, Glove Box Door, Console Door and Rear Compartment Lid Hinges	Multi-Purpose Lubricant, Superlube (GM Part No. U.S. 12346241, in Canada 10953474, or equivalent).
Weatherstrip Conditioning	Dielectric Silicone Grease (GM Part No. U.S. 12345579, in Canada 10953014, or equivalent).

Part E: Maintenance Record

After the scheduled services are performed, record the date, odometer reading and who performed the service and any additional information from "Owner Checks and Services" or "Periodic Maintenance" on the following record pages. Also, you should retain all maintenance receipts.

Maintenance Record

Date	Odometer Reading	Serviced By	Maintenance Record

Maintenance Record (cont'd)

Date	Odometer Reading	Serviced By	Maintenance Record

Maintenance Record (cont'd)

Date	Odometer Reading	Serviced By	Maintenance Record

Section 7 Customer Assistance Information

Customer Assistance Information	7-2	Reporting Safety Defects	7-9
Customer Satisfaction Procedure	7-2	Reporting Safety Defects to the United States	
Online Owner Center	7-3	Government	7-9
Customer Assistance for Text Telephone		Reporting Safety Defects to the Canadian	
(TTY) Users	7-4	Government	7-10
Customer Assistance Offices	7-4	Reporting Safety Defects to General Motors	7-10
GM Mobility Program for Persons with		Service Publications Ordering Information	7-10
Disabilities	7-5		
Roadside Assistance Program	7-6		
Courtesy Transportation	7-7		

Customer Assistance Information

Customer Satisfaction Procedure

Your satisfaction and goodwill are important to your dealer and to Buick. Normally, any concerns with the sales transaction or the operation of your vehicle will be resolved by your dealer's sales or service departments. Sometimes, however, despite the best intentions of all concerned, misunderstandings can occur. If your concern has not been resolved to your satisfaction, the following steps should be taken:

STEP ONE: Discuss your concern with a member of dealership management. Normally, concerns can be quickly resolved at that level. If the matter has already been reviewed with the sales, service or parts manager, contact the owner of the dealership or the general manager.

STEP TWO: If after contacting a member of dealership management, it appears your concern cannot be resolved by the dealership without further help, contact the Buick Customer Assistance Center by calling 1-800-521-7300. In Canada, contact GM of Canada Customer Communication Centre in Oshawa by calling 1-800-263-3777 (English) or 1-800-263-7854 (French).

We encourage you to call the toll-free number in order to give your inquiry prompt attention. Please have the following information available to give the Customer Assistance Representative:

- Vehicle Identification Number (This is available from the vehicle registration or title, or the plate at the top left of the instrument panel and visible through the windshield.)
- Dealership name and location
- Vehicle delivery date and present mileage

When contacting Buick, please remember that your concern will likely be resolved at a dealer's facility. That is why we suggest you follow Step One first if you have a concern.

STEP THREE: Both General Motors and your dealer are committed to making sure you are completely satisfied with your new vehicle. However, if you continue to remain unsatisfied after following the procedure outlined in Steps One and Two, you should file with the GM/BBB Auto Line Program to enforce any additional rights you may have. Canadian owners refer to your Warranty and Owner Assistance Information booklet for information on the Canadian Motor Vehicle Arbitration Plan (CAMVAP).

The BBB Auto Line Program is an out of court program administered by the Council of Better Business Bureaus to settle automotive disputes regarding vehicle repairs or the interpretation of the New Vehicle Limited Warranty. Although you may be required to resort to this informal dispute resolution program prior to filing a court action, use of the program is free of charge and your case will generally be heard within 40 days. If you do not agree with the decision given in your case, you may reject it and proceed with any other venue for relief available to you.

You may contact the BBB using the toll-free telephone number or write them at the following address:

BBB Auto Line
Council of Better Business Bureaus, Inc.
4200 Wilson Boulevard
Suite 800
Arlington, VA 22203-1804
Telephone: 1-800-955-5100

This program is available in all 50 states and the District of Columbia. Eligibility is limited by vehicle age, mileage and other factors. General Motors reserves the right to change eligibility limitations and/or discontinue its participation in this program.

Online Owner Center

The Owner Center is a resource for your GM ownership needs. You can find your specific vehicle information all in one place.

The Owner Center allows you to:

- Get e-mail service reminders.
- Access information about your specific vehicle, including tips and videos and an electronic version of this owner's manual. (United States only)
- Keep track of your vehicle's service history and maintenance schedule.
- Find GM dealers for service nationwide.
- Receive special promotions and privileges only available to members. (United States only)

Refer to the web for updated information.

To register your vehicle, visit www.MyGMLink.com. (United States) or My GM Canada within www.gmcanada.com (Canada).

Customer Assistance for Text Telephone (TTY) Users

To assist customers who are deaf, hard of hearing, or speech-impaired and who use Text Telephones (TTYs), Buick has TTY equipment available at its Customer Assistance Center. Any TTY user can communicate with Buick by dialing: 1-800-83-BUICK. (TTY users in Canada can dial 1-800-263-3830.)

Customer Assistance Offices

Buick encourages customers to call the toll-free number for assistance. If a U.S. customer wishes to write to Buick, the letter should be addressed to Buick's Customer Assistance Center.

United States – Customer Assistance

Buick Customer Assistance Center
P.O. Box 33136
Detroit, MI 48232-5136

1-800-521-7300
1-800-832-8425 (For Text Telephone devices (TTYs))
Roadside Assistance: 1-800-252-1112
Fax Number: 313-381-0022

From Puerto Rico:
1-800-496-9992 (English)
1-800-496-9993 (Spanish)
Fax Number: 313-381-0022

From U.S. Virgin Islands
1-800-496-9994
Fax Number: 313-381-0022

Canada – Customer Assistance

General Motors of Canada Limited
Customer Communication Centre, 163-005
1908 Colonel Sam Drive
Oshawa, Ontario L1H 8P7

1-800-263-3777 (English)
1-800-263-7854 (French)
1-800-263-3830 (For Text Telephone devices (TTYs))
Roadside Assistance: 1-800-268-6800

Overseas – Customer Assistance

Please contact the local General Motors Business Unit.

Mexico, Central America and Caribbean Islands/Countries (Except Puerto Rico and U.S. Virgin Islands) – Customer Assistance

General Motors de Mexico, S. de R.L. de C.V.
Customer Assistance Center
Paseo de la Reforma # 2740
Col. Lomas de Bezares
C.P. 11910, Mexico, D.F.
01-800-508-0000
Long Distance: 011-52-53 29 0 800

GM Mobility Program for Persons with Disabilities

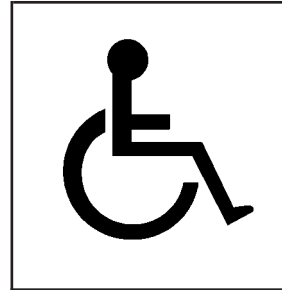

This program, available to qualified applicants, can reimburse you up to \$1,000 toward aftermarket driver or passenger adaptive equipment you may require for your vehicle (hand controls, wheelchair/scooter lifts, etc.).

This program can also provide you with free resource information, such as area driver assessment centers and mobility equipment installers. The program is available for a limited period of time from the date of vehicle purchase/lease. See your dealer for more details or call the GM Mobility Assistance Center at 1-800-323-9935. Text telephone (TTY) users, call 1-800-833-9935.

GM of Canada also has a Mobility Program. Call 1-800-GM-DRIVE (463-7483) for details. All TTY users call 1-800-263-3830.

Roadside Assistance Program

Buick Motor Division is proud to offer Buick Premium Roadside Assistance to customers for vehicles covered under the 3 year/36,000 mile (60 000 km) new car warranty (whichever occurs first).

Our commitment to Buick owners has always included superior service through our network of Buick dealers. Buick Premium Roadside Assistance provides an extra measure of convenience and security.

Buick's Roadside Assistance toll-free number is staffed by a team of technically trained advisors, who are available 24 hours a day, 365 days a year.

We take anxiety out of uncertain situations by providing minor repair information over the phone or making arrangements to tow your vehicle to the nearest Buick dealer.

We will provide the following services for 3 years/36,000 miles (60 000 km), at no expense to you:

- Fuel delivery
- Lock-out service (identification required)
- Tow to nearest dealership for warranty service
- Change a flat tire
- Jump starts

We have quick, easy access to telephone numbers of the following additional services depending on your needs:

- Hotels
- Glass replacement
- Tire repair facilities
- Rental vehicle or taxis
- Airports or train stations
- Police, fire department or hospitals

In many instances, mechanical failures are covered under Buick's comprehensive warranty. However, when other services are utilized, our advisors will explain any payment obligations you might incur.

For prompt and efficient assistance when calling, please provide the following information to give the advisor:

- Location of vehicle
- Telephone number of your location
- Vehicle model, year and color
- Mileage of vehicle
- Vehicle Identification Number (VIN)
- Vehicle license plate number

Buick reserves the right to limit services or reimbursement to an owner or driver when, in Buick's judgement, the claims become excessive in frequency or type of occurrence.

While we hope you never have the occasion to use our service, it is added security while traveling for you and your family. Remember, we're only a phone call away. Buick Roadside Assistance: 1-800-252-1112, text telephone (TTY) users, call 1-888-889-2438.

Canadian Roadside Assistance

Vehicles purchased in Canada have an extensive Roadside Assistance program accessible from anywhere in Canada or the United States. Please refer to the Warranty and Owner Assistance Information book.

Courtesy Transportation

Buick has always exemplified quality and value in its offering of motor vehicles. To enhance your ownership experience, we and our participating dealers are proud to offer Courtesy Transportation, a customer support program for new vehicles.

The Courtesy Transportation program is offered to retail purchase/lease customers in conjunction with the Bumper-to-Bumper coverage provided by the New Vehicle Limited Warranty. Several transportation options are available when warranty repairs are required. This will reduce your inconvenience during warranty repairs.

Plan Ahead When Possible

When your vehicle requires warranty service, you should contact your dealer and request an appointment. By scheduling a service appointment and advising your service consultant of your transportation needs, your dealer can help minimize your inconvenience.

If your vehicle cannot be scheduled into the service department immediately, keep driving it until it can be scheduled for service, unless, of course, the problem is safety-related. If it is, please call your dealership, let them know this, and ask for instructions.

If the dealer requests that you simply drop the vehicle off for service, you are urged to do so as early in the work day as possible to allow for same day repair.

Transportation Options

Warranty service can generally be completed while you wait. However, if you are unable to wait Buick helps minimize your inconvenience by providing several transportation options. Depending on the circumstances, your dealer can offer you one of the following:

Shuttle Service

Participating dealers can provide you with shuttle service to get to your destination with minimal interruption of your daily schedule. This includes a one way shuttle ride to a destination up to 10 miles from the dealership.

Public Transportation or Fuel Reimbursement

If your vehicle requires overnight warranty repairs, reimbursement up to \$30 per day (five days maximum) may be available for the use of public transportation such as a taxi or bus. In addition, should you arrange transportation through a friend or relative, reimbursement for reasonable fuel expenses up to \$10 per day (five day maximum may be available). Claim amounts should reflect actual costs and be supported by original receipts.

Courtesy Rental Vehicle

When your vehicle is unavailable due to overnight warranty repairs, your dealer may arrange to provide you with a courtesy rental vehicle or reimburse you for a rental vehicle you obtained, at actual cost, up to a maximum of \$30.00 per day supported by receipts. This requires that you sign and complete a rental agreement and meet state, local and rental vehicle provider requirements. Requirements vary and may include minimum age requirements, insurance coverage, credit card, etc. You are responsible for taxes, levies, usage fees, excessive mileage or rental usage beyond the completion of the repair.

Generally it is not possible to provide a like-vehicle as a courtesy rental.

Additional Program Information

Courtesy Transportation is available during the Bumper-to-Bumper warranty coverage period, but it *is not* part of the New Vehicle Limited Warranty. A separate booklet entitled Warranty and Owner Assistance Information furnished with each new vehicle provides detailed warranty coverage information.

Courtesy Transportation is available only at participating dealers and all program options, such as shuttle service, may not be available at every dealer. Please contact your dealer for specific information about availability. All Courtesy Transportation arrangements will be administered by appropriate dealer personnel.

Canadian Vehicles: For warranty repairs during the Complete Vehicle Coverage period of the General Motors of Canada New Vehicle Limited Warranty, alternative transportation may be available under the Courtesy Transportation Program. Please consult your dealer for details.

General Motors reserves the right to unilaterally modify, change or discontinue Courtesy Transportation at any time and to resolve all questions of claim eligibility pursuant to the terms and conditions described herein at its sole discretion.

Reporting Safety Defects

Reporting Safety Defects to the United States Government

If you believe that your vehicle has a defect which could cause a crash or could cause injury or death, you should immediately inform the National Highway Traffic Safety Administration (NHTSA), in addition to notifying General Motors.

If NHTSA receives similar complaints, it may open an investigation, and if it finds that a safety defect exists in a group of vehicles, it may order a recall and remedy campaign. However, NHTSA cannot become involved in individual problems between you, your dealer or General Motors.

To contact NHTSA, you may either call the Auto Safety Hotline toll-free at 1-800-424-9393 (or 366-0123 in the Washington, D.C. area) or write to:

NHTSA, U.S. Department of Transportation
Washington, D.C. 20590

You can also obtain other information about motor vehicle safety from the hotline.

Reporting Safety Defects to the Canadian Government

If you live in Canada, and you believe that your vehicle has a safety defect, you should immediately notify Transport Canada, in addition to notifying General Motors of Canada Limited. You may write to:

Transport Canada
330 Sparks Street
Tower C
Ottawa, Ontario K1A 0N5

Reporting Safety Defects to General Motors

In addition to notifying NHTSA (or Transport Canada) in a situation like this, we certainly hope you'll notify us.

Please call us at 1-800-521-7300, or write:

Buick Customer Assistance Center
P.O. Box 33136
Detroit, MI 48232-5136

In Canada, please call us at 1-800-263-3777 (English) or 1-800-263-7854 (French). Or, write:

General Motors of Canada Limited
Customer Communication Centre, 163-005
1908 Colonel Sam Drive
Oshawa, Ontario L1H 8P7

Service Publications Ordering Information

Service Manuals

Service Manuals have the diagnosis and repair information on engines, transmission, axle, suspension, brakes, electrical, steering, body, etc.

RETAIL SELL PRICE: \$120.00

Transmission, Transaxle, Transfer Case Unit Repair Manual

This manual provides information on unit repair service procedures, adjustments, and specifications for GM transmissions, transaxles, and transfer cases.

RETAIL SELL PRICE: \$50.00

Service Bulletins

Service Bulletins give technical service information needed to knowledgeably service General Motors cars and trucks. Each bulletin contains instructions to assist in the diagnosis and service of your vehicle.

In Canada, information pertaining to Product Service Bulletins can be obtained by contacting your General Motors dealer or by calling 1-800-GM-DRIVE (1-800-463-7483).

Owner's Information

Owner publications are written specifically for owners and intended to provide basic operational information about the vehicle. The owner's manual will include the Maintenance Schedule for all models.

In-Portfolio: Includes a Portfolio, Owner's Manual, and Warranty Booklet.

RETAIL SELL PRICE: \$35.00

Without Portfolio: Owner's Manual only.

RETAIL SELL PRICE: \$25.00

Current and Past Model Order Forms

Service Publications are available for current and past model GM vehicles. To request an order form, please specify year and model name of the vehicle.

ORDER TOLL FREE: 1-800-551-4123
Monday-Friday 8:00 AM - 6:00 PM Eastern Time

For Credit Card Orders Only
(VISA-MasterCard-Discover), visit Helm, Inc. on the World Wide Web at: www.helminc.com

Or you can write to:

Helm, Incorporated
P. O. Box 07130
Detroit, MI 48207

Prices are subject to change without notice and without incurring obligation. Allow ample time for delivery.

Note to Canadian Customers: All listed prices are quoted in U.S. funds. Canadian residents are to make checks payable in U.S. funds.

A

Accessory Power Outlets	3-22	Appearance Care (cont.)	
Adding Washer Fluid	5-36	Cleaning the Inside of Your Vehicle	5-77
Additional Program Information	7-9	Cleaning the Outside of Your Vehicle	5-80
Additives, Fuel	5-6	Finish Damage	5-83
Add-On Electrical Equipment	5-85	Sheet Metal Damage	5-82
Adjusting the Speakers (Balance/Fade)	3-57, 3-65	Underbody Maintenance	5-83
Air Bag Systems	1-46	Vehicle Care/Appearance Materials	5-84
How Does an Air Bag Restrain?	1-52	Weatherstrips	5-80
Servicing Your Air Bag-Equipped Vehicle	1-54	Ashtrays	3-23
What Makes an Air Bag Inflate?	1-51	Audio System(s)	3-55
What Will You See After an Air		Audio Steering Wheel Controls	3-78
Bag Inflates?	1-52	Care of Your Cassette Tape Player	3-79
When Should an Air Bag Inflate?	1-50	Care of Your CD Player	3-80
Where Are the Air Bags?	1-49	Care of Your CDs	3-80
Air Bag	3-36	Chime Level Adjustment	3-81
Readiness Light	3-36	Diversity Antenna System	3-81
Air Cleaner/Filter, Engine	5-18	Personal Choice Radio Controls	3-77
AM	3-78	Radio with Cassette and CD	3-62
Antenna, Diversity Antenna System	3-81	Radio with CD	3-56
Antenna, XM™ Satellite Radio		Setting the Time	3-55
Antenna System	3-81	Theft-Deterrent Feature	3-77
Anti-lock Brake System (ABS)	4-7	Trunk-Mounted CD Changer	3-73
Anti-Lock Brake, System Warning Light	3-38	Understanding Radio Reception	3-78
Appearance Care	5-77	XM™ Satellite Radio Antenna System	3-81
Care of Safety Belts	5-80	Automatic Door Locks	3-51
Chemical Paint Spotting	5-83	Automatic Level Control	4-35
		Automatic Operation	3-27
		Automatic Transaxle Check	6-18

Automatic Transaxle Shift Lock Control	
System Check	6-19
Automatic Transaxle	5-21
Fluid	5-21
Operation	2-25

B

Backing Up	4-40
Battery Load Management	3-20
Battery Replacement	2-8
Battery Warning Light	3-37
Battery	5-40
Before Leaving on a Long Trip	4-22
Body Lubrication Service	6-18
Brake Fluid	5-37
Brake Wear	5-39
Brake	2-27
Parking	2-27
System Inspection	6-22
System Warning Light	3-37
Brakes	5-37
Braking in Emergencies	4-8
Braking	4-6
Break-In, New Vehicle	2-21
Bulb Replacement	5-52
Front Turn Signal Lamps	5-53
Halogen Bulbs	5-52
Headlamp Aiming	5-47

Bulb Replacement (cont.)	
Headlamps	5-52
Replacement Bulbs	5-56
Taillamps and Back-Up Lamps	5-55
Taillamps, Turn Signal, and Stoplamps	5-53
Buying New Tires	5-62

C

California Fuel	5-5
Canada – Customer Assistance	7-4
Canadian Owners	ii
Canadian Roadside Assistance	7-7
Capacities and Specifications	5-93
Carbon Monoxide	4-25, 4-35, 2-14, 2-31
Care of	5-80
Safety Belts	5-80
Your Cassette Tape Player	3-79
Your CD Player	3-80
Your CDs	3-80
Cassette Tape Messages	3-71
Cassette Tape Player Service	6-17
CD Adapter Kits	3-71
CD Changer, Trunk-Mounted	3-73
Center Console Storage Area	2-42
Center Front Passenger Position, Safety Belts	1-19
Chains, Tires	5-66
Checking Coolant	5-25
Checking Engine Oil	5-13

Checking Things Under the Hood	5-10	Cleaning Leather	5-79
Checking Your Restraint Systems	1-54	Cleaning the Top of the Instrument Panel	5-79
Check	3-40	Cleaning Tires	5-82
Engine Light	3-40	Cleaning Vinyl	5-79
Tire Pressure System	5-59	Cleaning Windshield and Wiper Blades	5-81
Chemical Paint Spotting	5-83	Cleaning	5-77
Child Restraints	1-33	Inside of Your Vehicle	5-77
Child Restraint Systems	1-33	Outside of Your Vehicle	5-80
Infants and Young Children	1-29	Underbody Maintenance	5-83
Lower Anchorages and Top Tethers for		Weatherstrips	5-80
Children (LATCH System)	1-38	Climate Control System	3-24
Older Children	1-27	Climate Controls Personalization	3-31
Securing a Child Restraint Designed for		Dual Automatic	3-26
the LATCH System	1-40	Outlet Adjustment	3-30
Securing a Child Restraint in a Rear Seat		Steering Wheel Controls	3-31
Position	1-41	Compact Disc Errors	3-76
Securing a Child Restraint in the Right		Compact Disc Messages	3-62, 3-73
Front Seat Position	1-43	Compact Spare Tire	5-76
Top Strap Anchor Location	1-38	Compass Calibration	2-34
Top Strap	1-37	Compass Operation	2-34
Where to Put the Restraint	1-36	Compass Variance	2-34
Chime Level Adjustment	3-81	Content Theft-Deferrent	2-18
Cigarette Lighter	3-23	Control of a Vehicle	4-5
Cleaning Aluminum or Chrome-Plated Wheels	5-82	Convenience Net	2-43
Cleaning Exterior Lamps/Lenses	5-81	Coolant	3-40
Cleaning Fabric/Carpet	5-77	Engine Temperature Gage	3-40
Cleaning Glass Surfaces	5-79	Heater, Engine	2-24
Cleaning Interior Plastic Components	5-79	Cooling System	5-28

Cornering Lamps	3-15
Courtesy Lamps	3-18
Cruise Control Light	3-44
Cruise Control	3-11
Current and Past Model Order Forms	7-11
Customer Assistance Information	7-7
Courtesy Transportation	7-7
Customer Assistance for Text Telephone (TTY) Users	7-4
Customer Assistance Offices	7-4
Customer Satisfaction Procedure	7-2
GM Mobility Program for Persons with Disabilities	7-5
Reporting Safety Defects to General Motors	7-10
Reporting Safety Defects to the Canadian Government	7-10
Reporting Safety Defects to the United States Government	7-9
Roadside Assistance Program	7-6
Service Publications Ordering Information	7-10

D

Daytime Running Lamps	3-15
Defensive Driving	4-2
Defogging and Defrosting	3-25, 3-29
Delayed Entry Lighting	3-18

Delayed Exit Lighting	3-18
Delayed Locking	2-11, 3-53
Dinghy Towing	4-32
Diversity Antenna System	3-81
Doing Your Own Service Work	5-3
Dolly Towing	4-33
Door	2-10
Central Door Unlocking System	2-10
Delayed Locking	2-11
Door Ajar Reminder	2-11
Locks	2-9
Power Door Locks	2-10
Programmable Automatic Door Locks	2-11
Rear Door Security Locks	2-13
Driver ID	3-54
Driver Information Center (DIC)	3-45
DIC Controls and Displays	3-46
DIC Vehicle Personalization	3-50
DIC Warnings and Messages	3-49
Driver	1-12
Position, Safety Belt	1-12
Driving On Grades	4-41
Driving on Snow or Ice	4-26
Driving Through Deep Standing Water	4-19
Driving Through Flowing Water	4-20
Driving with a Trailer	4-39

Driving	4-16
At Night	4-16
City	4-20
Defensive	4-2
Drunken	4-2
Freeway	4-21
Hill and Mountain Roads	4-24
In Rain and on Wet Roads	4-17
Winter	4-25
Dual Automatic Climate Control System	3-26
Dual Sun Visor	2-17

E

Electrical System	5-85
Add-On Equipment	5-85
Fuses and Circuit Breakers	5-86
Power Windows and Other Power Options	5-86
Removing the Rear Seat Cushion	5-89
Emergency Trunk Release Handle	2-15
Emissions Inspection and Maintenance Programs	3-42
Engine Compartment Fuse Block	5-86
Engine Coolant Level Check	6-17
Engine Cooling When Trailer Towing	4-42
Engine Oil Additives	5-16
Engine Oil Level Check	6-17
Engine	5-18
Air Cleaner/Filter	5-18

Engine (cont.)	
Battery	5-40
Check and Service Engine Soon Light	3-40
Compartment Overview	5-12
Coolant Heater	2-24
Coolant Temperature Gage	3-40
Coolant	5-23
Cooling System Inspection	6-22
Exhaust	2-31
Oil	5-13
Overheating	5-26
Starting	2-23
Entry Lighting	3-18
Erasing HomeLink® Buttons	2-41
Express-Down Window	2-17
Extender, Safety Belt	1-26
Exterior Lamps	3-14
Exterior Lighting Battery Saver	3-17
Exterior Lights	3-53

F

Filter	5-18
Engine Air Cleaner	5-18
Finding a PTY Station (RDS and XM™)	3-66
Finding a PTY Station	3-59
Finding a Station	3-56, 3-64
Finish Care	5-81
Finish Damage	5-83

Flash-To-Pass	3-9
Flat Tire, Changing	5-67
Flat Tire	5-66
Fluid	5-21
Automatic Transaxle	5-21
Power Steering	5-35
Windshield Washer	5-36
FM Stereo	3-79
Following Distance	4-40
Front Reading Lamps	3-19
Fuel	5-4
Additives	5-6
California Fuel	5-5
Filling a Portable Fuel Container	5-9
Filling Your Tank	5-7
Fuels in Foreign Countries	5-6
Gage	3-45
Gasoline Octane	5-4
Gasoline Specifications	5-5
System Inspection	6-22
Fuses	5-86
Fuses and Circuit Breakers	5-86

G

Gage	3-40
Engine Coolant Temperature	3-40
Fuel	3-45

Gage (cont.)	
Speedometer	3-35
Tachometer	3-35
Garage Door Opener	2-38
Gasoline	5-4
Octane	5-4
Specifications	5-5
Gate Operator and Canadian Programming	2-41
Glove Box	2-42
GM Mobility Program for Persons with Disabilities	7-5

H

Hazard Warning Flashers	3-6
Head Restraints	1-6
Headlamp High/Low-Beam Changer	3-8
Headlamp	5-47
Aiming	5-47
Horizontal Aiming	5-49
Vertical Aiming	5-50
Headlamps On Reminder	3-15
Headlamps	5-52
Bulb Replacement	5-52
Front Turn Signal Lamps	5-53
Halogen Bulbs	5-52
Head-Up Display (HUD)	3-20
Heated Seats	1-4

Highway Hypnosis	4-23
Hill and Mountain Roads	4-24
Hitches	4-38
HomeLink Transmitter, Programming	2-39
HomeLink® Transmitter	2-38
Hood	5-10
Checking Things Under	5-10
Release	5-11
Horn	3-7
How to Add Coolant to the Coolant Recovery Tank	5-30
How to Add Coolant to the Radiator	5-31
How to Add Fluid	5-23
How to Check Power Steering Fluid	5-36
How to Check	5-21, 5-59
How to Inspect the Engine Air Cleaner/Filter	5-18
How to Use This Manual	ii
How to Wear Safety Belts Properly	1-11
Hydroplaning	4-19

I

If No Steam Is Coming From Your Engine	5-27
If Steam Is Coming From Your Engine	5-26
If the Light Is Flashing	3-41
If the Light Is On Steady	3-42

If You Are Stuck in Sand, Mud, Ice or Snow	4-30
If You Do Decide To Pull A Trailer	4-36
If You're Caught in a Blizzard	4-28
Ignition Positions	2-22
Ignition Transaxle Lock Check	6-20
Inadvertent Power Battery Saver	3-19
Infants and Young Children, Restraints	1-29
Inflation -- Tire Pressure	5-58
Inspection	6-22
Brake System	6-22
Engine Cooling System	6-22
Exhaust System	6-21
Fuel System	6-22
Part C - Periodic Maintenance	6-21
Steering, Suspension and Front Drive Axle	
Boot and Seal	6-21
Throttle System	6-22
Instrument Panel Brightness	3-17
Instrument Panel	3-33
Cluster	3-33
Overview	3-4
Interior Lamps	3-17

J

Jump Starting	5-42
---------------------	------

K

Key Lock Cylinders Service	6-18
Key Reminder Warning	2-23
Keyless Entry System	2-5
Keys	2-3

L

Lamps	3-14
Exterior	3-14
Interior	3-17
Language Selection	3-54
Lap Belt	1-19
Lap-Shoulder Belt	1-12, 1-21
LATCH System	1-38
Child Restraints	1-38
Securing a Child Restraint Designed for the LATCH System	1-40
Leaving Your Vehicle With the Engine Running	2-29
Leaving Your Vehicle	2-13
Lighted Visor Vanity Mirror	2-17
Light	3-36
Air Bag Readiness	3-36
Anti-Lock Brake System Warning	3-38
Battery Warning	3-37
Brake System Warning	3-37

Light (cont.)	
Cruise Control	3-44
Malfunction Indicator	3-40
Oil Pressure	3-43
Safety Belt Reminder	3-36
Security	3-44
Service Vehicle Soon	3-44
TCS Warning Light	3-39
Traction Control System (TCS) Warning	3-39
Loading Your Vehicle	4-33
Lockout Protection	2-13
Locks	2-10
Central Door Unlocking System	2-10
Delayed Locking	2-11
Door	2-9
Leaving Your Vehicle	2-13
Lockout Protection	2-13
Power Door	2-10
Programmable Automatic Door Locks	2-11
Rear Door Security Locks	2-13
Long Trip/Highway Definition	6-6
Long Trip/Highway Intervals	6-6
Long Trip/Highway Scheduled Maintenance	6-13
Loss of Control	4-15
Lumbar	1-3
Manual Controls	1-3
Power Controls	1-3

M

Maintenance, Normal Replacement Parts	5-94
Maintenance Schedule	6-17
At Each Fuel Fill	6-17
At Least Once a Month	6-17
At Least Once a Year	6-18
At Least Twice a Year	6-18
Brake System Inspection	6-22
Engine Cooling System Inspection	6-22
Exhaust System Inspection	6-21
Fuel System Inspection	6-22
How This Section is Organized	6-3
Introduction	6-2
Long Trip/Highway Scheduled Maintenance	6-13
Maintenance Requirements	6-2
Part A - Scheduled Maintenance Services	6-4
Part B - Owner Checks and Services	6-17
Part C - Periodic Maintenance Inspections	6-21
Part D - Recommended Fluids and Lubricants	6-23
Part E - Maintenance Record	6-24
Selecting the Right Schedule	6-5
Short Trip/City Scheduled Maintenance	6-6
Steering, Suspension and Front Drive Axle Boot and Seal Inspection	6-21
Throttle System Inspection	6-22
Using Your	6-4
Your Vehicle and the Environment	6-2

Maintenance When Trailer Towing	4-42
Making Turns	4-40
Malfunction Indicator Light	3-40
Manual Lumbar Controls	1-3
Manual Operation	3-27
Manual Seats	1-2
Matching Transmitter(s) to Your Vehicle	2-8
Memory Mirrors	2-44
Memory Seat	2-44
Memory Seats	3-53
Message	3-49
DIC Warnings and Messages	3-49
Mexico, Central America and Caribbean Islands/ Countries (Except Puerto Rico and U.S. Virgin Islands) – Customer Assistance	7-5
Mirror Operation	2-33, 2-34
Mirrors	2-33
Automatic Dimming Rearview with Compass	2-33
Automatic Dimming Rearview	2-33
Manual Rearview Mirror	2-33
Memory	2-44
Outside Automatic Dimming Heated Mirror	2-36
Outside Convex Mirror	2-36
Outside Curb View Assist Mirror	2-36
Outside Power Mirrors	2-35
MyGMLink.com	7-3

N

New Vehicle Break-In	2-21
Normal Maintenance Replacement Parts	5-94

O

Odometer	3-35
Off-Road Recovery	4-13
Oil	5-13
Engine	5-13
Pressure Light	3-43
Older Children, Restraints	1-27
Online Owner Center	7-3
OnStar [®] Personal Calling	2-38
OnStar [®] Services	2-37
OnStar [®] System	2-37
OnStar [®] Virtual Advisor	2-38
Other Warning Devices	3-6
Outlet Adjustment	3-30
Outside Curb View Assist Mirror	3-54
Outside	2-36
Automatic Dimming Heated Mirror	2-36
Convex Mirror	2-36
Curb View Assist Mirror	2-36
Power Mirrors	2-35

Overseas – Customer Assistance	7-5
Owners, Canadian	ii
Owner's Information	7-11

P

Park(P)	2-28
Shifting Into	2-28
Shifting Out of	2-30
Parking Brake and Automatic Transaxle Park (P)	
Mechanism Check	6-20
Parking on Hills	4-41
Parking	2-27
Brake	2-27
Over Things That Burn	2-31
Part A - Scheduled Maintenance Services	6-4
Part B - Owner Checks and Services	6-17
Part C - Periodic Maintenance Inspections	6-21
Part D - Recommended Fluids and Lubricants	6-23
Part E - Maintenance Record	6-24
Passenger Temperature Control	3-30
Passing	4-13, 4-40
PASS-Key [®] III Operation	2-20
PASS-Key [®] III	2-19
Perimeter Lighting	3-18, 3-53
Personal Choice Programming	2-11
Personal Choice Radio Controls	3-77

Personalization, Climate Controls	3-31
Personalization Features	2-6
Personalization Programming	2-12
Plan Ahead When Possible	7-7
Playing a Cassette Tape	3-70
Playing a Compact Disc	3-60, 3-71, 3-75
Playing the Radio	3-56, 3-63
Power Steering	4-10
Power	3-22
Accessory Outlets	3-22
Door Locks	2-10
Electrical System	5-86
Lumbar Controls	1-3
Seat	1-2
Steering Fluid	5-35
Windows	2-17
Programmable Automatic Door Locks	2-11
Programming the HomeLink Transmitter	2-39

Q

Questions and Answers About Safety Belts	1-11
--	------

R

Radiator Pressure Cap	5-26
Radio Data System (RDS)	3-62
Radio Messages	3-60, 3-67
Radios	3-55

Care of Your Cassette Tape Player	3-79
Care of Your CD Player	3-80
Care of Your CDs	3-80
Personal Choice Radio Controls	3-77
Radio with Cassette and CD	3-62
Radio with CD	3-56
Setting the Time	3-55
Theft-Deterrent	3-77
Trunk-Mounted CD Changer	3-73
Understanding Reception	3-78
Rainsense™ II Wipers	3-10
RDS Messages	3-59, 3-66
Rear Door Security Locks	2-13
Rear Safety Belt Comfort Guides	1-24
Rear Seat Passengers, Safety Belts	1-21
Rear Underseat Fuse Block	5-90
Rear Window Defogger	3-26, 3-29
Rearview Mirror, Automatic Dimming with Compass	2-33
Rearview Mirror, Automatic Dimming	2-33
Rearview Mirrors	2-33
Reclining Seatbacks	1-4
Recreational Vehicle Towing	4-32
Remote Keyless Entry System, Operation	2-5
Remote Keyless Entry System	2-5
Remote Trunk Release Lockout	2-14
Removing the Flat Tire and Installing the Spare Tire	5-70
Removing the Spare Tire and Tools	5-68

Removing the Wheel Covers and Wheel Nut Caps	5-69
Replacement Bulbs	5-56
Replacing Brake System Parts	5-40
Replacing Restraint System Parts	
After a Crash	1-55
Reporting Safety Defects	7-10
Canadian Government	7-10
General Motors	7-10
United States Government	7-9
Reprogramming a Single HomeLink® Button	2-41
Resetting Defaults	2-42
Restraint System Check	6-18
Checking Your Restraint Systems	1-54
Replacing Restraint System Parts	
After a Crash	1-55
Restraint Systems	1-54
Checking	1-54
Replacing Parts	1-55
Retained Accessory Power (RAP)	2-23
Right Front Passenger Position, Safety Belts	1-19
Roadside	7-6
Assistance Program	7-6
Rocking Your Vehicle To Get It Out	4-31
Running Your Engine While You Are Parked	2-32

S

Safety Belt	3-36
Reminder Light	3-36
Safety Belts	5-80
Care of	5-80
Center Front Passenger Position	1-19
Driver Position	1-12
How to Wear Safety Belts Properly	1-11
Questions and Answers About Safety Belts	1-11
Rear Safety Belt Comfort Guides for Children and Small Adults	1-24
Rear Seat Passengers	1-21
Right Front Passenger Position	1-19
Safety Belt Extender	1-26
Safety Belt Use During Pregnancy	1-18
Safety Belts Are for Everyone	1-6
Safety Chains	4-39
Safety Warnings and Symbols	iii
Seat	1-6
Head Restraints	1-6
Seats	1-4
Heated Seats	1-4
Manual Lumbar	1-3
Manual	1-2

Seats (cont.)		Shifting Out of Park (P)	2-30
Memory	2-44	Short Trip/City Definition	6-5
Power Lumbar	1-3	Short Trip/City Intervals	6-5
Power Seats	1-2	Short Trip/City Scheduled Maintenance	6-6
Reclining Seatbacks	1-4	Skidding	4-15
Securing a Child Restraint	1-40	Some Other Rainy Weather Tips	4-20
Designed for the LATCH System	1-40	Special Fabric Cleaning Problems	5-78
Rear Seat Position	1-41	Specifications, Capacities	5-93
Right Front Seat Position	1-43	Speedometer	3-35
Security Feedback	2-7, 3-52	Starter Switch Check	6-19
Security Light	3-44	Starting Your Engine	2-23
Selecting the Right Schedule, Maintenance	6-5	Steering in Emergencies	4-12
Sensors	3-25, 3-29	Steering, Suspension and Front Drive Axle	
Service Bulletins	7-11	Boot and Seal Inspection	6-21
Service Engine Soon Light	3-40	Steering Tips	4-10
Service Manuals	7-10	Steering Wheel Climate Controls	3-31
Service	5-3	Steering Wheel Controls, Audio	3-78
Adding Equipment to the Outside of		Steering	4-10
Your Vehicle	5-4	Storage Areas	2-42
Doing Your Own Work	5-3	Center Console Storage Area	2-42
Engine Soon Light	3-40	Convenience Net	2-43
Publications Ordering Information	7-10	Glove Box	2-42
Vehicle Soon Light	3-44	Storing the Flat Tire and Tools	5-74
Setting Preset Stations	3-57, 3-64	Storing the Spare Tire and Tools	5-75
Setting the Time	3-55	Stuck in Sand, Mud, Ice or Snow	4-30
Setting the Tone (Bass/Treble)	3-57, 3-65	Sun Visors	2-17
Sheet Metal Damage	5-82	Sunroof	2-43
Shifting Into Park (P)	2-28		

T

Tachometer	3-35	Tires (cont.)	
Taillamps	5-55	Wheel Alignment and Tire Balance	5-64
Back-Up Lamps	5-55	Wheel Replacement	5-65
Turn Signal, and Stoplamps	5-53	When It Is Time for New Tires	5-62
TCS Warning Light	3-39	To Use the Engine Coolant Heater	2-24
Testing the Alarm	2-19	Top Strap Anchor Location	1-38
Theater Dimming	3-18	Top Strap	1-37
Theft-Deterrent, Radio	3-77	Torque Lock	2-30
Theft-Deterrent Systems	2-18	Total Weight on Your Vehicle's Tires	4-38
Content Theft-Deterrent	2-18	Towing	4-32
PASS-Key® III Operation	2-20	Recreational Vehicle	4-32
PASS-Key® III	2-19	Towing a Trailer	4-35
Throttle System Inspection	6-22	Your Vehicle	4-31
Tilt Wheel	3-7	Traction	4-9
Tire Inflation Check	6-17	Control System (TCS)	4-9
Tires	5-58	Control System Warning Light	3-39
Buying New Tires	5-62	Trailer Brakes	4-39
Chains	5-66	Trailer Wiring Harness	4-39
Changing a Flat Tire	5-67	Transaxle Operation, Automatic	2-25
Check Tire Pressure System	5-59	Transaxle	5-21
Compact Spare Tire	5-76	Fluid, Automatic	5-21
If a Tire Goes Flat	5-66	Transmission, Transaxle, Transfer Case Unit	
Inflation -- Tire Pressure	5-58	Repair Manual	7-10
Inspection and Rotation	5-60	Transportation Options	7-8
Uniform Tire Quality Grading	5-63	Trip Odometer	3-35
		Trunk Lock Release	2-14
		Trunk Security Override	2-15

Trunk-Mounted CD Changer	3-73
Trunk	2-14
Turn and Lane-Change Signals	3-8
Turn Signal/Multifunction Lever	3-7
Turn Signals When Towing a Trailer	4-40
Twilight Sentinel®	3-16

U

Underbody Flushing Service	6-20
Understanding Radio Reception	3-78
Uniform Tire Quality Grading	5-63
United States – Customer Assistance	7-4
Used Replacement Wheels	5-66
Using Cleaner on Fabric	5-78
Using HomeLink®	2-41
Using RDS	3-58

V

Vehicle Identification	5-85
Number (VIN)	5-85
Service Parts Identification Label	5-85
Vehicle Personalization	3-50
DIC	3-50
Memory Seat and Mirrors	2-44
Vehicle Storage	5-41
Vehicle	4-5
Control	4-5

Vehicle (cont.)	
Damage Warnings	iv
Loading	4-33
Service Soon Light	3-44
Symbols	iv
Ventilation Adjustment	3-30
Visors	2-17

W

Warning Lights, Gages and Indicators	3-32
Warnings	3-49
DIC Warnings and Messages	3-49
Hazard Warning Flashers	3-6
Other Warning Devices	3-6
Safety and Symbols	iii
Vehicle Damage	iv
Washing Your Vehicle	5-80
Weatherstrip Lubrication	6-18
Weight of the Trailer Tongue	4-37
Weight of the Trailer	4-37
What Kind of Engine Oil to Use	5-14
What to Do with Used Oil	5-17
What to Use	5-24, 5-36
Wheels	5-64
Alignment and Tire Balance	5-64
Replacement	5-65
When to Add Engine Oil	5-14

When to Change Engine Oil (Vehicles with the GM Oil Life System)	5-16
When to Change Engine Oil (Vehicles Without the GM Oil Life System)	5-16
When to Check and Change	5-21
When to Check Power Steering Fluid	5-36
When to Check	5-59
When to Inspect the Engine Air Cleaner/Filter	5-18
When You Are Ready to Leave After Parking on a Hill	4-42
Where to Put the Restraint	1-36
Why Safety Belts Work	1-8
Window Lock Out	2-17, 3-52
Windows	2-16
Power	2-17
Windshield Washer Fluid Level Check	6-17
Windshield Washer	3-11
Fluid	5-36

Windshield Wiper	5-57
Blade Replacement	5-57
Windshield Wipers	3-9
Winter Driving	4-25
Wiper Activated Headlamps	3-14
Wiper Blade Check	6-18

X

XM™ Radio Satellite Service (USA Only)	3-63
XM™ Satellite Radio Antenna System	3-81
XM™ Satellite Radio Service (USA Only)	3-79

Y

Your Vehicle and the Environment	6-2
--	-----