

2011 Buick LaCrosse Owner Manual

In Brief	1-1
Instrument Panel	1-2
Initial Drive Information	1-4
Vehicle Features	1-16
Performance and Maintenance	1-22
Keys, Doors and Windows ...	2-1
Keys and Locks	2-2
Doors	2-12
Vehicle Security	2-14
Exterior Mirrors	2-16
Interior Mirrors	2-18
Windows	2-18
Roof	2-21
Seats and Restraints	3-1
Head Restraints	3-2
Front Seats	3-4
Rear Seats	3-11
Safety Belts	3-13
Airbag System	3-29
Child Restraints	3-44

Storage	4-1
Storage Compartments	4-1
Additional Storage Features ...	4-2
Instruments and Controls ...	5-1
Controls	5-2
Warning Lights, Gauges, and Indicators	5-9
Information Displays	5-25
Vehicle Messages	5-33
Vehicle Personalization	5-39
Universal Remote System ...	5-45
Lighting	6-1
Exterior Lighting	6-1
Interior Lighting	6-5
Lighting Features	6-6
Infotainment System	7-1
Introduction	7-1
Radio	7-12
Audio Players	7-20
Rear Seat Infotainment	7-36
Phone	7-46

Climate Controls	8-1
Climate Control Systems	8-1
Air Vents	8-8
Maintenance	8-8
Driving and Operating	9-1
Driving Information	9-2
Starting and Operating	9-16
Engine Exhaust	9-27
Automatic Transmission	9-28
Drive Systems	9-31
Brakes	9-32
Ride Control Systems	9-36
Cruise Control	9-39
Object Detection Systems ...	9-42
Fuel	9-50
Towing	9-55
Conversions and Add-Ons ...	9-62

2011 Buick LaCrosse Owner Manual

Vehicle Care	10-1
General Information	10-2
Vehicle Checks	10-4
Headlamp Aiming	10-30
Bulb Replacement	10-33
Electrical System	10-38
Wheels and Tires	10-46
Jump Starting	10-86
Towing	10-89
Appearance Care	10-92

Service and Maintenance ...	11-1
General Information	11-1
Scheduled Maintenance	11-2
Recommended Fluids, Lubricants, and Parts	11-7
Maintenance Records	11-10

Technical Data	12-1
Vehicle Identification	12-1
Vehicle Data	12-2

Customer Information	13-1
Customer Information	13-1
Reporting Safety Defects	13-16
Vehicle Data Recording and Privacy	13-18

Index	i-1
--------------------	-----



The names, logos, emblems, slogans, vehicle model names, and vehicle body designs appearing in this manual including, but not limited to, GM, the GM logo, BUICK, the BUICK Emblem, and LACROSSE are trademarks and/or service marks of General Motors LLC, its subsidiaries, affiliates, or licensors.

This manual describes features that may or may not be on your specific vehicle either because they are options that you did not purchase or due to changes subsequent to the printing of this owner manual. Please refer to the purchase documentation relating to your specific vehicle to confirm each of the features found on your vehicle. For vehicles first sold in Canada, substitute the name "General Motors of Canada Limited" for Buick Motor Division wherever it appears in this manual.



Manufactured under license under U.S. Patent #'s: 5,451,942; 5,956,674; 5,974,380; 5,978,762; 6,487,535 & other U.S. and worldwide patents issued & pending. DTS and the Symbol are registered trademarks and DTS Digital Surround and the DTS logos are trademarks of DTS, Inc. Product includes software. All Rights Reserved.



Manufactured under license from Dolby® Laboratories. Dolby and the double-D symbol are registered trademarks of Dolby Laboratories.



This product incorporates copyright protection technology that is protected by U.S. patents and other intellectual property rights. Use of this copyright protection technology must be authorized by Macrovision, and is intended for home and other

limited viewing uses only unless otherwise authorized by Macrovision. Reverse engineering or disassembly is prohibited.



"Made for iPod" means that an electronic accessory has been designed to connect specifically to iPod and has been certified by the developer to meet Apple performance standards. Apple is not responsible for the operation of this device or its compliance with safety and regulatory standards.

iPod, iPod classic, iPod nano, and iPod touch are trademarks of Apple Inc., registered in the U.S. and other countries.

Canadian Vehicle Owners

Propriétaires Canadiens

A French language copy of this manual can be obtained from your dealer or from:

On peut obtenir un exemplaire de ce guide en français auprès du concessionnaire ou à l'adresse suivante:

Helm, Incorporated
P.O. Box 07130
Detroit, MI 48207

1-800-551-4123
Numéro de poste 6438
de langue française
www.helminc.com

Using this Manual

To quickly locate information about the vehicle, use the Index in the back of the manual. It is an alphabetical list of what is in the manual and the page number where it can be found.

Danger, Warnings, and Cautions

Warning messages found on vehicle labels and in this manual describe hazards and what to do to avoid or reduce them.

Danger indicates a hazard with a high level of risk which will result in serious injury or death.

Warning or **Caution** indicates a hazard that could result in injury or death.



These mean there is something that could hurt you or other people.

Notice: This means there is something that could result in property or vehicle damage. This would not be covered by the vehicle's warranty.



A circle with a slash through it is a safety symbol which means "Do Not," "Do not do this," or "Do not let this happen."

Symbols

The vehicle has components and labels that use symbols instead of text. Symbols are shown along with the text describing the operation or information relating to a specific component, control, message, gauge, or indicator.

 : This symbol is shown when you need to see your owner manual for additional instructions or information.

 : This symbol is shown when you need to see a service manual for additional instructions or information.

vi Introduction

Vehicle Symbol Chart

Here are some additional symbols that may be found on the vehicle and what they mean. For more information on the symbol, refer to the Index.

 : Airbag Readiness Light

 : Air Conditioning

 : Antilock Brake System (ABS)

 : Audio Steering Wheel Controls or OnStar®

 : Brake System Warning Light

 : Charging System

 : Cruise Control

 : Engine Coolant Temperature

 : Exterior Lamps

 : Fog Lamps

 : Fuel Gauge

 : Fuses

 : Headlamp High/Low-Beam Changer

 : LATCH System Child Restraints

 : Malfunction Indicator Lamp

 : Oil Pressure

 : Power

 : Remote Vehicle Start

 : Safety Belt Reminders

 : Tire Pressure Monitor

 : Traction Control

 : Windshield Washer Fluid

In Brief

Instrument Panel

Instrument Panel 1-2

Initial Drive Information

Initial Drive Information 1-4

Remote Keyless Entry (RKE)

System 1-4

Remote Vehicle Start 1-4

Door Locks 1-5

Trunk Release 1-5

Windows 1-5

Seat Adjustment 1-6

Memory Features 1-7

Heated and Ventilated

Seats 1-9

Head Restraint Adjustment 1-9

Safety Belts 1-10

Sensing System for

Passenger Airbag 1-10

Mirror Adjustment 1-10

Steering Wheel

Adjustment 1-11

Interior Lighting 1-12

Exterior Lighting 1-12

Windshield Wiper/Washer 1-13

Climate Controls 1-14

Transmission 1-15

Vehicle Features

Radio(s) 1-16

Satellite Radio 1-17

Portable Audio Devices 1-17

Bluetooth® 1-17

Steering Wheel Controls 1-18

Cruise Control 1-18

Navigation System 1-19

Driver Information

Center (DIC) 1-19

Vehicle Personalization 1-20

Power Outlets 1-20

Universal Remote System ... 1-20

Sunroof 1-21

Performance and Maintenance

Traction Control

System (TCS) 1-22

Electronic Stability

Control (ESC) 1-22

Tire Pressure Monitor 1-22

Tire Sealant and

Compressor Kit 1-23

Engine Oil Life System 1-23

Driving for Better Fuel

Economy 1-23

Roadside Assistance

Program 1-24

OnStar® 1-24

Instrument Panel

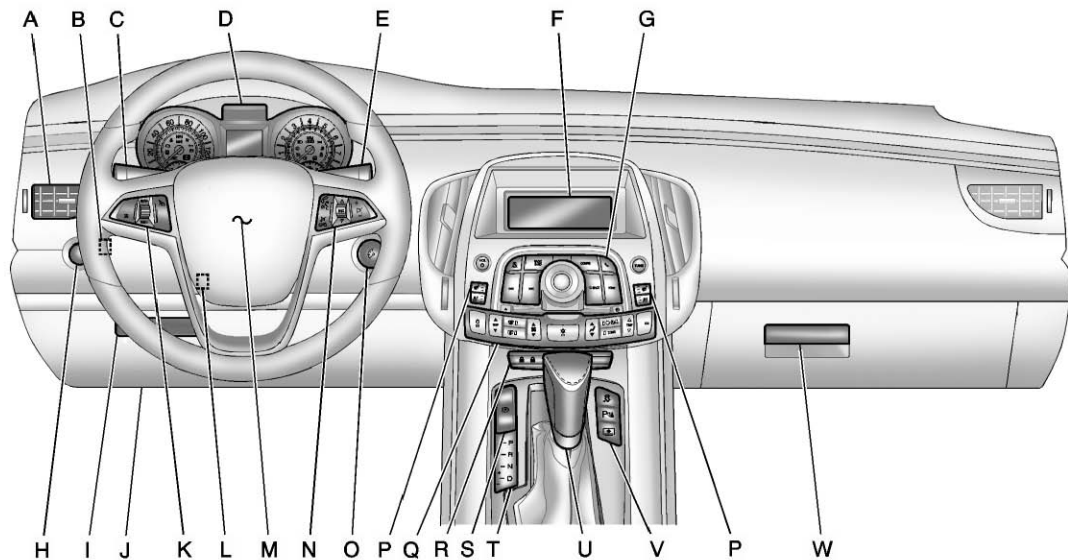

- A. *Air Vents on page 8-8.*
- B. *Head-Up Display (HUD) on page 5-29 (If Equipped).*
- C. *Turn and Lane-Change Lever. See Turn and Lane-Change Signals on page 6-4.*
Driver Information Center Buttons. See Driver Information Center (DIC) on page 5-25.
- D. *Instrument Cluster on page 5-10.*
Driver Information Center Display. See Driver Information Center (DIC) on page 5-25.
- E. *Windshield Wiper/Washer on page 5-3.*
- F. *Infotainment Display Screen.*
- G. *Infotainment on page 7-1.*
- H. *Exterior Lamp Controls on page 6-1.*
Fog Lamps on page 6-5 (If Equipped).
Instrument Panel Illumination Control on page 6-5.
- I. *Front Storage on page 4-1.*
- J. *Data Link Connector (DLC) (Out of View). See Malfunction Indicator Lamp on page 5-17.*
- K. *Cruise Control on page 9-39.*
- L. *Steering Wheel Adjustment on page 5-2.*
- M. *Horn on page 5-3.*
- N. *Steering Wheel Controls on page 5-2 (If Equipped).*
- O. *Ignition Positions (Key Access) on page 9-17 or Ignition Positions (Keyless Access) on page 9-19.*
- P. *Heated and Ventilated Front Seats on page 3-10.*
- Q. *Automatic Climate Control System on page 8-1 (If Equipped).*
Dual Automatic Climate Control System on page 8-4 (If Equipped).
- R. *Power Door Locks on page 2-11.*
Hazard Warning Flashers on page 6-4.
Passenger Sensing System on page 3-37.
- S. *Parking Brake on page 9-33.*
- T. *Shift Lever Position Indicator. See Automatic Transmission on page 9-28.*
- U. *Shift Lever. See Shifting Into Park on page 9-25.*
- V. *Traction Control System (TCS) on page 9-36.*
Electronic Stability Control (ESC) on page 9-37.
Ultrasonic Parking Assist on page 9-42.
Rear Window Sunshade (If Equipped). See Rear Window Sunshade on page 2-20.
- W. *Glove Box on page 4-1.*

Initial Drive Information

This section provides a brief overview about some of the important features that may or may not be on your specific vehicle.

For more detailed information, refer to each of the features which can be found later in this owner manual.

Remote Keyless Entry (RKE) System

The Remote Keyless Entry (RKE) transmitter will work up to 20 m (65 ft) away from the vehicle. On vehicles with remote start the distance will be greater.





Press the button to extend the key. The key can be used for all locks. This key is also used for the ignition, if the vehicle does not have push-button start

 : Press to unlock the driver door or all doors.

 : Press to lock all doors.

Lock and unlock feedback can be personalized.

 : Press and hold to open the trunk.



 : Press and release to locate the vehicle. Press and hold for more than two seconds to sound the panic alarm. Press again to cancel the panic alarm.

See *Keys* on page 2-2 and *Remote Keyless Entry (RKE) System Operation* on page 2-4.

Remote Vehicle Start

For vehicles with this feature, the engine can be started from outside of the vehicle.

Starting the Vehicle

1. Aim the Remote Keyless Entry transmitter at the vehicle.
2. Press .
3. Immediately after completing Step 2, press and hold  until the turn signal lamps flash, or for about 2 seconds if the vehicle is not in view.

When the vehicle starts, the parking lamps will turn on and remain on as long as the engine is running. The doors will be locked and the climate control system may come on.

The engine will continue to run for 10 minutes. Repeat the steps for a 10-minute time extension. Remote start can be extended only once.

Canceling a Remote Start



To cancel a remote start:

- Aim the RKE transmitter at the vehicle and press and hold  until the parking lamps turn off.
- Turn on the hazard warning flashers.
- Turn the vehicle on and then off.

See *Remote Vehicle Start on page 2-8*.

Door Locks

To lock or unlock the doors:

- From inside the vehicle, use the door lock knob or the power door lock controls, pull once on the door handle to unlock it, and a second time to open it.
- From outside, use the key, or press  or  on the Remote Keyless Entry (RKE) transmitter. See *Remote Keyless Entry (RKE) System Operation on page 2-4*.

See *Door Locks on page 2-10*.

Power Door Locks

On vehicles with power door locks, the controls are located on the center of the instrument panel.

 : Press to unlock the doors.

 : Press to lock the doors.

See *Power Door Locks on page 2-11*.

Trunk Release

The trunk may be opened by pressing  on the Remote Keyless Entry (RKE) transmitter or the touchpad located on the rear of the trunk above the license plate. See *Trunk on page 2-12* for more information.

Windows

On vehicles with power windows, the switches are on the driver door armrest. Each passenger door has a switch that controls only that window.

Press the switch to lower the window. Pull the switch up to raise it.

For more information, see *Power Windows on page 2-19*.

Seat Adjustment

Manual Seats

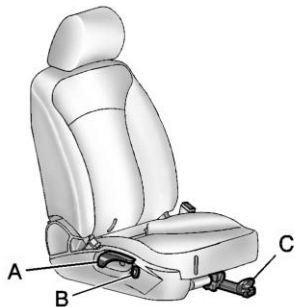

- A. Seatback Recline Lever
- B. Height Adjustment Switch
- C. Seat Position Handle

To adjust the seat position:

1. Pull the handle (C) under the front of the seat cushion.
2. Slide the seat to the desired position and release the handle.
3. Try to move the seat back and forth to be sure it is locked in place.

Press and hold the top or bottom of the switch (B) to raise or lower the seat. Release the switch when the desired height is reached.

To raise or recline the seatback, use the lever (A) on the outboard side of the seat.

See *Seat Adjustment on page 3-4* and *Reclining Seatbacks on page 3-8* for more information.

Power Seats

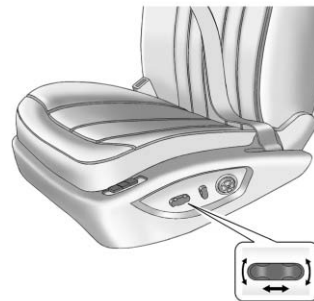

To adjust the seat:

- Move the seat forward or rearward by moving the horizontal control forward or rearward.
- Raise or lower the front or rear part of the seat cushion by moving the front or rear of the horizontal control up or down.
- Raise or lower the entire seat by moving the control up or down.

See *Power Seat Adjustment on page 3-5*.

Power Reclining Seatbacks

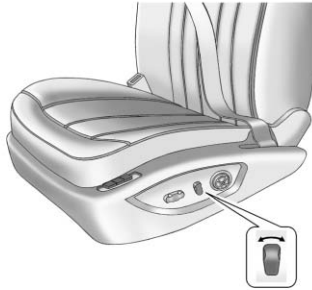

To raise or recline the seatback, tilt the top of the vertical control forward or rearward. See *Reclining Seatbacks* on page 3-8.

Lumbar Adjustment

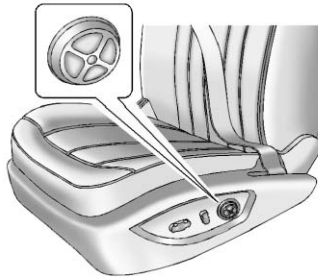

To adjust the lumbar support:

- Press and hold the front or rear of the control to increase or decrease lumbar support.
- Press and hold the top or bottom of the control to raise or lower lumbar support.

See *Lumbar Adjustment* on page 3-7.

Memory Features

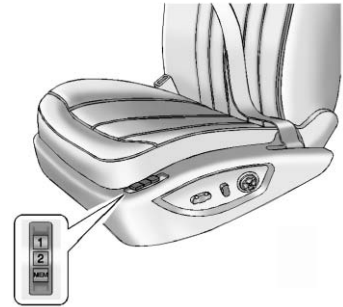

On vehicles with the memory feature, the “1” and “2” buttons on the outboard side of the driver seat are used to manually save and recall the driver seat and outside mirror positions. These manually stored positions are referred to as Button Memory positions.

1-8 In Brief

The vehicle will also automatically save driver seat and outside mirror positions to the current driver Remote Keyless Entry (RKE) transmitter when the ignition is placed in OFF. These automatically stored positions are referred to as RKE Memory positions.

Storing Button Memory Positions

To save positions into Button Memory:

1. Adjust the driver seat, seatback recliner, and both outside mirrors to the desired driving positions.
2. Press and release the MEM (Memory) button.
3. Press “1” until a beep sounds.
4. Repeat Steps 1 through 3 for a second driver using “2.”

To recall the manually saved Button Memory positions, press and hold “1” or “2.” The driver seat and outside mirrors move to the positions stored to those buttons when pressed. Releasing “1” or “2” before the stored positions are reached stops the recall.

To automatically recall RKE Memory positions, unlock the driver door with the RKE transmitter, and open the driver door. On vehicles with Keyless Access, opening the driver door when an RKE transmitter is present will activate the RKE Memory recall. If the driver door is already open, pressing the RKE transmitter  button will also activate the RKE Memory recall. The driver seat and outside mirrors will move to the previously saved RKE Memory positions.

See “Memory Seats” under *Power Seat Adjustment* on page 3-5 for more information.

Easy Exit Driver Seat

This feature moves the seat rearward allowing the driver more room to exit the vehicle.

To activate, place the ignition in OFF and open the driver door. If the driver door is already open, placing the ignition in OFF will activate the easy exit driver seat.

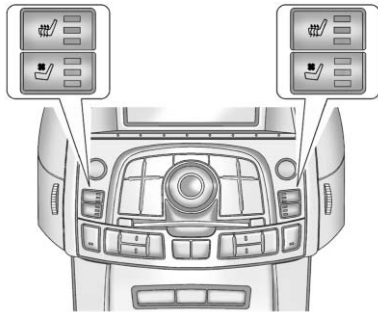

This feature is turned on or off using the vehicle personalization menu. See “Driver Seat Easy Exit” under *Vehicle Personalization* on page 5-39 for more information.

Heated and Ventilated Seats



**Heated and Ventilated
Seat Buttons Shown,
Heated Seat Buttons Similar**

If available, the buttons are on the climate control panel. To operate, the ignition must be on.

Press  to heat the seat cushion and seatback or , if equipped, to ventilate the seat.

Press the button once for the highest setting. With each press of the button, the seat will change to the next lower setting, and then to the off setting. The lights indicate three for the highest setting and one for the lowest.

For more information, see *Heated and Ventilated Front Seats* on page 3-10.

Head Restraint Adjustment

Do not drive until the head restraints for all occupants are installed and adjusted properly.

To achieve a comfortable seating position, change the seatback recline angle as little as necessary while keeping the seat and the head restraint height in the proper position.

For more information see *Head Restraints* on page 3-2 and *Seat Adjustment* on page 3-4.

Safety Belts

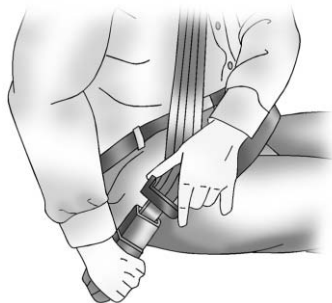

Refer to the following sections for important information on how to use safety belts properly.

- *Safety Belts on page 3-13.*
- *How to Wear Safety Belts Properly on page 3-17.*
- *Lap-Shoulder Belt on page 3-22.*
- *Lower Anchors and Tethers for Children (LATCH System) on page 3-52.*

Sensing System for Passenger Airbag



The passenger sensing system will turn off the right front passenger frontal airbag under certain conditions. The driver airbags, seat-mounted side impact airbags, and roof-rail airbags are not affected by the passenger sensing system.

The passenger airbag status indicator will be visible on the instrument panel when the vehicle is started. See *Passenger Sensing System on page 3-37* for more information.

Mirror Adjustment

Exterior

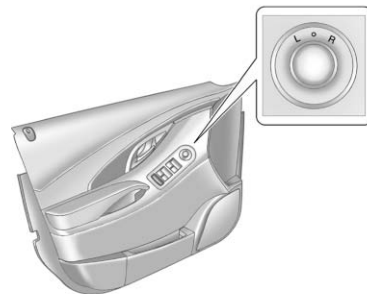

To adjust the mirrors:

1. Turn the control knob to the L (left) or R (right) selecting the driver or passenger mirror.
2. Push the control knob to the left, right, up, or down to adjust the mirror.

Vehicles with the memory feature can store a preferred mirror position. See “Memory Seats” under *Power Seat Adjustment* on page 3-5 for more information.

See *Power Mirrors* on page 2-16.

Manual Foldaway Mirrors

Vehicles with manual folded mirrors are folded inward to prevent damage when going through an automatic car wash. To fold, pull the mirror toward the vehicle. Push the mirror outward, to return it to the original position.

Automatic Dimming Feature

The driver outside mirror automatically adjusts for the glare of the headlamps behind you.

See *Power Mirrors* on page 2-16.

See *Folding Mirrors* on page 2-17.

Interior

Adjust this mirror for a clear view of the area behind the vehicle. Hold the mirror in the center to move it up, down, or side-to-side. To reduce headlamp glare from behind, push the tab forward for daytime and pull it for nighttime use.

Vehicles with OnStar® have three control buttons at the bottom of the mirror. See your dealer for more information on the system and how to subscribe to OnStar. See the OnStar® owner's guide for more information about the services OnStar provides.

See *Manual Rearview Mirror* on page 2-18.

Steering Wheel Adjustment

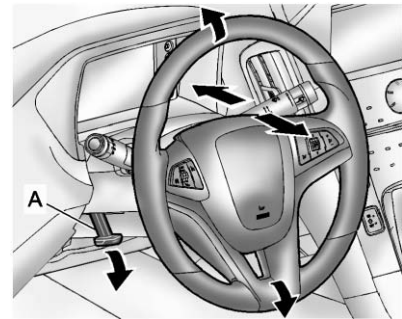

To adjust the steering wheel:

1. Pull the lever (A) down.
2. Move the steering wheel up or down.
3. Pull or push the steering wheel closer or away from you.
4. Pull the lever (A) up to lock the steering wheel in place.

Do not adjust the steering wheel while driving.

Interior Lighting

Dome Lamps

The interior lamps control located in the overhead console controls both the front and rear interior lamps.

To operate, press the following buttons:

 : Turns the lamps off.

 : Turns the lamps on when any door is opened.



 : Keeps the lamps on all the time.

Reading Lamps

There are front and rear reading lamps.

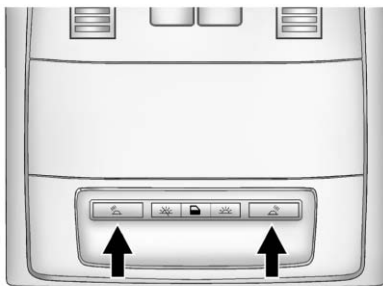
The front reading lamps are located in the overhead console.



  : Press to turn each lamp on or off.

The rear reading lamps are located in the headliner.

For more information on interior lighting, see *Instrument Panel Illumination Control* on page 6-5.

Exterior Lighting

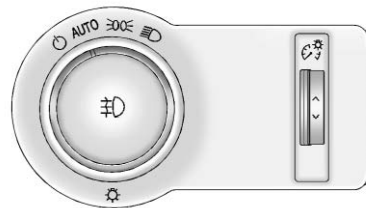

The exterior lamp control is located on the instrument panel on the outboard side of the steering wheel.

Turn the control to the following positions:

 : Turns off the exterior lamps. The knob returns to the AUTO position after it is released. Turn to off again to reactivate the AUTO mode.

AUTO: Automatically turns the exterior lamps on and off, depending on outside lighting.

The current status of the AUTO system is displayed in the Driver Information Center (DIC) uplevel display. See *Driver Information Center (DIC) on page 5-25*.

 : Turns on the parking lamps, together with the sidemarker lamps, taillamps, license plate lamps, and instrument panel lights.

 : Turns on the headlamps, together with the parking lamps, sidemarker lamps, taillamps, license plate lamps, and instrument panel lights.

For more information, see:

- *Exterior Lamp Controls on page 6-1.*
- *Daytime Running Lamps (DRL) on page 6-3.*
- *Fog Lamps on page 6-5.*

Windshield Wiper/Washer

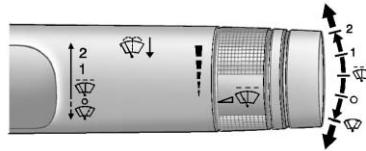



The windshield wiper lever is on the side of the steering column. With the ignition in ACC/ACCESSORY or ON/RUN, move the windshield wiper lever to select the wiper speed.

2: Fast wiper.

1: Slow wiper.

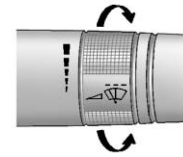
 : Turn the band up for more frequent wipes or down for less frequent wipes.



 : Turns the windshield wipers off.

 : Briefly move the wiper lever down for a single wipe or hold down for several wipes.

Windshield Washer

Pull the windshield wiper lever to spray windshield washer fluid and activate the wipers.

See *Windshield Wiper/Washer on page 5-3*.

Climate Controls

The heating, cooling, and ventilation for the vehicle can be controlled with these systems.

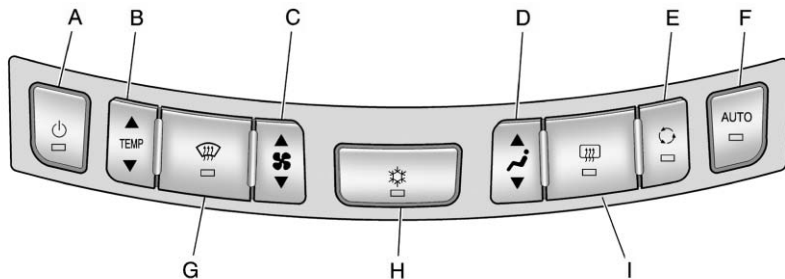

Automatic Climate Control System

- | | |
|------------------------------|-------------------------|
| A. Power | E. Recirculation |
| B. Temperature Control | F. AUTO |
| C. Fan Control | G. Defrost |
| D. Air Delivery Mode Control | H. Air Conditioning |
| | I. Rear Window Defogger |

Dual Automatic Climate Control System

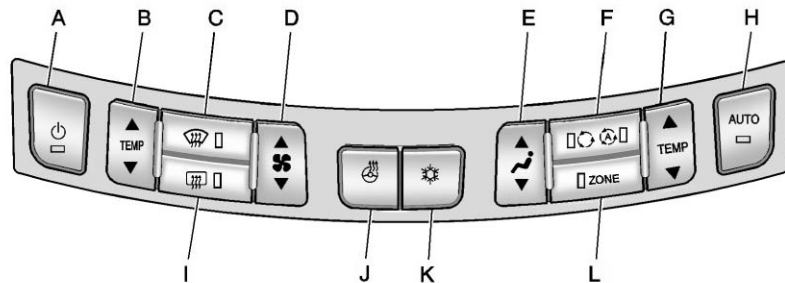

- A. Power
- B. Driver Temperature Control
- C. Defrost
- D. Fan Control
- E. Air Delivery Mode Control
- F. Recirculation/Automatic Recirculation
- G. Passenger Temperature Control
- H. AUTO

- I. Rear Window Defogger
- J. Heated Steering Wheel
- K. Air Conditioning
- L. ZONE

See *Automatic Climate Control System* on page 8-1 (If Equipped) or *Dual Automatic Climate Control System* on page 8-4 (If Equipped).

Transmission

Automatic Transmission

Driver Shift Control (DSC)

Driver Shift Control (DSC) allows shifting an automatic transmission similar to a manual transmission. DSC can be enabled through the shift lever. See *Manual Mode* on page 9-30.

Vehicle Features

Radio(s)

VOL/⏮ : Press to turn the system on and off. Turn to increase or decrease the volume.

RADIO/BAND: Press to choose between FM, AM, or XM™, if equipped.

TUNE: Turn to select radio stations.

⏮ : Press to seek the previous station or track.

⏭ : Press to seek the next station or track.

Buttons 1-6: Press to save and select favorite stations

INFO: Press to show available information about the current station or track.

For more information about these and other radio features, see *Operation on page 7-7*.

Storing a Favorite Station

Stations from all bands can be stored in the favorite lists in any order. Up to six stations can be stored in each favorite page and the number of available favorite pages can be set.

To store the station to a position in the list, press the corresponding numeric button 1-6 until the station can be heard again.

For more information, see “Storing and Retrieving Favorites” in *AM-FM Radio on page 7-12*.

Setting the Clock

Adjusting the Time

1. Press the CONFIG button and select Time Settings, or press ⏮.
2. Select Set Time.

3. Turn the Menu knob to adjust the highlighted number.
4. Press the SELECT button to select the next number.
5. To save the time and return to the Time Settings menu, press the BACK button at any time or press the SELECT button after adjusting the minutes.

Setting the 12/24 Hour Format

1. Press the CONFIG button and select Time Settings, or press ⏮.
2. Highlight 12/24 Hour Format.
3. Press the SELECT button to select the 12 hour or 24 hour display format.

For detailed instructions on setting the clock, see *Clock (Without Date Display) on page 5-5* or *Clock (With Date Display) on page 5-6*.

Satellite Radio

Vehicles with an XM™ Satellite Radio tuner and a valid XM Satellite Radio subscription can receive XM programming.

XM Satellite Radio Service

XM is a satellite radio service based in the 48 contiguous United States and 10 Canadian provinces. XM Satellite Radio has a wide variety of programming and commercial-free music, coast to coast, and in digital-quality sound. A fee is required to receive the XM service.

For more information refer to:

- www.xmradio.com or call 1-800-929-2100 (U.S.).
- www.xmradio.ca or call 1-877-438-9677 (Canada).

For more information, see *Satellite Radio* on page 7-15.

Portable Audio Devices

This vehicle has a 3.5 mm (1/8 in) auxiliary input and a USB port located in the center console. External devices such as iPods®, laptop computers, MP3 players, CD changers, and USB storage devices may be connected, depending on the audio system.

For more information, see *Auxiliary Devices (Radio with CD)* on page 7-31 or *Auxiliary Devices (Radio with CD/DVD and MEM)* on page 7-34.

Bluetooth®

The Bluetooth® system allows users with a Bluetooth-enabled cell phone to make and receive hands-free calls using the vehicle audio system, microphone, and controls.



The Bluetooth-enabled cell phone must be paired with the in-vehicle Bluetooth system before it can be used in the vehicle. Not all phones will support all functions.

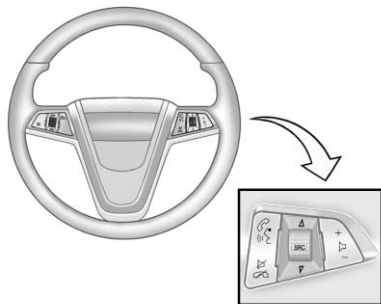

See *Bluetooth (Overview)* on page 7-46 or *Bluetooth (Infotainment Controls)* on page 7-48 or *Bluetooth (Voice Recognition)* on page 7-53.

Steering Wheel Controls





For vehicles with audio steering wheel controls, some audio controls can be adjusted at the steering wheel.



  : Press to interact with the available Bluetooth, OnStar, or navigation system.

  : Press to silence the vehicle speakers only. Press again to turn the sound on. For vehicles with OnStar or Bluetooth systems, press to reject an incoming call, or to end a current call.

 **SRC**  : Turn  or  to select a radio band or audio source.

Turn  or  to select the next or previous favorite radio station, CD, DVD track/chapter (with navigation), or MP3 track.

Press SRC to change between radio and CD or DVD.

  -: Press + to increase or - to decrease the volume.

For more information, see *Steering Wheel Controls* on page 5-2.

Cruise Control

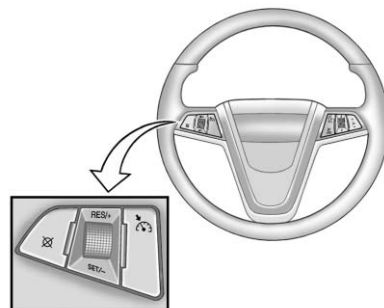

The cruise control buttons are located on the steering wheel.

 : Press to turn the cruise control system on and off. An indicator light will turn on or off in the instrument panel cluster.

⊗ : Press to disengage cruise control without erasing the set speed from memory.

RES/+ : Move the thumbwheel up to make the vehicle resume to a previously set speed or to accelerate.

SET/- : Move the thumbwheel down to set the speed and activate cruise control or make the vehicle decelerate.

See *Cruise Control* on page 9-39.

Navigation System

If the vehicle has a navigation system, there is a separate Navigation System Manual that includes information on the radio, audio players, and navigation system.

The navigation system provides detailed maps of most major freeways and roads. After a destination has been set, the system provides turn-by-turn instructions for reaching the destination. In addition, the system can help locate a variety of points of interest (POIs), such as banks, airports, restaurants, and more.

See the Navigation System Manual for more information.

Driver Information Center (DIC)

The DIC display is located in the center of the instrument panel cluster. It shows the status of many vehicle systems. The controls for the DIC are located on the turn signal lever.

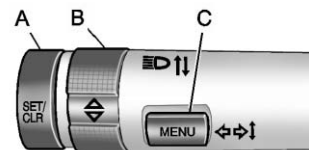

- A. **SET/CLR**: Press to set or clear the menu item when it is displayed.
- B. **△ ▽**: Use the thumbwheel to scroll through the items in each menu.
- C. **MENU**: Press to get to the Trip/Fuel Menu and the Vehicle Information Menu. This button is also used to return to or exit the last screen displayed on the DIC.

For more information, see *Driver Information Center (DIC)* on page 5-25.

Vehicle Personalization

Some vehicle features can be programmed by using the audio system controls. These features include:

- Climate and Air Quality
- Comfort and Convenience
- Collision/Detection Systems
- Language
- Lighting
- Power Door Locks
- Remote Lock/Unlock/Start

See *Vehicle Personalization* on page 5-39.

Power Outlets

The accessory power outlets can be used to plug in electrical equipment, such as a cell phone or MP3 player.

There are two accessory power outlets. One is located under the armrest inside the center console storage and the other is on the rear of the center floor console.

Remove the cover to access and replace when not in use.

See *Power Outlets* on page 5-7.

Universal Remote System



This system provides a way to replace up to three remote control transmitters used to activate devices such as garage door openers, security systems, and home automation devices.

Read the instructions completely before attempting to program the Universal Home Remote. Because of the steps involved, it may be helpful to have another person available to assist you with programming the Universal Home Remote.

See *Universal Remote System* on page 5-45.

Sunroof

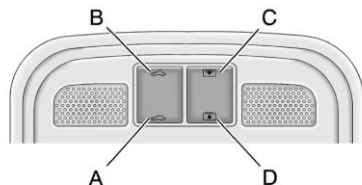

On vehicles with a sunroof, the switch is located on the overhead console.

The sunroof only operates when the ignition is in ON/RUN or ACC/ACCESSORY, or in Retained Accessory Power (RAP). See *Retained Accessory Power (RAP)* on page 9-24

Vent: The sunroof has an express-vent open feature. From the closed position, press the rear of the sunroof switch (B) to the first detent to vent the sunroof. To close the sunroof, press the front of the sunroof switch (A) to the second detent.

Express-open/Express-close:

To express-open the sunroof from the closed or vent position, fully press and release the rear of the switch (B). The sunroof opens automatically. To stop the sunroof partway, press the switch a second time. To express-close the sunroof, fully press and release the front of the switch (A). The sunroof closes automatically. To stop the sunroof partway, press the switch a second time.

If the sunshade is closed, it opens automatically with the sunroof but can also be express-opened/ express-closed by using the sunshade control (C) or (D). The sunshade cannot be fully closed with the sunroof open.

To express-open the sunshade from the closed position, fully press and release the rear of the switch (C). The sunshade opens automatically. To stop the sunshade partway, press the switch a second time. To express-close the sunshade fully press and release the front of the switch (D). The sunshade closes automatically. To stop the sunshade partway, press the switch a second time.

Notice: Forcing the sunshade forward of the sliding glass panel may cause damage and the sunroof may not operate properly. Always close the glass panel before closing the sunshade.



The sunroof glass panel cannot be opened or closed if the vehicle has an electrical failure.

See *Sunroof* on page 2-21.

Performance and Maintenance

Traction Control System (TCS)



The traction control system limits wheel spin. The system turns on automatically every time the vehicle is started.

- To turn off traction control, press and release  located on the console to the right of the shifter.  illuminates and the appropriate DIC message is displayed. See *Electronic Stability Control (ESC)/Traction Control System (TCS) Indicator/Warning Light* on page 5-22.
- Press and release the button again to turn on traction control.

For more information, see *Traction Control System (TCS)* on page 9-36.

Electronic Stability Control (ESC)

The Electronic Stability Control (ESC) system assists with directional control of the vehicle in difficult driving conditions. The system turns on automatically every time the vehicle is started.

- To turn off both traction control and ESC, press and hold , located on the console to the right of the shifter, until  illuminates and the appropriate DIC message is displayed. See *Electronic Stability Control (ESC)/Traction Control System (TCS) Indicator/Warning Light* on page 5-22.
- Press and release the button to turn on both systems.

For more information, see *Electronic Stability Control (ESC)* on page 9-37.

Tire Pressure Monitor

This vehicle may have a Tire Pressure Monitor System (TPMS).



The TPMS warning light alerts you to a significant loss in pressure of one of the vehicle's tires. If the warning light comes on, stop as soon as possible and inflate the tires to the recommended pressure shown on the Tire and Loading Information label. See *Vehicle Load Limits* on page 9-12. The warning light will remain on until the tire pressure is corrected.

During cooler conditions, the low tire pressure warning light may appear when the vehicle is first started and then turn off. This may be an early

indicator that the tire pressures are getting low and the tires need to be inflated to the proper pressure.

The TPMS does not replace normal monthly tire maintenance. It is the driver's responsibility to maintain correct tire pressures.

See *Tire Pressure Monitor System* on page 10-56.

Tire Sealant and Compressor Kit

This vehicle may come with a jack and spare tire or a tire sealant and compressor kit. The kit can be used to temporarily seal small punctures in the tread area of the tire.

See *Tire Sealant and Compressor Kit* on page 10-72 for complete operating information.

If the vehicle came with a jack and spare tire, see *If a Tire Goes Flat* on page 10-70.

Engine Oil Life System

The engine oil life system calculates engine oil life based on vehicle use and displays the CHANGE ENGINE OIL SOON message when it is time to change the engine oil and filter. The oil life system should be reset to 100% only following an oil change.

Resetting the Oil Life System

1. Turn the ignition to ON/RUN with the engine off.
2. Press the DIC menu button on the turn signal lever to enter the Vehicle Information Menu. Use the thumbwheel to scroll through the menu items until you reach REMAINING OIL LIFE.
3. Press the SET/CLR button to reset the oil life at 100%.
4. Turn the ignition to LOCK/OFF.

See *Engine Oil Life System* on page 10-13.

Driving for Better Fuel Economy

Driving habits can affect fuel mileage. Here are some driving tips to get the best fuel economy possible.

- Avoid fast starts and accelerate smoothly.
- Brake gradually and avoid abrupt stops.
- Avoid idling the engine for long periods of time.
- When road and weather conditions are appropriate, use cruise control.
- Always follow posted speed limits or drive more slowly when conditions require.
- Keep vehicle tires properly inflated.
- Combine several trips into a single trip.

1-24 In Brief

- Replace the vehicle's tires with the same TPC Spec number molded into the tire's sidewall near the size.
- Follow recommended scheduled maintenance.

Roadside Assistance Program

U.S.: **1-800-252-1112**

TTY Users (U.S.): **1-888-889-2438**

Canada: **1-800-268-6800**

Mexico: **01-800-466-0818**

As the owner of a new Buick, you are automatically enrolled in the Roadside Assistance program.

See *Roadside Assistance Program (U.S. and Canada)* on page 13-8 or *Roadside Assistance Program (Mexico)* on page 13-10 for more information.

Roadside Service and OnStar (U.S. and Canada)

If you have an active OnStar subscription, press the  button and the current GPS location will be sent to an OnStar Advisor who will assess your problem, contact Roadside Assistance, and relay your exact location to get the help you need.

Online Owner Center (U.S. and Canada)

The Online Owner Center is a complimentary service that includes online service reminders, vehicle maintenance tips, online owner manual, special privileges, and more.

Sign up today at:
www.buickownercenter.com
(U.S.) or **www.gm.ca** (Canada).

OnStar®





For vehicles with an active OnStar subscription, OnStar uses several innovative technologies and live Advisors to provide a wide range of safety, security, navigation, diagnostics, and calling services.

Automatic Crash Response

In a crash, built-in sensors can automatically alert an OnStar Advisor who is immediately connected to the vehicle to see if you need help.

How OnStar Service Works

 : Push this blue button to connect to a specially trained OnStar Advisor to verify your account information and to answer questions.

 : Push this red emergency button to get priority help from specially trained OnStar Emergency Advisors.

 : Push this button for hands-free, voice-activated calling and to give voice commands for Hands-Free Calling and Turn-by-Turn Navigation.

Automatic Crash Response, Emergency Services, Crisis Assist, Stolen Vehicle Assistance, Vehicle Diagnostics, Remote Door Unlock, Roadside Assistance, Turn-by-Turn Navigation, and Hands-Free Calling are available on most vehicles.

Not all OnStar services are available on all vehicles. For more information, see the OnStar Owner's Guide; visit www.onstar.com (U.S.) or www.onstar.ca (Canada); contact OnStar at 1-888-4-ONSTAR (1-888-466-7827) or TTY 1-877-248-2080; or push the  button to speak with an OnStar Advisor 24 hours a day, 7 days a week.

For a full description of OnStar services and system limitations, see the OnStar Owner's Guide in the glove box.

OnStar service is subject to the OnStar Terms and Conditions included in the OnStar Glove Box Kit.

OnStar service requires wireless communication networks and the Global Positioning System (GPS)

satellite network. Not all OnStar services are available everywhere or on all vehicles at all times.

OnStar service can't work unless the vehicle is in a place where OnStar has an agreement with a wireless service provider for service in that area, and the wireless service provider has coverage, network capacity, reception, and technology compatible with OnStar service. Service involving location information about the vehicle can't work unless GPS signals are available, unobstructed, and compatible with the OnStar hardware. The vehicle has to have a working electrical system and adequate battery power for the OnStar equipment to operate.

OnStar service may not work if the OnStar equipment isn't properly installed or you haven't maintained it and the vehicle is in good working order and in compliance with all government regulations. If you try to add, connect, or modify any equipment or software in the vehicle, OnStar service may not work. Other problems OnStar can't control may prevent service to you, such as hills, tall buildings, tunnels, weather, electrical system design and architecture of the vehicle, damage to important parts of the vehicle in a crash, or wireless phone network congestion or jamming.

See *Radio Frequency Statement on page 13-20* for information regarding Part 15 of the Federal Communications Commission (FCC) rules and Industry Canada Standards RSS-210/220/310.

OnStar Steering Wheel Controls



This vehicle may have a Talk/Mute button that can be used to interact with OnStar Hands-Free calling. See *Steering Wheel Controls on page 5-2* for more information.

On some vehicles, the Talk button can be used to dial numbers into voice mail systems, or to dial phone extensions. See the OnStar Owner's Guide for more information.

Your Responsibility

Increase the volume of the radio if the OnStar Advisor cannot be heard.

If the light next to the OnStar buttons is red, the system may not be functioning properly.

Push the  button and request a vehicle diagnostic check. If the light appears clear (no light appears), your OnStar subscription has expired and all services have been deactivated. Push the  button to confirm that the OnStar equipment is active.

Keys, Doors and Windows

Keys and Locks

Keys	2-2
Remote Keyless Entry (RKE) System	2-3
Remote Keyless Entry (RKE) System Operation	2-4
Remote Vehicle Start	2-8
Door Locks	2-10
Power Door Locks	2-11
Delayed Locking	2-12
Safety Locks	2-12

Doors

Trunk	2-12
-------------	------

Vehicle Security

Vehicle Security	2-14
Anti-Theft Alarm System	2-14
Immobilizer	2-14
Immobilizer Operation (Key Access)	2-14
Immobilizer Operation (Keyless Access)	2-15

Exterior Mirrors

Power Mirrors	2-16
Folding Mirrors	2-17
Heated Mirrors	2-17
Park Tilt Mirrors	2-17

Interior Mirrors

Manual Rearview Mirror	2-18
------------------------------	------

Windows

Windows	2-18
Power Windows	2-19
Sun Visors	2-20
Rear Window Sunshade	2-20

Roof

Sunroof	2-21
---------------	------

2-2 Keys, Doors and Windows

Keys and Locks

Keys

WARNING

Leaving children in a vehicle with the ignition key is dangerous for many reasons. Children or others could be badly injured or even killed. They could operate the power windows or other controls or even make the vehicle move. The windows will function with the keys in the ignition and children could be seriously injured or killed if caught in the path of a closing window. Do not leave the keys in a vehicle with children.

WARNING

Leaving children in a vehicle with the keyless access transmitter is dangerous for many reasons, children or others could be badly injured or even killed. They could operate the power windows or other controls or even make the vehicle move. The windows will function with the keyless access transmitter in the vehicle and they could be seriously injured or killed if caught in the path of a closing window. Do not leave the keyless access transmitter in a vehicle with children.



The key that is part of the Remote Keyless Entry (RKE) transmitter can be used for the ignition and all locks if the vehicle is a key access vehicle. If the vehicle has the keyless ignition, the key can be used for the locks.



Press the button on the RKE transmitter to extend the key. Press the button and the key blade to retract the key.

See your dealer if a new key is needed.

Notice: If the keys get locked in the vehicle, it may have to be damaged to get them out. Always carry a spare key.

If you are locked out of the vehicle, see *Roadside Assistance Program (U.S. and Canada)* on page 13-8 or *Roadside Assistance Program (Mexico)* on page 13-10.

Remote Keyless Entry (RKE) System

See *Radio Frequency Statement* on page 13-20 for information regarding Part 15 of the Federal Communications Commission (FCC) rules and Industry Canada Standards RSS-210/220/310.

If there is a decrease in the RKE operating range:

- Check the distance. The transmitter may be too far from the vehicle.
- Check the location. Other vehicles or objects may be blocking the signal.
- Check the transmitter's battery. See "Battery Replacement" later in this section.
- If the transmitter is still not working correctly, see your dealer or a qualified technician for service.

2-4 Keys, Doors and Windows

Remote Keyless Entry (RKE) System Operation

The transmitter functions will work up to 20 m (65 ft) away from the vehicle. On vehicles with remote start the distance will be greater.

Keep in mind that other conditions, such as those previously stated, can impact the performance of the transmitter.



RKE without Remote Start Shown

🔒 (Lock): Press to lock all doors.

The turn signal indicators may flash and/or the horn may sound to indicate locking, see “Locking Feedback” under *Vehicle Personalization* on page 5-39.

If the driver door is open when **🔒** is pressed, all doors lock except the driver door, if enabled through the vehicle personalization.

If the passenger door is open when **🔒** is pressed, all doors lock.

Pressing **🔒** may also arm the theft-deterrent system. See *Anti-Theft Alarm System* on page 2-14.

🔓 (Unlock): Press to unlock the driver door or all doors. See “Door Unlock Options” under *Vehicle Personalization* on page 5-39.

The turn signal indicators may flash and/or the horn may sound to indicate unlocking.

See “Unlock Feedback” under *Vehicle Personalization* on page 5-39.



Pressing **🔓** will disarm the theft-deterrent system. See *Anti-Theft Alarm System* on page 2-14.

Memory seat positions may be recalled when unlocking the vehicle. See “Memory Seats” under *Power Seat Adjustment* on page 3-5 and “Remote Recall” under *Vehicle Personalization* on page 5-39 for more information.

🚗 (Remote Trunk Release): Press and hold to unlock the trunk.

📶 (Vehicle Locator/Panic Alarm): Press and release one time to locate the vehicle. The exterior lamps flash and the horn chirps.

Press and hold **📶** for at least two seconds to sound the panic alarm. The horn sounds and the turn signals flash until **📶** is pressed again or the vehicle is started.

🔑 (Remote Vehicle Start): For vehicles with this feature, press  and then press and hold  within five seconds to start the engine from outside the vehicle using the RKE transmitter. See *Remote Vehicle Start* on page 2-8 for additional information.

Keyless Access Operation

Some vehicles have a keyless access system that lets you lock and unlock the doors and access the trunk without removing the RKE transmitter from your pocket, purse, briefcase, etc. The RKE transmitter should be within 1 m (3 ft) of the door or trunk being opened.

Keyless Unlocking

With the RKE transmitter within 1 m (3 ft), approach the front door and pull the handle to unlock and open the door. If the transmitter is recognized, the door will unlock and open.

Entering any door other than the driver door will always cause all of the doors to unlock. This is not customizable.

To customize which doors unlock when the driver door is opened, see “Door Unlock Options” under *Vehicle Personalization* on page 5-39.

Lock Sensor

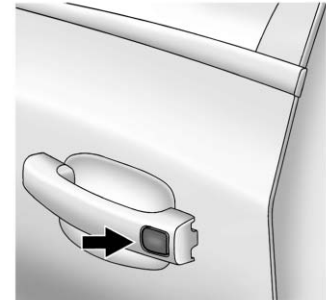

When all doors are closed and the ignition is off, the vehicle can be locked by pressing this area on the door handle. This feature will be available for several minutes after the vehicle has been turned off.

2-6 Keys, Doors and Windows

Keyless Trunk Opening

Lift up on the touch pad located above the license plate to open the trunk if the RKE transmitter is within range.

Programming Transmitters to the Vehicle

Only RKE transmitters programmed to the vehicle will work. If a transmitter is lost or stolen, a replacement can be purchased and programmed through your dealer. The vehicle can be reprogrammed so that lost or stolen transmitters no longer work. Any remaining transmitters will need to be reprogrammed. Each vehicle can have up to five transmitters matched to it.

Programming with a Recognized Transmitter (Keyless Access Vehicles Only)

A new transmitter can be programmed to the vehicle when there is one recognized transmitter. To program, the vehicle must be off and all of the transmitters, both currently recognized and new, must be with you.

1. Place the recognized transmitter(s) in the cupholder.
2. Insert the vehicle key of the new transmitter into the key lock cylinder located on the outside of the driver door and turn the key to the unlock position five times within 10 seconds.

The Driver Information Center (DIC) displays READY FOR REMOTE #2, 3, 4 or 5.

3. Place the new transmitter into the transmitter pocket. The transmitter pocket is located inside the center console storage area under the cupholder. The cupholder will need to be pulled out to access the transmitter pocket.
4. Press the ignition. When the transmitter is learned, the DIC will show that it is ready to program the next transmitter.
5. Remove the transmitter from the transmitter pocket and press .

To program additional transmitters, repeat Steps 3 through 5.

When all additional transmitters are programmed, press and hold the ignition for 10 seconds to exit programming mode.

Programming without a Recognized Transmitter (Keyless Access Vehicles Only)

If there are no currently recognized transmitters available, follow this procedure to program up to five transmitters. This feature is not available in Canada. This procedure will take approximately 30 minutes to complete. The vehicle must be off and all of the transmitters you wish to program must be with you.

1. Insert the vehicle key of the transmitter into the key lock cylinder located on the outside of the driver door and turn the key to the unlock position five times within 10 seconds.

The Driver Information Center (DIC) displays REMOTE LEARN PENDING, PLEASE WAIT.

2. Wait for 10 minutes until the DIC displays PRESS ENGINE START BUTTON TO LEARN and then press the ignition.

The DIC displays will again show REMOTE LEARN PENDING, PLEASE WAIT.

3. Repeat Step 2 two additional times. After the third time all previously known transmitters will no longer work with the vehicle. Remaining transmitters can be relearned during the next steps.

The DIC display should now show READY FOR REMOTE # 1.

4. Place the new transmitter into the transmitter pocket. The transmitter pocket is located inside the center console storage area under the cupholder. The cupholder will need to be pulled out to access the transmitter pocket.
5. Press the ignition. When the transmitter is learned the DIC will show that it is ready to program the next transmitter.
6. Remove the transmitter from the transmitter pocket and press .

To program additional transmitters, repeat Steps 4 through 6.

When all additional transmitters are programmed, press and hold the ignition for 10 seconds to exit programming mode.

2-8 Keys, Doors and Windows

Starting the Vehicle with a Low Transmitter Battery

If the transmitter battery is weak, the DIC may display NO REMOTE DETECTED when you try to start the vehicle. The REPLACE BATTERY IN REMOTE KEY message may also be displayed at this time.



To start the vehicle:

1. Remove the cupholder from the center console storage area.
2. Place the transmitter in the transmitter pocket with the buttons facing up.

3. With the vehicle in P (Park) or N (Neutral), press the brake pedal and the ignition control. See *Starting the Engine on page 9-20* for additional information about the vehicle's keyless ignition with push start.

Replace the transmitter battery as soon as possible.

Battery Replacement

Replace the battery if the REPLACE BATTERY IN REMOTE KEY message displays in the DIC. See "Replace Battery in Remote Key" under *Key and Lock Messages on page 5-36*.

The battery is not rechargeable. To replace the battery:

1. Push the button on the transmitter to extend the key.
2. Remove the battery cover by prying it with a finger.
3. Remove the battery by pushing on the battery and sliding it toward the keyblade.

4. Insert the new battery, positive side facing up. Push the battery down until it is held in place. Replace with a CR2032 or equivalent battery.
5. Snap the battery cover back on to the transmitter.

Remote Vehicle Start



If available, this feature allows the engine to be started from outside the vehicle.

The  button will be on the RKE transmitter if the vehicle has remote start.

Laws in some local communities may restrict the use of remote starters. For example, some laws may require a person using remote start to have the vehicle in view. Check local regulations for any requirements.

Starting the Engine Using Remote Start

To start the engine using the remote start feature:

1. Aim the Remote Keyless Entry transmitter at the vehicle.
2. Press .
3. Immediately after completing Step 2, press and hold  until the turn signal lamps flash, or for about 2 seconds if the vehicle is not in view.

Once the vehicle is started, the parking lamps will turn on and remain on as long as the engine is running.

Turn the ignition to ON/RUN (key access), or select the ON/RUN/START ignition position (keyless access), to drive the vehicle.

The engine will shut off after 10 minutes unless a time extension is done or the ignition is put in ON/RUN (key access) or ON/RUN/START (keyless access).

Vehicles with an automatic climate control system will default to a heating or cooling mode depending on the outside temperature during a remote start. When the key is turned to ON/RUN (key access), or the ON/RUN/START ignition position is selected (keyless access), the climate control system will turn on at the setting the vehicle was set to when the vehicle was last turned off. Vehicles with heated or heated and ventilated front seats can have this feature turn on automatically during a remote start. See “Remote Start Heated Seats” and “Remote Start Vented Seats” under *Vehicle Personalization* on page 5-39 for more information.

Extending Engine Run Time

For a 10-minute extension, repeat Steps 1 and 2 while the engine is still running. The remote start can only be extended once.

When the remote start is extended, the second 10 minutes will start immediately.

For example, if the vehicle has been running for five minutes, and 10 minutes are added, the engine will run for a total of 15 minutes.

A maximum of two remote starts or remote start attempts are allowed between ignition cycles.

The vehicle's ignition must be turned on and then back off before the remote start procedure can be used again.

2-10 Keys, Doors and Windows

Canceling a Remote Start

To cancel a remote start, do any of the following:

- Aim the RKE transmitter at the vehicle and press and hold  until the parking lamps turn off.
- Turn on the hazard warning flashers.
- Turn the vehicle on and then off.

Conditions in Which Remote Start Will Not Work

The remote start will not operate if:

- The key is in the ignition (key access) or the ignition is in any position other than OFF (keyless access).

- The transmitter is in the vehicle (keyless access).
- The hood is not closed.
- The hazard warning flashers are on.
- There is an emission control system malfunction.
- The engine coolant temperature is too high.
- The oil pressure is low.
- Two remote vehicle starts have already been used.
- The vehicle is not in P (Park).

Door Locks



Unlocked doors can be dangerous.

- Passengers, especially children, can easily open the doors and fall out of a moving vehicle. The chance of being thrown out of the vehicle in a crash is increased if the doors are not locked. So, all passengers should wear safety belts properly and the doors should be locked whenever the vehicle is driven.

(Continued)

WARNING (Continued)

- Young children who get into unlocked vehicles may be unable to get out. A child can be overcome by extreme heat and can suffer permanent injuries or even death from heat stroke. Always lock the vehicle whenever leaving it.
- Outsiders can easily enter through an unlocked door when slowing or stopping the vehicle. Lock the doors to help prevent this from happening.

To lock and unlock the door, use the Remote Keyless Entry (RKE) transmitter or the key from the outside and the door lock knob or switch from the inside.

From inside the vehicle with the doors locked, pull once on the door handle to unlock it, and a second time to open it.

Manually locking the driver door also automatically locks all other doors.

For more information see:

- *Remote Keyless Entry (RKE) System Operation on page 2-4.*
- *Power Door Locks on page 2-11.*
- *Vehicle Personalization on page 5-39.*

Power Door Locks

I (Unlock): Press to unlock all doors.

L (Lock): Press to lock all doors.

See "Power Door Locks" in *Vehicle Personalization on page 5-39.*

Delayed Locking

When locking the doors with the power lock switch and a door is open, the doors will lock five seconds after the last door is closed. You will hear three chimes to signal that the delayed locking feature is in use.

Pressing the power lock switch twice or the lock button on the RKE transmitter twice will override the delayed locking feature and immediately lock all the doors.

This feature will not operate if the key is in the ignition.

This feature can be programmed by using the Driver Information Center (DIC). See “Delayed Door Lock” under *Vehicle Personalization on page 5-39*.

Safety Locks

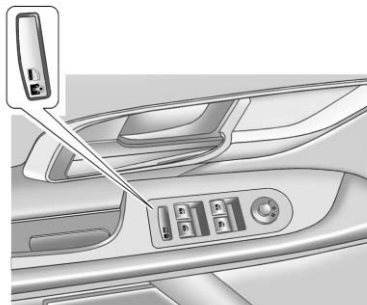

Press the button on the driver door armrest to activate the safety locks on the passenger rear doors.

This switch also disables the rear power windows.

Once activated, the light, located on the switch, illuminates and goes out when deactivated.

If the light flashes, the feature may not be working properly.

Doors

Trunk

WARNING

Exhaust gases can enter the vehicle if it is driven with the liftgate, trunk/hatch open, or with any objects that pass through the seal between the body and the trunk/hatch or liftgate. Engine exhaust contains Carbon Monoxide (CO) which cannot be seen or smelled. It can cause unconsciousness and even death.

(Continued)

WARNING (Continued)

If the vehicle must be driven with the liftgate, or trunk/hatch open:

- Close all of the windows.
- Fully open the air outlets on or under the instrument panel.
- Adjust the Climate Control system to a setting that brings in only outside air and set the fan speed to the highest setting. See Climate Control System in the Index.
- If the vehicle has a power liftgate, disable the power liftgate function.

For more information about carbon monoxide, see *Engine Exhaust* on page 9-27.

Remote Trunk Release

To open the trunk from the outside the vehicle, press  on the Remote Keyless Entry (RKE) transmitter, or press the touchpad above the license plate.

Emergency Trunk Release Handle

Notice: Do not use the emergency trunk release handle as a tie-down or anchor point when securing items in the trunk as it could damage the handle. The emergency trunk release handle is only intended to aid a person trapped in a latched trunk, enabling them to open the trunk from the inside.



There is an emergency trunk release handle located inside the trunk on the trunk latch. On some vehicles, the release handle can be accessed by folding the rear seat center seatback. See *Rear Seats* on page 3-11. Pull the release handle to open the trunk from the inside.

Vehicle Security

This vehicle has theft-deterrent features; however, they do not make it impossible to steal.

Anti-Theft Alarm System

This vehicle has an anti-theft alarm system.

Arming the System

To arm the system, press  on the RKE transmitter.

The alarm automatically arms after about 30 seconds. The security light, located on the instrument panel, flashes.

Press  on the RKE transmitter to open the trunk without setting off the alarm. The system rearms when the trunk is closed.

Disarming the System

To disarm the system, do one of the following:

- Press  on the RKE transmitter.
- Approach the vehicle with the RKE transmitter (keyless access).
- Start the engine.

The alarm automatically disarms.

How to Detect a Tamper Condition

If  is pressed and the horn sounds, an attempted break-in has occurred while the system was armed.

If the alarm has been activated, the THEFT ATTEMPTED message will appear on the DIC. See *Key and Lock Messages* on page 5-36 for additional information.

Immobilizer

See *Radio Frequency Statement* on page 13-20 for information regarding Part 15 of the Federal Communications Commission (FCC) rules and Industry Canada Standards RSS-210/220/310.

Immobilizer Operation (Key Access)

This vehicle has a passive theft-deterrent system.

The system does not have to be manually armed or disarmed.

The vehicle is automatically immobilized when the key is removed from the ignition.

The system is automatically disarmed when the vehicle is started with the correct key.

The key uses a transponder that matches an immobilizer control unit in the vehicle and automatically disarms the system. Only the correct key starts the vehicle. The vehicle may not start if the key is damaged.



The security light, located in the instrument panel cluster, comes on if there is a problem with arming or disarming the theft-deterrent system.

When trying to start the vehicle, the security light comes on briefly when the ignition is turned on.

If the engine does not start and the security light stays on, there is a problem with the system. Turn the ignition off and try again.

If the engine still does not start, and the key appears to be undamaged or the light continues to stay on, try another ignition key.

If the engine still does not start with the other key, the vehicle needs service. If the vehicle does start, the first key may be damaged. See your dealer who can service the theft-deterrent system and have a new key made.

Do not leave the key or device that disarms or deactivates the theft-deterrent system in the vehicle.

Immobilizer Operation (Keyless Access)

This vehicle has a passive theft-deterrent system.

The system does not have to be manually armed or disarmed.

The vehicle is automatically immobilized when the transmitter leaves the vehicle.

The immobilization system is disarmed when the ignition button is pushed in and a valid transmitter is found in the vehicle.



The security light, located in the instrument panel cluster, comes on if there is a problem with arming or disarming the theft-deterrent system.

2-16 Keys, Doors and Windows

The system has one or more transmitters that are matched to an immobilizer control unit in your vehicle. Only a correctly matched transmitter will start the vehicle. If the transmitter is ever damaged, you may not be able to start your vehicle.

When trying to start the vehicle, the security light comes on briefly when the ignition is turned on.

If the engine does not start and the security light stays on, there is a problem with the system. Turn the ignition off and try again.

If the RKE appears to be undamaged, try another transmitter. Or, you may try placing the transmitter in the transmitter pocket located in the center console. See “No Remote Detected” under *Key and Lock Messages on page 5-36*.

If the engine does not start with the other transmitter or when the transmitter is on the pocket in the center console, your vehicle needs service. See your dealer who can service the theft-deterrent system and have a new transmitter programmed to the vehicle.

Do not leave the key or device that disarms or deactivates the theft-deterrent system in the vehicle.

Exterior Mirrors

Power Mirrors

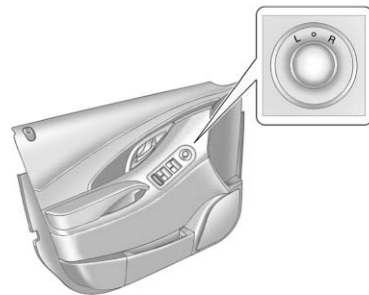

To adjust the mirrors:

1. Turn the control knob to the L (left) or R (right) selecting the driver or passenger mirror.
2. Push the control knob to the left, right, up, or down to adjust the mirror.

Vehicles with the memory feature can store a preferred mirror position. See “Memory Seats” under *Power Seat Adjustment* on page 3-5 for more information.

Folding Mirrors

Manual Foldaway Mirrors

The mirrors on vehicles with manual folded mirrors are folded inward to prevent damage when going through an automatic car wash. To fold, pull the mirror toward the vehicle. Push the mirror outward to return it to the original position.

Automatic Dimming Feature

The driver outside mirror automatically adjusts for the glare of the headlamps behind you.

Turn Signal Indicator

The vehicle may have a turn signal indicator lamp built into the mirror housing. The turn signal lamp flashes with the use of the vehicle's turn signal and hazard flashers.

Heated Mirrors

For vehicles with heated mirrors:

 **(Rear Window Defogger):**

Press to heat the mirrors.

See “Rear Window Defogger” under *Automatic Climate Control System* on page 8-1 for more information.

Park Tilt Mirrors

If the vehicle is equipped with memory mirrors, there is an option to have the mirrors tilt down, when in R (Reverse), to more easily see the ground near the vehicle.

When the vehicle is shifted to R (Reverse), both the driver and passenger mirrors will tilt downward. They will return to their previous position when the vehicle is shifted out of R (Reverse), the ignition is turned to OFF, or the vehicle is left in R (Reverse) for an extended period of time.

This feature can be turned on or off. See *Vehicle Personalization* on page 5-39.

Interior Mirrors

Manual Rearview Mirror

Adjust the inside rearview mirror for a clear view of the area behind your vehicle. To avoid glare of the headlamps from behind, push the tab forward for daytime and pull it for nighttime use.

Vehicles with OnStar[®] have three control buttons at the bottom of the mirror. See your dealer for more information about OnStar and how to subscribe to it. See the OnStar Owner's Guide for more information about the services OnStar provides.

Windows

WARNING

Leaving children, helpless adults, or pets in a vehicle with the windows closed is dangerous. They can be overcome by the extreme heat and suffer permanent injuries or even death from heat stroke. Never leave a child, a helpless adult, or a pet alone in a vehicle, especially with the windows closed in warm or hot weather.



The vehicle aerodynamics are designed to improve fuel economy performance. This may result in a pulsing sound when either rear window is down and the front windows are up. To reduce the sound, open either a front window or the sunroof (if equipped).

Power Windows

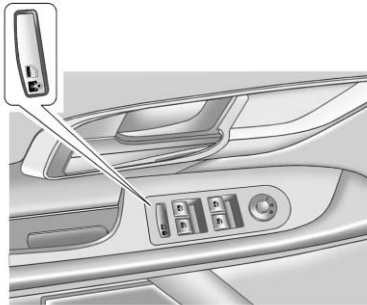

The power window switches located on the driver door control all four windows. The passenger doors have a window switch that controls that window. Push the switch down to open the window. Pull the front of the switch up to close it.

The switches work when the ignition is in ON/RUN or ACC/ACCESSORY, or in Retained Accessory Power (RAP). See *Retained Accessory Power (RAP)* on page 9-24.

Express Window Operation

Windows with an express-up or down feature allow the front windows to be lowered or raised without holding the switch. Rear windows only have express-down. Pull a window switch up or push it down all the way, release it, and the window goes down or up automatically. Stop the window by pushing or pulling the switch.

Rear Window Lockout

The rear window lockout button is on the driver door. Press  to disable the rear window controls. The light on the button comes on indicating the feature is in use. The rear windows can still be raised or lowered using the driver window switches when the lockout feature is active. To restore power to the rear windows, press the button again. The light on the button goes out. If the light flashes, the feature may not be working properly.

This switch also activates the safety locks. See *Safety Locks* on page 2-12.

Programming the Power Windows

If the battery on the vehicle has been recharged, disconnected, or is not working, you will need to reprogram each front power window for the express-up feature to work. Before reprogramming, replace or recharge the vehicle's battery.

To program each front window:

1. With the ignition in ON/RUN or ACC/ACCESSORY, or in Retained Accessory Power (RAP), close all doors.
2. Press and hold the power window switch until the window is fully open.
3. Pull the power window switch up until the window is fully closed.
4. Continue holding the switch up for approximately two seconds after the window is completely closed.

The window is now reprogrammed. Repeat the process for the other windows.

Sun Visors

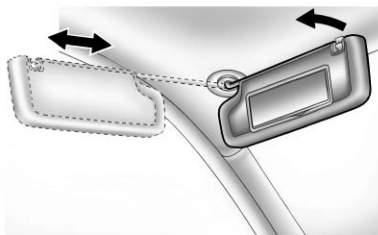

Pull the sun visor down to block glare. Detach the sun visor from the center mount to pivot to the side window, or to extend along the rod, if available.

Rear Window Sunshade

On vehicles with a rear window sunshade, the switch is on the console to the right of the shifter.

The sunshade only operates when the ignition is in ON/RUN or ACC/ACCESSORY.

To open the sunshade, press and release the switch. The sunshade will fully extend. To close the sunshade, press and release the switch again. The sunshade will fully close.

If the vehicle is shifted into R (Reverse) when the sunshade is extended, it will automatically close.

Roof

Sunroof

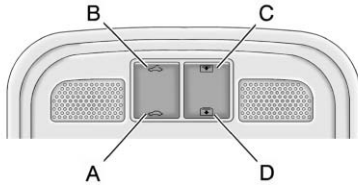

On vehicles with a sunroof, the switch is located on the overhead console.

The sunroof only operates when the ignition is in ON/RUN or ACC/ACCESSORY, or in Retained Accessory Power (RAP). See *Retained Accessory Power (RAP)* on page 9-24.

Vent

The sunroof has an express-vent open feature. From the closed position, press the rear of the sunroof switch (B) to the first detent to vent the sunroof. To close the sunroof, press the front of the sunroof switch (A) to the second detent.

Express-Open/Express-Close

To express-open the sunroof from the closed or vent position, fully press and release the rear of the switch (B). The sunroof opens automatically. To stop the sunroof partway, press the switch a second time. To express-close the sunroof, fully press and release the front of the switch (A). The sunroof closes automatically. To stop the sunroof partway, press the switch a second time.

If the sunshade is closed, it opens automatically with the sunroof but can also be express-opened/express-closed by using the sunshade control (C) or (D). The sunshade cannot be fully closed with the sunroof open.

2-22 Keys, Doors and Windows

To express-open the sunshade from the closed position, fully press and release the rear of the switch (C). The sunshade opens automatically. To stop the sunshade partway, press the switch a second time. To express-close the sunshade fully press and release the front of the switch (D). The sunshade closes automatically. To stop the sunshade partway, press the switch a second time.

Notice: Forcing the sunshade forward of the sliding glass panel may cause damage and the sunroof may not operate properly. Always close the glass panel before closing the sunshade.

The sunroof glass panel cannot be opened or closed if the vehicle has an electrical failure.

Anti-Pinch Feature

If an object is in the path of the sunroof while it is closing, the anti-pinch feature will detect the object and stop the sunroof from closing at the point of the obstruction. The sunroof and sunshade will then return to the open or vent position. To close the sunroof once the obstruction has been removed, refer to "Express-Open/Express-Close" earlier in this section.

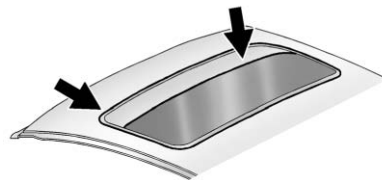

Dirt and debris may collect on the sunroof seal or in the track. This could cause issues with sunroof operation and noise. It could also plug the water drainage system. Periodically open the sunroof and remove any obstacles or loose debris. Wipe the sunroof seal and roof sealing area using a clean cloth, mild soap, and water. Do not remove grease from the sunroof.

Seats and Restraints

Head Restraints

Head Restraints 3-2

Front Seats

Seat Adjustment 3-4

Power Seat Adjustment 3-5

Lumbar Adjustment 3-7

Reclining Seatbacks 3-8

Heated and Ventilated Front

Seats 3-10

Rear Seats

Rear Seats 3-11

Rear Seat

Pass-Through Door 3-13

Safety Belts

Safety Belts 3-13

How to Wear Safety Belts

Properly 3-17

Lap-Shoulder Belt 3-22

Safety Belt Use During

Pregnancy 3-27

Safety Belt Extender 3-27

Safety System Check 3-27

Safety Belt Care 3-28

Replacing Safety Belt System

Parts After a Crash 3-28

Airbag System

Airbag System 3-29

Where Are the Airbags? 3-31

When Should an Airbag

Inflate? 3-32

What Makes an Airbag

Inflate? 3-34

How Does an Airbag

Restrain? 3-34

What Will You See After an

Airbag Inflates? 3-35

Passenger Sensing

System 3-37

Servicing the Airbag-Equipped

Vehicle 3-41

3-2 Seats and Restraints

- Adding Equipment to the Airbag-Equipped Vehicle ... 3-42
- Airbag System Check 3-43
- Replacing Airbag System Parts After a Crash 3-43

Child Restraints

- Older Children 3-44
- Infants and Young Children 3-46
- Child Restraint Systems 3-49
- Where to Put the Restraint ... 3-51
- Lower Anchors and Tethers for Children (LATCH System) 3-52
- Replacing LATCH System Parts After a Crash 3-61
- Securing Child Restraints (Rear Seat) 3-61
- Securing Child Restraints (Front Passenger Seat) 3-63

Head Restraints

The vehicle's front seats have adjustable head restraints in the outboard seating positions.

The vehicle's rear seats have adjustable head restraints in the outboard seating positions.

WARNING

With head restraints that are not installed and adjusted properly, there is a greater chance that occupants will suffer a neck/spinal injury in a crash. Do not drive until the head restraints for all occupants are installed and adjusted properly.



Adjust the head restraint so that the top of the restraint is at the same height as the top of the occupant's head. This position reduces the chance of a neck injury in a crash.

Front Seat

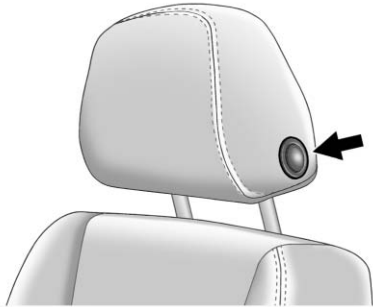

To raise or lower the head restraint, press the release button located on the side of the head restraint and pull up or push the head restraint down and release the button.

Pull and push on the head restraint after the button is released to make sure that it is locked in place.

The front head restraints are not designed to be removed.

Rear Seat

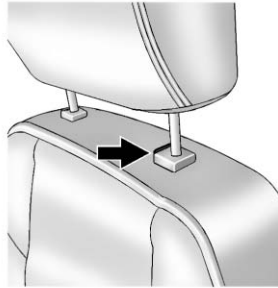

Pull the head restraint up to raise it. To lower the head restraint, press the release button, located on the head restraint post on the top of the seatback, while you push the head restraint down.

Push down on the head restraint after the button is released to make sure that it is locked in place.

If you are installing a child restraint in the rear seat, see “Securing a Child Restraint Designed for the LATCH System” under *Lower Anchors and Tethers for Children (LATCH System)* on page 3-52.

Front Seats

Seat Adjustment

Seat Position



WARNING

You can lose control of the vehicle if you try to adjust a manual driver seat while the vehicle is moving. The sudden movement could startle and confuse you, or make you push a pedal when you do not want to. Adjust the driver seat only when the vehicle is not moving.

To adjust the seat position:

1. Pull the handle under the front of the seat cushion.
2. Slide the seat to the desired position and release the handle.
3. Try to move the seat back and forth to be sure it is locked in place.

Height Adjustment

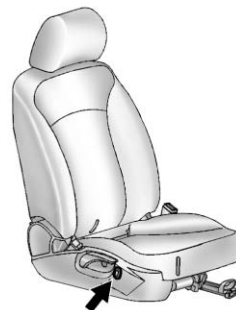

Press and hold the top or bottom of the switch to raise or lower the seat. Release the switch when the desired height is reached.

Power Seat Adjustment

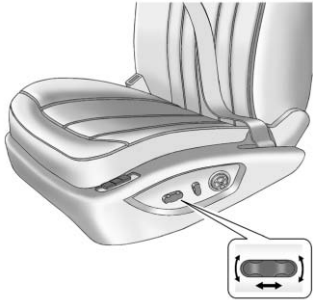

To adjust a power seat:

- Move the seat forward or rearward by sliding the control forward or rearward.
- Raise or lower the front or rear part of the seat cushion by moving the front or rear of the control up or down.
- Raise or lower the entire seat by moving the entire control up or down.

Memory Seats

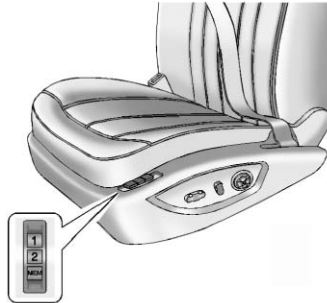

On vehicles with the memory feature, the “1” and “2” buttons on the outboard side of the driver seat are used to manually save and recall the driver seat and outside mirror positions. These manually stored positions are referred to as Button Memory positions.

The vehicle will also automatically save driver seat and outside mirror positions to the current driver Remote Keyless Entry (RKE) transmitter when the ignition is placed in OFF. These automatically stored positions are referred to as RKE Memory positions. See *Remote Keyless Entry (RKE) System Operation* on page 2-4 for more information.

Storing Button Memory Positions

To save positions into Button Memory:

1. Adjust the driver seat, seatback recliner, and both outside mirrors to the desired driving positions.
2. Press and release the MEM (Memory) button.
3. Press “1” until a beep sounds.
4. Repeat Steps 1 through 3 for a second driver using “2.”

3-6 Seats and Restraints

Recalling Button Memory Positions

To recall the manually saved Button Memory positions, press and hold “1” or “2.” The driver seat and outside mirrors move to the positions stored to those buttons when pressed. Releasing “1” or “2” before the stored positions are reached stops the recall.

If something has blocked the driver seat while recalling a memory position, the recall may stop. Remove the obstruction; then press and hold the appropriate manual control for the memory item that is not recalling for two seconds. Try recalling the memory position again by pressing the appropriate memory button. If the memory position is still not recalling, see your dealer for service.

Recalling RKE Memory Positions (Memory Remote Recall)

The Memory Remote Recall feature can recall the driver seat and outside mirrors to previously stored RKE Memory positions when entering the vehicle.

Every time the ignition is placed in OFF, the positions of the driver seat and outside mirrors are automatically stored to the RKE transmitter that was used to start the vehicle. These positions are called RKE Memory positions and may be different than the previously mentioned Button Memory positions saved to the “1” or “2” buttons.

To automatically recall RKE Memory positions, unlock the driver door with the RKE transmitter, and open the driver door. On vehicles with Keyless Access, opening the driver door when an RKE transmitter is present will activate the RKE Memory recall. If the driver door is already open, pressing the RKE transmitter  button will also activate the RKE Memory recall. The driver seat and outside mirrors will move to the previously saved RKE Memory positions.

This feature is turned on or off using the vehicle personalization menu. See “Remote Recall” under *Vehicle Personalization* on page 5-39 for more information.

To stop recall movement, press one of the memory, power mirror, or power seat controls.

If something has blocked the driver seat while recalling a memory position, the recall may stop. Remove the obstruction; then press and hold the appropriate manual control for the memory item that is not recalling for two seconds. Try recalling the memory position again by opening the driver door and pressing the RKE transmitter  button. If the memory position is still not recalling, see your dealer for service.

Easy Exit Driver Seat

This feature moves the seat rearward allowing the driver more room to exit the vehicle.

To activate, place the ignition in OFF and open the driver door. If the driver door is already open, placing the ignition in OFF will activate the easy exit driver seat.

This feature is turned on or off using the vehicle personalization menu. See “Driver Seat Easy Exit” under *Vehicle Personalization* on page 5-39 for more information.

To stop recall movement, press one of the memory or power seat controls.

If something has blocked the driver seat while recalling the exit position, the recall may stop. Remove the obstruction; then press and hold the power seat control rearward for two seconds. Try recalling the exit position again. If the exit position is still not recalling, see your dealer for service.

Lumbar Adjustment

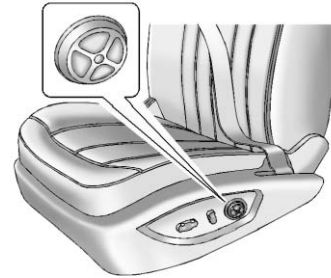

To increase or decrease lumbar support, press and hold the front or rear of the control.

To raise or lower lumbar support, press and hold the top or bottom of the control.

Release the control when the seatback reaches the desired level of lumbar support.

See *Power Seat Adjustment* on page 3-5 for more information.

Reclining Seatbacks



WARNING

Sitting in a reclined position when the vehicle is in motion can be dangerous. Even when buckled up, the safety belts cannot do their job when reclined like this.

(Continued)

WARNING (Continued)

The shoulder belt cannot do its job because it will not be against your body. Instead, it will be in front of you. In a crash, you could go into it, receiving neck or other injuries.

The lap belt cannot do its job either. In a crash, the belt could go up over your abdomen. The belt forces would be there, not at your pelvic bones. This could cause serious internal injuries.

For proper protection when the vehicle is in motion, have the seatback upright. Then sit well back in the seat and wear the safety belt properly.

Manual Reclining Seatbacks

WARNING

You can lose control of the vehicle if you try to adjust a manual driver seat while the vehicle is moving. The sudden movement could startle and confuse you, or make you push a pedal when you do not want to. Adjust the driver seat only when the vehicle is not moving.

WARNING

If either seatback is not locked, it could move forward in a sudden stop or crash. That could cause injury to the person sitting there. Always push and pull on the seatbacks to be sure they are locked.

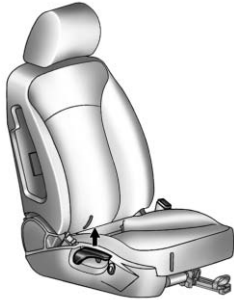

To recline the seatback:

1. Lift the recline lever.
2. Move the seatback to the desired position, and then release the lever to lock the seatback in place.
3. Push and pull on the seatback to make sure it is locked.

To return the seatback to the upright position:

1. Lift the lever fully without applying pressure to the seatback, and the seatback will return to the upright position.
2. Push and pull on the seatback to make sure it is locked.

Power Reclining Seatbacks

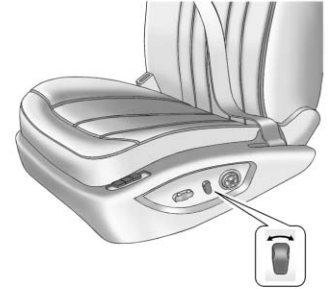

To adjust a power seatback, if equipped:

- Tilt the top of the control rearward to recline.
- Tilt the top of the control forward to raise.

Heated and Ventilated Front Seats

WARNING

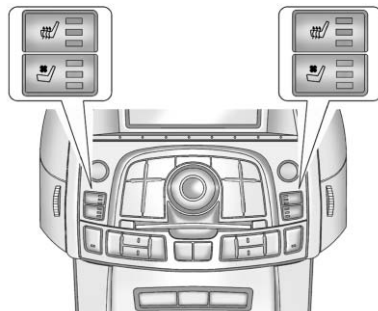

If you cannot feel temperature change or pain to the skin, the seat heater may cause burns even at low temperatures.

To reduce the risk of burns, people with such a condition should use care when using the seat heater, especially for long periods of time. Do not place anything on the seat that insulates against heat, such as a blanket, cushion, cover, or similar item. This may cause the seat heater to overheat. An overheated seat heater may cause a burn or may damage the seat.



Heated and Ventilated Seat Buttons Shown, Heated Seat Buttons Similar

If available, the buttons are on the climate control panel. To operate, the ignition must be on.

Press  to heat the seat cushion and seatback or , if equipped, to ventilate the seat.

Press the button once for the highest setting. With each press of the button, the seat will change to the next lower setting, and then to the off setting. The lights indicate three for the highest setting and one for the lowest.

The passenger seat may take longer to heat up.

Remote Start Heated and Ventilated Seats

During a remote start, the heated or ventilated seats, if equipped, can be turned on automatically. They are canceled when the ignition is turned on. Press the button to use the heated or ventilated seats after the vehicle is started.

The heated or ventilated seat indicator lights on the button do not turn on during a remote start.

The heated seat temperature performance of an unoccupied seat may be reduced. This is normal.

The heated or ventilated seats will not turn on during a remote start unless they are enabled in the vehicle personalization menu. See *Remote Vehicle Start on page 2-8* and “Remote Start Heated Seats” or “Remote Start Cooled Seats” under *Vehicle Personalization on page 5-39* for more information.

Rear Seats

Folding the Seatback

Either side of the seatback can be folded down for more cargo space. Fold a seatback only when the vehicle is not moving.

Notice: Folding a rear seat with the safety belts still fastened may cause damage to the seat or the safety belts. Always unbuckle the safety belts and return them to their normal stowed position before folding a rear seat.

To fold the seatback down:

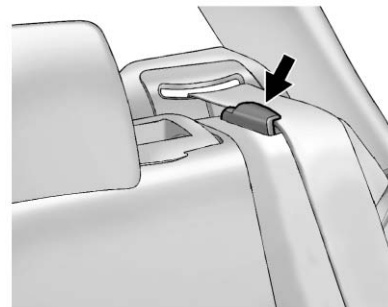

1. Be sure the safety belt is in the retainer clip.

3-12 Seats and Restraints

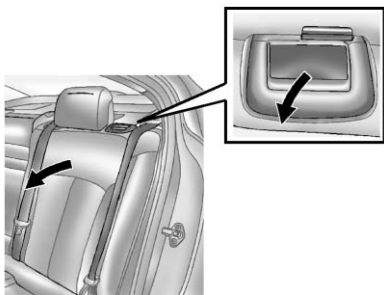

2. Pull on the lever on the top of the seatback to unlock it.

A tab near the seatback lever raises when the seatback is unlocked.

3. Fold the seatback down.

Repeat Steps 1 through 3 for the other seatback, if desired.

Raising the Seatback

WARNING

If either seatback is not locked, it could move forward in a sudden stop or crash. That could cause injury to the person sitting there. Always push and pull on the seatbacks to be sure they are locked.

WARNING

A safety belt that is improperly routed, not properly attached, or twisted will not provide the protection needed in a crash. The person wearing the belt could be seriously injured. After raising the rear seatback, always check to be sure that the safety belts are properly routed and attached, and are not twisted.

To raise a seatback:

1. Lift the seatback up and push it rearward to lock it in place. Make sure the safety belt is in the retainer clip and is not twisted or caught in the seatback.

A tab near the seatback lever retracts when the seatback is locked in place.
2. Push and pull the top of the seatback to be sure it is locked into position.
3. Repeat Steps 1 and 2 for the other seatback, if necessary.

When the seat is not in use, it should be kept in the upright, locked position.

Rear Seat Pass-Through Door

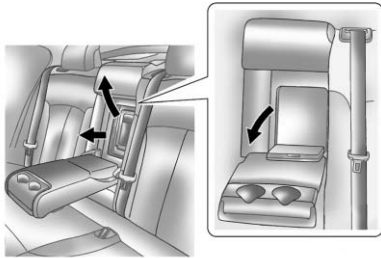

The vehicle may have a door in the rear seat that provides access to the trunk.

Lower the rear seat armrest to access the pass-through door. Pull the release handle to open the door. To close, push and latch the door.

Safety Belts

This section of the manual describes how to use safety belts properly. It also describes some things not to do with safety belts.

WARNING

Do not let anyone ride where a safety belt cannot be worn properly. In a crash, if you or your passenger(s) are not wearing safety belts, the injuries can be much worse. You can hit things inside the vehicle harder or be ejected from the vehicle. You and your passenger(s) can be seriously injured or killed. In the same crash, you might not be, if you are buckled up. Always fasten your safety belt, and check that your passenger(s) are restrained properly too.

WARNING

It is extremely dangerous to ride in a cargo area, inside or outside of a vehicle. In a collision, people riding in these areas are more likely to be seriously injured or killed. Do not allow people to ride in any area of your vehicle that is not equipped with seats and safety belts. Be sure everyone in the vehicle is in a seat and using a safety belt properly.

This vehicle has indicators as a reminder to buckle the safety belts. See *Safety Belt Reminders on page 5-14* for additional information.

3-14 Seats and Restraints

In most states and in all Canadian provinces, the law requires wearing safety belts. Here is why:

You never know if you will be in a crash. If you do have a crash, you do not know if it will be a serious one.

A few crashes are mild, and some crashes can be so serious that even buckled up, a person would not survive. But most crashes are in between. In many of them, people who buckle up can survive and sometimes walk away. Without safety belts they could have been badly hurt or killed.

After more than 40 years of safety belts in vehicles, the facts are clear. In most crashes buckling up does matter ... a lot!

Why Safety Belts Work

When you ride in or on anything, you go as fast as it goes.

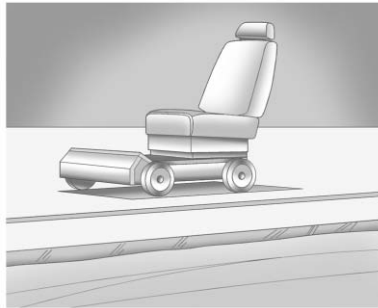

Take the simplest vehicle. Suppose it is just a seat on wheels.

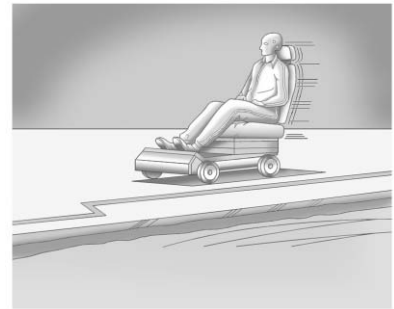

Put someone on it.

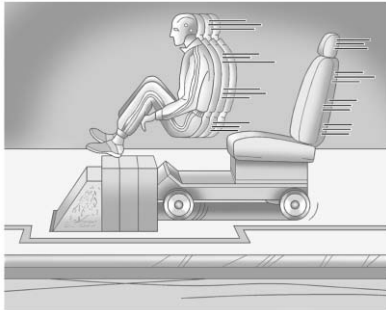

Get it up to speed. Then stop the vehicle. The rider does not stop.

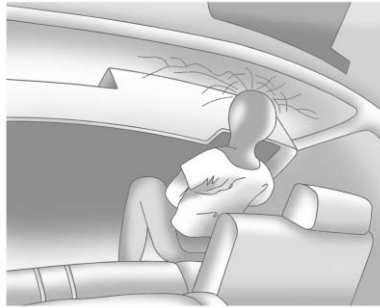

The person keeps going until stopped by something. In a real vehicle, it could be the windshield...

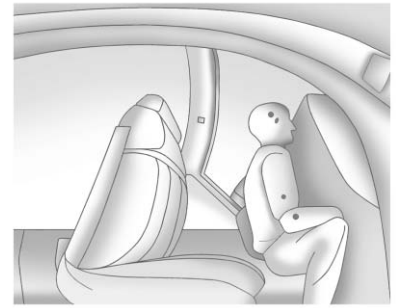

or the instrument panel...

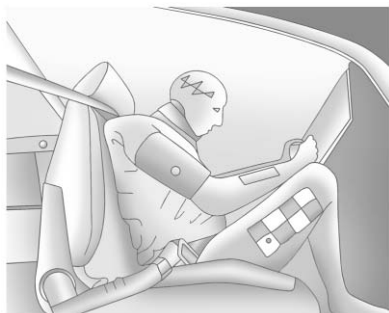

or the safety belts!

With safety belts, you slow down as the vehicle does. You get more time to stop. You stop over more distance, and your strongest bones take the forces. That is why safety belts make such good sense.

Questions and Answers About Safety Belts

Q: Will I be trapped in the vehicle after a crash if I am wearing a safety belt?

A: You *could* be — whether you are wearing a safety belt or not. But your chance of being conscious during and after an accident, so you *can* unbuckle and get out, is *much* greater if you are belted. And you can unbuckle a safety belt, even if you are upside down.

Q: If my vehicle has airbags, why should I have to wear safety belts?

A: Airbags are supplemental systems only; so they work *with* safety belts — not instead of them. Whether or not an airbag is provided, all occupants still have to buckle up to get the most protection. That is true not only in frontal collisions, but especially in side and other collisions.

Q: If I am a good driver, and I never drive far from home, why should I wear safety belts?

A: You may be an excellent driver, but if you are in a crash — even one that is not your fault — you and your passenger(s) can be hurt. Being a good driver does not protect you from things beyond your control, such as bad drivers.

Most accidents occur within 40 km (25 mi) of home. And the greatest number of serious injuries and deaths occur at speeds of less than 65 km/h (40 mph).

Safety belts are for everyone.

How to Wear Safety Belts Properly

This section is only for people of adult size.

Be aware that there are special things to know about safety belts and children. And there are different rules for smaller children and infants. If a child will be riding in the vehicle, see *Older Children on page 3-44* or *Infants and Young Children on page 3-46*. Follow those rules for everyone's protection.

It is very important for all occupants to buckle up. Statistics show that unbelted people are hurt more often in crashes than those who are wearing safety belts.

Occupants who are not buckled up can be thrown out of the vehicle in a crash. And they can strike others in the vehicle who are wearing safety belts.

First, before you or your passenger(s) wear a safety belt, there is important information you should know.

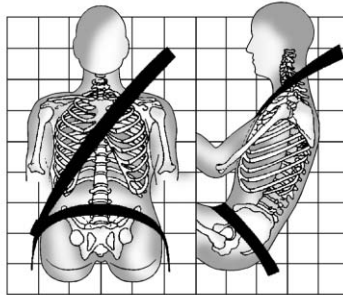

Sit up straight and always keep your feet on the floor in front of you. The lap part of the belt should be

worn low and snug on the hips, just touching the thighs. In a crash, this applies force to the strong pelvic bones and you would be less likely to slide under the lap belt. If you slid under it, the belt would apply force on your abdomen. This could cause serious or even fatal injuries. The shoulder belt should go over the shoulder and across the chest. These parts of the body are best able to take belt restraining forces.

The shoulder belt locks if there is a sudden stop or crash.

3-18 Seats and Restraints

Q: What is wrong with this?

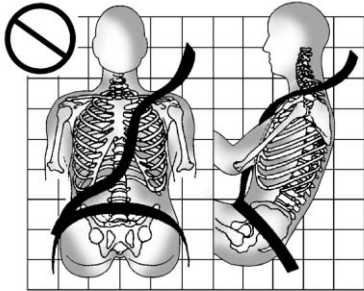

A: The shoulder belt is too loose. It will not give as much protection this way.

 **WARNING**

You can be seriously hurt if the shoulder belt is too loose. In a crash, you would move forward too much, which could increase injury. The shoulder belt should fit snugly against your body.

Q: What is wrong with this?

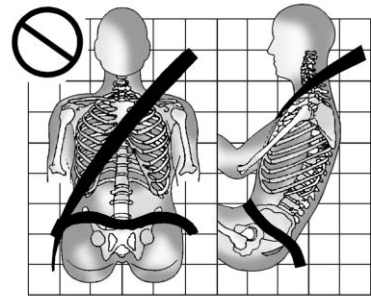

A: The lap belt is too loose. It will not give nearly as much protection this way.

⚠ WARNING

You can be seriously hurt if the lap belt is too loose. In a crash, you could slide under the lap belt and apply force on your abdomen. This could cause serious or even fatal injuries. The lap belt should be worn low and snug on the hips, just touching the thighs.

Q: What is wrong with this?

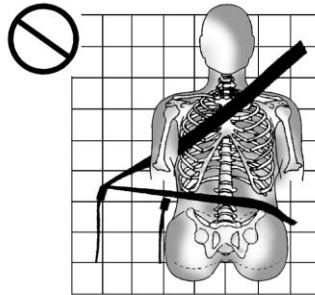

A: The belt is buckled in the wrong buckle.

⚠ WARNING

You can be seriously injured if the belt is buckled in the wrong place like this. In a crash, the belt would go up over your abdomen. The belt forces would be there, not on the pelvic bones. This could cause serious internal injuries. Always buckle the belt into the buckle nearest you.

3-20 Seats and Restraints

Q: What is wrong with this?

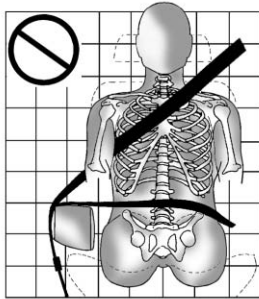

A: The belt is over an armrest.

WARNING

You can be seriously injured if the belt goes over an armrest like this. The belt would be much too high. In a crash, you can slide under the belt. The belt force would then be applied on the abdomen, not on the pelvic bones, and that could cause serious or fatal injuries. Be sure the belt goes under the armrests.

Q: What is wrong with this?

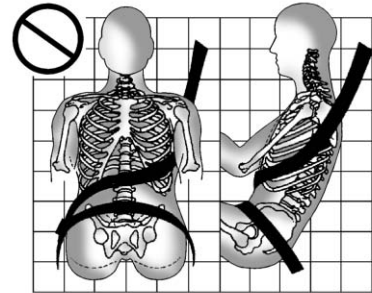

A: The shoulder belt is worn under the arm. It should be worn over the shoulder at all times.

⚠ WARNING

You can be seriously injured if you wear the shoulder belt under your arm. In a crash, your body would move too far forward, which would increase the chance of head and neck injury. Also, the belt would apply too much force to the ribs, which are not as strong as shoulder bones. You could also severely injure internal organs like your liver or spleen. The shoulder belt should go over the shoulder and across the chest.

Q: What is wrong with this?

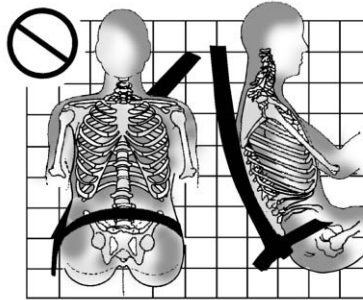

A: The belt is behind the body.

⚠ WARNING

You can be seriously injured by not wearing the lap-shoulder belt properly. In a crash, you would not be restrained by the shoulder belt. Your body could move too far forward increasing the chance of head and neck injury. You might also slide under the lap belt. The belt force would then be applied right on the abdomen. That could cause serious or fatal injuries. The shoulder belt should go over the shoulder and across the chest.

3-22 Seats and Restraints

Q: What is wrong with this?

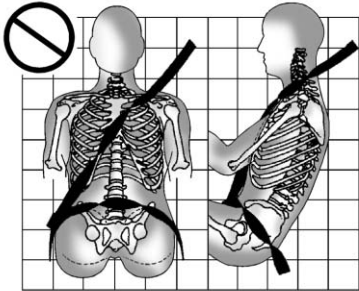

A: The belt is twisted across the body.

WARNING

You can be seriously injured by a twisted belt. In a crash, you would not have the full width of the belt to spread impact forces. If a belt is twisted, make it straight so it can work properly, or ask your dealer to fix it.

Lap-Shoulder Belt

All seating positions in the vehicle have a lap-shoulder belt.

The following instructions explain how to wear a lap-shoulder belt properly.

1. Adjust the seat, if the seat is adjustable, so you can sit up straight. To see how, see “Seats” in the Index.

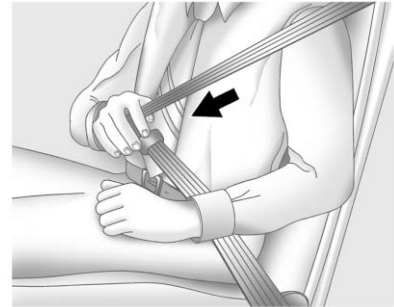

2. Pick up the latch plate and pull the belt across you. Do not let it get twisted.

The lap-shoulder belt may lock if you pull the belt across you very quickly. If this happens, let the belt go back slightly to unlock it. Then pull the belt across you more slowly.

If the shoulder portion of a passenger belt is pulled out all the way, the child restraint locking feature may be engaged. If this happens, let the belt go back all the way and start again.

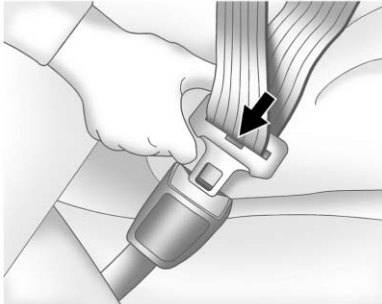

3. Push the latch plate into the buckle until it clicks.

Pull up on the latch plate to make sure it is secure. If the belt is not long enough, see *Safety Belt Extender* on page 3-27.

Position the release button on the buckle so that the safety belt could be quickly unbuckled if necessary.

If equipped with a shoulder belt height adjuster, move it to the height that is right for you. See “Shoulder Belt Height Adjustment” later in this section for instructions on use and important safety information.

4. To make the lap part tight, pull up on the shoulder belt.

It may be necessary to pull stitching on the safety belt through the latch plate to fully tighten the lap belt on smaller occupants.

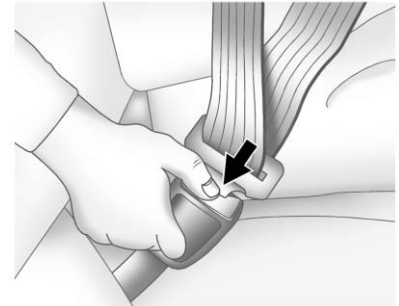

To unlatch the belt, push the button on the buckle. The belt should return to its stowed position. Slide the latch plate up the safety belt webbing, when the safety belt is not in use. The latch plate should rest on the stitching on the safety belt, near the guide loop on the side wall.

Before a door is closed, be sure the safety belt is out of the way. If a door is slammed against a safety belt, damage can occur to both the safety belt and the vehicle.

3-24 Seats and Restraints

Shoulder Belt Height Adjuster

The vehicle has a shoulder belt height adjuster for the driver and right front passenger seating positions.

Adjust the height so the shoulder portion of the belt is on the shoulder and not falling off of it. The belt should be close to, but not contacting, the neck. Improper shoulder belt height adjustment could reduce the effectiveness of the safety belt in a crash. See *How to Wear Safety Belts Properly* on page 3-17.

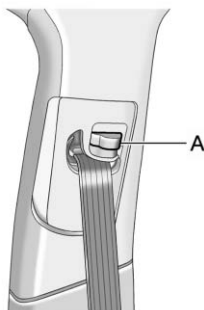

Press the release button (A) and move the height adjuster to the desired position. The adjuster can be moved up by pushing the slide/trim up. After the adjuster is set to the desired position, try to move it down without pushing the release button to make sure it has locked into position.

Safety Belt Pretensioners

This vehicle has safety belt pretensioners for front outboard occupants. Although the safety belt pretensioners cannot be seen, they are part of the safety belt assembly. They can help tighten the safety belts during the early stages of a moderate to severe frontal and near frontal crash if the threshold conditions for pretensioner activation are met.

Pretensioners work only once. If the pretensioners activate in a crash, the pretensioners and probably other parts of the vehicle's safety belt system will need to be replaced. See *Replacing Safety Belt System Parts After a Crash* on page 3-28.

Rear Safety Belt Comfort Guides

This vehicle may have rear shoulder belt comfort guides. If not, they are available through your dealer. The guides may provide added safety belt comfort for older children who have outgrown booster seats and for some adults. When installed and properly adjusted, the comfort guide positions the belt away from the neck and head.

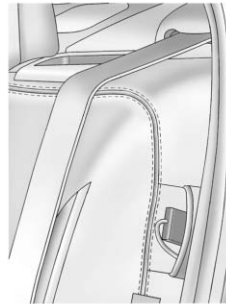

1. Remove the guide from its storage pocket on the side of the seat.

There is one guide for each outside passenger position in the rear seat. Here is how to install a comfort guide to the safety belt:

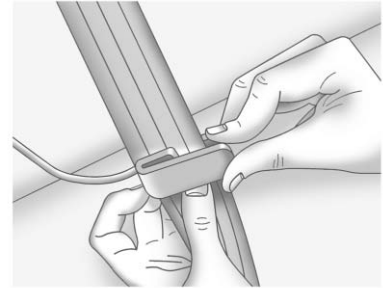

2. Place the guide over the belt, and insert the two edges of the belt into the slots of the guide.

3-26 Seats and Restraints

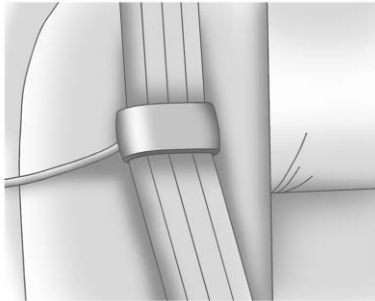

3. Be sure that the belt is not twisted and it lies flat. The elastic cord must be under the belt and the guide on top.

WARNING

A safety belt that is not properly worn may not provide the protection needed in a crash. The person wearing the belt could be seriously injured. The shoulder belt should go over the shoulder and across the chest. These parts of the body are best able to take belt restraining forces.

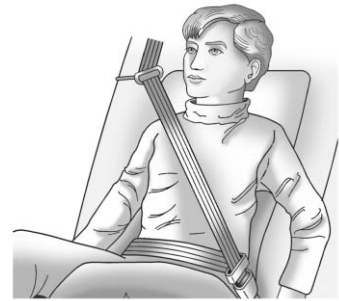

4. Buckle, position, and release the safety belt as described previously in this section. Make sure the shoulder portion of the belt is on the shoulder and not falling off of it. The belt should be close to, but not contacting, the neck.

Safety Belt Use During Pregnancy

Safety belts work for everyone, including pregnant women. Like all occupants, they are more likely to be seriously injured if they do not wear safety belts.



A pregnant woman should wear a lap-shoulder belt, and the lap portion should be worn as low as possible, below the rounding, throughout the pregnancy.

The best way to protect the fetus is to protect the mother. When a safety belt is worn properly, it is more likely that the fetus will not be hurt in a crash. For pregnant women, as for anyone, the key to making safety belts effective is wearing them properly.

Safety Belt Extender

If the vehicle's safety belt will fasten around you, you should use it.

But if a safety belt is not long enough, your dealer will order you an extender. When you go in to order it, take the heaviest coat you will wear, so the extender will be long enough for you. To help avoid personal injury, do not let someone else use it, and use it only for the seat it is made to fit. The extender has been designed for adults. Never use it for securing child seats. To wear it, attach it to the regular safety belt. For more information, see the instruction sheet that comes with the extender.

Safety System Check

Now and then, check that the safety belt reminder light, safety belts, buckles, latch plates, retractors, and anchorages are working properly. Look for any other loose or damaged safety belt system parts that might keep a safety belt system from doing its job. See your dealer to have it repaired. Torn or frayed safety belts may not protect you in a crash. They can rip apart under impact forces. If a belt is torn or frayed, get a new one right away.

Make sure the safety belt reminder light is working. See *Safety Belt Reminders on page 5-14* for more information.

Keep safety belts clean and dry. See *Safety Belt Care on page 3-28*.

Safety Belt Care

Keep belts clean and dry.

 **WARNING**

Do not bleach or dye safety belts. It may severely weaken them. In a crash, they might not be able to provide adequate protection. Clean safety belts only with mild soap and lukewarm water.

Replacing Safety Belt System Parts After a Crash

 **WARNING**

A crash can damage the safety belt system in the vehicle. A damaged safety belt system may not properly protect the person using it, resulting in serious injury or even death in a crash. To help make sure the safety belt systems are working properly after a crash, have them inspected and any necessary replacements made as soon as possible.

After a minor crash, replacement of safety belts may not be necessary. But the safety belt assemblies that were used during any crash may have been stressed or damaged. See your dealer to have the safety belt assemblies inspected or replaced.

New parts and repairs may be necessary even if the safety belt system was not being used at the time of the crash.

Have the safety belt pretensioners checked if the vehicle has been in a crash, or if the airbag readiness light stays on after you start the vehicle or while you are driving. See *Airbag Readiness Light* on page 5-14.

Airbag System

The vehicle has the following airbags:

- A frontal airbag for the driver.
- A frontal airbag for the right front passenger.
- A seat-mounted side impact airbag for the driver.
- A seat-mounted side impact airbag for the right front passenger.
- A roof-rail airbag for the driver and the passenger seated directly behind the driver.
- A roof-rail airbag for the right front passenger and the passenger seated directly behind the right front passenger.

The vehicle may have the following airbags:

- A seat-mounted side impact airbag for the rear seat passenger seated directly behind the driver.
- A seat-mounted side impact airbag for the rear seat passenger seated directly behind the right front passenger.

All of the airbags in the vehicle will have the word AIRBAG embossed in the trim or on an attached label near the deployment opening.

For frontal airbags, the word AIRBAG will appear on the middle part of the steering wheel for the driver and on the instrument panel for the right front passenger.

With seat-mounted side impact airbags, the word AIRBAG will appear on the side of the seatback closest to the door.

With roof-rail airbags, the word AIRBAG will appear along the headliner or trim.

Airbags are designed to supplement the protection provided by safety belts. Even though today's airbags are also designed to help reduce the risk of injury from the force of an inflating bag, all airbags must inflate very quickly to do their job.

3-30 Seats and Restraints

Here are the most important things to know about the airbag system:

WARNING

You can be severely injured or killed in a crash if you are not wearing a safety belt — even if the vehicle has airbags. Airbags are designed to work with safety belts, but do not replace them.

Also, airbags are not designed to deploy in every crash. In some crashes safety belts are the only restraint. See *When Should an Airbag Inflate?* on page 3-32.

Wearing a safety belt during a crash helps reduce your chance of hitting things inside the vehicle or being ejected from it. Airbags are “supplemental restraints” to the safety belts. Everyone in the vehicle should wear a safety belt properly — whether or not there is an airbag for that person.

WARNING

Airbags inflate with great force, faster than the blink of an eye. Anyone who is up against, or very close to, any airbag when it inflates can be seriously injured or killed. Do not sit unnecessarily close to any airbag, as you would be if you were sitting on the edge of the seat or leaning forward.

Safety belts help keep you in position before and during a crash. Always wear a safety belt, even with airbags. The driver should sit as far back as possible while still maintaining control of the vehicle.

Occupants should not lean on or sleep against the door or side windows in seating positions with seat-mounted side impact airbags and/or roof-rail airbags.

WARNING

Children who are up against, or very close to, any airbag when it inflates can be seriously injured or killed. Airbags plus lap-shoulder belts offer protection for adults and older children, but not for young children and infants. Neither the vehicle's safety belt system nor its airbag system is designed for them. Young children and infants need the protection that a child restraint system can provide. Always secure children properly in the vehicle. To read how, see *Older Children* on page 3-44 or *Infants and Young Children* on page 3-46.



There is an airbag readiness light on the instrument panel cluster, which shows the airbag symbol. The system checks the airbag electrical system for malfunctions. The light tells you if there is an electrical problem. See *Airbag Readiness Light* on page 5-14 for more information.

Where Are the Airbags?

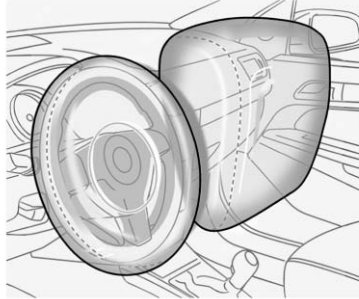

The driver frontal airbag is in the middle of the steering wheel.

The right front passenger frontal airbag is in the instrument panel on the passenger side.

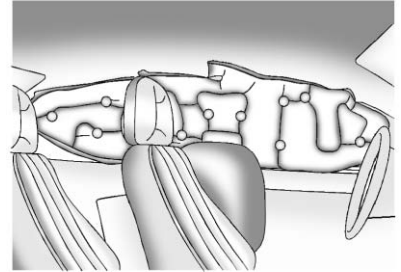

Driver Side Shown, Passenger Side Similar

The seat-mounted side impact airbags for the driver and right front passenger are in the side of the seatbacks closest to the door.

The roof-rail airbags for the driver, right front passenger, and second row outboard passengers are in the ceiling above the side windows.

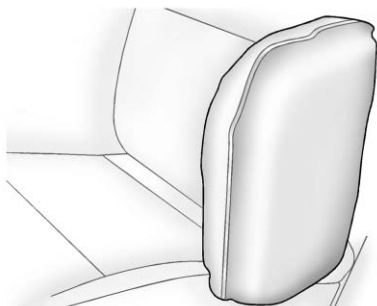

**Rear Seat Driver Side Shown,
Passenger Side Similar**

If the vehicle has second row seat-mounted side impact airbags, they are in the sides of the rear seatback closest to the door.



WARNING

If something is between an occupant and an airbag, the airbag might not inflate properly or it might force the object into

(Continued)

WARNING (Continued)

that person causing severe injury or even death. The path of an inflating airbag must be kept clear. Do not put anything between an occupant and an airbag, and do not attach or put anything on the steering wheel hub or on or near any other airbag covering.

Do not use seat accessories that block the inflation path of a seat-mounted side impact airbag.

Never secure anything to the roof of a vehicle with roof-rail airbags by routing a rope or tie down through any door or window opening. If you do, the path of an inflating roof-rail airbag will be blocked.

When Should an Airbag Inflate?

Frontal airbags are designed to inflate in moderate to severe frontal or near frontal crashes to help reduce the potential for severe injuries mainly to the driver's or right front passenger's head and chest. However, they are only designed to inflate if the impact exceeds a predetermined deployment threshold. Deployment thresholds are used to predict how severe a crash is likely to be in time for the airbags to inflate and help restrain the occupants.

Whether the frontal airbags will or should deploy is not based on how fast your vehicle is traveling. It depends largely on what you hit, the direction of the impact, and how quickly your vehicle slows down.

Frontal airbags may inflate at different crash speeds.

For example:

- If the vehicle hits a stationary object, the airbags could inflate at a different crash speed than if the vehicle hits a moving object.
- If the vehicle hits an object that deforms, the airbags could inflate at a different crash speed than if the vehicle hits an object that does not deform.
- If the vehicle hits a narrow object (like a pole), the airbags could inflate at a different crash speed than if the vehicle hits a wide object (like a wall).
- If the vehicle goes into an object at an angle, the airbags could inflate at a different crash speed than if the vehicle goes straight into the object.

Thresholds can also vary with specific vehicle design.

Frontal airbags are not intended to inflate during vehicle rollovers, rear impacts, or in many side impacts.

In addition, the vehicle has dual-stage frontal airbags. Dual-stage airbags adjust the restraint according to crash severity. The vehicle has electronic frontal sensors, which help the sensing system distinguish between a moderate frontal impact and a more severe frontal impact. For moderate frontal impacts, dual-stage airbags inflate at a level less than full deployment. For more severe frontal impacts, full deployment occurs.

The vehicle has seat-mounted side impact and roof-rail airbags. See *Airbag System* on page 3-29.

Seat-mounted side impact and roof-rail airbags are intended to inflate in moderate to severe side crashes. In addition, these roof-rail airbags are intended to inflate during a rollover or in a severe frontal impact. Seat-mounted side impact and roof-rail airbags will inflate if the crash severity is above the system's designed threshold level. The threshold level can vary with specific vehicle design.

Roof-rail airbags are not intended to inflate in rear impacts. Both roof-rail airbags will deploy when either side of the vehicle is struck or if the sensing system predicts that the vehicle is about to roll over, or in a severe frontal impact.

3-34 Seats and Restraints

In any particular crash, no one can say whether an airbag should have inflated simply because of the damage to a vehicle or because of what the repair costs were. For frontal airbags, inflation is determined by what the vehicle hits, the angle of the impact, and how quickly the vehicle slows down. For seat-mounted side impact and roof-rail airbags, deployment is determined by the location and severity of the side impact.

In a rollover event, roof-rail airbag deployment is determined by the direction of the roll.

What Makes an Airbag Inflate?

In a deployment event, the sensing system sends an electrical signal triggering a release of gas from the inflator. Gas from the inflator fills the airbag causing the bag to break out of the cover and deploy. The inflator, the airbag, and related hardware are all part of the airbag module.

Frontal airbag modules are located inside the steering wheel and instrument panel. For vehicles with seat-mounted side impact airbags, there are airbag modules in the side of the front seatbacks closest to the door. For vehicles with roof-rail airbags, there are airbag modules in the ceiling of the vehicle, near the side windows that have occupant seating positions.

How Does an Airbag Restrain?

In moderate to severe frontal or near frontal collisions, even belted occupants can contact the steering wheel or the instrument panel. In moderate to severe side collisions, even belted occupants can contact the inside of the vehicle.

Airbags supplement the protection provided by safety belts. Frontal airbags distribute the force of the impact more evenly over the occupant's upper body, stopping the occupant more gradually. Seat-mounted side impact and roof-rail airbags distribute the force of the impact more evenly over the occupant's upper body.

But airbags would not help in many types of collisions, primarily because the occupant's motion is not toward those airbags. See *When Should an Airbag Inflate?* on page 3-32 for more information.

Airbags should never be regarded as anything more than a supplement to safety belts.

What Will You See After an Airbag Inflates?

After the frontal airbags and seat-mounted side impact airbags inflate, they quickly deflate, so quickly that some people may not even realize an airbag inflated. Roof-rail airbags may still be at least partially inflated for some time after they deploy. Some components of the airbag module may be hot for

several minutes. For location of the airbag modules, see *What Makes an Airbag Inflate?* on page 3-34.

The parts of the airbag that come into contact with you may be warm, but not too hot to touch. There may be some smoke and dust coming from the vents in the deflated airbags. Airbag inflation does not prevent the driver from seeing out of the windshield or being able to steer the vehicle, nor does it prevent people from leaving the vehicle.

 **WARNING**

When an airbag inflates, there may be dust in the air. This dust could cause breathing problems for people with a history of asthma or other breathing trouble. To avoid this, everyone in the

(Continued)

WARNING (Continued)

vehicle should get out as soon as it is safe to do so. If you have breathing problems but cannot get out of the vehicle after an airbag inflates, then get fresh air by opening a window or a door. If you experience breathing problems following an airbag deployment, you should seek medical attention.

The vehicle has a feature that may automatically unlock the doors, turn on the interior lamps and hazard warning flashers, and shut off the fuel system after the airbags inflate. You can lock the doors, turn off the interior lamps and hazard warning flashers by using the controls for those features.

3-36 Seats and Restraints

WARNING

A crash severe enough to inflate the airbags may have also damaged important functions in the vehicle, such as the fuel system, brake and steering systems, etc. Even if the vehicle appears to be drivable after a moderate crash, there may be concealed damage that could make it difficult to safely operate the vehicle.

Use caution if you should attempt to restart the engine after a crash has occurred.

In many crashes severe enough to inflate the airbag, windshields are broken by vehicle deformation. Additional windshield breakage may also occur from the right front passenger airbag.

- Airbags are designed to inflate only once. After an airbag inflates, you will need some new parts for the airbag system. If you do not get them, the airbag system will not be there to help protect you in another crash. A new system will include airbag modules and possibly other parts. The service manual for your vehicle covers the need to replace other parts.
- The vehicle has a crash sensing and diagnostic module which records information after a crash. See *Vehicle Data Recording and Privacy on page 13-18* and *Event Data Recorders on page 13-18*.
- Let only qualified technicians work on the airbag systems. Improper service can mean that an airbag system will not work properly. See your dealer for service.

Passenger Sensing System

The vehicle has a passenger sensing system for the right front passenger position. The passenger airbag status indicator will be visible on the instrument panel when the vehicle is started.



The words ON and OFF will be visible during the system check. If you are using remote start,

if equipped, to start the vehicle from a distance you may not see the system check. When the system check is complete, either the word ON or the word OFF will be visible. See *Passenger Airbag Status Indicator* on page 5-15.

The passenger sensing system turns off the right front passenger frontal airbag under certain conditions. The driver airbags, seat-mounted side impact airbags, and roof-rail airbags are not affected by the passenger sensing system.

The passenger sensing system works with sensors that are part of the right front passenger seat.

The sensors are designed to detect the presence of a properly-seated occupant and determine if the right front passenger frontal airbag should be enabled (may inflate) or not.

According to accident statistics, children are safer when properly secured in a rear seat in the correct child restraint for their weight and size.

We recommend that children be secured in a rear seat, including: an infant or a child riding in a rear-facing child restraint; a child riding in a forward-facing child seat; an older child riding in a booster seat; and children, who are large enough, using safety belts.

3-38 Seats and Restraints

A label on the sun visor says, "Never put a rear-facing child seat in the front." This is because the risk to the rear-facing child is so great, if the airbag deploys.

WARNING

A child in a rear-facing child restraint can be seriously injured or killed if the right front passenger airbag inflates. This is because the back of the rear-facing child restraint would be very close to the inflating airbag. A child in a forward-facing child restraint can be seriously injured or killed if the right front passenger airbag inflates and the passenger seat is in a forward position.

(Continued)

WARNING (Continued)

Even if the passenger sensing system has turned off the right front passenger frontal airbag, no system is fail-safe. No one can guarantee that an airbag will not deploy under some unusual circumstance, even though the airbag is turned off.

Secure rear-facing child restraints in a rear seat, even if the airbag is off. If you secure a forward-facing child restraint in the right front seat, always move the front passenger seat as far back as it will go. It is better to secure the child restraint in a rear seat.

The passenger sensing system is designed to turn off the right front passenger frontal airbag if:

- The right front passenger seat is unoccupied.
- The system determines that an infant is present in a rear-facing infant seat.
- The system determines that a small child is present in a child restraint.
- The system determines that a small child is present in a booster seat.
- A right front passenger takes his/her weight off of the seat for a period of time.
- The right front passenger seat is occupied by a smaller person, such as a child who has outgrown child restraints.
- Or, if there is a critical problem with the airbag system or the passenger sensing system.

When the passenger sensing system has turned off the right front passenger frontal airbag, the off indicator will light and stay lit to remind you that the airbags are off. See *Passenger Airbag Status Indicator on page 5-15*.

The passenger sensing system is designed to turn on (may inflate) the right front passenger frontal airbag anytime the system senses that a person of adult size is sitting properly in the right front passenger seat. When the passenger sensing system has allowed the airbag to be enabled, the on indicator will light and stay lit to remind you that the airbag is active.

For some children who have outgrown child restraints and for very small adults, the passenger sensing system may or may not turn

off the right front passenger frontal airbag, depending upon the person's seating posture and body build. Everyone in the vehicle who has outgrown child restraints should wear a safety belt properly — whether or not there is an airbag for that person.

 **WARNING**

If the airbag readiness light ever comes on and stays on, it means that something may be wrong with the airbag system. To help avoid injury to yourself or others, have the vehicle serviced right away. See *Airbag Readiness Light on page 5-14* for more information, including important safety information.

If the On Indicator is Lit for a Child Restraint

If a child restraint has been installed and the on indicator is lit:

1. Turn the vehicle off.
2. Remove the child restraint from the vehicle.
3. Remove any additional items from the seat such as blankets, cushions, seat covers, seat heaters, or seat massagers.
4. Reinstall the child restraint following the directions provided by the child restraint manufacturer and refer to *Securing Child Restraints (Rear Seat) on page 3-61* or *Securing Child Restraints (Front Passenger Seat) on page 3-63*.

3-40 Seats and Restraints

5. If, after reinstalling the child restraint and restarting the vehicle, the on indicator is still lit, turn the vehicle off. Then slightly recline the vehicle seatback and adjust the seat cushion, if adjustable, to make sure that the vehicle seatback is not pushing the child restraint into the seat cushion.

Also make sure the child restraint is not trapped under the vehicle head restraint. If this happens, adjust the head restraint. See *Head Restraints* on page 3-2.

6. Restart the vehicle.

If the on indicator is still lit, secure the child in the child restraint in a rear seat position in the vehicle, and check with your dealer.

If the Off Indicator is Lit for an Adult-Size Occupant



If a person of adult-size is sitting in the right front passenger seat, but the off indicator is lit, it could be because that person is not sitting properly in the seat. If this happens,

use the following steps to allow the system to detect that person and enable the right front passenger frontal airbag:

1. Turn the vehicle off.
2. Remove any additional material from the seat, such as blankets, cushions, seat covers, seat heaters, or seat massagers.
3. Place the seatback in the fully upright position.
4. Have the person sit upright in the seat, centered on the seat cushion, with legs comfortably extended.
5. Restart the vehicle and have the person remain in this position for two to three minutes after the on indicator is lit.

Additional Factors Affecting System Operation

Safety belts help keep the passenger in position on the seat during vehicle maneuvers and braking, which helps the passenger sensing system maintain the passenger airbag status. See “Safety Belts” and “Child Restraints” in the Index for additional information about the importance of proper restraint use.

A thick layer of additional material, such as a blanket or cushion, or aftermarket equipment such as seat covers, seat heaters, and seat massagers can affect how well the passenger sensing system operates. We recommend that you not use seat covers or other aftermarket equipment except when approved by GM for your specific vehicle. See *Adding Equipment to the Airbag-Equipped Vehicle on page 3-42* for more information about modifications that can affect how the system operates.

WARNING

Stowing of articles under the passenger seat or between the passenger seat cushion and seatback may interfere with the proper operation of the passenger sensing system.

Servicing the Airbag-Equipped Vehicle

Airbags affect how the vehicle should be serviced. There are parts of the airbag system in several places around the vehicle. Your dealer and the service manual have information about servicing the vehicle and the airbag system. To purchase a service manual, see *Service Publications Ordering Information on page 13-15*.

WARNING

For up to 10 seconds after the ignition is turned off and the battery is disconnected, an airbag can still inflate during improper service. You can be injured if you are close to an airbag when it inflates. Avoid yellow connectors. They are probably part of the airbag system. Be sure to follow proper service procedures, and make sure the person performing work for you is qualified to do so.

Adding Equipment to the Airbag-Equipped Vehicle

Q: Is there anything I might add to or change about the vehicle that could keep the airbags from working properly?

A: Yes. If you add things that change the vehicle's frame, bumper system, height, front end or side sheet metal, they may keep the airbag system from working properly. Changing or moving any parts of the front seats, safety belts, the airbag sensing and diagnostic module, steering wheel, instrument panel, roof-rail airbag modules, ceiling headliner or pillar garnish trim, front sensors, side impact sensors, or airbag wiring can affect the operation of the airbag system.

In addition, the vehicle has a passenger sensing system for the right front passenger position, which includes sensors

that are part of the passenger seat. The passenger sensing system may not operate properly if the original seat trim is replaced with non-GM covers, upholstery or trim, or with GM covers, upholstery or trim designed for a different vehicle. Any object, such as an aftermarket seat heater or a comfort enhancing pad or device, installed under or on top of the seat fabric, could also interfere with the operation of the passenger sensing system. This could either prevent proper deployment of the passenger airbag(s) or prevent the passenger sensing system from properly turning off the passenger airbag(s). See *Passenger Sensing System* on page 3-37.

If you have questions, call Customer Assistance. The phone numbers and addresses for Customer

Assistance are in Step Two of the Customer Satisfaction Procedure in this manual. See *Customer Satisfaction Procedure (U.S. and Canada)* on page 13-1 or *Customer Satisfaction Procedure (Mexico)* on page 13-3.

Q: Because I have a disability, I have to get my vehicle modified. How can I find out whether this will affect my airbag system?

A: If you have questions, call Customer Assistance. The phone numbers and addresses for Customer Assistance are in Step Two of the Customer Satisfaction Procedure in this manual. See *Customer Satisfaction Procedure (U.S. and Canada)* on page 13-1 or *Customer Satisfaction Procedure (Mexico)* on page 13-3.

In addition, your dealer and the service manual have information about the location of the airbag sensors, sensing and diagnostic module and airbag wiring.

Airbag System Check

The airbag system does not need regularly scheduled maintenance or replacement. Make sure the airbag readiness light is working. See *Airbag Readiness Light* on page 5-14 for more information.

Notice: If an airbag covering is damaged, opened, or broken, the airbag may not work properly. Do not open or break the airbag coverings. If there are any opened or broken airbag covers, have the airbag covering and/or airbag module replaced. For the location of the airbag modules, see *What Makes an Airbag Inflate?* on page 3-34. See your dealer for service.

Replacing Airbag System Parts After a Crash

WARNING

A crash can damage the airbag systems in the vehicle. A damaged airbag system may not work properly and may not protect you and your passenger(s) in a crash, resulting in serious injury or even death. To help make sure the airbag systems are working properly after a crash, have them inspected and any necessary replacements made as soon as possible.

If an airbag inflates, you will need to replace airbag system parts. See your dealer for service.

If the airbag readiness light stays on after the vehicle is started or comes on when you are driving, the airbag system may not work properly. Have the vehicle serviced right away. See *Airbag Readiness Light* on page 5-14 for more information.

Child Restraints

Older Children

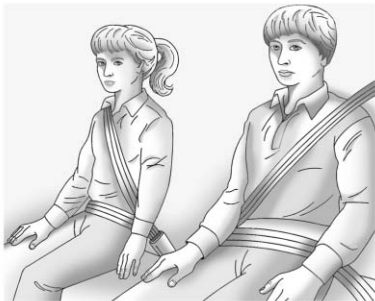

Older children who have outgrown booster seats should wear the vehicle's safety belts.

The manufacturer's instructions that come with the booster seat, state the weight and height limitations for that booster. Use a booster seat with a lap-shoulder belt until the child passes the below fit test:

- Sit all the way back on the seat. Do the knees bend at the seat edge? If yes, continue. If no, return to the booster seat.
- Buckle the lap-shoulder belt. Does the shoulder belt rest on the shoulder? If yes, continue. If no, then return to the booster seat.
- Does the lap belt fit low and snug on the hips, touching the thighs? If yes, continue. If no, return to the booster seat.
- Can proper safety belt fit be maintained for the length of the trip? If yes, continue. If no, return to the booster seat.

Q: What is the proper way to wear safety belts?

A: An older child should wear a lap-shoulder belt and get the additional restraint a shoulder belt can provide. The shoulder belt should not cross the face or neck. The lap belt should fit snugly below the hips, just touching the top of the thighs. This applies belt force to the child's pelvic bones in a crash. It should never be worn over the abdomen, which could cause severe or even fatal internal injuries in a crash.

According to accident statistics, children and infants are safer when properly restrained in a child restraint system or infant restraint system secured in a rear seating position.

In a crash, children who are not buckled up can strike other people who are buckled up, or can be thrown out of the vehicle. Older children need to use safety belts properly.

⚠ WARNING

Never do this.

Never allow two children to wear the same safety belt. The safety belt can not properly spread the impact forces. In a crash, the two children can be crushed together and seriously injured. A safety belt must be used by only one person at a time.

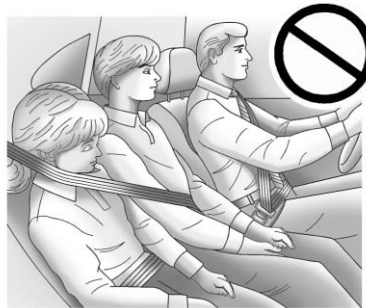

⚠ WARNING

Never do this.

Never allow a child to wear the safety belt with the shoulder belt behind their back. A child can be seriously injured by not wearing the lap-shoulder belt properly. In a crash, the child would not be restrained by the shoulder belt. The child could move too far

(Continued)

WARNING (Continued)

forward increasing the chance of head and neck injury. The child might also slide under the lap belt. The belt force would then be applied right on the abdomen. That could cause serious or fatal injuries. The shoulder belt should go over the shoulder and across the chest.



Infants and Young Children

Everyone in a vehicle needs protection! This includes infants and all other children. Neither the distance traveled nor the age and size of the traveler changes the need, for everyone, to use safety restraints. In fact, the law in every state in the United States and in every Canadian province says children up to some age must be restrained while in a vehicle.

WARNING

Children can be seriously injured or strangled if a shoulder belt is wrapped around their neck and the safety belt continues to tighten. Never leave children unattended in a vehicle and never allow children to play with the safety belts.

Airbags plus lap-shoulder belts offer protection for adults and older children, but not for young children

and infants. Neither the vehicle's safety belt system nor its airbag system is designed for them. Every time infants and young children ride in vehicles, they should have the protection provided by appropriate child restraints.

Children who are not restrained properly can strike other people, or can be thrown out of the vehicle.

⚠ WARNING

Never do this.

Never hold an infant or a child while riding in a vehicle. Due to crash forces, an infant or a child will become so heavy it is not possible to hold it during a crash. For example, in a crash at only 40 km/h (25 mph), a 5.5 kg (12 lb) infant will suddenly become a 110 kg (240 lb) force on a person's arms. An infant should be secured in an appropriate restraint.



⚠ WARNING

Never do this.

Children who are up against, or very close to, any airbag when it inflates can be seriously injured or killed. Never put a rear-facing child restraint in the right front seat. Secure a rear-facing child restraint in a rear seat. It is also

(Continued)

WARNING (Continued)

better to secure a forward-facing child restraint in a rear seat. If you must secure a forward-facing child restraint in the right front seat, always move the front passenger seat as far back as it will go.



3-48 Seats and Restraints

Q: What are the different types of add-on child restraints?

A: Add-on child restraints, which are purchased by the vehicle owner, are available in four basic types. Selection of a particular restraint should take into consideration not only the child's weight, height, and age but also whether or not the restraint will be compatible with the motor vehicle in which it will be used.

For most basic types of child restraints, there are many different models available. When purchasing a child restraint, be sure it is designed to be used in a motor vehicle. If it is, the restraint will have a label saying that it meets federal motor vehicle safety standards.

The restraint manufacturer's instructions that come with the restraint state the weight and height limitations for a particular child restraint. In addition, there are many kinds of restraints available for children with special needs.

WARNING

To reduce the risk of neck and head injury during a crash, infants need complete support. This is because an infant's neck is not fully developed and its head weighs so much compared with the rest of its body. In a crash, an infant in a rear-facing child restraint settles into the restraint, so the crash forces can be distributed across the strongest part of an infant's body, the back and shoulders. Infants should always be secured in rear-facing child restraints.

WARNING

A young child's hip bones are still so small that the vehicle's regular safety belt may not remain low on the hip bones, as it should. Instead, it may settle up around the child's abdomen. In a crash, the belt would apply force on a body area that is unprotected by any bony structure. This alone could cause serious or fatal injuries. To reduce the risk of serious or fatal injuries during a crash, young children should always be secured in appropriate child restraints.

Child Restraint Systems

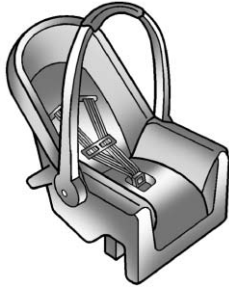

(A) Rear-Facing Infant Seat

A rear-facing infant seat (A) provides restraint with the seating surface against the back of the infant.

The harness system holds the infant in place and, in a crash, acts to keep the infant positioned in the restraint.



(B) Forward-Facing Child Seat

A forward-facing child seat (B) provides restraint for the child's body with the harness.

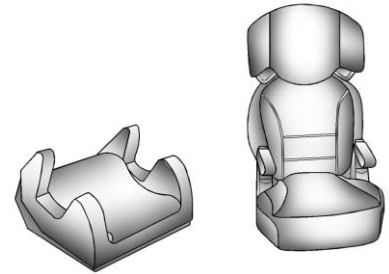

(C) Booster Seats

A booster seat (C) is a child restraint designed to improve the fit of the vehicle's safety belt system. A booster seat can also help a child to see out the window.

Securing an Add-On Child Restraint in the Vehicle

WARNING

A child can be seriously injured or killed in a crash if the child restraint is not properly secured in the vehicle. Secure the child restraint properly in the vehicle using the vehicle safety belt or LATCH system, following the instructions that came with that child restraint and the instructions in this manual.

To help reduce the chance of injury, the child restraint must be secured in the vehicle. Child restraint systems must be secured in vehicle seats by lap belts or the lap belt portion of a lap-shoulder belt, or by the LATCH system.

See *Lower Anchors and Tethers for Children (LATCH System)* on page 3-52 for more information. Children can be endangered in a crash if the child restraint is not properly secured in the vehicle.

When securing an add-on child restraint, refer to the instructions that come with the restraint which may be on the restraint itself or in a booklet, or both, and to this manual. The child restraint instructions are important, so if they are not available, obtain a replacement copy from the manufacturer.

Keep in mind that an unsecured child restraint can move around in a collision or sudden stop and injure people in the vehicle. Be sure to properly secure any child restraint in the vehicle — even when no child is in it.

In some areas, Certified Child Passenger Safety Technicians (CPSTs) are available to inspect and demonstrate how to correctly use and install child restraints. In the U.S., refer to the National Highway Traffic Safety Administration (NHTSA) website to locate the nearest child safety seat inspection station. For CPST availability in Canada, check with Transport Canada or the Provincial Ministry of Transportation office.

Securing the Child within the Child Restraint

WARNING

A child can be seriously injured or killed in a crash if the child is not properly secured in the child restraint. Secure the child properly following the instructions that came with that child restraint.

Where to Put the Restraint

According to accident statistics, children and infants are safer when properly restrained in a child restraint system or infant restraint system secured in a rear seating position.

We recommend that children and child restraints be secured in a rear seat, including: an infant or a child riding in a rear-facing child restraint; a child riding in a forward-facing child seat; an older child riding in a booster seat; and children, who are large enough, using safety belts.

A label on your sun visor says, "Never put a rear-facing child seat in the front." This is because the risk to the rear-facing child is so great if the airbag deploys.

WARNING

A child in a rear-facing child restraint can be seriously injured or killed if the right front passenger airbag inflates. This is because the back of the rear-facing child restraint would be very close to the inflating airbag. A child in a forward-facing child restraint can be seriously injured or killed if the right front passenger airbag inflates and the passenger seat is in a forward position.

Even if the passenger sensing system has turned off the right front passenger frontal airbag, no system is fail-safe. No one can guarantee that an airbag will not deploy under some unusual circumstance, even though it is turned off.

(Continued)

WARNING (Continued)

Secure rear-facing child restraints in a rear seat, even if the airbag is off. If you secure a forward-facing child restraint in the right front seat, always move the front passenger seat as far back as it will go. It is better to secure the child restraint in a rear seat.

See *Passenger Sensing System* on page 3-37 for additional information.

When securing a child restraint in a rear seating position, study the instructions that came with your child restraint to make sure it is compatible with this vehicle.

Child restraints and booster seats vary considerably in size, and some may fit in certain seating positions better than others. Always make sure the child restraint is properly secured.

Depending on where you place the child restraint and the size of the child restraint, you may not be able to access adjacent safety belt assemblies or LATCH anchors for additional passengers or child restraints. Adjacent seating positions should not be used if the child restraint prevents access to or interferes with the routing of the safety belt.

Wherever a child restraint is installed, be sure to secure the child restraint properly.

Keep in mind that an unsecured child restraint can move around in a collision or sudden stop and injure people in the vehicle. Be sure to properly secure any child restraint in your vehicle — even when no child is in it.

Lower Anchors and Tethers for Children (LATCH System)

The LATCH system holds a child restraint during driving or in a crash. This system is designed to make installation of a child restraint easier. The LATCH system uses anchors in the vehicle and attachments on the child restraint that are made for use with the LATCH system.

Make sure that a LATCH-compatible child restraint is properly installed using the anchors, or use the vehicle's safety belts to secure the restraint, following the instructions that came with that restraint, and also the instructions in this manual.

When installing a child restraint with a top tether, you must also use either the lower anchors or the safety belts to properly secure the child restraint. A child restraint must never be installed using only the top tether and anchor.

In order to use the LATCH system in the vehicle, you need a child restraint that has LATCH attachments. The child restraint manufacturer will provide you with instructions on how to use the child restraint and its attachments. The following explains how to attach a child restraint with these attachments in the vehicle.

Not all vehicle seating positions or child restraints have lower anchors and attachments or top tether anchors and attachments.

Lower Anchors

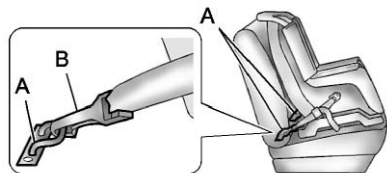

Lower anchors (A) are metal bars built into the vehicle. There are two lower anchors for each LATCH seating position that will accommodate a child restraint with lower attachments (B).

Top Tether Anchor

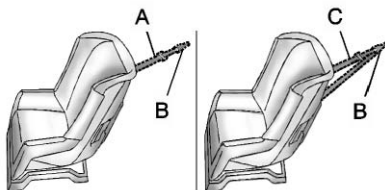

A top tether (A, C) anchors the top of the child restraint to the vehicle. A top tether anchor is built into the vehicle. The top tether attachment (B) on the child restraint connects to the top tether anchor in the vehicle in order to reduce the forward movement and rotation of the child restraint during driving or in a crash.

The child restraint may have a single tether (A) or a dual tether (C). Either will have a single attachment (B) to secure the top tether to the anchor.

Some child restraints that have a top tether are designed for use with or without the top tether being attached. Others require the top tether always to be attached.

In Canada, the law requires that forward-facing child restraints have a top tether, and that the tether be attached. Be sure to read and follow the instructions for the child restraint.

3-54 Seats and Restraints

Lower Anchor and Top Tether Anchor Locations

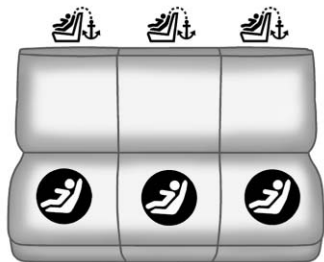

Rear Seat

 (Top Tether Anchor): Seating positions with top tether anchors.

 (Lower Anchor): Seating positions with two lower anchors.



To assist you in locating the lower anchors, each rear anchor position has a label, near the crease between the seatback and the seat cushion.



To assist you in locating the top tether anchors, the top tether anchor symbol is located on the cover.

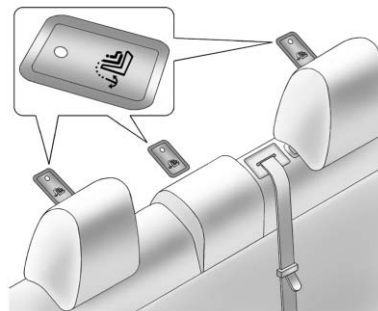

The top tether anchors are located under the covers, behind the rear seat, on the filler panel. Be sure to use an anchor located on the same side of the vehicle as the seating position where the child restraint will be placed.

Do not secure a child restraint in a position without a top tether anchor if a national or local law requires that the top tether be attached, or if the instructions that come with the child restraint say that the top tether must be attached.

According to accident statistics, children and infants are safer when properly restrained in a child restraint system or infant restraint system secured in a rear seating position. See *Where to Put the Restraint* on page 3-51 for additional information.

Securing a Child Restraint Designed for the LATCH System

WARNING

If a LATCH-type child restraint is not attached to anchors, the child restraint will not be able to protect the child correctly. In a crash, the child could be seriously injured or killed. Install a LATCH-type child restraint properly using the anchors, or use the vehicle safety belts to secure the restraint, following the instructions that came with the child restraint and the instructions in this manual.

WARNING

Do not attach more than one child restraint to a single anchor. Attaching more than one child restraint to a single anchor could cause the anchor or attachment to come loose or even break during a crash. A child or others could be injured. To reduce the risk of serious or fatal injuries during a crash, attach only one child restraint per anchor.

WARNING

Children can be seriously injured or strangled if a shoulder belt is wrapped around their neck and the safety belt continues to tighten. Buckle any unused safety belts behind the child restraint so children cannot reach them. Pull the shoulder belt all the way out of the retractor to set the lock, if the vehicle has one, after the child restraint has been installed.

Notice: Do not let the LATCH attachments rub against the vehicle's safety belts. This may damage these parts. If necessary, move buckled safety belts to avoid rubbing the LATCH attachments.

Do not fold the empty rear seat with a safety belt buckled. This could damage the safety belt or the seat. Unbuckle and return the safety belt to its stowed position, before folding the seat.

If you need to secure more than one child restraint in the rear seat, see *Where to Put the Restraint on page 3-51*.

You cannot secure three child restraints using the LATCH anchors in the rear seat at the same time, but you can install two of them. If you want to do this, install one LATCH child restraint in the passenger-side position, and install the other one either in the driver-side position or in the center position. If you need to install child restraints in both the center and driver-side position, the one in the center seating position will need to be secured using the vehicle safety belts instead of the LATCH anchors.

Refer to the following illustration to learn which anchors to use.

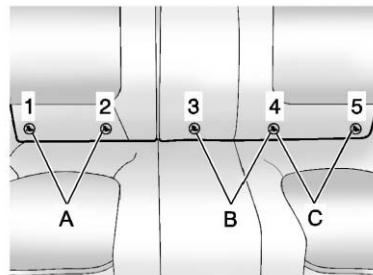

- A. Passenger Side Rear Seating Position and Lower Anchors 1 and 2
- B. Center Rear Seating Position and Lower Anchors 3 and 4
- C. Driver Side Rear Seating Position and Lower Anchors 4 and 5

There are five lower LATCH anchors in the rear seat.

- Use anchors 1 and 2 when installing a child restraint using LATCH in seating position A.
- Use anchors 3 and 4 when installing a child restraint using LATCH in seating position B.
- Use anchors 4 and 5 when installing a child restraint using LATCH in seating position C.

Installing child restraints using LATCH in seating positions B and C at the same time is prohibited.

Make sure to attach the child restraint at the proper anchor location.

This system is designed to make installation of child restraints easier. When using lower anchors, do not use the vehicle's safety belts. Instead use the vehicle's anchors and child restraint attachments to secure the restraints. Some restraints also use another vehicle anchor to secure a top tether.

1. Attach and tighten the lower attachments to the lower anchors. If the child restraint does not have lower attachments or the desired seating position does not have lower anchors, secure the child restraint with the top tether and the safety belts. Refer to the child restraint manufacturer instructions and the instructions in this manual.
 - 1.1. Find the lower anchors for the desired seating position.

- 1.2. Put the child restraint on the seat.

If the head restraint interferes with the proper installation of the child restraint, the head restraint may be removed. See "Head Restraint Removal and Reinstallation" at the end of this section.

- 1.3. Attach and tighten the lower attachments on the child restraint to the lower anchors.
2. If the child restraint manufacturer recommends that the top tether be attached, attach and tighten the top tether to the top tether anchor, if equipped. Refer to the child restraint instructions and the following steps:
 - 2.1. Find the top tether anchor.

Open the cover to expose the anchor.

3-58 Seats and Restraints

2.2. Route, attach, and tighten the top tether according to the child restraint instructions and the following instructions:

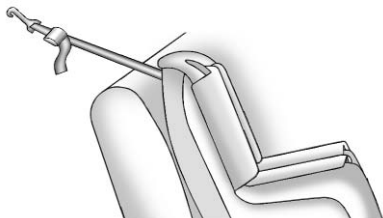

- If the position you are using does not have a headrest or head restraint, or the headrest or head restraint has been removed, and you are using a single tether, route the tether over the seatback.

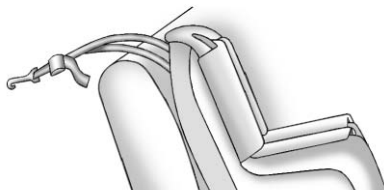

- If the position you are using does not have a headrest or head restraint, or the headrest or head restraint has been removed, and you are using a dual tether, route the tether over the seatback.

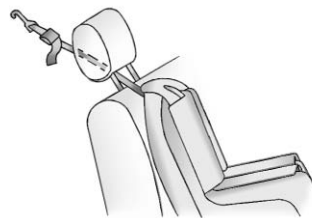

- If the position you are using has an adjustable headrest or head restraint and you are using a single tether, route the tether under the headrest or head restraint and in between the headrest or head restraint posts. See *Head Restraints* on page 3-2.

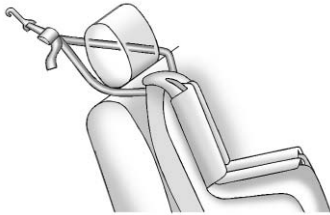

- If the position you are using has an adjustable headrest or head restraint and you are using a dual tether route the tether around the headrest or head restraint.
3. Before placing a child in the child restraint, make sure it is securely held in place. To check, grasp the child restraint at the LATCH path and attempt to move it side to side and back and forth. There should be no more than 2.5 cm (1 in) of movement, for proper installation.

Head Restraint Removal and Reinstallation

The rear outboard head restraints can be removed if they interfere with the proper installation of the child restraint.

To remove the head restraint:

1. Partially fold the seatback forward. See *Rear Seats on page 3-11* for additional information.

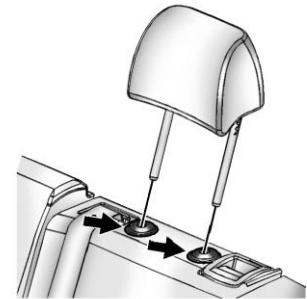

2. Press both buttons on the head restraint posts at the same time, and pull up on the head restraint.

3-60 Seats and Restraints

3. Store the head restraint in the trunk of the vehicle.
4. When the child restraint is removed, reinstall the head restraint before the seating position is used.

WARNING

With head restraints that are not installed and adjusted properly, there is a greater chance that occupants will suffer a neck/spinal injury in a crash. Do not drive until the head restraints for all occupants are installed and adjusted properly.

To reinstall the head restraint:

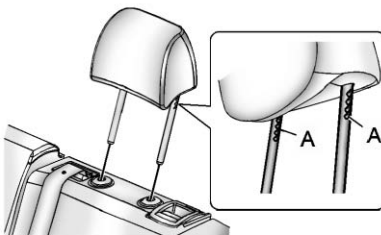

1. Insert the head restraint posts into the holes in the top of the seatback. The notches (A) on the posts must face the driver side of the vehicle.

2. Push the head restraint down. If necessary, press the height adjustment release button to further lower the head restraint. See *Head Restraints* on page 3-2.
3. Try to move the head restraint to make sure that it is locked in place.

Replacing LATCH System Parts After a Crash

WARNING

A crash can damage the LATCH system in the vehicle. A damaged LATCH system may not properly secure the child restraint, resulting in serious injury or even death in a crash. To help make sure the LATCH system is working properly after a crash, see your dealer to have the system inspected and any necessary replacements made as soon as possible.

If the vehicle has the LATCH system and it was being used during a crash, new LATCH system parts may be needed.

New parts and repairs may be necessary even if the LATCH system was not being used at the time of the crash.

Securing Child Restraints (Rear Seat)

When securing a child restraint in a rear seating position, study the instructions that came with the child restraint to make sure it is compatible with this vehicle.

If the child restraint has the LATCH system, see *Lower Anchors and Tethers for Children (LATCH System)* on page 3-52 for how and where to install the child restraint using LATCH. If a child restraint is secured in the vehicle using a safety belt and it uses a top tether, see *Lower Anchors and Tethers for Children (LATCH System)* on page 3-52 for top tether anchor locations.

Do not secure a child seat in a position without a top tether anchor if a national or local law requires that the top tether be anchored, or if the instructions that come with the child restraint say that the top strap must be anchored.

If the child restraint does not have the LATCH system, you will be using the safety belt to secure the child restraint in this position. Be sure to follow the instructions that came with the child restraint. Secure the child in the child restraint when and as the instructions say.

If more than one child restraint needs to be installed in the rear seat, be sure to read *Where to Put the Restraint* on page 3-51.

1. Put the child restraint on the seat.

If the head restraint interferes with the proper installation of the child restraint, the head restraint may be removed. See “Head Restraint Removal and Reinstallation” under *Lower Anchors and Tethers for Children (LATCH System)* on page 3-52.

3-62 Seats and Restraints

2. Pick up the latch plate, and run the lap and shoulder portions of the vehicle's safety belt through or around the restraint. The child restraint instructions will show you how.

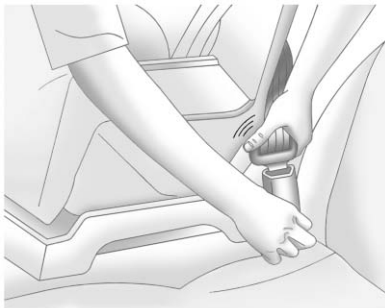

3. Push the latch plate into the buckle until it clicks.
Position the release button on the buckle so that the safety belt could be quickly unbuckled if necessary.



4. Pull the shoulder belt all the way out of the retractor to set the lock. When the retractor lock is set, the belt can be tightened but not pulled out of the retractor.

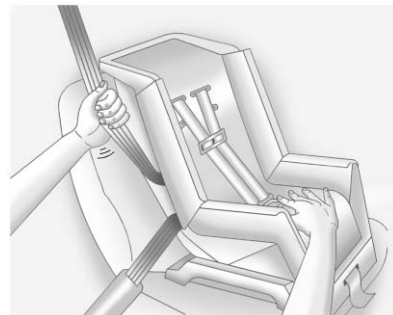

5. To tighten the belt, push down on the child restraint, pull the shoulder portion of the belt to tighten the lap portion of the belt, and feed the shoulder belt back into the retractor. When installing a forward-facing child restraint, it may be helpful to use your knee to push down on the child restraint as you tighten the belt.

Try to pull the belt out of the retractor to make sure the retractor is locked. If the retractor is not locked, repeat Steps 4 and 5.

6. If the child restraint has a top tether, follow the child restraint manufacturer's instructions regarding the use of the top tether. See *Lower Anchors and Tethers for Children (LATCH System)* on page 3-52 for more information.
7. Before placing a child in the child restraint, make sure it is securely held in place. To check, grasp the child restraint at the safety belt path and attempt to move it side-to-side and back-and-forth. When the child restraint is properly installed, there should be no more than 2.5 cm (1 in) of movement.

To remove the child restraint, unbuckle the vehicle safety belt and let it return to the stowed position. If the top tether is attached to a top tether anchor, disconnect it. If the head restraint was removed, reinstall it before the seating position is used. See "Head Restraint Removal and Reinstallation" under *Lower Anchors and Tethers for Children (LATCH System)* on page 3-52 for additional information on installing the head restraint properly.

Securing Child Restraints (Front Passenger Seat)

This vehicle has airbags. A rear seat is a safer place to secure a forward-facing child restraint. See *Where to Put the Restraint* on page 3-51.

In addition, the vehicle has a passenger sensing system which is designed to turn off the right front passenger frontal airbag and seat-mounted side impact airbag under certain conditions. See *Passenger Sensing System* on page 3-37 and *Passenger Airbag Status Indicator* on page 5-15 for more information, including important safety information.

3-64 Seats and Restraints

A label on the sun visor says, “Never put a rear-facing child seat in the front.” This is because the risk to the rear-facing child is so great if the airbag deploys.

WARNING

A child in a rear-facing child restraint can be seriously injured or killed if the right front passenger airbag inflates. This is because the back of the rear-facing child restraint would be very close to the inflating airbag. A child in a forward-facing child restraint can be seriously injured or killed if the right front passenger airbag inflates and the passenger seat is in a forward position.

(Continued)

WARNING (Continued)

Even if the passenger sensing system has turned off the right front passenger frontal airbag, no system is fail-safe. No one can guarantee that an airbag will not deploy under some unusual circumstance, even though it is turned off.

Secure rear-facing child restraints in a rear seat, even if the airbag is off. If you secure a forward-facing child restraint in the right front seat, always move the front passenger seat as far back as it will go. It is better to secure the child restraint in a rear seat.

See *Passenger Sensing System* on page 3-37 for additional information.

If the child restraint has the LATCH system, see *Lower Anchors and Tethers for Children (LATCH System)* on page 3-52 for how and where to install the child restraint using LATCH. If a child restraint is secured using a safety belt and it uses a top tether, see *Lower Anchors and Tethers for Children (LATCH System)* on page 3-52 for top tether anchor locations.

Do not secure a child seat in a position without a top tether anchor if a national or local law requires that the top tether be anchored, or if the instructions that come with the child restraint say that the top strap must be anchored.

In Canada, the law requires that forward-facing child restraints have a top tether, and that the tether be attached.

You will be using the lap-shoulder belt to secure the child restraint in this position. Follow the instructions that came with the child restraint.

1. Move the seat as far back as it will go before securing the forward-facing child restraint.

When the passenger sensing system has turned off the right front passenger frontal airbag and seat-mounted side airbag, the off indicator on the passenger airbag status indicator should light and stay lit when you start the vehicle. See *Passenger Airbag Status Indicator on page 5-15*.

2. Put the child restraint on the seat.
3. Pick up the latch plate, and run the lap and shoulder portions of the vehicle's safety belt through or around the restraint. The child restraint instructions will show you how.

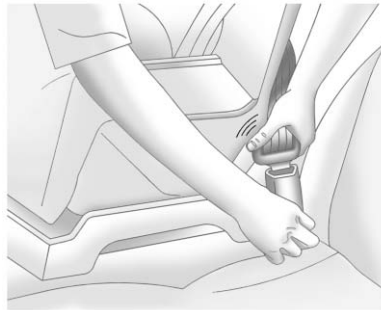

4. Push the latch plate into the buckle until it clicks. Position the release button on the buckle so that the safety belt could be quickly unbuckled if necessary.



5. Pull the shoulder belt all the way out of the retractor to set the lock. When the retractor lock is set, the belt can be tightened but not pulled out of the retractor.

3-66 Seats and Restraints

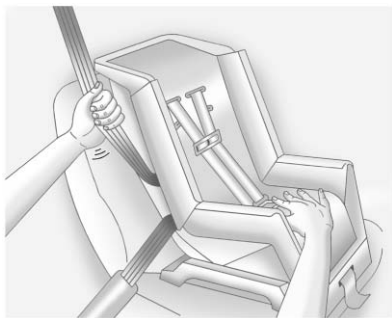

6. To tighten the belt, push down on the child restraint, pull the shoulder portion of the belt to tighten the lap portion of the belt, and feed the shoulder belt back into the retractor. When installing a forward-facing child restraint, it may be helpful to use your knee to push down on the child restraint as you tighten the belt.

Try to pull the belt out of the retractor to make sure the retractor is locked. If the retractor is not locked, repeat Steps 5 and 6.

7. Before placing a child in the child restraint, make sure it is securely held in place. To check, grasp the child restraint at the safety belt path and attempt to move it side-to-side and back-and-forth. When the child restraint is properly installed, there should be no more than 2.5 cm (1 in) of movement.

If the airbags are off, the off indicator in the passenger airbag status indicator will come on and stay on when the vehicle is started.

If a child restraint has been installed and the on indicator is lit, see "If the On Indicator is Lit for a Child Restraint" under *Passenger Sensing System* on page 3-37 for more information.

To remove the child restraint, unbuckle the vehicle safety belt and let it return to the stowed position.

Storage

Storage Compartments

Glove Box	4-1
Cupholders	4-1
Front Storage	4-1
Center Console Storage	4-1

Additional Storage Features

Convenience Net	4-2
-----------------------	-----

Storage Compartments

Glove Box

The glove box is located on the passenger side of the instrument panel. Lift up on the lever to open it.

Cupholders

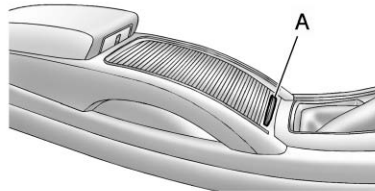

There are removable cupholders located in the center console. Slide the cover (A) to access the cupholders. Cupholders are also located in the rear armrest.

Front Storage

The driver's storage compartment is located near the left side of the steering column on the bottom of the instrument panel. Pull the cover down to open.

Center Console Storage

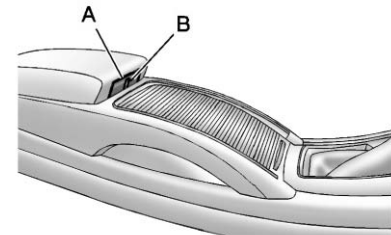

The armrest can be adjusted by sliding it to the desired position.

The center console has an upper tray and a lower main storage area.

4-2 Storage

To access the main storage area, adjust the armrest to the rear position and push button (A) to open. Push button (B) to access the upper tray.

An accessory power outlet is in the lower area. See *Power Outlets* on page 5-7.

Some vehicles might also have input jacks for auxiliary audio devices. See *Auxiliary Devices (Radio with CD)* on page 7-31 or *Auxiliary Devices (Radio with CD/DVD and MEM)* on page 7-34.

Additional Storage Features

Convenience Net

Use the convenience net located in the trunk to store small loads as far forward as possible. The net should not be used to store heavy loads. Attach the loops on each corner of the net to the hooks located on the sides of the trunk.

Instruments and Controls

Controls

Steering Wheel Adjustment ...	5-2
Steering Wheel Controls	5-2
Heated Steering Wheel	5-3
Horn	5-3
Windshield Wiper/Washer	5-3
Compass	5-5
Clock (Without Date Display)	5-5
Clock (With Date Display)	5-6
Power Outlets	5-7

Warning Lights, Gauges, and Indicators

Warning Lights, Gauges, and Indicators	5-9
Instrument Cluster	5-10
Speedometer	5-11
Odometer	5-11

Tachometer	5-11
Fuel Gauge	5-11
Engine Coolant Temperature Gauge	5-13
Safety Belt Reminders	5-14
Airbag Readiness Light	5-14
Passenger Airbag Status Indicator	5-15
Charging System Light	5-16
Malfunction Indicator Lamp	5-17
Brake System Warning Light	5-19
Electric Parking Brake Light	5-20
Antilock Brake System (ABS) Warning Light	5-21
Traction Off Light	5-21
Electronic Stability Control (ESC) Indicator Light	5-22
Electronic Stability Control (ESC)/Traction Control System (TCS) Indicator/Warning Light	5-22

Tire Pressure Light	5-23
Engine Oil Pressure Light	5-23
Low Fuel Warning Light	5-24
Security Light	5-24
High-Beam On Light	5-24
Front Fog Lamp Light	5-25
Taillamp Indicator Light	5-25
Cruise Control Light	5-25

Information Displays

Driver Information Center (DIC)	5-25
Head-Up Display (HUD)	5-29

Vehicle Messages

Vehicle Messages	5-33
Battery Voltage and Charging Messages	5-33
Brake System Messages	5-33
Compass Messages	5-34
Cruise Control Messages	5-34
Door Ajar Messages	5-34
Engine Cooling System Messages	5-35

5-2 Instruments and Controls

Engine Oil Messages	5-35
Engine Power Messages	5-36
Fuel System Messages	5-36
Key and Lock Messages	5-36
Lamp Messages	5-37
Object Detection System Messages	5-37
Ride Control System Messages	5-37
Anti-Theft Alarm System Messages	5-38
Tire Messages	5-38
Transmission Messages	5-38
Window Messages	5-39

Vehicle Personalization

Vehicle Personalization	5-39
-------------------------------	------

Universal Remote System

Universal Remote System ...	5-45
Universal Remote System Programming	5-45
Universal Remote System Operation	5-48

Controls Steering Wheel Adjustment

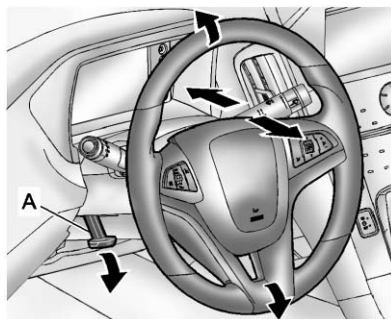

To adjust the steering wheel:

1. Pull the lever (A) down.
2. Move the steering wheel up or down.
3. Pull or push the steering wheel closer or away from you.
4. Pull the lever (A) up to lock the steering wheel in place.

Do not adjust the steering wheel while driving.

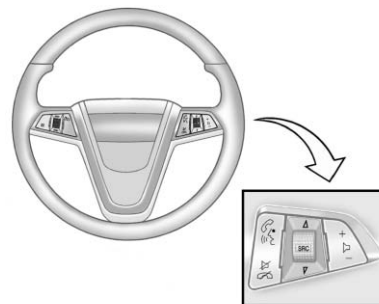

Steering Wheel Controls





For vehicles with audio steering wheel controls, some audio controls can be adjusted at the steering wheel.

 **(Push to Talk):** For vehicles with a Bluetooth®, OnStar®, or navigation system, press to interact with those systems.

See *Bluetooth (Overview)* on page 7-46 or *Bluetooth (Infotainment Controls)* on page 7-48 or *Bluetooth (Voice Recognition)* on page 7-53, the OnStar Owner's Guide, or the separate Navigation System Manual for more information.

  (**Mute/End Call**): Press to silence the vehicle speakers only. Press again to turn the sound on. For vehicles with OnStar or Bluetooth systems, press to reject an incoming call, or end a current call.

 **SRC**  (**Rotary Control**): Press to select an audio source.

Press  or  to select the next or previous favorite radio station, CD, DVD track/chapter (with navigation), or MP3 track.

+  - (Volume): Press + to increase the volume. Press - to decrease the volume.

Heated Steering Wheel

For vehicles with a heated steering wheel, the button for this feature is located on the climate control system.

 : Press to turn the heated steering wheel on or off. A light on the button displays when the feature is turned on.

The steering wheel takes about three minutes to start heating.

Horn

Press near the horn symbols or press on the steering wheel pad to sound the horn.

Windshield Wiper/Washer

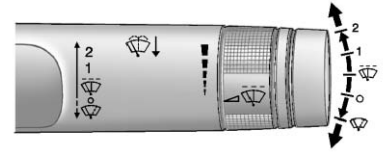

The windshield wiper lever is on the side of the steering column. With the ignition in ACC/ACCESSORY or ON/RUN, move the windshield wiper lever to select the wiper speed.

- 2:** Use for fast wipes.
- 1:** Use for slow wipes.

5-4 Instruments and Controls

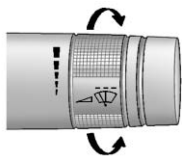

(Adjustable Interval Wipes):

Turn the band up for more frequent wipes or down for less frequent wipes.

 (Off): Use to turn the windshield wipers off.

 (Mist): For a single wipe, briefly move the wiper lever down. For several wipes, hold the wiper lever down.

Clear ice and snow from the wiper blades before using them. If they are frozen to the windshield, carefully loosen or thaw them.

Damaged wiper blades should be replaced. See *Wiper Blade Replacement* on page 10-29.

Heavy snow or ice can overload the wipers. A circuit breaker stops them until the motor cools.

Wipe Parking

If the ignition is turned to LOCK/OFF while the wipers are on 1, 2, or , they will immediately stop.

If the windshield wiper lever is then moved to OFF before the driver door is opened, or within 10 minutes, the wipers will restart and move to the base of the windshield.

If the ignition is turned to LOCK/OFF during a windshield wash, the wipers will stop when they reach the base of the windshield.

Windshield Washer

Pull the windshield wiper lever toward you to spray windshield washer fluid and activate the wipers.

The wipers will continue until the lever is released or the maximum wash time is reached.

When the windshield wiper lever is released, additional wipes may occur depending on how long the windshield washer had been activated. See *Washer Fluid* on page 10-24 for information on filling the windshield washer fluid reservoir.

WARNING

In freezing weather, do not use the washer until the windshield is warmed. Otherwise the washer fluid can form ice on the windshield, blocking your vision.

Compass

The vehicle may have a compass display on the Driver Information Center (DIC). The compass receives its heading and other information from the Global Positioning System (GPS) antenna, StabiliTrak, and vehicle speed information.

Avoid covering the GPS antenna for long periods of time with objects that may interfere with the antenna's ability to receive a satellite signal. See *Backglass Antenna on page 7-19* and *Satellite Radio Antenna on page 7-20* for the location of the vehicle's antennas.

The compass system is designed to operate for a certain number of miles or degrees of turn before needing a signal from the GPS satellites. When the compass display shows CAL, drive the vehicle for a short distance in an open area where it can receive a GPS signal. The compass system will automatically determine when the GPS signal is restored and provide a heading again. See *Compass Messages on page 5-34* for more information on the messages that may be displayed for the compass.

Clock (Without Date Display)

The infotainment system controls are used to access the time and date settings through the menu system. See *Operation on page 7-7* for information about how to use the menu system.

Setting the Time

1. Press the CONFIG button and select Time Settings, or press .
2. Select Set Time.

5-6 Instruments and Controls

3. Turn the Menu knob to adjust the highlighted value.
4. Press the SELECT button to select the next value.
5. To save the time and return to the Time Settings menu, press the ⇨ BACK button at any time or press the SELECT button after adjusting the minutes.

Setting the 12/24 Hour Format

1. Press the CONFIG button and select Time Settings, or press ⌚.
2. Highlight 12/24 Hour Format.
3. Press the SELECT button to select the 12 hour or 24 hour display format.

Clock (With Date Display)

The infotainment system controls are used to access the time and date settings through the menu system. See *Operation on page 7-7* for information about how to use the menu system.

Setting the Time and Date

1. Press the CONFIG button and select Time and Date Settings, or press ⌚.
2. Select Set Time or Set Date.
3. Turn the Menu knob to adjust the highlighted value.

4. Press the SELECT button to select the next value.
5. To save the time or date and return to the Time and Date Settings menu, press the ⇨ BACK button at any time or press the SELECT button after adjusting the minutes or year.

Setting the 12/24 Hour Format

1. Press the CONFIG button and select Time and Date Settings, or press ⌚.
2. Highlight Set Time Format.
3. Press the SELECT button to select the 12 hour or 24 hour display format.

Setting the Month & Day Format

1. Press the CONFIG button and select Time and Date Settings, or press ⌚.
2. Highlight Set Date Format.
3. Press the SELECT button to select MM/DD/YY (month/day/year) or DD/MM/YY (day/month/year).

Setting the Auto Time Adjust

1. Press the CONFIG button and select Time and Date Settings, or press ⌚.
2. Highlight Auto Time Adjust.
3. Press the SELECT button to turn Auto Time Adjust on or off.
4. Press the SELECT button to select Time Zone, and then select the Time Zone.
5. Press the SELECT button to turn Daylight Savings on or off.

Power Outlets

The accessory power outlets can be used to plug in electrical equipment, such as a cell phone or MP3 player.

There are two accessory power outlets. One is located under the armrest inside the center console storage and the other is on the rear of the center floor console.

These outlets are powered when the ignition is in ON/RUN or ACC/ACCESSORY, or until the driver door is opened within 10 minutes of turning off the vehicle. See *Retained Accessory Power (RAP)* on page 9-24.

5-8 Instruments and Controls

Remove the cover to access and replace when not in use.

Certain electrical accessories may not be compatible with the accessory power outlets and could overload vehicle or adapter fuses. If there is a problem, see your dealer.

When adding electrical equipment, be sure to follow the installation instructions included with the equipment. See *Add-On Electrical Equipment* on page 9-62.

Notice: Hanging heavy equipment from the power outlet can cause damage not covered by the vehicle warranty. The power outlets are designed for accessory power plugs only, such as cell phone charge cords.

Power Outlet 110 Volt Alternating Current

The vehicle may have a power outlet that can be used to plug in electrical equipment with a maximum limit of 150 watts.



The power outlet is located on the rear of the center console.

An indicator light on the outlet comes on when in use. The light comes on when the ignition is in ON/RUN and equipment requiring less than 150 watts is plugged into the outlet, and no system fault is detected.

If you try to connect equipment using more than 150 watts or a system fault is detected, the equipment may operate for a short period and turn itself off. A protection circuit shuts off the power supply and the indicator light turns off. To reset the circuit, unplug the item and plug it back in or turn the Remote Accessory Power (RAP) off and then back on.

See *Retained Accessory Power (RAP)* on page 9-24. Prolonged usage of the power outlet at the maximum load of 150 watts may cause the outlet to overheat and automatically shut down. The power restarts when equipment that operates within the limit is plugged into the outlet and a system fault is not detected.

The power outlet is not designed for and may not work properly, if any of the following is plugged in:

- Equipment with high initial peak wattage such as: compressor-driven refrigerators and electric power tools.
- Other equipment requiring an extremely stable power supply such as: microcomputer-controlled electric blankets, touch sensor lamps, etc.

Warning Lights, Gauges, and Indicators

Warning lights and gauges can signal that something is wrong before it becomes serious enough to cause an expensive repair or replacement. Paying attention to the warning lights and gauges could prevent injury.

Warning lights come on when there could be a problem with a vehicle function. Some warning lights come on briefly when the engine is started to indicate they are working.

Gauges can indicate when there could be a problem with a vehicle function. Often gauges and warning lights work together to indicate a problem with the vehicle.

When one of the warning lights comes on and stays on while driving, or when one of the gauges shows there may be a problem, check the section that explains what to do. Follow this manual's advice. Waiting to do repairs can be costly and even dangerous.

Instrument Cluster

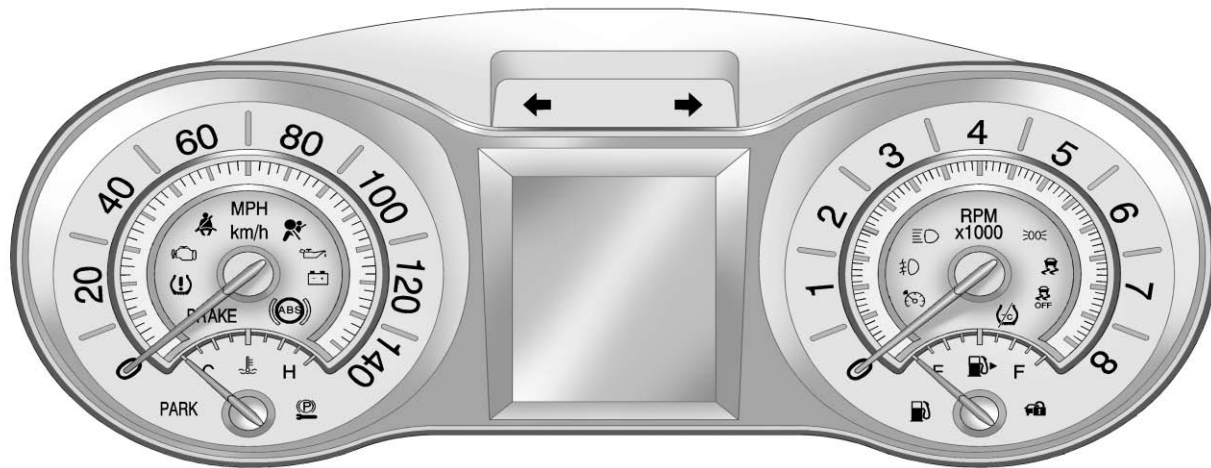

English Shown, Metric Similar

Speedometer

The speedometer shows the vehicle's speed in either kilometers per hour (km/h) or miles per hour (mph).

Odometer

The odometer shows how far the vehicle has been driven, in either kilometers or miles.

This vehicle has a tamper-resistant odometer. If the vehicle needs a new odometer installed, the new one is set to the mileage of the old odometer. If this is not possible, it is set at zero and a label is put on the driver door to show the old mileage reading.

Tachometer

The tachometer displays the engine speed in revolutions per minute (rpm).

Notice: If the engine is operated with the tachometer in the shaded warning area, the vehicle could be damaged, and the damages would not be covered by the vehicle warranty. Do not operate the engine with the tachometer in the shaded warning area.

Fuel Gauge

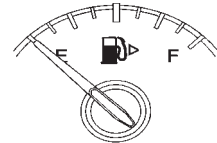

English

5-12 Instruments and Controls

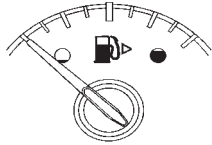

Metric

When the ignition is on, the fuel gauge indicates about how much fuel is left in the tank.

An arrow on the fuel gauge indicates the side of the vehicle the fuel door is on.

When the indicator nears empty, the low fuel light comes on. There is still a little fuel left, but the fuel tank should be filled soon.

Here are four things that some owners ask about. None of these show a problem with the fuel gauge:

- At the service station, the fuel pump shuts off before the gauge reads full.
- It takes a little more or less fuel to fill up than the gauge indicated. For example, the gauge indicated the tank was half full, but it actually took a little more or less than half the tank's capacity to fill the tank.
- The gauge moves a little while turning a corner or speeding up.
- The gauge takes a few seconds to stabilize after the ignition is turned on, and goes back to empty when the ignition is turned off.

Engine Coolant Temperature Gauge

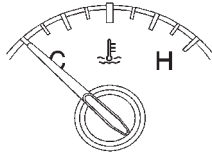

English

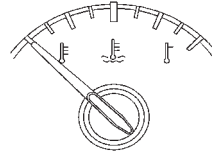

Metric

This gauge shows the engine coolant temperature.

If the gauge pointer moves toward the shaded area, the engine is too hot.

This reading indicates the same thing as the warning light. It means that the engine coolant has overheated. If the vehicle has been operating under normal driving conditions, pull off the road, stop the vehicle, and turn off the engine as soon as possible. See *Engine Overheating* on page 10-21 for more information.

Safety Belt Reminders

Driver Safety Belt Reminder Light

There is a driver safety belt reminder light on the instrument panel cluster.



When the vehicle is started this light flashes and a chime may come on to remind the driver to fasten their safety belt. Then the light stays on solid until the belt is buckled. This cycle may continue several times if the driver remains or becomes unbuckled while the vehicle is moving.

If the driver safety belt is buckled, neither the light nor the chime comes on.

Passenger Safety Belt Reminder Light



When the vehicle is started this light flashes and a chime comes on to remind passengers to fasten their safety belt. Then the light stays on solid until the belt is buckled. This cycle continues several times if the passenger remains or becomes unbuckled while the vehicle is moving.

If the passenger safety belt is buckled, neither the chime nor the light comes on.

The front passenger safety belt warning light and chime may turn on if an object is put on the seat such as a briefcase, handbag, grocery bag, laptop or other electronic device. To turn off the warning light and/or chime, remove the object from the seat or buckle the safety belt

Airbag Readiness Light

This light shows if there is an electrical problem. The system check includes the airbag sensor, the pretensioners, the airbag modules, the wiring, and the crash sensing and diagnostic module. For more information on the airbag system, see *Airbag System on page 3-29*.



The airbag readiness light comes on solid and stays on for several seconds when the vehicle is started. Then the light goes out.

If it stays on solid after the vehicle has been started or comes on while driving, the airbag system may not work properly. Have the vehicle serviced right away.

WARNING

If the airbag readiness light stays on after the vehicle is started or comes on while driving, it means the airbag system might not be working properly. The airbags in the vehicle might not inflate in a crash, or they could even inflate without a crash. To help avoid injury, have the vehicle serviced right away.

Passenger Airbag Status Indicator

The vehicle has a passenger sensing system. See *Passenger Sensing System* on page 3-37 for important safety information. The instrument panel has a passenger airbag status indicator.



When the vehicle is started, the passenger airbag status indicator will light the words ON and OFF for several seconds as a system check.

5-16 Instruments and Controls

If you are using remote start, if equipped, to start the vehicle from a distance, you may not see the system check. Then, after several more seconds, the status indicator will light either the word ON or OFF to let you know the status of the right front passenger frontal airbag.

If the word ON is lit on the passenger airbag status indicator, it means that the right front passenger frontal airbag is enabled (may inflate).

If the word OFF is lit on the airbag status indicator, it means that the passenger sensing system has turned off the right front passenger frontal airbag.

If, after several seconds, both status indicator lights remain on, or if there are no lights at all, there may be a problem with the lights or the passenger sensing system. See your dealer for service.

WARNING

If the airbag readiness light ever comes on and stays on, it means that something may be wrong with the airbag system. To help avoid injury to yourself or others, have the vehicle serviced right away. See *Airbag Readiness Light on page 5-14* for more information, including important safety information.

Charging System Light

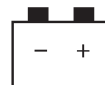

The charging system light comes on briefly when the ignition is turned on, but the engine is not running, as a check to show the light is working. The light turns off when the engine is started. If it does not, have the vehicle serviced by your dealer.

If the light stays on, or comes on while driving, there could be a problem with the electrical charging system. Have it checked by your dealer. Driving while this light is on could drain the battery.

If a short distance must be driven with the light on, be sure to turn off all accessories, such as the radio and air conditioner.

Malfunction Indicator Lamp

A computer system called OBD II (On-Board Diagnostics-Second Generation) monitors operation of the fuel, ignition, and emission control systems. It ensures that emissions are at acceptable levels for the life of the vehicle, helping to produce a cleaner environment.



This light should come on when the ignition is on, but the engine is not running, as a check to show it is working. If it does not, have the vehicle serviced by your dealer.

If the malfunction indicator lamp comes on and stays on while the engine is running, this indicates that there is an OBD II problem and service is required.

Malfunctions often are indicated by the system before any problem is apparent. Being aware of the light can prevent more serious damage to the vehicle. This system assists the service technician in correctly diagnosing any malfunction.

Notice: If the vehicle is continually driven with this light on, after a while, the emission controls might not work as well, the vehicle fuel economy might not be as good, and the engine might not run as smoothly. This could lead to costly repairs that might not be covered by the vehicle warranty.

Notice: Modifications made to the engine, transmission, exhaust, intake, or fuel system of the vehicle or the replacement of the original tires with other than those of the same Tire Performance Criteria (TPC) can affect the vehicle's emission controls and can cause this light to come on. Modifications to these systems could lead to costly repairs not covered by the vehicle warranty. This could also result in a failure to pass a required Emission Inspection/Maintenance test. See *Accessories and Modifications on page 10-3*.

This light comes on during a malfunction in one of two ways:

Light Flashing: A misfire condition has been detected. A misfire increases vehicle emissions and could damage the emission control system on the vehicle. Diagnosis and service might be required.

5-18 Instruments and Controls

To prevent more serious damage to the vehicle:

- Reduce vehicle speed.
- Avoid hard accelerations.
- Avoid steep uphill grades.
- If towing a trailer, reduce the amount of cargo being hauled as soon as it is possible.

If the light continues to flash, when it is safe to do so, stop the vehicle. Find a safe place to park the vehicle. Turn the vehicle off, wait at least 10 seconds, and restart the engine. If the light is still flashing, follow the previous steps and see your dealer for service as soon as possible.

Light On Steady: An emission control system malfunction has been detected on the vehicle. Diagnosis and service might be required.

The following may correct an emissions system malfunction:

- Make sure the fuel cap is fully installed. See *Filling the Tank on page 9-53*. The diagnostic system can determine if the fuel cap has been left off or improperly installed. A loose or missing fuel cap allows fuel to evaporate into the atmosphere. A few driving trips with the cap properly installed should turn the light off.
- Make sure the electrical system is not wet. The system could be wet if the vehicle was driven through a deep puddle of water. The condition is usually corrected when the electrical system dries out. A few driving trips should turn the light off.

- Make sure to fuel the vehicle with quality fuel. Poor fuel quality causes the engine not to run as efficiently as designed and can cause: stalling after start-up, stalling when the vehicle is changed into gear, misfiring, hesitation on acceleration, or stumbling on acceleration. These conditions might go away once the engine is warmed up.

If one or more of these conditions occurs, change the fuel brand used. It will require at least one full tank of the proper fuel to turn the light off.

See *Recommended Fuel on page 9-50*.

If none of the above have made the light turn off, your dealer can check the vehicle. The dealer has the proper test equipment and diagnostic tools to fix any mechanical or electrical problems that might have developed.

Emissions Inspection and Maintenance Programs

Some state/provincial and local governments may have programs to inspect the on-vehicle emission control equipment. For the inspection, the emission system test equipment is connected to the vehicle's Data Link Connector (DLC).

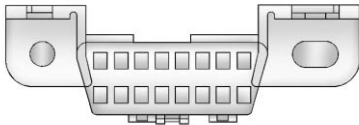

The DLC is under the instrument panel to the left of the steering wheel. See your dealer if assistance is needed.

The vehicle may not pass inspection if:

- The malfunction indicator lamp is on with the engine running, or if the light does not come on when the ignition is turned to ON/RUN while the engine is off.
- The critical emission control systems have not been completely diagnosed by the system. This can happen if the battery has recently been replaced or if the battery has run down. The diagnostic system evaluates critical emission control systems during normal driving. This can take several days of routine driving. If this has been done and the vehicle still does not pass the inspection, your dealer can prepare the vehicle for inspection.

Brake System Warning Light

The vehicle brake system consists of two hydraulic circuits. If one circuit is not working, the remaining circuit can still work to stop the vehicle. For normal braking performance, both circuits need to be working.

If the warning light comes on, there is a brake problem. Have your brake system inspected right away.

BRAKE



English

Metric

If the vehicle has antilock brakes, this light should come on when the vehicle is placed in START. If it does not, have the vehicle serviced by your dealer.

If the light comes on while driving, pull off the road and stop carefully. The pedal may be harder to push or it can go closer to the floor. It may take longer to stop. Try turning off and restarting the vehicle one or two times. If the light is still on, have the vehicle towed for service. See *Antilock Brake System (ABS) Warning Light* on page 5-21 and *Towing the Vehicle* on page 10-89.

WARNING

The brake system might not be working properly if the brake system warning light is on. Driving with the brake system warning light on can lead to a crash. If the light is still on after the vehicle has been pulled off the road and carefully stopped, have the vehicle towed for service.

Electric Parking Brake Light

PARK

English



Metric

For vehicles with the Electric Parking Brake (EPB), the parking brake status light comes on when the brake is applied. If the light continues flashing after the parking brake is released, or while driving, there is a problem with the Electric Parking Brake system. A **SERVICE PARKING BRAKE** message may also display in the Driver Information Center (DIC). See *Brake System Messages* on page 5-33 for more information.

If the light does not come on, or remains flashing, see your dealer.



For vehicles with the Electric Parking Brake (EPB), the parking brake warning light should come on briefly when ignition is placed in ON/RUN. If it does not come on, then have it fixed so it will be ready to warn if there is a problem.

If this light comes on, there is a problem with a system on the vehicle that is causing the parking brake system to work at a reduced level. The vehicle can still be driven, but should be taken to a dealer as soon as possible. See *Parking Brake* on page 9-33 for more information.

For vehicles with the uplevel cluster, this telltale displays in the Driver Information Center (DIC) screen.

Antilock Brake System (ABS) Warning Light



This light comes on briefly when the engine is started.

If the light does not come on, have it fixed so it will be ready to warn if there is a problem.

If the ABS light stays on, turn the ignition off.

If the light comes on while driving, stop as soon as it is safely possible and turn off the vehicle.

Then start the engine again to reset the system. If the ABS light stays on, or comes on again while driving, the vehicle needs service. A chime may also sound when the light comes on steady.

If the ABS light is the only light on, the vehicle has regular brakes, but the antilock brakes are not functioning.

If both the ABS and the brake system warning light are on, the vehicle's antilock brakes are not functioning and there is a problem with the regular brakes. See your dealer for service.

See *Brake System Warning Light on page 5-19*.

See *Brake System Messages on page 5-33* for all brake related DIC messages.

Traction Off Light



This light comes on when the Traction Control System (TCS) has been turned off by pressing and releasing the traction control button.

This light also comes on and the system turns off if there is a problem with the traction control system.

If the light comes on and stays on for an extended period of time while the system is turned on, the vehicle needs service.

See *Traction Control System (TCS) on page 9-36* and *Electronic Stability Control (ESC) on page 9-37* for more information.

Electronic Stability Control (ESC) Indicator Light



This light comes on briefly while starting the engine.

If it does not, have the vehicle serviced by your dealer. If the system is working normally the indicator light then goes off.

If the light comes on and stays on while driving, there could be a problem with the ESC and the vehicle might need service. When this warning light is on, the ESC is off and does not limit wheel spin.

The light flashes if the system is active and is working to assist the driver with directional control of the vehicle in difficult driving conditions.

For vehicles with the uplevel cluster, this light is shown in the Driver Information Center (DIC) screen.

See *Electronic Stability Control (ESC) on page 9-37* for more information.

Electronic Stability Control (ESC)/Traction Control System (TCS) Indicator/Warning Light



This light comes on when the Electronic Stability Control (ESC) system is turned off. When the ESC is off the Traction Control System (TCS) is also off, and wheel spin is not limited. If the ESC is off, the system does not assist in controlling the vehicle. Switch on the TCS and the ESC and the warning light turns off.

See *Traction Control System (TCS) on page 9-36* and *Electronic Stability Control (ESC) on page 9-37* for more information.

Tire Pressure Light



For vehicles with the Tire Pressure Monitor System (TPMS), this light comes on briefly when the engine is started. It provides information about tire pressures and the TPMS.

When the Light is On Steady

This indicates that one or more of the tires are significantly underinflated.

A tire pressure message can accompany the light. See *Tire Messages on page 5-38* for more information. Stop as soon as possible, and inflate the tires to the pressure value shown on the Tire and Loading Information label. See *Tire Pressure on page 10-54* for more information.

When the Light Flashes First and Then is On Steady

This indicates that there may be a problem with the TPMS. The light flashes for about a minute and stays on steady for the remainder of the ignition cycle. This sequence repeats with every ignition cycle. See *Tire Pressure Monitor Operation on page 10-57* for more information.

Engine Oil Pressure Light



Do not keep driving if the oil pressure is low. The engine can become so hot that it catches fire. Someone could be burned. Check the oil as soon as possible and have the vehicle serviced.

Notice: Lack of proper engine oil maintenance can damage the engine. The repairs would not be covered by the vehicle warranty. Always follow the maintenance schedule for changing engine oil.



The oil pressure light should come on briefly as the engine is started. If it does not come on have the vehicle serviced by your dealer.

If the light comes on and stays on, it means that oil is not flowing through the engine properly. The vehicle could be low on oil and might have some other system problem. See your dealer.

For vehicles with the uplevel cluster, this telltale displays in the Driver Information Center (DIC) screen.

Low Fuel Warning Light



This light, below the fuel gauge, comes on briefly when the engine is started.

If it does not come on have the vehicle serviced by your dealer. If the system is working normally, the indicator light then goes off.

This light also comes on when the fuel tank is low on fuel. When fuel is added the light should go off. If it does not, have your vehicle serviced.

For vehicles with the uplevel cluster, this telltale displays in the Driver Information Center (DIC) screen.

Security Light



This light flashes when the security system is activated.

For more information, see *Vehicle Security* on page 2-14.

For vehicles with the uplevel cluster, this telltale displays in the Driver Information Center (DIC) screen.

High-Beam On Light



This light comes on when the high-beam headlamps are in use.

See *Headlamp High/Low-Beam Changer* on page 6-2 for more information.

Front Fog Lamp Light



For vehicles with fog lamps, this light comes on when the fog lamps are on.

The light goes out when the fog lamps are turned off. See *Fog Lamps on page 6-5* for more information.

Taillamp Indicator Light



This light comes on when the taillamps are in use.

Cruise Control Light



This light is white whenever the cruise control is set and turns green when the cruise control is active.

The light goes out when the cruise control is turned off. See *Cruise Control on page 9-39* for more information.

For vehicles with the uplevel cluster, this telltale will be shown in the Driver Information Center (DIC) screen.

Information Displays

Driver Information Center (DIC)

The Driver Information Center (DIC) displays information about the vehicle. It also displays warning messages if a system problem is detected. See *Vehicle Messages on page 5-33* for more information. All messages appear in the DIC display located in the center of the instrument panel cluster.

On some models, the DIC may have some warning lights or indicators shown in the top portion of the display. See *Warning Lights, Gauges, and Indicators on page 5-9* for more information.

The vehicle may also have features that can be customized through the controls on the radio. See *Vehicle Personalization on page 5-39* for more information.

DIC Operation and Displays

The DIC has different displays which can be accessed by using the DIC buttons located on the turn signal lever located on the left side of the steering wheel. The DIC displays trip, fuel, vehicle system information, and warning messages if a system problem is detected.

The bottom of the DIC display shows what position the shift lever is in, the odometer, and the direction the vehicle is driving.

In cold weather the DIC display may change slowly. This is normal and will move more quickly as the vehicle's interior temperature rises.

DIC Buttons



MENU: Press to get to the Trip/Fuel Menu and the Vehicle Information Menu.

△ ▽ (Thumbwheel): Use to scroll through the items in each menu. A small marker will move across the bottom of the page as you scroll through the items. This shows where each page is in the menu.

SET/CLR (Set/Clear): Press to set or clear the menu item when it is displayed.

Trip/Fuel Menu Items

Press MENU on the turn signal lever until Trip/Fuel Information Menu is displayed. Use △ ▽ to scroll through the following menu items:

- Digital Speedometer
- Trip 1
- Trip 2
- Fuel Range
- Average Fuel Economy
- Average Vehicle Speed
- Timer
- Turn-by-Turn

Digital Speedometer

The speedometer shows how fast the vehicle is moving in either kilometers per hour (km/h) or miles per hour (mph). The speedometer cannot be reset.

Trip 1 and Trip 2

This display shows the current distance traveled, in either kilometers (km) or miles (mi), since the last reset for the trip odometer. The trip odometer can be reset to zero by pressing SET/CLR while the trip odometer display is showing.

Fuel Range

This display shows the approximate distance the vehicle can be driven without refueling. The fuel range estimate is based on an average of the vehicle's fuel economy over recent driving history and the amount of fuel remaining in the fuel tank. Fuel range cannot be reset.

Average Fuel Economy

This display shows the approximate average liters per 100 kilometers (L/100 km) or miles per gallon (mpg). This number is calculated based on the number of L/100 km (mpg) recorded since the last time this menu item was reset. The fuel economy can be reset by pressing SET/CLR while the Average Fuel Economy display is showing.

Average Vehicle Speed

This display shows the average speed of the vehicle in miles per hour (mph) or kilometers per hour (km/h). This average is calculated based on the various vehicle speeds recorded since the last reset of this value. The average speed can be reset by pressing SET/CLR while the Average Vehicle Speed display is showing.

Timer

This display can be used as a timer. To start the timer, press SET/CLR while Timer is displayed. The display will show the amount of time that has passed since the timer was last reset, not including time the ignition is off. Time will continue to be counted as long as the ignition is on, even if another display is being shown on the DIC. The timer will record up to 99 hours, 59 minutes and 59 seconds (99:59:59) after which the display will return to zero. To stop the timer, press SET/CLR briefly while Timer is displayed. To reset the timer to zero, press and hold SET/CLR.

Turn-by-Turn

This display is used for the OnStar or Navigation System Turn-by-Turn guidance. See the OnStar manual or the Navigation manual, if the vehicle has navigation, for more information.

Vehicle Information Menu Items

Press MENU on the turn signal lever until Vehicle Information Menu is displayed. Use \triangle ∇ to scroll through the following menu items:

- Unit
- Tire Pressure
- Remaining Oil Life
- Battery Voltage

Unit

Move \triangle ∇ to switch between Metric or US when the Unit display is active. Press SET/CLR to confirm the setting. This will change the displays on the cluster and DIC to either metric or English (US) measurements.

Tire Pressure

The display will show a vehicle with the approximate pressures of all four tires. Tire pressure is displayed in either kilopascal (kPa) or pounds per square inch (psi). See *Tire Pressure Monitor System on page 10-56* and *Tire Pressure Monitor Operation on page 10-57* for more information.

Remaining Oil Life

This display shows an estimate of the oil's remaining useful life. If REMAINING OIL LIFE 99% is displayed, that means 99% of the current oil life remains.

When the remaining oil life is low, the CHANGE ENGINE OIL SOON message will appear on the display.

See *Engine Oil Messages on page 5-35*. The oil should be changed as soon as possible. See *Engine Oil on page 10-9*. In addition to the engine oil life system monitoring the oil life, additional maintenance is recommended in the Maintenance Schedule in this manual. See *Scheduled Maintenance on page 11-2* for more information.

Remember, the Oil Life display must be reset after each oil change. It will not reset itself. Also, be careful not to reset the Oil Life display accidentally at any time other than when the oil has just been changed. It cannot be reset accurately until the next oil change. To reset the engine oil life system, press SET/CLR while the Oil Life display is active. See *Engine Oil Life System on page 10-13*.

Battery Voltage

This display, available on some vehicles, shows the current battery voltage. If the voltage is in the normal range, the value will display. For example, the display may read Battery Voltage 15.0 Volts. The vehicle's charging system regulates voltage based on the state of the battery. The battery voltage can fluctuate while viewing this information on the DIC. This is normal. See *Charging System Light* on page 5-16 for more information. If there is a problem with the battery charging system, the DIC will display a message

Compass

The vehicle may have a compass display in the Driver Information Center (DIC). See *Compass* on page 5-5 for more information.

Head-Up Display (HUD)

WARNING

If the HUD image is too bright or too high in your field of view, it may take you more time to see things you need to see when it is dark outside. Be sure to keep the HUD image dim and placed low in your field of view.

For vehicles with the Head-Up Display (HUD), some information concerning the operation of the vehicle is projected onto the windshield. This includes the speedometer reading, RPM reading, transmission position, outside air temperature, compass heading and a brief display of the current radio station, including XM information or CD track. It will also display turn-by-turn navigation information if the vehicle has a navigation radio. The images are

projected through the HUD lens located on the driver side of the instrument panel.

Notice: If you try to use the HUD image as a parking aid, you may misjudge the distance and damage your vehicle. Do not use the HUD image as a parking aid.

The tap shift gear will also appear on the HUD if the vehicle has tap shift and it is active.

The HUD information can be displayed in one of three languages, English, French, or Spanish. The speedometer reading and other numerical values can be displayed in either English or metric units.

The language selection is changed through the radio and the units of measurement is changed through the trip computer in the Driver Information Center (DIC). See *AM-FM Radio* on page 7-12 and *Driver Information Center (DIC)* on page 5-25.

5-30 Instruments and Controls

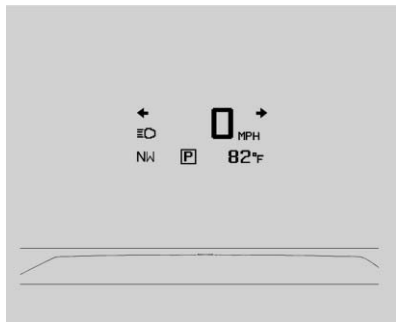

**HUD Display on the Vehicle
Windshield**

The HUD information appears as an image focused out toward the front of the vehicle.

When the ignition key is turned to ON/RUN, the HUD will display an introductory message for a short time, until the HUD is ready.

The following indicator lights come on the instrument panel when activated and also appear on the HUD:

- Turn Signal Indicators
- High-Beam Indicator Symbol

The HUD temporarily displays some vehicle warnings, such as CHECK TIRE PRESSURE and FUEL LEVEL LOW when these messages are on the DIC trip computer.

The HUD also displays the following messages on vehicles with these systems, when they are active:

- TRACTION CONTROL ACTIVE
- STABILITRAK ACTIVE

When the HUD is on, the speedometer reading is continually displayed. The current radio station or CD track number will display for a short period of time

after the radio or CD track status changes. This happens whenever radio information is changed. The speedometer size is reduced when radio, CD information, warnings, or turn-by-turn navigation information are displayed on the HUD.



The HUD control is located to the left of the steering wheel.

To adjust the HUD image so that items are properly displayed, do the following:

1. Adjust the driver seat to a comfortable position.
2. Start the engine.
3. Adjust the HUD controls.

Use the following settings to adjust the HUD.

OFF: To turn HUD off, turn the HUD dimming knob fully counterclockwise until the HUD display turns off.

Brightness: Turn the dimming knob clockwise or counterclockwise to brighten or dim the display.

∧ **(Up):** ∨ **(Down):** Press the up or down arrows to center the HUD image in your view. The HUD image can only be adjusted up and down, not side to side.

PAGE: Press to select the display formats. Release the PAGE button when the format number with the desired display is shown on the HUD. If vehicle messages are displayed, pressing PAGE may clear the message.

The three formats are as follows:



English Shown, Metric Similar

Format One: This display gives the speedometer reading (in English or metric units), turn signal indication, high-beam indication, transmission positions, outside air temperature, and compass heading.



English Shown, Metric Similar

Format Two: This display includes the information in Format One without the transmission information, the outside air temperature, and compass heading.



English Shown, Metric Similar

Format Three: This display includes all the information in Format One along with a circular tachometer, but without outside air temperature and compass heading.

5-32 Instruments and Controls

All formats will show the turn-by-turn navigation information and provide details about the next driving maneuver to be made. When you near your destination, the HUD will display a distance bar that will empty the closer you get to your destination. All navigation information is provided to the HUD by the navigation radio or OnStar[®] service, for vehicles that have these features.



English Shown, Metric Similar

The HUD image displayed on the windshield will automatically dim and brighten to compensate for outside lighting. However, the HUD brightness control can still be adjusted as needed.

The HUD image can temporarily light up depending on the angle and position of the sunlight on the HUD display. This is normal and will change when the angle of the sunlight on the HUD display changes.

Polarized sunglasses could make the HUD image harder to see.

Care of the HUD

Clean the inside of the windshield as needed to remove any dirt or film that could reduce the sharpness or clarity of the HUD image.

To clean the HUD lens, use a soft, clean cloth that has household glass cleaner sprayed on it. Wipe the HUD lens gently, then dry it. Do not spray cleaner directly on the lens because the cleaner could leak into the unit.

If You Cannot See the HUD Image When the Ignition Is On

- Is anything covering the HUD lens?
- Is the HUD dimmer setting bright enough?
- Is the HUD image adjusted to the proper height?
- Are you wearing polarized sunglasses?
- Still no HUD image? Check the fuse in the instrument panel fuse block. See *Instrument Panel Fuse Block* on page 10-42.

If the HUD Image Is Not Clear

- Is the HUD image too bright?
- Are the windshield and HUD lens clean?

If the HUD image is not correct, contact your dealer.

Keep in mind that the windshield is part of the HUD system.

Vehicle Messages

Messages displayed on the DIC indicate the status of the vehicle or some action that may be needed to correct a condition. Multiple messages may display one after the other.

The messages that do not require immediate action can be acknowledged and cleared by pressing SET/CLR. The messages that require immediate action cannot be cleared until that action is performed. All messages should be taken seriously and clearing the messages does not correct the problem.

Battery Voltage and Charging Messages

BATTERY SAVER ACTIVE

This message displays when the vehicle has detected that the battery voltage is dropping beyond a reasonable point. The battery saver system starts reducing certain features of the vehicle that you may be able to notice. At the point that features are disabled, this message is displayed. It means that the vehicle is trying to save the charge in the battery. Turn off unnecessary accessories to allow the battery to recharge.

LOW BATTERY

This message is displayed when the battery voltage is low. See *Battery on page 10-27* for more information.

SERVICE BATTERY CHARGING SYSTEM

This message is displayed when there is a fault in the battery charging system. Take the vehicle to your dealer for service.

Brake System Messages

BRAKE FLUID LOW

This message is displayed when the brake fluid level is low. See *Brake Fluid on page 10-25*.

PRESS BRAKE PEDAL TO RELEASE PARK BRAKE

This message is displayed if you attempt to release the electric parking brake without the brake pedal applied. See *Parking Brake on page 9-33* for more information.

RELEASE PARK BRAKE SWITCH

This message is displayed if the electric parking brake is on while the vehicle is in motion. Release it before you attempt to drive. See *Parking Brake on page 9-33* for more information.

SERVICE BRAKE ASSIST

This message may be displayed when there is a problem with the brake boost assist system. When this message is displayed, the brake boost assist motor might be heard operating and you might notice pulsation in the brake pedal. This is normal under these conditions. Take the vehicle to your dealer for service.

SERVICE PARKING BRAKE

This message is displayed when there is a problem with the electric parking brake. See *Parking Brake on page 9-33* for more information. Take the vehicle to your dealer.

Compass Messages

CAL

This message is displayed when the compass needs to be calibrated. See *Compass on page 5-5*.

— — —

Three dashes will be displayed if the compass needs service. See your dealer for service.

Cruise Control Messages

APPLY BRAKE BEFORE CRUISE

If this message displays when attempting to activate cruise control, apply the brake pedal and try again.

CRUISE SET TO XXX

This message displays when the cruise control is set and shows the speed it was set to. See *Cruise Control on page 9-39* for more information.

Door Ajar Messages

DRIVER DOOR OPEN

This message will display when the driver door is open. Close the door completely.

HOOD OPEN

This message will display when the hood is open. Close the hood completely.

LEFT REAR DOOR OPEN

This message will display when the driver side rear door is open. Close the door completely.

PASSENGER DOOR OPEN

This message will display when the front passenger door is open. Close the door completely.

RIGHT REAR DOOR OPEN

This message will display when the passenger side rear door is open. Close the door completely.

TRUNK OPEN

This message will display when the trunk is open. Close the trunk completely.

Engine Cooling System Messages**A/C OFF DUE TO HIGH ENGINE TEMP**

This message displays when the engine coolant becomes hotter than the normal operating temperature. To avoid added strain on a hot engine, the air conditioning compressor automatically turns off. When the coolant temperature returns to normal, the air conditioning compressor turns back on. You can continue to drive the vehicle.

If this message continues to appear, have the system repaired by your dealer as soon as possible to avoid damage to the engine.

COOLANT LEVEL LOW ADD COOLANT

This message will display if the coolant is low. See *Engine Coolant on page 10-18*.

ENGINE OVERHEATED — IDLE ENGINE

This message displays when the engine coolant temperature is too hot. Stop and allow the vehicle to idle until it cools down.

ENGINE OVERHEATED — STOP ENGINE

This message displays and a continuous chime sounds if the engine cooling system reaches unsafe temperatures for operation. Stop and turn off the vehicle as soon as it is safe to do so to avoid severe damage. This message clears when the engine has cooled to a safe operating temperature.

HIGH COOLANT TEMPERATURE

This message displays if the coolant temperature is hot. See *Engine Overheating on page 10-21*.

Engine Oil Messages**CHANGE ENGINE OIL SOON**

This message displays when the engine oil needs to be changed. When you change the engine oil, be sure to reset the Oil Life System. See *Engine Oil Life System on page 10-13* and *Driver Information Center (DIC) on page 5-25* for information on how to reset the system. See *Engine Oil on page 10-9* and *Scheduled Maintenance on page 11-2* for more information.

ENGINE OIL HOT, IDLE ENGINE

This message displays when the engine oil temperature is too hot. Stop and allow the vehicle to idle until it cools down.

ENGINE OIL LOW — ADD OIL

This message displays when the engine oil level is too low. Check the oil level. See *Engine Oil* on page 10-9.

OIL PRESSURE LOW — STOP ENGINE

This message displays if low oil pressure levels occur. Stop the vehicle as soon as safely possible and do not operate it until the cause of the low oil pressure has been corrected. Check the oil as soon as possible and have the vehicle serviced by your dealer.

Engine Power Messages

ENGINE POWER IS REDUCED

This message displays when the vehicle's engine power is reduced. Reduced engine power can affect the vehicle's ability to accelerate. If this message is on, but there is no reduction in performance, proceed to your destination.

The performance may be reduced the next time the vehicle is driven. The vehicle may be driven at a reduced speed while this message is on, but maximum acceleration and speed may be reduced. Anytime this message stays on, the vehicle should be taken to your dealer for service as soon as possible.

Fuel System Messages

FUEL LEVEL LOW

This message displays when the vehicle is low on fuel. Refuel as soon as possible.

TIGHTEN GAS CAP

This message displays when the fuel cap is not on tight. Tighten the fuel cap.

Key and Lock Messages

NO REMOTE DETECTED

This message displays when the transmitter battery is weak on vehicles with keyless access. See "Starting the Vehicle with a Low Transmitter Battery" under *Remote Keyless Entry (RKE) System Operation* on page 2-4 for more information.

REPLACE BATTERY IN REMOTE KEY

This message displays when the battery in the Remote Keyless Entry (RKE) transmitter needs to be replaced.

Lamp Messages

AFL (Adaptive Forward Lighting) LAMPS NEED SERVICE

This message displays when the Adaptive Forward Lighting (AFL) system is disabled and needs service. See your dealer. See *Adaptive Forward Lighting (AFL)* on page 6-4 for more information.

Object Detection System Messages

PARK ASSIST OFF

This message is displayed when the park assist system has been turned off. See *Ultrasonic Parking Assist* on page 9-42.

SERVICE PARK ASSIST

This message is displayed if there is a problem with the park assist system. Take the vehicle to your dealer for service.

Ride Control System Messages

SERVICE REAR AXLE

This message displays when there is a problem with the All-Wheel Drive (AWD) System. See your dealer for service.

SERVICE TRACTION CONTROL

This message displays when there is a problem with the Traction Control System (TCS). When this message is displayed, the system will not limit wheel spin. Adjust your driving accordingly. See your dealer for service.

SERVICE STABILITRAK

This message displays if there is a problem with the StabiliTrak[®] system. If this message appears, try to reset the system. Stop; turn off the engine for at least 15 seconds; then start the engine again. If this message still comes on, it means there is a problem. See your dealer for service. The vehicle is safe to drive, however, you do not have the benefit of StabiliTrak, so reduce your speed and drive accordingly.

SPORT MODE ON

This message displays when using the selective ride control. See *Selective Ride Control* on page 9-38 for more information.

TRACTION CONTROL OFF

This message displays when the Traction Control System (TCS) is turned off. Adjust your driving accordingly.

Anti-Theft Alarm System Messages

THEFT ATTEMPTED

This message displays if the vehicle detects a tamper condition.

Tire Messages

TIRE PRESSURE LOW ADD AIR TO TIRE

On vehicles with the Tire Pressure Monitor System (TPMS), this message displays when the pressure in one or more of the vehicle's tires is low.

The low tire pressure warning light will also come on. See *Tire Pressure Light* on page 5-23.

If a tire pressure message appears on the DIC, stop as soon as you can. Inflate the tires by adding air until the tire pressure is equal to the values shown on the Tire and Loading Information label.

See *Tires* on page 10-46, *Vehicle Load Limits* on page 9-12, and *Tire Pressure* on page 10-54.

You can receive more than one tire pressure message at a time. To read the other messages that may have been sent at the same time, press the SET/CLR button. The DIC also shows the tire pressure values. See *Driver Information Center (DIC) on page 5-25*.

SERVICE TIRE MONITOR SYSTEM

This message displays if there is a problem with the Tire Pressure Monitor System (TPMS). See *Tire Pressure Monitor Operation* on page 10-57 for more information.

TIRE LEARNING ACTIVE

This message displays when the system is learning new tires. See *Tire Pressure Monitor Operation* on page 10-57 for more information.

Transmission Messages

SERVICE TRANSMISSION

This message displays if there is a problem with the transmission. See your dealer.

SHIFT TO PARK

This message displays when the transmission needs to be shifted to P (Park). This may appear when attempting to remove the key if the vehicle is not in P (Park).

TRANSMISSION HOT — IDLE ENGINE

This message displays and a chime sounds if the transmission fluid in the vehicle gets hot. Driving with the transmission fluid temperature high can cause damage to the vehicle. Stop the vehicle and let it idle to allow the transmission to cool. This message clears when the fluid temperature reaches a safe level.

Window Messages

OPEN, THEN CLOSE DRIVER WINDOW

This message is displayed when the window needs to be reprogrammed. If the vehicle's battery has been recharged or disconnected, you will need to reprogram each front window for the express-up feature to work. See *Power Windows on page 2-19* for more information.

OPEN, THEN CLOSE PASSENGER WINDOW

This message is displayed when the window needs to be reprogrammed. If the vehicle's battery has been recharged or disconnected, you will need to reprogram each front window for the express-up feature to work. See *Power Windows on page 2-19* for more information.

Vehicle Personalization

The audio system controls are used to access the personalization menus for customizing vehicle features.

CONFIG (Configuration):

Press to access the Configuration Settings Menu.

MENU/SELECT Knob: Press the center of this knob to enter the menus and select menu items. Turn the knob to scroll through the menus.

↩ **BACK:** Press to exit or move backward in a menu.

Entering the Personalization Menus

1. Press CONFIG to access the Configuration Settings menu.
2. Turn the MENU/SELECT knob to highlight Vehicle Settings.

3. Press the center of the MENU/SELECT knob to select the Vehicle Settings menu.

The following list of menu items will be available:

- Climate and Air Quality
- Comfort and Convenience
- Collision/Detection Systems
- Language
- Lighting
- Power Door Locks
- Remote Lock/Unlock/Start
- Return to Factory Settings

Turn the MENU/SELECT knob to highlight the menu. Press the knob to select it. Each of the menus is detailed in the following information.

Climate and Air Quality

Select the Climate and Air Quality menu and the following will be displayed:

- Auto Fan Control
- Air Quality Control
- Auto Heated Seats
- Remote Start Heated Seats
- Remote Start Cooled Seats
- Auto Defog
- Auto Rear Defog

Auto Fan Control

This will allow you to select the automatic fan speed. It can be adjusted to run lower or higher than normal.

Press the MENU/SELECT knob when Auto Fan Control is highlighted to open the menu. Turn the knob to highlight High, Medium, or Low. Press the knob to confirm the selection and move back to the last menu.

Air Quality Control

This will allow you to select whether the system will operate at high or low sensitivity. Only vehicles with the dual zone climate control will have this option.

Press the MENU/SELECT knob when Air Quality Control is highlighted to open the menu. Turn the knob to highlight High or Low. Press the knob to confirm the selection and move back to the last menu.

Remote Start Heated Seats

When on, this feature will turn the heated seats on when using remote start on cold days.

Press the MENU/SELECT knob when Remote Start Heated Seats is highlighted. Turn the knob to select On or Off. Press the knob to confirm and go back to the last menu.

Remote Start Cooled Seats

When on, this feature will turn the cooled seats on when using remote start on warm days.

Press the MENU/SELECT knob when Remote Start Cooled Seats is highlighted. Turn the knob to select On or Off. Press the knob to confirm and go back to the last menu.

Auto Defog

This will allow you to turn the auto defog on or off. Only vehicles with the dual zone climate control will have this option.

Press the MENU/SELECT knob when Auto Defog is highlighted to open the menu. Turn the knob to highlight On or Off. Press the knob to confirm the selection and move back to the last menu.

Auto Rear Defog

This will allow you to turn the auto rear defog on or off. This feature will automatically turn on the rear defogger when it is cold outside.

Press the MENU/SELECT knob when Auto Rear Defog is highlighted to open the menu. Turn the knob to highlight On or Off. Press the knob to confirm the selection and move back to the last menu.

Comfort and Convenience

Select the Comfort and Convenience menu and the following will be displayed:

- Chime Volume
- Driver Seat Easy Exit
- Park Tilt Mirrors

Chime Volume

This allows the selection of the chime volume level.

Press the MENU/SELECT knob when Chime Volume is highlighted. Turn the knob to select Normal or High. Press the knob to confirm and go back to the last menu.

Driver Seat Easy Exit

When on, this feature will move the driver seat rearward upon turning the ignition off and the driver door being opened. This may be performed to make it easier to exit the vehicle. See "Easy Exit Driver Seat" under *Power Seat Adjustment on page 3-5* for more information.

This allows you to turn the easy exit seat feature on or off.

Press the MENU/SELECT knob when Driver Seat Easy Exit is highlighted. Turn the knob to select On or Off. Press the knob to confirm and go back to the last menu.

Park Tilt Mirrors

When on, both the driver and passenger mirrors will tilt downward when the vehicle is shifted to R (Reverse) to improve visibility of the ground near the rear wheels. They will return to their previous driving position when the vehicle is shifted out of R (Reverse), the ignition is turned to OFF, or the vehicle is left in R (Reverse). See *Park Tilt Mirrors on page 2-17* for more information.

This allows you to turn the park tilt mirrors feature on or off.

Press the MENU/SELECT knob when Park Tilt Mirrors is highlighted. Turn the knob to select Driver & Passenger or Off. Press the knob to confirm and go back to the last menu.

Collision/Detection Systems

Select the Collision/Detection Systems menu and the following will be displayed:

- Side Blind Zone Alert System

Side Blind Zone Alert System

This allows the Side Blind Zone Alert System feature to be turned on or off.

Press the MENU/SELECT knob when Park Assist is highlighted. Turn the knob to select On or Off. Press the knob to confirm and go back to the last menu.

Language

Select the Language menu and the following will be displayed:

- English
- French
- Spanish

Turn the MENU/SELECT knob to select the language. Press the knob to confirm and go back to the last menu.

Lighting

Select the Lighting menu and the following will be displayed:

- Exit Lighting
- Vehicle Locator Lights

Exit Lighting

This allows the selection of how long the exterior lamps stay on when leaving the vehicle when it is dark outside.

Press the MENU/SELECT knob when Exit Lighting is highlighted. Turn the knob to select Off, 30 Seconds, 1 Minute, or 2 Minutes. Press the knob to confirm and go back to the last menu.

Vehicle Locator Lights

This allows the vehicle locator lights to be turned on or off. The vehicle locator lights come on when unlocking the vehicle with the RKE transmitter.

Press the MENU/SELECT knob when Vehicle Locator Lights is highlighted. Turn the knob to select On or Off. Press the knob to confirm and go back to the last menu.

Power Door Locks

Select Power Door Locks and the following will be displayed:

- Unlocked Door Anti Lock Out
- Delayed Door Lock
- Auto Door Unlock

Unlocked Door Anti Lock Out

When on, this feature will keep the driver door from locking when the door is open. If off is selected, the Delayed Door Lock menu will be available and the door will lock as programmed through this menu.

Press the MENU/SELECT knob when Auto Door Unlock is highlighted. Turn the knob to select On or Off. Press the knob to confirm and go back to the last menu.

Delayed Door Lock

When on, this feature will delay the locking of the doors until five seconds after the last door is closed. You will hear three chimes to signal delayed locking is in use.

Pressing either the power lock button or the lock button on the RKE transmitter twice will override the delayed locking feature and immediately lock all of the doors.

Press the MENU/SELECT knob when Delayed Door Lock is highlighted. Turn the knob to select On or Off. Press the knob to confirm and go back to the last menu.

Auto Door Unlock

This allows selection of which of the doors will automatically unlock when the vehicle is shifted into P (Park).

Press the MENU/SELECT knob when Auto Door Unlock is highlighted. Turn the knob to select All Doors, Driver Door, or Off. Press the knob to confirm and go back to the last menu.

Remote Lock/Unlock/Start

Select Remote Lock/Unlock/Start and the following will be displayed:

- Unlock Feedback (Lights)
- Locking Feedback
- Door Unlock Options
- Remote Recall
- Passive Entry
- Remote Left In Vehicle

Unlock Feedback (Lights)

When on, the exterior lamps will flash when unlocking the vehicle with the RKE transmitter.

Press the MENU/SELECT knob when Unlock Feedback (Lights) is highlighted. Turn the knob to select On or Off. Press the knob to confirm and go back to the last menu.

5-44 Instruments and Controls

Locking Feedback

This allows selection of what type of feedback is given when locking the vehicle with the RKE transmitter.

Press the MENU/SELECT knob when Locking Feedback is highlighted. Turn the knob to select Lights and Horn, Lights Only, Horn Only, or Off. Press the knob to confirm and go back to the last menu.

Door Unlock Options

This allows selection of which doors will unlock when pressing the unlock button on the RKE transmitter.

Press the MENU/SELECT knob when Door Unlock Options is highlighted. Turn the knob to select All Doors or Driver Door Only. When set to Driver Door Only, the

driver door will unlock the first time the unlock button is pressed and all doors will unlock when the button is pressed a second time. When set to All Doors, all of the doors will unlock at the first press of the unlock button. Press the knob to confirm and go back to the last menu.

Remote Recall

When on, this feature will recall the current driver's last seat and outside mirror positions upon unlocking the driver door with the RKE, and opening that door. The current driver is identified when the RKE is used to unlock the driver door. If keyless access equipped, the recall will occur upon opening the driver door. See "Memory Remote Recall" under *Power Seat Adjustment on page 3-5* for more information.

This allows the Remote Recall feature to be turned on or off. Remote Recall is when the memorized settings will be recalled as you unlock and enter the vehicle.

Press the MENU/SELECT knob when Remote Recall is highlighted. Turn the knob to select On or Off. Press the knob to confirm and go back to the last menu.

Passive Entry

This allows the Passive Entry feature to be turned on or off.

Press the MENU/SELECT knob when Passive Entry is highlighted. Turn the knob to select On or Off. Press the knob to confirm and go back to the last menu.

Remote Left In Vehicle

This allows the Remote Left In Vehicle reminder feature to be turned on or off. If on, the horn will chirp if a remote is left in the vehicle.

Press the MENU/SELECT knob when Remote Left In Vehicle is highlighted. Turn the knob to select On or Off. Press the knob to confirm and go back to the last menu.

Return to Factory Settings

Select Return to Factory Settings to return all of the vehicle personalization to the default settings. Turn the knob to select Yes or No. Press the knob to confirm and go back to the last menu.

Universal Remote System

See *Radio Frequency Statement on page 13-20* for information regarding Part 15 of the Federal Communications Commission (FCC) rules and Industry Canada Standards RSS-210/220/310.

Universal Remote System Programming



If the vehicle has this feature, you will see these buttons with one LED indicator next to them in the overhead console.

This system provides a way to replace up to three remote control transmitters used to activate devices such as garage door openers, security systems, and home automation devices.

Do not use the Universal Remote system with any garage door opener that does not have the stop and reverse feature. This includes any garage door opener model manufactured before April 1, 1982.

Read the instructions completely before attempting to program the Universal Remote system. Because of the steps involved, it may be helpful to have another person available to assist with programming the Universal Remote system.

Keep the original hand-held transmitter for use in other vehicles as well as for future Universal Remote system programming. It is also recommended that upon the sale of the vehicle, the programmed Universal Remote system buttons be erased for security purposes. See “Erasing Universal Remote System Buttons” later in this section.

When programming a garage door, park outside of the garage. Park directly in line with and facing the garage door opener motor-head or gate motor-head. Be sure that people and objects are clear of the garage door or gate being programmed.

It is recommended that a new battery be installed in the hand-held transmitter for quicker and more accurate transmission of the radio-frequency signal.

Programming the Universal Remote System

For questions or help programming the Universal Remote system, call 1-800-355-3515 or go to www.homelink.com.

Programming a garage door opener involves time-sensitive actions, so read the entire procedure before starting. Otherwise, the device will time out and the procedure will have to be repeated.

To program up to three devices:

1. Hold the end of the hand-held transmitter about 3 to 8 cm (1 to 3 in) away from the Universal Remote system buttons while keeping the indicator light in view. The hand-held transmitter was supplied by the manufacturer of the garage door opener receiver (motor-head unit).

2. At the same time, press and hold both the hand-held transmitter button and one of the three Universal Remote system buttons to be used to operate the garage door. Do not release the Universal Remote system button or the hand-held transmitter button until the indicator light changes from a slowly to a rapidly flashing light. You now may release both buttons.

Some entry gates and garage door openers may require substitution of Step 2 with the procedure noted in “Gate Operator and Canadian Programming” later in this section.

3. Press and hold for five seconds the newly trained Universal Remote system button (the button selected in Step 2) while observing the indicator light and garage door activation.

- If the indicator light stays on continuously or the garage door starts to move when the Universal Remote system button is pressed and released, then the programming is complete. There is no need to continue programming Steps 4 through 6.
- If the Universal Remote system indicator light blinks rapidly for two seconds, then turns to a constant light and the garage door does not move, continue with programming Steps 4 through 6.

It may be helpful to have another person assist with the remaining Steps 4 through 6.

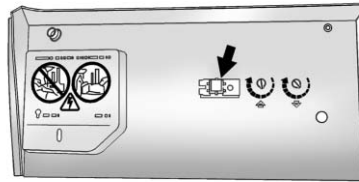

“Learn” or “Smart” Buttons

4. After Steps 1 through 3 have been completed, locate the “Learn” or “Smart” button inside the garage on the garage door opener receiver (motor-head unit). The name and color of the button may vary by manufacturer.
5. Firmly press and release the “Learn” or “Smart” button. After you press this button, you will have 30 seconds to complete Step 6.

6. Immediately return to the vehicle. Firmly press and hold for two seconds the Universal Remote system button, selected in Step 2 to control the garage door, and then release it. If the garage door does not move or the lamp on the garage door opener receiver (motor-head unit) does not flash, press and hold the same button a second time for two seconds, and then release it. Again, if the door does not move or the garage door lamp does not flash, press and hold the same button a third time for two seconds, and then release.

The Universal Remote system should now activate the garage door.

To program the remaining two Universal Remote system buttons, begin with Step 1 of “Programming the Universal Remote System.”

Gate Operator and Canadian Programming

If you have questions or need help programming the Universal Remote system, call 1-800-355-3515 or go to www.homelink.com.

Canadian radio-frequency laws require transmitter signals to time out or quit after several seconds of transmission. This may not be long enough for the Universal Remote system to pick up the signal during programming. Similarly, some U.S. gate operators are manufactured to time out in the same manner.

If you live in Canada, or you are having difficulty programming a gate operator or garage door opener by using the “Programming the Universal Remote System” procedures, regardless of where you live, replace Step 2 under “Programming the Universal Remote System” with the following:

Continue to press and hold the Universal Remote system button while you press and release every two seconds (cycle) the hand-held transmitter button until the frequency signal has been successfully accepted by the Universal Remote system. The Universal Remote system indicator light will flash slowly at first and then rapidly. Proceed with Step 3 under “Programming the Universal Remote System” to complete.

Universal Remote System Operation

Using the Universal Remote System

Press and hold the appropriate Universal Remote system button for at least half of a second. The indicator light will come on while the signal is being transmitted.

Erasing Universal Remote System Buttons

All programmed buttons should be erased when the vehicle is sold or the lease ends.

To erase all programmed buttons on the Universal Remote system device:

1. Press and hold down the two outside buttons until the indicator light begins to flash. This should take about 10 seconds.
2. Release both buttons.

Reprogramming a Single Universal Remote System Button

To reprogram any of the three Universal Remote system buttons:

1. Press and hold the desired Universal Remote system button. Do not release the button.
2. The indicator light will begin to flash after 20 seconds. Without releasing the button, proceed with Step 1 of the section "Programming the Universal Remote System."

If you have questions or need help programming the Universal Remote system, call 1-800-355-3515 or go to www.homelink.com. You may also call the customer assistance phone number under *Customer Assistance Offices (U.S. and Canada)* on page 13-5 or *Customer Assistance Offices (Mexico)* on page 13-6.

Lighting

Exterior Lighting

Exterior Lamp Controls	6-1
Exterior Lamps Off Reminder	6-2
Headlamp High/Low-Beam Changer	6-2
Flash-to-Pass	6-2
Daytime Running Lamps (DRL)	6-3
Automatic Headlamp System	6-3
Adaptive Forward Lighting (AFL)	6-4

Hazard Warning Flashers	6-4
Turn and Lane-Change Signals	6-4
Fog Lamps	6-5

Interior Lighting

Instrument Panel Illumination Control	6-5
Dome Lamps	6-5
Reading Lamps	6-5
Sun Visor Lamps	6-5

Lighting Features

Entry Lighting	6-6
Exit Lighting	6-6
Battery Load Management	6-6
Battery Power Protection	6-7

Exterior Lighting

Exterior Lamp Controls

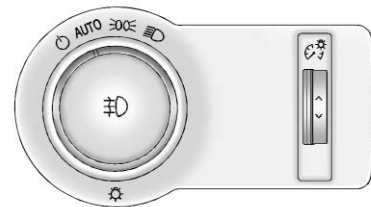

The exterior lamp control is located on the instrument panel on the outboard side of the steering wheel.

6-2 Lighting

Turn the control to the following positions:

 **(Off):** Turns off the exterior lamps. The knob returns to the AUTO position after it is released. Turn to off again to reactivate the AUTO mode.

AUTO (Automatic): Automatically turns the exterior lamps on and off, depending on outside lighting.

The current status of the AUTO system is displayed in the Driver Information Center (DIC) uplevel display. See *Driver Information Center (DIC) on page 5-25*.

 **(Parking Lamps):** Turns on the parking lamps together with the following:

- Sidemarker Lamps
- Taillamps
- License Plate Lamps
- Instrument Panel Lights

 **(Headlamps):** Turns on the headlamps together with the following:

- Sidemarker Lamps
- Taillamps
- License Plate Lamps
- Instrument Panel Lights
- Parking Lamps

Exterior Lamps Off Reminder

A warning chime sounds if the driver door is opened while the ignition is off and the exterior lamps are on.

Headlamp High/Low-Beam Changer

 **Headlamp High/Low-Beam Changer:** Push the turn signal/lane change lever away from you and release, to turn the high beams on. To return to low beams, push the lever again or pull it toward you and release.



This indicator light turns on in the instrument panel cluster when the high-beam headlamps are on.

Flash-to-Pass

To flash the high beams, pull the turn signal/lane change lever toward you, and release.

Daytime Running Lamps (DRL)

Daytime Running Lamps (DRL) can make it easier for others to see the front of your vehicle during the day. Fully functional daytime running lamps are required on all vehicles first sold in Canada.

The DRL system turns on the low-beam headlamps at a reduced brightness. For vehicles with High Intensity Discharge (HID) headlamps, the dedicated DRL will come on when all of the following conditions are met:

- The engine is running.
- The exterior lamp band is in AUTO.
- The light sensor determines it is daytime.

When the DRL are on, the low-beam headlamps will be on. The taillamps, sidemarker, instrument panel lights, and other lamps will not be on.

The DRL turn off when the headlamps are turned to \cup or the ignition is off.

Automatic Headlamp System

When the exterior lamp control is set to AUTO and it is dark enough outside, the headlamps come on automatically.

There is a light sensor located on top of the instrument panel. Do not cover the sensor or the headlamps will come on when they are not needed.

The system may also turn on the headlamps when driving through a parking garage or tunnel.

When it is bright enough outside, the headlamps will turn off or may change to Daytime Running Lamps (DRL).

The automatic headlamp system turns off when the exterior lamp control is turned to \cup or the ignition is off.

6-4 Lighting

Adaptive Forward Lighting (AFL)

The Adaptive Forward Lighting System (AFL) pivots the headlamps horizontally to provide greater road illumination while turning. To enable AFL, set the exterior lamp switch to the AUTO position. Moving the switch out of the AUTO position deactivates the system. AFL operates when the vehicle speed is greater than 3 km/h (2 mph). AFL does not operate when the transmission is in R (Reverse). AFL is not immediately operable after starting the vehicle; driving a short distance is required to calibrate the AFL. See *Exterior Lamp Controls* on page 6-1.

Hazard Warning Flashers

▲ Hazard Warning Flasher: Press this button located on the instrument panel below the climate control system, to make the front and rear turn signal lamps flash on and off. Press again to turn the flashers off.

The hazard warning flashers turn on automatically if the airbags deploy.

Turn and Lane-Change Signals



Move the lever all the way up or down to signal a turn.

An arrow on the instrument panel cluster flashes in the direction of the turn or lane change.

Raise or lower the lever until the arrow starts to flash to signal a lane change. Hold it there until the lane change is completed. If the lever is briefly pressed and released, the turn signal flashes three times.

The turn and lane-change signal can be turned off manually by moving the lever back to its original position.

If after signaling a turn or lane change the arrow flashes rapidly or does not come on, a signal bulb might be burned out.

Have the bulbs replaced. If the bulb is not burned out, check the fuse. See *Fuses and Circuit Breakers* on page 10-39.

Fog Lamps

For vehicles with fog lamps, the button is located on the exterior lamp control, on the outboard side of the steering wheel.

To turn on the fog lamps, the ignition and the headlamps or parking lamps must be on.

If the fog lamps are turned on while the exterior lamp switch is in the AUTO position, the headlamps come on automatically.

 : Press to turn on or off. An indicator light on the instrument panel cluster comes on when the fog lamps are on.

Some localities have laws that require the headlamps to be on along with the fog lamps.

Interior Lighting

Instrument Panel Illumination Control

The brightness of the instrument panel lighting and steering wheel controls can be adjusted. Use the thumbwheel located next to the exterior lamps control on the outboard side of the steering wheel.

 : Move the thumbwheel up or down to brighten or dim the lights.

Dome Lamps

The interior lamps control located in the overhead console controls both the front and rear interior lamps.

To operate, press the following buttons:

 (Off): Turns the lamps off.

 **Door**: Turns the lamps on when any door is opened.



 **ON**: Keeps the lamps on all the time.

Reading Lamps

There are front and rear reading lamps.

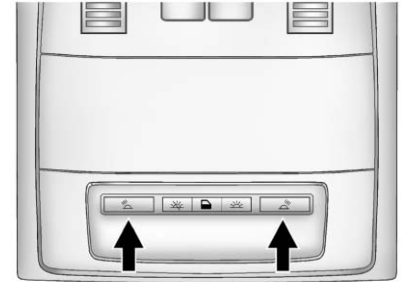
The front reading lamps are located in the overhead console.



  : Press to turn each lamp on or off.

The rear reading lamps are located in the headliner.

Sun Visor Lamps

This lamp turns on when the cover is opened.

Lighting Features

Entry Lighting

The headlamps, taillamps, license plate lamps, back-up lamps, dome lamps, and most of the interior lights turn on briefly, when the Remote Keyless Entry (RKE)  button is pressed, or when the door handle is pulled on a keyless access vehicle. See *Ignition Positions (Key Access)* on page 9-17 or *Ignition Positions (Keyless Access)* on page 9-19. After about 30 seconds the exterior lamps turn off, and then the dome lamps and remaining interior lights will dim to off. Entry lighting can be disabled manually by changing the ignition out of the OFF position, or by pressing the RKE  button.

This feature can be changed. See *Vehicle Personalization* on page 5-39.

Exit Lighting

The headlamps, taillamps, parking lamps, back-up lamps, and license plate lamps come on at night, or in areas with limited lighting, when the key is removed from the ignition. The dome lamps also come on when the key is removed from the ignition. The exterior lights and dome lamps remain on after the door is closed for a set amount of time, then automatically turn off.

For a vehicle with keyless access, the exterior lights and dome lamps automatically turn on when a door is opened after the ignition is turned off. See *Ignition Positions (Key Access)* on page 9-17 or *Ignition Positions (Keyless Access)* on page 9-19.

The exterior lights turn off immediately by turning the exterior lamps control to OFF.

This feature can be changed. See *Vehicle Personalization* on page 5-39.

Battery Load Management

The vehicle has Electric Power Management (EPM) that estimates the battery's temperature and state of charge. It then adjusts the voltage for best performance and extended life of the battery.

When the battery's state of charge is low, the voltage is raised slightly to quickly bring the charge back up. When the state of charge is high, the voltage is lowered slightly to prevent overcharging. If the vehicle has a voltmeter gauge or a voltage display on the Driver Information Center (DIC), you may see the voltage move up or down. This is normal. If there is a problem, an alert will be displayed.

The battery can be discharged at idle if the electrical loads are very high. This is true for all vehicles. This is because the generator (alternator) may not be spinning fast enough at idle to produce all the power needed for very high electrical loads.

A high electrical load occurs when several of the following are on, such as: headlamps, high beams, fog lamps, rear window defogger, climate control fan at high speed, heated seats, engine cooling fans, trailer loads, and loads plugged into accessory power outlets.

EPM works to prevent excessive discharge of the battery. It does this by balancing the generator's output and the vehicle's electrical needs.

It can increase engine idle speed to generate more power, whenever needed. It can temporarily reduce the power demands of some accessories.

Normally, these actions occur in steps or levels, without being noticeable. In rare cases at the highest levels of corrective action, this action may be noticeable to the driver. If so, a Driver Information Center (DIC) message might be displayed, such as BATTERY SAVER ACTIVE, BATTERY VOLTAGE LOW, or LOW BATTERY. If one of these messages displays, it is recommended that the driver reduce the electrical loads as much as possible. See *Driver Information Center (DIC)* on page 5-25.

Battery Power Protection

The battery saver feature is designed to protect the vehicle's battery.

If the exterior lamps or any interior light is left on and the ignition is turned off, the battery rundown protection system automatically turns the lamp off after about 10 minutes.

Infotainment System

Introduction

Infotainment 7-1
 Theft-Deterrent Feature 7-2
 Overview (Radio with CD) 7-3
 Overview (Radio with CD/DVD and MEM) 7-5
 Operation 7-7

Radio

AM-FM Radio 7-12
 Satellite Radio 7-15
 Radio Reception 7-19
 Backglass Antenna 7-19
 Satellite Radio Antenna 7-20

Audio Players

CD Player 7-20
 CD/DVD Player 7-23
 Mass Storage Media (MEM) 7-27
 Auxiliary Devices (Radio with CD) 7-31
 Auxiliary Devices (Radio with CD/DVD and MEM) 7-34

Rear Seat Infotainment

Rear Seat Entertainment (RSE) System 7-36

Phone

Bluetooth (Overview) 7-46
 Bluetooth (Infotainment Controls) 7-48
 Bluetooth (Voice Recognition) 7-53

Introduction

Infotainment

Read the following pages to become familiar with the audio system's features.

 WARNING
<p>Taking your eyes off the road for extended periods could cause a crash resulting in injury or death to you or others. Do not give extended attention to entertainment tasks while driving.</p>

This system provides access to many audio and non-audio listings.

7-2 Infotainment System

To minimize taking your eyes off the road while driving, do the following while the vehicle is parked:

- Become familiar with the operation and controls of the audio system.
- Set up the tone, speaker adjustments, and preset radio stations.

For more information, see *Defensive Driving* on page 9-2.

Notice: Contact your dealer before adding any equipment.

Adding audio or communication equipment could interfere with the operation of the engine, radio, or other systems, and could damage them. Follow federal rules covering mobile radio and telephone equipment.

The vehicle has Retained Accessory Power (RAP). With RAP, the audio system can be played even after the ignition is turned off. See *Retained Accessory Power (RAP)* on page 9-24 for more information.

Navigation System

For vehicles with a navigation system, see the separate Navigation System Manual.

Theft-Deterrent Feature

The theft-deterrent feature works by learning a portion of the Vehicle Identification Number (VIN) to the infotainment system. The infotainment system does not operate if it is stolen or moved to a different vehicle.

Overview (Radio with CD)

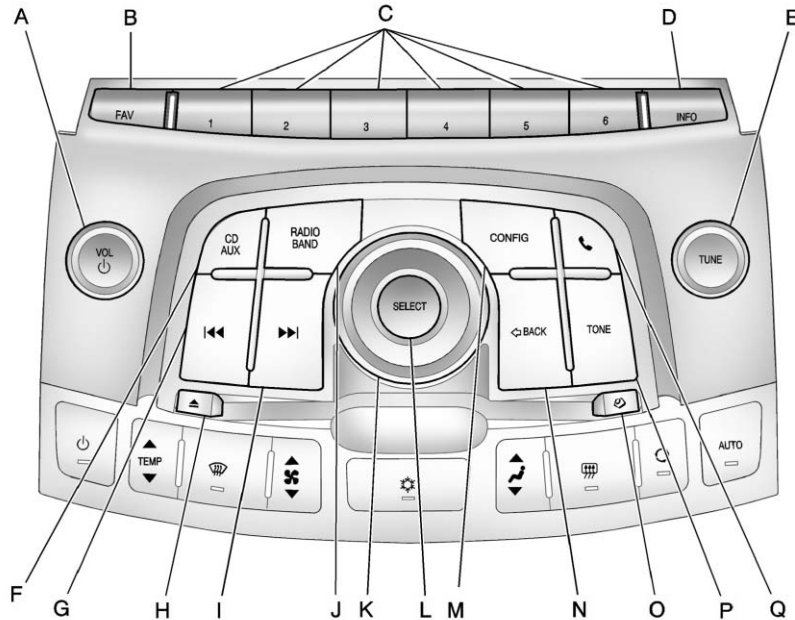

- A. VOL/ 
 - Turns the system on or off and adjusts the volume.
- B. FAV
 - Radio: Opens the favorites list.
- C. Buttons 1 to 6
 - Radio: Saves and selects favorite stations.
- D. INFO
 - Radio: Shows available information about the current station.
 - CD: Shows available information about the current track.
- E. TUNE
 - Radio: Manually selects radio stations.
 - CD: Selects tracks.

7-4 Infotainment System

F. CD/AUX

- Selects the CD player or an external audio source.

G.

- Radio: Seeks the previous station.
- CD: Select the previous track or rewinds within a track.

H. CD Eject

- Removes a disc from the CD slot.

I.

- Radio: Seeks the next station.
- CD: Select the next track or fast forwards within a track.

J. RADIO/BAND

- Changes the band while listening to the radio.
- Selects the radio when listening to a different audio source.

K. Menu Knob

- Opens menus, highlights menu items, or sets numeric values while in a menu.

L. SELECT

- Selects menu items.

M. CONFIG

- Opens the Settings menu.

N. BACK

- Menu: Moves one level back.
- Character Input: Deletes the last character.

O.

- Opens the Clock menu.

P. TONE

- Opens the Tone menu.

Q.

- Opens the Phone main menu.
- Mutes the audio system.

Overview (Radio with CD/DVD and MEM)

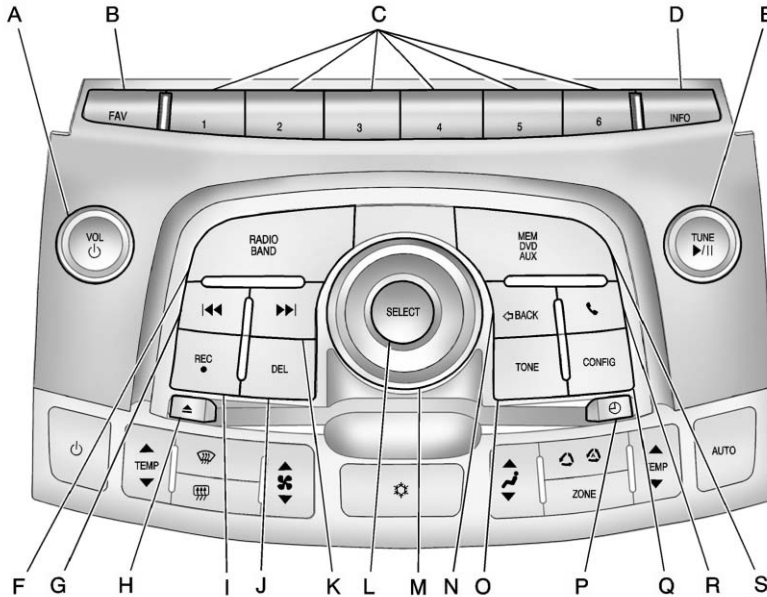

- A. VOL/ 
 - Turns the system on or off and adjusts the volume.
- B. FAV
 - Radio: Opens the favorites list.
 - MEM: Opens the favorites list.
- C. Buttons 1 to 6
 - Radio: Saves and selects favorite stations.
 - MEM: Saves and selects favorite tracks and playlists.
- D. INFO
 - Radio: Shows available information about the current station.
 - CD: Shows available information about the current track.

7-6 Infotainment System

E. TUNE/▶/||

- Manually selects radio stations and pauses time shifted content.
- CD/DVD: Select tracks, pauses playback, and stops playback.
- MEM: Select tracks and pauses playback.

F. RADIO/BAND

- Changes the band while listening to the radio.
- Selects the radio when listening to a different audio source.

G. ◀◀

- Radio: Seeks the previous station.
- CD: Selects the previous track or rewinds within a track.
- MEM: Selects the previous track or rewinds within a track.

H. ▲ CD Eject

- Removes a disc from the CD slot.

I. REC ●

- AUX: Records content from audio CDs, MP3/WMA CDs, and USB mass storage devices.

J. DEL

- MEM: Deletes the current track from MEM.

K. ▶▶

- Radio: Seeks the next station.
- CD: Selects the next track or fast forwards within a track.
- MEM: Selects the next track or fast forwards within a track.

L. SELECT

- Selects menu items.

M. Menu Knob

- Opens menus, highlights menu items, or sets numeric values while in a menu.

N. ⇨ BACK

- Menu: Moves one level back.
- Character Input: Deletes the last character.

O. TONE

- Opens the Tone menu.

P. ⌚

- Opens the Clock menu.

Q. CONFIG

- Opens the Settings menu.

- R. 
- Opens the Phone main menu.
 - Mutes the audio system.
- S. MEM/DVD/AUX
- Selects MEM, CD/DVD, USB, or a connected front or rear auxiliary audio source.

Operation

Controls

The infotainment system is operated by using the pushbuttons, multifunction knobs, menus shown on the display, and steering wheel controls, if equipped.

Turning the System On or Off





VOL/  (Volume/Power): Press to turn the system on and off.



Automatic Switch-Off

If the infotainment system has been turned on after the ignition is turned off, the system will turn off automatically after 10 minutes.

Volume Control

VOL/  (Volume/Power): Turn to adjust the volume.

 (Phone/Mute): For vehicles with OnStar[®], press and hold  to mute the infotainment system. Press and hold  again, or turn the VOL/  knob to cancel mute.

For vehicles without OnStar[®], press  to mute the infotainment system. Press  again, or turn the VOL/  knob to cancel mute.

Menu System

Controls

The Menu knob, SELECT button, and  BACK button are used to navigate the menu system.

Menu Knob: Turn to:

- Enter the menu system.
- Highlight a menu option.
- Select a value.

SELECT: Press to:

- Select or activate the highlighted menu option.
- Confirm a set value.
- Turn a system setting on or off.

 **BACK:** Press to:

- Exit a menu.
- Return from a submenu screen to the previous menu screen.
- Delete the last character in a sequence.

7-8 Infotainment System

Selecting a Menu Option

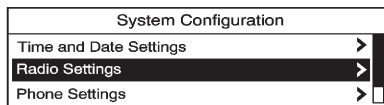

1. Turn the Menu knob to move the highlighted bar.
2. Press the SELECT button to select the highlighted option.

Submenus

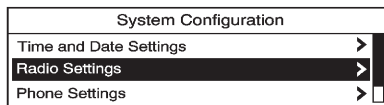

An arrow on the right-hand edge of the menu indicates that it has a submenu with other options.

Activating a Setting

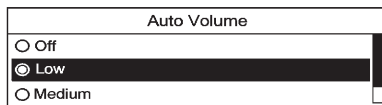

1. Turn the Menu knob to highlight the setting.
2. Press the SELECT button to activate the setting.

Setting a Value

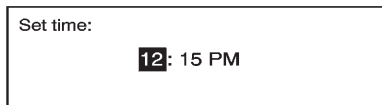

1. Turn the Menu knob to change the current value of the setting.
2. Press the SELECT button to confirm the setting.

Turning a Function On or Off

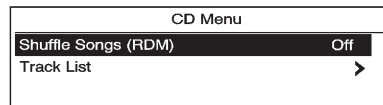

1. Turn the Menu knob to highlight the function.
2. Press the SELECT button to turn the function on or off.

Entering a Character Sequence

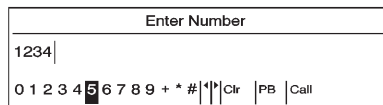

1. Turn the Menu knob to highlight the character.
2. Press the SELECT button to select the character.

Press the ⇨ BACK button to delete the last character in the sequence or press and hold to delete the entire character sequence.

Audio Settings

The audio settings can be set for each radio band and each audio player source.

To quickly reset an audio setting value to 0:

1. Press the TONE button.
2. Select the audio setting.
3. Press and hold the SELECT button until the value changes to 0.

Press the ⇨ BACK button to go back to the Tone Settings menu.

Adjusting the Treble, Midrange, and Bass

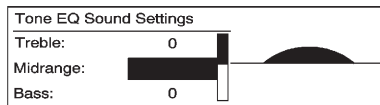

1. Press the TONE button.
2. Select Treble, Midrange, or Bass.
3. Select the value.

Press the ⇨ BACK button to go back to the Tone Settings menu.

Adjusting the Fader and Balance

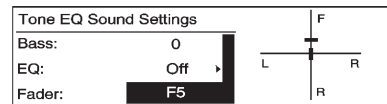

1. Press the TONE button.
2. Select Fader or Balance.
3. Select the value.

Press the ⇨ BACK button to go back to the Tone Settings menu.

7-10 Infotainment System

Adjusting the EQ (Equalizer)

For vehicles with an equalizer:



1. Press the TONE button.
2. Select EQ.
3. Select the setting.

Press the ↵ BACK button to go back to the Tone Settings menu.

DSP (Digital Signal Processing) Settings

For vehicles with DSP, it is used to provide a choice of different listening experiences.

The DSP settings for the Radio with CD are:

- *normal* - Select this setting to adjust the audio for stereo mode. This provides the best sound quality for the driver seat first, with the front passenger second.
- *hk surround* - Select to enable hk surround. This produces a true 6.1 matrix surround from any two channel digital source. This feature is not available in AM/FM radio mode.

The DSP settings for the Radio with CD/DVD and MEM are:

- *2.0 normal* - Select this setting to adjust the audio for stereo mode. This provides the best sound quality for the driver seat first, with the front passenger second.
- *hk surround* - Select to enable hk surround. This produces a true 6.1 matrix surround from any two channel digital source. This feature is not available in AM/FM radio mode.

To adjust the DSP settings:

1. Press the TONE button.
2. Select DSP.
3. Select the setting.

Press the ↵ BACK button to go back to the Tone Settings menu.

System Settings

Configuring the Number of Favorite Pages

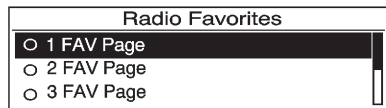

To configure the number of available favorite pages:

1. Press the CONFIG button.
2. Select Radio Settings.
3. Select Radio Favorites.
4. Select the number of available favorite pages.
5. Press the ↵ BACK button to go back to the System Configuration menu.

Auto Volume

The auto volume feature automatically adjusts the radio volume to compensate for road and wind noise as the vehicle speeds up or slows down, so that the volume level is consistent.

The level of volume compensation can be selected, or the auto volume feature can be turned off.

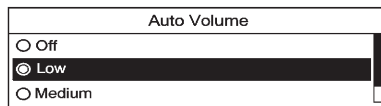

1. Press the CONFIG button.
2. Select Radio Settings.
3. Select Auto Volume.
4. Select the setting.
5. Press the ↵ BACK button to go back to the System Configuration menu.

Maximum Startup Volume

The maximum volume played when the Radio with CD is first turned on can be set.

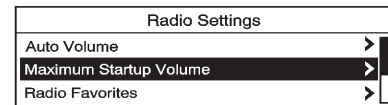

1. Press the CONFIG button.
2. Select Radio Settings.
3. Select Maximum Startup Volume.
4. Select the setting.
5. Press the ↵ BACK button to go back to the System Configuration menu.

Radio

AM-FM Radio

Control Buttons

The buttons used to control the radio are:

RADIO/BAND: Press to turn the radio on and choose between AM, FM, and XM™, if equipped.

Menu Knob: Turn to navigate the available menus.

TUNE: Turn to search for stations.

INFO: Press to display additional information that may be available for the current song.

◀◀ / ▶▶: Press to search for stations.

FAV: Press to open the favorites list and select the favorites page.

1 to 6: Press to select preset stations.

▶/|| (Play/Pause): Press to pause time shifted content, if equipped.

RDS (Radio Data System)

The radio may have RDS.

The RDS feature is available for use only on FM stations that broadcast RDS information.

This feature only works when the information from the radio station is available. In rare cases, a radio station could broadcast incorrect information that causes the radio features to work improperly. If this happens, contact the radio station.

While the radio is tuned to an FM-RDS station, the station name or call letters display.

Radio Menus

Radio menus are available for AM and FM.

Turn the Menu knob to open the main radio menu for that band.

Selecting a Band

Press the RADIO/BAND button to choose AM, FM, or XM, if equipped. The last station that was playing starts playing again.

Selecting a Station

Seek Tuning (Radio with CD)

If the radio station is not known:

Briefly press **◀◀** or **▶▶** to automatically search for the next available station. If a station is not found, the radio switches to a more sensitive search level. If a station still is not found, the frequency that was last active begins to play.

If the radio station is known:

Press and hold **◀◀** or **▶▶** until the station on the display is reached, then release the button.

Seek Tuning (Radio with CD/DVD and MEM)

Briefly press **◀◀** or **▶▶** to automatically search for the next available station. If a station is not found, the radio switches to a more sensitive search level. If a station still is not found, the frequency that was last active begins to play.

Manual Tuning

Turn the TUNE knob to select the frequency on the display.

Favorites List

1. Turn the Menu knob.
2. Select Favorites List.
3. Select the station.

Station Lists

1. Turn the Menu knob.
2. Select AM or FM Station List.
All receivable stations in the current reception area are displayed. If a station list has not been created, an automatic station search is done.
3. Select the station.

Category Lists

Most stations that broadcast an RDS program type code specify the type of programming transmitted. Some stations change the program type code depending on the content. The system stores the RDS stations sorted by program type in the FM category list.

To search for a programming type determined by station:

1. Turn the Menu knob.
2. Select FM category list. A list of all programming types available displays.
3. Select the programming type. A list of stations that transmit programming of the selected type displays.
4. Select the station.

The category lists are updated when the station lists are updated.

Updating Station & Category Lists

If stations stored in the station list can no longer be received:

1. Turn the Menu knob.
2. Select Update AM or FM Station List, if the stations stored in the station list are no longer received. A station search will be completed and the first station in the updated list will play.

To cancel the station search, press the SELECT button.

Storing a Station as a Favorite

Stations from all bands can be stored in any order in the favorite pages.

Up to six stations can be stored in each favorite page and the number of available favorite pages can be set.

7-14 Infotainment System

Storing Stations

To store the station to a position in the list, press the corresponding button 1 to 6 until a beep is heard.

Retrieving Stations



Press the FAV button to open a favorite page or to switch to another favorite page. Briefly press one of the 1 to 6 buttons to retrieve the station.



Time Shifting (Radio with CD/DVD and MEM)

The radio with MEM time shift feature can rewind 20 minutes of FM/AM content. While listening to the radio, the content from the current station is always being buffered.

Press  to pause the radio. The radio displays the time shift status bar. The status bar shows the amount of content stored in the buffer and the current pause point.

To resume playback from the current pause point, press  again. The radio is no longer live, but played from the time shift buffer. A status bar displays below the station number.

Press and hold  or  to fast forward or rewind through the time shift buffer. Hold  until the end of the recorded buffer resumes live playback.

Press and release  or  to jump forward or back 30 seconds in the time shift buffer.

When the radio station is changed, the buffer is cleared and automatically restarted for the current station. Content from a previously tuned station is no longer available.

The time shift feature is not available while recording or with other sources of playback.

Pausing AM/FM with the Vehicle Turned Off

If AM/FM is paused when the vehicle is turned off, the radio continues to buffer the current radio station for up to 20 minutes. If the vehicle is turned back on within 20 minutes, the radio resumes playback from the paused point.

Satellite Radio

Vehicles with an XM™ Satellite Radio tuner and a valid XM Satellite Radio subscription can receive XM programming.

XM Satellite Radio Service

XM is a satellite radio service based in the 48 contiguous United States and 10 Canadian provinces. XM Satellite Radio has a wide variety of programming and commercial-free music, coast to coast, and in digital-quality sound. A service fee is required to receive the XM service. If XM Service needs to be reactivated, the radio will display "No Subscription Please Renew" on channel XM1. For more information, contact XM at www.xmradio.com or 1-800-929-2100 in the U.S., and www.xmradio.ca or 1-877-438-9677 in Canada.

Control Buttons

The buttons used to control the XM radio are:

RADIO/BAND: Press to turn the radio on and choose between AM, FM, and XM, if equipped.

◀◀ / ▶▶: Press to go to the previous or next channel.

FAV: Press to open the favorites list.

1 to 6: Press to select a favorite.

TUNE: Turn to select channel.

INFO: Press to display additional information that may be available about the current song.

▶/|| (Play/Pause): Press to pause time shifted content, if equipped.

Selecting the XM Band

Press the RADIO/BAND button to choose between the AM, FM and XM bands. The last channel played in that band begins to play when that band is selected.

XM Categories

XM channels are organized in categories.

Removing or Adding Categories

Channels in a category that have been removed can still be accessed by using ◀◀ or ▶▶, or the TUNE knob.

To add or remove categories:

1. Press the CONFIG button.
2. Select Radio Settings.
3. Select XM Categories.
4. Turn the Menu knob to highlight the category.
5. Press the SELECT button to remove or add the category.

Selecting an XM Channel

XM channels can be selected by using ◀◀, ▶▶, the TUNE knob, or the menu system.

Selecting a Channel Using ◀◀ or ▶▶ (Radio with CD)

- Press and release ◀◀ or ▶▶ to go to the previous or next channel.
- Press and hold ◀◀ or ▶▶ to scroll through the previous or next channel until the channel is reached.

Selecting a Channel Using ◀◀ or ▶▶ (Radio with CD/DVD and MEM)

Press and release ◀◀ or ▶▶ to go to the previous or next channel.

Selecting a Channel Using the TUNE Knob

To select an XM channel using the TUNE knob:

Turn the TUNE knob to highlight an XM channel, the channel is selected after a short delay.

To select a channel using the menu:

1. Turn the Menu knob and select Channel List.
2. Select the desired channel.

Selecting a Channel Using the Menu System

1. Turn the Menu knob.
2. Select XM Category List.
3. Select the category.
4. Select the channel.

Storing an XM Channel as a Favorite

Channels from all bands can be stored in any order in the favorite pages.

Up to six channels can be stored in each favorite page and the number of available favorite pages can be set.

Storing a Channel as a Favorite

To store the channel to a position in the list, press and hold the corresponding 1 to 6 button until the channel can be heard again.

Retrieving Channels

Press the FAV button to open a favorite page or to change to another favorite page. Briefly press one of the 1 to 6 buttons to retrieve the channel.

Time Shifting (Radio with CD/DVD and MEM)

The radio with MEM time shift feature can rewind 20 minutes of XM content. While listening to the radio, the content from the current channel is always being buffered.

Press **▶/||** to pause the radio.

The radio displays the time shift status bar. The status bar shows the amount of content stored in the buffer and the current pause point.

To resume playback from the current pause point, press **▶/||** again. The radio is no longer live, but played from the time shift buffer. A status bar displays below the channel number.

Press and hold **▶▶** or **◀◀** to fast forward or rewind through the time shift buffer. Hold **▶▶** until the end of the recorded buffer resumes live playback.

Press and release **▶▶** or **◀◀** to go to the next or previous song in the time shift buffer.

When the channel is changed, the buffer is cleared and automatically restarted for the current channel. Content from a previously tuned station is no longer available.

The time shift feature is not available while recording or with other sources of playback.

Pausing XM with the Vehicle Turned Off

If XM is paused when the vehicle is turned off, the radio continues to buffer the current radio station for up to 20 minutes. If the vehicle is turned back on within 20 minutes, the radio resumes playback from the paused point.

XM Messages

XL (Explicit Language Channels): These channels, or any others, can be blocked by request, by calling 1-800-929-2100 in the U.S. and 1-877-438-9677 in Canada.

XM Updating: The encryption code in the receiver is being updated. No action is required. This process should take no longer than 30 seconds.

Loading XM: The audio system is acquiring and processing audio and text data. No action is needed. This message should disappear shortly.

Channel Off Air: This channel is not currently in service. Tune in to another channel.

7-18 Infotainment System

Channel Unauth: This channel is blocked or cannot be received with your XM Subscription package.

Channel Unavailable: This previously assigned channel is no longer assigned. Tune to another station.

No Artist Info: The system is working properly. No artist information is available at this time on this channel.

No Title Info: The system is working properly. No song title information is available at this time on this channel.

No CAT Info: The system is working properly. No category information is available at this time on this channel.

No Information: The system is working properly. No text or informational messages are available at this time on this channel.

No Subscription Please Renew: XM subscription needs to be reactivated. Contact XM at www.xmradio.com or call 1-800-929-2100 in the U.S. and www.xmradio.ca or call 1-877-438-9677 in Canada.

No XM Signal: The system is working properly. The vehicle may be in a location that where the XM signal is being blocked. When the vehicle is moved into an open area, the signal should return.

CAT Not Found: The system is working properly. There are no channels available for the selected category.

XM Radio ID: If tuned to channel 0, this message alternates with the XM Radio eight-digit radio ID label. This label is needed to activate the service.

Unknown: If this message is received when tuned to channel 0, there could be a receiver fault. Consult with your dealer.

Check Antenna: If this message does not clear within a short period of time, the receiver could have a fault. Consult with your dealer.

XM Not Available: If this message does not clear within a short period of time, the receiver could have a fault. Consult with your dealer.

Radio Reception

Frequency interference and static can occur during normal radio reception if items such as cellular phone chargers, vehicle convenience accessories, and external electronic devices are plugged into the accessory power outlet. If there is interference or static, unplug the item from the accessory power outlet.

FM

FM signals only reach about 16 to 65 km (10 to 40 mi). Although the radio has a built-in electronic circuit that automatically works to reduce interference, some static can occur, especially around tall buildings or hills, causing the sound to fade in and out.

AM

The range for most AM stations is greater than for FM, especially at night. The longer range can cause station frequencies to interfere with each other. For better radio reception, most AM radio stations boost the power levels during the day, and then reduce these levels during the night. Static can also occur when things like storms and power lines interfere with radio reception. When this happens, try reducing the treble on the radio.

XM™ Satellite Radio Service

XM satellite radio service gives digital radio reception from coast to coast in the 48 contiguous United States, and in Canada. Just as with FM, tall buildings or hills can interfere with satellite radio signals, causing the sound to fade in and out. In addition, traveling or standing under heavy foliage, bridges, garages, or tunnels may cause loss of the XM signal for a period of time.

Cellular Phone Usage

Cellular phone usage may cause interference with the vehicle's radio. This interference may occur when making or receiving phone calls, charging the phone's battery, or simply having the phone on. This interference can cause an increased level of static while listening to the radio. If static is received while listening to the radio, unplug the cellular phone and turn it off.

Backglass Antenna

The AM-FM antenna is integrated with the rear window defogger, located in the rear window. Make sure that the inside surface of the rear window is not scratched and that the lines on the glass are not damaged. If the inside surface is damaged, it could interfere with radio reception. For proper radio reception, the antenna connector needs to be properly attached to the post on the glass.

If a cellular telephone antenna needs to be attached to the glass, make sure that the grid lines for the AM-FM antenna are not damaged. There is enough space between the grid lines to attach a cellular telephone antenna without interfering with radio reception.

Notice: Using a razor blade or sharp object to clear the inside rear window can damage the rear window antenna and/or the rear window defogger. Repairs would not be covered by the vehicle warranty. Do not clear the inside rear window with sharp objects.

Notice: Do not apply aftermarket glass tinting with metallic film. The metallic film in some tinting materials will interfere with or distort the incoming radio reception. Any damage caused to your backglass antenna due to metallic tinting materials will not be covered by the vehicle warranty.

Satellite Radio Antenna

For vehicles with XM satellite radio service, the antenna is located on the roof of the vehicle. Keep the antenna clear of obstructions for clear radio reception.

Audio Players

CD Player

The CD player can play audio CDs and MP3 CDs.

The CD player will not play 8 cm (3 in) CDs.

Care of CDs

Sound quality can be reduced due to disc quality, recording method, quality of the music recorded, and how the disc has been handled. Handle discs carefully and store them in their original cases or other protective cases away from direct sunlight and dust. If the bottom surface of a disc is damaged, the disc may not play properly or at all.

Do not touch the bottom surface of a disc while handling it; this could damage the surface. Pick up discs by grasping the outer edges or the edge of the hole and the outer edge.

If the bottom surface of a disc is dirty, take a soft, lint-free cloth, or dampen a clean, soft cloth in a mild neutral detergent solution mixed with water, and clean it. Wipe the disc from the center to the outer edge.

Care of the CD Player

Do not add a label to a disc, as it could get caught in the CD player. If a label is needed, label the top of the recorded disc with a marking pen.

Do not use disc lens cleaners because they could contaminate the lens of the disc optics and damage the CD player.

Notice: If a label is added to a CD, more than one CD is inserted into the slot at a time, or an attempt is made to play scratched or damaged CDs, the CD player could be damaged. While using the CD player, use only CDs in good condition without any label, load one CD at a time, and keep the CD player and the loading slot free of foreign materials, liquids, and debris.

Control Buttons

The buttons used to control the CD player are:

CD/AUX: Press to use the CD player.

▶▶ / ◀◀: Press to select tracks or to fast forward or rewind within a track.

INFO: Press to display additional information about the current track that may be available.

TUNE: Turn to select tracks.

Menu Knob: Turn to enter the menu.

SELECT: Press to select an item.

▲ (Eject): Press to eject the disc.

Inserting a CD

With the printed side facing up, insert a disc into the CD slot until it is drawn in.

Removing a CD

Press .

The disc is pushed out of the CD slot.

If the disc is not removed after it is ejected, it is pulled back in after a few seconds.



Playing a CD or MP3 CD

Press the CD/AUX button. If there is a disc in the player, it begins playing.

Information about the disc and current track is shown on the display depending on the data stored.

Selecting a CD Track

Using the control buttons:

- Press  or  to select the previous or next track.
- Turn the TUNE knob.



Using the CD Menu:

1. Turn the Menu knob.
2. Select Tracks List.
3. Select the track.

Playing Tracks in Random Order



Turn the Menu knob and then set Shuffle Songs to On.

Fast Forward and Rewind

Press and hold  or  to fast forward or rewind within the current track.

Selecting an MP3 Track

Using the control buttons:

- Press  or  to select the previous or next track.
- Turn the TUNE knob.

Using the CD Menu:

1. Turn the Menu knob.
2. Select Playlists/Folders.
3. Select the playlist or folder.
4. Select the track.

Searching for MP3 Tracks

The search feature may take some time to display the information after reading the disc due to the amount of information stored on the disc. FM automatically plays while the disc is being read.

Tracks can be searched by:

- Playlists
- Artists
- Albums
- Song Titles
- Genres
- Folder View

To search for tracks:

1. Turn the Menu knob.
2. Select Search.
3. Select: Playlists, Artists, Albums, Song Titles, Genres, or Folder View.
4. Select the track.

CD/DVD Player

The CD/DVD player can play CDs, DVD-As, MP3/WMA CDs, MP3/WMA DVDs, and DVD-Vs.

The CD/DVD player will not play 8 cm (3 in) discs.

Care of CDs and DVDs

Sound quality can be reduced due to disc quality, recording method, quality of the music recorded, and how the disc has been handled. Handle discs carefully and store them in their original cases or other protective cases away from direct

sunlight and dust. If the bottom surface of a disc is damaged, the disc may not play properly or at all. Do not touch the bottom surface of a disc while handling it; this could damage the surface. Pick up discs by grasping the outer edges or the edge of the hole and the outer edge.

If the bottom surface of a disc is dirty, take a soft, lint-free cloth, or dampen a clean, soft cloth in a mild neutral detergent solution mixed with water, and clean it. Wipe the disc from the center to the outer edge.

Care of the CD/DVD Player

Do not add a label to a disc, as it could get caught in the CD/DVD player. If a label is needed, label the top of the recorded disc with a marking pen.

Do not use disc lens cleaners because they could contaminate the lens of the disc optics and damage the CD/DVD player.

Notice: If a label is added to a CD, more than one CD is inserted into the slot at a time, or an attempt is made to play scratched or damaged CDs, the CD player could be damaged. While using the CD player, use only CDs in good condition without any label, load one CD at a time, and keep the CD player and the loading slot free of foreign materials, liquids, and debris.

Control Buttons

The buttons used to control the CD/DVD player are:

MEM/DVD/AUX: Press to choose between the MEM, CD/DVD, and AUX.

▶▶ / ◀◀: Press to select tracks or to fast forward or rewind within a track.

INFO: Press to display additional information about the disc that may be available.

TUNE: Turn to select tracks.

Menu Knob: Turn to enter the menu.

SELECT: Press to select an item.

▲ (Eject): Press to eject the disc.

▶/||: Press to pause a CD, DVD-A, or DVD-V; press again to resume playback. Press and hold to stop a DVD-V disc.

Inserting a CD or DVD

With the printed side facing up, insert a disc into the slot until it is drawn in.

Removing a CD or DVD

Press **▲**.

The disc is pushed out of the CD/DVD slot.

If the disc is not removed after it is ejected, it is pulled back in after a few seconds.

Playing a CD or DVD-A Disc

Press the MEM/DVD/AUX button if there is a disc in the player. It begins playing.

Information about the disc and current track is shown on the display depending on the data stored.

Selecting CD or DVD-A Tracks

Using the control buttons:

- Press **⏮** or **⏭** to select the previous or next track.
- Turn the TUNE knob.

Using the menu:

1. Turn the Menu knob.
2. Select Tracks List.
3. Select the track.

Pausing a CD or DVD-A Track

Press **⏸** to pause a CD or DVD-A track. Press **⏸** again to continue playing the track.

Playing CD or DVD-A Tracks in Random Order

Turn the Menu knob and set Shuffle Songs to On.

Fast Forward and Rewind

Press and hold **⏭** or **⏮** to fast forward or rewind within the current track.

Playing an MP3 CD or DVD

Files that are not stored in folders are displayed in the root directory (disc).

The search rate increases if the Menu knob is continuously turned while searching in a list.

Selecting an MP3 Track

Using the control buttons:

- Press **⏮** or **⏭** to select the previous or next track.
- Turn the TUNE knob.

Using the CD or DVD Menu:

1. Turn the Menu knob.
2. Select Folder List.
3. Select the folder.
4. Select the track.

Searching for MP3s on a CD or DVD

It is normal for the search feature to take some time to display the information after reading the disc due to the amount of information stored on the disc. The infotainment system automatically switches to FM while the disc is being read.

Files that do not have any meta data stored in the ID3 tag display as Unknown.

Tracks can be searched for by:

- Playlists
- Artists
- Albums
- Song Titles
- Genres

The number of objects in each category is shown in parentheses after the category.

To search for tracks:

1. Turn the Menu knob.
2. Select Search.
3. Select: Playlists, Artists, Albums, Song Titles, or Genres.
4. Select the track. The search rate increases if the Menu knob is continuously turned while searching in a list.

Playing MP3 Tracks in Random Order

Turn the Menu knob and then set Shuffle Songs to On.

Recording an Audio or MP3 CD to MEM

See *Mass Storage Media (MEM)* on page 7-27 for more information.

Playing a DVD-V

See *Rear Seat Entertainment (RSE) System* on page 7-36 for information about how to control a Video DVD using the wireless remote control.

Selecting a Chapter

Using the control buttons:

- Press **◀◀** or **▶▶** to select the previous or next chapter.
- Turn the TUNE knob.

Using DVD menu:

1. Turn the Menu knob.
2. Select Chapter List.
3. Select the chapter.

Selecting a Title

1. Turn the Menu knob.
2. Select Title List.
3. Select the title.

Changing the Audio Stream

1. Turn the Menu knob.
2. Select Audio Stream.
3. Select Change Audio Stream.
4. Press SELECT to change the selection.

Select Cancel to exit the menu.

Pausing a DVD

1. Turn the Menu knob.
2. Select Pause to pause the disc. Select Unpause to start playback.

Navigating the DVD-V Disc Menu

Use the following actions to navigate the title menu on a DVD-V Disc.

- Select/Enter
- Cursor UP
- Cursor DOWN
- Cursor RIGHT
- Cursor LEFT
- Up Menu

Use the following actions to navigate the menu on a DVD-V Disc while playing chapters.

- Pause (Play)
- Chapter List
- Title List
- DVD/DVD
- DVD/AUX
- AUX/DVD
- AUX/AUX

To navigate the menu:

1. Turn the Menu knob.
2. Select the action.

Mass Storage Media (MEM)

Infotainment systems with MEM storage are able to record up to 1.1 GB (gigabyte) of music from audio CDs, MP3/WMA/AAC discs, and USB storage devices. The MEM player can also time shift audio from AM, FM, and XM radio.

Music or content stored in MEM that you did not create, or have the right to distribute, must be deleted before the sale or end of lease of the vehicle.

Control Buttons

The buttons used to control the MEM player are:

MEM/DVD/AUX: Press to select the MEM player.

▶▶ / ◀◀: Press to select tracks or to fast forward or rewind within a track.

INFO: Press to display additional information about the MEM track that may be available.

TUNE/▶/||: Press to pause the track currently playing; press again to resume playback. Turn to select tracks.

● REC: Press to record music from a CD or USB drive.

DEL: Press to delete the current track from MEM.

FAV (Favorites): Press to display MEM favorites.

1 to 6: Press to select a track or playlist stored in that numeric position.

Recording from Audio CDs

The infotainment system can record the current song playing or all songs from an audio CD to MEM. A status bar appears on the top of the display when the recording process starts and disappears when the process has ended. Copy protected CDs cannot be recorded to MEM.

Recording to MEM

Press ● REC, then select Record Current Song or Record All Songs on Disc. If the track has started playing, the system will restart the track and begin recording from the beginning of the track. When the song recording is completed, the message Song Recorded to MEM displays, and there may be a slight pause.

Songs recorded to MEM are stored as the current date, disc, and track number.

Re-recording a Previously Recorded Disc

If the disc or track has already been recorded to MEM, the message The Song(s) is Already Recorded displays.

Stopping the Recording

Press the ● REC button while recording from an audio CD to display the stop recording option. Select Stop Recording Song to MEM.

Renaming Recorded Discs

Discs that have been recorded to MEM can be renamed.

1. Turn the Menu knob.
2. Select Rename Recorded Discs.
3. Select the disc.
4. Select Album or Artist to rename either one.
5. Use the Menu knob to enter the character sequence.
See *Operation on page 7-7* for more information.

Recording from MP3/WMA Discs or USB Storage Devices

USB Host Support

The USB connector uses the USB standards, 1.1 and 2.0.

USB Supported Devices

- USB Flash Drives
- Portable USB Hard Drives

Recording to MEM

Press ● REC, then select Record Current Song or Record Current Folder.

The information stored by MEM is titled according to the ID3 tag associated with it.

Re-recording a Previously Recorded Disc

If the disc or track has already been recorded to MEM, the message The Song(s) is Already Recorded displays.

Stopping the Recording

Press the ● REC button while recording from an MP3/WMA CD or USB storage device to display the stop recording option. Select Stop Recording Song to MEM.

Deleting Tracks from MEM

Individual tracks and all tracks can be deleted from MEM.

To delete individual tracks, press and release the DEL button while the track is playing.

To delete all tracks from MEM, press and hold the DEL button while a track is playing.

Playing from MEM

Playing Back a Previously Recorded CD

Turn the TUNE knob to select a track if MEM is already playing from the previously recorded disc.

1. Select Recorded Disc List.
2. Select the disc.
3. Select the track.

Searching for a Track

Tracks can be searched for by:

- Playlists
- Artists
- Albums
- Song Titles
- Genres

The number of objects in each category is shown in parentheses after the category.

To search for tracks:

1. Turn the Menu knob.
2. Select Search.
3. Select: Playlists, Artists, Albums, Song Titles, or Genres.
4. Select the track. The search rate increases if the Menu knob is continuously turned while searching in a list.

Shuffle Songs

Select the Shuffle Songs option from the MEM menu to randomly play back tracks stored in MEM.

Configuring MEM Favorites

During MEM playback, press the FAV button to change between favorite categories. The favorite categories are:

- Playlists
- Artists
- Albums
- Genres

To remove MEM favorites categories:

1. Press the CONFIG button.
2. Select Radio Settings.
3. Select MEM Favorites.
4. Remove the checkmark from the box to remove that MEM favorites category.

Replace the checkmark to re-add the removed category.

Saving MEM Tracks as Favorites

Favorites can be saved by pressing and holding one of the 1 to 6 buttons. Favorites can be stored according to the following list:

Playlist: Adds the currently playing track to the playlist selected.

Artist: Saves the artist associated with the currently playing track in the indicated favorites position.

Album: Saves the album associated with the currently playing track in the indicated favorites position.

Genre: Saves the genre associated with the currently playing track in the indicated favorites position.

Creating Playlists

To create a playlist using tracks stored in MEM:

1. Select Playlist from the MEM favorites.
2. Select the track to be stored in the playlist.
3. Press and hold one of the 1 to 6 buttons until the track can be heard again to store the track.
4. Repeat Steps 1 though 3 to store additional tracks in the playlist.

Auxiliary Devices (Radio with CD)

The optional AUX input allows portable devices to connect to the vehicle using the 3.5 mm (1/8 in) input jack or the USB port.

Portable devices are controlled by using the menu system described in *Operation on page 7-7*.

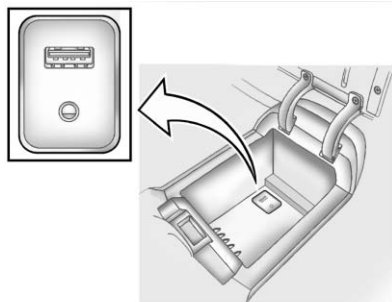

The AUX input is located in the center console.

3.5 mm Jack

Connect a 3.5 mm (1/8 in) cable to the auxiliary input jack to use a portable audio player.

Playback of an audio device that is connected to the 3.5 mm jack can only be controlled using the controls on the device.

Adjusting the Volume

Turn the VOL/  knob to adjust the volume of the infotainment system after the volume level has been set on the portable audio device.

USB Port

For vehicles with a USB port, the following devices may be connected and controlled by the infotainment system.

- iPods
- PlaysForSure Devices (PFD)
- USB Drives
- Zunes

Not all iPods, PFDs, USB Drives, and Zunes are compatible with the infotainment system.

Connecting and Controlling an iPod®

Not all iPods can be controlled by the infotainment system.

Connecting an iPod

Connect the iPod to the USB port.

Searching for a Track

Tracks can be searched for by:

- Playlists
- Artists
- Albums
- Song Titles
- Podcasts
- Genres
- Audiobooks
- Composers

To search for tracks:

1. Turn the Menu knob.
2. Select Search.
3. Select: Playlists, Artists, Albums, Song Titles, Podcasts, Genres, Audiobooks, or Composers.
4. Select the track.

Shuffle

Turn the Menu knob and set Shuffle Songs (Random) to On or Off, then press the ⇨ BACK button to return the main screen.

On: Plays tracks in the current folder in random order.

Off: Plays tracks in the current folder in sequential order.

Repeat

Turn the Menu knob and set Repeat to On or Off, then press the ⇨ BACK button to return the main screen.

On: Repeats the current track.

Off: Playback starts from the beginning of the current track after the last track finishes.

Connecting and Controlling a PlaysForSure Device (PFD) or Zune™

Connecting a PFD or Zune

Connect the PFD or Zune to the USB port.

Searching for a Track

Tracks can be searched for by:

- Playlists
- Artists
- Albums
- Song Titles
- Podcasts
- Genres

To search for tracks:

1. Turn the Menu knob.
2. Select Search.
3. Select: Playlists, Artists, Albums, Song Titles, Podcasts, or Genres.
4. Select the track.

Shuffle Functionality

Turn the Menu knob and set Shuffle Songs (Random) to On or Off.

On: Plays current tracks in random order.

Off: Plays current tracks in sequential order.

Repeat Functionality

Turn the Menu knob and set Repeat to On or Off.

Repeat On: Repeats the current track.

Repeat Off: Playback starts from the beginning of the current track after the last track finishes.

Connecting and Controlling a USB Drive

The infotainment system can only play back .mp3 and .wma files from a USB drive.

Only the first 2,500 songs are recognized on the device.

When a device is not supported, the message "No supported data found. You can safely disconnect the device" appears.

Connecting a USB Drive

Connect the USB drive to the USB port.

Searching for a Track

It is normal for the search feature to take some time to display the information after reading the device due to the amount of information stored.

Files that do not have any meta data stored in the ID3 tag display as Unknown.

Tracks can be searched for by:

- Playlists*
- Artists
- Albums
- Song Titles
- Genres
- Folder View

*This only displays if a playlist is found on the device.

To search for tracks:

1. Turn the Menu knob.
2. Select Search.
3. Select: Playlists, Artists, Albums, Song Titles, Genres, or Folder View.
4. Select the track.

Shuffle Functionality

Turn the Menu knob and set Shuffle Songs (Random) to On or Off.

On: Plays current tracks in random order.

Off: Plays current tracks in sequential order.

Repeat Functionality

Turn the Menu knob and set Repeat to On or Off.

Repeat On: Repeats the current track.

Repeat Off: Playback starts from the beginning of the current track after the last track finishes.

Auxiliary Devices (Radio with CD/DVD and MEM)

The optional AUX input allows portable devices to be connected using the 3.5 mm (1/8 in) input jack or the USB port.

Portable devices are controlled by using the menu system described in *Operation on page 7-7*.

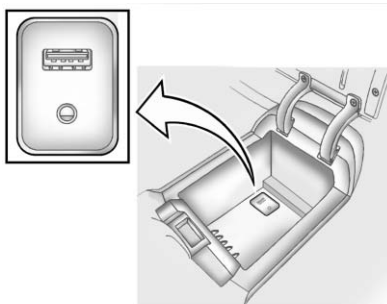

The AUX input is located in the center console.

3.5 mm Jack

Connect a 3.5 mm (1/8 in) cable to the auxiliary input jack to use a portable audio player.

Playback of an audio device that is connected to the 3.5 mm jack can only be controlled using the controls on the device.

Adjusting the Volume

Turn the VOL/  knob to adjust the volume of the infotainment system after the volume level has been set on the portable audio device.

USB Port

The following devices may be connected to the USB port and controlled by the infotainment system.

- iPods
- USB Mass Storage Devices

Not all iPods or USB Mass Storage Devices are compatible with the infotainment system.

Connecting and Controlling an iPod®

Not all iPods can be controlled by the infotainment system.

Connecting an iPod

Connect the iPod to the USB port.

Selecting a Track

Using the control buttons:

- Press **◀◀** SEEK or **▶▶** SEEK to select the previous or next track.
- Turn the TUNE knob to select a track in the current submenu. The track will start to play.

Playing Tracks in Random Order

Turn the Menu knob and set Shuffle Songs to On or Off.

Shuffle On: Plays current tracks in random order.

Shuffle Off: Plays current tracks in sequential order.

Searching for a Track

Tracks can be searched for by:

- Playlists
- Artists
- Albums
- Song Titles
- Genres
- Composers
- Audiobooks

The number of objects in each category is shown in parentheses after the category.

To search for tracks:

1. Turn the Menu knob.
2. Select Search.
3. Select: Playlists, Artists, Albums, Song Titles, Genres, Composers, or Audiobooks.
4. Select the track. The search rate increases if the Menu knob is continuously turned while searching in a list.

Connecting and Controlling a USB Drive

Files that are not stored in folders are displayed in the root directory (USB).

Connecting a USB Drive

Connect the USB drive to the USB port.

Disconnecting a USB Drive

A USB drive should be ejected from the USB port before disconnecting it. To eject a USB drive:

1. Turn the Menu knob.
2. Select USB Eject.

Playing Tracks in Random Order

Turn the Menu knob and then set Shuffle Songs to On.

Selecting a Track

Using the control buttons:

- Press **⏮** or **⏭** to select the previous or next track.
- Turn the TUNE knob to select a track in the current submenu. The track will start to play.

Selecting a track in a different folder:

1. Turn the Menu knob.
2. Select Folder List.
3. Select the folder.
4. Select the track.

Searching for Tracks

It is normal for the search feature to take some time to display the information after reading the device due to the amount of information stored.

Files that do not have any meta data stored in the ID3 tag display as Unknown.

Tracks can be searched by:

- Playlists
- Artists
- Albums
- Song Titles
- Genres

The number of objects in each category is shown in parentheses after the category.

To search for tracks:

1. Turn the Menu knob.
2. Select Search.
3. Select: Playlists, Artists, Albums, Song Titles, or Genres.
4. Select the track. The search rate increases if the Menu knob is continuously turned while searching in a list.

Recording Tracks to MEM

See *Mass Storage Media (MEM)* on page 7-27 for more information.

Rear Seat Infotainment

Rear Seat Entertainment (RSE) System

The vehicle may have a DVD Rear Seat Entertainment (RSE) system. The RSE system works with the vehicle's infotainment system. The DVD player is part of the front radio. The RSE system includes a radio with a DVD player, two rear seat video display screens, audio/video jacks, two wireless headphones, and a remote control. See *CD/DVD Player* on page 7-23 or the separate navigation system manual for more information on the vehicle's DVD system.

Before Driving

The RSE is for rear seat passengers only. The driver cannot safely view the video screen while driving.

In severe or extreme weather conditions, the RSE system may not work until the temperature is within the operating range. The operating range is above -20°C (-4°F) and below 60°C (140°F). If the temperature is outside of this range, heat or cool the vehicle until it is within the operating range.

Global Off

Depending on the infotainment system, the RSE system may have a Global Off feature. The Global Off feature disables all RSE system features. Press and hold the radio power button for

more than three seconds for Global Off to disable the RSE features. On some infotainment systems, the Global Off feature can be turned off by performing one of the following:

- Press and hold the radio power button for more than three seconds.
- Insert or eject any disc.
- Insert a DVD video disc.
- Press the remote control power button.
- Press the MEM/DVD/AUX button or $\blacktriangleright/\parallel$ when a DVD video disc is in the player.
- Press the SRC button on the steering wheel when a DVD video disc is in the player.
- Cycle the ignition.

Headphones

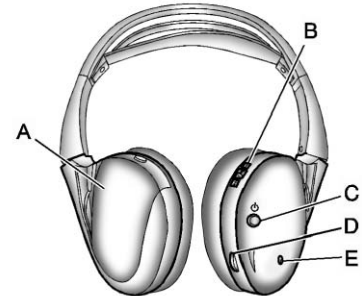

- A. Battery Cover
- B. Channel 1 or 2 Switch
- C. Power Button
- D. Volume Control
- E. Power Indicator Light

RSE includes two 2-channel wireless headphones. Channel 1 is dedicated to the DVD player, and Channel 2 is dedicated to any external auxiliary device connected to the A/V jacks.

7-38 Infotainment System

The headphones are used to listen to various multi-media. The wireless headphones have an On/Off button, channel 1/2 switch, and a volume control. Turn the headphones off when not in use.

Push the On/Off button to turn on the headphones. A light on the headphones comes on. If the light does not come on, check the batteries. Intermittent sound or static can also indicate weak batteries. See “Battery Replacement” later in this section for more information.

Infrared transmitters are on the top of the left seatback video screen. The headphones shut off automatically to save the battery power if the RSE system is shut off or if the headphones are out of range of the transmitters for more than three minutes. Moving too far forward or stepping out of the vehicle can cause the headphones to lose the signal or have static.

To adjust the volume on the headphones, use the volume control.

For optimal audio performance, the headphones must be worn correctly. Headphones should be worn with the headband over the top of the head for best audio reception. The symbol L (Left) appears on the outside bottom edge of the ear cup and should be positioned on the left ear. The symbol R (Right) appears on the outside bottom edge of the ear cup and should be positioned on the right ear.

Notice: Do not store the headphones in heat or direct sunlight. This could damage the headphones and repairs will not be covered by the warranty. Storage in extreme cold can weaken the batteries. Keep the headphones stored in a cool, dry place.

If the foam ear pads attached to the headphones become worn or damaged, the pads can be replaced separately from the headphone set. To purchase replacement ear pads, call 1-888-293-3332, then prompt zero (0), or contact your dealer.

Battery Replacement

To change the batteries:

1. Loosen the screw to the battery door located on the left side of the headphones.
2. Slide the battery door open.
3. Replace the two AAA batteries.
4. Replace the battery door and tighten the screw.

Remove the batteries if the headphones are not going to be used for a long period of time.

Audio/Video (A/V) Jacks

If available, the A/V jacks are located on the rear of the floor console. They allow audio or video cables to be connected from an auxiliary device such as a camcorder or a video game system.

The A/V jacks are color coded:

- Yellow for video input.
- White for left audio input.
- Red for right audio input.

Power for auxiliary devices is not supplied by the radio system.

To use the auxiliary inputs of the RSE system:

1. Connect the auxiliary device cables to the A/V jacks.
2. Power on both the auxiliary device and the RSE video screen.

Changing the Source on the Video Display Screens

The image from the auxiliary device can be switched between the video display screens.







To change the display:

1. Press the AUX button on the remote control to change the source of both video screens from the DVD player to the auxiliary device.
2. Press the AUX button a second time to change the left video screen source to the DVD player and the right video screen to the auxiliary device.

3. Press the AUX button a third time to change the left video screen source to the auxiliary device and the right video screen to the DVD player.
4. Press the AUX button a fourth time to change the source of both video screens to the DVD player.

Changing the RSE Video Screen Settings

The screen display mode, brightness, and language can be changed from the setup menu using the remote control. To change a setting:

1. Press .
2. Use , , , , and  to select the settings.
3. Press  again to exit the setup menu.

Audio Output

Audio from the DVD player or auxiliary inputs can be heard through the following:

- Wireless Headphones
- Vehicle Speakers

The RSE system transmits the audio signal to the wireless headphones if an audio signal is available. See “Headphones” earlier in this section for more information.

The front seat passengers are able to listen to playback from the A/V jacks through the vehicle speakers by selecting Rear A/V as the source on the radio.

Video Screens

The video screens are located in the back of the driver and front passenger seats.

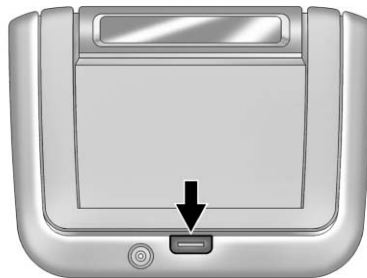

To use the video screen:

1. Push the release button located on the seatback console.
2. Move the screen to the desired viewing position.

Push the video screen down into its locked position when it is not in use. The screen turns off automatically.

Only the left RSE seatback console contains the infrared transmitters for the wireless headphones. They may be visible as eight illuminated LEDs. These LEDs are not on the right video screen. Both seatback consoles contain an infrared receiver for the remote control. They are located at the top of each console.

Notice: Avoid directly touching the video screen, as damage may occur. See “Cleaning the Video Screen” later in this section for more information.

Video Screen Input Jack

Each video screen is equipped with a video input jack to allow video cables to be connected from an auxiliary device such as a camcorder or a video game system. This signal will override any video provided by the RSE system; either the DVD or auxiliary A/V jack source. The RSE system must be on for this input to operate.

Remote Control



To use the remote control, aim it at the transmitter window at either seatback console and press the

button. Direct sunlight or very bright light could affect the ability of the RSE transmitter to receive signals from the remote control. Check the batteries if the remote control does not seem to be working. See “Battery Replacement” later in this section. Objects blocking the line of sight could also affect the function of the remote control.

If a CD, DVD, or MP3 disc is in the Radio DVD slot, the remote control  button can be used to turn on the video screen display and start the disc. The infotainment system can also turn on the video screen display. See *CD/DVD Player on page 7-23* or the separate navigation system manual for more information.

Notice: Storing the remote control in a hot area or in direct sunlight can damage it, and the repairs will not be covered by the warranty. Storage in extreme cold can weaken the batteries. Keep the remote control stored in a cool, dry place.

Remote Control Buttons

 **(Power):** Press to turn the video screens on and off.

 **(Illumination):** Press to turn the remote control backlight on. The backlight times out after several seconds if no other button is pressed.

 **(Title):** Press to return to the main menu of the DVD. This function could vary for each disc.

 **(Main Menu):** Press to access the DVD menu. The DVD menu is different on every DVD. Use the navigation arrows to move the cursor. After making a selection press the enter button. This button only operates when using a DVD.

 **(Menu Navigation Arrows):** Use the arrow buttons to navigate through a menu.

 **(Enter):** Press to select the highlighted choice in any menu.









7-42 Infotainment System

 **(Display Menu):** Press to adjust the brightness and screen display mode, and display the language menu.

 **(Return):** Press to exit the current active menu and return to the previous menu. This button operates only when the display menu or a DVD menu is active.





 **(Stop):** Press to stop playing, rewinding, or fast forwarding a DVD. Press twice to return to the beginning of the DVD.





 **(Play/Pause):** Press to start playing a DVD. Press to pause a DVD while it is playing. Press again to continue playing.

Depending on the infotainment system in the vehicle, DVD playback may be slowed down by pressing   then . Reverse slow play by pressing   then . Press   again to cancel slow play.

 **(Previous Track/Chapter):** Press to go to the start of the current track or chapter. Press again to go to the previous track or chapter. This button may not work when the DVD is playing the copyright information or the previews.

 **(Next Track/Chapter):** Press to go to the beginning of the next chapter or track. This button might not work when the DVD is playing the copyright information or the previews.

 **(Fast Reverse):** Press to quickly reverse the DVD or CD. To stop fast reversing a DVD video, press  . To stop fast reversing a DVD audio or CD, release . This button might not work when the DVD is playing the copyright information or the previews.

 **(Fast Forward):** Press to fast forward the DVD or CD. To stop fast forwarding a DVD video, press  . To stop fast forwarding a DVD audio or CD, release . This button might not work when the DVD is playing the copyright information or the previews.

 **(Audio):** Press to change audio tracks on DVDs that have this feature when the DVD is playing.

 **(Subtitles):** Press to turn ON/OFF subtitles and to move through subtitle options when a DVD is playing.

AUX (Auxiliary): Press to switch the video display between the DVD player and an auxiliary source.

The AUX button also controls the source display between the left and right video screens as described in the table below:

Aux Button Press	Left Screen	Right Screen
Default State (No Press)	DVD Media	DVD Media
First Press	Aux Video Source	Aux Video Source
Second Press	DVD Media	Aux Video Source
Third Press	Aux Video Source	DVD Media
Fourth Press	Return to Default State	Return to Default State

 **(Camera):** Press to change the camera angle on DVDs that have this feature when the DVD is playing.

 **(Clear) (If Available):** Press this button within three seconds after inputting a numeric selection, to clear all numeric inputs.

 **10 (Double Digit Entries) (If Available):** Press this button to select chapter or track numbers greater than 9. Press this button before inputting the number.

1 through 0 (Numeric Keypad): The numbered keypad provides the capability of direct chapter or track number selection.

Replacing the Remote Control

If the remote control becomes lost or damaged, a new universal remote control can be purchased. Use a Toshiba® code set for replacement universal remote controls.

Battery Replacement

To change the remote control batteries:

1. Slide back the rear cover on the remote control.
2. Replace the two batteries in the compartment.
3. Replace the battery cover.

Remove the batteries from the remote control if unused for an extended period of time.

7-44 Infotainment System

Tips and Troubleshooting Chart

Problem	Recommended Action
No power.	The ignition might not be turned to ON/RUN or ACC/ACCESSORY.
The picture does not fill the screen. There are black borders on the top and bottom or on both sides or it looks stretched out.	Check the display mode settings in the setup menu by pressing the display menu button on the remote control.
In auxiliary mode, the picture moves or scrolls.	Check the auxiliary input connections at both devices.
The remote control does not work.	Check to make sure there is no obstruction between the remote control and the transmitter window. Check the batteries to make sure they are not dead or installed incorrectly.
After stopping the player, I push Play but sometimes the DVD starts where I left off and sometimes at the beginning.	If the Stop button was pressed one time, the DVD player resumes playing where the DVD was stopped. If the stop button was pressed two times the DVD player begins to play from the beginning of the DVD.

Tips and Troubleshooting Chart (cont.)

Problem	Recommended Action
The auxiliary source is running but there is no picture or sound.	Check that the RSE video screen is in the auxiliary source mode by pressing the AUX button on the remote control. Check the auxiliary input connections at both devices.
Sometimes the wireless headphone audio cuts out or buzzes.	Check for obstructions, low batteries, reception range, and interference from cellular telephone towers or by using a cellular telephone in the vehicle. Check that the headphones are on correctly using the L (left) and R (right) on the headphones. Check that the headphones are positioned properly with the headband across the top of the head.
I lost the remote and/or the headphones.	See your dealer for assistance.
The DVD is playing, but there is no picture or sound.	Check that the RSE video screen is sourced to the DVD player by pressing the AUX button on the remote control.

DVD Display Error Messages

The DVD display error message depends on which radio the vehicle has. The video screen may display one of the following:

Disc Load/Eject Error or

Mechanical Error: There are disc load or eject problems.

Disc Format Error or Unknown

Format: The disc is inserted with the disc label wrong side up, or the disc is damaged.

Disc Region Error or Disc Error:

The disc is not from a correct region.

No Disc Inserted: No disc is present when the  EJECT or MEM/DVD/AUX button is pressed on the radio.

DVD Distortion

Video distortion can occur when operating cellular phones, scanners, CB radios, Global Position Systems (GPS)*, two-way radios, mobile fax, or walkie talkies.

It might be necessary to turn off the DVD player when operating one of these devices in or near the vehicle.

*Excludes the OnStar[®] System.

Cleaning the RSE Seatback Console

Use only a clean cloth dampened with clean water to clean the RSE seatback console surface.

Cleaning the Video Screen

Use only a clean cloth dampened with clean water. Use care when touching or cleaning the screen as damage could result.

Phone

Bluetooth (Overview)

For vehicles equipped with Bluetooth capability, the system can interact with many cell phones, allowing:

- Placement and receipt of calls in a hands-free mode.
- Sharing of the cell phone's address book or contact list with the vehicle.

To minimize driver distraction, before driving, and with the vehicle parked:

- Become familiar with the features of the cell phone. Organize the phone book and contact lists clearly and delete duplicate or rarely used entries. If possible, program speed dial or other shortcuts.
- Review the controls and operation of the infotainment system.

- Pair cell phone(s) to the vehicle. The system may not work with all cell phones. See “Pairing a Phone” in this section for more information.
- If the cell phone has voice dialing capability, learn to use that feature to access the address book or contact list. See “Voice Pass-Thru” in this section for more information.
- See “Storing and Deleting Phone Numbers” in this section for more information.

Vehicles with a Bluetooth system can use a Bluetooth-capable cell phone with a Hands-Free Profile to make and receive phone calls. The infotainment system and voice recognition are used to control the system. The system can be used while the ignition is in ON/RUN or ACC/ACCESSORY. The range of the Bluetooth system can be up to 9.1 m (30 ft). Not all phones support all functions and not all phones work with the Bluetooth system. See www.gm.com/bluetooth for more information about compatible phones.

 **WARNING**

When using a cell phone, it can be distracting to look too long or too often at the screen of the phone or the infotainment (navigation) system. Taking your eyes off the road too long or too often could cause a crash resulting in injury or death. Focus your attention on driving.

Bluetooth Controls

Use the buttons located on the infotainment system and the steering wheel to operate the Bluetooth system.

Steering Wheel Controls

 (Push To Talk): Press to answer incoming calls, to confirm system information, and to start voice recognition.

 (Mute/End Call): Press to end a call, reject a call, or cancel an operation.

Infotainment System Controls

For information about how to navigate the menu system using the infotainment controls, see *Operation on page 7-7*.

 (Phone): Press to enter the Phone main menu.

Voice Recognition

The voice recognition system uses commands to control the system and dial phone numbers.

Noise: The system may not recognize voice commands if there is too much background noise.

When to Speak: A tone sounds to indicate that the system is ready for a voice command. Wait for the tone and then speak.

How to Speak: Speak clearly in a calm and natural voice.

Audio System

When using the Bluetooth system, sound comes through the vehicle's front audio system speakers and overrides the audio system.

Use the VOL/  knob during a call to change the volume level. The adjusted volume level remains in memory for later calls. The system maintains a minimum volume level.

Other Information

The Bluetooth[®] word mark and logos are owned by the Bluetooth[®] SIG, Inc. and any use of such marks by General Motors is under license. Other trademarks and trade names are those of their respective owners.

See *Radio Frequency Statement on page 13-20* for Federal Communications Commission and Industry Canada information.

Bluetooth (Infotainment Controls)

For information about how to navigate the menu system using the infotainment controls, see *Operation on page 7-7*.

Pairing

A Bluetooth-enabled cell phone must be paired to the Bluetooth system first and then connected to the vehicle before it can be used. See the cell phone manufacturer user guide for Bluetooth functions before pairing the cell phone. If a Bluetooth phone is not connected, calls will be made using OnStar[®] Hands-Free Calling, if available. Refer to the OnStar Owner's Guide for more information.

The pairing process can be started by using the voice recognition system or the controls on the infotainment system.

Pairing Information:

- Up to five cell phones can be paired to the Bluetooth system.
- The pairing process is disabled when the vehicle is moving.
- The Bluetooth system links with the first available paired cell phone in the order the phone was paired.
- Only one paired cell phone can be connected to the Bluetooth system at a time.
- Pairing should only need to be completed once, unless changes to the pairing information have been made or the phone is deleted.

To link to a different paired phone, see “Linking to a Different Phone” later in this section.

Pairing a Phone

1. Press the CONFIG button.
2. Select Phone Settings.
3. Select Bluetooth.
4. Select Pair Device (Phone). A four-digit Personal Identification Number (PIN) appears on the display.

If the “Add new GPS device” option is selected, the system will start a search for Bluetooth “Handsfree” profile devices just like if “Add new Phone” was selected. The additional GPS location feature which would provide the vehicle's GPS location through the Bluetooth Serial Port Profile is not available.

5. Start the pairing process on the cell phone that will be paired to the vehicle. Reference the cell phone manufacturer's user guide for information on this process.

Locate the device named “Your Vehicle” in the list on the cell phone and follow the instructions on the cell phone to enter the four-digit PIN provided by the system.

6. The system prompts for a name for the phone and confirms the name provided. This name is used to indicate which phone is connected.
7. The system responds with “<Phone name> has been successfully paired” after the pairing process is complete.
8. Repeat Steps 1 through 7 to pair additional phones.

Listing All Paired and Connected Phones

1. Press the CONFIG button.
2. Select Phone Settings.
3. Select Bluetooth.
4. Select Device List.

Deleting a Paired Phone

1. Press the CONFIG button.
2. Select Phone Settings.
3. Select Bluetooth.
4. Select Device List.
5. Select the phone to delete and follow the on-screen prompts.

Linking to a Different Phone

To link to a different phone, the new phone must be in the vehicle and available to be connected to the Bluetooth system before the process is started.

1. Press the CONFIG button.
2. Select Phone Settings.
3. Select Bluetooth.
4. Select Device List.
5. Select the new phone to link to and follow the on-screen prompts.

If delete is selected, the highlighted phone will be deleted.

Making a Call Using Phone Book

For cell phones that support the phone book feature, the Bluetooth system can use the contacts stored on your cell phone to make calls. See your cell phone's owner's guide or contact your wireless provider to find out if this feature is supported by your phone.

When a cell phone supports the phone book feature, the Phone Book and Call Lists menus are automatically available.

The Phone Book menu allows you to access the phone book stored in the cell phone to make a call.

The Call Lists menu allows you to access the phone numbers from the Incoming Calls, Outgoing Calls, and Missed Calls menus on your cell phone to make a call.

Radio with CD

To make a call using the Phone Book menu:

1. Press  twice.
2. Select Phone Book.
3. You can search through the list by selecting the letter group the phone book entry begins with, or press the SELECT button to scroll through the entire list of names/numbers in the phone book.
4. Select the name or number you want to call.

To make a call using the Call Lists menu:

1. Press  twice.
2. Select Call Lists.
3. Select the Incoming Calls, Outgoing Calls, or Missed Calls list.
4. Select the name or number you want to call.

Radio with CD/DVD and MEM

1. Press .
2. Select Phone Book.
3. Search through the list by selecting the letter group the phone book entry begins with, or press the SELECT button to scroll through the entire list of names/numbers in the phone book.
4. Select the name or number you want to call.

To make a call using the Call Lists menu:

1. Press .
2. Select Call Lists.
3. Select the Incoming Calls, Outgoing Calls, or Missed Calls list.
4. Select the name or number you want to call.

Making a Call

Radio with CD

1. Press  twice.
2. Enter the character sequence. See “Entering a Character Sequence” in *Operation on page 7-7* for more information.
3. Select Call to start dialing the number.

Radio with CD/DVD and MEM

1. Press .
2. Select Enter number.
3. Enter the character sequence. See “Entering a Character Sequence” in *Operation on page 7-7* for more information.
4. Select Call to start dialing the number.

Accepting or Declining a Call

When a call is received, the infotainment system mutes and a ring tone is heard in the vehicle.

Accepting a Call

Turn the menu knob to Answer and press the SELECT button.

Declining a Call

Turn the menu knob to Decline and press the SELECT button.

Call Waiting

Call waiting must be supported on the Bluetooth phone and enabled by the wireless service carrier to work.

Accepting a Call

Turn the menu knob to Answer and press the SELECT button.

Declining a Call

Turn the menu knob to Decline and press the SELECT button.

Switching Between Calls (Call Waiting Calls Only)

To switch between calls:

1. Turn the menu knob.
2. Select Switch Call from the menu.

Conference Calling

Conference calling and three-way calling must be supported on the Bluetooth phone and enabled by the wireless service carrier to work.

To start a conference while in a current call:

1. Turn the menu knob.
2. Select Enter Number.
3. Enter the character sequence then select Call. See “Entering a Character Sequence” in *Operation on page 7-7* for more information.
4. After the call has been placed, turn the Menu knob and choose Merge Calls.
5. To add more callers to the conference call, repeat Steps 1 through 4. The number of callers that can be added is limited by your wireless service carrier.

Ending a Call

Turn the Menu knob and select Hang Up.

Muting a Call

To Mute a Call

Turn the Menu knob and select Mute Call.

To Cancel Mute

Turn the Menu knob and select Mute Call.

Dual Tone Multi-Frequency (DTMF) Tones

The in-vehicle Bluetooth system can send numbers during a call. This is used when calling a menu-driven phone system.

1. Turn the Menu knob and select Enter Number.
2. Enter the character sequence. See “Entering a Character Sequence” in *Operation on page 7-7* for more information.

Bluetooth (Voice Recognition)

Using Voice Recognition

To use voice recognition, press  located on the steering wheel. The system responds differently depending on what kind of infotainment system the vehicle has installed.

For vehicles without a navigation system, the system responds “Ready,” followed by a tone. After the tone, say a command.

For vehicles with a navigation system, the system responds with a tone. After the tone say “Hands Free” to use the Bluetooth voice recognition system. The system then responds with “Ready,” followed by a tone. After the tone, say a command.

For additional information say “Help” while you are in a voice recognition menu.

Pairing

A Bluetooth cell phone must be paired to the Bluetooth system and then connected to the vehicle before it can be used. See your cell phone manufacturer’s user guide for Bluetooth functions before pairing the cell phone. If a Bluetooth phone is not connected, calls will be made using OnStar Hands-Free Calling, if available. Refer to the OnStar owner’s guide for more information.



Pairing Information

- Up to five cell phones can be paired to the Bluetooth system.
- The pairing process is disabled when the vehicle is moving.
- Pairing only needs to be completed once, unless the pairing information on the cell phone changes or the cell phone is deleted from the system.

7-54 Infotainment System

- Only one paired cell phone can be connected to the Bluetooth system at a time.
- If multiple paired cell phones are within range of the system, the system connects to the first available paired cell phone in the order that they were first paired to the system. To link to a different paired phone, see “Linking to a Different Phone” later in this section.



Pairing a Phone

1. Press  . For vehicles with a navigation system, say “Hands Free” after the tone.
2. Say “Bluetooth.”
3. Say “Pair.” The system responds with instructions and a four-digit PIN. The PIN is used in Step 5.

4. Start the pairing process on the cell phone that you want to pair. For help with this process, see your cell phone manufacturer’s user guide.
5. Locate the device named “Your Vehicle” in the list on the cell phone. Follow the instructions on the cell phone to enter the PIN that was provided in Step 3. After the PIN is successfully entered, the system prompts you to provide a name for the paired cell phone. This name will be used to indicate which phones are paired and connected to the vehicle. See “Listing All Paired and Connected Phones” later in this section for more information.
6. Repeat Steps 1 through 5 to pair additional phones.



Listing All Paired and Connected Phones

The system can list all cell phones paired to it. If a paired cell phone is also connected to the vehicle, the system responds with “is connected” after that phone name.

1. Press  . For vehicles with a navigation system, say “Hands Free” after the tone.
2. Say “Bluetooth.”
3. Say “List.”



Deleting a Paired Phone

If the phone name you want to delete is unknown, see “Listing All Paired and Connected Phones.”

1. Press  . For vehicles with a navigation system, say “Hands Free” after the tone.
2. Say “Bluetooth.”
3. Say “Delete.” The system asks for which phone to delete.
4. Say the name of the phone you want to delete.

Connecting to a Different Phone

To connect to a different cell phone, the Bluetooth system looks for the next available cell phone in the order in which all the available cell phones were paired. Depending on which cell phone you want to connect to, you may have to use this command several times.

1. Press  . For vehicles with a navigation system, say “Hands Free” after the tone.
2. Say “Bluetooth.”
3. Say “Change phone.”
 - If another cell phone is found, the response will be “<Phone name> is now connected.”
 - If another cell phone is not found, the original phone remains connected.

Storing and Deleting Phone Numbers

The system can store up to 30 phone numbers as name tags in the Hands-Free Directory that is shared between the Bluetooth and OnStar systems.

The following commands are used to delete and store phone numbers.



Store: This command will store a phone number or a group of numbers as a name tag.

Digit Store: This command allows a phone number to be stored as a name tag by entering the digits one at a time.

Delete: This command is used to delete individual name tags.

Delete All Name Tags: This command deletes all stored name tags in the Hands-Free Calling Directory and the OnStar Turn-by-Turn Destinations Directory.



Using the “Store” Command

1. Press  . For vehicles with a navigation system, say “Hands Free” after the tone.
2. Say “Store.”
3. Say the phone number or group of numbers you want to store all at once with no pauses, then follow the directions given by the system to save a name tag for this number.

Using the “Digit Store” Command



If an unwanted number is recognized by the system, say “Clear” at any time to clear the last number.

To hear all of the numbers recognized by the system, say “Verify” at any time.

1. Press  . For vehicles with a navigation system, say “Hands Free” after the tone.
2. Say “Digit Store.”

3. Say each digit, one at a time, that you want to store. After each digit is entered, the system repeats back the digit it heard followed by a tone. After the last digit has been entered, say "Store," and then follow the directions given by the system to save a name tag for this number.



Using the "Delete" Command

1. Press  . For vehicles with a navigation system, say "Hands Free" after the tone.
2. Say "Delete."
3. Say the name tag you want to delete.

Using the "Delete All Name Tags" Command

This command deletes all stored name tags in the Hands Free Calling Directory and the OnStar Turn-by-Turn Destinations Directory.



To delete all name tags:

1. Press  . For vehicles with a navigation system, say "Hands Free" after the tone.
2. Say "Delete all name tags."

Listing Stored Numbers

The List command will list all the stored numbers and name tags.

Using the "List" Command

1. Press  . For vehicles with a navigation system, say "Hands Free" after the tone.
2. Say "Directory."
3. Say "Hands Free Calling."
4. Say "List."

Making a Call



Calls can be made using the following commands.

Dial or Call: The dial or call command can be used interchangeably to dial a phone number or a stored name tag.

Digit Dial: This command allows a phone number to be dialed by entering the digits one at a time.

Re-dial: This command is used to dial the last number used on the cell phone.

Using the "Dial" or "Call" Command

1. Press  . For vehicles with a navigation system, say "Hands Free" after the tone.
2. Say "Dial" or "Call."
3. Say the entire number without pausing or say the name tag.



Once connected, the person called will be heard through the audio speakers.

Using the “Digit Dial” Command

The digit dial command allows a phone number to be dialed by entering the digits one at a time. After each digit is entered, the system repeats back the digit it heard followed by a tone.



If an unwanted number is recognized by the system, say “Clear” at any time to clear the last number.

To hear all of the numbers recognized by the system, say “Verify” at any time.

1. Press  . For vehicles with a navigation system, say “Hands Free” after the tone.
2. Say “Digit Dial.”
3. Say each digit, one at a time, that you want to dial. After each digit is entered, the system repeats back the digit it heard followed by a tone. After the last digit has been entered, say “Dial.”

Once connected, the person called will be heard through the audio speakers.





Using the “Re-dial” Command

1. Press  . For vehicles with a navigation system, say “Hands Free” after the tone.
2. After the tone, say “Re-dial.”

Once connected, the person called will be heard through the audio speakers.







Receiving a Call

When an incoming call is received, the audio system mutes and a ring tone is heard in the vehicle.

- Press   to answer the call.
- Press   to ignore a call.





Call Waiting

Call waiting must be supported on the cell phone and enabled by the wireless service carrier.

- Press   to answer an incoming call when another call is active. The original call is placed on hold.
- Press   again to return to the original call.
- To ignore the incoming call, no action is required.
- Press   to disconnect the current call and switch to the call on hold.

Three-Way Calling

Three-way calling must be supported on the cell phone and enabled by the wireless service carrier.



1. While on a call, press  .
2. Say “Three-way call.”
3. Use the dial or call command to dial the number of the third party to be called.
4. Once the call is connected, press   to link all the callers together.



Ending a Call

Press   to end a call.

Muting a Call

During a call, all sounds from inside the vehicle can be muted so that the person on the other end of the call cannot hear them.

To mute a call, press  , and then say “Mute Call.”

To cancel mute, press  , and then say “Un-mute Call.”



Transferring a Call

Audio can be transferred between the Bluetooth system and the cell phone.



The cell phone must be paired and connected with the Bluetooth system before a call can be transferred. The connection process can take up to two minutes after the ignition is turned to ON/RUN.

To Transfer Audio from the Bluetooth System to a Cell Phone

During a call with the audio in the vehicle:

1. Press  .
2. Say “Transfer Call.”



To Transfer Audio to the Bluetooth System from a Cell Phone

During a call with the audio on the cell phone, press  . The audio transfers to the vehicle. If the audio does not transfer to the vehicle, use the audio transfer feature on the cell phone. See your cell phone manufacturer’s user guide for more information.

Voice Pass-Thru

Voice pass-thru allows access to the voice recognition commands on the cell phone. See your cell phone manufacturer's user guide to see if the cell phone supports this feature.



To access contacts stored in the cell phone:

1. Press  . For vehicles with a navigation system, say "Hands Free" after the tone.
2. Say "Bluetooth." The system responds "Bluetooth ready," followed by a tone.
3. Say "Voice." The system responds "OK, accessing <phone name>."
 - The cell phone's normal prompt messages will go through their cycle according to the phone's operating instructions.

Dual Tone Multi-Frequency (DTMF) Tones

The Bluetooth system can send numbers and the numbers stored as name tags during a call. You can use this feature when calling a menu-driven phone system. Account numbers can also be stored for use.

Sending a Number or Name Tag During a Call

1. Press  . The system responds "Ready," followed by a tone.
2. Say "Dial."
3. Say the number or name tag to send.

Clearing the System

Unless information is deleted out of the in-vehicle Bluetooth system, it will be retained indefinitely. This includes all saved name tags in the phone book and phone pairing information. For information on how to delete this information, see "Deleting a Paired Phone" and "Storing and Deleting Phone Numbers."

Climate Controls

Climate Control Systems

- Automatic Climate Control System 8-1
- Dual Automatic Climate Control System 8-4

Air Vents

- Air Vents 8-8

Maintenance

- Air Intake 8-8
- Passenger Compartment Air Filter 8-8

Climate Control Systems

Automatic Climate Control System

For vehicles with this system, it controls the heating, cooling, and ventilation.

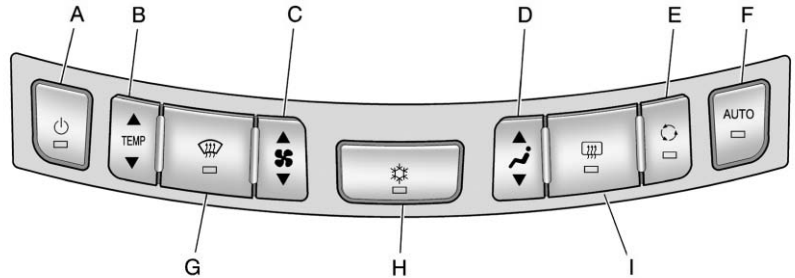

- | | |
|--|---|
| <ul style="list-style-type: none"> A. Power B. Temperature Control C. Fan Control D. Air Delivery Mode Control E. Recirculation | <ul style="list-style-type: none"> F. AUTO G. Defrost H. Air Conditioning I. Rear Window Defogger |
|--|---|

8-2 Climate Controls



Automatic Operation

The system automatically controls the fan speed, air delivery, air conditioning, and recirculation in order to heat or cool the vehicle to the desired temperature.

When the AUTO indicator light is on, the system is in full automatic operation. If the air delivery mode, fan speed, recirculation, or air conditioning setting is adjusted, the AUTO indicator turns off and the selected settings will appear on the display.

To place the system in automatic mode do the following:

1. Press AUTO.
2. Set the temperature. Allow the system time to stabilize. Adjust the temperature as needed for best comfort.

 /  **(Temperature Control):** Press to increase or decrease the temperature.

Manual Operation

 **(Power):** Press to turn the fan on or off.

 **(Fan Control):** Press to increase or decrease the fan speed. The fan speed setting appears on the main display. Pressing either button cancels automatic fan control and the fan can be controlled manually. Press AUTO to return to automatic operation.

 **(Air Delivery Mode Control):** Press to change the direction of the airflow. The current mode appears in the display screen. Pressing either button cancels automatic air delivery control and the direction of the airflow can be controlled manually. Press AUTO to return to automatic operation.

To change the current mode, select one of the following:

 **(Vent):** Air is directed to the instrument panel outlets.

 **(Bi-Level):** Air is divided between the instrument panel outlets and the floor outlets.

 **(Tri-Level):** Air is divided between the windshield, instrument panel, and floor outlets.

 **(Floor):** Air is directed to the floor outlets.

 **(Defog):** Clears the windows of fog or moisture. Air is directed to the windshield and floor outlets.

 **(Defrost):** Clears the windshield of fog or frost more quickly. Air is directed to the windshield. Selecting defrost will disable automatic control.

For best results, clear all snow and ice from the windshield before defrosting.

 **(Air Conditioning):** Press to turn the air conditioning system on or off. If the fan is turned off or the outside temperature falls below freezing, the air conditioning system will not run.

Pressing this button cancels automatic air conditioning and turns off the air conditioner. Press AUTO to return to automatic operation and the air conditioner runs automatically as needed. When the indicator light is on, the air conditioner runs automatically to cool the air inside the vehicle or to dry the air needed to defog the windshield faster.

 **(Recirculation):** Press to alternate between recirculating air inside the vehicle or pulling in outside air. When the indicator light is on, air is being recirculated inside the vehicle. This helps to quickly cool the air inside the vehicle or prevent outside air and odors from entering.

Pressing this button cancels automatic recirculation. Press AUTO to return to automatic operation and recirculation runs automatically as needed.

Rear Window Defogger

 **(Rear Window Defogger):**

Press to turn the rear window defogger on or off.

The rear window defogger turns off automatically after about 10 minutes. If turned on again it runs for about five minutes before turning off. The defogger can also be turned off by turning the ignition to ACC/ACCESSORY or LOCK/OFF.

The rear window defogger can be set to automatic operation. See "Climate and Air Quality" under *Vehicle Personalization on page 5-39*. When auto rear defog is selected, the rear window defogger turns on automatically when the interior temperature is cold and the outside temperature is about 4°C (40°F) and below. The auto rear defogger turns off automatically after about 10 minutes, or after five minutes if the outside temperature is not as cold.

For vehicles with heated outside rearview mirrors, they turn on when the rear window defogger button is on and help to clear fog or frost from the surface of the mirror. See *Heated Mirrors on page 2-17*.

Notice: Do not try to clear frost or other material from the inside of the front windshield and rear window with a razor blade or anything else that is sharp. This may damage the rear window defogger grid and affect your radio's ability to pick up stations clearly. The repairs wouldn't be covered by your warranty.

Remote Start Climate Control Operation: For vehicles with the remote vehicle start feature, the climate control system may run when the vehicle is started remotely. The system uses the driver's previous settings to heat or cool the inside of the vehicle. See *Remote Vehicle Start on page 2-8*.

The rear window defogger turns on if it is cold outside.

8-4 Climate Controls

Sensor

The solar sensor, located on top of the instrument panel near the windshield, monitors the solar heat.

The climate control system uses the sensor information to adjust the temperature, fan speed, recirculation, and air delivery mode for best comfort.

Do not cover the sensor or the automatic climate control system may not work properly.

Dual Automatic Climate Control System

For vehicles with this system, it controls the heating, cooling, and ventilation.

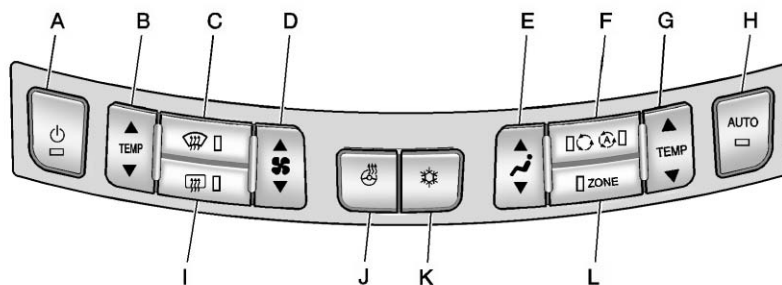

- A. Power
- B. Driver Temperature Control
- C. Defrost
- D. Fan Control
- E. Air Delivery Mode Control
- F. Recirculation/Automatic Recirculation

- G. Passenger Temperature Control
- H. AUTO
- I. Rear Window Defogger
- J. Heated Steering Wheel
- K. Air Conditioning
- L. ZONE

Automatic Operation

The system automatically controls the fan speed, air delivery, air conditioning, and recirculation in order to heat or cool the vehicle to the desired temperature.

When the AUTO indicator light is on, the system is in full automatic operation. If the air delivery mode, fan speed, recirculation, or air conditioning setting is adjusted, the AUTO indicator turns off and the selected settings will appear on the display.

To place the system in automatic mode do the following:

1. Press AUTO.
2. Set the temperature. Allow the system time to stabilize. Adjust the temperature as needed for best comfort.

▲ TEMP ▼ (Driver and Passenger Temperature Control)

The temperature can be adjusted separately for the driver and the passenger. Press to increase or decrease the temperature.

ZONE: Press to link all climate zone settings to the driver's settings. The ZONE indicator light will turn off. When the passenger settings are adjusted, the ZONE indicator light is on.

Manual Operation

 **(Power):** Press to turn the fan off or on.

 **(Fan Control):** Press to increase or decrease the fan speed. The fan speed setting appears on the main display. Pressing either button cancels automatic fan control and the fan is controlled manually. Press AUTO to return to automatic operation.

(Air Delivery Mode Control)

Press to change the direction of the airflow. The current mode appears in the display screen. Pressing either button cancels automatic air delivery control and the direction of the airflow is controlled manually. Press AUTO to return to automatic operation.

To change the current mode, select one of the following:

 **(Vent):** Air is directed to the instrument panel outlets.

 **(Bi-Level):** Air is divided between the instrument panel outlets and the floor outlets.

 **(Tri-Level):** Air is divided between the windshield, instrument panel, and floor outlets.

 **(Floor):** Air is directed to the floor outlets.

 **(Defog):** Clears the windows of fog or moisture. Air is directed to the windshield and floor outlets.

8-6 Climate Controls

 **(Defrost):** Clears the windshield of fog or frost more quickly. Air is directed to the windshield.



For best results, clear all snow and ice from the windshield before defrosting.

 **(Air Conditioning):** Press to turn the air conditioning system on or off. If the fan is turned off or the outside temperature falls below freezing, the air conditioner will not run.

Pressing this button cancels automatic air conditioning and turns off the air conditioner. Press AUTO to return to automatic operation and the air conditioner runs automatically as needed. When the indicator light is on, the air conditioner runs automatically to cool the air inside the vehicle or to dry the air needed to defog the windshield faster.

 **(Recirculation/Auto Recirculation):** Press to change to automatic control of air recirculation inside the vehicle. When the auto recirculation indicator light is on, the air is automatically recirculated as needed to help quickly cool the air inside the vehicle.

In auto recirculation control, the Air Quality Control system may operate when pollution is detected. To adjust the sensitivity of the Air Quality Control, see “Climate and Air Quality” under *Vehicle Personalization on page 5-39*.

When the  indicator light is on, air is recirculated inside the vehicle. If both indicator lights are off, outside air will flow into the vehicle. Press AUTO or  to return to automatic operation.

Auto Defog: The climate control system may have a sensor to automatically detect high humidity inside the vehicle. When high humidity is detected, the climate control system may adjust to outside air supply and turn on the air conditioner. The fan speed may slightly increase to help prevent fogging. If the climate control system does not detect possible window fogging, it returns to normal operation. To turn Auto Defog off or on, see “Climate and Air Quality” under *Vehicle Personalization on page 5-39*.

Rear Window Defogger

(Rear Window Defogger):

Press to turn the rear window defogger on or off.

The rear window defogger turns off automatically after about 10 minutes. If turned on again it runs for about five minutes before turning off. The defogger can also be turned off by turning the ignition to ACC/ACCESSORY or LOCK/OFF.

The rear window defogger can be set to automatic operation. See "Climate and Air Quality" under *Vehicle Personalization on page 5-39*. When auto rear defog is selected, the rear window defogger turns on automatically when the interior temperature is cold and the outside temperature is about 4°C (40°F) and below. The auto rear defogger turns off automatically

after about 10 minutes, or after five minutes if the outside temperature is not as cold.

For vehicles with heated outside rearview mirrors, they turn on when the rear window defogger button is on and help to clear fog or frost from the surface of the mirror. See *Heated Mirrors on page 2-17*.

Notice: Do not try to clear frost or other material from the inside of the front windshield and rear window with a razor blade or anything else that is sharp. This may damage the rear window defogger grid and affect your radio's ability to pick up stations clearly. The repairs wouldn't be covered by your warranty.

 (Heated Steering Wheel): For vehicles with this feature, press to turn on or off. See *Heated Steering Wheel on page 5-3*.

Remote Start Climate Control

Operation: For vehicles with the remote vehicle start feature, the climate control system may run when the vehicle is started remotely. The system uses the driver's previous settings to heat or cool the inside of the vehicle. See *Remote Vehicle Start on page 2-8*.

The rear window defogger turns on if it is cold outside.

Sensor

The solar sensor, located on top of the instrument panel near the windshield, monitors the solar heat.

The climate control system uses the sensor information to adjust the temperature, fan speed, recirculation, and air delivery mode for best comfort.

Do not cover the sensor or the automatic climate control system may not work properly.

Air Vents

Use the louvers located on the air vents to change the direction of the airflow.

To open the vent, move the thumbwheel to **I**. To close the vent, move the thumbwheel to **O**.

Operation Tips

- Keep all outlets open whenever possible for best system performance.
- Keep the path under all seats clear of objects to help circulate the air inside the vehicle more effectively.
- Use of non-GM approved hood deflectors can adversely affect the performance of the system.

Maintenance

Air Intake

Clear away any ice, snow, or leaves from the air intake at the base of the windshield that can block the flow of air into the vehicle.

Passenger Compartment Air Filter

The filter removes dust, pollen, and other airborne irritants from outside air that is pulled into the vehicle.

The filter should be replaced as part of routine scheduled maintenance. See *Scheduled Maintenance on page 11-2* for replacement intervals. To find out what type of filter to use, see *Maintenance Replacement Parts on page 11-9*.

The passenger compartment air filter can be accessed by removing the entire glove box.

1. Open the passenger side door. Remove the end cover located on the side of the instrument panel in the top right corner. Remove the screw affixed to the side of the glove box.
2. Open the glove box door and remove the attached screws from around the glove box.
3. Lower the loosened glove box housing.
4. Unplug both wire cables and remove the glove box.

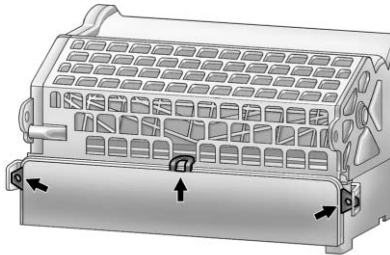

5. Pull the three tabs to release and open the filter door.

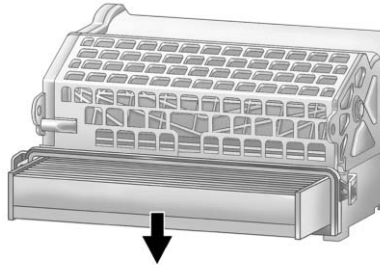

6. Remove the old air filter.
7. Install the new air filter.
8. Reinstall the air filter door.
Re-install the glove box.

See your dealer if additional assistance is needed.

Driving and Operating

Driving Information

Defensive Driving	9-2
Drunk Driving	9-2
Control of a Vehicle	9-3
Braking	9-3
Steering	9-4
Off-Road Recovery	9-6
Loss of Control	9-6
Driving on Wet Roads	9-7
Highway Hypnosis	9-8
Hill and Mountain Roads	9-8
Winter Driving	9-9
If the Vehicle is Stuck	9-11
Vehicle Load Limits	9-12

Starting and Operating

New Vehicle Break-In	9-16
Ignition Positions (Key Access)	9-17
Ignition Positions (Keyless Access)	9-19
Starting the Engine	9-20
Engine Heater	9-23
Retained Accessory Power (RAP)	9-24
Shifting Into Park	9-25
Shifting Out of Park	9-26
Parking Over Things That Burn	9-27

Engine Exhaust

Engine Exhaust	9-27
Running the Vehicle While Parked	9-28

Automatic Transmission

Automatic Transmission	9-28
Manual Mode	9-30

Drive Systems

All-Wheel Drive	9-31
-----------------------	------

Brakes

Antilock Brake System (ABS)	9-32
Parking Brake	9-33
Brake Assist	9-35
Hill Start Assist (HSA)	9-35

Ride Control Systems

Traction Control System (TCS)	9-36
Electronic Stability Control (ESC)	9-37
Limited-Slip Differential	9-38
Selective Ride Control	9-38

Cruise Control

Cruise Control	9-39
----------------------	------

Object Detection Systems

Ultrasonic Parking Assist	9-42
Side Blind Zone Alert (SBZA)	9-44
Rear Vision Camera (RVC)	9-46

9-2 Driving and Operating

Fuel

Fuel	9-50
Recommended Fuel	9-50
Gasoline Specifications (U.S. and Canada Only)	9-51
California Fuel Requirements	9-51
Fuels in Foreign Countries ...	9-52
Fuel Additives	9-52
Filling the Tank	9-53
Filling a Portable Fuel Container	9-54

Towing

General Towing Information	9-55
Driving Characteristics and Towing Tips	9-56
Trailer Towing	9-60
Towing Equipment	9-61

Conversions and Add-Ons

Add-On Electrical Equipment	9-62
--------------------------------------	------

Driving Information

Defensive Driving

Defensive driving means “always expect the unexpected.” The first step in driving defensively is to wear the safety belt. See *Safety Belts on page 3-13*.

WARNING

Assume that other road users (pedestrians, bicyclists, and other drivers) are going to be careless and make mistakes. Anticipate what they might do and be ready. In addition:

- Allow enough following distance between you and the driver in front of you.
- Focus on the task of driving.

(Continued)

WARNING (Continued)

Driver distraction can cause collisions resulting in injury or possible death. These simple defensive driving techniques could save your life.

Drunk Driving

WARNING

Drinking and then driving is very dangerous. Your reflexes, perceptions, attentiveness, and judgment can be affected by even a small amount of alcohol. You can have a serious — or even fatal — collision if you drive after drinking. Do not drink and drive or ride with a driver who has been drinking. Ride home in a cab; or if you are with a group, designate a driver who will not drink.

Death and injury associated with drinking and driving is a global tragedy.

Alcohol affects four things that anyone needs to drive a vehicle: judgment, muscular coordination, vision, and attentiveness.

Police records show that almost 40 percent of all motor vehicle-related deaths involve alcohol. In most cases, these deaths are the result of someone who was drinking and driving. In recent years, more than 17,000 annual motor vehicle-related deaths have been associated with the use of alcohol, with about 250,000 people injured.

For persons under 21, it is against the law in every U.S. state to drink alcohol. There are good medical, psychological, and developmental reasons for these laws.

The obvious way to eliminate the leading highway safety problem is for people never to drink alcohol and then drive.

Medical research shows that alcohol in a person's system can make crash injuries worse, especially injuries to the brain, spinal cord, or heart. This means that when anyone who has been drinking — driver or passenger — is in a crash, that person's chance of being killed or permanently disabled is higher than if the person had not been drinking.

Control of a Vehicle

The following three systems help to control the vehicle while driving — brakes, steering, and accelerator. At times, as when driving on snow or ice, it is easy to ask more of those control systems than the tires and road can provide. Meaning, you can lose control of the vehicle. See *Traction Control System (TCS)* on page 9-36.

Adding non-dealer accessories can affect vehicle performance. See *Accessories and Modifications* on page 10-3.

Braking

See *Brake System Warning Light* on page 5-19.

Braking action involves perception time and reaction time. Deciding to push the brake pedal is perception time. Actually doing it is reaction time.

Average reaction time is about three-fourths of a second. But that is only an average. It might be less with one driver and as long as two or three seconds or more with another. Age, physical condition, alertness, coordination, and eyesight all play a part. So do alcohol, drugs, and frustration. But even in three-fourths of a second, a vehicle moving at 100 km/h (60 mph) travels 20 m (66 ft). That could be a lot of distance in an emergency, so keeping enough space between the vehicle and others is important.

9-4 Driving and Operating

And, of course, actual stopping distances vary greatly with the surface of the road, whether it is pavement or gravel; the condition of the road, whether it is wet, dry, or icy; tire tread; the condition of the brakes; the weight of the vehicle; and the amount of brake force applied.

Avoid needless heavy braking. Some people drive in spurts — heavy acceleration followed by heavy braking — rather than keeping pace with traffic. This is a mistake. The brakes might not have time to cool between hard stops. The brakes will wear out much faster with a lot of heavy braking. Keeping pace with the traffic and allowing realistic following distances eliminates a lot of unnecessary braking. That means better braking and longer brake life.

If the engine ever stops while the vehicle is being driven, brake normally but do not pump the brakes. If the brakes are pumped, the pedal could get harder to push down. If the engine stops, there will still be some power brake assist but it will be used when the brake is applied. Once the power assist is used up, it can take longer to stop and the brake pedal will be harder to push.

Adding non-dealer accessories can affect vehicle performance. See *Accessories and Modifications on page 10-3*.

Steering

Power Steering

If power steering assist is lost because the engine stops or the power steering system is not functioning, the vehicle can be steered but it will take more effort.

Speed Variable Assist Steering

The vehicle has a steering system that varies the amount of effort required to steer the vehicle in relation to the speed of the vehicle.

The amount of steering effort required is less at slower speeds to make the vehicle more maneuverable and easier to park. At faster speeds, the steering effort increases to provide a sport-like feel to the steering. This provides maximum control and stability.

If the vehicle seems harder to steer than normal when parking or driving slowly, there may be a problem with the system. You will still have power steering, but steering will be stiffer than normal at slow speeds. See your dealer for service.

Steering Tips

It is important to take curves at a reasonable speed.

Traction in a curve depends on the condition of the tires and the road surface, the angle at which the curve is banked, and vehicle speed. While in a curve, speed is the one factor that can be controlled.

If there is a need to reduce speed, do it before entering the curve, while the front wheels are straight.

Try to adjust the speed so you can drive through the curve. Maintain a reasonable, steady speed. Wait to accelerate until out of the curve, and then accelerate gently into the straightaway.

Steering in Emergencies

There are times when steering can be more effective than braking. For example, you come over a hill and find a truck stopped in your lane, or a car suddenly pulls out from nowhere, or a child darts out from between parked cars and stops right in front of you. These problems can be avoided by braking — if you can stop in time. But sometimes you cannot stop in time because there is no room. That is the time for evasive action — steering around the problem.

The vehicle can perform very well in emergencies like these. First apply the brakes. See *Braking on page 9-3*. It is better to remove as much speed as possible from a collision. Then steer around the problem, to the left or right depending on the space available.



An emergency like this requires close attention and a quick decision. If holding the steering wheel at the recommended 9 and 3 o'clock positions, it can be turned a full 180 degrees very quickly without removing either hand. But you have to act fast, steer quickly, and just as quickly straighten the wheel once you have avoided the object.

The fact that such emergency situations are always possible is a good reason to practice defensive driving at all times and wear safety belts properly.

Off-Road Recovery

The vehicle's right wheels can drop off the edge of a road onto the shoulder while driving.

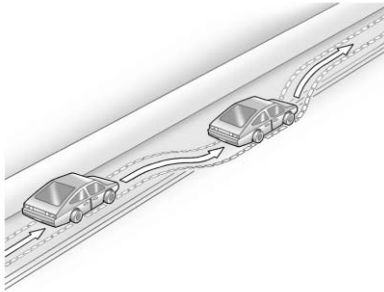

If the level of the shoulder is only slightly below the pavement, recovery should be fairly easy. Ease off the accelerator and then,

if there is nothing in the way, steer so that the vehicle straddles the edge of the pavement. Turn the steering wheel 8 to 13 cm (3 to 5 in), about one-eighth turn, until the right front tire contacts the pavement edge. Then turn the steering wheel to go straight down the roadway.

Loss of Control

Let us review what driving experts say about what happens when the three control systems — brakes, steering, and acceleration — do not have enough friction where the tires meet the road to do what the driver has asked.

In any emergency, do not give up. Keep trying to steer and constantly seek an escape route or area of less danger.

Skidding

In a skid, a driver can lose control of the vehicle. Defensive drivers avoid most skids by taking reasonable care suited to existing conditions, and by not overdriving those conditions. But skids are always possible.

The three types of skids correspond to the vehicle's three control systems. In the braking skid, the wheels are not rolling. In the steering or cornering skid, too much speed or steering in a curve causes tires to slip and lose cornering force. And in the acceleration skid, too much throttle causes the driving wheels to spin.

If the vehicle starts to slide, ease your foot off the accelerator pedal and quickly steer the way you want the vehicle to go. If you start steering quickly enough, the vehicle may straighten out. Always be ready for a second skid if it occurs.

Of course, traction is reduced when water, snow, ice, gravel, or other material is on the road. For safety, slow down and adjust your driving to these conditions. It is important to slow down on slippery surfaces because stopping distance is longer and vehicle control more limited.

While driving on a surface with reduced traction, try to avoid sudden steering, acceleration, or braking, including reducing vehicle speed by shifting to a lower gear. Any sudden changes could cause the tires to slide. You might not realize the surface is slippery until the vehicle is skidding. Learn to recognize warning clues — such as enough water, ice, or packed snow on the road to make a mirrored surface — and slow down when you have any doubt.

Remember: Antilock brakes help avoid only the braking skid.

Driving on Wet Roads

Rain and wet roads can reduce vehicle traction and affect your ability to stop and accelerate. Always drive slower in these types of driving conditions and avoid driving through large puddles and deep-standing or flowing water.

WARNING

Wet brakes can cause crashes. They might not work as well in a quick stop and could cause pulling to one side. You could lose control of the vehicle.

After driving through a large puddle of water or a car/vehicle wash, lightly apply the brake pedal until the brakes work normally.

(Continued)

WARNING (Continued)

Flowing or rushing water creates strong forces. Driving through flowing water could cause the vehicle to be carried away. If this happens, you and other vehicle occupants could drown. Do not ignore police warnings and be very cautious about trying to drive through flowing water.

Hydroplaning

Hydroplaning is dangerous. Water can build up under the vehicle's tires so they actually ride on the water. This can happen if the road is wet enough and you are going fast enough. When the vehicle is hydroplaning, it has little or no contact with the road.

There is no hard and fast rule about hydroplaning. The best advice is to slow down when the road is wet.

9-8 Driving and Operating

Other Rainy Weather Tips

Besides slowing down, other wet weather driving tips include:

- Allow extra following distance.
- Pass with caution.
- Keep windshield wiping equipment in good shape.
- Keep the windshield washer fluid reservoir filled.
- Have good tires with proper tread depth. See *Tires on page 10-46*.
- Turn off cruise control.

Highway Hypnosis

Always be alert and pay attention to your surroundings while driving. If you become tired or sleepy, find a safe place to park the vehicle and rest.

Other driving tips include:

- Keep the vehicle well ventilated.
- Keep interior temperature cool.
- Keep your eyes moving — scan the road ahead and to the sides.
- Check the rearview mirror and vehicle instruments often.

Hill and Mountain Roads

Driving on steep hills or through mountains is different than driving on flat or rolling terrain. Tips for driving in these conditions include:

- Keep the vehicle serviced and in good shape.
- Check all fluid levels and brakes, tires, cooling system, and transmission.
- Shift to a lower gear when going down steep or long hills.

WARNING

If you do not shift down, the brakes could get so hot that they would not work well. You would then have poor braking or even none going down a hill. You could crash. Shift down to let the engine assist the brakes on a steep downhill slope.

⚠ WARNING

Coasting downhill in N (Neutral) or with the ignition off is dangerous. The brakes will have to do all the work of slowing down and they could get so hot that they would not work well. You would then have poor braking or even none going down a hill. You could crash. Always have the engine running and the vehicle in gear when going downhill.

- Stay in your own lane. Do not swing wide or cut across the center of the road. Drive at speeds that let you stay in your own lane.
- Top of hills: Be alert — something could be in your lane (stalled car, accident).

- Pay attention to special road signs (falling rocks area, winding roads, long grades, passing or no-passing zones) and take appropriate action.

Winter Driving**Driving on Snow or Ice**

Drive carefully when there is snow or ice between the tires and the road, creating less traction or grip. Wet ice can occur at about 0°C (32°F) when freezing rain begins to fall, resulting in even less traction. Avoid driving on wet ice or in freezing rain until roads can be treated with salt or sand.

Drive with caution, whatever the condition. Accelerate gently so traction is not lost. Accelerating too quickly causes the wheels to spin and makes the surface under the tires slick, so there is even less traction.

Try not to break the fragile traction. If you accelerate too fast, the drive wheels will spin and polish the surface under the tires even more.

The *Antilock Brake System (ABS)* on page 9-32 improves vehicle stability during hard stops on slippery roads, but apply the brakes sooner than when on dry pavement.

Allow greater following distance on any slippery road and watch for slippery spots. Icy patches can occur on otherwise clear roads in shaded areas. The surface of a curve or an overpass can remain icy when the surrounding roads are clear. Avoid sudden steering maneuvers and braking while on ice.

Turn off cruise control on slippery surfaces.

9-10 Driving and Operating

Blizzard Conditions

Being stuck in snow can be a serious situation. Stay with the vehicle unless there is help nearby. If possible, use the *Roadside Assistance Program (U.S. and Canada)* on page 13-8 or *Roadside Assistance Program (Mexico)* on page 13-10. To get help and keep everyone in the vehicle safe:

- Turn on the hazard warning flashers.
- Tie a red cloth to an outside mirror.

WARNING

Snow can trap engine exhaust under the vehicle. This may cause exhaust gases to get inside. Engine exhaust contains Carbon Monoxide (CO) which cannot be seen or smelled. It can cause unconsciousness and even death.

(Continued)

WARNING (Continued)

If the vehicle is stuck in the snow:

- Clear away snow from around the base of your vehicle, especially any that is blocking the exhaust pipe.
- Check again from time to time to be sure snow does not collect there.
- Open a window about 5 cm (2 in) on the side of the vehicle that is away from the wind to bring in fresh air.
- Fully open the air outlets on or under the instrument panel.
- Adjust the climate control system to a setting that circulates the air inside the vehicle and set the fan speed to the highest setting. See Climate Control System in the Index.

(Continued)

WARNING (Continued)

For more information about carbon monoxide, see *Engine Exhaust* on page 9-27.

Snow can trap exhaust gases under your vehicle. This can cause deadly CO (Carbon Monoxide) gas to get inside. CO could overcome you and kill you. You cannot see it or smell it, so you might not know it is in your vehicle. Clear away snow from around the base of your vehicle, especially any that is blocking the exhaust.

Run the engine for short periods only as needed to keep warm, but be careful.

To save fuel, run the engine for only short periods as needed to warm the vehicle and then shut the engine off and close the window most of the way to save heat. Repeat this until help arrives but only when you feel really uncomfortable from the cold. Moving about to keep warm also helps.

If it takes some time for help to arrive, now and then when you run the engine, push the accelerator pedal slightly so the engine runs faster than the idle speed. This keeps the battery charged to restart the vehicle and to signal for help with the headlamps. Do this as little as possible to save fuel.

If the Vehicle is Stuck

Slowly and cautiously spin the wheels to free the vehicle when stuck in sand, mud, ice, or snow.

If stuck too severely for the traction system to free the vehicle, turn the traction system off and use the rocking method.

WARNING

If the vehicle's tires spin at high speed, they can explode, and you or others could be injured. The vehicle can overheat, causing an engine compartment fire or other damage. Spin the wheels as little as possible and avoid going above 55 km/h (35 mph).

For information about using tire chains on the vehicle, see *Tire Chains* on page 10-69.

Rocking the Vehicle to Get it Out

Turn the steering wheel left and right to clear the area around the front wheels. Turn off any traction system. Shift back and forth between R (Reverse) and a forward gear, spinning the wheels as little as possible. To prevent transmission wear, wait until the wheels stop spinning before shifting gears. Release the accelerator pedal while shifting, and press lightly on the accelerator pedal when the transmission is in gear. Slowly spinning the wheels in the forward and reverse directions causes a rocking motion that could free the vehicle. If that does not get the vehicle out after a few tries, it might need to be towed out. If the vehicle does need to be towed out, see *Towing the Vehicle* on page 10-89.

Vehicle Load Limits

It is very important to know how much weight the vehicle can carry. This weight is called the vehicle capacity weight and includes the weight of all occupants, cargo and all nonfactory-installed options. Two labels on the vehicle show how much weight it may properly carry, the Tire and Loading Information label and the Certification label.

WARNING

Do not load the vehicle any heavier than the Gross Vehicle Weight Rating (GVWR), or either the maximum front or rear Gross Axle Weight Rating (GAWR). This can cause systems to break and change the way the vehicle handles. This could cause loss of control and a crash. Overloading can also shorten the life of the vehicle.

Tire and Loading Information Label

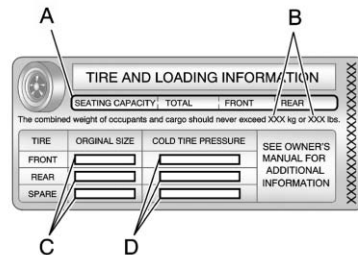

Label Example

A vehicle-specific Tire and Loading Information label is attached to the vehicle's center pillar (B-pillar). With the driver's door open, you will find the label attached below the door lock post.

The Tire and Loading Information label shows the number of occupant seating positions (A), and the maximum vehicle capacity weight (B) in kilograms and pounds.

The Tire and Loading Information label also shows the tire size of the original equipment tires (C) and the recommended cold tire inflation pressures (D). For more information on tires and inflation see *Tires on page 10-46* and *Tire Pressure on page 10-54*.

There is also important loading information on the Certification label. It tells you the Gross Vehicle Weight Rating (GVWR) and the Gross Axle Weight Rating (GAWR) for the front and rear axle. See "Certification Label" later in this section.

Steps for Determining Correct Load Limit

1. Locate the statement "The combined weight of occupants and cargo should never exceed XXX kg or XXX lbs" on your vehicle's placard.
2. Determine the combined weight of the driver and passengers that will be riding in your vehicle.
3. Subtract the combined weight of the driver and passengers from XXX kg or XXX lbs.
4. The resulting figure equals the available amount of cargo and luggage load capacity. For example, if the "XXX" amount equals 1400 lbs and there will be five 150 lb passengers in your vehicle, the amount of available cargo and luggage load capacity is 650 lbs (1400 - 750 (5 x 150) = 650 lbs).
5. Determine the combined weight of luggage and cargo being loaded on the vehicle. That weight may not safely exceed the available cargo and luggage load capacity calculated in Step 4.

9-14 Driving and Operating

6. If your vehicle will be towing a trailer, the load from your trailer will be transferred to your vehicle. Consult this manual to determine how this reduces the available cargo and luggage load capacity of your vehicle.

See *Trailer Towing on page 9-60* for important information on towing a trailer, towing safety rules, and trailering tips.

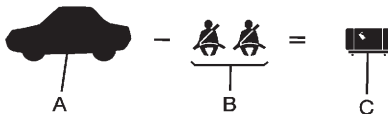

Example 1

- A. Vehicle Capacity Weight for Example 1 = 453 kg (1,000 lbs).
- B. Subtract Occupant Weight @ 68 kg (150 lbs) × 2 = 136 kg (300 lbs).
- C. Available Occupant and Cargo Weight = 317 kg (700 lbs).

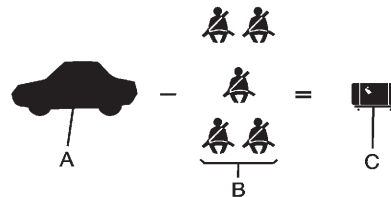

Example 2

- A. Vehicle Capacity Weight for Example 2 = 453 kg (1,000 lbs).
- B. Subtract Occupant Weight @ 68 kg (150 lbs) × 5 = 340 kg (750 lbs).
- C. Available Cargo Weight = 113 kg (250 lbs).

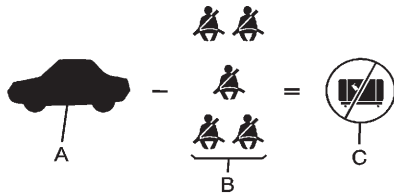

Example 3

- A. Vehicle Capacity Weight for Example 3 = 453 kg (1,000 lbs).
- B. Subtract Occupant Weight @ 91 kg (200 lbs) × 5 = 453 kg (1,000 lbs).
- C. Available Cargo Weight = 0 kg (0 lbs).

Refer to the vehicle's Tire and Loading Information label for specific information about the vehicle's capacity weight and

seating positions. The combined weight of the driver, passengers, and cargo should never exceed the vehicle's capacity weight.

Certification Label

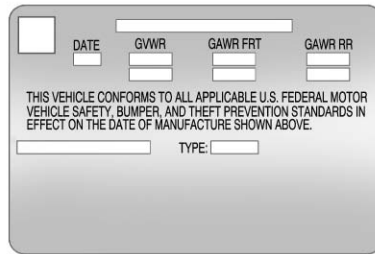

Label Example

A vehicle-specific Certification label is attached to the driver side center pillar (B-pillar). The label tells the gross weight capacity of the vehicle, called the Gross Vehicle Weight Rating (GVWR). The GVWR includes the weight of the vehicle, all

occupants, fuel, and cargo. Never exceed the GVWR for the vehicle, or the Gross Axle Weight Rating (GAWR) for either the front or rear axle.

And, if there is a heavy load, it should be spread out. See "Steps for Determining Correct Load Limit" earlier in this section.

⚠ WARNING

Do not load the vehicle any heavier than the Gross Vehicle Weight Rating (GVWR), or either the maximum front or rear Gross Axle Weight Rating (GAWR). This can cause systems to break and change the way the vehicle handles. This could cause loss of control and a crash. Overloading can also shorten the life of the vehicle.

If you put things inside the vehicle — like suitcases, tools, packages, or anything else — they will go as fast as the vehicle goes. If you have to stop or turn quickly, or if there is a crash, they will keep going.

WARNING

Things inside the vehicle can strike and injure people in a sudden stop or turn, or in a crash.

- Put things in the cargo area of the vehicle. In the cargo area, put them as far forward as possible. Try to spread the weight evenly.

(Continued)

WARNING (Continued)

- Never stack heavier things, like suitcases, inside the vehicle so that some of them are above the tops of the seats.
- Do not leave an unsecured child restraint in the vehicle.
- Secure loose items in the vehicle.
- Do not leave a seat folded down unless needed.

Starting and Operating

New Vehicle Break-In

Notice: The vehicle does not need an elaborate break-in. But it will perform better in the long run if you follow these guidelines:

- Do not drive at any one constant speed, fast or slow, for the first 805 km (500 mi). Do not make full-throttle starts. Avoid downshifting to brake or slow the vehicle.
- During the first 1 000 km (600 mi), avoid using more than moderate acceleration in lower gears and avoid vehicle speeds above 110 km/h (68 mph).
- Between the first 1 000 km (600 mi) and 5 000 km (3,000 mi), heavy acceleration in lower gears can be used.

Vehicle speeds above 110 km/h (68 mph) should be limited to five minutes per use.

- Avoid making hard stops for the first 322 km (200 mi) or so. During this time the new brake linings are not yet broken in. Hard stops with new linings can mean premature wear and earlier replacement. Follow this breaking-in guideline every time you get new brake linings.
- Do not tow a trailer during break-in. See *Driving Characteristics and Towing Tips* on page 9-56 for the trailer towing capabilities of your vehicle and more information.

Following break-in, engine speed and load can be gradually increased.

Ignition Positions (Key Access)

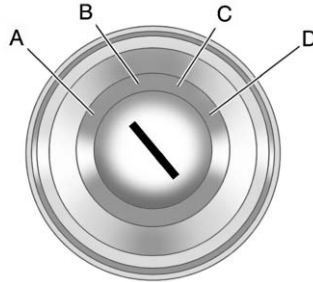

The ignition switch has four different positions.

Notice: Using a tool to force the key to turn in the ignition could cause damage to the switch or break the key. Use the correct key, make sure it is all the way in, and turn it only with your hand. If the key cannot be turned by hand, see your dealer.

The key must be fully extended to start the vehicle.

To shift out of P (Park), turn the ignition to ON/RUN and apply the brake pedal.

A (STOPPING THE ENGINE/ LOCK/OFF): When the vehicle is stopped, turn the ignition switch to LOCK/OFF to turn the engine off. Retained Accessory Power (RAP) will remain active. See *Retained Accessory Power (RAP)* on page 9-24 for more information.

This is the only position from which the key can be removed. This locks the ignition and automatic transmission.

Do not turn the engine off when the vehicle is moving. This will cause a loss of power assist in the brake and steering systems and disable the airbags.

9-18 Driving and Operating

In an emergency, if the vehicle must be shut off while driving:

1. Brake using a firm and steady pressure. Do not pump the brakes repeatedly. This may deplete power assist, requiring increased brake pedal force.
2. Shift the vehicle to N (Neutral). This can be done while the vehicle is moving. After shifting to N (Neutral), firmly apply the brakes and steer the vehicle to a safe location.
3. Come to a complete stop, shift to P (Park), and turn the ignition to LOCK/OFF. On vehicles with an automatic transmission, the shift lever must be in P (Park) to turn the ignition switch to the LOCK/OFF position.
4. Set the parking brake. See *Parking Brake* on page 9-33.

WARNING

Turning off the vehicle while moving may cause loss of power assist in the brake and steering systems and disable the airbags. While driving, only shut the vehicle off in an emergency.

5. If the vehicle must be shut off while driving, turn the ignition to ACC/ACCESSORY.

The ignition switch can bind in the LOCK/OFF position with the wheels turned off center. If this happens, move the steering wheel from right to left while turning the key to ACC/ACCESSORY. If this does not work, then the vehicle needs service.

B (ACC/ACCESSORY): This position provides power to some of the electrical accessories. It unlocks the ignition. To move the key from ACC/ACCESSORY to LOCK/OFF, the shift lever must be in P (Park).

C (ON/RUN): The ignition switch stays in this position when the engine is running. This position can be used to operate the electrical accessories, including the ventilation fan and 12-volt power outlet, as well as to display some warning and indicator lights. The transmission is also unlocked in this position.

The battery could be drained if the key is left in the ACC/ACCESSORY or ON/RUN position with the engine off. The vehicle might not restart if the battery is allowed to drain for an extended period of time.

D (START): This position starts the engine. When the engine starts, release the key. The ignition switch will return to ON/RUN for normal driving.

A warning tone sounds when the driver door is opened when the ignition is still in ACC/ACCESSORY and the key is in the ignition.

Ignition Positions (Keyless Access)

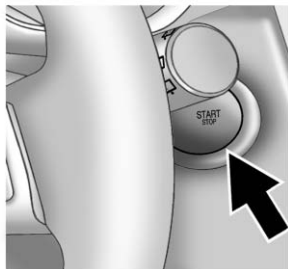

The vehicle has an electronic keyless ignition with push-button start.

Pressing the button cycles it through three modes, ACC/ACCESSORY, ON/RUN/START, and Stopping the Engine/OFF.

The transmitter must be in the vehicle for the system to operate. If the push-button start is not working, the vehicle may be near

a strong radio antenna signal causing interference to the keyless access system. See *Remote Keyless Entry (RKE) System Operation* on page 2-4 for more information.

To shift out of P (Park), the vehicle must be in ACC/ACCESSORY or ON/RUN and the brake pedal must be applied.

Stopping the Engine/OFF (No LED Lights): When the vehicle is stopped, press the engine START/STOP button once to turn the engine off.

If the vehicle is in P (Park), the ignition will turn off, and Retained Accessory Power (RAP) will remain active. See *Retained Accessory Power (RAP)* on page 9-24 for more information.

If the vehicle is not in P (Park), the ignition will return to ACC/ACCESSORY and display the message SHIFT TO PARK in the Driver Information Center (DIC).

See *Transmission Messages* on page 5-38 for more information. When the vehicle is shifted into P (Park), the ignition system will switch to OFF.

Do not turn the engine off when the vehicle is moving. This will cause a loss of power assist in the brake and steering systems and disable the airbags.

In an emergency, if the vehicle must be shut off while driving:

1. Brake using a firm and steady pressure. Do not pump the brakes repeatedly. This may deplete power assist, requiring increased brake pedal force.
2. Shift the vehicle to N (Neutral). This can be done while the vehicle is moving. After shifting to N (Neutral), firmly apply the brakes and steer the vehicle to a safe location.

3. Come to a complete stop, shift to P (Park), and turn the ignition to LOCK/OFF. On vehicles with an automatic transmission, the shift lever must be in P (Park) to turn the ignition switch to the LOCK/OFF position.
4. Set the parking brake. See *Parking Brake* on page 9-33.

 **WARNING**

Turning off the vehicle while moving may cause loss of power assist in the brake and steering systems and disable the airbags. While driving, only shut the vehicle off in an emergency.

5. If the vehicle must be shut off while driving, switch the ignition to ACC/ACCESSORY.

ACC/ACCESSORY (Amber LED Light): This mode allows you to use some electrical accessories when the engine is off.

With the ignition off, pressing the button one time without the brake pedal applied will place the ignition system in ACC/ACCESSORY.

The ignition will switch from ACC/ACCESSORY to OFF after five minutes to prevent battery run down.

ON/RUN/START (Green LED Light): This mode is for driving and starting. With the ignition off, and the brake pedal applied, pressing the button once will place the ignition system in ON/RUN/START. Once engine cranking begins, release the button. Engine cranking will continue until the engine starts. See *Starting the Engine* on page 9-20 for more information. The ignition will then remain in ON/RUN.

Starting the Engine

Move the shift lever to P (Park) or N (Neutral). The engine will not start in any other position. To restart the engine when the vehicle is already moving, use N (Neutral) only.

Notice: Do not try to shift to P (Park) if the vehicle is moving. If you do, you could damage the transmission. Shift to P (Park) only when the vehicle is stopped.

Notice: The engine is designed to work with the electronics in the vehicle. If you add electrical parts or accessories, you could change the way the engine operates. Before adding electrical equipment, check with your dealer. If you do not, the engine might not perform properly. Any resulting damage would not be covered by the vehicle warranty.

Starting Procedure (Key Access)

1. With your foot off the accelerator pedal, turn the ignition key to START. When the engine starts, let go of the ignition.

The idle speed will go down as your engine gets warm. Do not race the engine immediately after starting it. Operate the engine and transmission gently to allow the oil to warm up and lubricate all moving parts.

The vehicle has a Computer-Controlled Cranking System. This feature assists in starting the engine and protects components. If the ignition key is turned to the START position, and then released when the engine begins cranking, the engine will continue cranking for a few seconds or until the vehicle

starts. If the engine does not start and the key is held in START for many seconds, cranking will be stopped after 15 seconds to prevent cranking motor damage. To prevent gear damage, this system also prevents cranking if the engine is already running. Engine cranking can be stopped by turning the ignition switch to ACC/ACCESSORY or LOCK/OFF.

Notice: Cranking the engine for long periods of time, by returning the key to the START position immediately after cranking has ended, can overheat and damage the cranking motor, and drain the battery. Wait at least 15 seconds between each try, to let the cranking motor cool down.

2. If the engine does not start after 5-10 seconds, especially in very cold weather (below -18°C or 0°F), it could be flooded with too much gasoline. Try pushing the accelerator pedal all the way to the floor and holding it there as you hold the key in START, or press the START button, for up to a maximum of 15 seconds. Wait at least 15 seconds between each try, to allow the cranking motor to cool down. When the engine starts, let go of the key or button, and the accelerator. If the vehicle starts briefly but then stops again, do the same thing. This clears the extra gasoline from the engine. Do not race the engine immediately after starting it. Operate the engine and transmission gently until the oil warms up and lubricates all moving parts.

Starting Procedure (Keyless Access)

1. If the vehicle has the keyless access system, the transmitter must be in the vehicle. Put your foot on the brake pedal and push the START button. When the engine begins cranking, let go of the button.

The idle speed will go down as your engine gets warm. Do not race the engine immediately after starting it. Operate the engine and transmission gently to allow the oil to warm up and lubricate all moving parts.

If the transmitter is not in the vehicle or something is interfering with the transmitter, the Driver Information Center

(DIC) will display NO REMOTE DETECTED. See *Driver Information Center (DIC) on page 5-25* for more information.

If the battery in the keyless access transmitter needs replacing, the DIC displays REPLACE BATTERY IN REMOTE KEY. The vehicle can still be driven. See “Starting the Vehicle with a Low Transmitter Battery” in *Remote Keyless Entry (RKE) System Operation on page 2-4* for more information.

The vehicle has a Computer-Controlled Cranking System. This feature assists in starting the engine and protects components. If the START button is pressed, and then released when the engine

begins cranking, the engine will continue cranking for a few seconds or until the vehicle starts. If the engine does not start and the button is pressed for many seconds, cranking will be stopped after 15 seconds to prevent cranking motor damage. To prevent gear damage, this system also prevents cranking if the engine is already running. Engine cranking can be stopped by pressing the START button a second time.

Notice: Cranking the engine for long periods of time, by returning the key to the START position immediately after cranking has ended, can overheat and damage the cranking motor, and drain the battery. Wait at least 15 seconds between each try, to let the cranking motor cool down.

2. If the engine does not start after 5-10 seconds, especially in very cold weather (below -18°C or 0°F), it could be flooded with too much gasoline. Try pushing the accelerator pedal all the way to the floor and holding it there as you hold the key in START, or press the START button, for up to a maximum of 15 seconds. Wait at least 15 seconds between each try, to allow the cranking motor to cool down. When the engine starts, let go of the key or button, and the accelerator. If the vehicle starts briefly but then stops again, do the same thing. This clears the extra gasoline from the engine. Do not race the engine immediately after starting it. Operate the engine and transmission gently until the oil warms up and lubricates all moving parts.

Engine Heater

The engine coolant heater, if available, can help in cold weather conditions at or below -18°C (0°F) for easier starting and better fuel economy during engine warm-up. Plug in the coolant heater at least four hours before starting the vehicle. An internal thermostat in the plug-end of the cord will prevent engine coolant heater operation at temperatures above -18°C (0°F).

To Use the Engine Coolant Heater

1. Turn off the engine.
2. Open the hood and unwrap the electrical cord.

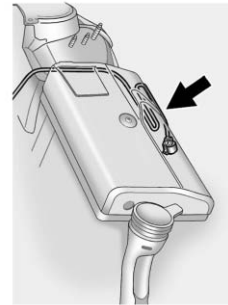

V6 Engine

The electrical cord is located on the driver side of the engine compartment, between the fender and the engine compartment fuse block on vehicles with a six cylinder engine.

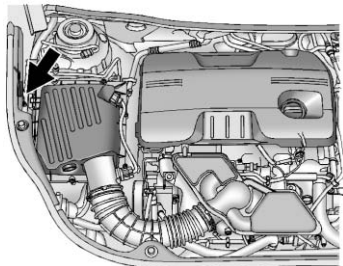

4 Cylinder Engine

The electrical cord is located on the passenger side of the engine compartment, between the fender and the air cleaner on vehicles with a four cylinder engine.

3. Plug it into a normal, grounded 110-volt AC outlet.

WARNING

Plugging the cord into an ungrounded outlet could cause an electrical shock. Also, the wrong kind of extension cord could overheat and cause a fire. You could be seriously injured. Plug the cord into a properly grounded three-prong 110-volt AC outlet. If the cord will not reach, use a heavy-duty three-prong extension cord rated for at least 15 amps.

4. Before starting the engine, be sure to unplug and store the cord as it was before to keep it away from moving engine parts.

The length of time the heater should remain plugged in depends on several factors. Ask a dealer in the area where you will be parking the vehicle for the best advice on this.

Retained Accessory Power (RAP)

These vehicle accessories can be used for up to 10 minutes after the engine is turned off:

- Audio System
- Power Windows
- Sunroof (If Equipped)
- Auxiliary Power Outlet

Power to the audio system will continue to operate for up to 10 minutes or until the driver door is opened.

Power to the power windows and sunroof will continue to operate for up to 10 minutes or until any door is opened.

All of these features will work when the ignition is in ON/RUN or ACC/ACCESSORY.

Shifting Into Park

WARNING

It can be dangerous to get out of the vehicle if the shift lever is not fully in P (Park) with the parking brake firmly set. The vehicle can roll. If you have left the engine running, the vehicle can move suddenly. You or others could be injured. To be sure the vehicle will not move, even when you are on fairly level ground, use the steps that follow.

1. Hold the brake pedal down and set the parking brake.
See Parking Brake on page 9-33 for more information.
2. Move the shift lever into P (Park) by pushing the lever all the way toward the front of the vehicle.
3. Turn the ignition off.

Leaving the Vehicle with the Engine Running

WARNING

It can be dangerous to leave the vehicle with the engine running. The vehicle could move suddenly if the shift lever is not fully in P (Park) with the parking brake firmly set. And, if you leave the vehicle with the engine running, it could overheat and even catch fire. You or others could be injured. Do not leave the vehicle with the engine running.

If you have to leave the vehicle with the engine running, be sure the vehicle is in P (Park) and the parking brake is firmly set before you leave it. After you have moved the shift lever into P (Park), hold down the regular brake pedal. See if you can move the shift lever away from P (Park) without first pulling it toward you. If you can, it means that the shift lever was not fully locked into P (Park).

Torque Lock

Torque lock is when the weight of the vehicle puts too much force on the parking pawl in the transmission. This happens when parking on a hill and shifting the transmission into P (Park) is not done properly and then it is difficult to shift out of P (Park). To prevent torque lock, set the parking brake and then shift into P (Park). To find out how, see "Shifting Into P (Park)" listed previously.

If torque lock does occur, your vehicle may need to be pushed uphill by another vehicle to relieve the parking pawl pressure, so you can shift out of P (Park).

If you are towing a trailer and parking on a hill, see *Driving Characteristics and Towing Tips* on page 9-56.

Shifting Out of Park

Automatic Transmission Shift Lock

The vehicle has an electronic shift lock release system. The shift lock release is designed to:

- Prevent ignition key removal unless the shift lever is in P (Park).
- Prevent movement of the shift lever out of P (Park), unless the ignition is in ON/RUN and the brake pedal is applied.

The shift lock is always functional except in the case of an uncharged or low voltage (less than 9-volt) battery.

If the vehicle has an uncharged battery or a battery with low voltage, try charging or jump starting the battery. See *Jump Starting* on page 10-86.

If the console shift lever cannot be moved out of P (Park):

1. Apply and maintain the regular brakes.
2. Turn the ignition to the ON/RUN position. See *Ignition Positions (Key Access)* on page 9-17 or *Ignition Positions (Keyless Access)* on page 9-19 for more information.
3. Let up on the shift lever and make sure the shift lever is pushed all the way into P (Park).
4. Press the shift lever button.
5. Move the shift lever into the desired gear.

If you still cannot move the shift lever from P (Park), consult your dealer or a professional towing service.

Parking Over Things That Burn

 **WARNING**

Things that can burn could touch hot exhaust parts under the vehicle and ignite. Do not park over papers, leaves, dry grass, or other things that can burn.

Engine Exhaust

 **WARNING**

Engine exhaust contains Carbon Monoxide (CO) which cannot be seen or smelled. Exposure to CO can cause unconsciousness and even death.

Exhaust may enter the vehicle if:

- The vehicle idles in areas with poor ventilation (parking garages, tunnels, deep snow that may block underbody airflow or tail pipes).
- The exhaust smells or sounds strange or different.
- The exhaust system leaks due to corrosion or damage.
- The vehicle exhaust system has been modified, damaged or improperly repaired.

(Continued)

WARNING (Continued)

- There are holes or openings in the vehicle body from damage or after-market modifications that are not completely sealed.

If unusual fumes are detected or if it is suspected that exhaust is coming into the vehicle:

- Drive it only with the windows completely down.
- Have the vehicle repaired immediately.

Never park the vehicle with the engine running in an enclosed area such as a garage or a building that has no fresh air ventilation.

Running the Vehicle While Parked

It is better not to park with the engine running. But if you ever have to, here are some things to know.

WARNING

Idling a vehicle in an enclosed area with poor ventilation is dangerous. Engine exhaust may enter the vehicle. Engine exhaust contains Carbon Monoxide (CO) which cannot be seen or smelled. It can cause unconsciousness and even death. Never run the engine in an enclosed area that has no fresh air ventilation. For more information, see *Engine Exhaust* on page 9-27.

WARNING

It can be dangerous to get out of the vehicle if the automatic transmission shift lever is not fully in P (Park) with the parking brake firmly set. The vehicle can roll. Do not leave the vehicle when the engine is running unless you have to. If you have left the engine running, the vehicle can move suddenly. You or others could be injured. To be sure the vehicle will not move, even when you are on fairly level ground, always set the parking brake and move the shift lever to P (Park).

Follow the proper steps to be sure the vehicle will not move. See *Shifting Into Park* on page 9-25.

If parking on a hill and pulling a trailer, see *Driving Characteristics and Towing Tips* on page 9-56.

Automatic Transmission

The automatic transmission has a shift lever located on the console between the seats.

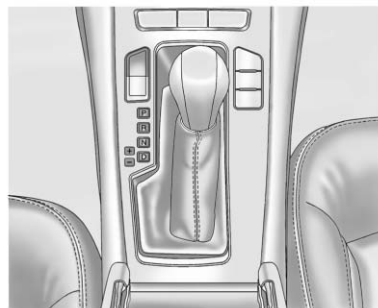

P (Park): This position locks the front wheels. It is the best position to use when starting the engine because the vehicle cannot move easily.

 **WARNING**

It is dangerous to get out of the vehicle if the shift lever is not fully in P (Park) with the parking brake firmly set. The vehicle can roll.

Do not leave the vehicle when the engine is running unless you have to. If you have left the engine running, the vehicle can move suddenly. You or others could be injured. To be sure the vehicle will not move, even when you are on fairly level ground, always set the parking brake and move the shift lever to P (Park). See *Shifting Into Park* on page 9-25. If you are pulling a trailer, see *Driving Characteristics and Towing Tips* on page 9-56.

Make sure the shift lever is fully in P (Park) before starting the engine. The vehicle has an automatic transmission shift lock control system. The regular brake must

be fully applied first and then the shift lever button pressed before shifting from P (Park) when the ignition key is in ON/RUN. If you cannot shift out of P (Park), ease pressure on the shift lever, then push the shift lever all the way into P (Park) as you maintain brake application. Then press the shift lever button and move the shift lever into another gear. See *Shifting Out of Park* on page 9-26.

R (Reverse): Use this gear to back up.

Notice: Shifting to R (Reverse) while the vehicle is moving forward could damage the transmission. The repairs would not be covered by the vehicle warranty. Shift to R (Reverse) only after the vehicle is stopped.

To rock the vehicle back and forth to get out of snow, ice, or sand without damaging the transmission, see *If the Vehicle is Stuck* on page 9-11.

N (Neutral): In this position, the engine does not connect with the wheels. To restart the engine when the vehicle is already moving, use N (Neutral) only. Also, use N (Neutral) when the vehicle is being towed.

 **WARNING**

Shifting into a drive gear while the engine is running at high speed is dangerous. Unless your foot is firmly on the brake pedal, the vehicle could move very rapidly. You could lose control and hit people or objects. Do not shift into a drive gear while the engine is running at high speed.

Notice: Shifting out of P (Park) or N (Neutral) with the engine running at high speed may damage the transmission. The repairs would not be covered by the vehicle warranty. Be sure the engine is not running at high speed when shifting the vehicle.

D (Drive): This position is for normal driving. It provides the best fuel economy. If more power is needed for passing, and the vehicle is:

- Going less than 56 km/h (35 mph), push the accelerator pedal about halfway down.
- Going about 56 km/h (35 mph) or more, push the accelerator all the way down.

Notice: If the vehicle seems to accelerate slowly or not shift gears when you go faster, and you continue to drive the vehicle that way, you could damage the transmission. Have the vehicle serviced right away. You can drive in L (Low) when you are driving less than 56 km/h (35 mph) and D (Drive) for higher speeds until then.

Manual Mode: This position is shown on the shifter as a +/- . It allows the driver to select the gears appropriate for current driving conditions. See *Manual Mode on page 9-30* for more information.

Manual Mode

Driver Shift Control (DSC)

Notice: If you drive the vehicle at a high rpm without upshifting while using Driver Shift Control (DSC), you could damage the vehicle. Always upshift when necessary while using DSC.

Driver Shift Control (DSC) allows you to shift an automatic transmission similar to a manual transmission. To use the DSC feature:

With Selective Ride Control

1. Move the shift lever to the left from D (Drive).

The vehicle will be in Sport Mode. The gear indicator in the DIC will still display a D for Drive, and the SPORT MODE ON message will be displayed momentarily. See *Driver Information Center (DIC) on page 5-25*. When you are in Sport Mode, the vehicle will

still shift automatically, but chassis tuning is modified. See *Selective Ride Control on page 9-38*. If you move the shift lever forward or rearward, the transmission will enter Manual Mode, and the DIC gear indicator will change to an M followed by a number representing the gear the vehicle is currently in.

2. In Manual Mode, press the shift lever forward to upshift or rearward to downshift.

Without Selective Ride Control

1. Move the shift lever to the left from D (Drive).

The transmission will enter Manual Mode. The DIC gear indicator will change to an M followed by a number representing the gear the vehicle is currently in.

2. In Manual Mode, press the shift lever forward to upshift or rearward to downshift.



**Uplevel Display Shown,
Base Model Similar**

The display on the instrument panel cluster will show which gear the vehicle is in. The number indicates the requested gear range when moving the shift lever forward or rearward.

The transmission will only allow you to shift into gears appropriate for the vehicle speed and engine revolutions per minute (rpm). The transmission will not automatically shift to the next lower gear if the engine rpm is too high, nor to the next higher gear when the maximum engine rpm is reached.

While in the DSC mode, the transmission will automatically downshift when the vehicle comes to a stop. This will allow for more power during take-off.

When accelerating the vehicle from a stop in snowy and icy conditions, you may want to shift into second gear. A higher gear allows you to gain more traction on slippery surfaces.

Drive Systems

All-Wheel Drive

Vehicles with this feature always send engine power to all four wheels. It is fully automatic, and adjusts itself as needed for road conditions.

When using a compact spare tire on an AWD vehicle, the system automatically detects the compact spare and disables AWD. To restore AWD operation and prevent excessive wear on the system, replace the compact spare with a full-size tire as soon as possible. See *Compact Spare Tire* on page 10-85 for more information.

Brakes

Antilock Brake System (ABS)

This vehicle has the Antilock Brake System (ABS), an advanced electronic braking system that helps prevent a braking skid.

When the engine is started and the vehicle begins to drive away, ABS checks itself. A momentary motor or clicking noise might be heard while this test is going on, and it might even be noticed that the brake pedal moves a little. This is normal.



If there is a problem with ABS, this warning light stays on. See *Antilock Brake System (ABS) Warning Light on page 5-21*.

If driving safely on a wet road and it becomes necessary to slam on the brakes and continue braking to avoid a sudden obstacle, a computer senses that the wheels are slowing down. If one of the wheels is about to stop rolling, the computer will separately work the brakes at each wheel.

ABS can change the brake pressure to each wheel, as required, faster than any driver could. This can help the driver steer around the obstacle while braking hard.

As the brakes are applied, the computer keeps receiving updates on wheel speed and controls braking pressure accordingly.

Remember: ABS does not change the time needed to get a foot up to the brake pedal or always decrease stopping distance. If you get too close to the vehicle in front of you, there will not be enough time to apply the brakes if that vehicle suddenly slows or stops. Always leave enough room up ahead to stop, even with ABS.

Using ABS

Do not pump the brakes. Just hold the brake pedal down firmly and let ABS work. You might hear the ABS pump or motor operating and feel the brake pedal pulsate, but this is normal.

Braking in Emergencies

ABS allows the driver to steer and brake at the same time. In many emergencies, steering can help more than even the very best braking.

Parking Brake

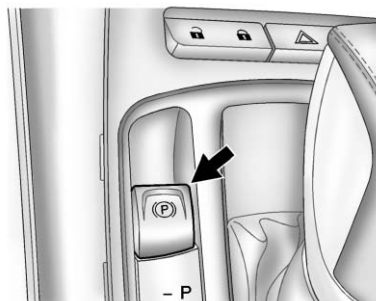

The vehicle has an Electric Parking Brake (EPB). The switch for the EPB is in the center console.

The EPB can always be activated, even if the ignition is off. To prevent draining the battery, avoid repeated cycles of the EPB system when the engine is not running.

The system has a parking brake status light and a parking brake warning light. See *Electric Parking Brake Light* on page 5-20. There are also three Driver Information Center (DIC) messages. See *Brake System Messages* on page 5-33 for more information. In case of insufficient electrical power, the EPB cannot be applied or released.

Before leaving the vehicle, check the parking brake status light to ensure that the parking brake is applied.

EPB Apply

The EPB can be applied any time the vehicle is stopped. The EPB is applied by momentarily lifting up on the EPB switch. Once fully applied, the parking brake status light will be on. While the brake is being applied, the status light will flash until full apply is reached. If the light does not come on, or remains flashing, you need to have the vehicle serviced. Do not drive the vehicle if the parking brake status light is flashing. See your dealer. See *Electric Parking Brake Light* on page 5-20 for more information.

If the EPB is applied while the vehicle is in motion, a chime will sound, and the DIC message RELEASE PARK BRAKE SWITCH will be displayed. The vehicle will decelerate as long as the switch is held in the up position. Releasing the EPB switch during the deceleration will release the parking brake. If the switch is held in the up position until the vehicle comes to a stop, the EPB will remain applied.

If the parking brake status light flashes continuously, the EPB is only partially applied or released, or there is a problem with the EPB. The DIC message SERVICE PARK BRAKE will be displayed. If this light flashes continuously, release the EPB, and attempt to apply it again. If this light continues to flash, do not drive the vehicle. See your dealer.

If the parking brake warning light is on, the EPB has detected an error in another system and is operating with reduced functionality. To apply the EPB when this light is on, lift up on the EPB switch and hold it in the up position. Full application of the parking brake by the EPB system may take a longer period of time than normal when this light is on. Continue to hold the switch until the parking brake status light remains on. If the parking brake warning light is on, see your dealer.

If the EPB fails to apply, the rear wheels should be blocked to prevent vehicle movement.

EPB Release

To release the EPB, place the ignition in the ON/RUN position, apply and hold the brake pedal, and push down momentarily on the EPB switch. If you attempt to release the EPB without the brake pedal applied, a chime will sound, and the DIC message PRESS BRAKE PEDAL TO RELEASE PARK BRAKE will be displayed. The EPB is released when the parking brake status light is off.

If the parking brake warning light is on, the EPB has detected an error in another system and is operating with reduced functionality. To release the EPB when this light is on, push down on the EPB switch and hold it in the down position. EPB release may take a longer period of time than normal when this light is on. Continue to hold the switch until the parking brake status light is off. If the light is on, see your dealer.

Notice: Driving with the parking brake on can overheat the brake system and cause premature wear or damage to brake system parts. Make sure that the parking brake is fully released and the brake warning light is off before driving.

Automatic EPB Release

The EPB will automatically release if the vehicle is running, placed into gear, and an attempt is made to drive away. Avoid rapid acceleration when the EPB is applied, to preserve parking brake lining life.

For maximum EPB force when towing a trailer or parking on a hill, pull the EPB switch twice. If you are towing a trailer and parking on a hill, see *Driving Characteristics and Towing Tips on page 9-56* for more information.

Brake Assist

This vehicle has a brake assist feature designed to assist the driver in stopping or decreasing vehicle speed in emergency driving conditions. This feature uses the stability system hydraulic brake control module to supplement the power brake system under conditions where the driver has quickly and forcefully applied the brake pedal in an attempt to quickly stop or slow down the vehicle. The stability system hydraulic brake control module increases brake pressure at each corner of the vehicle until the ABS activates. Minor brake pedal pulsation or pedal movement during this time is normal and the driver should continue to apply the brake pedal as the driving situation dictates. The brake assist feature will automatically disengage when the brake pedal is released or brake pedal pressure is quickly decreased.

Hill Start Assist (HSA)

This vehicle has a Hill Start Assist (HSA) feature, which may be useful when the vehicle is stopped on a grade. This feature is designed to prevent the vehicle from rolling, either forward or rearward, during vehicle drive off. After the driver completely stops and holds the vehicle in a complete standstill on a grade, HSA will be automatically activated. During the transition period between when the driver releases the brake pedal and starts to accelerate to drive off on a grade, HSA holds the braking pressure to ensure that there is no rolling. The brakes will automatically release when the accelerator pedal is applied within the two-second window. It will not activate if the vehicle is in a drive gear and facing downhill or if the vehicle is facing uphill and in R (Reverse).

Ride Control Systems

Traction Control System (TCS)

The vehicle has a traction control system that limits wheel spin. This is especially useful in slippery road conditions. On a front-wheel-drive vehicle, the system operates if it senses that one or both of the front wheels are spinning or beginning to lose traction. On an All-Wheel-Drive (AWD) vehicle, the system will operate if it senses that any of the wheels are spinning or beginning to lose traction. When this happens, the system brakes the spinning wheel(s) and/or reduces engine power to limit wheel spin.

The system may be heard or felt while it is working, but this is normal.



The TCS/StabiliTrak warning light flashes to indicate that the traction control system is active.

This warning light comes on if there is a problem with the traction control system.

See *Traction Off Light on page 5-21*. When this warning light is on, the system does not limit wheel spin. Adjust your driving accordingly.

TCS automatically comes on whenever the vehicle is started. To limit wheel spin, especially in slippery road conditions, the system should always be left on. But, TCS can be turned off if needed.

Notice: Do not repeatedly brake or accelerate heavily when TCS is off. The vehicle's driveline could be damaged.





The TCS off light comes on to indicate that the traction control system has been turned off.

When TCS is switched off on AWD vehicles, the system may still make noise. This is normal and necessary with the AWD hardware on the vehicle.

It might be necessary to turn the system off if the vehicle gets stuck in sand, mud or snow and rocking the vehicle is required. See *If the Vehicle is Stuck on page 9-11* for more information. See also *Winter Driving on page 9-9* for information on using TCS when driving in snowy or icy conditions.



To turn the system off, press  located on the console to the right of the shifter.

Press and release  and the traction control system turns off and the traction control system warning light comes on. Press  again to turn the system back on. For information on turning StabiliTrak off and on, see *Electronic Stability Control (ESC)* on page 9-37.

Adding non-GM accessories can affect the vehicle's performance. See *Accessories and Modifications* on page 10-3 for more information.

Electronic Stability Control (ESC)

The vehicle has a vehicle stability enhancement system called StabiliTrak. It is an advanced computer controlled system that assists with directional control of the vehicle in difficult driving conditions.

StabiliTrak activates when the computer senses a difference between the intended path and the direction the vehicle is actually traveling. StabiliTrak selectively applies braking pressure at any one of the vehicle's brakes to help steer the vehicle in the intended direction.



When the stability control system activates, the Traction Control System (TCS)/StabiliTrak light flashes on the instrument panel. This also occurs when traction control is activated. A noise might be heard or vibration might be felt in the brake pedal. This is normal. Continue to steer the vehicle in the intended direction.

If there is a problem detected with StabiliTrak, the TCS/StabiliTrak light comes on and the system is not operational. See *Electronic Stability Control (ESC)/Traction Control System (TCS) Indicator/Warning Light* on page 5-22. Driving should be adjusted accordingly.

9-38 Driving and Operating

StabiliTrak comes on automatically whenever the vehicle is started. To assist with directional control of the vehicle, the system should always be left on.



StabiliTrak can be turned off if needed by pressing and holding  until the StabiliTrak Off light comes on the instrument panel. For information on turning TCS off and on, see *Traction Control System (TCS)* on page 9-36.

If cruise control is being used when StabiliTrak activates, the cruise control automatically disengages. Press the cruise control button to reengage when road conditions allow. See *Cruise Control* on page 9-39 for more information.

Limited-Slip Differential

Vehicles with a limited-slip differential can give more traction on snow, mud, ice, sand, or gravel. It works like a standard differential most of the time, but when traction is low, this feature allows the drive wheel with the most traction to move the vehicle.

Selective Ride Control

The vehicle may have a ride control system called Selective Ride Control. The system provides the following performance benefits:

- Reduced Impact Harshness
- Improved Road Isolation
- Improved High-Speed Stability
- Improved Handling Response
- Better Control of Body Ride Motions

To switch from TOUR to SPORT mode, move the shift lever to the left while the transmission is in D (Drive).

TOUR: Use for normal city and highway driving. This setting provides a smooth, soft ride.

SPORT: Use where road conditions or personal preference demand more control. This setting provides more “feel,” or response to road conditions through increased steering effort and suspension tuning.

The setting can be changed at any time. Based on road conditions, steering wheel angle, and vehicle speed, the system automatically adjusts to provide the best handling while providing a smooth ride. The TOUR and SPORT modes will feel similar on a smooth road.

Cruise Control

With cruise control, the vehicle can maintain a speed of about 40 km/h (25 mph) or more without keeping your foot on the accelerator. Cruise control does not work at speeds below 40 km/h (25 mph).

On vehicles with the Traction Control System (TCS) or Electronic Stability Control (ESC), the system may begin to limit wheel spin while you are using cruise control. If this happens, the cruise control will automatically disengage. See *Traction Control System (TCS)* on page 9-36 or *Electronic Stability Control (ESC)* on page 9-37.

WARNING

Cruise control can be dangerous where you cannot drive safely at a steady speed. So, do not use the cruise control on winding roads or in heavy traffic.

Cruise control can be dangerous on slippery roads. On such roads, fast changes in tire traction can cause excessive wheel slip, and you could lose control. Do not use cruise control on slippery roads.

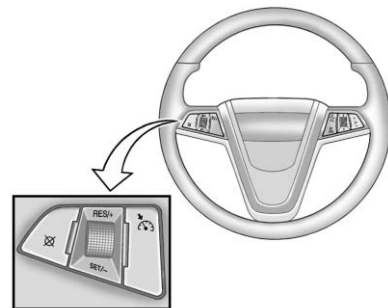

The cruise control buttons are located on the steering wheel.

 **(On/Off):** Press to turn the cruise control system on and off. An indicator light will turn on or off in the instrument panel cluster.

 **(Cancel):** Press to disengage cruise control without erasing the set speed from memory.

RES/+ (Resume/Accelerate):

Move the thumbwheel up to make the vehicle resume to a previously set speed or to accelerate.

SET/- (Set/Coast): Move the thumbwheel down to set the speed and activate cruise control or make the vehicle decelerate.

Setting Cruise Control

If the cruise button is on when not in use, it could get bumped and go into cruise when not desired. Keep the cruise control switch off when cruise is not being used.

1. Press  to turn the cruise control system on. The indicator light in the instrument panel cluster comes on.
2. Get to the speed desired.

3. Move the thumbwheel down toward SET/- and release it. The desired set speed briefly appears in the instrument panel cluster.
4. Take your foot off the accelerator pedal.

Resuming a Set Speed

If the cruise control is set at a desired speed and then the brakes are applied or the Cancel button is pressed, the cruise control is disengaged without erasing the set speed from memory.

Once the vehicle reaches about 40 km/h (25 mph) or more, move the thumbwheel up toward RES/+ briefly. The vehicle returns to the previous set speed and stays there.

Increasing Speed While Using Cruise Control

If the cruise control system is already activated,

- Move the thumbwheel up toward RES/+ and hold it until the vehicle accelerates to the desired speed, and then release it.
- To increase the speed in small amounts, move the thumbwheel up toward RES/+ briefly and then release it. Each time this is done, the vehicle goes about 1.6 km/h (1 mph) faster.

Reducing Speed While Using Cruise Control

If the cruise control system is already activated,

- Move the thumbwheel toward SET/- and hold until the desired lower speed is reached, then release it.
- To slow down in small amounts, move the thumbwheel toward SET/- briefly and then release it. Each time this is done, the vehicle goes about 1.6 km/h (1 mph) slower.

Passing Another Vehicle While Using Cruise Control



Use the accelerator pedal to increase the vehicle's speed. When you take your foot off the pedal, the vehicle will slow down to the previous set cruise control speed.

Using Cruise Control on Hills

How well the cruise control works on hills depends upon the vehicle's speed, load, and the steepness of the hills. When going up steep hills, you might have to step on the accelerator pedal to maintain the vehicle's speed. When going downhill, you might have to brake or shift to a lower gear to maintain the vehicle's speed. When the brakes are applied the cruise control shuts off.

Ending Cruise Control

There are three ways to end cruise control:

- To disengage cruise control, step lightly on the brake pedal or clutch; when cruise control disengages, the indicator light will not be lit.
- Press  on the steering wheel.
- To turn off the cruise control, press  on the steering wheel.

Erasing Speed Memory

The cruise control set speed is erased from memory by pressing the  button or if the ignition is turned off.

Object Detection Systems

Ultrasonic Parking Assist

For vehicles with the Ultrasonic Rear Parking Assist (URPA) system, it assists the driver with parking and avoiding objects while in R (Reverse). URPA operates at speeds less than 8 km/h (5 mph), and the sensors on the rear bumper detect objects up to 2.5 m (8 ft) behind the vehicle, and at least 20 cm (8 in) off the ground.

WARNING

The Ultrasonic Rear Parking Assist (URPA) system does not replace driver vision. It cannot detect:

- Objects that are below the bumper, underneath the vehicle, or too close or far from the vehicle.
- Children, pedestrians, bicyclists, or pets.

If you do not use proper care before and while backing, vehicle damage, injury, or death could occur. Even with URPA, always check behind the vehicle before backing up. While backing, be sure to look for objects and check the vehicle's mirrors.

How the System Works

URPA comes on automatically when the shift lever is moved into R (Reverse). A single tone sounds to indicate the system is working.

URPA operates only at speeds less than 8 km/h (5 mph).

An obstacle is indicated by audible beeps. The interval between the beeps becomes shorter as the vehicle gets closer to the obstacle. When the distance is less than 30 cm (12 in) the beeps are continuous.

To be detected, objects must be at least 20 cm (8 in) off the ground and below trunk level. Objects must also be within 2.5 m (8 ft) from the rear bumper. The distance objects can be detected may be less during warmer or humid weather.

PARK ASSIST OFF displays on the Driver Information Center (DIC) to indicate that URPA is off. The message disappears after a short period of time.

Turning the System On and Off

The URPA system can be turned on and off using the park assist button located next to the shift lever.



The park assist button lights up when the system is on and turns off when it has been disabled.

URPA defaults to the on setting each time the vehicle is started.

When the System Does Not Seem to Work Properly

SERVICE PARK ASSIST: If this message occurs, take the vehicle to your dealer to repair the system.

PARK ASSIST OFF: If the URPA system does not activate due to a temporary condition, the message displays on the DIC. See *Driver Information Center (DIC)* on page 5-25 for more information. This can occur under the following conditions:

- The driver has disabled the system.
- The ultrasonic sensors are not clean. Keep the vehicle's rear bumper free of mud, dirt, snow, ice, and slush. For cleaning instructions, see *Exterior Care* on page 10-92.

- An object was hanging out of the trunk during the last drive cycle. Once the object is removed, URPA will return to normal operation.
- The vehicle's bumper is damaged. Take the vehicle to your dealer to repair the system.
- Other conditions may affect system performance, such as vibrations from a jackhammer or the compression of air brakes on a very large truck.

If the system is still disabled after driving forward at least 40 km/h (25 mph), take the vehicle to your dealer.

Side Blind Zone Alert (SBZA)

The vehicle may have a Side Blind Zone Alert (SBZA) system. Read this entire section before using the system.

WARNING

SBZA is only a lane changing aid and does not replace driver vision. SBZA does not detect:

- Vehicles outside the side blind zones which may be rapidly approaching.
- Pedestrians, bicyclists, or animals.

Failure to use proper care when changing lanes may result in damage to the vehicle, injury, or death. Always check the outside and rearview mirrors, glance over your shoulder, and use the turn signal before changing lanes.

When the system detects a vehicle in the side blind zone, amber SBZA displays will light up in the side mirrors. This indicates that it may be unsafe to change lanes. Before making a lane change, always check the SBZA display, check the outside and rearview mirrors, look over your shoulder for vehicles and hazards, and use the turn signal.

SBZA Detection Zones

The SBZA sensor covers a zone of approximately one lane over from both sides of the vehicle, or 3.5 m (11 ft). This zone starts at each side mirror and goes back approximately 5.0 m (16 ft.). The height of the zone is approximately between 0.5 m (1.5 ft) and 2.0 m (6 ft) off the ground.

The SBZA detection zones do not change if the vehicle is towing a trailer. So be extra careful when changing lanes while towing a trailer.

How the System Works

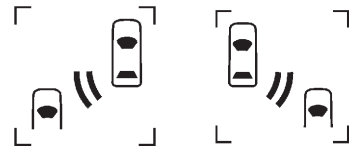

Left Side Mirror Display

Right Side Mirror Display

When the vehicle is started, both outside mirror displays will briefly come on to indicate that the system is operating. While driving forward, the left or right side mirror SBZA display will light up if a vehicle is detected in that blind zone. If you activate a turn signal and a vehicle has been detected on the same side, the SBZA display will flash to give you extra warning not to change lanes.

SBZA displays do not come on while the vehicle is approaching or passing other vehicles. At speeds greater than 32 km/h (20 mph), SBZA displays may come on when a vehicle you have passed remains in or drops back into the detection zone.

SBZA can be disabled through Vehicle Personalization.

See *Vehicle Personalization on page 5-39* for more information.

If the SBZA is disabled by the driver, the SBZA mirror displays will not light up during normal driving.

When the System Does Not Seem To Work Properly

Occasional missed alerts can occur under normal circumstances and will increase in wet conditions. The system does not need to be serviced due to an occasional missed alert. The number of missed alerts will increase with increased rainfall or road spray.

If the SBZA displays do not light up when the system is on and vehicles are in the blind zone, the system may need service. Take the vehicle to your dealer.

SBZA is designed to ignore stationary objects; however, the system may occasionally light up due to guard rails, signs, trees, shrubs, and other stationary objects. This is normal system operation; the vehicle does not need service.

SBZA does not operate when the left or right corners of the rear bumper are covered with mud, dirt, snow, ice, or slush, or in heavy rainstorms. For cleaning instructions, see *Exterior Care on page 10-92*. If the infotainment display still shows the SIDE BLIND ZONE SYS. UNAVAILABLE message after cleaning the bumper, see your dealer.

The SBZA displays may remain on if a trailer is attached to the vehicle, or a bicycle or object is extending out to either side of the vehicle.

When SBZA is disabled for any reason other than the driver turning it off, the driver will not be able to turn SBZA back on using Vehicle Personalization. The SIDE BLIND ZONE ALERT ON option will not be selectable if the conditions for normal system operation are not met. Until normal operating conditions for SBZA are met, you should not rely upon SBZA while driving.

SBZA Error Messages

The following messages may appear on the infotainment display:

SIDE BLIND ZONE ALERT

SYSTEM OFF: This message indicates that the driver has turned the system off.

SIDE BLIND ZONE SYS.

UNAVAILABLE: This message indicates that the SBZA system is disabled because the sensor is blocked and cannot detect vehicles in the blind zone. The sensor may be blocked by mud, dirt, snow, ice, or slush. This message may also activate during heavy rain or due to road spray. The vehicle does not need service. For cleaning, see *Exterior Care on page 10-92.*

SERVICE SIDE BLIND ZONE

ALERT SYSTEM: If this message appears, both SBZA displays will remain on indicating there is a problem with the SBZA system. If these displays remain on after continued driving, the system needs service. Take the vehicle to your dealer.

FCC Information

See *Radio Frequency Statement on page 13-20* for FCC information.

Rear Vision Camera (RVC)

This vehicle may have an RVC system. Read this entire section before using it.

The RVC system can assist the driver when backing up by displaying a view of the area behind the vehicle.

WARNING

The Rear Vision Camera (RVC) system does not replace driver vision. RVC does not:

- Detect objects that are outside the camera's field of view, below the bumper, or underneath the vehicle.
- Detect children, pedestrians, bicyclists, or pets.

(Continued)

WARNING (Continued)

Do not back the vehicle by only looking at the RVC screen, or use the screen during longer, higher speed backing maneuvers or where there could be cross-traffic. Your judged distances using the screen will differ from actual distances.

If you do not use proper care before backing up, you could hit a vehicle, child, pedestrian, bicyclist, or pet, resulting in vehicle damage, injury, or death. Even though the vehicle has the RVC system, always check carefully before backing up by checking behind and around the vehicle.

An image appears on the navigation screen with the message Check Surroundings for Safety when the vehicle is shifted into R (Reverse). The navigation screen goes to the previous screen after approximately 10 seconds once the vehicle is shifted out of R (Reverse).

To cancel the delay, do one of the following:

- Press a hard key on the navigation system.
- Shift into P (Park).
- Reach a vehicle speed of 8 km/h (5 mph).

Turning the Rear Vision Camera System On or Off

To turn the RVC system on or off:

1. Shift into P (Park).
2. Press the CONFIG button to enter the configure menu options.
3. Select Display.

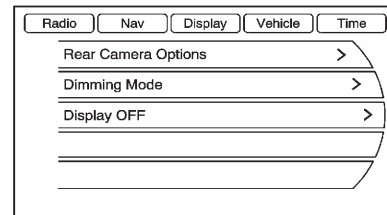

4. Select Rear Camera Options.
5. Select Camera. When a checkmark appears next to the Camera option, then the RVC system is on.

Symbols

The navigation system may have a feature that lets the driver view symbols on the navigation screen while using the RVC. The Ultrasonic Rear Park Assist (URPA) system must not be disabled to use the caution symbols. The error message Rear Parking Assist Symbols Unavailable may display if URPA has been disabled and the symbols have been turned on. See *Ultrasonic Parking Assist* on page 9-42.

The symbols appear and may cover an object when viewing the navigation screen when an object is detected by the URPA system.

To turn the symbols on or off:

1. Shift into P (Park).
2. Press the CONFIG button to enter the configure menu options.
3. Select Display.
4. Select Rear Camera Options.
5. Select Symbols. When a checkmark appears next to the Symbols option, symbols will appear.

Guidelines

The RVC system has a guideline overlay that can help the driver align the vehicle when backing into a parking spot.

To turn the guidelines on or off:

1. Shift into P (Park).
2. Press the CONFIG button to enter the configure menu options.

3. Select Display.
4. Select Rear Camera Options.
5. Select Guidelines. When a checkmark appears next to the Guidelines option, guidelines will appear.

Rear Vision Camera Error Messages

SERVICE REAR VISION CAMERA SYSTEM: This message can display when the system is not receiving information it requires from other vehicle systems.

If any other problem occurs or if a problem persists, see your dealer.

Rear Vision Camera Location

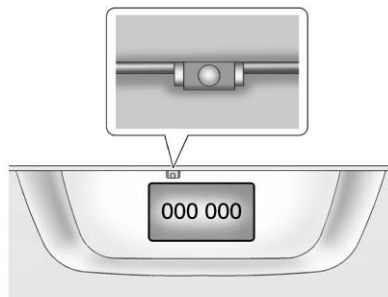

The camera is located above the license plate.

The area displayed by the camera is limited. It does not display objects that are close to either corner or under the bumper and can vary depending on vehicle orientation or road conditions. The distance of the image that appears on the screen is different from the actual distance.

The following illustration shows the field of view that the camera provides.

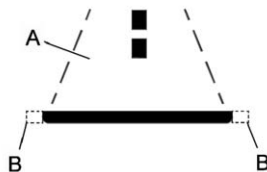
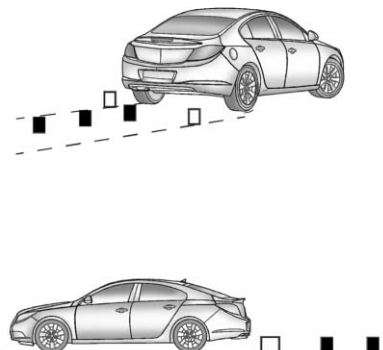

- A. View displayed by the camera.
- B. Corner of the rear bumper.

When the System Does Not Seem to Work Properly

The RVC system may not work properly or display a clear image if:

- The RVC is turned off. See “Turning the Rear Camera System On or Off” earlier in this section.
- It is dark.
- The sun or the beam of headlamps are shining directly into the camera lens.
- Ice, snow, mud, or anything else builds up on the camera lens. Clean the lens, rinse it with water, and wipe it with a soft cloth.
- The back of the vehicle is in an accident. The position and mounting angle of the camera can change or the camera can be affected. Be sure to have the camera and its position and mounting angle checked at your dealer.

Fuel

Use of the recommended fuel is an important part of the proper maintenance of this vehicle. To help keep the engine clean and maintain optimum vehicle performance, we recommend the use of gasoline advertised as TOP TIER Detergent Gasoline.

Look for the TOP TIER label on the fuel pump to ensure gasoline meets enhanced detergency standards developed by auto companies. A list of marketers providing TOP TIER Detergent Gasoline can be found at www.toptiergas.com.



The eighth digit of the Vehicle Identification Number (VIN) shows the code letter or number that identifies the vehicle's engine. The VIN is at the top left of the instrument panel. See *Vehicle Identification Number (VIN)* on page 12-1.

Recommended Fuel

If the vehicle has a 2.4L L4 engine (VIN Code C), use regular unleaded gasoline with a posted octane rating of 87 or higher. If the octane rating is less than 87, an audible knocking noise, commonly referred to as spark knock, might be heard when driving. If this occurs, use a gasoline rated at 87 octane or higher as soon as possible. If heavy knocking is heard when using gasoline rated at 87 octane or higher, the engine needs service.

If the vehicle has the 3.6L V6 engine (VIN Code D), use premium unleaded gasoline with a posted octane rating of 91 or higher.

You can also use regular unleaded gasoline rated at 87 octane or higher, but the vehicle's acceleration could be slightly reduced, and a slight audible knocking noise, commonly referred to as spark knock, might be heard. If the octane is less than 87, a heavy knocking noise might be heard when driving. If this occurs, use a gasoline rated at 87 octane or higher as soon as possible. Otherwise, you could damage the engine. If heavy knocking is heard when using gasoline rated at 87 octane or higher, the engine needs service.

Gasoline Specifications (U.S. and Canada Only)

At a minimum, gasoline should meet ASTM specification D 4814 in the United States or CAN/CGSB-3.5 or 3.511 in Canada. Some gasolines contain an octane-enhancing additive called methylcyclopentadienyl manganese tricarbonyl (MMT). We recommend against the use of gasolines containing MMT. See *Fuel Additives on page 9-52* for additional information.

California Fuel Requirements

If the vehicle is certified to meet California Emissions Standards, it is designed to operate on fuels that meet California specifications. See the underhood emission control label. If this fuel is not available in states adopting California Emissions Standards, the vehicle will operate satisfactorily on fuels meeting federal specifications, but emission control system performance might be affected. The malfunction indicator lamp could turn on and the vehicle might fail a smog-check test. See *Malfunction Indicator Lamp on page 5-17*. If this occurs, return to your authorized dealer for diagnosis. If it is determined that the condition is caused by the type of fuel used, repairs might not be covered by the vehicle warranty.

Fuels in Foreign Countries

Never use leaded gasoline or any other fuel not recommended in the previous text on fuel. Costly repairs caused by use of improper fuel would not be covered by the vehicle warranty.

To check the fuel availability, ask an auto club, or contact a major oil company that does business in the country where you will be driving.

Fuel Additives

To provide cleaner air, all gasolines in the United States are now required to contain additives that help prevent engine and fuel system deposits from forming, allowing the emission control system to work properly. In most cases, nothing should have to be added to the fuel. However, some gasolines contain only the minimum amount of additive required to meet

U.S. Environmental Protection Agency regulations. To help keep fuel injectors and intake valves clean and avoid problems due to dirty injectors or valves, look for gasoline that is advertised as TOP TIER Detergent Gasoline. Look for the TOP TIER label on the fuel pump to ensure gasoline meets enhanced detergency standards developed by the auto companies. A list of marketers providing TOP TIER Detergent Gasoline can be found at www.toptiergas.com.

For customers who do not use TOP TIER Detergent Gasoline regularly, one bottle of GM Fuel System Treatment PLUS, added to the fuel tank at every engine oil change, can help clean deposits from fuel injectors and intake valves. GM Fuel System Treatment PLUS is the only gasoline additive recommended by General Motors. It is available at your dealer.

Gasolines containing oxygenates, such as ethers and ethanol, and reformulated gasolines might be available in your area. We recommend that you use these gasolines, if they comply with the specifications described earlier. However, E85 (85% ethanol) and other fuels containing more than 10% ethanol must not be used in vehicles that were not designed for those fuels.

Notice: This vehicle was not designed for fuel that contains methanol. Do not use fuel containing methanol. It can corrode metal parts in the fuel system and also damage plastic and rubber parts. That damage would not be covered under the vehicle warranty.

Some gasolines that are not reformulated for low emissions can contain an octane-enhancing additive called methylcyclopentadienyl manganese tricarbonyl (MMT); ask the attendant where you buy gasoline whether the fuel contains MMT. We recommend against the use of such gasolines. Fuels containing MMT can reduce spark plug life and affect emission control system performance. The malfunction indicator lamp might turn on. If this occurs, return to your dealer for service.

Filling the Tank

WARNING

Fuel vapor burns violently and a fuel fire can cause bad injuries. To help avoid injuries to you and others, read and follow all the instructions on the fuel pump island. Turn off the engine when refueling. Do not smoke near fuel or when refueling the vehicle. Do not use cellular phones. Keep sparks, flames, and smoking materials away from fuel. Do not leave the fuel pump unattended when refueling the vehicle. This is against the law in some places. Do not re-enter the vehicle while pumping fuel. Keep children away from the fuel pump; never let children pump fuel.

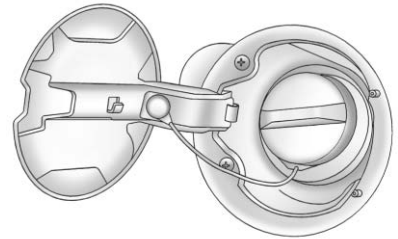

The tethered fuel cap is behind the fuel door on the vehicle's passenger side. Turn the fuel cap counterclockwise to remove.

9-54 Driving and Operating

While refueling, hang the tethered fuel cap from the hook on the fuel door. Reinstall the cap by turning it clockwise until it clicks

WARNING

Fuel can spray out on you if you open the fuel cap too quickly. If you spill fuel and then something ignites it, you could be badly burned. This spray can happen if the tank is nearly full, and is more likely in hot weather. Open the fuel cap slowly and wait for any hiss noise to stop. Then unscrew the cap all the way.

Do not top off or overfill the tank and wait a few seconds before removing the nozzle. Clean fuel from painted surfaces as soon as possible. See *Exterior Care* on page 10-92.

WARNING

If a fire starts while you are refueling, do not remove the nozzle. Shut off the flow of fuel by shutting off the pump or by notifying the station attendant. Leave the area immediately.

Notice: If a new fuel cap is needed, be sure to get the right type of cap from your dealer. The wrong type of fuel cap might not fit properly, might cause the malfunction indicator lamp to light, and could damage the fuel tank and emissions system. See *Malfunction Indicator Lamp* on page 5-17.

Filling a Portable Fuel Container

WARNING

Never fill a portable fuel container while it is in the vehicle. Static electricity discharge from the container can ignite the fuel vapor. You can be badly burned and the vehicle damaged if this occurs. To help avoid injury to you and others:

- Dispense fuel only into approved containers.
- Do not fill a container while it is inside a vehicle, in a vehicle's trunk, pickup bed, or on any surface other than the ground.

(Continued)

WARNING (Continued)

- Bring the fill nozzle in contact with the inside of the fill opening before operating the nozzle. Contact should be maintained until the filling is complete.
- Do not smoke while pumping fuel.
- Do not use a cellular phone while pumping fuel.

Towing

General Towing Information

Only use towing equipment that has been designed for the vehicle. Contact your dealer or trailering dealer for assistance with preparing the vehicle for towing a trailer.

See the following trailer towing information in this section:

- For information on driving while towing a trailer, see “Driving Characteristics and Towing Tips.”

- For maximum vehicle and trailer weights, see “Trailer Towing.”
- For information on equipment to tow a trailer, see “Towing Equipment.”

For information on towing a disabled vehicle, see *Towing the Vehicle on page 10-89*. For information on towing the vehicle behind another vehicle such as a motor home, see *Recreational Vehicle Towing on page 10-89*.

Driving Characteristics and Towing Tips

WARNING

The driver can lose control when pulling a trailer if the correct equipment is not used or the vehicle is not driven properly. For example, if the trailer is too heavy, the brakes may not work well — or even at all. The driver and passengers could be seriously injured. The vehicle may also be damaged; the resulting repairs would not be covered by the vehicle warranty. Pull a trailer only if all the steps in this section have been followed. Ask your dealer for advice and information about towing a trailer with the vehicle.

The vehicle can tow a trailer when equipped with the proper trailer towing equipment. For trailering capacity, see *Trailer Towing on page 9-60*. Trailering changes handling, acceleration, braking, durability and fuel economy.

With the added weight, the engine, transmission, wheel assemblies and tires are forced to work harder and under greater loads. The trailer also adds wind resistance, increasing the pulling requirements. For safe trailering, correctly use the proper trailering equipment.

The following information has important trailering tips and rules for your safety and that of your passengers. Read this section carefully before pulling a trailer.

Pulling a Trailer

Here are some important points:

- There are many laws, including speed limit restrictions that apply to trailering. Check for legal requirements.
- Do not tow a trailer at all during the first 1 600 km (1,000 mi) the new vehicle is driven. The engine, axle or other parts could be damaged.
- During the first 800 km (500 mi) that a trailer is towed, do not drive over 80 km/h (50 mph) and do not make starts at full throttle. This reduces wear on the vehicle.
- The vehicle can tow in D (Drive). Use a lower gear if the transmission shifts too often.

- Do not use the Fuel Saver Mode when towing.
- Obey speed limit restrictions. Do not drive faster than the maximum posted speed for trailers, or no more than 90 km/h (55 mph), to reduce wear on the vehicle.

Driving with a Trailer

Towing a trailer requires experience. Get familiar with handling and braking with the added trailer weight. The vehicle is now longer and not as responsive as the vehicle is by itself.

Check all trailer hitch parts and attachments, safety chains, electrical connectors, lamps, tires and mirror adjustments. If the trailer has electric brakes, start the vehicle and trailer moving and then apply the trailer brake controller by hand to be sure the brakes are working.

During the trip, check regularly to be sure that the load is secure, and the lamps and trailer brakes are working properly.

Towing with a Stability Control System

When towing, the sound of the stability control system might be heard. The system is reacting to the vehicle movement caused by the trailer, which mainly occurs during cornering. This is normal when towing heavier trailers.

Following Distance

Stay at least twice as far behind the vehicle ahead as you would when driving the vehicle without a trailer. This can help to avoid situations that require heavy braking and sudden turns.

Passing

More passing distance is needed when towing a trailer. Because the rig is longer, it is necessary to go farther beyond the passed vehicle before returning to the lane.

Backing Up

Hold the bottom of the steering wheel with one hand. To move the trailer to the left, move that hand to the left. To move the trailer to the right, move your hand to the right. Always back up slowly and, if possible, have someone guide you.

Making Turns

Notice: Making very sharp turns while trailering could cause the trailer to come in contact with the vehicle. The vehicle could be damaged. Avoid making very sharp turns while trailering.

When turning with a trailer, make wider turns than normal so the trailer will not strike soft shoulders, curbs, road signs, trees or other objects. Use the turn signal well in advance and avoid jerky or sudden maneuvers.

Turn Signals when Towing a Trailer

The turn signal indicators on the instrument panel flash whenever signaling a turn or lane change. Properly hooked up, the trailer lamps also flash, telling other drivers the vehicle is turning, changing lanes or stopping.

When towing a trailer, the arrows on the instrument panel flash for turns even if the bulbs on the trailer are burned out. Check occasionally to be sure the trailer bulbs are still working.

Driving on Grades

Reduce speed and shift to a lower gear before starting down a long or steep downgrade. If the transmission is not shifted down, the brakes might have to be used so much that they would get hot and no longer work well.

The vehicle can tow in D (Drive). Use a lower gear if the transmission shifts too often.

When towing at high altitude on steep uphill grades, engine coolant boils at a lower temperature than at normal altitudes. If the engine is turned off immediately after towing at high altitude on steep uphill grades, the vehicle could show signs similar to engine overheating. To avoid this, let the engine run while parked, preferably on level ground, with the transmission in P (Park) for a few minutes before turning the engine off. If the overheat warning comes on, see *Engine Overheating on page 10-21*.

Parking on Hills

WARNING

Parking the vehicle on a hill with the trailer attached can be dangerous. If something goes wrong, the rig could start to move. People can be injured, and both the vehicle and the trailer can be damaged. When possible, always park the rig on a flat surface.

If parking the rig on a hill:

1. Press the brake pedal, but do not shift into P (Park) yet. Turn the wheels into the curb if facing downhill or into traffic if facing uphill.
2. Have someone place chocks under the trailer wheels.

3. When the wheel chocks are in place, release the brake pedal until the chocks absorb the load.
4. Reapply the brake pedal. Then apply the parking brake and shift into P (Park).
5. Release the brake pedal.

Leaving After Parking on a Hill

1. Apply and hold the brake pedal while you:
 - Start the engine.
 - Shift into a gear.
 - Release the parking brake.
2. Let up on the brake pedal.
3. Drive slowly until the trailer is clear of the chocks.
4. Stop and have someone pick up and store the chocks.

Maintenance when Trailer Towing

The vehicle needs service more often when pulling a trailer. See the Maintenance Schedule booklet for more information. Things that are especially important in trailer operation are automatic transmission fluid, engine oil, axle lubricant, belts, cooling system and brake system. Inspect these before and during the trip.

Check periodically to see that all hitch nuts and bolts are tight.

Engine Cooling when Trailer Towing

The cooling system may temporarily overheat during severe operating conditions. See *Engine Overheating* on page 10-21.

Trailer Towing

Before pulling a trailer, there are three important considerations that have to do with weight:

- The weight of the trailer.
- The weight of the trailer tongue.
- The total weight on your vehicle's tires.

Weight of the Trailer

How heavy can a trailer safely be?

For a vehicle with a V6 engine, it should never weigh more than 454 kg (1,000 lbs). But even that can be too heavy.

It depends on how the rig is used. For example, speed, altitude, road grades, outside temperature and how much the vehicle is used to pull a trailer are all important. It can

depend on any special equipment on the vehicle, and the amount of tongue weight the vehicle can carry. See "Weight of the Trailer Tongue" later in this section for more information.

Maximum trailer weight is calculated assuming only the driver is in the tow vehicle and it has all the required trailering equipment.

The weight of additional optional equipment, passengers and cargo in the tow vehicle must be subtracted from the maximum trailer weight.

Ask your dealer for trailering information or advice, or write us at our Customer Assistance Offices. See *Customer Assistance Offices (U.S. and Canada)* on page 13-5 or *Customer Assistance Offices (Mexico)* on page 13-6 for more information.

Weight of the Trailer Tongue

The tongue load (A) of any trailer is an important weight to measure because it affects the total gross weight of the vehicle. The Gross Vehicle Weight (GVW) includes the curb weight of the vehicle, any cargo carried in it, and the people who will be riding in the vehicle. If there are a lot of options, equipment, passengers or cargo in the vehicle, it will reduce the tongue weight the vehicle can carry, which will also reduce the trailer weight the vehicle can tow. If towing a trailer, the tongue load must be added to the GVW because the vehicle will be carrying that weight, too. See *Vehicle Load Limits* on page 9-12 for more information.

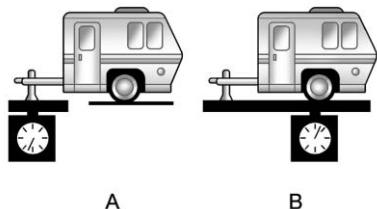

The trailer tongue (A) should weigh 10-15 percent of the total loaded trailer weight (B).

After loading the trailer, weigh the trailer and then the tongue, separately, to see if the weights are proper. If they are not, adjustments might be made by moving some items around in the trailer.

Total Weight on Your Vehicle's Tires

Be sure the vehicle's tires are inflated to the upper limit for cold tires. These numbers can be found on the Tire-Loading Information label. See *Vehicle Load Limits on page 9-12*. Make sure not to go over the GVW limit for the vehicle, including the weight of the trailer tongue.

Towing Equipment

Hitches

Use the correct hitch equipment. See your dealer or a hitch dealer for assistance.

- The rear bumper on the vehicle is not intended for hitches. Do not attach rental hitches or other bumper-type hitches to it. Use only a frame-mounted hitch that does not attach to the bumper.
- Will any holes be made in the body of the vehicle when the trailer hitch is installed? If there are, seal the holes when the hitch is removed. If the holes are not sealed, dirt, water, and deadly carbon monoxide (CO) from the exhaust can get into the vehicle. See *Engine Exhaust on page 9-27*.

Safety Chains

Always attach chains between the vehicle and the trailer. Cross the safety chains under the tongue of the trailer to help prevent the tongue from contacting the road if it becomes separated from the hitch. Leave enough slack so the rig can turn. Never allow safety chains to drag on the ground.

Trailer Brakes

Does the trailer have its own brakes? Be sure to read and follow the instructions for the trailer brakes so they are installed, adjusted, and maintained properly.

Because the vehicle has antilock brakes, do not tap into the vehicle's brake system. If this is done, both brake systems will not work well, or at all.

Conversions and Add-Ons

Add-On Electrical Equipment

Notice: Do not add anything electrical to the vehicle unless you check with your dealer first. Some electrical equipment can damage the vehicle and the damage would not be covered by the vehicle's warranty. Some add-on electrical equipment can keep other components from working as they should.

Add-on equipment can drain the vehicle's 12-volt battery, even if the vehicle is not operating.

The vehicle has an airbag system. Before attempting to add anything electrical to the vehicle, see *Servicing the Airbag-Equipped Vehicle* on page 3-41 and *Adding Equipment to the Airbag-Equipped Vehicle* on page 3-42.

Vehicle Care

General Information

General Information	10-2
California Proposition 65 Warning	10-3
California Perchlorate Materials Requirements	10-3
Accessories and Modifications	10-3

Vehicle Checks

Doing Your Own Service Work	10-4
Hood	10-5
Engine Compartment Overview	10-6
Engine Oil	10-9
Engine Oil Life System	10-13
Automatic Transmission Fluid	10-15
Engine Air Cleaner/Filter	10-15

Cooling System	10-17
Engine Coolant	10-18
Engine Overheating	10-21
Overheated Engine Protection Operating Mode	10-22
Power Steering Fluid	10-23
Washer Fluid	10-24
Brakes	10-24
Brake Fluid	10-25
Battery	10-27
Starter Switch Check	10-27
Automatic Transmission Shift Lock Control Function Check	10-28
Ignition Transmission Lock Check	10-28
Park Brake and P (Park) Mechanism Check	10-29
Wiper Blade Replacement	10-29

Headlamp Aiming

Headlamp Aiming	10-30
-----------------------	-------

Bulb Replacement

Bulb Replacement	10-33
Halogen Bulbs	10-33
High Intensity Discharge (HID) Lighting	10-33
Headlamps, Front Turn Signal and Parking Lamps	10-34
Taillamps, Turn Signal, Stoplamps, and Back-Up Lamps	10-35
License Plate Lamp	10-36
Replacement Bulbs	10-37

Electrical System

Electrical System Overload	10-38
Fuses and Circuit Breakers	10-39
Engine Compartment Fuse Block	10-39
Instrument Panel Fuse Block	10-42
Rear Compartment Fuse Block	10-44

10-2 Vehicle Care

Wheels and Tires

Tires	10-46
Winter Tires	10-47
Tire Sidewall Labeling	10-48
Tire Designations	10-50
Tire Terminology and Definitions	10-51
Tire Pressure	10-54
Tire Pressure Monitor System	10-56
Tire Pressure Monitor Operation	10-57
Tire Inspection	10-61
Tire Rotation	10-61
When It Is Time for New Tires	10-63
Buying New Tires	10-64
Different Size Tires and Wheels	10-66
Uniform Tire Quality Grading	10-66
Wheel Alignment and Tire Balance	10-68

Wheel Replacement	10-68
Tire Chains	10-69
If a Tire Goes Flat	10-70
Tire Sealant and Compressor Kit	10-72
Storing the Tire Sealant and Compressor Kit	10-79
Tire Changing	10-79
Compact Spare Tire	10-85

Jump Starting

Jump Starting	10-86
---------------------	-------

Towing

Towing the Vehicle	10-89
Recreational Vehicle Towing	10-89

Appearance Care

Exterior Care	10-92
Interior Care	10-97
Floor Mats	10-100

General Information

For service and parts needs, visit your dealer. You will receive genuine GM parts and GM-trained and supported service people.

Genuine GM parts have one of these marks:

ACDelco.

Genuine  | **Parts**

 | **Goodwrench.**

 | **Accessories**

California Proposition 65 Warning

Most motor vehicles, including this one, contain and/or emit chemicals known to the State of California to cause cancer and birth defects or other reproductive harm. Engine exhaust, many parts and systems, many fluids, and some component wear by-products contain and/or emit these chemicals.

California Perchlorate Materials Requirements

Certain types of automotive applications, such as airbag initiators, seat belt pretensioners, and lithium batteries contained in Remote Keyless Entry transmitters, may contain perchlorate materials. Special handling may be necessary. For additional information, see www.dtsc.ca.gov/hazardouswaste/perchlorate.

Accessories and Modifications

Adding non-dealer accessories to the vehicle can affect vehicle performance and safety, including such things as airbags, braking, stability, ride and handling, emissions systems, aerodynamics, durability, and electronic systems like antilock brakes, traction control, and stability control. Some of these accessories could even cause malfunction or damage not covered by the vehicle warranty.

10-4 Vehicle Care

Damage to vehicle components resulting from the installation or use of non-GM certified parts, including control module modifications, is not covered under the terms of the vehicle warranty and may affect remaining warranty coverage for affected parts.

GM Accessories are designed to complement and function with other systems on the vehicle. Your GM dealer can accessorize the vehicle using genuine GM Accessories. When you go to your GM dealer and ask for GM Accessories, you will know that GM-trained and supported service technicians will perform the work using genuine GM Accessories.

Also, see *Adding Equipment to the Airbag-Equipped Vehicle on page 3-42*.

Vehicle Checks

Doing Your Own Service Work

 **WARNING**

You can be injured and the vehicle could be damaged if you try to do service work on a vehicle without knowing enough about it.

- Be sure you have sufficient knowledge, experience, the proper replacement parts, and tools before attempting any vehicle maintenance task.

(Continued)

WARNING (Continued)

- Be sure to use the proper nuts, bolts, and other fasteners. Metric and English fasteners can be easily confused. If the wrong fasteners are used, parts can later break or fall off. You could be hurt.

If doing some of your own service work, use the proper service manual. It tells you much more about how to service the vehicle than this manual can. To order the proper service manual, see *Service Publications Ordering Information on page 13-15*.

This vehicle has an airbag system. Before attempting to do your own service work, see *Servicing the Airbag-Equipped Vehicle* on page 3-41.

Keep a record with all parts receipts and list the mileage and the date of any service work performed. See *Maintenance Records* on page 11-10.

Hood

To open the hood, do the following:

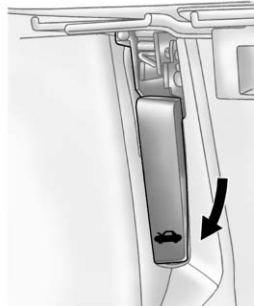

1. Pull the interior hood release handle located to the left of the steering column below the instrument panel.

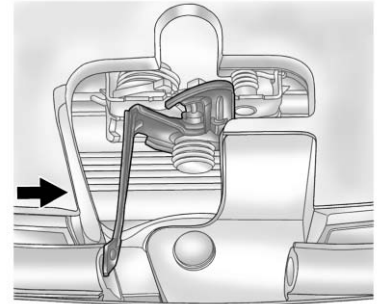

2. Push the secondary hood release lever, located under the center of the hood above the grille, to the right to disengage it.
3. Lift the hood.

Before closing the hood, make sure all the filler caps are properly secured. Pull the hood down and close it firmly.

Engine Compartment Overview

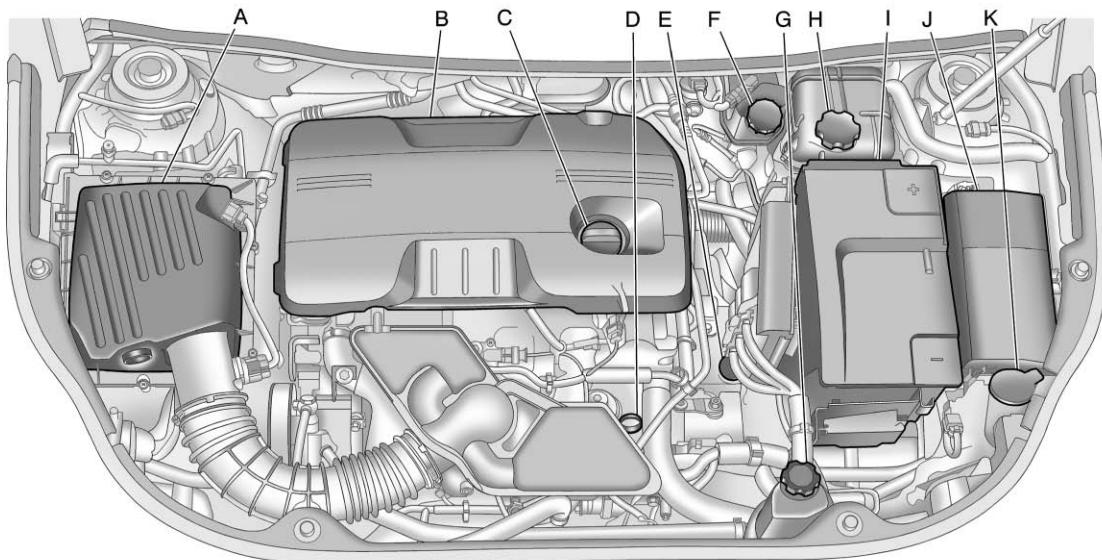

2.4 L L4 Engine

- A. *Engine Air Cleaner/Filter on page 10-15.*
- B. Engine Cover.
- C. Engine Oil Fill Cap. See *Engine Oil on page 10-9.*
- D. Engine Oil Dipstick. See *Engine Oil on page 10-9.*
- E. Transmission Fluid Cap and Dipstick. See *Automatic Transmission Fluid on page 10-15.*
- F. Brake Master Cylinder Reservoir. See *Brakes on page 10-24.*
- G. Power Steering Reservoir and Cap. See *Power Steering Fluid on page 10-23.*
- H. Coolant Surge Tank and Pressure Cap. See *Engine Coolant on page 10-18.*
- I. Battery Cover. See *Battery on page 10-27.*
- J. *Engine Compartment Fuse Block on page 10-39.*
- K. Windshield Washer Fluid Reservoir. See *Washer Fluid on page 10-24.*

10-8 Vehicle Care

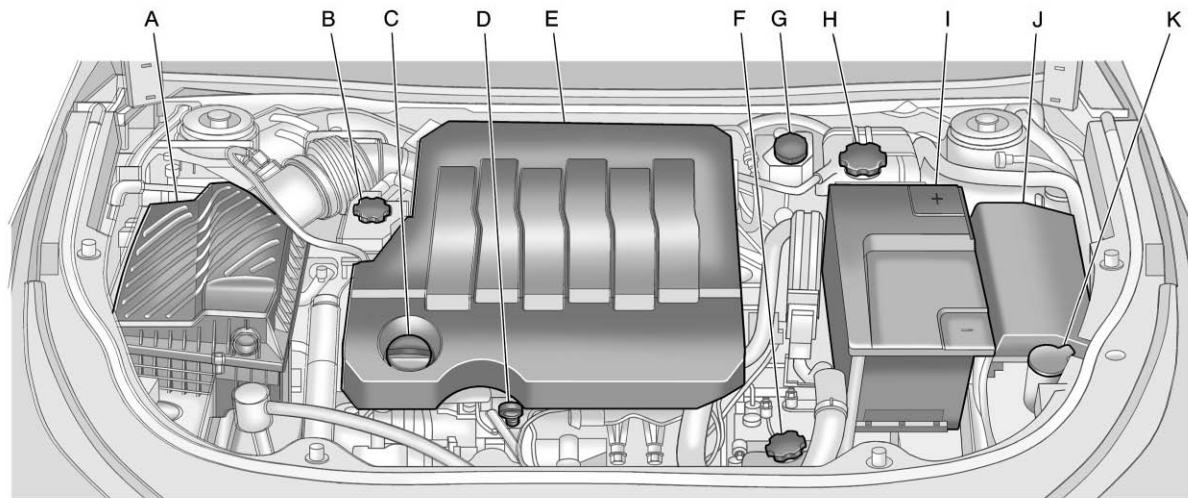

3.6 L V6 Engine

- A. *Engine Air Cleaner/Filter on page 10-15.*
- B. *Power Steering Reservoir and Cap. See Power Steering Fluid on page 10-23.*
- C. *Engine Oil Fill Cap. See Engine Oil on page 10-9.*
- D. *Engine Oil Dipstick. See Engine Oil on page 10-9.*
- E. *Engine Cover.*
- F. *Transmission Fluid Cap and Dipstick. See Automatic Transmission Fluid on page 10-15.*
- G. *Brake Master Cylinder Reservoir. See Brakes on page 10-24.*
- H. *Coolant Surge Tank and Pressure Cap. See Engine Coolant on page 10-18.*
- I. *Battery Cover. See Battery on page 10-27.*
- J. *Engine Compartment Fuse Block on page 10-39.*
- K. *Windshield Washer Fluid Reservoir. See Washer Fluid on page 10-24.*

Engine Oil

To ensure proper engine performance and long life, careful attention must be paid to engine oil. Following these simple, but important steps will help protect your investment:

- Always use engine oil approved to the proper specification and of the proper viscosity grade. See “Selecting the Right Engine Oil” in this section.
- Check the engine oil level regularly and maintain the proper oil level. See “Checking Engine Oil” and “When to Add Engine Oil” in this section.
- Change the engine oil at the appropriate time. See *Engine Oil Life System on page 10-13.*
- Always dispose of engine oil properly. See “What to Do with Used Oil” in this section.

Checking Engine Oil

It is a good idea to check the engine oil level at each fuel fill.

In order to get an accurate reading, the vehicle must be on level ground. The engine oil dipstick handle is a yellow loop.

See *Engine Compartment Overview* on page 10-6 for the location of the engine oil dipstick.

Obtaining an accurate oil level reading is essential:

1. If the engine has been running recently, turn off the engine and allow several minutes for the oil to drain back into the oil pan. Checking the oil level too soon after engine shutoff will not provide an accurate oil level reading.
2. Pull out the dipstick and clean it with a paper towel or cloth, then push it back in all the way. Remove it again, keeping the tip down, and check the level.

When to Add Engine Oil



If the oil is below the cross-hatched area at the tip of the dipstick, add 1 L (1 qt) of the recommended oil and then recheck the level. See "Selecting the Right Engine Oil" in this section for an explanation of what kind of oil to use. For engine oil crankcase capacity, see *Capacities and Specifications* on page 12-2.

Notice: Do not add too much oil. Oil levels above or below the acceptable operating range shown on the dipstick are harmful to the engine. If you find that you have an oil level above the operating range, i.e., the engine has so much oil that the oil level gets above the cross-hatched area that shows the proper operating range, the engine could be damaged. You should drain out the excess oil or limit driving of the vehicle and seek a service professional to remove the excess amount of oil.

See *Engine Compartment Overview* on page 10-6 for the location of the engine oil fill cap.

Add enough oil to put the level somewhere in the proper operating range. Push the dipstick all the way back in when through.

Selecting the Right Engine Oil

Selecting the right engine oil depends on both the proper oil specification and viscosity grade:

Specification

Use and ask for engine oils with the dexos™ certification mark. Oils meeting the requirements of the vehicle should have the dexos certification mark on the container. This certification mark indicates that the oil has been approved to the dexos specification.



This vehicle was filled at the factory with dexos-approved engine oil.

Notice: Use only engine oil that is approved to the dexos specification or an equivalent engine oil of the appropriate viscosity grade. Engine oils approved to the dexos specification will show the dexos symbol on the container.

Failure to use the recommended engine oil or equivalent can result in engine damage not covered by the vehicle warranty. If you are unsure whether the oil is approved to the dexos specification, ask your service provider.

Use of Substitute Engine Oils if dexos is unavailable: In the event that dexos-approved engine oil is not available at an oil change or for maintaining proper oil level, you may use substitute engine oil displaying the API Starburst symbol and of SAE 5W-30 viscosity grade.

10-12 Vehicle Care

Use of oils that do not meet the dexos specification, however, may result in reduced performance under certain circumstances.

Viscosity Grade

SAE 5W-30 is the best viscosity grade for the vehicle. Do not use other viscosity oils such as SAE 10W-30, 10W-40, or 20W-50.

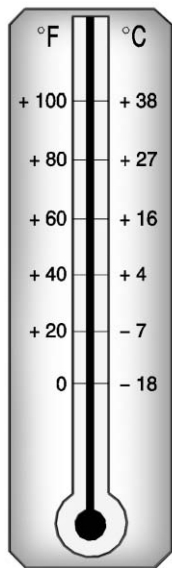

Cold Temperature Operation:
In an area of extreme cold, where the temperature falls below -29°C (-20°F), an SAE 0W-30 oil should be used. An oil of this viscosity grade will provide easier cold starting for the engine at extremely low temperatures. When selecting an oil of the appropriate viscosity grade, be sure to always select an oil that meets the required specification, dexos. See "Specification" earlier in this section for more information.

Engine Oil Additives/Engine Oil Flushes

Do not add anything to the oil. The recommended oils with the dexos specification and displaying the dexos certification mark are all that is needed for good performance and engine protection.

Engine oil system flushes are not recommended and could cause engine damage not covered by the vehicle warranty.

What to Do with Used Oil

Used engine oil contains certain elements that can be unhealthy for your skin and could even cause cancer. Do not let used oil stay on your skin for very long. Clean your skin and nails with soap and water, or a good hand cleaner. Wash or properly dispose of clothing or rags containing used engine oil. See the manufacturer's warnings about the use and disposal of oil products.

Used oil can be a threat to the environment. If you change your own oil, be sure to drain all the oil from the filter before disposal. Never dispose of oil by putting it in the trash or pouring it on the ground, into sewers, or into streams or bodies of water. Recycle it by taking it to a place that collects used oil.

Engine Oil Life System

When to Change Engine Oil

This vehicle has a computer system that indicates when to change the engine oil and filter. This is based on engine revolutions and engine temperature, and not on mileage. Based on driving conditions, the mileage at which an oil change is indicated can vary considerably. For the oil life system to work properly, the system must be reset every time the oil is changed.

When the system has calculated that oil life has been diminished, it indicates that an oil change is necessary. A CHANGE ENGINE OIL SOON message comes on.

See *Engine Oil Messages on page 5-35*. Change the oil as soon as possible within the next 1 000 km (600 miles). It is possible that, if driving under the best conditions, the oil life system might indicate that an oil change is not necessary for up to a year. The engine oil and filter must be changed at least once a year and, at this time, the system must be reset. Your dealer has trained service people who will perform this work and reset the system. It is also important to check the oil regularly over the course of an oil drain interval and keep it at the proper level.

If the system is ever reset accidentally, the oil must be changed at 5 000 km (3,000 miles) since the last oil change. Remember to reset the oil life system whenever the oil is changed.

How to Reset the Engine Oil Life System

Reset the system whenever the engine oil is changed so that the system can calculate the next engine oil change. To reset the system:

1. Turn the ignition to ON/RUN with the engine off.
2. Press the DIC menu button on the turn signal lever to enter the Vehicle Information Menu. Use the thumbwheel to scroll through the menu items until you reach REMAINING OIL LIFE.
3. Press the SET/CLR button to reset the oil life at 100%.
4. Turn the ignition to LOCK/OFF.

The system is reset when the CHANGE ENGINE OIL SOON message is off and the REMAINING OIL LIFE 100% message is displayed.

If the CHANGE ENGINE OIL message comes back on when the vehicle is started, the engine oil life system has not been reset. Repeat the procedure.

Automatic Transmission Fluid

How to Check Automatic Transmission Fluid

It is not necessary to check the transmission fluid level. A transmission fluid leak is the only reason for fluid loss. If a leak occurs, take the vehicle to your dealer service department and have it repaired as soon as possible.

There is a special procedure for checking and changing the transmission fluid. Because this procedure is difficult, you should have this done at your dealer service department.

Contact your dealer for additional information or the procedure can be found in the service manual. To purchase a service manual, see *Service Publications Ordering Information on page 13-15*.

Change the fluid and filter at the intervals listed in *Scheduled Maintenance on page 11-2*, and be sure to use the fluid listed in *Recommended Fluids and Lubricants on page 11-7*.

Engine Air Cleaner/Filter

The engine air cleaner/filter is located in the engine compartment on the driver side of the vehicle. See *Engine Compartment Overview on page 10-6* for more information on location.

When to Inspect the Engine Air Cleaner/Filter

Inspect the air cleaner/filter at the scheduled maintenance intervals and replace it at the first oil change after each 80 000 km (50,000 mi) interval. See *Scheduled Maintenance on page 11-2* for more information. If you are driving in dusty/dirty conditions, inspect the filter at each engine oil change.

How to Inspect the Engine Air Cleaner/Filter

To inspect the air cleaner/filter, remove the filter from the vehicle and lightly shake the filter to release loose dust and dirt. If the filter remains covered with dirt, a new filter is required.

10-16 Vehicle Care

To inspect or replace the engine air cleaner/filter do the following:

2.4 L L4 Engine

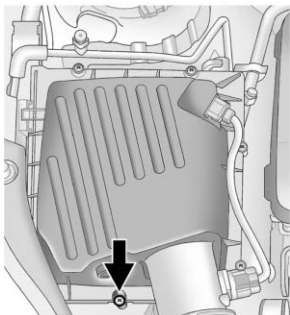

1. Remove the screws on top of the engine air cleaner/filter housing.
2. Lift the filter cover housing away from the engine.
3. Pull out the filter.
4. Inspect or replace the engine air cleaner/filter.

5. Lower the filter cover housing toward the engine.
6. Install the screws on the top of the housing to lock the cover in place.

3.6 L V6 Engine

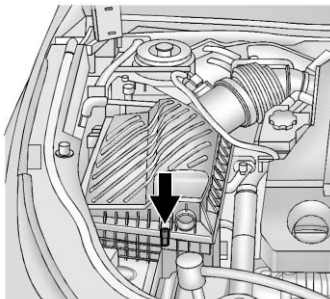

1. Remove the screws on top of the engine air cleaner/filter housing.
2. Lift the filter cover housing away from the engine.
3. Pull out the filter.

4. Inspect or replace the engine air cleaner/filter.
5. Lower the filter cover housing toward the engine.
6. Install the screws on the top of the housing to lock the cover in place.

WARNING

Operating the engine with the air cleaner/filter off can cause you or others to be burned. The air cleaner not only cleans the air; it helps to stop flames if the engine backfires. Use caution when working on the engine and do not drive with the air cleaner/filter off.

Notice: If the air cleaner/filter is off, dirt can easily get into the engine, which could damage it. Always have the air cleaner/filter in place when you are driving.

Cooling System

The cooling system allows the engine to maintain the correct working temperature.

When it is safe to lift the hood:

2.4 L L4 Engine

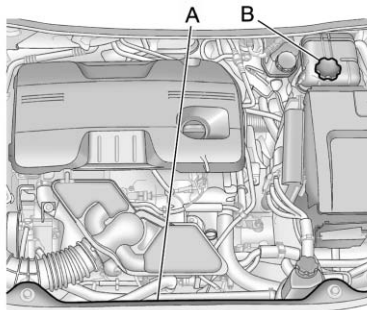

- A. Engine Cooling Fan (Out of View)
- B. Coolant Surge Tank and Pressure Cap

3.6 L V6 Engine

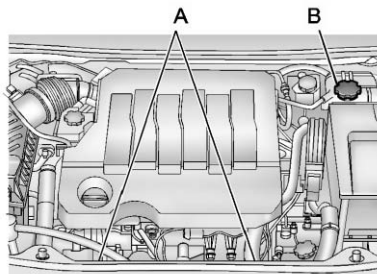

- A. Engine Cooling Fans (Out of View)
- B. Coolant Surge Tank and Pressure Cap

WARNING

An electric engine cooling fan under the hood can start up even when the engine is not running and can cause injury. Keep hands, clothing, and tools away from any underhood electric fan.

WARNING

Heater and radiator hoses, and other engine parts, can be very hot. Do not touch them. If you do, you can be burned.

Do not run the engine if there is a leak. If you run the engine, it could lose all coolant. That could cause an engine fire, and you could be burned. Get any leak fixed before you drive the vehicle.

Notice: Using coolant other than DEX-COOL® can cause premature engine, heater core, or radiator corrosion. In addition, the engine coolant could require changing sooner, at 50 000 km (30,000 mi) or 24 months, whichever occurs first. Any repairs would not be covered by the vehicle warranty. Always use DEX-COOL (silicate-free) coolant in the vehicle.

Engine Coolant

The cooling system in the vehicle is filled with DEX-COOL[®] engine coolant. This coolant is designed to remain in the vehicle for 5 years or 240 000 km (150,000 mi), whichever occurs first.

The following explains the cooling system and how to check and add coolant when it is low. If there is a problem with engine overheating, see *Engine Overheating* on page 10-21.

What to Use

WARNING

Adding only plain water or some other liquid to the cooling system can be dangerous. Plain water and other liquids, can boil before the proper coolant mixture will. The coolant warning system is set for the proper coolant mixture. With plain water or the wrong mixture, the engine could get too hot but you would not get the overheat warning. The engine could catch fire and you or others could be burned. Use a 50/50 mixture of clean, drinkable water and DEX-COOL coolant.

Use a 50/50 mixture of clean, drinkable water and DEX-COOL coolant. If using this mixture, nothing else needs to be added. This mixture:

- Gives freezing protection down to -37°C (-34°F), outside temperature.
- Gives boiling protection up to 129°C (265°F), engine temperature.
- Protects against rust and corrosion.
- Will not damage aluminum parts.
- Helps keep the proper engine temperature.

Notice: If an improper coolant mixture is used, the engine could overheat and be badly damaged. The repair cost would not be covered by the vehicle warranty. Too much water in the mixture can freeze and crack the engine, radiator, heater core, and other parts.

Never dispose of engine coolant by putting it in the trash, pouring it on the ground, or into sewers, streams, or bodies of water. Have the coolant changed by an authorized service center, familiar with legal requirements regarding used coolant disposal. This will help protect the environment and your health.

Checking Coolant

The vehicle must be on a level surface when checking the coolant level.

Check to see if coolant is visible in the coolant surge tank. If the coolant inside the coolant surge tank is boiling, do not do anything else until it cools down. If coolant is visible but the coolant level is not at or above the mark pointed to, add a 50/50 mixture of clean, drinkable water and DEX-COOL coolant at the coolant surge tank, but be sure the cooling system is cool before this is done.

If no coolant is visible in the coolant surge tank, add coolant as follows:

How to Add Coolant to the Coolant Surge Tank

WARNING

You can be burned if you spill coolant on hot engine parts. Coolant contains ethylene glycol and it will burn if the engine parts are hot enough. Do not spill coolant on a hot engine.

Notice: This vehicle has a specific coolant fill procedure. Failure to follow this procedure could cause the engine to overheat and be severely damaged.

WARNING

An electric engine cooling fan under the hood can start up even when the engine is not running and can cause injury. Keep hands, clothing, and tools away from any underhood electric fan.

WARNING

Steam and scalding liquids from a hot cooling system can blow out and burn you badly. They are under pressure, and if you turn the surge tank pressure cap — even a little — they can come out at high speed. Never turn the cap when the cooling system, including the surge tank pressure cap, is hot. Wait for the cooling system and surge tank pressure cap to cool if you ever have to turn the pressure cap.



The coolant surge tank pressure cap can be removed when the cooling system, including the surge tank pressure cap and upper radiator hose, is no longer hot.

1. Turn the pressure cap slowly counterclockwise. If a hiss is heard, wait for that to stop. A hiss means there is still some pressure left.
2. Then keep turning the cap and remove it.

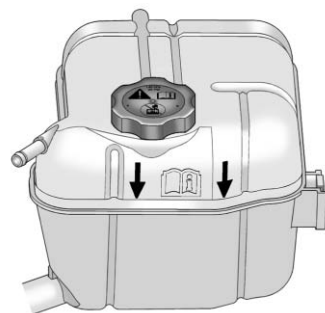

3. Fill the coolant surge tank with the proper mixture to the mark pointed to on the front of the coolant surge tank.

4. With the coolant surge tank cap off, start the engine and let it run until the upper radiator hose starts getting hot. Watch out for the engine cooling fan(s). By this time, the coolant level inside the coolant surge tank may be lower. If the level is lower, add more of the proper mixture to the coolant surge tank until the level reaches the mark pointed to on the front of the coolant surge tank.
5. Replace the cap. Be sure the cap is hand-tight and fully seated.

Notice: If the pressure cap is not tightly installed, coolant loss and possible engine damage may occur. Be sure the cap is properly and tightly secured.

If coolant is needed, add the proper DEX-COOL coolant mixture at the coolant surge tank.

Engine Overheating

The vehicle has several indicators to warn of engine overheating.

There is a coolant temperature gauge and a warning light on the instrument panel cluster that indicate an overheated engine condition. See *Engine Coolant Temperature Gauge* on page 5-13 for more information.

You may decide not to lift the hood when this warning appears, but instead get service help right away. See *Roadside Assistance Program (U.S. and Canada)* on page 13-8 or *Roadside Assistance Program (Mexico)* on page 13-10.

If you do decide to lift the hood, make sure the vehicle is parked on a level surface.

Then check to see if the engine cooling fans are running. If the engine is overheating, the fan(s) should be running. If not, do not continue to run the engine and have the vehicle serviced.

Notice: Engine damage from running the engine without coolant is not covered by the warranty.

If Steam is Coming from the Engine Compartment

See *Overheated Engine Protection Operating Mode* on page 10-22 for information on driving to a safe place in an emergency.

If No Steam is Coming from the Engine Compartment

If an engine overheat warning is displayed but no steam can be seen or heard, the problem might not be too serious. Sometimes the engine can get a little too hot when the vehicle:

- Climbs a long hill on a hot day
- Stops after high-speed driving
- Idles for long periods in traffic
- Tows a trailer

If the overheat warning displays with no sign of steam:

1. Turn the air conditioning off.
2. Turn the heater on to the highest temperature and to the highest fan speed. Open the windows as necessary.

3. In heavy traffic, let the engine idle in N (Neutral) while stopped. If it is safe to do so, pull off the road, shift to P (Park) or N (Neutral) and let the engine idle.

If the temperature overheat gauge is no longer in the overheat zone or an overheat warning no longer displays, the vehicle can be driven. Continue to drive the vehicle slowly for about 10 minutes. Keep a safe vehicle distance from the vehicle in front. If the warning does not come back on, continue to drive normally.

If the warning continues, pull over, stop, and park the vehicle right away.

If there is no sign of steam, idle the engine for three minutes while parked. If the warning is still displayed, turn off the engine until it cools down. Also, see *Overheated Engine Protection Operating Mode* on page 10-22.

Overheated Engine Protection Operating Mode

This emergency operating mode allows the vehicle to be driven to a safe place in an emergency situation. If an overheated engine condition exists, an overheat protection mode which alternates firing groups of cylinders helps prevent engine damage. In this mode, there is significant loss in power and engine performance. The engine coolant temperature warning light comes on the instrument panel, to indicate the vehicle has entered overheated engine protection operating mode. The temperature gauge also indicates an overheat condition exists. Driving extended km (mi) and/or towing a trailer in the overheat protection mode should be avoided.

Power Steering Fluid



See *Engine Compartment Overview on page 10-6* for information on the location of the power steering fluid reservoir.

When to Check Power Steering Fluid

It is not necessary to regularly check power steering fluid unless a leak is suspected in the system or an unusual noise is heard. A fluid loss in this system could indicate a problem. Have the system inspected and repaired.

How to Check Power Steering Fluid

Check the level after the vehicle has been driven for at least 20 minutes so the fluid is warm.

To check the power steering fluid:

1. Turn the ignition to LOCK/OFF and let the engine compartment cool down.
2. Wipe the cap and the top of the reservoir clean.
3. Unscrew the cap and pull it straight up.
4. Wipe the dipstick with a clean rag.
5. Replace the cap and completely tighten it.
6. Remove the cap again and look at the fluid level on the dipstick.



When the engine is hot, the level should be at the hot MAX level. When the engine is cold, the fluid level should be between MIN and MAX on the dipstick.

What to Use

To determine what kind of fluid to use, see *Recommended Fluids and Lubricants on page 11-7*. Always use the proper fluid.

Washer Fluid

What to Use

When windshield washer fluid is needed, be sure to read the manufacturer instructions before use. If operating the vehicle in an area where the temperature can fall below freezing, use a fluid that has sufficient protection against freezing.

Adding Washer Fluid



Open the cap with the washer symbol on it. Add washer fluid until the tank is full. See *Engine Compartment Overview* on page 10-6 for reservoir location.

Notice:

- **When using concentrated washer fluid, follow the manufacturer's instructions for adding water.**
- **Do not mix water with ready-to-use washer fluid. Water can cause the solution to freeze and damage the washer fluid tank and other parts of the washer system. Also, water does not clean as well as washer fluid.**
- **Fill the washer fluid tank only three-quarters full when it is very cold. This allows for fluid expansion if freezing occurs, which could damage the tank if it is completely full.**
- **Do not use engine coolant (antifreeze) in the windshield washer. It can damage the windshield washer system and paint.**

Brakes

This vehicle has disc brakes. Disc brake pads have built-in wear indicators that make a high-pitched warning sound when the brake pads are worn and new pads are needed. The sound can come and go or be heard all the time the vehicle is moving, except when applying the brake pedal firmly.

WARNING

The brake wear warning sound means that soon the brakes will not work well. That could lead to a crash. When the brake wear warning sound is heard, have the vehicle serviced.

Notice: Continuing to drive with worn-out brake pads could result in costly brake repair.

Some driving conditions or climates can cause a brake squeal when the brakes are first applied or lightly applied. This does not mean something is wrong with the brakes.

Properly torqued wheel nuts are necessary to help prevent brake pulsation. When tires are rotated, inspect brake pads for wear and evenly tighten wheel nuts in the proper sequence to torque specifications in *Capacities and Specifications on page 12-2*.

Brake linings should always be replaced as complete axle sets.

Brake Pedal Travel

See your dealer if the brake pedal does not return to normal height, or if there is a rapid increase in pedal travel. This could be a sign that brake service might be required.

Brake Adjustment

Every time the brakes are applied, with or without the vehicle moving, the brakes adjust for wear.

Replacing Brake System Parts

The braking system on a vehicle is complex. Its many parts have to be of top quality and work well together if the vehicle is to have really good braking. The vehicle was designed and tested with top-quality brake parts. When parts of the braking system are replaced, be sure to get new, approved replacement parts. If this is not done, the brakes might not work properly. For example, installing disc brake pads that are wrong for the vehicle, can change the balance between the front and rear brakes — for the worse. The braking performance expected can change in many other ways if the wrong replacement brake parts are installed.

Brake Fluid



The brake master cylinder reservoir is filled with DOT 3 brake fluid as indicated on the reservoir cap. See *Engine Compartment Overview on page 10-6* for the location of the reservoir.

There are only two reasons why the brake fluid level in the reservoir might go down:

- The brake fluid level goes down because of normal brake lining wear. When new linings are installed, the fluid level goes back up.
- A fluid leak in the brake hydraulic system can also cause a low fluid level. Have the brake hydraulic system fixed, since a leak means that sooner or later the brakes will not work well.

Do not top off the brake fluid. Adding fluid does not correct a leak. If fluid is added when the linings are worn, there will be too much fluid when new brake linings are installed. Add or remove brake fluid, as necessary, only when work is done on the brake hydraulic system.

 **WARNING**

If too much brake fluid is added, it can spill on the engine and burn, if the engine is hot enough. You or others could be burned, and the vehicle could be damaged. Add brake fluid only when work is done on the brake hydraulic system.

When the brake fluid falls to a low level, the brake warning light comes on. See *Brake System Warning Light* on page 5-19.

What to Add

Use only new DOT 3 brake fluid from a sealed container. See *Recommended Fluids and Lubricants* on page 11-7.

Always clean the brake fluid reservoir cap and the area around the cap before removing it. This helps keep dirt from entering the reservoir.

 **WARNING**

With the wrong kind of fluid in the brake hydraulic system, the brakes might not work well. This could cause a crash. Always use the proper brake fluid.

Notice:

- **Using the wrong fluid can badly damage brake hydraulic system parts. For example, just a few drops of mineral-based oil, such as engine oil, in the brake hydraulic system can damage brake hydraulic system parts so badly that they will have to be replaced. Do not let someone put in the wrong kind of fluid.**
- **If brake fluid is spilled on the vehicle's painted surfaces, the paint finish can be damaged. Be careful not to spill brake fluid on the vehicle. If you do, wash it off immediately.**

Battery

Refer to the replacement number on the original battery label when a new battery is needed.

DANGER

Battery posts, terminals, and related accessories contain lead and lead compounds, chemicals known to the State of California to cause cancer and reproductive harm. Wash hands after handling.

If the battery has a very low charge or is dead, it might not be possible to remove the ignition key from the ignition switch or shift out of P (Park). See *Shifting Out of Park* on page 9-26.

Vehicle Storage

WARNING

Batteries have acid that can burn you and gas that can explode. You can be badly hurt if you are not careful. See *Jump Starting* on page 10-86 for tips on working around a battery without getting hurt.

Infrequent Usage: Remove the black, negative (-) cable from the battery to keep the battery from running down.

Extended Storage: Remove the black, negative (-) cable from the battery or use a battery trickle charger.

Starter Switch Check

WARNING

When you are doing this inspection, the vehicle could move suddenly. If the vehicle moves, you or others could be injured.

1. Before starting this check, be sure there is enough room around the vehicle.
2. Firmly apply both the parking brake and the regular brake. See *Parking Brake* on page 9-33.

Do not use the accelerator pedal, and be ready to turn off the engine immediately if it starts.

3. Try to start the engine in each gear. The vehicle should start only in P (Park) or N (Neutral). If the vehicle starts in any other position, contact your dealer for service.

Automatic Transmission Shift Lock Control Function Check

 **WARNING**

When you are doing this inspection, the vehicle could move suddenly. If the vehicle moves, you or others could be injured.

1. Before starting this check, be sure there is enough room around the vehicle. It should be parked on a level surface.

2. Firmly apply the parking brake. See *Parking Brake* on page 9-33.

Be ready to apply the regular brake immediately if the vehicle begins to move.

3. With the engine off, turn the ignition on, but do not start the engine. Without applying the regular brake, try to move the shift lever out of P (Park) with normal effort. If the shift lever moves out of P (Park), contact your dealer for service.

Ignition Transmission Lock Check

While parked, and with the parking brake set, try to turn the ignition to LOCK/OFF in each shift lever position.

- The ignition should turn to LOCK/OFF only when the shift lever is in P (Park).
- With the key access ignition system, the ignition key should come out only in LOCK/OFF. See *Ignition Positions (Key Access)* on page 9-17 or *Ignition Positions (Keyless Access)* on page 9-19.

Contact your dealer if service is required.

Park Brake and P (Park) Mechanism Check

WARNING

When you are doing this check, the vehicle could begin to move. You or others could be injured and property could be damaged. Make sure there is room in front of the vehicle in case it begins to roll. Be ready to apply the regular brake at once should the vehicle begin to move.

Park on a fairly steep hill, with the vehicle facing downhill. Keeping your foot on the regular brake, set the parking brake.

- To check the parking brake's holding ability: With the engine running and the transmission in N (Neutral), slowly remove foot pressure from the regular brake pedal. Do this until the vehicle is held by the parking brake only.
- To check the P (Park) mechanism's holding ability: With the engine running, shift to P (Park). Then release the parking brake followed by the regular brake.

Contact your dealer if service is required.

Wiper Blade Replacement

Windshield wiper blades should be inspected for wear and cracking. See *Scheduled Maintenance on page 11-2* for more information.

Replacement blades come in different types and are removed in different ways. For proper type and length, see *Maintenance Replacement Parts on page 11-9*.

To replace the windshield wiper blade:

1. Pull the windshield wiper assembly away from the windshield.

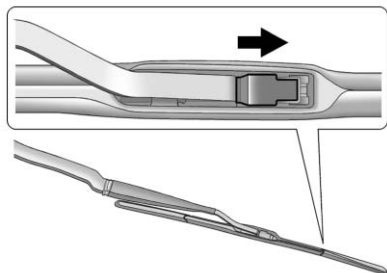

2. Lift up on the plastic latch in the middle of the wiper blade where the wiper arm attaches.
3. With the latch open, pull the wiper blade down toward the windshield far enough to release it from the J-hooked end of the wiper arm.

4. Remove the wiper blade.

Allowing the wiper blade arm to touch the windshield when no wiper blade is installed could damage the windshield. Any damage that occurs would not be covered by the vehicle warranty. Do not allow the wiper blade to touch the windshield.

5. Reverse Steps 1 through 3 for wiper blade replacement.

Headlamp Aiming

The headlamp aiming system has been preset at the factory.

If the vehicle is damaged in an accident, the aim of the headlamps may be affected and adjustment may be necessary.

It is recommended that a dealer adjust the headlamps. To re-aim the headlamps yourself, use the following procedure.

The vehicle should be properly prepared as follows:

- The vehicle should be placed so the headlamps are 7.6 m (25 ft) from a light-colored wall.
- The vehicle must have all four tires on a level surface which is level all the way to the wall.

- The vehicle should be placed so it is perpendicular to the wall or other flat surface.
- The vehicle should not have any snow, ice, or mud on it.
- The vehicle should be fully assembled and all other work stopped while headlamp aiming is being performed.
- The vehicle should be normally loaded with a full tank of fuel and one person or 75 kg (160 lbs) sitting in the driver seat.
- Tires should be properly inflated.

Headlamp aiming is done with the vehicle's low-beam headlamps. The high-beam headlamps will be correctly aimed if the low-beam headlamps are aimed properly.

To adjust the vertical aim:
1. Open the hood. See *Hood* on page 10-5.

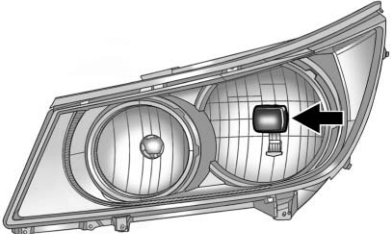

Base

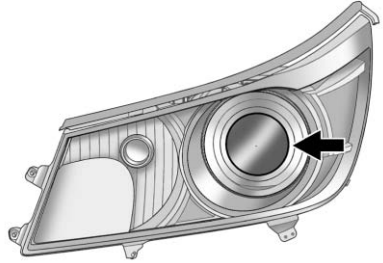

Uplevel

2. Locate the aim dot on the lens of the low-beam headlamp.
3. Measure the distance from the ground to the aim dot on the low-beam headlamp. Record the distance.

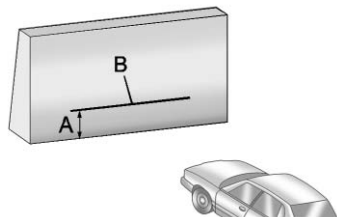

4. At the wall, measure from the ground upward (A) to the recorded distance from Step 3 and mark it.
5. Draw or tape a horizontal line (B) on the wall the width of the vehicle at the height of the mark in Step 4.

Notice: Do not cover a headlamp to improve beam cut-off when aiming. Covering a headlamp may cause excessive heat build-up which may cause damage to the headlamp.

6. Turn on the low-beam headlamps and place a piece of cardboard or equivalent in front of the headlamp not being adjusted. This allows only the beam of light from the headlamp being adjusted to be seen on the flat surface.

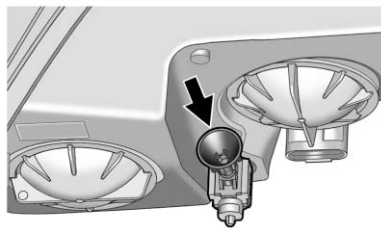

Base

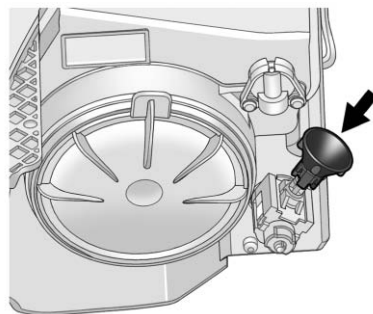

Uplevel

7. Locate the vertical headlamp aiming screw, which are under the hood near each headlamp assembly.
8. Turn the vertical aiming screw until the headlamp beam is aimed to the horizontal tape line. Turn it clockwise or counterclockwise to raise or lower the angle of the beam.

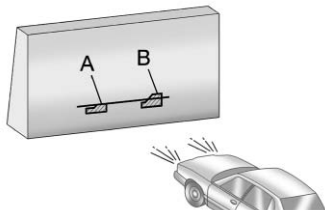

9. Make sure that the light from the headlamp is positioned at the bottom edge of the horizontal tape line. The lamp on the left (A) shows the correct headlamp aim. The lamp on the right (B) shows the incorrect headlamp aim.
10. Repeat Steps 7 through 9 for the opposite headlamp.

Bulb Replacement

For the proper type of replacement bulbs, see *Replacement Bulbs* on page 10-37.

For any bulb changing procedure not listed in this section, contact your dealer.

Halogen Bulbs

⚠ WARNING

Halogen bulbs have pressurized gas inside and can burst if you drop or scratch the bulb. You or others could be injured. Be sure to read and follow the instructions on the bulb package.

High Intensity Discharge (HID) Lighting

⚠ WARNING

The low beam high intensity discharge lighting system operates at a very high voltage. If you try to service any of the system components, you could be seriously injured. Have your dealer or a qualified technician service them.

After an HID headlamp bulb has been replaced, the beam might be a slightly different shade than it was originally. This is normal.

Headlamps, Front Turn Signal and Parking Lamps

Base Headlamp Assembly

The base model vehicle has a halogen high-beam headlamp, a low-beam/Daytime Running Lamp (DRL) headlamp, and a turn signal/parking lamp on the headlamp assembly.

To replace one of these bulbs:

1. Open the hood. See *Hood* on page 10-5.

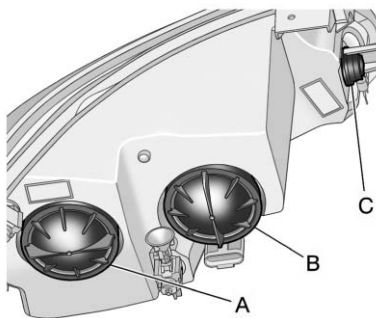

- A. Low-Beam Headlamp/DRL
- B. High-Beam Headlamp
- C. Parking/Turn Signal Lamp

2. If replacing a headlamp bulb, remove the dust cover from the back of the headlamp housing by turning counterclockwise one-quarter turn.

3. Remove the bulb socket from the headlamp by turning counterclockwise one-quarter turn.
4. Remove the bulb from the socket. If replacing the high/low-beam bulb, pry the two clips on either end of the bulb and pull straight out.
5. Install the new bulb in the socket.

6. Install the bulb socket by turning clockwise one-quarter turn.
7. If a headlamp bulb was replaced, install the dust cover in the back of the headlamp housing by turning clockwise one-quarter turn.

Uplevel Headlamp Assembly

The uplevel model vehicle has a high intensity discharge (HID) high/low beam, a dedicated DRL and a parking/turn signal lamp on the headlamp assembly. See *High Intensity Discharge (HID) Lighting* on page 10-33 for more information.

To replace one of these bulbs:

1. Open the hood. See *Hood* on page 10-5.

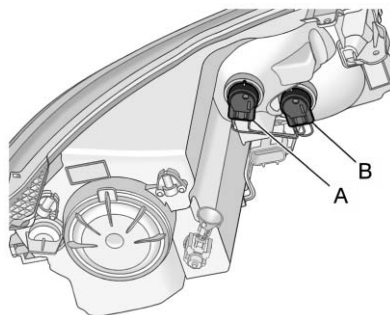

- A. DRL Lamp
- B. Parking/Turn Signal Lamp

2. Turn the bulb socket counterclockwise to remove it from the headlamp assembly.
3. Pull the bulb straight out from the socket.
4. Push the new bulb into the socket and reinstall the socket into the headlamp assembly by turning it clockwise.

Taillamps, Turn Signal, Stoplamps, and Back-Up Lamps

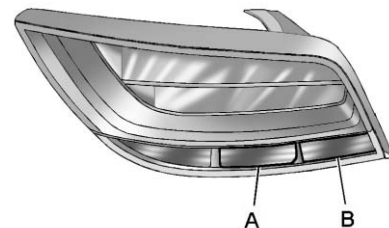

- A. Turn Signal Lamp
- B. Back-Up Lamp

To replace one of these lamps:

1. Open the trunk. See *Trunk* on page 2-12.
2. Remove fasteners and pull back the trunk trim.

10-36 Vehicle Care

3. Remove the four plastic wing nuts retaining the taillamp assembly in place.
4. Pull out the taillamp assembly and disconnect the wiring harness.

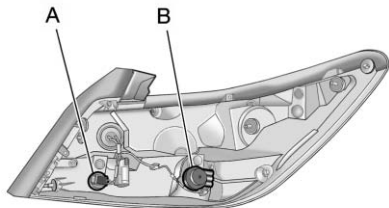

- A. Back-Up Lamp
B. Turn Signal Lamp

5. Turn the bulb socket counterclockwise to remove it.
6. Pull the old bulb straight out of the bulb socket.
7. Push the new bulb straight into the bulb socket until it clicks.
8. Turn the bulb socket clockwise to reinstall.
9. Reconnect the wiring harness.
10. Push the taillamp assembly back into place on the vehicle.
11. Turn the four wing nuts clockwise to reinstall them.
12. Place the trunk trim to its original location.

License Plate Lamp

The license plate lamps for this vehicle are on the trunk lid.

To replace one of these bulbs:

1. Open the trunk. See *Trunk* on page 2-12 for more information.

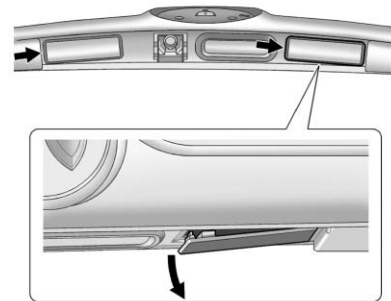

2. Push the end on either of the lamp assemblies (passenger side shown) and then move the lamp assembly down to remove it from the trunk lid.

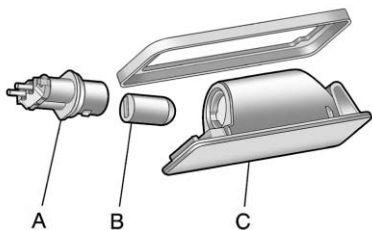

- A. Bulb Socket
- B. Bulb
- C. Lamp Assembly

3. Turn the bulb socket (A) counterclockwise to remove it from the lamp assembly (C).
4. Pull the bulb (B) straight out of the bulb socket.
5. Push the replacement bulb straight into the bulb socket and turn the bulb socket clockwise to install it into the lamp assembly.
6. Move the lamp assembly into the trunk lid engaging the clip side first.
7. Push on the lamp side opposite the clip until the lamp assembly snaps into place.

Replacement Bulbs

Exterior Lamp	Bulb Number
Back-Up Lamp	W16WLL
Daytime Running Lamp (Uplevel)	3157K LCP
Front Turn Signal/ Parking Lamp	3757NAK LCP
Headlamp High Beam (Base)	H9
Headlamp Low Beam (Base)	H11LL
License Plate Lamp	W5WLL
Rear Turn Signal	3757AK LCP

For replacement bulbs not listed here, contact your dealer.

Electrical System

Electrical System Overload

The vehicle has fuses and circuit breakers to protect against an electrical system overload.

When the current electrical load is too heavy, the circuit breaker opens and closes, protecting the circuit until the current load returns to normal or the problem is fixed. This greatly reduces the chance of circuit overload and fire caused by electrical problems.

Fuses and circuit breakers protect the following in the vehicle:

- Headlamp Wiring
- Windshield Wiper Motor
- Power Windows and Other Power Accessories

Replace a bad fuse with a new one of the identical size and rating.

If there is a problem on the road and a fuse needs to be replaced, the same amperage fuse can be borrowed. Choose some feature of the vehicle that is not needed to use and replace it as soon as possible.

Headlamp Wiring

An electrical overload may cause the lamps to go on and off, or in some cases to remain off. Have the headlamp wiring checked right away if the lamps go on and off or remain off.

Windshield Wipers

If the wiper motor overheats due to heavy snow or ice, the windshield wipers will stop until the motor cools and will then restart.

Although the circuit is protected from electrical overload, overload due to heavy snow or ice may cause wiper linkage damage. Always clear ice and heavy snow from the windshield before using the windshield wipers.

If the overload is caused by an electrical problem and not snow or ice, be sure to get it fixed.

Fuses and Circuit Breakers

The wiring circuits in the vehicle are protected from short circuits by a combination of fuses and circuit breakers. This greatly reduces the chance of damage caused by electrical problems.

To check a fuse, look at the silver-colored band inside the fuse. If the band is broken or melted, replace the fuse. Be sure to replace a bad fuse with a new one of the identical size and rating.

Fuses of the same amperage can be temporarily borrowed from another fuse location, if a fuse goes out. Replace the fuse as soon as possible.

To identify and check fuses, circuit breakers, and relays, see *Engine Compartment Fuse Block on page 10-39*, *Instrument Panel Fuse Block on page 10-42*, and *Rear Compartment Fuse Block on page 10-44*.

Engine Compartment Fuse Block

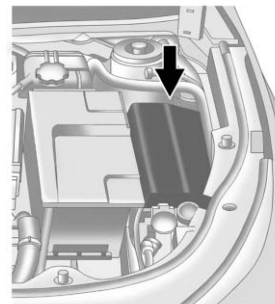

To remove the fuse block cover, squeeze the three retaining clips on the cover and lift it straight up.

Notice: Spilling liquid on any electrical component on the vehicle may damage it. Always keep the covers on any electrical component.

10-40 Vehicle Care

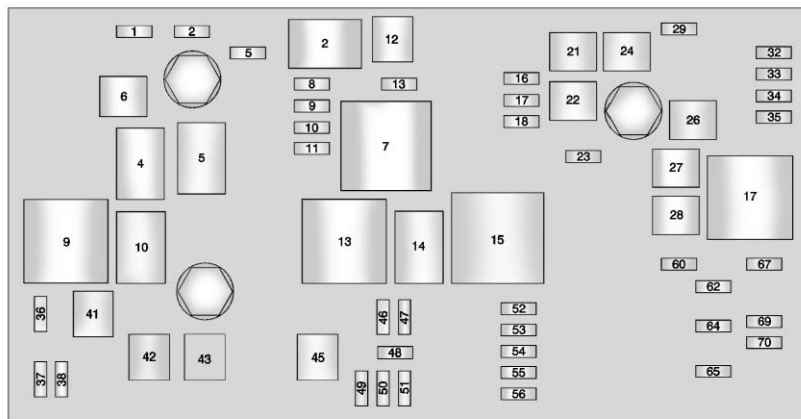

Engine Compartment Fuse Block

The vehicle may not be equipped with all of the fuses, relays, and features shown.

J-Case Fuses	Usage
6	Wiper
12	Starter

J-Case Fuses	Usage
21	Rear Power Windows
22	Sunroof
24	Front Power Windows

J-Case Fuses	Usage
26	Antilock Brake System Pump
27	Electric Park Brake
28	Rear Window Defogger
41	Brake Vacuum Pump
42	Cooling Fan K2
45	Cooling Fan K1

Mini Fuses	Usage
1	Transmission Control Module
2	Engine Control Module Battery
5	Engine Control Module Ignition
8	Ignition Coils - Even
9	Ignition Coils - Odd

Mini Fuses	Usage
10	Engine Control Module
11	Post Catalytic Converter Oxygen Sensor Heater
13	Trans Ignition/Fuel System Control Module
16	MAF
17	Airbag Module
18	SBZ Ignition
23	Variable Effort Steering
29	Power Lumbar, Left
32	Body Control Module
33	Heated Seat
34	Antilock Brake System Valves
35	Amplifier

Mini Fuses	Usage
36	AFL Ignition
37	Right High Beam
38	Left High Beam
46	Cooling Fan Relay
47	Pre Catalytic Converter Oxygen Sensor Heater
48	Fog Lamps
49	Right High Intensity Discharge Headlamp
50	Left High Intensity Discharge Headlamp
51	Horn
52	Cluster Ignition
53	Inside Rearview Mirror, Rear Vision Camera, Vacuum Pump

Mini Fuses	Usage
54	Heating, Ventilation and Air Conditioning
55	Outside Rearview Mirror, Universal Garage Door Opener, Window Switch
56	Windshield Washer
60	Heated Mirror
62	Canister Vent
64	AFL Battery
65	Theft-Deterrent Horn
67	Fuel System Control Module
69	Regulated Voltage Control Sensor
70	Ultrasonic Parking Assist/Side Blind Zone

Mini Relays	Usage
7	Engine Control Module
9	Cooling Fan
13	Cooling Fan
15	Run/Crank
17	Rear Window Defogger

Micro Relays	Usage
2	Starter
4	Wiper Speed
5	Wiper Control
10	Cooling Fan
14	Headlamp Low Beam

Instrument Panel Fuse Block

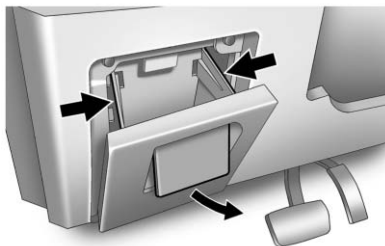

The instrument panel fuse block is located in the instrument panel, on the driver side of the vehicle. To access the fuses, open the fuse panel door by pulling down at the top.

Press in on the sides of the door to release it from the instrument panel.

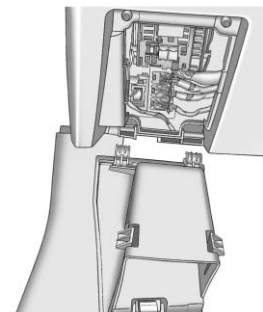

Pull the door toward you to release it from the hinge.

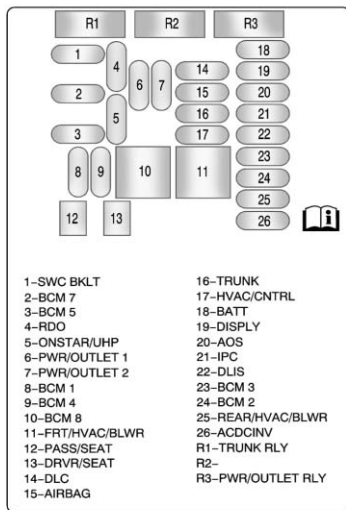

Instrument Panel Fuse Block

The vehicle may not be equipped with all of the fuses, relays, and features shown.

Fuses	Usage
1	Steering Wheel Controls Backlight
2	Body Control Module 7
3	Body Control Module 5
4	Radio
5	OnStar Universal Hands-Free Phone
6	Power Outlet 1
7	Power Outlet 2
8	Body Control Module 1
9	Body Control Module 4

Fuses	Usage
10	Body Control Module 8
11	Front Heater Ventilation Air Conditioning/Blower
12	Passenger Seat
13	Driver Seat
14	Diagnostic Link Connector
15	Airbag
16	Trunk
17	Heater Ventilation Air Conditioning Controller

10-44 Vehicle Care

Fuses	Usage
18	Radio, OnStar, Universal Hands-Free Phone
19	Display
20	Automatic Occupant Sensing
21	Instrument Panel Cluster
22	Discrete Logic Ignition Switch
23	Body Control Module 3

Fuses	Usage
24	Body Control Module 2
25	Rear Heater Ventilation Air Conditioning/Blower
26	AC/DC Inverter

Relays	Usage
R1	Trunk Relay
R2	Not Used
R3	Power Outlet Relay

Rear Compartment Fuse Block

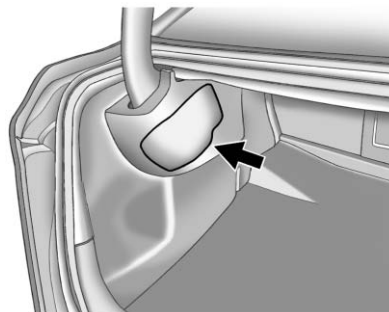

The rear compartment fuse block is located on the left side of the trunk behind a cover.

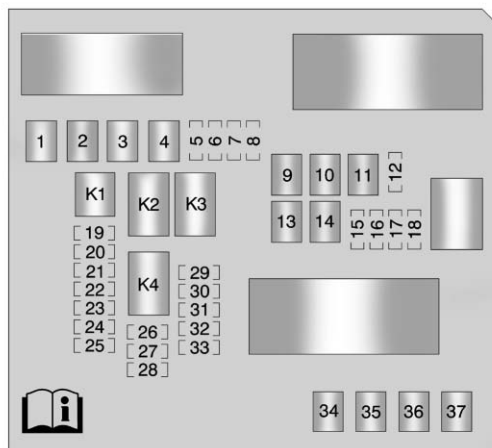

Mini Fuses	Usage
17	Not Used
18	PEPS
19	Not Used
20	Rear Sunshade, Ventilated Seats
21	Not Used
22	Not Used
23	Not Used
24	Not Used
25	Not Used
26	Not Used
27	Not Used
28	Not Used
29	Not Used
30	Not Used

The vehicle may not be equipped with all of the fuses, relays, and features shown.

Mini Fuses	Usage
5	Not Used
6	Heated Steering Wheel

Mini Fuses	Usage
7	Not Used
8	Not Used
12	Not Used
15	Not Used
16	Not Used

Mini Fuses	Usage
31	Electronic Suspension Control
32	Rear Seat Infotainment
33	All-Wheel Drive

J-Case Fuses	Usage
1	Not Used
2	Not Used
3	Not Used
4	Not Used
9	Not Used
10	Not Used
11	Not Used

J-Case Fuses	Usage
13	Not Used
14	Not Used
34	Not Used
35	PEPS
36	Not Used
37	Not Used

Relays	Usage
K1	Not Used
K2	Seat Ventilation, Sunshade
K3	Heated Steering Wheel
K4	Not Used

Wheels and Tires

Tires

Every new GM vehicle has high-quality tires made by a leading tire manufacturer. See the warranty manual for information regarding the tire warranty and where to get service. For additional information refer to the tire manufacturer.

WARNING

- Poorly maintained and improperly used tires are dangerous.
- Overloading the tires can cause overheating as a result of too much flexing. There could be a blowout and a serious crash. See *Vehicle Load Limits* on page 9-12.

(Continued)

WARNING (Continued)

- Underinflated tires pose the same danger as overloaded tires. The resulting crash could cause serious injury. Check all tires frequently to maintain the recommended pressure. Tire pressure should be checked when the tires are cold.
- Overinflated tires are more likely to be cut, punctured, or broken by a sudden impact — such as when hitting a pothole. Keep tires at the recommended pressure.

(Continued)

WARNING (Continued)

- Worn or old tires can cause a crash. If the tread is badly worn, replace them.
- Replace any tires that have been damaged by impacts with potholes, curbs, etc.
- Improperly repaired tires can cause a crash. Only the dealer or an authorized tire service center should repair, replace, dismount, and mount the tires.
- Do not spin the tires in excess of 55 km/h (35 mph) on slippery surfaces such as snow, mud, ice, etc. Excessive spinning may cause the tires to explode.

Winter Tires

Consider installing winter tires on the vehicle if frequent driving on snow or ice covered roads is expected. All season tires provide good overall performance on most surfaces, but they may not offer the traction or the same level of performance as winter tires on snow or ice covered roads.

Winter tires, in general, are designed for increased traction on snow and ice covered roads. With winter tires, there may be decreased dry road traction, increased road noise, and shorter tread life. After changing to winter tires, be alert for changes in vehicle handling and braking.

See your dealer for details regarding winter tire availability and proper tire selection. Also, see *Buying New Tires* on page 10-64.

If using snow tires:

- Use tires of the same brand and tread type on all four wheel positions.
- Use only radial ply tires of the same size, load range, and speed rating as the original equipment tires.

Winter tires with the same speed rating as the original equipment tires may not be available for H, V, W, Y, and ZR speed rated tires. If winter tires with a lower speed rating are chosen, never exceed the tire's maximum speed capability.

Tire Sidewall Labeling

Useful information about a tire is molded into its sidewall. The examples below show a typical passenger vehicle tire and a compact spare tire sidewall.

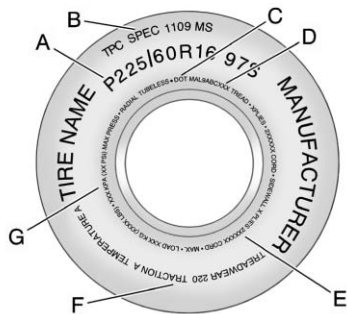

Passenger (P-Metric) Tire Example

(A) Tire Size: The tire size is a combination of letters and numbers used to define a particular tire's width, height,

aspect ratio, construction type, and service description. See the "Tire Size" illustration later in this section for more detail.

(B) TPC Spec (Tire Performance Criteria Specification): Original equipment tires designed to GM's specific tire performance criteria have a TPC specification code molded onto the sidewall. GM's TPC specifications meet or exceed all federal safety guidelines.

(C) DOT (Department of Transportation): The Department of Transportation (DOT) code indicates that the tire is in compliance with the U.S. Department of Transportation Motor Vehicle Safety Standards.

(D) Tire Identification

Number (TIN): The letters and numbers following the DOT (Department of Transportation) code are the Tire Identification Number (TIN). The TIN shows the manufacturer and plant code, tire size, and date the tire was manufactured. The TIN is molded onto both sides of the tire, although only one side may have the date of manufacture.

(E) Tire Ply Material: The type of cord and number of plies in the sidewall and under the tread.

(F) Uniform Tire Quality Grading (UTQG): Tire manufacturers are required to grade tires based on three performance factors: treadwear, traction, and temperature resistance. For more information see *Uniform Tire Quality Grading on page 10-66*.

(G) Maximum Cold Inflation

Load Limit: Maximum load that can be carried and the maximum pressure needed to support that load.

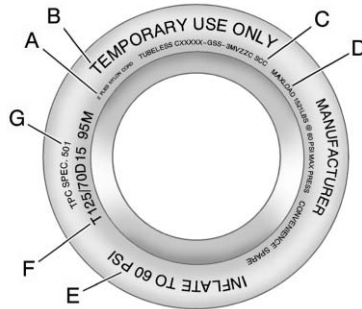

Compact Spare Tire Example

(A) Tire Ply Material: The type of cord and number of plies in the sidewall and under the tread.

(B) Temporary Use Only:

The compact spare tire or temporary use tire has a tread life of approximately 5 000 km (3,000 mi) and should not be driven at speeds over 105 km/h (65 mph). The compact spare tire is for emergency use when a regular road tire has lost air and gone flat. If the vehicle has a compact spare tire, see *Compact Spare Tire on page 10-85* and *If a Tire Goes Flat on page 10-70*.

(C) Tire Identification

Number (TIN): The letters and numbers following the DOT (Department of Transportation) code is the Tire Identification Number (TIN). The TIN shows the manufacturer and plant code, tire size, and date the tire was manufactured. The TIN is molded onto both sides of the tire, although only one side may have the date of manufacture.

(D) Maximum Cold Inflation

Load Limit: Maximum load that can be carried and the maximum pressure needed to support that load.

(E) Tire Inflation:

The temporary use tire or compact spare tire should be inflated to 420 kPa (60 psi). For more information on tire pressure and inflation see *Tire Pressure* on page 10-54.

(F) Tire Size: A combination of letters and numbers define a tire's width, height, aspect ratio, construction type, and service description. The letter T as the first character in the tire size means the tire is for temporary use only.

(G) TPC Spec (Tire Performance Criteria Specification):

Original equipment tires designed to GM's specific tire performance criteria have a TPC specification code molded onto the sidewall. GM's TPC specifications meet or exceed all federal safety guidelines.

Tire Designations

Tire Size

The following is an example of a typical passenger vehicle tire size.

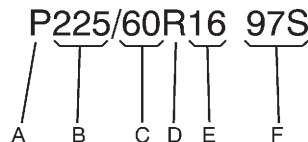

(A) Passenger (P-Metric) Tire:

The United States version of a metric tire sizing system. The letter P as the first character in the tire size means a passenger vehicle tire engineered to standards set by the U.S. Tire and Rim Association.

(B) Tire Width: The three-digit number indicates the tire section width in millimeters from sidewall to sidewall.

(C) Aspect Ratio: A two-digit number that indicates the tire height-to-width measurements. For example, if the tire size aspect ratio is 60, as shown in item C of the illustration, it would mean that the tire's sidewall is 60 percent as high as it is wide.

(D) Construction Code: A letter code is used to indicate the type of ply construction in the tire. The letter R means radial ply construction; the letter D means diagonal or bias ply construction; and the letter B means belted-bias ply construction.

(E) Rim Diameter: Diameter of the wheel in inches.

(F) Service Description: These characters represent the load index and speed rating of the tire. The load index represents the load carrying capacity a tire is certified to carry. The speed rating is the maximum speed a tire is certified to carry a load.

Tire Terminology and Definitions

Air Pressure: The amount of air inside the tire pressing outward on each square inch of the tire. Air pressure is expressed in psi (pounds per square inch) or kPa (kilopascal).

Accessory Weight: The combined weight of optional accessories. Some examples of optional accessories are, automatic transmission, power steering, power brakes, power windows, power seats, and air conditioning.

Aspect Ratio: The relationship of a tire's height to its width.

Belt: A rubber coated layer of cords that is located between the plies and the tread. Cords may be made from steel or other reinforcing materials.

Bead: The tire bead contains steel wires wrapped by steel cords that hold the tire onto the rim.

Bias Ply Tire: A pneumatic tire in which the plies are laid at alternate angles less than 90 degrees to the centerline of the tread.

Cold Tire Pressure: The amount of air pressure in a tire, measured in kPa (kilopascal) or psi (pounds per square inch) before a tire has built up heat from driving. See *Tire Pressure on page 10-54*.

Curb Weight: The weight of a motor vehicle with standard and optional equipment including the maximum capacity of fuel, oil, and coolant, but without passengers and cargo.

DOT Markings: A code molded into the sidewall of a tire signifying that the tire is in compliance with the U.S. Department of Transportation (DOT) Motor Vehicle Safety Standards. The DOT code includes the Tire Identification Number (TIN), an alphanumeric designator which can also identify the tire manufacturer, production plant, brand, and date of production.

GVWR: Gross Vehicle Weight Rating. See *Vehicle Load Limits on page 9-12*.

GAWR FRT: Gross Axle Weight Rating for the front axle. See *Vehicle Load Limits on page 9-12*.

GAWR RR: Gross Axle Weight Rating for the rear axle. See *Vehicle Load Limits on page 9-12*.

Intended Outboard Sidewall: The side of an asymmetrical tire, that must always face outward when mounted on a vehicle.

Kilopascal (kPa): The metric unit for air pressure.

Light Truck (LT-Metric) Tire: A tire used on light duty trucks and some multipurpose passenger vehicles.

Load Index: An assigned number ranging from 1 to 279 that corresponds to the load carrying capacity of a tire.

Maximum Inflation Pressure: The maximum air pressure to which a cold tire can be inflated. The maximum air pressure is molded onto the sidewall.

Maximum Load Rating: The load rating for a tire at the maximum permissible inflation pressure for that tire.

Maximum Loaded Vehicle Weight: The sum of curb weight, accessory weight, vehicle capacity weight, and production options weight.

Normal Occupant Weight: The number of occupants a vehicle is designed to seat multiplied by 68 kg (150 lbs). See *Vehicle Load Limits on page 9-12*.

Occupant Distribution: Designated seating positions.

Outward Facing Sidewall:

The side of an asymmetrical tire that has a particular side that faces outward when mounted on a vehicle. The side of the tire that contains a whitewall, bears white lettering, or bears manufacturer, brand, and/or model name molding that is higher or deeper than the same moldings on the other sidewall of the tire.

Passenger (P-Metric) Tire:

A tire used on passenger cars and some light duty trucks and multipurpose vehicles.

Recommended Inflation

Pressure: Vehicle manufacturer's recommended tire inflation pressure as shown on the tire placard. See *Tire Pressure on page 10-54* and *Vehicle Load Limits on page 9-12*.

Radial Ply Tire: A pneumatic tire in which the ply cords that extend to the beads are laid at 90 degrees to the centerline of the tread.

Rim: A metal support for a tire and upon which the tire beads are seated.

Sidewall: The portion of a tire between the tread and the bead.

Speed Rating: An alphanumeric code assigned to a tire indicating the maximum speed at which a tire can operate.

Traction: The friction between the tire and the road surface. The amount of grip provided.

Tread: The portion of a tire that comes into contact with the road.

Treadwear Indicators: Narrow bands, sometimes called wear bars, that show across the tread of a tire when only 1.6 mm (1/16 in) of tread remains. See *When It Is Time for New Tires on page 10-63*.

UTQGS (Uniform Tire Quality Grading Standards):

A tire information system that provides consumers with ratings for a tire's traction, temperature, and treadwear. Ratings are determined by tire manufacturers using government testing procedures. The ratings are molded into the sidewall of the tire. See *Uniform Tire Quality Grading on page 10-66*.

Vehicle Capacity Weight:

The number of designated seating positions multiplied by 68 kg (150 lbs) plus the rated cargo load. See *Vehicle Load Limits on page 9-12*.

Vehicle Maximum Load on the

Tire: Load on an individual tire due to curb weight, accessory weight, occupant weight, and cargo weight.

Vehicle Placard: A label permanently attached to a vehicle showing the vehicle capacity weight and the original equipment tire size and recommended inflation pressure. See "Tire and Loading Information Label" under *Vehicle Load Limits on page 9-12*.

Tire Pressure

Tires need the correct amount of air pressure to operate effectively.

Notice: Neither tire underinflation nor overinflation is good. Underinflated tires, or tires that do not have enough air, can result in:

- **Tire overloading and over-heating which could lead to a blowout.**
- **Premature or irregular wear.**
- **Poor handling.**
- **Reduced fuel economy.**

Overinflated tires, or tires that have too much air, can result in:

- **Unusual wear.**
- **Poor handling.**
- **Rough ride.**
- **Needless damage from road hazards.**

A vehicle-specific Tire and Loading Information label is attached to the vehicle. This label shows the vehicle's original equipment tires and the correct inflation pressures for the tires when they are cold. The recommended cold tire inflation pressure, shown on the label, is the minimum amount of air pressure needed to support the vehicle's maximum load carrying capacity.

For additional information regarding how much weight the vehicle can carry, and an example of the Tire and Loading Information label, see *Vehicle Load Limits on page 9-12*. How you load the vehicle affects vehicle handling and ride comfort. Never load the vehicle with more weight than it was designed to carry.

When to Check

Check the tires once a month or more. Do not forget to check the compact spare tire, if the vehicle has one. The compact spare should be at 420 kPa (60 psi). For additional information regarding the compact spare tire, see *Compact Spare Tire on page 10-85*.

How to Check

Use a good quality pocket-type gauge to check tire pressure. You cannot tell if the tires are properly inflated simply by looking at them. Radial tires may look properly inflated even when they are underinflated. Check the tire's inflation pressure when the tires are cold. Cold means the vehicle has been sitting for at least three hours or driven no more than 1.6 km (1 mi).

Remove the valve cap from the tire valve stem. Press the tire gauge firmly onto the valve to get a pressure measurement.

If the cold tire inflation pressure matches the recommended pressure on the Tire and Loading Information label, no further adjustment is necessary. If the inflation pressure is low, add air until you reach the recommended amount.

If you overfill the tire, release air by pushing on the metal stem in the center of the tire valve. Re-check the tire pressure with the tire gauge.

Be sure to put the valve caps back on the valve stems. They help prevent leaks by keeping out dirt and moisture.

Tire Pressure Monitor System

The Tire Pressure Monitor System (TPMS) uses radio and sensor technology to check tire pressure levels. The TPMS sensors monitor the air pressure in your tires and transmit tire pressure readings to a receiver located in the vehicle.

Each tire, including the spare (if provided), should be checked monthly when cold and inflated to the inflation pressure recommended by the vehicle manufacturer on the vehicle placard or tire inflation pressure label. (If your vehicle has tires of a different size than the size indicated on the vehicle placard or tire inflation pressure label, you should determine the proper tire inflation pressure for those tires.)

As an added safety feature, your vehicle has been equipped with a tire pressure monitoring system (TPMS) that illuminates a low tire

pressure telltale when one or more of your tires is significantly under-inflated.

Accordingly, when the low tire pressure telltale illuminates, you should stop and check your tires as soon as possible, and inflate them to the proper pressure. Driving on a significantly under-inflated tire causes the tire to overheat and can lead to tire failure. Under-inflation also reduces fuel efficiency and tire tread life, and may affect the vehicle's handling and stopping ability.

Please note that the TPMS is not a substitute for proper tire maintenance, and it is the driver's responsibility to maintain correct tire pressure, even if under-inflation has not reached the level to trigger illumination of the TPMS low tire pressure telltale.

Your vehicle has also been equipped with a TPMS malfunction indicator to indicate when the system is not operating properly.

The TPMS malfunction indicator is combined with the low tire pressure telltale. When the system detects a malfunction, the telltale will flash for approximately one minute and then remain continuously illuminated. This sequence will continue upon subsequent vehicle start-ups as long as the malfunction exists.

When the malfunction indicator is illuminated, the system may not be able to detect or signal low tire pressure as intended. TPMS malfunctions may occur for a variety of reasons, including the installation of replacement or alternate tires or wheels on the vehicle that prevent the TPMS from functioning properly. Always check the TPMS malfunction telltale after replacing one or more tires or wheels on your vehicle to ensure that the replacement or alternate tires and wheels allow the TPMS to continue to function properly.

See *Tire Pressure Monitor Operation* on page 10-57 for additional information.

Federal Communications Commission (FCC) and Industry Canada

See *Radio Frequency Statement on page 13-20* for information regarding Part 15 of the Federal Communications Commission (FCC) rules and Industry Canada Standards RSS-210/220/310.

Tire Pressure Monitor Operation

This vehicle may have a Tire Pressure Monitor System (TPMS). The TPMS is designed to warn the driver when a low tire pressure condition exists. TPMS sensors are mounted onto each tire and wheel assembly, excluding the spare tire and wheel assembly. The TPMS sensors monitor the air pressure in the tires and transmits the tire pressure readings to a receiver located in the vehicle.



When a low tire pressure condition is detected, the TPMS illuminates the low tire pressure warning light located on the instrument cluster. If the warning light comes on, stop as soon as possible and inflate the tires to the recommended pressure shown on the tire loading information label. See *Vehicle Load Limits on page 9-12*.

A message to check the pressure in a specific tire displays in the Driver Information Center (DIC). The low tire pressure warning light and the DIC warning message come on at each ignition cycle until the tires are inflated to the correct inflation pressure. Using the DIC, tire pressure levels can be viewed.

For additional information and details about the DIC operation and displays see *Driver Information Center (DIC) on page 5-25*.

The low tire pressure warning light may come on in cool weather when the vehicle is first started, and then turn off as the vehicle is driven. This could be an early indicator that the air pressure is getting low and needs to be inflated to the proper pressure.

A Tire and Loading Information label, attached to your vehicle, shows the size of the original equipment tires and the correct inflation pressure for the tires when they are cold. See *Vehicle Load Limits on page 9-12*, for an example of the Tire and Loading Information label and its location. Also see *Tire Pressure on page 10-54*.

The TPMS can warn about a low tire pressure condition but it does not replace normal tire maintenance. See *Tire Inspection on page 10-61*, *Tire Rotation on page 10-61* and *Tires on page 10-46*.

Notice: Tire sealant materials are not all the same. A non-approved tire sealant could damage the TPMS sensors. TPMS sensor damage caused by using an incorrect tire sealant is not covered by the vehicle warranty. Always use only the GM-approved tire sealant available through your dealer or included in the vehicle.

Factory-installed Tire Inflator Kits use a GM approved liquid tire sealant. Using non-approved tire sealants could damage the TPMS sensors. See *Tire Sealant and Compressor Kit on page 10-72* for information regarding the inflator kit materials and instructions.

TPMS Malfunction Light and Message

The TPMS will not function properly if one or more of the TPMS sensors are missing or inoperable. When the system detects a malfunction, the low tire warning light flashes for about one minute and then stays on for the remainder of the ignition cycle. A DIC warning message also displays. The malfunction light and DIC warning message come on at each ignition cycle until the problem is corrected. Some of the conditions that can cause these to come on are:

- One of the road tires has been replaced with the spare tire. The spare tire does not have a TPMS sensor. The malfunction light and DIC message should go off after the road tire is replaced and the sensor matching process is performed successfully. See "TPMS Sensor Matching Process" later in this section.

- The TPMS sensor matching process was not done or not completed successfully after rotating the tires. The malfunction light and the DIC message should go off after successfully completing the sensor matching process. See "TPMS Sensor Matching Process" later in this section.
- One or more TPMS sensors are missing or damaged. The malfunction light and the DIC message should go off when the TPMS sensors are installed and the sensor matching process is performed successfully. See your dealer for service.

- Replacement tires or wheels do not match the original equipment tires or wheels. Tires and wheels other than those recommended could prevent the TPMS from functioning properly. See *Buying New Tires* on page 10-64.
- Operating electronic devices or being near facilities using radio wave frequencies similar to the TPMS could cause the TPMS sensors to malfunction.

If the TPMS is not functioning properly it cannot detect or signal a low tire condition. See your dealer for service if the TPMS malfunction light and DIC message comes on and stays on.

TPMS Sensor Matching Process

Each TPMS sensor has a unique identification code. The identification code needs to be matched to a new tire/wheel position after rotating the vehicle's tires or replacing one or more of the TPMS sensors. The TPMS sensor matching process should also be performed after replacing a spare tire with a road tire containing the TPMS sensor. The malfunction light and the DIC message should go off at the next ignition cycle. The sensors are matched to the tire/wheel positions, using a TPMS relearn tool, in the following order: driver side front tire, passenger side front tire, passenger side rear tire, and driver side rear. See your dealer for service or to purchase a relearn tool.

There are two minutes to match the first tire/wheel position, and five minutes overall to match all four tire/wheel positions. If it takes longer, the matching process stops and must be restarted.

The TPMS sensor matching process is:

1. Set the parking brake.
2. Turn the ignition to ON/RUN with the engine off.
3. Use the MENU button to select the Vehicle Information Menu in the Driver Information Center (DIC).
4. Use the thumbwheel to scroll to the Tire Pressure Menu Item screen.

10-60 Vehicle Care

5. Press the SET/CLR button to begin the sensor matching process.
A message asking if the process should begin should appear.
6. Press the SET/CLR button again to confirm the selection.
The horn sounds twice to signal the receiver is in relearn mode and the TIRE LEARNING ACTIVE message displays on the DIC screen.
7. Start with the driver side front tire.
8. Place the relearn tool against the tire sidewall, near the valve stem. Then press the button to activate the TPMS sensor. A horn chirp confirms that the sensor identification code has been matched to this tire and wheel position.
9. Proceed to the passenger side front tire, and repeat the procedure in Step 8.
10. Proceed to the passenger side rear tire, and repeat the procedure in Step 8.
11. Proceed to the driver side rear tire, and repeat the procedure in Step 8. The horn sounds two times to indicate the sensor identification code has been matched to the driver side rear tire, and the TPMS sensor matching process is no longer active. The TIRE LEARNING ACTIVE message on the DIC display screen goes off.
12. Turn the ignition to LOCK/OFF.
13. Set all four tires to the recommended air pressure level as indicated on the Tire and Loading Information label.

Tire Inspection

GM recommends that the tires, including the spare tire, if the vehicle has one, be inspected for signs of wear or damage at least once a month.

Replace the tire if:

- The indicators at three or more places around the tire can be seen.
- There is cord or fabric showing through the tire's rubber.
- The tread or sidewall is cracked, cut, or snagged deep enough to show cord or fabric.

- The tire has a bump, bulge, or split.
- The tire has a puncture, cut, or other damage that cannot be repaired well because of the size or location of the damage.

Tire Rotation

Tires should be rotated every 12 000 km (7,500 mi). See *Scheduled Maintenance on page 11-2*.

The purpose of a regular tire rotation is to achieve a uniform wear for all tires on the vehicle. This will ensure that the vehicle continues to perform most like it did when the tires were new.

Any time you notice unusual wear, rotate the tires as soon as possible and check wheel alignment. Also check for damaged tires or wheels. See *When It Is Time for New Tires on page 10-63* and *Wheel Replacement on page 10-68*.

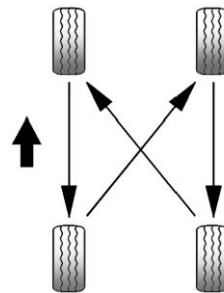

When rotating the vehicle's tires, always use the correct rotation pattern shown here.

10-62 Vehicle Care

Do not include the compact spare tire in the tire rotation.

After the tires have been rotated, adjust the front and rear inflation pressures as shown on the Tire and Loading Information label. See *Tire Pressure on page 10-54* and *Vehicle Load Limits on page 9-12*.

Reset the Tire Pressure Monitor System. See *Tire Pressure Monitor Operation on page 10-57*.

Make certain that all wheel nuts are properly tightened. See “Wheel Nut Torque” under *Capacities and Specifications on page 12-2*.

WARNING

Rust or dirt on a wheel, or on the parts to which it is fastened, can make wheel nuts become loose after time. The wheel could come off and cause an accident. When changing a wheel, remove any rust or dirt from places where the wheel attaches to the vehicle. In an emergency, use a cloth or a paper towel to do this; but be sure to use a scraper or wire brush later, if needed, to get all the rust or dirt off. See *If a Tire Goes Flat on page 10-70*.

Lightly coat the center of the wheel hub with wheel bearing grease after a wheel change or tire rotation to prevent corrosion or rust build-up. Do not get grease on the flat wheel mounting surface or on the wheel nuts or bolts.

When It Is Time for New Tires

Factors such as maintenance, temperatures, driving speeds, vehicle loading, and road conditions affect the wear rate of the tires.

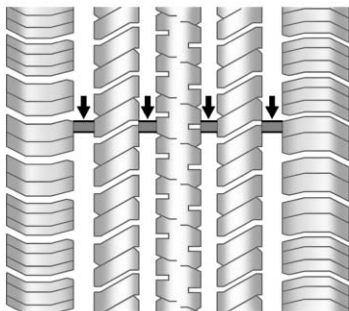

Treadwear indicators are one way to tell when it is time for new tires. Treadwear indicators appear when

the tires have only 1.6 mm (1/16 in) or less of tread remaining. See *Tire Inspection* on page 10-61 and *Tire Rotation* on page 10-61 for more information.

The rubber in tires ages over time. This also applies for the spare tire, if the vehicle has one, even if it is never used. Multiple conditions including temperatures, loading conditions, and inflation pressure maintenance affect how fast aging takes place. Tires will typically need to be replaced due to wear before they may need to be replaced due to age. Consult the tire manufacturer for more information on when tires should be replaced.

Vehicle Storage

Tires age when stored normally mounted on a parked vehicle. Park a vehicle that will be stored for at least a month in a cool, dry, clean area away from direct sunlight to slow aging. This area should be free of grease, gasoline, or other substances that can deteriorate rubber.

Parking for an extended period can cause flat spots on the tires that may result in vibrations while driving. When storing a vehicle for at least a month, remove the tires or raise the vehicle to reduce the weight from the tires.

Buying New Tires

GM has developed and matched specific tires for the vehicle. The original equipment tires installed on the vehicle, when it was new, were designed to meet General Motors Tire Performance Criteria Specification (TPC Spec) system rating. If you need replacement tires, GM strongly recommends that you get tires with the same TPC Spec rating. This way, the vehicle will continue to have tires that are designed to give the same performance and vehicle safety, during normal use, as the original tires.

GM's exclusive TPC Spec system considers over a dozen critical specifications that impact the overall performance of the vehicle, including brake system performance, ride and handling, traction control, and tire pressure monitoring performance. GM's TPC Spec number is molded onto the tire's sidewall near the tire size. If the tires have an all-season tread design, the TPC Spec number will be followed by an MS for mud and snow. See *Tire Sidewall Labeling on page 10-48* for additional information.

GM recommends replacing tires in sets of four. This is because uniform tread depth on all tires

will help keep the vehicle performing most like it did when the tires were new. Replacing less than a full set of tires can affect the braking and handling performance of the vehicle. See *Tire Inspection on page 10-61* and *Tire Rotation on page 10-61* for information on proper tire rotation.

WARNING

Tires could explode during improper service. Attempting to mount or dismount a tire could cause injury or death. Only your dealer or authorized tire service center should mount or dismount the tires.

 **WARNING**

Mixing tires could cause you to lose control while driving. If you mix tires of different sizes, brands, or types (radial and bias-belted tires), the vehicle may not handle properly, and you could have a crash. Using tires of different sizes, brands, or types may also cause damage to the vehicle. Be sure to use the correct size, brand, and type of tires on all wheels. It is all right to drive with the compact spare temporarily, as it was developed for use on the vehicle. See *Compact Spare Tire* on page 10-85.

 **WARNING**

Using bias-ply tires on the vehicle may cause the wheel rim flanges to develop cracks after many miles of driving. A tire and/or wheel could fail suddenly and cause a crash. Use only radial-ply tires with the wheels on the vehicle.

If you must replace the vehicle's tires with those that do not have a TPC Spec number, make sure they are the same size, load range, speed rating, and construction type (radial and bias-belted tires) as the vehicle's original tires.

Vehicles that have a tire pressure monitoring system could give an inaccurate low-pressure warning if non-TPC Spec rated tires are installed on the vehicle. Non-TPC Spec rated tires may give a low-pressure warning that is higher or lower than the proper warning level you would get with TPC Spec rated tires. See *Tire Pressure Monitor System* on page 10-56.

The vehicle's original equipment tires are listed on the Tire and Loading Information label. See *Vehicle Load Limits* on page 9-12 for more information about the Tire and Loading Information label and its location on the vehicle.

Different Size Tires and Wheels

If wheels or tires are installed that are a different size than the original equipment wheels and tires, vehicle performance, including its braking, ride and handling characteristics, stability, and resistance to rollover may be affected. If the vehicle has electronic systems such as antilock brakes, rollover airbags, traction control, and electronic stability control, the performance of these systems can also be affected.

WARNING

If different sized wheels are used, there may not be an acceptable level of performance and safety if tires not recommended for those wheels are selected. This increases the chance of a crash and serious injury. Only use GM specific wheel and tire systems developed for the vehicle, and have them properly installed by a GM certified technician.

See *Buying New Tires on page 10-64* and *Accessories and Modifications on page 10-3* for additional information.

Uniform Tire Quality Grading

Quality grades can be found where applicable on the tire sidewall between tread shoulder and maximum section width. For example:

Treadwear 200 Traction AA Temperature A

The following information relates to the system developed by the United States National Highway Traffic Safety Administration (NHTSA), which grades tires by treadwear, traction, and temperature performance. This applies only to vehicles sold in the United States.

The grades are molded on the sidewalls of most passenger car tires. The Uniform Tire Quality Grading (UTQG) system does not apply to deep tread, winter-type snow tires, space-saver, or temporary use spare tires, tires with nominal rim diameters of 10 to 12 inches (25 to 30 cm), or to some limited-production tires.

While the tires available on General Motors passenger cars and light trucks may vary with respect to these grades, they must also conform to federal safety requirements and additional General Motors Tire Performance Criteria (TPC) standards.

All Passenger Car Tires Must Conform to Federal Safety Requirements In Addition To These Grades.

Treadwear

The treadwear grade is a comparative rating based on the wear rate of the tire when tested under controlled conditions on a specified government test course. For example, a tire graded 150 would wear one and a half (1½) times as well on the government course as a tire graded 100. The relative performance of tires depends upon the actual conditions of their use, however, and may depart significantly from the norm due to variations in driving habits, service practices and differences in road characteristics and climate.

Traction – AA, A, B, C

The traction grades, from highest to lowest, are AA, A, B, and C. Those grades represent the tire's ability to stop on wet pavement as measured under controlled conditions on specified government test surfaces of asphalt and concrete. A tire marked C may have poor traction performance. Warning: The traction grade assigned to this tire is based on straight-ahead braking traction tests, and does not include acceleration, cornering, hydroplaning, or peak traction characteristics.

Temperature – A, B, C

The temperature grades are A (the highest), B, and C, representing the tire's resistance to the generation of heat and its ability to dissipate heat when tested under controlled conditions on a specified indoor laboratory test wheel. Sustained high temperature can cause the material of the tire to degenerate and reduce tire life, and excessive temperature can lead to sudden tire failure. The grade C corresponds to a level of performance which all passenger car tires must meet under the Federal Motor Safety Standard No. 109. Grades B and A represent higher levels of performance on the laboratory test wheel than the minimum required by law. Warning: The temperature grade for this tire is

established for a tire that is properly inflated and not overloaded. Excessive speed, underinflation, or excessive loading, either separately or in combination, can cause heat buildup and possible tire failure.

Wheel Alignment and Tire Balance

The tires and wheels were aligned and balanced at the factory to provide the longest tire life and best overall performance. Adjustments to wheel alignment and tire balancing will not be necessary on a regular basis. However, check the alignment if there is unusual tire wear or if the vehicle is pulling to one side or the other. If the vehicle vibrates when driving on a smooth road, the tires and wheels might need to be rebalanced. See your dealer for proper diagnosis.

Wheel Replacement

Replace any wheel that is bent, cracked, or badly rusted or corroded. If wheel nuts keep coming loose, the wheel, wheel bolts, and wheel nuts should be replaced. If the wheel leaks air, replace it. Some aluminum wheels can be repaired. See your dealer if any of these conditions exist.

Your dealer will know the kind of wheel that is needed.

Each new wheel should have the same load-carrying capacity, diameter, width, offset, and be mounted the same way as the one it replaces.

Replace wheels, wheel bolts, wheel nuts, or Tire Pressure Monitor System (TPMS) sensors with new GM original equipment parts.

 **WARNING**

Using the wrong replacement wheels, wheel bolts, or wheel nuts can be dangerous. It could affect the braking and handling of the vehicle. Tires can lose air, and cause loss of control, causing a crash. Always use the correct wheel, wheel bolts, and wheel nuts for replacement.

Notice: The wrong wheel can also cause problems with bearing life, brake cooling, speedometer or odometer calibration, headlamp aim, bumper height, vehicle ground clearance, and tire or tire chain clearance to the body and chassis.

See *If a Tire Goes Flat* on page 10-70 for more information.

Used Replacement Wheels **WARNING**

Replacing a wheel with a used one is dangerous. How it has been used or how far it has been driven may be unknown. It could fail suddenly and cause a crash. When replacing wheels, use a new GM original equipment wheel.

Tire Chains **WARNING**

Do not use tire chains. There is not enough clearance. Tire chains used on a vehicle without the proper amount of clearance can cause damage to the brakes, suspension or other vehicle parts.

(Continued)

WARNING (Continued)

The area damaged by the tire chains could cause you to lose control of the vehicle and you or others may be injured in a crash.

Use another type of traction device only if its manufacturer recommends it for use on the vehicle and tire size combination and road conditions. Follow that manufacturer's instructions. To help avoid damage to the vehicle, drive slowly, readjust or remove the device if it is contacting the vehicle, and do not spin the vehicle's wheels. If you do find traction devices that will fit, install them on the front tires.

If a Tire Goes Flat

It is unusual for a tire to blowout, especially if the tires are maintained properly. See Tires. If air goes out of a tire, it is much more likely to leak out slowly. But if there is ever a blowout, here are a few tips about what to expect and what to do:

If a front tire fails, the flat tire creates a drag that pulls the vehicle toward that side. Take your foot off the accelerator pedal and grip the steering wheel firmly. Steer to maintain lane position, and then gently brake to a stop, well off the road, if possible.

AA rear blowout, particularly on a curve, acts much like a skid and may require the same correction as used in a skid. Stop pressing

the accelerator pedal and steer to straighten the vehicle. It may be very bumpy and noisy. Gently brake to a stop, well off the road, if possible.

WARNING

Driving on a flat tire will cause permanent damage to the tire. Re-inflating a tire after it has been driven on while severely underinflated or flat may cause a blowout and a serious crash. Never attempt to re-inflate a tire that has been driven on while severely underinflated or flat. Have your dealer or an authorized tire service center repair or replace the flat tire as soon as possible.

WARNING

Lifting a vehicle and getting under it to do maintenance or repairs is dangerous without the appropriate safety equipment and training. If a jack is provided with the vehicle, it is designed only for changing a flat tire. If it is used for anything else, you or others could be badly injured or killed if the vehicle slips off the jack. If a jack is provided with the vehicle, only use it for changing a flat tire.

If a tire goes flat, avoid further tire and wheel damage by driving slowly to a level place, well off the road, if possible. Turn on the hazard warning flashers. See *Hazard Warning Flashers* on page 6-4.

⚠ WARNING

Changing a tire can be dangerous. The vehicle can slip off the jack and roll over or fall causing injury or death. Find a level place to change the tire. To help prevent the vehicle from moving:

1. Set the parking brake firmly.
2. Put an automatic transmission shift lever in P (Park), or shift a manual transmission to 1 (First) or R (Reverse).

(Continued)

WARNING (Continued)

3. Turn off the engine and do not restart while the vehicle is raised.
4. Do not allow passengers to remain in the vehicle.
5. Place wheel blocks on both sides of the tire at the opposite corner of the tire being changed.

This vehicle may come with a jack and spare tire or a tire sealant and compressor kit. To use the jacking equipment to change a spare tire safely, follow the instructions below. Then see *Tire Changing on page 10-79*. To use the tire sealant and compressor kit, see *Tire Sealant and Compressor Kit on page 10-72*.

When the vehicle has a flat tire (B), use the following example as a guide to assist you in the placement of wheel blocks (A).

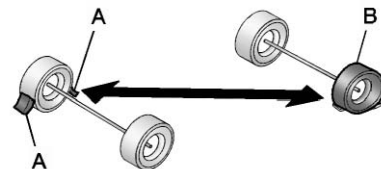

A. Wheel Block

B. Flat Tire

The following information explains how to repair or change a tire.

Tire Sealant and Compressor Kit

WARNING

Idling a vehicle in an enclosed area with poor ventilation is dangerous. Engine exhaust may enter the vehicle. Engine exhaust contains Carbon Monoxide (CO) which cannot be seen or smelled. It can cause unconsciousness and even death. Never run the engine in an enclosed area that has no fresh air ventilation. For more information, see *Engine Exhaust* on page 9-27.

WARNING

Overinflating a tire could cause the tire to rupture and you or others could be injured. Be sure to read and follow the tire sealant and compressor kit instructions and inflate the tire to its recommended pressure. Do not exceed the recommended pressure.

WARNING

Storing the tire sealant and compressor kit or other equipment in the passenger compartment of the vehicle could cause injury. In a sudden stop or collision, loose equipment could strike someone. Store the tire sealant and compressor kit in its original location.

If this vehicle has a tire sealant and compressor kit, there may not be a spare tire, tire changing equipment, and on some vehicles there may not be a place to store a tire.

The tire sealant and compressor can be used to temporarily seal punctures up to 6 mm (¼ in) in the tread area of the tire. It can also be used to inflate an under inflated tire.

If the tire has been separated from the wheel, has damaged sidewalls, or has a large puncture, the tire is too severely damaged for the tire sealant and compressor kit to be effective. See *Roadside Assistance Program (U.S. and Canada)* on page 13-8 or *Roadside Assistance Program (Mexico)* on page 13-10.

Read and follow all of the tire sealant and compressor kit instructions.

The kit includes:

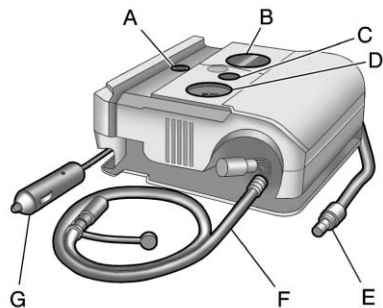

- A. On/Off Button
- B. Selector Switch (Sealant/Air or Air Only)
- C. Pressure Relief Button
- D. Pressure Gauge
- E. Air Only Hose (Black)
- F. Sealant/Air Hose (Clear)
- G. Power Plug

Tire Sealant

Read and follow the safe handling instructions on the label adhered to the compressor.

Check the tire sealant expiration date on the sealant canister. The sealant canister should be replaced before its expiration date. Replacement sealant canisters are available at your local dealer. See "Removal and Installation of the Sealant Canister" following.

There is only enough sealant to seal one tire. After usage, the sealant canister and sealant/air hose assembly must be replaced. See "Removal and Installation of the Sealant Canister" following.

Using the Tire Sealant and Compressor Kit to Temporarily Seal and Inflate a Punctured Tire

Follow the directions closely for correct sealant usage.

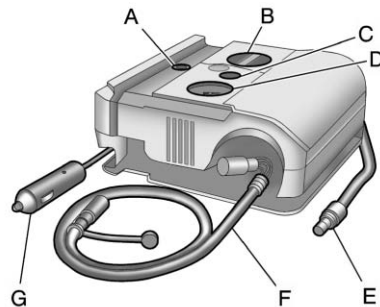

When using the tire sealant and compressor kit during cold temperatures, warm the kit in a heated environment for five minutes. This will help to inflate the tire faster.

10-74 Vehicle Care

If a tire goes flat, avoid further tire and wheel damage by driving slowly to a level place. Turn on the hazard warning flashers. See *Hazard Warning Flashers on page 6-4*.

See *If a Tire Goes Flat on page 10-70* for other important safety warnings.

Do not remove any objects that have penetrated the tire.

1. Remove the tire sealant and compressor kit from its storage location. See *Storing the Tire Sealant and Compressor Kit on page 10-79*.

2. Unwrap the sealant/air hose (F) and the power plug (G).

3. Place the kit on the ground.

Make sure the tire valve stem is positioned close to the ground so the hose will reach it.

4. Remove the valve stem cap from the flat tire by turning it counterclockwise.

5. Attach the sealant/air hose (F) onto the tire valve stem. Turn it clockwise until it is tight.

6. Plug the power plug (G) into the accessory power outlet in the vehicle. Unplug all items from other accessory power outlets. See *Power Outlets on page 5-7*.

If the vehicle has an accessory power outlet, do not use the cigarette lighter.

If the vehicle only has a cigarette lighter, use the cigarette lighter.

Do not pinch the power plug cord in the door or window.

7. Start the vehicle. The vehicle must be running while using the air compressor.

8. Turn the selector switch (B) clockwise to the Sealant + Air position.

9. Press the on/off (A) button to turn the tire sealant and compressor kit on.

The compressor will inject sealant and air into the tire.

The pressure gauge (D) will initially show a high pressure while the compressor pushes the sealant into the tire. Once the sealant is completely dispersed into the tire, the pressure will quickly drop and start to rise again as the tire inflates with air only.

10. Inflate the tire to the recommended inflation pressure using the pressure gauge (D). The recommended inflation pressure can be found on the Tire and Loading Information label. See *Tire Pressure on page 10-54*.

The pressure gauge (D) may read higher than the actual tire pressure while the compressor is on. Turn the compressor off to get an accurate pressure reading. The compressor may be turned on/off until the correct pressure is reached.

Notice: If the recommended pressure cannot be reached after approximately 25 minutes, the vehicle should not be driven farther. The tire is too severely damaged and the tire sealant and compressor kit cannot inflate the tire. Remove the power plug from the accessory power outlet and unscrew the inflating hose from the tire valve. See *Roadside Assistance Program (U.S. and Canada)* on page 13-8 or *Roadside Assistance Program (Mexico)* on page 13-10.

11. Press the on/off button (A) to turn the tire sealant and compressor kit off.

The tire is not sealed and will continue to leak air until the vehicle is driven and the sealant is distributed in the tire; therefore, Steps 12 through 18 must be done immediately after Step 11.

Be careful while handling the tire sealant and compressor kit as it could be warm after usage.

12. Unplug the power plug (G) from the accessory power outlet in the vehicle.
13. Turn the sealant/air hose (F) counterclockwise to remove it from the tire valve stem.
14. Replace the tire valve stem cap.

15. Return the sealant/air hose (F) and the power plug (G) back in their original locations.



16. If the flat tire was able to inflate to the recommended inflation pressure, remove the maximum speed label from the sealant canister and place it in a highly visible location. Do not exceed the speed on this label until the damaged tire is repaired or replaced.
17. Return the equipment to its original storage location in the vehicle.
18. Immediately drive the vehicle 8 km (5 mi) to distribute the sealant in the tire.

19. Stop at a safe location and check the tire pressure. Refer to Steps 1 through 11 under “Using the Tire Sealant and Compressor Kit without Sealant to Inflate a Tire (Not Punctured).”

If the tire pressure has fallen more than 68 kPa (10 psi) below the recommended inflation pressure, stop driving the vehicle. The tire is too severely damaged and the tire sealant cannot seal the tire. See *Roadside Assistance Program (U.S. and Canada)* on page 13-8 or *Roadside Assistance Program (Mexico)* on page 13-10.

If the tire pressure has not dropped more than 68 kPa (10 psi) from the recommended inflation pressure, use the compressor kit to inflate the tire to the recommended inflation pressure.

20. Wipe off any sealant from the wheel, tire, and vehicle.
21. Dispose of the used sealant canister and sealant/air hose (F) assembly at a local dealer or in accordance with local state codes and practices.
22. Replace it with a new canister available from your dealer.
23. After temporarily sealing a tire using the tire sealant and compressor kit, take the vehicle to an authorized dealer within 161 km (100 mi) of driving to have the tire repaired or replaced.

Using the Tire Sealant and Compressor Kit without Sealant to Inflate a Tire (Not Punctured)

To use the air compressor to inflate a tire with air only and not sealant:

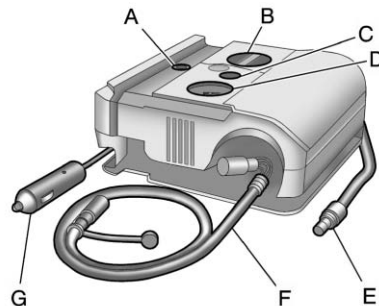

If a tire goes flat, avoid further tire and wheel damage by driving slowly to a level place. Turn on the hazard warning flashers. See *Hazard Warning Flashers* on page 6-4.

See *If a Tire Goes Flat on page 10-70* for other important safety warnings.

1. Remove the tire sealant and compressor kit from its storage location. See *Storing the Tire Sealant and Compressor Kit on page 10-79*.
2. Unwrap the air only hose (E) and the power plug (G).
3. Place the kit on the ground.
Make sure the tire valve stem is positioned close to the ground so the hose will reach it.
4. Remove the tire valve stem cap from the flat tire by turning it counterclockwise.
5. Attach the air only hose (E) onto the tire valve stem by turning it clockwise until it is tight.

6. Plug the power plug (G) into the accessory power outlet in the vehicle. Unplug all items from other accessory power outlets. See *Power Outlets on page 5-7*.

If the vehicle has an accessory power outlet, do not use the cigarette lighter.

If the vehicle only has a cigarette lighter, use the cigarette lighter.

Do not pinch the power plug cord in the door or window.

7. Start the vehicle. The vehicle must be running while using the air compressor.
8. Turn the selector switch (B) counterclockwise to the Air Only position.
9. Press the on/off (A) button to turn the compressor on.

The compressor will inflate the tire with air only.

10. Inflate the tire to the recommended inflation pressure using the pressure gauge (D). The recommended inflation pressure can be found on the Tire and Loading Information label. See *Tire Pressure on page 10-54*.

The pressure gauge (D) may read higher than the actual tire pressure while the compressor is on. Turn the compressor off to get an accurate reading. The compressor may be turned on/off until the correct pressure is reached. If the tire is inflated higher than the recommended pressure, press the pressure relief button (C), if equipped, until the proper pressure reading is reached. This option is only functional when using the air only hose (E).

11. Press the on/off button (A) to turn the tire sealant and compressor kit off.

Be careful while handling the tire sealant and compressor kit as it could be warm after usage.

12. Unplug the power plug (G) from the accessory power outlet in the vehicle.
13. Disconnect the air only hose (E) from the tire valve stem, by turning it counterclockwise, and replace the tire valve stem cap.
14. Return the air only hose (E) and the power plug (G) back to their original locations.
15. Return the equipment to its original storage location in the vehicle.

Removal and Installation of the Sealant Canister

To remove the sealant canister:

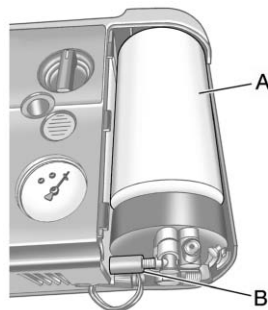

1. Remove the plastic cover.
2. Unscrew the connector (B) from the canister (A).

3. Pull up on the canister (A) to remove it.
4. Replace with a new canister which is available from your dealer.
5. Push the new canister into place.
6. Screw the connector (B) to the canister (A).
7. Slide the plastic cover back on.

Storing the Tire Sealant and Compressor Kit

To access the tire sealant and compressor kit:

1. Open the trunk. See *Trunk* on page 2-12.
2. Lift the cover.

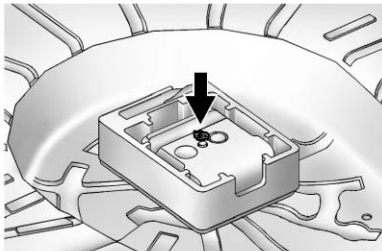

3. Turn the wing nut counterclockwise to remove it.
4. Remove the tire sealant and compressor kit.

To store the tire sealant and compressor kit, reverse the steps.

Tire Changing

Removing the Spare Tire and Tools

The equipment you need is located in the trunk.

1. Open the trunk.
2. Remove the spare tire cover.

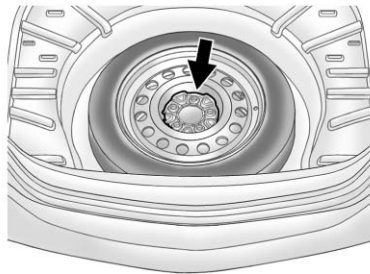

3. Turn the retainer nut counterclockwise and remove the spare tire.
4. Place the spare tire next to the tire being changed.

5. The jack and tools are stored below the spare tire.

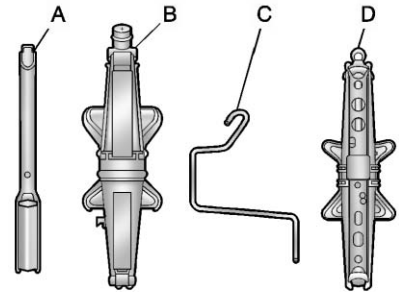

This vehicle will have either a coin/pierce jack (D) and a jack handle extension (C) or a hex head jack (B) and a jack lift assist tool (A).

Place the tools next to the tire being changed.

Removing the Flat Tire and Installing the Spare Tire

1. Do a safety check before proceeding. See *If a Tire Goes Flat on page 10-70* for more information.
2. Turn the wheel wrench counterclockwise to loosen the wheel nut caps.

If needed, finish loosening them by hand. The nut caps will not come off of the wheel cover.

The edge of the wheel cover could be sharp, so do not try to remove the cover with your bare hands. Do not drop the cap or lay it face down, as it could become scratched or damaged.

Store the wheel cover in the trunk until you have the flat tire repaired or replaced.

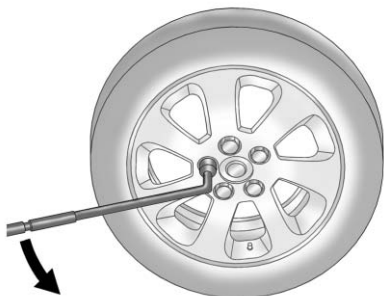

3. Turn the wheel wrench counterclockwise to loosen all the wheel nuts, but do not remove them yet.

Notice: Make sure that the jack lift head is in the correct position or you may damage your vehicle. The repairs would not be covered by your warranty.

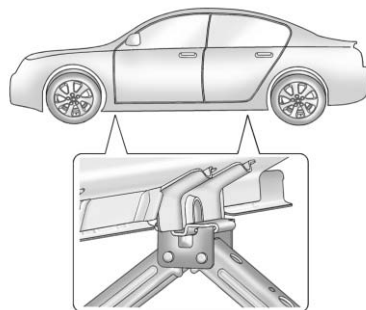

4. Position the jack head, as shown.

Set the jack to the necessary height before positioning it below the jacking point.

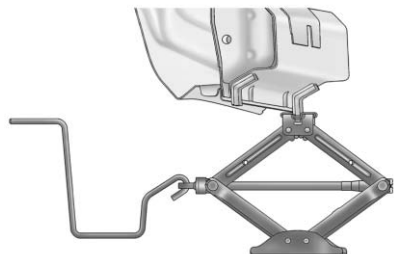

**Coin/Pierce Jack Shown,
Hex Head Jack Similar**

5. If you have a coin/pierce jack, attach the jack handle extension to the jack by sliding the hook through the end of the jack.

If you have a hex head jack, attach the jack lift assist tool to the jack by fitting both ends of the jack and tool over one another.

⚠ WARNING

Getting under a vehicle when it is jacked up is dangerous. If the vehicle slips off the jack, you could be badly injured or killed. Never get under a vehicle when it is supported only by a jack.

⚠ WARNING

Raising the vehicle with the jack improperly positioned can damage the vehicle and even make the vehicle fall. To help avoid personal injury and vehicle damage, be sure to fit the jack lift head into the proper location before raising the vehicle.

⚠ WARNING

Lifting a vehicle and getting under it to do maintenance or repairs is dangerous without the appropriate safety equipment and training. If a jack is provided with the vehicle, it is designed only for changing a flat tire. If it is used for anything else, you or others could be badly injured or killed if the vehicle slips off the jack. If a jack is provided with the vehicle, only use it for changing a flat tire.

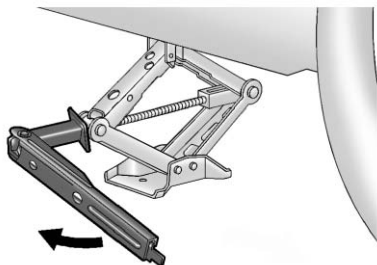

**Hex Head Jack Shown,
Coin/Pierce Jack Similar**

6. Turn the jack handle clockwise to raise the vehicle far enough off the ground for the compact spare to fit under the vehicle.

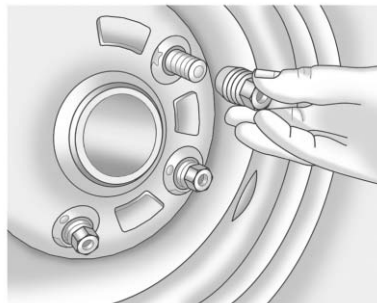

7. Remove all of the wheel nuts.
8. Remove the flat tire.

⚠ WARNING

Rust or dirt on a wheel, or on the parts to which it is fastened, can make wheel nuts become loose after time. The wheel could come off and cause an accident. When changing a wheel, remove any rust or dirt from places where the wheel attaches to the vehicle.

(Continued)

WARNING (Continued)

In an emergency, use a cloth or a paper towel to do this; but be sure to use a scraper or wire brush later, if needed, to get all the rust or dirt off. See *If a Tire Goes Flat* on page 10-70.

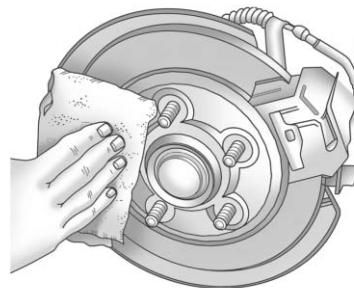

9. Remove any rust or dirt from the wheel bolts, mounting surfaces, and spare wheel.

10. Install the compact spare tire.

⚠ WARNING

Never use oil or grease on bolts or nuts because the nuts might come loose. The vehicle's wheel could fall off, causing a crash.

11. Put the wheel nuts back on with the rounded end of the nuts toward the wheel. Turn each nut clockwise by hand until the wheel is held against the hub.
12. Lower the vehicle by turning the jack handle counterclockwise. Lower the jack completely.

⚠ WARNING

Wheel nuts that are improperly or incorrectly tightened can cause the wheels to become loose or

(Continued)

WARNING (Continued)

come off. The wheel nuts should be tightened with a torque wrench to the proper torque specification after replacing. Follow the torque specification supplied by the aftermarket manufacturer when using accessory locking wheel nuts. See *Capacities and Specifications* on page 12-2 for original equipment wheel nut torque specifications.

Notice: Improperly tightened wheel nuts can lead to brake pulsation and rotor damage. To avoid expensive brake repairs, evenly tighten the wheel nuts in the proper sequence and to the proper torque specification. See *Capacities and Specifications* on page 12-2 for the wheel nut torque specification.

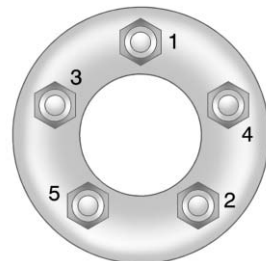

13. Tighten the wheel nuts firmly in a crisscross sequence, as shown.
14. Lower the jack all the way and remove the jack from under the vehicle.
15. Tighten the wheel nuts firmly with the wheel wrench.

Notice: Wheel covers will not fit on the vehicle's compact spare. If you try to put a wheel cover on the compact spare, the cover or the spare could be damaged.

Storing a Flat or Spare Tire and Tools

⚠ WARNING

Storing a jack, a tire, or other equipment in the passenger compartment of the vehicle could cause injury. In a sudden stop or collision, loose equipment could strike someone. Store all these in the proper place.

To store the flat or spare tire and tools:

1. If the flat tire is larger than the spare tire, use the longer mounting bolt.

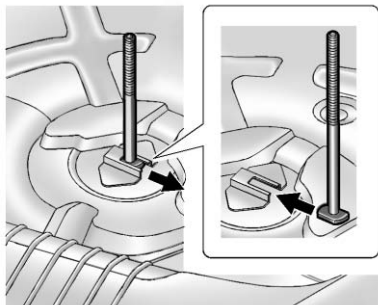

2. Slide the shorter bolt to remove it from the floor and insert the longer one.
3. Replace the jack and tools in their original storage location.

4. Place the tire, lying flat, facing up in the spare tire well.

Secure it with the retainer nut.

Place the floor cover over the tire even though it may not lay flat if the tire is larger than the spare.

The compact spare is for temporary use only. Replace the compact spare tire with a full-size tire as soon as you can.

Compact Spare Tire

 **WARNING**

Driving with more than one compact spare tire at a time could result in loss of braking and handling. This could lead to a crash and you or others could be injured. Use only one compact spare tire at a time.

If this vehicle has a compact spare tire, it was fully inflated when the vehicle was new; however, it can lose air after a time. Check the inflation pressure regularly. It should be 420 kPa (60 psi).

After installing the compact spare on the vehicle, stop as soon as possible and make sure the spare tire is correctly inflated. The compact spare is made to perform well at speeds up to 105 km/h (65 mph) for distances up to 5 000 km (3,000 mi), so you can finish your trip and have the full-size tire repaired or replaced at your convenience. Of course, it is best to replace the spare with a full-size tire as soon as possible. The spare tire will last longer and be in good shape in case it is needed again.

Notice: When the compact spare is installed, do not take the vehicle through an automatic car wash with guide rails. The compact spare can get caught on the rails which can damage the tire, wheel and other parts of the vehicle.

Do not use the compact spare on other vehicles.

Do not mix the compact spare tire or wheel with other wheels or tires. They will not fit. Keep the spare tire and its wheel together.

Notice: Tire chains will not fit the compact spare. Using them can damage the vehicle and can damage the chains too. Do not use tire chains on the compact spare.

Jump Starting

For more information about the vehicle battery, see *Battery* on page 10-27.

If the battery has run down, try to use another vehicle and some jumper cables to start your vehicle. Be sure to use the following steps to do it safely.

WARNING

Batteries can hurt you. They can be dangerous because:

- They contain acid that can burn you.
- They contain gas that can explode or ignite.
- They contain enough electricity to burn you.

If you do not follow these steps exactly, some or all of these things can hurt you.

Notice: Ignoring these steps could result in costly damage to the vehicle that would not be covered by the warranty.

Trying to start the vehicle by pushing or pulling it will not work, and it could damage the vehicle.

The jump start positive (A) is located under a trim cover in the engine compartment on the driver side of the vehicle.

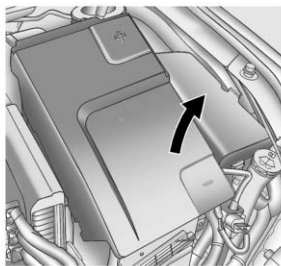

This post is used instead of a direct connection to the battery.

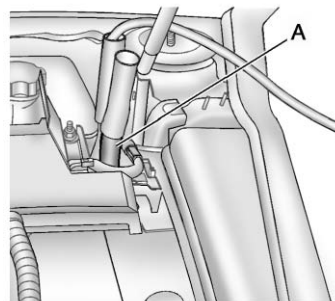

1. Check the other vehicle. It must have a 12-volt battery with a negative ground system.

Notice: Only use a vehicle that has a 12-volt system with a negative ground for jump starting. If the other vehicle does not have a 12-volt system with a negative ground, both vehicles can be damaged.

2. Position the two vehicles so that they are not touching.

- 3. Set the parking brake firmly and put the shift lever in P (Park). See *Shifting Into Park* on page 9-25.

Notice: If the radio or other accessories are left on during the jump starting procedure, they could be damaged. The repairs would not be covered by the warranty. Always turn off the radio and other accessories when jump starting the vehicle.

- 4. Turn the ignition to LOCK/OFF and switch off all lights and accessories in both vehicles, except the hazard warning flashers if needed.

⚠ WARNING

An electric fan can start up even when the engine is not running and can injure you. Keep hands, clothing and tools away from any underhood electric fan.

⚠ WARNING

Using a match near a battery can cause battery gas to explode. People have been hurt doing this, and some have been blinded. Use a flashlight if you need more light.

Be sure the battery has enough water. You do not need to add water to the battery installed in your new vehicle. But if a battery has filler caps, be sure the right amount of fluid is there. If it is low, add water to take care of that first. If you don't, explosive gas could be present.

Battery fluid contains acid that can burn you. Do not get it on you. If you accidentally get it in your eyes or on your skin, flush the place with water and get medical help immediately.

⚠ WARNING

Fans or other moving engine parts can injure you badly. Keep your hands away from moving parts once the engine is running.

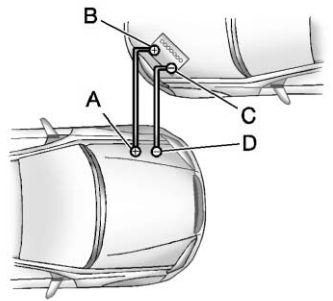

- 5. Connect one end of the red positive (+) cable to the jump start positive (+) post (A). Use a remote positive (+) terminal if the vehicle has one.

10-88 Vehicle Care

- Do not let the other end of the red positive (+) cable touch metal. Connect it to the positive (+) terminal of the good battery (B). Use a remote positive (+) terminal if the vehicle has one.
- Connect one end of the black negative (-) cable to the negative (-) terminal of the good battery (C). Use a remote negative (-) terminal if the vehicle has one.

Do not let the other end touch anything until the next step. The other end of the negative (-) cable does not go to the dead battery. It goes to a heavy, unpainted metal engine part or to a remote negative (-) terminal on the vehicle with the dead battery.

- Connect the other end of the black negative (-) cable to an unpainted heavy metal engine part (D) away from the dead battery, but not near engine parts that move.
- Start the engine in the vehicle with the good battery and run the engine at idle speed for at least four minutes.
- Try to start the vehicle that had the dead battery. If it will not start after a few tries, it probably needs service.

Notice: If the jumper cables are connected or removed in the wrong order, electrical shorting may occur and damage the vehicle. The repairs would not be covered by the vehicle warranty. Always connect and remove the jumper cables in the correct order, making sure that the cables do not touch each other or other metal.

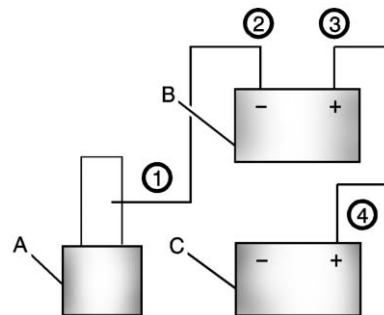

Jumper Cable Removal

- Heavy, Unpainted Metal Engine Part or Remote Negative (-) Terminal
- Good Battery or Remote Positive (+) and Remote Negative (-) Terminals
- Dead Battery or Remote Positive (+) Terminal

To disconnect the jumper cables from both vehicles:

1. Disconnect the black negative (-) cable from the vehicle that had the dead battery.
2. Disconnect the black negative (-) cable from the vehicle with the good battery.
3. Disconnect the red positive (+) cable from the vehicle with the good battery.
4. Disconnect the red positive (+) cable from the other vehicle.
5. Return the caps over the positive (+) and negative (-) terminals to their original positions.

Towing

Towing the Vehicle

Notice: To avoid damage, the disabled vehicle should be towed with all four wheels off the ground. Care must be taken with vehicles that have low ground clearance and/or special equipment. Always flatbed on a car carrier.

Consult your dealer or a professional towing service if the disabled vehicle must be towed. See *Roadside Assistance Program (U.S. and Canada)* on page 13-8 or *Roadside Assistance Program (Mexico)* on page 13-10.

To tow the vehicle behind another vehicle for recreational purposes, such as behind a motor home, see "Recreational Vehicle Towing" in this section.

Recreational Vehicle Towing

Recreational vehicle towing means towing the vehicle behind another vehicle such as a motor home. The two most common types of recreational vehicle towing are known as dinghy towing and dolly towing. Dinghy towing is towing the vehicle with all four wheels on the ground. Dolly towing is towing the vehicle with two wheels on the ground and two wheels up on a device known as a dolly.

Here are some important things to consider before recreational vehicle towing:

- What is the towing capacity of the towing vehicle? Be sure to read the tow vehicle manufacturer's recommendations.

10-90 Vehicle Care

- What is the distance that will be travelled? Some vehicles have restrictions on how far and how long they can tow.
- Is the proper towing equipment going to be used? See your dealer or trailering professional for additional advice and equipment recommendations.
- Is the vehicle ready to be towed? Just as preparing the vehicle for a long trip, make sure the vehicle is prepared to be towed.

Dinghy Towing from the Front

When dinghy towing, the vehicle should be run at the beginning of each day and at each RV fuel stop for about five minutes. This will ensure proper lubrication of transmission components.

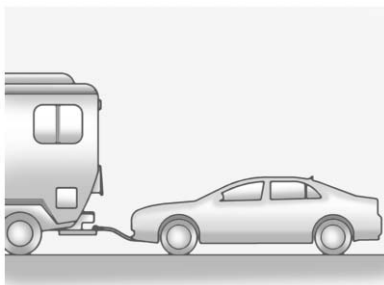

Use the following procedure to dinghy tow the vehicle from the front with all four wheels on the ground:

1. Position the vehicle being towed behind the tow vehicle and shift the transmission to P (Park).
2. Turn the engine off and firmly set the parking brake.

3. Following the manufacturer's instructions, securely attach the vehicle being towed to the tow vehicle.
4. Turn the ignition to ACC/ ACCESSORY and shift the transmission to N (Neutral).
5. Release the parking brake only after the vehicle being towed is firmly attached to the towing vehicle.

When towing the vehicle for extended periods of time, start the vehicle as often as possible to prevent battery drain. This should be done when the tow vehicle is parked.

Dinghy Towing from the Rear

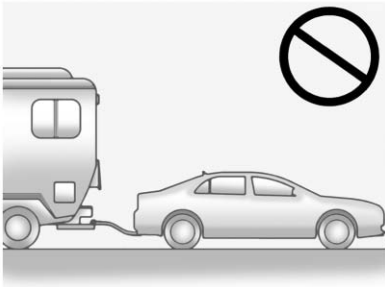

The vehicle was not designed to be towed from the rear with all four wheels on the ground.

Dolly Towing from the Front (Front-Wheel Drive)

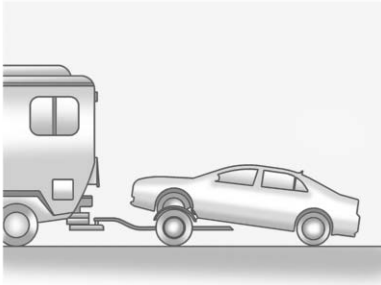

Vehicles with front-wheel drive can be dolly towed from the front.

Use the following procedure to dolly tow the vehicle from the front:

1. Attach the dolly to the tow vehicle following the dolly manufacturer's instructions.

2. Drive the front wheels onto the dolly.
3. Shift the transmission to P (Park).
4. Firmly set the parking brake.
5. Use an adequate clamping device designed for towing to ensure that the front wheels are locked into the straight-ahead position.
6. Secure the vehicle to the dolly following the manufacturer's instructions.
7. Release the parking brake only after the vehicle being towed is firmly attached to the towing vehicle.
8. Turn the ignition to LOCK/OFF.

Dolly Towing from the Front (All-Wheel Drive)

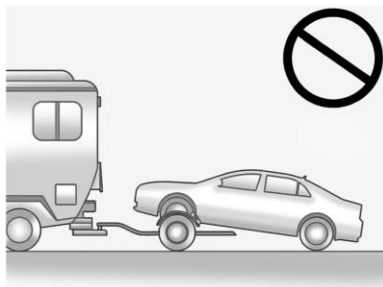

Vehicles with all-wheel drive cannot be dolly towed.

Dolly Towing from the Rear

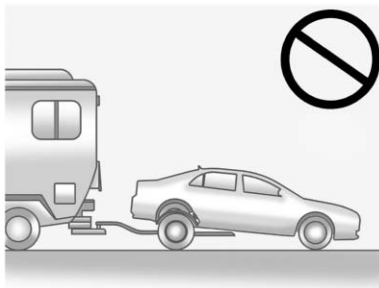

The vehicle cannot be dolly towed from the rear.

Appearance Care

Exterior Care

Cleaning Exterior Lamps/Lenses

Use only lukewarm or cold water, a soft cloth, and a car washing soap to clean exterior lamps and lenses. Follow instructions under "Washing the Vehicle" later in this section.

Finish Care

Occasional waxing or mild polishing of the vehicle by hand may be necessary to remove residue from the paint finish. Approved cleaning products can be obtained from your dealer.

If the vehicle has a basecoat/clearcoat paint finish, the clearcoat gives more depth and gloss to the colored basecoat. Always use waxes and polishes that are non-abrasive and made for a basecoat/clearcoat paint finish.

Notice: Machine compounding or aggressive polishing on a basecoat/clearcoat paint finish may damage it. Use only non-abrasive waxes and polishes that are made for a basecoat/clearcoat paint finish on the vehicle.

Foreign materials such as calcium chloride and other salts, ice melting agents, road oil and tar, tree sap, bird droppings, chemicals from industrial chimneys, etc., can damage the vehicle's finish if they remain on painted surfaces. Wash the vehicle as soon as possible. If necessary, use non-abrasive cleaners that are marked safe for painted surfaces to remove foreign matter.

Exterior painted surfaces are subject to aging, weather, and chemical fallout that can take their toll over a period of years. To keep the paint finish looking new, keep the vehicle garaged or covered whenever possible.

Protecting Exterior Bright Metal Parts

Bright metal parts should be cleaned regularly to keep their luster. Wash with water or use chrome polish on chrome or stainless steel trim, if necessary.

Use special care with aluminum trim. To avoid damaging protective trim, never use auto or chrome polish, steam, or caustic soap to clean aluminum. A coating of wax, rubbed to high polish, is recommended for all bright metal parts.

Washing the Vehicle

To preserve the vehicle's finish, keep it clean by washing it often.

Do not wash the vehicle in direct sunlight and use a car washing soap.

Notice: Do not use cleaning agents that are petroleum based or that contain acid or abrasives, as they can damage the paint, metal, or plastic on the vehicle. Approved cleaning products can be obtained from your dealer. Follow all manufacturer directions regarding correct product usage, necessary safety precautions, and appropriate disposal of any vehicle care product. Certain cleaners contain chemicals that can damage the emblems or nameplates on the vehicle. Check the cleaning

product label. If it states that it should not be used on plastic parts, do not use it on the vehicle or damage may occur and it would not be covered by the warranty.

Rinse the vehicle well, before washing and after, to remove all cleaning agents completely. If they are allowed to dry on the surface, they could stain.

Dry the finish with a soft, clean chamois or an all-cotton towel to avoid surface scratches and water spotting.

High pressure car washes could cause water to enter the vehicle. Avoid using high pressure washes closer than 30 cm (12 in) to the surface of the vehicle. Use of power washers exceeding 8,274 kPa (1,200 psi) can result in damage or removal of paint and decals.

Notice: Conveyor systems on some automatic car washes could damage the vehicle. There may not be enough clearance for the undercarriage. Check with the car wash manager before using the automatic car wash.

Weatherstrips

Silicone grease on weatherstrips will make them last longer, seal better, and not stick or squeak. Apply silicone grease with a clean cloth. During very cold, damp weather frequent application may be required. See *Recommended Fluids and Lubricants* on page 11-7.

Wheels and Trim — Aluminum or Chrome

The vehicle may have either aluminum or chrome-plated wheels.

Keep the wheels clean using a soft, clean cloth with mild soap and water. Rinse with clean water. After rinsing thoroughly, dry with a soft, clean towel. A wax may then be applied.

Notice: Chrome wheels and other chrome trim may be damaged if the vehicle is not washed after driving on roads that have been sprayed with magnesium, calcium or sodium chloride. These chlorides are used on roads for conditions such as ice and dust. Always wash the chrome with soap and water after exposure.

Notice: Do not use strong soaps, chemicals, abrasive polishes, cleaners, brushes, or cleaners that contain acid on aluminum or chrome-plated wheels, because the surface could be damaged.

The repairs would not be covered by the vehicle warranty. Use only approved cleaners on aluminum or chrome-plated wheels.

Notice: Never drive a vehicle that has aluminum or chrome-plated wheels through an automatic car wash that uses silicone carbide tire cleaning brushes, as this could cause damage. The repairs would not be covered by the vehicle warranty.

Notice: Driving the vehicle through an automatic car wash that has silicone carbide tire cleaning brushes, could damage the aluminum or chrome-plated wheels. The repairs would not be covered by the vehicle warranty. Never drive a vehicle that has aluminum or chrome-plated wheels through an automatic car wash that uses silicone carbide tire cleaning brushes.

Windshield and Wiper Blades

Clean the outside of the windshield with glass cleaner.

Clean the rubber blades using a lint-free cloth or paper towel soaked with windshield washer fluid or a mild detergent. Wash the windshield thoroughly when cleaning the blades. Bugs, road grime, sap, and a buildup of vehicle wash/wax treatments may cause wiper streaking. Replace the wiper blades if they are worn or damaged.

Wipers can be damaged by:

- Extreme dusty conditions
- Sand and salt
- Heat and sun
- Snow and ice, without proper removal

Tires

Use a stiff brush with tire cleaner to clean the tires.

Notice: Using petroleum-based tire dressing products on the vehicle may damage the paint finish and/or tires. When applying a tire dressing, always wipe off any overspray from all painted surfaces on the vehicle.

Sheet Metal Damage

If the vehicle is damaged and requires sheet metal repair or replacement, make sure the body repair shop applies anti-corrosion material to parts repaired or replaced to restore corrosion protection.

Original manufacturer replacement parts will provide the corrosion protection while maintaining the vehicle warranty.

Finish Damage

Any stone chips, fractures, or deep scratches in the finish should be repaired right away. Bare metal will corrode quickly and may develop into major repair expense.

Minor chips and scratches can be repaired with touch-up materials available from your dealer. Larger areas of finish damage can be corrected in your dealer's body and paint shop.

Underbody Maintenance

Chemicals used for ice and snow removal and dust control can collect on the underbody. If these are not removed, corrosion and rust can develop on the underbody parts such as fuel lines, frame, floor pan, and exhaust system even though they have corrosion protection.

At least every spring, flush these materials from the underbody with plain water. Clean any areas where mud and debris can collect. Dirt packed in close areas of the frame should be loosened before being flushed. Your dealer or an underbody car washing system can do this.

Chemical Paint Spotting

Some weather and atmospheric conditions can create a chemical fallout. Airborne pollutants can fall upon and attack painted surfaces on the vehicle. This damage can take two forms: blotchy, ring-shaped discolorations, and small, irregular dark spots etched into the paint surface.

Interior Care

The interior will continue to look its best if it is cleaned often. Dust and dirt can accumulate on the upholstery and cause damage to the carpet, fabric, leather, and plastic surfaces. Stains should be removed quickly as extreme heat could cause them to set rapidly.

Lighter colored interiors may require more frequent cleaning. Newspapers and garments that can transfer color to home furnishings can also transfer color to the interior.

Remove dust from small buttons and knobs with a small brush with soft bristles.

Your dealer has products for cleaning the interior. When cleaning the interior, only use cleaners specifically designed for the surfaces that are being

cleaned. Permanent damage can result from using cleaners on surfaces for which they were not intended. Apply the cleaner directly to the cleaning cloth to prevent over-spray. Remove any accidental over-spray from other surfaces immediately.

Notice: Using abrasive cleaners when cleaning glass surfaces on the vehicle, could scratch the glass and/or cause damage to the rear window defogger. When cleaning the glass on the vehicle, use only a soft cloth and glass cleaner.

Cleaners can contain solvents that can become concentrated in the interior. Before using cleaners, read and adhere to all safety instructions on the label. While cleaning the interior, maintain adequate ventilation by opening the doors and windows.

Do not clean the interior using the following cleaners or techniques:

- Never use a knife or any other sharp object to remove a soil from any interior surface.
- Never use a stiff brush. It can cause damage.
- Never apply heavy pressure or rub aggressively with a cleaning cloth. Use of heavy pressure can damage the interior and does not improve the effectiveness of soil removal.
- Avoid laundry detergents or dishwashing soaps with degreasers. Using too much soap will leave a residue that leaves streaks and attracts dirt. For liquid cleaners, about 20 drops per 3.78 L (1 gal) of water is a good guide. Use only mild, neutral-pH soaps.
- Do not heavily saturate the upholstery while cleaning.
- Cleaners that contain solvents can damage the interior.

Fabric/Carpet

Use a vacuum cleaner with a soft brush attachment to remove dust and loose dirt. A canister vacuum with rotating brushes in the nozzle may only be used on floor carpet and carpeted floor mats. For soils, always try to remove them first with plain water or club soda. Before cleaning, gently remove as much of the soil as possible using one of the following techniques:

- For liquids: gently blot the remaining soil with a paper towel. Allow the soil to absorb into the paper towel until no more can be removed.
- For solid dry soils: remove as much as possible and then vacuum.

To clean:

1. Saturate a lint-free, clean white cloth with water or club soda.
2. Remove excess moisture.

3. Start on the outside edge of the soil and gently rub toward the center. Continue cleaning, using a clean area of the cloth each time it becomes soiled.
4. Continue to gently rub the soiled area.
5. If the soil is not completely removed, use a mild soap solution and repeat the cleaning process with plain water.

If any of the soil remains, a commercial fabric cleaner or spot lifter may be necessary. Test a small hidden area for colorfastness before using a commercial upholstery cleaner or spot lifter. If the locally cleaned area gives any impression that a ring formation may result, clean the entire surface.

A paper towel can be used to blot excess moisture from the fabric or carpet after the cleaning process.

Leather

Leather, and lighter colored leather in particular, will need more frequent cleaning to prevent the buildup of dust, dirt, and colors transferred from other items so that these do not become permanent stains.

To remove dust, a soft cloth dampened with water can be used. If a more thorough cleaning is necessary, a soft cloth dampened with a mild soap solution can be used. Your dealer has a GM approved leather cleaner available that provides superior cleaning performance when used regularly on finished automotive leathers. Allow the leather to dry naturally.

Do not use heat, steam, spot lifters or spot removers, or shoe polish on leather. Many commercial leather cleaners and coatings that are sold to preserve and protect leather may permanently change the appearance and feel of the leather and are not recommended. Do not use silicone or wax-based products, or those containing organic solvents to clean the interior because they can alter the appearance by increasing the gloss in a non-uniform manner.

Instrument Panel, Vinyl, and Other Plastic Surfaces

To remove dust, a soft cloth dampened with water can be used. If a more thorough cleaning is necessary, a clean soft cloth dampened with a mild soap solution

can be used to gently remove dust and dirt. Never use spot lifters or removers on plastic surfaces. Many commercial cleaners and coatings that are sold to preserve and protect soft plastic surfaces may permanently change the appearance and feel of the interior and are not recommended. Do not use silicone or wax-based products, or those containing organic solvents to clean the interior because they can alter the appearance by increasing the gloss in a non-uniform manner.

Some commercial products may increase gloss on the instrument panel. The increase in gloss may cause annoying reflections in the windshield and even make it difficult to see through the windshield under certain conditions.

Notice: Air fresheners contain solvents that may cause damage to plastics and painted surfaces. Follow the manufacturer's instructions when using air fresheners in the vehicle. If air freshener comes in contact with paint or a plastic surface, blot immediately with a soft cloth. Damage caused by using air fresheners would not be covered by the vehicle warranty.

Care of Safety Belts

Keep belts clean and dry.

WARNING

Do not bleach or dye safety belts. It may severely weaken them. In a crash, they might not be able to provide adequate protection. Clean safety belts only with mild soap and lukewarm water.

Floor Mats

WARNING

If a floor mat is the wrong size or is not properly installed, it can interfere with the accelerator pedal and/or brake pedal. Interference with the pedals can cause unintended acceleration and/or increased stopping distance which can cause a crash and injury. Make sure the floor mat does not interfere with the accelerator or brake pedal.

Use the following guidelines for proper floor mat usage:

- The original equipment floor mats were designed for your vehicle. If the floor mats need replacing, it is recommended that GM certified floor mats be purchased. Non-GM floor mats may not fit properly and may interfere with the accelerator or brake pedal. Always check that the floor mats do not interfere with the pedals.
- Use the floor mat with the correct side up. Do not turn it over.
- Do not place anything on top of the driver side floor mat.
- Use only a single floor mat on the driver side.
- Do not place one floor mat on top of another.

Removing and Replacing the Floor Mats

Pull up on the rear of the floor mat to unlock each retainer and remove.

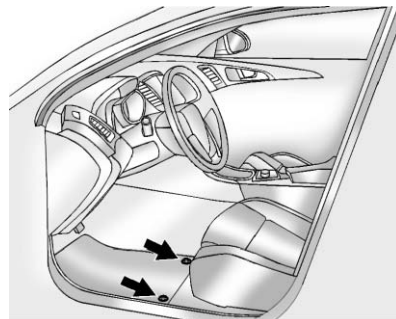

Reinstall by lining up the floor mat retainer openings over the carpet retainers and snap into position.

Make sure the floor mat is properly secured in place.

Verify the floor mat does not interfere with the accelerator or the brake pedal.

Service and Maintenance

General Information

General Information 11-1

Scheduled Maintenance

Scheduled Maintenance 11-2

Recommended Fluids, Lubricants, and Parts

Recommended Fluids and Lubricants 11-7

Maintenance Replacement Parts 11-9

Maintenance Records

Maintenance Records 11-10

General Information

Notice: Maintenance intervals, checks, inspections, recommended fluids, and lubricants are necessary to keep this vehicle in good working condition. Damage caused by failure to follow scheduled maintenance might not be covered by the vehicle warranty.

As the vehicle owner, you are responsible for the scheduled maintenance in this section. We recommend having your dealer perform these services. Proper vehicle maintenance helps to keep the vehicle in good working condition, improves fuel economy, and reduces vehicle emissions for better air quality.

Because of all the different ways people use vehicles, maintenance needs vary. The vehicle might need more frequent checks and services. Please read the information under Scheduled Maintenance. To keep the vehicle in good condition, see your dealer.

The maintenance schedule is for vehicles that:

- Carry passengers and cargo within recommended limits on the Tire and Loading Information label. See *Vehicle Load Limits on page 9-12*.
- Are driven on reasonable road surfaces within legal driving limits.
- Use the recommended fuel. See *Recommended Fuel on page 9-50*.

WARNING

Performing maintenance work can be dangerous. Some jobs can cause serious injury. Perform maintenance work only if you have the required know-how and the proper tools and equipment. If in doubt, see your dealer to have a qualified technician do the work. See *Doing Your Own Service Work* on page 10-4.

At your dealer, you can be certain that you will receive the highest level of service available. Your dealer has specially trained service technicians, uses genuine

replacement parts, as well as, up-to-date tools and equipment to ensure fast and accurate diagnostics.

The proper replacement parts, fluids, and lubricants to use are listed in *Recommended Fluids and Lubricants* on page 11-7 and *Maintenance Replacement Parts* on page 11-9. We recommend the use of genuine parts from your dealer.

Rotation of New Tires

To maintain ride, handling, and performance of the vehicle, it is important that the first rotation service for new tires be performed. Tires should be rotated every 12 000 km/7,500 miles. See *Tire Rotation* on page 10-61.

Scheduled Maintenance

When the Change Engine Oil Soon Message Displays

Change engine oil and filter. See *Engine Oil* on page 10-9. *An Emission Control Service*.

When the CHANGE ENGINE OIL SOON message displays, service is required for the vehicle as soon as possible, within the next 1 000 km/600 miles. If driving under the best conditions, the engine oil life system might not indicate the need for vehicle service for more than a year. The engine oil and filter must be changed at least once a year and the oil life system must be reset. Your dealer has trained service technicians who will perform this work and reset the system.

If the engine oil life system is reset accidentally, service the vehicle within 5 000 km/3,000 miles since the last service. Reset the oil life system whenever the oil is changed. See *Engine Oil Life System* on page 10-13.

Every Engine Oil Change

- Change engine oil and filter. Reset oil life system. See *Engine Oil* on page 10-9 and *Engine Oil Life System* on page 10-13. An Emission Control Service.
- Engine coolant level check. See *Engine Coolant* on page 10-18.

- Engine cooling system inspection. Visual inspection of hoses, pipes, fittings, and clamps and replacement, if needed.
- Windshield washer fluid level check. See *Washer Fluid* on page 10-24.
- Windshield wiper blade inspection for wear, cracking, or contamination and windshield and wiper blade cleaning, if contaminated. See *Exterior Care* on page 10-92. Worn or damaged wiper blade replacement. See *Wiper Blade Replacement* on page 10-29.
- Tire inflation pressures check. See *Tire Pressure* on page 10-54.

- Tire wear inspection. See *Tire Inspection* on page 10-61.
- Rotate tires if necessary. See *Tire Rotation* on page 10-61.
- Fluids visual leak check (or every 12 months, whichever occurs first). A leak in any system must be repaired and the fluid level checked.
- Engine air cleaner filter inspection. See *Engine Air Cleaner/Filter* on page 10-15.
- Brake system inspection (or every 12 months, whichever occurs first).
- Steering and suspension inspection. Visual inspection for damaged, loose, or missing parts or signs of wear.

11-4 Service and Maintenance

- Body hinges and latches, key lock cylinders, folding seat hardware, and sunroof (if equipped) lubrication. See *Recommended Fluids and Lubricants* on page 11-7. More frequent lubrication may be required when the vehicle is exposed to a corrosive environment. Applying silicone grease on weatherstrips with a clean cloth makes them last longer, seal better, and not stick or squeak.
- Restraint system component check. See *Safety System Check* on page 3-27.
- Fuel system inspection for damage or leaks.
- Exhaust system and nearby heat shields inspection for loose or damaged components.

Additional Required Services

Every 12 000 km/7,500 Miles

- Rotate tires. Tires should be rotated every 12 000 km/7,500 miles. See *Tire Rotation* on page 10-61.

At Each Fuel Stop

- Engine oil level check. See *Engine Oil* on page 10-9.
- Engine coolant level check. See *Engine Coolant* on page 10-18.
- Windshield washer fluid level check. See *Washer Fluid* on page 10-24.

Once a Month

- Tire inflation check. See *Tire Pressure* on page 10-54.
- Tire wear inspection. See *Tire Inspection* on page 10-61.
- Sunroof track and seal inspection, if equipped. See *Sunroof* on page 2-21.

Once a Year

- See *Starter Switch Check* on page 10-27.
- See *Automatic Transmission Shift Lock Control Function Check* on page 10-28.
- See *Ignition Transmission Lock Check* on page 10-28.
- See *Park Brake and P (Park) Mechanism Check* on page 10-29.
- Accelerator pedal check for damage, high effort, or binding. Replace if needed.
- Underbody flushing service.

- Hood/Decklid/Liftgate/Liftglass Support Gas Strut Service: Visually inspect gas strut, if equipped, for signs of wear, cracks, or other damage. Check the hold open ability of the gas strut. Contact your dealer if service is required.

First Engine Oil Change After Every 40 000 km/25,000 Miles

- Passenger compartment air filter replacement (or every 24 months, whichever occurs first). More frequent replacement may be needed if you drive in areas with heavy traffic, areas with poor air quality, or areas with high dust levels. Replacement may also be needed if you notice reduced air flow, windows fogging up, or odors. Your dealer can help you determine when it is the right time to replace the filter.

First Engine Oil Change After Every 80 000 km/50,000 Miles

- Engine air cleaner filter replacement. See *Engine Air Cleaner/Filter on page 10-15*.
- Automatic transmission fluid change (severe service) for vehicles mainly driven in heavy city traffic in hot weather, in hilly or mountainous terrain, when frequently towing a trailer, or used for taxi, police, or delivery service. See *Automatic Transmission Fluid on page 10-15*.

- All-wheel drive only: Transfer case fluid change (severe service) for vehicles mainly driven when frequently towing a trailer, or used for taxi, police, or delivery service. Check vent hose at transfer case for kinks and proper installation. Check to be sure vent hose is unobstructed, clear, and free of debris. During any maintenance, if a power washer is used to clean mud and dirt from the underbody, care should be taken to not directly spray the transfer case output seals. High pressure water can overcome the seals and contaminate the transfer case fluid. Contaminated fluid will decrease the life of the transfer case and should be replaced.

11-6 Service and Maintenance

- Evaporative control system inspection. Check all fuel and vapor lines and hoses for proper hook-up, routing, and condition. Check that the purge valve, if the vehicle has one, works properly. Replace as needed. *An Emission Control Service. The U.S. Environmental Protection Agency or the California Air Resources Board has determined that the failure to perform this maintenance item will not nullify the emission warranty or limit recall liability prior to the completion of the vehicle's useful life. We, however, urge that all recommended maintenance services be performed at the indicated intervals and the maintenance be recorded.*

First Engine Oil Change After Every 160 000 km/100,000 Miles

- Automatic transmission fluid change (normal service). *See Automatic Transmission Fluid on page 10-15.*
- All-wheel drive only: Transfer case fluid change (normal service). Check vent hose at transfer case for kinks and proper installation. Check to be sure vent hose is unobstructed, clear, and free of debris. During any maintenance, if a power washer is used to clean mud and dirt from the underbody, care should be taken to not directly spray the transfer case output seals. High pressure water can overcome the seals and contaminate the transfer case fluid. Contaminated fluid will decrease the life of the transfer case and should be replaced.

- Spark plug replacement and spark plug wires inspection. *An Emission Control Service.*

First Engine Oil Change After Every 240 000 km/150,000 Miles

- Engine cooling system drain, flush, and refill (or every five years, whichever occurs first). *See Cooling System on page 10-17. An Emission Control Service.*
- Engine drive belts inspection for fraying, excessive cracks, or obvious damage (or every 10 years, whichever occurs first). Replace, if needed.

Recommended Fluids, Lubricants, and Parts

Recommended Fluids and Lubricants

Usage	Fluid/Lubricant
Engine Oil	The engine requires engine oil approved to the dexos specification. Oils meeting this specification can be identified with the dexos certification mark. Look for and use only an engine oil that displays the dexos certification mark of the proper viscosity grade. See <i>Engine Oil on page 10-9</i> .
Engine Coolant	50/50 mixture of clean, drinkable water and use only DEX-COOL Coolant. See <i>Engine Coolant on page 10-18</i> .
Hydraulic Brake System	DOT 3 Hydraulic Brake Fluid (GM Part No. 88862806, in Canada 88862807).
Windshield Washer	Optikleen [®] Washer Solvent.
Hydraulic Power Steering System	DEXRON [®] -VI Automatic Transmission Fluid.
Automatic Transmission	DEXRON [®] -VI Automatic Transmission Fluid.

11-8 Service and Maintenance

Usage	Fluid/Lubricant
Key Lock Cylinders	Multi-Purpose Lubricant, Superlube (GM Part No. 12346241, in Canada 10953474).
Hood Latch Assembly, Secondary Latch, Pivots, Spring Anchor, and Release Pawl	Lubriplate Lubricant Aerosol (GM Part No. 12346293, in Canada 992723) or lubricant meeting requirements of NLGI #2, Category LB or GC-LB.
Hood and Door Hinges	Multi-Purpose Lubricant, Superlube (GM Part No. 12346241, in Canada 10953474).
Weatherstrip Conditioning	Weatherstrip Lubricant (GM Part No. 3634770, in Canada 10953518) or Dielectric Silicone Grease (GM Part No. 12345579, in Canada 992887).

Maintenance Replacement Parts

Replacement parts identified below by name, part number, or specification can be obtained from your dealer.

Part	GM Part Number	ACDelco Part Number
Engine Air Cleaner/Filter	55560894	A3128C
Engine Oil Filter		
2.4L L4 Engine	12605566	PF457G
3.6L V6 Engine	89017525	PF63
Passenger Compartment Air Filter Element	13271191	CF176
Spark Plugs		
2.4L L4 Engine	12620540	41-108
3.6L V6 Engine	12622561	41-109
Wiper Blades		
Driver Side – 65 cm (25.6 in)	25892079	—
Passenger Side – 45 cm (17.7 in)	25882578	—

Technical Data

Vehicle Identification

Vehicle Identification Number (VIN)	12-1
Service Parts Identification Label	12-1

Vehicle Data

Capacities and Specifications	12-2
Engine Drive Belt Routing ...	12-4

Vehicle Identification

Vehicle Identification Number (VIN)



This legal identifier is in the front corner of the instrument panel, on the left side of the vehicle. It can be seen through the windshield from outside. The VIN also appears on the Vehicle Certification and Service Parts labels and certificates of title and registration.

Engine Identification

The eighth character in the VIN is the engine code. This code identifies the vehicle's engine, specifications, and replacement parts. See "Engine Specifications" under *Capacities and Specifications* on page 12-2 for the vehicle's engine code.

Service Parts Identification Label

This label, in the trunk, has the following information:

- Vehicle Identification Number (VIN).
- Model designation.
- Paint information.
- Production options and special equipment.

Do not remove this label from the vehicle.

Vehicle Data

Capacities and Specifications

Application	Capacities	
	Metric	English
Air Conditioning Refrigerant R134a	For the air conditioning system refrigerant charge amount, see the refrigerant label located under the hood. See your dealer for more information.	
Engine Cooling System		
2.4L L4 Engine	7.1 L	7.5 qt
3.6L V6 Engine	9.4 L	9.9 qt
Engine Oil with Filter		
2.4L L4 Engine	4.7 L	5.0 qt
3.6L V6 Engine	5.2 L	5.5 qt
Fuel Tank		
AWD	74.0 L	19.5 gal
FWD	70.5 L	18.6 gal

Application	Capacities	
	Metric	English
Transmission Fluid* (Drain and Refill)		
2.4L L4 Engine, 6-Speed Automatic	8.0 L	8.5 qt
3.6L V6 Engine, 6-Speed Automatic	9.0 L	9.5 qt
Wheel Nut Torque	150 N•m	110 lb ft
*See <i>Automatic Transmission Fluid</i> on page 10-15 for information on checking fluid level.		
All capacities are approximate. When adding, be sure to fill to the approximate level, as recommended in this manual. Recheck fluid level after filling.		

Engine Specifications

Engine	VIN Code	Transmission	Spark Plug Gap
2.4L L4 Engine	C	Automatic	0.9 mm (0.035 in)
3.6L V6 Engine	D	Automatic	1.10 mm (0.043 in)

12-4 Technical Data

Engine Drive Belt Routing

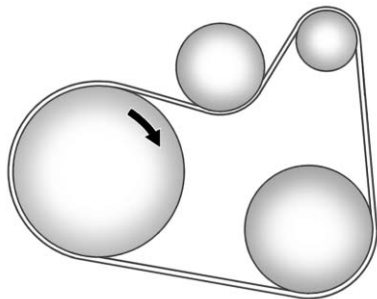

**2.4L L4 Engine
(Electric Power Steering)**

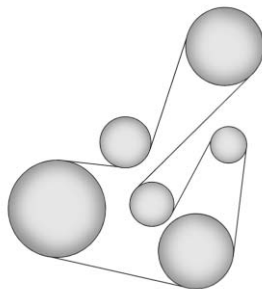

**2.4L L4 Engine
(Hydraulic Power Steering)**

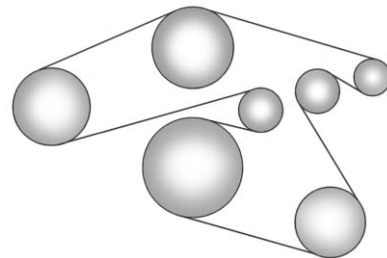

3.6L V6 Engines

Customer Information

Customer Information

Customer Satisfaction Procedure (U.S. and Canada)	13-1
Customer Satisfaction Procedure (Mexico)	13-3
Customer Assistance Offices (U.S. and Canada)	13-5
Customer Assistance Offices (Mexico)	13-6
Customer Assistance for Text Telephone (TTY) Users (U.S. and Canada)	13-6
Online Owner Center	13-7
GM Mobility Reimbursement Program (U.S. and Canada)	13-8
Roadside Assistance Program (U.S. and Canada)	13-8
Roadside Assistance Program (Mexico)	13-10
Scheduling Service Appointments (U.S. and Canada)	13-11

Courtesy Transportation Program (U.S. and Canada)	13-11
Collision Damage Repair (U.S. and Canada)	13-13
Service Publications Ordering Information	13-15

Reporting Safety Defects

Reporting Safety Defects to the United States Government	13-16
Reporting Safety Defects to the Canadian Government	13-17
Reporting Safety Defects to General Motors	13-17

Vehicle Data Recording and Privacy

Vehicle Data Recording and Privacy	13-18
Event Data Recorders	13-18
OnStar®	13-19
Navigation System	13-19
Radio Frequency Identification (RFID)	13-19
Radio Frequency Statement	13-20

Customer Information

Customer Satisfaction Procedure (U.S. and Canada)

Your satisfaction and goodwill are important to the dealer and to Buick. Normally, any concerns with the sales transaction or the operation of the vehicle will be resolved by the dealer's sales or service departments. Sometimes, however, despite the best intentions of all concerned, misunderstandings can occur. If your concern has not been resolved to your satisfaction, the following steps should be taken:

STEP ONE: Discuss your concern with a member of dealership management. Normally, concerns can be quickly resolved at that level. If the matter has already been reviewed with the sales, service, or parts manager, contact the owner of the dealership or the general manager.

13-2 Customer Information

STEP TWO: If after contacting a member of dealership management, it appears your concern cannot be resolved by the dealership without further help, in the U.S., call 1-800-521-7300. In Canada, contact General Motors of Canada Customer Communication Centre at 1-800-263-3777 (English) or 1-800-263-7854 (French).

We encourage you to call the toll-free number in order to give the inquiry prompt attention. Have the following information available to give the Customer Assistance representative:

- Vehicle Identification Number (VIN). This is available from the vehicle registration or title, or the plate at the top left of the instrument panel and visible through the windshield.
- Dealership name and location.
- Vehicle delivery date and present mileage.

When contacting Buick, remember that your concern will likely be resolved at a dealer's facility. That is why we suggest following Step One first.

STEP THREE — U.S. Owners:

Both General Motors and the dealer are committed to making sure you are completely satisfied with the new vehicle. However, if you continue to remain unsatisfied after following the procedure outlined in Steps One and Two, you can file with the Better Business Bureau (BBB) Auto Line[®] Program to enforce your rights.

The BBB Auto Line Program is an out-of-court program administered by the Council of Better Business Bureaus to settle automotive disputes regarding vehicle repairs or the interpretation of the New Vehicle Limited Warranty. Although you may be required to resort to this informal dispute resolution program prior to filing a court action, use of the program is free of charge and your

case will generally be heard within 40 days. If you do not agree with the decision given in your case, you may reject it and proceed with any other venue for relief available to you.

You may contact the BBB Auto Line Program using the toll-free telephone number or write them at the following address:

BBB Auto Line Program
Council of Better Business
Bureaus, Inc.
4200 Wilson Boulevard
Suite 800
Arlington, VA 22203-1838

Telephone: 1-800-955-5100
www.dr.bbb.org/goauto

This program is available in all 50 states and the District of Columbia. Eligibility is limited by vehicle age, mileage, and other factors. General Motors reserves the right to change eligibility limitations and/or discontinue its participation in this program.

STEP THREE — Canadian

Owners: In the event that you do not feel your concerns have been addressed after following the procedure outlined in Steps One and Two, General Motors of Canada Limited wants you to be aware of its participation in a no-charge Mediation/Arbitration program. General Motors of Canada Limited has committed to binding arbitration of owner disputes involving factory-related vehicle service claims. The program provides for the review of the facts involved by an impartial third party arbiter, and may include an informal hearing before the arbiter. The program is designed so that the entire dispute settlement process, from the time you file your complaint to the final decision, should be completed in approximately 70 days. We believe our impartial program

offers advantages over courts in most jurisdictions because it is informal, quick, and free of charge.

For further information concerning eligibility in the Canadian Motor Vehicle Arbitration Plan (CAMVAP), call toll-free 1-800-207-0685, or call the General Motors Customer Communication Centre, 1-800-263-3777 (English), 1-800-263-7854 (French), or write to:

Mediation/Arbitration Program
c/o Customer Communication
Centre
General Motors of Canada Limited
Mail Code: CA1-163-005
1908 Colonel Sam Drive
Oshawa, Ontario L1H 8P7

The inquiry should be accompanied by the Vehicle Identification Number (VIN).

**Customer Satisfaction
Procedure (Mexico)**

Did you get the Warranty Extension Plan? This plan is recommended by General Motors to supplement the warranty included with the new vehicle purchase.

See your dealer for details.

13-4 Customer Information

Customer Assistance Procedure

Owner satisfaction and goodwill are very important to your dealer and General Motors.

Normally, any problem with the transaction, sale, or usage of the vehicle must be handled by your dealer sales or service departments. However, we recognize that despite the good intentions of all parties involved, sometimes a misunderstanding may occur.

If you have a problem that has not been satisfactorily handled through the normal means, we suggest the following steps:

STEP ONE

Explain your case to the dealer service agent, service manager, dealer sales agent, or sales manager, depending on your case.

Make sure that they have all necessary information. They are interested in your continual satisfaction.

STEP TWO

If you are not satisfied, please contact the general manager or the dealership owner to ask for their help. If they are not able to resolve your case, ask them to contact the right people at General Motors for support, if needed.

STEP THREE

If your case is not resolved in a reasonable amount of time by your dealer, please call the General Motors Customer Assistance Center (CAC) and provide the following information:

- Name
- Address
- Phone number

- Model year
- Brand
- Vehicle Identification Number (VIN)
- Mileage
- Delivery date
- Description of the problem
- Dealership name
- Dealership address

See *Customer Assistance Offices (U.S. and Canada)* on page 13-5 or *Customer Assistance Offices (Mexico)* on page 13-6 for more information.

Customer Assistance Offices (U.S. and Canada)

Buick encourages customers to call the toll-free number for assistance. However, if a customer wishes to write or e-mail Buick, the letter should be addressed to:

United States

Buick Customer Assistance Center
P.O. Box 33136
Detroit, MI 48232-5136
www.Buick.com

1-800-521-7300
1-800-832-8425 (For Text
Telephone devices (TTYs))
Roadside Assistance:
1-800-252-1112

From Puerto Rico:

1-800-496-9992 (English)
1-800-496-9993 (Spanish)

From U.S. Virgin Islands:

1-800-496-9994

Canada

General Motors of Canada Limited
Customer Communication Centre,
Mail Code: CA1-163-005
1908 Colonel Sam Drive
Oshawa, Ontario L1H 8P7
www.gm.ca

1-800-263-3777 (English)
1-800-263-7854 (French)
1-800-263-3830 (For Text
Telephone devices (TTYs))
Roadside Assistance:
1-800-268-6800

All Overseas Locations

Please contact the local
General Motors Business Unit.

Mexico, Central America and Caribbean Islands/Countries (Except Puerto Rico and U.S. Virgin Islands)

General Motors de Mexico,
S. de R.L. de C.V.
Customer Assistance Center
Av. Ejercito Nacional #843
Col. Granada
C.P. 11520, Mexico, D.F.

01-800-466-0818
Long Distance: 011-52-53 29 0818

13-6 Customer Information

Customer Assistance Offices (Mexico)

To contact the Customer Assistance Center (CAC), use the phone numbers listed in this section.

Customer assistance is available Monday through Friday, 08:00 to 20:00 hours, and Saturdays from 08:00 to 15:00 hours.

All e-mail inquiries to the Customer Assistance Center (CAC) should be sent to: cac.buick@gm.com.

Mexico

From Mexico City

5329-0818

From Other Mexico Locations

01-800-466-0818

United States and Canada

1-800-521-7300

Costa Rica

00-800-052-1005

Guatemala

1-800-999-5252

Panama

00-800-052-0001

Dominican Republic

1-888-751-5301

El Salvador

800-6273

Honduras

800-0122-6101

Customer Assistance for Text Telephone (TTY) Users (U.S. and Canada)

To assist customers who are deaf, hard of hearing, or speech-impaired and who use Text Telephones (TTYs), Buick has TTY equipment available at its Customer Assistance Center. Any TTY user can communicate with Buick by dialing: 1-800-832-8425. TTY users in Canada can dial 1-800-263-3830.

Online Owner Center

Buick Owner Center (U.S.) www.buickownercenter.com

Information and services customized for your specific vehicle — all in one convenient place.

- Digital owner manual, warranty information, and more.
- Storage for online service and maintenance records.
- Buick dealer locator for service nationwide.
- Exclusive privileges and offers.
- Recall notices for your specific vehicle.
- OnStar and GM Cardmember Services Earnings summaries.

Other Helpful Links:

Buick — www.buick.com

Buick Merchandise —
www.buickmerchandise.com

Help Center — www.buick.com/pages/mds/helpcenter/faq.do

- FAQ (Frequently Asked Questions)
- Contact Us

My GM Canada www.gm.ca

My GM Canada is a password-protected section of www.gm.ca where you can save information on GM vehicles, get personalized offers, and use handy tools and forms with greater ease.

Here are a few of the valuable tools and services you will have access to:

- **My Showroom:** Find and save information on vehicles and current offers in your area.
- **My Dealers:** Save details such as address and phone number for each of your preferred GM dealers.
- **My Driveway:** Access quick links to parts and service estimates, check trade-in values, or schedule a service appointment by adding the vehicles you own to your driveway profile.
- **My Preferences:** Manage your profile and use tools and forms with greater ease.

To sign up, visit the My GM.ca section within www.gm.ca.

GM Mobility Reimbursement Program (U.S. and Canada)



This program is available to qualified applicants for cost reimbursement of eligible aftermarket adaptive equipment required for the vehicle, such as hand controls or a wheelchair/scooter lift for the vehicle.

For more information on the limited offer, visit www.gmmobility.com or call the GM Mobility Assistance Center at 1-800-323-9935. Text Telephone (TTY) users, call 1-800-833-9935.

General Motors of Canada also has a Mobility Program. Call 1-800-GM-DRIVE (463-7483) for details. TTY users call 1-800-263-3830.

Roadside Assistance Program (U.S. and Canada)

For U.S.-purchased vehicles, call **1-800-252-1112; (Text Telephone (TTY): 1-888-889-2438)**.

For Canadian-purchased vehicles, call **1-800-268-6800**.

Service is available 24 hours a day, 365 days a year.

Calling for Assistance

When calling Roadside Assistance, have the following information ready:

- Your name, home address, and home telephone number.
- Telephone number of your location.
- Location of the vehicle.
- Model, year, color, and license plate number of the vehicle.
- Odometer reading, Vehicle Identification Number (VIN), and delivery date of the vehicle.
- Description of the problem.

Coverage

Services are provided up to 5 years/160 000 km (100,000 mi), whichever comes first.

In the U.S., anyone driving the vehicle is covered. In Canada, a person driving the vehicle without permission from the owner is not covered.

Roadside Assistance is not a part of the New Vehicle Limited Warranty. Buick and General Motors of Canada Limited reserve the right to make any changes or discontinue the Roadside Assistance program at any time without notification.

Buick and General Motors of Canada Limited reserve the right to limit services or payment to an owner or driver if they decide the claims are made too often, or the same type of claim is made many times.

Services Provided

- **Emergency Fuel Delivery:** Delivery of enough fuel for the vehicle to get to the nearest service station.
- **Lock-Out Service:** Service to unlock the vehicle if you are locked out. A remote unlock may be available if you have OnStar®. For security reasons, the driver must present identification before this service is given.
- **Emergency Tow from a Public Road or Highway:** Tow to the nearest Buick dealer for warranty service, or if the vehicle was in a crash and cannot be driven. Assistance is also given when the vehicle is stuck in sand, mud, or snow.

- **Flat Tire Change:** Service to change a flat tire with the spare tire. The spare tire, if equipped, must be in good condition and properly inflated. It is the owner's responsibility for the repair or replacement of the tire if it is not covered by the warranty.
- **Battery Jump Start:** Service to jump start a dead battery.

Services Not Included in Roadside Assistance

- Impound towing caused by violation of any laws.
- Legal fines.
- Mounting, dismounting, or changing of snow tires, chains, or other traction devices.
- Towing or services for vehicles driven on a non-public road or highway.

Services Specific to Canadian-Purchased Vehicles

- **Fuel delivery:** Reimbursement is approximately \$5 Canadian. Diesel fuel delivery may be restricted. Propane and other fuels are not provided through this service.
- **Lock-Out Service:** Vehicle registration is required.
- **Trip Routing Service:** Detailed maps of North America are provided when requested either with the most direct route or the most scenic route. There is a six request limit per year. Additional travel information is also available. Allow three weeks for delivery.
- **Trip Interruption Benefits and Assistance:** Must be over 250 kilometers from where your trip was started to qualify. General Motors of Canada

Limited requires pre-authorization, original detailed receipts, and a copy of the repair orders. Once authorization has been received, the Roadside Assistance advisor will help you make arrangements and explain how to receive payment.

- **Alternative Service:** If assistance cannot be provided right away, the Roadside Assistance advisor may give permission to get local emergency road service. You will receive payment, up to \$100, after sending the original receipt to Roadside Assistance. Mechanical failures may be covered, however any cost for parts and labor for repairs not covered by the warranty are the owner responsibility.

Roadside Assistance Program (Mexico)

Roadside Assistance is available 24 hours a day, 365 days of the year.

For detailed information about Roadside Assistance, please see the brochure provided with your new vehicle or visit our website at: www.buick.com.mx. Navigate the site and click on "Asistencia en el Camino." E-mail correspondence should be sent to: asistencia.buick@gm.com.

To contact Roadside Assistance by phone, use the following numbers:

Mexico

01-800-466-0818

United States

1-866-466-8197

Canada

1-800-268-6800

Scheduling Service Appointments (U.S. and Canada)

When the vehicle requires warranty service, contact the dealer and request an appointment. By scheduling a service appointment and advising the service consultant of your transportation needs, the dealer can help minimize your inconvenience.

If the vehicle cannot be scheduled into the service department immediately, keep driving it until it can be scheduled for service, unless, of course, the problem is safety related. If it is, please call the dealership, let them know this, and ask for instructions.

If the dealer requests you to bring the vehicle for service, you are urged to do so as early in the work day as possible to allow for the same day-repair.

Courtesy Transportation Program (U.S. and Canada)

To enhance your ownership experience, we and our participating dealers are proud to offer Courtesy Transportation, a customer support program for vehicles with the Bumper-to-Bumper (Base Warranty Coverage period in Canada), extended powertrain, and/or hybrid-specific warranties in both the U.S. and Canada.

Several Courtesy Transportation options are available to assist in reducing inconvenience when warranty repairs are required.

Courtesy Transportation is not a part of the New Vehicle Limited Warranty. A separate booklet entitled "Warranty and Owner Assistance Information" furnished with each new vehicle provides detailed warranty coverage information.

Transportation Options

Warranty service can generally be completed while you wait. However, if you are unable to wait, GM helps to minimize inconvenience by providing several transportation options. Depending on the circumstances, the dealer can offer one of the following:

Shuttle Service

Shuttle service is the preferred means of offering Courtesy Transportation. Dealers may provide shuttle service to get you to your destination with minimal interruption of your daily schedule. This includes one-way or round-trip shuttle service within reasonable time and distance parameters of the dealer's area.

13-12 Customer Information

Public Transportation or Fuel Reimbursement

If the vehicle requires overnight warranty repairs, and public transportation is used instead of the dealer's shuttle service, the expense must be supported by original receipts and can only be up to the maximum amount allowed by GM for shuttle service. In addition, for U.S. customers, should you arrange transportation through a friend or relative, limited reimbursement for reasonable fuel expenses may be available. Claim amounts should reflect actual costs and be supported by original receipts. See the dealer for information regarding the allowance amounts for reimbursement of fuel or other transportation costs.

Courtesy Rental Vehicle

The dealer may arrange to provide you with a courtesy rental vehicle or reimburse you for a rental vehicle that you obtain if the vehicle is kept for an overnight warranty repair. Rental reimbursement will be limited and must be supported by original receipts. This requires that you sign and complete a rental agreement and meet state/provincial, local, and rental vehicle provider requirements. Requirements vary and may include minimum age requirements, insurance coverage, credit card, etc. You are responsible for fuel usage charges and may also be responsible for taxes, levies, usage fees, excessive mileage, or rental usage beyond the completion of the repair.

It may not be possible to provide a like vehicle as a courtesy rental.

Additional Program Information

All program options, such as shuttle service, may not be available at every dealer. Please contact the dealer for specific information about availability. All Courtesy Transportation arrangements will be administered by appropriate dealer personnel.

General Motors reserves the right to unilaterally modify, change, or discontinue Courtesy Transportation at any time and to resolve all questions of claim eligibility pursuant to the terms and conditions described herein at its sole discretion.

Collision Damage Repair (U.S. and Canada)

If the vehicle is involved in a collision and it is damaged, have the damage repaired by a qualified technician using the proper equipment and quality replacement parts. Poorly performed collision repairs diminish the vehicle resale value, and safety performance can be compromised in subsequent collisions.

Collision Parts

Genuine GM Collision parts are new parts made with the same materials and construction methods as the parts with which the vehicle was originally built. Genuine GM Collision parts are the best choice to ensure that the vehicle's designed appearance, durability, and safety are preserved. The use of Genuine GM parts can help maintain the GM New Vehicle Limited Warranty.

Recycled original equipment parts may also be used for repair. These parts are typically removed from vehicles that were total losses in prior crashes. In most cases, the parts being recycled are from undamaged sections of the vehicle. A recycled original equipment GM part may be an acceptable choice to maintain the vehicle's originally designed appearance and safety performance; however, the history of these parts is not known. Such parts are not covered by the GM New Vehicle Limited Warranty, and any related failures are not covered by that warranty.

Aftermarket collision parts are also available. These are made by companies other than GM and may not have been tested for the vehicle. As a result, these parts may fit poorly, exhibit premature

durability/corrosion problems, and may not perform properly in subsequent collisions. Aftermarket parts are not covered by the GM New Vehicle Limited Warranty, and any vehicle failure related to such parts is not covered by that warranty.

Repair Facility

GM also recommends that you choose a collision repair facility that meets your needs before you ever need collision repairs. The dealer may have a collision repair center with GM-trained technicians and state-of-the-art equipment, or be able to recommend a collision repair center that has GM-trained technicians and comparable equipment.

Insuring The Vehicle

Protect your investment in the GM vehicle with comprehensive and collision insurance coverage. There are significant differences in the quality of coverage afforded by various insurance policy terms. Many insurance policies provide reduced protection to the GM vehicle by limiting compensation for damage repairs by using aftermarket collision parts. Some insurance companies will not specify aftermarket collision parts. When purchasing insurance, we recommend that you ensure that the vehicle will be repaired with GM original equipment collision parts. If such insurance coverage is not available from your current insurance carrier, consider switching to another insurance carrier.

If the vehicle is leased, the leasing company may require you to have insurance that ensures repairs with Genuine GM Original Equipment Manufacturer (OEM) parts or Genuine Manufacturer replacement parts. Read the lease carefully, as you may be charged at the end of the lease for poor quality repairs.

If a Crash Occurs

If there has been an injury, call emergency services for help. Do not leave the scene of a crash until all matters have been taken care of. Move the vehicle only if its position puts you in danger, or you are instructed to move it by a police officer.

Give only the necessary information to police and other parties involved in the crash.

For emergency towing see *Roadside Assistance Program (U.S. and Canada)* on page 13-8 or *Roadside Assistance Program (Mexico)* on page 13-10.

Gather the following information:

- Driver name, address, and telephone number.
- Driver license number.
- Owner name, address, and telephone number.
- Vehicle license plate number.
- Vehicle make, model, and model year.
- Vehicle Identification Number (VIN).
- Insurance company and policy number.
- General description of the damage to the other vehicle.

Choose a reputable repair facility that uses quality replacement parts. See "Collision Parts" earlier in this section.

If the airbag has inflated, see *What Will You See After an Airbag Inflates?* on page 3-35.

Managing the Vehicle Damage Repair Process

In the event that the vehicle requires damage repairs, GM recommends that you take an active role in its repair. If you have a pre-determined repair facility of choice, take the vehicle there, or have it towed there. Specify to the facility that any required replacement collision parts be original equipment parts, either new Genuine GM parts or recycled original GM parts. Remember, recycled parts will not be covered by the GM vehicle warranty.

Insurance pays the bill for the repair, but you must live with the repair. Depending on your policy limits,

your insurance company may initially value the repair using aftermarket parts. Discuss this with the repair professional, and insist on Genuine GM parts. Remember, if the vehicle is leased, you may be obligated to have the vehicle repaired with Genuine GM parts, even if your insurance coverage does not pay the full cost.

If another party's insurance company is paying for the repairs, you are not obligated to accept a repair valuation based on that insurance company's collision policy repair limits, as you have no contractual limits with that company. In such cases, you can have control of the repair and parts choices as long as the cost stays within reasonable limits.

Service Publications Ordering Information

Service Manuals

Service Manuals have the diagnosis and repair information on the engines, transmission, axle, suspension, brakes, electrical, steering, body, etc.

Service Bulletins

Service Bulletins give additional technical service information needed to knowledgeably service General Motors cars and trucks. Each bulletin contains instructions to assist in the diagnosis and service of the vehicle.

Owner Information

Owner publications are written specifically for owners and intended to provide basic operational information about the vehicle. The Owner Manual includes the Maintenance Schedule for all models.

In-Portfolio: Includes a Portfolio, Owner Manual, and Warranty Booklet.

RETAIL SELL PRICE:
\$35.00 (U.S.) plus handling and shipping fees.

Without Portfolio: Owner Manual only.

RETAIL SELL PRICE:
\$25.00 (U.S.) plus handling and shipping fees.

Current and Past Models

Technical Service Bulletins and Manuals are available for current and past model GM vehicles.

ORDER TOLL FREE:
1-800-551-4123 Monday - Friday
8:00 AM - 6:00 PM Eastern Time

For Credit Card Orders Only (VISA-MasterCard-Discover), visit Helm, Inc. at: www.helminc.com.

Or write to:

Helm, Incorporated
P.O. Box 07130
Detroit, MI 48207

Prices are subject to change without notice and without incurring obligation. Allow ample time for delivery.

All listed prices are quoted in U.S. funds. Make checks payable in U.S. funds.

Reporting Safety Defects

Reporting Safety Defects to the United States Government

If you believe that your vehicle has a defect which could cause a crash or could cause injury or death, you should immediately inform the National Highway Traffic Safety Administration (NHTSA) in addition to notifying General Motors.

If NHTSA receives similar complaints, it may open an investigation, and if it finds that a safety defect exists in a group of vehicles, it may order a recall and remedy campaign.

However, NHTSA cannot become involved in individual problems between you, your dealer, or General Motors.

To contact NHTSA, you may call the Vehicle Safety Hotline toll-free at 1-888-327-4236 (TTY: 1-800-424-9153); go to <http://www.safercar.gov>; or write to:

Administrator, NHTSA
1200 New Jersey Avenue, S.E.
Washington, D.C. 20590

You can also obtain other information about motor vehicle safety from <http://www.safercar.gov>.

Reporting Safety Defects to the Canadian Government

If you live in Canada, and you believe that the vehicle has a safety defect, notify Transport Canada immediately, and notify General Motors of Canada Limited. Call them at 1-800-333-0510 or write to:

Transport Canada
Road Safety Branch
2780 Sheffield Road
Ottawa, Ontario K1B 3V9

Reporting Safety Defects to General Motors

In addition to notifying NHTSA (or Transport Canada) in a situation like this, please notify General Motors.

Call 1-800-521-7300, or write:

Buick Customer Assistance Center
P.O. Box 33136
Detroit, MI 48232-5136

In Canada, call 1-800-263-3777 (English) or 1-800-263-7854 (French), or write:

General Motors of Canada Limited
Customer Communication Centre,
Mail Code: CA1-163-005
1908 Colonel Sam Drive
Oshawa, Ontario L1H 8P7

Vehicle Data Recording and Privacy

This GM vehicle has a number of sophisticated computers that record information about the vehicle's performance and how it is driven. For example, the vehicle uses computer modules to monitor and control engine and transmission performance, to monitor the conditions for airbag deployment and deploy airbags in a crash, and, if so equipped, to provide antilock braking to help the driver control the vehicle. These modules may store data to help the dealer technician service the vehicle. Some modules may also store data about how you operate the vehicle, such as rate of fuel consumption or average speed. These modules may also retain the owner's personal preferences, such as radio pre-sets, seat positions, and temperature settings.

Event Data Recorders

This vehicle has an Event Data Recorder (EDR). The main purpose of an EDR is to record, in certain crash or near crash-like situations, such as an airbag deployment or hitting a road obstacle, data that will assist in understanding how a vehicle's systems performed. The EDR is designed to record data related to vehicle dynamics and safety systems for a short period of time, typically 30 seconds or less. The EDR in this vehicle is designed to record such data as:

- How various systems in the vehicle were operating.
- Whether or not the driver and passenger safety belts were buckled/fastened.
- How far, if at all, the driver was pressing the accelerator and/or brake pedal.
- How fast the vehicle was traveling.

This data can help provide a better understanding of the circumstances in which crashes and injuries occur.

Important: EDR data is recorded by the vehicle only if a non-trivial crash situation occurs; no data is recorded by the EDR under normal driving conditions and no personal data (e.g., name, gender, age, and crash location) is recorded. However, other parties, such as law enforcement, could combine the EDR data with the type of personally identifying data routinely acquired during a crash investigation.

To read data recorded by an EDR, special equipment is required, and access to the vehicle or the EDR is needed. In addition to the vehicle manufacturer, other parties, such as law enforcement, that have the special equipment, can read the information if they have access to the vehicle or the EDR.

GM will not access this data or share it with others except: with the consent of the vehicle owner or, if the vehicle is leased, with the consent of the lessee; in response to an official request by police or similar government office; as part of GM's defense of litigation through the discovery process; or, as required by law. Data that GM collects or receives may also be used for GM research needs or may be made available to others for research purposes, where a need is shown and the data is not tied to a specific vehicle or vehicle owner.

OnStar®

If the vehicle is equipped with an active OnStar system, that system may also record data in crash or near crash-like situations. The OnStar Terms and Conditions provides information on data collection and use and is available in the OnStar glove box kit, at www.onstar.com (U.S.) or www.onstar.ca (Canada), or by pressing the  button and speaking to an advisor.

Navigation System

If the vehicle has a navigation system, use of the system may result in the storage of destinations, addresses, telephone numbers, and other trip information. Refer to the navigation system operating manual for information on stored data and for deletion instructions.

Radio Frequency Identification (RFID)

RFID technology is used in some vehicles for functions such as tire pressure monitoring and ignition system security, as well as in connection with conveniences such as key fobs for remote door locking/unlocking and starting, and in-vehicle transmitters for garage door openers. RFID technology in GM vehicles does not use or record personal information or link with any other GM system containing personal information.

Radio Frequency Statement

This vehicle has systems that operate on a radio frequency that comply with Part 15 of the Federal Communications Commission (FCC) rules and with Industry Canada Standards RSS-210/220/310.

Operation is subject to the following two conditions:

1. The device may not cause interference.
2. The device must accept any interference received, including interference that may cause undesired operation of the device.

Changes or modifications to any of these systems by other than an authorized service facility could void authorization to use this equipment.

A

Accessories and
Modifications 10-3

Accessory Power 9-24

Adaptive Forward
Lighting (AFL) 6-4

Add-On Electrical
Equipment 9-62

Adjustments
Lumbar, Front Seats 3-7

Air Cleaner/Filter, Engine 10-15

Air Conditioning 8-1

Air Filter, Passenger
Compartment 8-8

Air Intake 8-8

Air Vents 8-8

Airbag System
Check 3-43

How Does an Airbag
Restrain? 3-34

Passenger Sensing
System 3-37

What Makes an Airbag
Inflate? 3-34

Airbag System (cont.)
What Will You See After
an Airbag Inflates? 3-35

When Should an Airbag
Inflate? 3-32

Where Are the Airbags? 3-31

Airbags
Adding Equipment to the
Vehicle 3-42

Passenger Status Indicator 5-15

Readiness Light 5-14

Servicing Airbag-Equipped
Vehicles 3-41

System Check 3-29

Alarm System
Anti-Theft 2-14

All-Wheel Drive 9-31

AM-FM Radio 7-12

Antenna
Satellite Radio 7-20

Anti-Theft
Alarm System 2-14

Alarm System Messages 5-38

Antilock Brake
System (ABS) 9-32

Warning Light 5-21

Appearance Care
Exterior 10-92

Interior 10-97

Assistance Program,
Roadside 13-8, 13-10

Audio Players 7-20

CD 7-20

CD/DVD 7-23

Audio System
Backglass Antenna 7-19

Radio Reception 7-19

Theft-Deterrent Feature 7-2

Automatic
Climate Control System 8-1

Headlamp System 6-3

Automatic Transmission 9-28

Fluid 10-15

Manual Mode 9-30

Shift Lock Control
Function Check 10-28

Auxiliary Devices 7-31, 7-34

B

Battery	10-27
Jump Starting	10-86
Load Management	6-6
Power Protection	6-7
Voltage and Charging Messages	5-33
Blade Replacement, Wiper ...	10-29
Bluetooth	7-46, 7-48, 7-53
Brake System Warning Light ...	5-19
Brakes	10-24
Antilock	9-32
Assist	9-35
Fluid	10-25
Parking	9-33
System Messages	5-33
Braking	9-3

Break-In, New Vehicle	9-16
Bulb Replacement	10-37
Fog Lamps	6-5
Halogen Bulbs	10-33
Headlamp Aiming	10-30
Headlamps	10-33
Headlamps, Front Turn Signal and Parking Lamps	10-34
High Intensity Discharge (HID) Lighting	10-33
License Plate Lamps	10-36
Taillamps, Turn Signal, Stoptlamps, and Back-Up Lamps	10-35
Buying New Tires	10-64

C

Calibration	5-5
California Fuel Requirements	9-51
Perchlorate Materials Requirements	10-3
Warning	10-3
Camera, Rear Vision	9-46
Canadian Vehicle Owners	iv
Capacities and Specifications	12-2
Carbon Monoxide Engine Exhaust	9-27
Trunk	2-12
Winter Driving	9-9
Cautions, Danger, and Warnings	v

CD Player	7-20	Cleaning		Cooling System	10-17
CD/DVD Player	7-23	Exterior Care	10-92	Engine Messages	5-35
Center Console Storage	4-1	Interior Care	10-97	Courtesy Transportation	
Chains, Tire	10-69	Climate Control Systems		Program	13-11
Charging		Automatic	8-1	Cruise Control	9-39
System Light	5-16	Dual Automatic	8-4	Light	5-25
Check		Clock	5-5, 5-6	Messages	5-34
Engine Light	5-17	Cluster, Instrument	5-10	Cupholders	4-1
Ignition		Collision Damage Repair	13-13	Customer Assistance	13-6
Transmission Lock	10-28	Compact Spare Tire	10-85	Offices	13-5, 13-6
Child Restraints		Compass	5-5	Text Telephone (TTY)	
Infants and Young		Messages	5-34	Users	13-6
Children	3-46	Compressor Kit, Tire		Customer Information	
Lower Anchors and		Sealant	10-72	Service Publications	
Tethers for Children	3-52	Control of a Vehicle	9-3	Ordering Information	13-15
Older Children	3-44	Convenience Net	4-2	Customer Satisfaction	
Securing	3-61, 3-63	Coolant		Procedure	13-1, 13-3
Systems	3-49	Engine	10-18		
Circuit Breakers	10-39	Engine Temperature			
		Gauge	5-13		

D

Damage Repair, Collision	13-13
Danger, Warnings, and Cautions	v
Data Recorders, Event	13-18
Daytime Running Lamps (DRL)	6-3
Defensive Driving	9-2
Delayed Locking	2-12
Devices, Auxiliary	7-31, 7-34
Differential, Limited-Slip	9-38
Displays	5-29
Dome Lamps	6-5
Door	
Ajar Messages	5-34
Delayed Locking	2-12
Locks	2-10
Power Locks	2-11
Rear Seat Pass-Through	3-13
Drive Systems	
All-Wheel Drive	9-31
Driver Information Center (DIC)	5-25

Driving

Characteristics and Towing Tips	9-56
Defensive	9-2
Drunk	9-2
Highway Hypnosis	9-8
Hill and Mountain Roads	9-8
If the Vehicle is Stuck	9-11
Loss of Control	9-6
Off-Road Recovery	9-6
Vehicle Load Limits	9-12
Wet Roads	9-7
Winter	9-9
Driving for Better Fuel Economy	1-23
Dual Automatic Climate Control System	8-4
DVD	
Rear Seat Entertainment System	7-36
DVD/CD Player	7-23

E

Electric Parking Brake Light ...	5-20
Electrical Equipment, Add-On	9-62
Electrical System	
Engine Compartment Fuse Block	10-39
Fuses and Circuit Breakers	10-39
Instrument Panel Fuse Block	10-42
Overload	10-38
Rear Compartment Fuse Block	10-44
Electronic Stability Control	9-37
Electronic Stability Control (ESC)/Traction Control System (TCS) Indicator Warning Light	5-22

Electronic Stability Control
 Indicator Light 5-22

Engine
 Air Cleaner/Filter 10-15
 Check and Service Engine
 Soon Light 5-17
 Compartment Overview 10-6
 Coolant 10-18
 Coolant Temperature
 Gauge 5-13
 Cooling System 10-17
 Cooling System Messages ... 5-35
 Drive Belt Routing 12-4
 Exhaust 9-27
 Heater 9-23
 Overheated Protection
 Operating Mode 10-22
 Overheating 10-21
 Power Messages 5-36
 Pressure Light 5-23
 Running While Parked 9-28
 Starting 9-20

Engine Oil
 Life System 10-13
 Messages 5-35
 Entry Lighting 6-6
 Equipment, Towing 9-61
 Event Data Recorders 13-18
 Exit Lighting 6-6
 Extender, Safety Belt 3-27
 Exterior Lamp Controls 6-1
 Exterior Lamps Off Reminder ... 6-2

F

Features
 Memory 1-7

Filter,
 Engine Air Cleaner 10-15

Flash-to-Pass 6-2

Flashers, Hazard Warning 6-4

Flat Tire 10-70
 Changing 10-79

Floor Mats 10-100

Fluid
 Automatic Transmission 10-15
 Brakes 10-25
 Power Steering 10-23
 Washer 10-24

Fog Lamps
 Bulb Replacement 6-5

Folding Mirrors 2-17

Front Fog Lamps
 Light 5-25

Front Seats
 Adjustment 3-4
 Heated and Ventilated 3-10

Front Storage 4-1

Fuel 9-50
 Additives 9-52
 Filling a Portable Fuel
 Container 9-54
 Filling the Tank 9-53
 Fuels in Foreign Countries ... 9-52
 Gasoline Specifications 9-51

Fuel (cont.)	
Gauge	5-11
Low Fuel Warning Light	5-24
Recommended	9-50
Requirements, California	9-51
System Messages	5-36
Fuel Economy	
Driving	1-23
Fuses	
Engine Compartment	
Fuse Block	10-39
Fuses and Circuit	
Breakers	10-39
Instrument Panel Fuse	
Block	10-42
Rear Compartment Fuse	
Block	10-44

G

Garage Door Opener	5-45
Programming	5-45
Gasoline	
Specifications	9-51
Gauges	
Engine Coolant	
Temperature	5-13
Fuel	5-11
Odometer	5-11
Speedometer	5-11
Tachometer	5-11
Warning Lights and	
Indicators	5-9
General Information	
Service and Maintenance	11-1
Towing	9-55
Vehicle Care	10-2
Glove Box	4-1
GM Mobility Reimbursement	
Program	13-8

H

Halogen Bulbs	10-33
Hazard Warning Flashers	6-4
Head Restraints	3-2
Head Up Display	5-29
Headlamps	
Adaptive Forward	
Lighting (AFL)	6-4
Aiming	10-30
Automatic	6-3
Bulb Replacement	10-33
Daytime Running	
Lamps (DRL)	6-3
Flash-to-Pass	6-2
High Intensity Discharge	
(HID) Lighting	10-33
High-Beam On Light	5-24
High/Low Beam Changer	6-2
Heated	
Steering Wheel	5-3

Heated and Ventilated Front
 Seats 3-10
 Heated Mirrors 2-17
 Heater
 Engine 9-23
 Heating and Air Conditioning ... 8-1
 High-Beam On Light 5-24
 Highway Hypnosis 9-8
 Hill and Mountain Roads 9-8
 Hill Start Assist (HSA) 9-35
 Hood 10-5
 Horn 5-3
 How to Wear Safety Belts
 Properly 3-17

I

Ignition Positions 9-17, 9-19
 Ignition Transmission Lock
 Check 10-28
 Immobilizer 2-14
 Infants and Young Children,
 Restraints 3-46
 Infotainment 7-1
 Instrument Cluster 5-10
 Introduction iii

J

Jump Starting 10-86

K

Key and Lock Messages 5-36
 Keyless Entry
 Remote (RKE) System 2-4
 Keys 2-2

L

Labeling, Tire Sidewall 10-48
 Lamp Messages 5-37
 Lamps
 Daytime Running (DRL) 6-3
 Dome 6-5
 Exterior Controls 6-1
 Exterior Lamps Off
 Reminder 6-2
 Headlamps, Front Turn
 Signal and Parking
 Lamps 10-34
 License Plate 10-36
 Malfunction Indicator 5-17
 Reading 6-5
 Sun Visor 6-5
 Lap-Shoulder Belt 3-22

LATCH System	
Replacing Parts After a	
Crash	3-61
LATCH, Lower Anchors and	
Tethers for Children	3-52
Light	
Electronic Stability Control	
(ESC)/Traction Control	
System (TCS) Indicator	
Warning	5-22
Lighting	
Adaptive Forward	6-4
Entry	6-6
Exit	6-6
Illumination Control	6-5
Lights	
Airbag Readiness	5-14
Antilock Brake System	
(ABS) Warning	5-21
Brake System Warning	5-19
Charging System	5-16
Cruise Control	5-25
Electric Parking Brake	5-20
Engine Oil Pressure	5-23

Lights (cont.)	
Flash-to-Pass	6-2
Front Fog Lamps	5-25
High-Beam On	5-24
High/Low Beam Changer	6-2
Low Fuel Warning	5-24
Safety Belt Reminders	5-14
Security	5-24
Taillamp Indicator	5-25
Tire Pressure	5-23
Traction Off	5-21
Limited-Slip Differential	9-38
Locks	
Delayed Locking	2-12
Door	2-10
Power Door	2-11
Safety	2-12
Loss of Control	9-6
Low Fuel Warning Light	5-24
Lower Anchors and	
Tethers for Children	
(LATCH System)	3-52
Lumbar Adjustment	3-7
Front Seats	3-7

M

Maintenance	
Records	11-10
Maintenance Schedule	
Recommended Fluids and	
Lubricants	11-7
Scheduled Maintenance	11-2
Malfunction Indicator Lamp	5-17
Manual Mode	9-30
Mass Storage Media (MEM) ...	7-27
Memory Features	1-7
Messages	
Anti-Theft Alarm System	5-38
Battery Voltage and	
Charging	5-33
Brake System	5-33
Compass	5-34
Door Ajar	5-34
Engine Cooling System	5-35
Engine Oil	5-35
Engine Power	5-36
Fuel System	5-36
Key and Lock	5-36

Messages (cont.)	
Lamp	5-37
Object Detection System	5-37
Ride Control System	5-37
Tire	5-38
Transmission	5-38
Vehicle	5-33
Window	5-39
Mirrors	
Folding	2-17
Heated	2-17
Manual Rearview	2-18
Park Tilt	2-17
Power	2-16
Monitor System, Tire	
Pressure	10-56

N

Navigation	
Vehicle Data Recording and Privacy	13-19
Net, Convenience	4-2
New Vehicle Break-In	9-16

O

Object Detection System	
Messages	5-37
Object Detection, Side Blind	
Zone Alert (SBZA)	9-44
Odometer	5-11
Off-Road	
Recovery	9-6
Oil	
Engine	10-9
Engine Oil Life System	10-13
Messages	5-35
Pressure Light	5-23
Older Children, Restraints	3-44
Online Owner Center	13-7
OnStar® System	1-24
Operation, Infotainment	
System	7-7
Outlets	
Power	5-7
Overheated Engine	
Protection	
Operating Mode	10-22
Overheating, Engine	10-21
Overview, Infotainment	
System	7-3, 7-5

P

Park	
Shifting Into	9-25
Shifting Out of	9-26
Park Tilt Mirrors	2-17
Parking	
Assist, Ultrasonic	9-42
Brake	9-33
Brake and P (Park)	
Mechanism Check	10-29
Over Things That Burn	9-27
Passenger Airbag Status	
Indicator	5-15
Passenger Compartment Air	
Filter	8-8
Passenger Sensing System	3-37
Perchlorate Materials	
Requirements, California	10-3
Personalization	
Vehicle	5-39
Phone	
Bluetooth	7-46, 7-48, 7-53

Power	
Door Locks	2-11
Mirrors	2-16
Outlets	5-7
Protection, Battery	6-7
Retained Accessory (RAP) ...	9-24
Seat Adjustment	3-5
Steering Fluid	10-23
Windows	2-19
Pregnancy, Using Safety	
Belts	3-27
Privacy	
Radio Frequency	
Identification (RFID)	13-19
Program	
Courtesy Transportation	13-11
Proposition 65 Warning,	
California	10-3

R

Radio Frequency	
Identification (RFID)	13-19
Statement	13-20
Radios	
AM-FM Radio	7-12
CD/DVD Player	7-23
Reception	7-19
Satellite	7-15
Reading Lamps	6-5
Rear Seat Entertainment	
System	7-36
Rear Seat	
Pass-Through Door	3-13
Rear Seats	3-11
Rear Vision Camera (RVC) ...	9-46
Rearview Mirrors	2-18
Reclining Seatbacks	3-8
Recommended Fluids and	
Lubricants	11-7
Recommended Fuel	9-50
Records	
Maintenance	11-10
Recreational Vehicle	
Towing	10-89
Reimbursement Program,	
GM Mobility	13-8
Remote Keyless Entry	
(RKE) System	2-3, 2-4
Remote Vehicle Start	2-8
Replacement Bulbs	10-37
Replacement Parts	
Airbags	3-43
Maintenance	11-9
Replacing Airbag System	3-43
Replacing LATCH System	
Parts After a Crash	3-61

Replacing Safety Belt System Parts After a Crash 3-28

Reporting Safety Defects

Canadian Government 13-17

General Motors 13-17

U.S. Government 13-16

Restraints

Where to Put 3-51

Retained Accessory

Power (RAP) 9-24

Ride Control Systems 9-37

Electronic Stability (ESC) 9-37

Enhanced Traction

System (ETS) 9-38

Messages 5-37

Selective 9-38

Roads

Driving, Wet 9-7

Roadside Assistance

Program 13-8, 13-10

Roof

Sunroof 2-21

Rotation, Tires 10-61

Routing, Engine Drive Belt 12-4

Running the Vehicle While

Parked 9-28

S

Safety Belts 3-13

Care 3-28

Extender 3-27

How to Wear Safety Belts

Properly 3-17

Lap-Shoulder Belt 3-22

Reminders 5-14

Replacing After a Crash 3-28

Use During Pregnancy 3-27

Safety Defects Reporting

Canadian Government 13-17

General Motors 13-17

U.S. Government 13-16

Safety Locks 2-12

Safety System Check 3-27

Satellite Radio 7-15

Scheduled Maintenance 11-2

Scheduling Appointments 13-11

Sealant Kit, Tire 10-72

Seats

Adjustment, Front 3-4

Head Restraints 3-2

Heated and Ventilated

Front 3-10

Lumbar Adjustment, Front 3-7

Power Adjustment, Front 3-5

Rear 3-11

Reclining Seatbacks 3-8

Securing Child

Restraints 3-61, 3-63

Security

Light 5-24

Vehicle 2-14

Selective Ride Control 9-38

Service		
Accessories and Modifications	10-3	
Doing Your Own Work	10-4	
Engine Soon Light	5-17	
Maintenance Records	11-10	
Maintenance, General Information	11-1	
Parts Identification Label	12-1	
Publications Ordering Information	13-15	
Scheduling Appointments	13-11	
Servicing the Airbag	3-41	
Shift Lock Control Function Check, Automatic Transmission	10-28	
Shifting Into Park	9-25	
Out of Park	9-26	
Side Blind Zone Alert	9-44	
Signals, Turn and Lane-Change	6-4	
Spare Tire Compact	10-85	
Specifications and Capacities	12-2	
Speedometer	5-11	
Start Assist, Hills	9-35	
Start Vehicle, Remote	2-8	
Starter Switch Check	10-27	
Starting the Engine	9-20	
Steering	9-4	
Fluid, Power	10-23	
Heated Wheel	5-3	
Wheel Adjustment	5-2	
Wheel Controls	5-2	
Stoplamps and Back-Up Lamps Bulb Replacement	10-35	
Storage Mass Media (MEM)	7-27	
Storage Areas Center Console	4-1	
Convenience Net	4-2	
Front	4-1	
Glove Box	4-1	
Storing the Tire Sealant and Compressor Kit	10-79	
Stuck Vehicle	9-11	
Sun Visor Lamps	6-5	
Sun Visors	2-20	
Sunroof	2-21	
Symbols	v	
System Infotainment	7-1	

T

Tachometer 5-11
 Taillamp Indicator Light 5-25
 Taillamps
 Bulb Replacement 10-35
 Text Telephone (TTY) Users ... 13-6
 Theft-Deterrent
 Systems 2-14, 2-15
 Immobilizer 2-14
 Time 5-5, 5-6
 Tires
 Buying New Tires 10-64
 Chains 10-69
 Changing 10-79
 Compact Spare 10-85
 Designations 10-50
 Different Size 10-66
 If a Tire Goes Flat 10-70
 Inflation Monitor System 10-57
 Inspection 10-61
 Messages 5-38

Tires (cont.)
 Pressure Light 5-23
 Pressure Monitor System ... 10-56
 Rotation 10-61
 Sealant and
 Compressor Kit 10-72
 Sealant and Compressor
 Kit, Storing 10-79
 Sidewall Labeling 10-48
 Terminology and
 Definitions 10-51
 Uniform Tire Quality
 Grading 10-66
 Wheel Alignment and Tire
 Balance 10-68
 Wheel Replacement 10-68
 When It Is Time for New
 Tires 10-63
 Winter 10-47
 Towing
 Driving Characteristics 9-56
 Equipment 9-61
 General Information 9-55

Towing (cont.)
 Recreational Vehicle 10-89
 Trailer 9-60
 Vehicle 10-89
 Traction
 Control System (TCS) 9-36
 Limited-Slip Differential 9-38
 Off Light 5-21
 Selective Ride Control 9-38
 Trailer Towing 9-60
 Transmission
 Automatic 9-28
 Fluid, Automatic 10-15
 Messages 5-38
 Transportation Program,
 Courtesy 13-11
 Trunk 2-12
 Turn and Lane-Change
 Signals 6-4
 Turn Signal
 Bulb Replacement 10-35

U

Ultrasonic Parking Assist	9-42
Uniform Tire Quality Grading	10-66
Universal Remote System	5-45
Operation	5-48
Programming	5-45
Using this Manual	iv

V

Vehicle	
Canadian Owners	iv
Control	9-3
Identification	
Number (VIN)	12-1
Load Limits	9-12
Messages	5-33
Personalization	5-39
Remote Start	2-8
Security	2-14
Towing	10-89

Vehicle Care

Storing the Tire Sealant and Compressor Kit	10-79
Tire Pressure	10-54
Vehicle Identification	
Service Parts Identification Label	12-1
Ventilation, Air	8-8
Visors	2-20

W

Warning	
Brake System Light	5-19
Warning Lights, Gauges, and Indicators	5-9
Warnings	v
Cautions and Danger	v
Hazard Flashers	6-4
Washer Fluid	10-24

Wheels

Alignment and Tire	
Balance	10-68
Different Size	10-66
Replacement	10-68
When It Is Time for New Tires	10-63
Where to Put the Restraint	3-51
Windows	2-18
Messages	5-39
Power	2-19
Windshield	
Wiper/Washer	5-3
Winter Driving	9-9
Winter Tires	10-47
Wiper Blade Replacement	10-29