

790 Duke

Art. no. 3213749en



KTM

Congratulations on your decision to purchase a KTM motorcycle. You are now the owner of a state-of-the-art sports vehicle that will continue giving you pleasure for a long time if you maintain it properly.

We wish you good and safe riding at all times!

Enter the serial numbers of your vehicle below.

Vehicle identification number (📖 p. 24)	Dealer's stamp
Engine number (📖 p. 25)	
Key number (📖 p. 25)	

The Owner's Manual contained the latest information for this model series at the time of going to print. However, minor differences due to further developments in design cannot be ruled out completely.

All specifications are non-binding. KTM Sportmotorcycle GmbH specifically reserves the right to modify or delete technical specifications, prices, colors, forms, materials, services, designs, equipment, etc., without prior notice and without specifying reasons, to adapt these to local conditions, as well as to stop production of a particular model without prior notice. KTM accepts no liability for delivery options, deviations from figures and descriptions, misprints, and other errors. The models portrayed partly contain special equipment that does not belong to the regular scope of supply.

© 2018 KTM Sportmotorcycle GmbH, Mattighofen Austria
All rights reserved



3213749en

09/2018

Reproduction, even in part, as well as copying of all kinds, is permitted only with the express written permission of the copyright owner.



REG.NO. 12 100 6061

KTM Sportmotorcycle GmbH
Stallhofnerstraße 3
5230 Mattighofen, Austria

ISO 9001(12 100 6061)

KTM applies quality assurance processes that lead to the highest possible product quality as defined in the ISO 9001 international quality management standard.

Issued by: TÜV Management Service

This document is valid for the following models:

790 Duke EU (F9603R5, F9603R6)

790 Duke L EU (F9603R8)

1	MEANS OF REPRESENTATION	9	4	VIEW OF VEHICLE	20
	1.1 Symbols used	9	4.1	View of vehicle, front left (example) ...	20
	1.2 Formats used.....	10	4.2	View of vehicle, rear right (example).....	22
2	SAFETY ADVICE.....	11	5	SERIAL NUMBERS	24
	2.1 Use definition – intended use.....	11	5.1	Vehicle identification number.....	24
	2.2 Misuse.....	11	5.2	Type label	24
	2.3 Safety advice.....	11	5.3	Key number.....	25
	2.4 Degrees of risk and symbols	12	5.4	Engine number	25
	2.5 Tampering warning.....	13	5.5	Fork part number	26
	2.6 Safe operation	13	5.6	Shock absorber article number	26
	2.7 Protective clothing	14	5.7	Steering damper article number	27
	2.8 Work rules.....	15	6	CONTROLS.....	28
	2.9 Environment.....	15	6.1	Clutch lever.....	28
	2.10 Owner's Manual	16	6.2	Hand brake lever.....	28
3	IMPORTANT NOTES.....	17	6.3	Throttle grip	29
	3.1 Manufacturer and implied warranty....	17	6.4	Switches on the left side of the handlebar.....	29
	3.2 Fuel, auxiliary substances	17	6.4.1	Combination switch.....	29
	3.3 Spare parts, accessories	17	6.4.2	Light switch	30
	3.4 Service	18	6.4.3	Menu switch.....	31
	3.5 Figures	18	6.4.4	Turn signal switch.....	31
	3.6 Customer service.....	18	6.4.5	Horn button	32

TABLE OF CONTENTS

6.5	Switches on the right side of the handlebar.....	33	7.11	Coolant temperature indicator	57
6.5.1	Emergency OFF switch/electric starter button	33	7.12	Trip distance counter	58
6.6	Ignition and steering lock.....	34	7.13	Menu.....	59
6.7	Opening fuel tank filler cap.....	35	7.13.1	Favorites.....	59
6.8	Closing the fuel tank filler cap.....	37	7.13.2	Trip 1	60
6.9	Seat lock.....	38	7.13.3	Trip 2	61
6.10	Tool set.....	38	7.13.4	General Info	62
6.11	Grab handle	39	7.13.5	Settings	63
6.12	Passenger foot pegs	39	7.13.6	Bluetooth® (optional).....	63
6.13	Shift lever	40	7.13.7	Distance	64
6.14	Foot brake lever	41	7.13.8	Temp.....	65
6.15	Side stand.....	41	7.13.9	Pressure	66
7	COMBINATION INSTRUMENT	43	7.13.10	Fuel Cons.....	67
7.1	Combination instrument	43	7.13.11	Language	68
7.2	Activation and test	43	7.13.12	Clock/Date	68
7.3	Day-Night mode.....	45	7.13.13	DRL	69
7.4	Warnings.....	46	7.13.14	TPMS warning	71
7.5	Indicator lamps.....	48	7.13.15	Quick Selector 1	72
7.6	Display	52	7.13.16	Quick Selector 2.....	73
7.7	TRACK display.....	54	7.13.17	Set Favorites	74
7.8	Shift warning light	55	7.13.18	Service	75
7.9	Fuel level display	56	7.13.19	Extra functions	75
7.10	Time.....	57	7.13.20	Warnings.....	76
			7.13.21	Ride Mode	77
			7.13.22	Track.....	78
			7.13.23	Anti-wheelie mode	79













7.13.24	Launch control	80	9	PREPARING FOR USE.....	100
7.13.25	MTC + MSR	80	9.1	Advice on preparing for first use	100
7.13.26	ABS.....	81	9.2	Running in the engine	102
7.13.27	ABS Mode.....	82	9.3	Loading the vehicle	102
7.13.28	Quick Shift +.....	83	10	RIDING INSTRUCTIONS.....	105
7.13.29	Shift Light	84	10.1	Checks and maintenance measures when preparing for use	105
7.13.30	KTM MY RIDE (optional)	85	10.2	Starting the vehicle	106
7.13.31	Pairing (optional)	86	10.3	Starting off.....	107
7.13.32	Audio player (optional)	88	10.4	Launch-Control	108
7.13.33	Telephony (optional)	90	10.5	Starting off with launch control	108
8	ERGONOMICS	91	10.6	Quickshifter +.....	110
8.1	Handlebar position	91	10.7	Shifting, riding	111
8.2	Adjusting the handlebar position 	91	10.8	Engine traction torque control (MSR).....	117
8.3	Adjusting the basic position of the clutch lever	93	10.9	Applying the brakes.....	118
8.4	Adjusting the basic position of the hand brake lever	94	10.10	Stopping, parking.....	120
8.5	Adjusting the basic position of the foot brake lever 	95	10.11	Transporting	122
8.6	Checking the basic position of the shift lever.....	97	10.12	Refueling	123
8.7	Adjusting the basic position of the shift lever 	98	11	SERVICE SCHEDULE	126
			11.1	Additional information	126
			11.2	Required work	126
			11.3	Recommended work	129

TABLE OF CONTENTS

12	TUNING THE CHASSIS	130	14	BRAKE SYSTEM	151
12.1	Adjusting the spring preload of the shock absorber 	130	14.1	Anti-lock braking system (ABS)	151
13	SERVICE WORK ON THE CHASSIS.....	131	14.2	Checking the brake discs	153
13.1	Raising the motorcycle with the rear lifting gear	131	14.3	Checking the front brake fluid level	155
13.2	Removing the rear of the motorcycle from the lifting gear	131	14.4	Adding front brake fluid 	156
13.3	Lifting the motorcycle with the front lifting gear	132	14.5	Checking the front brake linings	158
13.4	Taking the motorcycle off the front lifting gear	133	14.6	Checking the free travel of the foot brake lever	160
13.5	Cleaning the dust boots of the fork legs 	134	14.7	Checking the rear brake fluid level	161
13.6	Removing the passenger seat	136	14.8	Adding rear brake fluid 	162
13.7	Mounting the passenger seat.....	137	14.9	Checking the rear brake linings	164
13.8	Removing the front rider's seat	138	15	WHEELS, TIRES	166
13.9	Mounting the front rider's seat.....	139	15.1	Removing the front wheel 	166
13.10	Checking the chain for dirt.....	140	15.2	Installing the front wheel 	168
13.11	Cleaning the chain	141	15.3	Removing the rear wheel 	172
13.12	Checking the chain tension	143	15.4	Installing the rear wheel 	175
13.13	Adjusting the chain tension.....	145	15.5	Checking the rear hub damping rubber pieces 	178
13.14	Checking the chain, rear sprocket, engine sprocket, and chain guide	147	15.6	Checking the tire condition	180
			15.7	Checking tire pressure	182
			15.8	Using tire repair spray	184

16	ELECTRICAL SYSTEM	185	17.2	Checking the antifreeze and coolant level	213
16.1	Daytime running light (DRL).....	185	17.3	Checking the coolant level in the compensating tank.....	215
16.2	Removing the 12-V battery 🛠.....	186	17.4	Draining the coolant 🛠.....	217
16.3	Installing the 12-V battery 🛠.....	189	17.5	Filling/bleeding the cooling system 🛠.....	219
16.4	Charging the 12-V battery 🛠.....	191	17.6	Change the coolant	221
16.5	Changing the main fuse.....	195	18	TUNING THE ENGINE.....	225
16.6	Changing ABS fuses.....	197	18.1	Ride Mode	225
16.7	Changing the fuses of individual power consumers	199	18.2	Motorcycle traction control (MTC)....	226
16.8	Loosening the headlight mask with the headlight	202	18.3	Slip adjustment	227
16.9	Mounting the headlight mask with the headlight	203	18.4	Throttle response	227
16.10	Removing the cover of the headlight mask rack	204	19	SERVICE WORK ON THE ENGINE	229
16.11	Installing the cover of the headlight mask rack	206	19.1	Checking the engine oil level.....	229
16.12	Checking the headlight setting	208	19.2	Changing the engine oil and oil filter, cleaning the oil screens 🛠.....	230
16.13	Adjusting the headlight range.....	209	19.3	Adding engine oil	234
16.14	Diagnostics connector	210	19.4	Checking the free travel of the clutch lever	236
16.15	Front ACC1 and ACC2	210	19.5	Setting the free travel of the clutch lever 🛠.....	237
16.16	ACC1 and ACC2 rear	211			
17	COOLING SYSTEM	212			
17.1	Cooling system	212			

TABLE OF CONTENTS

20	CLEANING, CARE	238	24	DECLARATIONS OF CONFORMITY	269
20.1	Cleaning the motorcycle	238	24.1	Declarations of conformity	269
20.2	Checks and maintenance steps for winter operation	241	24.2	Country-specific declarations of conformity	270
21	STORAGE	243	25	SUBSTANCES	271
21.1	Storage	243	26	AUXILIARY SUBSTANCES	274
21.2	Preparing for use after storage	245	27	STANDARDS	276
22	TROUBLESHOOTING	246	28	INDEX OF SPECIAL TERMS	277
23	TECHNICAL DATA	250	29	LIST OF ABBREVIATIONS	278
23.1	engine	250	30	LIST OF SYMBOLS	279
23.2	Engine tightening torques	252	30.1	Red symbols	279
23.3	Capacities	257	30.2	Yellow and orange symbols	279
23.3.1	Engine oil	257	30.3	Green and blue symbols	280
23.3.2	Coolant	258			
23.3.3	Fuel	258			
23.4	Chassis	258			
23.5	Electrical system	260			
23.6	Tires	261			
23.7	Fork	261			
23.8	Shock absorber	262			
23.9	Chassis tightening torques	262			
				INDEX	281

1.1 Symbols used

The meaning of specific symbols is described below.



Indicates an expected reaction (e.g. of a work step or a function).



Indicates an unexpected reaction (e.g. of a work step or a function).



All work marked with this symbol requires specialist knowledge and technical understanding. In the interest of your own safety, have these jobs performed by an authorized KTM workshop! Your motorcycle will be optimally cared for there by specially trained experts using the auxiliary tools required.



Indicates a page reference (more information is provided on the specified page).



Indicates information with more details or tips.



Indicates the result of a testing step.

1 MEANS OF REPRESENTATION

V

Indicates a voltage measurement.

A

Indicates a current measurement.



Indicates the end of an activity, including potential rework.

1.2 Formats used

The typographical formats used in this document are explained below.

Proprietary name

Indicates a proprietary name.

Name®

Indicates a protected name.

Brand™

Indicates a brand available on the open market.

Underlined terms

Refer to technical details of the vehicle or indicate technical terms, which are explained in the glossary.

2.1 Use definition – intended use

The vehicle is designed and constructed to withstand the usual demands of regular traffic and use on race courses.

This vehicle is not suitable for offroad use.



Info

This vehicle is only authorized for operation on public roads in its homologated version.

2.2 Misuse

The vehicle must only be used as intended.

Dangers can arise for people, property and the environment through use not as intended.

Any use of the vehicle beyond the intended and defined use constitutes misuse.

Misuse also includes the use of operating and auxiliary fluids which do not meet the required specification for the respective use.

2.3 Safety advice

A number of safety instructions need to be followed to operate the product described safely. Therefore read this instruction and all further instructions included carefully. The safety instructions are highlighted in the text and are referred to at the relevant passages.

2 SAFETY ADVICE



Info

Various information and warning labels are attached in prominent locations on the product described. Do not remove any information or warning labels. If they are missing, you or others may not recognize dangers and may therefore be injured.

2.4 Degrees of risk and symbols



Danger

Identifies a danger that will immediately and invariably lead to fatal or serious permanent injury if the appropriate measures are not taken.



Warning

Identifies a danger that is likely to lead to fatal or serious injury if the appropriate measures are not taken.

Note

Identifies a danger that will lead to considerable machine and material damage if the appropriate measures are not taken.



Note

Indicates a danger that will lead to environmental damage if the appropriate measures are not taken.

2.5 Tampering warning

Tampering with the noise control system is prohibited. Federal law prohibits the following acts or the causing thereof:

- 1 The removal or rendering inoperative by any person other than for purposes of servicing, repair, or replacement, of any device or element of design incorporated into any new vehicle for the purpose of noise control prior to its sale or delivery to the ultimate purchaser or while it is in use, or
- 2 the use of the vehicle after such device or element of design has been removed or rendered inoperative by any person.

Among those acts presumed to constitute tampering are the acts listed below:

- 1 Removal or puncturing of the main silencers, baffles, header pipes or any other components which conduct exhaust gases.
- 2 Removal or puncturing of parts of the intake system.
- 3 Lack of proper maintenance.
- 4 Replacing moving parts of the vehicle, or parts of the exhaust system or intake system, with parts other than those specified by the manufacturer.

2.6 Safe operation



Danger

Danger of accidents A rider who is not fit to ride poses a danger to him or herself and others.

- Do not operate the vehicle if you are not fit to ride due to alcohol, drugs or medication.
- Do not operate the vehicle if you are physically or mentally impaired.

2 SAFETY ADVICE



Danger

Danger of poisoning Exhaust gases are toxic and inhaling them may result in unconsciousness and death.

- Always make sure there is sufficient ventilation when running the engine.
- Use effective exhaust extraction when starting or running the engine in an enclosed space.



Warning

Danger of burns Some vehicle components become very hot when the vehicle is operated.

- Do not touch any parts such as the exhaust system, radiator, engine, shock absorber, or brake system before the vehicle parts have cooled down.
- Let the vehicle parts cool down before you perform any work on the vehicle.

Only operate the vehicle when it is in perfect technical condition, in accordance with its intended use, and in a safe and environmentally compatible manner.

An appropriate driver's license is needed to ride the vehicle on public roads.

Have malfunctions that impair safety promptly eliminated by an authorized KTM workshop.

Adhere to the information and warning labels on the vehicle.

2.7 Protective clothing



Warning

Risk of injury Missing or poor protective clothing presents an increased safety risk.

- Wear appropriate protective clothing such as helmet, boots, gloves as well as trousers and a jacket with protectors on all rides.
 - Always wear protective clothing that is in good condition and meets the legal regulations.
-

In the interest of your own safety, KTM recommends that you only operate the vehicle while wearing protective clothing.

2.8 Work rules

Special tools are necessary for certain tasks. The tools are not a component of the vehicle, but can be ordered using the number in parentheses. Example: bearing puller (15112017000)

During assembly, use new parts to replace parts which cannot be reused (e.g. self-locking screws and nuts, seals, sealing rings, O-rings, pins, and lock washers).

In the case of certain screws, a screw adhesive (e.g. **Loctite®**) is required. Observe the manufacturer's instructions.

After disassembly, clean the parts that are to be reused and check them for damage and wear. Change damaged or worn parts.

After completing a repair or service work, check the operating safety of the vehicle.

2.9 Environment

If you use your motorcycle responsibly, you can ensure that problems and conflicts do not occur. To protect the future of the motorcycle sport, make sure that you use your motorcycle legally, display environmental consciousness, and respect the rights of others.

When disposing of used oil, other operating and auxiliary fluids, and used components, comply with the laws and regulations of the respective country.

Because motorcycles are not subject to the EU regulations governing the disposal of used vehicles, there are no legal regulations that pertain to the disposal of an end-of-life motorcycle. Your authorized KTM dealer will be glad to advise you.

2.10 Owner's Manual

It is important that you read this Owner's Manual carefully and completely before making your first trip. The Owner's Manual contains useful information and many tips on how to operate, handle, and service your motorcycle. Only then will you find out how to customize the vehicle ideally for your own use and how you can protect yourself from injury.

Keep the Owner's Manual in an accessible place to enable you to refer to it as needed.

If you would like to know more about the vehicle or have questions on the material you read, please contact an authorized KTM dealer.

The Owner's Manual is an important component of the vehicle and must be handed over to the new owner if the vehicle is sold.

The Owner's Manual is also available for download from your authorized KTM dealer and on the KTM website.
International KTM Website: <http://www.ktm.com>

3.1 Manufacturer and implied warranty

The work specified in the service schedule may only be performed in an authorized KTM workshop and must be recorded in both the Service & Warranty Booklet and in the **KTM Dealer.net**, otherwise any warranty coverage will become void. Damage or secondary damage caused by tampering with and/or conversions on the vehicle is not covered by the manufacturer warranty.

Additional information on the manufacturer or manufacturer warranty and the procedures involved can be found in the Service & Warranty Booklet.

3.2 Fuel, auxiliary substances



Note

Environmental hazard Improper handling of fuel is a danger to the environment.

- Do not allow fuel to enter the groundwater, the soil, or the sewage system.

Use fuels and auxiliary substances in accordance with the Owner's Manual and specification.

3.3 Spare parts, accessories

For your own safety, only use spare parts and accessory products that are approved and/or recommended by KTM and have them installed by an authorized KTM workshop. KTM accepts no liability for other products and any resulting damage or loss.

Certain spare parts and accessory products are specified in parentheses in the descriptions. Your authorized KTM dealer will be glad to advise you.

3 IMPORTANT NOTES

The current **KTM PowerParts** for your vehicle can be found on the KTM website.
International KTM Website: <http://www.ktm.com>

3.4 Service

A prerequisite for perfect operation and prevention of premature wear is that the service, care, and tuning work on the engine and chassis is properly carried out as described in the Owner's Manual. Incorrect adjustment and tuning of the engine and chassis can lead to damage and breakage of components.

Use of the vehicle under difficult conditions, such in rain, high heat or with a heavy load, can lead to considerably more rapid wear of components such as the drive train, brake system, or suspension components. For this reason, it may be necessary to inspect or replace parts before the next scheduled service.

It is imperative that you adhere to the stipulated run-in times and service intervals. If you observe these exactly, you will ensure a much longer service life for your motorcycle.

3.5 Figures

The figures contained in the manual may depict special equipment.

In the interest of clarity, some components may be shown disassembled or may not be shown at all. It is not always necessary to disassemble the component to perform the activity in question. Please follow the instructions in the text.

3.6 Customer service

Your authorized KTM dealer will be happy to answer any questions you may have on your vehicle and KTM.

A list of authorized KTM dealers can be found on the KTM website.
International KTM Website: <http://www.ktm.com>

4 VIEW OF VEHICLE

4.1 View of vehicle, front left (example)



- ① Combination instrument (📖 p. 43)
- ② Ignition and steering lock (📖 p. 34)
- ③ Clutch lever (📖 p. 28)
- ④ Passenger seat
- ⑤ Grab handle (📖 p. 39)
- ⑥ Seat lock (📖 p. 38)
- ⑦ Side stand (📖 p. 41)
- ⑧ Shift lever (📖 p. 40)
- ⑨ Engine number (📖 p. 25)

4 VIEW OF VEHICLE

4.2 View of vehicle, rear right (example)

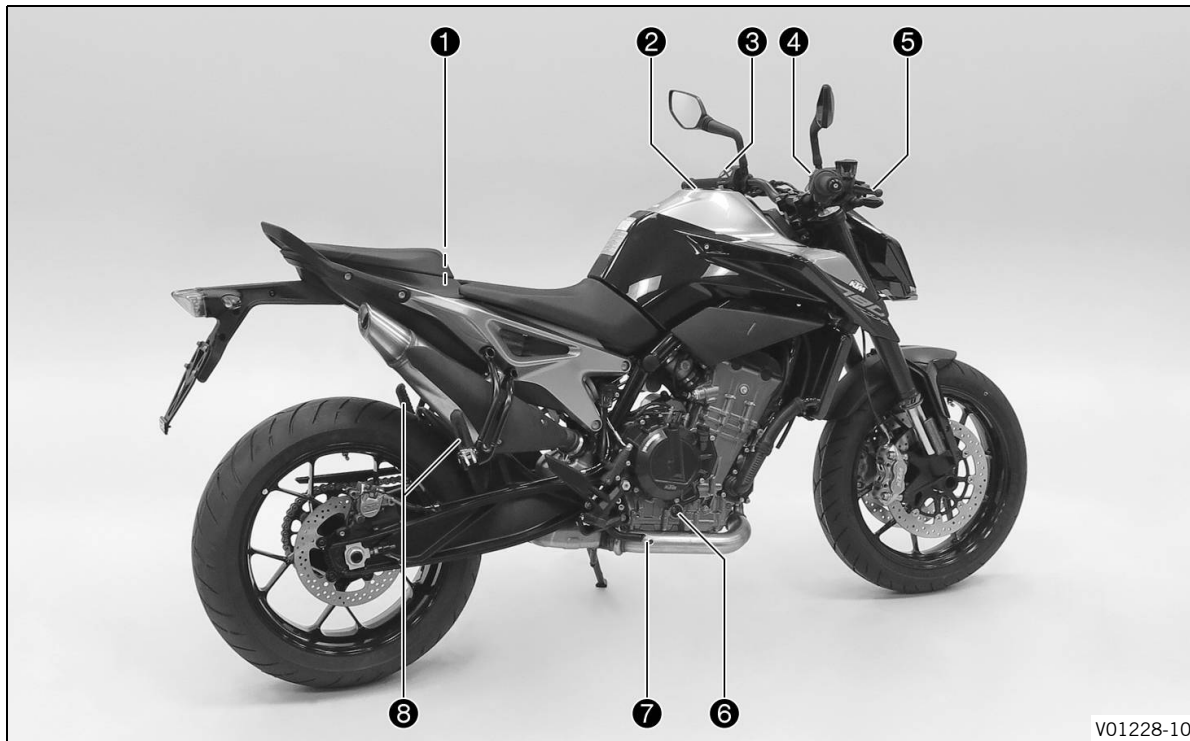

- ① Tool set (📖 p. 38)
- ② Fuel tank filler cap
- ③ Light switch (📖 p. 30)
- ③ Turn signal switch (📖 p. 31)
- ③ Horn button (📖 p. 32)
- ④ Emergency OFF switch/electric starter button (📖 p. 33)
- ⑤ Hand brake lever (📖 p. 28)
- ⑥ Level viewer, engine oil
- ⑦ Foot brake lever (📖 p. 41)
- ⑧ Passenger foot pegs (📖 p. 39)

5 SERIAL NUMBERS

5.1 Vehicle identification number

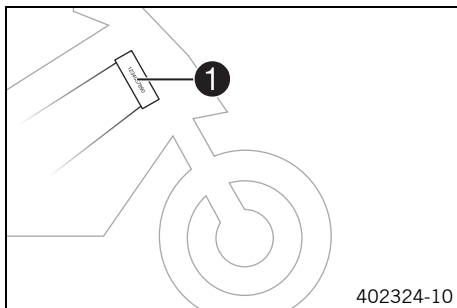

The vehicle identification number ❶ is stamped on the right side of the steering head.

5.2 Type label

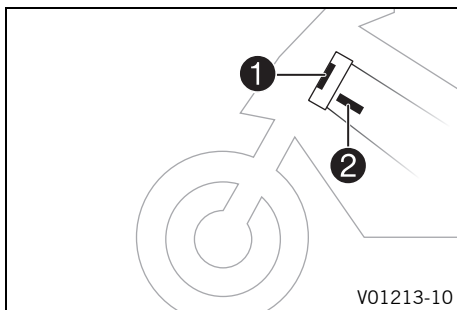

The type label Europe ❶ is located on the steering head on the left.

Type label Australia ❷ is located on the frame behind the steering head at the top left.

5.3 Key number

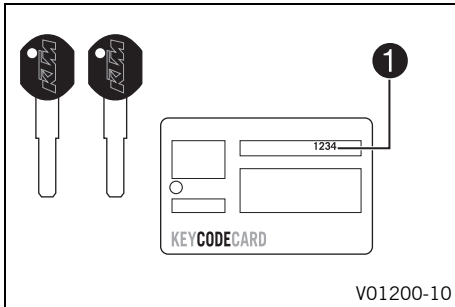

The key number **1** can be found on the **KEYCODECARD**.



Info

You need the key number to order a spare key. Keep the **KEYCODECARD** in a safe place.

5.4 Engine number

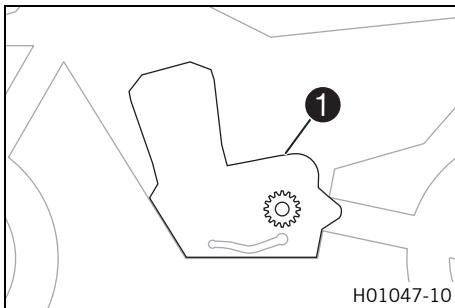

The engine number **1** is stamped onto the engine case at the top.

5 SERIAL NUMBERS

5.5 Fork part number

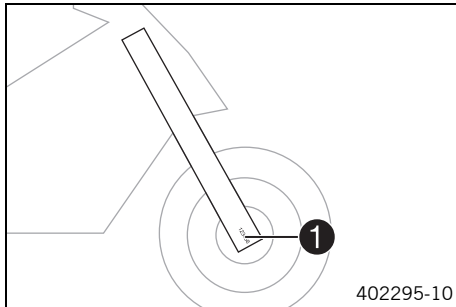

The fork part number **1** is stamped on the inner side of the fork stub.

5.6 Shock absorber article number

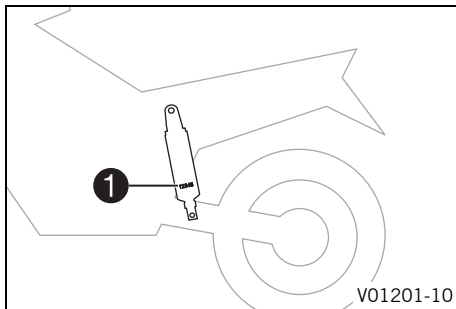

Shock absorber article number **1** is on the left side of the shock absorber.

5.7 Steering damper article number

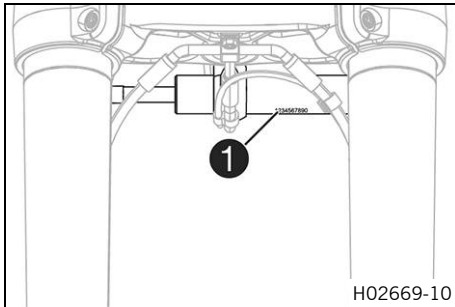

Steering damper article number **1** is embossed on the underside of the steering damper.

6 CONTROLS

6.1 Clutch lever

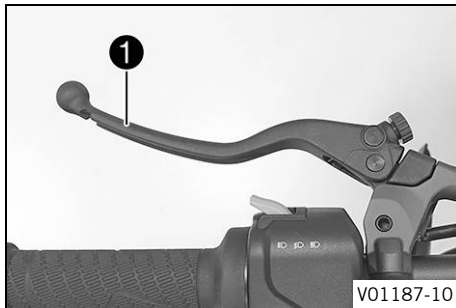

Clutch lever **1** is fitted on the handlebar on the left.

6.2 Hand brake lever

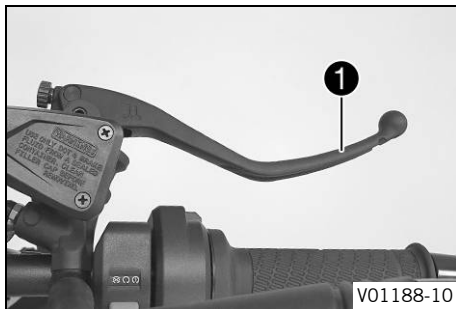

The hand brake lever **1** is located on the right side of the handlebar.

The front brake is engaged using the hand brake lever.

6.3 Throttle grip

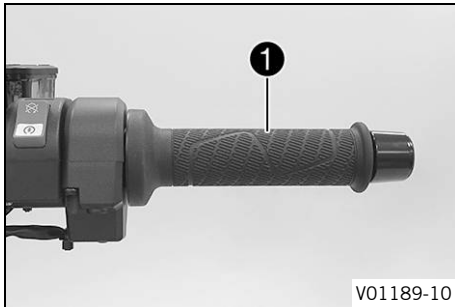

The throttle grip **1** is fitted on the right side of the handlebar.

6.4 Switches on the left side of the handlebar

6.4.1 Combination switch

The combination switch is fitted on the left side of the handlebar.

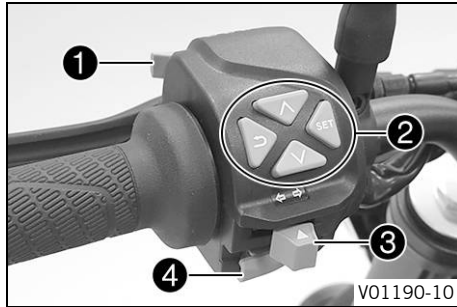

Overview of the left combination switch

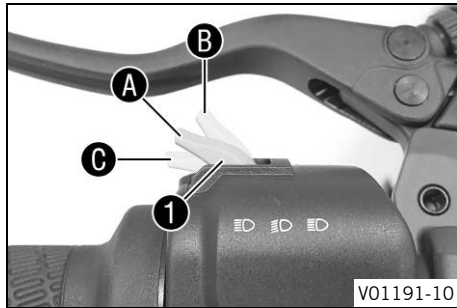

- ❶ Light switch (📖 p. 30)
- ❷ Menu switch (📖 p. 31)
- ❸ Turn signal switch (📖 p. 31)
- ❹ Horn button (📖 p. 32)

6.4.2 Light switch



Light switch ❶ is fitted on the left side of the handlebar.

Possible states

	Low beam on – Light switch in position A . In this position, the low beam and the tail light are switched on.
	High beam on – Push the light switch to position B . In this position, the high beam and the tail light are switched on.
	Headlight flasher – Push the light switch into position C .

6.4.3 Menu switch

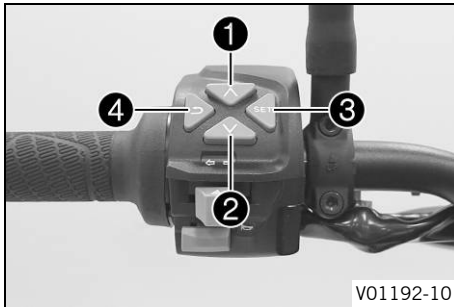

The menu switch is fitted in the middle of the left combination switch.

The menu buttons are used to control the display on the combination instrument.

Button **1** is the **UP** button.

Button **2** is the **DOWN** button.

Button **3** is the **SET** button.

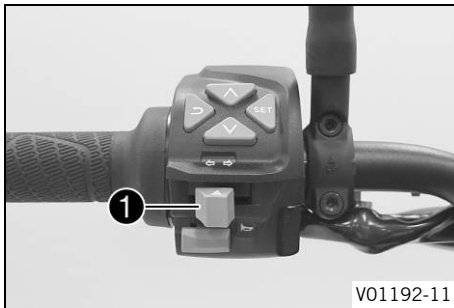

Button **4** is the **BACK** button.

6.4.4 Turn signal switch



The turn signal switch **1** is fitted on the left side of the handlebar.

Possible states

	Turn signal off
	Left turn signal on – Turn signal switch pressed to the left. The turn signal switch returns to the center position after activation.
	Right turn signal on – Turn signal switch pressed to the right. The turn signal switch returns to the center position after activation.

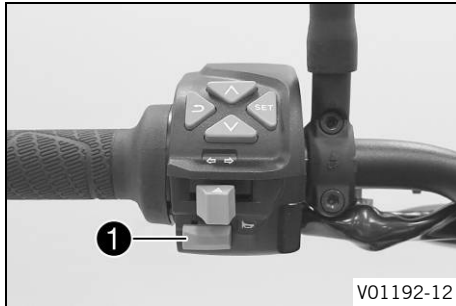

To switch off the turn signal, press the turn signal switch towards the switch housing.

6.4.5 Horn button



The horn button ❶ is fitted on the left side of the handlebar.

Possible states

- Horn button  in neutral position
- Horn button  pressed – The horn is operated in this position.

6.5 Switches on the right side of the handlebar

6.5.1 Emergency OFF switch/electric starter button

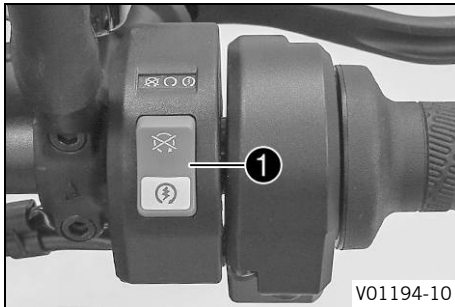

The emergency OFF switch/electric starter button ❶ is located on the right side of the combination switch.

Possible states

	<p>Emergency OFF switch/electric starter button off (top position) – In this position, the ignition circuit is interrupted, a running engine stops, and a non-running engine cannot be started. A message appears on the display.</p>
	<p>Emergency OFF switch/electric starter button on (middle position) – This position is required for operation; the ignition circuit is closed.</p>
	<p>Starter motor on (lower position) – In this position, the starter motor is actuated.</p>

6.6 Ignition and steering lock



The ignition and steering lock is located in front of the upper triple clamp.

Possible states

	Ignition off – In this position, the ignition circuit is interrupted, a running engine stops, and a non-running engine will not start. The ignition key can be removed.
	Ignition on – In this position, the ignition circuit is closed and the engine can be started.
	Steering locked – In this position, the ignition circuit is interrupted and the steering locked. The ignition key can be removed.

6.7 Opening fuel tank filler cap



Danger

Fire hazard Fuel is highly flammable.

The fuel in the fuel tank expands when warm and can escape if overfilled.

- Do not refuel the vehicle in the vicinity of open flames or lit cigarettes.
- Switch off the engine for refueling.
- Make sure that no fuel is spilled; particularly not on hot parts of the vehicle.
- If any fuel is spilled, wipe it off immediately.
- Observe the specifications for refueling.



Warning

Danger of poisoning Fuel is poisonous and a health hazard.

- Avoid skin, eye and clothing contact with fuel.
- Immediately consult a doctor if you swallow fuel.
- Do not inhale fuel vapors.
- In case of skin contact, rinse the affected area with plenty of water.
- Rinse the eyes thoroughly with water, and consult a doctor in case of fuel contact with the eyes.
- Change your clothing in case of fuel spills on them.
- Keep fuels correctly in a suitable canister, and out of the reach of children.



Note

Environmental hazard Improper handling of fuel is a danger to the environment.

- Do not allow fuel to enter the groundwater, the soil, or the sewage system.

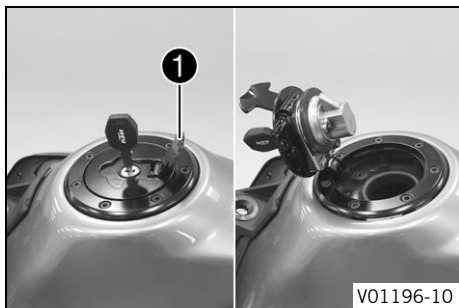

- Lift cover **1** of the fuel tank filler cap and insert the ignition key into the lock.

Note

Danger of damage The ignition key may break if overloaded. Damaged ignition keys must be replaced.

- Push down on the fuel tank filler cap to take pressure off the ignition key.
- Turn the ignition key 90° clockwise.
- Lift the fuel tank filler cap.

6.8 Closing the fuel tank filler cap

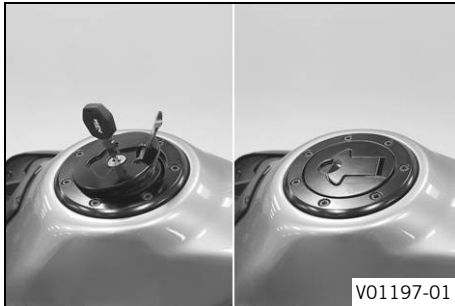

- Fold down the fuel tank filler cap.
- Turn the ignition key 90° clockwise.
- Push down the fuel tank filler cap and turn the ignition key counterclockwise until the lock closes.



Warning

Fire hazard Fuel is highly flammable, toxic and a health hazard.

- Check that the fuel tank filler cap is locked correctly after closing.
 - Change your clothing if fuel spills on them.
 - Rinse the affected area immediately with plenty of water in the event of contact with the skin.
-
- Remove the ignition key and close the cover.



6.9 Seat lock

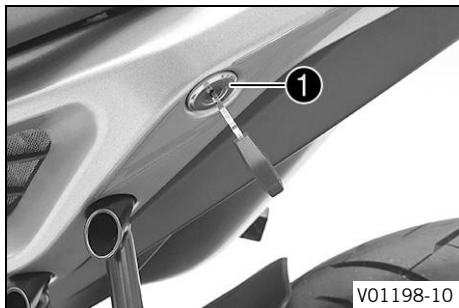

The seat lock **1** is located on the left side of the vehicle. It can be locked with the ignition key.

6.10 Tool set

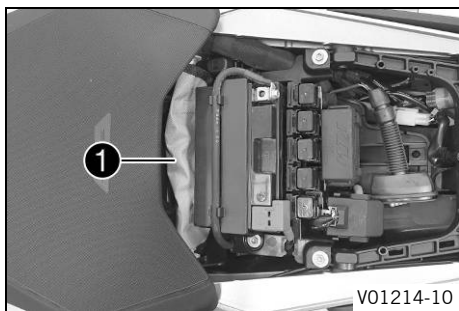

The tool set **1** is located under the passenger seat.

6.11 Grab handle

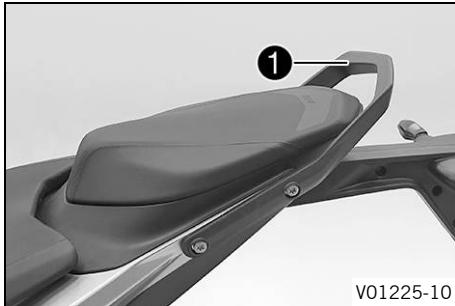

The grab handle ① is used for maneuvering the motorcycle. If you carry a passenger, the passenger can hold onto the grab handles during the trip.

6.12 Passenger foot pegs

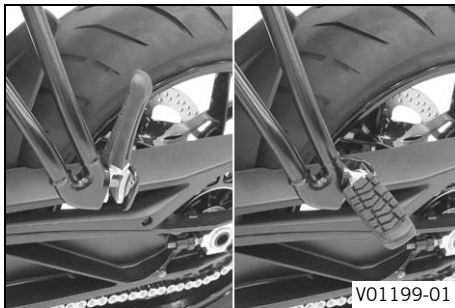

The passenger foot pegs can be folded up and down.

Possible states

- Passenger foot pegs folded up – For operation without a passenger.
- Passenger foot pegs folded down – For operation with a passenger.

6 CONTROLS

6.13 Shift lever

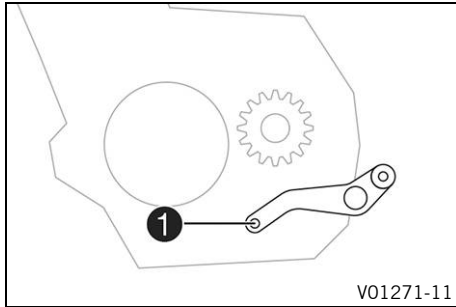

The shift lever ❶ is mounted on the left side of the engine.

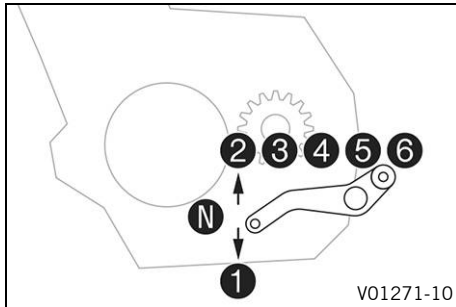

The gear positions can be seen in the photograph.
The neutral or idle position is between the first and second gears.

6.14 Foot brake lever

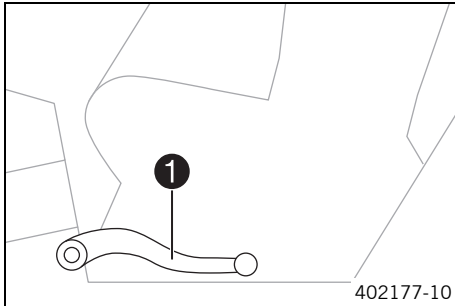

Foot brake lever ① is located in front of the right footrest. The rear brake is engaged with the foot brake lever.

6.15 Side stand

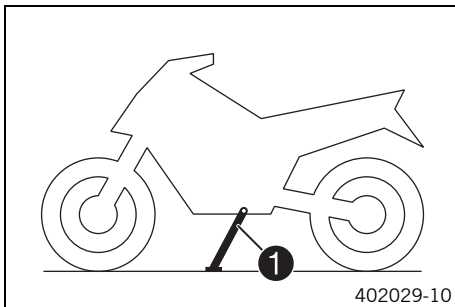

The side stand ① is located on the left of the vehicle. The side stand is used for parking the motorcycle.

i Info

The side stand must be folded up during motorcycle use. The side stand is coupled with the safety starting system; follow the riding instructions.

Possible states

- Side stand folded out – The vehicle can be supported on the side stand. The safety starting system is active.

- Side stand folded in – This position is mandatory when riding the motorcycle. The safety starting system is inactive.

7.1 Combination instrument

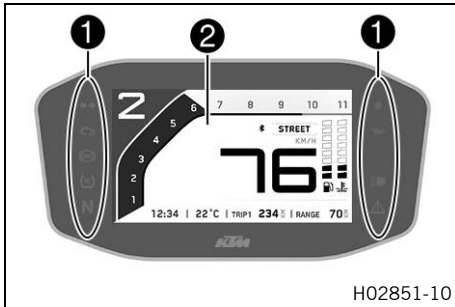

The combination instrument is attached in front of the handlebar. The combination instrument is divided into two function areas.

① indicator lamps (📖 p. 48)

Display ②

7.2 Activation and test



Activation

The combination instrument is activated when the ignition is switched on.



Info

The brightness of the displays is controlled by an ambient light sensor in the combination instrument.

Test

The welcome text appears on the display and the indicator lamps are briefly activated for a function check.



Info

The malfunction indicator lamp always lights up as long as the engine is not running. If the engine is running and the malfunction indicator lamp lights up, stop (taking care not to endanger yourself or other road users in the process) and contact an authorized KTM workshop.

The oil pressure warning lamp always lights up as long as the engine is not running. If the engine is running and the oil pressure warning lamp lights up, stop immediately (taking care not to endanger yourself or other road users in the process) and switch off the engine.

The ABS warning lamp and TC indicator lamp light up until a speed of approx. 6 km/h (approx. 4 mph) or more has been reached.

7.3 Day-Night mode

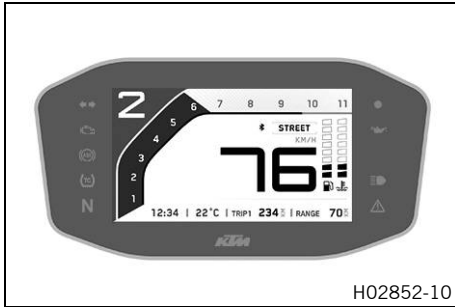

Day mode is shown in a bright color.

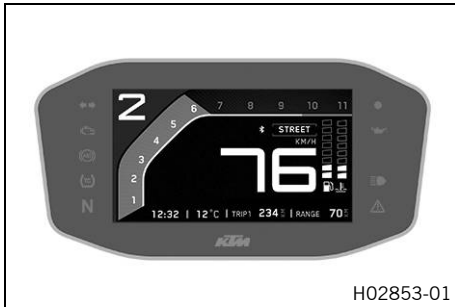

Night mode is shown in a dark color.

i Info



The ambient light sensor in the combination instrument measures the brightness of the environment and automatically switches the display to day or night mode. The display is brightened, darkened or switched to the other mode depending on the brightness measured by the ambient light sensor.

The display mode cannot be changed manually.

7 COMBINATION INSTRUMENT

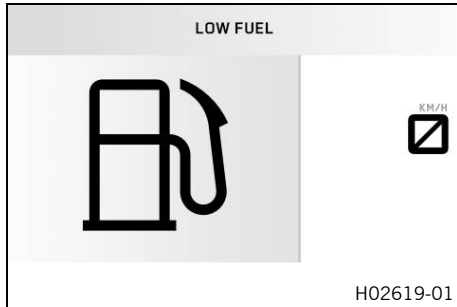
7.4 Warnings



If the general warning lamp  lights up among the indicator lamps ( p. 48), the corresponding message appears in the display.

Pressing any button confirms receipt of the information and the message is cleared.

All the existing warnings are displayed in the **Warnings** menu until they are no longer active.

7 COMBINATION INSTRUMENT

7.5 Indicator lamps



The indicator lamps offer additional information about the operating state of the motorcycle.
When the ignition is switched on, all indicator lamps light up briefly.







Info

The malfunction indicator lamp always lights up as long as the engine is not running. If the engine is running and the malfunction indicator lamp lights up, stop (taking care not to endanger yourself or other road users in the process) and contact an authorized KTM workshop.





The oil pressure warning lamp always lights up as long as the engine is not running. If the engine is running and the oil pressure warning lamp lights up, stop immediately (taking care not to endanger yourself or other road users in the process) and switch off the engine.

The ABS warning lamp and TC indicator lamp light up until a speed of approx. 6 km/h (approx. 4 mph) or more has been reached.

Possible states

	The turn signal indicator lamp flashes green simultaneously with the turn signal – The turn signal is switched on.
	Malfunction indicator lamp lights up yellow – The <u>OBD</u> has detected an error in the vehicle electronics. Come safely to a halt, and contact an authorized KTM workshop.
	ABS warning lamp lights up/flashes yellow – Status or error messages relating to <u>ABS</u> . The ABS warning lamp flashes if the ABS mode Supermoto is enabled.
	TC indicator lamp lights up yellow – MTC ( p. 226) is not enabled or is currently intervening. The TC indicator lamp also lights up if an error is detected. Contact an authorized KTM workshop. The TC indicator lamp flashes if MTC actively engages or if the <u>Launch Control</u> ( p. 108) is activated.

7 COMBINATION INSTRUMENT

	The idle indicator lamp lights up green – The transmission is in neutral.
	The immobilizer indicator lamp lights up or flashes red – Status or error message of the alarm system.
	The oil pressure warning lamp lights up red – The oil pressure is too low. Stop immediately, taking care not to endanger yourself or other road users in the process, and switch off the engine.
	The high beam indicator lamp lights up blue – The high beam is switched on.
	The general warning lamp lights up yellow – A note/warning on operating safety has been detected. This is also shown in the display.

7 COMBINATION INSTRUMENT

7.6 Display

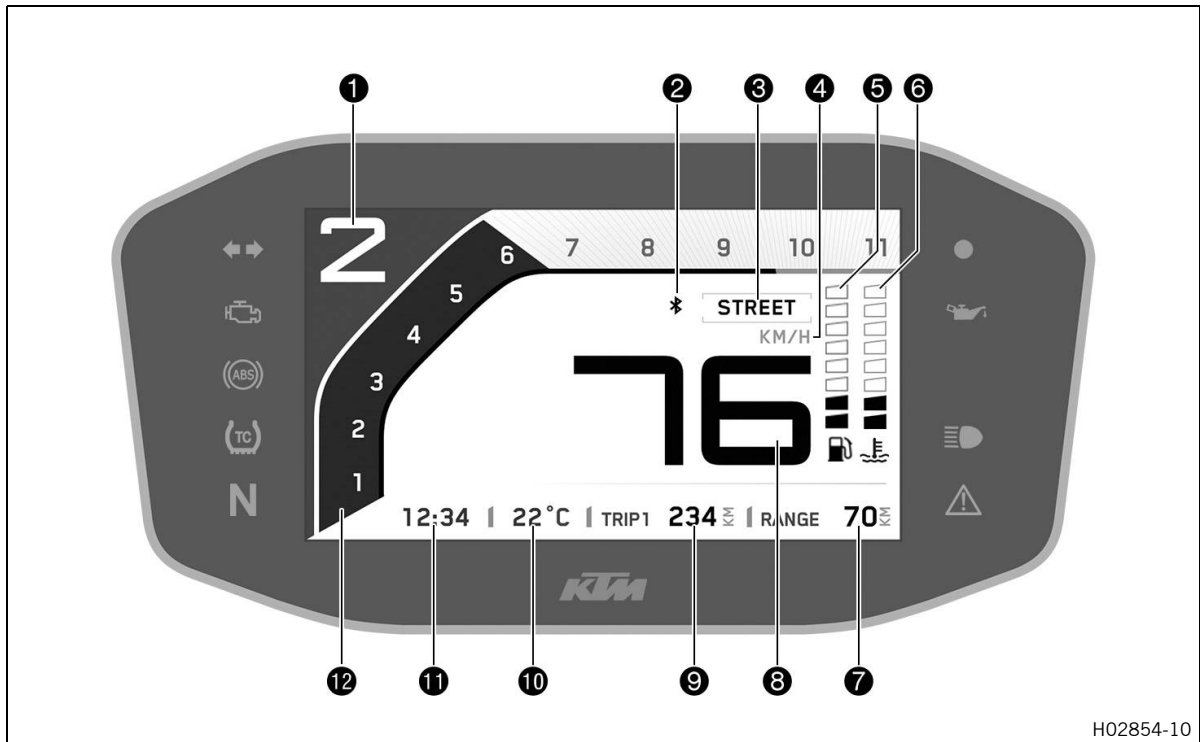

H02854-10

**Info**

The figure shows the start screen of the combination instrument. If the menu is opened, the speed is still displayed.

- ① Gear display
- ② **Bluetooth®** (optional)
- ③ **Ride Mode** (📖 p. 225)
- ④ Unit for the speedometer
- ⑤ Fuel level display (📖 p. 56)
- ⑥ Coolant temperature indicator (📖 p. 57)
- ⑦ Range display
- ⑧ Speed
- ⑨ Trip distance counter (📖 p. 58)
- ⑩ Ambient temperature
- ⑪ Time (📖 p. 57)
- ⑫ Tachometer
- ⑫ Shift warning light (📖 p. 55)
The shift warning light is integrated in the tachometer display.

7 COMBINATION INSTRUMENT

7.7 TRACK display

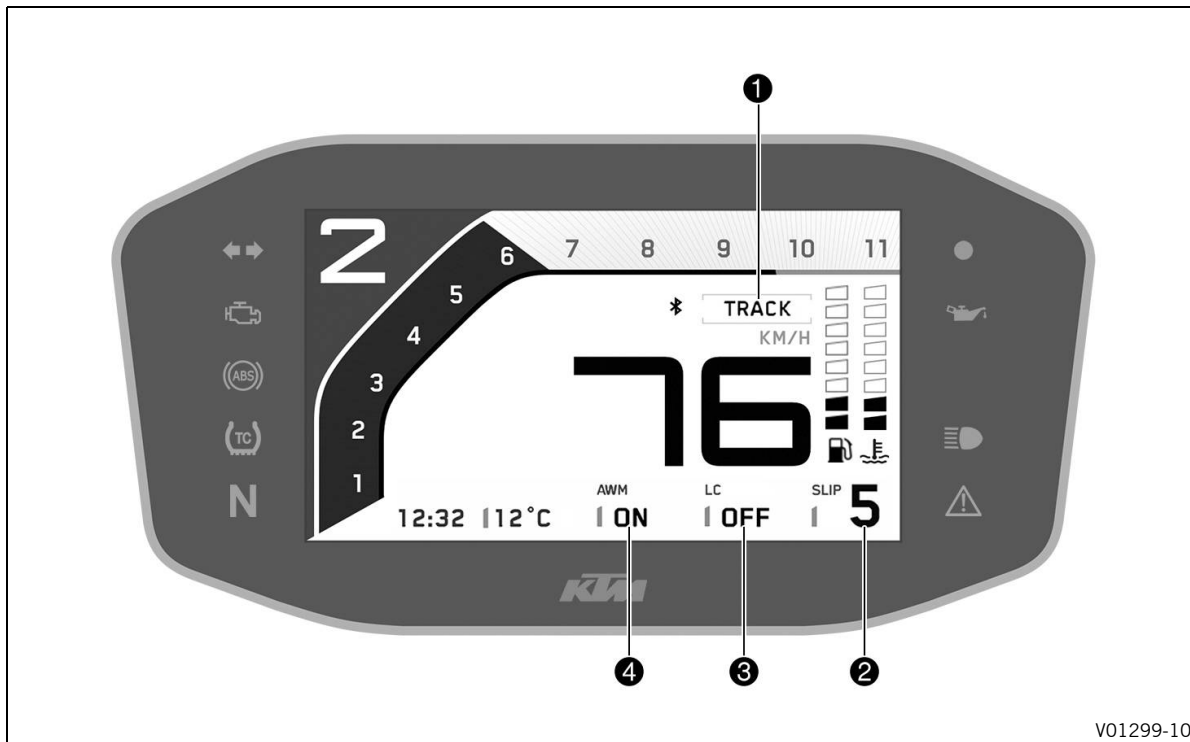

V01299-10

**Info**

The figure shows the start screen of the combination instrument in active drive mode **TRACK**. If the menu is opened, the speed is still displayed.

- ❶ Throttle response (📖 p. 227)
- ❷ Slip adjustment (📖 p. 227)
- ❸ Launch-Control (📖 p. 108)
- ❹ Anti Wheelie Mode

7.8 Shift warning light

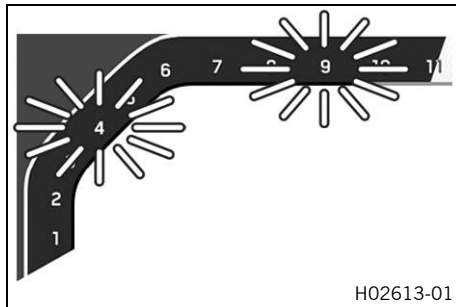

The shift warning light is integrated in the tachometer display. In the **Shift Light** menu, the engine speed for the shift warning light can be set. The shift warning light is always active during the running-in phase (up to 1,000 km / 600 mi). The shift warning light can only be deactivated, and the values for **Lights up** and **Flashes** can only be adjusted after this. The shift warning light lights up orange at **Lights up** and flashes orange at **Flashes**.

Coolant temperature	> 35 °C (> 95 °F)
Lights up	Shift warning light lights up orange
Flashes	Shift warning light flashes orange
Coolant temperature	≤ 35 °C (≤ 95 °F)

7 COMBINATION INSTRUMENT

The shift warning light always lights up at	6,500 rpm
---	-----------

7.9 Fuel level display

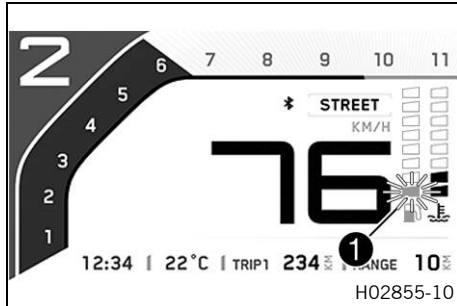

The fuel level indicator ① consists of bars. The more bars are lit, the more fuel is in the fuel tank.



Info

If the fuel level is getting low, the last bar lights up orange and the following warning **LOW FUEL** also appears. The fuel level is displayed with a slight delay to prevent the indicator from constantly moving while riding. The fuel level display is not updated while the side stand is folded out or the emergency off switch is switched off. Once the side stand is folded up and the emergency OFF switch is switched on, the fuel level display is next updated after 2 minutes. The fuel level display flashes if the combination instrument does not receive a signal from the fuel level sensor.

7.10 Time

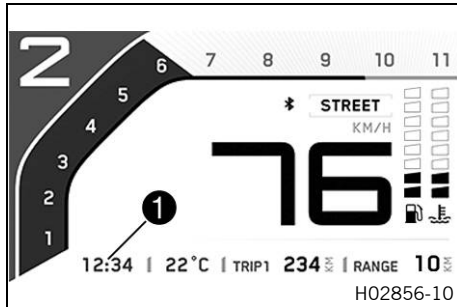

The time ❶ is displayed in 24 hour format in all languages except for EN-US. The time ❶ is displayed in 12 hour format if the language is set to EN-US.

The time can be configured in the **Clock/Date** menu.

i Info

The time must be reset if the 12-V battery was disconnected from the vehicle or the fuse was removed.

7.11 Coolant temperature indicator

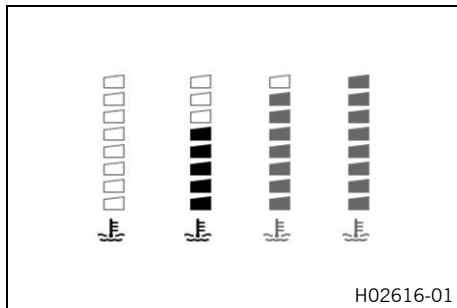

Note

Engine failure Overheating damages the engine.

- If the coolant temperature warning is displayed, stop immediately and take care not to endanger yourself or other traffic participants in the process.
- Allow the engine and cooling system to cool down.
- Check and, if necessary, correct the coolant level on the cooling system while it is in a cooled state.

The temperature indicator consists of eight bars. The more bars that light up, the hotter the coolant.

7 COMBINATION INSTRUMENT

Emergency operation is automatically activated at 120 °C coolant temperature.



Info

When all the bars light up, the warning **ENGINE TEMP HIGH** also appears.

Possible states

- The engine is cold – Up to three bars light up.
- Engine warm – Four to five bars light up.
- Engine hot – Six to eight bars light up.
- Engine very hot – All eight bars flash orange.

7.12 Trip distance counter

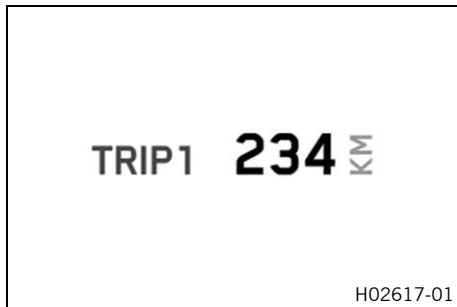

Trip 1 is displayed in the start screen as a trip distance counter. This cannot be changed.

Information about the total riding distance covered can be accessed in the **General Info** menu under menu item **Odometer**.

The trip distance counter can be configured in the **Trip 1** menu. Information about other distances traveled can be accessed and configured in the **Trip 2** menu.

7.13 Menu

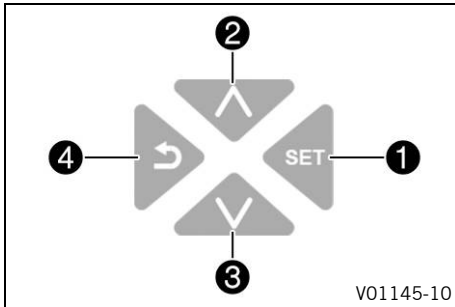

i Info

Press the **SET** button **1** to open the menu.

Navigate through the menu using the **UP** button **2** or the **DOWN** button **3**.

Press the **BACK** button **4** to close the current menu or the menu overview.

7.13.1 Favorites

< BACK		FAVORITES	
RIDE MODE	[STREET]		
TRIP 1	234KM	 KM/H	
TRIP TIME 1	03:21H		
MTC	[ON]		
FUEL RANGE	70KM		

H02858-01

- Press the **SET** button when the menu is closed.
- Pressing the **SET** button again opens the menu.
- Press the **UP** or **DOWN** button to activate the menu item and select it with the **SET** button.

You can directly open five freely configurable menus in the **Favorites** menu.

The **Favorites** menu is configured in the **Set Favorites** menu.

7 COMBINATION INSTRUMENT

7.13.2 Trip 1

< BACK	TRIP 1	 KM/H
TRIP 1	234KM	
ØCONSUMPTION1	3.3L/100KM	
ØSPEED1	86KM/H	
TRIP TIME 1	03:21H	
FUEL RANGE	70KM	

H02859-01

- Press the **SET** button when the menu is closed.
- Press the **UP** or **DOWN** button until the **Trips/Data** menu is marked on the display. Press the **SET** button to open the menu.
- Press the **UP** or **DOWN** button until the **Trip 1** menu is marked on the display. Press the **SET** button to open the menu.

Trip 1 shows the distance since the last reset, such as between two refueling stops. **Trip 1** is running and counts up to **9999**.

ØConsumption1 indicates the average fuel consumption based on **Trip 1** and **Trip time 1**.

ØSpeed1 indicates the average speed based on **Trip 1** and **Trip time 1**.

Trip time 1 shows the journey time on the basis of **Trip 1** and runs as soon as a speed signal is received.

Fuel range indicates the possible distance you can cover with the fuel reserve.

Press and hold the button **SET** for 3–5 seconds.

In the **Trip 1** menu all entries apart from **Fuel range** are deleted.

7.13.3 Trip 2

< BACK	TRIP 2	
TRIP 2	678KM	
ØCONSUMPTION2	3.7L/100KM	
ØSPEED2	93KM/H	
TRIP TIME 2	07:56H	
FUEL RANGE	70KM	
H02857-01		

- Press the **SET** button when the menu is closed.
- Press the **UP** or **DOWN** button until the **Trips/Data** menu is marked on the display. Press the **SET** button to open the menu.
- Press the **UP** or **DOWN** button until the **Trip 2** menu is marked on the display. Press the **SET** button to open the menu.

Trip 2 shows the distance since the last reset, such as between two refueling stops. **Trip 2** is running and counts up to **9999**.

ØConsumption2 indicates the average consumption based on **Trip 2** and **Trip time 2**.

ØSpeed2 indicates the average speed based on **Trip 2** and **Trip time 2**.

Trip time 2 shows the journey time on the basis of **Trip 2** and runs as soon as a speed signal is received.

Fuel range indicates the possible distance you can cover with the fuel reserve.

Press and hold the button **SET** for 3–5 seconds.

In the **Trip 2** menu all entries apart from **Fuel range** are deleted.

7.13.4 General Info

< BACK	GENERAL INFO
DATE	12.01.2018
ODOMETER	1234KM
BATTERY	12.0V
TYRE PRESS FRON	2.3
TYRE PRESS REAR	2.6

KM/H 

V01111-01



Warning

Danger of accidents The tire pressure monitoring system does not eliminate the necessity to check the tires before going on a ride.

To avoid false alarms, the tire pressure values are evaluated over a period of several minutes.

- Check the tire pressure before every ride.
- Correct the tire pressure if the tire pressure deviates from the specified value.
- Even if the tire pressure values are correct, stop the vehicle immediately if its behavior indicates a loss of pressure in the tires.

- Press the **SET** button when the menu is closed.
- Press the **UP** or **DOWN** button until the **Trips/Data** menu is marked on the display. Press the **SET** button to open the menu.
- Press the **UP** or **DOWN** button until the **General Info** menu is marked on the display. Press the **SET** button to open the menu.

Date shows the date.

Odometer shows the total distance covered.

Battery indicates the battery voltage.

Tire press fron (optional) indicates the tire pressure at the front.

Tire press rear (optional) indicates the tire pressure at the rear.

7.13.5 Settings

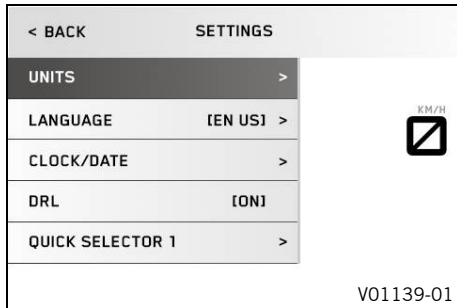

Condition

- The motorcycle is stationary.
 - Press the **SET** button when the menu is closed.
 - Press the **UP** or **DOWN** button until the **Trips/Data** menu is marked on the display. Press the **SET** button to open the menu.
 - Press the **UP** or **DOWN** button until the **Settings** menu is marked on the display. Press the **SET** button to open the menu.

Settings for units or various values are made in the **Settings** menu. Several functions can be enabled or disabled.

7.13.6 Bluetooth® (optional)

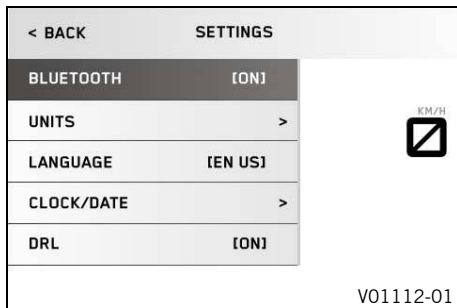

Condition

- The motorcycle is stationary.
- Function **KTM MY RIDE** (optional) activated.
 - Press the **SET** button when the menu is closed.
 - Press the **UP** or **DOWN** button until the **Trips/Data** menu is marked on the display. Press the **SET** button to open the menu.
 - Press the **UP** or **DOWN** button until the **Settings** menu is marked on the display. Press the **SET** button to open the menu.
 - Press the **UP** or **DOWN** button until **Bluetooth®** is marked on the display.
 - Switch the **Bluetooth®** on and off using the **SET** button.



Info

The **Bluetooth®** function can only be used in conjunction with **KTM MY RIDE** (optional).

If a device has been paired via the menu **Pairing** but is currently not connected, the **Bluetooth®** symbol flashes when the **Bluetooth®** function is switched on. The **Bluetooth®** symbol lights up as soon as a device is connected.

7.13.7 Distance

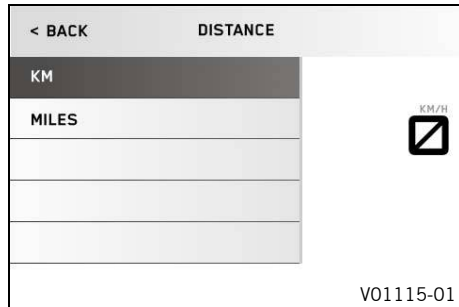

Condition

- The motorcycle is stationary.
 - Press the **SET** button when the menu is closed.
 - Press the **UP** or **DOWN** button until the **Trips/Data** menu is marked on the display. Press the **SET** button to open the menu.
 - Press the **UP** or **DOWN** button until the **Settings** menu is marked on the display. Press the **SET** button to open the menu.
 - Press the **UP** or **DOWN** button until **Units** is marked on the display. Pressing the **SET** button again opens the menu.
 - Press the **UP** or **DOWN** button until **Distance** is marked on the display. Pressing the **SET** button again sets the unit of measure.

Select kilometers **km** or miles **mi** for the distance.

7.13.8 Temp

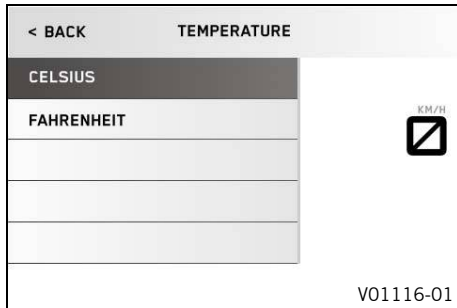
**Condition**

- The motorcycle is stationary.
- Press the **SET** button when the menu is closed.
- Press the **UP** or **DOWN** button until the **Trips/Data** menu is marked on the display. Press the **SET** button to open the menu.
- Press the **UP** or **DOWN** button until the **Settings** menu is marked on the display. Press the **SET** button to open the menu.
- Press the **UP** or **DOWN** button until **Units** is marked on the display. Pressing the **SET** button again opens the menu.
- Press the **UP** or **DOWN** button until **Temp** is marked on the display. Pressing the **SET** button again sets the unit of measure.

Select **°C** or **°F** for the temperature indicator.

7 COMBINATION INSTRUMENT

7.13.9 Pressure

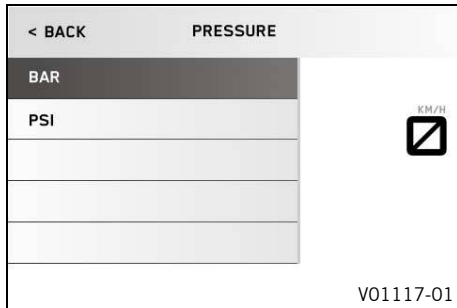

Condition

- The motorcycle is stationary.
- Model with **TPMS**.
 - Press the **SET** button when the menu is closed.
 - Press the **UP** or **DOWN** button until the **Trips/Data** menu is marked on the display. Press the **SET** button to open the menu.
 - Press the **UP** or **DOWN** button until the **Settings** menu is marked on the display. Press the **SET** button to open the menu.
 - Press the **UP** or **DOWN** button until **Units** is marked on the display. Pressing the **SET** button again opens the menu.
 - Press the **UP** or **DOWN** button until **Pressure** is marked on the display. Pressing the **SET** button again sets the unit of measure.

Select **bar** or **psi**.

7.13.10 Fuel Cons

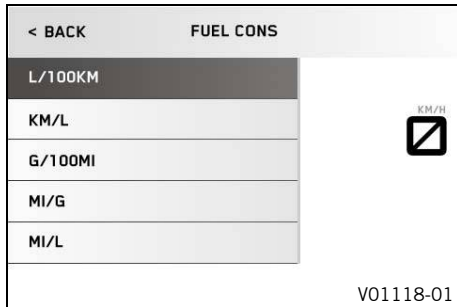
**Condition**

- The motorcycle is stationary.
- Press the **SET** button when the menu is closed.
- Press the **UP** or **DOWN** button until the **Trips/Data** menu is marked on the display. Press the **SET** button to open the menu.
- Press the **UP** or **DOWN** button until the **Settings** menu is marked on the display. Press the **SET** button to open the menu.
- Press the **UP** or **DOWN** button until **Units** is marked on the display. Pressing the **SET** button again opens the menu.
- Press the **UP** or **DOWN** button until **Fuel Cons** is marked on the display. Pressing the **SET** button again sets the unit of measure.

Select one of the available consumption displays.

7 COMBINATION INSTRUMENT

7.13.11 Language

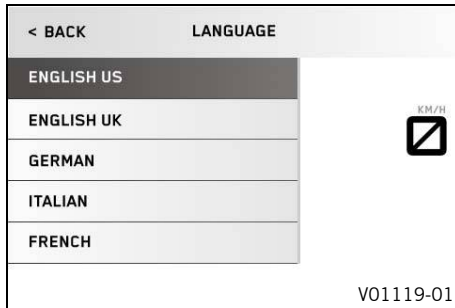

Condition

- The motorcycle is stationary.
 - Press the **SET** button when the menu is closed.
 - Press the **UP** or **DOWN** button until the **Trips/Data** menu is marked on the display. Press the **SET** button to open the menu.
 - Press the **UP** or **DOWN** button until the **Settings** menu is marked on the display. Press the **SET** button to open the menu.
 - Press the **UP** or **DOWN** button until **Language** is marked on the display. Press the **SET** button again to select the language.

The menu languages are US English, UK English, German, Italian, French, and Spanish.

7.13.12 Clock/Date

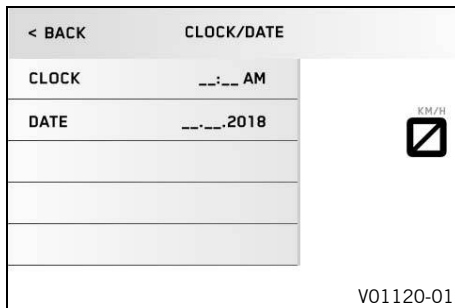

Condition

- The motorcycle is stationary.
 - Press the **SET** button when the menu is closed.
 - Press the **UP** or **DOWN** button until the **Trips/Data** menu is marked on the display. Press the **SET** button to open the menu.
 - Press the **UP** or **DOWN** button until the **Settings** menu is marked on the display. Press the **SET** button to open the menu.
 - Press the **UP** or **DOWN** button until **Clock/Date** is marked on the display. Pressing the **SET** button again opens the menu.

- Press the **UP** or **DOWN** button to set the clock and confirm with the **SET** button.
- Press the **UP** or **DOWN** button to set the date and confirm with the **SET** button.

If the 12-V battery has been disconnected, the time and date must be set.



Info

If the 12-V battery has been disconnected, the software version is also displayed.

7.13.13 DRL

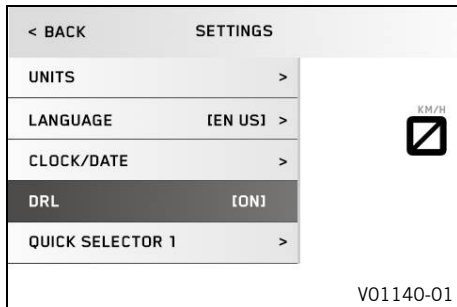

Condition

- The motorcycle is stationary.
- Press the **SET** button when the menu is closed.
- Press the **UP** or **DOWN** button until the **Trips/Data** menu is marked on the display. Press the **SET** button to open the menu.
- Press the **UP** or **DOWN** button until the **Settings** menu is marked on the display. Press the **SET** button to open the menu.



Warning

Danger of accidents When visibility is poor, the daytime running light is not a substitute for the low beam. Automatic switching between the daytime running light and low beam may only be partially available when visibility is significantly impaired due to fog, snow or rain.

- Ensure that the appropriate type of lighting is always selected.
 - If necessary switch off the daytime running lights using the menu before going on a ride or when stopped so that the low beam is switched on permanently.
 - Note the legal regulations regarding the daytime running light.
-
- Press the **UP** or **DOWN** button until **DRL** is marked on the display. Press the **SET** button to switch the daytime running light on or off.

7.13.14 TPMS warning

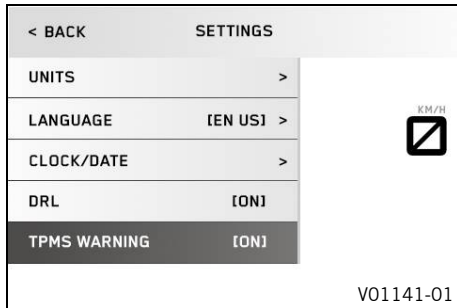

Condition

- The motorcycle is stationary.
- Model with **TPMS**.
- Press the **SET** button when the menu is closed.
- Press the **UP** or **DOWN** button until the **Trips/Data** menu is marked on the display. Press the **SET** button to open the menu.
- Press the **UP** or **DOWN** button until the **Settings** menu is marked on the display. Press the **SET** button to open the menu.
- Press the **UP** or **DOWN** button until **TPMS warning** is marked on the display. Press the **SET** button to switch indications of tire pressure being too high, or too low, on or off.

Guideline

Tire pressure when solo	
front	2.3 bar (33 psi)
rear	2.6 bar (38 psi)
Tire pressure with passenger / full payload	
front	2.3 bar (33 psi)
rear	2.6 bar (38 psi)

7.13.15 Quick Selector 1

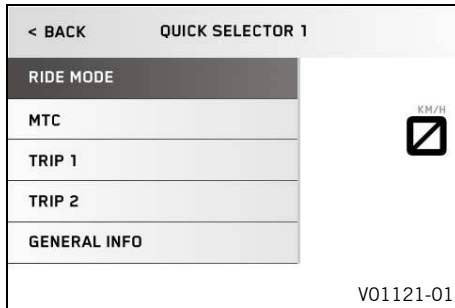

Condition

- The motorcycle is stationary.
 - Press the **SET** button when the menu is closed.
 - Press the **UP** or **DOWN** button until the **Trips/Data** menu is marked on the display. Press the **SET** button to open the menu.
 - Press the **UP** or **DOWN** button until the **Settings** menu is marked on the display. Press the **SET** button to open the menu.
 - Press the **UP** or **DOWN** button until the **Quick Selector 1** menu is marked on the display. Press the **SET** button to open the menu.
 - Press the **UP** or **DOWN** button until the desired menu is marked.
 - Press the **SET** button to confirm the selection.

A menu can be defined for direct selection in the **Quick Selector 1** menu.

When the menu is closed, the menu defined in **Quick Selector 1** is opened by pressing the **UP** button.



Info

In drive mode **TRACK**, the **UP** button can be used to set the slip adjustment.

7.13.16 Quick Selector 2

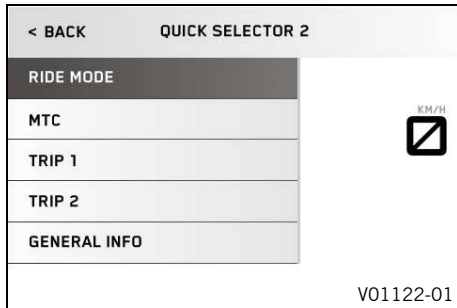
**Condition**

- The motorcycle is stationary.
 - Press the **SET** button when the menu is closed.
 - Press the **UP** or **DOWN** button until the **Trips/Data** menu is marked on the display. Press the **SET** button to open the menu.
 - Press the **UP** or **DOWN** button until the **Settings** menu is marked on the display. Press the **SET** button to open the menu.
 - Press the **UP** or **DOWN** button until the **Quick Selector 2** menu is marked on the display. Press the **SET** button to open the menu.
 - Press the **UP** or **DOWN** button until the desired menu is marked.
 - Press the **SET** button to confirm the selection.

A menu can be defined for direct selection in the **Quick Selector 2** menu.

When the menu is closed, the menu defined in **Quick Selector 2** is opened by pressing the **DOWN** button.

i **Info**

In drive mode **TRACK**, the **DOWN** button can be used to set the slip adjustment.

7.13.17 Set Favorites

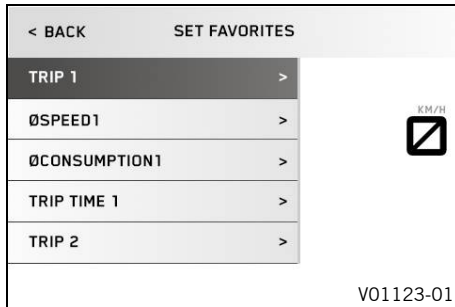

Condition

- The motorcycle is stationary.
 - Press the **SET** button when the menu is closed.
 - Press the **UP** or **DOWN** button until the **Trips/Data** menu is marked on the display. Press the **SET** button to open the menu.
 - Press the **UP** or **DOWN** button until the **Settings** menu is marked on the display. Press the **SET** button to open the menu.
 - Press the **UP** or **DOWN** button until the **Set Favorites** menu is marked on the display. Press the **SET** button to open the menu.
 - Press the **UP** or **DOWN** button to select the menu. Press the **SET** button to set the menu for quick selection.

The **Favorites** menu is configured in the **Set Favorites** menu.

7.13.18 Service

< BACK	SERVICE
NEXT SERVICE IN:	
	xxxxKM
NEXT SERVICE ON	
	MM/YYYY
VERSION	xx.xx
V01125-01	

Condition

- The motorcycle is stationary.
 - Press the **SET** button when the menu is closed.
 - Press the **UP** or **DOWN** button until the **Trips/Data** menu is marked on the display. Press the **SET** button to open the menu.
 - Press the **UP** or **DOWN** button until the **Service** menu is marked on the display. Press the **SET** button to open the menu.

The **Service** menu displays when the next service is due and the software version.

7.13.19 Extra functions

< BACK	EXTRA FUNCTIONS
KTM MY RIDE	
V01126-01	

Condition

- The motorcycle is stationary.
- Motorcycle with optional supplementary function.
 - Press the **SET** button when the menu is closed.
 - Press the **UP** or **DOWN** button until **Trips/Data** is marked on the display. Press the **SET** button to open the menu.
 - Press the **UP** or **DOWN** button until **Extra functions** is marked on the display. Press the **SET** button to open the menu.
 - Use the **UP** or **DOWN** button to navigate through the extra functions.



Info

The optional extra functions are listed in **Extra functions**. The current **KTM PowerParts** and the available software for your vehicle can be found on the KTM website.

7.13.20 Warnings

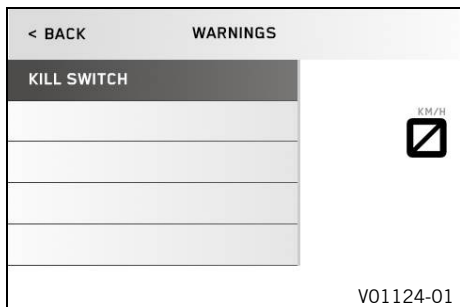

Condition

- At least one warning present.
 - Press the **SET** button when the menu is closed.
 - Press the **UP** or **DOWN** button until the **Trips/Data** menu is marked on the display. Press the **SET** button to open the menu.
 - Press the **UP** or **DOWN** button until the **Warnings** menu is marked on the display. Press the **SET** button to open the menu.
 - Use the **UP** or **DOWN** button to navigate through the warnings.
- In the **Warnings** menu, warnings that occurred are displayed and stored until they are no longer enabled.

7.13.21 Ride Mode

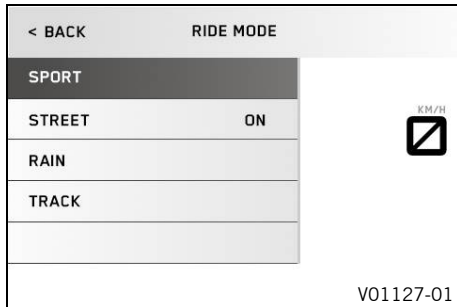

- Press the **SET** button when the menu is closed.
- Press the **UP** or **DOWN** button until the **Ride Mode** menu is marked on the display. Press the **SET** button to open the menu.
- Use the **UP** or **DOWN** button to navigate through the menu. The **SET** button can be used to select engine and motorcycle traction control settings that are coordinated with each other.
 - ✓ **SPORT** – homologated performance with very direct response; the motorcycle traction control allows greater slip on the rear wheel.
 - ✓ **STREET** – homologated performance with balanced response; the motorcycle traction control allows normal slip on the rear wheel.
 - ✓ **RAIN** – reduced homologated performance for better rideability; the motorcycle traction control allows normal slip on the rear wheel.
 - ✓ **TRACK** – setting with homologated performance and extremely direct response. The motorcycle traction control and the characteristic map of the throttle response can be individually set.

**Info**

Do not open the throttle during the selection.

7.13.22 Track

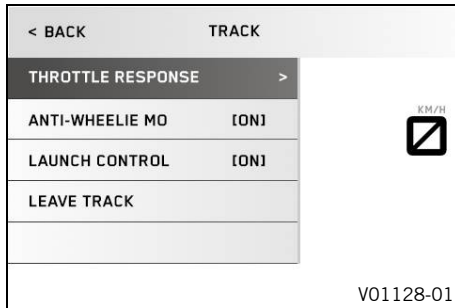

Condition

- The drive mode **TRACK** is activated.
 - Press the **SET** button when the menu is closed.
 - Press the **UP** or **DOWN** button until the **Ride Mode** menu is marked on the display. Press the **SET** button to open the menu.
 - Use the **UP** or **DOWN** button to navigate through the menu. Use the **SET** button to adjust the individual settings of the **TRACK PACK**.



Info

Do not open the throttle when setting it. The drive mode **TRACK** is ended via **Leave Track** and automatically switches to the drive mode **STREET**. Do not open the throttle when doing so.

7.13.23 Anti-wheelie mode

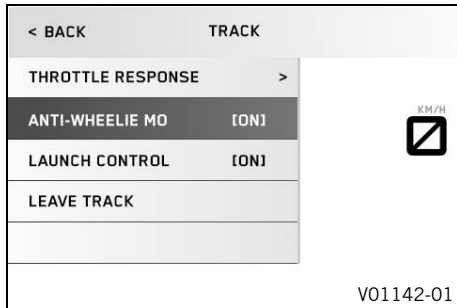

Condition

- The drive mode **TRACK** is activated.
- Press the **SET** button when the menu is closed.
- Press the **UP** or **DOWN** button until the menu item **Anti-wheelie mo** is marked on the display.



Warning

Danger of accidents When Anti Wheelie Mode is disabled, the motorcycle traction control no longer counteracts the raising of the front wheel.

- Only switch off the Anti Wheelie Mode if you have the appropriate experience.
-
- Switch the Anti Wheelie Mode on and off using the **SET** button.

7 COMBINATION INSTRUMENT

7.13.24 Launch control

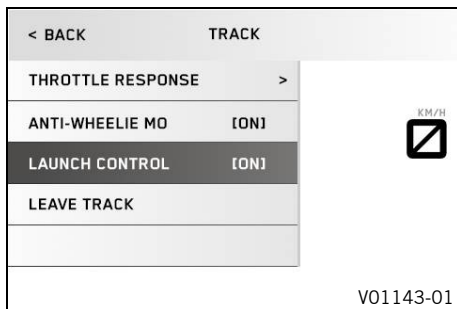

Condition

- The drive mode **TRACK** is activated.
 - Press the **SET** button when the menu is closed.
 - Press the **UP** or **DOWN** button until the menu item **Launch control** is marked on the display.
 - Switch the launch control (📖 p. 108) on and off using the **SET** button.

7.13.25 MTC + MSR

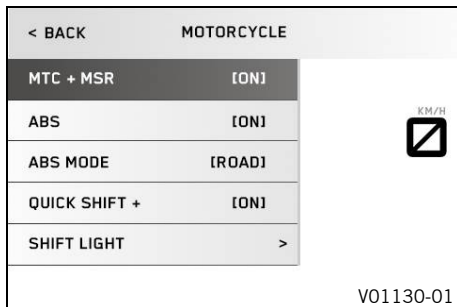

Condition

- **ABS ModeSupermoto** is not activated.
 - Press the **SET** button when the menu is closed.
 - Press the **UP** or **DOWN** button until the **Motorcycle** menu is marked on the display. Press the **SET** button to open the menu.
 - Press the **UP** or **DOWN** button until **MTC + MSR** is marked on the display.
 - Keep the **SET** button pressed for 3-5 seconds to switch **MTC + MSR** on or off.

**Info**

Do not open the throttle when switching on or off. After the ignition is switched on, the motorcycle traction control and engine traction torque control are enabled again.

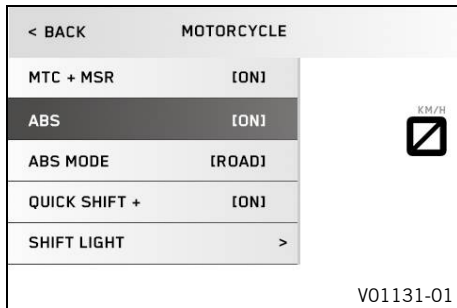
7.13.26 ABS**Condition**

- The motorcycle is stationary.

Note

Voiding of the government approval for road use and the insurance coverage If the ABS is switched off completely, the vehicle's approval for road use is invalidated.

- Only operate the vehicle in closed-off areas remote from public road traffic if the ABS is switched off completely.
- Press the **SET** button when the menu is closed.
- Press the **UP** or **DOWN** button until the **Motorcycle** menu is marked on the display. Press the **SET** button to open the menu.
- Press the **UP** or **DOWN** button until **ABS** is marked on the display.
- Keep the **SET** button pressed for 3-5 seconds to switch off the ABS.



Info

Do not open the throttle during deactivation. After the ignition is switched back on, ABS is reactivated.

7.13.27 ABS Mode

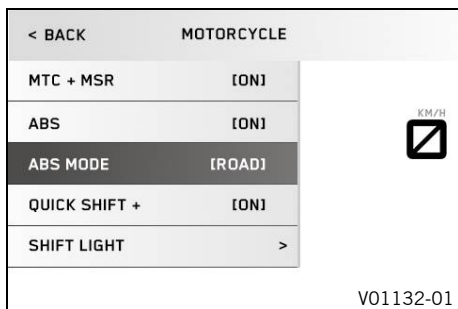

Condition

- The motorcycle is stationary.
 - **ABS** is switched on.
- Press the **SET** button when the menu is closed.
 - Press the **UP** or **DOWN** button until the **Motorcycle** menu is marked on the display. Press the **SET** button to open the menu.
 - Press the **UP** or **DOWN** button until **ABS Mode** is marked on the display.
 - Keep the **SET** button pressed for 3-5 seconds to change the ABS mode.

**Info**

Do not open the throttle during the selection.

If the ABS mode **Road** is enabled, ABS controls both wheels.

If the ABS mode **Supermoto** is enabled, ABS only controls the front wheel. The ABS warning lamp flashes slowly to remind you that the **Supermoto** ABS mode is enabled. The rear wheel is not controlled by ABS and may lock during braking maneuvers. **MSR** is deactivated.

After the ignition is switched back on, the ABS mode is reset to **Road**.

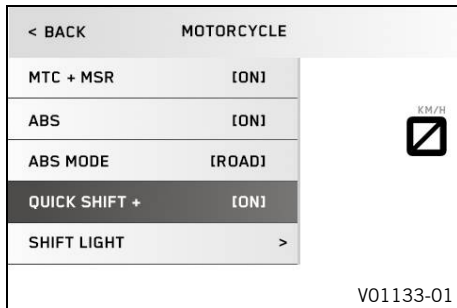
7.13.28 Quick Shift +**Condition**

- The motorcycle is stationary.
 - Press the **SET** button when the menu is closed.
 - Press the **UP** or **DOWN** button until the **Motorcycle** menu is marked on the display. Press the **SET** button to open the menu.
 - Press the **UP** or **DOWN** button until **Quick Shift +** is marked on the display.
 - Switch quickshifter + (📖 p. 110) on and off using the **SET** button.

7.13.29 Shift Light

< BACK	SHIFT LIGHT	
LIGHTS UP	8000	
FLASHES	9800	
SHIFT LIGHT	[ON]	

V01134-01

Condition

- The motorcycle is stationary.
- **ODO** > 1,000 km (600 mi).
 - Press the **SET** button when the menu is closed.
 - Press the **UP** or **DOWN** button until the **Motorcycle** menu is marked on the display. Press the **SET** button to open the menu.
 - Press the **UP** or **DOWN** button until the **Shift Light** menu is marked on the display. Press the **SET** button to open the menu.
 - Press the **UP** or **DOWN** button to select the function. Use the **SET** button to set the engine speed for the gear shift recommendation.

Once the engine speed reaches the engine speed specified at **Lights up**, the speed display lights up orange.

Once the engine speed reaches the engine speed specified at **Flashes**, the speed display flashes orange.

The gear shift recommendation can be switched on or off with the function **Shift Light**.

7.13.30 KTM MY RIDE (optional)

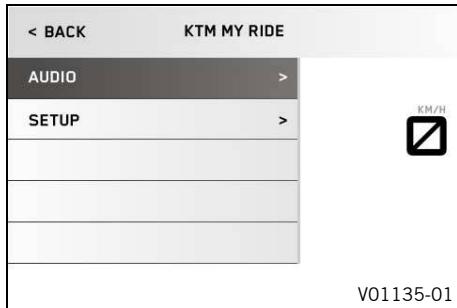
**Condition**

- Function **KTM MY RIDE** (optional) activated.
- Function **Bluetooth®** (optional) activated.
 - Press the **SET** button when the menu is closed.
 - Press the **UP** or **DOWN** button until the **KTM MY RIDE** menu is marked on the display. Press the **SET** button to open the menu.

In **KTM MY RIDE**, an appropriate cellphone or headset can be paired via **Bluetooth®** with the **KTM MY RIDE** control unit.

**Info**

Not every cellphone and headset is suitable for pairing with the **KTM MY RIDE** control unit.

The standard **Bluetooth®** 2.1 must be supported.

7.13.31 Pairing (optional)

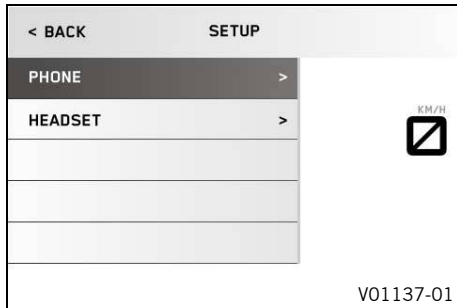

Condition

- The motorcycle is stationary.
- Function **KTM MY RIDE** (optional) activated.
- **Bluetooth**® (optional) is switched on.
- The **Bluetooth**® should also be switched on in the device to be paired.
- The **Bluetooth**® visibility must be activated on the device that is to be paired.
 - Press the **SET** button when the menu is closed.
 - Press the **UP** or **DOWN** button until the **KTM MY RIDE** menu is marked on the display. Press the **SET** button to open the menu.
 - Press the **UP** or **DOWN** button until **Setup** is marked on the display. Press the **SET** button to open the menu.
 - Press the **UP** or the **DOWN** button until the menu item **Phone** or **Headset** is marked.



Info

Two cellphones or headsets can never be paired simultaneously with the **KTM MY RIDE** control unit. Only one cellphone and one headset can be paired with the **KTM MY RIDE** control unit at the same time.

- In the submenu **Phone**, a suitable cellphone can be paired with the **KTM MY RIDE** control unit.
- In the submenu **Headset**, a suitable headset can be paired with the **KTM MY RIDE** control unit.
- Press the **SET** button to open the menu.
- When pairing the device for the first time, press the **UP** or **DOWN** button until **Pairing** is marked. Press the **SET** button to open the menu.
- Navigate to the device required using the **UP** or **DOWN** button. Confirm the selection using the **SET** button.



Info

The headset pairing is now finished.

-
- Confirmation of the **Passkey** successfully completes the cellphone pairing.



Info

When a suitable device has been successfully paired, the name of the paired cellphone or headset appears in each case in the **Phone** or **Headset** menu.

Press the **UP** or **DOWN** button until paired device is marked on the display. The paired device can be deleted by pressing the **SET** button.

The device most recently linked is automatically paired with the **KTM MY RIDE** control unit when **Bluetooth®** is switched on and as soon as this device is in range and has not been previously deleted.

Not every cellphone or headset is suitable for pairing with the **KTM MY RIDE** control unit.

7.13.32 Audio player (optional)



Condition

- Function **KTM MY RIDE** (optional) activated.
- **Bluetooth®** (optional) is switched on.
- Similarly, the **Bluetooth®** is also switched on when devices are paired.
- Headset connected to a suitable audio device.
 - Press the **SET** button when the menu is closed.
 - Press the **UP** or **DOWN** button until the **KTM MY RIDE** menu is marked on the display. Press the **SET** button to open the menu.

**Warning**

Danger of accidents Headphone volume which is too high distracts attention from traffic activity.

- Always select headphone volume which is low enough for you to still clearly hear acoustic signals.

- Press the **UP** or **DOWN** button until **Audio player** is marked on the display. Press the **SET** button to open the menu.
- Press and hold the **UP** button to increase the audio volume.
- Press and hold the **DOWN** button to reduce the audio volume.
- Press the **UP** button briefly to change to the next audio track.
- Press the **DOWN** button briefly to play the audio track from the beginning.
- Press the **DOWN** button twice to change to the previous audio track.
- Press the **SET** button to play or pause the audio track.

**Tip**

With some cellphones, the cellphone audio player needs to be started before a playback is possible. The audio function can be added to **Quick Selector 1** or **Quick Selector 2** for easier operation.

7.13.33 Telephony (optional)

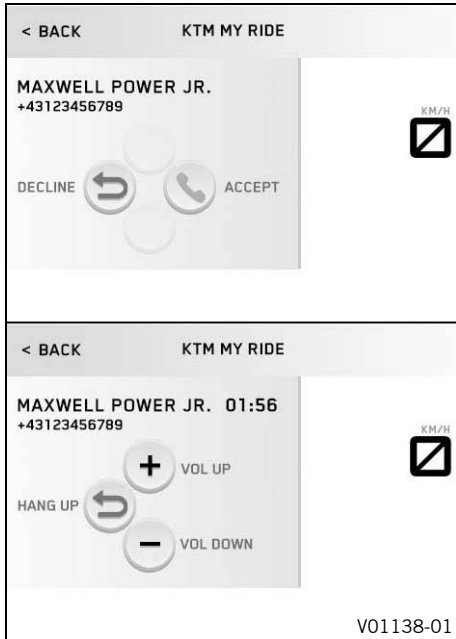

Condition

- Function **KTM MY RIDE** (optional) activated.
- **Bluetooth®** (optional) switched on.
- Similarly, the **Bluetooth®** function is also switched on when devices are paired.
- Headset linked with appropriate cellphone.



Warning

Danger of accidents Headphone volume which is too high distracts attention from traffic activity.

- Always select headphone volume which is low enough for you to still clearly hear acoustic signals.

- Press the **SET** button to accept an incoming call.
- Press the **BACK** button to reject an incoming call.
- Press and hold the **UP** button to increase the audio volume.
- Press and hold the **DOWN** button to reduce the audio volume.



Info

The call duration and contact are displayed. Depending on the cellphone settings, the contact is shown by name.

8.1 Handlebar position

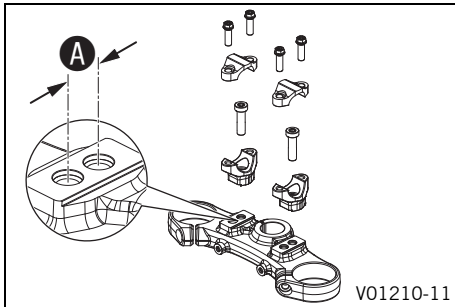

On the upper triple clamp there are two holes at a distance of **A** apart.

Hole distance A	15 mm (0.59 in)
------------------------	-----------------

The handlebar can be mounted in two different positions. This allows the handlebar to be mounted in the most comfortable position for the rider.



Info

KTM recommends the front handlebar position when using the vehicle on a race track.

8.2 Adjusting the handlebar position



Warning

Danger of accidents A repaired handlebar poses a safety risk.

If the handlebar is bent or straightened, the material becomes fatigued. The handlebar may break as a result.

- Change the handlebar if the handlebar is damaged or bent.

8 ERGONOMICS

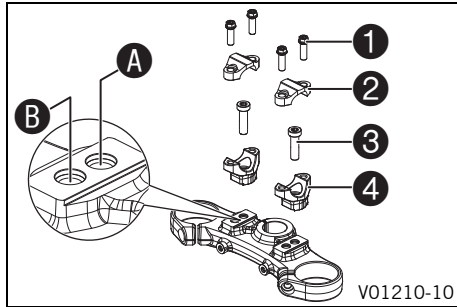

- Remove screws ①. Take off the handlebar clamps ②. Position the handlebar so that screws ③ are accessible.



Info

Cover the components to protect them against damage. Do not kink the cables and lines.

- Remove screws ③. Take off handlebar supports ④.
- Move the handlebar supports into the desired position A or B. Mount and tighten screws ③.

Guideline

Mount the left and right handlebar supports in the same position.

Screw, handlebar support	M10	45 Nm (33.2 lbf ft) Loctite®243™
--------------------------	-----	--

- Position the handlebar.



Info

Make sure the cables and wiring are positioned correctly.

- Position the handlebar clamp. Mount screws ① and tighten evenly.

Guideline

Screw, handlebar clamp	M8	20 Nm (14.8 lbf ft)
------------------------	----	---------------------



8.3 Adjusting the basic position of the clutch lever

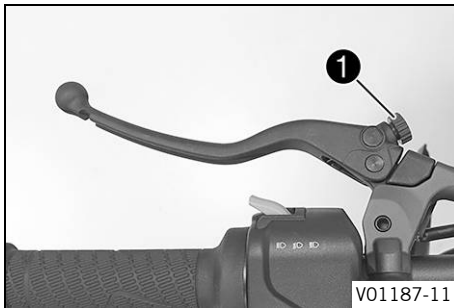

- Push the clutch lever forward.
- Adjust the basic position of the clutch lever to your hand size by turning adjusting screw ①.



Info

Turn the adjusting screw clockwise to increase the distance between the clutch lever and the handlebar. Turn the adjusting screw counterclockwise to decrease the distance between the clutch lever and the handlebar.

The range of adjustment is limited.

Only turn the adjusting screw by hand, and do not use force.

Do not make any adjustments while riding.



8.4 Adjusting the basic position of the hand brake lever

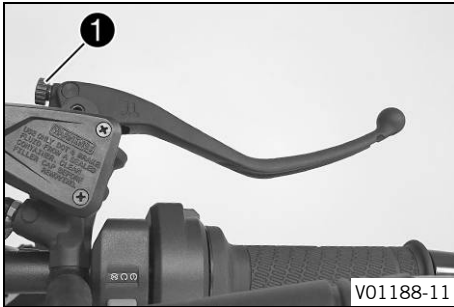

- Push the hand brake lever forward.
- Adjust the basic position of the hand brake lever to your hand size by turning adjusting screw ❶.

Info

Turn the adjusting screw clockwise to increase the distance between the hand brake lever and the handlebar.

Turn the adjusting screw counterclockwise to decrease the distance between the hand brake lever and the handlebar.

The range of adjustment is limited.

Only turn the adjusting screw by hand, and do not use force.

Do not make any adjustments while riding.

8.5 Adjusting the basic position of the foot brake lever ↗



Warning

Danger of accidents The brake system fails in the event of overheating.

If there is no free travel on the foot brake lever, pressure builds up in the brake system on the rear brake.

- Set the free travel on the foot brake lever in accordance with the specification.

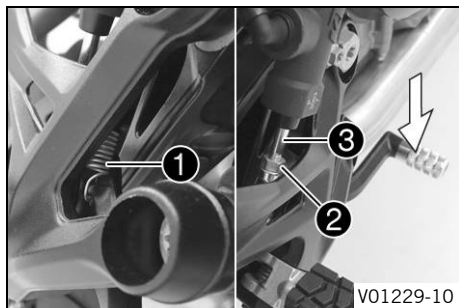

- Detach spring ①.
- Loosen nut ②.



Tip

Press the foot brake lever downwards to make this easier.

- Turn the push rod ③ to set the basic position of the foot brake lever.

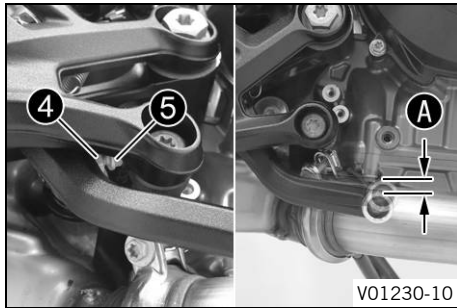

Info

The range of adjustment is limited.

The screw must be screwed in by at least five full turns. Screwing the push rod into the ball joint adjusts the foot brake lever downwards.

Screwing the push rod out of the ball joint adjusts the brake lever upwards.

- Loosen nut **4** and turn screw **5** correspondingly until the free travel **A** is present. If necessary, adjust the basic position of the foot brake lever.

Guideline

Free travel at foot brake lever	3 ... 5 mm (0.12 ... 0.2 in)
---------------------------------	------------------------------

- Hold screw **5** and tighten nut **4**.

Guideline

Remaining nuts, chassis	M6	10 Nm (7.4 lbf ft)
-------------------------	----	--------------------

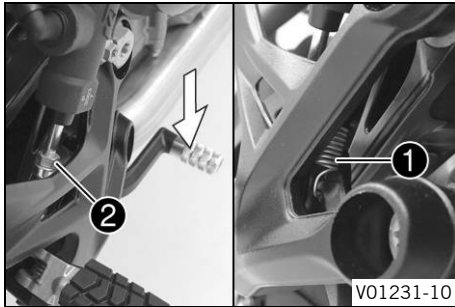

- Tighten nut ②.

Guideline

Nut, push rod, foot brake lever	M6	6 Nm (4.4 lbf ft)
---------------------------------	----	-------------------

i Tip
Press the foot brake lever downwards to make this easier.

- Attach spring ①.

8.6 Checking the basic position of the shift lever

i Info
When driving, the shift lever must not touch the rider's boot when in the basic position. If the shift lever is permanently touching the boot, the transmission will be subject to excessive load; this can cause a malfunction of the quickshifter.

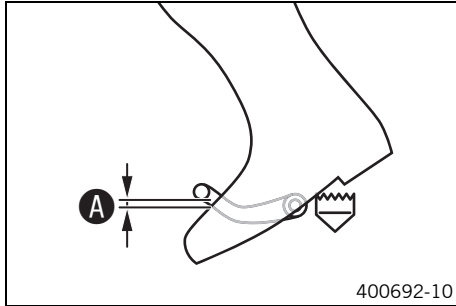

- Sit on the vehicle in the riding position and determine distance **A** between the upper edge of your boot and the shift lever.

Distance between shift lever and upper edge of boot	10 ... 20 mm (0.39 ... 0.79 in)
---	---------------------------------

- » If the distance does not meet specifications:
 - Set the basic position of the shift lever. 📖 (p. 98)

8.7 Adjusting the basic position of the shift lever 📖

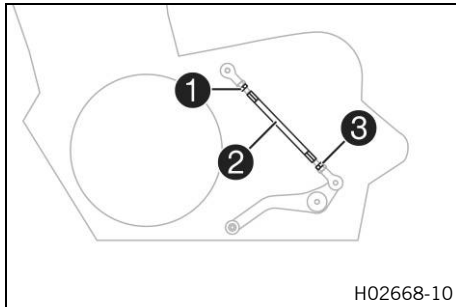

- Loosen nut **1**, holding threaded rod **2**.
- Loosen nut **3**, holding threaded rod **2**.



Info

Nut **3** has a left-handed thread.

- Turn threaded rod **2** to adjust the shift lever.



Info

The range of adjustment is limited.
The shift lever must not come into contact with any other vehicle components during the shift procedure.

- Tighten nut **3** while holding threaded rod **2**.

Guideline

Nut, shift rod	M6LH	6 Nm (4.4 lbf ft)
----------------	------	-------------------

- Tighten nut ❶ while holding threaded rod ❷.

Guideline

Nut, shift rod	M6	6 Nm (4.4 lbf ft)
----------------	----	-------------------



9.1 Advice on preparing for first use



Danger

Danger of accidents A rider who is not fit to ride poses a danger to him or herself and others.

- Do not operate the vehicle if you are not fit to ride due to alcohol, drugs or medication.
- Do not operate the vehicle if you are physically or mentally impaired.



Warning

Risk of injury Missing or poor protective clothing presents an increased safety risk.

- Wear appropriate protective clothing such as helmet, boots, gloves as well as trousers and a jacket with protectors on all rides.
- Always wear protective clothing that is in good condition and meets the legal regulations.



Warning

Danger of crashing Different tire tread patterns on the front and rear wheel impair the handling characteristic.

Different tire tread patterns can make the vehicle significantly more difficult to control.

- Make sure that only tires with a similar tire tread pattern are fitted to the front and rear wheel.



Warning

Danger of accidents Non-approved or non-recommended tires and wheels impact the handling characteristic.

- Only use tires/wheels approved by KTM with the corresponding speed index.



Warning

Danger of accidents New tires have reduced road grip.

The contact surface on new tires is not yet roughened.

- Run in new tires with moderate riding at alternating angles.
Running-in phase 200 km (124 mi)



Warning

Danger of accidents The brake system fails in the event of overheating.

If the foot brake lever is not released, the brake linings drag continuously.

- Take your foot off the foot brake lever when you are not braking.



Info

When using your vehicle, remember that others may feel disturbed by excessive noise.

- Make sure that the pre-sales inspection work has been carried out by an authorized KTM workshop.
 - ✓ You receive a delivery certificate and the Service & Manufacturer Warranty Booklet at vehicle handover.
- Before riding for the first time, read the entire Owner's Manual carefully.
- Get to know the controls.
- Adjust the basic position of the clutch lever. (📖 p. 93)
- Adjust the basic position of the hand brake lever. (📖 p. 94)
- Adjust the basic position of the foot brake lever. (👉 📖 p. 95)

9 PREPARING FOR USE

- Get used to handling the motorcycle in a suitable area before making a longer trip. Try also to ride as slowly as possible to get a better feel for the motorcycle.
- Hold the handlebar firmly with both hands and keep your feet on the footrests when riding.
- Run the engine in. (📖 p. 102)

9.2 Running in the engine

- During the running-in phase, do not exceed the specified engine speed.

Guideline

Maximum engine speed	
During the first: 1,000 km (620 mi)	6,500 rpm
After the first: 1,000 km (620 mi)	9,800 rpm

- Avoid fully opening the throttle!

9.3 Loading the vehicle



Warning

Danger of accidents Total weight and axle loads influence the handling characteristic.

The total weight consists of: motorcycle ready for operation and with a full tank, driver and passenger with protective clothing and helmet, and luggage.

- Do not exceed the maximum permissible overall weight or the axle loads.



Warning

Danger of accidents Improper mounting of cases or the tank rucksack impairs the handling characteristic.

- Mount and secure cases and tank rucksack according to the manufacturer's instructions.



Warning

Danger of accidents Unstable handling characteristics at high speed.

- Adapt your speed according to your payload. Ride more slowly if your motorcycle is loaded with cases or other baggage.

Maximum speed with baggage

130 km/h (80.8 mph)



Warning

Danger of accidents The luggage system will be damaged if it is overloaded.

- Read the manufacturer information on maximum payload when mounting cases.



Warning

Danger of accidents Luggage which has slipped impairs visibility.

If the tail light is covered, you are less visible to traffic behind you, especially when it is dark.

- Check that your luggage is fixed properly at regular intervals.



Warning

Danger of accidents A high payload alters the handling characteristic and increases the stopping distance.

- Adapt your speed to your payload.

9 PREPARING FOR USE



Warning

Danger of accidents Pieces of luggage which have slipped impair the handling characteristic.

- Check that your luggage is fixed properly at regular intervals.



Warning

Fire hazard The hot exhaust system may burn luggage.

- Fasten your luggage in such a way that it cannot be burned or singed by the hot exhaust system.

- If you carry luggage, make sure you secure it firmly as close as possible to the center of the vehicle and ensure even weight distribution between the front and rear wheels.
- Do not exceed the maximum permissible weight and the maximum permissible axle loads.

Guideline

Maximum permissible overall weight	430 kg (948 lb.)
Maximum permissible front axle load	160 kg (353 lb.)
Maximum permissible rear axle load	270 kg (595 lb.)

10.1 Checks and maintenance measures when preparing for use



Info

Before every trip, check the condition of the vehicle and ensure that it is roadworthy. The vehicle must be in perfect technical condition when it is being operated.

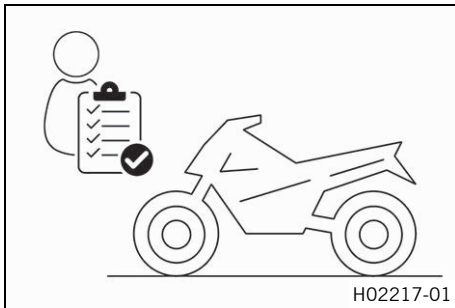

- Check the engine oil level. (📖 p. 229)
- Check the front brake fluid level. (📖 p. 155)
- Check the rear brake fluid level. (📖 p. 161)
- Check the front brake linings. (📖 p. 158)
- Check the rear brake linings. (📖 p. 164)
- Check that the brake system is functioning properly.
- Check the coolant level in the compensating tank. (📖 p. 215)
- Check the chain for dirt. (📖 p. 140)
- Check the chain tension. (📖 p. 143)
- Check the tire condition. (📖 p. 180)
- Check tire pressure. (📖 p. 182)
- Check the settings of all controls and ensure that they can be operated smoothly.
- Check that the electrical system is functioning properly.
- Check that luggage is properly secured.
- Sit on the motorcycle and check the rear mirror setting.
- Check the fuel level.



10.2 Starting the vehicle



Danger

Danger of poisoning Exhaust gases are toxic and inhaling them may result in unconsciousness and death.

- Always make sure there is sufficient ventilation when running the engine.
- Use effective exhaust extraction when starting or running the engine in an enclosed space.

Note

Engine damage High revving speed with a cold engine negatively impacts the lifespan of the engine.

- Always run the engine warm at a low speed.

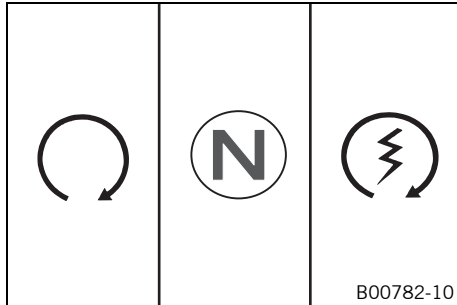

- Take the motorcycle off side stand and sit in the motorcycle.
- Make sure that the emergency OFF switch/electric starter button is in the middle position ○.
- Switch on the ignition by turning the ignition key to the position ○.
 - ✓ After you switch on the ignition, you can hear the fuel pump working for about two seconds. The function check of the combination instrument is run at the same time.
 - ✓ The ABS warning lamp lights up and goes back out after starting off.
- Shift the transmission to neutral position.
 - ✓ The green idle indicator lamp **N** lights up.

- Turn the emergency OFF switch/electric starter button to the lower position (3).



Info

Do not press the emergency off switch/electric starter button into the lower position (3) until the combination instrument function check has been completed.

When starting, **DO NOT** open the throttle. If you open the throttle during the starting procedure, fuel is not injected by the engine management system and the engine cannot start.

Press the emergency OFF switch/electric starter button into the lower position (3) for a maximum of 5 seconds.

Wait for a least 5 seconds before trying again.

This motorcycle is equipped with a safety starting system. You can only start the engine if the transmission is in neutral or if the clutch lever is pulled when a gear is engaged. If the side stand is folded out and you shift into gear and release the clutch, the engine stops.



10.3 Starting off

- Pull the clutch lever, engage 1st gear, release the clutch lever slowly and simultaneously open the throttle carefully.



10.4 Launch-Control

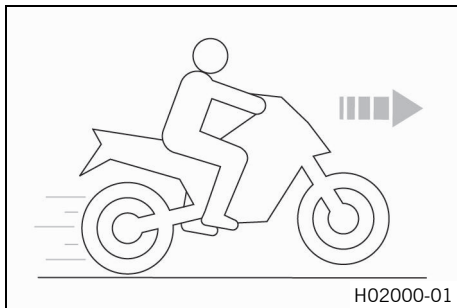

Launch Control is a vehicle electronics function.

Launch control adjusts the engine speed in order to achieve the best possible acceleration.

Launch control can be used for starting off for a maximum of three times in succession. Launch control is temporarily deactivated after the third starting off in order to protect the engine, transmission and cooling system from overloading.

Launch control is also deactivated if all conditions for activation are no longer met.

Launch control is enabled again in the following cases: the engine runs for at least three minutes, the engine is switched off for 20 minutes or a distance of 1.5 km (0.93 mi) has been covered.

10.5 Starting off with launch control



Warning

Danger of accidents Launch control enables very powerful acceleration which may ask too much of a novice rider.

- Only use the launch control if you have the appropriate experience.
- Do not use launch control on public roads.

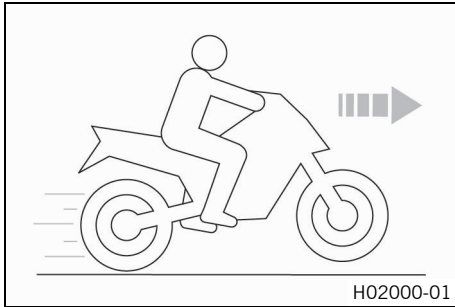

Condition

The drive mode **TRACK** is activated.

First gear is engaged.

The TC indicator lamp does not light up.

Coolant temperature: > 60 °C (> 140 °F)

Total riding distance covered: > 1,000 km (> 620 mi)

- Activate launch control in the combination instrument.
 - ✓ The number of available starts is indicated on the start screen.
- Apply full throttle with the clutch lever pulled.
 - ✓ The engine speed is adjusted.

9,000 rpm
 - ✓ The TC indicator lamp flashes quickly.
- Release the clutch lever quickly but in a controlled manner.



10 RIDING INSTRUCTIONS

10.6 Quickshifter +

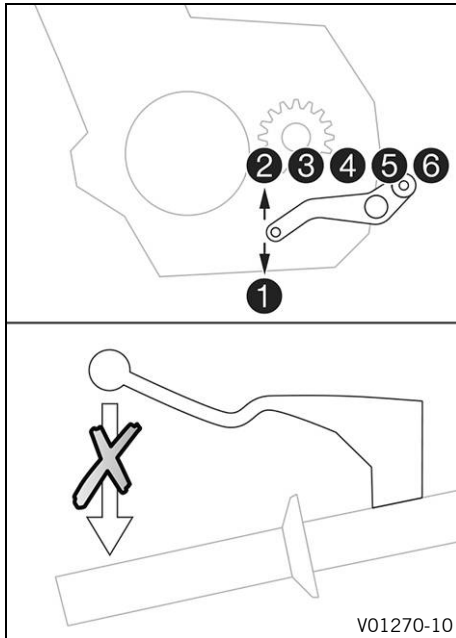

If the quickshifter + is activated, you can shift up and down without actuating the clutch.

Because there is no need to close the throttle grip, uninterrupted gear shifts are possible.

The quickshifter + uses the shifter shaft position to check whether or not a shift should be initiated, and sends a corresponding signal to the engine control.

If the quickshifter + is disabled in the combination instrument, the clutch needs to be actuated in the normal way for each shift.

10.7 Shifting, riding



Warning

Danger of accidents Abrupt load alterations can cause the vehicle to get out of control.

- Avoid abrupt load alterations and sudden braking actions.
- Adapt your speed to the road conditions.



Warning

Danger of accidents If you change down at high engine speed, the rear wheel blocks and the engine races.

- Do not change into a low gear at high engine speed.



Warning

Danger of accidents An incorrect ignition key position causes malfunctions.

- Do not change the ignition key position while driving.



Warning

Danger of accidents Adjustments to the vehicle distract attention from traffic activity.

- Make all adjustments when the vehicle is at a standstill.



Warning

Risk of injury The passenger may fall from the motorcycle if they conduct themselves incorrectly.

- Ensure that the passenger sits correctly on the passenger seat, places his or her feet on the passenger foot pegs and holds on to the rider or the grab handles.
- Note the regulations governing the minimum age of passengers in your country.



Warning

Danger of accidents A risky riding style constitutes a major risk.

- Comply with traffic regulations and ride defensively and with foresight to detect sources of danger as early as possible.



Warning

Danger of accidents Cold tires have reduced road grip.

- Ride the first miles carefully on every journey at moderate speed until the tires reach operating temperature.



Warning

Danger of accidents New tires have reduced road grip.

The contact surface on new tires is not yet roughened.

- Run in new tires with moderate riding at alternating angles.
Running-in phase 200 km (124 mi)

**Warning**

Danger of accidents Total weight and axle loads influence the handling characteristic.

The total weight consists of: motorcycle ready for operation and with a full tank, driver and passenger with protective clothing and helmet, and luggage.

- Do not exceed the maximum permissible overall weight or the axle loads.

**Warning**

Danger of accidents Pieces of luggage which have slipped impair the handling characteristic.

- Check that your luggage is fixed properly at regular intervals.

**Warning**

Danger of accidents A fall can damage the vehicle more seriously than it may first appear.

- Check the vehicle after a fall as you do when preparing for use.

Note

Engine damage Unfiltered intake air has a negative effect on the service life of the engine.

Dust and dirt will enter the engine without an air filter.

- Never start to use the vehicle without an air filter.

Note

Engine failure Overheating damages the engine.

- If the coolant temperature warning is displayed, stop immediately and take care not to endanger yourself or other traffic participants in the process.
- Allow the engine and cooling system to cool down.
- Check and, if necessary, correct the coolant level on the cooling system while it is in a cooled state.

Note

Transmission damage Incorrect use of the quickshifter+ will damage the transmission.

The quickshifter+ can only be used if the function is enabled in the combination instrument.

The quickshifter+ is not active if you pull the clutch lever.

- Only use the quickshifter+ in the permitted speed range shown.

i Info

If unusual noises occur while riding, stop immediately (taking care not to endanger yourself or other road users in the process), switch off the engine and contact an authorized KTM workshop.

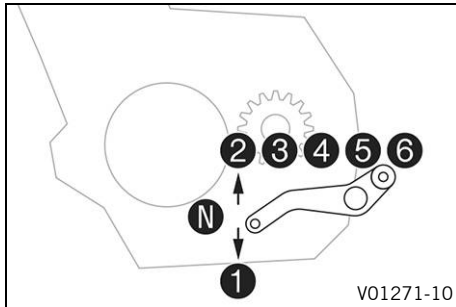



- Shift into a higher gear when conditions allow (incline, road situation, etc.).
- Release the throttle while simultaneously pulling the clutch lever, shift into the next gear, release the clutch lever, and open the throttle.

i Info

You can see the positions of the 6 forward gears in the figure. The neutral or idle position is between the first and second gears. First gear is used for starting off and for steep inclines.

The operating temperature is reached when 5 bars of the temperature indicator light up.

- After reaching maximum speed by fully opening the throttle grip, turn the throttle back so it is $\frac{3}{4}$ open. This will barely reduce the speed but fuel consumption will be considerably lower.
- Accelerate only up to a speed suitable for the road surface and weather conditions. Particularly in bends, do not shift, and accelerate very carefully.
- Brake if necessary and close the throttle at the same time in order to shift down.
- Pull the clutch lever and shift into a lower gear, release the clutch lever slowly, and open the throttle or shift again.
- If the engine stalls (e.g. at a crossroads), just pull the clutch lever and press the emergency OFF switch/electric starter button into the lower position (⊖). The transmission must not be shifted into neutral.
- Switch off the engine if running at idle speed or stationary for a long time.
- If the oil pressure warning lamp  lights up during a trip, stop immediately and switch off the engine. Contact an authorized KTM workshop.
- If the malfunction indicator lamp  lights up during a trip, please contact an authorized KTM workshop as soon as possible.
- If the general warning lamp  lights up during a trip, the display shows a message.

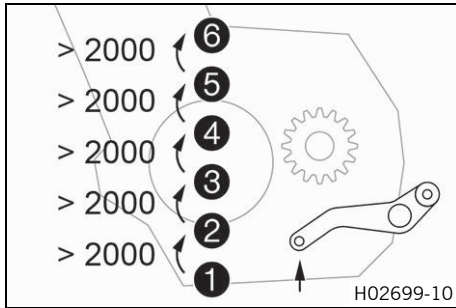

Info

Very important messages are stored in the **Warnings** menu.

- If the ice warning appears in the combination instrument, the roads may be icy. Adjust your speed to the road conditions.
- If the quickshifter + is enabled in the combination instrument, you can shift up in the speed range shown without pulling the clutch lever.



Info

The minimum engine speed before shifting up in revolutions per minute is shown in the figure. Pull the shift lever quickly back to the stop without changing the throttle twist grip position.

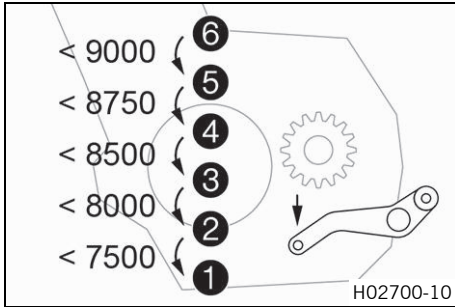

- If the quickshifter + is enabled in the combination instrument, you can shift down in the speed range shown without pulling the clutch lever.



Info

The maximum engine speed before shifting down in revolutions per minute is shown in the figure. Depress the shift lever quickly back to the stop without changing the throttle twist grip position.

10.8 Engine traction torque control (MSR)

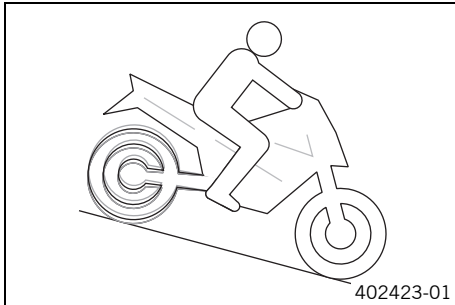

The **MSR** is a function of the engine control. If the engine braking effect is too great, the **MSR** prevents the rear wheel from locking or sliding away on a sloping position. To avoid slip of the rear wheel, the **MSR** only opens the throttle valve as far as absolutely necessary. The **MSR** is applied on surfaces, where the friction is too low to open the slipper clutch. To further increase ride safety, the **MSR** is slope dependent.



Info

When the **ABS** or active ABS mode **Supermoto** is switched off, the **MSR** is not active.

10.9 Applying the brakes



Warning

Danger of accidents Moisture and dirt impair the brake system.

- Brake carefully several times to dry out and remove dirt from the brake linings and the brake discs.



Warning

Danger of accidents A spongy pressure point on the front or rear brake reduces braking efficiency.

- Check the brake system and do not continue riding until the problem is eliminated. (Your authorized KTM workshop will be glad to help.)



Warning

Danger of accidents The brake system fails in the event of overheating.

If the foot brake lever is not released, the brake linings drag continuously.

- Take your foot off the foot brake lever when you are not braking.



Warning

Danger of accidents Higher total weight increases the stopping distance.

- Take the longer stopping distance into account when carrying a passenger or luggage with you.



Warning

Danger of accidents Salt on the roads impairs the brake system.

- Brake carefully several times to remove salt from the brake linings and the brake discs.

**Warning**

Danger of accidents ABS may increase the stopping distance in certain situations.

- Adjust application of the brakes to the respective riding situation and riding surface conditions.

**Warning**

Danger of accidents Excessively forceful application of the brakes blocks the wheels.

The ABS effectiveness is only ensured if it is switched on.

- Leave the ABS switched on in order to benefit from the protective effect.

**Warning**

Danger of accidents The rear wheel can lock due to the engine braking effect.

- Pull in the clutch, if you perform emergency or full braking, or if you brake on a slippery ground.

-
- When braking, release the throttle and apply the front and rear brakes at the same time.

**Info**

When ABS is active, you can achieve maximum braking power even on low grip surfaces such as sandy, wet, or slippery terrain without locking of the tires.

**Warning**

Danger of accidents Banked or laterally sloping ground reduces the maximum possible delay.

- If possible finish braking before going into a bend.

10 RIDING INSTRUCTIONS

- Braking should always be completed before you go into a bend. Change down to a lower gear appropriate to your road speed.
- On long downhill stretches, use the braking effect of the engine. Change down one or two gears, but do not over rev the engine. As a result, you will have to apply the brakes far less frequently and the brake system will not overheat.

10.10 Stopping, parking



Warning

Risk of injury People who act without authorization endanger themselves and others.

- Do not leave the vehicle unattended if the engine is running.
- Protect the vehicle against access by unauthorized persons.
- Lock the steering and remove the ignition key if you leave the vehicle unattended.



Warning

Danger of burns Some vehicle components become very hot when the vehicle is operated.

- Do not touch any parts such as the exhaust system, radiator, engine, shock absorber, or brake system before the vehicle parts have cooled down.
- Let the vehicle parts cool down before you perform any work on the vehicle.

Note

Material damage The vehicle may be damaged by incorrect procedure when parking.

Significant damage may be caused if the vehicle rolls away or falls over.
The components for parking the vehicle are designed only for the weight of the vehicle.

- Park the vehicle on a firm and level surface.
- Ensure that nobody sits on the vehicle when the vehicle is parked on a stand.

Note

Fire hazard Hot vehicle components pose a fire hazard and explosion risk.

- Do not park the vehicle near to materials which are highly flammable or explosive.
- Allow the vehicle to cool down before covering it.

-
- Apply the brakes on the motorcycle.
 - Shift the transmission to neutral position.
 - Switch off the ignition by turning the ignition key to the position ☒.



Info

If the engine is switched off with the emergency OFF switch and the ignition remains switched on at the ignition lock, power continues to flow to most power consumers. This discharges the 12-V battery. You should therefore always switch off the engine with the ignition lock – the emergency OFF switch is intended for emergencies only.

-
- Park the motorcycle on a firm surface.
 - Swing the side stand forward with your foot as far as it will go and lean the vehicle on it.
 - Lock the steering by turning the handlebar fully to the left, pressing down the ignition key to the position ☒ and turning it to the position ☒. To make the steering lock engage more easily, move the handlebar a little to the left and right. Remove the ignition key.



10.11 Transporting

Note

Danger of damage The parked vehicle can roll away or fall over.

- Park the vehicle on a firm and level surface.

Note

Fire hazard Hot vehicle components pose a fire hazard and explosion risk.

- Do not park the vehicle near to materials which are highly flammable or explosive.
- Allow the vehicle to cool down before covering it.

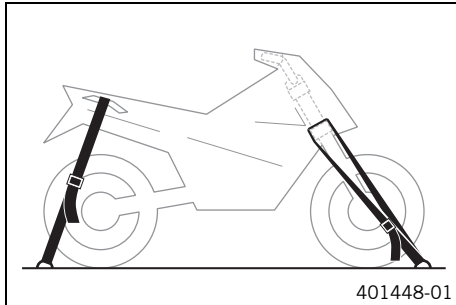

- Switch off the engine.
- Use tension belts or other suitable devices to secure the motorcycle against falling over or rolling away.

10.12 Refueling



Danger

Fire hazard Fuel is highly flammable.

The fuel in the fuel tank expands when warm and can escape if overfilled.

- Do not refuel the vehicle in the vicinity of open flames or lit cigarettes.
- Switch off the engine for refueling.
- Make sure that no fuel is spilled; particularly not on hot parts of the vehicle.
- If any fuel is spilled, wipe it off immediately.
- Observe the specifications for refueling.



Warning

Danger of poisoning Fuel is poisonous and a health hazard.

- Avoid skin, eye and clothing contact with fuel.
- Immediately consult a doctor if you swallow fuel.
- Do not inhale fuel vapors.
- In case of skin contact, rinse the affected area with plenty of water.
- Rinse the eyes thoroughly with water, and consult a doctor in case of fuel contact with the eyes.
- Change your clothing in case of fuel spills on them.

Note

Material damage Inadequate fuel quality causes the fuel filter to quickly become clogged.

10 RIDING INSTRUCTIONS

In some countries and regions, the available fuel quality and cleanliness may not be sufficient. This will result in problems with the fuel system.

- Refuel only with clean fuel that meets the specified standards. (Your authorized KTM workshop will be glad to help.)



Note

Environmental hazard Improper handling of fuel is a danger to the environment.

- Do not allow fuel to enter the groundwater, the soil, or the sewage system.
-

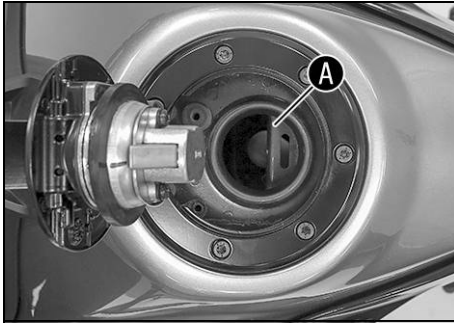

- Switch off the engine.
- Open fuel tank filler cap. (📖 p. 35)
- Fill the fuel tank with fuel up to the lower edge **A** of the filler neck.

Total fuel tank capacity, approx.	14 l (3.7 US gal)	Super unleaded (ROZ 95/RON 95/PON 91) (📖 p. 273)
-----------------------------------	----------------------	---

- Close the fuel tank filler cap. (📖 p. 37)



V01463-10

11 SERVICE SCHEDULE









11.1 Additional information

Any further work that results from the compulsory work or from the recommended work must be ordered separately and invoiced separately.

Different service intervals may apply in your country, depending on the local operating conditions.

Individual service intervals and scopes may change in the course of technical developments. The most up-to-date service schedule can always be found on KTM Dealer.net. Your authorized KTM dealer will be happy to advise you.

11.2 Required work

	Every two years				
	Every year				
	every 30,000 km (18,600 mi)				
	every 15,000 km (9,300 mi)				
	after 1,000 km (620 mi)				
Read out the fault memory using the KTM diagnostics tool. 	○	●	●	●	●
Program shift shaft sensor. 	○	●	●	●	●
Check that the electrical system is functioning properly. 	○	●	●	●	●
Change the engine oil and oil filter and clean the oil screens.   p. 230	○	●	●	●	●
Check the front brake linings.  p. 158	○	●	●	●	●
Check the rear brake linings.  p. 164	○	●	●	●	●
Check the brake discs.  p. 153	○	●	●	●	●
Check the brake lines for damage and leakage. 	○	●	●	●	●

	Every two years				
	Every year				
	every 30,000 km (18,600 mi)				
	every 15,000 km (9,300 mi)				
	after 1,000 km (620 mi)				
Check the front brake fluid level. (📖 p. 155)	○	●	●	●	●
Check the rear brake fluid level. (📖 p. 161)	○	●	●	●	●
Change the front brake fluid. 🛠️					●
Change the rear brake fluid. 🛠️					●
Check the free travel of the clutch lever. (📖 p. 236)	○	●	●	●	●
Check the free travel of the foot brake lever. (📖 p. 160)	○	●	●	●	●
Check the shock absorber and fork for leaks. Perform fork service as needed and depending on how the vehicle is used. 🛠️	○	●	●	●	●
Clean the dust boots of the fork legs. 🛠️ (📖 p. 134)		●	●		
Check steering head bearing play. 🛠️	○	●	●	●	●
Check the tire condition. (📖 p. 180)	○	●	●	●	●
Check tire pressure. (📖 p. 182)	○	●	●	●	●
Check the chain, rear sprocket, engine sprocket, and chain guide. (📖 p. 147)		●	●	●	●
Check the chain tension. (📖 p. 143)	○	●	●	●	●
Change the spark plugs. 🛠️			●		
Check the valve clearance. 🛠️			●		
Check the antifreeze and coolant level. (📖 p. 213)	○	●	●	●	●

11 SERVICE SCHEDULE

		Every two years			
		Every year			
	every 30,000 km (18,600 mi)				
	every 15,000 km (9,300 mi)				
	after 1,000 km (620 mi)				
Check the cables for damage and for routing without kinks. 🐾		●	●	●	●
Change the air filter, clean the air filter box. 🐾		●	●		
Check fuel pressure and absorbing elements of the fuel tank bracket. 🐾		●	●	●	●
Check the headlight setting. (📖 p. 208)	○	●	●		
Check that the radiator fan is functioning properly. 🐾	○	●	●	●	●
Final check: Check the vehicle is roadworthy and take a test ride. 🐾	○	●	●	●	●
Read out the fault memory using the KTM diagnostics tool after a test ride. 🐾	○	●	●	●	●
Set the service interval display. 🐾	○	●	●	●	●
Make the service entry in KTM Dealer.net and in the Service & Manufacturer Warranty Booklet. 🐾	○	●	●	●	●

- One-time interval
- Periodic interval

11.3 Recommended work

	Every four years				
	Every year				
	every 30,000 km (18,600 mi)				
	every 15,000 km (9,300 mi)				
	after 1,000 km (620 mi)				
Check the frame. 🛠️				•	
Check the swingarm. 🛠️				•	
Check/clean the oil nozzle for clutch lubrication. 🛠️	○	•	•		
Check the fork bearing for play. 🛠️		•	•		
Check the wheel bearing for play. 🛠️		•	•		
Change the coolant. (📖 p. 221)					•
Empty the drainage hoses. 🛠️	○	•	•	•	•
Check all hoses (e.g. fuel, cooling, bleeder, drainage hoses, etc.) and sleeves for cracking, tightness, and correct routing. 🛠️		•	•	•	•
Grease all moving parts (e.g. side stand, hand lever, chain, etc.) and check for smooth operation. 🛠️	○	•	•	•	•
Check the screws and nuts for tightness. 🛠️	○	•	•	•	•

- One-time interval
- Periodic interval

12 TUNING THE CHASSIS

12.1 Adjusting the spring preload of the shock absorber



Warning

Danger of accidents Modifications to the suspension setting may seriously alter the handling characteristic.

- Ride slowly to start with after making adjustments to get the feel of the new handling characteristic.



Info

The spring preload defines the initial status of the spring operation on the shock absorber. The best spring preload setting is achieved when it is set for the weight of the rider and that of any luggage and a passenger, thus ensuring an ideal compromise between handling and stability.

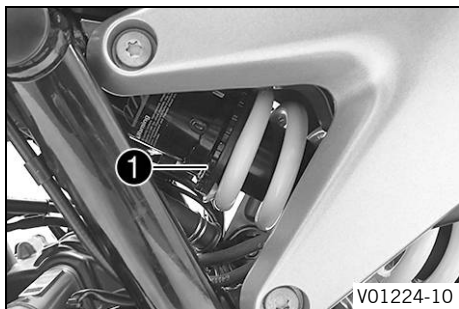

- Set the spring preload by turning at the adjusting device **1** using the hook wrench from the tool set.

Guideline

Spring preload	
Standard	5 clicks



Info

The spring preload can be set to 10 different positions.

13.1 Raising the motorcycle with the rear lifting gear

Note

Danger of damage The parked vehicle can roll away or fall over.

- Park the vehicle on a firm and level surface.

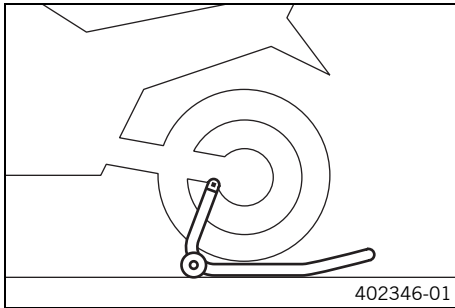

- Mount the supports of the lifting gear.
- Insert the adapter in the rear lifting gear.

Retaining adapter (63529955000)

Rear wheel work stand (69329955000)

- Stand the motorcycle upright, align the lifting gear to the swingarm and the adapters, and raise the motorcycle.



13.2 Removing the rear of the motorcycle from the lifting gear

Note

Danger of damage The parked vehicle can roll away or fall over.

- Park the vehicle on a firm and level surface.

13 SERVICE WORK ON THE CHASSIS

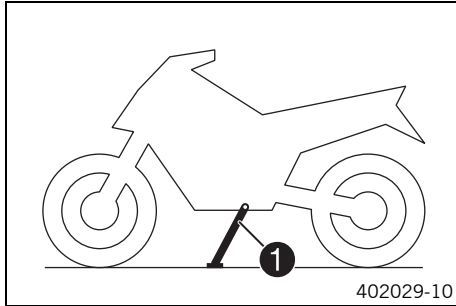

- Secure the motorcycle against falling over.
- Remove the rear lifting gear and lean the vehicle on side stand ①.

13.3 Lifting the motorcycle with the front lifting gear

Note

Danger of damage The parked vehicle can roll away or fall over.

- Park the vehicle on a firm and level surface.

Preparatory work

- Raise the motorcycle with the rear lifting gear. (📖 p. 131)

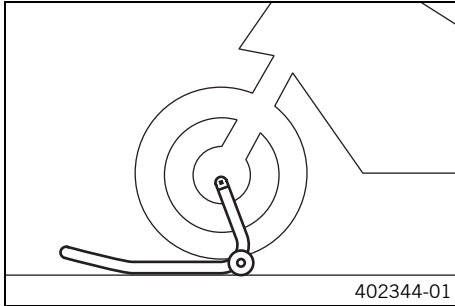

Main work

- Move the handlebar to the straight-ahead position. Align the lifting gear at the front with the adapters to the fork legs.

Front wheel work stand, small (61129965100)



Info

Always raise the motorcycle at the rear first.

- Lift the motorcycle at the front.



13.4 Taking the motorcycle off the front lifting gear

Note

Danger of damage The parked vehicle can roll away or fall over.

- Park the vehicle on a firm and level surface.

13 SERVICE WORK ON THE CHASSIS

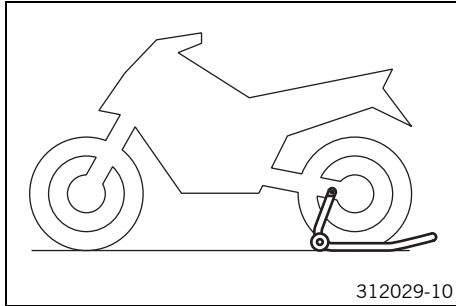

- Secure the motorcycle against falling over.
- Remove the front lifting gear.

13.5 Cleaning the dust boots of the fork legs

Preparatory work

- Raise the motorcycle with the rear lifting gear. (📖 p. 131)
- Lift the motorcycle with the front lifting gear. (📖 p. 132)

Main work

- Push dust boots ❶ of both fork legs downward.

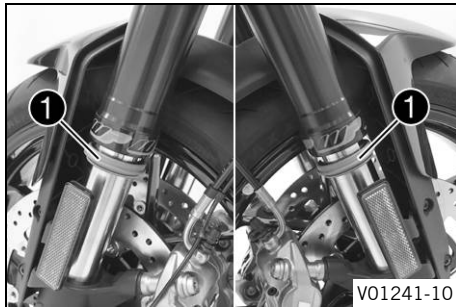

Info

The dust boots remove dust and coarse dirt particles from the inside fork tubes. Over time, dirt can accumulate behind the dust boots. If this dirt is not removed, the oil seals behind can start to leak.



Warning

Danger of accidents Oil or grease on the brake discs reduces the braking effect.

- Always keep the brake discs free of oil and grease.
- Clean the brake discs with brake cleaner when necessary.

- Clean and oil the dust boots and inner fork tubes of both fork legs.

Universal oil spray (📖 p. 275)

- Press the dust boots back into their installation position.
- Remove excess oil.

Finishing work

- Take the motorcycle off the front lifting gear. (📖 p. 133)
- Remove the rear of the motorcycle from the lifting gear. (📖 p. 131)



13 SERVICE WORK ON THE CHASSIS

13.6 Removing the passenger seat

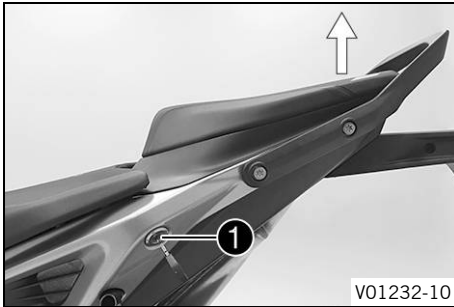

- Insert the ignition key in seat lock ① and turn it clockwise.
- Raise the rear of the passenger seat cover, push it toward the rear, and remove it upward.
- Remove the ignition key from the seat lock.

13.7 Mounting the passenger seat

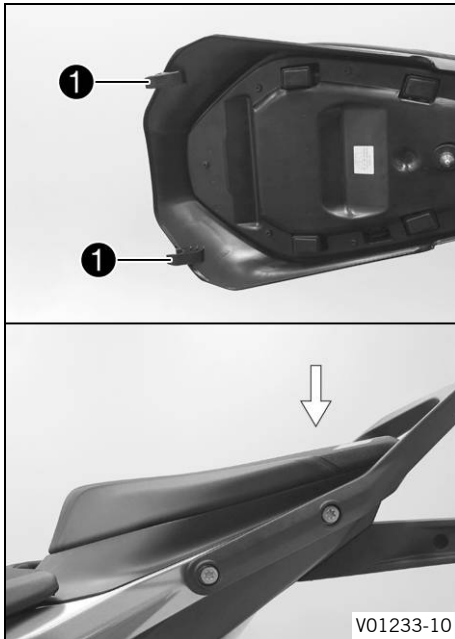

- Hook holding lugs ① of the passenger seat onto the storage compartment, lower the rear and push forward.
- Press passenger seat downward until it clicks into place.



Warning

Danger of accidents The seat can come loose from the anchoring if it is not mounted correctly.

- After assembly, check whether the seat is correctly locked and cannot be pulled up.
-
- Finally, check that the passenger seat is correctly mounted.



13.8 Removing the front rider's seat

Preparatory work

- Remove the passenger seat. (📖 p. 136)

Main work

- Remove screws ❶.
- Raise the rear of the front rider's seat, pull the seat back, and lift it off.

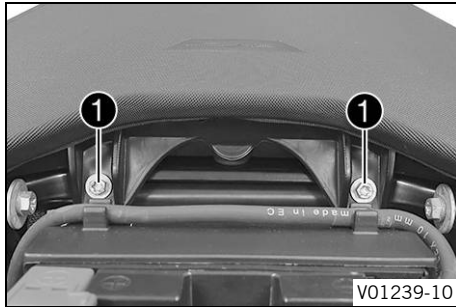

13.9 Mounting the front rider's seat

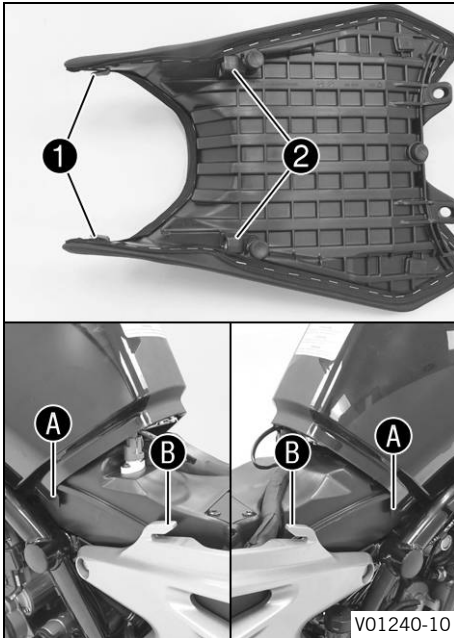

Main work

- Push the front rider's seat forward and lower at the rear.
 - ✓ The holding lugs ① engage in the loops ①A on the tank.
 - ✓ The holding lugs ② engage in the loops ②B on the frame.

13 SERVICE WORK ON THE CHASSIS

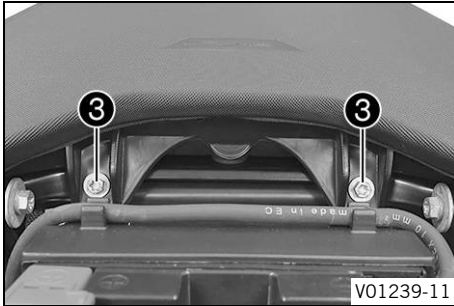

- Mount and tighten screws ③.

Guideline

Remaining screws, chassis	M6	10 Nm (7.4 lbf ft)
------------------------------	----	--------------------

- Finally, check that the front rider's seat is correctly mounted.

Finishing work

- Mount the passenger seat. (📖 p. 137)

13.10 Checking the chain for dirt

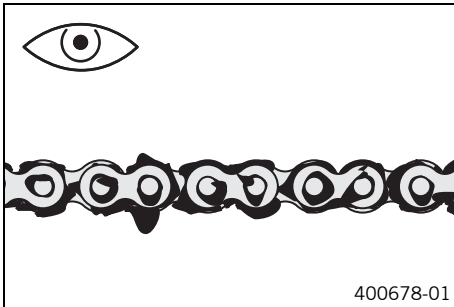

- Check the chain for heavy soiling.
 - » If the chain is very dirty:
 - Clean the chain. (📖 p. 141)

13.11 Cleaning the chain



Warning

Danger of accidents Lubricants on the tires reduces the road grip.

- Remove lubricants from the tires using a suitable cleaning agent.



Warning

Danger of accidents Oil or grease on the brake discs reduces the braking effect.

- Always keep the brake discs free of oil and grease.
- Clean the brake discs with brake cleaner when necessary.



Note

Environmental hazard Hazardous substances cause environmental damage.

- Dispose of oils, grease, filters, fuel, cleaning agents, brake fluid, etc., correctly and in compliance with the applicable regulations.



Info

The service life of the chain depends largely on its maintenance.

Preparatory work

- Raise the motorcycle with the rear lifting gear. (📖 p. 131)

13 SERVICE WORK ON THE CHASSIS

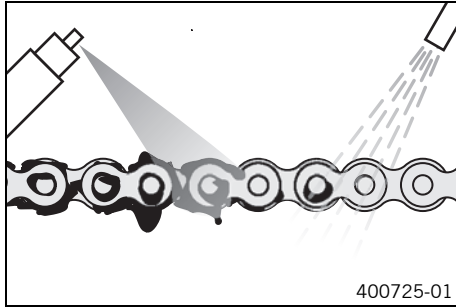

Main work

- Rinse off loose dirt with a soft jet of water.
- Remove old grease residue with chain cleaner.

Chain cleaner (📖 p. 274)

- After drying, apply chain spray.

Street chain spray (📖 p. 275)

Finishing work

- Remove the rear of the motorcycle from the lifting gear.
(📖 p. 131)

13.12 Checking the chain tension



Warning

Danger of accidents Incorrect chain tension damages components and results in accidents.

If the chain is tensioned too much, the chain, engine sprocket, rear sprocket, transmission and rear wheel bearings wear more quickly. Some components may break if overloaded.

If the chain is too loose, the chain may fall off the engine sprocket or the rear sprocket. As a result, the rear wheel locks or the engine will be damaged.

- Check the chain tension regularly.
- Set the chain tension in accordance with the specification.

Preparatory work

- Raise the motorcycle with the rear lifting gear. (📖 p. 131)

13 SERVICE WORK ON THE CHASSIS

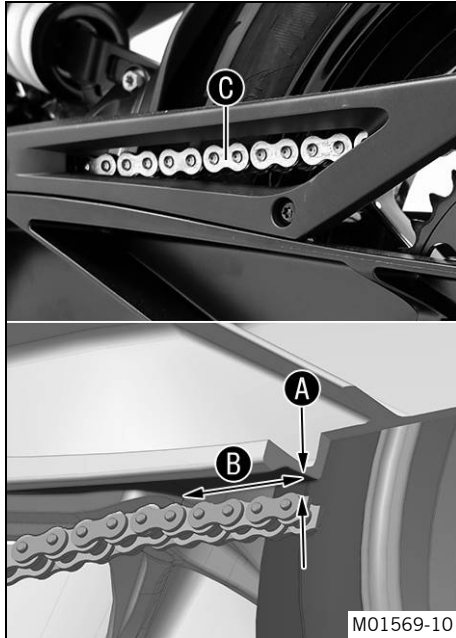

Main work

- Shift the transmission to neutral position.
- Push the chain behind the chain sliding piece up and determine the chain tension **A** between the swingarm and the upper edge of the chain.

Guideline

Distance B from the chain sliding piece	2.5 cm (0.98 in)
--	------------------

Measure the distance from the flat part of the swingarm directly above the chain, not from the edge of the swingarm.

i Info

Top chain section **C** must be taut.
Chain wear is not always even. Repeat this measurement at different chain positions.

Chain tension	2 ... 5 mm (0.08 ... 0.2 in)
---------------	------------------------------

- » If the chain tension does not meet the specification:
 - Adjust the chain tension. (📖 p. 145)

Finishing work

- Remove the rear of the motorcycle from the lifting gear. (📖 p. 131)

13.13 Adjusting the chain tension



Warning

Danger of accidents Incorrect chain tension damages components and results in accidents.

If the chain is tensioned too much, the chain, engine sprocket, rear sprocket, transmission and rear wheel bearings wear more quickly. Some components may break if overloaded.

If the chain is too loose, the chain may fall off the engine sprocket or the rear sprocket. As a result, the rear wheel locks or the engine will be damaged.

- Check the chain tension regularly.
- Set the chain tension in accordance with the specification.

Preparatory work

- Raise the motorcycle with the rear lifting gear. (📖 p. 131)
- Check the chain tension. (📖 p. 143)

13 SERVICE WORK ON THE CHASSIS

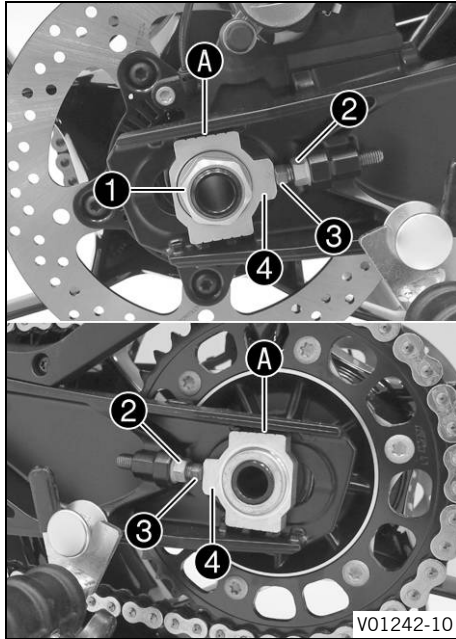

Main work

- Loosen nut ①.
- Loosen nuts ②.
- Adjust the chain tension by turning adjusting screws ③ left and right.

Guideline

Chain tension	2 ... 5 mm (0.08 ... 0.2 in)
Turn the adjusting screws ③ on the left and right so that the markings on the left and right chain adjusters ④ are in the same position relative to the reference marks ④. The rear wheel is then correctly aligned.	

Info

The top chain section must be taut.
Chain wear is not always even. Repeat this measurement at different chain positions.

- Tighten nuts ②.
- Make sure that chain adjusters ④ are fitted correctly on adjusting screws ③.
- Tighten nut ①.

Guideline

Nut, rear wheel spindle	M25x1.5	90 Nm (66.4 lbf ft) Thread and contact area of wheel spindle greased
-------------------------	---------	---

Finishing work

- Check the chain tension. (📖 p. 143)
- Remove the rear of the motorcycle from the lifting gear. (📖 p. 131)



13.14 Checking the chain, rear sprocket, engine sprocket, and chain guide

Preparatory work

- Raise the motorcycle with the rear lifting gear. (📖 p. 131)

Main work

- Check the rear sprocket and engine sprocket for wear.
 - » If the rear sprocket and engine sprocket are worn:
 - Change the drivetrain kit. 🛠️



Info

The engine sprocket, rear sprocket, and chain should always be replaced together.

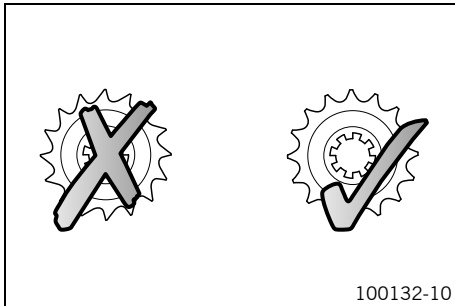

13 SERVICE WORK ON THE CHASSIS

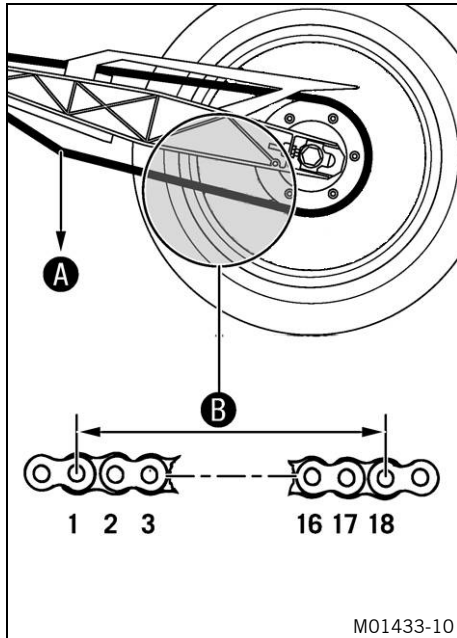

- Shift the transmission to neutral position.
- Pull on the lower chain section with the specified weight **A**.

Guideline

Weight of chain wear measurement

15 kg (33 lb.)

- Measure distance **B** of 18 chain rollers in the lower chain section.



Info

Chain wear is not always even. Repeat this measurement at different chain positions.

Maximum distance B from 18 chain rollers at the longest chain section
--

272 mm (10.71 in)

- » If distance **B** is greater than the specified measurement:
 - Change the drivetrain kit. 🔧



Info

When a new chain is mounted, the rear sprocket and engine sprocket should also be changed. New chains wear out faster on old, worn sprockets. For safety reasons, the chain has no chain joint.

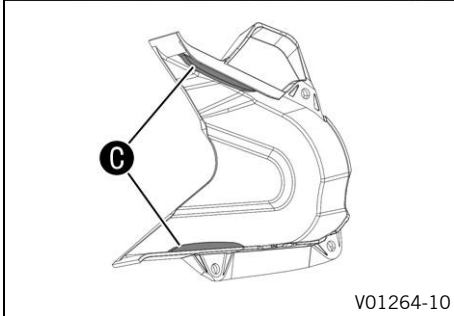
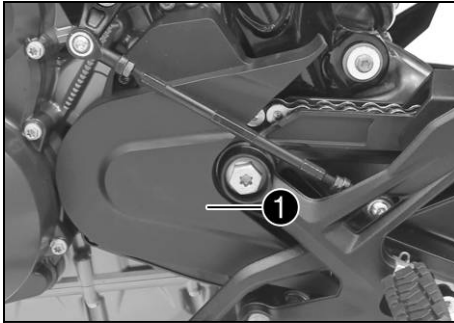

- Check the engine sprocket cover **1** for wear.
 - » If the engine sprocket cover is highly worn in the marked area **C**:
 - Change the engine sprocket cover. 🛠️
- Check the engine sprocket cover **1** for tightness.
 - » If the engine sprocket cover is loose:
 - Tighten the screws on the engine sprocket cover.

Guideline

Screw, engine sprocket cover	M5	5 Nm (3.7 lbf ft) Loctite®243™
------------------------------	----	--

13 SERVICE WORK ON THE CHASSIS

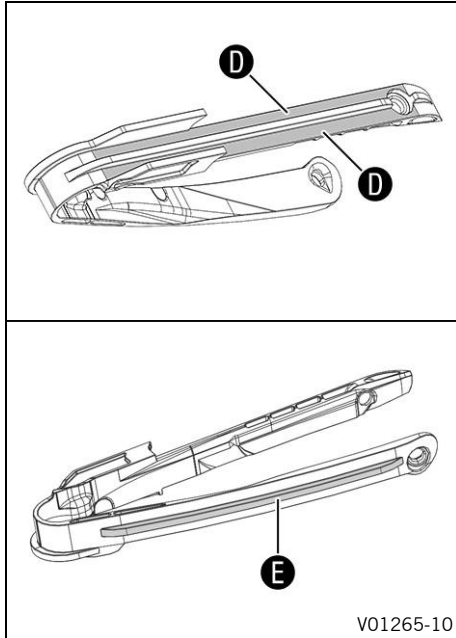

- Check the chain sliding guard for wear.
 - » If continuous signs of wear to the chain are visible on the chain sliding guard in the area **D** marked:
 - Replace the chain sliding guard. 🛠️
 - » If the chain sliding guard is highly worn on the underside in the marked area **E**:
 - Replace the chain sliding guard. 🛠️
- Check that the chain sliding guard is firmly seated.
 - » If the chain sliding guard is loose:
 - Tighten the screws on the chain sliding guard.

Guideline

Remaining screws, chassis	M5	5 Nm (3.7 lbf ft)
---------------------------	----	-------------------

Finishing work

- Remove the rear of the motorcycle from the lifting gear.
(📖 p. 131)

14.1 Anti-lock braking system (ABS)

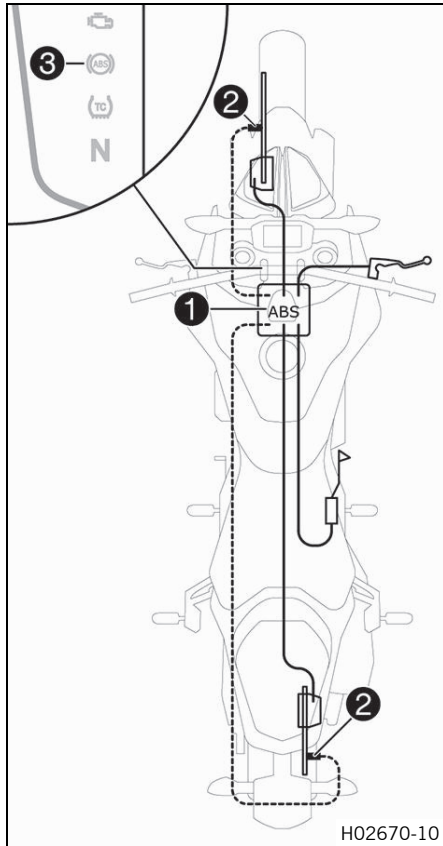

The ABS module ①, which consists of a hydraulic unit, ABS control unit, and return pump, is installed under the fuel tank. One wheel speed sensor ② is located in each case on the front and the rear wheel.

**Warning**

Danger of accidents Changes to the vehicle impair the function of the ABS.

- Only allow the rear wheel to spin with the front brake applied away from public road traffic if the ABS is switched off.
- Do not make any changes to the suspension travel.
- Only use spare parts on the brake system which have been approved and recommended by KTM.
- Only use tires/wheels approved by KTM with the corresponding speed index.
- Maintain the specified tire pressure.
- Service work and repairs must be performed professionally. (Your authorized KTM workshop will be glad to help.)

Note

Voiding of the government approval for road use and the insurance coverage If the ABS is switched off completely, the vehicle's approval for road use is invalidated.

- Only operate the vehicle in closed-off areas remote from public road traffic if the ABS is switched off completely.
-

The ABS is a safety system that prevents locking of the wheels when driving straight ahead without the influence of lateral forces.



Warning

Danger of accidents Driving aids can only prevent a rollover within the physical limitations.

It is not always possible to compensate for extreme riding situations, for example with luggage loaded with a high center of gravity, varying road surfaces, steep descents or full braking without disengaging the gear.

- Adapt your riding style to the road conditions and your driving ability.
-

The ABS operates with two independent brake circuits (front and rear brakes). During normal operation, the brake system operates like a conventional brake system without ABS. When the ABS control unit detects a locking tendency in a wheel, ABS begins reg-

ulating the brake pressure. The control function causes a slight pulsing of the hand and foot brake levers.

The ABS warning lamp  must light up after the ignition is switched on and go out after starting off. If it does not go out after starting off or if it lights up while riding, this indicates a fault in the ABS system. In this case, the ABS is no longer enabled and the wheels may lock during braking. The brake system itself stays functional; only ABS control is not available.

The ABS warning lamp may also light up if the rotating speeds of the front and rear wheels differ greatly under extreme riding conditions, for example when making "wheelies" or if the rear wheel spins. This causes the ABS to switch off.

To reactivate the ABS, stop the vehicle and switch off the ignition. The ABS is reactivated when the vehicle is switched on again. The ABS warning lamp goes out after starting off.

14.2 Checking the brake discs



Warning

Danger of accidents Worn-out brake discs reduce the braking effect.

- Make sure that worn-out brake discs are replaced immediately. (Your authorized KTM workshop will be glad to help.)

14 BRAKE SYSTEM

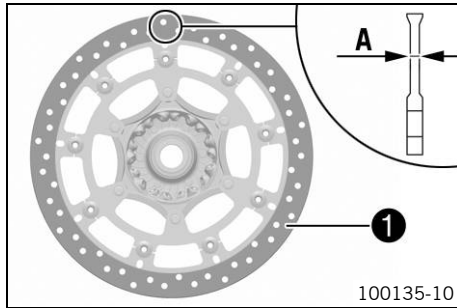

- Check the front and rear brake disc thickness at multiple points for the dimension **A**.



Info

Wear will reduce the thickness of the brake disc at contact surface **1** of the brake linings.

Brake discs - wear limit	
front	4.5 mm (0.177 in)
rear	4.5 mm (0.177 in)

- » If the brake disc thickness is less than the specified value.
 - Change the front brake discs. 🛠️
 - Change the rear brake disc. 🛠️
- Check the front and rear brake discs for damage, cracking, and deformation.
 - » If the brake disc exhibits damage, cracking, or deformation:
 - Change the front brake discs. 🛠️
 - Change the rear brake disc. 🛠️

14.3 Checking the front brake fluid level



Warning

Danger of accidents An insufficient brake fluid level will cause the brake system to fail.

If the brake fluid level drops below the specified marking or the specified value, the brake system is leaking or the brake linings are worn down.

- Check the brake system and do not continue riding until the problem is eliminated. (Your authorized KTM workshop will be glad to help.)



Warning

Danger of accidents Old brake fluid reduces the braking effect.

- Make sure that brake fluid for the front and rear brake is changed in accordance with the service schedule. (Your authorized KTM workshop will be glad to help.)

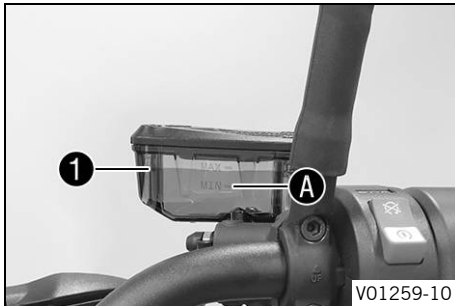

- Move the brake reservoir mounted on the handlebar to a horizontal position.
- Check the brake fluid level in brake fluid reservoir ①.
 - » If the brake fluid level has dropped below **MIN** marking ①:
 - Add front brake fluid. 📖 (p. 156)



14.4 Adding front brake fluid



Warning

Danger of accidents An insufficient brake fluid level will cause the brake system to fail.

If the brake fluid level drops below the specified marking or the specified value, the brake system is leaking or the brake linings are worn down.

- Check the brake system and do not continue riding until the problem is eliminated. (Your authorized KTM workshop will be glad to help.)



Warning

Skin irritation Brake fluid causes skin irritation.

- Keep brake fluid out of the reach of children.
- Wear suitable protective clothing and safety glasses.
- Do not allow brake fluid to come into contact with the skin, the eyes or clothing.
- Consult a doctor immediately if brake fluid has been swallowed.
- Rinse the affected area with plenty of water in the event of contact with the skin.
- Rinse eyes thoroughly with water immediately and consult a doctor if brake fluid comes into contact with the eyes.
- If brake fluid spills on to your clothing, change the clothing.

**Warning**

Danger of accidents Old brake fluid reduces the braking effect.

- Make sure that brake fluid for the front and rear brake is changed in accordance with the service schedule. (Your authorized KTM workshop will be glad to help.)

**Note**

Environmental hazard Hazardous substances cause environmental damage.

- Dispose of oils, grease, filters, fuel, cleaning agents, brake fluid, etc., correctly and in compliance with the applicable regulations.

**Info**

Never use DOT 5 brake fluid. It is silicone-based and purple in color. Oil seals and brake lines are not designed for DOT 5 brake fluid.

Avoid contact between brake fluid and painted parts. Brake fluid attacks paint.

Only use clean brake fluid from a sealed container.

Preparatory work

- Check the front brake linings. (📖 p. 158)

14 BRAKE SYSTEM

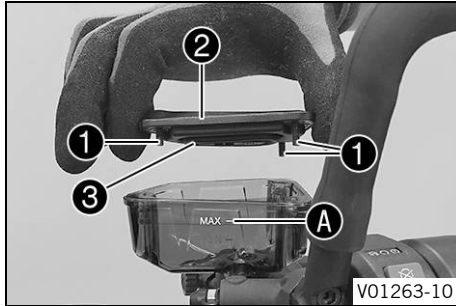

Main work

- Move the brake reservoir mounted on the handlebar to a horizontal position.
- Remove screws ❶.
- Take off cover ❷ with membrane ❸.
- Add brake fluid up to **MAX** marking **A**.

Brake fluid DOT 4 / DOT 5.1 (📖 p. 271)

- Position cover ❷ with membrane ❸.
- Mount and tighten screws ❶.



Info

Clean up overflowed or spilled brake fluid immediately with water.

14.5 Checking the front brake linings



Warning

Danger of accidents Worn-out brake linings reduce the braking effect.

- Ensure that worn-out brake linings are replaced immediately. (Your authorized KTM workshop will be glad to help.)



Warning

Danger of accidents Damaged brake discs reduce the braking effect.

If the brake linings are not changed in time, the brake lining carriers grind against the brake disc. As a consequence, the braking effect is greatly reduced and the brake discs are destroyed.

- Check the brake linings regularly.

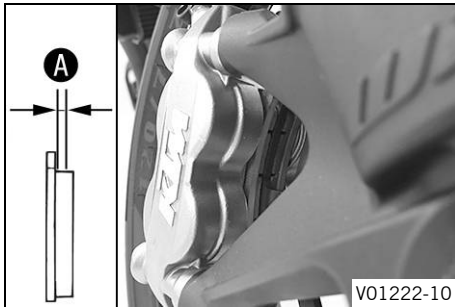

- Check the brake linings for minimum thickness **A**.

Minimum thickness A	$\geq 1 \text{ mm } (\geq 0.04 \text{ in})$
----------------------------	---

- » If the minimum thickness is less than specified:
 - Change the front brake linings. 🛠️
- Check the brake linings for damage and cracking.
 - » If there is damage or cracking:
 - Change the front brake linings. 🛠️

14.6 Checking the free travel of the foot brake lever



Warning

Danger of accidents The brake system fails in the event of overheating.

If there is no free travel on the foot brake lever, pressure builds up in the brake system on the rear brake.

- Set the free travel on the foot brake lever in accordance with the specification.

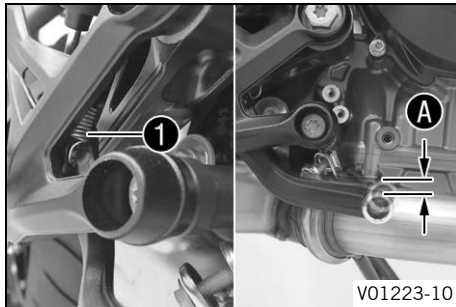

- Detach spring ①.
- Move the foot brake lever back and forth between the end stop and the contact to the foot brake cylinder piston and check free travel ①.

Guideline

Free travel at foot brake lever	3 ... 5 mm (0.12 ... 0.2 in)
---------------------------------	------------------------------

- » If the free travel does not match the specification:
 - Adjust the basic position of the foot brake lever. 🛠️ (📖 p. 95)
- Attach spring ①.

14.7 Checking the rear brake fluid level



Warning

Danger of accidents An insufficient brake fluid level will cause the brake system to fail.

If the brake fluid level drops below the **MIN** marking, the brake system is leaking or the brake linings are worn down.

- Check the brake system and do not continue riding until the problem is eliminated. (Your authorized KTM workshop will be glad to help.)



Warning

Danger of accidents Old brake fluid reduces the braking effect.

- Make sure that brake fluid for the front and rear brake is changed in accordance with the service schedule. (Your authorized KTM workshop will be glad to help.)

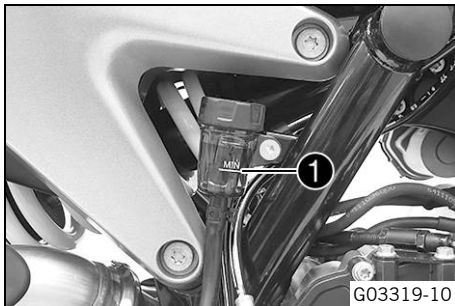

- Stand the vehicle upright.
- Check the brake fluid level in the brake fluid reservoir.
 - » If the fluid level reaches the **MIN** marking ①:
 - Add rear brake fluid. 🛠️ (📖 p. 162)

14.8 Adding rear brake fluid



Warning

Danger of accidents An insufficient brake fluid level will cause the brake system to fail.

If the brake fluid level drops below the **MIN** marking, the brake system is leaking or the brake linings are worn down.

- Check the brake system and do not continue riding until the problem is eliminated. (Your authorized KTM workshop will be glad to help.)



Warning

Skin irritation Brake fluid causes skin irritation.

- Keep brake fluid out of the reach of children.
- Wear suitable protective clothing and safety glasses.
- Do not allow brake fluid to come into contact with the skin, the eyes or clothing.
- Consult a doctor immediately if brake fluid has been swallowed.
- Rinse the affected area with plenty of water in the event of contact with the skin.
- Rinse eyes thoroughly with water immediately and consult a doctor if brake fluid comes into contact with the eyes.
- If brake fluid spills on to your clothing, change the clothing.

**Warning**

Danger of accidents Old brake fluid reduces the braking effect.

- Make sure that brake fluid for the front and rear brake is changed in accordance with the service schedule. (Your authorized KTM workshop will be glad to help.)

**Note**

Environmental hazard Hazardous substances cause environmental damage.

- Dispose of oils, grease, filters, fuel, cleaning agents, brake fluid, etc., correctly and in compliance with the applicable regulations.

**Info**

Never use DOT 5 brake fluid. It is silicone-based and purple in color. Oil seals and brake lines are not designed for DOT 5 brake fluid.

Avoid contact between brake fluid and painted parts. Brake fluid attacks paint.

Only use clean brake fluid from a sealed container.

Preparatory work

- Check the rear brake linings. (📖 p. 164)

14 BRAKE SYSTEM

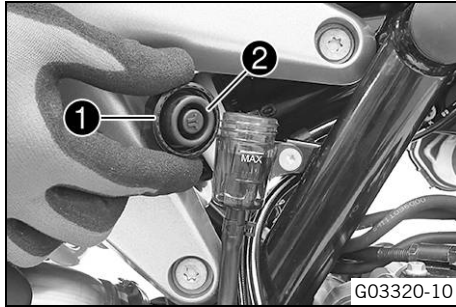

Main work

- Stand the vehicle upright.
- Remove screw cap ① with insert and membrane ②.
- Add brake fluid up to the **MAX** marking.

Brake fluid DOT 4 / DOT 5.1 (📖 p. 271)

- Mount and tighten screw cap with insert and membrane.



Info

Clean up overflowed or spilled brake fluid immediately with water.

14.9 Checking the rear brake linings



Warning

Danger of accidents Worn-out brake linings reduce the braking effect.

- Ensure that worn-out brake linings are replaced immediately. (Your authorized KTM workshop will be glad to help.)



Warning

Danger of accidents Damaged brake discs reduce the braking effect.

If the brake linings are not changed in time, the brake lining carriers grind against the brake disc. As a consequence, the braking effect is greatly reduced and the brake discs are destroyed.

- Check the brake linings regularly.

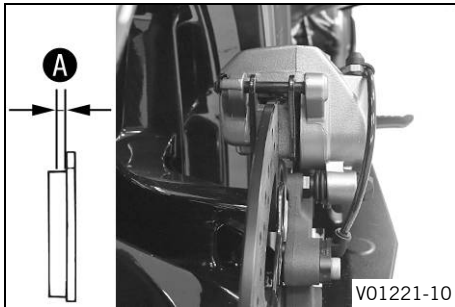

- Check the brake linings for minimum thickness **A**.

Minimum thickness A	$\geq 1 \text{ mm } (\geq 0.04 \text{ in})$
----------------------------	---

- » If the minimum thickness is less than specified:
 - Change the rear brake linings. 🛠️
- Check the brake linings for damage and cracking.
 - » If there is wear or tearing:
 - Change the rear brake linings. 🛠️

15.1 Removing the front wheel

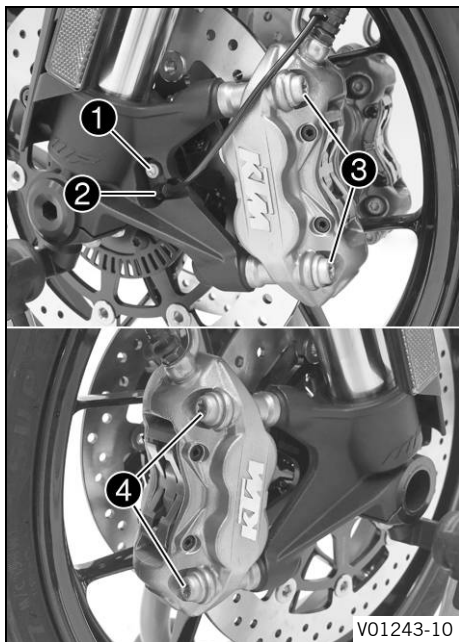

Preparatory work

- Raise the motorcycle with the rear lifting gear. (📖 p. 131)
- Lift the motorcycle with the front lifting gear. (📖 p. 132)

Main work

- Remove screw **1** and pull wheel speed sensor **2** out of the hole.
- Remove screws **3**.
- Press back the brake linings by slightly tilting the left brake caliper laterally on the brake disc. Pull the left brake caliper carefully back from the brake disc and hang to the side.



Info

Do not operate the hand brake lever if the brake caliper has been removed.

- Remove screws **4**.
- Press back the brake linings by slightly tilting the right brake caliper laterally on the brake disc. Pull the right brake caliper carefully back from the brake disc and hang to the side.



Info

Do not operate the hand brake lever if the brake caliper has been removed.

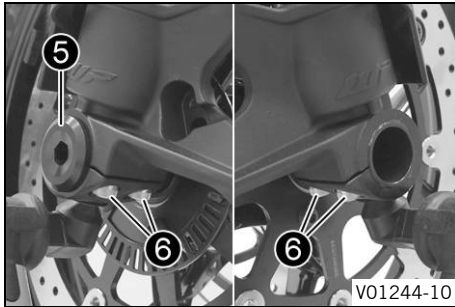

- Loosen screw 5 by several rotations.
- Loosen screws 6.
- Press on screw 5 to push the wheel spindle out of the axle clamp.
- Remove screw 5.



Warning

Danger of accidents Damaged brake discs reduce the braking effect.

- Always lay the wheel down in such a way that the brake discs are not damaged.

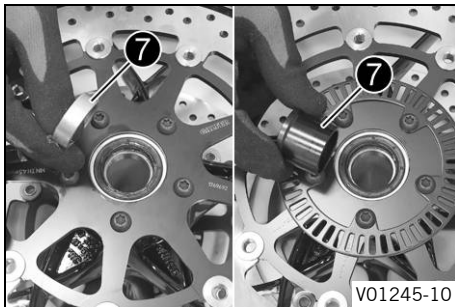

- Hold the front wheel and remove the wheel spindle. Take the front wheel out of the fork.
- Remove spacers 7.

15.2 Installing the front wheel 🛠️



Warning

Danger of accidents Oil or grease on the brake discs reduces the braking effect.

- Always keep the brake discs free of oil and grease.
- Clean the brake discs with brake cleaner when necessary.

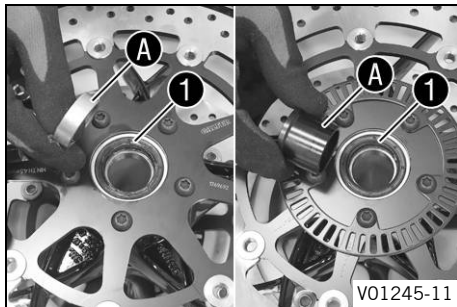

- Check the wheel bearing for damage and wear.
 - » If the wheel bearing is damaged or worn:
 - Change front wheel bearing. 🛠️
- Clean and grease shaft seal rings **1** and contact surfaces **A** of the spacers.

Long-life grease (📖 p. 274)



- Insert wide spacer ② on the left in the direction of travel.
- Insert narrow spacer ③ on the right in the direction of travel.



Info

Arrow ① indicates the direction of travel of the front wheel.

The ABS sensor wheel is on the left viewed in the direction of travel.

15 WHEELS, TIRES

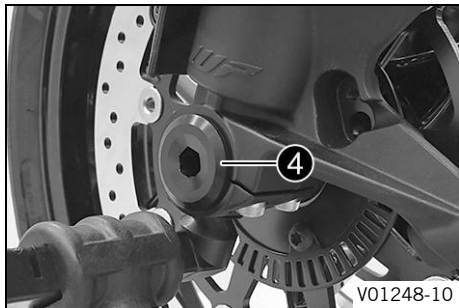

- Clean screw ④ and the wheel spindle.
- Grease wheel spindle lightly.

Long-life grease (📖 p. 274)

- Jack up the front wheel into the fork, position it, and insert the wheel spindle.
- Mount and tighten screw ④.

Guideline

Screw, front wheel spindle	M25x1.5	45 Nm (33.2 lbf ft) Thread greased
----------------------------	---------	---------------------------------------

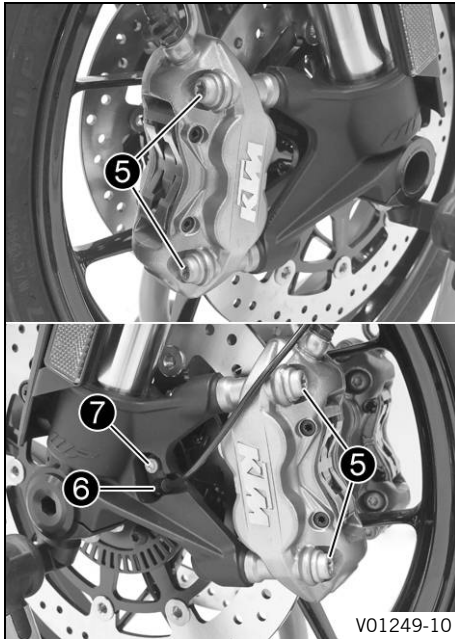

- Position both brake calipers.
- ✓ The brake linings are correctly positioned.
- Mount screws **5** on both sides but do not tighten yet.

Guideline

Screw, front brake caliper	M10x1.25	45 Nm (33.2 lbf ft) Loctite®243™
----------------------------	----------	--

- Operate the hand brake lever repeatedly until the brake linings are in contact with the brake disc and there is a pressure point. Fix the hand brake lever in the activated position.
- ✓ The brake calipers straighten.
- Tighten screws **5** on both sides.

Guideline

Screw, front brake caliper	M10x1.25	45 Nm (33.2 lbf ft) Loctite®243™
----------------------------	----------	--

- Position wheel speed sensor **6** in the hole.
- Mount and tighten screw **7**.

Guideline

Remaining screws, chassis	M6	10 Nm (7.4 lbf ft)
---------------------------	----	--------------------

- Remove the locking piece of the hand brake lever.
- Take the motorcycle off the front lifting gear. (📖 p. 133)

15 WHEELS, TIRES

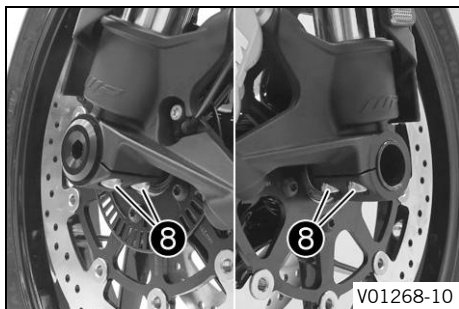

- Remove the rear of the motorcycle from the lifting gear. (📖 p. 131)
- Operate the front brake and compress the fork a few times firmly.
 - ✓ The fork legs straighten.
- Tighten screws ⑧.

Guideline

Screw, fork stub	M8	15 Nm (11.1 lbf ft)
------------------	----	---------------------

15.3 Removing the rear wheel 🛠️

Preparatory work

- Raise the motorcycle with the rear lifting gear. (📖 p. 131)

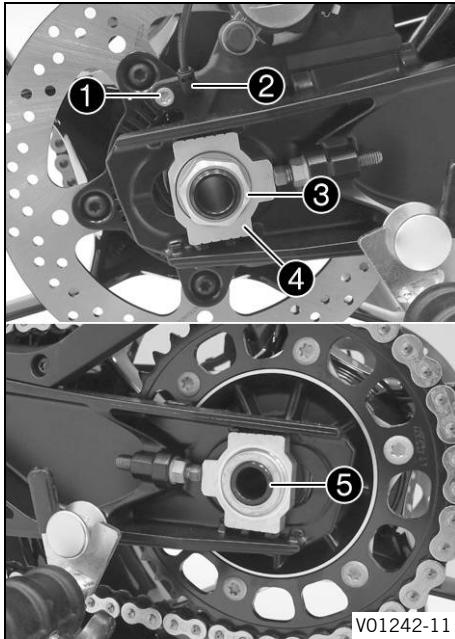

Main work

- Press the brake caliper onto the brake disc by hand in order to push back the brake piston.
- Remove screw **1** and pull wheel speed sensor **2** out of the hole.
- Remove nut **3**. Remove chain adjuster **4**.
- Pull out wheel spindle **5** far enough to allow the rear wheel to be pushed forward.

15 WHEELS, TIRES

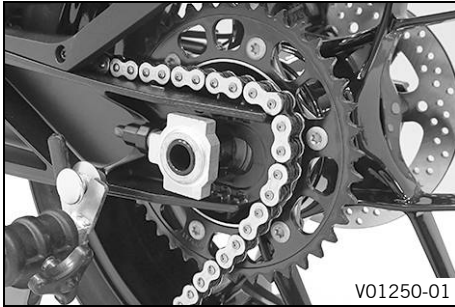

- Push the rear wheel forward as far as possible. Remove the chain from the rear sprocket.



Info

Cover the components to protect them against damage.

- Hold the rear wheel and remove the wheel spindle.
- Pull the rear wheel back until the brake caliper bracket is suspended freely between the brake disc and rim.



Warning

Danger of accidents Reduced effectiveness of brakes due to damaged brake discs.

- Always lay down the wheel in such a way that the brake discs are not damaged.

- Take the rear wheel out of the swingarm.



Info

Do not operate the foot brake lever when the rear wheel is removed.

15.4 Installing the rear wheel 🛠️



Warning

Danger of accidents Oil or grease on the brake discs reduces the braking effect.

- Always keep the brake discs free of oil and grease.
- Clean the brake discs with brake cleaner when necessary.



Warning

Danger of accidents There is no braking effect to start with at the rear brake after installing the rear wheel.

- Actuate the foot brake several times before going on a ride until you can feel a firm pressure point.

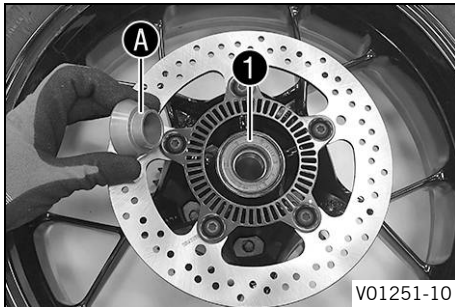

Main work

- Check the rear hub damping rubber pieces. 🛠️ (📖 p. 178)
- Check the wheel bearing for damage and wear.
 - » If the wheel bearing is damaged or worn:
 - Change the rear wheel bearing. 🛠️
- Remove spacer.
- Clean and grease shaft seal ring **1** and contact surface **A** of the spacer.

Long-life grease (📖 p. 274)

- Insert the spacer.

15 WHEELS, TIRES

- Clean and grease the thread of the wheel spindle and nut.

Long-life grease (📖 p. 274)

- Clean and grease the wheel spindle.

Long-life grease (📖 p. 274)

- Clean the contact areas on the brake caliper bracket and swingarm.

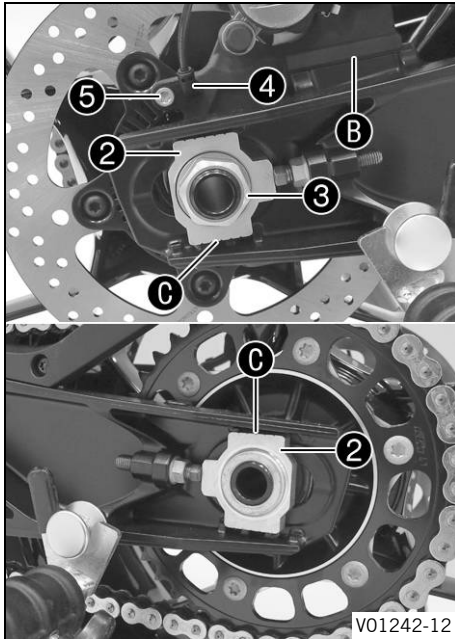

- Engage the thrust bearing of brake caliper bracket **B** and the swingarm.
- Jack up the rear wheel into the swingarm, position it, and insert the wheel spindle.
- ✓ The brake linings are correctly positioned.
- Place the chain on the sprocket.
- Position chain adjuster **2**. Mount nut **3**, but do not tighten it yet.

i Info

Mount the left and right chain adjusters in the same position.

- Make sure that chain adjusters **2** are fitted correctly on the adjusting screws. Tighten nut **3**.

Guideline

In order for the rear wheel to be correctly aligned, the markings on the left and right chain adjusters must be in the same position relative to reference markings **C**.

Nut, rear wheel spindle	M25x1.5	90 Nm (66.4 lbf ft) Thread and contact area of wheel spindle greased
-------------------------	---------	---

- Position wheel speed sensor **4** in the hole.
- Mount and tighten screw **5**.

Guideline

Remaining screws, chassis	M6	10 Nm (7.4 lbf ft)
---------------------------	----	--------------------

- Operate the foot brake lever repeatedly until the brake linings are in contact with the brake disc and there is a pressure point.

Finishing work

- Check the chain tension. (📖 p. 143)
- Remove the rear of the motorcycle from the lifting gear. (📖 p. 131)

15.5 Checking the rear hub damping rubber pieces 🛠️

Info

The engine power is transmitted from the rear sprocket to the rear wheel via the 6 damping rubber pieces. They eventually wear out during operation. If the damping rubber pieces are not changed in time, the rear sprocket carrier and the rear hub will be damaged.

Preparatory work

- Raise the motorcycle with the rear lifting gear. (📖 p. 131)
- Remove the rear wheel. 🛠️ (📖 p. 172)

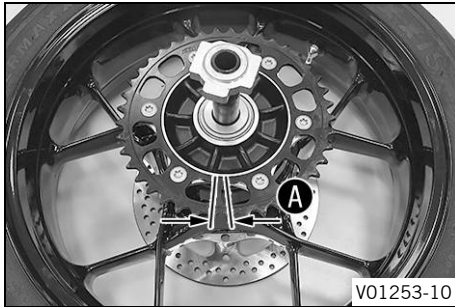
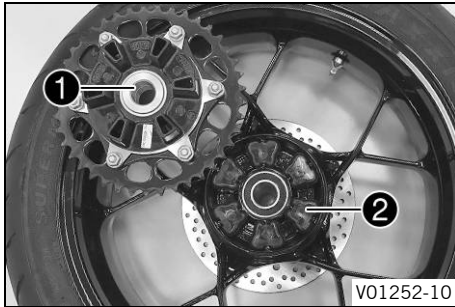

Main work

- Check bearing **1**.
 - » If the bearing is damaged or worn:
 - Change the bearing of the rear sprocket carrier. 🛠️
- Check the damping rubber pieces **2** of the rear hub for damage and wear.
 - » If the damping rubber pieces of the rear hub are damaged or worn:
 - Change all the damping rubber pieces of the rear hub.
- Lay the rear wheel on a workbench with the rear sprocket facing upwards and insert the wheel spindle in the hub.
- To check play **A**, hold the rear wheel tight and try to turn the rear sprocket with your hand.



Info

Measure the play on the outside of the rear sprocket.

Play of damping rubber pieces on rear wheel	≤ 5 mm (≤ 0.2 in)
---	-------------------

- » If clearance **A** is larger than the specified value:
 - Change all the damping rubber pieces of the rear hub. 🛠️

Finishing work

- Install the rear wheel.  (📖 p. 175)
- Check the chain tension. (📖 p. 143)
- Remove the rear of the motorcycle from the lifting gear. (📖 p. 131)

15.6 Checking the tire condition



Warning

Danger of accidents If a tire bursts while riding, the vehicle becomes uncontrollable.

- Ensure that damaged or worn tires are replaced immediately. (Your authorized KTM workshop will be glad to help.)



Warning

Danger of crashing Different tire tread patterns on the front and rear wheel impair the handling characteristic.

Different tire tread patterns can make the vehicle significantly more difficult to control.

- Make sure that only tires with a similar tire tread pattern are fitted to the front and rear wheel.



Warning

Danger of accidents Non-approved or non-recommended tires and wheels impact the handling characteristic.

- Only use tires/wheels approved by KTM with the corresponding speed index.



Warning

Danger of accidents New tires have reduced road grip.

The contact surface on new tires is not yet roughened.

- Run in new tires with moderate riding at alternating angles.
Running-in phase 200 km (124 mi)



Info

The type, condition, and pressure of the tires all have a major impact on the handling characteristic of the motorcycle.

Worn tires have a negative effect on handling characteristics, especially on wet surfaces.

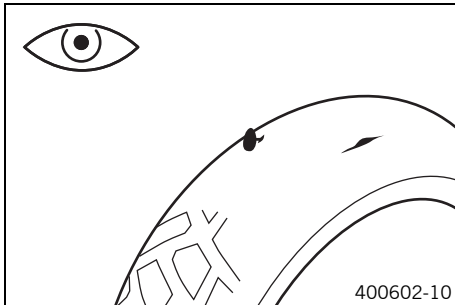

- Check the front and rear tires for cuts, run-in objects, and other damage.
 - » If the tires have cuts, run-in objects, or other damage:
 - Change the tires. 🛠️
- Check the tread depth.



Info

Adhere to the legally required minimum tread depth.

Minimum tread depth	$\geq 2 \text{ mm } (\geq 0.08 \text{ in})$
---------------------	---

- » If the tread depth is less than the minimum tread depth:
 - Change the tires. 🛠️

15 WHEELS, TIRES

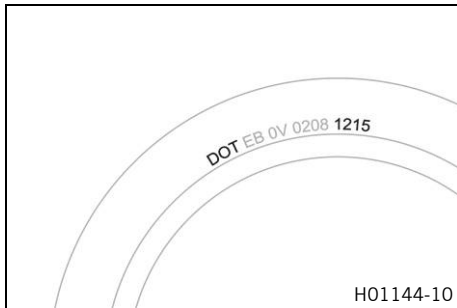

- Check the tire age.



Info

The tire date of manufacture is usually contained in the tire label and is indicated by the last four digits of the **DOT** number. The first two digits indicate the week of manufacture and the last two digits the year of manufacture.

KTM recommends that the tires be changed after 5 years at the latest, regardless of the actual state of wear.

- » If the tires are more than 5 years old:
 - Change the tires. 🛠️

15.7 Checking tire pressure



Info

Low tire pressure leads to abnormal wear and overheating of the tire.

Correct tire pressure ensures optimal riding comfort and maximum tire service life.

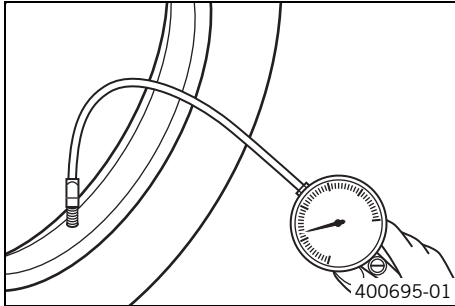

- Remove the protection cap.
- Check the tire pressure when the tires are cold.

Tire pressure when solo	
front	2.3 bar (33 psi)
rear	2.6 bar (38 psi)

Tire pressure with passenger / full payload	
front	2.3 bar (33 psi)
rear	2.6 bar (38 psi)

- » If the tire pressure does not meet specifications:
 - Correct the tire pressure.
- Mount the protection cap.



15.8 Using tire repair spray

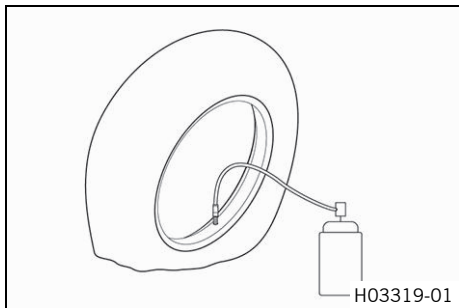

Warning

Danger of accidents Incorrect use of tire repair spray will result in the repaired tire losing pressure.

Tire repair spray cannot be used for all types of damage.

- Observe the instructions and specifications of the manufacturer of the tire repair spray.
- After repairing a tire with tire repair spray, ride slowly and carefully.
- Ride no further than to the nearest workshop and have the tire changed.

Tire repair spray should only be used in an emergency. We recommend transporting the broken down vehicle to the nearest workshop instead of using tire repair spray.

(Option: With TPMS)

Note

Material damage Tire repair spray damages the tire pressure sensor.

- Note that after using tire repair spray, the tire pressure sensor may need to be replaced.

16.1 Daytime running light (DRL)

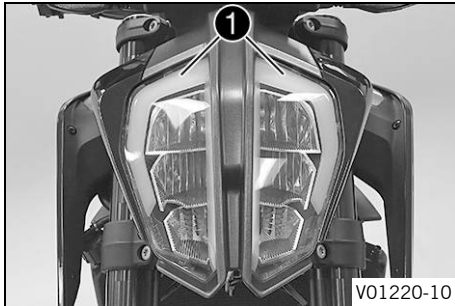

Warning

Danger of accidents When visibility is poor, the daytime running light is not a substitute for the low beam.

Automatic switching between the daytime running light and low beam may only be partially available when visibility is significantly impaired due to fog, snow or rain.

- Ensure that the appropriate type of lighting is always selected.
- If necessary switch off the daytime running lights using the menu before going on a ride or when stopped so that the low beam is switched on permanently.
- Note the legal regulations regarding the daytime running light.

The daytime running light (DRL) is integrated in the main headlight.

The daytime running light (DRL) must only be switched on when visibility conditions are good.

Activate the daytime running light (DRL) in the combination instrument.

This is controlled by the ambient light sensor in the combination instrument. When visibility conditions are good, the low beam is switched off and the daytime running light is switched on.



Info

The position light **1** lights up with all types of lighting.

16.2 Removing the 12-V battery





Warning

Risk of injury Battery acid and battery gases cause serious chemical burns.

- Keep 12 V batteries out of the reach of children.
- Wear suitable protective clothing and safety glasses.
- Avoid contact with battery acid and battery gases.
- Keep sparks or open flames away from the 12 V battery.
- Only charge 12 V batteries in well-ventilated rooms.
- Rinse the affected area immediately with plenty of water in the event of contact with the skin.
- Rinse eyes with water for at least 15 minutes and consult a doctor immediately if battery acid and battery gases get into the eyes.

Preparatory work

- Switch off the ignition by turning the ignition key to the position .
- Remove the passenger seat. ( p. 136)

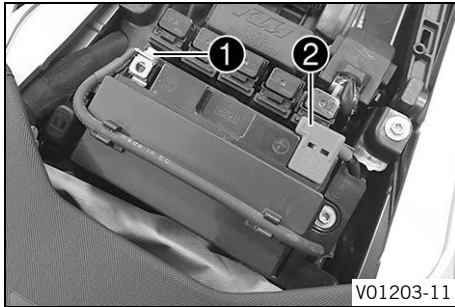

Main work

- Disconnect negative cable **1** from the 12-V battery.
- Remove positive terminal cover **2**.

16 ELECTRICAL SYSTEM

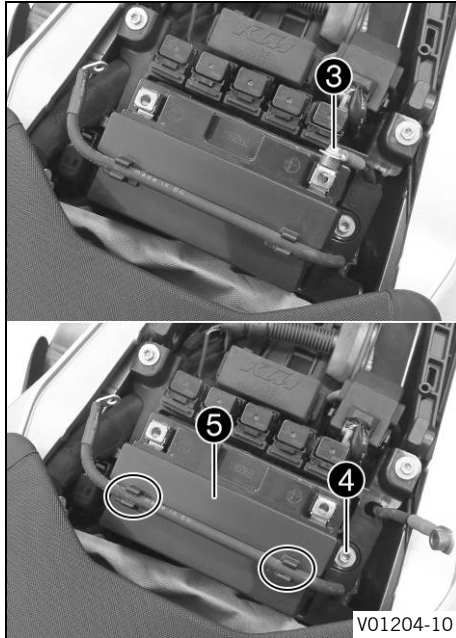

- Disconnect positive cable ③ from the 12-V battery.
- Take negative cable out of holders on the battery support bracket.
- Remove screw ④.
- Pull battery support bracket ⑤ to the side.
- Pull the 12-V battery upwards and out of the battery compartment.

16.3 Installing the 12-V battery

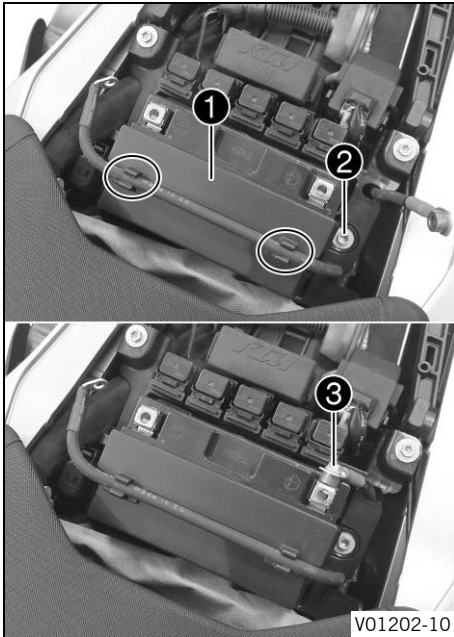

Main work

- Position the 12-V battery in the battery compartment.

12 V battery (HTZ12A-BS) (📖 p. 260)

- ✓ The battery terminals face opposite the direction of travel.

- Position battery support bracket ①.
- Mount and tighten screw ②.

Guideline

Remaining screws, chassis	M6	10 Nm (7.4 lbf ft)
---------------------------	----	--------------------

- Connect positive cable ③ to the 12 V battery.

Guideline

Screw, battery terminal	M6x20	4.5 Nm (3.32 lbf ft)
-------------------------	-------	----------------------



Info

Make sure the cable lies in the recess provided for this next to the battery compartment.

- Hook negative cable into the holders on the battery support bracket.

16 ELECTRICAL SYSTEM

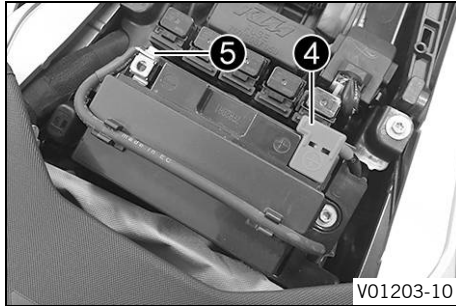

- Mount positive terminal cover ④.
- Connect negative cable ⑤ to the 12 V battery.

Guideline

Screw, battery terminal	M6x12	4.5 Nm (3.32 lbf ft)
-------------------------	-------	-------------------------

Finishing work

- Mount the passenger seat. (📖 p. 137)
- Set the time and date.



16.4 Charging the 12-V battery



Warning

Risk of injury Battery acid and battery gases cause serious chemical burns.

- Keep 12 V batteries out of the reach of children.
- Wear suitable protective clothing and safety glasses.
- Avoid contact with battery acid and battery gases.
- Keep sparks or open flames away from the 12 V battery.
- Only charge 12 V batteries in well-ventilated rooms.
- Rinse the affected area immediately with plenty of water in the event of contact with the skin.
- Rinse eyes with water for at least 15 minutes and consult a doctor immediately if battery acid and battery gases get into the eyes.



Note

Environmental hazard 12 V batteries contain environmentally hazardous materials.

- Do not dispose of 12 V batteries as household waste.
- Dispose of 12 V batteries at a collection point for used batteries.



Note

Environmental hazard Hazardous substances cause environmental damage.

- Dispose of oils, grease, filters, fuel, cleaning agents, brake fluid, etc., correctly and in compliance with the applicable regulations.



Info

Even when there is no load on the 12-V battery, it discharges steadily each day.

The charging level and the method of charging are very important for the service life of the 12-V battery. Rapid recharging with a high charging current shortens the service life of the battery.



If the charging current, charging voltage, or charging time is exceeded, electrolyte escapes through the safety valves. This reduces the capacity of the 12-V battery.

If the 12-V battery is depleted from starting the vehicle repeatedly, the battery must be charged immediately.

If the 12-V battery is left in a discharged state for an extended period, it will become deeply discharged and sulfating occurs, destroying the battery.

The 12-V battery is maintenance-free. The acid level does not have to be checked.

Preparatory work

- Switch off the ignition by turning the ignition key to the position .
- Remove the passenger seat. ( p. 136)

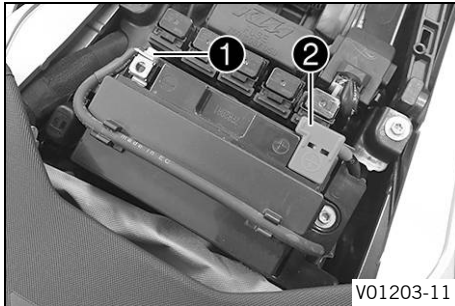

Main work

- Disconnect negative cable **1** of the 12-V battery to avoid damaging the onboard electronics.
- Remove positive terminal cover **2**.



- Connect the battery charger to the 12-V battery. Switch on the battery charger.

Battery charger (58429074000)

You can also use the battery charger to test the open-circuit voltage and starting ability of the 12-V battery, and to test the alternator. In addition, you cannot overcharge the 12-V battery with this device.



Info

Charge the 12-V battery to a maximum of 10 % of the capacity specified on the battery housing.

- Switch off the battery charger after charging and disconnect from the 12-V battery.

Guideline

The charging current, charging voltage, and charging time must not be exceeded.	
Recharge the 12-V battery regularly when the motorcycle is not being used	3 months

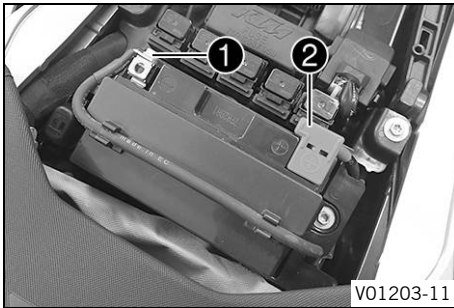

- Mount positive terminal cover ②.
- Connect negative cable ① to the 12 V battery.

Finishing work

- Mount the passenger seat. (📖 p. 137)
- Set the time and date.

16.5 Changing the main fuse



Warning

Fire hazard Incorrect fuses overload the electrical system.

- Only use fuses with the required ampere value.
- Do not bypass or repair fuses.



Info

The main fuse protects all power consumers of the vehicle. The main fuse is under the passenger seat.

Preparatory work

- Switch off the ignition by turning the ignition key to the position ☒.
- Remove the passenger seat. (📖 p. 136)

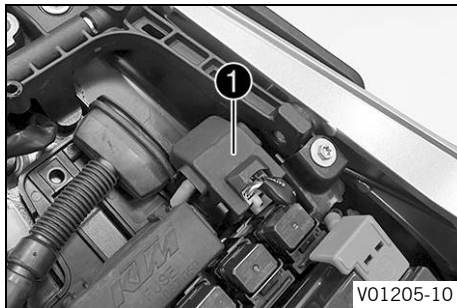

Main work

- Remove protection cap ❶.

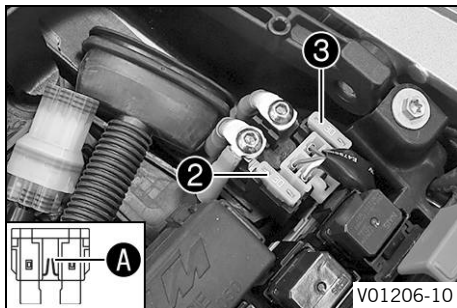

- Remove faulty main fuse ❷.

i Info

A faulty fuse has a burned-out fuse wire **A**.
A spare fuse **3** is located in the starter relay.

- Insert a new main fuse.

Fuse (58011109130) (📖 p. 260)

i Tip

Insert a new spare fuse into the starter relay to have it available when needed.

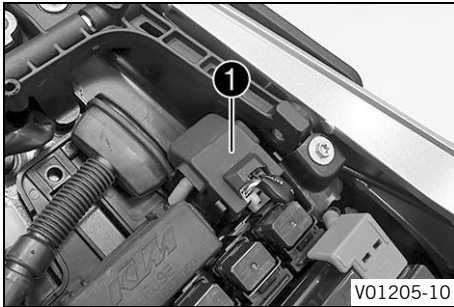

- Mount protection cap ❶.

Finishing work

- Mount the passenger seat. (📖 p. 137)
- Set the time and date.



16.6 Changing ABS fuses



Warning

Fire hazard Incorrect fuses overload the electrical system.

- Only use fuses with the required ampere value.
- Do not bypass or repair fuses.

i Info

Two fuses for the ABS are located under the passenger seat. These fuses protect the return pump and the hydraulic unit of the ABS. The third fuse, which protects the ABS control unit, is located in the fuse box.

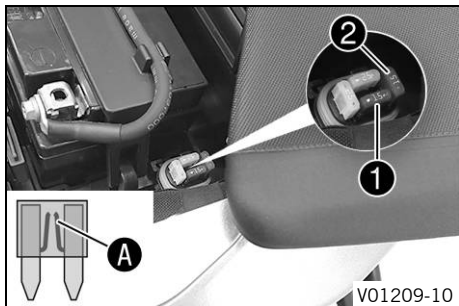

Preparatory work

- Switch off the ignition by turning the ignition key to the position ⌘.
- Remove the passenger seat. (📖 p. 136)

To change the fuse of the ABS hydraulic unit:

- Remove the protection cap and fuse ❶.

i Info

A faulty fuse has a burned-out fuse wire **A**.

- Insert a spare fuse with the correct rating.

Fuse (75011088015) (📖 p. 260)

i Tip

Insert spare fuse ❷ in the fuse box so that it is available if needed.

- Mount the protection cap.

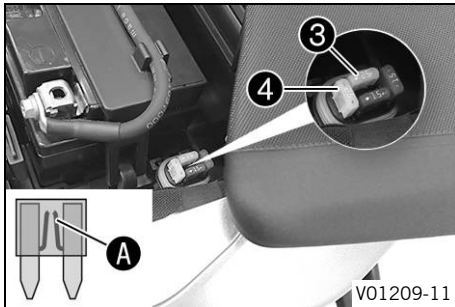

To change the fuse of the ABS return pump:

- Remove the protection cap and fuse ③.

i Info

A faulty fuse has a burned-out fuse wire **A**.

- Insert a spare fuse with the correct rating.

Fuse (75011088025) (📖 p. 260)

i Tip

Insert spare fuse ④ in the fuse box so that it is available if needed.

- Mount the protection cap.

Finishing work

- Mount the passenger seat. (📖 p. 137)

16.7 Changing the fuses of individual power consumers



Warning

Fire hazard Incorrect fuses overload the electrical system.

- Only use fuses with the required ampere value.
- Do not bypass or repair fuses.



Info

The fuse box containing the fuses of individual power consumers is located under the seat.

Preparatory work

- Switch off the ignition by turning the ignition key to the position ☒.
- Remove the passenger seat. (📖 p. 136)

Main work

- Open fuse box cover **1**.

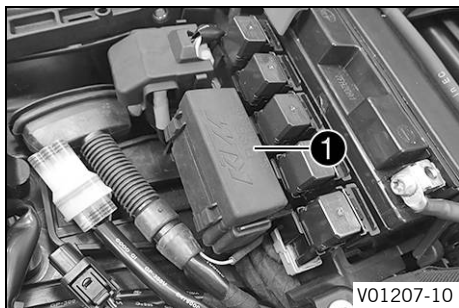

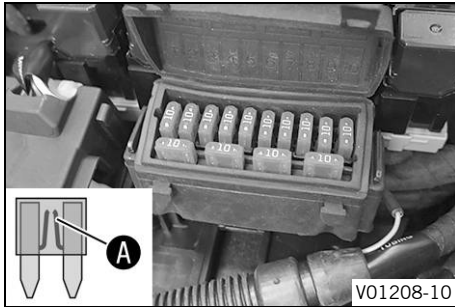

- Remove the faulty fuse.

Guideline

Fuse 1 - 10 A - ignition
Fuse 2 - 10 A - ignition, engine electronics control unit, electronic fuel injection, evaporate emission control system, lambda sensor, immobilizer/alarm system
Fuse 3 - 10 A - fuel pump
Fuse 4 - 10 A - radiator fan
Fuse 5 - 10 A - horn, combination instrument, brake light
Fuse 6 - 10 A - high beam, low beam, position light, tail light, license plate lamp
Fuse 7 - 10 A - ACC1
Fuse 8 - 10 A - ACC2
Fuse 9 - 10 A - ABS control unit, diagnostics connector, 5D sensor, TPMS (optional)
Fuse 10 - 10 A - headlight control unit
Fuse SPARE - 10 A - spare fuses



Info

A faulty fuse has a burned-out fuse wire **A**.

- Insert a spare fuse with the correct rating.

Fuse (75011088010) (📖 p. 260)



Tip

Replace the spare fuse in the fuse box so that it is available if needed.

- Check that the power consumer is functioning properly.
- Close the fuse box cover.

Finishing work

- Mount the passenger seat. (📖 p. 137)

16.8 Loosening the headlight mask with the headlight

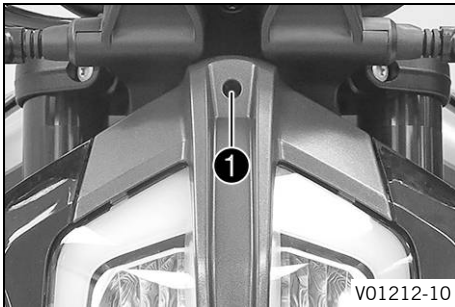

- Switch off the ignition by turning the ignition key to the position ⌘.
- Fully unscrew adjusting screw ①.



Info

The adjusting screw is fastened to the headlight mask by a ball head holder. Do not pull the adjusting screw out of the ball head adjuster.

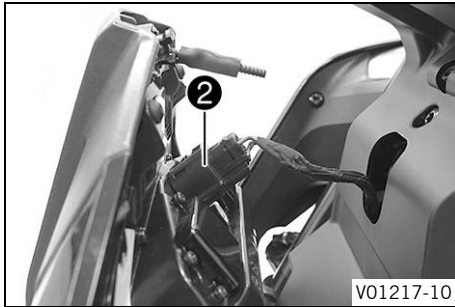

- Swivel the headlight mask forwards slightly and disconnect connector ②.
- Swivel the headlight mask all the way forwards.

16.9 Mounting the headlight mask with the headlight

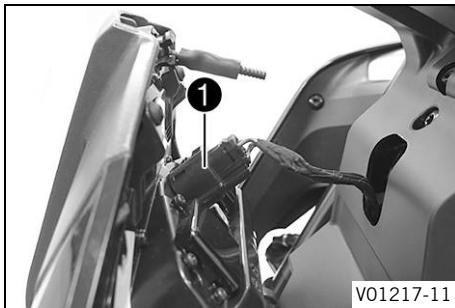

Main work

- Swivel the headlight mask up.
- Plug in connector ①.
- Position the headlight mask.

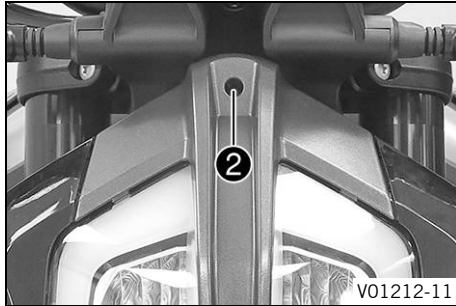

- Mount adjusting screw ②.

Finishing work

- Check the headlight setting. (📖 p. 208)

16.10 Removing the cover of the headlight mask rack

i Info

The cover of the headlight mask rack must be removed in order to gain access to the ACC1 and ACC2 power supply.

Preparatory work

- Loosen the headlight mask with the headlight. (📖 p. 202)

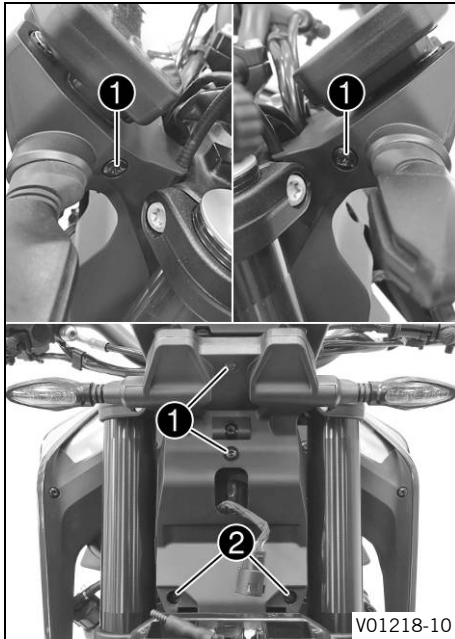

Main work

- Remove screws ①.
- Remove screws ②.

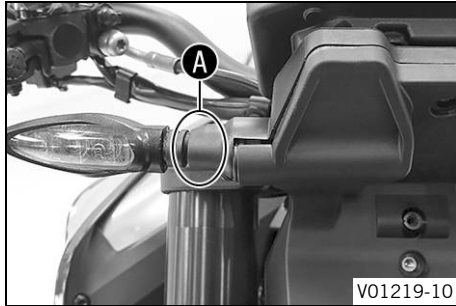

- Hold turn signal in the area **A** and carefully press against the direction of travel.
- ✓ The cover is detached as illustrated.
- Repeat the operation on the opposite side.
- Take off the cover.

16.11 Installing the cover of the headlight mask rack

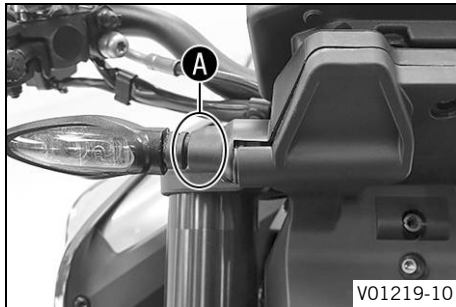

Main work

- Position cover by guiding the plug-in connector of the headlight through the opening.
- Hold turn signal in the area **A** and carefully press against the direction of travel, while pressing the cover tight at the same time.
- ✓ The cover engages with an audible click.
- Repeat the operation on the opposite side.

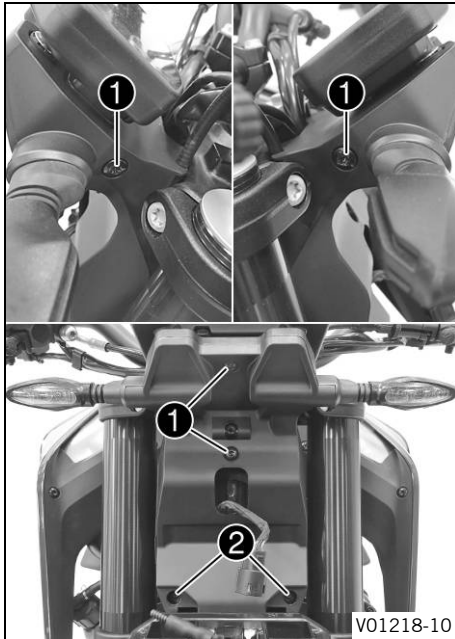

- Mount and tighten screws ①.

Guideline

Remaining screws, chassis	M5	5 Nm (3.7 lbf ft)
------------------------------	----	-------------------

- Mount and tighten screws ②.

Guideline

Screw, headlight	EJOTPT® K50x14	2 Nm (1.5 lbf ft)
------------------	--------------------------	-------------------

Finishing work

- Mount the headlight mask with the headlight. (📖 p. 203)
- Check the headlight setting. (📖 p. 208)



16.12 Checking the headlight setting

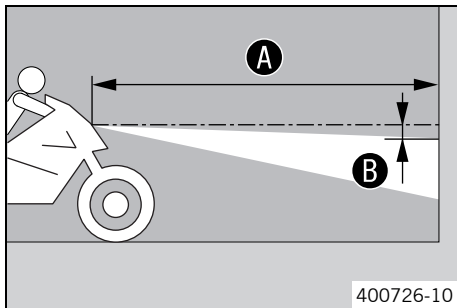

– Position the vehicle upright on a horizontal surface in front of a light wall and make a marking at the height of the center of the low beam headlight.

– Make another mark at a distance **B** under the first marking.

Guideline

Distance B	5 cm (2 in)
-------------------	-------------

– Position the vehicle perpendicular to the wall at a distance **A** from the wall and switch on the low beam.

Guideline

Distance A	5 m (16 ft)
-------------------	-------------

– The rider now mounts the motorcycle with luggage and passenger if applicable.

– Check the headlight setting.

The light-dark boundary must be exactly on the lower marking when the motorcycle is ready to be operated with the rider mounted along with any luggage and a passenger if applicable.

» If the boundary between light and dark does not meet specifications:

– Adjust the headlight range. (📖 p. 209)

16.13 Adjusting the headlight range

Preparatory work

- Check the headlight setting. (📖 p. 208)

Main work

- Turn adjusting screw **1** to adjust the headlight range.

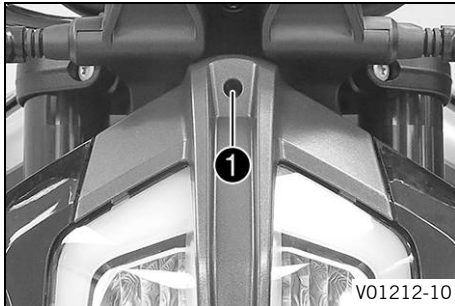

i Info

Turn clockwise to increase the headlight range; turn counterclockwise to reduce the headlight range. If you have a payload, you may have to correct the headlight range.

Screw **1** also secures the headlight. Ensure the screw is always screwed in far enough.

- Set the headlight to marking **B**.

Guideline

The light-dark boundary must lie exactly on lower marking **B** when the motorcycle is ready to operate with the rider mounted along with any luggage and a passenger, if applicable.

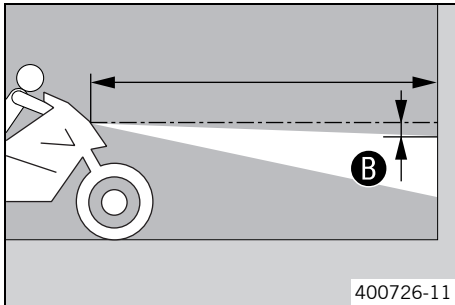

16 ELECTRICAL SYSTEM

16.14 Diagnostics connector

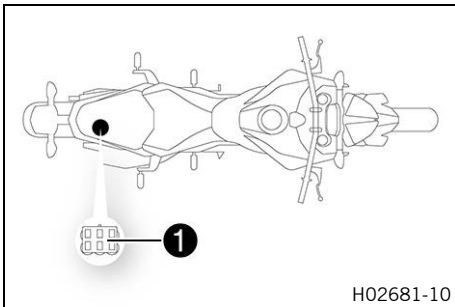

Diagnostics connector **1** is located under the passenger seat.

16.15 Front ACC1 and ACC2

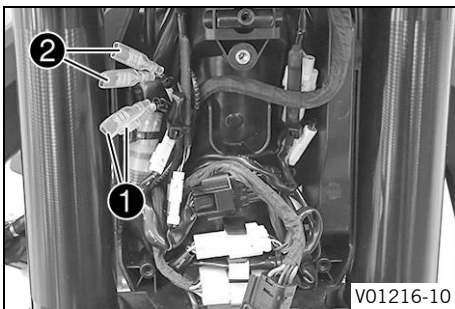

Installation location

- Power supplies ACC1 **1** and ACC2 **2** front are located under the cover of the headlight mask rack.

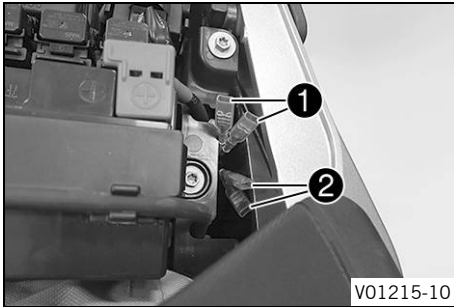
16.16 ACC1 and ACC2 rear**Installation location**

- The rear power supplies ACC1 **1** and ACC2 **2** are located under the passenger seat next to the battery compartment.

17 COOLING SYSTEM

17.1 Cooling system

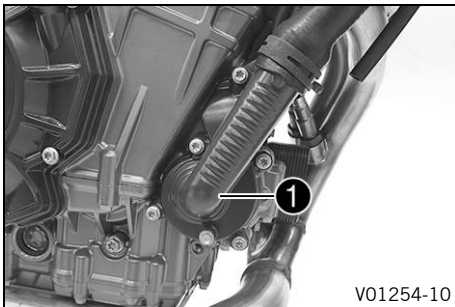

Water pump **1** in the engine ensures forced circulation of the coolant.

The pressure resulting from the warming of the cooling system is regulated by a valve in radiator cap **2**. Heat expansion causes excess coolant to flow into compensating tank **3**. When the temperature falls, this surplus coolant is sucked back into the cooling system. This ensures that operating the vehicle at the specified coolant temperature will not result in a risk of malfunctions.

115 °C (239 °F)

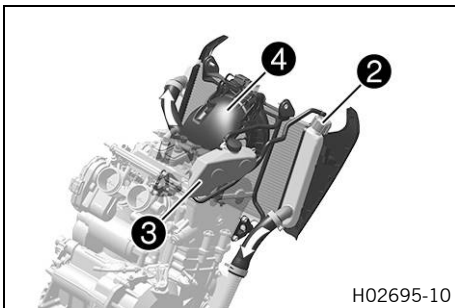

The coolant is cooled by the air stream and a radiator fan **4**, which is activated at high temperature.

The lower the speed, the less the cooling effect. Dirty cooling fins also reduce the cooling effect.

17.2 Checking the antifreeze and coolant level



Warning

Danger of scalding During motorcycle operation, the coolant gets very hot and is under pressure.

- Do not open the radiator, the radiator hoses or other cooling system components if the engine or the cooling system are at operating temperature.
- Allow the cooling system and the engine to cool down before you open the radiator, the radiator hoses or other components of the cooling system.
- In the event of scalding, rinse the area affected immediately with lukewarm water.



Warning

Danger of poisoning Coolant is toxic and a health hazard.

- Keep coolant out of the reach of children.
- Do not allow coolant to come into contact with the skin, the eyes and clothing.
- Consult a doctor immediately if coolant is swallowed.
- Rinse the affected area immediately with plenty of water in the event of contact with the skin.
- Rinse eyes thoroughly with water and consult a doctor immediately if coolant gets into the eyes.
- Change clothing if coolant spills onto your clothing.

Condition

The engine is cold.

Preparatory work

- Stand the motorcycle upright on a horizontal surface.

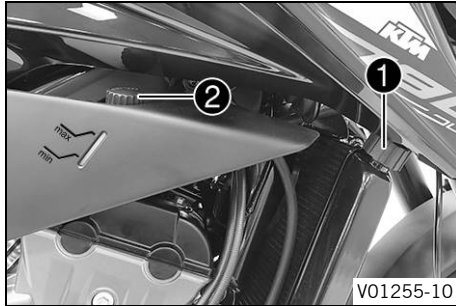

Main work

- Remove radiator cap **1** and cap **2** of the compensating tank.
- Check the antifreeze in the coolant.

Antifreeze	-25 ... -45 °C (-13 ... -49 °F)
------------	---------------------------------

- » If the antifreeze in the coolant does not match the specified value:
 - Correct the antifreeze in the coolant.
- Check the coolant level in the compensating tank.

The coolant level must be between **MIN** and **MAX**.

- » If the coolant level in the compensating tank is not at the required level, but the tank is not empty:
 - Replenish coolant up to a level between **MIN** and **MAX**.

Coolant (📖 p. 271)

- » If there is no coolant in the compensating tank:
 - Check the cooling system for leaks. 🛠️



Info

Do not start up the motorcycle!

- Fill/bleed the cooling system. 🛠️ (📖 p. 219)
- Mount cap **2** of the compensating tank.
- Check the coolant level in the radiator.

The radiator must be filled completely.

- » If the coolant level does not match the specified value:
 - Check the coolant level and the reason for the loss.
- » If you had to add more coolant than the specified amount:
 - > 0.50 l (> 0.53 qt.)
 - Fill/bleed the cooling system. 🛠️ (📖 p. 219)
- Mount radiator cap ❶.



17.3 Checking the coolant level in the compensating tank



Warning

Danger of scalding During motorcycle operation, the coolant gets very hot and is under pressure.

- Do not open the radiator, the radiator hoses or other cooling system components if the engine or the cooling system are at operating temperature.
- Allow the cooling system and the engine to cool down before you open the radiator, the radiator hoses or other components of the cooling system.
- In the event of scalding, rinse the area affected immediately with lukewarm water.



Warning

Danger of poisoning Coolant is toxic and a health hazard.

- Keep coolant out of the reach of children.
- Do not allow coolant to come into contact with the skin, the eyes and clothing.
- Consult a doctor immediately if coolant is swallowed.
- Rinse the affected area immediately with plenty of water in the event of contact with the skin.
- Rinse eyes thoroughly with water and consult a doctor immediately if coolant gets into the eyes.
- Change clothing if coolant spills onto your clothing.



Condition

The engine is cold.

The radiator is completely full.

Preparatory work

- Park the motorcycle on a horizontal surface.

Main work

- Check the coolant level in the compensating tank.

The coolant level must be between **MIN** and **MAX**.

- » If the coolant level in the compensating tank is not at the required level, but the tank is not empty:
 - Remove the cap of the compensating tank.
 - Replenish coolant up to a level between **MIN** and **MAX**.

Coolant (📖 p. 271)

- Mount the cap of the compensating tank.

- » If there is no coolant in the compensating tank:
 - Check the cooling system for leaks. 🐾

**Info**

Do not start up the motorcycle!

-
- Fill/bleed the cooling system. 🐾 (📖 p. 219)
- 

17.4 Draining the coolant 🐾

**Warning**

Danger of scalding During motorcycle operation, the coolant gets very hot and is under pressure.

- Do not open the radiator, the radiator hoses or other cooling system components if the engine or the cooling system are at operating temperature.
- Allow the cooling system and the engine to cool down before you open the radiator, the radiator hoses or other components of the cooling system.
- In the event of scalding, rinse the area affected immediately with lukewarm water.



Warning

Danger of poisoning Coolant is toxic and a health hazard.

- Keep coolant out of the reach of children.
- Do not allow coolant to come into contact with the skin, the eyes and clothing.
- Consult a doctor immediately if coolant is swallowed.
- Rinse the affected area immediately with plenty of water in the event of contact with the skin.
- Rinse eyes thoroughly with water and consult a doctor immediately if coolant gets into the eyes.
- Change clothing if coolant spills onto your clothing.

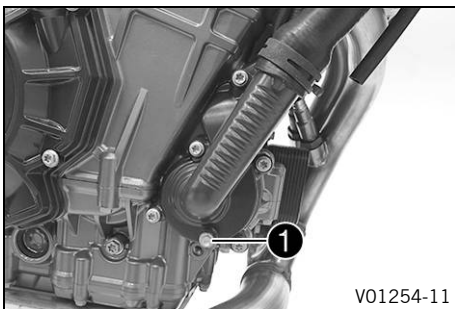

Condition

The engine is cold.

- Position the motorcycle upright.
- Place an appropriate container under the engine.
- Remove screw ❶ with the seal ring.
- Remove the radiator cap.
- Completely drain the coolant.
- Mount and tighten screw ❶ with a new seal ring.

Guideline

Screw plug, water pump drain hole	EJOTALtracs® Plus 60x14	8 Nm (5.9 lbf ft) Loctite®243™
---	------------------------------------	--

- Mount the radiator cap.

17.5 Filling/bleeding the cooling system



Warning

Danger of poisoning Coolant is toxic and a health hazard.

- Keep coolant out of the reach of children.
- Do not allow coolant to come into contact with the skin, the eyes and clothing.
- Consult a doctor immediately if coolant is swallowed.
- Rinse the affected area immediately with plenty of water in the event of contact with the skin.
- Rinse eyes thoroughly with water and consult a doctor immediately if coolant gets into the eyes.
- Change clothing if coolant spills onto your clothing.

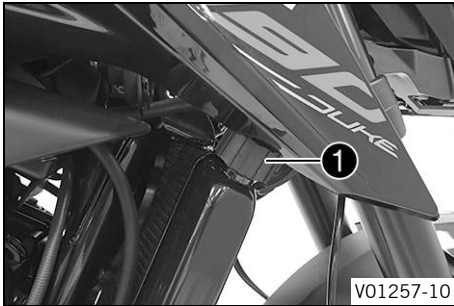

- Remove radiator cap ①.

17 COOLING SYSTEM

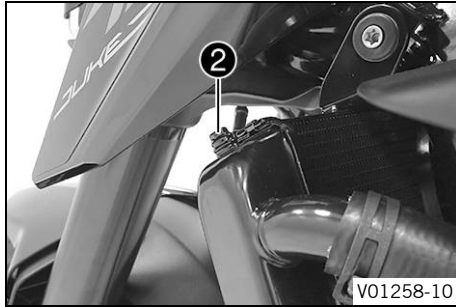

- Remove bleeder screw ②.
- Tilt the vehicle slightly to the right.
- Pour in coolant until it emerges without bubbles at the vent hole, and then mount and tighten bleeder screw ② immediately.

Coolant	1.20 l (1.27 qt.)	Coolant (📖 p. 271)
---------	----------------------	--------------------

- Completely fill the radiator with coolant. Mount radiator cap ①.
- Rest the vehicle on the side stand.
- Check the coolant level in the compensating tank. (📖 p. 215)



Danger

Danger of poisoning Exhaust gases are toxic and inhaling them may result in unconsciousness and death.

- Always make sure there is sufficient ventilation when running the engine.
- Use effective exhaust extraction when starting or running the engine in an enclosed space.

- Start the engine and run it until the 5th bar of the temperature indicator lights up.
- Stop the engine and allow it to cool down.

- When the engine is cool, check the coolant level in the radiator and, if necessary, add coolant.
- Check the coolant level in the compensating tank. (📖 p. 215)



17.6 Change the coolant



Warning

Danger of scalding During motorcycle operation, the coolant gets very hot and is under pressure.

- Do not open the radiator, the radiator hoses or other cooling system components if the engine or the cooling system are at operating temperature.
- Allow the cooling system and the engine to cool down before you open the radiator, the radiator hoses or other components of the cooling system.
- In the event of scalding, rinse the area affected immediately with lukewarm water.



Warning

Danger of poisoning Coolant is toxic and a health hazard.

- Keep coolant out of the reach of children.
- Do not allow coolant to come into contact with the skin, the eyes and clothing.
- Consult a doctor immediately if coolant is swallowed.
- Rinse the affected area immediately with plenty of water in the event of contact with the skin.
- Rinse eyes thoroughly with water and consult a doctor immediately if coolant gets into the eyes.
- Change clothing if coolant spills onto your clothing.

17 COOLING SYSTEM

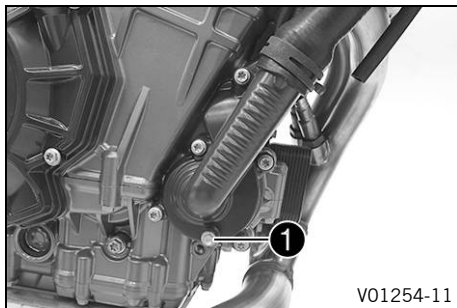

- Position the motorcycle upright.
- Place an appropriate container under the engine.
- Remove screw **1** with the seal ring.

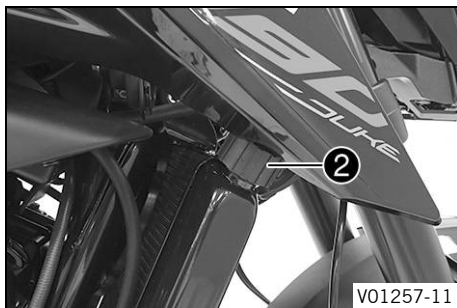

- Remove radiator cap **2**.
- Completely drain the coolant.
- Mount and tighten screw **1** with a new seal ring.

Guideline

Screw plug, water pump drain hole	EJOTALtracs® Plus 60x14	8 Nm (5.9 lbf ft) Loctite®243™
---	------------------------------------	--

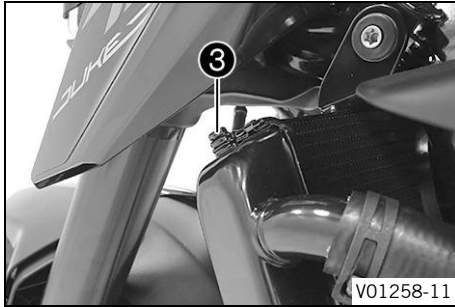

- Remove bleeder screw ③.
- Tilt the vehicle slightly to the right.
- Pour in coolant until it emerges without bubbles at the vent hole, and then mount and tighten bleeder screw ③ immediately.

Coolant	1.20 l (1.27 qt.)	Coolant (📖 p. 271)
---------	----------------------	--------------------

- Completely fill the radiator with coolant. Mount radiator cap ②.
- Rest the vehicle on the side stand.



Danger

Danger of poisoning Exhaust gases are toxic and inhaling them may result in unconsciousness and death.

- Always make sure there is sufficient ventilation when running the engine.
- Use effective exhaust extraction when starting or running the engine in an enclosed space.

- Start the engine and run it until the 5th bar of the temperature indicator lights up.
- Stop the engine and allow it to cool down.

- After the engine has cooled down, check the coolant level in the radiator and in the compensating tank again and add more coolant if necessary.



18.2 Motorcycle traction control (MTC)

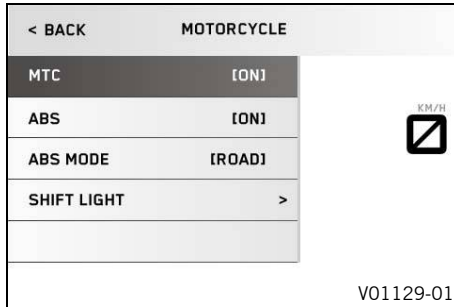



The motorcycle traction control (MTC) lowers the engine torque in case of loss of traction in the rear wheel.

Info

When motorcycle traction control is switched off, the rear wheel may spin during strong acceleration and on surfaces with low grip, resulting in a risk of crashing. After the ignition is switched on, motorcycle traction control is enabled again.

The motorcycle traction control is controlled via the **Ride Mode** ( p. 225) menu on the combination instrument. The motorcycle traction control can be switched off in the **Motorcycle** menu.

Info

When the motorcycle traction control is active, the TC indicator lamp  flashes. When motorcycle traction control is switched off, the TC indicator lamp  lights up.

18.3 Slip adjustment

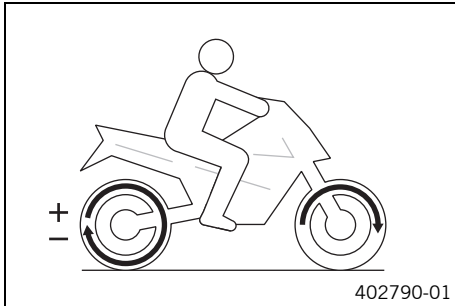

The slip adjustment is a motorcycle traction control function. The slip adjustment allows the motorcycle traction control to be tuned through nine levels to the desired characteristic map. Level 1 allows the maximum slip on the rear wheel, and level 9 the minimum.

The slip adjustment can be set while riding with a closed menu using the **UP** or **DOWN** button.



Info

The slip adjustment is only available in drive mode **TRACK**.

18.4 Throttle response

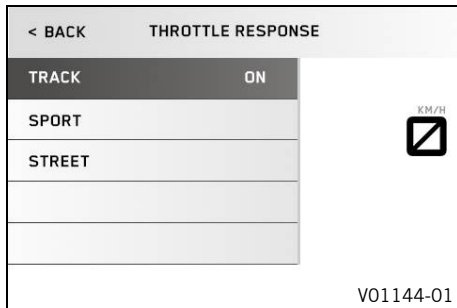

Possible states

- **TRACK** – Extremely direct response
- **SPORT** – Very direct response.
- **STREET** – Balanced response

The characteristic map of the throttle response can be adjusted in the **Throttle response** menu.

The **Throttle response** can also be set while riding with a closed throttle grip.



Info

Throttle response is only available in drive mode **TRACK**.

19.1 Checking the engine oil level



Info

The engine oil level must be checked at normal engine operating temperature.

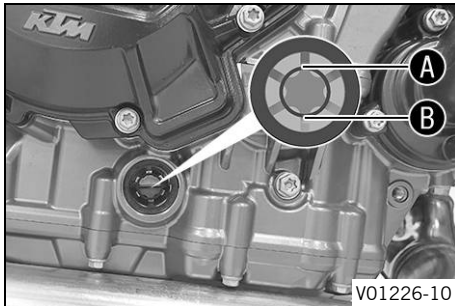

- Stand the motorcycle upright on a horizontal surface.
- Check the engine oil level.



Info

After switching off the engine, wait one minute before checking the level.

The engine oil must be between marking **A** and marking **B** of the oil level viewer.

- » If the engine oil level is below the marking **B**:
 - Add engine oil. (📖 p. 234)
- » If the engine oil level is above the marking **A**:
 - Correct engine oil level.

19.2 Changing the engine oil and oil filter, cleaning the oil screens



Warning

Danger of scalding Engine and gear oil get very hot when the motorcycle is ridden.

- Wear suitable protective clothing and safety gloves.
- In the event of scalding, rinse the area affected immediately with lukewarm water.



Note

Environmental hazard Hazardous substances cause environmental damage.

- Dispose of oils, grease, filters, fuel, cleaning agents, brake fluid, etc., correctly and in compliance with the applicable regulations.



Info

Drain the engine oil while the engine is at operating temperature.

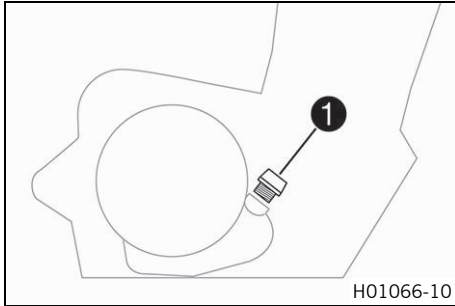

Main work

- Rest the motorcycle on its side stand on a horizontal surface.
- Place an appropriate container under the engine.
- Remove oil filler plug **1** with the O-ring from the clutch cover.

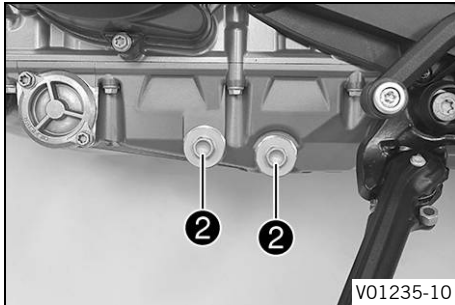

- Remove oil drain plugs **2** with the magnets, O-rings, and oil screens.

19 SERVICE WORK ON THE ENGINE

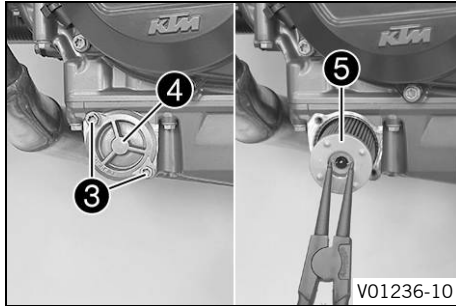

- Remove screws **3**. Take off oil filter cover **4** with the O-ring.
- Pull oil filter **5** out of the oil filter housing.

Lock ring plier (51012011000)

- Completely drain the engine oil.
- Thoroughly clean the parts and sealing surfaces.

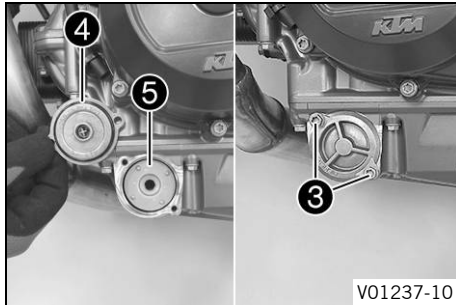

- Insert new oil filter **5**.



Info

Only insert the oil filter by hand.

- Oil the O-ring of the oil filter cover. Position oil filter cover **4**.
- Mount and tighten screws **3**.

Guideline

Screw, oil filter cover	M5	6 Nm (4.4 lbf ft)
-------------------------	----	-------------------

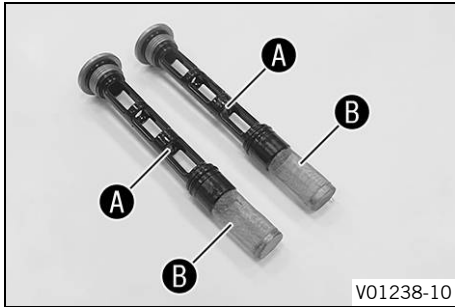

- Thoroughly clean magnets **A** and oil screens **B** of the oil drain plugs.

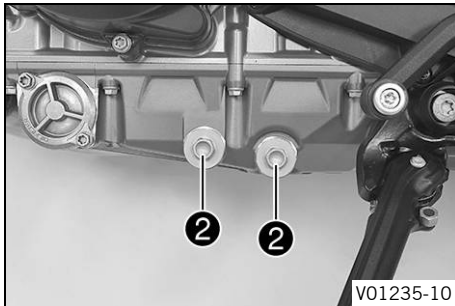

- Mount the oil drain plugs **2** with magnets and new seal rings, and tighten.

Guideline

Plug, oil screen	M20x1.5	20 Nm (14.8 lbf ft)
------------------	---------	---------------------

- Fill up with engine oil at the clutch cover.

Engine oil	2.8 l (3 qt.)	Engine oil (SAE 10W/50) (📖 p. 272)
------------	---------------	--

19 SERVICE WORK ON THE ENGINE

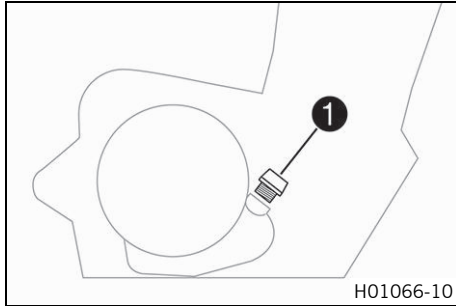

- Mount and tighten filler plug ① with the O-ring.



Danger

Danger of poisoning Exhaust gases are toxic and inhaling them may result in unconsciousness and death.

- Always make sure there is sufficient ventilation when running the engine.
- Use effective exhaust extraction when starting or running the engine in an enclosed space.

- Start the engine and check for tightness.

Finishing work

- Check the engine oil level. (📖 p. 229)

19.3 Adding engine oil



Info

Too little engine oil or poor-quality engine oil will result in premature wear of the engine.

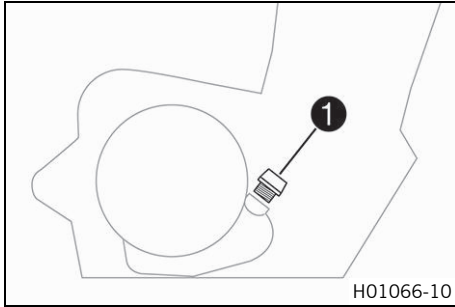

Main work

- Remove filler plug **1** with the O-ring, and fill up with engine oil.
- Fill engine oil to the middle of the level viewer.

Engine oil (SAE 10W/50) (📖 p. 272)



Info

In order to achieve optimal engine oil performance, it is not advisable to mix different engine oils. We recommend changing the engine oil when necessary.

- Mount and tighten filler plug **1** with the O-ring.



Danger

Danger of poisoning Exhaust gases are toxic and inhaling them may result in unconsciousness and death.

- Always make sure there is sufficient ventilation when running the engine.
- Use effective exhaust extraction when starting or running the engine in an enclosed space.

- Start the engine and check for tightness.

Finishing work

- Check the engine oil level. (📖 p. 229)

19.4 Checking the free travel of the clutch lever

Note

Clutch damage If there is no free travel by the clutch lever, the clutch will begin to slip.

- Check the free travel of the clutch lever each time before using the motorcycle.
- Adjust the free travel of the clutch lever when necessary in accordance with the specification.

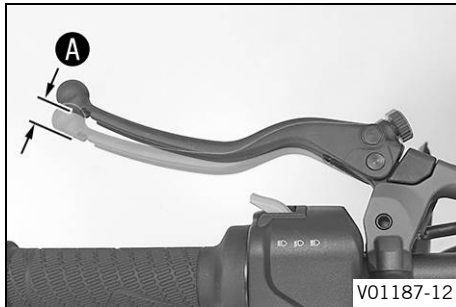

- Check the clutch lever for smooth operation.
- Move the handlebar to the straight-ahead position.
- Pull the clutch lever until resistance is perceptible, and determine the free travel **A**.

Free travel of clutch lever A	5 mm (0.2 in)
--------------------------------------	---------------

- » If the free travel of the clutch lever does not meet specifications:
 - Set the free travel of the clutch lever. 🗨️ (📖 p. 237)
- Move the handlebar to and fro over the entire steering range.

The free travel of the clutch lever must not change.

- » If the free travel of the clutch lever changes:

- Check the routing of the clutch cable.



19.5 Setting the free travel of the clutch lever

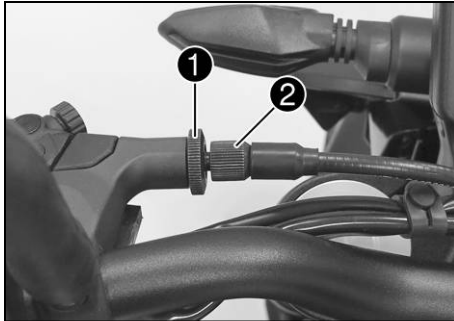

- Move the handlebar to the straight-ahead position.
- Loosen lock nut ①.
- Adjust the free travel A by turning adjusting screw ②.

Guideline

Free travel of clutch lever A	5 mm (0.2 in)
-------------------------------	---------------

- Tighten lock nut ①.

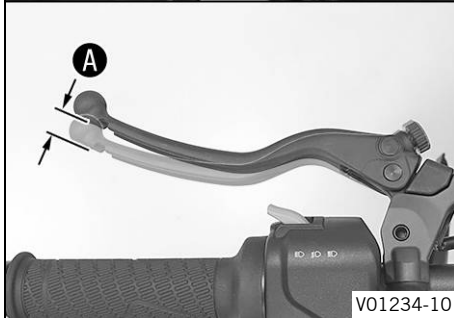

20.1 Cleaning the motorcycle

Note

Material damage Components become damaged or destroyed if a pressure cleaner is used incorrectly. The high pressure forces water into the electrical components, connectors, throttle cables, and bearings, etc. Pressure which is too high causes malfunctions and destroys components.

- Do not direct the water jet directly on to electrical components, connectors, throttle cables or bearings.
- Maintain a minimum distance between the nozzle of the pressure cleaner and the component.

Minimum clearance 60 cm (23.6 in)



Note

Environmental hazard Hazardous substances cause environmental damage.

- Dispose of oils, grease, filters, fuel, cleaning agents, brake fluid, etc., correctly and in compliance with the applicable regulations.
-



Info

To maintain the value and appearance of the motorcycle over a long period, clean it regularly. Avoid direct sunshine when cleaning the motorcycle.

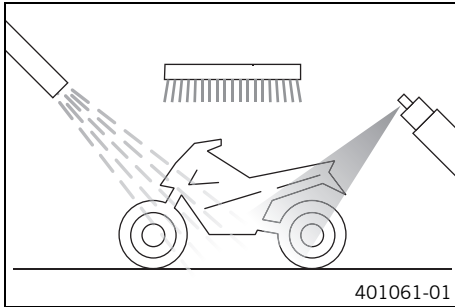

- Close off the exhaust system to keep water from entering.
- Remove loose dirt first with a soft jet of water.
- Spray heavily soiled parts with a normal commercial motorcycle cleaner and then brush off with a soft brush.

Motorcycle cleaner (📖 p. 274)



Info

Use warm water containing normal motorcycle cleaner and a soft sponge. Never apply motorcycle cleaner to a dry vehicle; always rinse the vehicle with water first. If the vehicle was operated in road salt, clean it with cold water. Warm water would enhance the corrosive effects of salt.

- After rinsing the motorcycle with a gentle spray of water, allow it to dry thoroughly.
- Remove the closure of the exhaust system.



Warning

Danger of accidents Moisture and dirt impair the brake system.

- Brake carefully several times to dry out and remove dirt from the brake linings and the brake discs.

- After cleaning, ride the vehicle a short distance until the engine warms up.



Info

The heat produced causes water at inaccessible locations in the engine and on the brake system to evaporate.

-
- After the motorcycle has cooled down, lubricate all moving parts and pivot points.
 - Clean the chain. (📖 p. 141)
 - Treat bare metal (except for brake discs and the exhaust system) with a corrosion inhibitor.

Preserving materials for paints, metal and rubber
(📖 p. 275)

- Treat all painted parts with a mild paint care product.

Perfect finish and high gloss polish for paints (📖 p. 274)



Info

Do not polish parts that were matte when delivered as this would strongly impair the material quality.

-
- Treat all plastic parts and powder-coated parts with a mild cleaning and care product.

Special cleaner for glossy and matte paint finishes, metal and plastic surfaces (📖 p. 275)

- Lubricate the ignition/steering lock.

Universal oil spray (📖 p. 275)



20.2 Checks and maintenance steps for winter operation



Info

If you use the motorcycle in winter, salt can be expected on the roads. You should therefore take precautions against aggressive road salt.

After riding on salted roads, thoroughly clean the vehicle with cold water and dry it well. Warm water enhances the corrosive effects of salt.

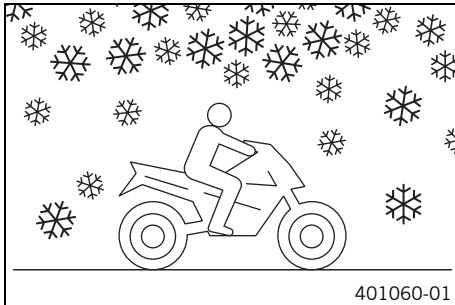

- Clean the motorcycle. (📖 p. 238)
- Clean the brake system.



Info

After **EVERY** trip on salted roads, thoroughly clean the brake calipers and brake linings, after they have cooled down and without removing them, with cold water and dry them carefully.

After riding on salted roads, thoroughly clean the motorcycle with cold water and dry it well.

- Treat the engine, the swingarm, and all other bare or zinc-plated parts (except the brake discs) with a wax-based corrosion inhibitor.



Info

Corrosion inhibitor must not come in contact with the brake discs as this would greatly reduce the braking force.

-
- Clean the chain. (📖 p. 141)

21.1 Storage



Info

If you plan to garage the motorcycle for a longer period, perform the following steps or have them performed.

Before storing the motorcycle, check all parts for function and wear. If service, repairs, or replacements are necessary, you should do this during the storage period (less workshop overload). In this way, you can avoid long workshop waiting times at the start of the new season.

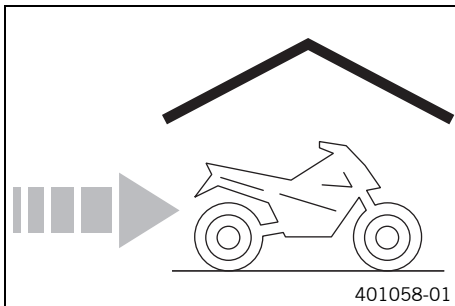

- When refueling for the last time before taking the motorcycle out of service, add fuel additive.

Fuel additive (📖 p. 274)

- Refuel. (📖 p. 123)
- Clean the motorcycle. (📖 p. 238)
- Change the engine oil and oil filter and clean the oil screens. 🛠️ (📖 p. 230)
- Check the antifreeze and coolant level. (📖 p. 213)
- Check tire pressure. (📖 p. 182)
- Remove the 12-V battery. 🛠️ (📖 p. 186)
- Charge the 12-V battery. 🛠️ (📖 p. 191)

Guideline

Storage temperature of the 12-V battery without direct sunlight	0 ... 35 °C (32 ... 95 °F)
---	----------------------------

- Store the vehicle in a dry location that is not subject to large fluctuations in temperature.



Info

KTM recommends jacking up the motorcycle.

- Raise the motorcycle with the rear lifting gear. (📖 p. 131)
- Lift the motorcycle with the front lifting gear. (📖 p. 132)
- Cover the vehicle with a tarp or similar cover that is permeable to air.



Info

Do not use non-porous materials since they prevent humidity from escaping, thus causing corrosion. Avoid running the engine for a short time only. Since the engine cannot warm up properly, the water vapor produced during combustion condenses and causes valves and the exhaust system to rust.

21.2 Preparing for use after storage

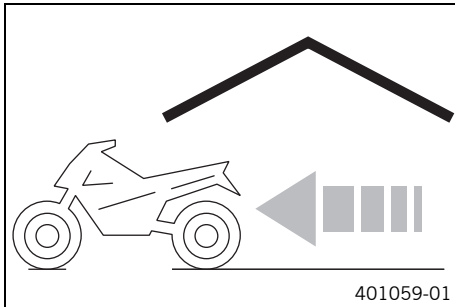

- Take the motorcycle off the front lifting gear. (📖 p. 133)
- Remove the rear of the motorcycle from the lifting gear. (📖 p. 131)
- Charge the 12-V battery. 🔌 (📖 p. 191)
- Install the 12-V battery. 🔌 (📖 p. 189)
- Set the time and date.
- Perform checks and maintenance measures when preparing for use. (📖 p. 105)
- Take a test ride.



22 TROUBLESHOOTING

Faults	Possible cause	Action
Engine does not crank when the electric starter button is pressed	Operating error	– Carry out the start procedure. (📖 p. 106)
	12 V battery discharged	– Charge the 12-V battery. 🛠️ (📖 p. 191) – Check the open-circuit current. 🛠️
	Fuse 1, 2 or 3 blown	– Change the fuses of individual power consumers. (📖 p. 199)
	Main fuse burned out	– Change the main fuse. (📖 p. 195)
	No ground connection present	– Check the ground connection.
Engine turns only if the clutch lever is drawn	The vehicle is in gear	– Shift the transmission to neutral position.
	The vehicle is in gear and the side stand is folded out	– Shift the transmission to neutral position.
Engine turns but does not start	Operating error	– Carry out the start procedure. (📖 p. 106)
	Fuse 3 blown	– Change the fuses of individual power consumers. (📖 p. 199)
	The plug-in connection of the fuel hose connection is not connected	– Connect the plug-in connection of the fuel line.
	Error in the electronic fuel injection	– Read out the fault memory using the KTM diagnostics tool. 🛠️

Faults	Possible cause	Action
Engine turns but does not start	Throttle opened while starting	<ul style="list-style-type: none"> – When starting, DO NOT open the throttle. – Carry out the start procedure. (📖 p. 106)
Engine has too little power	Air filter is very dirty	<ul style="list-style-type: none"> – Remove the air filter. 🛠️ – Install the air filter. 🛠️
	Fuel filter is very dirty	<ul style="list-style-type: none"> – Check the fuel pressure. 🛠️
	Error in the electronic fuel injection	<ul style="list-style-type: none"> – Read out the fault memory using the KTM diagnostics tool. 🛠️
Engine overheats	Too little coolant in cooling system	<ul style="list-style-type: none"> – Check the cooling system for leakage. – Check the coolant level in the compensating tank. (📖 p. 215)
	Radiator fins very dirty	<ul style="list-style-type: none"> – Clean radiator fins.
	Foam formation in cooling system	<ul style="list-style-type: none"> – Drain the coolant. 🛠️ (📖 p. 217) – Fill/bleed the cooling system. 🛠️ (📖 p. 219)
	Buckled or damaged radiator hose	<ul style="list-style-type: none"> – Change the radiator hose. 🛠️
	Thermostat is faulty	<ul style="list-style-type: none"> – Check the thermostat. 🛠️
	Fuse 4 blown	<ul style="list-style-type: none"> – Change the fuses of individual power consumers. (📖 p. 199)
	Defect in radiator fan system	<ul style="list-style-type: none"> – Check the radiator fan system. 🛠️

Faults	Possible cause	Action
Malfunction indicator lamp lights up or flashes	Error in the electronic fuel injection	– Read out the fault memory using the KTM diagnostics tool. 🛠️
N The idling speed indicator lamp does not light up when the transmission is in neutral	Gear position sensor not programmed	– Read out the fault memory using the KTM diagnostics tool. 🛠️
Engine dies during the trip	Lack of fuel	– Refuel. (📖 p. 123)
	Fuse 1 , 2 or 3 blown	– Change the fuses of individual power consumers. (📖 p. 199)
The ABS warning lamp lights up	ABS fuse is blown	– Change ABS fuses. (📖 p. 197)
	Large difference in wheel speeds of the front and rear wheels	– Stop the vehicle, switch off the ignition, and start it again.
	Malfunction in ABS	– Read out the ABS fault memory using the KTM diagnostics tool. 🛠️
High oil consumption	Engine vent hose bent	– Route the vent hose without bends or change it if necessary.
	Engine oil level too high	– Check the engine oil level. (📖 p. 229)
	Engine oil too thin (low viscosity)	– Change the engine oil and oil filter and clean the oil screens. 🛠️ (📖 p. 230)
Headlight and position light are not functioning	Fuse 6 blown	– Change the fuses of individual power consumers. (📖 p. 199)

Faults	Possible cause	Action
Turn signal, brake light, and horn are not functional	Fuse 5 blown	<ul style="list-style-type: none"> – Change the fuses of individual power consumers. (📖 p. 199)
Time is not (correctly) displayed	Fuse 1 is blown	<ul style="list-style-type: none"> – Change the fuses of individual power consumers. (📖 p. 199) – Set the time and date.
12 V battery discharged	Ignition not switched off when vehicle was parked	<ul style="list-style-type: none"> – Charge the 12-V battery. 🔧 (📖 p. 191)
	The 12-V battery is not being charged by the alternator	<ul style="list-style-type: none"> – Check the charging voltage. 🔧 – Check the open-circuit current. 🔧
Combination instrument shows nothing on the display	Fuse 1 or 2 blown	<ul style="list-style-type: none"> – Change the fuses of individual power consumers. (📖 p. 199) – Set the time and date.

23.1 engine

Design	2-cylinder 4-stroke in-line engine, water-cooled
Displacement	799 cm ³ (48.76 cu in)
Stroke	65.7 mm (2.587 in)
Bore	88 mm (3.46 in)
Compression ratio	12.7:1
Control	DOHC, 4 valves per cylinder controlled via cam lever, chain drive
Valve diameter, intake	36 mm (1.42 in)
Valve diameter, exhaust	29 mm (1.14 in)
Valve play, cold	
Intake at: 20 °C (68 °F)	0.10 ... 0.15 mm (0.0039 ... 0.0059 in)
Exhaust at: 20 °C (68 °F)	0.15 ... 0.20 mm (0.0059 ... 0.0079 in)
Crankshaft bearing	Slide bearing
Conrod bearing	Slide bearing
Piston pin bearing	Piston pin with ceramic coating
Pistons	Forged light alloy
Piston rings	1 compression ring, 1 lower compression ring, 1 oil ring with spring expander
Engine lubrication	Semi-dry sump lubrication system with two rotor pumps

Primary transmission	39:75
Clutch	Slipper clutch in oil bath/mechanically operated
Transmission	6-gear transmission, claw shifted
Transmission ratio	
First gear	13:37
Second gear	17:34
Third gear	20:31
Fourth gear	22:28
Fifth gear	24:26
Sixth gear	23:22
Mixture preparation	Electronic fuel injection
Ignition	Contactless controlled fully electronic ignition with digital ignition adjustment
Alternator	12 V, 400 W
Spark plug	NGK LMAR9AI-10
Spark plug electrode gap	1.0 mm (0.039 in)
Cooling	Water cooling, permanent circulation of coolant by water pump
Idle speed	1,750 \pm 50 rpm
Starting aid	Starter motor

23.2 Engine tightening torques

Screw plug, water pump drain hole	EJOTALtracs®Plus 60x14	8 Nm (5.9 lbf ft)	Loctite®243™
Hose clamp, intake flange	M4	2.5 Nm (1.84 lbf ft)	
Nozzle, engine vent	M5	2 Nm (1.5 lbf ft)	Loctite®243™
Oil nozzle for piston cooling	M5	2 Nm (1.5 lbf ft)	Loctite®243™
Oil nozzle in cylinder head	M5	2 Nm (1.5 lbf ft)	Loctite®243™
Remaining screws, engine	M5	6 Nm (4.4 lbf ft)	
Screw, cam lever axial lock	M5	6 Nm (4.4 lbf ft)	Loctite®243™
Screw, crankshaft speed sensor	M5	6 Nm (4.4 lbf ft)	Loctite®243™
Screw, gear position sensor	M5	6 Nm (4.4 lbf ft)	Loctite®243™
Screw, oil filter cover	M5	6 Nm (4.4 lbf ft)	
Screw, pressure plate	M5	3 Nm (2.2 lbf ft)	Loctite®243™
Screw, shift drum retaining bracket	M5	6 Nm (4.4 lbf ft)	Loctite®243™

Screw, shift shaft sensor	M5	6 Nm (4.4 lbf ft)	Loctite®243™
Screw, thermostat case	M5	6 Nm (4.4 lbf ft)	Loctite®243™
Remaining screws, engine	M6	10 Nm (7.4 lbf ft)	
Screw, alternator cover	M6x30	10 Nm (7.4 lbf ft)	
Screw, alternator cover	M6x35	10 Nm (7.4 lbf ft)	
Screw, bearing bridge of balancer shaft bearing	M6	12 Nm (8.9 lbf ft)	
Screw, bleeder flange	EJOT screw M6	8 Nm (5.9 lbf ft)	Loctite®243™
Screw, camshaft bearing bridge	M6	10 Nm (7.4 lbf ft)	
Screw, clutch cable retaining bracket	M6	10 Nm (7.4 lbf ft)	
Screw, clutch cover	M6	10 Nm (7.4 lbf ft)	
Screw, clutch release lever	M6	10 Nm (7.4 lbf ft)	Loctite®243™
Screw, clutch spring	M6	10 Nm (7.4 lbf ft)	
Screw, cylinder head	M6	10 Nm (7.4 lbf ft)	
Screw, engine case	M6x30	12 Nm (8.9 lbf ft)	
Screw, engine case	M6x60	12 Nm (8.9 lbf ft)	
Screw, heat exchanger	M6	10 Nm (7.4 lbf ft)	
Screw, ignition coil	M6	8 Nm (5.9 lbf ft)	

23 TECHNICAL DATA

Screw, locking lever	M6	10 Nm (7.4 lbf ft)	Loctite®243™
Screw, main shaft bearing support	M6	10 Nm (7.4 lbf ft)	Loctite®243™
Screw, oil pan	M6x30	10 Nm (7.4 lbf ft)	
Screw, oil pan	M6x35	10 Nm (7.4 lbf ft)	
Screw, oil pump cover	M6	10 Nm (7.4 lbf ft)	Loctite®243™
Screw, oil pump idler gear	M6	12 Nm (8.9 lbf ft)	Loctite®243™
Screw, oil pump unit	M6	10 Nm (7.4 lbf ft)	
Screw, shift drum locating	M6	10 Nm (7.4 lbf ft)	Loctite®243™
Screw, shift lever	M6	14 Nm (10.3 lbf ft)	Loctite®243™
Screw, shift shaft retaining bracket	M6	10 Nm (7.4 lbf ft)	Loctite®243™
Screw, starter motor	M6	10 Nm (7.4 lbf ft)	
Screw, stator	M6	10 Nm (7.4 lbf ft)	Loctite®243™
Screw, timing chain shaft	M6	10 Nm (7.4 lbf ft)	
Screw, upper guide rail	M6x20	8 Nm (5.9 lbf ft)	Loctite®243™

Screw, valve cover	M6	10 Nm (7.4 lbf ft)
Screw, water pump cover	M6	10 Nm (7.4 lbf ft)
Screw, water pump wheel	M6	10 Nm (7.4 lbf ft) Loctite®243™
Freewheel ring bolt	M8	14 Nm (10.3 lbf ft) Loctite®243™
Nut, exhaust flange	M8	15 Nm (11.1 lbf ft) Copper paste
Oil nozzle for clutch lubrication	M8	5 Nm (3.7 lbf ft) Loctite®243™
Remaining screws for engine	M8	20 Nm (14.8 lbf ft)
Screw plug, locking screw	M8	15 Nm (11.1 lbf ft)
Screw, conrod bearing	M8	1st stage 5 Nm (3.7 lbf ft) 2nd stage 15 Nm (11.1 lbf ft) 3rd stage 90° Collar and thread oiled
Screw, engine case	M8x45	25 Nm (18.4 lbf ft) Screw support greased
Screw, engine case	M8x55	25 Nm (18.4 lbf ft) Screw support greased

23 TECHNICAL DATA

Screw, engine case	M8x65	25 Nm (18.4 lbf ft) Screw support greased
Screw, engine case	M8x90	25 Nm (18.4 lbf ft) Screw support greased
Screw, timing chain tensioning rail	M8	15 Nm (11.1 lbf ft) Loctite®243™
Stud, exhaust flange	M8	15 Nm (11.1 lbf ft) Loctite®243™
Engine coolant temperature sensor	M10	10 Nm (7.4 lbf ft)
Screw plug, bearing support	M10	12 Nm (8.9 lbf ft) Loctite®243™
Screw plug, oil hole, timing chain shaft	M10	12 Nm (8.9 lbf ft) Loctite®243™
Screw, cylinder head	M10	Tightening sequence: Observe tightening sequence. 1st stage 5 Nm (3.7 lbf ft) 2nd stage 15 Nm (11.1 lbf ft) 3rd stage 90° 4th stage 90° Collar greased / thread oiled
Spark plug	M10	10 Nm (7.4 lbf ft)

Oil pressure sensor	M10x1	10 Nm (7.4 lbf ft)
Screw plug, cam lever axis	M10x1	10 Nm (7.4 lbf ft)
Screw, unlocking of timing chain tensioner	M10x1	10 Nm (7.4 lbf ft)
Screw plug, cylinder head oil drain	M12	15 Nm (11.1 lbf ft)
Screw, rotor	M12x1.5	90 Nm (66.4 lbf ft) Loctite®243™
Screw plug, water jacket	M16	20 Nm (14.8 lbf ft)
Nut, engine sprocket	M20x1.5	100 Nm (73.8 lbf ft) Loctite®243™
Nut, inner clutch hub	M20x1.5	90 Nm (66.4 lbf ft) Loctite®243™
Plug, oil screen	M20x1.5	20 Nm (14.8 lbf ft)
Plug, timing chain tensioner	M24x1.5	25 Nm (18.4 lbf ft)
Screw in alternator cover	M24x1.5	8 Nm (5.9 lbf ft)

23.3 Capacities

23.3.1 Engine oil

Engine oil	2.8 l (3 qt.)	Engine oil (SAE 10W/50) ( p. 272)
------------	---------------	--

23 TECHNICAL DATA

23.3.2 Coolant

Coolant	1.20 l (1.27 qt.)	Coolant (📖 p. 271)
---------	-------------------	--------------------

23.3.3 Fuel

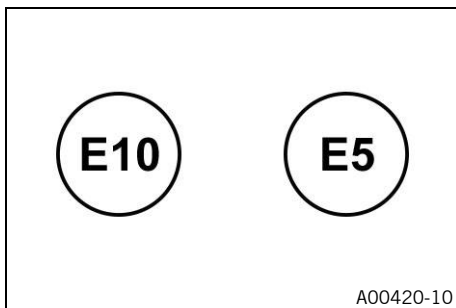

Please observe the labels on EU fuel pumps.

Total fuel tank capacity, approx.	14 l (3.7 US gal)	Super unleaded (ROZ 95/RON 95/PON 91) (📖 p. 273)
-----------------------------------	-------------------	--

23.4 Chassis

Frame	Lattice frame made of chrome molybdenum steel tubing, powder-coated
Fork	WP Suspension Up Side Down 4357
Shock absorber	WP Suspension 4614

Suspension travel	
front	140 mm (5.51 in)
rear	150 mm (5.91 in)
Brake system	
front	Double disc brake with radially mounted four-piston brake calipers, floating brake discs
rear	Disc brake with single-piston brake caliper, floating
Brake discs - diameter	
front	300 mm (11.81 in)
rear	240 mm (9.45 in)
Brake discs - wear limit	
front	4.5 mm (0.177 in)
rear	4.5 mm (0.177 in)
Tire pressure when solo	
front	2.3 bar (33 psi)
rear	2.6 bar (38 psi)
Tire pressure with passenger / full payload	
front	2.3 bar (33 psi)
rear	2.6 bar (38 psi)
Secondary drive ratio	16:41
Chain	5/8 x 1/4" (520) X-ring
Steering head angle	66°

23 TECHNICAL DATA

Wheelbase	1,475 ± 15 mm (58.07 ± 0.59 in)
Seat height unloaded	825 mm (32.48 in)
Ground clearance unloaded	186 mm (7.32 in)
Weight without fuel, approx.	174.6 kg (384.9 lb.)
Maximum permissible front axle load	160 kg (353 lb.)
Maximum permissible rear axle load	270 kg (595 lb.)
Maximum permissible overall weight	430 kg (948 lb.)

23.5 Electrical system

12 V battery	HTZ12A-BS	Battery voltage: 12 V Nominal capacity: 10 Ah Maintenance-free
Fuse	75011088010	10 A
Fuse	75011088015	15 A
Fuse	75011088025	25 A
Fuse	58011109130	30 A

Low beam/high beam	LED
Daytime running light/position light	LED
Combination instrument lighting and indicator lamps	LED
Turn signal	LED
Brake/tail light	LED

License plate lamp	LED
--------------------	-----

23.6 Tires

Front tire	Rear tire
120/70 ZR 17 M/C (58W) TL (J) Maxxis Supermaxx ST	180/55 ZR 17 M/C (73W) TL (G) Maxxis Supermaxx ST
The tires specified represent one of the possible series production tires. Additional information is available in the Service section under: http://www.ktm.com	

23.7 Fork

Fork article number	05.58.6R.26	
Fork	WP Suspension Up Side Down 4357	
Spring rate		
Medium (standard)	6.0 ... 9.0 N/mm (34.3 ... 51.4 lb/in)	
Fork length	765 mm (30.12 in)	
Spring length with preload spacer(s)	367 mm (14.45 in)	
Air chamber length	108 mm (4.25 in)	
Fork oil per fork leg	470 ml (15.89 fl. oz.)	Fork oil (SAE 4) (48601166S1) (📖 p. 273)

23.8 Shock absorber

Shock absorber article number	01.58.4R.26	
Shock absorber	WP Suspension 4614	
Spring preload	Standard	
	5 clicks	
Inbuilt length	387 mm (15.24 in)	
Spring length	185 mm (7.28 in)	
Spring rate	Medium (standard)	
	130 ... 160 N/mm (742 ... 914 lb/in)	
Shock absorber oil	Shock absorber fluid (SAE 2.5) (50180751S1) (📖 p. 273)	

23.9 Chassis tightening torques

Remaining screws, chassis	EJOTPT® K45x12	1 Nm (0.7 lbf ft)
Remaining screws, chassis	EJOTPT® K50x12	1 Nm (0.7 lbf ft)
Remaining screws, chassis	EJOTPT® K50x14	1 Nm (0.7 lbf ft)
Remaining screws, chassis	EJOTPT® K50x16	2 Nm (1.5 lbf ft)
Remaining screws, chassis	EJOTPT® K50x18	2 Nm (1.5 lbf ft)
Screw, headlight	EJOTPT® K50x14	2 Nm (1.5 lbf ft)
Remaining nuts, chassis	M4	3 Nm (2.2 lbf ft)

Remaining screws, chassis	M4	3 Nm (2.2 lbf ft)	
Screw, fixed grip, left	M4	2 Nm (1.5 lbf ft)	
Remaining nuts, chassis	M5	5 Nm (3.7 lbf ft)	
Remaining screws, chassis	M5	5 Nm (3.7 lbf ft)	
Screw, air filter box	M5	3 Nm (2.2 lbf ft)	
Screw, brake fluid reservoir for rear brake	M5	5 Nm (3.7 lbf ft)	Loctite®243™
Screw, cable on starter motor	M5	3 Nm (2.2 lbf ft)	
Screw, combination instrument	M5	4 Nm (3 lbf ft)	
Screw, combination switch, left	M5	2 Nm (1.5 lbf ft)	
Screw, combination switch, right	M5	5 Nm (3.7 lbf ft)	
Screw, engine sprocket cover	M5	5 Nm (3.7 lbf ft)	Loctite®243™
Screw, headlight mask	M5	5 Nm (3.7 lbf ft)	Loctite®243™
Screw, heat guard	M5	5 Nm (3.7 lbf ft)	Loctite®243™
Screw, side stand switch	M5	2 Nm (1.5 lbf ft)	Loctite®243™
Screw, support roller	M5	4 Nm (3 lbf ft)	Loctite®243™
Screw, throttle grip	M5	3.5 Nm (2.58 lbf ft)	
Screw, trim	M5	3 Nm (2.2 lbf ft)	

23 TECHNICAL DATA

Nut, hand brake lever	M6	Attach torque to nut. 10 Nm (7.4 lbf ft)
Nut, push rod, foot brake lever	M6	6 Nm (4.4 lbf ft)
Nut, shift rod	M6	6 Nm (4.4 lbf ft)
Nut, shift rod	M6LH	6 Nm (4.4 lbf ft)
Remaining nuts, chassis	M6	10 Nm (7.4 lbf ft)
Remaining screws, chassis	M6	10 Nm (7.4 lbf ft)
Screw, angle sensor	M6	5 Nm (3.7 lbf ft)
Screw, ball joint of push rod on foot brake cylinder	M6	10 Nm (7.4 lbf ft) Loctite®243™
Screw, battery terminal	M6x12	4.5 Nm (3.32 lbf ft)
Screw, battery terminal	M6x20	4.5 Nm (3.32 lbf ft)
Screw, brake assembly	M6	5 Nm (3.7 lbf ft)
Screw, clutch assembly	M6	5 Nm (3.7 lbf ft)
Screw, foot brake cylinder	M6	10 Nm (7.4 lbf ft) Loctite®243™
Screw, foot brake lever stub	M6	10 Nm (7.4 lbf ft) Loctite®243™
Screw, fuel tank bracket	M6	10 Nm (7.4 lbf ft) Loctite®243™
Screw, fuel tank spoiler	M6	3 Nm (2.2 lbf ft)
Screw, ground wire on frame	M6	6 Nm (4.4 lbf ft)
Screw, ground wire to starter motor	M6	10 Nm (7.4 lbf ft)

Screw, ignition lock (tamper-proof screw)	M6	22 Nm (16.2 lbf ft) Loctite®243™
Screw, license plate holder	M6	10 Nm (7.4 lbf ft) Loctite®243™
Screw, lower radiator bracket	M6	5 Nm (3.7 lbf ft)
Screw, magnetic holder on side stand	M6	2 Nm (1.5 lbf ft) Loctite®243™
Screw, manifold clamp	M6	8 Nm (5.9 lbf ft) Copper paste
Screw, seat lock	M6	10 Nm (7.4 lbf ft) Loctite® 222™
Screw, shift lever stub	M6	10 Nm (7.4 lbf ft) Loctite®243™
Screw, shift rod	M6	10 Nm (7.4 lbf ft) Loctite®243™
Screw, shift shaft deflector on shift shaft	M6	10 Nm (7.4 lbf ft) Loctite®243™
Screw, wheel speed sensor	M6	6 Nm (4.4 lbf ft)
Nut, manifold on cylinder head	M8	Observe tightening sequence. 20 Nm (14.8 lbf ft) Copper paste
Pin, rear brake caliper	M8	22 Nm (16.2 lbf ft)
Remaining nuts, chassis	M8	25 Nm (18.4 lbf ft)
Remaining screws, chassis	M8	25 Nm (18.4 lbf ft)

23 TECHNICAL DATA

Screw, bottom triple clamp	M8	12 Nm (8.9 lbf ft)	
Screw, cross member	M8x18	25 Nm (18.4 lbf ft)	Loctite®243™
Screw, cross member in rear	M8x35	25 Nm (18.4 lbf ft)	Loctite®243™
Screw, foot brake lever	M8	25 Nm (18.4 lbf ft)	Loctite®2701™
Screw, footrest bracket, rear	M8x25	25 Nm (18.4 lbf ft)	Loctite®243™
Screw, footrest bracket, rear	M8x40	25 Nm (18.4 lbf ft)	Loctite®243™
Screw, fork stub	M8	15 Nm (11.1 lbf ft)	
Screw, front brake disc	M8	30 Nm (22.1 lbf ft)	Loctite®2701™
Screw, grab handle	M8x50	25 Nm (18.4 lbf ft)	Loctite®243™
Screw, handlebar clamp	M8	20 Nm (14.8 lbf ft)	
Screw, linkage bracket, front engine fixing arm	M8	25 Nm (18.4 lbf ft)	Loctite®243™
Screw, main silencer fastening	M8	15 Nm (11.1 lbf ft)	
Screw, passenger seat bracket	M8	25 Nm (18.4 lbf ft)	Loctite®243™
Screw, presilencer on frame	M8	25 Nm (18.4 lbf ft)	Loctite®243™

Screw, rear brake disc	M8	30 Nm (22.1 lbf ft) Loctite®2701™
Screw, shift lever	M8	25 Nm (18.4 lbf ft) Loctite®2701™
Screw, spring holder plate on side stand bracket	M8	15 Nm (11.1 lbf ft) Loctite®2701™
Screw, steering damper on holder	M8	8 Nm (5.9 lbf ft) Loctite®243™
Screw, steering damper on triple clamp	M8	8 Nm (5.9 lbf ft) Loctite®243™
Screw, steering stem	M8	20 Nm (14.8 lbf ft) Loctite®243™
Screw, top triple clamp	M8	15 Nm (11.1 lbf ft)
Securing bolt for brake linings	M8	10 Nm (7.4 lbf ft)
Engine carrying screw	M10	45 Nm (33.2 lbf ft) Loctite®243™
Remaining nuts, chassis	M10	45 Nm (33.2 lbf ft)
Remaining screws, chassis	M10	45 Nm (33.2 lbf ft)
Screw, front footrest bracket	M10x30	45 Nm (33.2 lbf ft) Loctite®243™
Screw, front footrest bracket	M10x60	45 Nm (33.2 lbf ft) Loctite®243™
Screw, front footrest bracket	M10x80	45 Nm (33.2 lbf ft) Loctite®243™

23 TECHNICAL DATA

Screw, handlebar support	M10	45 Nm (33.2 lbf ft) Loctite®243™
Screw, side stand	M10	35 Nm (25.8 lbf ft) Loctite®243™
Screw, subframe	M10	38 Nm (28 lbf ft) Loctite®2701™
Banjo bolt, brake line	M10x1	25 Nm (18.4 lbf ft)
Screw, front brake caliper	M10x1.25	45 Nm (33.2 lbf ft) Loctite®243™
Screw, bottom shock absorber	M12	80 Nm (59 lbf ft) Loctite®2701™
Screw, swingarm pivot	M12	100 Nm (73.8 lbf ft)
Screw, top shock absorber	M12	80 Nm (59 lbf ft) Loctite®2701™
Lambda sensor	M18x1.5	50 Nm (36.9 lbf ft)
Adjusting screw, swingarm	M20LHx1.5	10 Nm (7.4 lbf ft)
Nut, rear wheel spindle	M25x1.5	90 Nm (66.4 lbf ft) Thread and contact area of wheel spindle greased
Screw, front wheel spindle	M25x1.5	45 Nm (33.2 lbf ft) Thread greased
Screw, steering head	M25x1.5	18 Nm (13.3 lbf ft)

24.1 Declarations of conformity



Info

The functional and equipment scope is model-dependent and may not include all wireless systems and application areas referred to.

COBO SpA hereby declares that the **BT-ROUTER** wireless system conforms with the relevant guidelines. The full text of the Declaration of Conformity is available at the following Internet address.
Certification website: <http://www.ktm.com/btrouter>

KTM AG hereby declares that the **Immo641** wireless system conforms with the relevant guidelines. The full text of the Declaration of Conformity is available at the following Internet address.
Certification website: <http://www.ktm.com/immo641>

Schrader Electronics Ltd hereby declares that the **Tyre Pressure Monitoring System** wireless system conforms with the relevant guidelines. The full text of the Declaration of Conformity is available at the following Internet address.
Certification website: <http://www.ktm.com/tpms>

24.2 Country-specific declarations of conformity

Immo641



CNC COMISSION NACIONAL
DE COMUNICACIONES
H-21170

TRA
REGISTERED No:
ER63251/18
DEALER No:
DA74519/18

Complies with
IMDA Standards
DA103787

ictQATAR
Type Approval reg. No.:
CRA/SA/2018/R-7050

57743/SDPPI/2018
PLG ID: 7757

RTIKTM18-0315, KTM, Minda Immo641
La operación de este equipo está sujeta a las siguientes dos condiciones: (1) es posible que este equipo o dispositivo no cause interferencia perjudicial y (2) este equipo o dispositivo debe aceptar cualquier interferencia, incluyendo la que pueda causar su operación no deseada.



UA.TR.109

Israel 51-65016

מרביר זה פטור מרישיון הפעלה אלוותי.
המרביר אסור לשימוש למתן שרות לצד ג'.
אסור להחליף אנטנת המכשיר המקוריית.
אסור לעשות במכשיר כל שינוי טכני.

This product contains radio equipment (125 kHz transmitter) which is conform with the regulations for communications equipment (extremely low-power radio station) specified in article 6, paragraph 1 of the Radio Law Enforcement Regulations.



"This product does not need an Israeli wireless operation license.
It is forbidden to use this product for service to third party.
It is forbidden to replace the original antenna
It is forbidden to make any technical change in this product.

AGREE PAR L'ANRT MAROC
Numéro d'agrément: MR 16565 ANRT 2018
Date d'agrément: 15/05/2018

" Este equipamento opera em caráter secundário, isto é, não tem direito a proteção contra interferência prejudicial, mesmo de estações do mesmo tipo, e não pode causar interferência a sistemas operando em caráter primário."

V01421-01

Brake fluid DOT 4 / DOT 5.1

Standard/classification

- DOT

Guideline

- Use only brake fluid that complies with the specified standard (see specifications on the container) and that exhibits the corresponding properties.

Recommended supplier

Castrol

- REACT PERFORMANCE DOT 4

MOTOREX®

- Brake Fluid DOT 5.1

Coolant

Guideline

- Only use high-grade, silicate-free coolant with corrosion inhibitor additive for aluminum motors. Low grade and unsuitable antifreeze causes corrosion, deposits and frothing.
- Do not use pure water as only coolant is able to meet the requirements needed in terms of corrosion protection and lubrication properties.
- Only use coolant that complies with the requirements stated (see specifications on the container) and that has the relevant properties.

Antifreeze protection to at least	-25 °C (-13 °F)
-----------------------------------	-----------------

The mixture ratio must be adjusted to the necessary antifreeze protection. Use distilled water if the coolant needs to be diluted.

The use of premixed coolant is recommended.

Observe the coolant manufacturer specifications for antifreeze protection, dilution and miscibility (compatibility) with other coolants.

Recommended supplier

MOTOREX®

- **COOLANT M3.0**

Engine oil (SAE 10W/50)

Standard/classification

- JASO T903 MA2 (📖 p. 276)
- SAE (📖 p. 276) (SAE 10W/50)

Guideline

- Use only engine oils that comply with the specified standards (see specifications on the container) and that possess the corresponding properties.

Fully synthetic engine oil

Recommended supplier

MOTOREX®

- **Power Synt 4T**

Fork oil (SAE 4) (48601166S1)

Standard/classification

- SAE (📖 p. 276) (SAE 4)

Guideline

- Use only oils that comply with the specified standards (see specifications on the container) and that exhibit the corresponding properties.

Shock absorber fluid (SAE 2.5) (50180751S1)

Standard/classification

- SAE (📖 p. 276) (SAE 2.5)

Guideline

- Use only oils that comply with the specified standards (see specifications on the container) and that exhibit the corresponding properties.

Super unleaded (ROZ 95/RON 95/PON 91)

Standard/classification

- DIN EN 228 (ROZ 95/RON 95/PON 91)

Guideline

- Only use unleaded super fuel that matches or is equivalent to the specified fuel grade.
- Fuel with an ethanol content of up to 10 % (E10 fuel) is safe to use.



Info

Do **not** use fuel containing methanol (e. g. M15, M85, M100) or more than 10 % ethanol (e. g. E15, E25, E85, E100).

Chain cleaner

Recommended supplier

MOTOREX®

- Chain Clean

Fuel additive

Recommended supplier

MOTOREX®

- Fuel Stabilizer

Long-life grease

Recommended supplier

MOTOREX®

- Bike Grease 2000

Motorcycle cleaner

Recommended supplier

MOTOREX®

- Moto Clean

Perfect finish and high gloss polish for paints

Recommended supplier

MOTOREX®

- Moto Shine

Preserving materials for paints, metal and rubber

Recommended supplier

MOTOREX®

- Moto Protect

Special cleaner for glossy and matte paint finishes, metal and plastic surfaces

Recommended supplier

MOTOREX®

- Quick Cleaner

Street chain spray

Guideline

Recommended supplier

MOTOREX®

- Chainlube Road Strong

Universal oil spray

Recommended supplier

MOTOREX®

- Joker 440 Synthetic

JASO T903 MA2

Different technical development directions required a separate specification for motorcycles – the **JASO T903 MA2** standard.

Earlier, engine oils from the automobile industry were used for motorcycles because there was no separate motorcycle specification.

Whereas long service intervals are demanded for automobile engines, the focus for motorcycle engines is on high performance at high engine speeds.

In most motorcycle engines, the transmission and clutch are lubricated with the same oil.

The **JASO T903 MA2** standard meets these special requirements.

SAE

The SAE viscosity classes were defined by the Society of Automotive Engineers and are used for classifying oils according to their viscosity. The viscosity describes only one property of oil and says nothing about quality.



ABS	Anti-lock braking system	Safety system that prevents locking of the wheels when driving straight ahead without the influence of lateral forces
DRL	Daytime Running Light	Light, which enhances the visibility of the vehicle during the day but is not focused, and in contrast to low beam does not illuminate the road surface
ETTC	Engine traction torque control	Auxiliary function of the engine control, which prevents rear wheel locking with excessive engine braking effect, by lightly opening the throttle valve
-	KTM MY RIDE	System for wireless communication with appropriate cellphones and headsets for telephony and audio
-	Launch control	Vehicles electronics functions for achieving the best possible acceleration from a standing position
MTC	Motorcycle Traction Control	Auxiliary function of the motor control that reduces engine torque with spinning rear wheel
OBD	On-board diagnosis	Vehicle system, which monitors the specified parameters of the vehicle electronics
-	Quickshifter +	Engine electronics function for shifting up and down without clutch actuation

29 LIST OF ABBREVIATIONS

Art. no.	Article number
ca.	circa
cf.	compare
e.g.	for example
etc.	et cetera
i.a.	inter alia
no.	number
poss.	possibly





30.1 Red symbols

Red symbols indicate an error condition that requires immediate intervention.

	The immobilizer indicator lamp lights up or flashes red – Status or error message of the alarm system.
	The oil pressure warning lamp lights up red – The oil pressure is too low. Stop immediately, taking care not to endanger yourself or other road users in the process, and switch off the engine.



30.2 Yellow and orange symbols

Yellow and orange symbols indicate an error condition that requires prompt intervention. Active driving aids are also represented by yellow or orange symbols.

	Malfunction indicator lamp lights up yellow – The OBD has detected an error in the vehicle electronics. Come safely to a halt, and contact an authorized KTM workshop.
	ABS warning lamp lights up/flashes yellow – Status or error messages relating to ABS. The ABS warning lamp flashes if the ABS mode Supermoto is enabled.
	TC indicator lamp lights up yellow – MTC (📖 p. 226) is not enabled or is currently intervening. The TC indicator lamp also lights up if an error is detected. Contact an authorized KTM workshop. The TC indicator lamp flashes if MTC actively engages or if the Launch Control (📖 p. 108) is activated.
	The general warning lamp lights up yellow – A note/warning on operating safety has been detected. This is also shown in the display.

30.3 Green and blue symbols

Green and blue symbols reflect information.

	The turn signal indicator lamp flashes green simultaneously with the turn signal – The turn signal is switched on.
	The idle indicator lamp lights up green – The transmission is in neutral.
	The high beam indicator lamp lights up blue – The high beam is switched on.

1

12-V battery

charging	191
installing	189
removing	186

A

ABS	151
------------	-----

ABS fuses

changing	197
----------	-----

ACC1

front	210
rear	211

ACC2

front	210
rear	211

Accessories	17
--------------------	----

Antifreeze

checking	213
----------	-----

Anti-lock braking system	151
---------------------------------	-----

Auxiliary substances	17
-----------------------------	----

B

Brake discs

checking	153
----------	-----

Brake fluid

front brake, adding	156
of rear brake, adding	162

Brake fluid level

front brake, checking	155
rear brake, checking	161

Brake linings

front brake, checking	158
rear brake, checking	164

Brake system	151-165
---------------------	---------

Brakes	118
---------------	-----

Brakes, applying	118
-------------------------	-----

C

Capacity

coolant	220, 223, 258
engine oil	233, 257
fuel	125, 258

Chain

checking	147
cleaning	141

dirt, checking for	140	KTM MY RIDE	85
Chain tension		Language	68
adjusting	145	Launch control	80
checking	143	menu	59
Clutch lever	28	MTC + MSR	80
basic position, adjusting	93	overview	43
Combination instrument	43-90	Pairing	86
ABS	81	Pressure	66
ABS Mode	82	Quick Shift +	83
activation and test	43	Quick Selector 1	72
Anti-wheelie mode	79	Quick Selector 2	73
Audio player	88	Ride Mode	77, 225
Bluetooth®	63	Service	75
Clock/Date	68	Set Favorites	74
coolant temperature indicator	57	Settings	63
day-night mode	45	shift warning light	55
display	52	Shift Light	84
Distance	64	slip adjustment	227
DRL	69	telephony	90
Extra functions	75	Temp	65
Favorites	59	Throttle response	227
fuel level display	56	time	57
Fuel Cons	67	TPMS warning	71
General Info	62	Track	78
indicator lamps	48	TRACK display	54

trip distance counter	58
Trip 1	60
Trip 2	61
warnings	46, 76
Combination switch	29
overview	30
Coolant	
draining	217
Coolant level	
checking	213
checking in the compensating tank	215
Cooling system	212
filling/bleeding	219
Cover of the headlight mask rack	
installing	206
removing	204
Customer service	18
D	
Declarations of conformity	269-270
country-specific	270
Diagnostics connector	210

E	
Electric starter button	33
Emergency OFF switch	33
Engine	
running in	102
Engine number	25
Engine oil	
adding	234
changing	230
Engine oil level	
checking	229
Engine sprocket	
checking	147
Engine traction torque control	117
Environment	15
F	
Figures	18
Foot brake lever	41
basic position, adjusting	95
free travel, checking	160
Fork legs	
dust boots, cleaning	134

Fork part number	26	Handlebar position	91
Free travel of clutch lever		adjusting	91
checking	236	Headlight	
setting	237	daytime running light	185
Front rider's seat		range, adjusting	209
mounting	139	setting, checking	208
Front rider's seat		Headlight mask with headlight	
removing	138	loosening	202
Front wheel		mounting	203
installing	168	Horn button	32
removing	166	I	
Fuel tank filler cap		Ignition lock	34
closing	37	Implied warranty	17
opening	35	Indicator lamps	48
Fuel, oils, etc.	17	Intended use	11
Fuse		K	
individual power consumers, changing	199	Key number	25
G		L	
Grab handle	39	Launch control	108
H		Light switch	30
Hand brake lever	28	Loading the vehicle	102
basic position, adjusting	94	Luggage	102

M	
Main fuse	
changing	195
Manufacturer warranty	17
Misuse	11
Motorcycle	
cleaning	238
lifting with front lifting gear	132
raising with the rear lifting gear	131
removing the rear from the lifting gear	131
taking off front lifting gear	133
Motorcycle traction control	226
MSR	117
MTC	226
O	
Oil filter	
changing	230
Oil screens	
cleaning	230
Owner's Manual	16
P	
Parking	120

Passenger foot pegs	39
Passenger seat	
mounting	137
removing	136
Preparing for use	
advice on preparing for first use	100
after storage	245
checks and maintenance measures when	
preparing for use	105
Protective clothing	14
Q	
Quickshifter +	110
R	
Rear hub damping rubber pieces	
checking	178
Rear sprocket	
checking	147
Rear wheel	
installing	175
removing	172
Refueling	
fuel	123

Riding	111
starting off	107
starting off with launch control	108

S

Safe operation	13
Seat lock	38
Service	18
Service schedule	126-129
Shift lever	40
basic position, adjusting	98
basic position, checking	97
Shifting	111
Shock absorber	
spring preload, adjusting	130
Shock absorber article number	26
Side stand	41
Slip adjustment	227
Spare parts	17
Starting	106
Steering damper article number	27
Steering lock	34
Stopping	120
Storage	243-245

Switch

on the left side of the handlebar	29
on the right side of the handlebar	33

T

Technical data

capacities	257
chassis	258
chassis tightening torques	262
electrical system	260
engine	250-268
engine tightening torques	252
fork	261
shock absorber	262
tires	261
Throttle grip	29
Tire condition	
checking	180
Tire pressure	
checking	182
Tire repair spray	
using	184
Tool set	38
Transporting	122

Troubleshooting	246-249
Turn signal switch	31
Type label	24
U	
Use definition	11
V	
Vehicle identification number	24
View of vehicle	
front left	20
rear right	22
W	
Winter operation	
checks and maintenance steps	241
Work rules	15

READY TO RACE

[» www.ktm.com](http://www.ktm.com)



3213749en

09/2018



KTM Sportmotorcycle GmbH
3230 Mattighofen/Austria
<http://www.ktm.com>



REG. NO. 12 100 6061

Photo: Mitterbauer/KTM