

## 1290 SUPER DUKE R EVO

ART. NO. 3214549EN





Congratulations on your decision to purchase a KTM motorcycle. You are now the owner of a state-of-the-art sports motorcycle that will give you enormous pleasure if you service and maintain it properly.

We hope you enjoy riding this vehicle!

Enter the serial numbers of your vehicle below.

Vehicle identification number (📖 p. 17)	Dealer's stamp
Engine number (📖 p. 18)	
Key number (📖 p. 17)	

The Owner's Manual contained the latest information for this model series at the time of publication. However, minor differences due to further developments in design cannot be ruled out completely.

All specifications contained herein are non-binding. KTM Sportmotorcycle GmbH specifically reserves the right to modify or delete technical specifications, prices, colors, forms, materials, services, designs, equipment, etc., without prior notice and without specifying reasons, to adapt these to local conditions, as well as to stop production of a particular model without prior notice. KTM accepts no liability for delivery options, deviations from figures and descriptions, misprints, and other errors. The models portrayed partly contain special equipment that does not belong to the regular scope of supply.

© 2022 KTM Sportmotorcycle GmbH, Mattighofen Austria

All rights reserved

Reproduction, even in part, as well as copying of all kinds, is permitted only with the express written permission of the copyright owner.



ISO 9001(12 100 6061)

KTM applies quality assurance processes that lead to the highest possible product quality as defined in the ISO 9001 international quality management standard.

Issued by: TÜV Management Service

REG.NO. 12 100 6061

KTM Sportmotorcycle GmbH  
Stallhofnerstraße 3  
5230 Mattighofen, Austria

This document is valid for the following models:

1290 SUPER DUKE R EVO US (F9975VS, F9975VT)





3214549en

01/2022

# TABLE OF CONTENTS

1	MEANS OF REPRESENTATION .....	6	6.8	Horn button.....	21
1.1	Symbols used .....	6	6.9	Cruise control buttons .....	21
1.2	Formats used.....	6	6.10	+RES/-SET button.....	22
2	SAFETY ADVICE.....	7	6.11	Combination switch, right .....	23
2.1	Use definition – intended use.....	7	6.12	Hazard warning flasher switch .....	23
2.2	Misuse.....	7	6.13	Start button/emergency OFF switch ...	23
2.3	Safety advice.....	7	6.14	RACE-ON button.....	24
2.4	Degrees of risk and symbols.....	7	6.15	C1 and C2 switch .....	24
2.5	Overview of labels .....	8	6.16	Steering lock (antenna).....	24
2.6	Reporting safety defects .....	10	6.17	Immobilizer.....	25
2.7	Noise emission warranty .....	10	6.18	RACE-ON key .....	25
2.8	Operating noise warning .....	10	6.19	Opening fuel tank filler cap.....	25
2.9	Manufacturer warranty for the exhaust monitoring system.....	10	6.20	Closing the fuel tank filler cap.....	26
2.10	Consumer rights.....	11	6.21	Seat lock.....	27
2.11	Tampering warning.....	11	6.22	Tool set.....	27
2.12	Safe operation .....	11	6.23	Supporting strap .....	27
2.13	Protective clothing .....	12	6.24	Passenger foot pegs .....	27
2.14	Work rules.....	12	6.25	Shift lever .....	28
2.15	Environment.....	12	6.26	Foot brake lever .....	28
2.16	Owner's Manual .....	12	6.27	Side stand.....	28
3	IMPORTANT NOTES.....	14	7	COMBINATION INSTRUMENT .....	29
3.1	Manufacturer warranty, implied warranty.....	14	7.1	Combination instrument .....	29
3.2	Fuel, auxiliary substances.....	14	7.2	Activation and test .....	29
3.3	Spare parts, technical accessories .....	14	7.3	Day-night mode .....	30
3.4	Service .....	14	7.4	Warnings.....	31
3.5	Figures .....	14	7.5	Ice warning .....	31
3.6	Customer service.....	14	7.6	Indicator lamps.....	32
4	VIEW OF VEHICLE .....	15	7.7	Display .....	33
4.1	View of vehicle, front left (example) ...	15	7.8	TRACK Display (optional).....	34
4.2	View of vehicle, rear right (example).....	16	7.9	Performance layout (optional).....	35
5	SERIAL NUMBERS .....	17	7.10	Small widget .....	36
5.1	Vehicle identification number.....	17	7.11	Large widget.....	36
5.2	Type label .....	17	7.12	Odometer .....	37
5.3	Key number.....	17	7.13	Engine speed.....	37
5.4	Engine number .....	18	7.14	Shift warning light .....	37
5.5	Fork part number .....	18	7.15	Cruise control indicator.....	38
5.6	Shock absorber article number .....	18	7.16	Speed .....	38
5.7	Steering damper article number .....	18	7.17	ABS Mode display.....	38
6	CONTROLS.....	19	7.18	Ride display .....	38
6.1	Clutch lever.....	19	7.19	Damp display .....	39
6.2	Hand brake lever.....	19	7.20	Load display.....	39
6.3	Throttle grip .....	19	7.21	Anti Dive display.....	39
6.4	Combination switch, left side .....	19	7.22	Fork display.....	39
6.5	Light switch .....	20	7.23	Shock display .....	40
6.6	Menu buttons .....	20	7.24	Gear display .....	40
6.7	Turn signal switch.....	20	7.25	Heated grip (optional).....	40
			7.26	Seat heater (optional).....	40
			7.27	Coolant temperature indicator .....	41
			7.28	Fuel level display .....	41
			7.29	Ambient air temperature indicator .....	41
			7.30	Time.....	42
			7.31	Favorites display .....	42
			7.32	Navigation display (optional) .....	42

7.33	Menu.....	42	7.46	NAVIGATION widget.....	66
7.33.1	KTM MY RIDE (optional) .....	43	7.47	FAVORITES widget.....	66
7.33.2	Audio (optional).....	43	7.48	Widget INFO.....	67
7.33.3	Navigation (optional).....	44	7.49	HEATING widget.....	67
7.33.4	Navigation information (optional).....	44	7.50	MUSIC widget .....	68
7.33.5	Volume (optional) .....	45	8	ERGONOMICS .....	69
7.33.6	Pairing (optional) .....	46	8.1	Handlebar position.....	69
7.33.7	Telephony (optional) .....	47	8.2	Adjusting the handlebar position  .....	69
7.33.8	Trip 1 .....	48	8.3	Adjusting the basic position of the clutch lever .....	70
7.33.9	Trip 2 .....	48	8.4	Adjusting the basic position of the hand brake lever .....	70
7.33.10	General Info .....	48	8.5	Setting the step plate of the foot brake lever .....	70
7.33.11	TPMS .....	49	8.6	Checking the basic position of the shift lever.....	71
7.33.12	Warnings.....	49	8.7	Setting the shift lever stub.....	71
7.33.13	Service .....	50	8.8	Adjusting the footrests  .....	71
7.33.14	Extra Functions .....	50	8.9	Adjusting the tilt of the combination instrument .....	73
7.33.15	Ride Mode .....	50	9	PREPARING FOR USE.....	75
7.33.16	Track (optional) .....	51	9.1	Advice on preparing for first use .....	75
7.33.17	Throttle Response (optional) .....	51	9.2	Running in the engine .....	76
7.33.18	Anti Wheelie Mode (optional) .....	52	9.3	Loading the vehicle.....	76
7.33.19	Launch Control (optional) .....	52	10	RIDING INSTRUCTIONS.....	78
7.33.20	Slip Adjuster (optional).....	53	10.1	Checks and maintenance measures when preparing for use .....	78
7.33.21	Motorcycle .....	53	10.2	Starting the vehicle.....	78
7.33.22	Heated Grips (optional) .....	54	10.3	Launch Control (optional) .....	80
7.33.23	Heated Seat (optional) .....	54	10.4	Starting off.....	80
7.33.24	MTC+MSR (optional).....	54	10.5	Starting off with launch control (optional) .....	80
7.33.25	ABS.....	55	10.6	Quickshifter+ (optional) .....	81
7.33.26	Quickshifter + (optional).....	55	10.7	Shifting, riding .....	81
7.33.27	Suspension .....	55	10.8	MSR (optional) .....	84
7.33.28	Damping.....	56	10.9	Applying the brakes.....	84
7.33.29	Preload Adjuster .....	56	10.10	Stopping, parking.....	85
7.33.30	Anti Dive (optional) .....	57	10.11	Transporting.....	86
7.33.31	Fork (optional).....	57	10.12	Towing in the event of a breakdown ...	87
7.33.32	Shock (optional) .....	58	10.13	Refueling .....	87
7.33.33	Settings.....	58	11	SERVICE SCHEDULE .....	89
7.33.34	C1 and C2 buttons.....	58	11.1	Additional information.....	89
7.33.35	Bluetooth (optional) .....	59	11.2	Required work .....	89
7.33.36	Headset Type .....	59	11.3	Recommended work.....	90
7.33.37	Display Theme.....	59	12	SUSPENSION SETTING.....	91
7.33.38	Button Illumination.....	60	12.1	Fork/shock absorber .....	91
7.33.39	Shift Light .....	60	12.2	Preload adjuster.....	91
7.33.40	Daytime Runn. Light .....	61	12.3	Suspension Mode.....	92
7.34	Setting the time and date .....	61			
7.35	Units .....	62			
7.36	Distance .....	62			
7.37	Temperature.....	63			
7.38	Pressure.....	63			
7.39	Consumption .....	63			
7.40	Language .....	64			
7.41	Heated Grips (optional).....	64			
7.42	Heated Seat (optional).....	64			
7.43	Small widget .....	65			
7.44	Large widget.....	65			
7.45	KTM MY RIDE widget.....	65			

# TABLE OF CONTENTS

13	SERVICE WORK ON THE CHASSIS.....	93	16	ELECTRICAL SYSTEM .....	120
13.1	Lifting the motorcycle with the rear lifting gear .....	93	16.1	Daytime running light (DRL).....	120
13.2	Removing the rear of motorcycle from the lifting gear .....	93	16.2	Removing the 12-V battery 🛠.....	120
13.3	Lifting the motorcycle with the front lifting gear .....	93	16.3	Installing the 12-V battery 🛠.....	121
13.4	Taking the motorcycle off the front lifting gear .....	94	16.4	Charging the 12-V battery 🛠.....	122
13.5	Raising the motorcycle with the work stand (inserted) 🛠.....	94	16.5	Changing the RACE-ON key battery .....	124
13.6	Removing the motorcycle from the work stand (inserted) 🛠.....	95	16.6	Changing the main fuse .....	125
13.7	Cleaning the dust boots of the fork legs 🛠.....	95	16.7	Changing the fuses in the fuse box .....	126
13.8	Removing the passenger seat .....	96	16.8	Changing the turn signal bulb .....	127
13.9	Mounting the passenger seat.....	96	16.9	Checking the headlight setting .....	128
13.10	Removing the front rider's seat.....	96	16.10	Adjusting the headlight range.....	128
13.11	Mounting the front rider's seat.....	97	16.11	Connecting the USB cable .....	129
13.12	Removing left fuel tank spoiler.....	98	16.12	Disconnecting the USB cable.....	129
13.13	Installing the left fuel tank spoiler .....	98	16.13	Diagnostics connector .....	129
13.14	Removing the main silencer 🛠.....	99	16.14	Front ACC1 and ACC2 .....	130
13.15	Installing the main silencer 🛠.....	100	16.15	ACC1 and ACC2 rear .....	130
13.16	Checking the chain for dirt.....	101	17	COOLING SYSTEM .....	131
13.17	Cleaning the chain .....	101	17.1	Checking the coolant level in the compensating tank.....	131
13.18	Checking the chain tension .....	102	17.2	Correcting the coolant level in the compensating tank.....	131
13.19	Adjusting the chain tension.....	103	18	ENGINE TUNING .....	133
13.20	Checking the chain, rear sprocket, engine sprocket, and chain guide .....	104	18.1	Ride Mode .....	133
13.21	Checking/correcting the fluid level of the hydraulic clutch.....	105	18.2	Motorcycle traction control (MTC) ....	133
14	BRAKE SYSTEM .....	107	18.3	Anti wheelie mode (optional).....	134
14.1	Anti-lock braking system (ABS) .....	107	18.4	Slip adjustment (optional).....	134
14.2	Checking the brake discs .....	108	18.5	Throttle Response (optional) .....	134
14.3	Checking the front brake fluid level .....	109	19	SERVICE WORK ON THE ENGINE .....	135
14.4	Adding front brake fluid 🛠.....	109	19.1	Checking the engine oil level.....	135
14.5	Checking the front brake linings .....	110	19.2	Changing the engine oil and oil filter, cleaning the oil screens 🛠.....	135
14.6	Checking the rear brake fluid level .....	111	19.3	Adding engine oil.....	138
14.7	Adding rear brake fluid 🛠.....	111	20	CLEANING, CARE .....	140
14.8	Checking the brake linings of the rear brake.....	113	20.1	Cleaning the motorcycle .....	140
15	WHEELS, TIRES .....	114	20.2	Checks and maintenance steps for winter operation.....	141
15.1	Removing the front wheel 🛠.....	114	21	STORAGE .....	142
15.2	Installing the front wheel 🛠.....	114	21.1	Storage .....	142
15.3	Removing the rear wheel 🛠.....	116	21.2	Preparing for use after storage.....	143
15.4	Installing the rear wheel 🛠.....	116	22	TROUBLESHOOTING .....	144
15.5	Checking the tire condition .....	117	23	TECHNICAL DATA.....	146
15.6	Checking tire pressure .....	118	23.1	Engine .....	146
15.7	Using tire repair spray .....	119	23.2	Engine tightening torques .....	147
			23.3	Capacities .....	149
			23.3.1	Engine oil .....	149
			23.3.2	Coolant .....	149

23.3.3	Fuel .....	150
23.4	Chassis .....	150
23.5	Electrical system.....	151
23.6	Tires .....	151
23.7	Fork.....	151
23.8	Shock absorber .....	152
23.9	Chassis tightening torques .....	152
24	DECLARATIONS OF CONFORMITY .....	157
24.1	Declarations of conformity .....	157
25	SUBSTANCES .....	159
26	AUXILIARY SUBSTANCES .....	161
27	STANDARDS .....	162
28	INDEX OF SPECIAL TERMS .....	163
29	LIST OF ABBREVIATIONS.....	164
30	LIST OF SYMBOLS.....	165
30.1	Red symbols.....	165
30.2	Yellow and orange symbols.....	165
30.3	Green and blue symbols.....	165
	INDEX .....	166

# 1 MEANS OF REPRESENTATION

## 1.1 Symbols used

The meaning of specific symbols is described below.



Indicates an expected reaction (e.g. of a work step or a function).



Indicates an unexpected reaction (e.g. of a work step or a function).



Indicates work that requires expert knowledge and technical understanding. In the interest of your own safety, have these jobs performed by an authorized KTM workshop! Your motorcycle will be cared for there to the highest degree by specially trained experts using the special tools required.



Indicates a page reference (more information is provided on the specified page).



Indicates information with more details or tips.



Indicates the result of a testing step.



Indicates a voltage measurement.



Indicates a current measurement.



Indicates the end of an activity, including potential rework.

## 1.2 Formats used

The typographical formats used in this document are explained below.

**Proprietary name**

Indicates a proprietary name.

**Name<sup>®</sup>**

Indicates a protected name.

**Brand<sup>™</sup>**

Indicates a brand available on the open market.

**Underlined terms**

Refer to technical details of the vehicle or indicate technical terms, which are explained in the glossary.



## 2.1 Use definition – intended use

The vehicle is designed and constructed to withstand the usual demands of regular traffic and use on race courses. This vehicle is not suitable for offroad use.



### Info

This vehicle is only authorized for operation on public roads in its homologated version.

## 2.2 Misuse

The vehicle must only be used as intended.

Dangers can arise for people, property and the environment through use not as intended.

Any use of the vehicle beyond the intended and defined use constitutes misuse.

Misuse also includes the use of operating and auxiliary fluids which do not meet the required specification for the respective use.

## 2.3 Safety advice

A number of safety instructions need to be followed to operate the product described safely. Therefore read this instruction and all further instructions included carefully. The safety instructions are highlighted in the text and are referred to at the relevant passages.



### Info

Various information and warning labels are attached in prominent locations on the product described. Do not remove any information or warning labels. If they are missing, you or others may not recognize dangers and may therefore be injured.

## 2.4 Degrees of risk and symbols



### Danger

Identifies a danger that will immediately and invariably lead to fatal or serious permanent injury if the appropriate measures are not taken.



### Warning

Identifies a danger that is likely to lead to fatal or serious injury if the appropriate measures are not taken.



### Caution

Identifies a danger that may lead to minor injuries if the appropriate measures are not taken.

### Note

Identifies a danger that will lead to considerable machine and material damage if the appropriate measures are not taken.



### Note

Indicates a danger that will lead to environmental damage if the appropriate measures are not taken.

## 2.5 Overview of labels

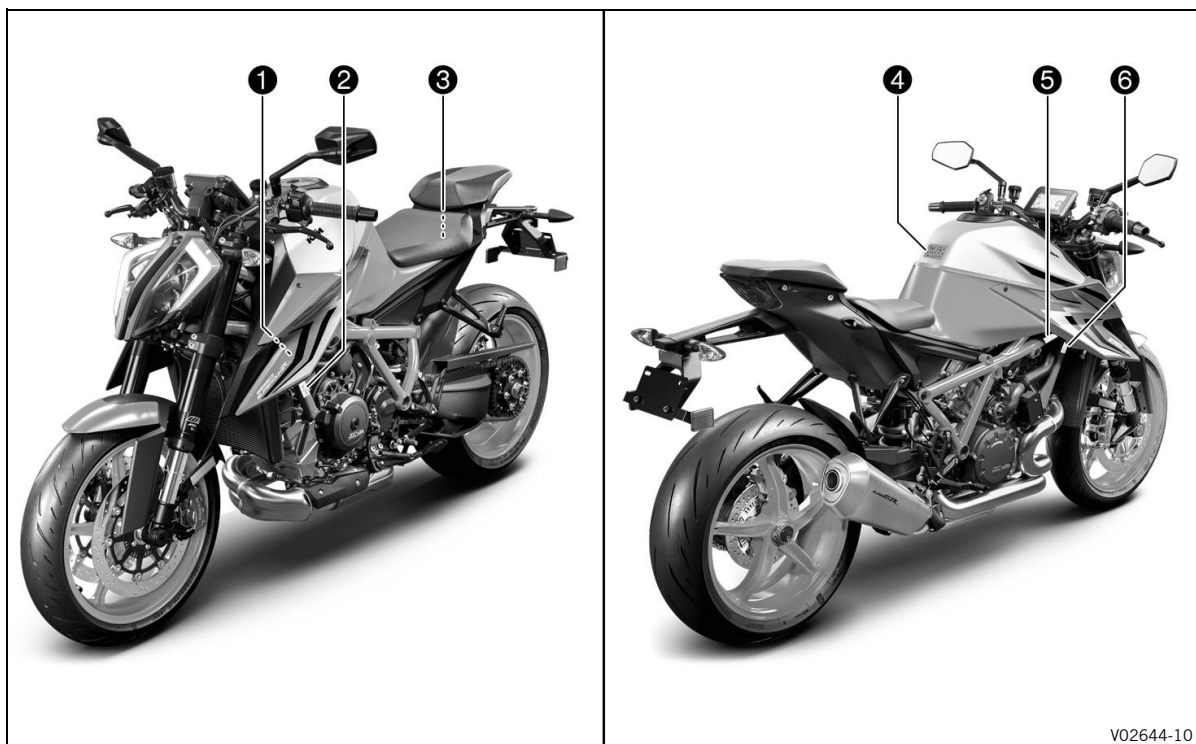

V02644-10

- |   |                                     |
|---|-------------------------------------|
| 1 | Information on noise emissions      |
| 2 | Type label for Canada               |
| 3 | Information on chain tension        |
| 4 | Information on preparations for use |
| 5 | Type label for USA                  |
| 6 | Information on emissions control    |

<p>MOTORCYCLE NOISE EMISSION CONTROL INFORMATION KTM AG, AUSTRIA</p>	
<p>THIS MOTORCYCLE, MEETS EPA NOISE EMISSION REQUIREMENTS OF    dBA AT    RPM BY THE FEDERAL TEST PROCEDURE. MODIFICATIONS WHICH CAUSE THIS MOTORCYCLE TO EXCEED FEDERAL NOISE STANDARDS ARE PROHIBITED BY U.S. FEDERAL LAW. SEE OWNER'S MANUAL.</p>	
<p>Motorcycle Type :</p>	<p>V02645-01</p>

Information on noise emissions

MANUFACTURED BY/FABRIQUÉ PAR: <b>KTM AG</b>		
GVPR/PNBV: KG	DATE:	
V.I.N./N.I.V.:		
TYPE: <b>MC</b>		
GAWR/PNBE	TIRE/PNEU-DIMENSION-RIM/JANTE	COLD INFL. PRESS PRESS. DE GONFL. À FROID PSI/LPC KPA
1st KG		
2nd KG		
THIS VEHICLE CONFORMS TO ALL APPLICABLE STANDARDS PRESCRIBED UNDER THE CANADIAN MOTOR VEHICLE SAFETY REGULATIONS IN EFFECT ON THE DATE OF MANUFACTURE - CE VÉHICULE EST CONFORME À TOUTES LES NORMES QUI LUI SONT APPLICABLES ES VERTU DU RÉGLEMENT SUR LA SÉCURITÉ DES VÉHICULES AUTOMOBILES DU CANADA EN VIGUEUR À LA DATE DE SA FABRICATION		
		V02646-01

Type label for Canada

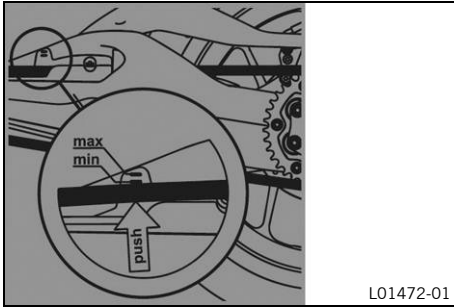

Information on chain tension

**ACHTUNG**  
Lesen Sie vor der ersten Inbetriebnahme des Fahrzeuges die gesamte Bedienungsanleitung aufmerksam durch!

**IMPORTANT**  
Please read the entire owner's manual carefully before putting the vehicle into operation for the first time.

**ATTENZIONE**  
Prima della messa in funzione iniziale del veicolo, leggere con attenzione l'intero manuale d'uso!

**ATTENTION**  
Lire attentivement l'ensemble du manuel d'utilisation avant de mettre le véhicule en service!

**ATENCIÓN**  
Lea completa y atentamente el manual de instrucciones antes de poner en servicio por primera vez el vehículo!

F00491-01

Information on preparations for use

<b>KTM</b> MFD. BY KTM AG AUSTRIA		DATE	
MOTORCYCLE			
GVWR	lbs	kg	
GAWR FRONT	lbs	kg WITH	TIRE, TYPE,
	RIM, AT	psi	bar COLD
GAWR REAR	lbs	kg WITH	TIRE, TYPE,
	RIM, AT	psi	bar COLD
THIS VEHICLE CONFORMS TO ALL APPLICABLE U.S. FEDERAL MOTOR VEHICLE SAFETY STANDARDS IN EFFECT ON THE DATE OF MANUFACTURER SHOWN ABOVE.			
			V02647-01

Type label for USA

VEHICLE EMISSION CONTROL INFORMATION

**KTM** MANUFACTURER:  
IMPORTER:

ENGINE DISPLACEMENT: ENGINE EXHAUST EMISSION CONTROL SYSTEM:

ENGINE FAMILY: EVAPORATIVE FAMILY: PERMEATION FAMILY: MODEL NAME:

THIS VEHICLE CONFORMS WITH US EPA AND CALIFORNIA REGULATIONS APPLICABLE TO MODEL YEAR NEW MOTORCYCLES AND IS CERTIFIED TO EXHAUST EMISSION STANDARDS IN CALIFORNIA.

ENGINE TUNEUP SPECIFICATIONS:  
IGNITION TIMING:  
IDLE SPEED:  
IDLE Mixture:  
VALVE CLEARANCE:  
SPARK PLUG:  
SPARK PLUG GAP:  
FUEL:  
OIL:

F03609-01

Information on emissions control

### 2.6 Reporting safety defects

If you believe that your vehicle has a defect which could cause an accident resulting in injury or death, you should immediately inform the National Highway Traffic Safety Administration (NHTSA) in addition to notifying KTM North America, Inc.

If the NHTSA receives multiple similar complaints, it may open an investigation. and if it finds that a safety defect exists in a group of vehicles, it may order a recall and remedy campaign. However, NHTSA cannot become involved in individual problems between you, your dealer, or KTM North America, Inc.

You can contact the NHTSA via the toll-free "Auto Safety Hotline" on 1-888-327-4236, visit the [www.nhtsa.dot.gov](http://www.nhtsa.dot.gov) website, or write to: NHTSA Headquarters, 1200 New Jersey Avenue, SE, West Building, Washington, DC 20590, USA. You can also obtain other information about motor vehicle safety from the hotline.

### 2.7 Noise emission warranty

KTM warrants that this exhaust system, at the time of sale, meets all applicable U.S. EPA Federal noise standards.

This manufacturer's warranty extends to the first person who purchases this exhaust system for purposes other than resale, and to all subsequent buyers.

Warranty claims should be directed to:

KTM North America, Inc., Customer Support, 1119 Milan Ave., Amherst, OH 44001, USA

Phone: (440) 985-3553

[www.ktmusa.com](http://www.ktmusa.com)

KTM Canada, Inc., Customer Support, 8701 Rue Samuel-Hatt, Chambly, QC J3L 6V4, Canada

Phone: (450) 441-4451

[www.ktmcanada.com](http://www.ktmcanada.com)

### 2.8 Operating noise warning

This product should be checked for necessary repair or replacement parts if the motorcycle noise has increased significantly through use. Otherwise, the owner may become subject to penalties under the applicable ordinances.

### 2.9 Manufacturer warranty for the exhaust monitoring system

KTM North America, Inc. guarantees that, at the time of sale, the exhaust monitoring system complies with all the standards of the US Environmental Protection Agency (EPA) and the California Air Resources Board (CARB). This manufacturer warranty applies in respect of the first owner of the motorcycle and all subsequent owners. Your exhaust monitoring system may include parts, such as the fuel injection system, ignition, catalytic converter, control units, hoses, connectors and other emission related assemblies, fuel tank, crankcase breather, fuel tank lid for vehicles with fuel evaporation monitoring, oil filler cap, pressure control valve, fuel/vapor separator, canister, ignition coils, ignition wire, capacitors, and spark plugs, if a fault occurs before the first scheduled replacement and includes the hoses, fittings, and pipes that are used directly in these components.

If the warranty conditions are met, KTM will repair your motorcycle for you free of charge, including diagnosis, parts, and labor.

As the owner of the motorcycle, you are responsible for the required maintenance specified in the Owner's Manual.

Please note that KTM is entitled to reject warranty claims if your motorcycle or a part fails due to misuse, negligence, an accident, participation in racing or similar events, improper maintenance or unauthorized modifications.

#### Scope of the manufacturer's warranty

- Five (5) years or 30,000 kilometers (18,641 miles), whichever occurs first.

If you have any questions regarding the manufacturer warranty for the exhaust monitoring system, please address these to:

KTM North America, Inc., Customer Support, 1119 Milan Ave., Amherst, OH 44001, USA

Phone: (888) 985-6090

U.S. Environmental Protection Agency, 2000 Traverwood Drive, Ann Arbor, MI 48105, USA

California Air Resources Board, 1001 "I" Street, Sacramento, CA 95814, USA

## 2.10 Consumer rights

Warranty claims must be submitted to an authorized KTM workshop. If you are not satisfied, please contact:

KTM North America, Inc., Customer Support, 1119 Milan Ave., Amherst, OH 44001, USA

Phone: (440) 985-3553

www.ktmusa.com

KTM Canada, Inc., Customer Support, 8701 Rue Samuel-Hatt, Chambly, QC J3L 6V4, Canada

Phone: (450) 441-4451

www.ktmcanada.com

Different rights may apply, according to national or regional legislation.

## 2.11 Tampering warning

Tampering with the noise control system is prohibited. Federal law prohibits the following acts or the causing thereof:

- 1 The removal or rendering inoperative by any person other than for purposes of servicing, repair, or replacement, of any device or element of design incorporated into any new vehicle for the purpose of noise control prior to its sale or delivery to the ultimate purchaser or while it is in use, or
- 2 the use of the vehicle after such device or element of design has been removed or rendered inoperative by any person.

Among those acts presumed to constitute tampering are the acts listed below:

- 1 Removal or puncturing of the main silencers, baffles, header pipes or any other components which conduct exhaust gases.
- 2 Removal or puncturing of parts of the intake system.
- 3 Lack of proper maintenance.
- 4 Replacing moving parts of the vehicle, or parts of the exhaust system or intake system, with parts other than those specified by the manufacturer.

## 2.12 Safe operation



### Danger

**Danger of accidents** A rider who is not fit to ride poses a danger to him or herself and others.

- Do not operate the vehicle if you are not fit to ride due to alcohol, drugs or medication.
- Do not operate the vehicle if you are physically or mentally impaired.



### Danger

**Danger of poisoning** Exhaust gases are toxic and inhaling them may result in unconsciousness and death.

- Always make sure there is sufficient ventilation when running the engine.
- Use effective exhaust extraction when starting or running the engine in an enclosed space.



### Warning

**Danger of burns** Some vehicle components become very hot when the vehicle is operated.

- Do not touch any parts such as the exhaust system, radiator, engine, shock absorber, or brake system before the vehicle parts have cooled down.
- Let the vehicle parts cool down before you perform any work on the vehicle.

Only operate the vehicle when it is in perfect technical condition, in accordance with its intended use, and in a safe and environmentally compatible manner.

The vehicle should only be used by trained persons. An appropriate driver's license is needed to ride the vehicle on public roads.

Have malfunctions that impair safety promptly eliminated by an authorized KTM workshop.

Adhere to the information and warning labels on the vehicle.

### 2.13 Protective clothing



#### Warning

**Risk of injury** Missing or poor protective clothing presents an increased safety risk.

- Wear appropriate protective clothing such as helmet, boots, gloves as well as trousers and a jacket with protectors on all rides.
- Always wear protective clothing that is in good condition and meets the legal regulations.

In the interest of your own safety, KTM recommends that you only operate the vehicle while wearing protective clothing.

### 2.14 Work rules

Unless specified otherwise, the ignition must be turned off during all work (models with ignition lock, models with remote key) or the engine must be at a standstill (models without ignition lock or remote key). Special tools are necessary for certain tasks. The tools are not a component of the vehicle, but can be ordered using the number in parentheses. Example: bearing puller (15112017000)  
Unless otherwise noted, normal conditions apply to all tasks and descriptions.

Ambient temperature	20 °C (68 °F)
Ambient air pressure	1,013 mbar (14.69 psi)
Relative air humidity	60 ± 5 %

During assembly, use new parts to replace parts which cannot be reused (e.g. self-locking screws and nuts, expansion screws, seals, sealing rings, O-rings, pins, and lock washers).

In the case of certain screws, a screw adhesive (e.g. **Loctite**®) is required. Observe the manufacturer's instructions.

If thread locker (e.g., **Precote**®) has already been applied to a new part, do not apply any additional thread locker. After disassembly, clean the parts that are to be reused and check them for damage and wear. Change damaged or worn parts.

After completing a repair or service work, check the operating safety of the vehicle.

### 2.15 Environment

If you use your motorcycle responsibly, you can ensure that problems and conflicts do not occur. To protect the future of the motorcycle sport, make sure that you use your motorcycle legally, display environmental consciousness, and respect the rights of others.

When disposing of used oil, other operating and auxiliary fluids, and used components, comply with the laws and regulations of the respective country.

Because motorcycles are not subject to the EU regulations governing the disposal of used vehicles, there are no legal regulations that pertain to the disposal of an end-of-life motorcycle. Your authorized KTM dealer will be glad to advise you.

### 2.16 Owner's Manual

Read this owner's manual carefully and completely before making your first trip. The Owner's Manual contains useful information and many tips on how to operate, handle, and service your motorcycle. This is the only way to find out how best to customize the vehicle for your own use and how you can protect yourself from injury.



#### Tip

Store the Owner's Manual on your terminal device, for example, so that you can read it whenever you need to.

If you would like to know more about the vehicle or have questions on the material you read, please contact an authorized KTM dealer.

The Owner's Manual is an important component of the vehicle. If the vehicle is sold, the Owner's Manual must be downloaded again by the new owner.

The Owner's Manual can be downloaded several times using the QR code or the link on the delivery certificate.

The Owner's Manual is also available for download from your authorized KTM dealer and on the KTM website. A printed copy can also be ordered from your authorized KTM dealer.

International KTM Website: [KTM.COM](http://KTM.COM)

### 3.1 Manufacturer warranty, implied warranty

The work prescribed in the service schedule must only be carried out in an authorized KTM workshop and confirmed in the **KTM Dealer.net**, as otherwise all warranty claims will be void. Damage or secondary damage caused by tampering with and/or conversions on the vehicle are not covered by the manufacturer warranty.

### 3.2 Fuel, auxiliary substances



#### Note

**Environmental hazard** Improper handling of fuel is a danger to the environment.

- Do not allow fuel to enter the groundwater, the soil, or the sewage system.

Use fuels and auxiliary substances in accordance with the Owner's Manual and specification.

### 3.3 Spare parts, technical accessories

For your own safety, only use spare parts and accessory products that are approved and/or recommended by KTM and have them installed by an authorized KTM workshop. KTM accepts no liability for other products and any resulting damage or loss.

Certain spare parts and accessory products are specified in parentheses in the descriptions. Your authorized KTM dealer will be glad to advise you.

The latest news **KTM PowerParts** on your vehicle can be found on the KTM website.  
International KTM Website: [KTM.COM](http://KTM.COM)

### 3.4 Service

A prerequisite for perfect operation and prevention of premature wear is that the service, care, and tuning work on the engine and chassis is properly carried out as described in the Owner's Manual. An incorrect suspension setting can lead to damage and breakage of chassis components.

Use of the vehicle under difficult conditions, such as dusty environments, heavy rain, high heat or with a heavy load, can lead to considerably more rapid wear of components such as the air filter, drive train, brake system, or suspension components. For this reason, it may be necessary to inspect or replace parts before the next scheduled service.

It is imperative that you adhere to the stipulated run-in times and service intervals. If you observe these exactly, you will ensure a much longer service life for your motorcycle.

The relevant mileage or time interval is whichever occurs first.

### 3.5 Figures

The figures contained in the manual may depict special equipment.

In the interest of clarity, some components may be shown disassembled or may not be shown at all. It is not always necessary to disassemble the component to perform the activity in question. Please follow the instructions in the text.

### 3.6 Customer service

Your authorized KTM dealer will be happy to answer any questions you may have on your vehicle and KTM.

A list of authorized KTM dealers can be found on the KTM website.  
International KTM Website: [KTM.COM](http://KTM.COM)



## 4.1 View of vehicle, front left (example)

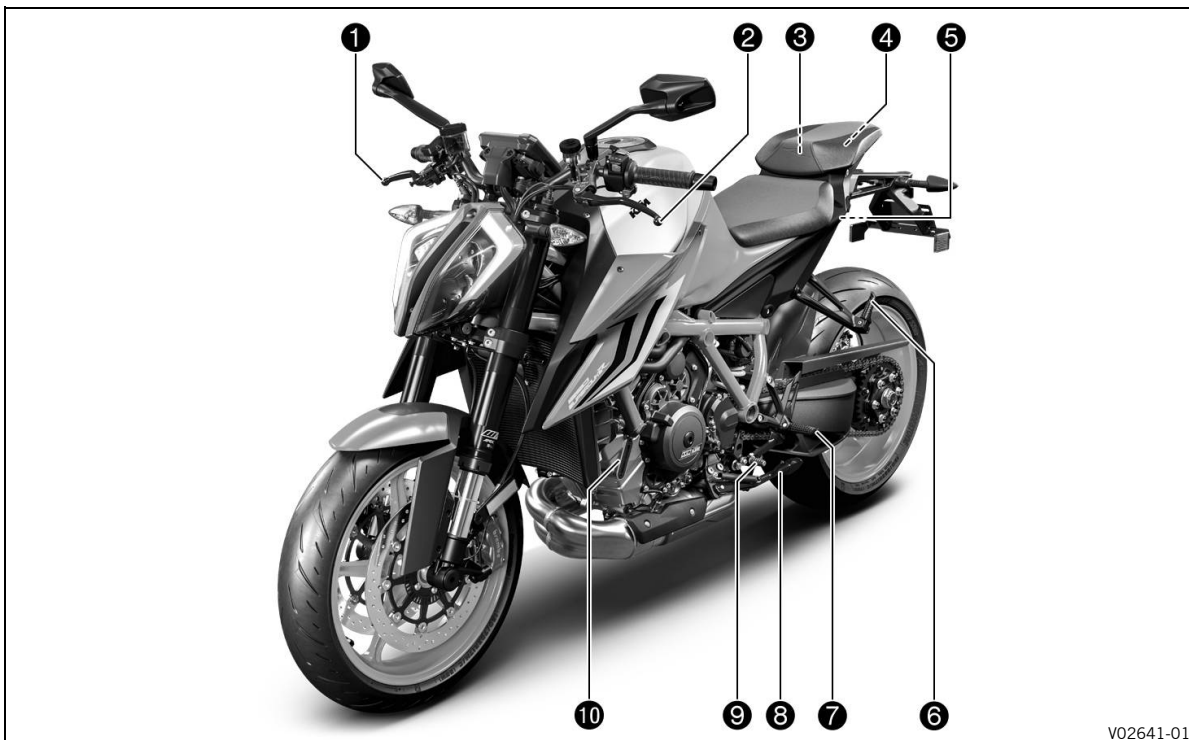

V02641-01

- ① Hand brake lever (📖 p. 19)
- ② Clutch lever (📖 p. 19)
- ③ Supporting strap (📖 p. 27)
- ④ Tool set (📖 p. 27)
- ⑤ Seat lock (📖 p. 27)
- ⑥ Passenger foot pegs (📖 p. 27)
- ⑦ Rider footrests
- ⑧ Side stand (📖 p. 28)
- ⑨ Shift lever (📖 p. 28)
- ⑩ Engine oil level viewer

## 4.2 View of vehicle, rear right (example)

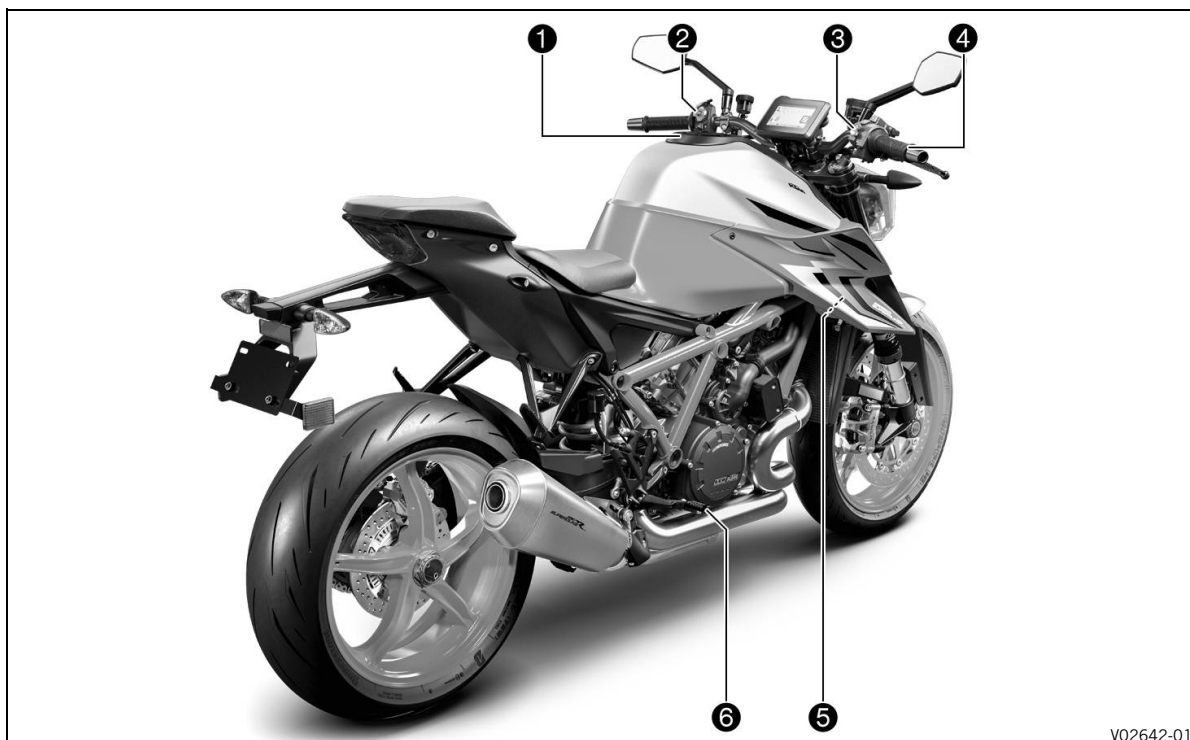

V02642-01

- ❶ Fuel tank filler cap
- ❷ Combination switch, left side (📖 p. 19)
- ❸ Start button/emergency OFF switch (📖 p. 23)
- ❹ RACE-ON button (📖 p. 24)
- ❺ Hazard warning flasher switch (📖 p. 23)
- ❻ C1 and C2 switch (📖 p. 24)
- ❼ Throttle grip (📖 p. 19)
- ❽ Cooling system compensating tank
- ❾ Foot brake lever (📖 p. 28)

## 5.1 Vehicle identification number

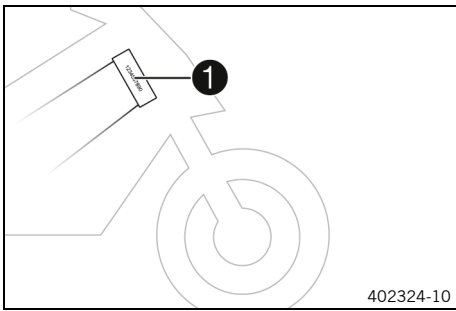

The vehicle identification number **1** is stamped on the right side of the steering head.  
The vehicle identification number is also shown on the type label.

## 5.2 Type label

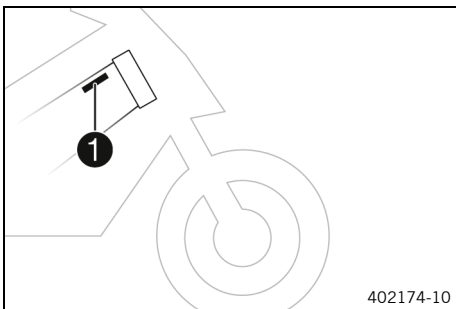

The USA type label **1** is located on the frame on the right.

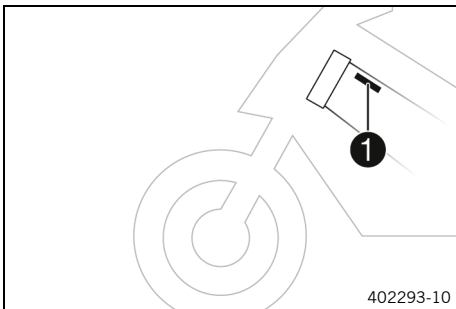

The Canada type label **1** is located on the frame on the left.

## 5.3 Key number

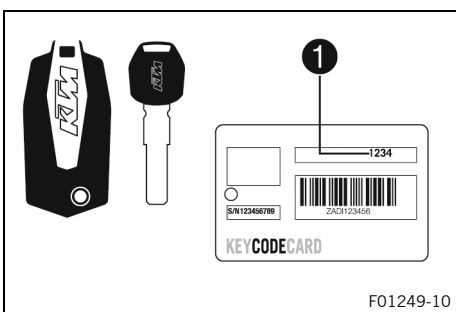

The key number **Code number 1** can be found on the **KEYCODECARD**.



### Info

You need the key number to order a spare key. Keep the **KEYCODECARD** in a safe place.

# 5 SERIAL NUMBERS

## 5.4 Engine number

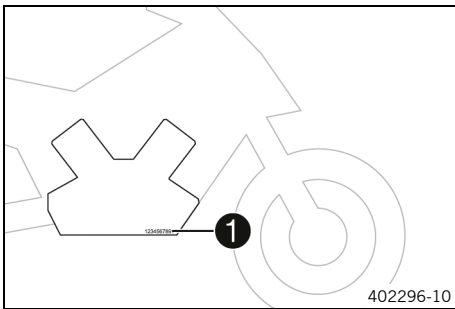

The engine number **1** is stamped on the right side of the engine.

## 5.5 Fork part number

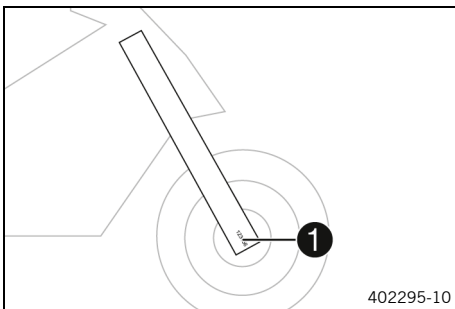

The fork part number **1** is stamped on the inside of the axle clamp.

## 5.6 Shock absorber article number

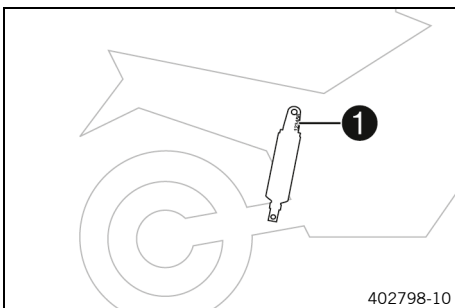

The shock absorber article number **1** is stamped on the top of the shock absorber above the adjusting ring towards the engine side.

## 5.7 Steering damper article number

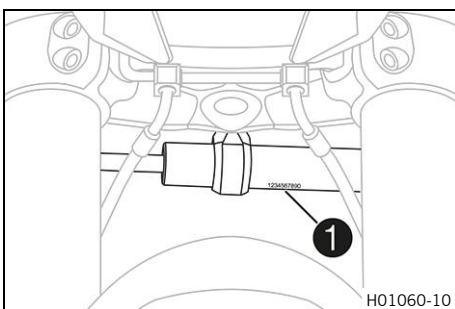

Steering damper item number **1** is embossed on the underside of the steering damper.

## 6.1 Clutch lever

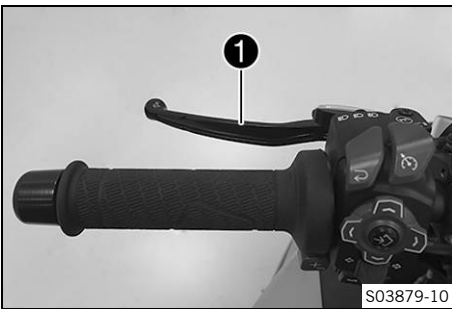

Clutch lever **1** is fitted on the handlebar on the left. The clutch is activated hydraulically and adjusts itself automatically.

## 6.2 Hand brake lever

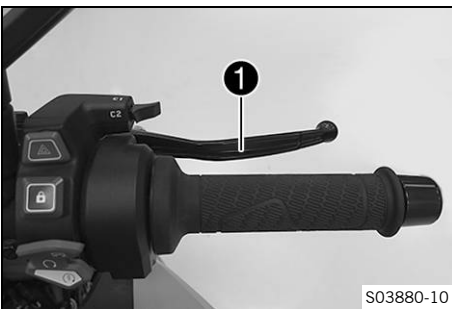

The hand brake lever **1** is fitted on the right side of the handlebar. The front brake is engaged using the hand brake lever.

## 6.3 Throttle grip

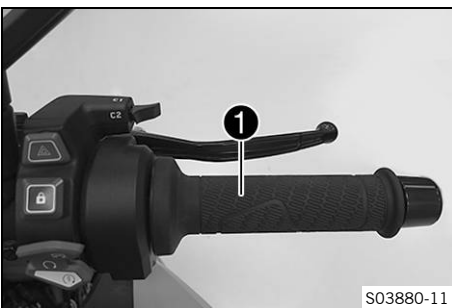

The throttle grip **1** is fitted on the right side of the handlebar.

## 6.4 Combination switch, left side

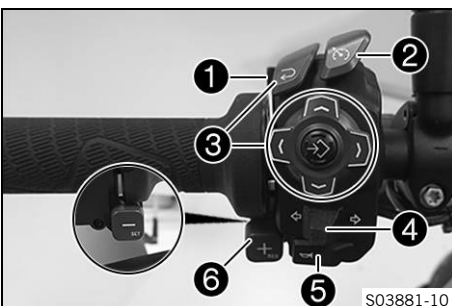

The left combination switch is fitted on the left side of the handlebar.

### Overview of the left combination switch

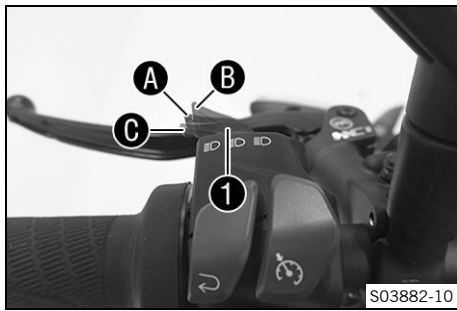

- 1** Light switch (📖 p. 20)
- 2** Cruise control buttons (📖 p. 21)
- 3** Menu buttons (📖 p. 20)
- 4** Turn signal switch (📖 p. 20)
- 5** Horn button (📖 p. 21)
- 6** +RES/-SET button (📖 p. 22)

## 6.5 Light switch



The light switch **1** is fitted on the combination switch on the left.

### Possible states

	Low beam on – Light switch in position <b>A</b> . In this position, the low beam and the tail light are switched on.
	High beam on – Light switch in position <b>B</b> . In this position, the high beam and the tail light are switched on.
	Headlight flasher – Light switch in position <b>C</b> . The headlight flasher is operated in this position. The light switch returns automatically to the position <b>A</b> after use.

## 6.6 Menu buttons

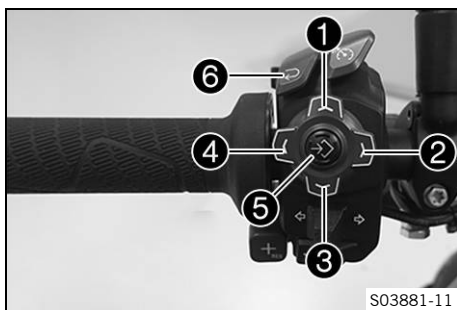

The menu buttons are fitted in the middle of the left combination switch.

The menu buttons are used to control the display on the combination instrument.

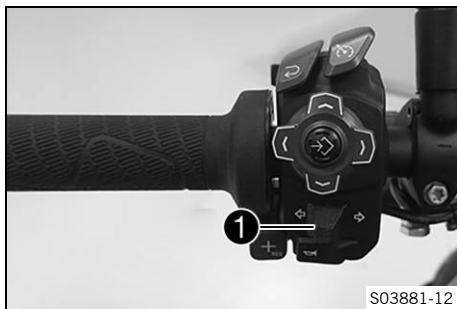

- Button **1** is the **UP** button.
- Button **2** is the **RIGHT** button.
- Button **3** is the **DOWN** button.
- Button **4** is the **LEFT** button.
- Button **5** is the **SET** button.
- Button **6** is the **BACK** button.

## 6.7 Turn signal switch



Turn signal switch **1** is fitted on the combination switch on the left.

### Possible states

	Turn signal off – Turn signal switch pushed toward the switch housing.
	Left turn signal, on – Turn signal switch pressed to the left. The turn signal switch returns automatically to the central position after use.
	Right turn signal, on – Turn signal switch pressed to the right. The turn signal switch returns automatically to the central position after use.

**i** **Info**

An automatic turn signal switch-off function (**ATIR**) is available as a software feature.

The **ATIR** function uses a time and distance counter.

If the turn signal has been on for at least 10 seconds and 150 meters of riding distance, the turn signal is switched off.

If the vehicle is stationary, both counters are stopped.

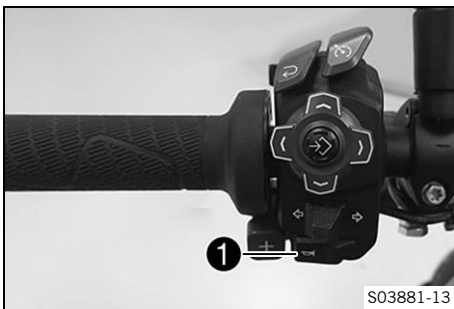

If the turn signal switch is reactivated, both counters are reset.

**6.8** **Horn button**



Horn button **1** is fitted on the left side of the handlebar.

**Possible states**

- The horn button  is in the basic position
- The horn button  is pressed – The horn is operated in this position.

**6.9** **Cruise control buttons**

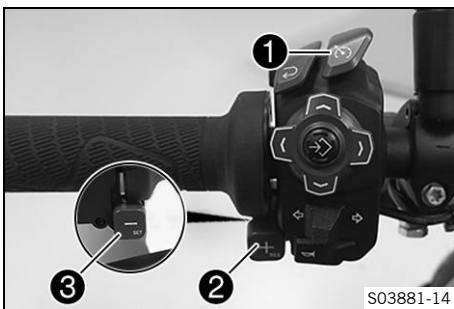

The cruise control buttons **1**, **2** and **3** of the are located on the left side of the combination switch.

**Possible states**

- Cruise control system button  in the basic position.
- The **+RES** button is pressed briefly. – The last saved speed is reapplied. Every subsequent brief pressing increases the target speed by 1 km/h or 1 mph.
- Button **+RES** is pressed and held. – The target speed increases in increments of 5 km/h or 5 mph.
- Button **-SET** is pressed. – The cruise control function is activated and the current speed is maintained. Every subsequent brief press reduces the target speed by 1 km/h or 1 mph.
- Button **-SET** is pressed and held. – The target speed decreases in increments of 5 km/h or 5 mph.

**i** **Info**

After activating the cruise control function, the throttle grip can be turned back to the basic position. The selected speed will be maintained.

If no target speed has yet been saved, this can be saved once using the **+RES** button.

If the cruise speed is exceeded for less than 30 seconds by turning the throttle grip, the cruise control remains activated.

To switch off the cruise control system function press the cruise control system button again.

In addition, the cruise control system function is deactivated when one of the following events occurs:

- Operating the hand brake lever
- Operating the foot brake lever
- Operating the clutch lever
- Gear change without quickshifter+
- Turning the throttle grip beyond the basic position
- Control of the motorcycle traction control (**MTC**)
- Slip at the rear wheel or lifting front wheel
- A malfunction occurring, which impairs the cruise control system function
- Exceeding the target speed for more than 30 seconds when overtaking



### Warning

**Danger of accidents** The cruise control system function is not suitable for all riding situations.

The selected target speed will not be reached, if the engine power is not sufficient for a gradient.

The selected target speed will be exceeded if the engine braking effect is not sufficient on an incline.

- Do not use the cruise control systems function on winding roads.
- Do not use the cruise control systems on slippery road surfaces (e.g. rain, ice or snow), where there is poor visibility or on unpaved surfaces (e.g. sand, stones or gravel).
- Do not use the cruise control systems function if the traffic does not permit a constant speed.

The cruise control system function is only available when motorcycle traction control (**MTC**) is activated.

When motorcycle traction control (**MTC**) is switched off, the cruise control system function is also switched off.

The cruise control system function cannot be activated during rapid acceleration.

The cruise control system function can only be activated in third, fourth, fifth and sixth-gear.

The control range is from 40 to 200 km/h or from 25 to 125 mph.

## 6.10 +RES/-SET button

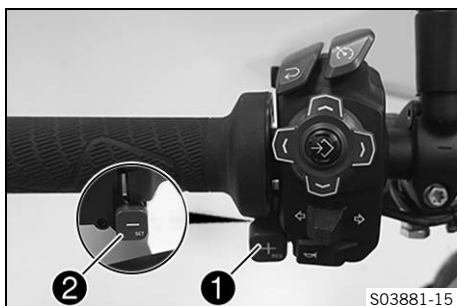

The **+RES** button ① is fitted on the handlebar, front left.

The **-SET** button ② is fitted on the handlebar, rear left.



### Info

The **+RES** and **-SET** buttons are used to control the cruise control when the cruise control function is activated.

If the cruise control function is disabled and riding mode **Performance** or **Track** is set, the **+RES** and **-SET** buttons are used to adjust the **Slip Adjuster**.



6.11 Combination switch, right

The right combination switch is fitted on the right side of the handlebar.

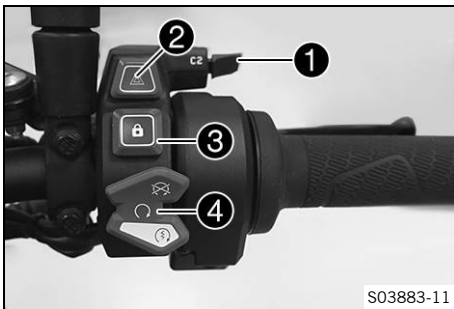

Overview of the right combination switch

- ❶ C1 and C2 switch (🗨️ p. 24)
- ❷ Hazard warning flasher switch (🗨️ p. 23)
- ❸ RACE-ON button (🗨️ p. 24)
- ❹ Start button/emergency OFF switch (🗨️ p. 23)

6.12 Hazard warning flasher switch



The hazard warning flasher switch ❶ is fitted on the right side of the combination switch.

The hazard warning flasher is used to indicate emergency situations.

**i** Info

The hazard warning flasher can be activated or deactivated while the ignition is switched on or up to 60 seconds after the ignition is switched off.

Only keep the hazard warning flasher activated as long as necessary as it depletes the 12-V battery.

Possible states

↔	Hazard warning flasher on – All four turn signals and the green turn signal indicator lights in the combination instrument flash.
---	-----------------------------------------------------------------------------------------------------------------------------------

6.13 Start button/emergency OFF switch



The start button/emergency OFF switch ❶ is fitted on the right side of the combination switch.

Possible states

	Start button/emergency OFF switch off (upper position) – In this position, the ignition circuit is interrupted, a running engine stops, and cannot be started. A message appears on the display.
	Start button/emergency OFF switch on (middle position) – This position is required for operation; the ignition circuit is closed.
	Starter motor on (lower position) – In this position, the starter motor is actuated.

## 6.14 RACE-ON button

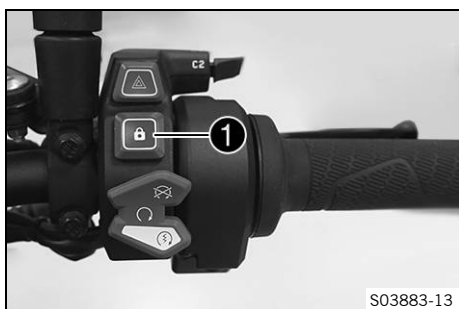

The RACE-ON button ① is fitted on the right side of the combination switch.

### **i** Info

The RACE-ON button performs the ignition lock function on this vehicle.  
The steering can only be locked if the handlebar is turned to the left.

### **Possible states**

- RACE-ON button (🔑) in the basic position.
- RACE-ON button (🔑) pressed briefly – Pressing briefly switches the ignition on and unlocks the steering lock or switches the ignition off. The RACE-ON indicator lamp lights up briefly once for confirmation.
- RACE-ON button (🔑) pressed and held – Pressing and holding switches the ignition off and locks the steering lock.

## 6.15 C1 and C2 switch

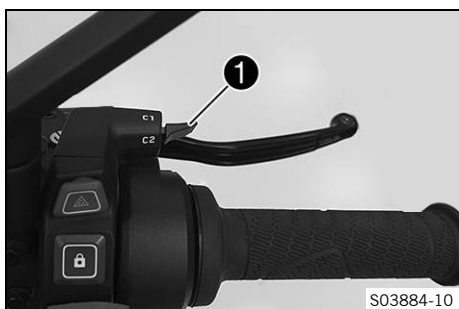

The C1 and C2 switch is fitted on the right of the combination switch.

### **i** Info

The C1 and C2 switch enables quick access to various menus.  
The C1 and C2 switch can be freely configured.

## 6.16 Steering lock (antenna)



On this vehicle, the ignition/steering lock is replaced by a remote key with transponder (RACE-ON key (🔑 p. 25)).  
In order to activate the steering lock, the handlebar must be turned fully to the left.

The steering is locked and unlocked electromechanically via the RACE-ON button (🔑 (🔑 p. 24)).

If the battery voltage of the RACE-ON key is too low, place either the RACE-ON key or the black ignition key in area **A** and repeat starting.

### **i** Info

Store the ignition key safely again as soon as the engine has been started.

### **Possible states**

- Ignition off, steering locked – In this operating mode, the ignition circuit is interrupted and the steering locked.
- Ignition off, steering unlocked – In this operating mode, the ignition circuit is interrupted and the steering unlocked.
- Ignition on, steering unlocked – In this operating mode, the ignition circuit is closed and the steering unlocked.

6.17 Immobilizer

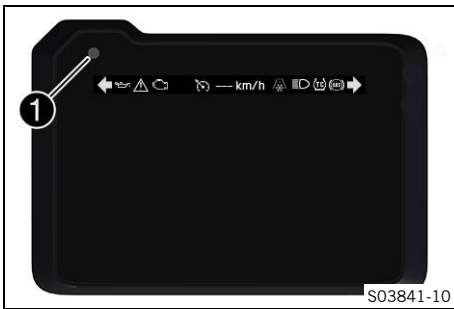

The electronic immobilizer secures the vehicle against unauthorized use.  
 The immobilizer is activated and the engine electronics are locked as soon as the ignition is switched off via the RACE-ON button (p. 24).  
 The RACE ON indicator light **1** can indicate malfunctions by flashing.  
 If the optional alarm system is installed, RACE ON indicator lamp **1** flashes when the ignition is switched off and the alarm system is switched on.

6.18 RACE-ON key

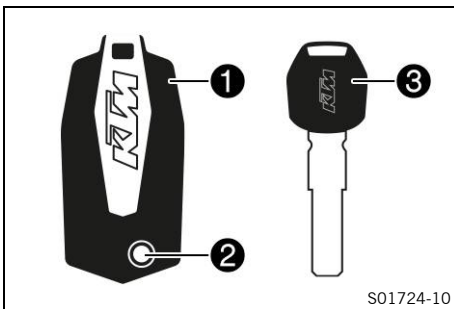

In this vehicle, the RACE-ON key **1** performs all the functions of the conventional ignition key.  
 Press the **2** button to fold out the key bit. The key bit is only used for unlocking the seat lock and for opening the cases (optional).  
 The black ignition key **3** is only intended for situations in which the RACE-ON key is not available or is not functional.  
 The black ignition key can be used to start the vehicle if the RACE-ON key battery voltage is too low and the transponder is not recognized by the vehicle. The black Race-on key can also be used to unlock the seat lock and open the cases (optional).

**i Info**  
 The ignition keys contain electronic components. Always maintain a distance of several centimeters to other devices with electronic components.

A lost ignition key must be deactivated by an authorized KTM workshop to prevent unauthorized persons from operating the vehicle.  
 The ignition keys supplied are activated when delivered.  
 Up to four ignition keys in total can be activated by an authorized KTM workshop. The key number must be provided in each case.

6.19 Opening fuel tank filler cap

**! Danger**  
**Fire hazard** Fuel is highly flammable.  
 The fuel in the fuel tank expands when warm and can escape if overfilled.

- Do not fuel the vehicle in the vicinity of open flames or lit cigarettes.
- Switch off the engine for refueling.
- Make sure that no fuel is spilled; particularly not on hot parts of the vehicle.
- If any fuel is spilled, wipe it off immediately.
- Observe the specifications for refueling.



## Warning

**Danger of poisoning** Fuel is poisonous and a health hazard.

- Avoid skin, eye and clothing contact with fuel.
- Immediately consult a doctor if you swallow fuel.
- Do not inhale fuel vapors.
- In case of skin contact, rinse the affected area with plenty of water.
- Rinse the eyes thoroughly with water, and consult a doctor in case of fuel contact with the eyes.
- Change your clothing in case of fuel spills on them.
- Keep fuels correctly in a suitable canister, and out of the reach of children.



## Note

**Environmental hazard** Improper handling of fuel is a danger to the environment.

- Do not allow fuel to enter the groundwater, the soil, or the sewage system.

## Condition

The motorcycle is stationary.

The engine is switched off.

The ignition has been switched on or off for less than 1 minute.

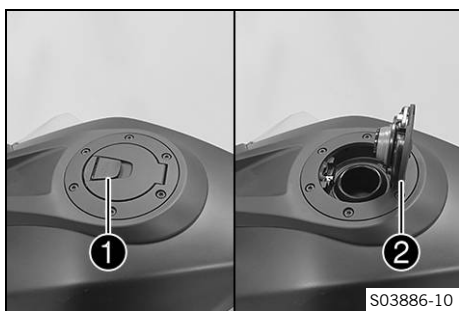

- Fold up cover ❶ slowly.
- ✓ The fuel tank filler cap is unlocked.
- Fold up fuel tank filler cap ❷.

## 6.20 Closing the fuel tank filler cap

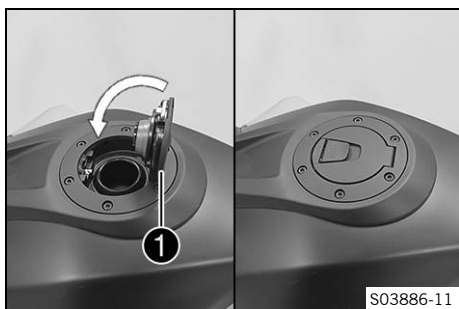

## Warning

**Fire hazard** Fuel is highly flammable, toxic and a health hazard.

- Check that the fuel tank filler cap is locked correctly after closing.
- Change your clothing if fuel spills on them.
- Rinse the affected area immediately with plenty of water in the event of contact with the skin.

- Fold down fuel tank filler cap ❶ and push it down.
- ✓ The fuel tank filler cap locks audibly in place.

## 6.21 Seat lock



Seat lock **1** is located on the left side of the vehicle under the seat. It can be unlocked using the RACE-ON key or the black ignition key.

## 6.22 Tool set



The tool set **1** is located under the passenger seat.

## 6.23 Supporting strap

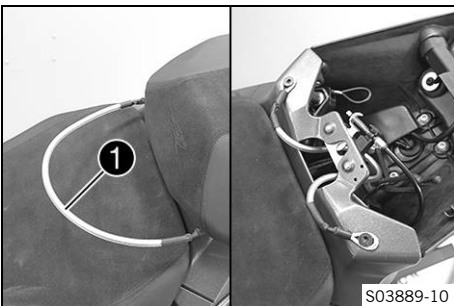

Supporting strap **1** is attached underneath the passenger seat.

### **i** Info

If the supporting strap is not needed, it can be stowed underneath the pillion bench.

The passenger can hold onto the supporting strap **1** during the trip.

## 6.24 Passenger foot pegs

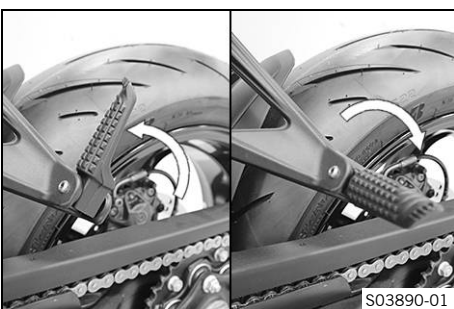

The passenger foot pegs can be folded up and down.

### **Possible states**

- Passenger foot pegs folded up – For operation without a passenger.
- Passenger foot pegs folded down – For operation with a passenger.

## 6.25 Shift lever

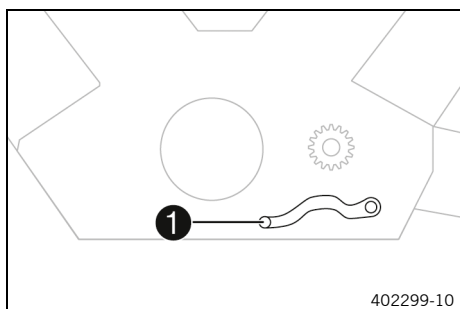

The shift lever ❶ is fitted on the left side of the engine.

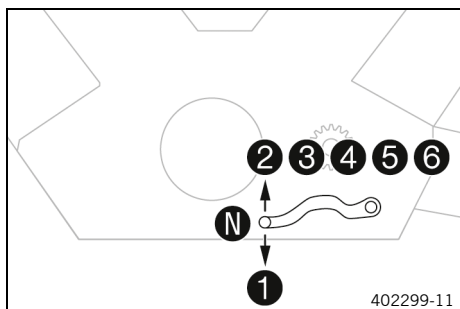

The gear positions can be seen in the figure.  
The idle position is between first and second gears.

## 6.26 Foot brake lever

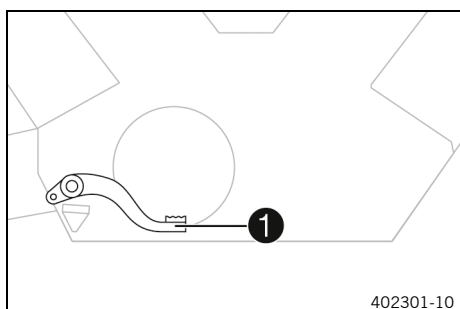

Foot brake lever ❶ is located in front of the right footrest.  
The rear brake is engaged with the foot brake lever.

## 6.27 Side stand

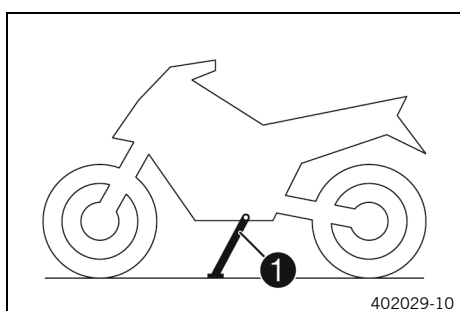

Side stand ❶ is located on the left of the vehicle.  
The side stand is used for parking the motorcycle.

### **i** Info

The side stand must be folded up during motorcycle use.  
The side stand is coupled with the safety starting system;  
see the instructions in the "Stopping, parking" chapter.

### Possible states

- Side stand folded out – The vehicle can be supported on the side stand. The safety starting system is active.
- Side stand folded in – This position is mandatory when riding the motorcycle. The safety starting system is inactive.

## 7.1 Combination instrument



S03758-10

The combination instrument is attached in front of the handlebar.  
The combination instrument is divided into two function areas.

① indicator lamps (📖 p. 32)

Display ②

## 7.2 Activation and test



### Activation

The combination instrument is activated when the ignition is switched on.



### Info

The brightness of the displays is controlled by an ambient light sensor in the combination instrument.

### Test

The welcome sequence appears on the display and the indicator lamps are briefly activated for a function check.

## **i** Info

The malfunction indicator lamp always lights up as long as the engine is not running. If the engine is running and the malfunction indicator lamp lights up, stop (taking care not to endanger yourself or other road users in the process) and contact an authorized KTM workshop.

The oil pressure warning lamp always lights up as long as the engine is not running. If the engine is running and the oil pressure warning lamp lights up, stop immediately (taking care not to endanger yourself or other road users in the process) and switch off the engine.

The ABS warning lamp and TC indicator lamp light up until a speed of approx. 6 km/h (approx. 4 mph) or more has been reached.

## 7.3 Day-night mode

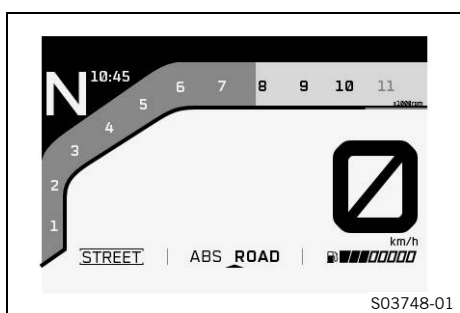

Day mode is shown in a bright color.

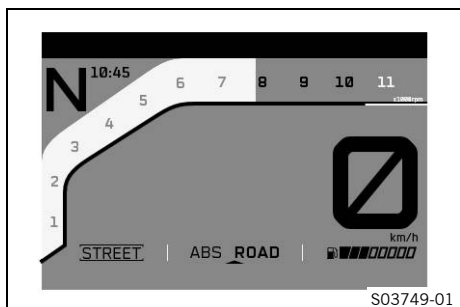

Night mode is shown in a dark color.

## **i** Info

The ambient light sensor in the combination instrument measures the brightness of the environment and automatically switches the display to day or night mode. The display is brightened, darkened or switched to the other mode depending on the brightness measured by the ambient light sensor.

In the **Display Theme** menu, the display mode can be changed manually between **AUTOMATIC** and **NIGHT**.



## 7.4 Warnings

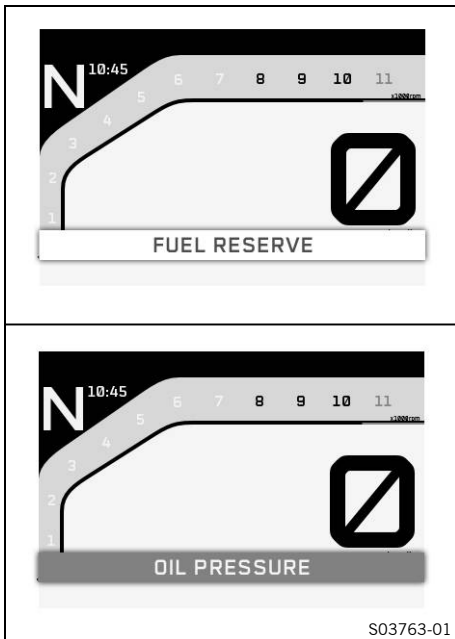



Warnings appear on the bottom edge of the display; these are marked yellow or red depending on their relevance. Yellow warnings indicate malfunctions or information which require prompt intervention or an adjustment to the riding style. Red warnings indicate malfunctions or information which require immediate intervention.

### **i** Info

Warnings can be hidden by pressing any button. All the existing warnings are displayed in the **Warnings** menu until they are no longer active.

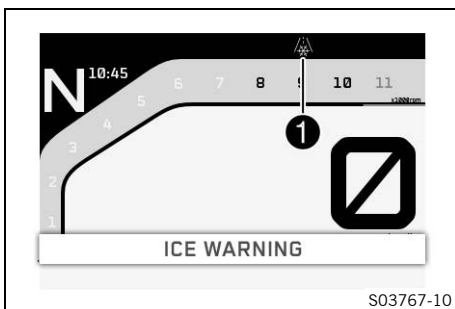
## 7.5 Ice warning



The ice warning  goes on when there is an increased risk of ice on the roads.

The ice warning  is shown in area **1** of the display.

The ice warning  appears on the display when the ambient temperature drops below the specified value.

Temperature	4 °C (39 °F)
-------------	--------------

The ice warning  goes out on the display when the ambient temperature rises above the specified value again.

Temperature	6 °C (43 °F)
-------------	--------------

### **i** Info

When the ice warning  lights up, the warning **ICE WARNING** also appears.

## 7.6 Indicator lamps



S03764-01

The indicator lamps offer additional information about the operating state of the motorcycle. When the ignition is switched on, all indicator lamps light up briefly.

### **i** Info







The malfunction indicator lamp always lights up as long as the engine is not running. If the engine is running and the malfunction indicator lamp lights up, stop (taking care not to endanger yourself or other road users in the process) and contact an authorized KTM workshop.

The oil pressure warning lamp always lights up as long as the engine is not running. If the engine is running and the oil pressure warning lamp lights up, stop immediately (taking care not to endanger yourself or other road users in the process) and switch off the engine.

The ABS warning lamp and TC indicator lamp light up until a speed of approx. 6 km/h (approx. 4 mph) or more has been reached.

### Possible states

	RACE-ON indicator lamp lights up/flashes yellow/red – Status or error messages relating to Race-on system/alarm system.
	The left turn signal indicator lamp flashes green with a steady rhythm – The left turn signal is switched on.
	The high beam indicator lamp lights up blue – The high beam is switched on.
	The general warning lamp lights up yellow – A note/warning note on operating safety has been detected. This is also shown in the display.
	The ABS warning lamp lights up yellow – Status or error messages relating to <u>ABS</u> . When ABS <b>Supermoto</b> mode is activated, SM is shown in the display.

	TC indicator lamp lights up/flashes yellow – The <b>MTC</b> (📖 p. 133) is not active, is currently intervening or a Launch Control Start is being executed. The TC indicator lamp also lights up if a malfunction is detected. Contact an authorized KTM workshop. The TC indicator lamp flashes if the motorcycle traction control actively engages.
	The oil pressure warning lamp lights up red – The oil pressure is too low. Stop immediately, taking care not to endanger yourself or other road users in the process, and switch off the engine.
	The cruise control system indicator lamp lights up yellow – The cruise control system function is switched on, but cruise control is not activated.
	The cruise control system indicator lamp lights up green – The cruise control system function is switched on and cruise control is activated.
	The malfunction indicator lamp lights up yellow – The <b>OBD</b> has detected a malfunction in the vehicle electronics.
	The right turn signal indicator lamp flashes green with a steady rhythmic flash – The right turn signal is switched on.

## 7.7 Display



**i Info**  
The figure shows the start screen of the combination instrument. If the menu is opened, the speed is still displayed.

- ① Tachometer
- ① Shift warning light (📖 p. 37)
- ① The shift warning light is integrated in the tachometer display.
- ② Speed
- ③ Unit for the speedometer
- ④ Fuel level display (📖 p. 41)

- 5 ABS Mode display (📖 p. 38)
- 6 Ride Mode (📖 p. 133)
- 7 Gear display
- 8 Time (📖 p. 42)

## 7.8 TRACK Display (optional)

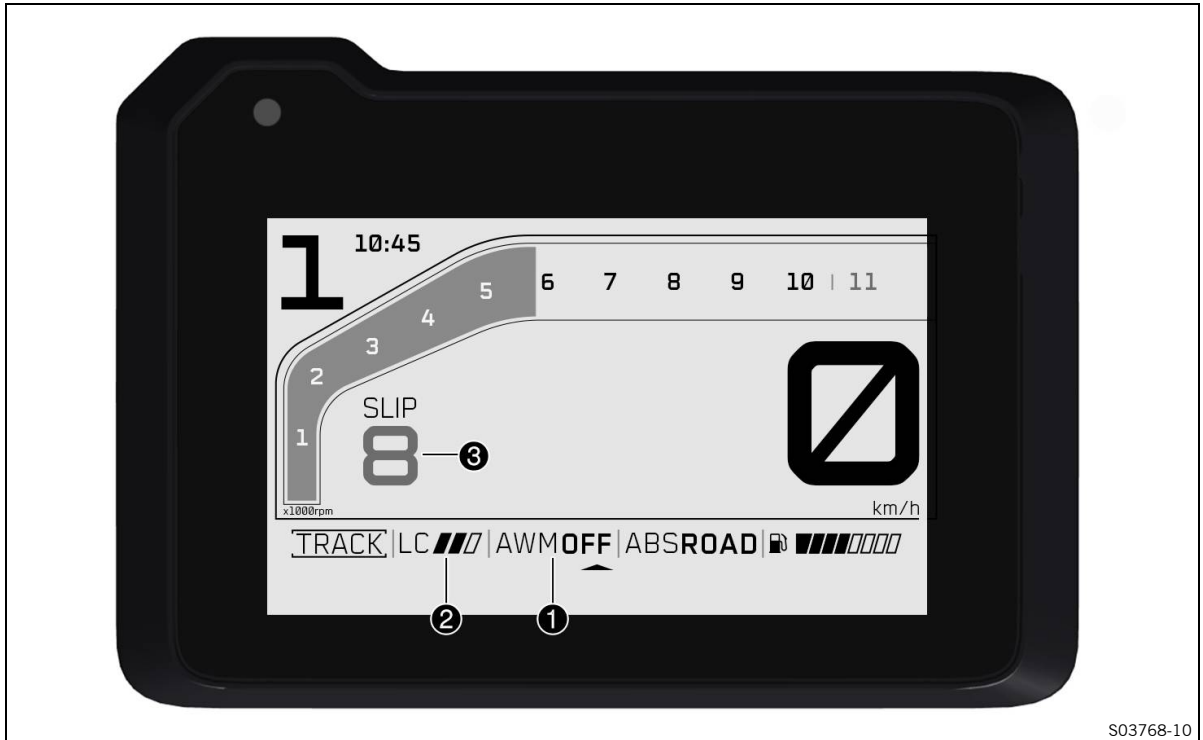

### **i** Info

The figure shows the start screen of the combination instrument in active drive mode **TRACK** (optional). If the menu is opened, the speed is still displayed.

- 1 Anti wheelie mode (optional) (📖 p. 134)
- 2 Launch Control (optional) (📖 p. 80)  
Slip adjustment (optional) (📖 p. 134)
- 3 If the slip adjustment changes in the widget, this indicator is replaced by the slip adjustment indicator for a few seconds.

## 7.9 Performance layout (optional)

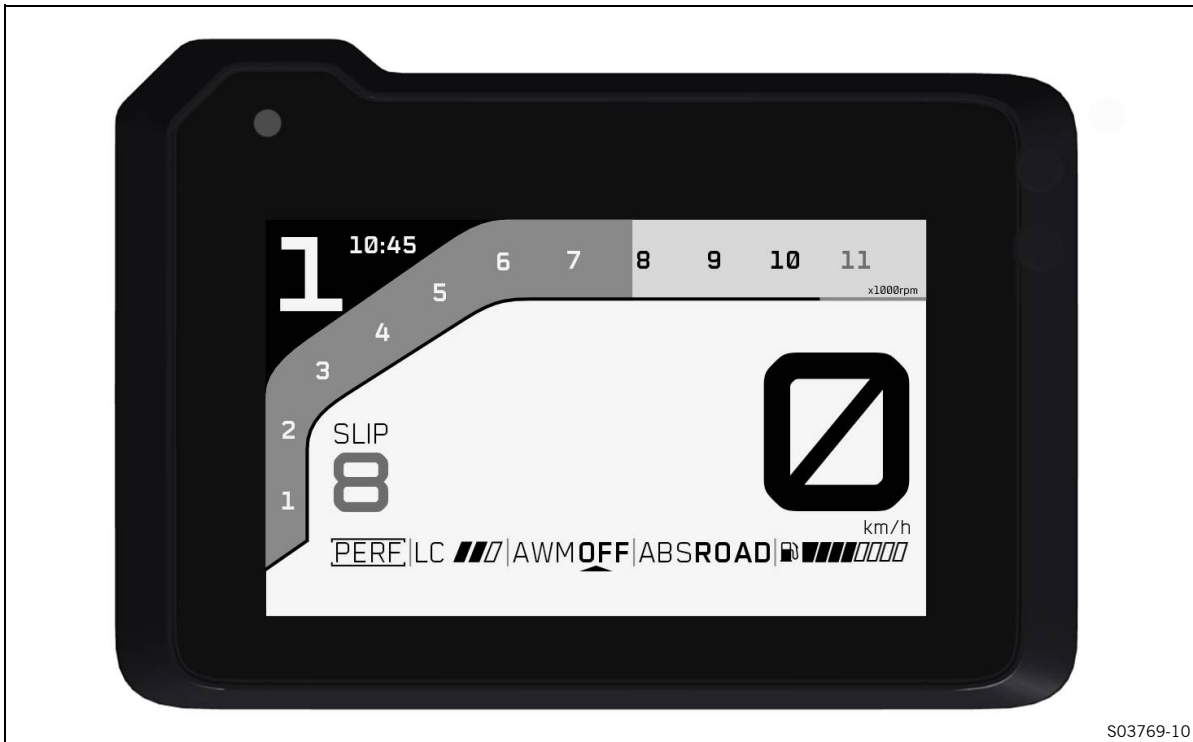

S03769-10

The figure shows the start screen of the combination instrument in active drive mode **TRACK** (optional) in the performance layout.

In the performance layout, you can use **KTM MY RIDE** in **TRACK** mode (optional).

If the menu is opened, the speed is still displayed.

## 7.10 Small widget



The figure shows the start screen of the combination instrument with the small widget opened. Information can be accessed in the small widget.

## 7.11 Large widget

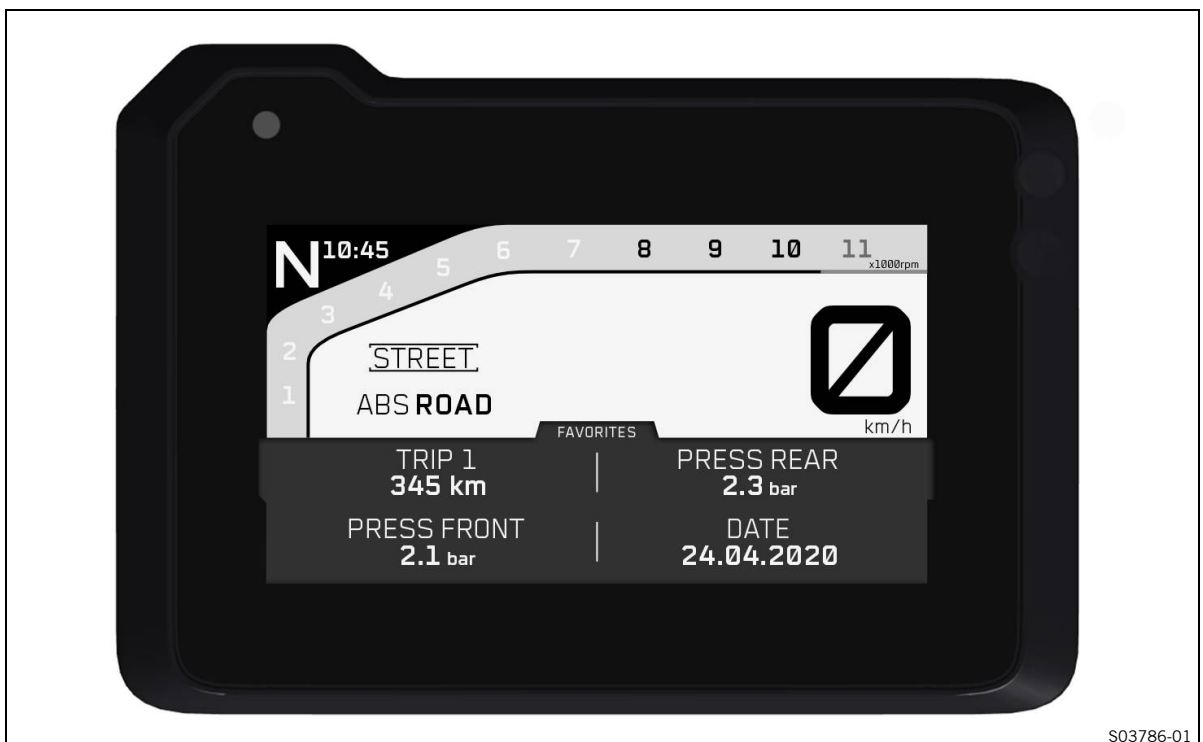

The figure shows the start screen of the combination instrument with the large widget opened. Information can be accessed and configured in the large widget.

## 7.12 Odometer

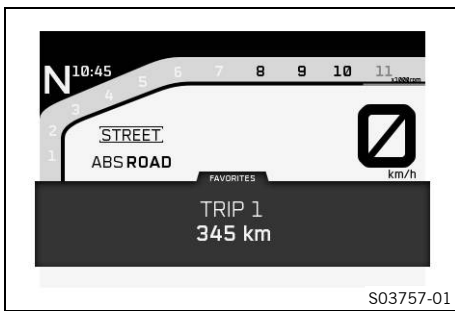

The odometer can be displayed in the **FAVORITES** widget as **Trip 1**. To do this, the information must be configured in the widget. Information on the total distance covered can be accessed in the **General Info** menu under menu item **ODO** or configured as widget information. The **Trip 1** menu displays further information. Information about other distances covered can be accessed in the **Trip 2** menu.

## 7.13 Engine speed

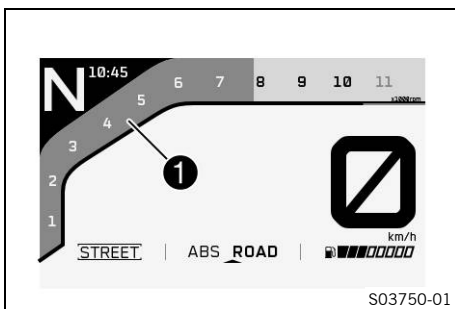

The engine speed is shown in area **1** of the display. The engine speed is measured in revolutions per minute.

## 7.14 Shift warning light

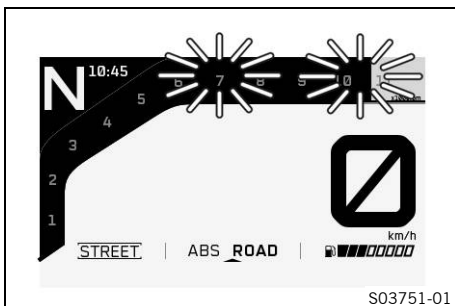

The shift warning light is integrated in the tachometer display. In the **Settings** menu under **Shift Light**, the engine speed for the shift warning light can be set. The shift warning light is always active during the running-in phase (up to 1,000 km / 621 mi). The shift warning light can only be deactivated, and the values for **RPM 1** and **RPM 2** can only be adjusted after this. The shift warning light flashes slowly at **RPM 1** and flashes quickly at **RPM 2**.

### **i** Info

In sixth-gear, the shift warning light is deactivated when the engine is warm after the first service.

Coolant temperature	≤ 35 °C (≤ 95 °F)
<b>ODO</b>	< 1,000 km (< 620 mi)
The shift warning light always lights up at	6,500 rpm
Coolant temperature	> 35 °C (> 95 °F)
<b>ODO</b>	> 1,000 km (> 620 mi)
<b>RPM 1</b> shift warning light	flashes slowly
<b>RPM 2</b> shift warning light	flashes quickly

## 7.15 Cruise control indicator

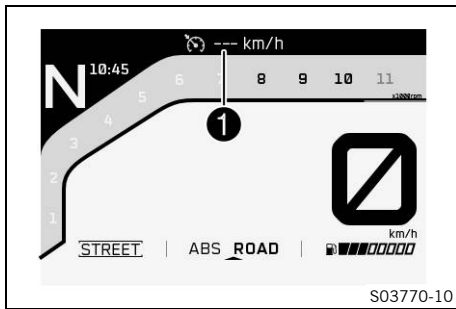

The operating state and active cruise control are shown in the **1** area of the display. Cruise control is operated using the cruise control buttons (📖 p. 21).

## 7.16 Speed

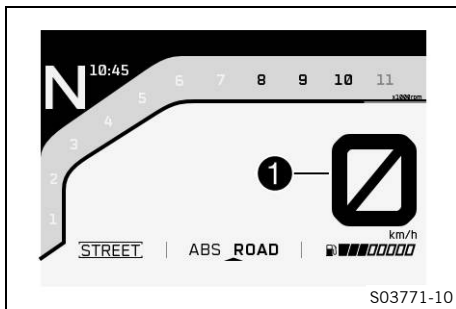

The speed is shown in area **1** of the display. The unit of speed can be configured in the **Settings** menu under **UNITS**. Speed is shown in kilometers per hour **km/h** or in miles per hour **mph**.

## 7.17 ABS Mode display

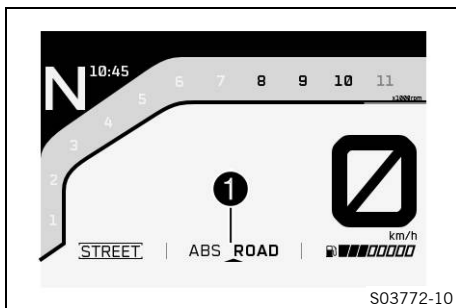

The ABS mode setting is shown in the **1** area of the display. In the menu **Motorcycle**, the ABS can be configured under **ABS Mode**.

## 7.18 Ride display

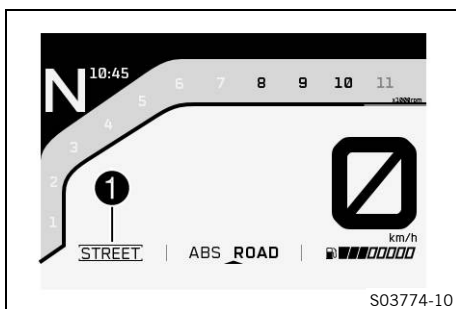

The riding mode (📖 p. 133) setting is shown in area **1** of the display. The riding mode can be configured in the menu **Ride Mode**.



## 7.19 Damp display

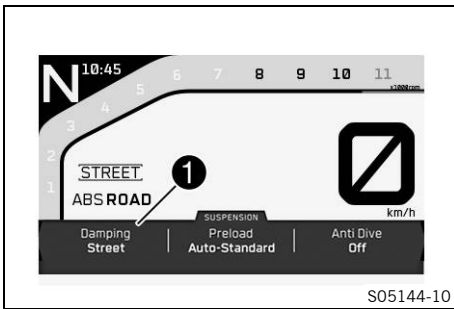

The **Damping** mode setting is shown in the ❶ area of the display. The damping can be configured in the **Motorcycle** menu under **Damping**.

## 7.20 Load display

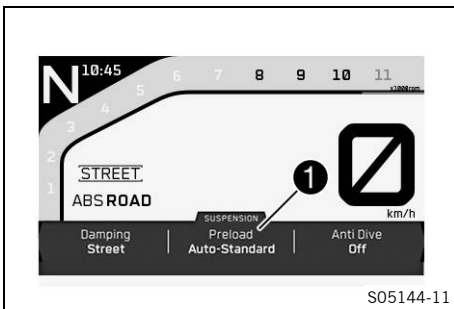

The payload setting is shown in area ❶ of the display. The payload can be configured in the **Motorcycle** menu under **Load**. Only configure the payload in an unloaded state.

## 7.21 Anti Dive display

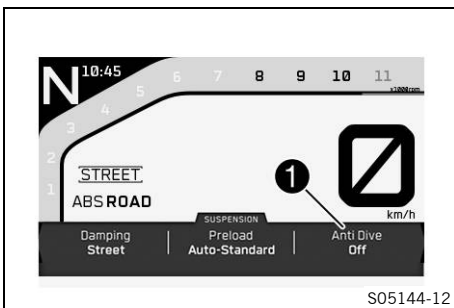

In the **SUSPENSION** widget of the display, the **Anti Dive** mode is displayed in the ❶ area. The function can be activated or deactivated in the **Motorcycle** menu under **Anti Dive**.

## 7.22 Fork display

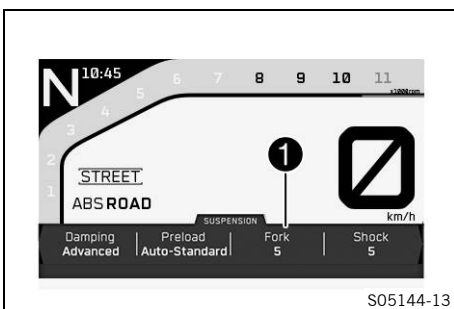

In the **SUSPENSION** widget of the display, the setting of the fork damping is displayed in the ❶ area. The fork damping can be configured in the **Motorcycle** menu under **Fork**.



### Info

Setting the fork damping manually is only possible in **ADVANCED** mode of the damping.

## 7.23 Shock display

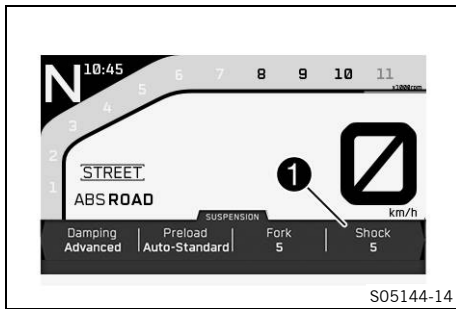

In the **SUSPENSION** widget of the display, the setting of the shock absorber damping is displayed in the **1** area. The shock absorber damping can be configured in the **Motorcycle** menu under **Shock**.

**i Info**  
Setting the shock absorber damping manually is only possible in **ADVANCED** mode of the damping.

## 7.24 Gear display

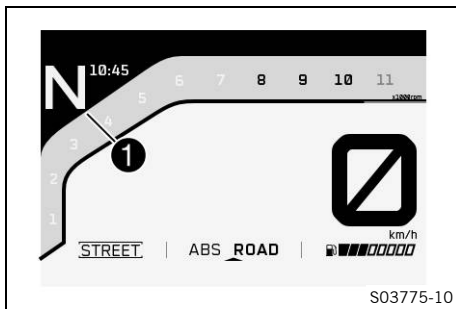

The current gear is shown in area **1** of the display.

## 7.25 Heated grip (optional)

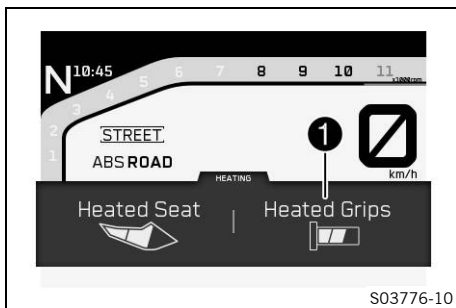

When the heated grip is activated, the **Heated Grips** symbol in area **1** is displayed in the **HEATING** widget. The heated grip can be configured in the **Motorcycle** menu under **Heated Grips** or in the **HEATING** widget under **Heated Grips**.

## 7.26 Seat heater (optional)

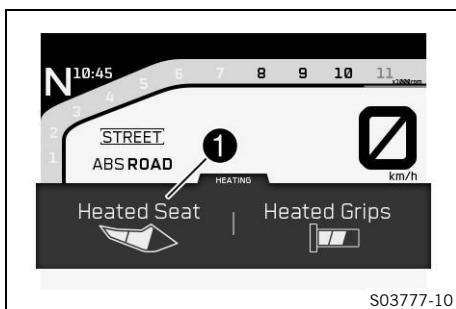

When the seat heating is activated, the **Heated Seats** symbol in area **1** is displayed in the **HEATING** widget. The seat heating can be configured in the **Motorcycle** menu under **Heated Seat** or in the **HEATING** widget under **Heated Seat**.

## 7.27 Coolant temperature indicator

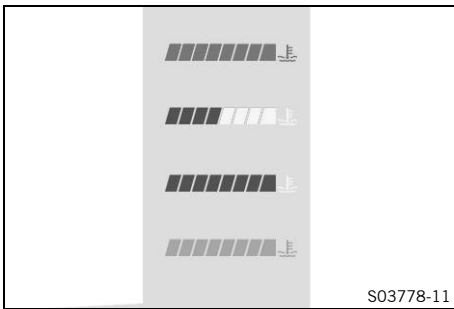

The coolant temperature indicator consists of bars. The more bars that light up, the hotter the coolant.



### Info

When all the bars flash, the warning **ENGINE TEMP HIGH** also appears.

### Possible states

- The engine is cold – None of the eight bars light up.
- Engine warm – Four bars light up.
- Engine hot – Five to eight bars light up.
- Engine very hot – all eight bars flash red.

## 7.28 Fuel level display

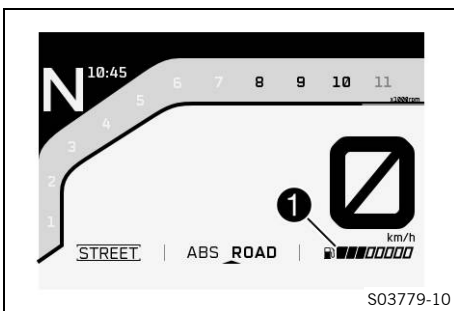

The fuel tank contents are shown in area **1** of the display. The fuel level indicator consists of bars. The more bars are lit, the more fuel is in the fuel tank.



### Info

If the fuel level is getting low, a bar flashes red and the following warning **LOW FUEL** also appears. The fuel level is displayed with a slight delay to prevent the indicator from constantly moving while riding. The fuel level display is not updated while the side stand is folded out or the emergency off switch is switched off. Once the side stand is folded up and the emergency OFF switch is switched on, the fuel level display is next updated after 2 minutes. The fuel level display flashes if the combination instrument does not receive a signal from the fuel level sensor.

## 7.29 Ambient air temperature indicator

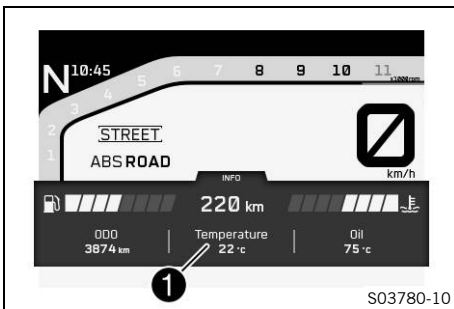

The large **INFO** widget displays the ambient air temperature in area **1**.

The units of the ambient temperature can be configured in the **Settings** menu under **Units**.

The ambient air temperature is displayed in **°C** or **°F**.

## 7.30 Time

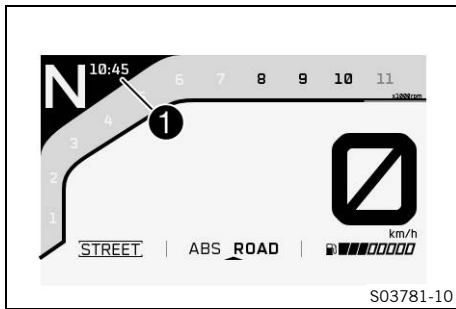

The time is shown in area **1** of the display.  
The time can be displayed in 24-hour format or 12-hour format in all languages.  
The time can be configured in the **Settings** menu under **Clock/Date**



### Info

The time must be set if the power supply has been interrupted.

## 7.31 Favorites display

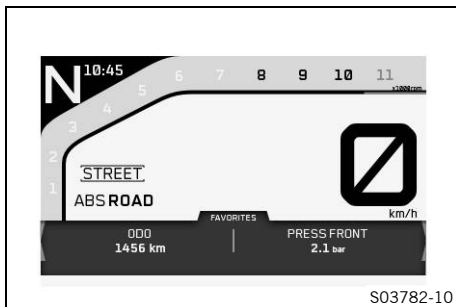

A range of information can be configured in the **FAVORITES** widget.  
Up to four pieces of information can be configured and displayed in the large **FAVORITES** widget.



### Info

The four pieces of information in the large widget are displayed in the small widget.  
Each set of information is displayed on two lines.  
Each set of information can be freely stored to a selected area.

## 7.32 Navigation display (optional)

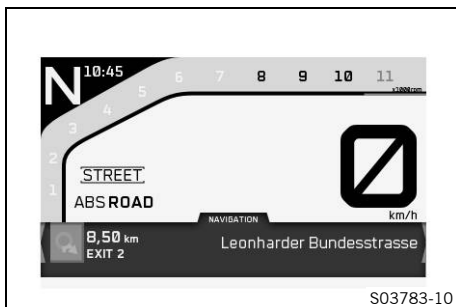

The direction arrow, the distance to the next waypoint and the street name are displayed in the small **NAVIGATION** widget when the navigation function is activated.  
The large **NAVIGATION** widget also displays the arrival time and the distance to the destination. The volume of the navigation can also be adjusted in the large widget.  
In the **KTM MY RIDE** menu under **Navigation** you can access information on navigation and adjust the volume.



### Info

The **Audio** function can be used with the navigation function at the same time.  
An incoming call is visualized in a small window at the top of the combination instrument display when the navigation function is active.

## 7.33 Menu

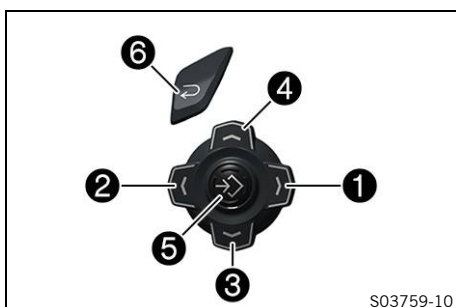

### Info

Press the **RIGHT** button **1** in the start screen to open the menu.  
Use the **RIGHT** button **1**, the **LEFT** button **2**, the **DOWN** button **3**, the **UP** button **4** and the **SET** button **5** to navigate in the menu.  
Press the **BACK** button **6** to close the current menu or the menu overview.

## 7.33.1 KTM MY RIDE (optional)

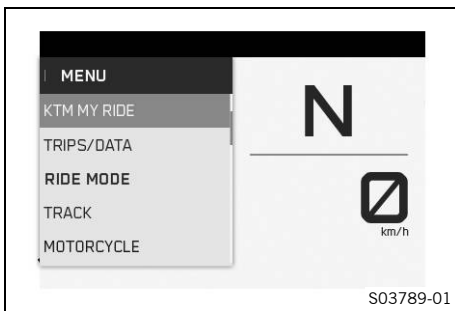

### Condition

- Function **KTM MY RIDE** (optional) activated.
- **Bluetooth®** is activated.
- Press the **RIGHT** button when the menu is closed.
- Press the **UP** or **DOWN** button until **KTM MY RIDE** is highlighted.
- ✓ Press the **RIGHT** button to open the menu.

In **KTM MY RIDE**, an appropriate cellphone or headset can be paired with the combination instrument via **Bluetooth®** and the navigation function can be configured.

### Info

Not every cellphone and headset is suitable for pairing with the combination instrument.  
The standard **Bluetooth®** 2.1 must be supported.

## 7.33.2 Audio (optional)

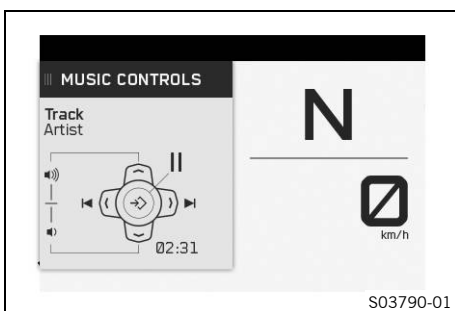

### Condition

- Function **KTM MY RIDE** (optional) activated.
- Function **Bluetooth®** (optional) activated.
- The combination instrument is connected to a suitable phone.
- The combination instrument is connected to a suitable **Bluetooth®** headset.
- The cellphone music player is open.
- Press the **RIGHT** button when the menu is closed.
- Press the **UP** or **DOWN** button until **KTM MY RIDE** is marked.
- ✓ Press the **RIGHT** button to open the menu.

### Warning

**Danger of accidents** Headphone volume which is too high distracts attention from traffic activity.

- Always select headphone volume which is low enough for you to still clearly hear acoustic signals.

- Press the **UP** or **DOWN** button until **Audio** is highlighted.
- ✓ Press the **RIGHT** button to open the menu.
- ✓ Press the **UP** button to increase the audio volume.
- ✓ Press the **DOWN** button to reduce the audio volume.
- ✓ Press the **RIGHT** button change to the next audio track.
- ✓ Briefly pressing the **LEFT** button twice changes to the previous audio title or plays the current audio title from the start, depending on the cellphone model.
- ✓ Press the **SET** button to play or pause the audio track.



### Tip

When using a wired headset, the volume **cannot** be controlled via the combination instrument. With some cellphones, the audio player needs to be started before playback is possible. For easier operation, the **Audio** function can be assigned to the **C1** or **C2** button.

### 7.33.3 Navigation (optional)

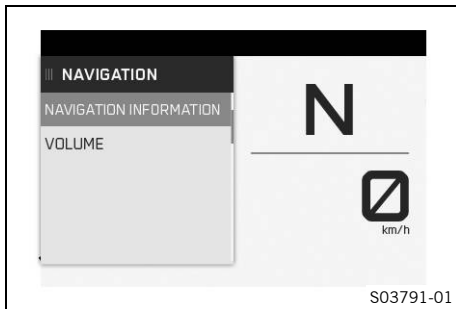

#### Condition

- Function **KTM MY RIDE** (optional) activated.
- The **KTM MY RIDE** app (optional) is installed and opened on a suitable cellphone (Android devices Version 6.0 and higher, iOS devices Version 10 and higher).
- Function **Bluetooth®** (optional) activated.
- The combination instrument is connected to a suitable phone.
- The GPS function is activated on the connected phone.
- For voice navigation: The combination instrument is connected to a suitable headset and an appropriate language package has been downloaded in the **KTM MY RIDE** app.
  - Press the **RIGHT** button when the menu is closed.
  - Press the **UP** or **DOWN** button until **KTM MY RIDE** is highlighted.
    - ✓ Press the **RIGHT** button to open the menu.
  - Press the **UP** or **DOWN** button until **Navigation** is highlighted.
    - ✓ Press the **RIGHT** button to confirm the selection.

You can access navigation information and adjust the volume in the menu **Navigation**.



### Info

The route guidance is displayed in the small and large **NAVIGATION** widget. The **Audio** function can be used with the navigation function at the same time. An incoming call is visualized in a small window at the top of the combination instrument display when the navigation function is active. When the navigation function is switched on and the device is connected, the **GPS** symbol appears on the combination instrument display.

### 7.33.4 Navigation information (optional)

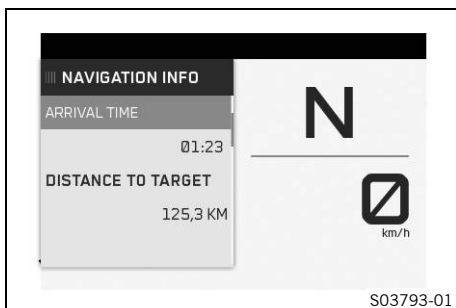

#### Condition

- Function **KTM MY RIDE** (optional) activated.
- The **KTM MY RIDE** app (optional) is installed and opened on a suitable cellphone (Android devices Version 6.0 and higher, iOS devices Version 10 and higher).
- Function **Bluetooth®** (optional) activated.
- The combination instrument is connected to a suitable phone.
- The GPS function is activated on the connected phone.
  - Press the **RIGHT** button when the menu is closed.

- Press the **UP** or **DOWN** button until **KTM MY RIDE** is highlighted.
  - ✓ Press the **RIGHT** button to open the menu.
- Press the **UP** or **DOWN** button until **Navigation** is highlighted.
  - ✓ Press the **RIGHT** button to confirm the selection.
- Press the **UP** or **DOWN** button until **Navigation Information** is highlighted.
  - ✓ Press the **RIGHT** button to open the menu.



### Info

**Arrival Time** shows the estimated arrival time of the phone.

**Distance to Target** shows the distance to the destination.

Information on the current navigation can be viewed in the **NAVIGATION** widget.

## 7.33.5 Volume (optional)

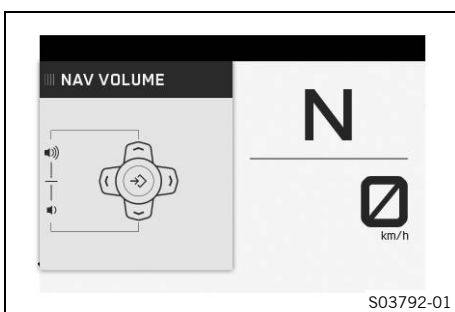

### Condition

- Function **KTM MY RIDE** (optional) activated.
  - The **KTM MY RIDE** app (optional) is installed and opened on a suitable cellphone (Android devices Version 6.0 and higher, iOS devices Version 10 and higher).
  - Function **Bluetooth®** (optional) activated.
  - The combination instrument is connected to a suitable phone.
  - The GPS function is activated on the connected phone.
  - For voice navigation: The combination instrument is connected to a suitable **Bluetooth** headset and an appropriate language package has been downloaded in the **KTM MY RIDE** app.
- Press the **RIGHT** button when the menu is closed.
  - Press the **UP** or **DOWN** button until **KTM MY RIDE** is highlighted.
    - ✓ Press the **RIGHT** button to open the menu.
  - Press the **UP** or **DOWN** button until **Navigation** is highlighted.
    - ✓ Press the **RIGHT** button to confirm the selection.



### Warning

**Danger of accidents** Headphone volume which is too high distracts attention from traffic activity.

- Always select headphone volume which is low enough for you to still clearly hear acoustic signals.

- Press the **UP** or **DOWN** button until **Volume** is highlighted.
  - ✓ Press the **RIGHT** button to open the menu.
- Press and hold the **UP** button in order to increase the volume.
- Press and hold the **DOWN** button in order to reduce the volume.

The volume of the navigation can be set in the large **NAVIGATION** widget.

## 7.33.6 Pairing (optional)

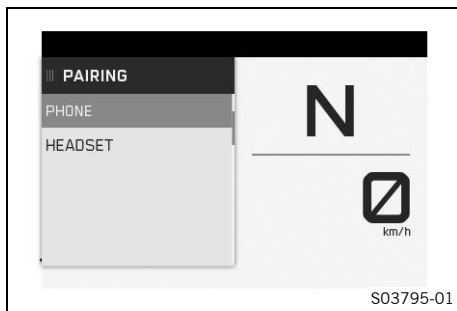

### Condition

- The motorcycle is stationary.
  - Function **KTM MY RIDE** (optional) activated.
  - Function **Bluetooth®** (optional) activated.
  - The **Bluetooth®** function should also be activated in the device to be paired.
- Press the **RIGHT** button when the menu is closed.
  - Press the **UP** or **DOWN** button until **KTM MY RIDE** is marked.
  - ✓ Press the **RIGHT** button to open the menu.
  - Press the **UP** or **DOWN** button until **Pairing** is highlighted.
  - ✓ Press the **RIGHT** button to open the menu.
  - Press the **UP** or **DOWN** button until the desired menu item **Phone** or **Headset** is marked.

A suitable cellphone can be paired with the combination instrument in the **Phone** submenu.

A suitable headset can be paired with the combination instrument in the **Headset** submenu.

- ✓ Press the **RIGHT** button to confirm the selection.

### Info

Two cellphones can never be paired simultaneously with the combination instrument. Only one cellphone and one headset per submenu item can be paired with the combination instrument at the same time. If the headset type is set for a wired headset, no **Bluetooth®** headset can be used.

- Press the **UP** or **DOWN** button until **Pairing** is marked.
- Press the **RIGHT** button to confirm the **Pairing** submenu item.

### Info

When pairing the combination instrument to a cellphone: A message appears on the combination instrument indicating that this is now ready for pairing. The pairing is completed successfully by confirming the **Passkey** on the cellphone and on the combination instrument using the **SET** button. When pairing the combination instrument to a headset: The registered trademark of the headset appears on the combination instrument. By pressing the **SET** button the device is selected, and confirmed with **Confirm** by pressing the **SET** button again. The pairing of a headset with the combination instrument is now completed.

### Info

When a suitable device has been successfully paired, the name of the paired cellphone or headset appears in each case in the **Phone** or **Headset** menu. Not every cellphone or headset is suitable for pairing with the combination instrument.



- If the device is in the range of the combination instrument and has not been deleted previously while the **Bluetooth®** function is active:
  - ✓ The device is automatically paired with the combination instrument.
  - ✗ If the device is not automatically paired with the combination instrument after approx. 30 seconds:
    - Restart combination instrument or **Pairing** repeat procedure.
- To delete a paired device, press the **UP** or button **DOWN** until the paired device is highlighted.
- Open the **delete Pairing** menu by pressing the **RIGHT** button and confirm with the **SET** button.

### 7.33.7 Telephony (optional)

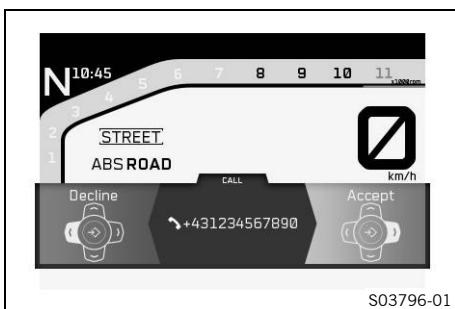

#### Condition

- Function **KTM MY RIDE** (optional) activated.
- Function **Bluetooth®** (optional) activated.
- The combination instrument is connected to a suitable cell-phone.
- The combination instrument is connected to a suitable headset.



#### Warning

- Danger of accidents** Headphone volume which is too high distracts attention from traffic activity.
- Always select headphone volume which is low enough for you to still clearly hear acoustic signals.

- Press the **RIGHT** button to accept an incoming call.
- Press the **LEFT** button to reject an incoming call.
- Press and hold the **UP** button in order to increase the volume.
- Press and hold the **DOWN** button in order to reduce the volume.
- Press the **BACK** button briefly to reduce the telephony display.



#### Info

The call duration and contact are displayed. Depending on the cellphone settings, the contact is shown by name.

When the telephony display is activated and reduced in size, a small window is displayed at the top edge of the combination instrument display.

An incoming call is visualized in a small window at the top of the combination instrument display when the navigation function is active.

## 7.33.8 Trip 1

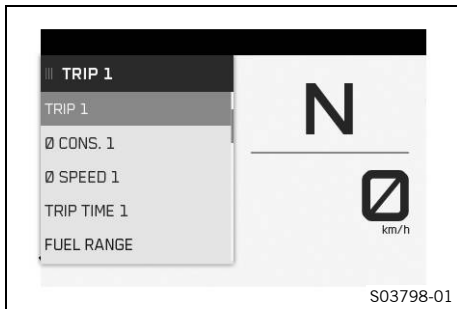

- Press the **RIGHT** button when the menu is closed.
- Press the **UP** or **DOWN** button until **Trips/Data** is highlighted.
  - ✓ Press the **RIGHT** button to open the menu.
- Press the **UP** or **DOWN** button until **Trip 1** is highlighted.
  - ✓ Press the **RIGHT** button to open the menu.

**Trip 1** displays the distance since the last reset, such as between two refueling stops. **Trip 1** is running and counts up to **9999**.

**ØCons1** indicates the average fuel consumption based on **Trip 1**.

**ØSpeed1** indicates the average speed based on **Trip 1** and **Trip Time1**.

**Trip Time1** shows the riding time on the basis of **Trip 1** and runs as soon as a speed signal is received.

**Fuel Range** displays the possible distance you can cover with the fuel reserve.

Press and hold the <b>SET</b> button for 3-5 seconds.	All the entries in the <b>Trip 1</b> menu are reset.
-------------------------------------------------------	------------------------------------------------------

## 7.33.9 Trip 2

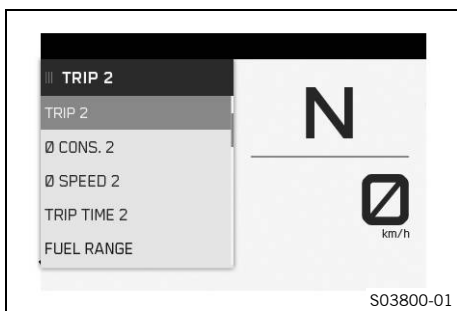

- Press the **RIGHT** button when the menu is closed.
- Press the **UP** or **DOWN** button until **Trips/Data** is highlighted.
  - ✓ Press the **RIGHT** button to open the menu.
- Press the **UP** or **DOWN** button until **Trip 2** is highlighted.
  - ✓ Press the **RIGHT** button to open the menu.

**Trip 2** displays the distance since the last reset, such as between two refueling stops. **Trip 2** is running and counts up to **9999**.

**ØCons2** indicates the average fuel consumption based on **Trip 2**.

**ØSpeed2** indicates the average speed based on **Trip 2** and **Trip Time2**.

**Trip Time2** shows the riding time on the basis of **Trip 2** and runs as soon as a speed signal is received.

**Fuel Range** displays the possible distance you can cover with the fuel reserve.

Press and hold the <b>SET</b> button for 3-5 seconds.	All the entries in the <b>Trip 2</b> menu are reset.
-------------------------------------------------------	------------------------------------------------------

## 7.33.10 General Info

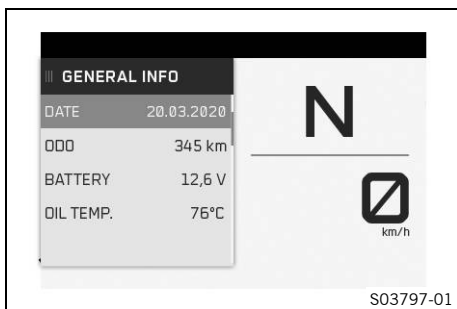

- Press the **RIGHT** button when the menu is closed.
- Press the **UP** or **DOWN** button until **Trips/Data** is highlighted.
  - ✓ Press the **RIGHT** button to open the menu.
- Press the **UP** or **DOWN** button until **General Info** is highlighted.
  - ✓ Press the **RIGHT** button to open the menu.

**Date** shows the date.

**ODO** displays the total distance covered.

**Battery** displays the battery voltage.

**Oil Temp** displays the engine oil temperature.

## 7.33.11 TPMS



### Condition

- Model with TPMS.
- Press the **RIGHT** button when the menu is closed.
- Press the **UP** or **DOWN** button until **Trips/Data** is highlighted.
- ✓ Press the **RIGHT** button to open the menu.



### Warning

**Danger of accidents** The tire pressure monitoring system does not eliminate the necessity to check the tires before going on a ride.

To avoid false alarms, the tire pressure values are evaluated over a period of several minutes.

- Check the tire pressure before every ride.
- Correct the tire pressure if the tire pressure deviates from the specified value.
- Even if the tire pressure values are correct, stop the vehicle immediately if its behavior indicates a loss of pressure in the tires.

- Press the **UP** or **DOWN** button until **TIRE AIR PRESSURE** is highlighted.

### Guideline

Tire pressure when solo	
front: with cold tires	2.5 bar (36 psi)
rear: with cold tires	2.5 bar (36 psi)

- ✓ Press the **RIGHT** button to open the menu.

The **TIRE AIR PRESSURE** menu displays the tire pressure of the front and rear tires.

**PRESS FRONT** indicates the tire pressure at the front.

**PRESS REAR** indicates the tire pressure at the rear.

## 7.33.12 Warnings

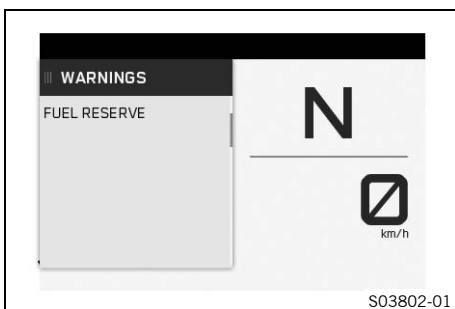

### Condition

- Message or warning is present.
- Press the **RIGHT** button when the menu is closed.
- Press the **UP** or **DOWN** button until **Trips/Data** is highlighted.
- ✓ Press the **RIGHT** button to open the menu.
- Press the **UP** or **DOWN** button until **Warnings** is highlighted.
- ✓ Press the **RIGHT** button to open the menu.
- Use the **UP** or **DOWN** button to navigate through the warnings.

All the warnings that have occurred are displayed in the **Warnings** menu.

## 7.33.13 Service

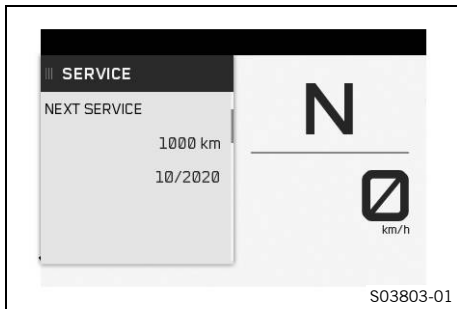

- Press the **RIGHT** button when the menu is closed.
- Press the **UP** or **DOWN** button until **Trips/Data** is highlighted.
  - ✓ Press the **RIGHT** button to open the menu.
- Press the **UP** or **DOWN** button until **Service** is highlighted.
  - ✓ Press the **RIGHT** button to open the menu.

The next service due is shown in the **Service** menu.

## 7.33.14 Extra Functions

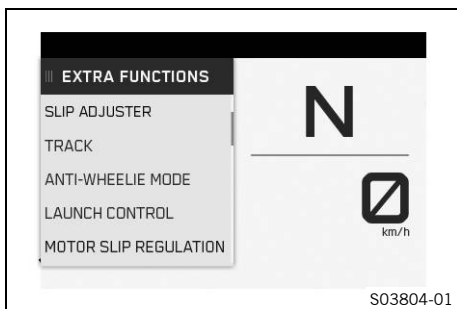

- Press the **RIGHT** button when the menu is closed.
- Press the **UP** or **DOWN** button until **Trips/Data** is highlighted.
  - ✓ Press the **RIGHT** button to open the menu.
- Press the **UP** or **DOWN** button until **Extra Functions** is highlighted.
  - ✓ Press the **RIGHT** button to open the menu.
- Use the **UP** or **DOWN** button to navigate through the extra functions.

The optional extra functions are listed in **Extra Functions**.

### **i** Info

The current **KTM PowerParts** and available software are listed on the KTM website.

## 7.33.15 Ride Mode

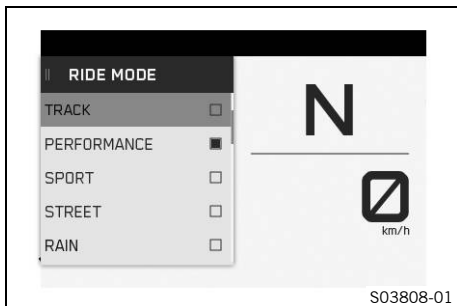

- Press the **RIGHT** button when the menu is closed.
- Press the **UP** or **DOWN** button until the **Ride Mode** menu is marked on the display.
  - ✓ Press the **RIGHT** button to open the menu.
- Use the **UP** or **DOWN** button to navigate through the menu.
- Press the **SET** button to select engine and motorcycle traction control settings that are coordinated with each other.

Guideline

Do not open the throttle during the selection.

- ✓ **TRACK** - Optional setting available with homologated performance and extremely direct response. The motorcycle traction control and the characteristics of the throttle response can be set individually.
- ✓ **PERFORMANCE** - Optional setting available with homologated performance and extremely direct response. The motorcycle traction control and the characteristics of the throttle response can be set individually. Combines the functions of TRACK mode with standard modes.
- ✓ **SPORT** - Homologated performance with very direct response; the motorcycle traction control allows greater slip on the rear wheel.

- ✓ **STREET** - Homologated performance with balanced response; the motorcycle traction control allows normal slip on the rear wheel.
- ✓ **RAIN** - Reduced homologated performance with soft response for improved rideability; the motorcycle traction control allows normal slip on the rear wheel.

### 7.33.16 Track (optional)

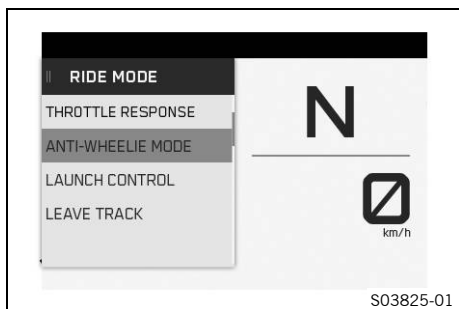

#### Condition

- The **TRACK** riding mode (optional) is activated.
- Press the **RIGHT** button when the menu is closed.
- Press the **UP** or **DOWN** button until **TRACK** is highlighted.
- ✓ Press the **RIGHT** button to open the menu.



#### Info

**TRACK** allows settings to be made for **TRACK** and **PERFORMANCE** mode.

The respective riding mode is ended via **LEAVE TRACK** or **LEAVE PERFORMANCE** when the throttle grip is closed and automatically switched to the driving mode **STREET**.

### 7.33.17 Throttle Response (optional)

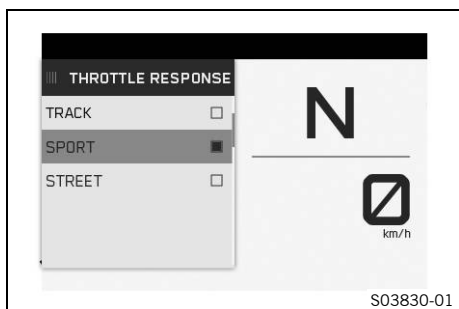

#### Condition

- The riding mode **TRACK** (optional) or **PERFORMANCE** (optional) is activated.
- Cruise control function deactivated.
- Press the **RIGHT** button when the menu is closed.
- Press the **UP** or **DOWN** button until **TRACK** is highlighted.
- ✓ Press the **RIGHT** button to open the menu.
- Press **UP** or **DOWN** button until **Throttle Response** is highlighted.
- ✓ Press the **RIGHT** button to open the menu.
- Press the **UP** or **DOWN** button until the required mode is marked.
- Press the **SET** button to confirm a mode.
- ✓ **TRACK**-Homologated performance with extremely direct response.
- ✓ **SPORT** - Homologated performance with direct response.
- ✓ **STREET** - Homologated performance with balanced response.
- Press the **BACK** button to close the **Throttle Response** menu.

## 7.33.18 Anti Wheelie Mode (optional)

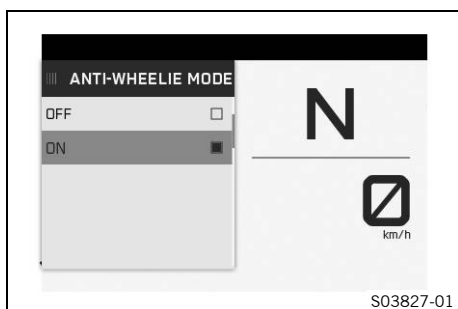

### Condition

- The riding mode **TRACK** (optional) or **PERFORMANCE** (optional) is activated.
- Press the **RIGHT** button when the menu is closed.
- Press the **UP** or **DOWN** button until **TRACK** is highlighted.
- ✓ Press the **RIGHT** button to open the menu.
- Press the **UP** or **DOWN** button until **Anti Wheelie Mode** is highlighted.
- ✓ Press the **RIGHT** button to open the menu.



### Warning

**Danger of accidents** When Anti Wheelie Mode is disabled, the motorcycle traction control no longer counteracts the raising of the front wheel.

- Only switch off the Anti Wheelie Mode if you have the appropriate experience.

- Press the **UP** or **DOWN** button until **Anti Wheelie Mode, OFF, or ON** is highlighted.
- Confirm the selection using the **SET** button.

## 7.33.19 Launch Control (optional)

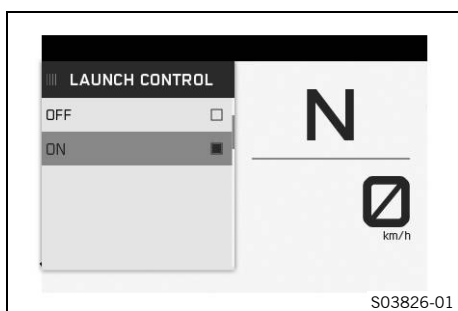

### Condition

- The riding mode **TRACK** (optional) or **PERFORMANCE** (optional) is activated.
- Press the **RIGHT** button when the menu is closed.
- Press the **UP** or **DOWN** button until **TRACK** is highlighted.
- ✓ Press the **RIGHT** button to open the menu.
- Press the **UP** or **DOWN** button until **Launch Control** is highlighted.
- ✓ Press the **RIGHT** button to open the menu.



### Warning

**Danger of accidents** Launch control enables very powerful acceleration which may ask too much of a novice rider.

- Only use the launch control if you have the appropriate experience.
- Do not use launch control on public roads.

- Press the **UP** or **DOWN** button until **Launch Control, OFF, or ON** is highlighted.
- Press the **SET** button to confirm the selection.

## 7.33.20 Slip Adjuster (optional)

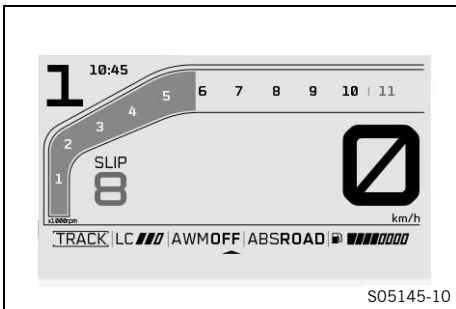

### Condition

- The **TRACK** or **PERFORMANCE** riding mode is activated.
- **MTC** is activated.
- Cruise control function deactivated.



### Warning

**Danger of accidents** An incorrectly selected riding mode makes control of the vehicle considerably more difficult.

The riding modes are each only suitable for certain conditions.

- Always select a riding mode that suits the surface on which you are riding, the weather and the riding situation.

- Set the desired slip with the **+RES** and **-SET** buttons when the menu is closed.
- Press the **+RES** or **-SET** button to set the maximum permitted slip of the motorcycle traction control.



### Info

Do not open the throttle during the selection.

The spin adjuster is a motorcycle traction control function. The slip adjustment allows the motorcycle traction control to be tuned through nine levels to the desired characteristic map. Level 1 allows the maximum slip on the rear wheel, and level 9 the minimum.

If the cruise control function is deactivated, the **+RES** and **-SET** buttons in the main display or in the **Slip Adjuster** menu can be used to adjust the **Slip Adjuster**.



### Info

The slip adjustment is only available in **TRACK** and **PERFORMANCE** riding mode.

The slip adjustment is only available when motorcycle traction control is activated.

## 7.33.21 Motorcycle

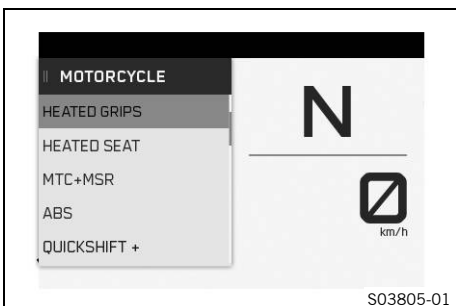

- Press the **RIGHT** button when the menu is closed.
- Press the **UP** or **DOWN** button until **Motorcycle** is highlighted.
- ✓ Press the **RIGHT** button to open the menu.

**Motorcycle** allows settings to be made for ABS, traction control and extra functions.

## 7.33.22 Heated Grips (optional)

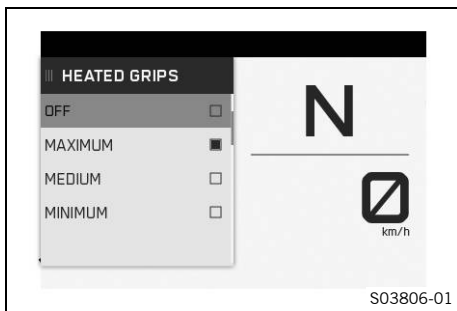

### Condition

- The **Heated Grips** menu is activated.
- Press the **RIGHT** button when the menu is closed.
- Press the **UP** or **DOWN** button until **Motorcycle** is highlighted.
  - ✓ Press the **RIGHT** button to open the menu.
- Press the **UP** or **DOWN** button until **Heated Grips** is highlighted.
  - ✓ Press the **RIGHT** button to open the menu.
- Press the **UP** or **DOWN** button to select the heating level or **OFF**.
- Press the **SET** button to confirm the selection.

### **i** Info

The heated grip can also be adjusted in the **HEATING** widget.

## 7.33.23 Heated Seat (optional)

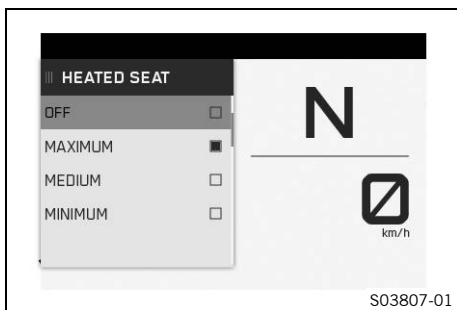

### Condition

- The **Heated Seat** menu is activated.
- Press the **RIGHT** button when the menu is closed.
- Press the **UP** or **DOWN** button until **Motorcycle** is highlighted.
  - ✓ Press the **RIGHT** button to open the menu.
- Press the **UP** or **DOWN** button until **Heated Seat** is highlighted.
  - ✓ Press the **RIGHT** button to open the menu.
- Press the **UP** or **DOWN** button to select the heating level or **OFF**.
- Press the **SET** button to confirm the selection.

### **i** Info

The seat heating can also be adjusted in the **HEATING** widget.

## 7.33.24 MTC+MSR (optional)

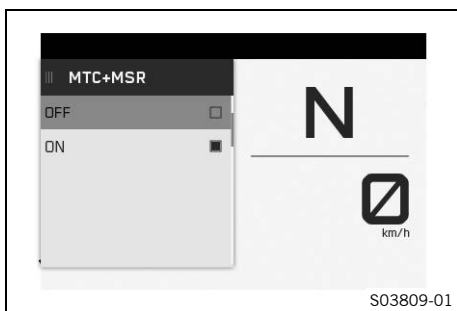

### Condition

- Cruise control function deactivated.
- Press the **RIGHT** button when the menu is closed.
- Press the **UP** or **DOWN** button until **Motorcycle** is highlighted.
  - ✓ Press the **RIGHT** button to open the menu.
- Press the **UP** or **DOWN** button until **MTC+MSR** is highlighted.
  - ✓ Press the **RIGHT** button to open the menu.
- Press the **UP** or **DOWN** button until **MTC+MSR**, **OFF**, or **ON** is highlighted.
- Press the **SET** button to confirm the selection.

### **i** Info

When riding mode **Track** or ABS mode **Supermoto** is active, the **MSR** is not active. After the ignition is switched on, the motorcycle traction control and engine traction torque control are enabled again.



## 7.33.25 ABS

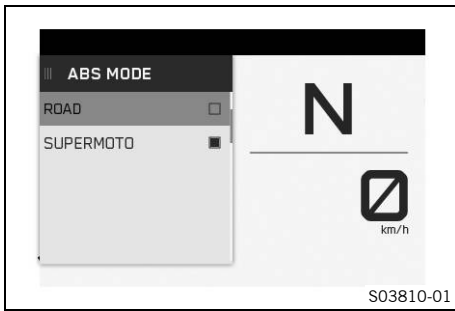

### Condition

- The motorcycle is stationary.
- Press the **RIGHT** button when the menu is closed.
- Press the **UP** or **DOWN** button until **Motorcycle** is highlighted.
- ✓ Press the **RIGHT** button to open the menu.
- Press the **UP** or **DOWN** button until **ABS** is highlighted.
- ✓ Press the **RIGHT** button to open the menu.
- Press the **UP** or **DOWN** button to select the desired **ABS** mode.
- Press the **SET** button to confirm the selection.



### Info

When the ABS mode **Road** is active, ABS controls both wheels.  
If the ABS mode **Supermoto** is active, the ABS only controls the front wheel and the **MSR** is not active. The rear wheel is not controlled by ABS and may lock during braking maneuvers.

## 7.33.26 Quickshifter + (optional)



- Press the **RIGHT** button when the menu is closed.
- Press the **UP** or **DOWN** button until **Motorcycle** is highlighted.
- ✓ Press the **RIGHT** button to open the menu.
- Press the **UP** or **DOWN** button until **Quickshifter +** is highlighted.
- ✓ Press the **RIGHT** button to open the menu.
- Press the **UP** or **DOWN** button until **Quickshifter +**, **OFF**, or **ON** is highlighted.
- Press the **SET** button to confirm the selection.

## 7.33.27 Suspension

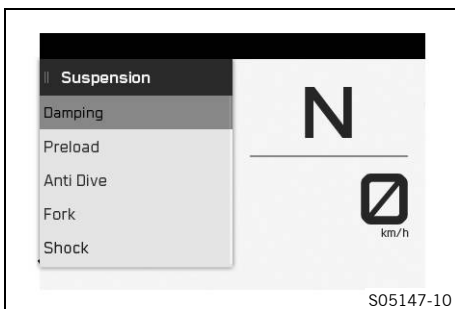

- Press the **RIGHT** button when the menu is closed.
- Press the **UP** or **DOWN** button until **Suspension** is highlighted.
- Press the **RIGHT** button to open the menu.

The suspension mode and other chassis settings can be configured in **Suspension**.

## 7.33.28 Damping

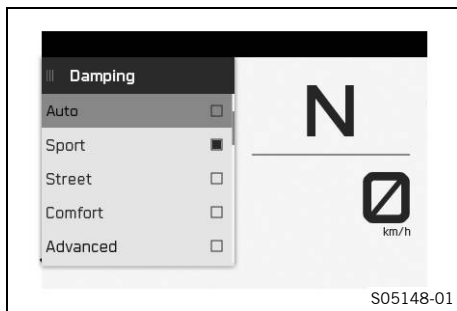

- Press the **RIGHT** button when the menu is closed.
- Press the **UP** or **DOWN** button until **Suspension** is highlighted. Press the **RIGHT** button to open the menu.
- Press the **UP** or **DOWN** button until **Damping** is highlighted.
  - ✓ Press the **RIGHT** button to open the menu.
- The **Damping Mode** can be selected by pressing the **UP** or **DOWN** button.
  - ✓ Press the **SET** button to confirm the selection.

Various settings for the damping of the suspension components can be selected in the **Damping** menu. The settings **Sport**, **Street**, **Comfort**, **Auto** (optional), **Track** (optional) and **Advanced** (optional) are available.

### **i** Info

In **Damping Mode Auto** (optional) the damping of the fork and shock absorber is automatically adjusted to the riding style of the rider.

In **Damping Advanced** (optional) the damping of the fork and the shock absorber can be configured individually in the **Fork** or **Shock** menu.

## 7.33.29 Preload Adjuster

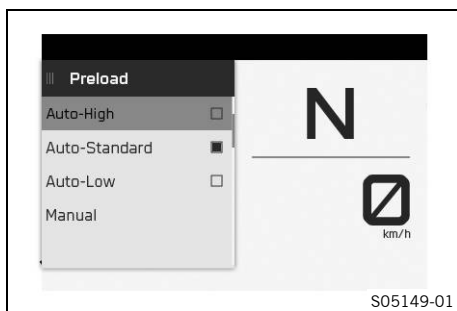

### Condition

- The rear wheel is under load.
- Press the **RIGHT** button when the menu is closed.
- Press the **UP** or **DOWN** button until **Suspension** is highlighted. Press the **RIGHT** button to open the menu.
- Press the **UP** or **DOWN** button until **Preload Adjuster** is highlighted.
  - ✓ Press the **RIGHT** button to open the menu.
- The **Preload Adjuster** can be selected by pressing the **UP** or **DOWN** button.
  - ✓ Press the **SET** button to confirm the selection.

The spring preload can be adjusted to the payload in the **Preload Adjuster** menu. 11 manual settings (0 % to 100 %) and 3 automatic settings **Low** (optional), **Standard** (optional) and **High** (optional) are available.

The rebound setting is automatically adapted to the load detected by the system.

**i Info**

The preload adjuster is only adjusted with the engine running.

In automatic settings **Low** (optional), **Standard** (optional) and **High** (optional) the spring preload is automatically adjusted to the load detected by the system during the journey.

In the **Low** (optional), **Standard** (optional) and **High** (optional) automatic settings, it is possible that no adjustment of the spring preload can be detected when stationary.

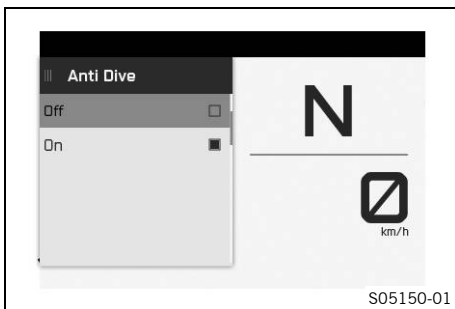
**7.33.30 Anti Dive (optional)****Condition**

- Model with **Suspension Pro**.
- Press the **RIGHT** button when the menu is closed.
- Press the **UP** or **DOWN** button until **Suspension** is highlighted. Press the **RIGHT** button to open the menu.
- Press the **UP** or **DOWN** button until **Anti Dive** is highlighted.
  - ✓ Press the **RIGHT** button to open the menu.
- Press the **UP** or **DOWN** button to select **Anti Dive** on or off.
  - ✓ Press the **SET** button to confirm the selection.

When **Anti Dive** is activated, the damping is automatically adjusted during braking to prevent the fork dipping strongly.

**7.33.31 Fork (optional)****Condition**

- Model with **Suspension Pro**.
- The **Suspension Mode Advanced** (optional) is activated.
- Press the **RIGHT** button when the menu is closed.
- Press the **UP** or **DOWN** button until **Suspension** is highlighted. Press the **RIGHT** button to open the menu.
- Press the **UP** or **DOWN** button until **Fork** is highlighted.
  - ✓ Press the **RIGHT** button to open the menu.
- The **Fork** can be configured by pressing the **UP** or **RIGHT** button.
  - ✓ Press the **SET** button to confirm the selection.

Eight levels are available in the **Fork** menu.

The damping of the fork is configured by the **Fork**.

**Softest** is the setting with the lowest damping, **Hardest** is the setting with the highest damping.

## 7.33.32 Shock (optional)



### Condition

- Model with **Suspension Pro**.
- The **Suspension Mode Advanced** (optional) is activated.
  - Press the **RIGHT** button when the menu is closed.
  - Press the **UP** or **DOWN** button until **Suspension** is highlighted. Press the **RIGHT** button to open the menu.
  - Press the **UP** or **DOWN** button until **Shock** is highlighted.
    - ✓ Press the **RIGHT** button to open the menu.
  - The **Shock** can be configured by pressing the **UP** or **RIGHT** button.
    - ✓ Press the **SET** button to confirm the selection.

Eight levels are available in the **Shock** menu.

The damping of the shock absorber is configured by the **Shock**. **Softest** is the setting with the lowest damping, **Hardest** is the setting with the highest damping.

## 7.33.33 Settings

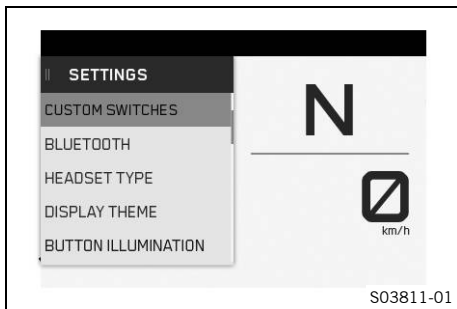

### Condition

- The motorcycle is stationary.
  - Press the **RIGHT** button when the menu is closed.
  - Press the **UP** or **DOWN** button until **Settings** is highlighted.
    - ✓ Press the **RIGHT** button to open the menu.

The combination instrument display can be configured in **Settings**. Settings can be made for units or various values. Several functions can be enabled or disabled.

## 7.33.34 C1 and C2 buttons

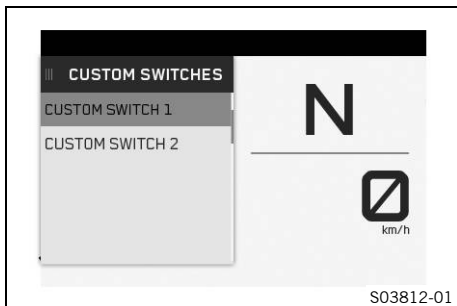

### Condition

- The motorcycle is stationary.
  - Press the **RIGHT** button when the menu is closed.
  - Press the **UP** or **DOWN** button until **Settings** is highlighted. Press the **RIGHT** button to open the menu.
  - Press **UP** or **DOWN** button until **Custom Switch 1** or **Custom Switch 2** is marked.
    - ✓ Press the **RIGHT** button to open the menu.
  - Press the **UP** or **DOWN** button to select the desired button and press the **SET** button to confirm.

### Info

In the **Custom Switches** menu, the C1 and C2 buttons can be assigned different quick accesses, e.g. **ABS** and **MTC+MSR**.

The **C1** switch is used to access the menu defined in **Custom Switch 1**.

The **C2** switch is used to access the menu defined in **Custom Switch 2**.

## 7.33.35 Bluetooth (optional)

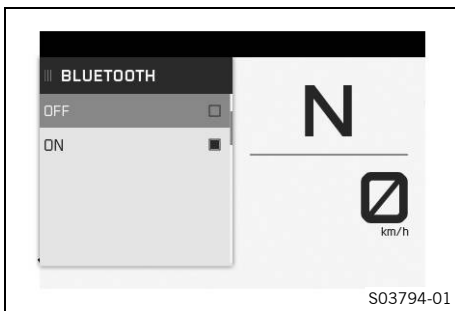
**Condition**

- The motorcycle is stationary.
- Press the **RIGHT** button when the menu is closed.
- Press the **UP** or **DOWN** button until **Settings** is highlighted.
  - ✓ Press the **RIGHT** button to open the menu.
- Press the **UP** or **DOWN** button until **Bluetooth®** is highlighted.
  - ✓ Press the **RIGHT** button to open the menu.
- Press the **UP** or **DOWN** button until **Bluetooth®, OFF**, or **ON** is highlighted.
- Press the **SET** button to confirm the selection.

**i Info**

The **Bluetooth®** function can only be used in conjunction with **KTM MY RIDE** (optional). When the **Bluetooth®** function is switched on, cellphone and helmet symbols appear in the **KTM MY RIDE** widget. As soon as there is a connection between the cellphone and/or a headset, the symbols are displayed filled in. The signal strength and the battery status of the cellphone are also displayed. Not every cellphone and headset is suitable for pairing with the combination instrument.

## 7.33.36 Headset Type

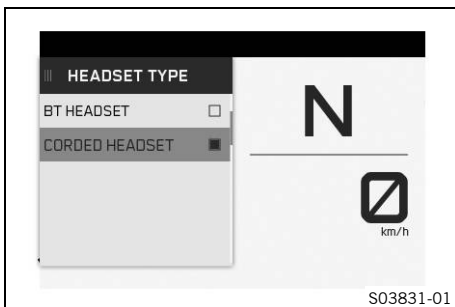

- Press the **RIGHT** button when the menu is closed.
- Press the **UP** or **DOWN** button until **Settings** is highlighted.
  - ✓ Press the **RIGHT** button to open the menu.
- Press the **UP** or **DOWN** button until **Headset Type** is highlighted.
  - ✓ Press the **RIGHT** button to open the menu.
- Press the **UP** or **DOWN** button until **BT HEADSET** or **CORDED HEADSET** is marked.
- Press the **SET** button to confirm the selection.

**i Info**

In the **Headset Type** menu, you can configure whether a **Bluetooth®** headset or a wired headset is used. With a wired headset, the volume cannot be controlled via the combination instrument.

## 7.33.37 Display Theme

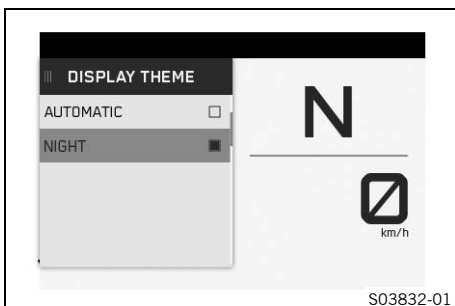

- Press the **RIGHT** button when the menu is closed.
- Press the **UP** or **DOWN** button until **Settings** is highlighted.
  - ✓ Press the **RIGHT** button to open the menu.
- Press the **UP** or **DOWN** button until **Display Theme** is highlighted.
  - ✓ Press the **RIGHT** button to open the menu.
- Press the **UP** or **DOWN** button until **AUTOMATIC** or **NIGHT** is marked.
- Press the **SET** button to confirm the selection.



### Info

In **AUTOMATIC** mode, the combination instrument automatically switches to day or night mode depending on the brightness.

In **NIGHT** mode, the combination instrument remains permanently in night mode.

## 7.33.38 Button Illumination

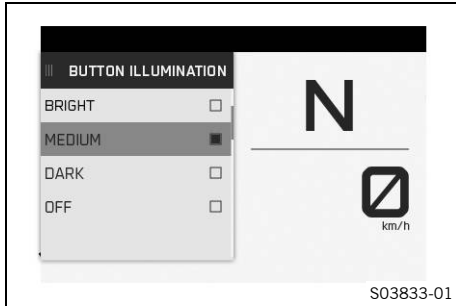

S03833-01

- Press the **RIGHT** button when the menu is closed.
- Press the **UP** or **DOWN** button until **Settings** is highlighted.
- ✓ Press the **RIGHT** button to open the menu.
- Press the **UP** or **DOWN** button until **Button Illumination** is highlighted.
- ✓ Press the **RIGHT** button to open the menu.
- Press the **UP** or **DOWN** button until the desired menu item **BRIGHT**, **MEDIUM**, **DARK**, or **OFF** is marked.
- Press the **SET** button to confirm the selection.



### Info

The brightness of the button lighting can be configured in the **Button Illumination** menu.

## 7.33.39 Shift Light



S03813-01

### Condition

- The motorcycle is stationary.
- **ODO** > 1,000 km (621 mi).
- Press the **RIGHT** button when the menu is closed.
- Press the **UP** or **DOWN** button until **Settings** is highlighted. Press the **RIGHT** button to open the menu.
- Press the **UP** or **DOWN** button until **Shift Light** is highlighted.
- ✓ Press the **RIGHT** button to open the menu.
- Press the **UP** or **DOWN** button to select the desired menu subitems.
- ✓ Press the **RIGHT** button to open the menu.
- Press the **UP** or **DOWN** button to adjust the value for **RPM1** and **RPM2** and press the **SET** button to confirm.



### Info

If the engine speed does not reach **RPM1**, the first value set, the engine speed display flashes slowly. If the engine speed does not reach **RPM2**, the second value set, the engine speed display flashes quickly.

- Switch the shift warning light off or on using the menu subitems **OFF** or **ON**.

## 7.33.40 Daytime Runn. Light

**Condition**

- The motorcycle is stationary.
- Press the **RIGHT** button when the menu is closed.
- Press the **UP** or **DOWN** button until **Settings** is highlighted.
- ✓ Press the **RIGHT** button to open the menu.

**Warning**

**Danger of accidents** When visibility is poor, the daytime running light is not a substitute for the low beam.

Automatic switching between the daytime running light and low beam may only be partially available when visibility is significantly impaired due to fog, snow or rain.

- Ensure that the appropriate type of lighting is always selected.
  - If necessary switch off the daytime running lights using the menu before going on a ride or when stopped so that the low beam is switched on permanently.
  - Make sure that the daytime running light is deactivated with the diagnostics tool when the menu item is not available, but the low beam is required. (Your authorized KTM workshop will be glad to help.)
  - Note the legal regulations regarding the daytime running light.
- Press the **UP** or **DOWN** button until **Daytime Runn. Light** is highlighted.
  - ✓ Press the **RIGHT** button to open the menu.
  - Press the **UP** or **DOWN** button until **Daytime Runn. Light, OFF,** or **ON** is highlighted.
  - Press the **SET** button to switch the daytime running light on or off.

## 7.34 Setting the time and date

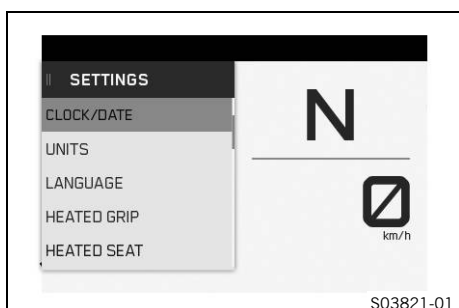
**Condition**

The motorcycle is stationary.

- Press **RIGHT** button when the menu is closed.
- Press the **UP** or **DOWN** button until **Settings** is marked.
- ✓ Press the **RIGHT** button to open the menu.
- Press the **UP** or **DOWN** button until **Clock/Date** is highlighted.
- ✓ Press the **RIGHT** button to open the menu.

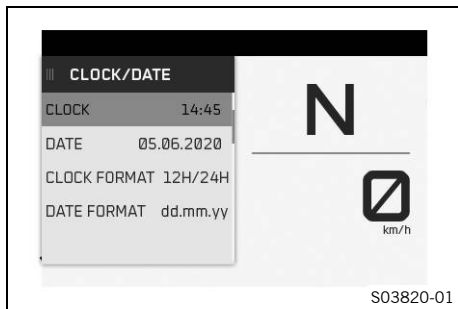

### Setting the clock

- Press the **UP** or **DOWN** button until the time is marked.
- Press the **SET** button.
  - ✓ The hour next to **Clock** flashes.
- Press the **UP** or **DOWN** button until the current hour is set.
- Press the **RIGHT** button.
  - ✓ The minute next to **Clock** flashes.
- Press the **UP** or **DOWN** button until the current minute is set.
- Press the **SET** button.
  - ✓ The time is stored.

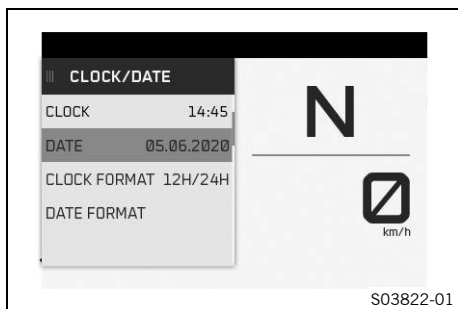

### Setting the date

- Press the **UP** or **DOWN** button until the date is marked.
- Press the **SET** button.
  - ✓ The day next to **Date** flashes.
- Press the **UP** or **DOWN** button until the current day is set.
- Press the **RIGHT** button.
  - ✓ The month next to **Date** flashes.
- Press the **UP** or **DOWN** button until the current month is set.
- Press the **RIGHT** button.
  - ✓ The year next to **Date** flashes.
- Press the **UP** or **DOWN** button until the current year is set.
- Press the **SET** button.
  - ✓ The date is stored.

## 7.35 Units

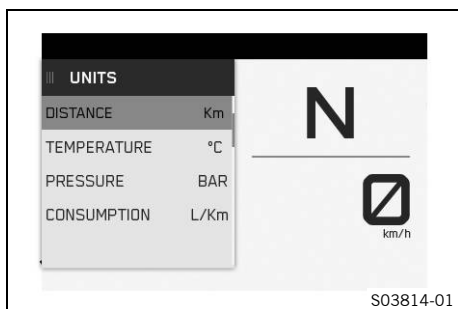

### Condition

- The vehicle is stationary.
- Press the **RIGHT** button when the menu is closed.
- Press the **UP** or **DOWN** button until **Settings** is highlighted.
  - ✓ Press the **RIGHT** button to open the menu.
- Press the **UP** or **DOWN** button until **Units** is highlighted.
  - ✓ Press the **RIGHT** button to open the menu.

**Units** allows settings to be made for units or various values.

## 7.36 Distance

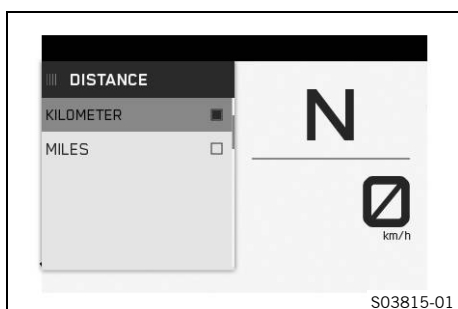

### Condition

- The motorcycle is stationary.
- Press the **RIGHT** button when the menu is closed.
- Press the **UP** or **DOWN** button until **Settings** is highlighted.
  - ✓ Press the **RIGHT** button to open the menu.
- Press the **UP** or **DOWN** button until **Units** is highlighted.
  - ✓ Press the **RIGHT** button to open the menu.
- Press the **UP** or **DOWN** button until **Distance** is highlighted.
  - ✓ Press the **RIGHT** button to open the menu.



- Activate the menu item using the **UP** or **DOWN** button.
- Press the **SET** button to confirm the desired unit.

## 7.37 Temperature

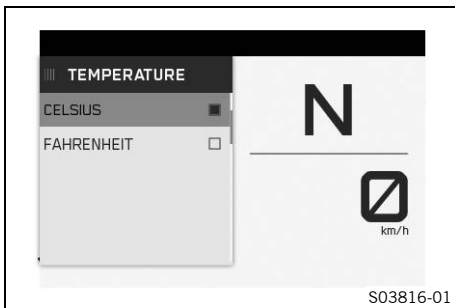

### Condition

- The motorcycle is stationary.
- Press the **RIGHT** button when the menu is closed.
- Press the **UP** or **DOWN** button until **Settings** is highlighted.
  - ✓ Press the **RIGHT** button to open the menu.
- Press the **UP** or **DOWN** button until **Units** is highlighted.
  - ✓ Press the **RIGHT** button to open the menu.
- Press the **UP** or **DOWN** button until **Temperature** is highlighted.
  - ✓ Press the **RIGHT** button to open the menu.
- Activate the menu item using the **UP** or **DOWN** button.
- Press the **SET** button to confirm the desired unit.

## 7.38 Pressure



### Condition

- The motorcycle is stationary.
- Press the **RIGHT** button when the menu is closed.
- Press the **UP** or **DOWN** button until **Settings** is highlighted.
  - ✓ Press the **RIGHT** button to open the menu.
- Press the **UP** or **DOWN** button until **Units** is highlighted.
  - ✓ Press the **RIGHT** button to open the menu.
- Press the **UP** or **DOWN** button until **Pressure** is highlighted.
  - ✓ Press the **RIGHT** button to open the menu.
- Activate the menu item using the **UP** or **DOWN** button.
- Press the **SET** button to confirm the desired unit.

## 7.39 Consumption

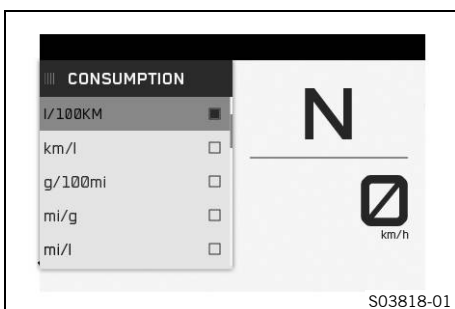

### Condition

- The motorcycle is stationary.
- Press the **RIGHT** button when the menu is closed.
- Press the **UP** or **DOWN** button until **Settings** is highlighted.
  - ✓ Press the **RIGHT** button to open the menu.
- Press the **UP** or **DOWN** button until **Units** is highlighted.
  - ✓ Press the **RIGHT** button to open the menu.
- Press the **UP** or **DOWN** button until **Consumption** is highlighted.
  - ✓ Press the **RIGHT** button to open the menu.
- Activate the menu item using the **UP** or **DOWN** button.
- Press the **SET** button to confirm the desired unit.

## 7.40 Language

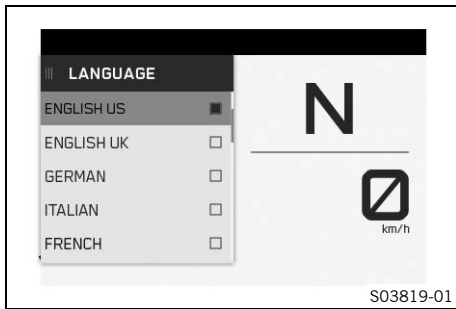

### Condition

- The motorcycle is stationary.
- Press the **RIGHT** button when the menu is closed.
- Press the **UP** or **DOWN** button until **Settings** is highlighted.
  - ✓ Press the **RIGHT** button to open the menu.
- Press the **UP** or **DOWN** button until **Units** is highlighted.
  - ✓ Press the **RIGHT** button to open the menu.
- Press the **UP** or **DOWN** button until **Language** is highlighted.
  - ✓ Press the **RIGHT** button to open the menu.
- Activate the menu item using the **UP** or **DOWN** button.
- Press the **SET** button to confirm the desired language.

The menu languages are US English, UK English, German, Italian, French, and Spanish.

## 7.41 Heated Grips (optional)

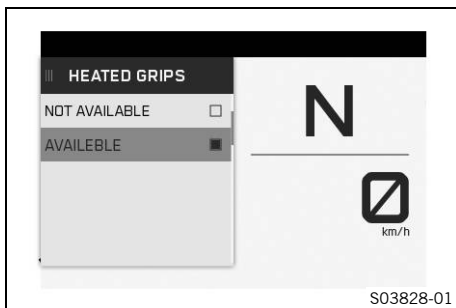

### Condition

- The motorcycle is stationary.
- Press the **RIGHT** button when the menu is closed.
- Press the **UP** or **DOWN** button until **Settings** is highlighted.
  - ✓ Press the **RIGHT** button to open the menu.
- Press the **UP** or **DOWN** button until **Heated Grips** is highlighted.
  - ✓ Press the **RIGHT** button to open the menu.
- Press the **UP** or **DOWN** button until **NOT AVAILABLE** or **AVAILABLE** is marked.
- Press the **SET** button to confirm the selection.

### Info

The heated grip is activated or deactivated in the **Settings** menu. The heated grip is controlled in the **Motorcycle** menu, in submenu **Heated Grips** or in the **HEATING** widget.

## 7.42 Heated Seat (optional)

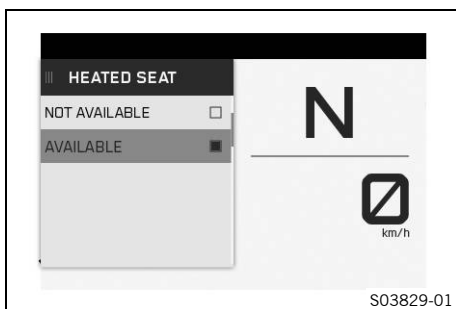

### Condition

- The motorcycle is stationary.
- Press the **RIGHT** button when the menu is closed.
- Press the **UP** or **DOWN** button until **Settings** is highlighted.
  - ✓ Press the **RIGHT** button to open the menu.
- Press the **UP** or **DOWN** button until **Heated Seat** is highlighted.
  - ✓ Press the **RIGHT** button to open the menu.
- Press the **UP** or **DOWN** button until **Heated Seat**, **NOT AVAILABLE**, or **AVAILABLE** is highlighted.
- Press the **SET** button to confirm the selection.

**i Info**  
The seat heating is activated or deactivated in the **Settings** menu. The seat heating is controlled in the **Motorcycle** menu, in **Heated Seat** submenu or in the widget **HEATING**.

## 7.43 Small widget

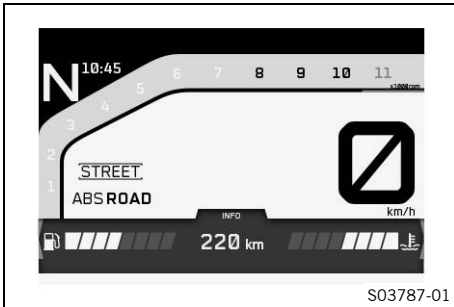

- Press the **UP** button once when the menu is closed.
- Use the **LEFT** or **RIGHT** button to change between the information displays.

**i Info**  
In the small widget you can switch between the individual widgets. All widgets dependent on optional menus and functions are only available if the corresponding option is installed in the vehicle.

## 7.44 Large widget

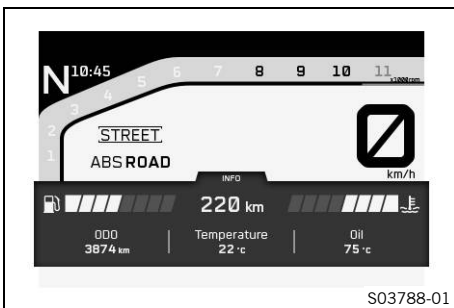

- Press the **UP** button twice when the menu is closed.
- ✓ The widget is large and displays all the information of the respective information display.

**i Info**  
All widgets dependent on optional menus and functions are only available if the corresponding option is installed in the vehicle.

## 7.45 KTM MY RIDE widget

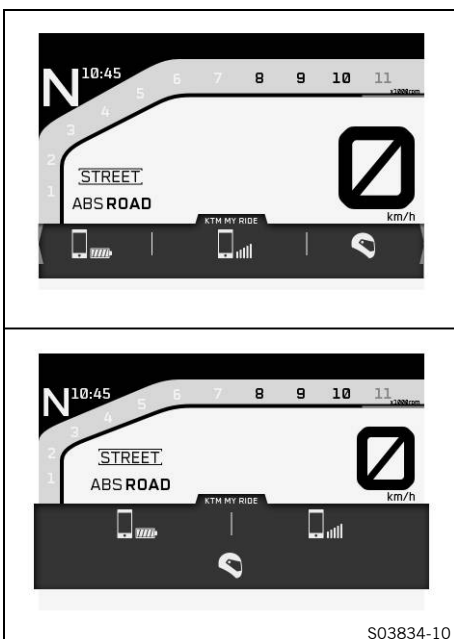

- Press the **UP** button once when the menu is closed.
- Use the **LEFT** or **RIGHT** button to change between the information displays until the **KTM MY RIDE** widget is displayed.
- Press the **SET** button to open the large widget.

The **KTM MY RIDE** widget displays various status information on the cellphone battery status, cellphone reception and the **Bluetooth®** connection to the headset.

**i Info**  
When the symbols are filled in, there is a connection between the combination instrument and the terminal device. When the symbols are not filled in, there is no connection between the combination instrument and the terminal device.

## 7.46 NAVIGATION widget



- Press the **UP** button once when the menu is closed.
- Use the **LEFT** or **RIGHT** button to change between the information displays until the **NAVIGATION** widget is displayed.
- Press the **SET** button to open the large widget.

### **i** Info

The **NAVIGATION** widget is only available if the navigation app is active and the **TRACK** mode is deactivated. The large **NAVIGATION** widget shows the direction arrow, the distance to the next waypoint, the road name, the arrival time and the distance to the destination. The volume of the navigation can be controlled with the **UP** or **DOWN** button.

## 7.47 FAVORITES widget

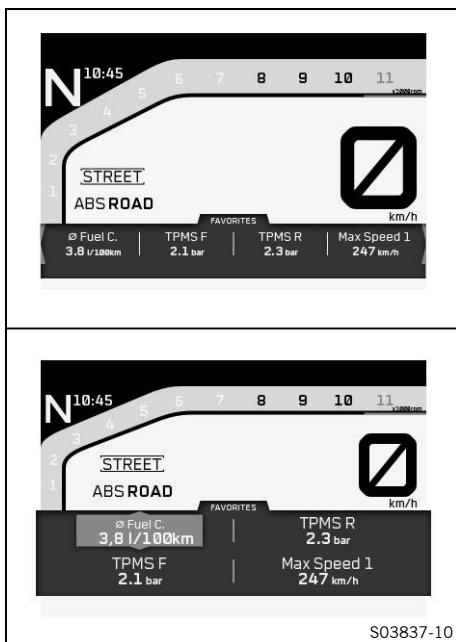

- Press the **UP** button once when the menu is closed.
- Use the **LEFT** or **RIGHT** button to change between the information displays until the **FAVORITES** widget is displayed.
- Press the **SET** button to open the large widget.

### **i** Info

In the large **FAVORITES** widget, up to four areas with different information types can be configured.

- Use the **LEFT** or **RIGHT** button to change between the individual areas until the desired area is highlighted.
- Press the **UP** or **DOWN** button to select the desired information type.

### **i** Info

The selection is accepted after a few seconds.

An area can be added using the selection item **Item Add**.

An area can be removed using the selection item **Item Remove**.

Up to four areas can be selected and configured.

The areas one to four are also the information displays in the small **FAVORITES** widget.

## 7.48 Widget INFO

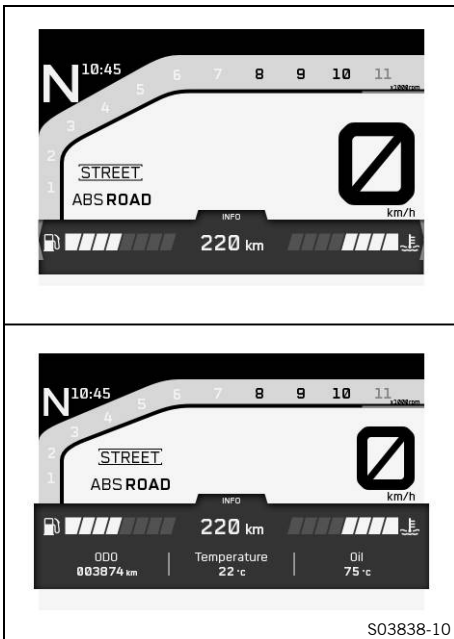

- Press the **UP** button once when the menu is closed.
- Use the **LEFT** or **RIGHT** button to change between the information displays until the **INFO** widget is displayed.
- Press the **SET** button to open the large widget.



### Info

The small **INFO** widget displays the fuel level indicator, the coolant temperature indicator and the remaining range.

The large **INFO** widget also displays the total mileage, the ambient air temperature and the oil temperature.

## 7.49 HEATING widget

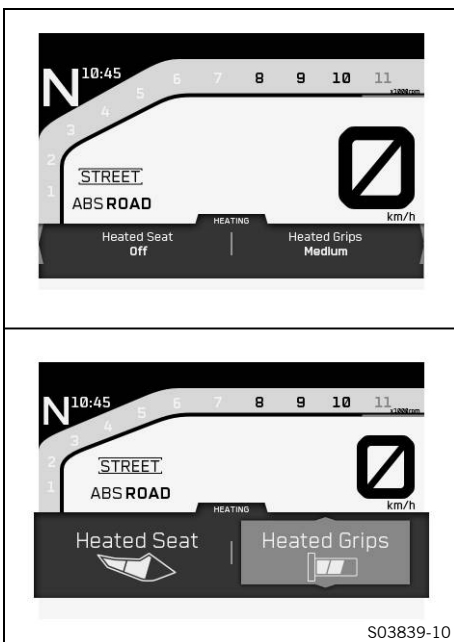

- Press the **UP** button once when the menu is closed.
- Use the **LEFT** or **RIGHT** button to change between the information displays until the **HEATING** widget is displayed.
- Press the **SET** button to open the large widget.
- Press the **LEFT** or **RIGHT** button to select the heating level or the heated grip.
- Press the **UP** or **DOWN** button to select the desired heating intensity.



### Info

The **HEATING** widget is only available if it has been activated in the menu **SETTINGS**.

A selection can be made between heating intensities **OFF**, **MAX**, **MED** or **MIN**.

The heating intensity is displayed in bars in the large widget. The more bars displayed, the higher the heating intensity.

## 7.50 MUSIC widget

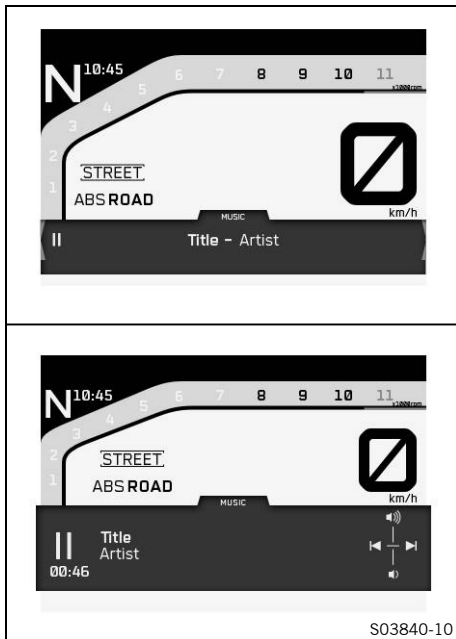

- Press the **UP** button once when the menu is closed.
- Use the **LEFT** or **RIGHT** button to change between the information displays until the **MUSIC** widget is displayed.



### Warning

**Danger of accidents** Headphone volume which is too high distracts attention from traffic activity.

- Always select headphone volume which is low enough for you to still clearly hear acoustic signals.

- Press the **SET** button to open the large widget.
- Press the **UP** button to increase the volume.
- Press the **DOWN** button to reduce the volume.
- Press the **RIGHT** button briefly to change to the next audio track.
- Depending on the cellphone model, press the **LEFT** button briefly or twice to change to the previous audio track or to play the current audio track from the start.
- Press the **SET** button to change between playback and pause.



### Tip

The **MUSIC** widget is only available if a cellphone and a headset are connected via **Bluetooth®** with the motorcycle.

With some cellphones, the cellphone's audio player needs to be started before playback is possible. For easier operation, the **MUSIC** function can be added to the **C1** or **C2** switch.

8.1 Handlebar position

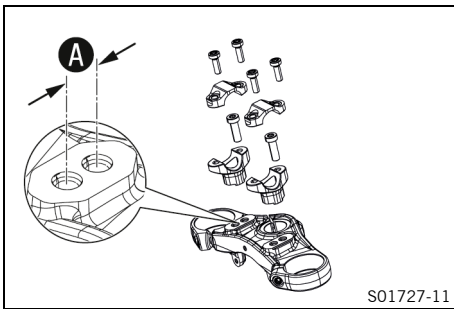

On the upper triple clamp there are two holes at a distance of **A** apart.

Hole distance <b>A</b>	15 mm (0.59 in)
------------------------	-----------------

The handlebar can be mounted in two different positions. In this way, the handlebar can be mounted in the most comfortable position for the rider.

**i Info**  
KTM recommends the front handlebar position when using the vehicle on a race track.

8.2 Adjusting the handlebar position ↩

**! Warning**  
**Danger of accidents** A repaired handlebar poses a safety risk.  
If the handlebar is bent or straightened, the material becomes fatigued. The handlebar may break as a result.  
– Change the handlebar if the handlebar is damaged or bent.

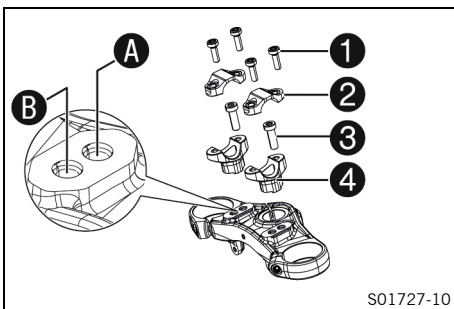

- Remove screws **1**. Take off the handlebar clamps **2**. Position the handlebar so that screws **3** are accessible.

**i Info**  
Cover the components to protect them against damage. Do not kink the cables and lines.

- Remove screws **3**. Take off handlebar supports **4**.
- Move the handlebar supports into the desired position **A** or **B**. Mount and tighten screws **3**.

Guideline  
Mount the left and right handlebar supports in the same position.

Screw, handlebar support	M10	40 Nm (29.5 lbf ft) <b>Loctite®243™</b>
--------------------------	-----	--------------------------------------------

- Position the handlebar.

**i Info**  
Make sure the cables and wiring are positioned correctly.

- Position the handlebar clamp. Mount screws **1** and tighten evenly.

Guideline

Screw, handlebar clamp	M8	20 Nm (14.8 lbf ft)
------------------------	----	---------------------

## 8.3 Adjusting the basic position of the clutch lever

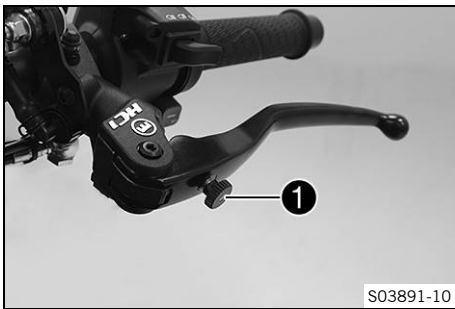

- Push the clutch lever forward.
- Adjust the basic position of the clutch lever to your hand size by turning adjusting screw ①.

### **i** Info

Turn the adjusting screw clockwise to increase the distance between the clutch lever and the handlebar. Turn the adjusting screw counterclockwise to decrease the distance between the clutch lever and the handlebar.

The range of adjustment is limited.

Only turn the adjusting screw by hand, and do not use force.

Do not make any adjustments while riding.

## 8.4 Adjusting the basic position of the hand brake lever

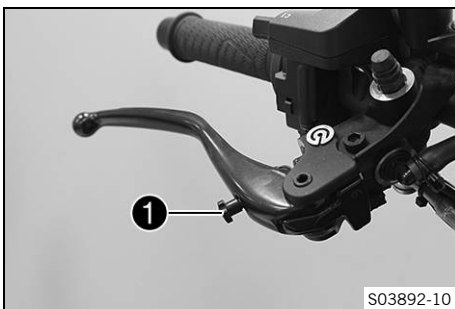

- Push the hand brake lever forward.
- Adjust the basic position of the hand brake lever to your hand size by turning adjusting screw ①.

### **i** Info

Turn the adjusting screw clockwise to increase the distance between the hand brake lever and the handlebar.

Turn the adjusting screw counterclockwise to decrease the distance between the hand brake lever and the handlebar.

The range of adjustment is limited.

Only turn the adjusting screw by hand, and do not use force.

Do not make any adjustments while riding.

## 8.5 Setting the step plate of the foot brake lever

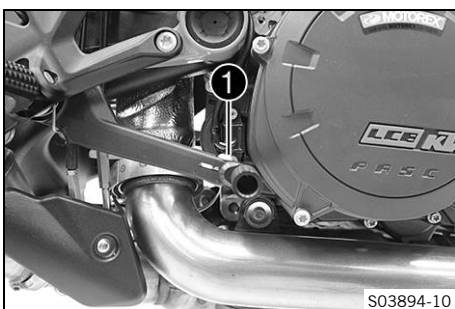

- Loosen screw ①.
- Turn the step plate of the foot brake lever to the desired position.

Guideline

Standard	Step plate positioned to the front
----------	------------------------------------

### **i** Info

The step plate of the foot brake lever can be freely rotated through 360 °.

The basic position of the foot brake lever is set at the factory and does not need to be changed.

- Tighten screw ①.



Guideline

Screw, step plate for foot brake lever	M6	10 Nm (7.4 lbf ft)
----------------------------------------	----	--------------------



**8.6 Checking the basic position of the shift lever**

**i Info**

When driving, the shift lever must not touch the rider's boot when in the basic position. If the shift lever is permanently touching the boot, the transmission will be subject to excessive load; this can cause a malfunction of the quickshifter.

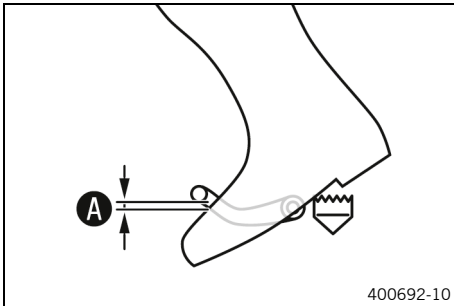

- Sit on the vehicle in the riding position and determine distance **A** between the upper edge of your boot and the shift lever.

Distance between shift lever and upper edge of boot	10 ... 20 mm (0.39 ... 0.79 in)
-----------------------------------------------------	---------------------------------

- » If the distance does not meet specifications:
  - Set the shift lever stub. (📖 p. 71)



**8.7 Setting the shift lever stub**

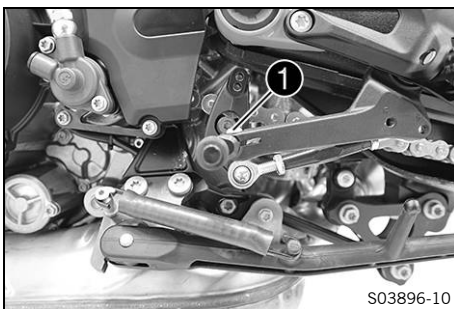

- Loosen screw **1**.
- Turn the shift lever stub to the desired position.

Guideline

Standard	Step plate positioned to the front
----------	------------------------------------

**i Info**

The shift lever stub can be freely rotated through 360°. The shift lever stub is set at the factory and does not need to be changed.

- Tighten the screw.

Guideline

Screw, shift lever stub	M6	10 Nm (7.4 lbf ft)
-------------------------	----	--------------------



**8.8 Adjusting the footrests ↩**

**i Info**

The adjustable footrest support allows a more comfortable lower footrest position (normal switching scheme) or a sporty upper footrest position (reverse switching scheme). The footrest support position and switching scheme can only be changed together.

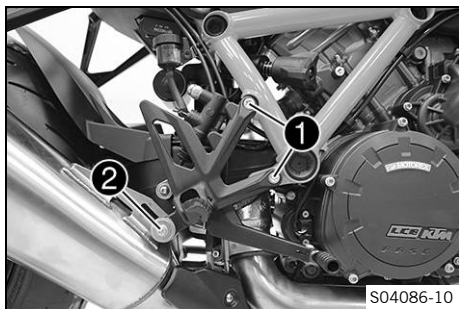

- Remove screws **1** on the right footrest support.

**i Info**  
Pay attention to the nut when removing the lower footrest support bolt.

- Loosen screw **2**.

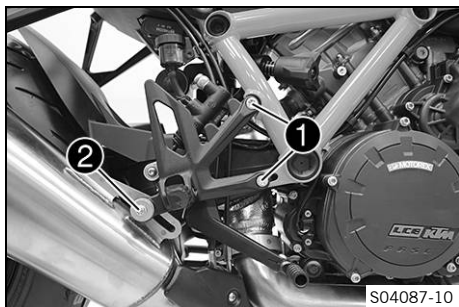

- Position the footrest bracket.
- Mount and tighten screws **1**.

Guideline

Screw, front rider footrest bracket	M8	25 Nm (18.4 lbf ft) <b>Loctite®243™</b>
-------------------------------------	----	--------------------------------------------

- Tighten screw **2**.

Guideline

Remaining screws, chassis	M8	25 Nm (18.4 lbf ft)
---------------------------	----	---------------------

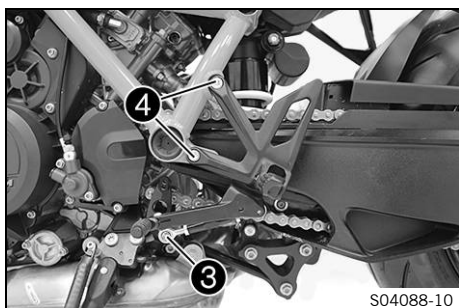

- Remove screw **3** of the shift linkage.
- Remove screws **4** on the left footrest support and take off the footrest support.

**i Info**  
Pay attention to the nut when removing the lower footrest support bolt.



- Separate the shift linkage from the shift lever and mount in position "R".

Guideline

Screw, shift rod	M6	5 Nm (3.7 lbf ft) <b>Loctite®243™</b>
------------------	----	------------------------------------------

**i Info**  
The shift linkage is set at the factory. It is not necessary to adjust the shift linkage. When the footrest support is returned to the standard position, the shift linkage on the shift lever must be mounted in position "S".

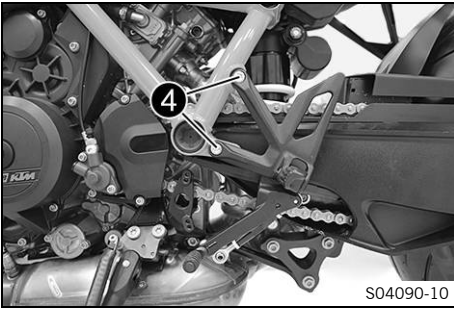

- Position the footrest bracket.
- Mount and tighten screws ④.

Guideline

Screw, front rider footrest bracket	M8	25 Nm (18.4 lbf ft) <b>Loctite®243™</b>
-------------------------------------	----	--------------------------------------------

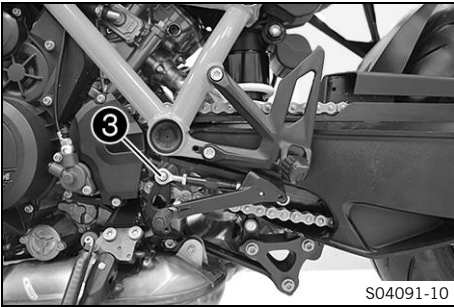

- Position the shift linkage at one of the upper positions of the shift shaft.

Guideline

Outer position	Shift power low, long shift path
Inner position	Shift power high, short shift path

**i Info**  
When the footrest support is returned to the standard position, one of the lower positions on the shift shaft must be used.

- Mount and tighten screw ③.

Guideline

Screw, shift rod	M6	5 Nm (3.7 lbf ft) <b>Loctite®243™</b>
------------------	----	------------------------------------------

**i Info**  
The switching scheme is now reversed.

### 8.9 Adjusting the tilt of the combination instrument

**i Info**  
The tilt of the combination instrument can be continuously adjusted using clamping on the handlebar.

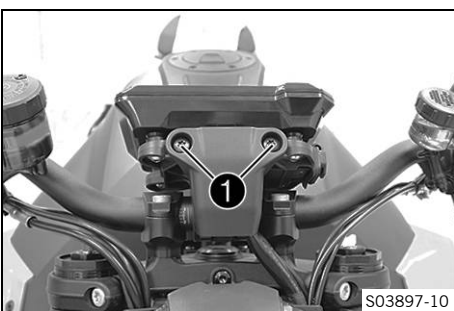

- Remove screws ① and take off the cover.

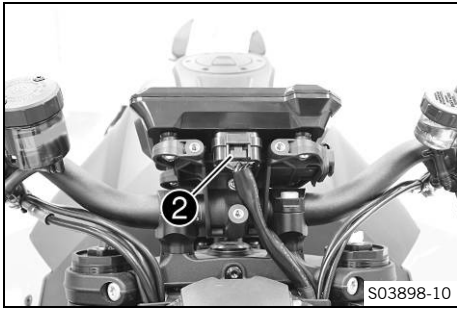

- Unplug connector **2**.

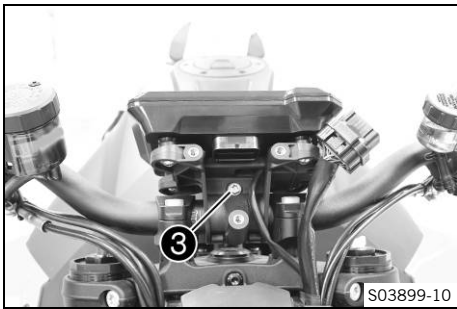

- Loosen screw **3**.
  - Adjust tilt of the combination instrument.
- Guideline

The combination instrument must also not touch any other components following completion of the work.

- Tighten screw **3**.
- Guideline

Screw, combination instrument clamping	M6	2 Nm (1.5 lbf ft)
----------------------------------------	----	-------------------

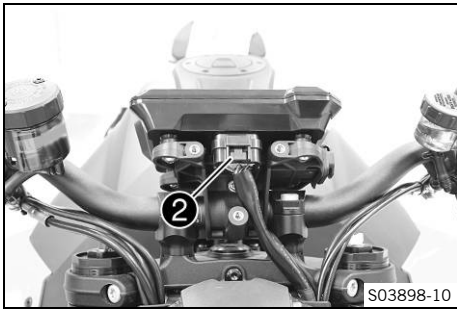

- Plug in connector **2**.

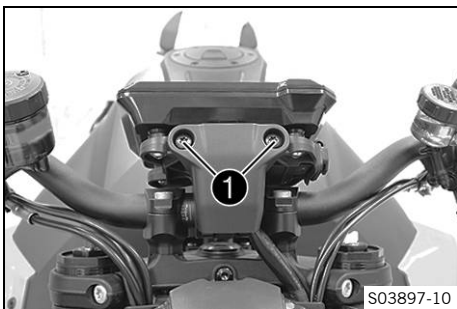

- Position the cover, mount and tighten screws **1**.

9.1 Advice on preparing for first use



**Danger**

**Danger of accidents** A rider who is not fit to ride poses a danger to him or herself and others.

- Do not operate the vehicle if you are not fit to ride due to alcohol, drugs or medication.
- Do not operate the vehicle if you are physically or mentally impaired.



**Warning**

**Risk of injury** Missing or poor protective clothing presents an increased safety risk.

- Wear appropriate protective clothing such as helmet, boots, gloves as well as trousers and a jacket with protectors on all rides.
- Always wear protective clothing that is in good condition and meets the legal regulations.



**Warning**

**Danger of crashing** Different tire tread patterns on the front and rear wheel impair the handling characteristic.

Different tire tread patterns can make the vehicle significantly more difficult to control.

- Make sure that only tires with a similar tire tread pattern are fitted to the front and rear wheel.



**Warning**

**Danger of accidents** Non-approved or non-recommended tires and wheels impact the handling characteristic.

- Only use tires/wheels approved by KTM with the corresponding speed index.



**Warning**

**Danger of accidents** New tires have reduced road grip.

The contact surface on new tires is not yet roughened.

- Run in new tires with moderate riding at alternating angles.
- |                  |                 |
|------------------|-----------------|
| Running-in phase | 200 km (124 mi) |
|------------------|-----------------|



**Warning**

**Danger of accidents** The brake system fails in the event of overheating.

If the foot brake lever is not released, the brake linings drag continuously.

- Take your foot off the foot brake lever if you do not want to brake.



**Info**

When using your vehicle, remember that others may feel disturbed by excessive noise.

- Make sure that the pre-sales inspection work has been carried out by an authorized KTM workshop.
  - ✓ You will receive a delivery certificate when the vehicle is handed over.
- Before riding for the first time, read the entire Owner's Manual carefully.
- Get to know the controls.
- Adjust the motorcycle to your requirements, as described in the "Ergonomics" chapter.
- Get used to the handling characteristic of the motorcycle in a suitable area before making a longer trip. Try also to ride as slowly as possible to get a better feel for the motorcycle.
- Hold the handlebar firmly with both hands and keep your feet on the footrests when riding.
- Run the engine in.



## 9.2 Running in the engine

- During the running-in phase, do not exceed the specified engine speed.

Guideline

Maximum engine speed	
During first: 1,000 km (620 mi)	6,500 rpm
After first: 1,000 km (620 mi)	10,250 rpm

- Avoid fully opening the throttle!

## 9.3 Loading the vehicle



**Warning**

**Danger of accidents** Total weight and axle loads influence the handling characteristic.

The total weight consists of: operational motorcycle with a full tank, rider and, if necessary, a passenger with protective clothing and helmet, and, if necessary, mounted luggage.

- Do not exceed the maximum permissible overall weight or the axle loads.



**Warning**

**Danger of accidents** Improper mounting of cases, tank rucksacks or other luggage impairs the handling characteristics.

Luggage mounted incorrectly can slip while the vehicle is in motion.

- Mount and secure all luggage according to the manufacturer's instructions.
- Check that your luggage is fixed properly at regular intervals.



**Warning**

**Danger of accidents** Carrying luggage alters handling characteristics at high speed.

- Adapt your speed to your payload.
  - Ride more slowly if your motorcycle is loaded with cases or other luggage.
- Maximum speed with luggage 130 km/h (80.8 mph)



**Warning**

**Danger of accidents** Overloading will destroy the baggage system.

- Observe the manufacturer's instructions on the maximum payload if you have panniers mounted to your motorcycle.



**Warning**

**Danger of accidents** Luggage which has slipped impairs visibility.

If the tail light is covered, you are less visible to traffic behind you, especially when it is dark.

- Check that your luggage is fixed properly at regular intervals.



**Warning**

**Danger of accidents** A high payload alters the handling characteristic and increases the stopping distance.

- Adapt your speed to your payload.



**Warning**

**Fire hazard** The hot exhaust system may burn luggage.

- Fasten your luggage in such a way that it cannot be burned or singed by the hot exhaust system.

- If luggage is carried, ensure it is fixed firmly as close as possible to the center of the vehicle and ensure even weight distribution between the front and rear wheels.
- Do not exceed the maximum permissible weight and maximum permissible axle loads.

Guideline

Maximum permissible overall weight	425 kg (937 lb.)
Maximum permissible front axle load	165 kg (364 lb.)
Maximum permissible rear axle load	260 kg (573 lb.)



## 10.1 Checks and maintenance measures when preparing for use

### **i** Info

Before every trip, check the condition of the vehicle and ensure that it is roadworthy. The vehicle must be in perfect technical condition when it is being operated.

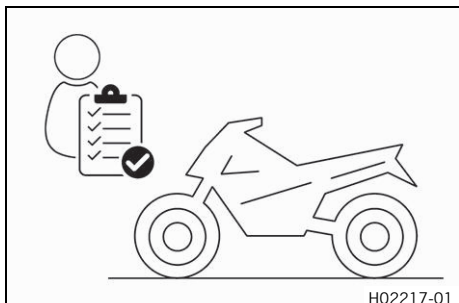

- Check the engine oil level. (📖 p. 135)
- Check the front brake fluid level. (📖 p. 109)
- Check the rear brake fluid level. (📖 p. 111)
- Check the front brake linings. (📖 p. 110)
- Check the brake linings of the rear brake. (📖 p. 113)
- Check that the brake system is functioning properly.
- Check the coolant level in the compensating tank. (📖 p. 131)
- Check the chain for dirt. (📖 p. 101)
- Check the chain tension. (📖 p. 102)
- Check tire condition. (📖 p. 117)
- Check tire pressure. (📖 p. 118)
- Check the settings of all controls and ensure that they can be operated smoothly.
- Check that the electrical system is functioning properly.
- Check that luggage is properly secured.
- Check the setting of the rear mirror.
- Check the fuel level.

## 10.2 Starting the vehicle



### **Danger**

**Danger of poisoning** Exhaust gases are toxic and inhaling them may result in unconsciousness and death.

- Always make sure there is sufficient ventilation when running the engine.
- Use effective exhaust extraction when starting or running the engine in an enclosed space.



### **Caution**

**Danger of accidents** Electronic components and safety devices will be damaged if the 12-V battery is discharged or missing.

If the 12-V battery is discharged or defective, malfunctions in the vehicle electronics can occur, especially when starting.

- Never operate the vehicle with a discharged 12-V battery or without a 12-V battery.

### **Note**

**Engine damage** High revving speed with a cold engine negatively impacts the lifespan of the engine.

- Always run the engine warm at a low speed.



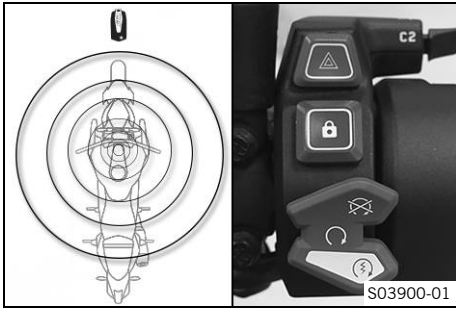

- Take the motorcycle off the side stand and sit on the motorcycle.
- Move the RACE-ON button within the range of the steering lock.
- Ensure that the RACE ON key stays in range while riding.

**Guideline**

Maximum range of the RACE-ON key around the steering lock	1.5 m (4.9 ft)
-----------------------------------------------------------	----------------



**Info**

The range may be reduced by decreases in RACE ON key battery voltage and by interfering radio waves. If the battery voltage of the RACE-ON key is too low, one of the ignition keys must be placed in the area of the steering lock (📖 p. 24) and must be safely stored again after starting.

- Make sure that the start button/emergency OFF switch is in the middle position ○.
- Switch on ignition; to do this, briefly press the RACE-ON button Ⓜ (maximum of 1 second).

**Guideline**

To avoid malfunctions in the control unit communication, do not switch the ignition off and on in rapid succession.
---------------------------------------------------------------------------------------------------------------------

- ✓ The steering is unlocked.
- ✓ The function check of the combination instrument is run.
- ✓ The ABS warning lamp goes out when starting off.



**Info**

If the steering does not unlock, move the handlebar slightly.

- Shift the transmission into neutral.
  - ✓ Neutral position **N** is displayed.
- Briefly press the start button/emergency OFF switch into the lower position Ⓜ.



**Info**

Only press the start button/emergency OFF switch into the lower position Ⓜ when the combination instrument function check has been completed.

Do not open the throttle to start.

If the starting attempt is unsuccessful, wait for 15 seconds before making another attempt at starting.

After 6 unsuccessful starting attempts, do not try again, and check the vehicle for other malfunctions instead.

This motorcycle is equipped with a safety starting system. You can only start the engine if the transmission is in neutral or if the clutch lever is pulled when a gear is engaged. If the side stand is folded out and you shift into gear, the engine stops.

## 10.3 Launch Control (optional)

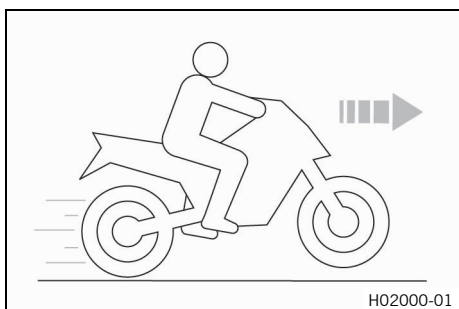

Launch Control is an optional vehicle electronics function. Launch control adjusts the engine speed in order to achieve the best possible acceleration. Launch control can be used for starting off for a maximum of three times in succession. Launch control is temporarily deactivated after the third starting off in order to protect the engine, transmission and cooling system from overloading. Launch control is also deactivated if all conditions for activation are no longer met. Launch control is enabled again in the following cases: the engine runs for at least three minutes, the engine is switched off for 20 minutes or a distance of 1.5 km (0.93 mi) has been covered.

## 10.4 Starting off

- Pull the clutch lever, shift into first gear, release the clutch lever slowly and at the same time open the throttle gently.

## 10.5 Starting off with launch control (optional)



### Warning

**Danger of accidents** Launch control enables very powerful acceleration which may ask too much of a novice rider.

- Only use the launch control if you have the appropriate experience.
- Do not use launch control on public roads.

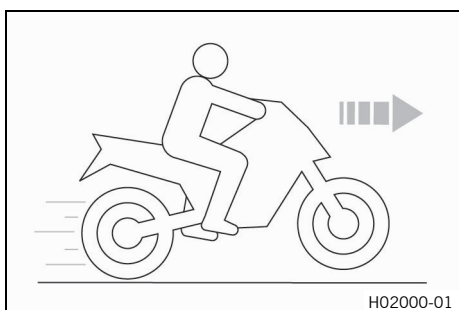

### Condition

The drive mode **TRACK** (optional) is activated.

First gear is engaged.

The TC indicator lamp does not light up.

Coolant temperature: > 60 °C (> 140 °F)

Total riding distance covered: > 1,000 km (> 620 mi)

- Activate launch control in the combination instrument.
  - ✓ The number of available starts is indicated on the start screen.
- Apply full throttle with the clutch lever pulled.
  - ✓ The engine speed is adjusted.
 

6,500 rpm
  - ✓ The TC indicator lamp flashes quickly.
- Release clutch lever quickly but in a controlled manner.

## 10.6 Quickshifter+ (optional)

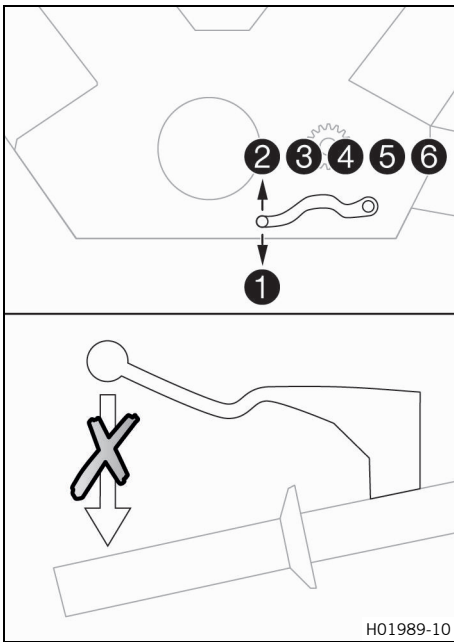

If the Quickshifter+ (optional) is activated, you can shift up and down without actuating the clutch. Because there is no need to close the throttle grip, uninterrupted gear shifts are possible. The quickshifter+ uses the shifter shaft position to check whether or not a shift should be initiated, and sends a corresponding signal to the engine control. If the quickshifter+ is disabled in the combination instrument, the clutch needs to be actuated in the normal way for each shift.

## 10.7 Shifting, riding



### Warning

**Danger of accidents** Abrupt load alterations can cause the vehicle to get out of control.

- Avoid abrupt load alterations and sudden braking actions.
- Adapt your speed to the road conditions.



### Warning

**Danger of accidents** If you change down at high engine speed, the rear wheel blocks and the engine races.

- Do not change into a low gear at high engine speed.



### Warning

**Danger of accidents** Adjustments to the vehicle distract attention from traffic activity.

- Make all adjustments when the vehicle is at a standstill.



### Warning

**Risk of injury** The passenger may fall from the motorcycle if they conduct themselves incorrectly.

- Ensure that the passenger sits correctly on the passenger seat, places his or her feet on the passenger foot pegs and holds on to the rider or the grab handles.
- Note the regulations governing the minimum age of passengers in your country.



### Warning

**Danger of accidents** A risky riding style constitutes a major risk.

- Comply with traffic regulations and ride defensively and with foresight to detect sources of danger as early as possible.



## Warning

**Danger of accidents** Cold tires have reduced road grip.

- Ride the first miles carefully on every journey at moderate speed until the tires reach operating temperature.



## Warning

**Danger of accidents** New tires have reduced road grip.

The contact surface on new tires is not yet roughened.

- Run in new tires with moderate riding at alternating angles.  
Running-in phase 200 km (124 mi)



## Warning

**Danger of accidents** Total weight and axle loads influence the handling characteristic.

The total weight consists of: operational motorcycle with a full tank, rider and, if necessary, a passenger with protective clothing and helmet, and, if necessary, mounted luggage.

- Do not exceed the maximum permissible overall weight or the axle loads.



## Warning

**Danger of accidents** Improper mounting of cases, tank rucksacks or other luggage impairs the handling characteristics.

Luggage mounted incorrectly can slip while the vehicle is in motion.

- Mount and secure all luggage according to the manufacturer's instructions.
- Check that your luggage is fixed properly at regular intervals.



## Warning

**Danger of accidents** A fall can damage the vehicle more seriously than it may first appear.

- Check the vehicle after a fall as you do when preparing for use.

## Note

**Engine damage** Unfiltered intake air has a negative effect on the service life of the engine.

Dust and dirt will enter the engine without an air filter.

- Only operate the vehicle if it is equipped with an air filter.

## Note

**Engine failure** Overheating damages the engine.

- If the coolant temperature warning is displayed, stop immediately and take care not to endanger yourself or other traffic participants in the process.
- Allow the engine and cooling system to cool down.
- Check and, if necessary, correct the coolant level on the cooling system while it is in a cooled state.

## Note

**Transmission damage** Incorrect use of Easy Shift will damage the transmission.

Easy Shift can only be used if the function is activated in the combination instrument.

Easy Shift is not active if you pull the clutch lever.

- Only use Easy Shift in the permitted speed range shown.



## Info

If you hear unusual noises while riding, stop immediately, switch off the engine, and contact an authorized KTM workshop.

All specifications regarding the switching direction refer to the standard switching scheme.

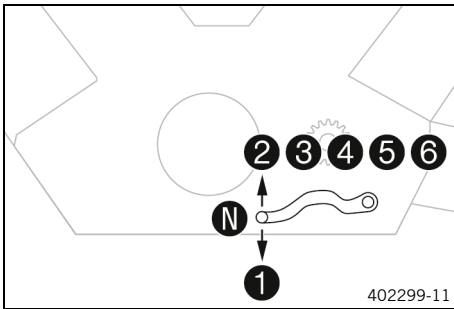



- Shift into a higher gear when conditions allow (incline, road situation, etc.).
- Release the throttle while simultaneously pulling the clutch lever, shift into the next gear, release the clutch lever, and open the throttle.



### Info

The gear positions can be seen in the figure. The idle position is between the first and second gears. First gear is used for starting off or for steep inclines.

- After reaching maximum speed by fully opening the throttle grip, turn the throttle back so it is  $\frac{3}{4}$  open. This will barely reduce the speed, but fuel consumption will be considerably lower.
- Accelerate only up to a speed suitable for the road surface and weather conditions. Particularly in bends, do not shift, and accelerate very carefully.
- Brake if necessary and close the throttle at the same time in order to shift down.
- Pull clutch lever and shift into a lower gear, release the clutch lever slowly, and open the throttle or shift again.
- If the engine stalls (e.g., at a crossroads), just pull clutch lever and press the start button/emergency OFF switch into the lower position (3). The transmission must not be shifted into neutral.
- Switch off the engine if you are likely to be running at idle speed or stationary for a long time.
- If the oil pressure warning lamp  lights up during a trip, stop immediately and switch off the engine. Contact an authorized KTM workshop.
- If the malfunction indicator lamp  lights up during a trip, please contact an authorized KTM workshop as soon as possible.
- If the general warning lamp  lights up during a trip, the display shows a message for 10 seconds.



### Info

Very important messages are stored in the **Warning** menu.

- If the ice warning appears in the combination instrument, the roads may be icy. Adjust your speed to the road conditions.

### Condition

The quickshifter + (optional) is enabled.

- If the quickshifter + is enabled in the combination instrument, one can shift up in the engine speed range shown without pulling the clutch lever.

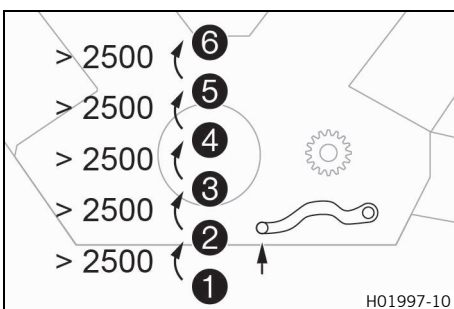

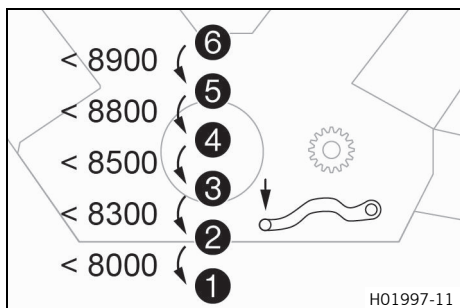

**i Info**  
The minimum engine speed before shifting up in revolutions per minute is shown in the figure. Pull the shift lever to the stop quickly without changing the throttle twist grip position.

- If the quickshifter+ is enabled in the combination instrument, one can shift down in the engine speed range shown without pulling the clutch lever.

**i Info**  
The maximum engine speed before shifting down in revolutions per minute is shown in the figure. Press the shift lever to the stop quickly without changing the throttle twist grip position.

## 10.8 MSR (optional)

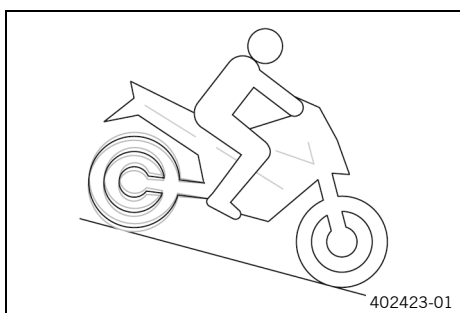

The **MSR** is an optional auxiliary function of the engine control. If the engine braking effect is too great, the **MSR** prevents the rear wheel from locking or sliding away on a sloping position. To avoid slip of the rear wheel, the **MSR** only opens the throttle valve as far as absolutely necessary. The **MSR** is applied on surfaces, where the friction coefficient is too low to open the slipper clutch. To further increase ride safety, the **MSR** is slope dependent.

**i Info**  
If **ABS** is disabled, the **cornering MTC** is disabled or **ABS Mode Supermoto** is enabled, the **MSR** is not active.

## 10.9 Applying the brakes

**! Warning**  
**Danger of accidents** Moisture and dirt impair the brake system.  
- Brake carefully several times to dry out and remove dirt from the brake linings and the brake discs.

**! Warning**  
**Danger of accidents** A spongy pressure point on the front or rear brake reduces braking efficiency.  
- Check the brake system and do not continue riding until the problem is eliminated. (Your authorized KTM workshop will be glad to help.)

**! Warning**  
**Danger of accidents** The brake system fails in the event of overheating. If the foot brake lever is not released, the brake linings drag continuously.  
- Take your foot off the foot brake lever if you do not want to brake.

**! Warning**  
**Danger of accidents** Higher total weight increases the stopping distance.  
- Take the longer stopping distance into account when carrying a passenger or luggage with you.



## Warning

**Danger of accidents** Salt on the roads impairs the brake system.

- Brake carefully several times to remove salt from the brake linings and the brake discs.



## Warning

**Danger of accidents** ABS may increase the stopping distance in certain situations.

- Adjust application of the brakes to the respective riding situation and riding surface conditions.



## Warning

**Danger of accidents** Excessively forceful application of the brakes blocks the wheels.

The ABS effectiveness is only ensured if it is switched on.

- Leave the ABS switched on in order to benefit from the protective effect.



## Warning

**Danger of accidents** Driving aids can reduce the probability of a fall only within physical limits.

It is not always possible to compensate for extreme riding situations, for example with luggage loaded with a high center of gravity, varying road surfaces, steep descents or full braking without disengaging the gear.

- Adapt your riding style to the road conditions and your driving ability.

- When braking, release the throttle and apply the front and rear brakes at the same time.



## Info

When the ABS is enabled, you can achieve maximum braking power even on low grip surfaces such as sandy, wet, or slippery terrain without locking of the wheels.



## Warning

**Danger of accidents** The rear wheel can lock due to the engine braking effect.

- Pull in the clutch, if you perform emergency or full braking, or if you brake on a slippery ground.



## Warning

**Danger of accidents** Banked or laterally sloping ground reduces the maximum possible delay.

- If possible finish braking before going into a bend.

- Always finish braking before you go into a bend. Change down to a lower gear appropriate to your road speed.
- Use the braking effect of the engine on long downhill stretches. Change down one or two gears, but do not over-rev the engine. In this way, you have to brake far less and the brakes do not overheat.



## 10.10 Stopping, parking



## Warning

**Risk of injury** People who act without authorization endanger themselves and others.

If a valid transponder is in range, the vehicle can be started.

- Do not leave the vehicle unattended if the engine is running.
- Never leave the vehicle unattended if the RACE-ON key or the black ignition key are close to the vehicle.
- Protect the vehicle against access by unauthorized persons.
- Lock the steering if you leave the vehicle unattended.



## Warning

**Danger of burns** Some vehicle components become very hot when the vehicle is operated.

- Do not touch any parts such as the exhaust system, radiator, engine, shock absorber, or brake system before the vehicle parts have cooled down.
- Let the vehicle parts cool down before you perform any work on the vehicle.

## Note

**Material damage** The vehicle may be damaged by incorrect procedure when parking.

Significant damage may be caused if the vehicle rolls away or falls over.

The components for parking the vehicle are designed only for the weight of the vehicle.

- Park the vehicle on a firm and level surface.
- Ensure that nobody sits on the vehicle when the vehicle is parked on a stand.

## Note

**Fire hazard** Hot vehicle components pose a fire hazard and explosion risk.

- Do not park the vehicle near to materials which are highly flammable or explosive.
- Allow the vehicle to cool down before covering it.

- 
- Apply the brakes on the motorcycle.
  - Shift the transmission into neutral.
  - Switch off ignition – to do this, briefly press the RACE-ON button  (maximum of 1 second) with the ignition switched on.



## Info

If the engine is switched off with the emergency OFF switch and the ignition remains switched on using the RACE-ON button, the power supply to most electrical power consumers remains uninterrupted. This discharges the 12-V battery. You should therefore always switch off the engine with the RACE-ON button – the emergency OFF switch is intended for emergencies only.

- 
- Park the motorcycle on a firm surface.
  - Swing side stand forward with your foot as far as it will go and lean the vehicle on it.
  - Move handlebar fully to the left and press and hold the RACE-ON button  (for at least 2 seconds).
    - ✓ The steering is locked.



## Info

If the steering lock does not engage, move the handlebar slightly.

## 10.11 Transporting

### Note

**Danger of damage** The parked vehicle can roll away or fall over.

- Park the vehicle on a firm and level surface.

### Note

**Fire hazard** Hot vehicle components pose a fire hazard and explosion risk.

- Do not park the vehicle near to materials which are highly flammable or explosive.
- Allow the vehicle to cool down before covering it.



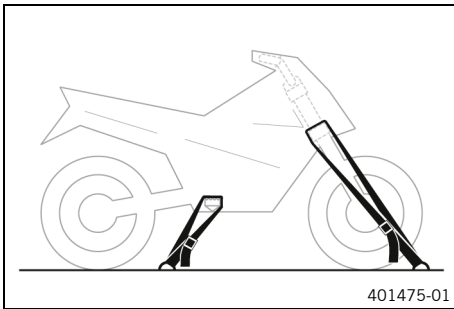

- Switch off the engine.
- Use tension belts or other suitable devices to secure the motorcycle against falling over or rolling away.

## 10.12 Towing in the event of a breakdown

### Note

**Danger of damage** Towing away using a towing vehicle is not an appropriate vehicle recovery method. Damage to the drive train or transmission may occur during towing.

- Do not use towing equipment where the wheels of the broken down vehicle remain on the road and rotate as it is towed.
- Always transport a broken down vehicle on a trailer or on the loading area of a transport vehicle.

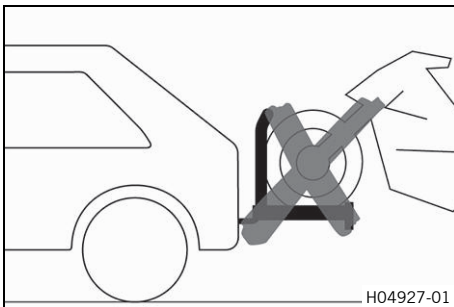

- Ensure that the broken down vehicle is properly secured on the trailer or transport vehicle.
- Observe local regulations for the recovery of broken down vehicles.

## 10.13 Refueling



### Danger

**Fire hazard** Fuel is highly flammable.

The fuel in the fuel tank expands when warm and can escape if overfilled.

- Do not fuel the vehicle in the vicinity of open flames or lit cigarettes.
- Switch off the engine for refueling.
- Make sure that no fuel is spilled; particularly not on hot parts of the vehicle.
- If any fuel is spilled, wipe it off immediately.
- Observe the specifications for refueling.



### Warning

**Danger of poisoning** Fuel is poisonous and a health hazard.

- Avoid skin, eye and clothing contact with fuel.
- Immediately consult a doctor if you swallow fuel.
- Do not inhale fuel vapors.
- In case of skin contact, rinse the affected area with plenty of water.
- Rinse the eyes thoroughly with water, and consult a doctor in case of fuel contact with the eyes.
- Change your clothing in case of fuel spills on them.

## Note

**Material damage** Inadequate fuel quality causes the fuel filter to quickly become clogged.

In some countries and regions, the available fuel quality and cleanliness may not be sufficient. This will result in problems with the fuel system.

- Refuel only with clean fuel that meets the specified standards. (Your authorized KTM workshop will be glad to help.)



## Note

**Environmental hazard** Improper handling of fuel is a danger to the environment.

- Do not allow fuel to enter the groundwater, the soil, or the sewage system.

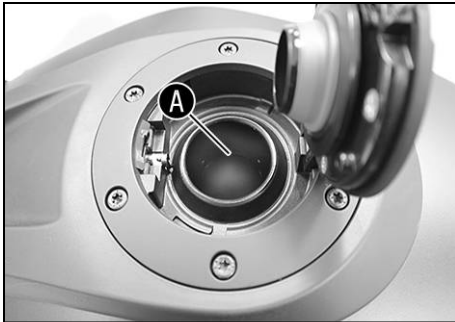

- Switch off the engine.
- Open fuel tank filler cap. (📖 p. 25)
- Fill the fuel tank with fuel up to the lower edge **A** of the filler neck.

Total fuel tank capacity, approx.	16 l (4.2 US gal)	Super unleaded (ROZ 95) (📖 p. 160)
-----------------------------------	----------------------	------------------------------------------

- Close the fuel tank filler cap. (📖 p. 26)



S03902-10

## 11.1 Additional information

Any further work that results from the compulsory work or from the recommended work must be ordered separately and invoiced separately.

Different service intervals may apply in your country, depending on the local operating conditions.

Individual service intervals and scopes may change in the course of technical developments. The most up-to-date service schedule can always be found on KTM Dealer.net. Your authorized KTM dealer will be happy to advise you.

## 11.2 Required work

	every 24 months	every 12 months	every 30,000 km (18,600 mi)	every 15,000 km (9,300 mi)	after 1,000 km (620 mi)
Read out the fault memory using the KTM diagnostics tool. 🛠️	○	●	●	●	●
Check the exhaust valve control unit with the KTM diagnostics tool. 🛠️		●	●	●	●
Program the shift shaft sensor. 🛠️	○	●	●	●	●
Check that the electrical system is functioning properly.	○	●	●	●	●
Change the engine oil and the oil filter, clean the oil screens. 🛠️ (📖 p. 135)	○	●	●	●	●
Check the front brake linings. (📖 p. 110)	○	●	●	●	●
Check the brake linings of the rear brake. (📖 p. 113)	○	●	●	●	●
Check the brake discs. (📖 p. 108)	○	●	●	●	●
Check the brake lines for damage and leakage.	○	●	●	●	●
Change the front brake fluid. 🛠️					●
Change the rear brake fluid. 🛠️					●
Change hydraulic clutch fluid. 🛠️					●
Check the front brake fluid level. (📖 p. 109)	○	●	●	●	
Check the rear brake fluid level. (📖 p. 111)	○	●	●	●	
Check/correct the fluid level of the hydraulic clutch. (📖 p. 105)		●	●	●	
Check the shock absorber and fork for leaks. Perform service as needed and depending on how the vehicle is used. 🛠️	○	●	●	●	●
Clean dust boots of the fork legs. 🛠️ (📖 p. 95)		●	●		
Check the steering head bearing play. 🛠️	○	●	●	●	●
Check tire condition. (📖 p. 117)	○	●	●	●	●
Check tire pressure. (📖 p. 118)	○	●	●	●	●
Check the chain, rear sprocket, engine sprocket, and chain guide. (📖 p. 104)		●	●	●	●
Check the chain tension. (📖 p. 102)	○	●	●	●	●
Measure the rear wheel bearing clearance.			●		
Check that the rear wheel nut (right side) is tightened to the specified torque. 🛠️	○	●	●	●	●
Check that the exhaust clamps have the prescribed tightening torque. 🛠️	○	●	●	●	●
Check the exhaust system for leaks. 🛠️	○	●	●	●	●
Change the spark plugs. 🛠️			●		
Check the valve clearance (air filter and spark plugs removed). 🛠️			●		
Change the SAS diaphragm valves. 🛠️			●		
Check the cables for damage and routing without sharp bends (fuel tank removed). 🛠️		●	●	●	●
Check the coolant level in the compensating tank. (📖 p. 131)	○	●	●	●	●

	every 24 months			
		every 12 months		
			every 30,000 km (18,600 mi)	
			every 15,000 km (9,300 mi)	
			after 1,000 km (620 mi)	
Change the air filter, clean the air filter box. 🛠️		•	•	
Check the fuel pressure. 🛠️		•	•	•
Check the headlight setting. (📖 p. 128)	○	•	•	
Check that the radiator fan is functioning properly. 🛠️	○	•	•	•
Final check: Check the vehicle is roadworthy and take a test ride. 🛠️	○	•	•	•
Read out the error memory after the test ride using the KTM diagnostics tool. 🛠️	○	•	•	•
Reset the service display using the KTM diagnostic tool. 🛠️	○	•	•	•
Make a service entry in <b>KTM Dealer.net</b> . 🛠️	○	•	•	•

- One-time interval
- Periodic interval

## 11.3 Recommended work

			every 48 months	
			every 12 months	
			every 30,000 km (18,600 mi)	
			every 15,000 km (9,300 mi)	
			after 1,000 km (620 mi)	
Check the frame. 🛠️			•	
Check the fork bearing. 🛠️			•	
Check/clean the oil nozzle for clutch lubrication. 🛠️	○	•	•	
Check the fork bearing. 🛠️			•	•
Check the wheel bearings. 🛠️			•	•
Check the shock absorber linkage for play. 🛠️			•	•
Grease all moving parts (e.g., side stand, hand lever, chain, ...) and check for smooth operation. 🛠️	○	•	•	•
Empty the drainage hoses. 🛠️	○	•	•	•
Check all hoses (e.g. fuel, cooling, bleeder, drainage, etc.) and sleeves for cracking, leaks, and incorrect routing. 🛠️			•	•
Check the antifreeze. 🛠️	○	•	•	•
Check the tightness of the safety-relevant screws and nuts which are easily accessible. 🛠️	○	•	•	•
Change the coolant. 🛠️				•

- One-time interval
- Periodic interval

## 12.1 Fork/shock absorber

Semi-active suspension **WP Semi-active Suspension** can be used to tune the suspension individually without the use of tools.

Electronic suspension setting **WP Semi-active Suspension** constantly regulates the damping behavior of the suspension taking into account various sensor data.

As a result, the electronic damping valves are matched to the current driving situation and terrain characteristics as well as the settings made by the rider in the **Preload Adjuster** and **Suspension Mode** menus.

Always adapt the suspension to your riding style and the payload.

In the **Preload Adjuster** menu, the suspension can be set to the loading condition.

In the **Suspension Mode** menu, the damping behavior of the suspension can be set.

## 12.2 Preload adjuster

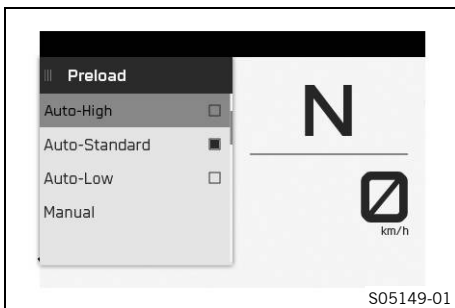

### Possible states

- 0 % - 20 % – Setting for rides without luggage and a passenger and a rider's weight up to 75 kg.
- 30% – Setting for rides without luggage and a passenger and a rider's weight up to 85 kg.
- 40% – Setting for rides without luggage and a passenger and a rider's weight up to 95 kg.
- 50 % - 60 % – Setting for rides with luggage, but without a passenger.
- 70 % - 80 % – Setting for rides with a passenger, but without luggage.
- 90 % - 100 % – Setting for rides with a passenger and luggage.
- Low (optional) – Automatic adjustment of the spring preload for a lot of sag on the rear wheel and therefore a low seat height and low riding geometry.
- Standard (optional) – Automatic adjustment of the spring preload, standard sag on the rear wheel and standard riding geometry.
- High (optional) – Automatic adjustment of the spring preload for a little sag on the rear wheel and therefore a slightly higher seat height and sportier riding geometry.

### **i** Info

Only make adjustments on the preload adjuster if the rear wheel is loaded and the motorcycle is not jacked up on the center stand.

The spring preload can be adjusted to the load in the **Preload Adjuster** menu. 11 manual settings (0 % to 100 %) and 3 automatic settings **Low** (optional), **Standard** (optional) and **High** (optional) are available.

The rebound setting is automatically adapted to the load detected by the system.

## **i** Info

Due to high electricity consumption, it is recommended that the preload adjuster is only set when the engine is running.

The manual settings given are guidelines and depend on the load.

High loads require a higher spring preload.

Low loads require a lower spring preload.

In automatic settings **Low** (optional), **Standard** (optional) and **High** (optional) the spring preload is automatically adjusted to the load detected by the system during the journey.

In the **Low** (optional), **Standard** (optional) and **High** (optional) automatic settings, it is possible that no adjustment of the spring preload can be detected when stationary.

The most recently selected rebound adjustment is shown on the display.

## **i** Info

The symbol of the last setting flashes until the new setting is adopted.

## 12.3 Suspension Mode

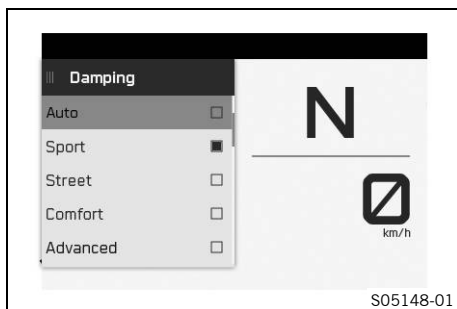

### Possible states

- **Auto** – Tuning of the suspension components is automatically adjusted to the riding style of the rider
- **Sport** – Tight tuning of the suspension components with very direct feedback from the chassis
- **Street** – Normal tuning of the suspension components with direct feedback from the chassis
- **Comfort** – Soft tuning of the suspension components with good feedback from the chassis
- **Track** – Tuning the suspension components for use on the race course
- **Advanced** (optional) – The tuning of the suspension components can be individually configured in the **Fork** menu or **Shock**.

Various settings for the damping of the suspension components can be selected in the **Suspension Mode** menu. The settings **Sport**, **Street**, **Comfort**, **Auto** (optional), **Track** (optional) and **Advanced** (optional) are available.

## 13.1 Lifting the motorcycle with the rear lifting gear

### Note

**Danger of damage** The parked vehicle can roll away or fall over.

- Park the vehicle on a firm and level surface.

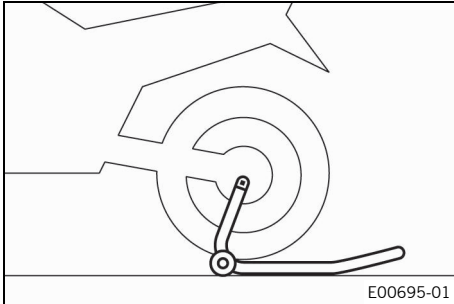

- Place the adapter into the rear lifting gear.

Rear wheel work stand for single-sided swing arm  
(61329955000)

- Position the motorcycle upright, place the lifting gear in the axle, and raise the motorcycle.



## 13.2 Removing the rear of motorcycle from the lifting gear

### Note

**Danger of damage** The parked vehicle can roll away or fall over.

- Park the vehicle on a firm and level surface.

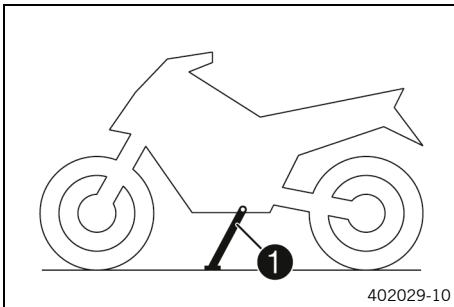

- Secure the motorcycle against falling over.
- Remove the rear wheel stand and lean the vehicle on side stand ①.



## 13.3 Lifting the motorcycle with the front lifting gear

### Note

**Danger of damage** The parked vehicle can roll away or fall over.

- Park the vehicle on a firm and level surface.

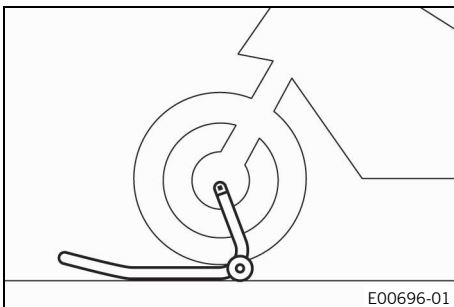

### Preparatory work

- Lift the motorcycle with the rear lifting gear. (📖 p. 93)

### Main work

- Move the handlebar to the straight-ahead position. Align the front lifting gear with the fork legs.

Front wheel work stand, small (61129965000)

### Info

Always raise the motorcycle at the rear first.

- Lift the motorcycle at the front.



## 13.4 Taking the motorcycle off the front lifting gear

### Note

**Danger of damage** The parked vehicle can roll away or fall over.

- Park the vehicle on a firm and level surface.

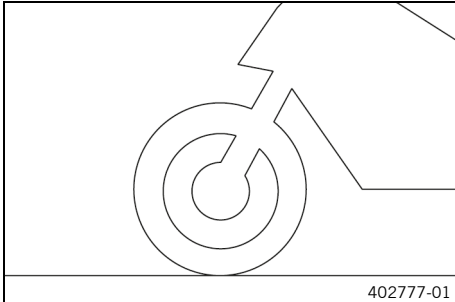

- Secure the motorcycle against falling over.
- Remove the front lifting gear.

## 13.5 Raising the motorcycle with the work stand (inserted) ↴

### Note

**Danger of damage** The parked vehicle can roll away or fall over.

- Park the vehicle on a firm and level surface.



- Remove the plastic caps on both sides.
- The plastic bushing of the work stand should engage in the opening of the swingarm pivot. Select the right height and width of the work stand.

Work stand (62529055200)

- Raise the motorcycle.

### **i** Info

Check that the work stand is properly seated.



## 13.6 Removing the motorcycle from the work stand (inserted) ↩

### Note

**Danger of damage** The parked vehicle can roll away or fall over.

- Park the vehicle on a firm and level surface.



- Remove the motorcycle from the work stand and rest it on the side stand.
- Remove the work stand.

Work stand (62529055200)

- Insert the plastic caps on both sides.



## 13.7 Cleaning the dust boots of the fork legs ↩

### Preparatory work

- Lift the motorcycle with the rear lifting gear. (📖 p. 93)
- Lift the motorcycle with the front lifting gear. (📖 p. 93)

### Main work

- Push dust boots ❶ of both fork legs downward.



### Info

The dust boots remove dust and coarse dirt particles from the inside fork tubes. Over time, dirt can accumulate behind the dust boots. If this dirt is not removed, the oil seals behind can start to leak.



### Warning

**Danger of accidents** Oil or grease on the brake discs reduces the braking effect.

- Always keep the brake discs free of oil and grease.
- Clean the brake discs with brake cleaner when necessary.

- Clean and oil the dust boots and inner fork tubes of both fork legs.

Universal oil spray (📖 p. 161)

- Press dust boots back into the installation position.
- Remove excess oil.

### Finishing work

- Take the motorcycle off the front lifting gear. (📖 p. 94)
- Remove the rear of the motorcycle from the lifting gear. (📖 p. 93)

## 13.8 Removing the passenger seat

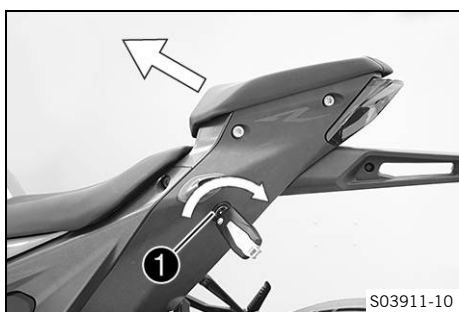

- Insert the RACE-ON key or the black ignition key into seat lock ❶ and turn clockwise.
- Lift passenger seat at the front and pull it out of the bracket toward the front.
- Remove the passenger seat.
- Remove the ignition key.

## 13.9 Mounting the passenger seat

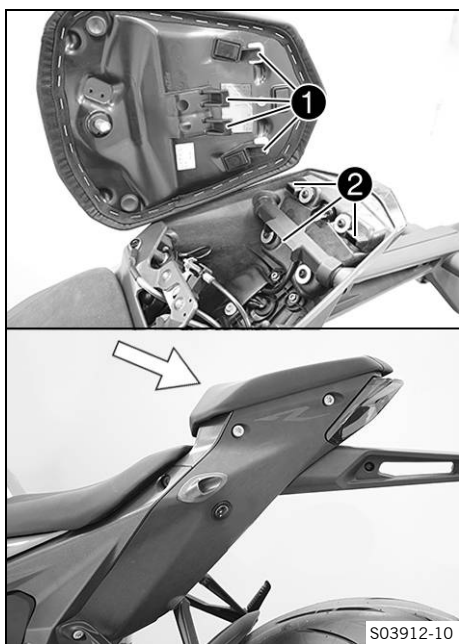

- Hook recesses ❶ of the passenger seat in guides ❷ and lower the front seat while pushing it back.
- Position the locking pin in the lock housing and push the passenger seat down at the front.
  - ✓ The locking pin engages with an audible click.
- Check that the passenger seat is mounted correctly.

## 13.10 Removing the front rider's seat

### Preparatory work

- Remove the passenger seat. (📖 p. 96)

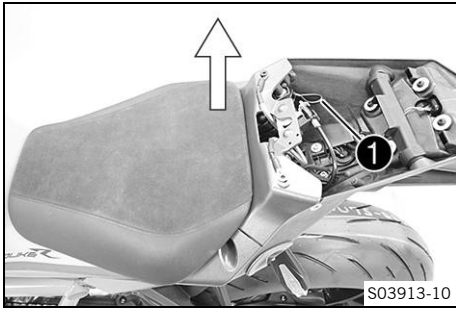

### Main work

- Unlock the front rider's seat with loop ❶ underneath the passenger seat.
- Raise the front rider's seat at the rear and remove it.



## 13.11 Mounting the front rider's seat

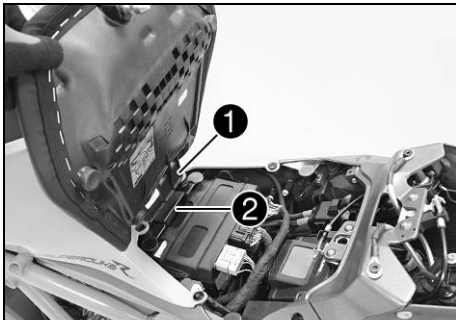

### Main work

- Hook recess ❶ of the front rider's seat into guide ❷, lower it at the rear and push it forward.
- Position the locking pin in the lock housing and push the passenger seat down at the front.
- ✓ The locking pin engages with an audible click.
- Check that the front rider's seat is mounted correctly.

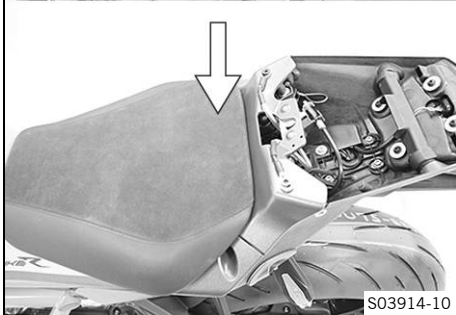

### Finishing work

- Mount the passenger seat. (📖 p. 96)



## 13.12 Removing left fuel tank spoiler

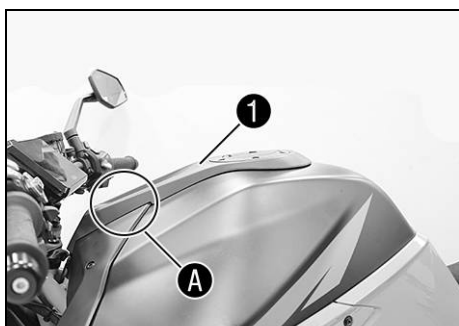

- Raise fuel tank cover **1** in area **A** and remove in the upward direction.

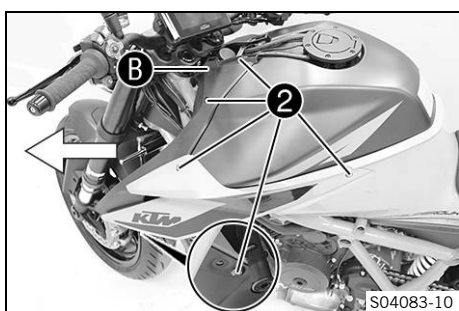

- Remove screws **2**.
- Raise the fuel tank spoiler in area **B** and remove it toward the front.

## 13.13 Installing the left fuel tank spoiler

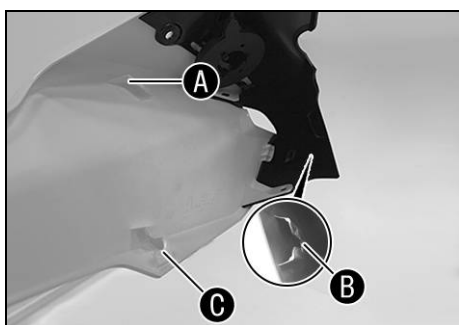

- Position the fuel tank spoiler on holding lugs **A**, **B** and **C** and slide from front to rear.

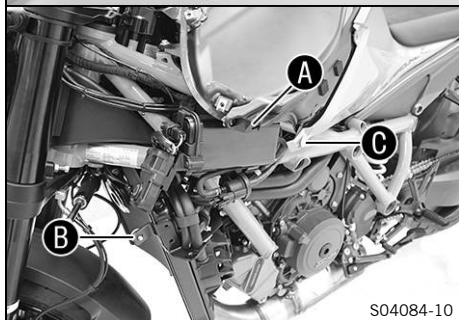

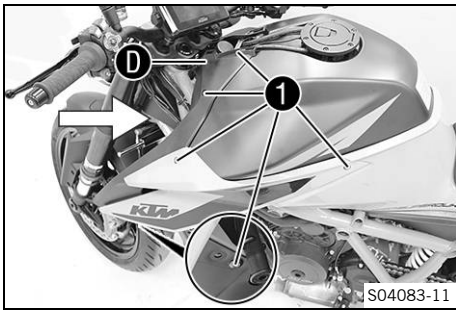

- Press the fuel tank spoiler in the rubber bushing in area **D**.
- Mount and tighten screws **1**.

Guideline

Screw, trim	M5	3.5 Nm (2.58 lbf ft)
-------------	----	-------------------------

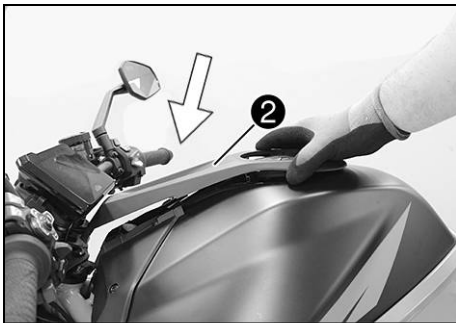

- Position fuel tank cover **2** on the fuel tank cap and press it in from the rear to the front.



## 13.14 Removing the main silencer



### Warning

**Danger of burns** The exhaust system gets very hot when the vehicle is driven.

- Allow the exhaust system to cool down before performing any work on the vehicle.

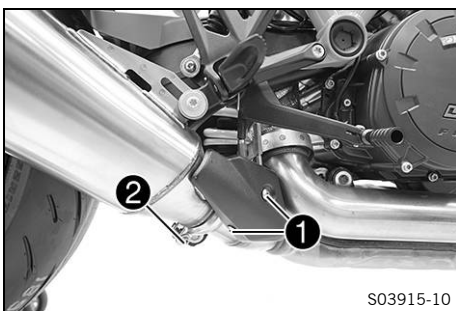

- Remove screws **1** and take off the cover.
- Remove screw **2** and take off exhaust clamp.

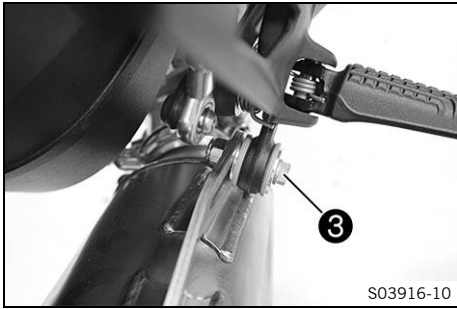

- Remove screw ③ with the washer.



### Warning

**Risk of injury** Moving parts of the exhaust valve constitute a risk of injury.

- Do not touch the exhaust valve if the main silencer has been removed.
- Make sure that nobody gets caught when the exhaust valve is actuated.

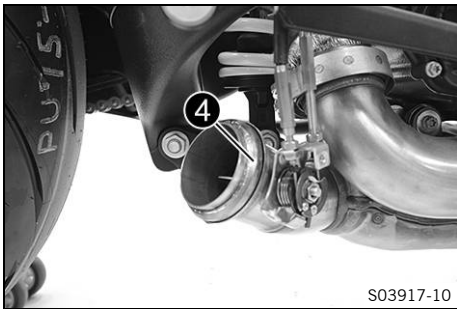

- Take off the main silencer.
- Remove seal ring ④.

## 13.15 Installing the main silencer

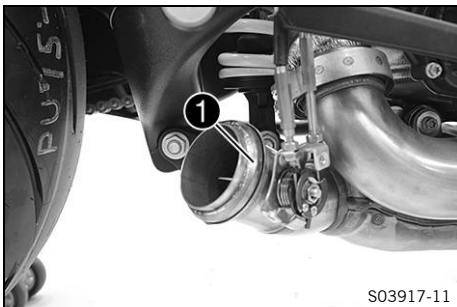

### Warning

**Risk of injury** Moving parts of the exhaust valve constitute a risk of injury.

- Do not touch the exhaust valve if the main silencer has been removed.
- Make sure that nobody gets caught when the exhaust valve is actuated.

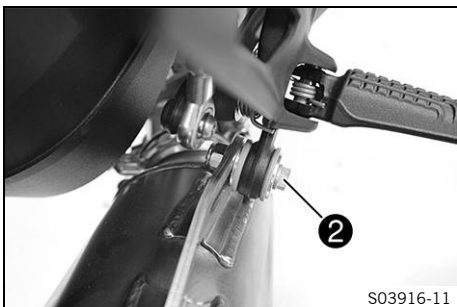

- Mount seal ring ①.
- Position the main silencer.
- Mount screw ② with the washer, but do not tighten yet.

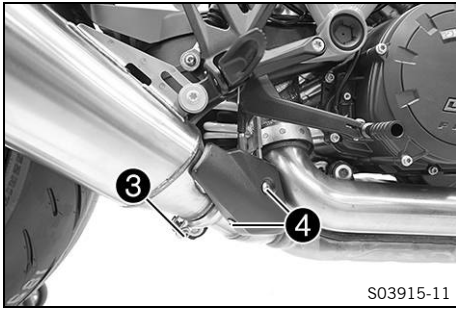

- Position the exhaust clamp.
- Mount and tighten screw ③.

Guideline

Screw, exhaust clamp on main silencer	M6	10 Nm (7.4 lbf ft)
---------------------------------------	----	--------------------

- Tighten screw ②.

Guideline

Remaining screws, chassis	M8	25 Nm (18.4 lbf ft)
---------------------------	----	---------------------

- Position the cover.
- Tighten screws ④.

Guideline

Screw, heat protector on main silencer	M5	4 Nm (3 lbf ft)
----------------------------------------	----	-----------------

## 13.16 Checking the chain for dirt

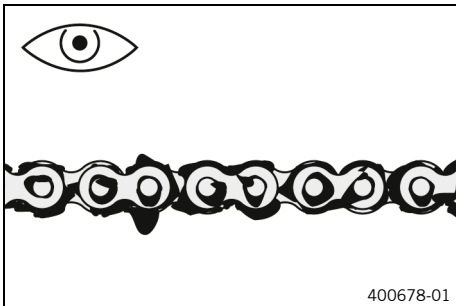

- Check the chain for coarse dirt accumulation.
  - » If the chain is very dirty:
    - Clean the chain. (📖 p. 101)

## 13.17 Cleaning the chain



### Warning

**Danger of accidents** Lubricants on the tires reduces the road grip.

- Remove lubricants from the tires using a suitable cleaning agent.



### Warning

**Danger of accidents** Oil or grease on the brake discs reduces the braking effect.

- Always keep the brake discs free of oil and grease.
- Clean the brake discs with brake cleaner when necessary.



### Note

**Environmental hazard** Hazardous substances cause environmental damage.

- Dispose of oils, grease, filters, fuel, cleaning agents, brake fluid, etc., correctly and in compliance with the applicable regulations.



### Info

The service life of the chain depends largely on its maintenance. Regular cleaning increases the service life of the chain.

## Preparatory work

- Lift the motorcycle with the rear lifting gear. (📖 p. 93)

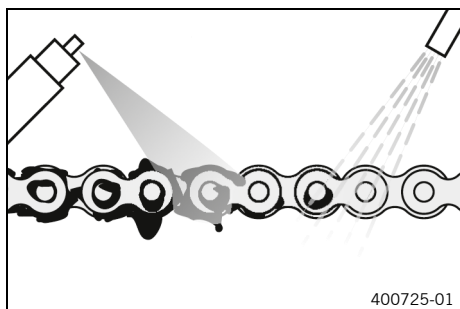

## Main work

- Rinse off loose dirt with a soft jet of water.
- Remove old grease residue with chain cleaner.

Chain cleaner (📖 p. 161)

- After drying, apply chain spray.

Street chain spray (📖 p. 161)

## Finishing work

- Remove the rear of the motorcycle from the lifting gear. (📖 p. 93)

## 13.18 Checking the chain tension



### Warning

**Danger of accidents** Incorrect chain tension damages components and results in accidents.

If the chain is tensioned too much, the chain, engine sprocket, rear sprocket, transmission and rear wheel bearings wear more quickly. Some components may break if overloaded.

If the chain is too loose, the chain may fall off the engine sprocket or the rear sprocket. As a result, the rear wheel locks or the engine will be damaged.

- Check the chain tension regularly.
- Set the chain tension in accordance with the specification.

## Preparatory work

- Lift the motorcycle with the rear lifting gear. (📖 p. 93)

## Main work

- Shift the transmission into neutral.
- At the chain sliding guard in the area of markings **A** and **B**, push the chain upward and determine the chain tension.

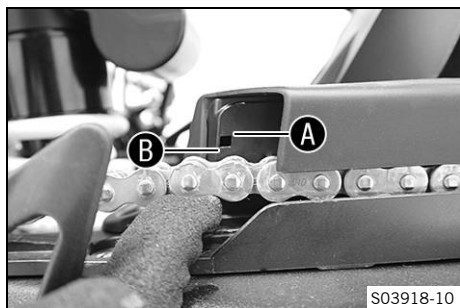

### Info

The lower chain section must be taut. Chain wear is not always even, so you should repeat this measurement at different chain positions.

The upper edge of the chain is located between markings **A** and **B**.

- » If the chain tension does not meet the specification:
  - Adjust the chain tension. (📖 p. 103)



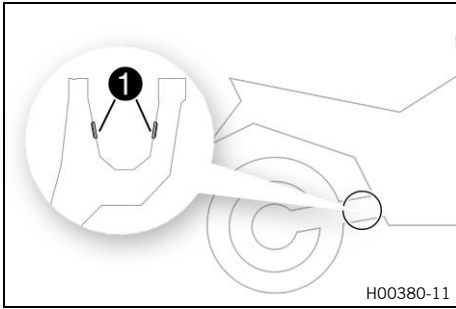

- Check protection caps ❶ for damage and tightness.
  - » If the protection caps are damaged or loose:
    - Replace the protection caps.

Link fork protection cap (61304041100)
----------------------------------------

### Finishing work

- Remove the rear of the motorcycle from the lifting gear. (📖 p. 93)

## 13.19 Adjusting the chain tension



### Warning

**Danger of accidents** Incorrect chain tension damages components and results in accidents.

If the chain is tensioned too much, the chain, engine sprocket, rear sprocket, transmission and rear wheel bearings wear more quickly. Some components may break if overloaded.

If the chain is too loose, the chain may fall off the engine sprocket or the rear sprocket. As a result, the rear wheel locks or the engine will be damaged.

- Check the chain tension regularly.
- Set the chain tension in accordance with the specification.

### Preparatory work

- Lift the motorcycle with the rear lifting gear. (📖 p. 93)
- Check the chain tension. (📖 p. 102)

### Main work

- Loosen screw ❶.
- Set the chain tension by turning the hub housing.

Holding wrench (61329085000)
------------------------------

Handle for holding wrench (60012060000)
-----------------------------------------



### Info

Turn clockwise to increase the chain tension; turn counterclockwise to reduce the chain tension. The tool required is in the tool set.

- Check the chain tension. (📖 p. 102)
- ✓ The chain tension matches the specified value.



### Info

Chain wear is not always even, so you should repeat this measurement at different chain positions.

- Tighten screw ❶.

### Guideline

Screw, eccentric	M16	70 Nm (51.6 lbf ft)
------------------	-----	---------------------

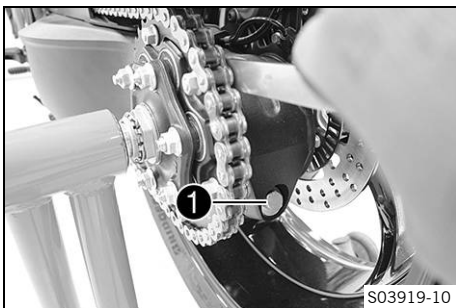

- Remove the rear of the motorcycle from the lifting gear. (📖 p. 93)

## 13.20 Checking the chain, rear sprocket, engine sprocket, and chain guide

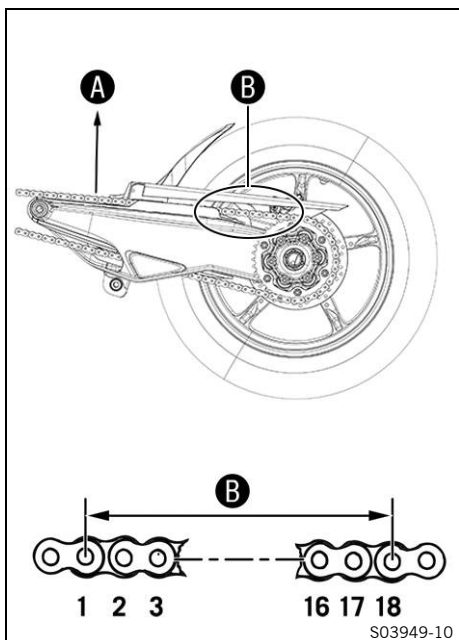
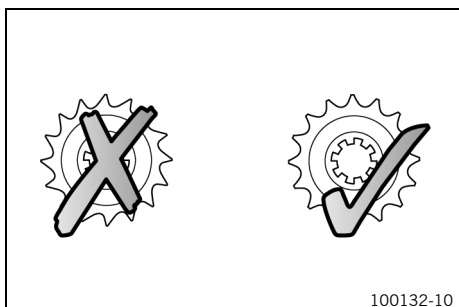

### Preparatory work

- Lift the motorcycle with the rear lifting gear. (📖 p. 93)

### Main work

- Check the chain, rear sprocket, and engine sprocket for wear.
  - » If the chain, rear sprocket or motor sprocket is worn:
    - Change the drivetrain kit. 🛠️

**i Info**  
The engine sprocket, the rear sprocket, and the chain should always be replaced together.

- Shift the transmission into neutral.
- Pull on the top section of the chain with the specified weight **A**.

### Guideline

Weight, chain wear measurement	15 kg (33 lb.)
--------------------------------	----------------

- Measure distance **B** of 18 chain rollers in the upper chain section.

**i Info**  
Chain wear is not always even, so you should repeat this measurement at different chain positions.

Maximum distance <b>B</b> from 18 chain rollers at the longest chain section	272 mm (10.71 in)
------------------------------------------------------------------------------	-------------------

- » If distance **B** is greater than the specified measurement:
  - Change the drivetrain kit. 🛠️

**i Info**  
When a new chain is mounted, the rear sprocket and the engine sprocket should also be changed.  
New chains wear out faster on an old, worn rear sprocket or engine sprocket.  
For safety reasons, the chain has no chain joint.



- Check the chain sliding guard for wear.
  - » If the chain sliding guard shows a lot of wear:
    - Change the chain sliding guard. 🛠️
- Check that the chain sliding guard is firmly seated.
  - » If the chain sliding guard is loose:
    - Tighten screws on the chain sliding guard.

Guideline

Screw, chain sliding guard	M5	5 Nm (3.7 lbf ft)
----------------------------	----	-------------------

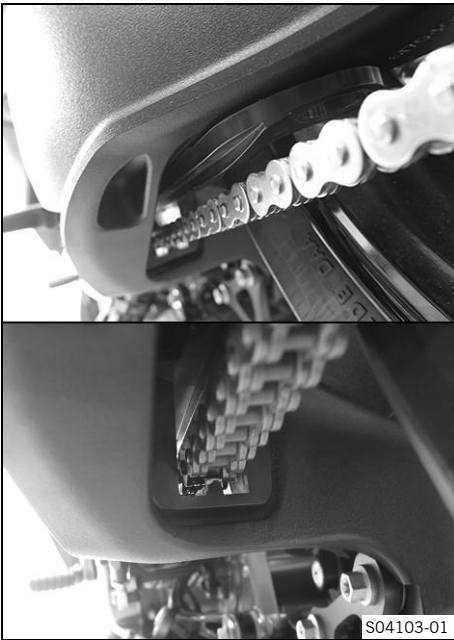

- Check the chain sliding piece for wear.
  - » If the lower edge of the chain is in line with or below the chain sliding piece:
    - Change the chain sliding piece. 🛠️
- Check that the chain sliding piece is firmly seated.
  - » If the chain sliding piece is loose:
    - Tighten screw on the chain sliding piece.

Guideline

Remaining screws, chassis	M8	25 Nm (18.4 lbf ft)
---------------------------	----	---------------------

### Finishing work

- Remove the rear of the motorcycle from the lifting gear. (📖 p. 93)

## 13.21 Checking/correcting the fluid level of the hydraulic clutch



### Warning

**Skin irritation** Brake fluid causes skin irritation.

- Keep brake fluid out of the reach of children.
- Wear suitable protective clothing and safety glasses.
- Do not allow brake fluid to come into contact with the skin, the eyes or clothing.
- Consult a doctor immediately if brake fluid has been swallowed.
- Rinse the affected area with plenty of water in the event of contact with the skin.
- Rinse eyes thoroughly with water immediately and consult a doctor if brake fluid comes into contact with the eyes.
- If brake fluid spills on to your clothing, change the clothing.



## Note

**Environmental hazard** Hazardous substances cause environmental damage.

- Dispose of oils, grease, filters, fuel, cleaning agents, brake fluid, etc., correctly and in compliance with the applicable regulations.



## Info

The fluid level rises with increasing wear of the clutch facing discs.

Never use DOT 5 brake fluid. It is silicone-based and purple in color. Oil seals and clutch lines are not designed for DOT 5 brake fluid.

Avoid contact between brake fluid and painted parts. Brake fluid attacks paint.

Only use clean brake fluid from a sealed container.

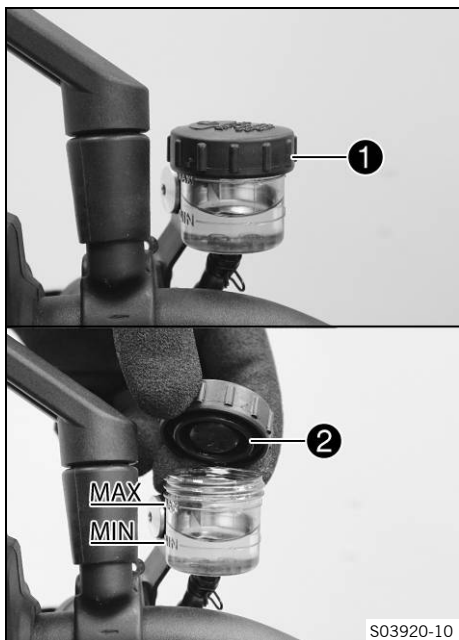

- Move the clutch fluid reservoir mounted on the handlebar to a horizontal position.
- Check the fluid level.

The fluid level must be between **MIN** and **MAX** markings.

» If the fluid level does not meet specifications:

- Remove screw cap **1** with membrane **2** and the shim.
- Correct the fluid level of the hydraulic clutch.

Brake fluid DOT 4 / DOT 5.1 (📖 p. 159)

- Mount and tighten screw cap **1** with membrane **2** and the shim.



## Info

Clean up overflowed or spilled brake fluid immediately with water.

## 14.1 Anti-lock braking system (ABS)

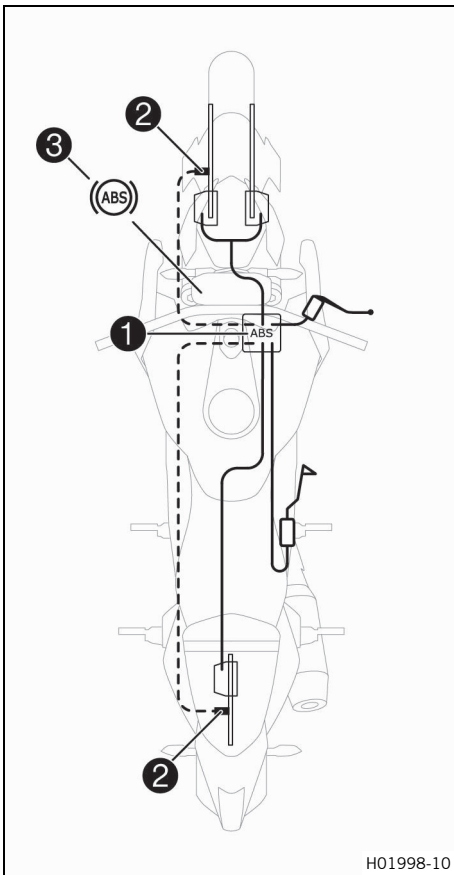

The ABS module ①, which consists of a hydraulic unit, ABS control unit, and return pump, is installed on the right side of the vehicle below the fuel tank. One wheel speed sensor ② is located in each case on the front and the rear wheel.



### Warning

**Danger of accidents** Changes to the vehicle impair the function of the ABS.

- Do not make any changes to the suspension travel.
- Only use spare parts on the brake system which have been approved and recommended by KTM.
- Only use tires/wheels approved by KTM with the corresponding speed index.
- Maintain the specified tire pressure.
- Ensure that service work and repairs are performed professionally. (Your authorized KTM workshop will be glad to help.)

The ABS is a safety system that, within physical limitations, can prevent locking and slipping of the wheels during braking.



### Warning

**Danger of accidents** Driving aids can reduce the probability of a fall only within physical limits.

It is not always possible to compensate for extreme riding situations, for example with luggage loaded with a high center of gravity, varying road surfaces, steep descents or full braking without disengaging the gear.

- Adapt your riding style to the road conditions and your driving ability.

ABS has two operating modes, the **Road** ABS mode and ABS mode **Supermoto**.

In **Road** ABS mode, the ABS controls both wheels.

In ABS mode **Supermoto**, the ABS only controls the front wheel. There is no ABS control on the rear wheel. The

ABS warning lamp ③ flashes slowly to remind you that the **Supermoto** ABS mode is enabled.



### Info

In the **Supermoto** ABS mode, the rear wheel may lock and there is a risk of falling.

The ABS operates with two independent brake circuits (front and rear brakes). When the ABS control unit detects a locking tendency in a wheel, ABS begins regulating the brake pressure. The control function causes a slight pulsing of the hand and foot brake levers.

The ABS warning lamp ③ must light up after the ignition is switched on and go out after starting off. If it does not go out after starting off or if it lights up while riding, this indicates a

malfunction in the ABS. In this case, the ABS is no longer enabled and the wheels may lock during braking. The brake system itself stays functional; only ABS control is not available.

The ABS warning lamp may also light up if the rotating speeds of the front and rear wheels differ greatly under extreme riding conditions, for example when making "wheelies" or if the rear wheel spins. This causes the ABS to switch off.

To reactivate the ABS, stop the vehicle and switch off the ignition. The ABS is reactivated when the vehicle is switched on again. The ABS warning lamp goes out after starting off.

### MSC

The **MSC** is a supplementary function for the ABS that can prevent blocking and slipping of the wheels during braking when the vehicle is inclined (riding in curves) within the physical limitations. Due to the inertial measurement unit, the ABS control is dependent on the angle of inclination and pitch.



### Info

The **MSC** is only active in **Road** ABS mode.

## 14.2 Checking the brake discs



### Warning

**Danger of accidents** Worn-out brake discs reduce the braking effect.

- Make sure that worn-out brake discs are replaced immediately. (Your authorized KTM workshop will be glad to help.)

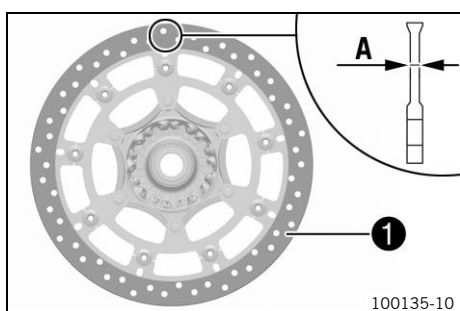

- Check the front and rear brake disc thickness at multiple points for the dimension **A**.



### Info

Wear will reduce the thickness of the brake disc at contact surface **1** of the brake linings.

Brake discs - wear limit	
front	4.5 mm (0.177 in)
rear	4.5 mm (0.177 in)

- » If the brake disc thickness is less than the specified value:
  - Change the front brake discs. 🛠️
  - Change the rear brake disc. 🛠️
- Check the front and rear brake discs for damage, cracking, and deformation.
  - » If the brake disc exhibits damage, cracking, or deformation:
    - Change the front brake discs. 🛠️
    - Change the rear brake disc. 🛠️

### 14.3 Checking the front brake fluid level



#### Warning

**Danger of accidents** An insufficient brake fluid level will cause the brake system to fail.

If the brake fluid level drops below the **MIN** marking, the brake system is leaking or the brake linings are worn down.

- Check the brake system and do not continue riding until the problem is eliminated. (Your authorized KTM workshop will be glad to help.)



#### Warning

**Danger of accidents** Old brake fluid reduces the braking effect.

- Make sure that brake fluid for the front and rear brake is changed in accordance with the service schedule. (Your authorized KTM workshop will be glad to help.)

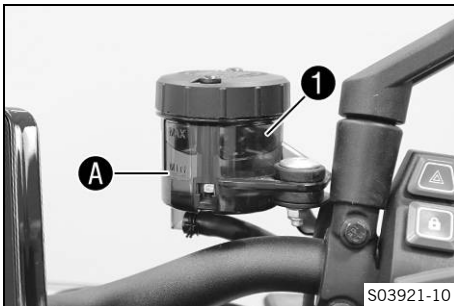

- Move the brake reservoir mounted on the handlebar to a horizontal position.
- Check the brake fluid level in brake fluid reservoir **1**.
  - » If the brake fluid level has dropped below **MIN** marking **A**:
    - Add front brake fluid. 📖 (p. 109)

### 14.4 Adding front brake fluid 📖



#### Warning

**Danger of accidents** An insufficient brake fluid level will cause the brake system to fail.

If the brake fluid level drops below the **MIN** marking, the brake system is leaking or the brake linings are worn down.

- Check the brake system and do not continue riding until the problem is eliminated. (Your authorized KTM workshop will be glad to help.)



#### Warning

**Skin irritation** Brake fluid causes skin irritation.

- Keep brake fluid out of the reach of children.
- Wear suitable protective clothing and safety glasses.
- Do not allow brake fluid to come into contact with the skin, the eyes or clothing.
- Consult a doctor immediately if brake fluid has been swallowed.
- Rinse the affected area with plenty of water in the event of contact with the skin.
- Rinse eyes thoroughly with water immediately and consult a doctor if brake fluid comes into contact with the eyes.
- If brake fluid spills on to your clothing, change the clothing.



#### Warning

**Danger of accidents** Old brake fluid reduces the braking effect.

- Make sure that brake fluid for the front and rear brake is changed in accordance with the service schedule. (Your authorized KTM workshop will be glad to help.)



## Note

**Environmental hazard** Hazardous substances cause environmental damage.

- Dispose of oils, grease, filters, fuel, cleaning agents, brake fluid, etc., correctly and in compliance with the applicable regulations.



## Info

Never use DOT 5 brake fluid. It is silicone-based and purple in color. Oil seals and brake lines are not designed for DOT 5 brake fluid.

Avoid contact between brake fluid and painted parts. Brake fluid attacks paint.

Only use clean brake fluid from a sealed container.

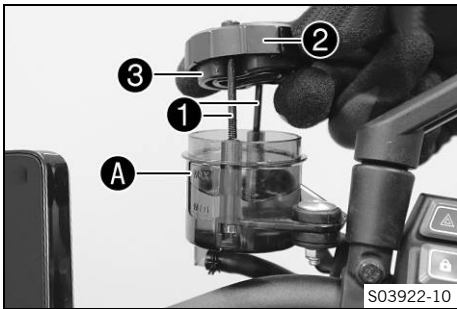

## Preparatory work

- Check the front brake linings. (📖 p. 110)

## Main work

- Move the brake reservoir mounted on the handlebar to a horizontal position.
- Remove screws ①.
- Take off cover ② with membrane ③.
- Add brake fluid up to **MAX** marking A.

Brake fluid DOT 4 / DOT 5.1 (📖 p. 159)

- Position cover ② with membrane ③.
- Mount and tighten screws ①.



## Info

Clean up overflowed or spilled brake fluid immediately with water.

## 14.5 Checking the front brake linings



### Warning

**Danger of accidents** Worn-out brake linings reduce the braking effect.

- Ensure that worn-out brake linings are replaced immediately. (Your authorized KTM workshop will be glad to help.)



### Warning

**Danger of accidents** Damaged brake discs reduce the braking effect.

If the brake linings are not changed in time, the brake lining carriers grind against the brake disc. As a consequence, the braking effect is greatly reduced and the brake discs are destroyed.

- Check the brake linings regularly.



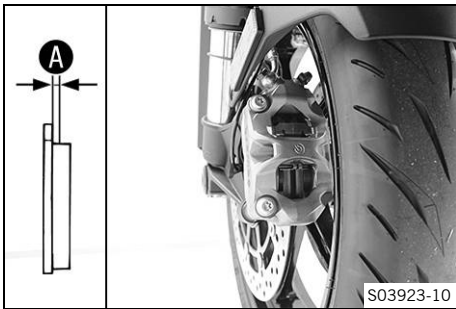

- Check all brake linings on both brake calipers to ensure they have the minimum thickness **A**.

Minimum thickness <b>A</b>	$\geq 1 \text{ mm } (\geq 0.04 \text{ in})$
----------------------------	---------------------------------------------

- » If the minimum thickness is less than specified:
  - Change the front brake linings. 🛠️
- Check all brake linings on both brake calipers for damage and cracking.
  - » If there is damage or cracking:
    - Change the front brake linings. 🛠️



## 14.6 Checking the rear brake fluid level



### Warning

**Danger of accidents** An insufficient brake fluid level will cause the brake system to fail.

If the brake fluid level drops below the **MIN** marking, the brake system is leaking or the brake linings are worn down.

- Check the brake system and do not continue riding until the problem is eliminated. (Your authorized KTM workshop will be glad to help.)



### Warning

**Danger of accidents** Old brake fluid reduces the braking effect.

- Make sure that brake fluid for the front and rear brake is changed in accordance with the service schedule. (Your authorized KTM workshop will be glad to help.)

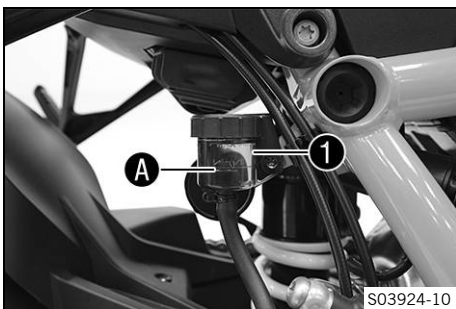

- Stand the vehicle upright.
- Check the brake fluid level in brake fluid reservoir **1**.
  - » If the fluid level reaches the **MIN** marking **A**:
    - Add rear brake fluid. 🛠️ (📖 p. 111)



## 14.7 Adding rear brake fluid 🛠️



### Warning

**Danger of accidents** An insufficient brake fluid level will cause the brake system to fail.

If the brake fluid level drops below the **MIN** marking, the brake system is leaking or the brake linings are worn down.

- Check the brake system and do not continue riding until the problem is eliminated. (Your authorized KTM workshop will be glad to help.)



## Warning

**Skin irritation** Brake fluid causes skin irritation.

- Keep brake fluid out of the reach of children.
- Wear suitable protective clothing and safety glasses.
- Do not allow brake fluid to come into contact with the skin, the eyes or clothing.
- Consult a doctor immediately if brake fluid has been swallowed.
- Rinse the affected area with plenty of water in the event of contact with the skin.
- Rinse eyes thoroughly with water immediately and consult a doctor if brake fluid comes into contact with the eyes.
- If brake fluid spills on to your clothing, change the clothing.



## Warning

**Danger of accidents** Old brake fluid reduces the braking effect.

- Make sure that brake fluid for the front and rear brake is changed in accordance with the service schedule. (Your authorized KTM workshop will be glad to help.)



## Note

**Environmental hazard** Hazardous substances cause environmental damage.

- Dispose of oils, grease, filters, fuel, cleaning agents, brake fluid, etc., correctly and in compliance with the applicable regulations.



## Info

Never use DOT 5 brake fluid. It is silicone-based and purple in color. Oil seals and brake lines are not designed for DOT 5 brake fluid.

Avoid contact between brake fluid and painted parts. Brake fluid attacks paint.

Only use clean brake fluid from a sealed container.

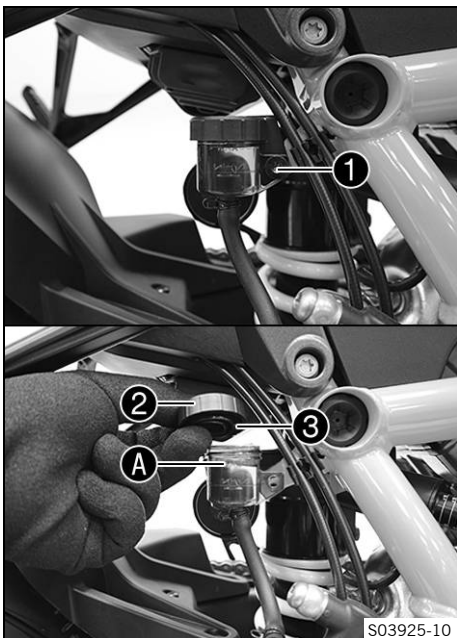

## Preparatory work

- Check the brake linings of the rear brake. (🗨 p. 113)

## Main work

- Position the vehicle upright.
- Remove screw **1** with the screw cap lock.



## Info

Make sure that the reservoir stays vertical and no brake fluid runs out.

- Remove screw cap **2** with the washer and membrane **3**.
- Add brake fluid up to the **MAX** marking **A**.

Brake fluid DOT 4 / DOT 5.1 (🗨 p. 159)

- Mount and tighten screw cap **2** with the shim and membrane **3**.
- Position the screw cap lock and mount and tighten screw **1**.

## Guideline

Screw, brake fluid reservoir, rear brake	M5	3.5 Nm (2.58 lbf ft) <b>Loctite®243™</b>
------------------------------------------	----	---------------------------------------------

**Info**

Use water to immediately clean up any brake fluid that has overflowed or spilled.

**14.8 Checking the brake linings of the rear brake****Warning**

**Danger of accidents** Worn-out brake linings reduce the braking effect.

- Ensure that worn-out brake linings are replaced immediately. (Your authorized KTM workshop will be glad to help.)

**Warning**

**Danger of accidents** Damaged brake discs reduce the braking effect.

If the brake linings are not changed in time, the brake lining carriers grind against the brake disc. As a consequence, the braking effect is greatly reduced and the brake discs are destroyed.

- Check the brake linings regularly.

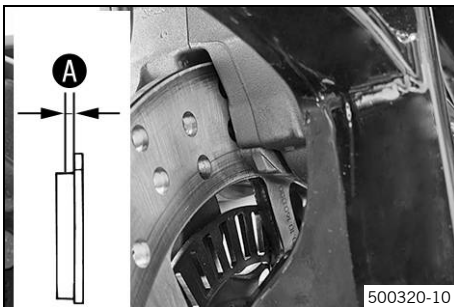

- Check the brake linings for minimum thickness **A**.

Minimum thickness <b>A</b>	$\geq 1 \text{ mm } (\geq 0.04 \text{ in})$
----------------------------	---------------------------------------------

- » If the minimum thickness is less than specified:
  - Change the rear brake linings. 🛠️
- Check the brake linings for damage and cracking.
  - » If there is damage or cracking:
    - Change the rear brake linings. 🛠️

## 15.1 Removing the front wheel

### Preparatory work

- Lift the motorcycle with the rear lifting gear. (📖 p. 93)
- Lift the motorcycle with the front lifting gear. (📖 p. 93)

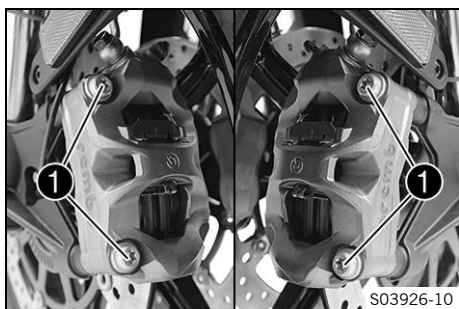

### Main work

- Remove screws ① from both brake calipers.
- Press back brake linings by slightly tilting the brake calipers laterally on the brake disc. Pull brake calipers carefully back from the brake discs and hang to the side.

### Info

Do not operate the hand brake lever if the brake calipers have been removed.

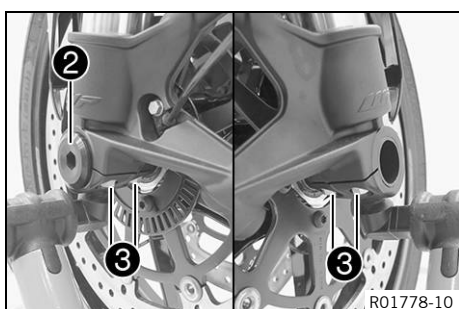

- Loosen screw ② and screws ③.
- Using your hand, press on screw ② to push the wheel spindle out of the axle clamp. Remove screw ②.

### Warning

**Danger of accidents** Damaged brake discs reduce the braking effect.

- Always lay the wheel down in such a way that the brake discs are not damaged.

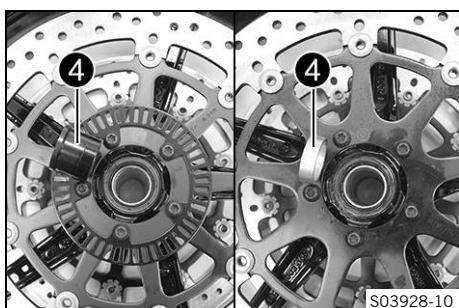

- Hold front wheel and remove wheel spindle. Take the front wheel out of the fork.
- Remove spacers ④.

## 15.2 Installing the front wheel

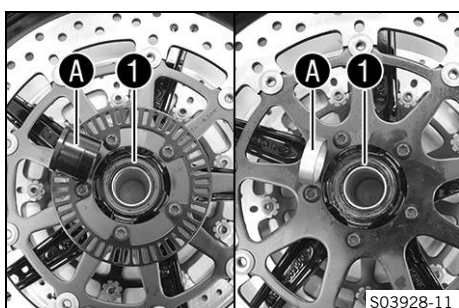

- Check the wheel bearing for damage and wear.
  - » If the wheel bearing is damaged or worn:
    - Change front wheel bearing. 🛠️
- Clean and grease shaft seal rings ① and contact surfaces A of the spacers.

Long-life grease (📖 p. 161)

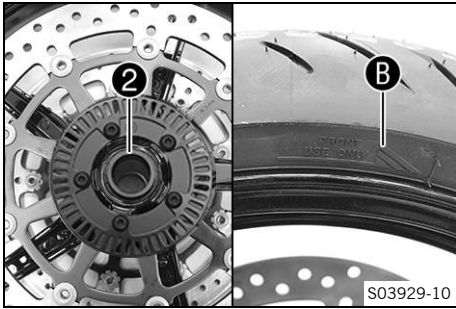

- Insert wide spacer **2** on the left in the direction of travel.

**i Info**  
 Arrow **B** indicates the direction of travel of the front wheel.  
 The wheel speed sensor wheel is on the left viewed in the direction of travel.

- Insert the narrow spacer on the right in the direction of travel.

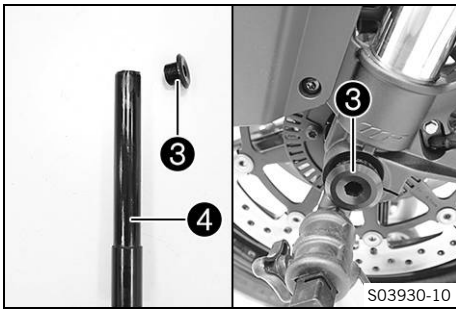

- Clean screw **3** and wheel spindle **4**.
- Grease wheel spindle **4** lightly.

**! Warning**  
**Danger of accidents** Oil or grease on the brake discs reduces the braking effect.

- Always keep the brake discs free of oil and grease.
- Clean the brake discs with brake cleaner when necessary.

Long-life grease (📖 p. 161)

- Jack up the front wheel into the fork, position it, and insert the wheel spindle.
- Mount and tighten screw **3**.

Guideline

Screw, front wheel spindle	M25x1.5	45 Nm (33.2 lbf ft) Thread greased
----------------------------	---------	---------------------------------------

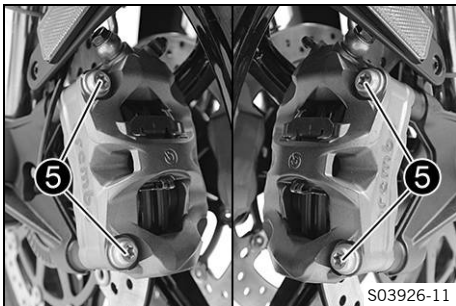

- Position brake calipers and check that the brake linings are seated correctly.
- Mount screws **5** on both brake calipers, but do not tighten yet.
- Operate the hand brake lever repeatedly until the brake linings are in contact with the brake disc and there is a pressure point. Secure the hand brake lever in the activated position.
- ✓ The brake calipers straighten.
- Tighten screws **5** on both brake calipers.

Guideline

Screw, front brake caliper	M10	45 Nm (33.2 lbf ft) <b>Loctite®243™</b>
----------------------------	-----	--------------------------------------------

- Remove the locking piece of the hand brake lever.
- Take the motorcycle off the front lifting gear. (📖 p. 94)
- Remove the rear of the motorcycle from the lifting gear. (📖 p. 93)

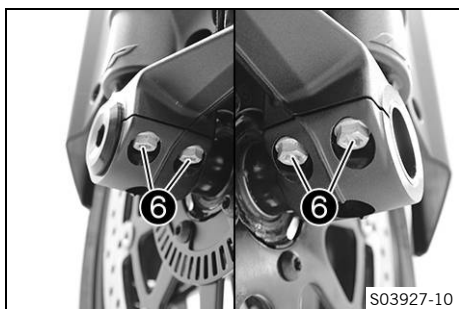

- Operate the front brake and compress the fork a few times firmly.

✓ The fork legs straighten.

- Tighten screws 6.

Guideline

Screw, axle clamp	M8	15 Nm (11.1 lbf ft)
-------------------	----	---------------------

## 15.3 Removing the rear wheel

### Preparatory work

- Lift the motorcycle with the rear lifting gear. (📖 p. 93)
- Remove main silencer. (🔧 p. 99)

### Main work

- Remove inside locking wire 1.
- Remove outside locking wire 2.

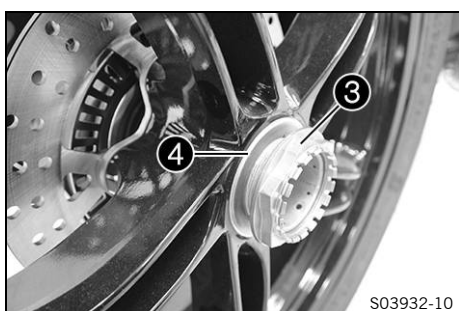
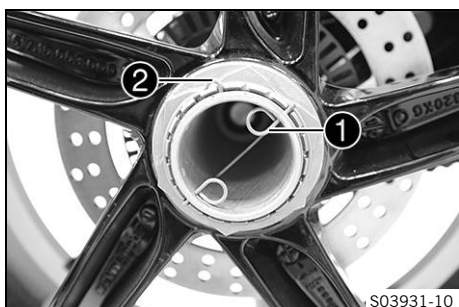

- Have an assistant operate the rear brake.
- Loosen nut 3 and remove it with washer 4.
- Take off the rear wheel.

## 15.4 Installing the rear wheel



### Warning

**Danger of accidents** Oil or grease on the brake discs reduces the braking effect.

- Always keep the brake discs free of oil and grease.
- Clean the brake discs with brake cleaner when necessary.

### Main work

- Check the rear wheel bearing for damage and wear.
  - » If the rear wheel bearing is damaged or worn:
    - Change the rear wheel bearing. (🔧)
- Clean and grease the threads of the wheel axle and axle nut.

Long-life grease (📖 p. 161)

- Slide the rear wheel onto the axle.

✓ Driving pins 1 engage in drilled holes A of the rim.

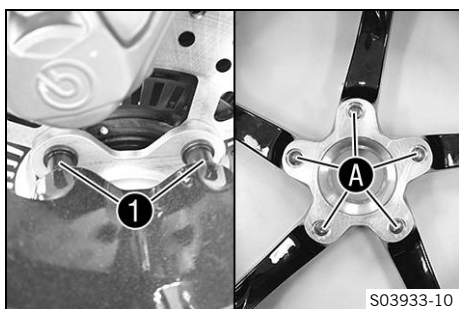

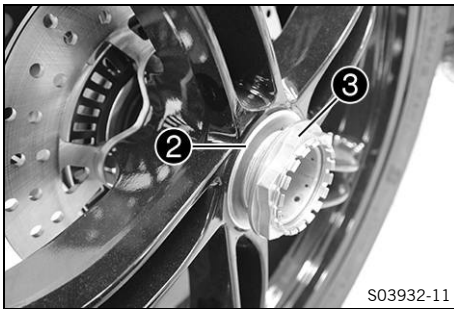

- Mount washer ② and nut ③.
- Have an assistant operate the rear brake.
- Tighten nut ③.

Guideline

Nut, rear axle	M50x1.5	250 Nm (184.4 lbf ft) Thread greased/lock locking wire with locking varnish
----------------	---------	--------------------------------------------------------------------------------------

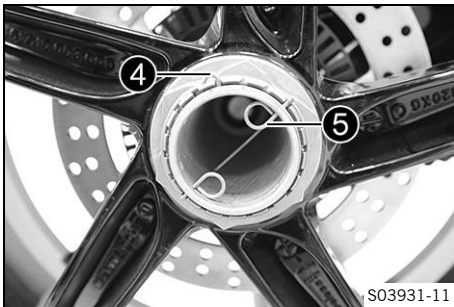

- Mount outside locking wire ④.
- Mount inside locking wire ⑤.
- ✓ The pins of the locking wires engage in the drilled holes of the wheel axle.

**Finishing work**

- Remove the rear of the motorcycle from the lifting gear. (📖 p. 93)
- Install the main silencer. 🛠️ (📖 p. 100)



## 15.5 Checking the tire condition



**Warning**

**Danger of accidents** If a tire bursts while riding, the vehicle becomes uncontrollable.

- Ensure that damaged or worn tires are replaced immediately. (Your authorized KTM workshop will be glad to help.)



**Warning**

**Danger of crashing** Different tire tread patterns on the front and rear wheel impair the handling characteristic.

Different tire tread patterns can make the vehicle significantly more difficult to control.

- Make sure that only tires with a similar tire tread pattern are fitted to the front and rear wheel.



**Warning**

**Danger of accidents** Non-approved or non-recommended tires and wheels impact the handling characteristic.

- Only use tires/wheels approved by KTM with the corresponding speed index.



**Warning**

**Danger of accidents** New tires have reduced road grip.

The contact surface on new tires is not yet roughened.

- Run in new tires with moderate riding at alternating angles.  
Running-in phase 200 km (124 mi)

**i Info**

Tire type, tire condition, and tire pressure influence the braking and handling characteristics of the vehicle. Worn tires are particularly unfavorable on wet surfaces.

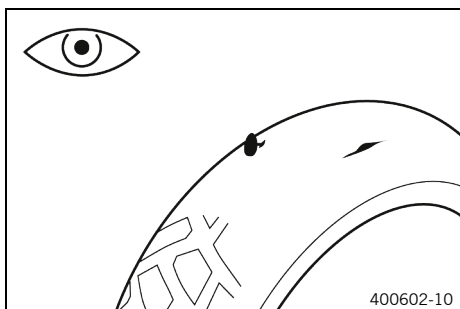

- Check front and rear tires for cuts, run-in objects, and other damage.
  - » If the tires have cuts, run-in objects, or other damage:
    - Change the tires. 🛠️
- Check tread depth.

**i Info**

Observe the minimum profile depth required by national law.

Minimum tread depth	≥ 2 mm (≥ 0.08 in)
---------------------	--------------------

- » If the tread depth is less than the minimum tread depth:
  - Change the tires. 🛠️
- Check tire age.

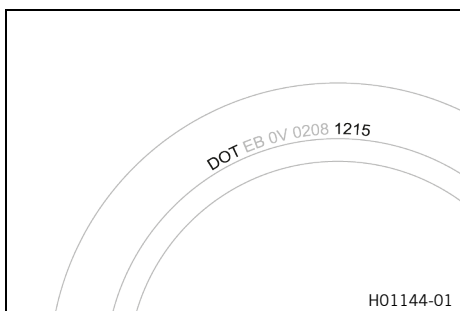

**i Info**

The tire date of manufacture is usually contained in the tire label and is indicated by the last four digits of the **DOT** number. The first two digits indicate the week of manufacture and the last two digits the year of manufacture. KTM recommends that the tires be changed after 5 years at the latest, regardless of the actual state of wear.

- » If the tires are more than 5 years old:
  - Change the tires. 🛠️

## 15.6 Checking tire pressure

**i Info**

Low tire pressure leads to abnormal wear and overheating of the tire. Correct tire pressure ensures optimal riding comfort and maximum tire service life.

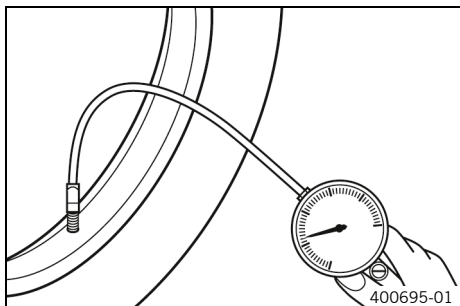

- Remove the protection cap.
- Check the tire pressure when the tires are cold.

Tire pressure when solo	
front: with cold tires	2.5 bar (36 psi)
rear: with cold tires	2.5 bar (36 psi)

Tire pressure with passenger / full payload	
front: with cold tires	2.5 bar (36 psi)
rear: with cold tires	2.9 bar (42 psi)

- » If the tire pressure does not meet specifications:
  - Correct the tire pressure.



- Mount the protection cap.



## 15.7 Using tire repair spray

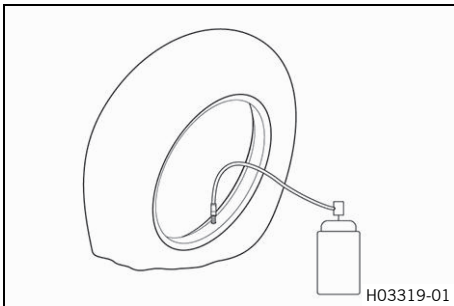

### Warning

**Danger of accidents** Incorrect use of tire repair spray will result in the repaired tire losing pressure.

Tire repair spray cannot be used for all types of damage.

- Observe the instructions and specifications of the manufacturer of the tire repair spray.
- After repairing a tire with tire repair spray, ride slowly and carefully.
- Ride no further than to the nearest workshop and have the tire changed.

Tire repair spray should only be used in an emergency. We recommend transporting the broken down vehicle to the nearest workshop instead of using tire repair spray.

### Note

**Material damage** Tire repair spray damages the tire pressure sensor.

- Note that after using tire repair spray, the tire pressure sensor may need to be replaced.

## 16.1 Daytime running light (DRL)

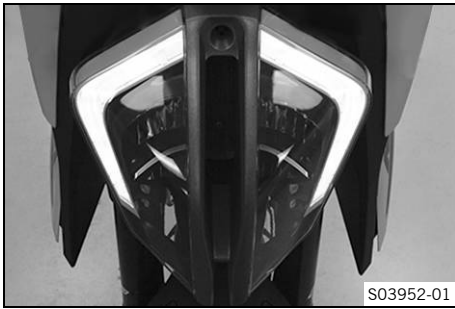

### Warning

**Danger of accidents** When visibility is poor, the daytime running light is not a substitute for the low beam.

Automatic switching between the daytime running light and low beam may only be partially available when visibility is significantly impaired due to fog, snow or rain.

- Ensure that the appropriate type of lighting is always selected.
- If necessary switch off the daytime running lights using the menu before going on a ride or when stopped so that the low beam is switched on permanently.
- Make sure that the daytime running light is deactivated with the diagnostics tool when the menu item is not available, but the low beam is required. (Your authorized KTM workshop will be glad to help.)
- Note the legal regulations regarding the daytime running light.

The daytime running (DRL)/position light is integrated in the main headlight. The daytime running light is brighter than the position light.

The daytime running light must only be switched on when visibility conditions are good.

This is controlled by the ambient light sensor in the combination instrument. When visibility conditions are good, the low beam with position light is switched off and the daytime running light is switched on.

When the daytime running light is switched off, the low beam with position light lights up.

On high beam or headlight flasher, the daytime running light changes automatically to the position light.

## 16.2 Removing the 12-V battery



### Warning

**Risk of injury** Battery acid and battery gases cause serious chemical burns.

- Keep 12 V batteries out of the reach of children.
- Wear suitable protective clothing and safety glasses.
- Avoid contact with battery acid and battery gases.
- Keep sparks or open flames away from the 12 V battery.
- Only charge 12 V batteries in well-ventilated rooms.
- Rinse the affected area immediately with plenty of water in the event of contact with the skin.
- Rinse eyes with water for at least 15 minutes and consult a doctor immediately if battery acid and battery gases get into the eyes.

**Caution**

**Danger of accidents** Electronic components and safety devices will be damaged if the 12-V battery is discharged or missing.

If the 12-V battery is discharged or defective, malfunctions in the vehicle electronics can occur, especially when starting.

- Never operate the vehicle with a discharged 12-V battery or without a 12-V battery.

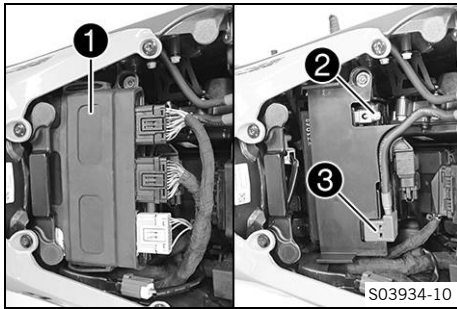
**Preparatory work**

- Remove the passenger seat. (📖 p. 96)
- Remove the front rider's seat. (📖 p. 96)

**Main work**

- Remove control unit ① and hang to the side.
- Disconnect negative cable ② from the 12-V battery.
- Remove positive terminal cover ③ and disconnect the positive cable from the 12-V battery.

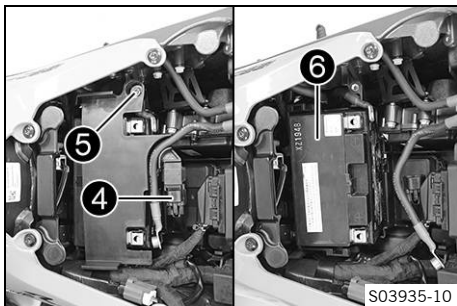

- Disconnect plug-in connector ④.
- Remove screw ⑤ and take off the battery cover.
- Take the 12-V battery ⑥ out of the battery compartment.

**16.3 Installing the 12-V battery****Warning**

**Risk of injury** Battery acid and battery gases cause serious chemical burns.

- Keep 12 V batteries out of the reach of children.
- Wear suitable protective clothing and safety glasses.
- Avoid contact with battery acid and battery gases.
- Keep sparks or open flames away from the 12 V battery.
- Only charge 12 V batteries in well-ventilated rooms.
- Rinse the affected area immediately with plenty of water in the event of contact with the skin.
- Rinse eyes with water for at least 15 minutes and consult a doctor immediately if battery acid and battery gases get into the eyes.

**Caution**

**Danger of accidents** Electronic components and safety devices will be damaged if the 12-V battery is discharged or missing.

If the 12-V battery is discharged or defective, malfunctions in the vehicle electronics can occur, especially when starting.

- Never operate the vehicle with a discharged 12-V battery or without a 12-V battery.

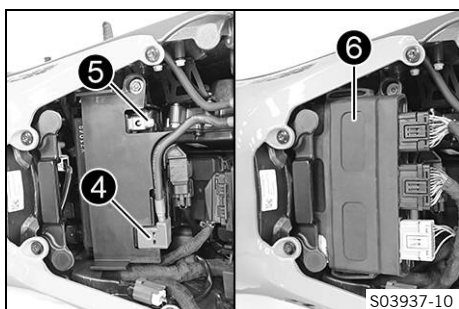
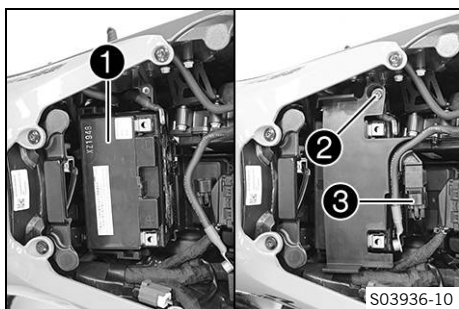

## Main work

- Insert 12-V battery ① into the battery compartment.

12-V battery (YTX14-BS) (📖 p. 151)
------------------------------------

- Position the battery cover, mount screw ②, and tighten.

### Guideline

Remaining screws, chassis	M5	5 Nm (3.7 lbf ft)
---------------------------	----	-------------------

- Join plug-in connector ③.

- Position the positive cable and mount and tighten the screw.

### Guideline

Screw, battery terminal	M6	4.5 Nm (3.32 lbf ft)
-------------------------	----	----------------------

- Mount positive terminal cover ④.

- Position negative cable ⑤ and mount and tighten the screw.

### Guideline

Screw, battery terminal	M6	4.5 Nm (3.32 lbf ft)
-------------------------	----	----------------------

- Position control unit ⑥.

## Finishing work

- Mount the front rider's seat. (📖 p. 97)
- Mount the passenger seat. (📖 p. 96)
- Set time and date.

## 16.4 Charging the 12-V battery ↗



### Warning

**Risk of injury** Battery acid and battery gases cause serious chemical burns.

- Keep 12 V batteries out of the reach of children.
- Wear suitable protective clothing and safety glasses.
- Avoid contact with battery acid and battery gases.
- Keep sparks or open flames away from the 12 V battery.
- Only charge 12 V batteries in well-ventilated rooms.
- Rinse the affected area immediately with plenty of water in the event of contact with the skin.
- Rinse eyes with water for at least 15 minutes and consult a doctor immediately if battery acid and battery gases get into the eyes.



### Note

**Environmental hazard** 12 V batteries contain environmentally hazardous materials.

- Do not dispose of 12 V batteries as household waste.
- Dispose of 12 V batteries at a collection point for used batteries.



### Note

**Environmental hazard** Hazardous substances cause environmental damage.

- Dispose of oils, grease, filters, fuel, cleaning agents, brake fluid, etc., correctly and in compliance with the applicable regulations.

**i Info**

Even when there is no load on the 12-V battery, it discharges steadily each day. The charging level and the method of charging are very important for the service life of the 12-V battery. Rapid recharging with a high charging current shortens the service life of the battery. If the charging current, charging voltage, or charging time is exceeded, electrolyte escapes through the safety valves. This reduces the capacity of the 12-V battery. If the 12-V battery is depleted by repeated starting, the 12-V battery must be charged immediately. If the 12-V battery is left in a discharged state for an extended period, it will become deeply discharged and sulfating occurs, thus destroying the battery. The 12-V battery is maintenance-free. The acid level does not have to be checked. If the 12-V battery is not charged by the KTM battery charger, the 12-V battery must be removed for charging. Otherwise, overvoltage may damage electronic components. Charge the 12-V battery according to the instructions on the battery housing.

**Preparatory work**

- Remove the passenger seat. (📖 p. 96)
- Remove the front rider's seat. (📖 p. 96)

**Main work**

- Pull off engine control unit **1** from the holder and hang to the side.
- Disconnect negative cable **2** from the 12 V battery to avoid damaging the onboard electronics.
- Remove positive terminal cover **3**.

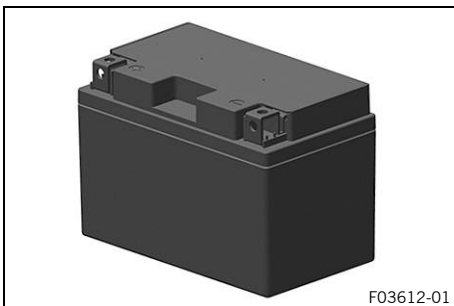
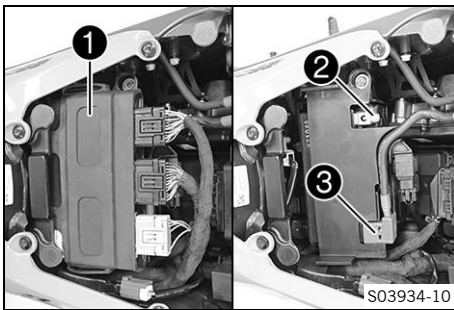

- Connect a battery charger to the 12-V battery. Connect the battery charger to the mains connection.

Battery charger (58429074200)

It is impossible to overcharge the 12-V battery using this battery charger.

This battery charger is not suitable for lithium-ion batteries.

**i Info**

Charge the 12-V battery to a maximum of 10 % of the capacity specified on the battery housing.

- Disconnect the battery charger from the mains connection and the 12-V battery after charging.

**Guideline**

The charging current, charging voltage, and charging time must not be exceeded.	
Recharge the 12-V battery regularly when the motorcycle is not being used	3 months

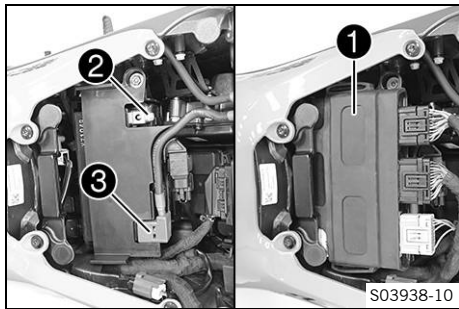

- Mount positive terminal cover ③.
- Position negative cable ② and mount and tighten the screw.

Guideline

Screw, battery terminal	M6	4.5 Nm (3.32 lbf ft)
-------------------------	----	-------------------------

- Position engine control unit ①.

### Finishing work

- Mount the front rider's seat. (📖 p. 97)
- Mount the passenger seat. (📖 p. 96)
- Set time and date. (📖 p. 61)

## 16.5 Changing the RACE-ON key battery



### Warning

**Risk of injury** Button cells may burst if misused.

Swallowing button cells leads to severe chemical burning and may result in death in under 2 hours.

- Keep button cells and the RACE-ON key out of the reach of children.
- Make sure the button cells can never be swallowed or ingested.
- Seek medical attention immediately if button cells are swallowed or ingested.
- Do not expose button cells to extreme temperatures or mechanical loads.

Permissible temperature -20 ... 50 °C (-4 ... 122 °F)

- Do not damage the RACE-ON key by e.g. cutting or squashing it.
- Do not use the RACE-ON key if the RACE-ON key is damaged or the battery compartment cannot be closed.
- Replace the RACE-ON key battery with the type specified only.

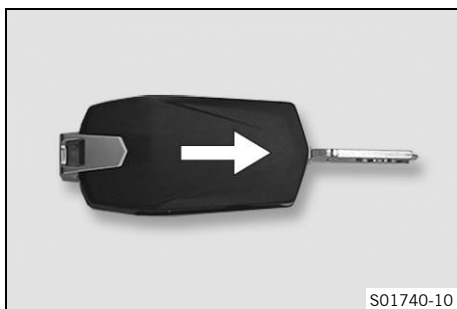

- Fold out the key bit of the RACE-ON key.
- Push lower half of the RACE-ON key in the direction of the arrow and take off.

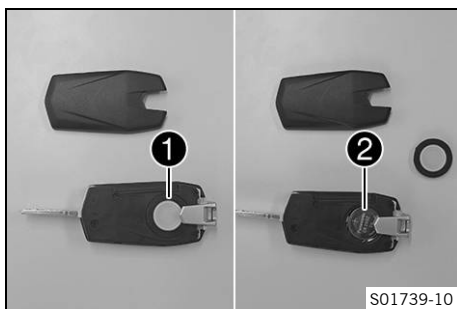

- Remove battery cover ①.
- Remove RACE-ON key battery ②.
- Insert new the RACE-ON key battery with label facing upward.

RACE-ON key battery (CR 2032) (📖 p. 151)
------------------------------------------

- Mount battery cover ①.

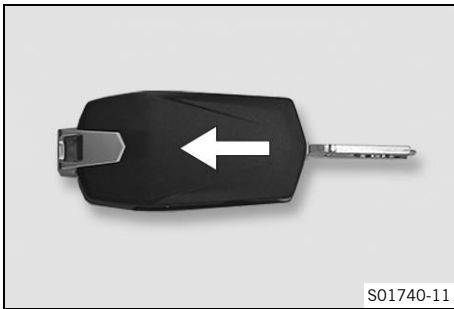

- Fit lower half of the RACE-ON key and snap into place in the direction of the arrow.



## 16.6 Changing the main fuse



### Warning

**Fire hazard** Incorrect fuses overload the electrical system.

- Only use fuses with the required ampere value.
- Do not bypass or repair fuses.

### Preparatory work

- Remove the passenger seat. (🔧 p. 96)
- Remove the front rider's seat. (🔧 p. 96)

### Main work

- Take off protection cap ❶.

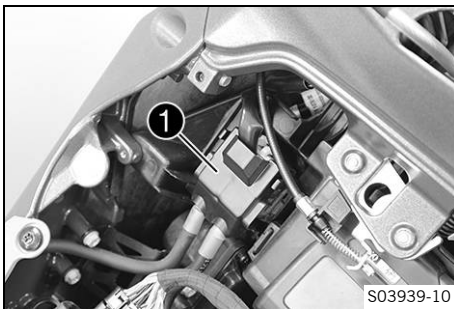

- Remove faulty main fuse ❷.

### i Info

A faulty fuse has a burned-out fuse wire **A**.  
A spare fuse ❸ is located in the starter relay.  
The main fuse protects all electrical power consumers of the vehicle.

- Insert a new main fuse.

Fuse (58011109130) (🔧 p. 151)

- Check that the electrical system is functioning properly.
- Mount protection caps ❶.

### i Tip

Insert a new spare fuse into the starter relay to have it available when needed.

### Finishing work

- Mount the front rider's seat. (🔧 p. 97)
- Mount the passenger seat. (🔧 p. 96)
- Set time and date.



## 16.7 Changing the fuses in the fuse box



### Warning

**Fire hazard** Incorrect fuses overload the electrical system.

- Only use fuses with the required ampere value.
- Do not bypass or repair fuses.



### Info

The fuse box containing the fuses of individual electrical power consumers is located under the seat.

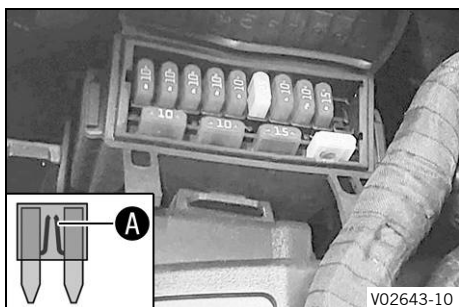
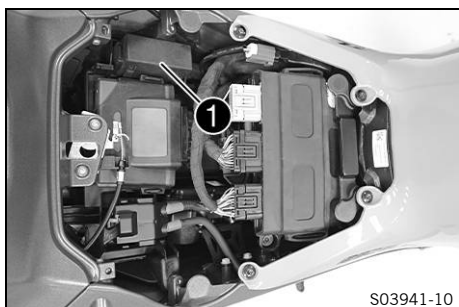

### Preparatory work

- Remove the passenger seat. (📖 p. 96)
- Remove the front rider's seat. (📖 p. 96)

### Main work

- Open fuse box cover **1**.

- Check the fuses.



### Info

A faulty fuse has a burned-out fuse wire **A**.

- Remove the faulty fuse.

### Guideline

Fuse <b>1</b> - 10 A - power supply for control units and components
----------------------------------------------------------------------

Fuse <b>2</b> - 10 A - ACC1
-----------------------------

Fuse <b>3</b> - 10 A - license plate lamp, tail light
-------------------------------------------------------

Fuse <b>4</b> - 10 A - permanent positive for headlight
---------------------------------------------------------

Fuse <b>5</b> - 10 A - control unit, ignition, electronic fuel injection, lambda sensor
-----------------------------------------------------------------------------------------

Fuse <b>6</b> - 25 A - ABS return pump
----------------------------------------

Fuse <b>7</b> - 10 A - ABS hydraulic unit
-------------------------------------------

Fuse <b>8</b> - 10 A - ACC2, USB socket
-----------------------------------------

Fuse <b>9</b> - 15 A - semi-active suspension
-----------------------------------------------

Fuse <b>10</b> - not assigned
-------------------------------

Fuse <b>res</b> - 10 A - spare fuses
--------------------------------------

Fuse <b>res</b> - 15 A - spare fuse
-------------------------------------

Fuse <b>res</b> - 25 A - spare fuse
-------------------------------------

- Insert the spare fuse with the correct rating.

Fuse (58011109110) (📖 p. 151)
-------------------------------

Fuse (58011109115) (📖 p. 151)
-------------------------------



Fuse (58011109125) (📖 p. 151)

**i Tip**  
Insert a spare fuse so that it is available if needed.

- Check the function of the electrical power consumers.
- Close the fuse box cover ❶.

#### Finishing work

- Mount the front rider's seat. (📖 p. 97)
- Mount the passenger seat. (📖 p. 96)



## 16.8 Changing the turn signal bulb

### Note

**Damage to reflector** Grease on the reflector reduces the light intensity.

Grease on the bulb will evaporate due to the heat and be deposited on the reflector.

- Clean and degrease the bulbs before mounting.
- Do not touch the bulbs with your bare hands.

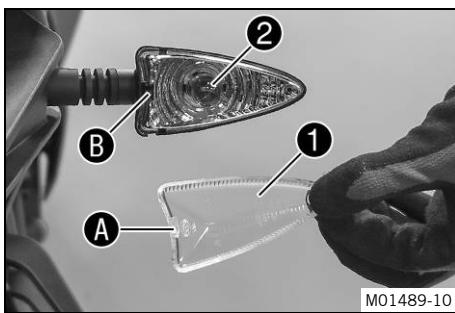

- Remove the screw on the front of the turn signal housing.
- Carefully remove turn signal glass ❶.
- Press bulb ❷ carefully into the socket, turn it counterclockwise by about 30°, and take it out of the socket.

**i Info**  
Do not touch the reflector with your fingers and keep it free from grease.

- Push the new bulb gently into the socket and turn it clockwise all the way in.

Turn signal (RY10W / socket BAU15s) (📖 p. 151)

- Check that the turn signal is functioning properly.
- Position the turn signal glass.

**i Info**  
Insert holding lug ❶ into cut-out ❷.

- Insert the screw and first turn counterclockwise until it engages in the thread with a small jerk. Tighten the screw lightly.



## 16.9 Checking the headlight setting

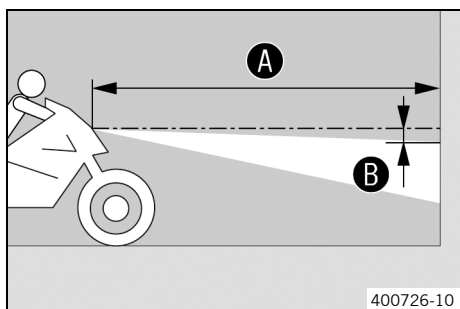

- Park the vehicle on a horizontal surface in front of a light-colored wall and make a mark at the height of the center of the low beam headlight.
- Make another mark at a distance **B** under the first marking.

Distance <b>B</b>	5 cm (2 in)
-------------------	-------------

- Position the vehicle perpendicular to the wall at a distance **A** from the wall and switch on the low beam.

Distance <b>A</b>	5 m (16 ft)
-------------------	-------------

- The rider now mounts the motorcycle with luggage and passenger if applicable.
- Check the headlight setting.

The light-dark boundary must be exactly on the lower marking when the motorcycle is ready to be operated with the rider mounted along with any luggage and a passenger if applicable.

- » If the boundary between light and dark does not meet specifications:
  - Adjust the headlight range. (📖 p. 128)

## 16.10 Adjusting the headlight range

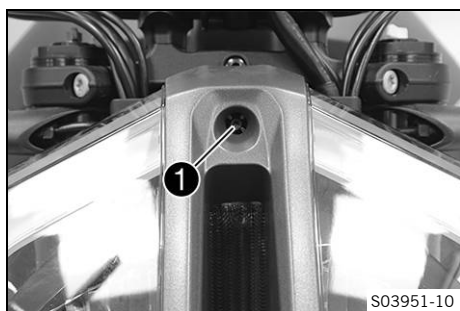

### Preparatory work

- Check the headlight setting. (📖 p. 128)

### Main work

- Turn adjusting screw **1** to adjust the headlight range.

**i Info**  
Turn clockwise to increase the headlight range; turn counterclockwise to reduce the headlight range. If you have a payload, you may have to correct the headlight range.  
Screw **1** also secures the headlight. Ensure the screw is always screwed in far enough.

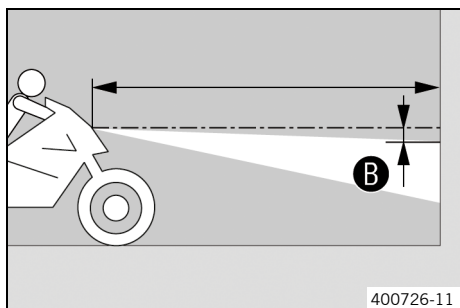

- Set the headlight to marking **B**.

Guideline  
The light-dark boundary must lie exactly on lower marking **B** when the motorcycle is ready to operate with the rider mounted along with any luggage and a passenger if applicable.

### 16.11 Connecting the USB cable

#### **i** Info

The USB socket is located on the left of the combination instrument.

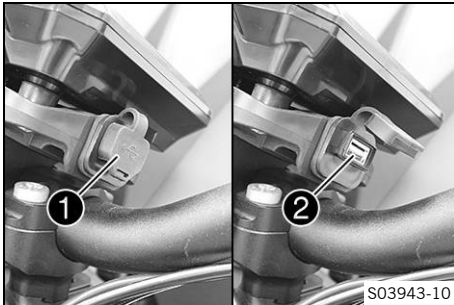

S03943-10

- Open USB socket cover ①.
- Connect a suitable USB cable to the USB socket ②.
- Connect the USB cable to the device.
- Route the cable on the handlebar and secure with the cable ties.

#### Guideline

Use the shortest possible USB cable.

Always ensure that connected devices are also protected against moisture.

Route and secure the cable in such a way that it cannot be damaged.



### 16.12 Disconnecting the USB cable

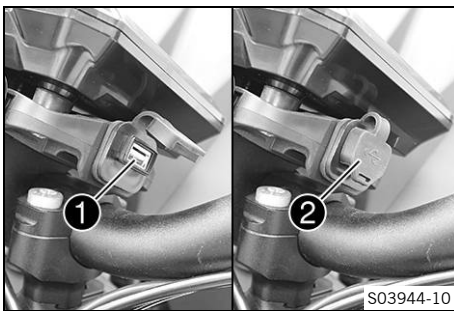

S03944-10

- Disconnect USB cable from the device.
- Disconnect USB cable from the USB socket ①.
- Close USB socket cover ②.



### 16.13 Diagnostics connector

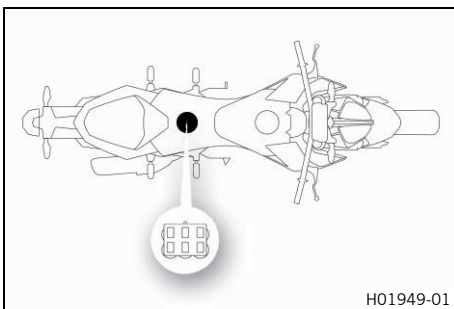

H01949-01

Diagnostics connector ① is located under the front rider's seat.

## 16.14 Front ACC1 and ACC2

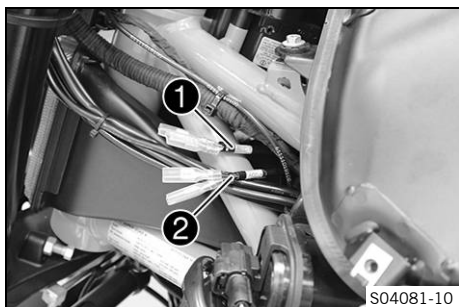

### Installation location

- Front power supplies ACC1 ① and ACC2 ② are located behind the fuel tank spoiler on the left between the triple clamps.

## 16.15 ACC1 and ACC2 rear

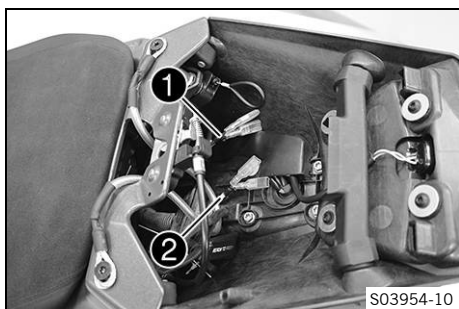

### Installation location

- Power supplies ACC1 ① and ACC2 ② rear are located under the seat.

## 17.1 Checking the coolant level in the compensating tank



### Warning

**Danger of scalding** During motorcycle operation, the coolant gets very hot and is under pressure.

- Do not open the radiator, the radiator hoses or other cooling system components if the engine or the cooling system are at operating temperature.
- Allow the cooling system and the engine to cool down before you open the radiator, the radiator hoses or other components of the cooling system.
- In the event of scalding, rinse the area affected immediately with lukewarm water.



### Warning

**Danger of poisoning** Coolant is toxic and a health hazard.

- Keep coolant out of the reach of children.
- Do not allow coolant to come into contact with the skin, the eyes and clothing.
- Consult a doctor immediately if coolant is swallowed.
- Rinse the affected area immediately with plenty of water in the event of contact with the skin.
- Rinse eyes thoroughly with water and consult a doctor immediately if coolant gets into the eyes.
- Change clothing if coolant spills onto your clothing.

### Condition

The engine is cold.  
The radiator is completely full.

- Park the motorcycle on a horizontal surface.
- Check the coolant level in the compensating tank ①.

The coolant level must be between **MIN** and **MAX**.

- » If there is no coolant in the compensating tank:
  - Check the cooling system for leaks. 🛠️



### Info

Do not start up the motorcycle!

- Add the coolant/bleed the cooling system. 🛠️
- » If the coolant in the compensating tank is not at the required level, but the tank is not empty:
  - Correct the coolant level in the compensating tank. (📖 p. 131)

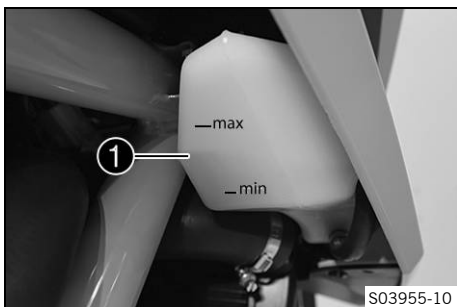

## 17.2 Correcting the coolant level in the compensating tank



### Warning

**Danger of scalding** During motorcycle operation, the coolant gets very hot and is under pressure.

- Do not open the radiator, the radiator hoses or other cooling system components if the engine or the cooling system are at operating temperature.
- Allow the cooling system and the engine to cool down before you open the radiator, the radiator hoses or other components of the cooling system.
- In the event of scalding, rinse the area affected immediately with lukewarm water.



## Warning

**Danger of poisoning** Coolant is toxic and a health hazard.

- Keep coolant out of the reach of children.
- Do not allow coolant to come into contact with the skin, the eyes and clothing.
- Consult a doctor immediately if coolant is swallowed.
- Rinse the affected area immediately with plenty of water in the event of contact with the skin.
- Rinse eyes thoroughly with water and consult a doctor immediately if coolant gets into the eyes.
- Change clothing if coolant spills onto your clothing.

## Condition

The engine is cold.

The radiator is completely full.

## Preparatory work

- Check the coolant level in the compensating tank. (📖 p. 131)

## Main work

- Remove cover ❶ of the compensating tank.
- Add coolant to the **MAX** marking.

Coolant (📖 p. 159)

- Mount cover ❶ of the compensating tank.



## 18.1 Ride Mode

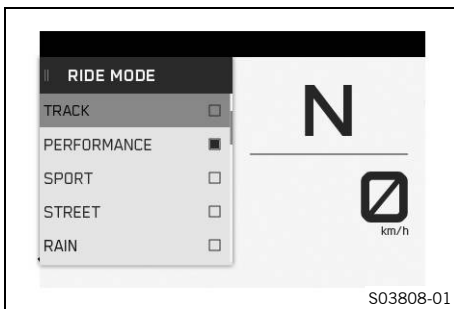

### Possible states

- **TRACK** – Optional setting available with homologated performance and extremely direct response. The motorcycle traction control and the characteristic map of the throttle response can be individually set.
- **PERFORMANCE** – Optional setting available with homologated performance and extremely direct response. The motorcycle traction control and throttle response characteristics can be individually adjusted and the **KTM MY RIDE** function can be used. Combines the functions of TRACK mode with standard modes.
- **SPORT** – Homologated performance with very direct response; the motorcycle traction control allows greater slip on the rear wheel.
- **STREET** – Homologated performance with balanced response; the motorcycle traction control allows normal slip on the rear wheel.
- **RAIN** – Reduced homologated performance with soft response for improved rideability; the motorcycle traction control allows less slip on the rear wheel.

Various vehicle tunings can be selected in the **Ride Mode** menu. There is **TRACK** (optional), **PERFORMANCE** (optional), **SPORT**, **STREET** and **RAIN**.

The riding mode selected last appears in the display.

The riding mode can also be changed while riding with a closed throttle grip and deactivated speed sensor.

### **i** Info

The riding mode selection does not influence the **ABS**.

## 18.2 Motorcycle traction control (MTC)

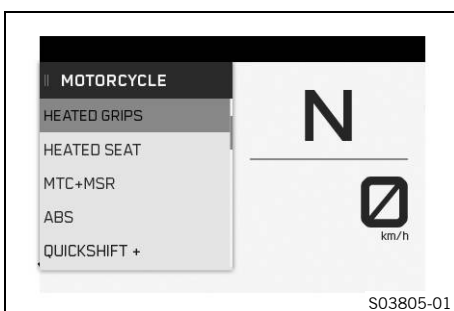

The motorcycle traction control (cornering MTC) lowers the engine torque in case of loss of traction in the rear wheel.

### **i** Info

When the motorcycle traction control is switched off, the rear wheel may spin during strong acceleration and on surfaces with low grip, resulting in a risk of falling. After the ignition is switched on, motorcycle traction control is enabled again.

The motorcycle traction control is controlled via the **Motorcycle** (🗨 p. 133) menu on the combination instrument. The motorcycle traction control can be switched off in the **MTC/ABS** menu.

### **i** Info

When the motorcycle traction control is active, the TC indicator lamp 🚦 flashes. When motorcycle traction control is switched off, the TC indicator lamp 🚦 lights up.

## 18.3 Anti wheelie mode (optional)

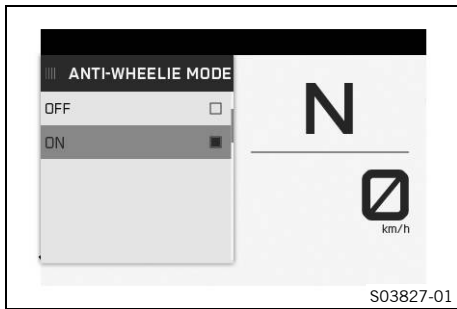

The **Anti Wheelie Mode** is an optional vehicle electronics function. Anti wheelie mode is intended to prevent the front wheel rising when accelerating.

## 18.4 Slip adjustment (optional)

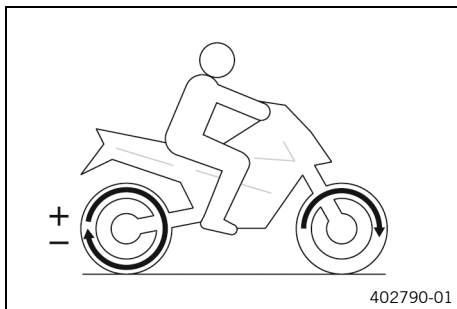

The slip adjustment is an optional motorcycle traction control function.

The slip adjustment allows the motorcycle traction control to be tuned through nine levels to the desired characteristics.

Level 1 allows the maximum slip on the rear wheel, and level 9 the minimum.

The slip adjustment can be set while riding with a closed menu using the **UP** or **DOWN** button.

### **i** Info

The slip adjustment is only available if riding mode **TRACK** or **PERFORMANCE** (📖 p. 133) (optional) is active.

## 18.5 Throttle Response (optional)



### Possible states

- TRACK – Extremely direct response
- SPORT – Very direct response
- STREET – Balanced response

The characteristic map of the throttle response can be adjusted in the **Throttle Response** menu.

The **Throttle Response** can also be set while riding with a closed throttle grip and deactivated speed sensor.

### **i** Info

**Throttle Response** is only available if riding mode **TRACK** or **PERFORMANCE** (📖 p. 133) (optional) is active.



## 19.1 Checking the engine oil level



### Info

Oil consumption depends on the riding style and the operating conditions.

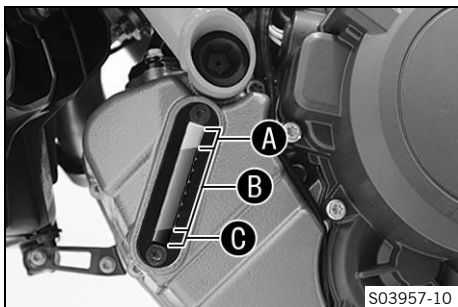

### Condition

The engine is at operating temperature.

### Preparatory work

- Stand the motorcycle upright on a horizontal surface.

### Main work

- Check the engine oil level in the engine oil level viewer.



### Info

After switching off the engine, wait one minute before checking the level.

The engine oil level should be in the upper area **B** of the engine oil level viewer.

- » When the engine oil level is in area **A** of the engine oil level viewer:
  - Do not add engine oil.
- » When the engine oil level is in area **B** of the engine oil level viewer:
  - Engine oil can be added.
- » When the engine oil level is in area **C** of the engine oil level viewer:
  - Add engine oil. (📖 p. 138)

## 19.2 Changing the engine oil and oil filter, cleaning the oil screens 🛠️



### Warning

**Danger of scalding** Engine and gear oil get very hot when the motorcycle is ridden.

- Wear suitable protective clothing and safety gloves.
- In the event of scalding, rinse the area affected immediately with lukewarm water.



### Note

**Environmental hazard** Hazardous substances cause environmental damage.

- Dispose of oils, grease, filters, fuel, cleaning agents, brake fluid, etc., correctly and in compliance with the applicable regulations.

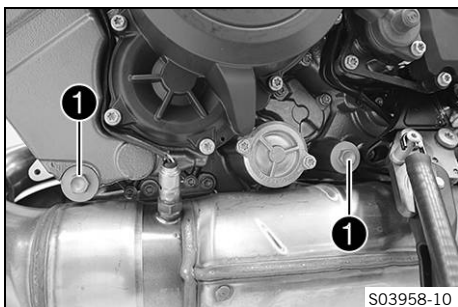

### Main work

- Stand the motorcycle on a level surface using the side stand.
- Place an appropriate container under the engine.
- In order to prevent oil from running over the exhaust system, use a mouldable funnel if necessary.
- Remove oil drain plugs **1** along with the magnets, the O-rings, and the oil screens.

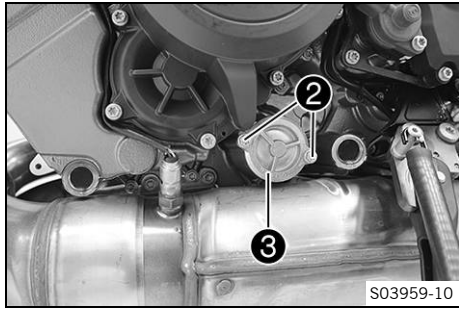

- Remove screws **2**. Take off oil filter cover **3** with the O-ring.

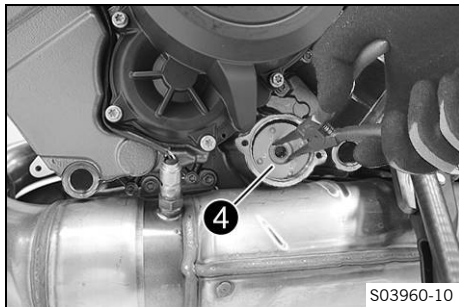

- Pull oil filter **4** out of the oil filter housing.

Lock ring plier (51012011000)

- Allow the engine oil to drain completely.
- Thoroughly clean the parts and the sealing surfaces.

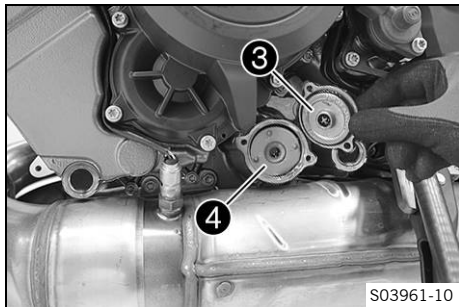

- Insert new oil filter **4**.



**Info**

Only insert the oil filter by hand.

- Oil the O-ring of the oil filter cover. Mount oil filter cover **3**.

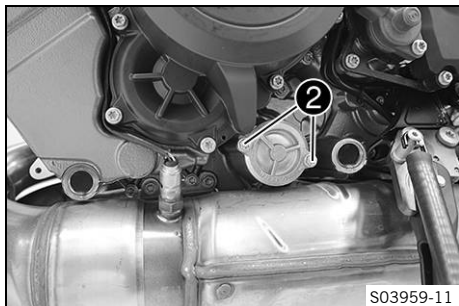

- Mount and tighten screws **2**.

Guideline

Remaining engine screws	M5	6 Nm (4.4 lbf ft)
-------------------------	----	-------------------

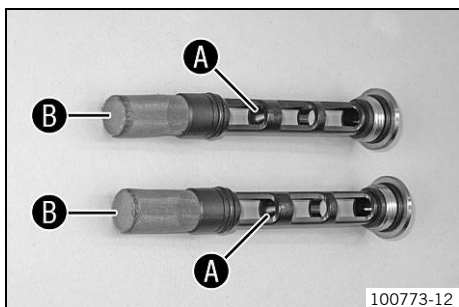

- Thoroughly clean magnets **A** and oil screens **B** of the oil drain plugs.

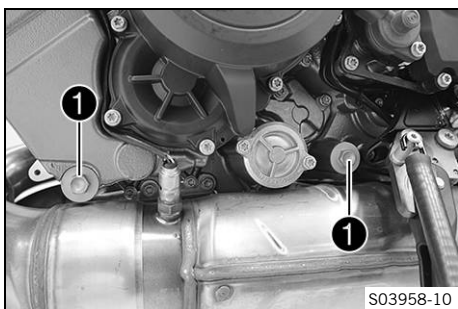

S03958-10

- Mount and tighten oil drain plugs **1** with magnets, O-rings, and oil screens.

Guideline

Oil drain plug	M20x1.5	20 Nm (14.8 lbf ft)
----------------	---------	---------------------

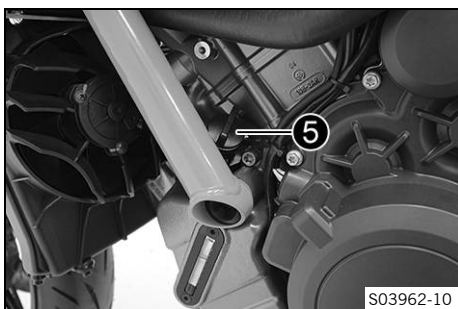

S03962-10

- Have the entire filling quantity available.

Engine oil Ambient temperature: $\geq 0\text{ }^{\circ}\text{C}$ ( $\geq 32\text{ }^{\circ}\text{F}$ )	3.50 l (3.7 qt.)	Engine oil (SAE 10W/50) (📖 p. 159)
Engine oil Ambient temperature: $< 0\text{ }^{\circ}\text{C}$ ( $< 32\text{ }^{\circ}\text{F}$ )		Engine oil (SAE 5W/40) (📖 p. 160)

- Add the oil quantity in two steps.
- Remove filler plug **5** with the O-ring, and fill up with the first partial quantity.

Engine oil (1st partial quantity) approx. Ambient temperature: $\geq 0\text{ }^{\circ}\text{C}$ ( $\geq 32\text{ }^{\circ}\text{F}$ )	3.0 l (3.2 qt.)	Engine oil (SAE 10W/50) (📖 p. 159)
Engine oil (1st partial quantity) approx. Ambient temperature: $< 0\text{ }^{\circ}\text{C}$ ( $< 32\text{ }^{\circ}\text{F}$ )		Engine oil (SAE 5W/40) (📖 p. 160)

- Mount filler plug **5** with the O-ring.



## Danger

**Danger of poisoning** Exhaust gases are toxic and inhaling them may result in unconsciousness and death.

- Always make sure there is sufficient ventilation when running the engine.
- Use effective exhaust extraction when starting or running the engine in an enclosed space.

- Start the engine and check it for leaks.
- Switch off the engine.

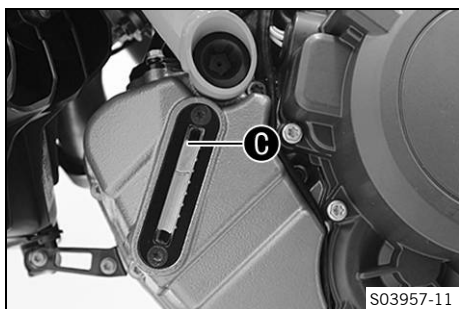

- Remove the filler plug with the O-ring and add the second partial quantity up to the upper marking **C** on the engine oil level viewer.

Engine oil (2nd partial quantity) approx. Ambient temperature: $\geq 0\text{ }^{\circ}\text{C}$ ( $\geq 32\text{ }^{\circ}\text{F}$ )	0.50 l (0.53 qt.)	Engine oil (SAE 10W/50) (📖 p. 159)
Engine oil (2nd partial quantity) approx. Ambient temperature: $< 0\text{ }^{\circ}\text{C}$ ( $< 32\text{ }^{\circ}\text{F}$ )		Engine oil (SAE 5W/40) (📖 p. 160)

- Mount the filler plug with the O-ring.



### Danger

**Danger of poisoning** Exhaust gases are toxic and inhaling them may result in unconsciousness and death.

- Always make sure there is sufficient ventilation when running the engine.
- Use effective exhaust extraction when starting or running the engine in an enclosed space.

- Start the engine and check it for leaks.

### Finishing work

- Check the engine oil level. (📖 p. 135)

## 19.3 Adding engine oil



### Info

Too little engine oil or poor-quality engine oil results in premature wear to the engine. The engine may be damaged if the engine oil level is too high.

### Condition

The engine is at operating temperature.

### Preparatory work

- Stand the motorcycle upright on a horizontal surface.
- Check the engine oil level. (📖 p. 135)

### Main work

- Remove filler plug **1** with the O-ring.

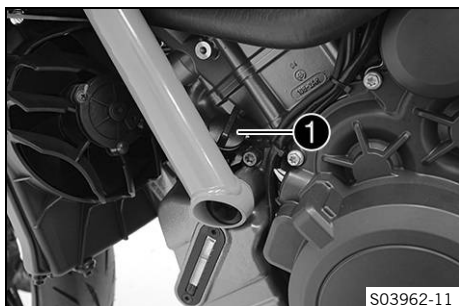

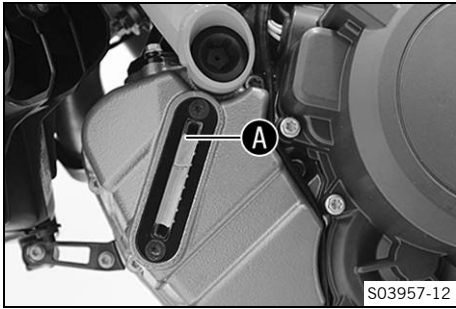

- Add the engine oil to upper marking **A** on the engine oil level viewer.

**Condition**

Ambient temperature:  $\geq 0\text{ }^{\circ}\text{C}$  ( $\geq 32\text{ }^{\circ}\text{F}$ )

Engine oil (SAE 10W/50) (📖 p. 159)

**Condition**

Ambient temperature:  $< 0\text{ }^{\circ}\text{C}$  ( $< 32\text{ }^{\circ}\text{F}$ )

Engine oil (SAE 5W/40) (📖 p. 160)



**Info**

In order to achieve optimal engine oil performance, it is not advisable to mix different engine oils. KTM recommends changing the engine oil where necessary.

- Mount the filler plug with the O-ring.



**Danger**

**Danger of poisoning** Exhaust gases are toxic and inhaling them may result in unconsciousness and death.

- Always make sure there is sufficient ventilation when running the engine.
- Use effective exhaust extraction when starting or running the engine in an enclosed space.

- Start the engine and check for leaks.

**Finishing work**

- Check the engine oil level. (📖 p. 135)



## 20.1 Cleaning the motorcycle

### Note

**Material damage** Components become damaged or destroyed if a pressure cleaner is used incorrectly. The high pressure forces water into the electrical components, connectors, throttle cables, and bearings, etc. Pressure which is too high causes malfunctions and destroys components.

- Do not direct the water jet directly on to electrical components, connectors, throttle cables or bearings.
- Maintain a minimum distance between the nozzle of the pressure cleaner and the component.  
Minimum clearance 60 cm (23.6 in)



### Note

**Environmental hazard** Hazardous substances cause environmental damage.

- Dispose of oils, grease, filters, fuel, cleaning agents, brake fluid, etc., correctly and in compliance with the applicable regulations.



### Info

Clean the motorcycle regularly to maintain its value and appearance over a long period. Avoid direct sunshine when cleaning the motorcycle.

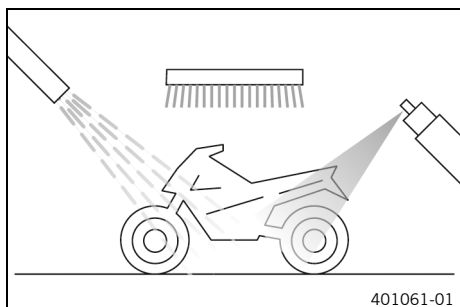

- Close off exhaust system to keep water from entering.
- Remove the coarse dirt particles with a gentle water jet.
- Spray the heavily soiled parts with a normal commercial motorcycle cleaner and clean using a brush.

Motorcycle cleaner (📖 p. 161)



### Info

Use warm water containing normal motorcycle cleaner and a soft sponge. Never apply motorcycle cleaner to a dry vehicle; always rinse the vehicle with water first. If the vehicle has been used on salted roads, use cold water for cleaning after riding. Warm water enhances the corrosive effects of salt.

- After rinsing the motorcycle with a gentle spray of water, allow it to dry thoroughly.
- Remove the closure of the exhaust system.



### Warning

**Danger of accidents** Moisture and dirt impair the brake system.

- Brake carefully several times to dry out and remove dirt from the brake linings and the brake discs.

- After cleaning, ride the vehicle a short distance until the engine warms up.



### Info

The heat produced causes water at inaccessible locations in the engine and on the brake system to evaporate.

- After the motorcycle has cooled down, lubricate all moving parts and pivot points.
- Clean the chain. (📖 p. 101)
- Treat bare metal (except for brake discs and the exhaust system) with a corrosion inhibitor.

Preserving materials for paints, metal and rubber (📖 p. 161)

- Treat the painted parts with a mild paint polish.

Perfect finish and high gloss polish for paints (📖 p. 161)

**i Info**  
Do not polish parts that were matte when delivered as this would strongly impair the material quality.

- Treat the plastic parts and powder-coated parts with a mild cleaning agent and care product.

Special cleaner for glossy and matte paint finishes, metal and plastic surfaces (📖 p. 161)

- Oil steering lock and seat lock.

Universal oil spray (📖 p. 161)



**20.2 Checks and maintenance steps for winter operation**

**i Info**  
If you use the motorcycle in winter, you must expect salt on the roads. You should therefore take precautions against aggressive road salt.  
If the vehicle has been used on salted roads, use cold water for cleaning after riding. Warm water enhances the corrosive effects of salt.

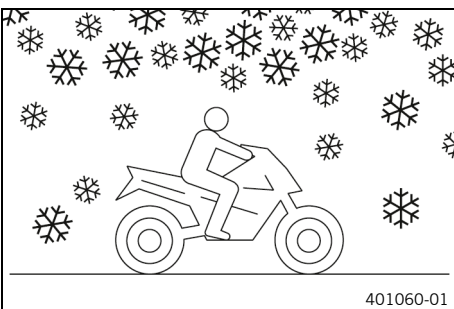

- Clean the motorcycle. (📖 p. 140)
- Clean the brakes.

**i Info**  
After **EVERY** trip on salted roads, thoroughly clean the brake calipers and brake linings, after they have cooled down and without removing them, with cold water and dry them carefully.  
After riding on salted roads, thoroughly clean the motorcycle with cold water and dry it well.

- Treat the engine, the link fork, and all other bare or zinc-plated parts (except the brake discs) with a wax-based corrosion inhibitor.

**i Info**  
Corrosion inhibitor must not come into contact with the brake discs. This would severely lower the braking effect.

- Clean the chain. (📖 p. 101)



## 21.1 Storage

### **i** Info

If the motorcycle is not being used for an extended length of time, additional measures are recommended. Before storing the motorcycle, check all parts for function and wear. If service, repairs, or replacements are necessary, you should do this during the storage period (less workshop overload). This allows you to avoid long waiting periods when the next season starts.

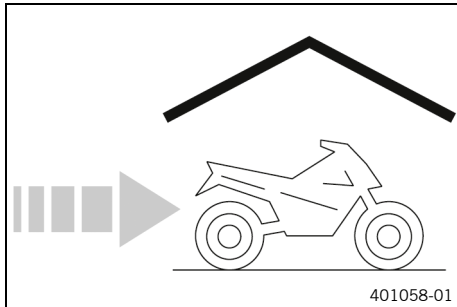

- When refueling for the last time before taking the motorcycle out of service, add fuel additive.

Fuel additive (📖 p. 161)
--------------------------

- Refuel. (📖 p. 87)
- Clean the motorcycle. (📖 p. 140)
- Change the engine oil and the oil filter, clean the oil screens. 🛠️ (📖 p. 135)
- Check the coolant fill level and antifreeze. 🛠️
- Check tire pressure. (📖 p. 118)
- Remove the 12-V battery. 🛠️ (📖 p. 120)

#### Guideline

Storage temperature of the 12-V battery without direct sunlight	0 ... 35 °C (32 ... 95 °F)
-----------------------------------------------------------------	----------------------------

- Charge the 12-V battery. 🛠️ (📖 p. 122)
- Store the vehicle in a dry location that is not subject to large fluctuations in temperature.

### **i** Info

KTМ recommends jacking up the motorcycle.

- Lift the motorcycle with the rear lifting gear. (📖 p. 93)
- Lift the motorcycle with the front lifting gear. (📖 p. 93)
- Cover the motorcycle with a tarp or cover that is permeable to air.

### **i** Info

Do not use non-porous materials since they prevent humidity from escaping, thus causing corrosion. Avoid running the engine for a short time only. Since the engine cannot warm up properly, the water vapor produced during combustion condenses and causes valves and the exhaust system to rust.



## 21.2 Preparing for use after storage

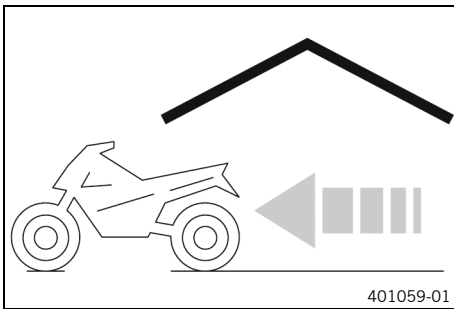

- Take the motorcycle off the front lifting gear. (📖 p. 94)
- Remove the rear of the motorcycle from the lifting gear. (📖 p. 93)
- Install the 12-V battery. 🛠️ (📖 p. 121)



### Info

If the 12-V battery was removed, the time and date must be set.

- Perform checks and maintenance measures when preparing for use. (📖 p. 78)
- Take a test ride.



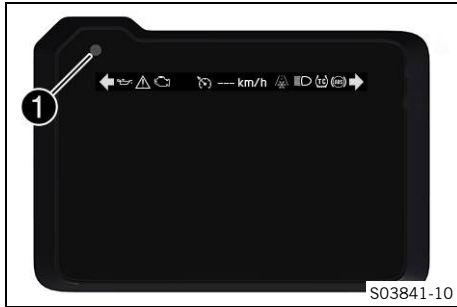

The RACE-ON indicator lamp **1** can indicate errors by flashing. These are indicated up to five seconds after the RACE ON button is actuated.

**i Info**  
Blink codes referring to **KTM RACE ON** are only displayed once and are not repeated.

Faults	Possible cause	Action
No response if the RACE-ON button is pressed	RACE-ON button faulty	<ul style="list-style-type: none"> <li>– Check the RACE-ON button for damage.</li> <li>– Check the cable and the plug of the RACE-ON button for damage.</li> </ul>
RACE-ON indicator lamp flashes twice	No response signal from the RACE-ON key	<ul style="list-style-type: none"> <li>– Ensure that the RACE-ON key is in range.</li> <li>– Remove other electronic devices from the vicinity of the RACE-ON antenna.</li> <li>– Check the battery compartment in the RACE-ON key for correct locking.</li> <li>– Check the battery compartment of the RACE-ON key for corrosion.</li> <li>– Change the RACE-ON key battery. (📖 p. 124)</li> <li>– Use black ignition key.</li> </ul>
RACE-ON indicator lamp flashes three times	12-V battery discharged	<ul style="list-style-type: none"> <li>– Charge the 12-V battery. (📖 p. 122)</li> <li>– Check the open-circuit current. (🔧)</li> </ul>
RACE-ON indicator lamp flashes four times	Steering lock bolt locked or tense	<ul style="list-style-type: none"> <li>– Move handlebar slightly.</li> </ul>
RACE-ON indicator lamp flashes five times	RACE-ON antenna faulty	<ul style="list-style-type: none"> <li>– Check the RACE-ON antenna for damage.</li> </ul>
The combination instrument shows nothing on the display	Fuse 1 is blown	<ul style="list-style-type: none"> <li>– Change the fuses in the fuse box. (📖 p. 126)</li> </ul>
	The main fuse is blown	<ul style="list-style-type: none"> <li>– Change the main fuse. (📖 p. 125)</li> </ul>
	12-V battery discharged	<ul style="list-style-type: none"> <li>– Charge the 12-V battery. (📖 p. 122)</li> <li>– Check the open-circuit current. (🔧)</li> </ul>
Engine does not rotate if the start button/emergency OFF switch is pressed into the lower position	Operating error	<ul style="list-style-type: none"> <li>– Carry out start procedure. (📖 p. 78)</li> </ul>
	12-V battery discharged	<ul style="list-style-type: none"> <li>– Charge the 12-V battery. (📖 p. 122)</li> <li>– Check the open-circuit current. (🔧)</li> </ul>
	Faulty safety starting system	<ul style="list-style-type: none"> <li>– Read out the fault memory using the KTM diagnostics tool. (🔧)</li> </ul>
The engine only turns if the clutch lever is drawn	Electronic fault	<ul style="list-style-type: none"> <li>– Read out the fault memory using the KTM diagnostics tool. (🔧)</li> </ul>
	The vehicle is in gear	<ul style="list-style-type: none"> <li>– Shift the transmission into neutral.</li> </ul>
The engine turns although a gear is engaged	Faulty safety starting system	<ul style="list-style-type: none"> <li>– Read out the fault memory using the KTM diagnostics tool. (🔧)</li> </ul>
	Faulty safety starting system	<ul style="list-style-type: none"> <li>– Read out the fault memory using the KTM diagnostics tool. (🔧)</li> </ul>

Faults	Possible cause	Action
The engine turns but does not start	Quick release coupling not joined	– Join the quick release coupling.
	Malfunction in the electronic fuel injection	– Read out the fault memory using the KTM diagnostics tool. 🛠️
	The fuel quality is insufficient	– Add suitable fuel.
The engine dies during the trip	Lack of fuel	– Refuel. (📖 p. 87)
	Malfunction in the electronic fuel injection	– Read out the fault memory using the KTM diagnostics tool. 🛠️
Malfunction indicator lamp lights up or flashes	Malfunction in the electronic fuel injection	– Read out the fault memory using the KTM diagnostics tool. 🛠️
The ABS warning lamp lights up	ABS fuse blown	– Change the fuses in the fuse box. (📖 p. 126)
	Large difference in wheel speeds of the front and rear wheels	– Stop the vehicle, switch off the ignition, and start it again.
	Malfunction in ABS	– Read out the fault memory using the KTM diagnostics tool. 🛠️
High oil consumption	The engine oil level is too high	– Check the engine oil level. (📖 p. 135)
	The engine oil is too thin (low viscosity)	– Change the engine oil and the oil filter, clean the oil screens. 🛠️ (📖 p. 135)
12-V battery discharged	The hazard warning flasher is switched on	– Switch off the hazard warning flasher. – Charge the 12-V battery. 🛠️ (📖 p. 122)
	The 12-V battery is not being charged by the alternator	– Check the charging voltage. 🛠️
	The ignition was not switched off while the vehicle was parked	– Charge the 12-V battery. 🛠️ (📖 p. 122)

## 23.1 Engine

Design	2-cylinder 4-stroke Otto engine, 75° V arrangement, water-cooled
Displacement	1,301 cm <sup>3</sup> (79.39 cu in)
Stroke	71 mm (2.8 in)
Bore	108 mm (4.25 in)
Compression ratio	13.5:1
Idle speed	1,400 ... 1,600 rpm
Control	DOHC, 4 valves per cylinder, chain-driven
Valve - valve plate diameter	
Intake	42 mm (1.65 in)
Exhaust	34 mm (1.34 in)
Valve clearance	
Intake at: 20 °C (68 °F)	0.10 ... 0.15 mm (0.0039 ... 0.0059 in)
Exhaust at: 20 °C (68 °F)	0.25 ... 0.30 mm (0.0098 ... 0.0118 in)
Crankshaft bearing	Sleeve bearing
Conrod bearing	Sleeve bearing
Piston	Forged light alloy
Piston ring	1 upper compression (rectangular) ring, 1 lower compression ring, 1 oil scraper ring
Engine lubrication	Dry sump lubrication system with 3 trochoidal pumps
Primary transmission	40:76
Clutch	Antihopping clutch in oil bath/hydraulically operated
Transmission	6-gear transmission, claw shifted
Transmission ratio	
1st gear	12:35
2nd gear	15:32
3rd gear	18:30
4th gear	20:27
5th gear	24:27
6th gear	27:26
Mixture preparation	Electronic fuel injection
Ignition system	Contactless controlled fully electronic ignition with digital ignition adjustment
Alternator	12 V, 450 W
Spark plug	
Inside spark plug	NGK LMAR7DI-10
Outside spark plug	NGK LKAR9DI-10
Electrode gap, spark plug	1 mm (0.04 in)
Cooling	Water cooling, permanent circulation of coolant by water pump
Cold start device	Starter motor

**23.2 Engine tightening torques**



Screw, damping plate	<b>EJOT Altracs®</b> M6x14	10 Nm (7.4 lbf ft) <b>Loctite®243™</b>
Screw, retaining bracket, valve cover, rear	<b>EJOT®</b> M6x12	8 Nm (5.9 lbf ft)
Hose clip, intake flange	M4	1.5 Nm (1.11 lbf ft)
Oil nozzle	M5	2 Nm (1.5 lbf ft) <b>Loctite®243™</b>
Remaining engine screws	M5	6 Nm (4.4 lbf ft)
Screw, bearing retainer	M5	5 Nm (3.7 lbf ft) <b>Loctite®243™</b>
Screw, bearing shells retaining bracket	M5	6 Nm (4.4 lbf ft) <b>Loctite®243™</b>
Screw, cable duct on the engine fixing arm	M5	5 Nm (3.7 lbf ft)
Screw, crankshaft speed sensor	M5	6 Nm (4.4 lbf ft) <b>Loctite®243™</b>
Screw, engine oil level viewer	M5	4 Nm (3 lbf ft) <b>Loctite®243™</b>
Screw, gear position sensor	M5	5 Nm (3.7 lbf ft) <b>Loctite®243™</b>
Screw, oil filter cover	M5	6 Nm (4.4 lbf ft)
Screw, resonator	M5	8 Nm (5.9 lbf ft) <b>Loctite®243™</b>
Screw, shift shaft sensor	M5	5 Nm (3.7 lbf ft) <b>Loctite®243™</b>
Screw, swingarm sensor	M5x12 – 8.8	5 Nm (3.7 lbf ft) <b>Loctite®243™</b>
Bleeder screw, cylinder head	M6	6 Nm (4.4 lbf ft)
Bleeder screw, water pump cover	M6	10 Nm (7.4 lbf ft)
Coolant connection screw on the cylinder head	M6	8 Nm (5.9 lbf ft) <b>Loctite®243™</b>
Freewheel ring bolt	M6 – 10.9	15 Nm (11.1 lbf ft) <b>Loctite® 648™</b>
Nut, cylinder head	M6	8 Nm (5.9 lbf ft)
Nut, starter cable	M6	4 Nm (3 lbf ft)
Remaining engine screws	M6	10 Nm (7.4 lbf ft)
Screw, alternator cover	M6	10 Nm (7.4 lbf ft)
Screw, camshaft bearing support	M6 – 10.9	10 Nm (7.4 lbf ft)
Screw, clutch cover	M6	10 Nm (7.4 lbf ft)
Screw, clutch spring	M6	12 Nm (8.9 lbf ft)
Screw, engine case	M6x60	10 Nm (7.4 lbf ft)
Screw, engine case	M6x80	10 Nm (7.4 lbf ft)
Screw, engine case	M6x90	10 Nm (7.4 lbf ft)
Screw, guide rail	M6	10 Nm (7.4 lbf ft) <b>Loctite®243™</b>
Screw, ignition coil	M6	8 Nm (5.9 lbf ft)

Screw, kickstarter gear support	M6	10 Nm (7.4 lbf ft) <b>Loctite®243™</b>
Screw, locking lever	M6	10 Nm (7.4 lbf ft) <b>Loctite®243™</b>
Screw, oil filler hose	M6	10 Nm (7.4 lbf ft) <b>Loctite®243™</b>
Screw, oil pump cover	M6	10 Nm (7.4 lbf ft) <b>Loctite®243™</b>
Screw, oil/water heat exchanger	M6	10 Nm (7.4 lbf ft) <b>Loctite®243™</b>
Screw, secondary air system	M6	10 Nm (7.4 lbf ft)
Screw, shift drum locating unit	M6 – 12.9	15 Nm (11.1 lbf ft) <b>Loctite®243™</b>
Screw, shift lever	M6	18 Nm (13.3 lbf ft)
Screw, starter motor	M6	10 Nm (7.4 lbf ft)
Screw, stator	M6	10 Nm (7.4 lbf ft) <b>Loctite®243™</b>
Screw, tube for oil/water heat exchanger	M6	10 Nm (7.4 lbf ft) <b>Loctite®243™</b>
Screw, valve cover	M6	10 Nm (7.4 lbf ft)
Screw, water pump cover	M6	10 Nm (7.4 lbf ft)
Screw, water pump wheel	M6	10 Nm (7.4 lbf ft) <b>Loctite®243™</b>
Stud, timing chain shaft	M6	3 Nm (2.2 lbf ft)
Vacuum connection	M6	2.5 Nm (1.84 lbf ft) <b>Loctite®243™</b>
Nozzle 100	M6x0.75	3 Nm (2.2 lbf ft) <b>Loctite®243™</b>
Oil nozzle for clutch lubrication	M6x0.75	2 Nm (1.5 lbf ft)
Crankshaft locking bolt	M8	12 Nm (8.9 lbf ft)
Screw, camshaft bearing support	M8 – 10.9	Step 1 10 Nm (7.4 lbf ft) Step 2 18 Nm (13.3 lbf ft)
Screw, camshaft bearing support	M8 – 10.9	Step 1 8.5 Nm (6.27 lbf ft) Step 2 14.5 Nm (10.7 lbf ft) Only applies when using: Hexagon socket bit (61229025000)
Screw, engine case	M8	18 Nm (13.3 lbf ft)
Screw, guide rail	M8	15 Nm (11.1 lbf ft) <b>Loctite®243™</b>
Screw, tensioning rail	M8	15 Nm (11.1 lbf ft) <b>Loctite®243™</b>
Stud, exhaust flange	M8	10 Nm (7.4 lbf ft)
Screw, engine bearer	M10	45 Nm (33.2 lbf ft)
Oil pressure sensor	M10x1	15 Nm (11.1 lbf ft)
Screw plug, cam lever axis	M10x1	12 Nm (8.9 lbf ft)

Screw plug, clutch lubrication	M10x1	8 Nm (5.9 lbf ft)
Screw plug, spreading transmission lock	M10x1	12 Nm (8.9 lbf ft)
Screw, conrod bearing	M10x1	Step 1 25 Nm (18.4 lbf ft) Step 2 30 Nm (22.1 lbf ft) Step 3 90°
Screw, unlocking of timing chain tensioner	M10x1	8 Nm (5.9 lbf ft)
Spark plug outside	M10x1	11 Nm (8.1 lbf ft)
Coolant temperature sensor	M10x1.25	12 Nm (8.9 lbf ft)
Cylinder head screw	M11x1.5	Tightening sequence: Using a crisscross pattern Step 1 15 Nm (11.1 lbf ft) Step 2 30 Nm (22.1 lbf ft) Step 3 90° Step 4 90°  Lubricated with engine oil
Screw, shock absorber bell crank	M12	80 Nm (59 lbf ft)
Screw, swingarm deflector	M12x90	80 Nm (59 lbf ft)
Rotor screw	M12x1.5	115 Nm (84.8 lbf ft)
Spark plug inside	M12x1.5	18 Nm (13.3 lbf ft)
Nut of engine sprocket	M20x1.5	100 Nm (73.8 lbf ft) <b>Loctite®243™</b>
Oil drain plug	M20x1.5	20 Nm (14.8 lbf ft)
Nut, inner clutch hub	M22x1.5	140 Nm (103.3 lbf ft)
Plug, timing-chain tensioner	M24x1.5	25 Nm (18.4 lbf ft)
Screw plug, alternator cover	M24x1.5	8 Nm (5.9 lbf ft)
Nut, primary gear wheel	M33LHx1.5	130 Nm (95.9 lbf ft) <b>Loctite®243™</b>

## 23.3 Capacities

### 23.3.1 Engine oil

Engine oil Ambient temperature: $\geq 0$ °C ( $\geq 32$ °F)	3.50 l (3.7 qt.)	Engine oil (SAE 10W/50) (  p. 159)
Engine oil Ambient temperature: $< 0$ °C ( $< 32$ °F)		Engine oil (SAE 5W/40) (  p. 160)

### 23.3.2 Coolant

Coolant	3.20 l (3.38 qt.)	Coolant (  p. 159)
---------	-------------------	-------------------------------------------------------------------------------------------------------

## 23.3.3 Fuel

Total fuel tank capacity, approx.	16 l (4.2 US gal)	Super unleaded (ROZ 95) (📖 p. 160)
Fuel reserve, approx.	3.5 l (3.7 qt.)	

## 23.4 Chassis

Frame	Lattice frame made of chrome molybdenum steel tubing, powder-coated	
Fork	<b>WP Suspension</b> <b>Semi-active Suspension</b>	
Shock absorber	<b>WP Suspension</b> <b>Semi-active Suspension</b>	
Suspension travel		
front	125 mm (4.92 in)	
rear	140 mm (5.51 in)	
Brake system		
front	Double disc brake with radially mounted four-piston brake calipers, floating brake discs	
rear	Single disc brake with dual-piston brake caliper, fixed brake disc	
Brake discs - diameter		
front	320 mm (12.6 in)	
rear	240 mm (9.45 in)	
Brake discs - wear limit		
front	4.5 mm (0.177 in)	
rear	4.5 mm (0.177 in)	
Tire pressure when solo		
front: with cold tires	2.5 bar (36 psi)	
rear: with cold tires	2.5 bar (36 psi)	
Secondary drive ratio	17:38	
Chain	5/8 x 5/16" (525) X-ring	
Steering head angle	65.2°	
Wheelbase	1,497 mm (58.94 in)	
Seat height unloaded	835 mm (32.87 in)	
Ground clearance unloaded	160 mm (6.3 in)	
Weight without fuel approx.	198 kg (437 lb.)	
Maximum permissible front axle load	165 kg (364 lb.)	
Maximum permissible rear axle load	260 kg (573 lb.)	
Maximum permissible overall weight	425 kg (937 lb.)	



**23.5 Electrical system**

12-V battery	YTX14-BS	Battery voltage: 12 V Nominal capacity: 12 Ah Maintenance-free
RACE-ON key battery	CR 2032	3 V
Fuse	58011109110	10 A
Fuse	58011109115	15 A
Fuse	58011109125	25 A
Fuse	58011109130	30 A
Low beam/high beam	LED	
Daytime running light/position light	LED	
Combination instrument lighting and indicator lamps	LED	
Turn signal	RY10W / socket BAU15s	12 V 10 W
Tail light	LED	
Brake light	LED	
License plate lamp	LED	

**23.6 Tires**

Front tire	Rear tire
<b>120/70 ZR 17 M/C (58W) TL</b> Bridgestone Battlax Hypersport S22 F	<b>200/55 ZR 17 M/C (78W) TL</b> Bridgestone Battlax Hypersport S22 R
The tires specified represent one of the possible series production tires. Additional information is available in the Service section under: KTM.COM	

**23.7 Fork**

Fork article number	0641C122V407000	
Fork	<b>WP Suspension Semi-active Suspension</b>	
Spring length with preload spacer(s)	336 mm (13.23 in)	
Spring rate		
Medium (standard)	18 N/mm (103 lb/in)	
Fork length	753 mm (29.65 in)	
Fork oil, fork leg, left	615 ml (20.79 fl. oz.)	Fork oil (SAE 4) (48601166S1) (📖 p. 160)
Fork oil, fork leg, right	390 ml (13.19 fl. oz.)	Fork oil (SAE 4) (48601166S1) (📖 p. 160)

## 23.8 Shock absorber

Shock absorber article number	0641C422V307000
Shock absorber	<b>WP SuspensionSemi-active Suspension</b>
Spring rate	
Medium (standard)	85 N/mm (485 lb/in)
Spring length	195 mm (7.68 in)
Static sag	20 mm (0.79 in)
Fitted length	356 mm (14.02 in)

## 23.9 Chassis tightening torques

Brake fluid reservoir for front brake cover	-	1 Nm (0.7 lbf ft)
Brake fluid reservoir for rear brake cover	-	3.5 Nm (2.58 lbf ft)
Remaining screws, chassis	<b>EJOT PT®</b> K50x12	1 Nm (0.7 lbf ft)
Remaining screws, chassis	<b>EJOT PT®</b> K50x14	1 Nm (0.7 lbf ft)
Remaining screws, chassis	<b>EJOT PT®</b> K50x16	2 Nm (1.5 lbf ft)
Remaining screws, chassis	<b>EJOT PT®</b> K50x18	2 Nm (1.5 lbf ft)
Remaining screws, chassis	<b>EJOT PT®</b> K45x12	1 Nm (0.7 lbf ft)
Screw, air filter box cover	<b>EJOT PT®</b> K60x30	2.5 Nm (1.84 lbf ft)
Screw, ball head holder on headlight	<b>EJOT ALtracs®</b> 50x12	7 Nm (5.2 lbf ft)
Screw, intake air temperature sensor	<b>EJOT PT®</b> K50x16	2 Nm (1.5 lbf ft)
Screw, radiator fan cover	<b>EJOT DELTA PT®</b> 40x46/10	1 Nm (0.7 lbf ft)
Screw, SAS on air filter box	<b>EJOT PT®</b> K50x16	2 Nm (1.5 lbf ft)
Screw, tail light	<b>EJOT PT®</b> K50x14	2.5 Nm (1.84 lbf ft)
Screw, fixed grip, left	M4	3 Nm (2.2 lbf ft)
Screw, side stand sensor	M4	2 Nm (1.5 lbf ft)
Remaining nuts, chassis	M5	5 Nm (3.7 lbf ft)
Remaining screws, chassis	M5	5 Nm (3.7 lbf ft)
Screw for throttle grip	M5	3.5 Nm (2.58 lbf ft)
Screw, 6D sensor holder	M5	2.7 Nm (1.99 lbf ft)
		<b>Loctite®243™</b>
screw, absorbing element, combination instrument	M5	2 Nm (1.5 lbf ft)
		<b>Loctite®243™</b>
Screw, cable channel	M5	5 Nm (3.7 lbf ft)
Screw, chain sliding guard	M5	5 Nm (3.7 lbf ft)
Screw, combination instrument	M5	1 Nm (0.7 lbf ft)
Screw, combination switch, left	M5	5 Nm (3.7 lbf ft)
Screw, combination switch, right	M5	5 Nm (3.7 lbf ft)
Screw, front turn signal bracket	M5	3.5 Nm (2.58 lbf ft)
Screw, fuel level sensor	M5	3 Nm (2.2 lbf ft)
Screw, fuel tank filler cap	M5	3 Nm (2.2 lbf ft)
Screw, fuel tank spoiler	M5	2.5 Nm (1.84 lbf ft)

Screw, fuse box support	M5	6 Nm (4.4 lbf ft)	
Screw, headlight locking cap	M5	3.5 Nm (2.58 lbf ft)	
Screw, heat protector on main silencer	M5	4 Nm (3 lbf ft)	
Screw, injection valve	M5	4 Nm (3 lbf ft)	<b>Loctite®243™</b>
Screw, intake trumpet	M5	6 Nm (4.4 lbf ft)	
Screw, radiator fan cover	M5	3.5 Nm (2.58 lbf ft)	
Screw, rear turn signal bracket	M5	3.5 Nm (2.58 lbf ft)	
Screw, trim	M5	3.5 Nm (2.58 lbf ft)	
Screw, wiring harness holding bracket	M5	3.5 Nm (2.58 lbf ft)	
Cable disk nut, exhaust valve control unit	M6	14 Nm (10.3 lbf ft)	
Ground fitting on frame	M6	10 Nm (7.4 lbf ft)	
Nut, cable on starter motor	M6	4 Nm (3 lbf ft)	
Remaining nuts, chassis	M6	10 Nm (7.4 lbf ft)	
Remaining screws, chassis	M6	10 Nm (7.4 lbf ft)	
Screw, 6D sensor	M6	6 Nm (4.4 lbf ft)	
Screw, ABS module fastening	M6	8 Nm (5.9 lbf ft)	
Screw, ball joint of push rod on foot brake cylinder	M6	5 Nm (3.7 lbf ft)	<b>Loctite®243™</b>
Screw, battery holder	M6	6 Nm (4.4 lbf ft)	
Screw, battery terminal	M6	4.5 Nm (3.32 lbf ft)	
Screw, cable on starter relay	M6	6 Nm (4.4 lbf ft)	
Screw, clutch assembly	M6	5 Nm (3.7 lbf ft)	<b>Loctite®243™</b>
Screw, cooler retaining bracket	M6	7 Nm (5.2 lbf ft)	
Screw, engine sprocket cover	M6	8 Nm (5.9 lbf ft)	
Screw, exhaust clamp on main silencer	M6	10 Nm (7.4 lbf ft)	
Screw, foot brake cylinder	M6	10 Nm (7.4 lbf ft)	<b>Loctite®243™</b>
Screw, front fuel tank	M6	8 Nm (5.9 lbf ft)	
Screw, front wheel speed sensor	M6	4 Nm (3 lbf ft)	
Screw, fuel pump	M6	6 Nm (4.4 lbf ft)	
Screw, fuel tank bridge	M6	8 Nm (5.9 lbf ft)	
Screw, fuel tank cover	M6	5 Nm (3.7 lbf ft)	
Screw, fuel tank spoiler	M6	6 Nm (4.4 lbf ft)	
Screw, fuse box support	M6	6 Nm (4.4 lbf ft)	
Screw, headlight on retaining bracket	M6	5 Nm (3.7 lbf ft)	
Screw, instrument support	M6	2 Nm (1.5 lbf ft)	
Screw, license plate holder on lower rear panel	M6	8 Nm (5.9 lbf ft)	
Screw, presilencer exhaust clamp	M6	10 Nm (7.4 lbf ft)	
Screw, radiator bracket	M6	5 Nm (3.7 lbf ft)	

Screw, radiator hose clip	M6	3 Nm (2.2 lbf ft)	
Screw, rear wheel speed sensor	M6	4 Nm (3 lbf ft)	
Screw, seat lock	M6	5 Nm (3.7 lbf ft)	<b>Loctite®243™</b>
Screw, shift lever stub	M6	10 Nm (7.4 lbf ft)	
Screw, shift rod	M6	5 Nm (3.7 lbf ft)	<b>Loctite®243™</b>
Screw, shift shaft deflector on shift shaft	M6	18 Nm (13.3 lbf ft)	<b>Loctite®243™</b>
Screw, steering damper bracket on frame	M6	8 Nm (5.9 lbf ft)	<b>Loctite®243™</b>
Screw, step plate for foot brake lever	M6	10 Nm (7.4 lbf ft)	
Screw, voltage regulator	M6	6 Nm (4.4 lbf ft)	
Nut, exhaust valve throttle cable	M6x1	5 Nm (3.7 lbf ft)	
Cable disk nut, exhaust valve	M8	7 Nm (5.2 lbf ft)	
Nut, rear sprocket	M8	36 Nm (26.6 lbf ft)	<b>Loctite®243™</b>
Nut, shift rod	M8	12 Nm (8.9 lbf ft)	
Nut, valve	M8	6 Nm (4.4 lbf ft)	<b>Loctite®243™</b>
Remaining nuts, chassis	M8	25 Nm (18.4 lbf ft)	
Remaining screws, chassis	M8	25 Nm (18.4 lbf ft)	
Screw, axle clamp	M8	15 Nm (11.1 lbf ft)	
Screw, bottom triple clamp	M8	15 Nm (11.1 lbf ft)	
Screw, cross connector on lower rear panel	M8	15 Nm (11.1 lbf ft)	<b>Loctite®243™</b>
Screw, foot brake lever	M8	20 Nm (14.8 lbf ft)	<b>Loctite®243™</b>
Screw, front brake disc	M8	28 Nm (20.7 lbf ft)	<b>Loctite®2701™</b>
Screw, front rider footrest bracket	M8	25 Nm (18.4 lbf ft)	<b>Loctite®243™</b>
Screw, handlebar clamp	M8	20 Nm (14.8 lbf ft)	
Screw, ignition lock (tamper-proof screw)	M8	25 Nm (18.4 lbf ft)	
Screw, passenger footrest unit	M8x25	25 Nm (18.4 lbf ft)	<b>Loctite®243™</b>
Screw, passenger footrest unit	M8x35	25 Nm (18.4 lbf ft)	<b>Loctite®243™</b>
Screw, presilencer	M8	25 Nm (18.4 lbf ft)	<b>Loctite®243™</b>
Screw, rear brake caliper	M8	25 Nm (18.4 lbf ft)	<b>Loctite®2701™</b>
Screw, rear brake disc	M8	28 Nm (20.7 lbf ft)	<b>Loctite®243™</b>
Screw, shift lever on footrest bracket	M8	20 Nm (14.8 lbf ft)	<b>Loctite®243™</b>

Screw, side stand bracket	M8	25 Nm (18.4 lbf ft) <b>Loctite®243™</b>
Screw, side stand spring	M8	15 Nm (11.1 lbf ft) <b>Loctite®2701™</b>
Screw, steering damper on triple clamp	M8	8 Nm (5.9 lbf ft) <b>Loctite®243™</b>
Screw, steering stem clamp	M8	20 Nm (14.8 lbf ft) <b>Loctite®243™</b>
Screw, subframe	M8	35 Nm (25.8 lbf ft) <b>Loctite®243™</b>
Screw, subframe brace	M8	25 Nm (18.4 lbf ft) <b>Loctite®243™</b>
Screw, subframe metal flange	M8	25 Nm (18.4 lbf ft) <b>Loctite®243™</b>
Screw, top triple clamp	M8	18 Nm (13.3 lbf ft)
Remaining nuts, chassis	M10	45 Nm (33.2 lbf ft)
Remaining screws, chassis	M10	45 Nm (33.2 lbf ft)
Screw, engine bearer	M10	45 Nm (33.2 lbf ft) <b>Loctite®243™</b>
Screw, front brake caliper	M10	45 Nm (33.2 lbf ft) <b>Loctite®243™</b>
Screw, handlebar support	M10	40 Nm (29.5 lbf ft) <b>Loctite®243™</b>
Screw, side stand	M10	40 Nm (29.5 lbf ft) <b>Loctite®243™</b>
Screw, side stand bracket	M10	55 Nm (40.6 lbf ft) <b>Loctite®243™</b>
Banjo bolt, brake line	M10x1	25 Nm (18.4 lbf ft)
Banjo bolt, brake line, connecting piece, rear	M10x1	25 Nm (18.4 lbf ft)
Nut, rear hub shock absorber carrier	M10x1.25	45 Nm (33.2 lbf ft) <b>Loctite®243™</b>
Screw, bottom shock absorber	M12	80 Nm (59 lbf ft) <b>Loctite®243™</b>
Screw, brake caliper support	M12	28 Nm (20.7 lbf ft)
Screw, side stand bracket	M12	80 Nm (59 lbf ft) <b>Loctite®243™</b>
Screw, top shock absorber	M12	80 Nm (59 lbf ft) <b>Loctite®243™</b>
Screw, triangular lever on link fork	M12	80 Nm (59 lbf ft) <b>Loctite®243™</b>
Lambda sensor	M12x1.25	24.5 Nm (18.07 lbf ft)
Screw, eccentric	M16	70 Nm (51.6 lbf ft)
Nut, fork pivot	M19x1.5	130 Nm (95.9 lbf ft) Thread greased
Screw, shock absorber support	M20x1.5	10 Nm (7.4 lbf ft) Thread and fitting greased
Screw, steering head, top	M20x1.5	12 Nm (8.9 lbf ft)
Nut, seat lock	M22x1.5	3 Nm (2.2 lbf ft)

## 23 TECHNICAL DATA

Screw, front wheel spindle	M25x1.5	45 Nm (33.2 lbf ft) Thread greased
Nut, rear axle, shock absorber side	M35x1.5	200 Nm (147.5 lbf ft) <b>Loctite® 262™</b> /lock the locking wire with locking varnish
Nut, rear axle	M50x1.5	250 Nm (184.4 lbf ft) Thread greased/lock locking wire with locking varnish

## 24.1 Declarations of conformity

### Info

The functional and equipment scope is model-dependent and may not include all wireless systems and application areas referred to.

#### **Connectivity Control Unit "CCU-2"**

FCC ID: 2AOW7-K001

IC: 5966A-K001

#### **KTM RACE ON system - Active Key**

FCC ID: VFZKLGKZADIO1

IC: 22239-KLGKZADIO1

#### **KTM RACE ON system - Main Unit**

FCC ID: VFZKLGKZADIO1

IC: 22239-KLGMZADIO1

#### **Tyre Pressure Monitoring System - Receiver "MC34MA4"**

FCC ID: MRXMC34MA4

IC: 2546A-MC34MA4

#### **Tyre Pressure Monitoring System - Sensor "RDC3"**

FCC ID: MRXRDC3

IC: 2546A-RDC3

#### **Declaration regarding modifications**

Alterations and modifications not expressly approved by the relevant authority may result in the user being prohibited from operating the equipment.

#### **Declaration regarding interference**

This device fulfills Part 15 of the FCC regulations as well as the license-free RSS standards of the Canadian Government Department **Industry Canada**.

Operation is subject to the following two conditions:

- 1 This device must not cause interference.
- 2 This device must be able to absorb any interference, including interference that potentially causes undesirable operation of the device.

#### **Note on radio transmissions**

This device corresponds to the FCC limit values for radiation exposure, which have been determined for a non-controlled environment, and fulfills the FCC guidelines for the load from radio frequencies.

The transmitter must not be set up near to other antennas or transmitters or operated in conjunction with other antennas or transmitters.

#### **Note on digital devices of Class B according to the FCC regulations**

This device has been tested and fulfills the limit values for digital devices of Class B according to the FCC regulations, Part 15.

These limit values are designed so as to provide sufficient protection from harmful interference in residential areas.

Devices of this type generate and use high frequencies and can also emit these. Therefore, if they are not installed and operated in accordance with the instructions, they may cause harmful interference to radio reception. However, there is no guarantee that interference will not occur in certain cases of application. Should this device cause harmful interference to radio or television reception, (check this by switching the device on and off), you can potentially eliminate this interference as follows:

## 24 DECLARATIONS OF CONFORMITY

- Re-align the receiving antenna.
- Increase the separation between device and radio receiver.
- Connect the device and the radio receiver to separate electric circuits.
- Consult your dealer or a radio/TV technician.

**CAN ICES-3 (B) / NMB-3 (B)**

This digital device of Class B fulfills the regulations in accordance with the Canadian Interference-Causing Equipment Standard ICES-003 / NMB-003.



**Brake fluid DOT 4 / DOT 5.1****Standard/classification**

- DOT

**Guideline**

- Use only brake fluid that complies with the specified standard (see specifications on the container) and that exhibits the corresponding properties.

**Recommended supplier****Castrol**

- **REACT PERFORMANCE DOT 4**

**MOTOREX®**

- **Brake Fluid DOT 5.1**

**Coolant****Guideline**

- Only use high-grade, silicate-free coolant with corrosion inhibitor additive for aluminum motors. Low grade and unsuitable antifreeze causes corrosion, deposits and frothing.
- Do not use pure water as only coolant is able to meet the requirements needed in terms of corrosion protection and lubrication properties.
- Only use coolant that complies with the requirements stated (see specifications on the container) and that has the relevant properties.

Antifreeze protection to at least	-25 °C (-13 °F)
-----------------------------------	-----------------

The mixture ratio must be adjusted to the necessary antifreeze protection. Use distilled water if the coolant needs to be diluted.

The use of premixed coolant is recommended.

Observe the coolant manufacturer specifications for antifreeze protection, dilution and miscibility (compatibility) with other coolants.

**Recommended supplier****MOTOREX®**

- **COOLANT M3.0**

**Engine oil (SAE 10W/50)****Standard/classification**

- JASO T903 MA2 (📖 p. 162)
- SAE (📖 p. 162) (SAE 10W/50)

**Guideline**

- Use only engine oils that comply with the specified standards (see specifications on the container) and that possess the corresponding properties.

Fully synthetic engine oil
----------------------------

**Recommended supplier****MOTOREX®**

- **Power Synt 4T**

## Engine oil (SAE 5W/40)

### Standard/classification

- JASO T903 MA2 (📖 p. 162)
- SAE (📖 p. 162) (SAE 5W/40)

### Guideline

- Use only engine oils that comply with the specified standards (see specifications on the container) and that possess the corresponding properties.

Fully synthetic engine oil

### Recommended supplier

**MOTOREX®**

- Power Synt 4T

## Fork oil (SAE 4) (48601166S1)

### Standard/classification

- SAE (📖 p. 162) (SAE 4)

### Guideline

- Use only oils that comply with the specified standards (see specifications on the container) and that exhibit the corresponding properties.

## Super unleaded (ROZ 95)

### Standard/classification

- DIN EN 228 (ROZ 95)

### Guideline

- Only use super unleaded fuel that matches or is equivalent to the specified standard.
- Fuel with an ethanol content of up to 10% (E10 fuel) is safe to use.



### Info

Do **not** use fuel containing methanol (e.g., M15, M85, M100) or more than 10% ethanol (e.g., E15, E25, E85, E100).

**Chain cleaner**

Recommended supplier  
MOTOREX®  
– Chain Clean

**Fuel additive**

Recommended supplier  
MOTOREX®  
– Fuel Stabilizer

**Long-life grease**

Recommended supplier  
MOTOREX®  
– Bike Grease 2000

**Motorcycle cleaner**

Recommended supplier  
MOTOREX®  
– Moto Clean

**Perfect finish and high gloss polish for paints**

Recommended supplier  
MOTOREX®  
– Moto Shine

**Preserving materials for paints, metal and rubber**

Recommended supplier  
MOTOREX®  
– Moto Protect

**Special cleaner for glossy and matte paint finishes, metal and plastic surfaces**

Recommended supplier  
MOTOREX®  
– Quick Cleaner

**Street chain spray**

Guideline  
Recommended supplier  
MOTOREX®  
– Chainlube Road Strong

**Universal oil spray**

Recommended supplier  
MOTOREX®  
– Joker 440 Synthetic

### **JASO T903 MA2**

Different technical development directions required a separate specification for motorcycles – the **JASO T903 MA2** standard.

Earlier, engine oils from the automobile industry were used for motorcycles because there was no separate motorcycle specification.

Whereas long service intervals are demanded for automobile engines, the focus for motorcycle engines is on high performance at high engine speeds.

In most motorcycle engines, the transmission and clutch are lubricated with the same oil.

The **JASO T903 MA2** standard meets these special requirements.

### **SAE**

The SAE viscosity classes were defined by the Society of Automotive Engineers and are used for classifying oils according to their viscosity. The viscosity describes only one property of oil and says nothing about quality.

ABS	Anti-lock braking system	Safety system that prevents locking of the wheels when driving straight ahead without the influence of lateral forces
ATIR	Automatic Turn Indicator Reset	Software, which automatically switches the indicator off according to a time or travel distance counter
DRL	Daytime Running Light	Light, which enhances the visibility of the vehicle during the day but is not focused, and in contrast to low beam does not illuminate the road surface
ETTC	Engine traction torque control	Auxiliary function of the engine control, which prevents rear wheel locking with excessive engine braking effect, by lightly opening the throttle valve
-	KTM RACE ON	System that releases the ignition, steering lock, and fuel tank filler cap via a remote key with a transponder
-	Launch control	Vehicles electronics functions for achieving the best possible acceleration from a standing position
MSC	Motorcycle stability control	This is an auxiliary function for the ABS, which can prevent locking and slipping of the wheels during braking while leaning at an angle, within physical limitations
MTC	Motorcycle Traction Control	Auxiliary function of the motor control that reduces engine torque with spinning rear wheel
OBD	On-board diagnosis	Vehicle system, which monitors the specified parameters of the vehicle electronics
-	Quickshifter +	Engine electronics function for shifting up and down without clutch actuation
TPMS	Tire pressure monitoring system	A safety system that monitors the tire pressure with the assistance of sensors in the tires and displays it to the rider

## 29 LIST OF ABBREVIATIONS

Art. no.	Article number
ca.	circa
cf.	compare
e.g.	for example
etc.	et cetera
i.a.	inter alia
no.	number
poss.	possibly







### 30.1 Red symbols

Red symbols indicate an error condition that requires immediate intervention.

	The oil pressure warning lamp lights up red – The oil pressure is too low. Stop immediately, taking care not to endanger yourself or other road users in the process, and switch off the engine.
-----------------------------------------------------------------------------------	--------------------------------------------------------------------------------------------------------------------------------------------------------------------------------------------------





### 30.2 Yellow and orange symbols

Yellow and orange symbols indicate an error condition that requires prompt intervention. Active driving aids are also represented by yellow or orange symbols.

	RACE-ON indicator lamp lights up/flashes yellow/red – Status or error messages relating to Race-on system/alarm system.
	The general warning lamp lights up yellow – A note/warning note on operating safety has been detected. This is also shown in the display.
	The ABS warning lamp lights up yellow – Status or error messages relating to ABS. When ABS <b>Supermoto</b> mode is activated, SM is shown in the display.
	TC indicator lamp lights up/flashes yellow – The <b>MTC</b> (p. 133) is not active, is currently intervening or a Launch Control Start is being executed. The TC indicator lamp also lights up if a malfunction is detected. Contact an authorized KTM workshop. The TC indicator lamp flashes if the motorcycle traction control actively engages.
	The cruise control system indicator lamp lights up yellow – The cruise control system function is switched on, but cruise control is not activated.
	The malfunction indicator lamp lights up yellow – The OBD has detected a malfunction in the vehicle electronics.

### 30.3 Green and blue symbols

Green and blue symbols reflect information.

	The left turn signal indicator lamp flashes green with a steady rhythm – The left turn signal is switched on.
	The high beam indicator lamp lights up blue – The high beam is switched on.
	The cruise control system indicator lamp lights up green – The cruise control system function is switched on and cruise control is activated.
	The right turn signal indicator lamp flashes green with a steady rhythmic flash – The right turn signal is switched on.

<b>+</b>		
<b>+RES/-SET button</b>		
operation	.....	22
<b>1</b>		
<b>12-V battery</b>		
charging	.....	122
installing	.....	121
removing	.....	120
<b>A</b>		
<b>ABS</b>	.....	107
<b>ACC1</b>		
front	.....	130
rear	.....	130
<b>ACC2</b>		
front	.....	130
rear	.....	130
<b>Anti Dive (optional)</b>	.....	57
<b>Anti wheelie mode</b>	.....	134
<b>Anti-lock braking system</b>	.....	107
<b>Applying the brakes</b>	.....	84
<b>Auxiliary substances</b>	.....	14
<b>B</b>		
<b>Brake discs</b>		
checking	.....	108
<b>Brake fluid</b>		
front brake, adding	.....	109
of rear brake, adding	.....	111
<b>Brake fluid level</b>		
front brake, checking	.....	109
rear brake, checking	.....	111
<b>Brake linings</b>		
front brake, checking	.....	110
rear brake, checking	.....	113
<b>Brake system</b>	.....	107-113
<b>Brakes</b>	.....	84
<b>Breakdown</b>		
towing	.....	87
<b>C</b>		
<b>C1 and C2 switch</b>	.....	24
<b>Capacity</b>		
Coolant	.....	149
engine oil	.....	137, 149
fuel	.....	88, 150
<b>Chain</b>		
checking	.....	104
cleaning	.....	101
dirt, checking for	.....	101
<b>Chain guide</b>		
checking	.....	104
<b>Chain tension</b>		
adjusting	.....	103
checking	.....	102
<b>Clutch</b>		
fluid level, checking/correcting	.....	105
<b>Clutch lever</b>	.....	19
basic position, adjusting	.....	70
<b>Combination instrument</b>	.....	29-68
<b>ABS</b>	.....	55
<b>ABS display</b>	.....	38
activation and test	.....	29
adjusting tilt	.....	73
ambient air temperature indicator	.....	41
<b>Anti Dive (optional)</b>	.....	57
<b>Anti Dive display</b>	.....	39
<b>Anti Wheelie Mode</b>	.....	52
<b>Audio</b>	.....	43
<b>Bluetooth</b>	.....	59
<b>Button Illumination</b>	.....	60
C1 and C2 buttons	.....	58
<b>Consumption</b>	.....	63
coolant temperature indicator	.....	41
cruise control indicator	.....	38
<b>Damp display</b>	.....	39
<b>Damping</b>	.....	56
day-night mode	.....	30
<b>Daytime Runn. Light</b>	.....	61
display	.....	33
<b>Display Theme</b>	.....	59
<b>Distance</b>	.....	62
engine speed	.....	37
<b>Extra Functions</b>	.....	50
FAVORITES widget	.....	66
<b>Favorites display</b>	.....	42
<b>Fork (optional)</b>	.....	57
<b>Fork display</b>	.....	39
fuel level display	.....	41
gear display	.....	40
<b>General Info</b>	.....	48
<b>Headset Type</b>	.....	59
heated grip (optional)	.....	40
<b>Heated Grips (optional)</b>	.....	54, 64
<b>Heated Seat (optional)</b>	.....	54, 64
HEATING widget	.....	67
ice warning	.....	31
indicator lamps	.....	32
KTM MY RIDE widget	.....	65
<b>KTM MY RIDE</b>	.....	43
<b>Language</b>	.....	64
large widget	.....	36, 65
<b>Launch Control</b>	.....	52



<b>Load display</b> . . . . .	39
menu . . . . .	42
<b>Motorcycle</b> . . . . .	53
<b>MTC+MSR</b> (optional) . . . . .	54
MUSIC widget . . . . .	68
Navigation . . . . .	44
Navigation information . . . . .	44
NAVIGATION widget . . . . .	66
<b>Navigation display</b> . . . . .	42
odometer . . . . .	37
overview . . . . .	29
<b>Pairing</b> . . . . .	46
performance layout (optional) . . . . .	35
<b>Preload Adjuster</b> . . . . .	56, 91
<b>Pressure</b> . . . . .	63
<b>Quickshifter +</b> (optional) . . . . .	55
<b>Ride display</b> . . . . .	38
<b>Ride Mode</b> . . . . .	50, 133
seat heater (optional) . . . . .	40
<b>Service</b> . . . . .	50
<b>Settings</b> . . . . .	58
shift warning light . . . . .	37
<b>Shock</b> (optional) . . . . .	58
<b>SHock display</b> . . . . .	40
slip adjustment . . . . .	134
<b>Slip Adjuster</b> . . . . .	53
small widget . . . . .	36, 65
speed . . . . .	38
<b>Suspension</b> . . . . .	55
<b>Suspension Mode</b> . . . . .	92
telephony . . . . .	47
<b>Temperature</b> . . . . .	63
<b>Throttle Response</b> . . . . .	51, 134
time . . . . .	42
<b>TPMS</b> . . . . .	49
<b>Track</b> . . . . .	51
TRACK Display (optional) . . . . .	34
<b>Trip 1</b> . . . . .	48
<b>Trip 2</b> . . . . .	48
<b>Units</b> . . . . .	62
Volume . . . . .	45
warnings . . . . .	31, 49
Widget INFO . . . . .	67
<b>Combination switch</b>	
left side . . . . .	19
right . . . . .	23
<b>Coolant level</b>	
compensating tank, checking . . . . .	131
correcting in the compensating tank . . . . .	131
<b>Cruise control system</b>	
operation . . . . .	21
<b>Customer service</b> . . . . .	14
<b>D</b>	
<b>Date</b>	
adjusting . . . . .	61
<b>Daytime running light</b> . . . . .	120
<b>Declarations of conformity</b> . . . . .	157-158
<b>Diagnostics connector</b> . . . . .	129
<b>DRL</b> . . . . .	120
<b>E</b>	
<b>Emergency OFF switch</b> . . . . .	23
<b>Engine</b>	
running in . . . . .	76
<b>Engine number</b> . . . . .	18
<b>Engine oil</b>	
adding . . . . .	138
changing . . . . .	135
<b>Engine oil level</b>	
checking . . . . .	135
<b>Engine sprocket</b>	
checking . . . . .	104
<b>Engine traction torque control</b> . . . . .	84
<b>Environment</b> . . . . .	12
<b>F</b>	
<b>Figures</b> . . . . .	14
<b>Foot brake lever</b> . . . . .	28
setting the step plate . . . . .	70
<b>Footrests</b>	
adjusting . . . . .	71
<b>Fork</b> . . . . .	91
<b>Fork legs</b>	
dust boots, cleaning . . . . .	95
<b>Fork part number</b> . . . . .	18
<b>Front rider's seat</b>	
mounting . . . . .	97
removing . . . . .	96
<b>Front wheel</b>	
installing . . . . .	114
removing . . . . .	114
<b>Fuel tank filler cap</b>	
closing . . . . .	26
opening . . . . .	25
<b>Fuel tank spoiler, left</b>	
installing . . . . .	98
removing . . . . .	98
<b>Fuel, oils, etc.</b> . . . . .	14
<b>Fuses</b>	
in fuse box, changing . . . . .	126

<b>H</b>		<b>O</b>	
<b>Hand brake lever</b> . . . . .	19	<b>Oil filter</b>	
basic position, adjusting . . . . .	70	changing . . . . .	135
<b>Handlebar position</b> . . . . .	69	<b>Oil screens</b>	
adjusting . . . . .	69	cleaning . . . . .	135
<b>Hazard warning flasher</b> . . . . .	23	<b>Owner's Manual</b> . . . . .	12
<b>Hazard warning flasher switch</b> . . . . .	23	<b>P</b>	
<b>Headlight</b>		<b>Parking</b> . . . . .	85
daytime running light . . . . .	120	<b>Passenger foot pegs</b> . . . . .	27
range, adjusting . . . . .	128	<b>Passenger seat</b>	
<b>Headlight setting</b>		mounting . . . . .	96
checking . . . . .	128	removing . . . . .	96
<b>Horn button</b> . . . . .	21	<b>Preload adjuster</b> . . . . .	56, 91
<b>I</b>		<b>Preparing for use</b>	
<b>Ice warning</b> . . . . .	31	advice on preparing for first use . . . . .	75
<b>Immobilizer</b> . . . . .	25	after storage . . . . .	143
<b>Implied warranty</b> . . . . .	14	checks and maintenance measures when	
<b>Indicator lamps</b> . . . . .	32	preparing for use . . . . .	78
<b>Intended use</b> . . . . .	7	<b>Protective clothing</b> . . . . .	12
<b>K</b>		<b>Q</b>	
<b>Key number</b> . . . . .	17	<b>Quickshifter+</b> . . . . .	81
<b>L</b>		<b>R</b>	
<b>Labels</b>		<b>RACE-ON button</b> . . . . .	24
overview . . . . .	8	<b>RACE-ON key</b> . . . . .	25
<b>Launch Control</b> . . . . .	80	RACE-ON key battery, changing . . . . .	124
<b>Light switch</b> . . . . .	20	<b>Rear sprocket</b>	
<b>Luggage</b> . . . . .	76	checking . . . . .	104
<b>M</b>		<b>Rear wheel</b>	
<b>Main fuse</b>		installing . . . . .	116
changing . . . . .	125	removing . . . . .	116
<b>Main silencer</b>		<b>Refueling</b>	
installing . . . . .	100	fuel . . . . .	87
removing . . . . .	99	<b>Riding</b> . . . . .	81
<b>Manufacturer warranty</b> . . . . .	14	starting off . . . . .	80
<b>Menu buttons</b> . . . . .	20	starting off with launch control . . . . .	80
<b>Misuse</b> . . . . .	7	<b>S</b>	
<b>Motorcycle</b>		<b>Safe operation</b> . . . . .	11
cleaning . . . . .	140	<b>Seat lock</b> . . . . .	27
lifting with front lifting gear . . . . .	93	<b>Service</b> . . . . .	14
lifting with rear lifting gear . . . . .	93	<b>Service schedule</b> . . . . .	89-90
raising with work stand (inserted) . . . . .	94	<b>Shift lever</b> . . . . .	28
removing from the work stand (inserted) . . . . .	95	basic position, checking . . . . .	71
removing the rear from the lifting gear . . . . .	93	<b>Shift lever stub</b>	
taking off front lifting gear . . . . .	94	adjusting . . . . .	71
<b>Motorcycle traction control</b> . . . . .	133	<b>Shifting</b> . . . . .	81
<b>MSR</b> . . . . .	84	<b>Shock absorber</b> . . . . .	91
		<b>Shock absorber article number</b> . . . . .	18

<b>Side stand</b> .....	28	<b>View of vehicle</b>	
<b>Slip adjustment</b> .....	134	front left .....	15
<b>Spare parts</b> .....	14	rear right .....	16
<b>Start button</b> .....	23	<b>W</b>	
<b>Starting</b> .....	78	<b>Winter operation</b>	
<b>Steering damper article number</b> .....	18	checks and maintenance steps .....	141
<b>Steering lock</b> .....	24	<b>Work rules</b> .....	12
<b>Stopping</b> .....	85		
<b>Storage</b> .....	142		
<b>Supporting strap</b> .....	27		
<b>Suspension setting</b> .....	91-92		
<b>T</b>			
<b>Technical accessories</b> .....	14		
<b>Technical data</b>			
capacities .....	149		
chassis .....	150		
chassis tightening torques .....	152		
electrical system .....	151		
engine .....	146		
engine tightening torques .....	147		
fork .....	151		
shock absorber .....	152		
tires .....	151		
<b>Throttle grip</b> .....	19		
<b>Time</b>			
adjusting .....	61		
<b>Tire condition</b>			
checking .....	117		
<b>Tire pressure</b>			
checking .....	118		
<b>Tire repair spray</b>			
using .....	119		
<b>Tool set</b> .....	27		
<b>Towing</b> .....	87		
<b>Transporting</b> .....	86		
<b>Troubleshooting</b> .....	144-145		
<b>Turn signal bulb</b>			
changing .....	127		
<b>Turn signal switch</b> .....	20		
<b>Type label</b> .....	17		
<b>U</b>			
<b>USB cable</b>			
connecting .....	129		
disconnecting .....	129		
<b>Use definition</b> .....	7		
<b>V</b>			
<b>Vehicle</b>			
loading .....	76		
<b>Vehicle identification number</b> .....	17		



3214549en

01/2022

