

## Brother PQ Series Accessories

*The PQ-series of high-speed straight stitch machines (1300, 1500 and 1500S) are designed to sew quickly and accurately with a wide variety of fabrics, even combinations of hard-to-handle materials!*

*With the extra height as well as extended fabric bed and specialized accessories, these machines lend them selves to many applications and are perfectly matched to the needs of today's sewers and quilters.*

*The pressure to the pressure foot is completely adjustable and with the four-level feed dog system, can handle the widest range of fabrics of any home machine on the market today. The unique pin feed system acts as a primary feed and pierces fabric up to 3 mm, pulling both fabrics through the sewing area evenly.*



*Due to the unique design of the PQ machines, only feet made specifically for them are recommended. This section is a reference of these standard and optional PQ-series accessories. Uses for each foot in the following Workbook section are suggestions to get you started. Whether you quilt, work with delicate bridal fabrics or heavy home decoration materials and trims, these feet will help make quick work of your project!*

*Product numbers for PQ standard feet are those used with the PQ-1500S.*

### PQ Feet Cross Referenced by Name in Workbook Section

Name	Number	Foot #	Name	Number	Foot #
Fabric Separator	184720-001 *	13	Quilting	XA7255-001 *	17
Feltscaper	SA180S	18	Rolled Hem	X57138-001 *	14
Gathering	SA171	10	Seam Guide	XA7256-001 *	12
General Purpose	XA1425-001 *	1	Spring Action 2, 5 8 mm	SA170	6-9
Heavyweight	SA173	5	Very Narrow	SA172	4
Invisible Zipper	148475-001 *	16	Walking	XA7253-001*	11
¼"	XA7258-001 *	3	Zipper	112797-001 *	15
Pin Feed	136021-001*	2			

*\* Foot is included with PQ1500S*

### PQ Feet Cross Referenced by Number in Workbook Section

Number	Name	Foot #	Number	Name	Foot #
SA170	Spring Action 2, 5 8 mm	6-9	XA7256-001 *	Seam Guide	12
SA171	Gathering	10	XA7258-001 *	¼"	3
SA172	Very Narrow	4	X57138-001 *	Rolled Hem	14
SA173	Heavyweight	5	112797-001 *	Zipper	15
SA180S	Feltscaper	18	136021-001*	Pin Feed	2
XA1425-001 *	General Purpose	1	148475-001 *	Invisible Zipper	16
XA7253-001*	Walking	11	184720-001 *	Fabric Separator	13
XA7255-001 *	Quilting	17			

# Brother PQ Series Accessories

The perfect “marriage” between feed pressure and feed dog settings is very important for successful stitching. Because the PQ-series machines can handle such a wide range of fabrics, you may need to make adjustments in settings to get the desired balanced stitch, based on your fabric, thread and technique. Adjustments might be made to the presser foot dial, thread tension, stitch length and occasionally bobbin tension, based on fabric, thread and needle used. This Workbook is a summary of your manual and the instruction sheets, which come with optional feet. The suggested settings for each foot are a place to start in your experiments. See your manual for other suggestions.

*In the chart at right, note that the feed dog settings are color keyed to the feed pressure levels. Refer to this chart as you make your samples.*

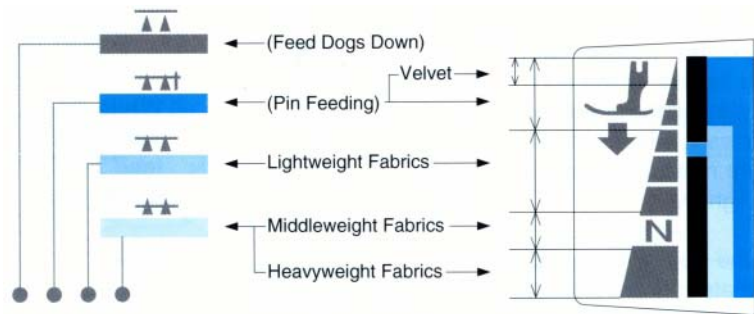

*The dial above the needle controls the upper thread tension. Start with about 4 and see if this gives you a balanced stitch. Feel free to loosen or tighten as needed.*

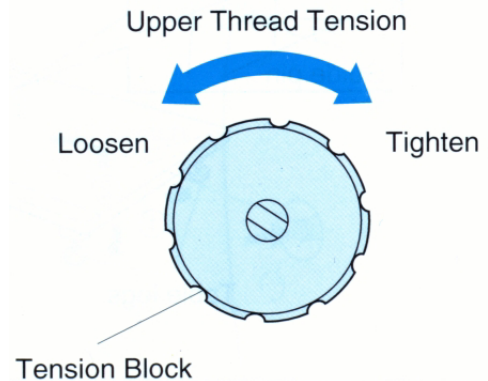

*The big dial on the right front of the machine controls the stitch length. Many projects use a setting between 2 and 4. Using 6 or 7 provides a long basting stitch.*

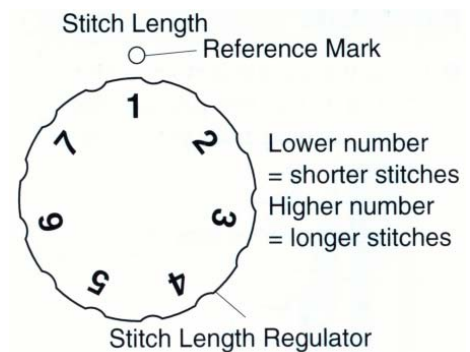

## Foot 1

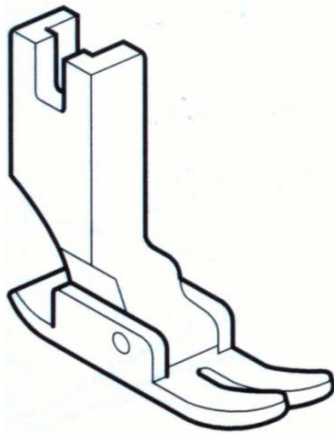

### General Purpose

#### XA1425-001

*Standard PQ foot. Use for most sewing, including thick fabrics or seams; can be used with pin feed.*

### Machine Set-Up:

Feed dogs; use one of the three settings based on fabric and whether the pin feed is used. Adjust other settings for fabric used.

### Materials Needed for Sample:

Linen-like fabric

### General Sewing Directions:

Depending on the fabric, use one of two methods of basic sewing. The traditional method has the bobbin and top thread pulled out behind the foot and the foot lowered over the fabric. With the balance wheel toward you, lower the needle in the fabric and then step gently on the foot pedal. At the beginning and end of a seam, press the reverse stitch lever to backstitch. With the technology in machines such as the PQ1500S, in most cases the fabric can just be placed under the presser foot and sewn, without pulling the thread behind the foot. If the thread cutter was used previously, the thread will be long enough to catch when you start to sew.

### Specific PQ Sample Directions:

Feed Dogs	Presser Foot Dial	Thread Tension	Stitch Length
★★	Midweight	+/- 4	2.5

This sample used the General Purpose foot to sew a ½” seam and then the width of the foot for topstitching. Use a different colored bobbin and fold back a corner to show the way a balanced stitch looks.

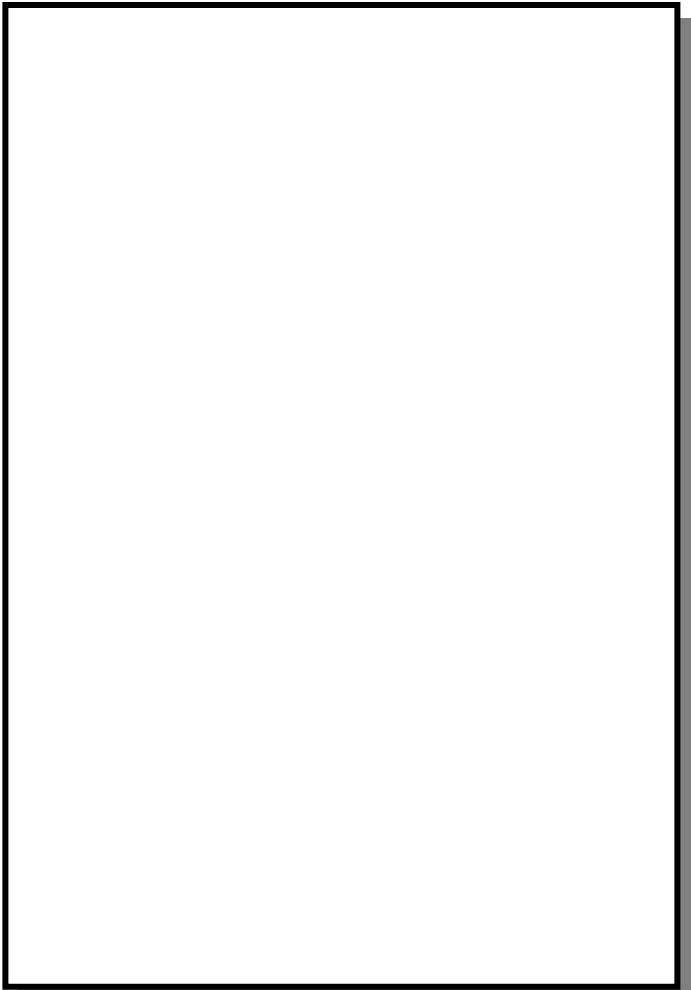

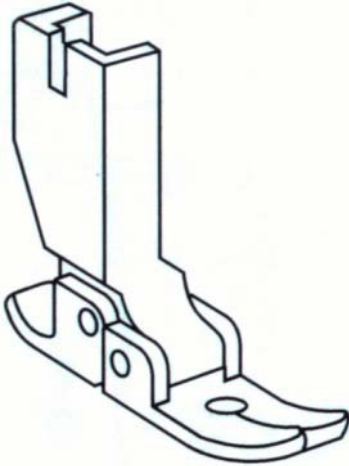

**Pin Feed  
 136021-001**

*Standard PQ foot. Used for perfect stitching on otherwise difficult fabrics like velvet, leather and suede or to attach trims, with the pin feed setting engaged.*

**Machine Set-Up:**

Feed dogs up, usually with pin feed setting. Adjust the pressure dial to match the pin feed position. Select other settings for fabric used.

**Materials Needed for Sample:**

Plaid and narrow rick rack

**General Sewing Directions:**

Follow the same instructions as the General Purpose foot but the pin feed passes through all layers of fabric.

**Specific PQ Sample Directions:**

Feed Dogs	Presser Foot Dial	Thread Tension	Stitch Length
	Pin feed	+/- 4	2.5

With the pin feed engaged you can sew on trims without pre-pinning or gluing. Use of a stripe or plaid as a guide means no marking either.

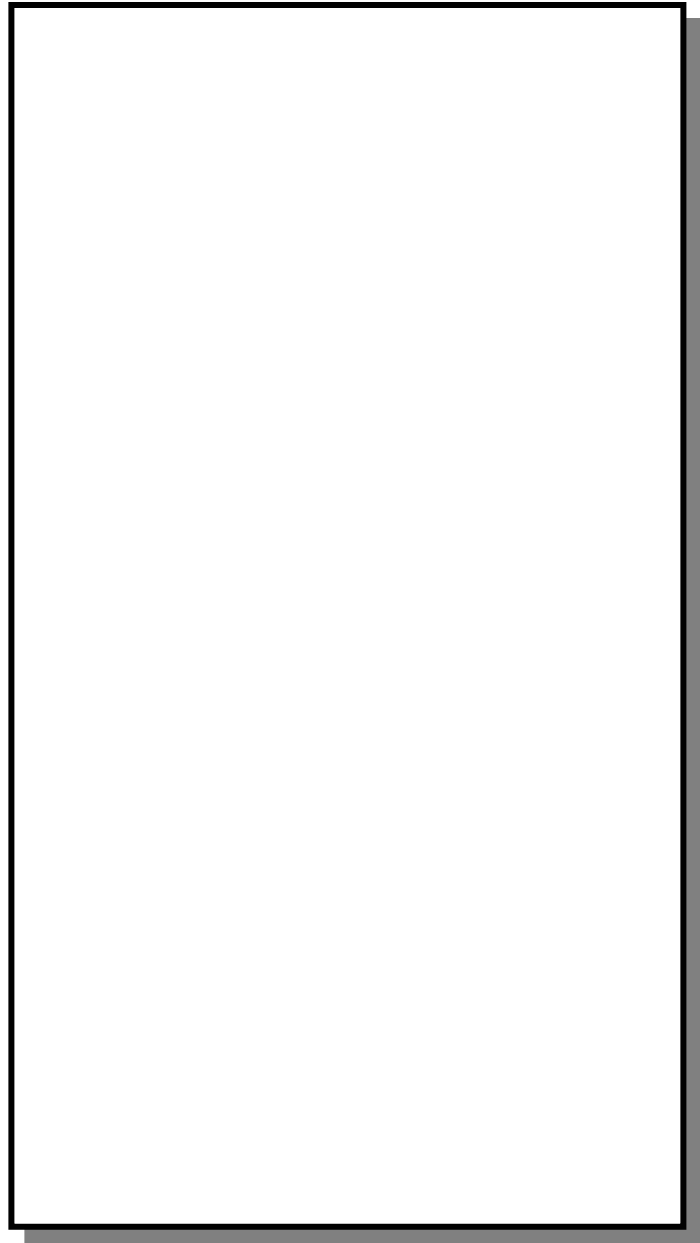

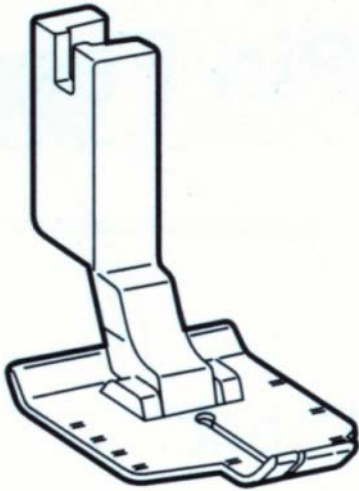

**1/4" Foot**

**XA7258-001**

*Standard PQ sewing foot for quilting seams*

**Machine Set-Up:**

Feed dogs up using one of the three settings based on fabric and whether the pin feed is used. Adjust other setting to match fabric used.

**Materials Needed for Samples:**

Quilting cotton, thin batting

**General Sewing Directions:**

Use the right side of the foot guided along the right fabric edge to create a 1/4" seam. Use the left edge to guide along a seam to top stitch 1/8" away from the seam.

**Specific ULT Sample Directions:**

Feed Dogs	Presser Foot Dial	Thread Tension	Stitch Length
★★	Midweight	+/- 4	2.5

The sample is made of 2" squares sewn together with 1/4" seams, sandwiched with batting/backing and quilted with 1/8" seams within the squares. Trim sample to fit.

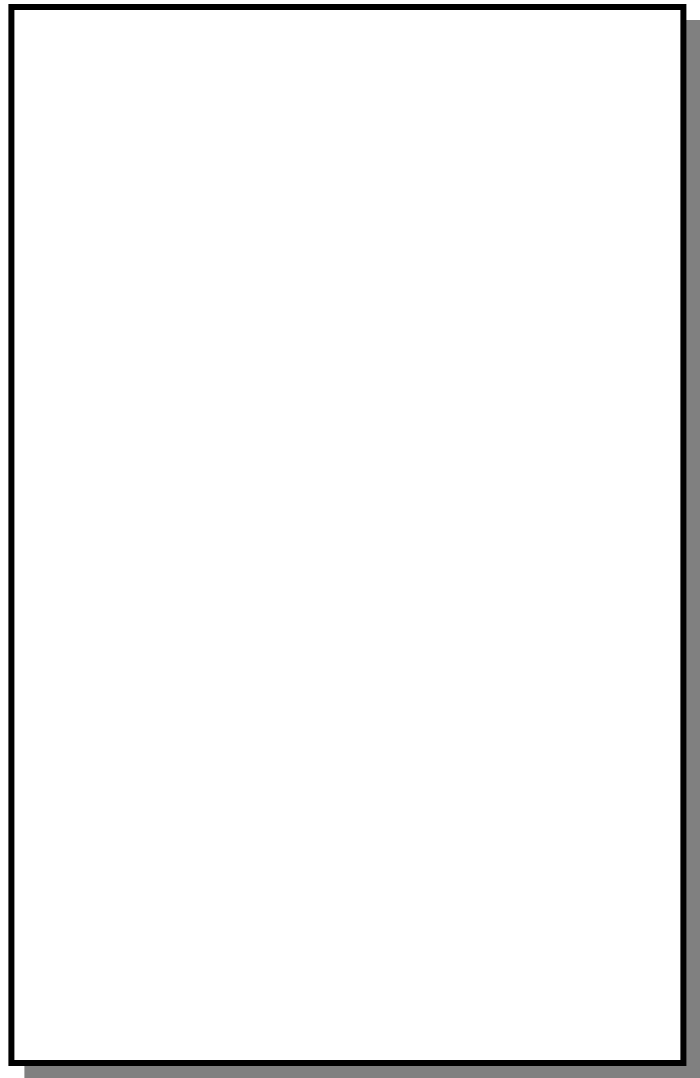



**Very Narrow**

**SA172**

*Optional PQ foot for sewing on lightweight and fine fabric, sewing in very tight areas or attaching zippers*

**Machine Set-Up:**

Feed dogs up using one of the three settings based on fabric and whether the pin feed is used. Presser foot dial, thread tension and stitch length are normally adjusted to produce a balanced stitch.

**Materials Needed for Sample:**

Quilting cotton, upholstery cord

**General Sewing Directions:**

Follow normal sewing instructions.

**Specific PQ Sample Directions:**

For double welting, cut fabric wider than three times width of double cord. Sample uses two-inch strip cut on straight of grain. Lay cords 1/2" from the edge of fabric. Fold the 1/2" section over the double cord, covering the full width. Fold over the entire piece, wrapping the cord completely, for a very tight fit. Sew between the cords. When through, trim off excess fabric close to stitching line. Apply cord to your project with the trimmed edge underneath.

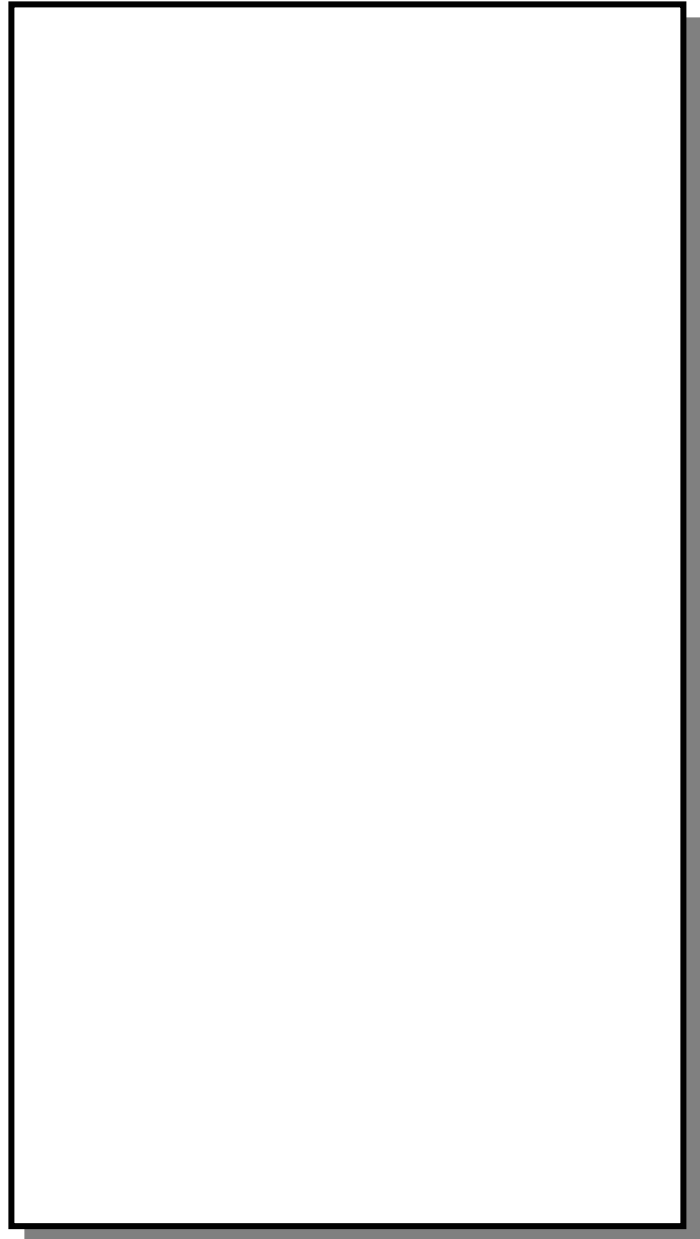

Feed Dogs	Presser Foot Dial	Thread Tension	Stitch Length
	Midweight	+/- 4	3





**Heavyweight  
 SA173**

*Optional PQ foot designed to sew canvas, fake fur or quilted fabrics without adding excess pressure to the fabric*

**Machine Set-Up:**

Feed dogs up using one of the three settings based on fabric and whether the pin feed is used. Adjust setting to fit fabric used.

**Materials Needed for Sample:**

Heavy upholstery fabric

**General Sewing Directions:**

Use the normal sewing techniques. The design of the foot accommodates heavy materials.

**Specific PQ Sample Directions:**

Feed Dogs	Presser Foot Dial	Thread Tension	Stitch Length
	Heavy weight	+/- 4	3

The sample uses heavy upholstery fabric, seamed and then folded over again to show how well this foot handles thick fabric.

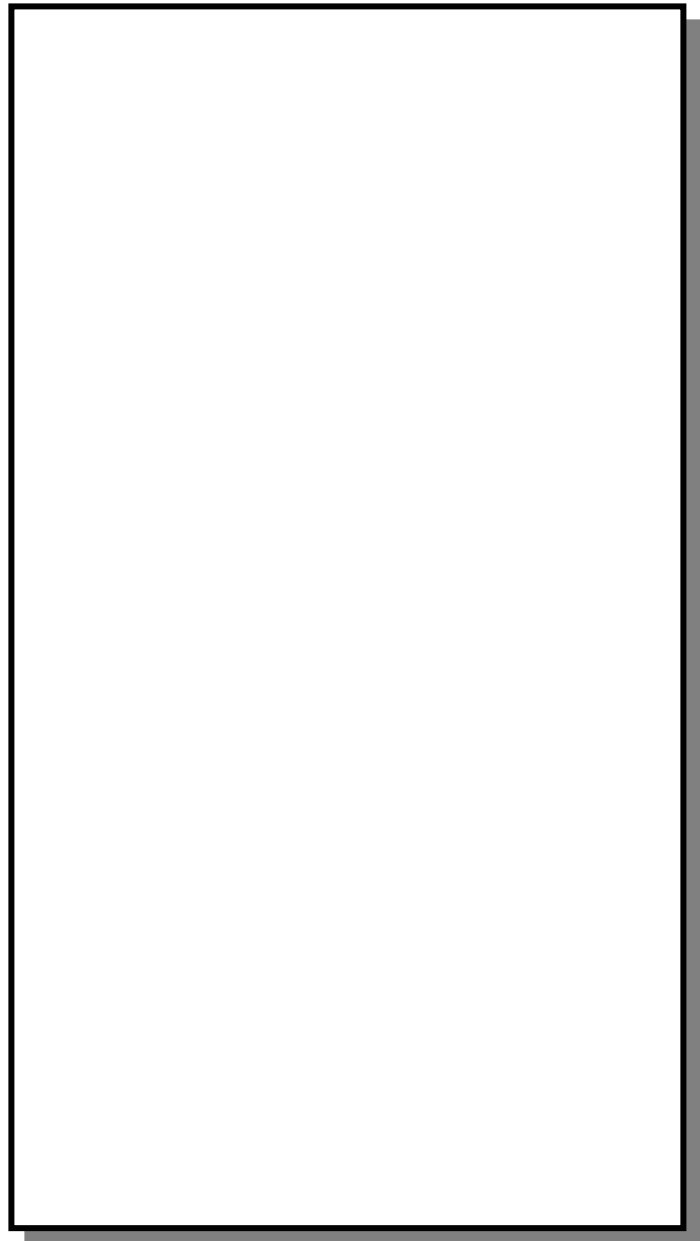



**Spring Action Guide 2 mm  
 SA170**

*Optional PQ foot, one of three feet in this collection, which are useful for pintucks and topstitching*

**Machine Set-Up:**

Feed dogs up using one of the three settings based on fabric and whether the pin feed is used. Adjust for the fabric used.

**Materials Needed for Sample:**

Chambray

**General Sewing Directions:**

Normal sewing instruction

**Specific PQ Sample Directions:**

Feed Dogs	Presser Foot Dial	Thread Tension	Stitch Length
★★	Midweight	+/- 4	2.5 to 3

The sample has narrow tucks, which are good for trim or insert in heirloom projects. Press creases 1/2" apart. Lay fold under the foot and guide with the off center ledge to sew seam. Press tucks to one side when complete.

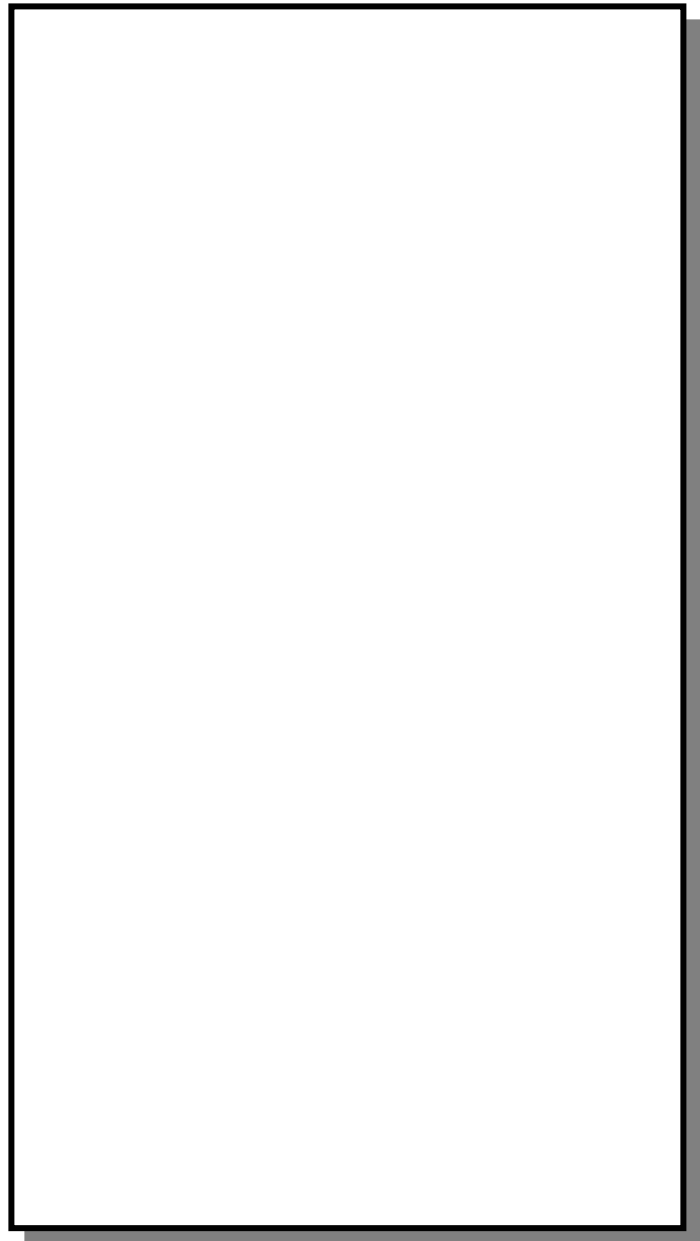



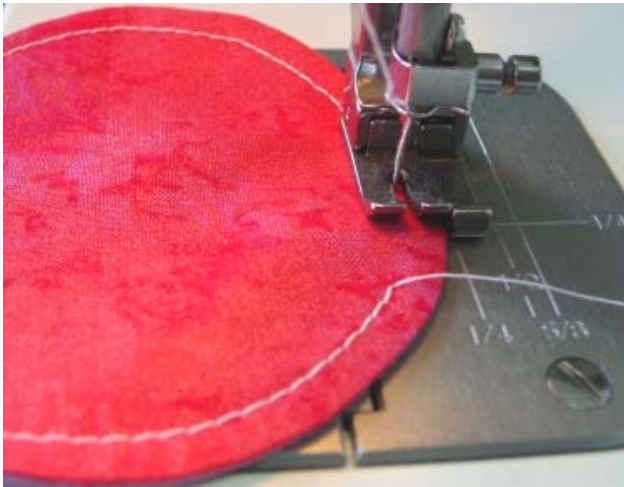

**Spring Action Guide 5 mm  
 SA170**

*Optional PQ foot, one of three feet in this collection, which are useful for pintucks and topstitching. The lip in these feet are great for guiding around shapes.*

**Machine Set-Up:**

Feed dogs up using one of the three settings based on fabric and whether the pin feed is used. Adjust for the fabric used.

**Materials Needed for Sample:**

Two layers quilting cotton

**General Sewing Directions:**

Normal sewing instructions

**Specific PQ Sample Directions:**

Feed Dogs	Presser Foot Dial	Thread Tension	Stitch Length
★★	Midweight	+/- 4	2.5 to 3.5

The sample used the foot to sew the seam and then to top stitch with a longer stitch, after turning the circle right side out and pressing.

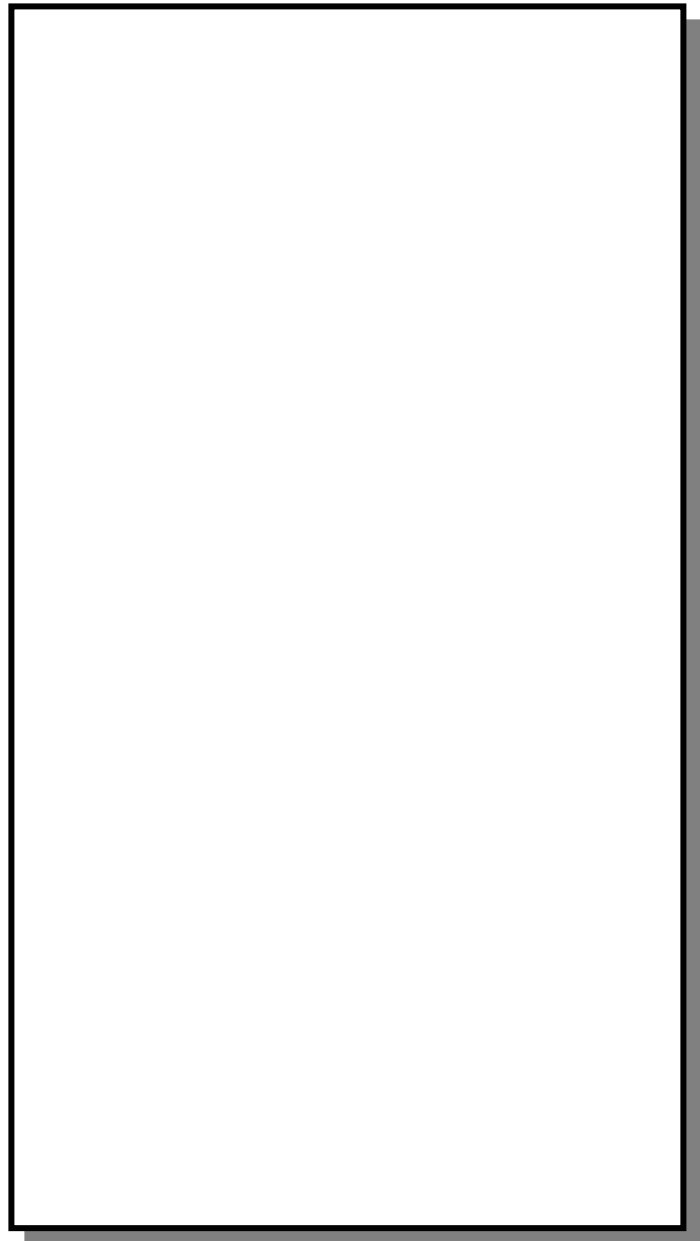

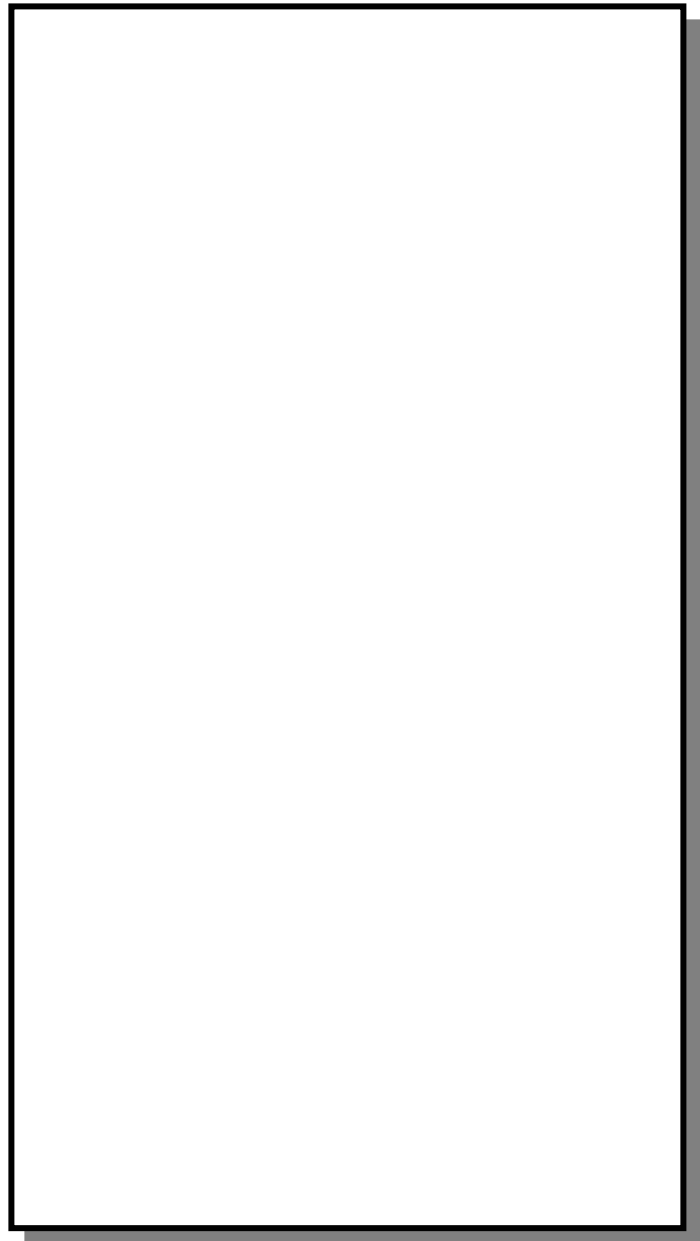

**Spring Action Guide 8 & 2 mm  
 SA170**

*Optional PQ foot, one of three feet in this collection, which are useful for pintucks and topstitching*

**Machine Set-Up:**

Feed dogs up using one of the three settings based on fabric and whether the pin feed is used. Adjust for the fabric used.

**Materials Needed for Sample:**

White cotton or linen

**General Sewing Directions:**

Normal sewing instructions were used. The feet did all the work.

**Specific PQ Sample Directions:**

Feed Dogs	Presser Foot Dial	Thread Tension	Stitch Length
★★	Midweight	+/- 4	3

Press creases 2 1/4" apart and use the 8 mm foot to sew the seam along each crease. Press pleats flat and sew again with 2 mm foot to anchor the pleat to the garment. Pleats can be anchored at top and bottom or left open.

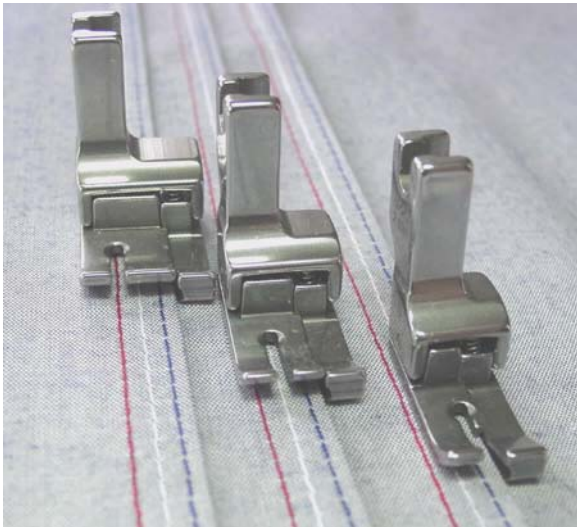

**Spring Action Guide 8, 5 & 2 mm  
 SA170**

*Optional PQ foot, all three feet in this collection, which are useful for pintucks and topstitching*

**Machine Set-Up:**

Feed dogs up using one of the three settings based on fabric and whether the pin feed is used. Adjust for the fabric used.

**Materials Needed for Sample:**

Chambray, three colors of thread

**General Sewing Directions:**

Normal sewing instructions were used. Sewing with all three feet created a decorative trim.

**Specific PQ Sample Directions:**

Feed Dogs	Presser Foot Dial	Thread Tension	Stitch Length
★★	Midweight	+/- 4	3.5

Mark and press creases 2 ¼” apart. Sew seam with 8 mm foot. With pleat flat (not laying on garment, sew again with the 5 mm and then with the 2 mm in other colors. The trimmed pleats will be open. The photo shows the distance from the edge the foot sews. The pleat could be sewn down to the garment as well.

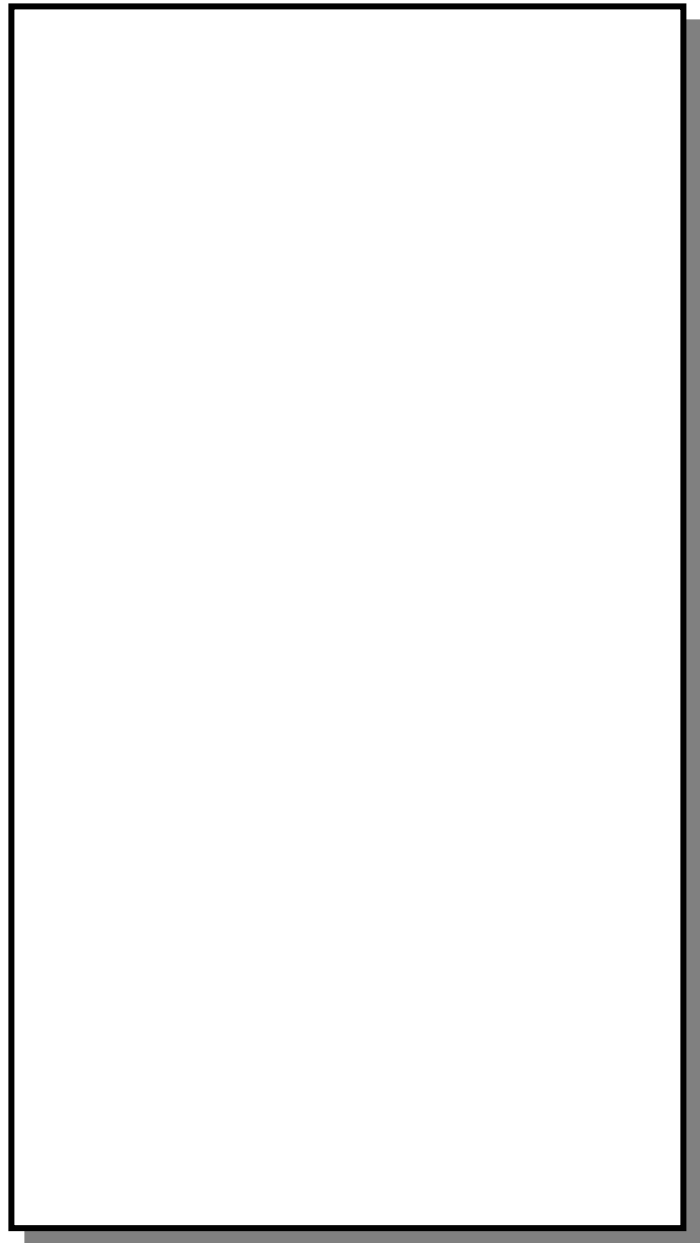



## Gathering

### SA171

*Optional PQ foot, used for creating gathered fabric or easing sleeve caps*

### Machine Set-Up:

Feed dogs up using one of two settings based on fabric. Adjust other settings for the fabric used.

### Materials Needed for Sample:

Middleweight linen-like fabric and batiste

### General Sewing Directions:

The amount of gathering or easing differs depending on the fabric being sewn, the tension of the upper thread and the stitch length. Adjust the settings based on your test of the fabric you plan to use.

### Specific PQ Sample Directions:

Sample one is a middleweight cotton and used a stitch length of 3.5 with tension about 4. For the batiste, the pressure foot dial and feed dogs were moved to lightweight and the tighter gather was achieved.

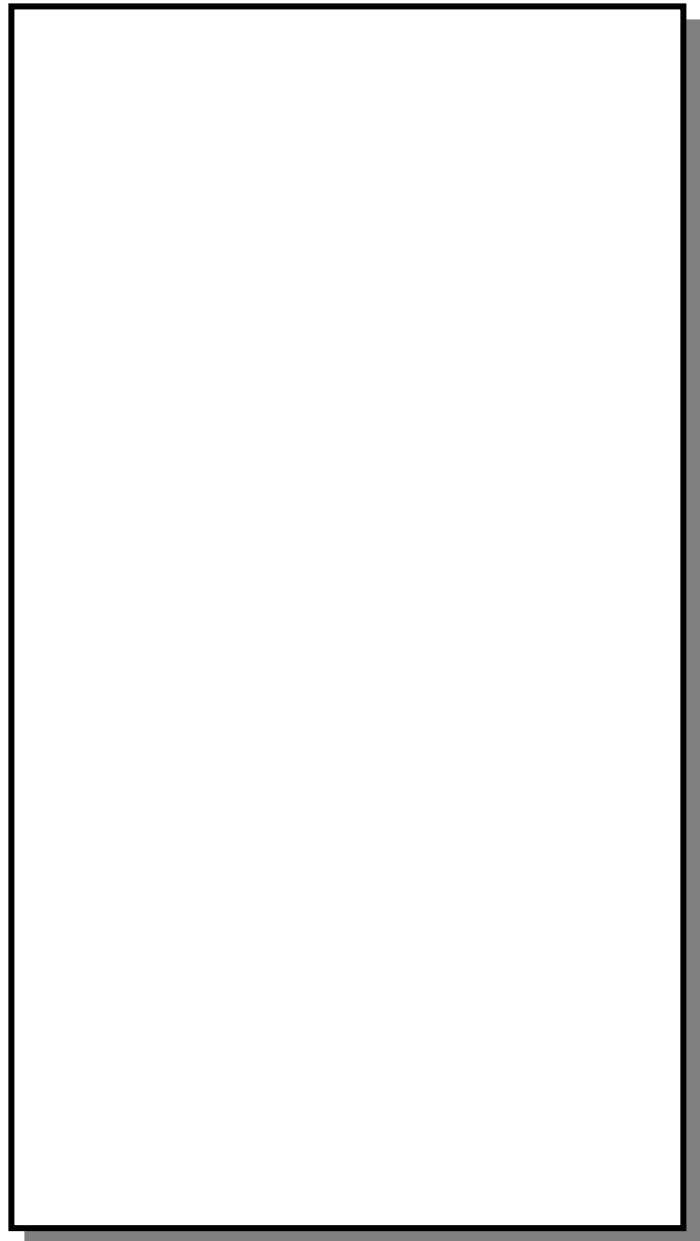

Feed Dogs	Presser Foot Dial	Thread Tension	Stitch Length
	Midweight	+/- 4	3.5

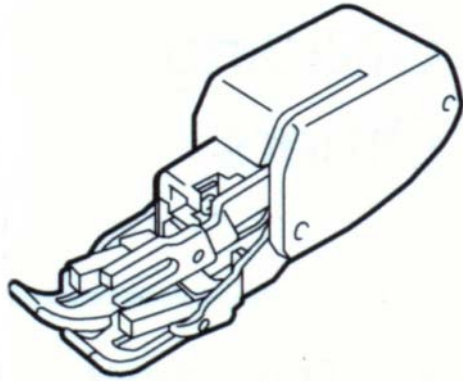

**Walking**

**XA7253-001**

*The walking foot holds the fabric between the presser foot, upper and lower feed dogs to better control difficult fabrics. It is standard on the PQ.*

**Machine Set-Up:**

Feed dogs up using one of two settings based on fabric. Adjust other settings for the fabric used. Pin feed is not used with this foot.

**Materials Needed for Sample:**

Cotton fabric, thin batting

**General Sewing Directions:**

While normal sewing techniques are used with this foot, it is important to not sew more than 70 per cent of maximum speed to allow the foot to work evenly. Test the presser foot settings to make sure it is not too strong as that will influence foot movement as well.

**Specific PQ Sample Directions:**

Squares 1 ½” each were sewn together in a checkerboard fashion with the ¼” foot. The pressed top was sandwiched with thin batting and backing and stitched together with the walking foot.

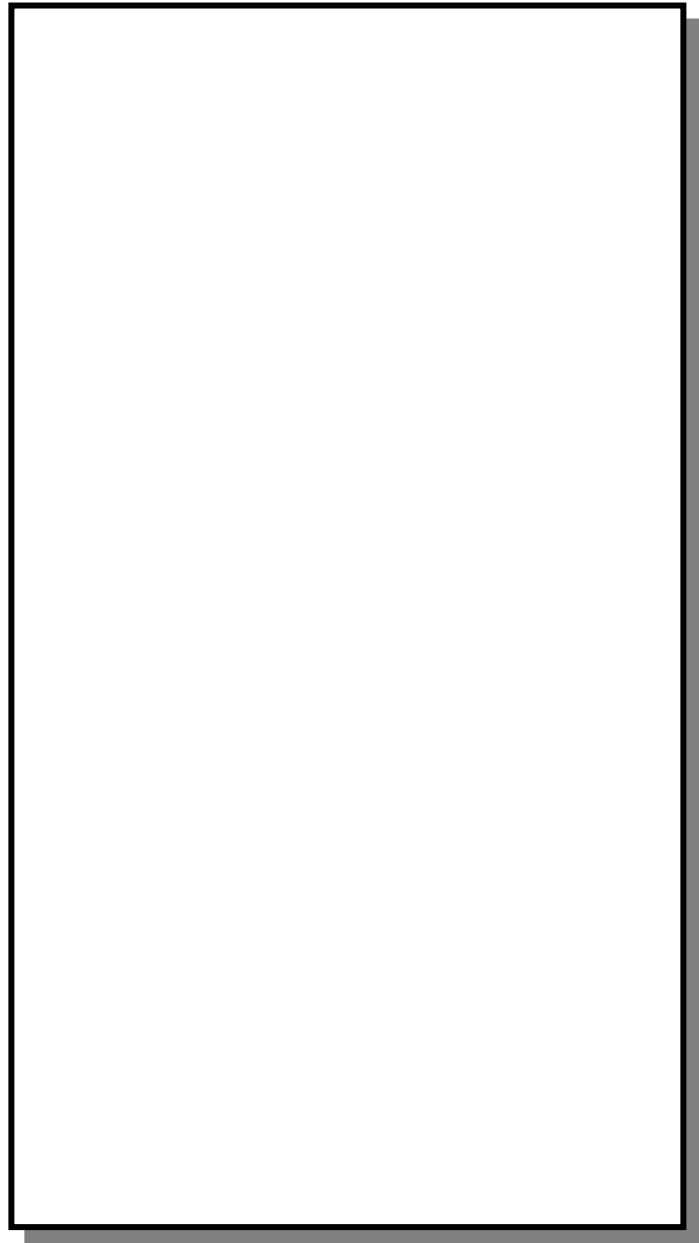

Feed Dogs	Presser Foot Dial	Thread Tension	Stitch Length
	Midweight	+/- 4	2.5 to 3

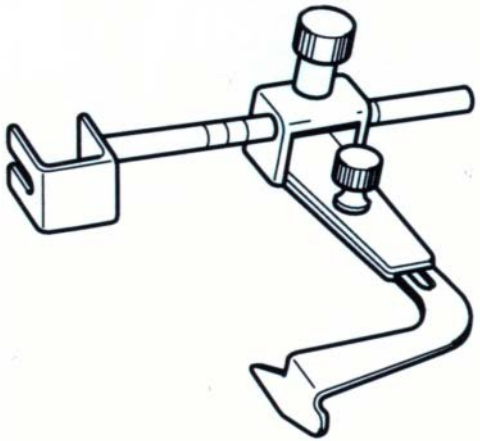

**Seam Guide  
 XA7256-001**

*Standard PQ part used to sew evenly spaced rows*

**Machine Set-Up:**

Feed dogs up using one of the three settings based on fabric and whether the pin feed is used. Other settings are based on the needs of the project.

**Materials Needed for Sample:**

Cotton quilting and batting

**General Sewing Directions:**

Position the main foot and slip the seam guide over it before tightening the screw. Use the side knobs to adjust the width of the guide from the sewing line.

**Specific PQ Sample Directions:**

Feed Dogs	Presser Foot Dial	Thread Tension	Stitch Length
	Pin feed	+/- 4	3

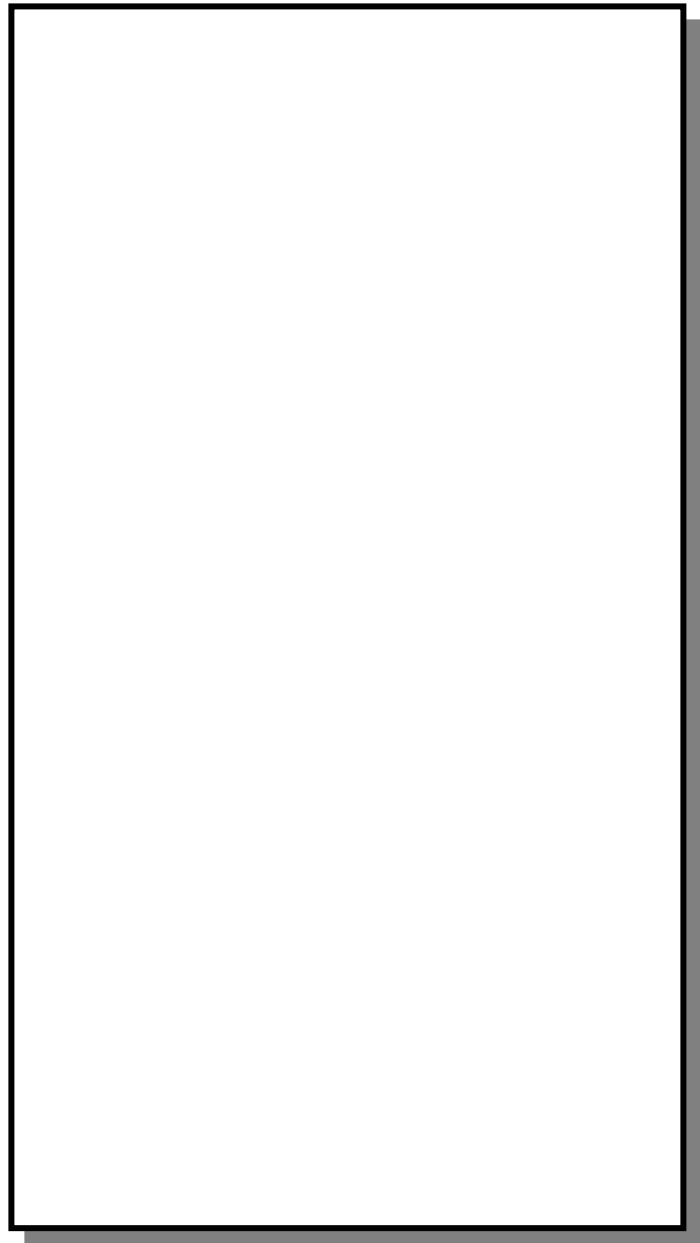

Settings are based on the foot and fabrics used. The sample used the Pin Feed foot with the Seam Guide set to 1/2" away from the seam and a stitch length of 3. Make your sample larger than you need and plan to cut it down to fit. Your edges are harder to guide when working this small.



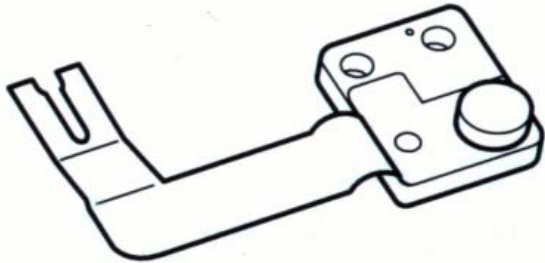

**Fabric Separator**  
**184720-001**

*Standard PQ part, which is used to sew hard-to-manage fabrics like velvet and lining together*

**Machine Set-Up:**

Use pin feed setting for feed dogs and pressure dial, other settings based on project.

**Materials Needed for Sample:**

Velvet and lining

**General Sewing Directions:**

Raise needle and foot and position separator so it sits under the presser foot and clears the needle. Secure liner plate with screws. Place velvet under the separator and lining above when sewing. Pull thread until lower needle catches the fabric. When not using the separator, it can be left in place but swung off to the right side of the machine bed.

**Specific PQ Sample Directions:**

Feed Dogs	Presser Foot Dial	Thread Tension	Stitch Length
	Pin feed	+/- 4	2 to 3

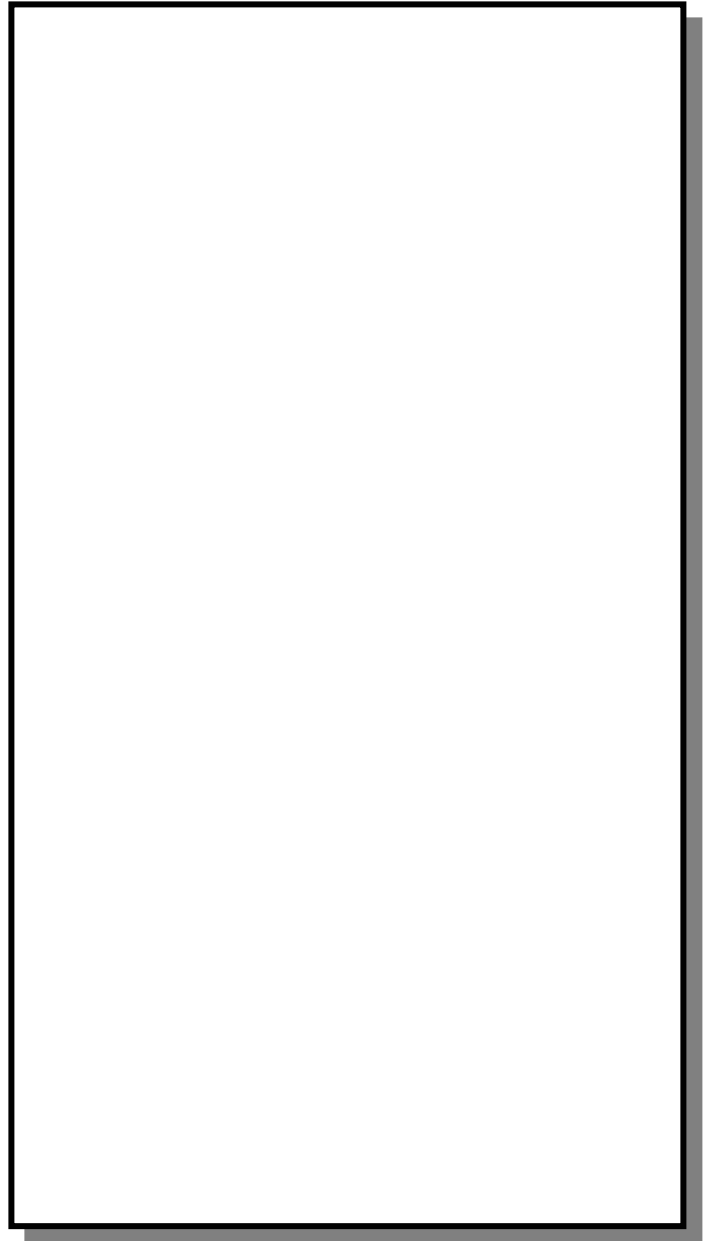

A soft velvet and lining were sewn together using the Pin Feed foot and the Fabric Separator. Make sure you engage the lower pin in the fabric before you start sewing and sew two to three reinforcement stitches as you start a row.



**Rolled Hem**

**X57138-001**

*Standard PQ foot. Use on the edge of fabric, such as hems of dresses or shirts, to fold the edge of the fabric in three while sewing.*

**Machine Set-Up:**

Feed dogs up using one of the three settings based on fabric and whether the pin feed is used. Other settings are based on the needs of the project.

**Materials Needed for Sample:**

Lightweight synthetic

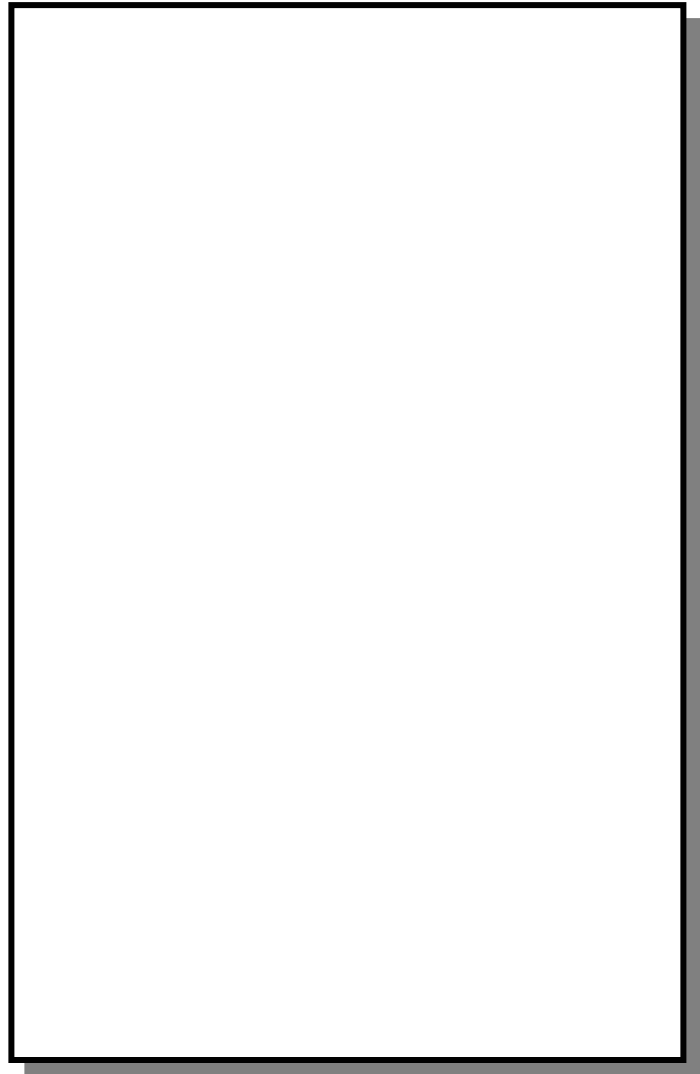

**General Sewing Directions:**

Insert needle about 1/4" from corner and take two stitches. Turn the hand wheel toward you to raise the needle, raise the presser foot and pull the fabric toward you. Hold the four threads in your left hand and use the threads to guide the fabric into the foot. Lower the presser foot. Pull gently on threads in left hand while sewing the first few stitches to hold them in place. Fold over hem and continue feeding folded hem toward the curved guide of the foot as you sew.

**Specific PQ Sample Directions:**

Follow General Directions for your sample. If the fabric is stiff, you may find it useful to also pre-crease the fabric to get it started going into the foot.

Feed Dogs	Presser Foot Dial	Thread Tension	Stitch Length
	Lightweight	+/- 4	2.5 to 3

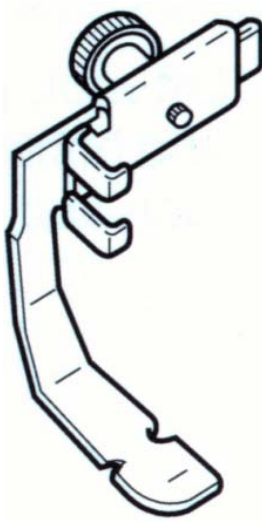

**Zipper Foot**

**112797-001**

*Standard PQ foot used for attaching zippers and piping*

**Machine Set-Up:**

Feed dogs up using one of the three settings based on fabric and whether the pin feed is used (such as attaching zippers to stretch fabric). Other settings are based on the needs of the project.

**Materials Needed for Sample:**

Corded piping, linen and cotton fabric, transfer web

**General Sewing Directions:**

Attach the foot and use screw at back to position the movable foot relative to the needle. Depending on the type of zipper you are installing, one of several methods may be used. Loosen the clamp screw at the back and slide the presser foot to either side so the needle fits in the opening on the foot without hitting the metal side. Turn the balance wheel slowly toward you to check that the needle does not hit the presser foot. Secure the clamp screw.

**Specific PQ Sample Directions:**

Sample uses corded piping as a trim, not anchored in a seam. Pin Feed and Seam Guide were used to decorate a plain fabric attached with transfer web to the center. The Zipper foot (with pin feed engaged) attached the trim.

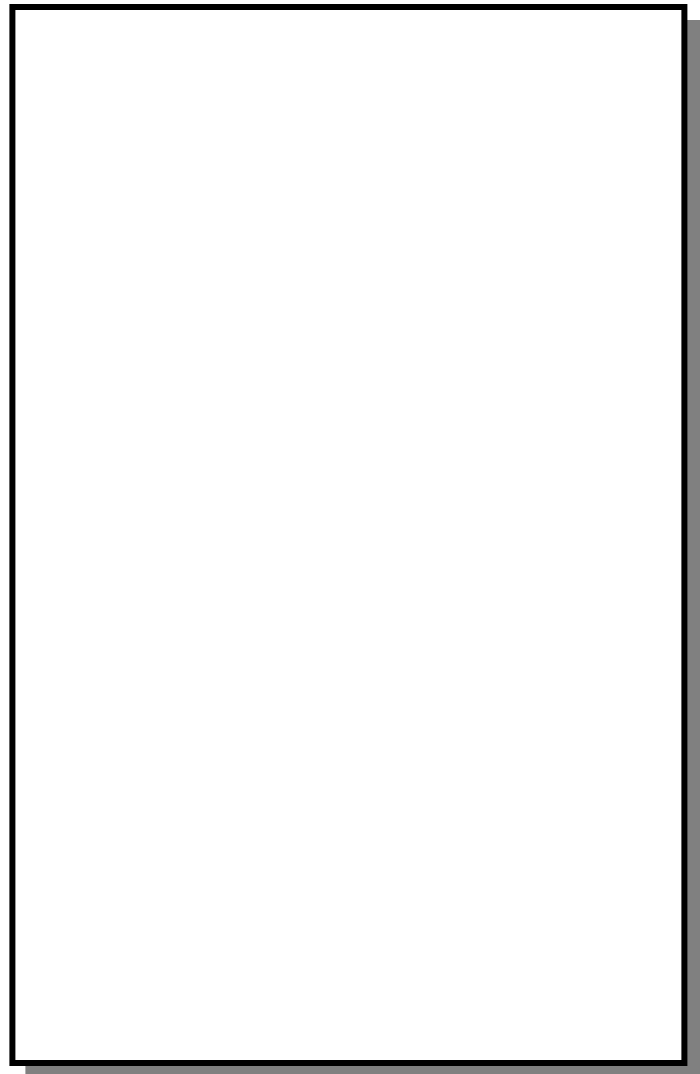

Feed Dogs	Presser Foot Dial	Thread Tension	Stitch Length
	Pin feed	+/- 4	2.5 to 3

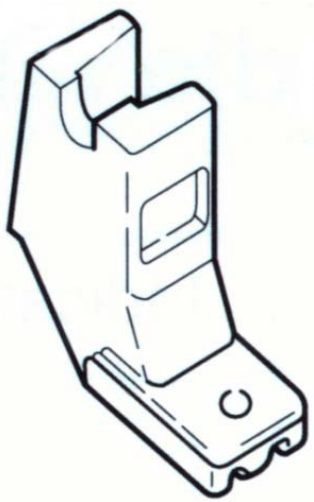

**Invisible Zipper Foot  
 148475-001**

*Standard PQ foot used to attach invisible zippers*

**Machine Set-Up:**

Feed dogs up using one of the three settings based on fabric and whether the pin feed is used (such as attaching zippers to stretch fabric). Other settings are based on the needs of the project.

**Materials Needed for Sample:**

Invisible zipper, lightweight linen

**General Sewing Directions:**

The following instructions are packaged with Coats & Clarks zippers. Open zipper. From the wrong side, press the zipper coils flat so that the two rows of stitching show. Pin the right side of the zipper to the right side of the fabric, coil on the 5/8" seamline and top of zipper 3/4" below the cut edge of fabric. With right groove of foot over coil, stitch until foot touches slider; backtack. Pin the right side of the free zipper to the right side of the remaining garment section, coil on 5/8" seamline and top stop of zipper 3/4" below cut edge of fabric. With the left groove of foot over coil, stitch until foot touches the slider; backtack. To stitch remainder of seam, close zipper. Attach zipper foot. Pull zipper ends out of the way and lower needle by hand, slightly above and 1/8" to the left of the last stitch. Lower foot and stitch seam for 2". Pull threads through to one side and tie. Change to regular presser foot and finish seam. Tack free end at bottom of each zipper tape to seam allowance only.

**Specific PQ Sample Directions:**

Follow General Directions.

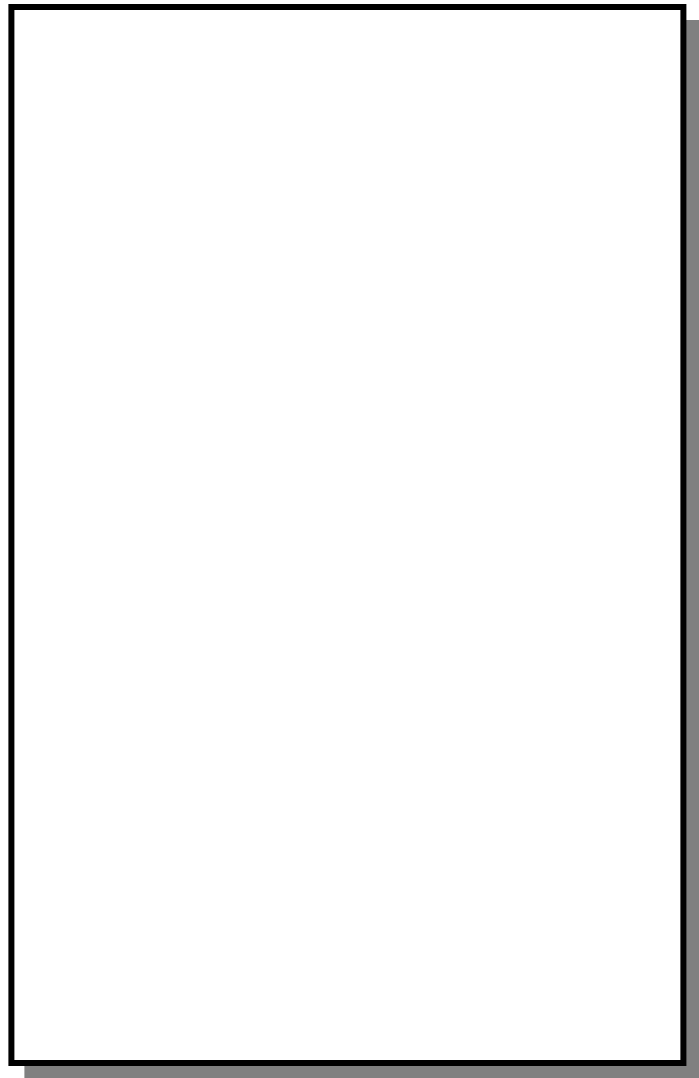

Feed Dogs	Presser Foot Dial	Thread Tension	Stitch Length
	Midweight	+/- 4	2 to 3



**Quilting**  
**XA7255-001**

*Standard PQ foot used for free motion quilting.*

**Machine Set-Up:**

Feed dogs down. Lower the foot pressure. There is no need to change other normal settings as you control stitch length as the sandwich is moved.

**Materials Needed for Sample:**

Poly/cotton quilting fabric, lightweight batting

**General Sewing Directions:**

Guide the work under the foot at a steady speed and movement.

**Specific ULT Sample Directions:**

Cut your sample sandwich at least twice the size you need as small samples are hard to control.

Temporary spray is good to hold the top/batting/bottom together. Move the fabric at a consistent pace coordinated with the speed you run your machine. The more you do free motion, the more even your stitches will become. If you use different colors or even variegated thread both top and bottom, you will occasionally see the bobbin come up. Patterned quilt backing will help mask this. Many free motion quilters use their machines to “draw” all over designs, too.

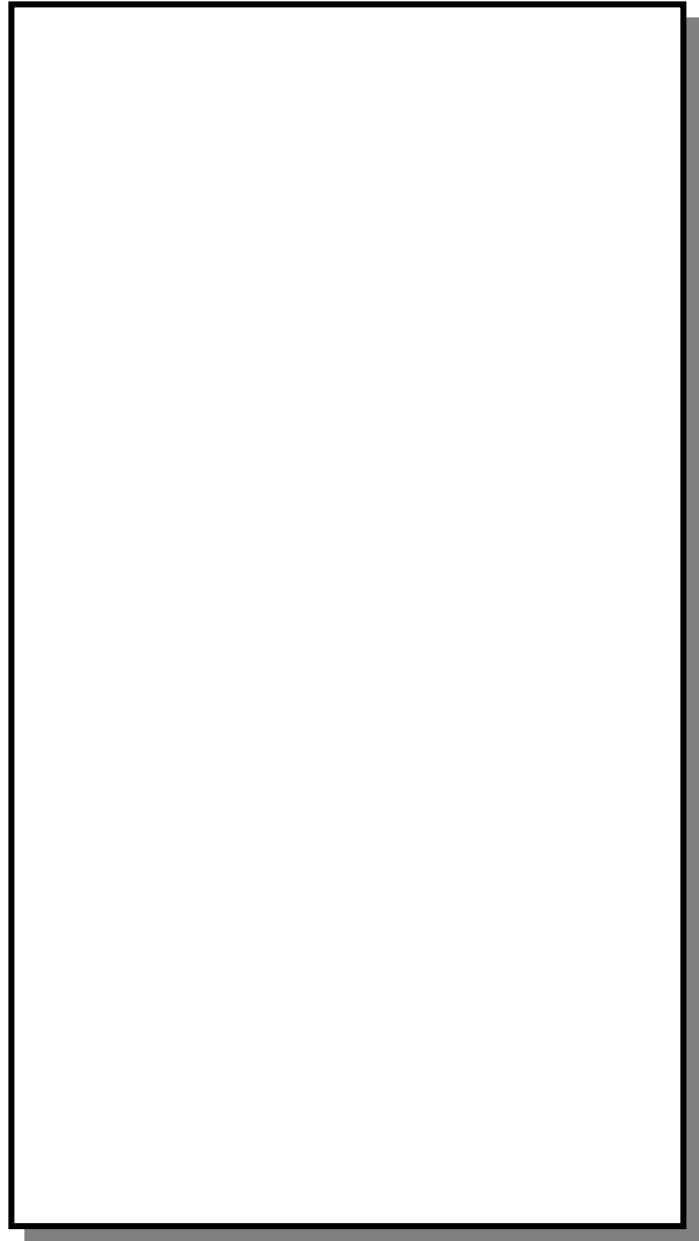

Feed Dogs	Presser Foot Dial	Thread Tension	Stitch Length
	N	+/- 4	NA



## **Feltscaper SA180S**

*Optional PQ foot accessory used for making felted projects.*

### **Machine Set-Up:**

Place feed dogs in down position before you install the Feltscaper. **Make sure the machine is turned off before you install this accessory. The felting needles are very sharp.** Follow the installation setup that comes with the accessory to ensure that the felting needles clear the sides of the needle felting foot and adjust the height to clear your materials.

### **Materials Needed for Sample:**

Wool tweed, roving, wool needlepoint wool

### **General Sewing Directions:**

Guide the work under the foot at a steady speed and movement. Arrange the roving/wool thread and anchor it with the needles. You may want to turn off the needle down button to make it easier to move from place to place. Adjust the Feltscaper “foot” level as you add more levels of yarn if your project doesn’t move easily under the unit. Empty the lint box frequently as you work. Keep your fingers away from the foot.

### **Specific ULT Sample Directions:**

The sample used multi-color roving twisted in loops and anchored with the Feltscaper. Form other loops with 100 per cent wool needlepoint Persian yarn and anchor with the needles. Form a bow with the yarn and tack it down.

