

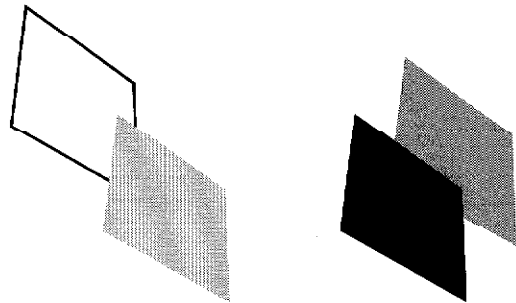

P-TÖUCH

540

USER'S GUIDE

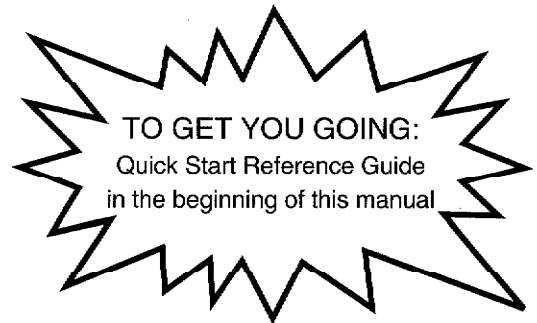

brother®

YOUR P-TOUCH 540

Thank you for purchasing the P-Touch 540!

Your new P-Touch will allow you to design and print labels for any application. Since it is extremely versatile, you will be able to create characters of many sizes and styles. In addition, by using the variety of tape cartridges available, you can print labels with different widths and exciting colors.

You no longer have to worry about urgent tasks that require professional printing. In the office, the factory, the lab and the home, the quality and performance of the P-Touch 540 makes it a very versatile machine.

Finally, as you may want to refer to this manual occasionally, we suggest that you keep it in a handy place.

FCC NOTICE

This equipment has been tested and found to comply with the limits for a Class B digital device, pursuant to Part 15 of the FCC Rules. These limits are designed to provide reasonable protection against harmful interference in a residential installation. This equipment generates, uses, and can radiate radio frequency energy and, if not installed and used in accordance with the instructions, may cause harmful interference to radio communications. However, there is no guarantee that interference will not occur in a particular installation. If this equipment does cause harmful interference to radio or television reception, which can be determined by turning the equipment off and on, the user is encouraged to try to correct the interference by one or more of the following measures:

Reorient or relocate the receiving antenna.

Increase the separation between the equipment and receiver.

Connect the equipment into an outlet on a circuit different from that to which the receiver is connected.

Consult the dealer or an experienced radio/TV technician for help.

Changes or modifications not expressly approved by Brother Industries, Ltd. could void the user's authority to operate the equipment.

This product is covered by one or more of the following patents.

USP4839742

USP4983058

EP315369

GB2223740

USP4922063

USP5009530

EP322918

USP4927278

USP5069557

EP322919

USP4966476

USP5120147

USP4976558

CONTENTS

ABOUT THIS MANUAL	1
QUICK REFERENCE GUIDE	2
BEFORE YOU START	
MACHINE DIAGRAM	6
GENERAL PRECAUTIONS.....	8
POWER SUPPLY	9
OPTIONAL AC ADAPTOR.....	10
TAPE CASSETTES	11
REMOVING THE LABEL BACKING.....	12
CLEANING THE PRINT HEAD AND ROLLERS.....	13
LEARNING THE ROPES	
INTRODUCTION.....	16
DOOR SIGN EXAMPLE.....	17
EQUIPMENT LABEL EXAMPLE.....	22
ADDRESS LABEL EXAMPLE.....	32
STORAGE SHELF LABEL EXAMPLE	36
FOR YOUR INFORMATION	
INTRODUCTION.....	44
FINDING YOUR WAY	45
POWER BUTTON.....	46
CURSORS	47
SHIFT, ALT & CAPS.....	48
CODE KEY	49
SYMBOLS	50
COMPOSITE CHARACTERS.....	52
RETURN.....	53
NEW BLOCK.....	55
SEQUENTIAL NUMBERING.....	56
CANCEL.....	58
CURSOR MOVEMENT	60
INSERT VS. OVERWRITE.....	61

BACKSPACE.....	63
LINE OUT.....	64
CLEAR.....	65
ZOOM MODE.....	66
LABEL LENGTH.....	67
CONTRAST.....	68
AUTO FORMATS.....	69
LOCAL FORMATTING.....	75
GLOBAL FORMATTING.....	77
FONT.....	79
SIZE/WIDTH.....	81
STYLE/ITALIC.....	83
UNDERLINING/FRAMING.....	86
FRAMING.....	87
TAPE FEED.....	88
VERTICAL PRINTING.....	89
MIRROR PRINTING.....	90
HORIZONTAL ALIGNMENT.....	91
VERTICAL ALIGNMENT.....	92
LENGTH.....	93
DISPLAY UNITS.....	94
STORING/RECALLING/DELETING.....	95
PRINTING & SPECIAL PRINTING.....	98
BAR CODING.....	100
ERROR MESSAGE LIST.....	105
TROUBLESHOOTING.....	111
MACHINE SPECIFICATIONS.....	112
FEATURES.....	113
INDEX.....	114

ABOUT THIS MANUAL

Although this machine is easy to use, we suggest that you read this manual carefully before starting. This manual consists of a reference guide and three main sections:

- QUICK REFERENCE GUIDE** This section provides a quick, simple guide to setting up and using the machine.
- BEFORE YOU START** This section provides basic information concerning the machine itself, tape cassettes, and power supplies.
- LEARNING THE ROPES** This tutorial section leads you through easy-to-follow practice sessions designed to help you become familiar with the machine's operations.
- FOR YOUR INFORMATION** This handy reference section contains detailed explanations of all the machine's features.

The *Quick Reference Guide* contains all the information you need to immediately begin using this machine to make simple labels. Please read the brief *Before You Start* section for more details on the setup and care of the machine.

If this is your first time using this machine or if you would like to brush up on some techniques, we suggest you work through the exercises in *Learning the Ropes*. If you have detailed questions about specific features, the *For Your Information* section will provide you with the answers.

Good luck! We hope you enjoy using your P-Touch 540.

QUICK REFERENCE GUIDE

Power Supply (Refer to pages 9 and 10 for details.)

Inserting the Batteries

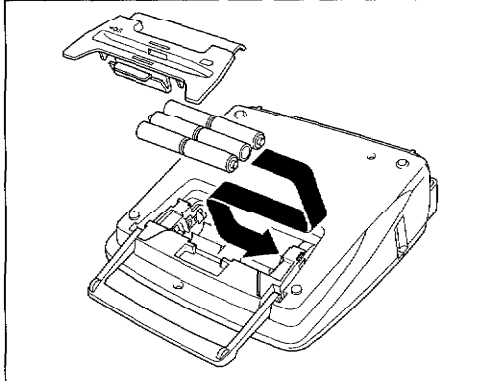

Remove the battery cover on the back of the machine and insert six **AA alkaline batteries**.

Connecting the Optional AC Adaptor

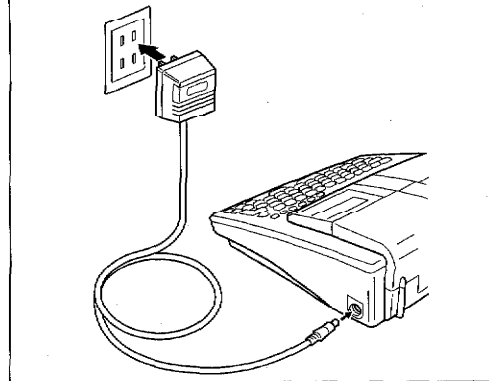

Insert the AC adaptor (model AD-30, sold separately) into the adaptor jack on the machine.

Tape Cassettes (Refer to page 11 for details.)

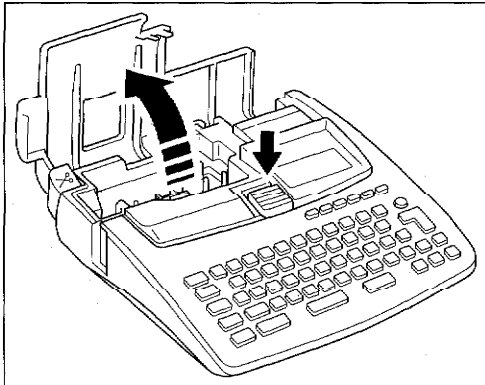

1. Press down on the cover release button and open the cover.

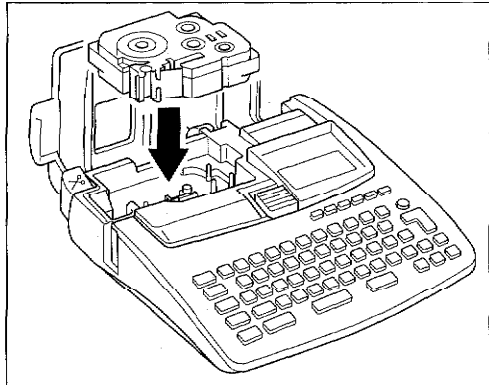

2. Insert a TZ tape cassette and close the cover.

Making Simple Labels

Mr. J. Smith

1. Press the power button.

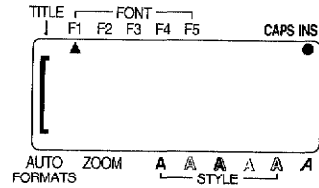

2. Enter "Mr. J. Smith".

a. Press **SHIFT** + **M**.

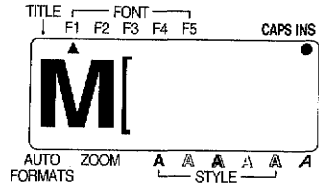

b. Press **R**, **.**, then **SPACE**.

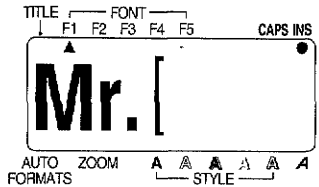

c. Press **SHIFT** + **J**. Next, press **.**, then **SPACE**.

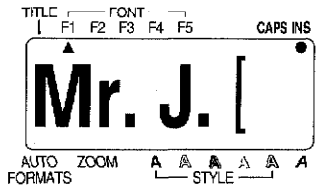

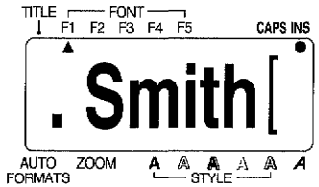

d. Press **SHIFT** + **S**. Then, press **.**, **T** and finally **H**.

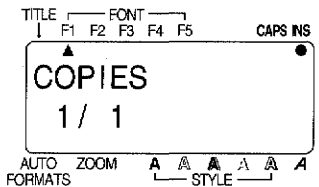

3. After entering the text, print out the label.

Press **SPECIAL PRINT** **PRINT**.



 To print multiple copies of the label,

press **CODE** + **SPECIAL PRINT** **PRINT**, then use **HOME**

and **END** to set the number of copies to be printed.

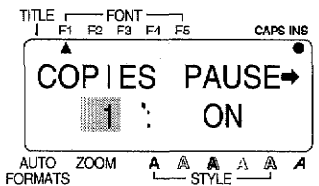

4. Affix the label.
 - a. Press the tape cutter lever to cut the tape.

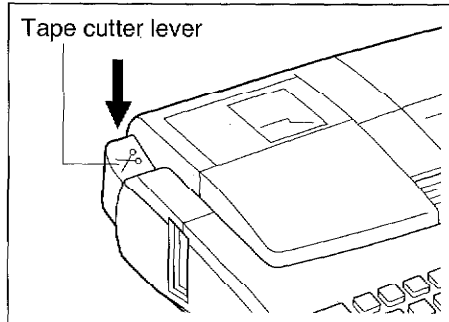

- b. Remove the label backing.

Use the enclosed lettering stick to remove the backing from labels made of laminated tape.

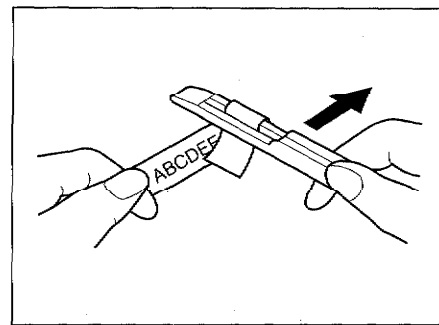
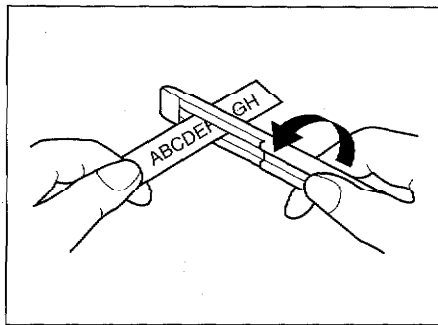

- c. Attach the label at the desired position.

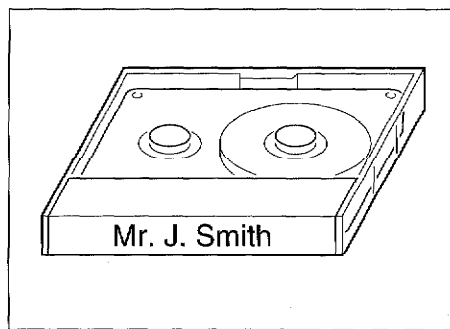

Demo printing (To print the sample label shown below, press + .)

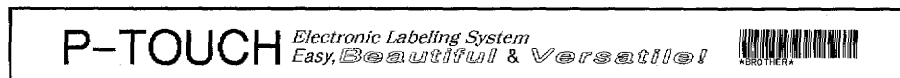

☞ Since three different sample labels are available, the type of sample label printed depends on the width of the tape.

***Before You
Start***

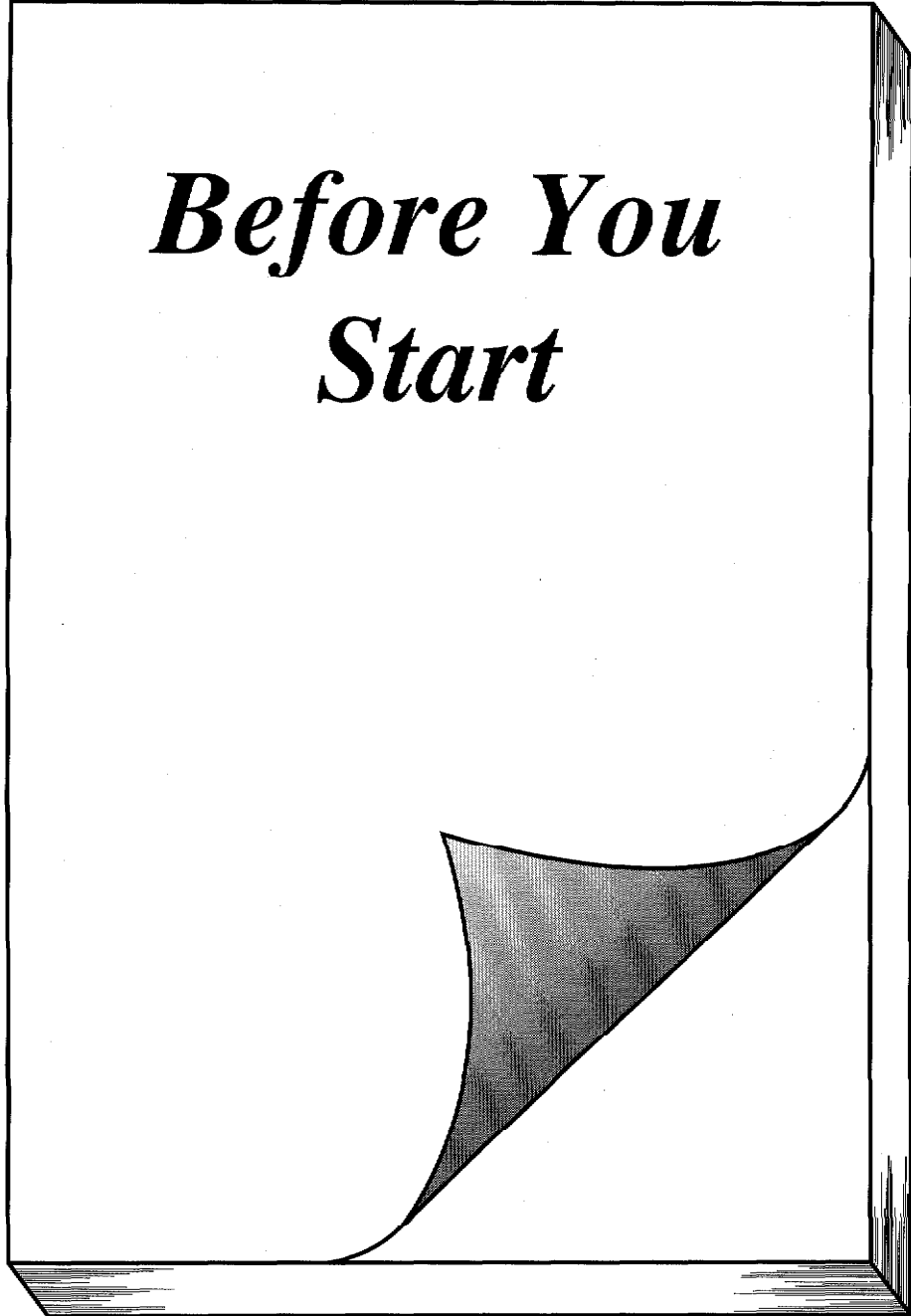

MACHINE DIAGRAM

KEYBOARD

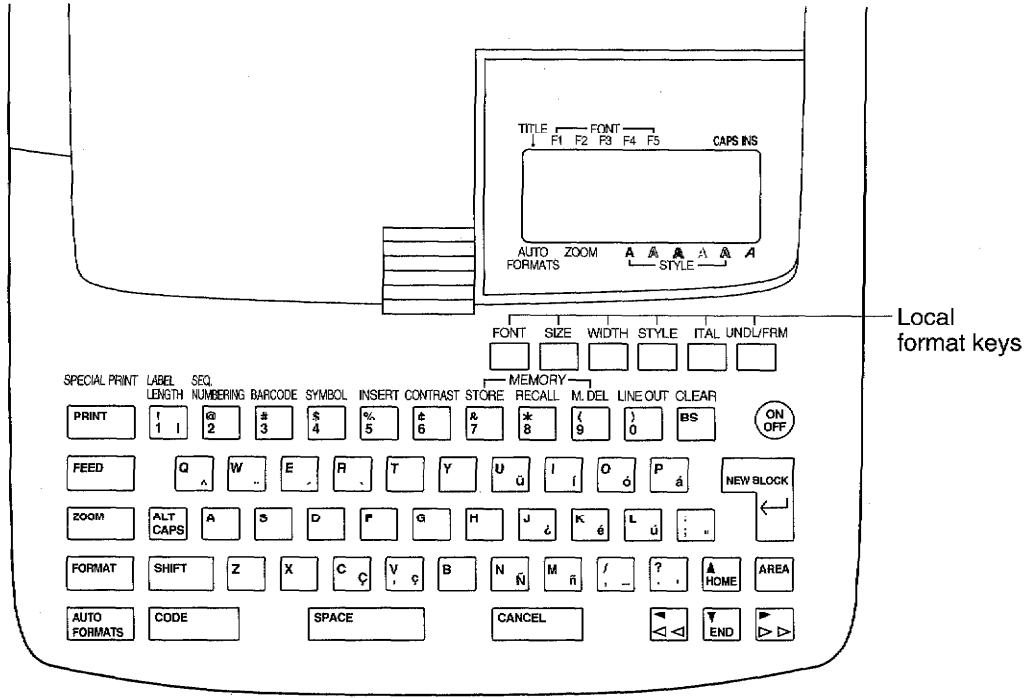

LCD DISPLAY

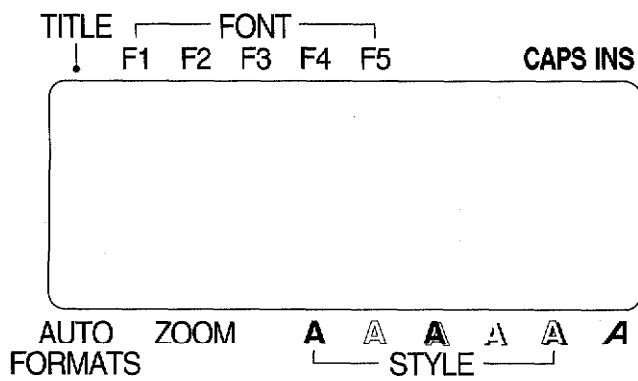

FEATURES

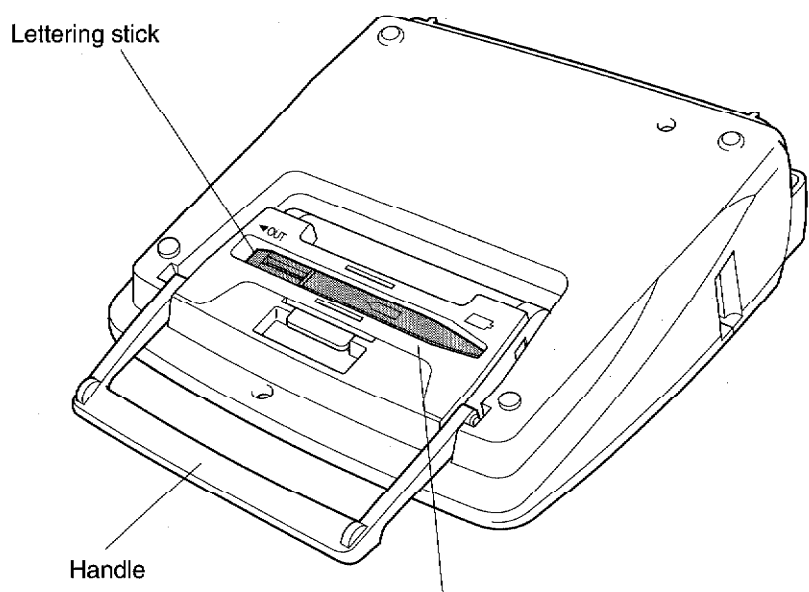
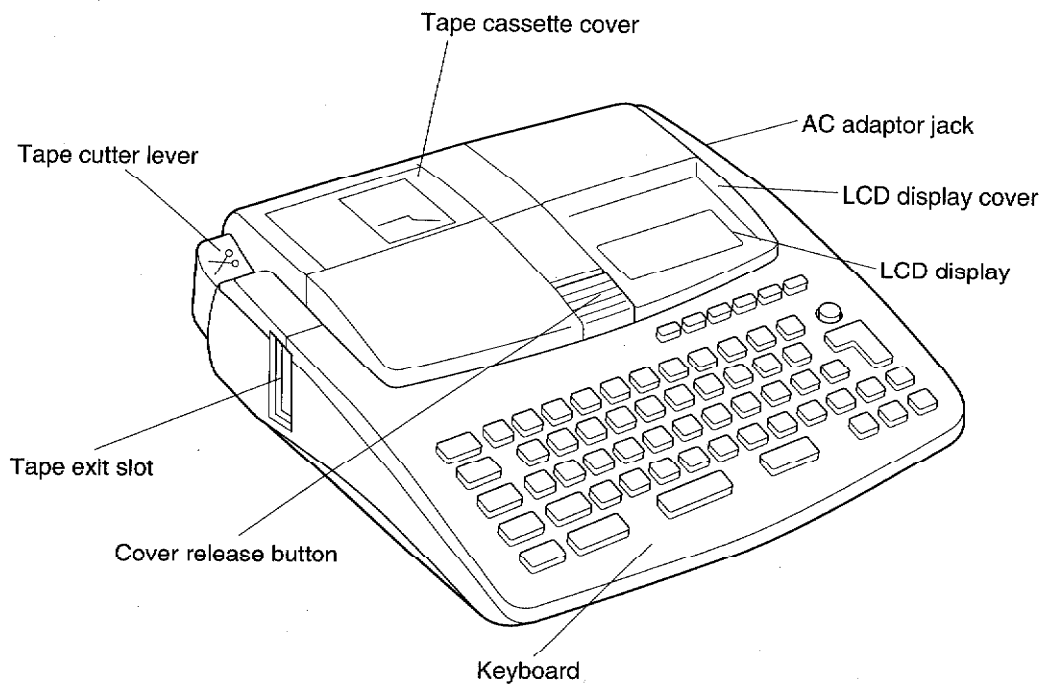

A clear protective film has been affixed to the LCD display cover to prevent it from being scratched or damaged during transport. Remove the film before operating the machine.

GENERAL PRECAUTIONS

- Use only Brother TZ tapes with this machine. Do not use tapes that do not have the  mark.
- Five TZ tape widths are available: 1/4" (6 mm), 3/8" (9 mm), 1/2" (12 mm), 3/4" (18 mm) and 1" (24 mm)
- Do not pull on the tape. This may damage the tape cassette.
- Avoid using the machine in extremely dusty places. Keep it out of both direct sunlight and rain.
- Do not expose the machine to high temperatures or high humidity. Never leave it on the dashboard or in the back of your car.
- Do not leave any rubber or vinyl on the machine for an extended period of time. Doing so may cause staining.
- Do not clean the machine with alcohol or other organic solvents. Use a soft, dry cloth only.
- Do not put any foreign objects onto or into the machine.
- To avoid injuries, do not touch the cutter's edge.
- When inserting new batteries, be sure to do so within five minutes of removing the old ones, otherwise all messages will be lost (unless the machine is plugged into an AC outlet with the AC adaptor).
- Use only the AC adaptor (model AD-30) designed exclusively for this machine. Use of any other adaptor will void the warranty.
- When the machine is not being used for a long period of time and it is not necessary to keep the messages stored in the memory, remove the batteries to prevent them from leaking and damaging the machine and disconnect the AC adaptor.
- When the AC adaptor is plugged into the machine, unplugging the adaptor from the AC outlet can delete all messages in the memory, even though batteries are installed.
- **Use AA alkaline batteries in this machine.**

POWER SUPPLY

This is a lightweight and portable machine. It can be used anywhere by installing six (6) **AA alkaline batteries**. When you change the batteries, always replace all six at the same time.

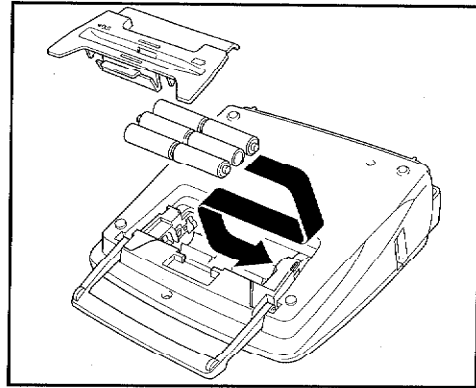
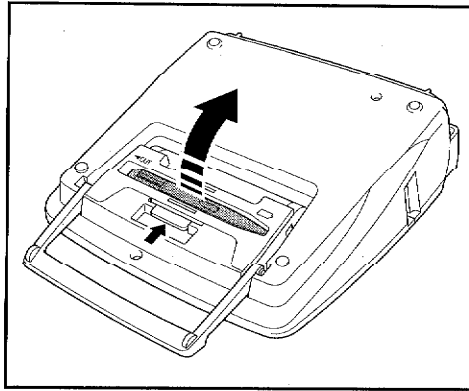

 Be sure to insert the new batteries within five minutes of removing the old ones, otherwise the message in the working area and any messages stored in the memory will be lost (unless the machine is plugged into an AC outlet with the AC adaptor).

If alkaline batteries are not used, large fonts and bar codes cannot be printed.

OPTIONAL AC ADAPTOR

The AC adaptor (model AD-30) allows you to use this machine anywhere a standard electrical outlet is available.

TO ATTACH THE AC ADAPTOR:

- (1) Insert the adaptor's small connector into the jack marked DC IN 7V on the right side of the machine.
- (2) Plug the large connector into the nearest standard electrical outlet.

 *Only use the AC adaptor designed exclusively for this machine.*

Remove the batteries and disconnect the AC adaptor if you do not intend to use your machine for an extended period of time. When the power is disconnected, all messages in the working area and the memory will be lost.

It is recommended that you use the AC adaptor when printing large fonts and bar codes on 3/4" (18-mm)- or 1" (24-mm)-wide tape since these operations can quickly run down the batteries.

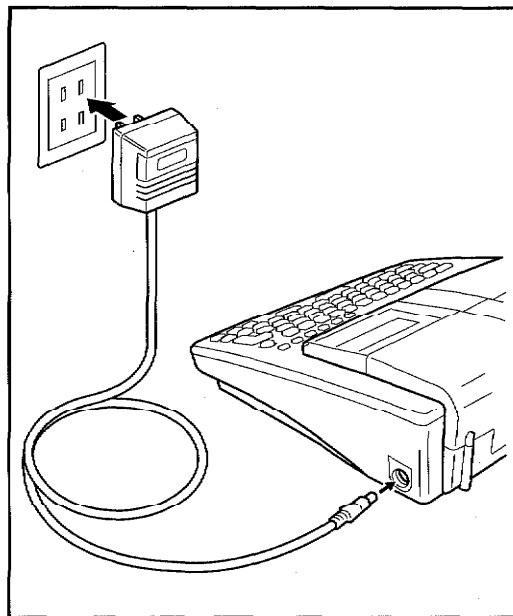

TAPE CASSETTES

A single TZ tape cassette is supplied with this unit. Since tapes for this machine are available in a wide variety of background colours, character colours and tape sizes, it is possible to make distinctive color-coded and stylized labels.

In addition, we have designed this machine to allow you to change the tape cassettes quickly and easily.

TO INSERT A TAPE CASSETTE:

- (1) Press down on the cover release button and lift open the compartment cover.

 *The machine will automatically turn off when the compartment cover is opened. The text that was displayed when the power went off will appear in the display when the machine is turned on again.*

- (2) If there is a tape cassette already in the compartment, remove it by pulling it straight up.

- (3) Remove the stopper from a new tape cassette and if the tape is loose, use your finger to wind it in the direction of the arrow on the tape cassette until it is taut. If you are using a previous tape, ensure the tape is taut prior to inserting it into the unit.

- (4) Insert the tape cassette firmly into the compartment.

 *When inserting the tape cassette, make sure that the inner ribbon does not catch on the corner of the metal guide.*

- (5) Close the compartment cover and turn on the machine.

- (6) Press the **FEED** key once to advance the tape and remove any slack.

- (7) Push down on the tape cutter lever.

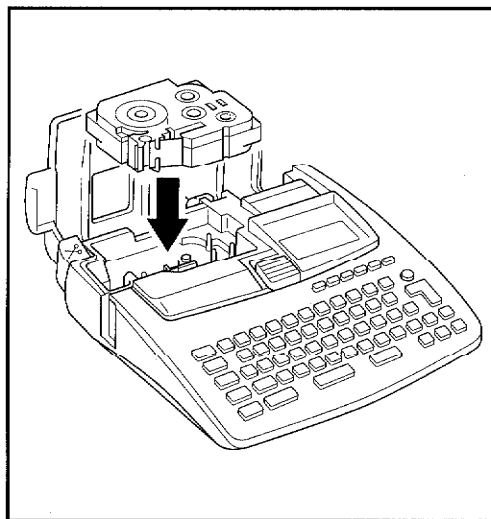
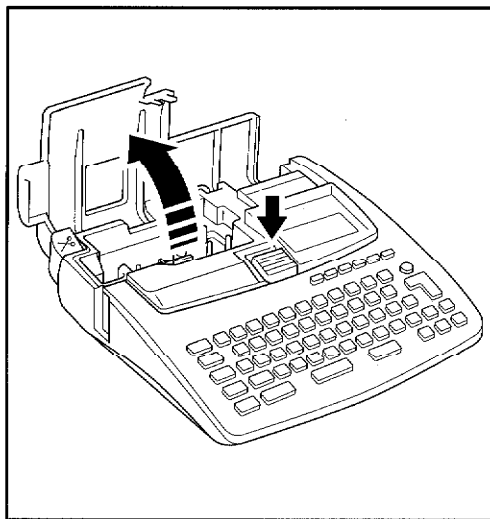

REMOVING THE LABEL BACKING

The enclosed stick enables you to remove the label backing from the tape easily.

- (1) Hold the tape in your left hand, with the printed surface facing up, and hold the stick in your right hand.
- (2) Pass the tape halfway through the long narrow hole in the stick.
- (3) After turning the stick three quarters of a turn towards you, pull the stick away from you as shown below.

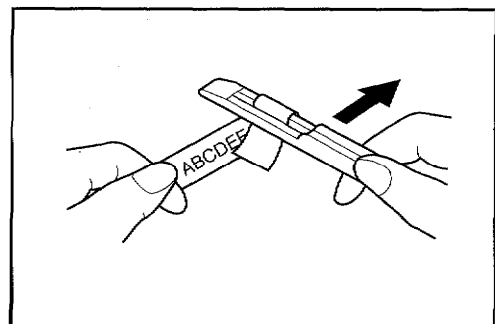
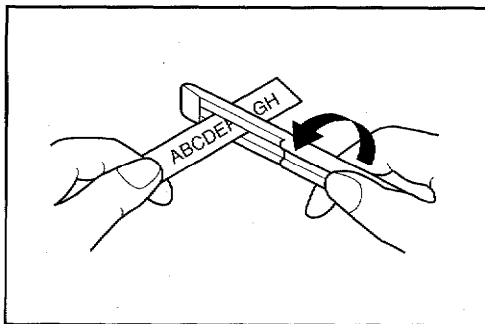

INSTANT LETTERING TAPE (RUB-ON TRANSFERS)

Instant lettering tapes act as rub-on character transfers. After creating a message, position the label on a sheet of paper. Then, by simply rubbing the instant lettering tape's non-printed side with the enclosed stick or one available on the market, you can transfer the tape's contents directly onto the paper.

Caution: Hold the tape very firmly and do not move it while rubbing the tape.

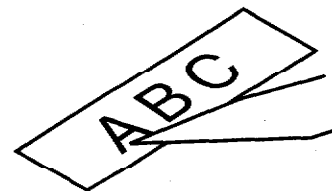
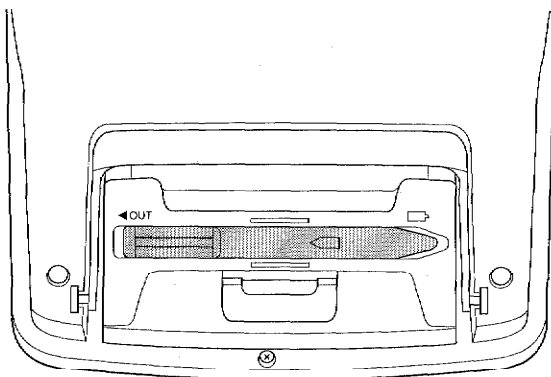

CLEANING THE PRINT HEAD AND ROLLERS

Occasionally, specks of dust or dirt become attached to the machine's print head. This is particularly likely when you are using the unit outdoors or in a very dusty environment. If a section of the print head is covered with dust, a blank horizontal streak may appear through the label message.

Therefore, as with a tape recorder, the machine's head may need to be cleaned from time to time.

TO CLEAN THE PRINT HEAD:

- (1) Turn off the machine.
- (2) Open the tape cassette cover and remove the tape cassette. The print head and rollers are located in the cassette compartment.
- (3) Print head: Use a dry cotton swab to gently wipe the print head with an up-and-down motion.
Rollers: Use a dry cotton swab to wipe each roller with an up-and-down motion while rotating them with your finger.
- (4) Try printing again.

If dust still remains:

- (5) Repeat step (3) using a cotton swab dipped in isopropyl (rubbing) alcohol.

If none of the above works, contact your service representative.

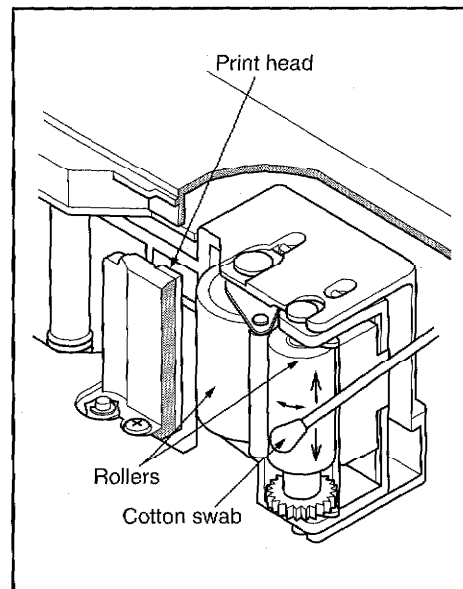
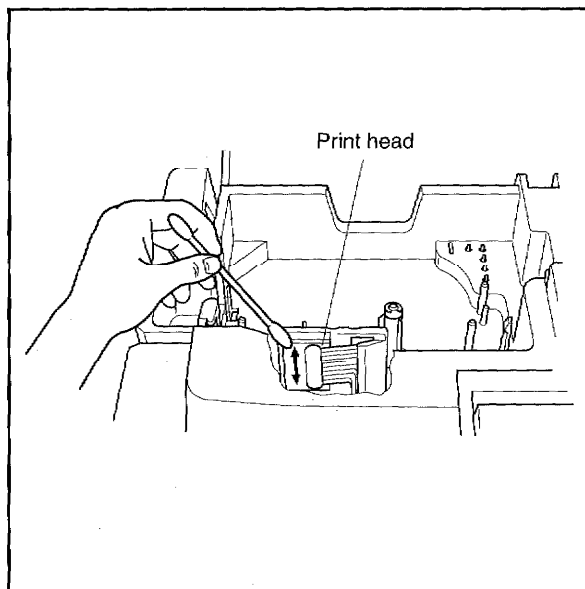

*Learning
the Ropes*

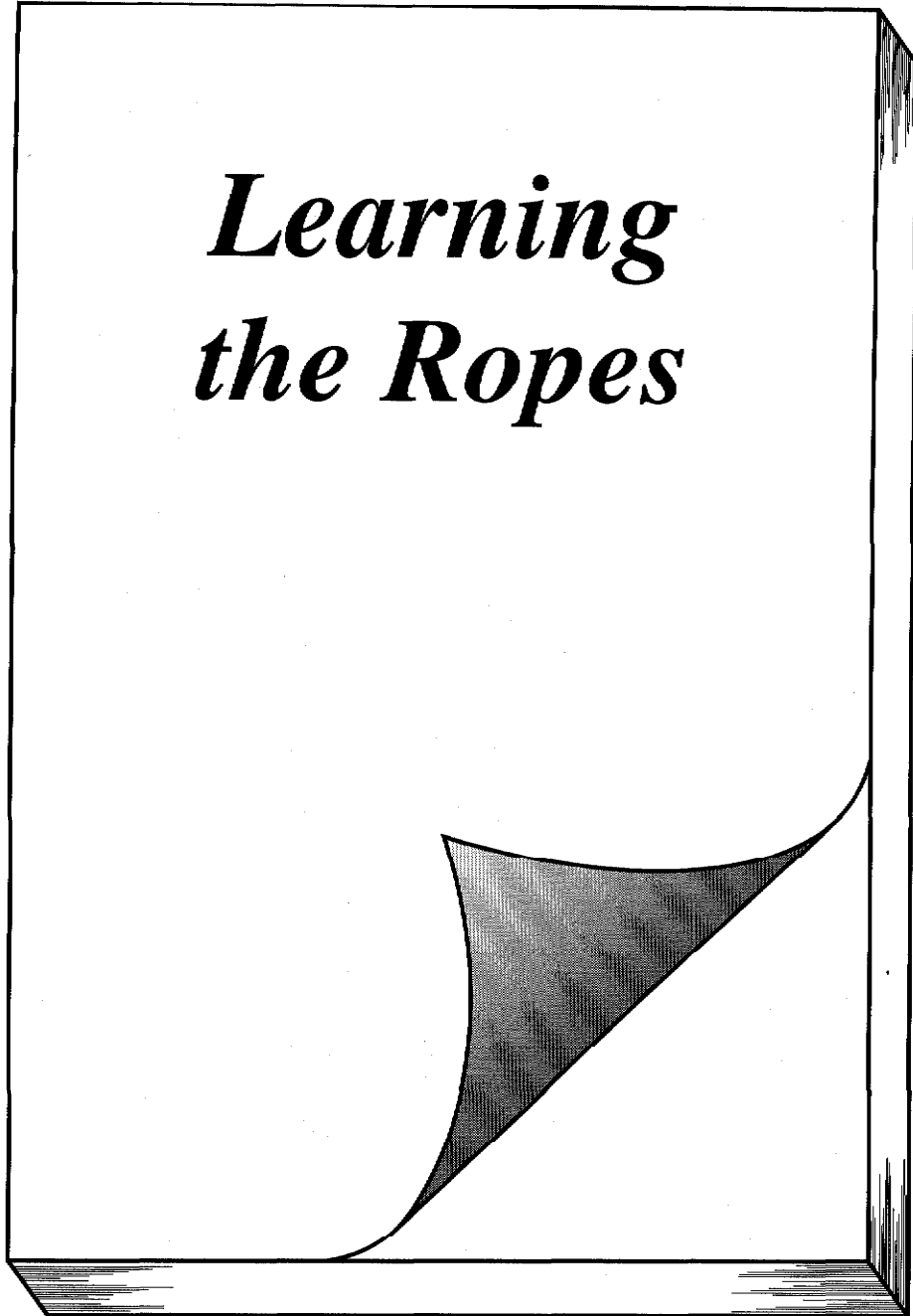

INTRODUCTION

In *Learning the Ropes*, you will find a series of label-making examples. As the featured label designs become increasingly more complex, you will learn how to use the more advanced features of this machine. The first exercise consists of creating a simple one-line door sign. The second, an equipment instruction label, takes advantage of several additional machine capabilities. The third is a four-line address label. Finally, the storage shelf label shows you how to use the unit's more expert functions.

If you are a first time user, we suggest that you work through these exercises to become acquainted with the various features of this machine. Since they do not require much time, they can be done in four separate practice sessions or all at once.

The *Learning the Ropes* examples consist of the following parts:

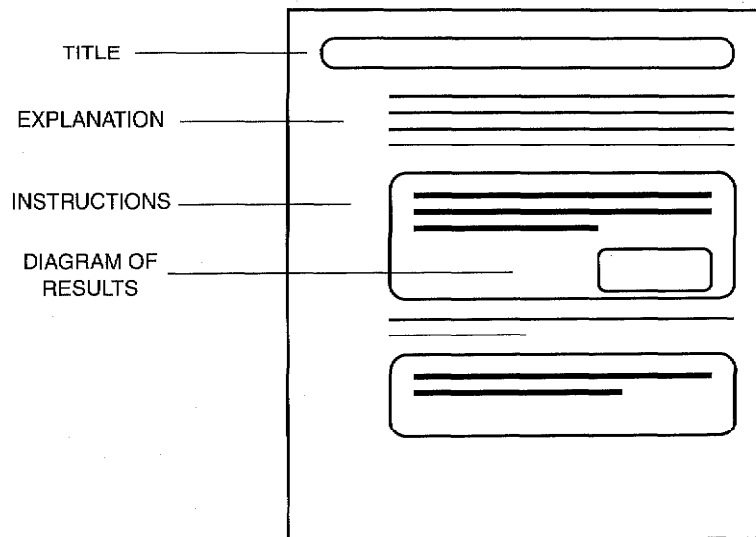

To best use this training section, simply follow the flow of the practice sessions. Read the background explanations, then follow the instructions, checking that your results match the diagrams provided. If you would like more detailed information about a particular point, simply check in the *For Your Information* section.

And now, let's see how easy it is to make beautiful labels with the P-Touch 540!

Example 1

DOOR SIGN EXAMPLE

MEETING ROOM 

Let's begin by turning on the power to the machine. The power button is located in the top right-hand corner of the keyboard.

To turn on the machine:

- Press  . When this machine is turned on, its display is in text entry mode.

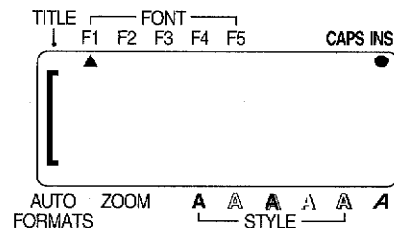

The text entry mode on this machine is a WYSIWYG (What You See Is What You Get) mode, which allows you to see the label as it will appear after it is printed. The flashing mark resembling a bracket is called a "cursor". This mark is like a pointer which shows your current position and lets you select certain characters in your text.

The message you create may sometimes be longer than this machine's LCD can display at one time. In this case, the cursor can be moved so different parts of the text can be viewed. If a character key or the right cursor key is pressed, causing the cursor to move beyond the right end of the text display, the text scrolls to the left one character at a time and the cursor is positioned at the right side of the display. If the left cursor key is pressed, causing the cursor to move past the left side of the display, the whole text display scrolls to the right and the cursor is positioned at the right side of the display.

The format settings are shown by the triangles and circles which appear at the top and bottom of the display. The default settings shown when the power is turned on for the first time have been preprogrammed into the machine and

represent the most common style settings for labels. However, you can create your own formats and can even define local formats, which are special style settings for portions of text within the label. Detailed explanations for creating and editing global and local formats can be found in the *Global Formatting* and *Local Formatting* sections of *For Your Information*.

This machine is also equipped with an Auto format function which allows you to enter text and symbols into preset label templates. With the Auto format mode, you can enter text into common formats so labels can be created easily and printed quickly.

Now, let's begin entering the text for our first label. To do so, we must first input a capital "M".

To input a capital M:

- Hold down **SHIFT** and press **M**.

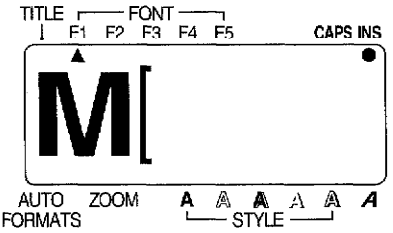

- Release **SHIFT** and type "eeting".

 Since the text is longer than the LCD display, part of the "M" moves off the display.

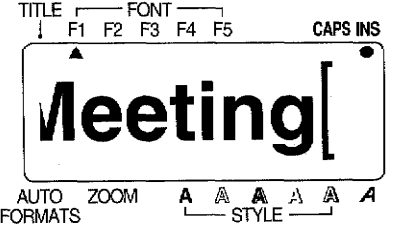

As on a typewriter, the **SPACE** key allows you to add a blank space in the message.

 The **SPACE** and **▶** keys have different functions. The **▶** key moves the cursor forward through inputted text without adding blank spaces.

To complete the "Meeting Room" label:

- Press once to add a blank space.

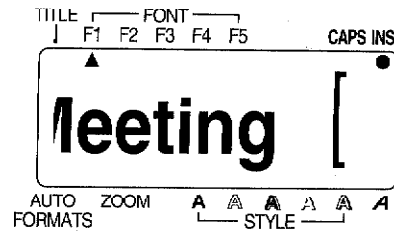

Next, enter the word "Room":

- Hold down and press .
- Release and type "oom".

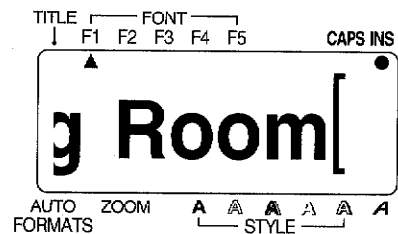





Once you have created a message, you can easily edit it by correcting mistakes or simply adjusting the text or style. For detailed explanations of text editing methods, see pages 61 to 65.

 The **BACKSPACE** key () allows you to remove characters from your message. The character immediately to the left of the cursor is deleted and all characters following the deleted character move one space to the left.

This machine has two types of entry modes: Insert and Overwrite. The Insert mode, INS, allows you to add characters in the middle of your message, while the Overwrite mode allows you to replace characters by typing over them. We will revise this label using the Overwrite function to change the lowercase letters in our message to uppercase characters which are more appropriate for a door sign. Since we will enter many uppercase letters, we will use the Caps mode which allows us to enter a string of capital letters without holding down the **SHIFT** key.

To overwrite lowercase letters with uppercase:

- Press  until the cursor is positioned in front of the first "e" in "Meeting".
- Press  +  to turn Insert mode off and Overwrite mode on. (The INS indicator in the upper right-hand corner of the display will go out.)
- Press  + . (The CAPS indicator should now light up.)

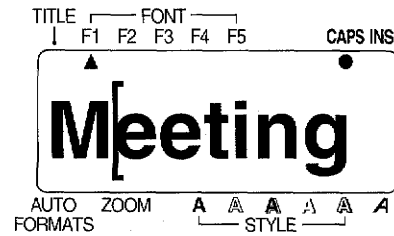

- Type "EETING". All letters automatically will be entered as uppercase without pressing .
- Now, do the same for the letters "oom" in "Room".

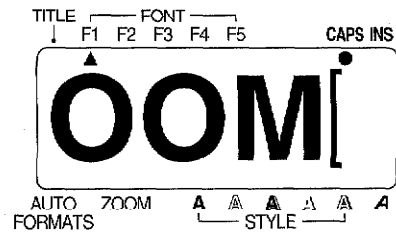



Finally, suppose we would like to add a "No smoking" symbol, just one of many available on this machine, to our door sign. A detailed explanation of symbol entry can be found in the *Symbols* section on page 50.

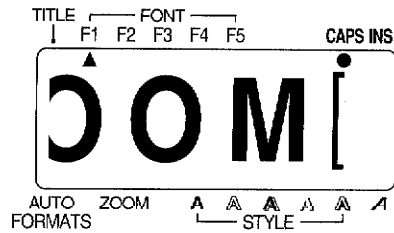

To add a "No smoking" symbol to the end of the message:

- Press  once to add a blank space to the right of "MEETING ROOM".

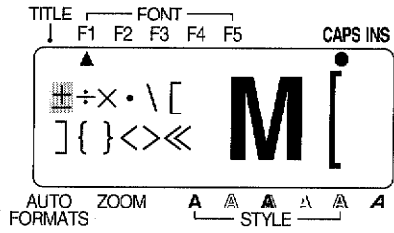

- Press  +  to display the first group of symbols.



- Press  or  until the group with the "No smoking" symbol is displayed, then press  until the "No smoking" symbol is highlighted.

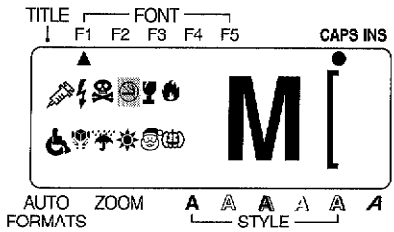

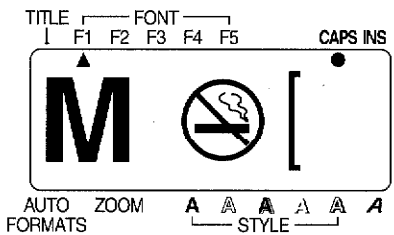

- Press  and the "No smoking" symbol will be added to your message.



 You can press the **CANCEL** key at any time to return to text entry mode from Symbol mode.

Since our message is finished, we can now print it. Though several print settings are available, we will use the default settings preprogrammed into the machine.

To print the label:

- Press  .

Example 2

EQUIPMENT LABEL EXAMPLE

Place original face down.
Turn off when finished.
Repairs: 123-4567



 The label in this example can be printed on 3/4" (18-mm)- or 1" (24-mm)-wide tape.

Although the entered characters may not seem to align properly in the LCD display, they will line up correctly on the printed label.

In this practice session, we will make a multi-line equipment instruction label.

To prepare for a new label:

- Turn on the power.

- If the previous work session's text data is still displayed, press  +  and the confirmation message "OK TO CLEAR?" is displayed.

- Press .

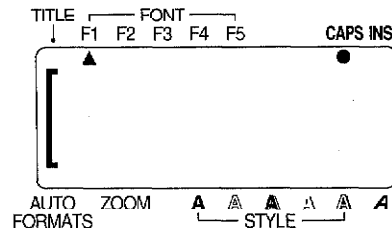

Let's assume we want to make an instruction label for an office photocopier. First, we will enter four lines of text containing both uppercase and lowercase letters, then edit it into a three-line label. If you have any questions about basic inputting, please review the previous example (Door Sign) or see pages 48 to 53 of *For Your Information*.

In our multi-line message, we will be using the **RETURN** key to end one line and start the next. This key operates like the Return on a typewriter by ending the current line and moving the cursor to the next line.

To enter a four-line message:

- Press **CODE** + **ALT CAPS** to turn Caps mode off. (The CAPS indicator should now be off.)
- Type "Place original face down."

 Since the text is longer than the LCD display, the first characters ("Place original face") move off the display to the left.

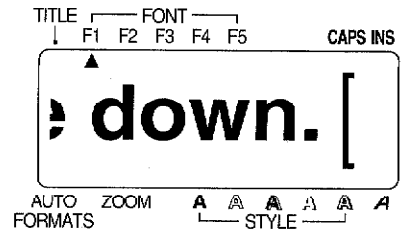

- Press **NEW BLOCK** + **←** to move the cursor to the next line so you can input another line of text.

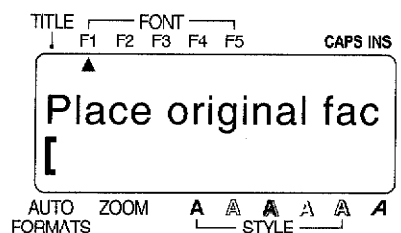

- Type "Turn off when finished." Again, the first characters will move off the display.

- Press **NEW BLOCK** + **←**.

- Then, type "Service Department" and press **NEW BLOCK** + **←**.



- Press **ZOOM** to enter Zoom mode and zoom in on the message so that it can be read more easily.

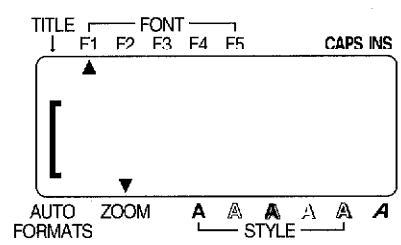

- To finish the message, type the Service Department's telephone number, "123-4567".

 To enter the dash (-), hold down **ALT CAPS** and press **! _**.

- Press **ZOOM** twice or **CANCEL** to return to text entry mode and check that the message is entered correctly.

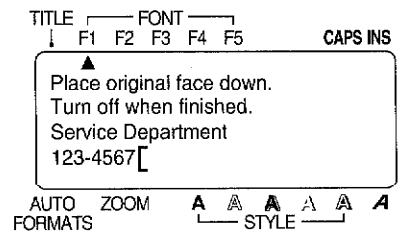



Press the **FORMAT** key at any time to view the current label formats. These settings can only be applied globally, i.e. to the entire message. For detailed explanations of the global format settings, see pages 87 to 93 of *For Your Information*.

To view the current label formats:

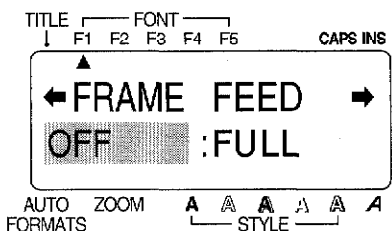
- Press **FORMAT**.



• Press  and  to scan through the format settings.

Any time you wish to return to text entry mode from Format mode without changing any of the settings, simply press the **CANCEL** key. A detailed explanation of the **CANCEL** key can be found on page 58 of *For Your Information*.

To return to the text entry mode:

- Press **CANCEL**.

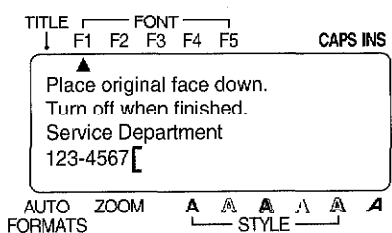

Now, let's edit the message, changing it from four to three lines and adjusting some of the text.

To edit the text message:

- Press **HOME** once to move the cursor to the third line.

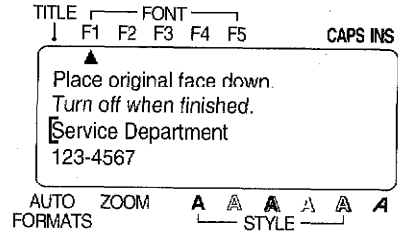

- Press **ZOOM** to zoom in on the message.

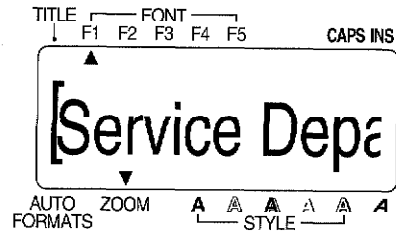

- Press **CODE** + **LINE OUT** to delete all of the text in the third line.

The total number of lines changes from four to three.

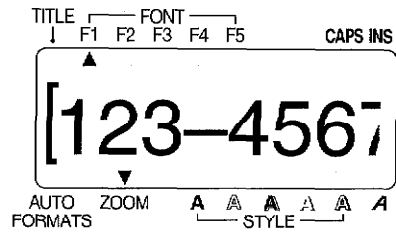

- Check the LCD display's indicators to make sure that Insert mode is on. If not, press

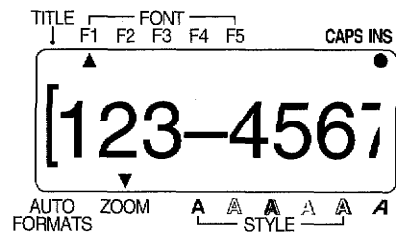
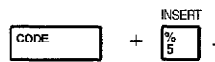

- Type "Repairs:" and add a space in front of the telephone number, "123-4567".

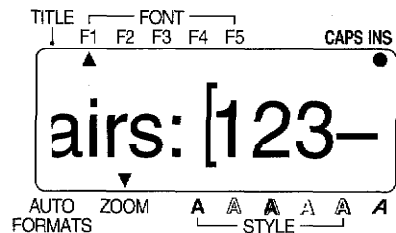

The message has now been created and edited. If it were printed now, the standard default settings would be used. The text would be aligned at the left margin and would not be framed or underlined. In addition, the characters would be auto-sized and printed using font F1 (Helsinki) and a normal style. For more details concerning format settings, please see pages 75 to 93 of *For Your Information*.

For this label, though, let's assume we want a different style of text: font F2 (Brussels), framed and horizontally centered. Therefore, we must change the format.

To change to font F2:

- Press **CODE** + **HOME** to move the cursor to the beginning of the message, then press **ARFA**.

 The "P" will be highlighted, signifying that it will be included in the local for matting field.

- Then, use **END** and **▶▶** to highlight all of the text.

The current FONT setting (F1) is indicated by the triangle.

- Press **FONT** until F2 is indicated, then press **NEW BLOCK**.

- Press **ZOOM** twice or **CANCEL** to return to text entry mode.

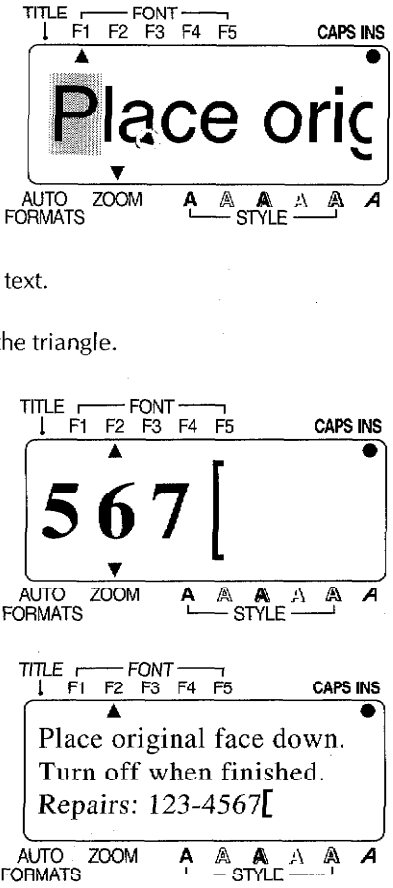

The diagram illustrates the process of changing font settings. It shows three stages of a text entry screen. In the first stage, the text 'Place orig' is displayed. A triangle points to the 'P', indicating the current font setting (F1). The screen also shows controls for TITLE, FONT (F1-F5), CAPS INS, AUTO FORMATS, ZOOM, and STYLE. In the second stage, the text '567' is displayed. The triangle has moved to the '5', indicating that font F2 is now selected. In the third stage, the text 'Place original face down. Turn off when finished. Repairs: 123-4567' is displayed. The triangle points to the first line, indicating that the font settings (F2) are applied to the entire text block.

Different format settings can be chosen either before or after the text is entered. The procedure shown above can be used to edit the font, size, width, style, italics, underline and framing settings of text which has already been entered. With this procedure, the arrow keys are used to move the cursor to select the text, then the local format keys below the display allow you to change the settings. Another way of changing the format settings is to choose them before the text is entered. With this method, once the settings are made, they do not revert back to their initial values until they are changed again.

To edit the label formats:

- Press **FORMAT**.

 *OFF is highlighted. This highlighting is like a cursor which shows the format setting that is currently "active". Items can only be changed when they are highlighted.*

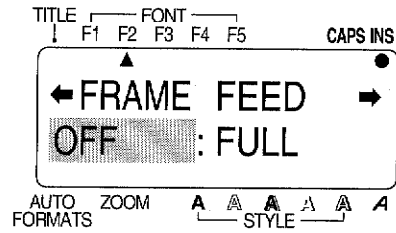

- Use **◀** and **▶** to move the cursor and **▲** and **▼** to choose the appropriate setting. Change the label framing format (FRAME) to the box setting (◻) and the horizontal alignment format (H.ALI) from LEFT to CENTER.

- Press **NEW BLOCK**.

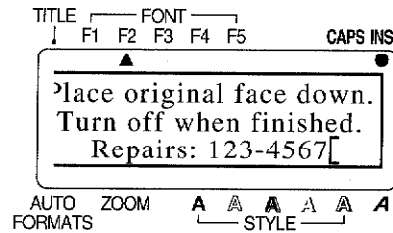

Now, let's take a look at how to store text files for future use and how to recall them when desired. Detailed explanations of the machine's memory can be found in the *Storing/Recalling/Deleting* section on pages 95 to 97.

To store the text file for future use:

- Press + .

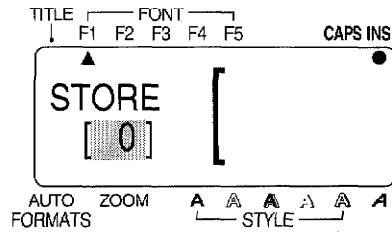

- Press . The text is stored as message "0" and can be recalled at any time.

A file can be assigned any number between 0 and 99 using and .

Let's assume a file had already been stored as "0". In this case, the message "OVERWRITE?" would appear

when is pressed.

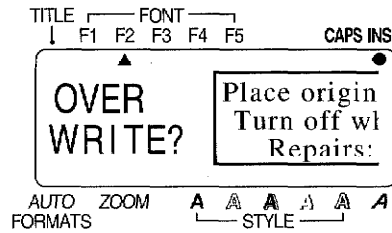

- Press and the previous file would be deleted and the new file would be saved as message "0".

If you do not want to delete the previous file, press to stop the operation.

Clearing removes all text from the working area. If you have not saved the information in the machine's memory, it will be lost. Since we have saved it, we can clear the working area without losing our work.

To clear the working area:

- Press **CODE** + **CLEAR BS**.
- Press **NEW BLOCK**.

Now, even though it is no longer displayed on the LCD, we can recall our copier instruction text file and print it.

To recall the text file:

- Press **CODE** + **RECALL * 8**.

Since the most recently stored file is displayed, which is, in this case, our desired file, press **NEW BLOCK**. The copier instruction file returns to the working area, where we can edit or print it.

Finally, let's assume that we have three photocopier machines onto which we want to attach the same label. Therefore, we need to print three copies of the same text. A detailed explanation of the repeat printing function can be found in the *Printing & Special Printing* section on pages 98 to 99.

To print three copies of the label:

- Press **CODE** + **SPECIAL PRINT PRINT**. The print options menu will be displayed.

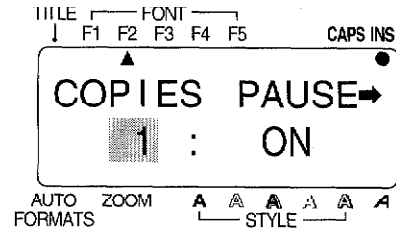

- Press **HOME** and **END** until the COPIES setting (currently 1) is set to 3.

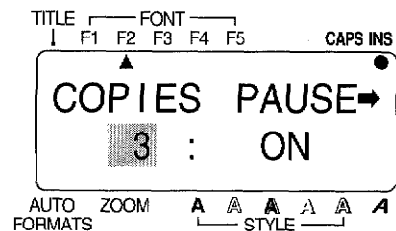

The PAUSE setting in Special print mode can be used to set whether or not the machine will pause while printing copies of labels so the tape can be cut.

To print without pausing between copies of labels:

- Press **LEFT** and **RIGHT** to select the PAUSE setting.

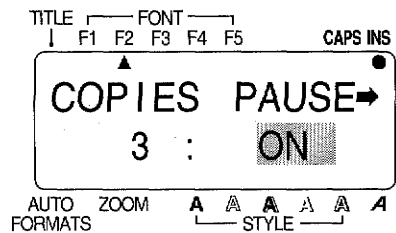

- Press **HOME** and **END** until the PAUSE setting (currently ON) is set to OFF.

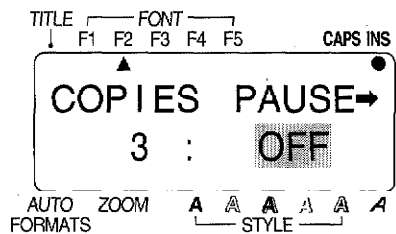

If we now wished to print three copies of the label, we could simply press the **RETURN** key. Three framed and horizontally centered labels with characters using font F2 (Brussels) would be printed.

If the cut pause setting is turned off, the three copies would be printed continuously.

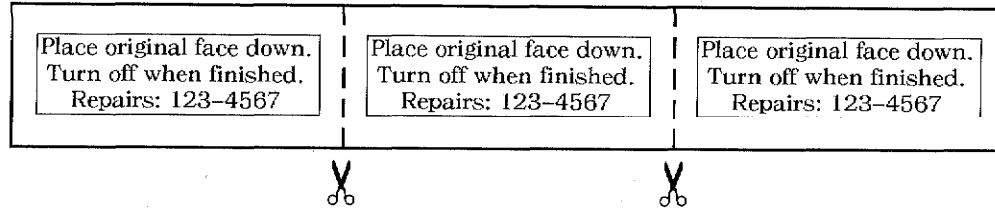

If the cut pause setting had been turned on, the machine would pause between the three copies so the tape could be cut.

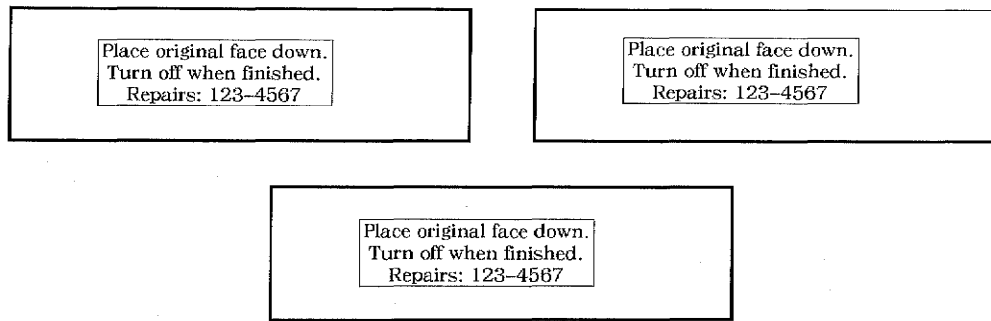

Since this would use quite a lot of tape for an example, we can now press the **CANCEL** key to escape from Special print mode and return to our text.

Example 3

ADDRESS LABEL EXAMPLE



Imports, Inc.
29 South Main Street
Malden, London
Attn.: Mr. Bill Reynolds

 The label in this example can be printed on 3/4" (18-mm)- or 1" (24-mm)-wide tape.

Although the entered characters may not seem to align properly in the LCD display, they will line up correctly on the printed label.

In this quick practice session, we will make a multi-line address label with local formatting. The local formatting will be used to emphasize a certain portion of the message.

To prepare for a new label:

- Turn on the power.
- If the previous work session's text data is still displayed, press  +  and a confirmation message is displayed.

• Press .

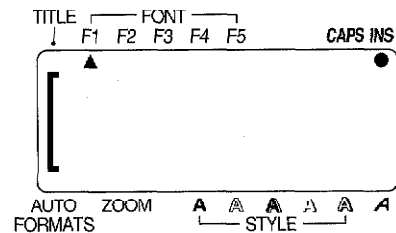

Now, we will enter the address: Imports, Inc.; 29 South Main Street; Malden, London.

To input the text:

- Type "Imports, Inc." and press

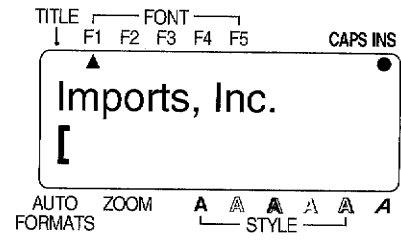

- Type "29 South Main Street" and press



- Type "Malden, London" and press

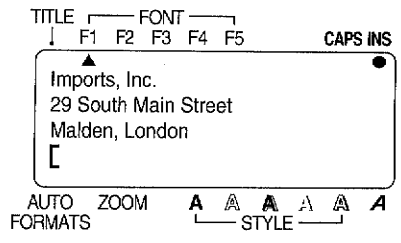

- Press



to zoom in on the message.

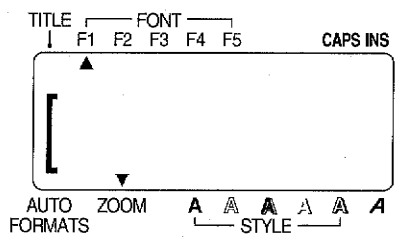

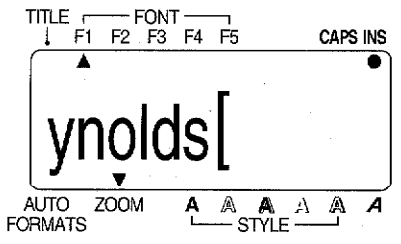

- Type "Attn.: Mr. Bill Reynolds".





Using the local format settings, we can now highlight a certain portion of our text by putting it in italics and underlining it. A detailed explanation of local formatting can be found on pages 79 to 86 and in the *Local Formatting* section on pages 75 to 76.

To emphasize the addressee's name:

- Press  until the cursor is positioned in front of the "M" in Mr.
- Press .

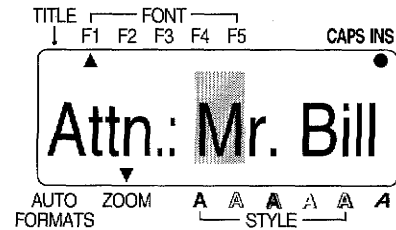
 The "M" will be highlighted, signifying that it will be included in the local formatting field.





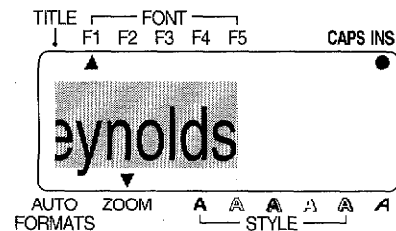

- Press  +  to highlight the characters "Mr. Bill Reynolds", all the letters to be locally formatted.





- Press  to set the character size to 13 points. The character size setting appears on the display.

 The current *STYLE* setting is indicated by the upside-down triangle. When a triangle is not displayed, the normal style setting is applied to the characters.

- Press  until the character *STYLE* setting changes to bold. (The indicator above **A** turns on.)
- Press  to turn on the italics setting. (The **A** indicator comes on.)
- Press  until the highlighted characters are underlined.



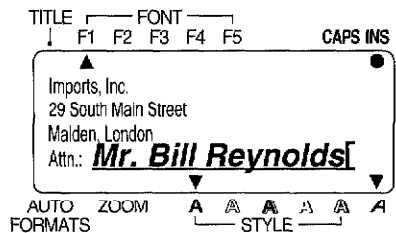

- Press . The addressee's name will now have its own special local format: bold, italicized and underlined characters.

- Press  twice or  to return to text entry mode.



Now, let's assume we wish to print one copy of this label to attach to a package.

To print one copy of the label:

- Press  +  to display the print options menu.
- Press  and  until the COPIES setting (currently 3 from the previous example) is set to 1.
- Press  to begin printing.

Example 4

STORAGE SHELF LABEL EXAMPLE

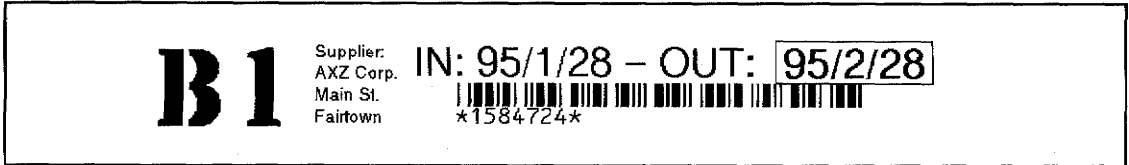

The label in this example can be printed on 3/4" (18-mm)- or 1" (24-mm)-wide tape.

Although the entered characters may not seem to align properly in the LCD display, they will line up correctly on the printed label.

In this final example, we will make a storage shelf label. This label would be used to describe the parts stored on a shelf. WYSIWYG text entry mode is very convenient when making complex, multi-block labels since it allows you to see the label as it will appear after it is printed.

Each time the number of lines changes, a new block of text must be created. Therefore, the text for our label must be entered in three separate blocks.

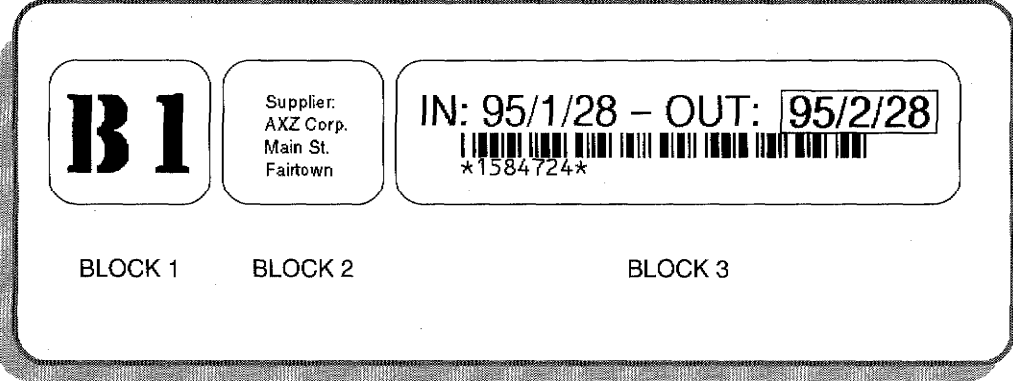

In this practice session, we will use local formatting and the multi-block applications, as well as more specialized features, such as bar coding and numbering.

To prepare for a new label:

- Turn on the power.
- If the previous work session's text data is still displayed, press **CODE** + **BS** and a confirmation message is displayed.

- Press **NEW BLOCK**.

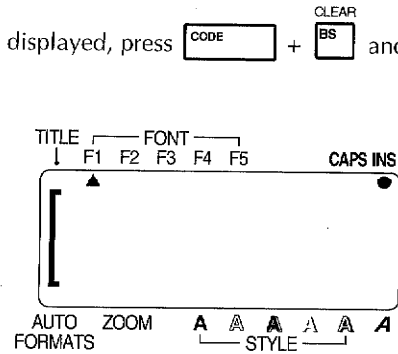

Now, we will enter the storage shelf label text.

To input the first block of text using font BIG F1:

- Press **FONT** until TITLE F1 is indicated and the TITLE F1 sample character is displayed.
- Type "B1".

If you have any questions about basic inputting or editing, please review the previous examples or see For Your Information.

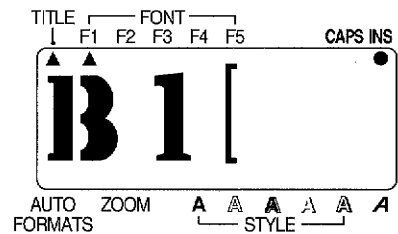

We now want to change from a one-line to a four-line block. In this case, we will not use a regular return, instead we will use the **NEW BLOCK** key. A detailed explanation of multi-block labelling can be found in the *New Block* section of *For Your Information*.

To input the remaining text:

- Press + ↵

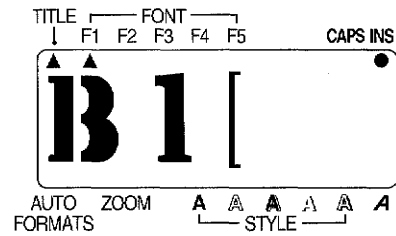

- Press until font F1 is selected and the F1 sample character is displayed.

- Type "Supplier:" and press ↵

- Then, type "AXZ Corp." and "Main St.",

pressing ↵ after each line.

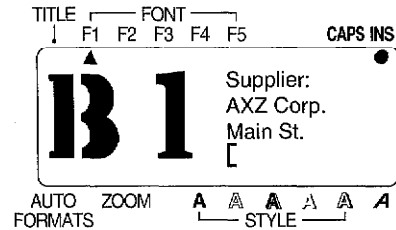

- Press to zoom in on the message.

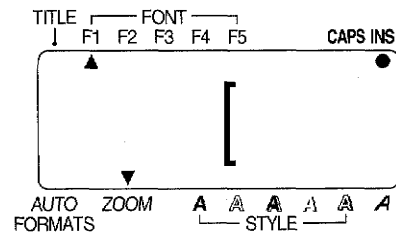

- Type "Fairtown".
- Press twice or to return to text entry mode.

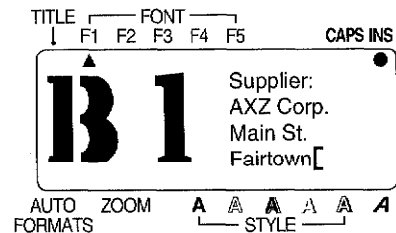

- Press + ↵

We now want to enter the text in the third block.

- Type "IN: 95/1/28 - OUT: 95/2/28" and press ↵. The cursor will move to the second line and the last characters of the line will move off the display.

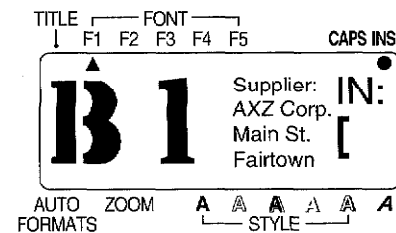

Now, we must enter the bar code information, the last portion of our message. Though many options exist for bar codes, let's assume you wish to use CODE 39 protocol with an undetermined (free) number of digits. A detailed explanation of bar coding can be found on pages 100 to 102. However, this explanation covers only the basics of this machine's bar coding function and is not intended as a comprehensive introduction to bar coding.

To enter Bar code mode:

- Press + . The bar code setting screen will appear.

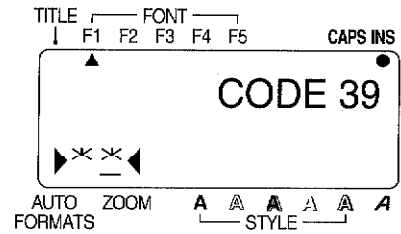

If we wished to use a different protocol or change any of the default bar code settings, we would press the **FORMAT** key. However, since we will use the default settings for this example, we can immediately input our data.

To enter the bar code data:

- Type the code, "1584724".

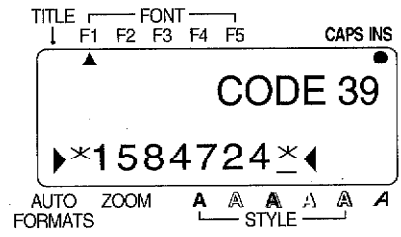

- Press .

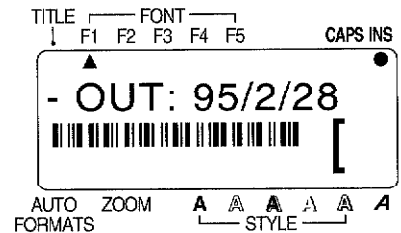

To move the cursor quickly from block to block, use the **▶▶** and **◀◀** keys. A detailed explanation of their operation can be found in the *Cursor Movement* section of *For Your Information*.

To emphasize the OUT date:

- Press and until the cursor is positioned to the left of the "9", the first character to be locally formatted.

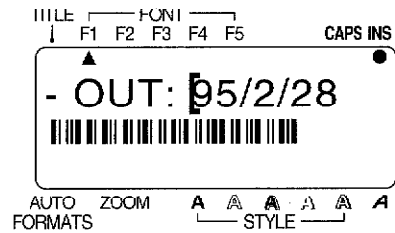

- Press . *The "9" will be highlighted, signifying that it will be included in the local formatting field.*

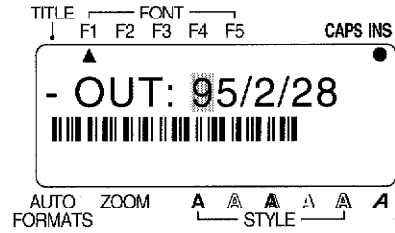

- Press until the characters "95/2/28", all the characters to be locally formatted, are highlighted.

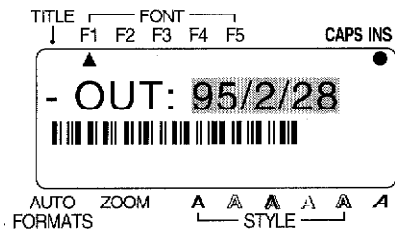

- Press until the character STYLE setting changes to bold. (The indicator above **A** turns on.)

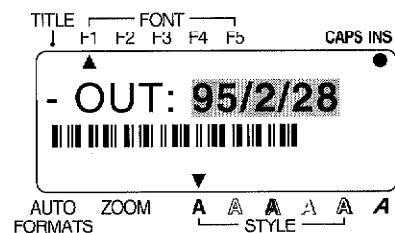

- Press until the highlighted characters are framed with a rectangle.

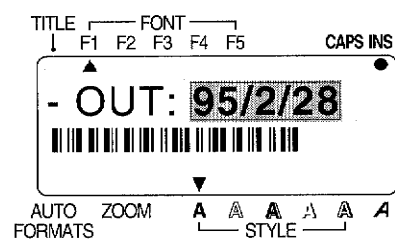

- Press . The characters "95/2/28" will now appear on the display with their own special local format: bold style and framed.

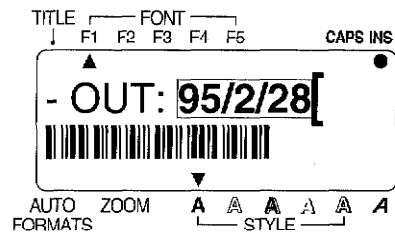



Next, we will practice using the numbering function. This feature is particularly useful for serial numbers and other codes which require sequential numbering. In this example, let's assume that we would like to increase the "1" in our parts code while the bar code information remains the same.

To make "1" a numbering field:

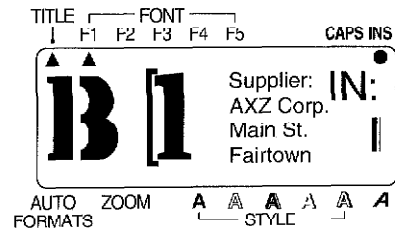
- Press  until the cursor is positioned to the left of the "1" in the parts code, the only number to be included in the numbering field.



- Press  +  and the message "SELECT FIELD!" is briefly displayed.

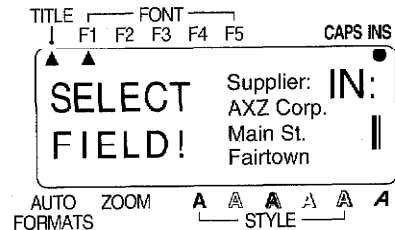



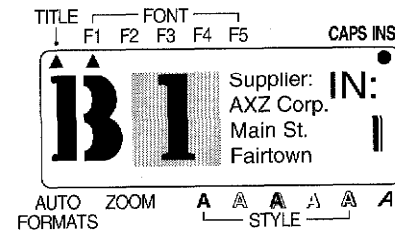

Then, the selected character will be highlighted.

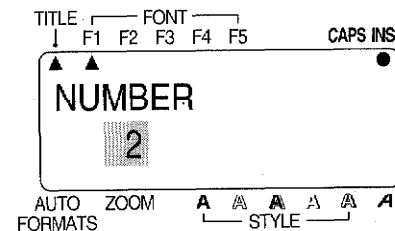



- Press  to select the numbering field and the NUMBER setting screen is displayed.



- Press  or  to print two copies of the label using the standard print settings. The number of the copy being printed is shown on the display.

 If you wished to print labels "B1", "B2" and so on, up to "B5", for example, press  and  until 5 is displayed under the NUMBER setting,

before pressing  or .

The parts code increases automatically. After the designated number of labels are printed, the display shows the label with the numbering field increased to the next value.

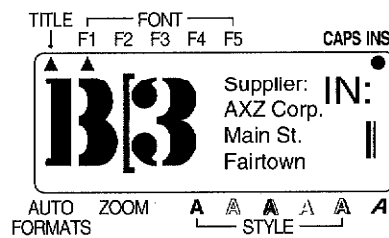
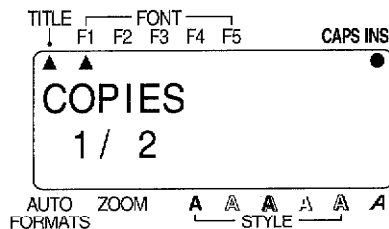

With the numbering feature, the numbers or letters included in the field will automatically increase when each label is printed. A detailed explanation of this function can be found in the *Sequential Numbering* section on pages 56 to 57.

Congratulations! This completes the fourth and final practice session in *Learning the Ropes*. We hope that these exercises, which cover most of this machine's features, have been both informative and enjoyable. If you wish, you can now go back and repeat any of these exercises, practice on your own or begin making your own labels. If you have questions about any of the operations, please turn to the *For Your Information* section of this manual.

*For Your
Information*

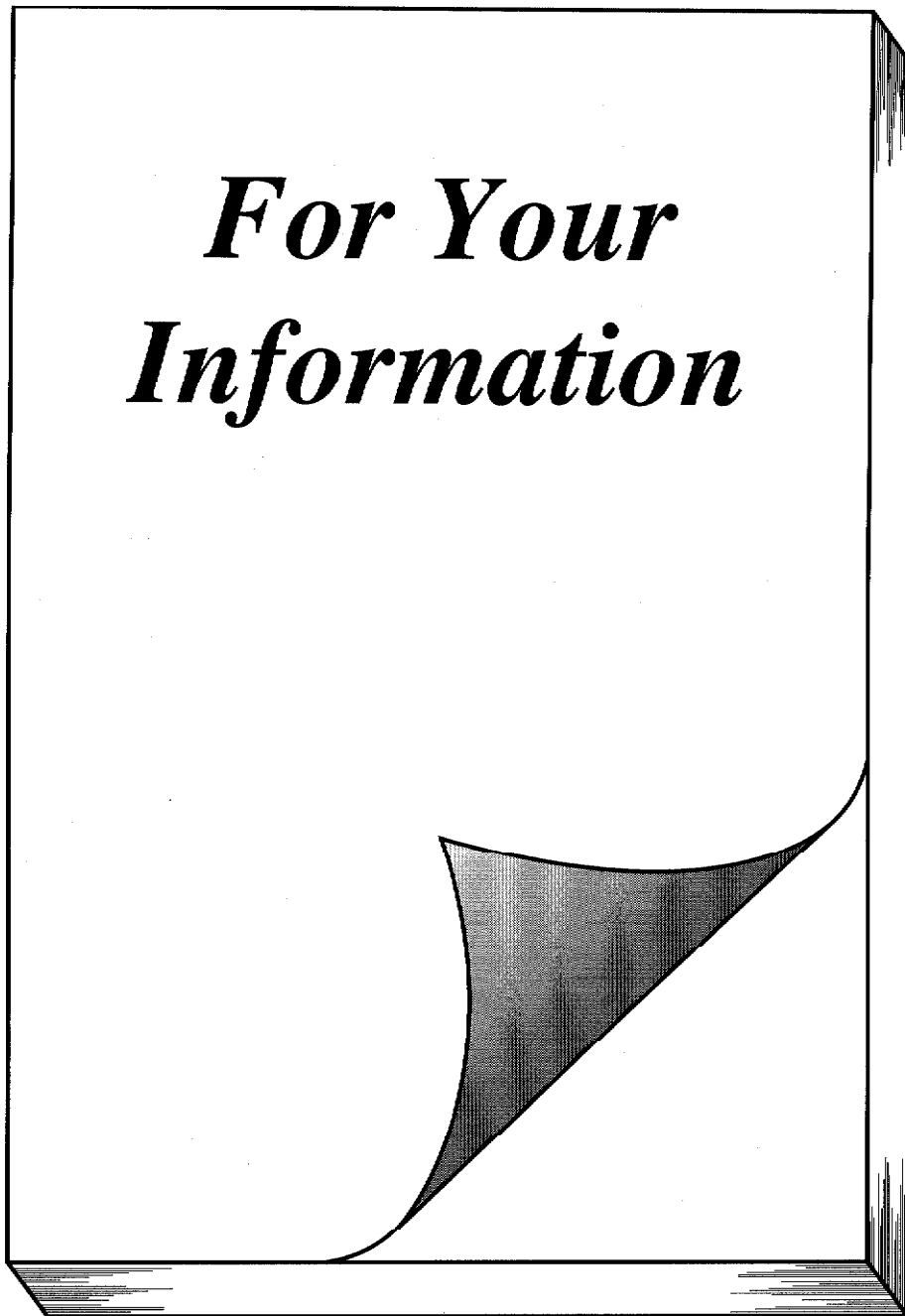

INTRODUCTION

In *For Your Information*, you will find detailed explanations of all the machine's features. Each topic is given its own page, making this reference section easy to use.

Operational examples of most features can also be found in the *Learning the Ropes* practice sessions. If you are a first time P-Touch user, we suggest that you work through these exercises before starting to make labels on your own.

This *For Your Information* section provides supplementary information. When you have a question about a particular point, locate that topic in the "Finding Your Way" contents list and turn to the page indicated.

FINDING YOUR WAY

This *For Your Information* reference guide gives detailed explanations of all of this machine's features. The following list shows which topics are covered and on which page an explanation of their operation can be found.

	PAGE		PAGE
INPUTTING		FORMATTING	
Power Button	46	Auto Formats	69
Cursors	47	Local Formatting	75
SHIFT, ALT & CAPS	48	Global Formatting	77
CODE Key	49	Text Formats:	
Symbols	50	Font	79
Composite Characters	52	Size/Width	81
Return	53	Style/Italic	83
New Block	55	Underlining/Framing	86
Sequential Numbering	56	Label Formats:	
Cancel	58	Framing	87
CURSOR MOVEMENT	60	Tape Feed	88
EDITING		Vertical Printing	89
Insert vs. Overwrite	61	Mirror Printing	90
Backspace	63	Horizontal Alignment	91
Line Out	64	Vertical Alignment	92
Clear	65	Length	93
DISPLAYING		Display Units	94
Zoom Mode	66	MEMORY	
Label Length	67	Storing/Recalling/Deleting	95
Contrast	68	PRINTING & SPECIAL PRINTING	98
		BAR CODING	100

POWER BUTTON

BACKGROUND

The power button is located in the top right-hand corner of the machine's keyboard. When the power is turned on, the previous session's information is displayed. The machine will automatically turn off if no key is pressed within 5 minutes.

If batteries have been installed in the machine or if it has been plugged in using the optional AC adaptor, the machine's internal memory will retain the last message created and display it after the machine is turned on. This automatic backup feature allows you to stop work on a message, turn off the machine and return to it later without having to re-enter the message.

 When the AC adaptor is plugged into the machine, unplugging the adaptor from the AC outlet can delete the contents of the memory, even if batteries are installed.

If six AA alkaline batteries have been installed or if the machine is plugged into an AC outlet using the AC adaptor, all data in the machine's memory will be retained. When changing the batteries, be sure to insert the new ones within five minutes of removing the old batteries, otherwise the messages in the working area and the memory will be lost.

The power button can also be used to "reset" the machine. This reset function is useful in two situations:

- (1) To clear all text files and format changes from the machine's memory.
- (2) To return the machine to a usable status if it has "locked up" (i.e. it does not respond when a key is pressed).

TO RESET THE MACHINE:

- (1) Turn the power off.
- (2) Hold down the **CODE** and **R** keys and turn the power back on.

Since all text files and format setting changes will be cleared from the memory, this should be done only as a last resort.

CURSORS

BACKGROUND

This machine has two different types of cursors.

The first, which resembles a bracket (|) in text entry mode or an underline in Auto format or Bar code mode, marks your current position in the text. Its operation is nearly identical to that of cursors on electronic typewriters or word processors. You can review and edit different parts of your message by moving the cursor backwards, forwards, up and down. Eight keys (◀, ▶, ▲, ▼, HOME, END, ◀◀ and ▶▶) let you move this cursor. Their operations are explained in the *Cursor Movement* section.

While the text cursor is used to mark or select points in text messages, another type of cursor allows you to choose characters and various settings. When a setting is highlighted, that setting is currently "active". For example, if the box setting (□) is highlighted below the framing setting (FRAME) in Format mode, the characters are framed with a rectangle. Also, when you select text fields for numbering or local formatting, the currently selected characters will be highlighted.

Both of these cursors — the text cursor for pointing and the highlighting cursor for choosing — help you create, view and edit label messages.

EXAMPLE

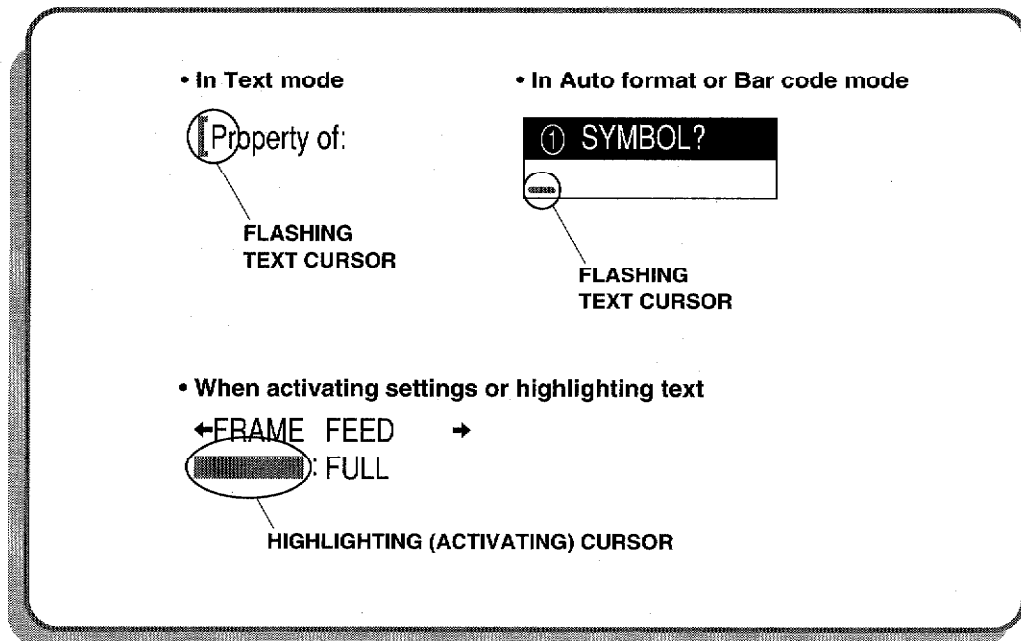

SHIFT, ALT & CAPS

BACKGROUND

Most characters can be entered simply by pressing their keys. However, to enter uppercase letters, accented characters and some common symbols, three special keys are necessary.

SHIFT KEY: This key allows you to type symbols located on the upper part of the keys and capital letters; however, symbols and characters in red must be entered while in Alt mode. To type a capital "A", hold down the **SHIFT** key and press the **A** key.

CAPS KEY: The **SHIFT** key is very useful for inputting a single capital letter, for example, at the beginning of a name. However, when you wish to enter a series of uppercase letters, the **CAPS** key should be used.

TO ENTER CAPS MODE:

Hold down the **CODE** key and press the **CAPS** key.

When this mode is on, the CAPS indicator on the top the LCD display turns on.

 Using the **SHIFT** key in Caps mode will produce lowercase letters.
TITLE fonts will only produce uppercase letters.

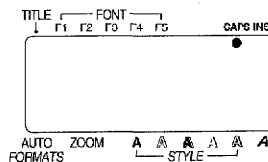

In Caps mode, uppercase letters can be typed simply by pressing the character keys (i.e. pressing the **SHIFT** key is not necessary). However, when number keys are pressed, numbers — not the symbols above them — appear. To exit Caps mode, hold down the **CODE** key and press the **CAPS** key. The indicator will turn off.

ALT KEY: The **ALT** key allows you to input characters and symbols written in red on the keys.

TO ENTER A CHARACTER WRITTEN IN RED:

Hold down the **ALT** key and press the key of the desired character written in red. To exit Alt mode, release the **ALT** key.

CODE KEY

BACKGROUND

While the **SHIFT**, **CAPS**, and **ALT** keys allow you to select various characters and symbols, the **CODE** key allows you to choose various functions. Functions written in green can be selected by pressing the **CODE** key.

EXAMPLE

To use the memory recall function:

- Press + .

To enter Symbol mode:

- Press + .

SYMBOLS

BACKGROUND

This machine has many special marks and symbols that can be entered into your text. When entered, they act like normal characters and can be both edited and deleted.

Though several symbols can be found on the machine's key tops, 126 additional marks are available in Symbol mode.

OPERATION

TO ENTER A NON-KEY TOP SYMBOL:

- (1) Hold down the **CODE** key and press the **SYMBOL** key to enter Symbol mode.
- (2) Press the ▲ and ▼ keys until the symbol you wish to enter appears on the display.
- (3) Press the ► and ◀ keys until that symbol is highlighted.
- (4) Press the **RETURN** key to enter the symbol into your message.

 *To continuously enter many symbols, select each symbol, then hold down the **CODE** key and press the **RETURN** key. Press the **RETURN** key after you have entered your last symbol and want to leave Symbol mode.*

The 126 symbols in Symbol mode cannot be entered in a bar code.

LIST

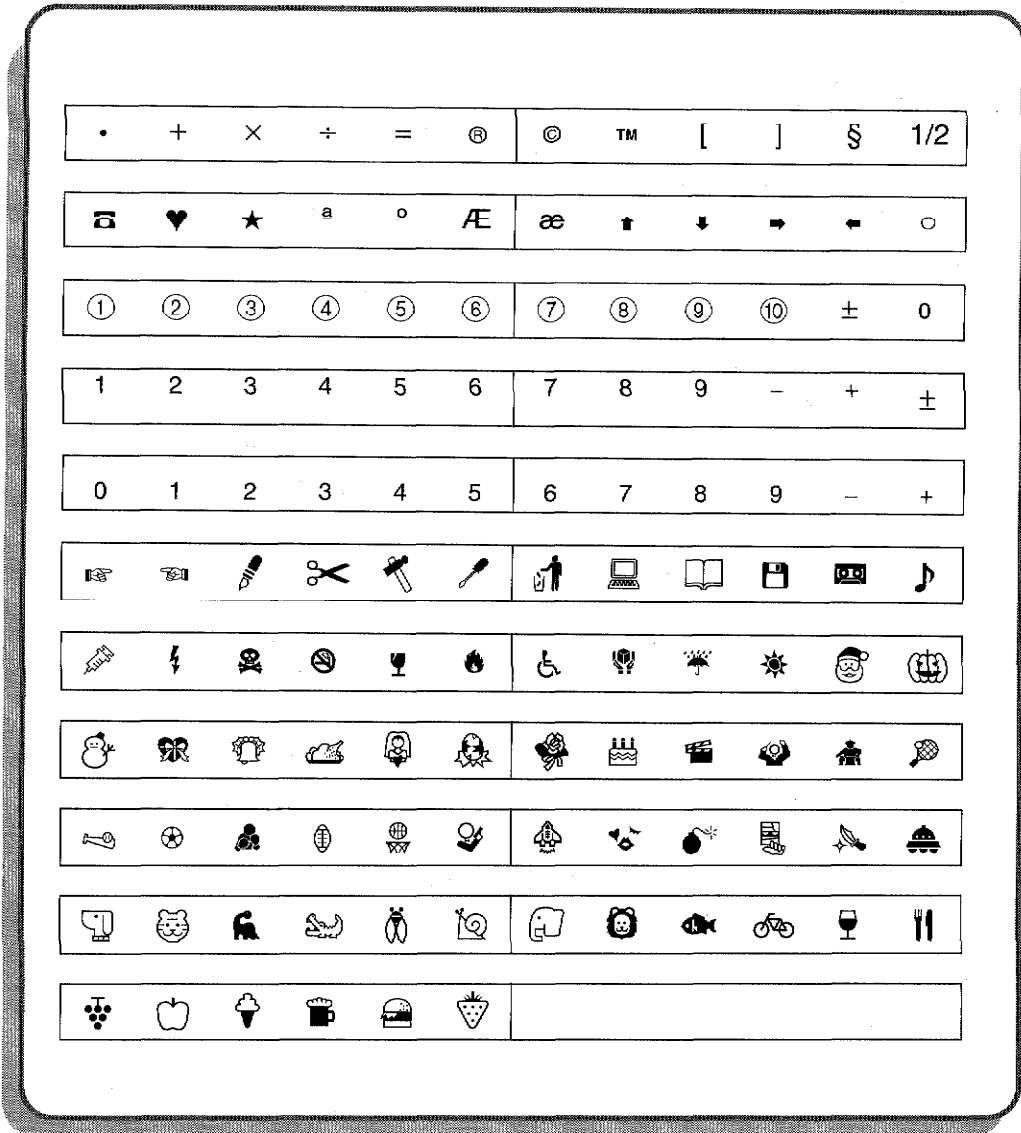

COMPOSITE CHARACTERS

BACKGROUND

In alphabets other than the English alphabet, composite characters, which consist of a letter and a diacritical mark, are often used. This machine can also display and print these characters. The diacritical marks available are ` , ^, ~ and ,.

Several composite characters can be found on the key tops. Characters such as é, à, and ñ can be entered in the same way as other characters. Before inputting a composite character as described below, check whether it is already available as a key-top character.

Diacritical Mark	Letters which can be used
¨	A E I O U a e i o u
´	A E I O U a e i o u
`	A E I O U a e i o u
^	A E I O U a e i o u
~	N n
¸	C c

OPERATION

TO INPUT A COMPOSITE CHARACTER:

- (1) Enter the diacritical mark needed for the composite character.
- (2) Type the letter you wish to combine with it.

 *The diacritical mark and the letter will alternately appear on the display.*

If the letter cannot be combined with the diacritical mark (see the above chart), the chosen letter will take the place of the mark.

If you press a cursor movement key or the **PRINT** key after inputting a diacritical mark, nothing will occur. To continue inputting your message, you must either enter a character or delete the mark with the **CANCEL** key or the **BACK-SPACE** key.

RETURN

BACKGROUND

The **RETURN** key is located on the right side of the keyboard. It is the largest, and one of the most often used keys. The **RETURN** key has three basic functions:

TO END A LINE:

Like the **RETURN** key on a typewriter or word processor, this machine's **RETURN** key lets you end one line of text and begin another. While entering the message, press the **RETURN** key when you have finished entering one line and wish to start the next. The cursor moves to the next line on the LCD display.

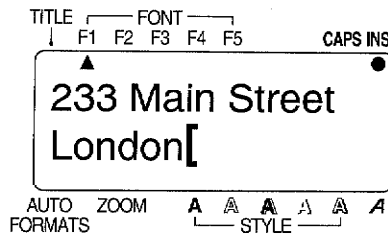

Press the **RETURN** key.

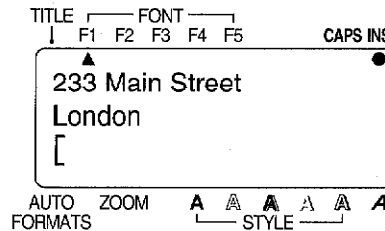

 The maximum number of text lines in a single block is five. If the cursor is located on the fifth line and you press the **RETURN** key, an error message will appear.

Since a block can only contain one text line when a **TITLE** font is used, an error message will appear if the **RETURN** key is pressed.

Tape	Maximum number of lines that can be printed
1/4" (6 mm)	2
3/8" (9 mm)	3
1/2"(12 mm)	3
3/4"(18 mm)	5
1"(24 mm)	5

TO ENTER AND CHOOSE ITEMS:

The **RETURN** key can also be used to enter and choose items. For example, in Symbol mode, a large group of symbols are displayed. After you have chosen the symbol you want to appear in your message, it will be highlighted, signifying that it is the "active" symbol. If the **RETURN** key is pressed, that symbol will be entered into your text message. In addition, after creating a text format, pressing the **RETURN** key applies the currently displayed settings to the current label.

TO ANSWER "YES":

Prompt questions sometimes appear on the LCD display, especially when the function that you have chosen will delete or affect files. In these cases, pressing the **RETURN** key is like answering positively. To answer "no", press the **CANCEL** key.

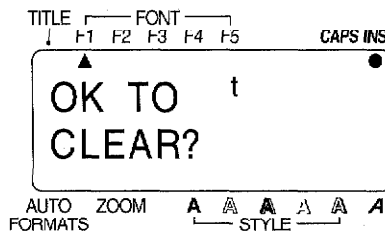

— If "yes", press the **RETURN** key.

— If "no", press the **CANCEL** key.

NEW BLOCK

BACKGROUND

Any time the number of lines in a section of the label changes, a new block must be created. Creating a new block is different from local formatting, which changes the type style within that line or those groups of lines.

Compare these two labels:

AXZ CORP. (123)456-7890

This is simply a single-block, single-line label with local formatting. After all the text has been typed in, the portion "(123) 456-7890" is assigned a smaller character size.

B1	Supplier:	IN: 1/28
	AXZ Corp.	
	Main St.	OUT: 2/28
	Fairtown	

This is a multi-block label. The first portion of this label is a single line, the second is four lines and the third, two lines. Therefore, when entering this type of text message, the **NEW BLOCK** key must be used.

After typing the first block of text, hold down the **CODE** key and press the **NEW BLOCK** key. The cursor will appear at the beginning of the first line in the next block.

 *The maximum number of blocks in a single label is five. If the cursor is located in the fifth block when the **CODE** key is held down and the **NEW BLOCK** key is pressed, an error message will appear.*

*When the cursor is positioned in the middle of a text block, holding down the **CODE** key and pressing the **NEW BLOCK** key causes the current block to be split into two.*

OPERATION

TO ENTER THE TEXT FOR THE LABEL

TOMMY	CLASS 2 ROOM 104
-------	---------------------

- (1) Type "TOMMY".
- (2) Since the next portion of text is a new two-line block, hold down the **CODE** key and press the **NEW BLOCK** key.
- (3) Type "CLASS 2".
- (4) Press the **RETURN** key.
- (5) Type "ROOM 104".

SEQUENTIAL NUMBERING

BACKGROUND

This machine's numbering feature allows you to designate a group of numbers and letters or a bar code as a "numbering" field and print a set number of labels in which the numbering field automatically increases by 1 after a label is printed. For example, a numbering field of 124 becomes 125. This type of automatic incrementation is very useful for printing serial number labels, production control labels or other labels requiring ascending codes.

OPERATION

TO DESIGNATE A PORTION OF TEXT AS A NUMBERING FIELD:

- (1) Position the cursor in front of the first character (number or letter) or the bar code you wish to include in the field.
- (2) Hold down the **CODE** key and press the **SEQ. NUMBERING** key. The message "SELECT FIELD!" is briefly displayed. The first character is highlighted, indicating that it is "active".
- (3) Use the **▶** and **◀** keys to highlight all the characters to be included in the field.

 *The numbering field cannot contain characters with different format settings.*

A numbering field can consist of a single bar code; no additional characters can be included in that numbering field.

A numbering field must be located entirely within one line of text of a single block. If you try to include text from two different lines or two different blocks in the numbering field, an error message will appear on the display.

- (4) Press the **RETURN** key. The NUMBER setting screen will be displayed.
- (5) Press the **▲** and **▼** keys until the desired setting appears. For example, if you want to count up from 10 to 15, set NUMBER to 6.
- (6) Press the **RETURN** or **PRINT** key. After the set number of labels has been printed, the display shows the label with the numbering field increased to the next value.

 *In any text message, only one numbering field can be selected.*

The maximum number of characters in a numbering field is five. If you try to choose more than five characters or insert an additional character into a five-character field, an error message will appear.

If you include a non-alphanumeric character such as a symbol in the numbering field, only the characters in the numbering field that can be increased will increment when the labels are printed, or only one label will be printed if only a non-alphanumeric character is included in the field.

- Letters and numbers automatically increase in the following manner:

0	→	1	→	9	→	0	→
A	→	B	→	Z	→	A	→
a	→	b	→	z	→	a	→

- Spaces (shown as “_” in the table below) can be used to control the number of digits printed:

0	0	→	1	→	9	→	0	→
_0	_0	→	_1	→	99	→	_0	→
A0	A0	→	A1	→	A9	→	B0	→

Spaces between letters in the numbering field simply adjust the space between them on the printed labels.

CANCEL

BACKGROUND

The **CANCEL** key is located in the bottom row of the keyboard. It has two basic functions.

TO LEAVE AN OPERATION MODE WITHOUT TAKING ANY ACTION:

In general, the **CANCEL** key returns you to the previous screen or activity. For example, if you enter an operation mode but decide you want to return to text entry or editing, you can press the **CANCEL** key.

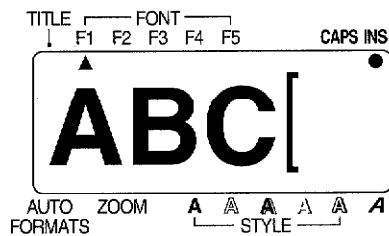

Press the **FORMAT** key to enter Format mode.

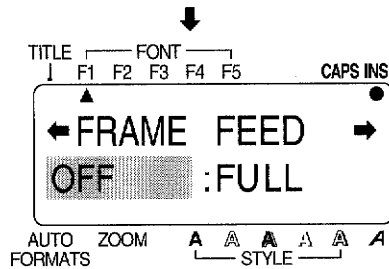

To escape from Format mode without changing any settings, press the **CANCEL** key.

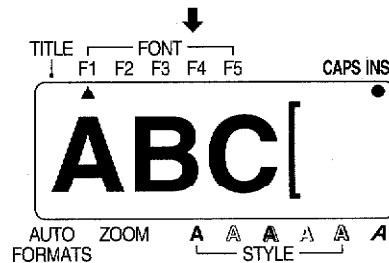

You will return to text entry mode.

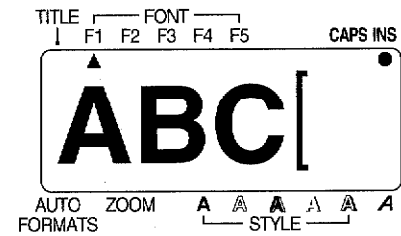

Hold down the **CODE** key and press the **SPECIAL PRINT** key to enter Special print mode.

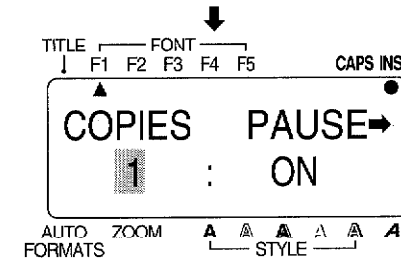

To escape from Special print mode without printing, press the **CANCEL** key.

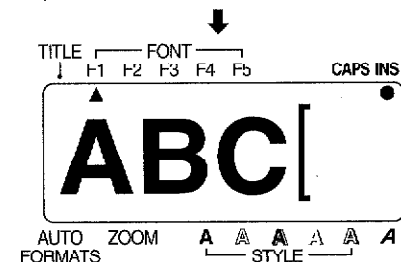

You will return to text entry mode.

TO ANSWER "NO":

Prompt questions sometimes appear on the LCD display, especially when the function that you wish to perform will delete or affect files. In these cases, pressing the **CANCEL** key is like answering negatively. To answer "yes", press the **RETURN** key.

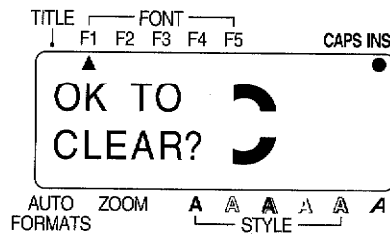

If "no", press the **CANCEL** key.

If "yes", press the **RETURN** key.



*When an error message is displayed, pressing the **CANCEL** key allows you to return to what you were doing previously.*

CURSOR MOVEMENT

BACKGROUND

After you have created a message, moving the cursor allows you to view or edit different parts of the text.



In general, pressing this key moves the cursor one space or character to the left. If the cursor is positioned at the beginning of a line when this key is pressed, the cursor moves to the end of the previous line.

Holding down the **CODE** key and pressing this key moves the cursor just before the first character of the current text block. If these keys are pressed again, the cursor moves to the first character of the previous block.

Holding down the **SHIFT** key and pressing this key moves the cursor to the beginning of the current line of text.



In general, pressing this key moves the cursor one space or character to the right. If the cursor is positioned at the end of a line when this key is pressed, the cursor moves to the beginning of the next line.

Holding down the **CODE** key and pressing this key moves the cursor just before the first character of the next text block.

Holding down the **SHIFT** key and pressing this key moves the cursor to the end of the current line of text.



Pressing this key moves the cursor just before the character directly above its current position in the previous line.

Holding down the **CODE** key and pressing this key positions the cursor at the beginning of the message.



Pressing this key moves the cursor just before the character directly below its current position in the next line.

Holding down the **CODE** key and pressing this key moves the cursor at the end of the message.

INSERT VS. OVERWRITE

BACKGROUND

Two character entry modes can be used during text editing: Insert mode and Overwrite mode.

- **INSERT MODE**

This machine's default setting is Insert mode. This allows you to insert, or add, characters into the middle of your message. Characters are inserted at the location of the cursor and all characters following the insertion point move one space to the right.

TO ENTER INSERT MODE:

Hold down the **CODE** key and press the **INSERT** key so the **INS** indicator in the upper right-hand corner of the LCD display turns on.

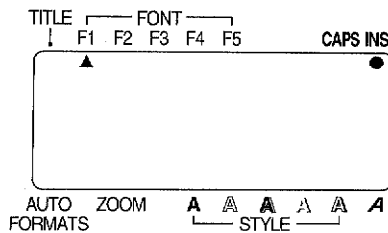

- **OVERWRITE MODE**

This machine can also operate in Overwrite mode. This allows you to change or replace characters simply by typing new ones over them.

TO ENTER OVERWRITE MODE:

Hold down the **CODE** key and press the **INSERT** key so the **INS** indicator on the LCD display turns off.

EXAMPLE

INSERT MODE	OVERWRITE MODE
<p>TITLE FONT CAPS INS</p> <p>↓ F1 F2 F3 F4 F5</p> <p>Imports, Inc. Main St.</p> <p>AUTO ZOOM A A A A A A FORMATS STYLE</p>	<p>TITLE FONT CAPS INS</p> <p>↓ F1 F2 F3 F4 F5</p> <p>Imports, Inc. East Main St.</p> <p>AUTO ZOOM A A A A A A FORMATS STYLE</p>
Type "East" and add a space.	Type "We".
<p>TITLE FONT CAPS INS</p> <p>↓ F1 F2 F3 F4 F5</p> <p>Imports, Inc. East Main St.</p> <p>AUTO ZOOM A A A A A A FORMATS STYLE</p>	<p>TITLE FONT CAPS INS</p> <p>↓ F1 F2 F3 F4 F5</p> <p>Imports, Inc. West Main St.</p> <p>AUTO ZOOM A A A A A A FORMATS STYLE</p>

BACKSPACE

BACKGROUND

The **BACKSPACE** key allows you to remove unwanted characters from your message. It differs from the ◀ key, which simply moves the cursor without changing the message. The **BACKSPACE** key, however, removes the character preceding the cursor.

OPERATION

TO DELETE A CHARACTER:

- (1) Using the cursor movement keys, position the cursor immediately to the right of the character you want to delete.
- (2) Press the **BACKSPACE** key.

EXAMPLE

General operation:

- Press  five times.

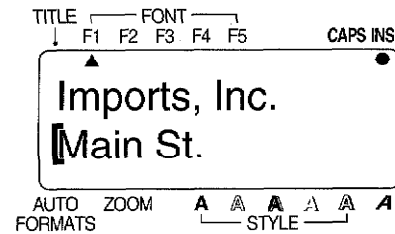
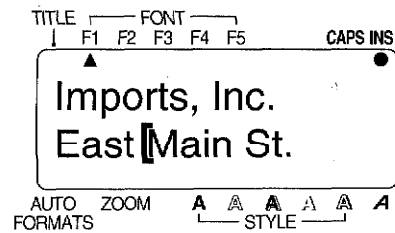

If the cursor is located in front of the first character in a line when this key is pressed, the two lines are joined together.

- Press .

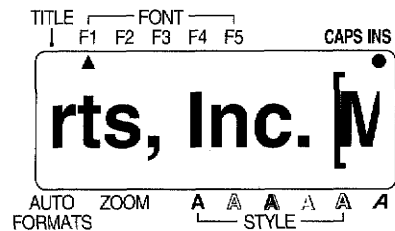

LINE OUT

BACKGROUND

The **LINE OUT** key allows you to remove unwanted lines of text from your message. Any symbols in the deleted line are also removed.

OPERATION

TO DELETE A LINE OF TEXT:

- (1) Using the cursor movement keys, position the cursor in the line you want to delete.
- (2) Hold down the **CODE** key and press the **LINE OUT** key.

EXAMPLE

General operation:

- Press **CODE** + **LINE OUT**.

The diagram illustrates the 'LINE OUT' operation on a terminal screen. It shows two states of the screen:

- Initial State:** The screen displays two lines of text: "Imports, Inc." and "West [Main St.". The cursor is positioned at the start of the second line. The terminal interface includes a header with "TITLE", "FONT" (F1-F5), and "CAPS INS" keys, and a footer with "AUTO FORMATS", "ZOOM", and "STYLE" (A) keys.
- After Operation:** The second line of text has been deleted, leaving only "Imports, Inc." and a cursor on the next line. The terminal interface remains the same.

CLEAR

BACKGROUND

The **CLEAR** key allows you to remove all text and symbols from the display and return the text formats to their default settings. In other words, the current text file is completely emptied. You can then begin entering an entirely new text message.

OPERATION



TO CLEAR A TEXT FILE:

- (1) Hold down the **CODE** key and press the **CLEAR** key.
- (2) Press the **RETURN** key.

 *The cursor can be located anywhere in the message.*

EXAMPLE

General operation:

- Press  +  and a confirmation message is displayed.

- Press .

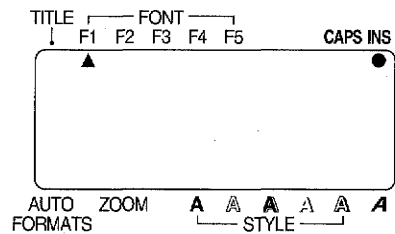
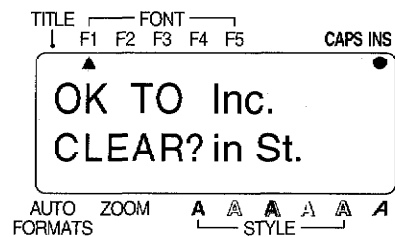
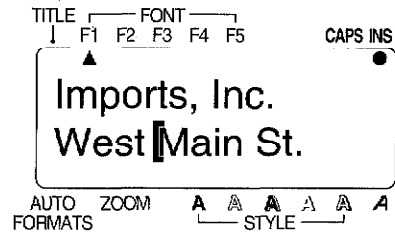

ZOOM MODE

BACKGROUND

Zoom mode allows you to see how a label will appear when it is printed by zooming out from the text, or to see parts of the message in detail by zooming in. The cursor keys can be used to move the cursor so different parts of the message can be seen.

OPERATION

TO ENTER ZOOM MODE:

- (1) Press the **ZOOM** key and the display zooms in to enlarge the message.
- (2) Press the **ZOOM** key again and the display zooms out to show the message as it will appear when it is printed.
- (3) Press the **ZOOM** key one more time or the **CANCEL** key to return the display to the text entry screen.

EXAMPLE

General operation:

- Press . The display zooms in on the message.

- Press . The display zoom out from the message.

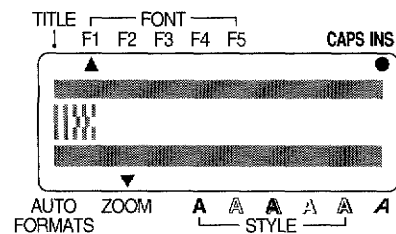
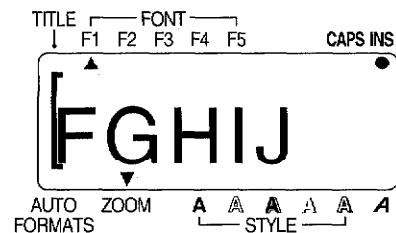
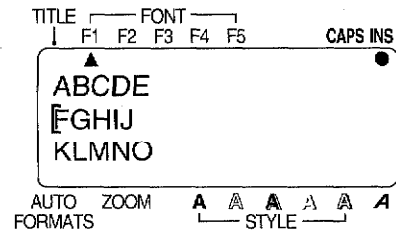

LABEL LENGTH

BACKGROUND

This mode briefly displays the length of the label in either inches or centimeters depending on the UNIT setting. For more information on changing the units that are displayed, see *Display Units* on page 94.

OPERATION

TO ENTER LABEL LENGTH MODE:

Hold down the **CODE** key and press the **LABEL LENGTH** key.

The length of the label is displayed briefly.

EXAMPLE

General operation:

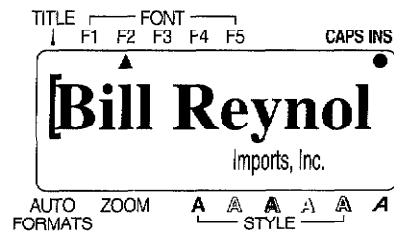

- Press **CODE** + **LABEL LENGTH** and the label length is briefly displayed.

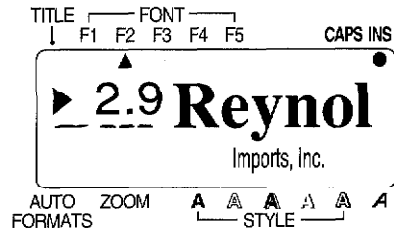

CONTRAST

BACKGROUND

This mode is used to adjust the contrast of the LCD display. Contrast mode can be entered from text entry mode or Auto format mode.

OPERATION

TO CHANGE THE CONTRAST:

- (1) Hold down the **CODE** key and press the **CONTRAST** key.
- (2) Press the **▶** and **◀** keys to adjust the contrast.
- (3) Press the **RETURN** key.

 Press the **SPACE** key to reset the contrast to its default setting.

EXAMPLE

General operation:

- Press **CODE** + **CONTRAST** and the contrast setting is displayed.

- Press **◀** and **▶** to adjust the contrast, then press **NEW BLOCK**.

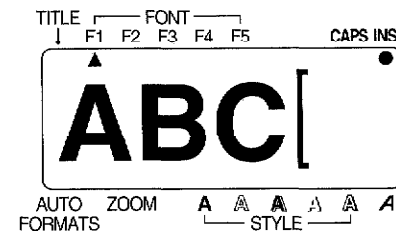
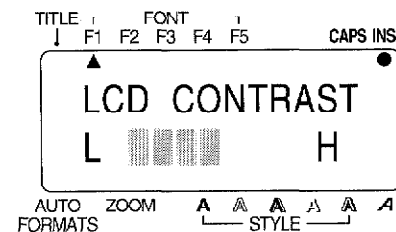
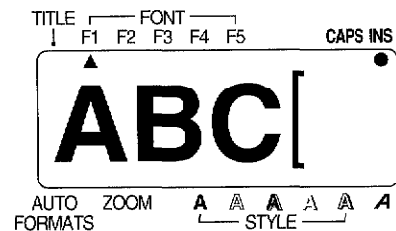

AUTO FORMATS

BACKGROUND

The **AUTO FORMATS** key is located in the lower left-hand corner of the keyboard. This mode allows you to quickly enter text into layout templates so labels can be printed easily by using the preset formats.

OPERATION

TO PRINT A LABEL USING AUTO FORMAT MODE:



- (1) Press the **AUTO FORMATS** key.
- (2) Press the **▲** and **▼** keys until your desired layout is displayed.
- (3) Enter the label contents and press the **RETURN** key.
- (4) Press the **PRINT** key to print the label.

EXAMPLE

General operation:

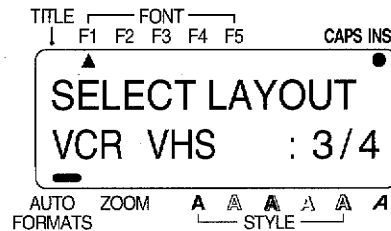
- Press . The AUTO FORMATS indicator turns on.



- Press  and  to until your desired layout is displayed.

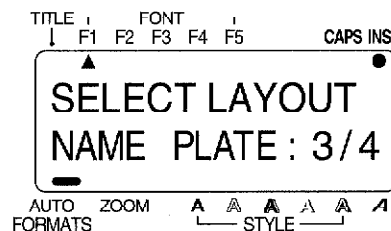

- Press .

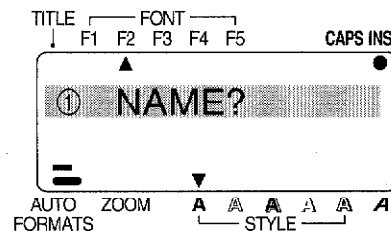

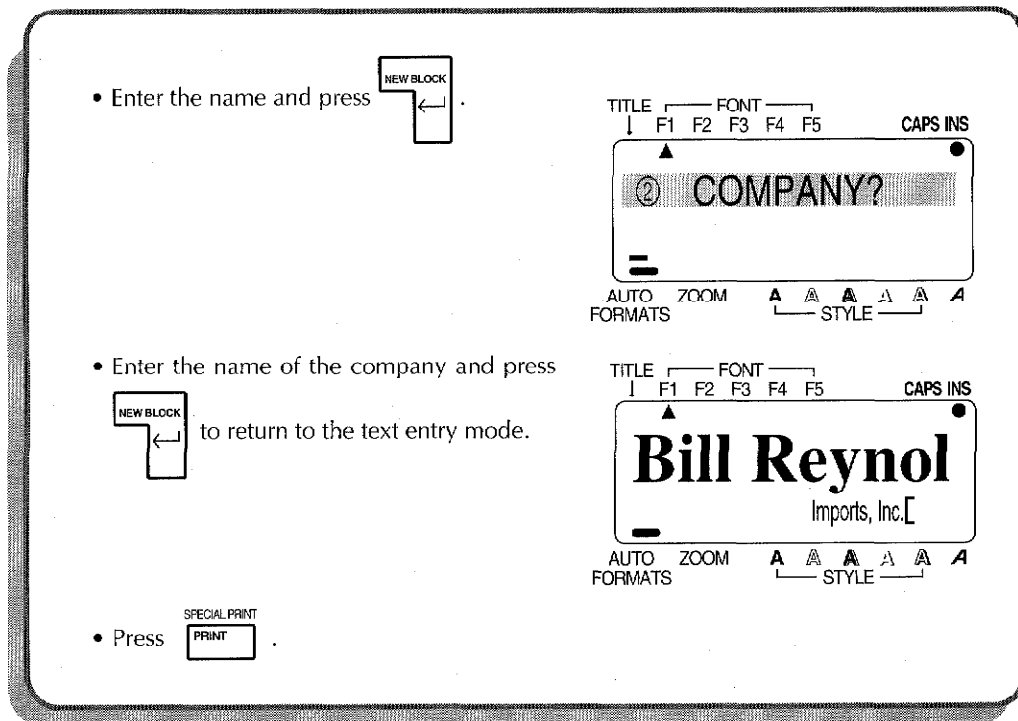

The following chart lists the entries for the label templates, allowing you to easily select the appropriate preset layout.

Label templates		Entries	
Ⓐ	VCR VHS (3/4" (18 mm))	① SYMBOL? ② TITLE? ③ SUB-TITLE?	④ DURATION? ⑤ REC. MODE? ⑥ DATE?
Ⓑ	VCR 8mm-1 (3/8" (9 mm))	① SYMBOL? ② TITLE? ③ SUB-TITLE?	④ DATE? ⑤ REC. MODE?
Ⓒ	VCR 8mm-2 (1/2" (12 mm))	① SYMBOL? ② TITLE? ③ SUB-TITLE?	④ DURATION? ⑤ REC. MODE? ⑥ DATE?
Ⓓ	VCR VHSC-1 (1/2" (12 mm))	① TITLE?	② SUB-TITLE?
Ⓔ	VCR VHSC-2 (3/4" (18 mm))	① SYMBOL? ② TITLE? ③ SUB-TITLE?	④ DURATION? ⑤ REC. MODE? ⑥ DATE?
Ⓕ	AUDIO-1 (1/4" (6 mm))	① SYMBOL? ② TITLE?	③ SUB-TITLE?
Ⓖ	AUDIO-2 (3/8" (9 mm)), (1/2" (12 mm))	① SYMBOL? ② TITLE?	③ SUB-TITLE?
Ⓗ	AUDIO-3 (3/8" (9 mm)), (1/2" (12 mm))	① SYMBOL?	② TITLE?

Label templates		Entries	
①	NAME PLATE (3/4" (18 mm)), (1" (24 mm))	① NAME?	② COMPANY?
②	ADDRESS (3/4" (18 mm)), (1" (24 mm))	① NAME? ② ADDRESS1?	③ ADDRESS2? ④ ADD.3/TEL?
③	EQUIPMENT (3/4" (18 mm)), (1" (24 mm))	① TITLE? ② NAME?	③ NUMBER?
④	EQUIPMENT (1/2" (12 mm))	① TITLE? ② SUB-TITLE?	③ NAME? ④ NUMBER?
⑤	SLIDE (1/2" (12 mm))	① TITLE? ② DATE?	③ SUB-TITLE?
⑥	PRICE (3/4" (18 mm)), (1" (24 mm))	① NAME?	② PRICE?
⑦	SALE PRICE (3/4" (18 mm)), (1" (24 mm))	① NAME? ② OLD PRICE?	③ NEW PRICE?
⑧	FILE LONG (3/4" (18 mm)), (1" (24 mm))	① TITLE?	
⑨	FILE LONGV (3/4" (18 mm)), (1" (24 mm))	① TITLE?	
⑩	FILE SHORT (3/8" (9 mm)), (1/2" (12 mm)), (3/4" (18 mm)), (1" (24 mm))	① TITLE?	
⑪	FLOPPY 3.5" (3/4" (18 mm)), (1" (24 mm))	① TITLE? ② SUB-TITLE?	③ NAME?
⑫	FLOPPY 5" (3/4" (18 mm)), (1" (24 mm))	① TITLE? ② SUB-TITLE?	③ NAME?

Ⓐ VCR VHS (3/4" (18 mm))

	CHAMPION'S CUP MEN'S SINGLE	90min STANDARD AUG.5,1995
---	---------------------------------------	---------------------------------

Ⓑ VCR 8mm-1 (3/8" (9 mm))

	A SNOWY DAY Mick's first ski experience	JAN.3,'95 Valdisei
---	---	-----------------------

Ⓒ VCR 8mm-2 (1/2" (12 mm))

	Kelly's 1st Birthday Birthday Party	120min SLOW JAN.10,1995
---	---	-------------------------------

Ⓓ VCR VHSC-1 (1/2" (12 mm))

	JOE & ANN'S WEDDING St. Michael's Church
---	--

Ⓔ VCR VHSC-2 (3/4" (18 mm))

	JOE & ANN'S WEDDING St. Michael's Church	120min NORMAL 11.6, '95
---	--	-------------------------------

Ⓕ AUDIO-1 (1/4" (6 mm))

	FAVORITE LOVE SONGS	Mari
---	---------------------	------

Ⓖ AUDIO-2 (3/8" (9 mm))

	FAVORITE LOVE SONGS	Mari
---	---------------------	------

AUDIO-2 (1/2" (12 mm))

	FAVORITE LOVE SONGS	Mari
---	---------------------	------

Ⓗ AUDIO-3 (3/8" (9 mm))

	OLDIES(1960 - 1970)
---	---------------------

AUDIO-3 (1/2" (12 mm))

	OLDIES(1960 - 1970)
---	---------------------

Ⓘ NAME PLATE (3/4" (18 mm))

Bill Reynolds ABC INTERNATIONAL CORP.

NAME PLATE (1" (24 mm))

Bill Reynolds ABC INTERNATIONAL CORP.

Ⓙ ADDRESS (3/4" (18 mm))

Smith's Rent-A-Bike 29 Green Road Los Angeles TEL: 345-6789

ADDRESS (1" (24 mm))

Smith's Rent-A-Bike 29 Green Road Los Angeles TEL: 345-6789

Ⓚ EQUIPMENT (3/4" (18 mm))

PROPERTY OF
SALES & MARKETING DIV.
0312

EQUIPMENT (1" (24 mm))

PROPERTY OF
SALES & MARKETING DIV.
0312

Ⓛ EQUIPMENT (1/2" (12 mm))

PROPERTY OF	SALES & MARKETING DIV.
NUMBER	0285

Ⓜ SLIDE (1/2" (12 mm))

HAWAII ISLAND
AUG 15, 1994
ISO: 70

Ⓝ PRICE (3/4" (18 mm))

LABEL PRINTER
\$249

PRICE (1" (24 mm))

LABEL PRINTER
\$249

Ⓞ SALE PRICE (3/4" (18 mm))

LABEL PRINTER
~~\$249~~ ➔ **\$229**

SALE PRICE (1" (24 mm))

LABEL PRINTER
~~\$249~~ ➔ **\$229**

Ⓟ FILE LONG (3/4" (18 mm))

'94 MARKET RESEARCH ①

FILE LONG (1" (24 mm))

'94 MARKET RESEARCH ①

ⓐ FILE LONGV (3/4" (18 mm))

M A R K E T R E S E A R C H

FILE LONGV (1" (24 mm))

M A R K E T R E S E A R C H

ⓑ FILE SHORT (3/8" (9 mm))

SALES RESULTS (1)

FILE SHORT (1/2" (12 mm))

SALES RESULTS (1)

FILE SHORT (3/4" (18 mm))

SALES RESULTS (1)

FILE SHORT (1" (24 mm))

SALES RESULTS (1)

ⓒ FLOPPY 3.5" (3/4" (18 mm))

DAILY FAX (5)
9/94 - Preset
J. Smith

FLOPPY 3.5" (1" (24 mm))

DAILY FAX (5)
9/94 - preset
J. Smith

ⓓ FLOPPY 5" (3/4" (18 mm))

NEW PRODUCTS (3)
Nov. Presentation
J. Smith

FLOPPY 5" (1" (24 mm))

NEW PRODUCTS (3)
Nov. Presentation
J. Smith

LOCAL FORMATTING

BACKGROUND

LOCAL FORMAT
FONT
SIZE
WIDTH
STYLE
ITAL
UNDL / FRM

The local format settings, shown in the table at the left, determine how the text is printed. After the text is entered, use the **AREA** and cursor keys to select the characters to be emphasized, then change the format using the local format keys below the LCD display. If the entire text is selected, the font, size, width, style, italicization, underlining and framing formats can be applied globally. In addition, local formats can be assigned before text entry.

Since the text entry mode is a WYSIWYG mode, the display shows the text with the selected formats so you can see how the label will appear after it is printed.

CREATING a local format can be done in two ways: by choosing the characters to be included and setting the format or by setting the format before entering the text.

TO CREATE A LOCAL FORMAT AFTER TEXT ENTRY:

- (1) Position the cursor in front of the first character you wish to assign a local format.
- (2) Press the **AREA** key. The first character will be highlighted.
- (3) Move the cursor by pressing the cursor keys until all characters to which you wish to assign the local format are highlighted. Select all of the characters in the message to change the format of the entire text.
- (4) Press the local format key, located below the LCD display, for the format to be set until the text appears on the display in the desired format.
- (5) Repeat step (4) until the text is formatted as you wish.
- (6) Press the **RETURN** key. This local format is applied to the chosen characters.

 Press the **AREA** or **CANCEL** key at any time to return to text entry mode without setting a local format.

TO CREATE A LOCAL FORMAT BEFORE TEXT ENTRY:

- (1) Press the local format key, located below the LCD display, for the format to be set until the sample text appears on the display in the desired format.
- (2) Repeat step (1) until the sample character is formatted as you wish.
- (3) Enter the text. All text will be entered using the applied format until the format settings are changed again.

EXAMPLE

General Operation:

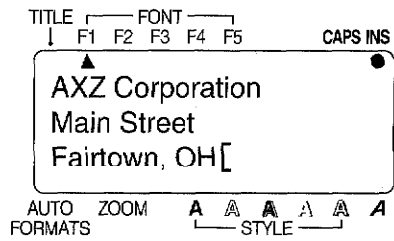

- Press + to move the cursor to the beginning of the message, then press .

- Then, use and to highlight the entire message.

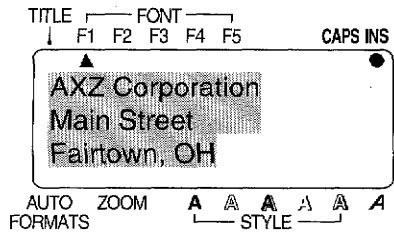

- Press until the character size is set to 10 points, until the indicator above the bold character style (**A**) comes on, and until the italics (*A*) indicator turns on.

- Press .

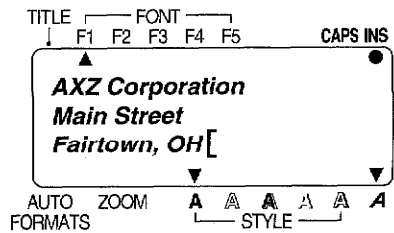

GLOBAL FORMATTING

BACKGROUND

GLOBAL FORMAT
FRAME
FEED
VERT
MIRROR
H. ALI
V. ALI
LENGTH
UNIT

The global format settings, shown in the table at the left, determine how the label is printed by establishing the orientation and alignment of the entire text message. These formats can be set at any time — before, during or after you enter your text.

Since the text entry mode is a WYSIWYG mode, the display shows the message with the selected formats so you can see how the label will appear after it is printed.

OPERATION

CREATING a global format is very simple.

TO CREATE A GLOBAL FORMAT:

- (1) Press the **FORMAT** key.
- (2) Press the **▶** and **◀** keys until the first setting you wish to change is highlighted.
- (3) Press the **▲** and **▼** keys until the desired setting is displayed.
- (4) Repeat steps (2) and (3) until all settings are as you wish.
- (5) Press the **RETURN** key. This new format is applied to your entire text file and the LCD display returns to text entry mode.

 Press the **FORMAT** key or the **CANCEL** key at any time to leave Format mode and return to text entry mode without making any changes.

Press the **SPACE** key to return the highlighted format setting to its default setting.

Hold down the **CODE** key and press the **SPACE** key to change all format settings back to their default settings (i.e. no underlining or framing, full tape feed, no vertical or mirror printing, left and bottom text alignment and automatic label length adjustment).



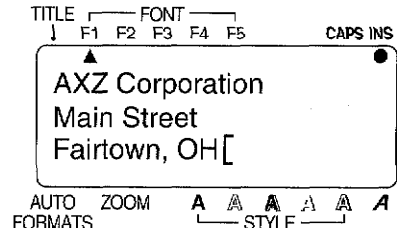

EXAMPLE

General Operation:

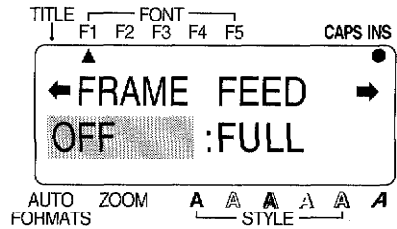

- Press  .



- Use  and  to move the cursor and  and  to choose the appropriate setting. Change the label framing format (FRAME) to the box setting () and the horizontal alignment format (H.ALI) from LEFT to CENTER.

- Press  .

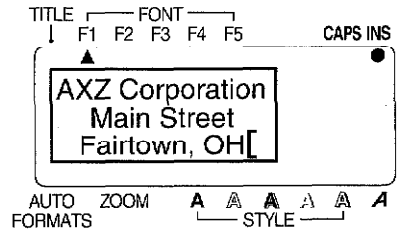

FONT

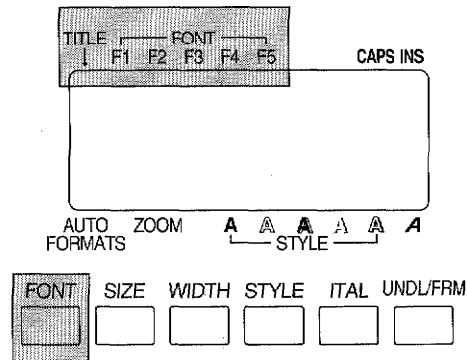

BACKGROUND

Eight different typefaces, or fonts, are available on this machine. The fonts are:

F1 (Helsinki)	TITLE F2 (Calgary)
F2 (Brussels)	TITLE F3 (Florida)
F3 (Bermuda)	TITLE F4 (Istanbul)
TITLE F1 (San Diego)	TITLE F5 (US)

The default setting is font F1.

 *The TITLE fonts are only available if the message consists of only one line or if 1/2" (12-mm)-, 3/4" (18-mm)- or 1" (24-mm)-wide tape is installed. In addition, letters entered using a TITLE font will only appear in uppercase.*

OPERATION

TO ENTER TEXT WITH A DIFFERENT FONT:

- (1) Insert the cursor where you wish to begin using a new font.
- (2) Press the **FONT** key until the sample character is displayed in the font you wish to use and your desired font is shown by the indicators above the LCD display.
- (3) Enter the text to which the chosen font is to be applied.

TO APPLY A FONT TO A SELECTED AREA:

- (1) Press the **AREA** key, then use the cursor keys to select the text to which you want to apply a new font.
- (2) Press the **FONT** key until the text is displayed in the font you wish to use and your desired font is shown by the indicators above the LCD display.
- (3) Press the **RETURN** key to apply the chosen font to the selected text.

EXAMPLE

F1	ABCDE
F2	ABCDE
F3	<i>ABCDE</i>
BIG F1	ABCDE
BIG F2	<i>ABCDE</i>
BIG F3	ABCDE
BIG F4	ABCDE
BIG F5	ABCDE

SIZE/WIDTH

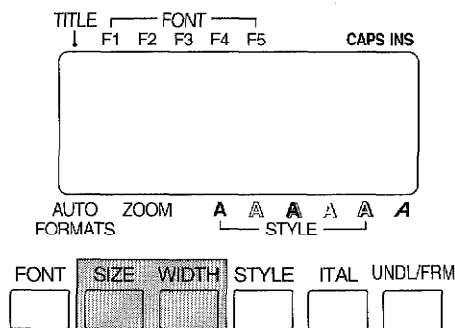

BACKGROUND

There are two character size settings: size and width. Usually, you will want to use the largest characters possible for the given tape and message. With the size set to AUTO, the machine compares your inputted message with the tape size and automatically uses the largest characters possible. Sometimes, however, you will want to assign a particular character size and width. To do so, six point sizes are available and each can be printed in narrow, medium or wide characters. The sizes and widths are:

6, 10, 13, 19, 26 & 38 points (all are available in the following widths: medium, narrow or wide)

AUTO (The largest possible character size is automatically chosen.)

The default size is AUTO and the default width is medium.

The following chart shows the character sizes that can be used with the tape widths listed.

Tape width	Size (pt)
1"(24 mm)	6, 10, 13, 19, 26, 38
3/4"(18 mm)	6, 10, 13, 19, 26, 38
1/2"(12 mm)	6, 10, 13, 19
3/8"(9 mm)	6, 10, 13, 19
1/4"(6 mm)	6, 10, 13

 When the Split printing parameter in Special print mode is turned on, the message will be printed using a larger character size.

OPERATION

TO ENTER TEXT WITH A DIFFERENT SIZE/WIDTH:

- (1) Insert the cursor where you wish to begin using a new character size or width.
- (2) Press the **SIZE** key until the sample character is displayed in the character size you wish to use and press the **WIDTH** key until the desired width is displayed.
- (3) Enter the text to which the chosen size or width is to be applied.

TO APPLY A SIZE/WIDTH TO THE SELECTED AREA:

- (1) Press the **AREA** key, then use the cursor keys to select the text to which you want to apply a new character size or width.
- (2) Press the **SIZE** key until the text is displayed in the character size you wish to use and press the **WIDTH** key until the text is displayed in the desired width.
- (3) Press the **RETURN** key to apply the chosen size or width to the selected text.

EXAMPLE

WIDTH SIZE	Wide	Medium	Narrow
38pt	ABC	ABC	ABC
26pt	ABC	ABC	ABC
19pt	ABC	ABC	ABC
13pt	ABC	ABC	ABC
10pt	ABC	ABC	ABC
6pt	ABC	ABC	ABC

STYLE/ITALIC

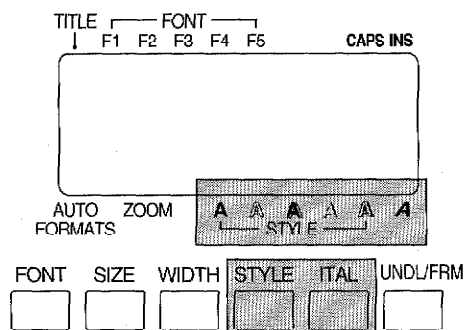

BACKGROUND

Six single styles, which can all be combined with the italic style, are available. The styles are:

Normal (No indicator)	Italic & Normal (A)
Bold (A)	Italic & Bold (A + A)
Outline (<u>A</u>)	Italic & Outline (A + A)
Solid (A)	Italic & Solid (A + A)
Shadow (<u>A</u>)	Italic & Shadow (A + A)
Outline + Shadow (<u>A</u>)	Italic & Outline + Shadow (A + A)

The default setting is normal with the italic style turned off. (No indicators are turned on.)

 Characters printed using the smaller sizes may be difficult to read if certain style settings (e.g. Italic & Shadow) are applied.

OPERATION

TO ENTER TEXT WITH A DIFFERENT STYLE/ITALIC:

- (1) Insert the cursor where you wish to begin using a new character style.
- (2) Press the **STYLE** and **ITAL** keys until the sample character is displayed in the style you wish to use and your desired character style is shown by the indicators below the LCD display.
- (3) Enter the text to which the chosen style is to be applied.

TO APPLY A STYLE/ITALIC TO A SELECTED AREA:

- (1) Press the **AREA** key, then use the cursor keys to select the text to which you want to apply a new character style.
- (2) Press the **STYLE** and **ITAL** keys until the text is displayed in the style you wish to use and your desired character style is shown by the indicators below the LCD display.
- (3) Press the **RETURN** key to apply the chosen style to the selected text.

EXAMPLE

	Normal	Bold	Outline
F1	ABCDE	ABCDE	ABCDE
F2	ABCDE	ABCDE	ABCDE
F3	<i>ABCDE</i>	<i>ABCDE</i>	<i>ABCDE</i>
TITLE F1	ABCDE	ABCDE	ABCDE
TITLE F2	<i>ABCDE</i>	<i>ABCDE</i>	<i>ABCDE</i>
TITLE F3	ABCDE	ABCDE	ABCDE
TITLE F4	ABCDE	ABCDE	ABCDE
TITLE F5	ABCDE	ABCDE	ABCDE

	Solid	Shadow	Outline + Shadow
F1	ABCDE	ABCDE	ABCDE
F2	ABCDE	ABCDE	ABCDE
F3	<i>ABCDE</i>	<i>ABCDE</i>	<i>ABCDE</i>
TITLE F1	ABCDE	ABCDE	ABCDE
TITLE F2	<i>ABCDE</i>	<i>ABCDE</i>	<i>ABCDE</i>
TITLE F3	ABCDE	ABCDE	ABCDE
TITLE F4	ABCDE	ABCDE	ABCDE
TITLE F5	ABCDE	ABCDE	ABCDE

	Italic & Normal	Italic & Bold	Italic & Outline
F1	<i>ABCDE</i>	<i>ABCDE</i>	<i>ABCDE</i>
F2	<i>ABCDE</i>	<i>ABCDE</i>	<i>ABCDE</i>
F3	<i>ABCDE</i>	<i>ABCDE</i>	<i>ABCDE</i>
TITLE F1	<i>ABCDE</i>	<i>ABCDE</i>	<i>ABCDE</i>
TITLE F2	<i>ABCDE</i>	<i>ABCDE</i>	<i>ABCDE</i>
TITLE F3	<i>ABCDE</i>	<i>ABCDE</i>	<i>ABCDE</i>
TITLE F4	<i>ABCDE</i>	<i>ABCDE</i>	<i>ABCDE</i>
TITLE F5	<i>ABCDE</i>	<i>ABCDE</i>	<i>ABCDE</i>

	Italic & Solid	Italic & Shadow	Italic & Outline + Shadow
F1	<i>ABCDE</i>	<i>ABCDE</i>	<i>ABCDE</i>
F2	<i>ABCDE</i>	<i>ABCDE</i>	<i>ABCDE</i>
F3	<i>ABCDE</i>	<i>ABCDE</i>	<i>ABCDE</i>
TITLE F1	<i>ABCDE</i>	<i>ABCDE</i>	<i>ABCDE</i>
TITLE F2	<i>ABCDE</i>	<i>ABCDE</i>	<i>ABCDE</i>
TITLE F3	<i>ABCDE</i>	<i>ABCDE</i>	<i>ABCDE</i>
TITLE F4	<i>ABCDE</i>	<i>ABCDE</i>	<i>ABCDE</i>
TITLE F5	<i>ABCDE</i>	<i>ABCDE</i>	<i>ABCDE</i>

UNDERLINING/FRAMING

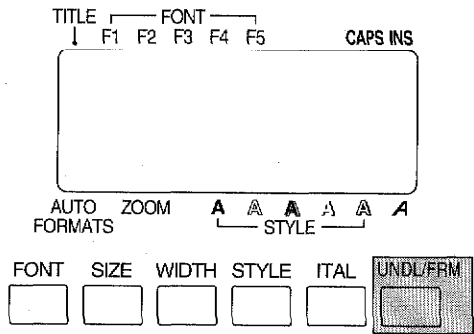

BACKGROUND

Selected characters in your message can be highlighted by framing them with a box or a box with rounded corners, underlining them, crossing them out, or shading them. The types of underlines and frames are:

Box

ABC

Rounded Box

ABC

Underline

ABC

Strike-out

~~**ABC**~~

Fill Pattern

ABC

The default setting is no underline or frame.

When the entire text message is removed from the display with the **CLEAR** key, this format will return to its default setting (no underline or frame).

OPERATION

TO ENTER TEXT WITH UNDERLINING/FRAMING:

- (1) Insert the cursor where you wish to begin using a new frame.
- (2) Press the **UNDL/FRM** key until the sample character is displayed with the frame you wish to use.
- (3) Enter the text to which the chosen frame is to be applied.

TO APPLY UNDERLINING/FRAMING TO A SELECTED AREA:

- (1) Press the **AREA** key, then use the cursor keys to select the text to which you want to apply a new frame.
- (2) Press the **UNDL/FRM** key until the sample character is displayed with the frame you wish to use.
- (3) Press the **RETURN** key to apply the chosen frame to the selected text.

FRAMING

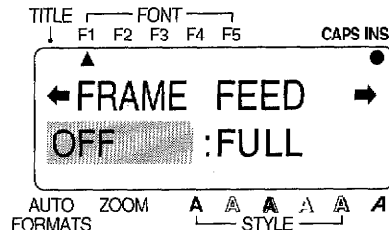

BACKGROUND

Unique labels can be created by framing your entire message using one of the many frames available. The types of frames are:

Box



Rounded Box

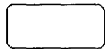

Sale



Pointing Finger

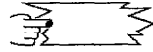

Name Plate



Dog

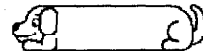

Movie Film

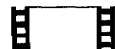

Dinosaur



Telephone



Hands



Window

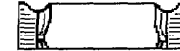

Banner

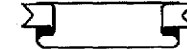

Fill Pattern



 This framing setting can only be applied to the entire label. It cannot be applied to only part of the text. However, the box, rounded box or the fill pattern can be applied locally by using the **AREA** and cursor keys to select the text, then pressing the **UNDL/FRM** key until the frame you wish to use is displayed.

OPERATION

TO SELECT THE FRAMING STYLE:

- (1) Press the **FORMAT** key.
 - (2) Press the **▶** and **◀** keys until the framing setting (FRAME) is highlighted.
 - (3) Press the **▲** and **▼** keys until the frame you wish to use is displayed.
-  The default setting (OFF) can be selected by pressing the **SPACE** key.
- (4) Press the **RETURN** key.

TAPE FEED

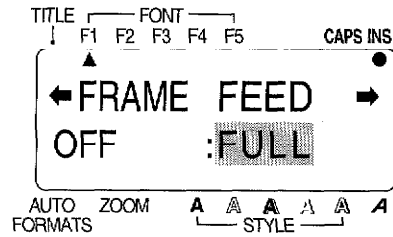

BACKGROUND

This machine can be set to leave equal margins of between 1/6" (4 mm) and 1" (24 mm) on the left and right sides of your label. The tape feed settings are:

- FULL (1" (24 mm))
- NONE (1/6" (4 mm))
- NARROW (1/3" (8 mm))
- MEDIUM (1/2" (12 mm))

 Since reducing the tape feed may decrease bar code readability, full tape feed is recommended when messages include bar codes. If instant (rub-on) lettering tape is installed, this setting will be ignored and the message will be printed with full margins.

OPERATION

TO SELECT A MARGIN WIDTH:

- (1) Press the **FORMAT** key.
 - (2) Press the ► and ◀ keys until the tape feed setting (FEED) is highlighted.
 - (3) Press the ▲ and ▼ keys until the margin width you wish to use is displayed.
-  The default setting (FULL) can be selected by pressing the **SPACE** key.
- (4) Press the **RETURN** key.

VERTICAL PRINTING

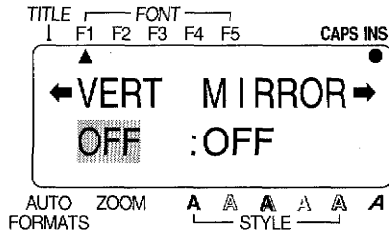

BACKGROUND

Characters in your message can be printed in a vertical orientation.

- ✎ *The vertical printing setting cannot be turned on if a TITLE font is used.*
- Vertical printing can only be applied to the entire label. It cannot be applied to only part of the text.*

OPERATION

TO SET THE VERTICAL PRINTING FUNCTION:

- (1) Press the **FORMAT** key.
- (2) Press the ▶ and ◀ keys until the vertical printing setting (VERT) is highlighted.
- (3) Press the ▲ and ▼ keys until the setting you wish to use is displayed.
- ✎ *The default setting (OFF) can be selected by pressing the **SPACE** key.*
- (4) Press the **RETURN** key.

EXAMPLE

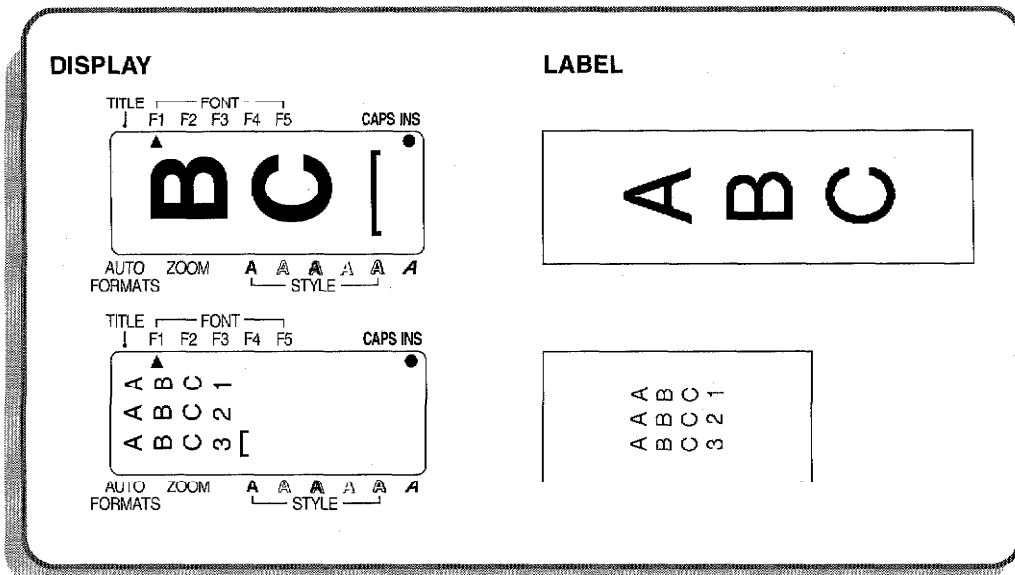

MIRROR PRINTING

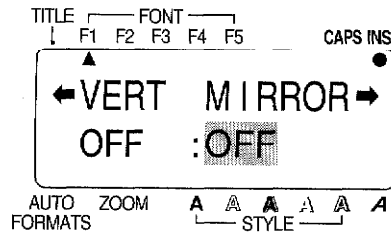

BACKGROUND

Your message can be printed as if it is seen through a mirror. When such labels (printed on clear tape) are affixed to glass, such as showroom windows, they can be correctly read from the opposite side.

- ☞ Use clear tape when using the mirror printing setting to make a label.
- Mirror printing can only be applied to the entire label. It cannot be applied to only part of the text.*

OPERATION

TO SET THE MIRROR PRINTING FUNCTION:

- (1) Press the **FORMAT** key.
 - (2) Press the ► and ◀ keys until the mirror printing setting (MIRROR) is highlighted.
 - (3) Press the ▲ and ▼ keys until the setting you wish to use is displayed.
- ☞ *The default setting (OFF) can be selected by pressing the **SPACE** key.*
- (4) Press the **RETURN** key.

EXAMPLE

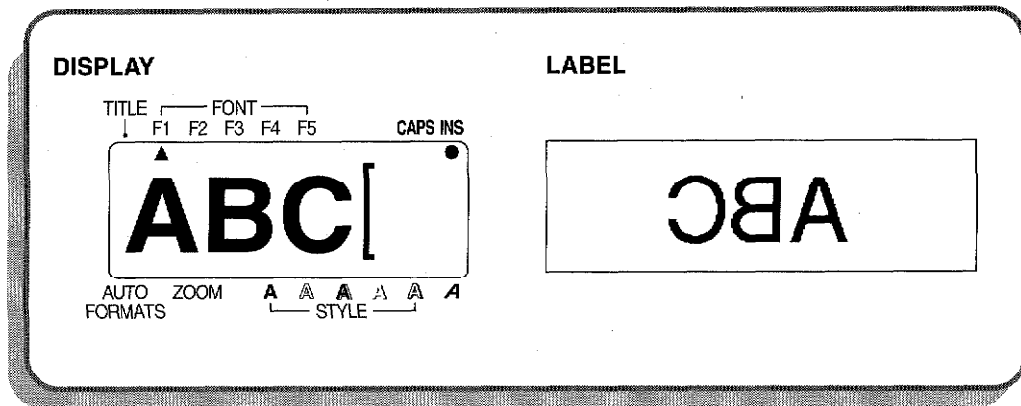

HORIZONTAL ALIGNMENT

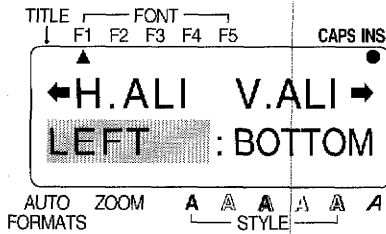

BACKGROUND

Characters in the blocks of your message can be horizontally aligned in any one of four ways:

- LEFT
- CENTER
- RIGHT
- JUSTIFY

The horizontal alignment setting can only be applied to the entire label. It cannot be applied to only part of the text.

If a tape length has been set, multi-block messages are assigned the JUSTIFY setting and spaces between the blocks are adjusted so that the text spreads out evenly along the tape.

OPERATION

TO SELECT A HORIZONTAL ALIGNMENT:

- (1) Press the **FORMAT** key.
- (2) Press the ▶ and ◀ keys until the horizontal alignment setting (H.ALI) is highlighted.
- (3) Press the ▲ and ▼ keys until the setting you wish to use is displayed.

*The default setting (LEFT) can be selected by pressing the **SPACE** key.*

- (4) Press the **RETURN** key.

EXAMPLE

LEFT	CENTER	RIGHT	JUSTIFY
ABC	ABC	ABC	A B C
DEFGHIJ	DEFGHIJ	DEFGHIJ	DEFGHIJ
KLNOP	KLNOP	KLNOP	K L N O P
G	G	G	G

VERTICAL ALIGNMENT

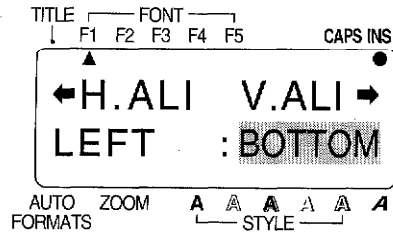

BACKGROUND

The blocks of your message can be vertically aligned in three ways:

BOTTOM
CENTER
TOP

 *The vertical alignment setting can only be applied to the entire label. It cannot be applied to only part of the text.*

OPERATION

TO SELECT A VERTICAL ALIGNMENT:

- (1) Press the **FORMAT** key.
 - (2) Press the **▶** and **◀** keys until the vertical alignment setting (V.ALI) is highlighted.
 - (3) Press the **▲** and **▼** keys until the setting you wish to use is displayed.
-  *The default setting (BOTTOM) can be selected by pressing the **SPACE** key.*
- (4) Press the **RETURN** key.

EXAMPLE

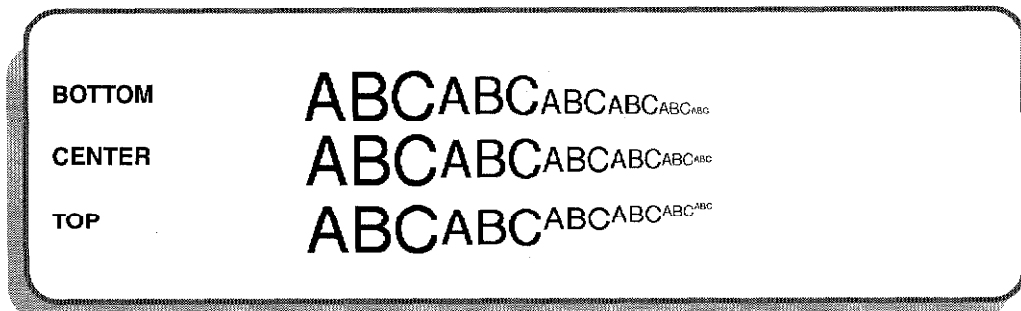

LENGTH

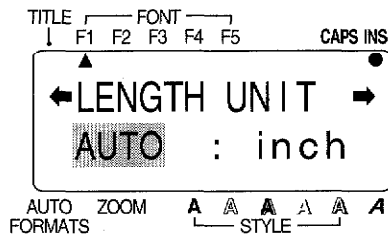

BACKGROUND

The label length can be set using two different methods. With the size to AUTO, the machine compares your inputted message with the tape size and automatically adjusts the label length to fit your message. Sometimes, however, you will want to assign a label length regardless of the message's size. The label length can be set from 1.5" (3.8 cm) to 11.3" (28.7 cm). The label lengths are:

In inches: AUTO 1.5 1.6 11.3 AUTO

In centimeters: AUTO 3.8 3.9 28.7 AUTO

 *The length setting can only be applied to the entire label. It cannot be applied to only part of the text.*

When a setting other than AUTO is selected for the label length, the message "TOO LONG" is displayed if the text will not fit within the specified length.

OPERATION

TO SELECT A TAPE LENGTH:

- (1) Press the **FORMAT** key.
- (2) Press the **▶** and **◀** keys until the tape length setting (LENGTH) is highlighted.
- (3) Press the **▲** and **▼** keys until the setting you wish to use is displayed. Pressing these keys once will increase the length by 0.1" (0.1 cm). Holding down these keys will increase the length in steps of 1" (1.0 cm) until the key is released.

 *The default setting (AUTO) can be selected by pressing the **SPACE** key.*

- (4) Press the **RETURN** key.

DISPLAY UNITS

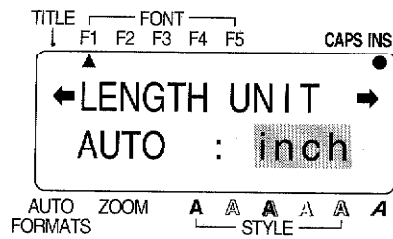

BACKGROUND

The measurements on the display are shown in either inches (inch) or centimeters (cm).

 *This setting is applied to all the measurements displayed. It is not available in local formatting.*

OPERATION

TO SELECT THE UNITS OF THE MEASUREMENTS:

- (1) Press the **FORMAT** key.
- (2) Press the ► and ◀ keys until the display units setting (UNIT) is highlighted.
- (3) Press the ▲ and ▼ keys until the setting you wish to use is displayed.

 *The default setting (inch) can be selected by pressing the **SPACE** key.*

- (4) Press the **RETURN** key.

STORING/RECALLING/DELETING

BACKGROUND

The machine's memory can be used to save and recall your most frequently used text messages. These messages remain in the memory, even if you clear the working area by holding down the **CODE** key and pressing the **CLEAR** key.

When stored, each file is given a number to make recall easier. File numbers are between 0 and 99. This machine's memory can store up to 3,400 characters. If the memory becomes full, subsequent storage attempts will cause the message "MEMORY FULL!" to be displayed. In this case, you must delete an existing text file before you can store the new one.

When a stored text file is recalled, a copy of that file is placed into the working area and can be edited, reformatted or printed. Since a copy is used, the original file is not removed from the memory, you can recall the same file any number of times without changing it. When recalling a file, if some text is currently in the working area, you must choose whether to replace the working area text with the stored file or to join them.

When a file is no longer needed, you can erase it from the memory using the M.DEL function. This function can also be used to make space in the memory when it is full.

OPERATION

TO STORE A TEXT FILE IN THE MEMORY:

- (1) Hold down the **CODE** key and press the **STORE** key.
- (2) Press the **▲** and **▼** keys to choose a number between 0 and 99.
- (3) Press the **RETURN** key. The file is saved and can be recalled at any time.

 *If a file is already stored under the selected number, you will be asked whether you want to overwrite the previous message with the new one.*

To replace the stored file with the new message:

- (4) Press the **RETURN** key. The new file will be stored under the selected number and the previously stored file will be deleted.

 *Press the **CANCEL** key or the **CODE** and **STORE** keys at any time to leave Store mode without storing your message.*

TO RECALL A FILE FROM THE MEMORY:

- (1) Hold down the **CODE** key and press the **RECALL** key. The number and the first characters of the most recently stored file are displayed.
- (2) Press the **▲** and **▼** keys until the file you want to recall is displayed.
- (3) Press the **RETURN** key.

- ☞ If there is no text in the working area, the file is now recalled. If there is some text in the working area, you will now be asked whether you want to join or overwrite the text with the recalled file.

To replace the working area text with the recalled file:

- (4) Press the ▲ and ▼ keys until OFF is displayed in the JOIN selection area.
- (5) Press the RETURN key. The stored text file is recalled and overwrites the message in the working area.

- ☞ If you choose to join the file and the working area text, the recalled file will be inserted in a new block at the cursor's position in the working area.

Press the CANCEL key or the CODE and RECALL keys at any time to leave Recall mode without performing any action.

EXAMPLE

General Operation:

- Press **CODE** + **RECALL** (F1/F2/F3/F4/F5). Press **HOME** and **END** until the text file you want to recall, "AXZ", is displayed.

- Press **NEW BLOCK**. A message is shown asking whether you wish to join the recalled message with the message currently entered in the display.

- Press **NEW BLOCK** to replace the working area text with the recalled file.

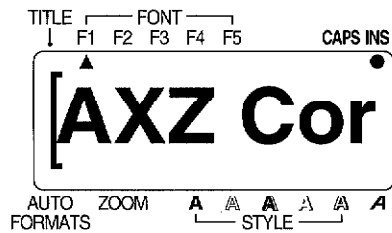
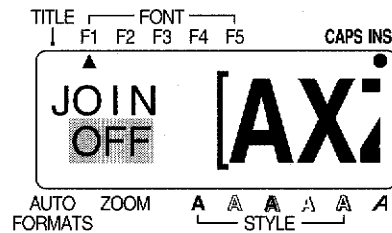
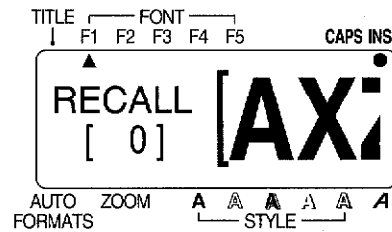
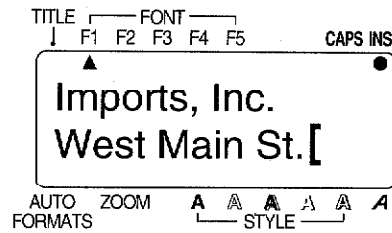

TO DELETE A FILE FROM THE MEMORY:

- (1) Hold down the **CODE** key and press the **M. DEL** key.
- (2) Press the **▲** and **▼** keys until the file you want to delete is displayed.
 - ☞ *Hold down the **CODE** key and press the **SPACE** key to select all the files in the memory. If you then decide not to delete all of the files in the memory, hold down the **CODE** key and press the **CLEAR** key.*
- (3) Press the **RETURN** key. The message "OK TO DELETE?" or "CLEAR ALL?" will be displayed.
- (4) To confirm, press the **RETURN** key again. The selected file or files are deleted.
 - ☞ *Press the **CANCEL** key or the **CODE** and **M. DEL** keys at any time to leave Memory delete mode without deleting the selected file or files.*

PRINTING & SPECIAL PRINTING

BACKGROUND

The **PRINT** key lets you print your text on the installed tape. The **SPECIAL PRINT** key allows you to set the number of copies of the label that will be printed, set whether the machine will pause between copies so that the tape can be cut, and turn the split printing function on and off.

PARAMETER	SETTINGS
Copies (COPIES)	1 to 99
Tape cut pause (PAUSE)	ON, OFF
Split printing (SPLIT)	OFF, ON

COPIES - This parameter determines how many copies of the current label will be printed.

TAPE CUT PAUSE - This parameter determines whether the machine will pause between copies so that the tape can be cut.

 *The left margin on the first label will be 1" (24 mm) even if this parameter is set to OFF.*

SPLIT PRINTING - This parameter determines whether the label will be split lengthwise and printed as two labels.

OPERATION

TO PRINT A LABEL:

Press the **PRINT** key. The text is printed once.

 *If the **PRINT** key is pressed in Auto format mode when the installed tape cassette is not the correct size for the label being printed, a message will appear to instruct you on which tape to install.*

*Press the **FEED** key to feed 1" (24 mm) of tape.*

TO PRINT A LABEL USING A SPECIAL PRINT PARAMETER:

(1) Hold down the **CODE** key and press the **SPECIAL PRINT** key.

If the default settings are O.K. (see Example), press the **RETURN** key.

To change the special print settings:

(2) Press the **▶** and **◀** keys until the first setting you wish to change is highlighted.

(3) Press the **▲** and **▼** keys until the desired setting is displayed. When the **COPIES** parameter is being set and these keys are pressed once, the setting will change by 1. However, if either of these keys are held down, the setting will continue changing in steps of 5 until the key is released.

 The default setting of the highlighted parameter can be selected by pressing the **SPACE** key or all special print settings can be returned to their default settings by holding down the **CODE** key and pressing the **SPACE** key.

- (4) Repeat steps (2) and (3) until your desired settings are displayed.
- (5) Press the **RETURN** key. The labels are printed using the print parameters that have been set.

EXAMPLE

(Text Message)

TITLE _____ FONT _____
 ↓ F1 F2 F3 F4 F5 CAPS INS

ABC1

AUTO ZOOM A A A A A A
 FORMATS STYLE

Tape feed is set to NONE.

Default Print Settings

COPIES: 1
 PAUSE: ON
 SPLIT: OFF

Custom Print Settings

Example 1
 COPIES: 2
 PAUSE: OFF
 SPLIT: OFF

Example 2
 COPIES: 1
 PAUSE: ON
 SPLIT: ON

Pause

1" (24 mm) 1/6" (4 mm) 1/6" (4 mm)

Example 1

1" (24 mm) 1/6" (4 mm) 1/6" (4 mm) 1/6" (4 mm)

Example 2

1/6" (4 mm) 1/6" (4 mm) 1/6" (4 mm) 1/6" (4 mm)

If the Split printing parameter is set to ON, labels like those shown above are printed. To put them together so there is no break in the characters, cut off the blank spaces on the bottom of the top label and on the top of the bottom label.

ABC1

When the Split printing parameter is turned on, only one full copy of the label will be printed, regardless of the copies parameter setting.

BAR CODING

BACKGROUND

The Bar Coding function, which enables bar codes to be printed as part of labels, is one of this machine's most advanced features.

 This section will explain how to enter a bar code into your text message. It is not intended as a comprehensive introduction to the concept of bar coding. For more detailed information, please consult one of the many reference books available.

Since this machine is not specifically designed for special bar code label making, some bar code readers may not be able to read the labels.

Use tape with black characters on white adhesive when making labels containing bar codes.

In Bar code mode, six different parameters can be set, allowing you to create custom bar codes.

PARAMETER	SETTINGS
Protocols (PROTO) _____	CODE 39, I-2/5, EAN13, EAN8, UPC-A, UPC-E, CODABAR, EAN 128, CODE 128, ISBN5, ISBN2, LASER B
Bar code width (WIDTH) _____	MEDIUM, SMALL, LARGE
Numbers printed below bar code (UNDER#) _____	ON, OFF
# of characters in code (CHARS) —	AUTO, 4 to 22
Ratio (RATIO) _____	3:1, 2.5:1, 2:1
Check digit (CH. DIG) _____	OFF, ON

We recommend printing bar codes using the MEDIUM or LARGE width and FULL tape feed.

When the tape feed is reduced or a SMALL bar code width is used, the bar code may be difficult to read.

OPERATION

TO ENTER A BAR CODE INTO YOUR MESSAGE:

- (1) Hold down the **CODE** key and press the **BARCODE** key. If the cursor is located in a bar code that has already been entered, the current bar code settings will be displayed.
- (2) Enter the bar code data. If you wish to edit an existing bar code, enter the new data.

To edit the bar code settings:

- (3) Press the **FORMAT** key.
- (4) Press the **▶** and **◀** keys until the first setting you wish to change is highlighted.
- (5) Press the **▲** and **▼** keys until the desired setting is displayed.
- (6) Repeat steps (4) and (5) until all settings are as you wish.
- (7) Press the **RETURN** key.
- (8) Hold down the **CODE** key and press the **SYMBOL** key, then press the **▲** and **▼** keys until the appropriate symbol is displayed.

The following symbols can only be entered when using protocols EAN 128 or CODE 128.

VALUE	CHARACTER	VALUE	CHARACTER	VALUE	CHARACTER
3	#	71	BEL	89	EM
4	\$	72	BS	90	SUB
11	+	73	HT	91	ESC
28	<	74	LF	91	{
29	=	75	VT	92	FS
30	>	76	FF	92	
32	@	77	CR	93	GS
59	[78	SO	93	}
60	\	79	SI	94	RS
61]	80	DLE	94	~
63	-	81	DC1	95	US
64	NUL	82	DC2	95	DEL
65	SOH	83	DC3	96	FNC 3
66	STX	84	DC4	97	FNC 2
67	ETX	85	NAK	100	FNC 4

VALUE	CHARACTER	VALUE	CHARACTER	VALUE	CHARACTER
68	EOT	86	SYN	102	FNC1
69	ENQ	87	ETB		
70	ACK	88	CAN		

The following symbols can only be entered when using protocols CODE 39 or CODABAR.

SYMBOL	CHARACTER
1	+
2	\$

(9) When your have finished, press the **RETURN** key.

TO DESIGNATE A BAR CODE AS A NUMBERING FIELD:

- (1) Position the cursor immediately before the bar code mark which you wish to select as the numbering field.
- (2) Hold down the **CODE** key and press the **SEQ. NUMBERING** key.
- (3) Press the ▲ and ▼ keys until the desired NUMBER setting appears.
- (4) Press the **RETURN** key. The set number of labels are printed.

EXAMPLE

General Operation:

• Press **CODE** + **# 3**.

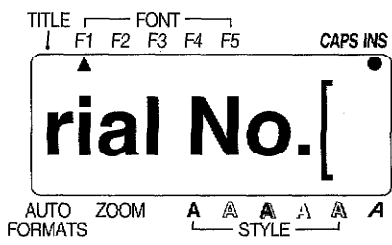

• Press **FORMAT**.

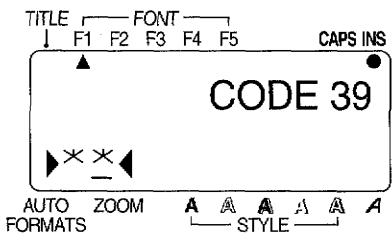

• Press **HOME** until EAN128 is displayed.

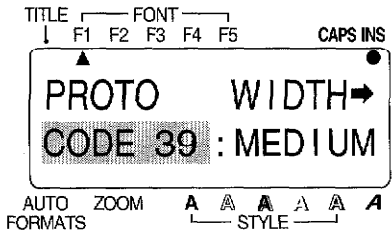

• Press **NEW BLOCK**.

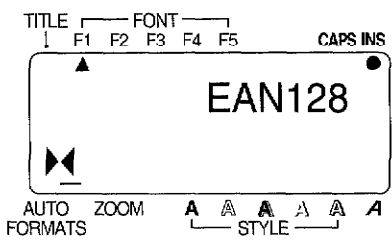
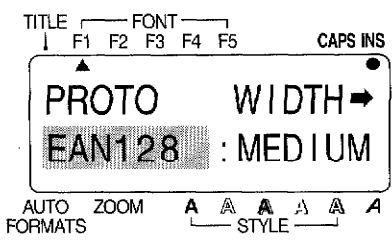

- Enter the bar code information ("123456").

TITLE | FONT | CAPS INS
| F1 F2 F3 F4 F5

EAN128

▶ 123456 ◀

AUTO ZOOM A A A A A A
FORMATS | STYLE |

- Press



TITLE | FONT | CAPS INS
| F1 F2 F3 F4 F5



AUTO ZOOM A A A A A A
FORMATS | STYLE |

ERROR MESSAGE LIST

ERROR MESSAGE	CAUSE	REMEDY
4 DIGIT MIN.	<ul style="list-style-type: none"> A minimum of four digits must be entered in a bar code. This message appears when less than four digits are entered. 	<ul style="list-style-type: none"> Enter a minimum of four digits before pressing the RETURN key.
5 BARS LIMIT!	<ul style="list-style-type: none"> Each label can contain no more than five bar codes. This message appears if five bar codes already exist when you press the BAR-CODE key or if you attempt to join a text file recalled from the memory to the current message, causing the number of bar codes to exceed the limit. 	<ul style="list-style-type: none"> Limit the number of bar codes in the text message to five.
5 LINE LIMIT!	<ul style="list-style-type: none"> Each block of text in a label can contain no more than five lines. This message appears if five lines already exist when you press the RETURN key or if you try to join a text file recalled from the memory to the current message, causing the block to exceed the five line limit. This message appears if the cursor is positioned at the beginning of a block when you press the BACKSPACE key to join two blocks, resulting in a block containing a total of more than five lines. 	<ul style="list-style-type: none"> Limit the number of lines in the current block to five and press the NEW BLOCK key. Adjust the total number of lines in the two blocks so that they will have no more than five lines after they are joined, otherwise do not attempt to join the two blocks.
5 BLOCK LIMIT!	<ul style="list-style-type: none"> Each label can contain no more than five blocks. This message appears if five blocks already exist when you press the NEW BLOCK key or if you try to join a text file recalled from the memory to the current message, causing the message to exceed the five block limit. 	<ul style="list-style-type: none"> Limit the number of blocks in the text message to five.

ERROR MESSAGE	CAUSE	REMEDY
BATTERIES WEAK	<ul style="list-style-type: none"> This message appears when the installed alkaline batteries become weak. 	<ul style="list-style-type: none"> Replace the batteries or use the AC adaptor.
BUFFER EMPTY!	<ul style="list-style-type: none"> This message appears if the LABEL LENGTH, AREA or SEQ. NUMBERING key is pressed when the working area buffer is empty. This message appears if you try to print, but no text has been entered into the working area. This message appears if you try to store a message as a text file, but no text has been entered into the working area. 	<ul style="list-style-type: none"> Enter some text before entering Label length, Area, or Seq. numbering mode. Enter text before printing. Enter text before storing.
BUFFER FULL!	<ul style="list-style-type: none"> There is a limit on the amount of text that can be entered into the working area. This message appears if you try to enter a character, a diacritical mark, return, new block or space when the working area buffer is already full. This message appears if a text format (font, size width, style, italicization, underlining or framing) key is pressed when the working area buffer is already full. This message appears if the RETURN key is pressed in Symbol or Bar code mode when the working area buffer is already full. This message appears if you try to join a text file recalled from the memory to the current message when the working area buffer is already full. 	<ul style="list-style-type: none"> You cannot enter any additional text in this text message. Delete some existing text so that more text can be entered. Press the CANCEL key and delete some of the text before changing the text format. Press the CANCEL key and delete some of the text before entering a symbol or bar code. Press the CANCEL key and delete some of the text before joining the file to the current message.

ERROR MESSAGE	CAUSE	REMEDY
CAN'T HERE	<ul style="list-style-type: none"> • This message appears if a character, symbol, return or new block is entered while the cursor is located in a bar code field. • This message appears if the cursor is located in a bar code field and a text format (font, size width, style, italicization, underlining or framing) key is pressed. • This message appears if a text file is recalled and joined to the current message while the cursor is located in a bar code field. 	<ul style="list-style-type: none"> • Move the cursor or delete the bar code field before entering the character, symbol, return or new block. • Move the cursor or delete the bar code field before pressing the text format key. • Move the cursor or delete the field before recalling the text file.
CHANGE ADAPTOR	<ul style="list-style-type: none"> • This message appears if a high-voltage adaptor is being used. 	<ul style="list-style-type: none"> • Remove the high-voltage adaptor and install the optional 7.0 V 1.2 A AC adaptor.
ERROR! UL/FRM	<ul style="list-style-type: none"> • A maximum of 25 characters can be underlined or framed. This message appears if you try to underline or frame more than 25 characters. 	<ul style="list-style-type: none"> • Reduce the number of characters that are underlined or framed.
FIXED SIZE!	<ul style="list-style-type: none"> • This message appears if the RETURN key is pressed when a TITLE font is selected. • This message appears if a 1/4" (6-mm)- or 3/8" (9-mm)-wide tape is inserted when text is entered using a TITLE font. • This message appears if the character size is changed when a TITLE font is selected. 	<ul style="list-style-type: none"> • Change the font. • Insert a tape cassette that is wide enough for TITLE font text to be printed on it. • Since the size is fixed, do not change it.

ERROR MESSAGE	CAUSE	REMEDY
INPUT ABCD AT BEGIN&END	<ul style="list-style-type: none"> This message appears when the CODABAR protocol is used in Bar code mode, but a letter between A and D has not been entered at the beginning and end of the bar code. 	<ul style="list-style-type: none"> Enter a letter between A and D at the beginning and end of the bar code.
INPUT WHOLE CODE	<ul style="list-style-type: none"> In Bar code mode, the number of digits required for a code can sometimes be set. This message appears if the set number of digits are not entered while inputting the bar code data. 	<ul style="list-style-type: none"> Input the correct number of digits or change the number of digits set in the bar code parameters.
INVAL. CHRS!	<ul style="list-style-type: none"> Numbering fields must be located within a single line. This message appears if characters in different lines are selected as the numbering field. Numbering fields cannot contain both characters and a bar code. This message appears if a bar code is selected together with other characters as a numbering field. 	<ul style="list-style-type: none"> Adjust the numbering field so that it contains characters located within a single line of text. Select either the bar code or the characters alone as the numbering field.
KEY ERROR -XX-	<ul style="list-style-type: none"> This message appears when there is a problem with the machine's circuits. 	<ul style="list-style-type: none"> Contact your service representative.

ERROR MESSAGE	CAUSE	REMEDY
LENGTH LIMIT!	<ul style="list-style-type: none"> • The length of one label message is limited to one meter. This message appears if a character, symbol, diacritical mark, bar code, space, return or new block is entered, causing the text to exceed the one meter limit. • This message appears if the entered text exceeds the one meter limit when the power is turned on or while trying to print. • This message appears if a file is recalled and joined to the current message, causing the text to exceed the one meter limit. • This message appears if the RETURN key is pressed in Format mode, causing the text to exceed the one meter limit. 	<ul style="list-style-type: none"> • Delete some of the text or reduce the character size. • Delete some of the text or reduce the character size. • Press the CANCEL key and delete some of the text before recalling the file or joining the working area text and the file. • Press the CANCEL key and delete some of the text before entering a frame or other global format setting.
LINE LIMIT!	<ul style="list-style-type: none"> • This message appears if the number of lines in the text is greater than the maximum number of lines possible for the installed tape. 	<ul style="list-style-type: none"> • Reduce the number of lines or install a tape of greater width.
MEMORY FULL!	<ul style="list-style-type: none"> • This machine can store about 3,400 characters in its memory. This message appears when you try to store a message that is too large to fit in the available memory space. 	<ul style="list-style-type: none"> • Stop trying to store the message or delete an unwanted file to make room for the new one.
NO FILES!	<ul style="list-style-type: none"> • This message appears if you try to recall or delete a text file from the memory when none are currently stored. 	<ul style="list-style-type: none"> • Do not attempt to recall or delete a text file.
NO TAPE!	<ul style="list-style-type: none"> • This message appears if you attempt to print a label or feed the tape when a tape cassette is not installed. 	<ul style="list-style-type: none"> • Install a tape cassette and try again.

ERROR MESSAGE	CAUSE	REMEDY
NUMBERING BUFFER FULL	<ul style="list-style-type: none"> This message appears if the RETURN key is pressed in Seq. numbering mode when the working area buffer is already full. 	<ul style="list-style-type: none"> Press the CANCEL key and delete some of the text before entering Seq. numbering mode.
RAM PROBLEM!	<ul style="list-style-type: none"> This message appears if there is a problem with the machine's random access memory. 	<ul style="list-style-type: none"> Contact your service representative.
REPLACE BATTERIES!	<ul style="list-style-type: none"> This message appears when the installed alkaline batteries are about to run out. 	<ul style="list-style-type: none"> Replace the batteries or use the AC adaptor.
ROM PROBLEM!	<ul style="list-style-type: none"> This message appears if there is a problem with the machine's read only memory. 	<ul style="list-style-type: none"> Contact your service representative.
SYSTEM ERROR!	<ul style="list-style-type: none"> This message appears if there is a problem with the machine's software. 	<ul style="list-style-type: none"> Contact your service representative.
TOO HIGH!	<ul style="list-style-type: none"> This message appears if the size of the text is larger than the width of the installed tape. 	<ul style="list-style-type: none"> Reduce the size of the characters or install a tape of greater width.
TOO LONG!	<ul style="list-style-type: none"> This message appears if the width of the text is longer than the label length that has been set. This message appears if the text inputted as an entry in Auto formats mode exceeds the preset length. 	<ul style="list-style-type: none"> Delete some of the text, reduce the character width or increase the preset label length. Enter fewer characters.
WRONG SELECT	<ul style="list-style-type: none"> This message appears if more than five characters are selected as the numbering field. This message appears if characters with different format settings are selected as the numbering field. 	<ul style="list-style-type: none"> Limit the numbering field to five characters. Only select characters with identical format settings.

TROUBLESHOOTING

PROBLEM	REMEDY
1. The display stays blank after you have turned on the machine.	<ul style="list-style-type: none">• Check that the AC adaptor is attached properly.• If you are using alkaline batteries, check that they are properly inserted.• If the batteries are low, replace them.
2. The machine does not print or the printed characters are blurred.	<ul style="list-style-type: none">• Check that the tape cassette has been inserted properly.• If the tape cassette is empty, replace it with a new one.• Make sure that the tape cassette cover has been closed.
3. The printed characters are not formed properly.	<ul style="list-style-type: none">• If you are using alkaline batteries, they may be low. Try using the AC adaptor.
4. Striped tape appears.	<ul style="list-style-type: none">• You have reached the end of the tape. Replace it with a new tape.

MACHINE SPECIFICATIONS

HARDWARE

Input device:	KEYBOARD - 63 keys
LCD:	112 × 32 dots 17 indicators
Print tape:	Pressure-sensitive, adhesive-based 26' 3" (8 m) long 5 widths available: 1/4" (6 mm) 3/8" (9 mm) 1/2" (12 mm) 3/4" (18 mm) 1" (24 mm)
Power supply:	6 AA alkaline batteries (optional AC adaptor model AD-30) Auto power off after 5 minutes
Print head:	128 dot / 180 dpi
Dimensions:	8 1/2" × 8 1/2" × 2 2/3" (215 × 215 × 68 mm)
Weight:	2 lbs 3 oz (1 kg)

SOFTWARE

Character size:	6 sizes (6, 10, 13, 19, 26 and 38 points) + AUTO All are available in NARROW, MEDIUM and WIDE
Character fonts:	8 built-in typefaces
Buffer size:	Single line - 1 m or 255 characters Multi-line Multi-block
Memory size:	3,400 characters
Number of characters:	247 characters
Print styles:	Normal, Bold, Outline, Solid, Shadow and Outline + Shadow (all can be combined with Italic)

FEATURES

The P-Touch 540 features the following:

- WYSIWYG display
- Auto format
- Multi-line printing (up to 5 lines)
- Multi-block printing (up to 5 blocks)
- 6 sizes & 12 styles
- Text and label framing
- Text underlining
- Vertical printing
- Mirror printing
- Horizontal & vertical alignment adjustment
- Adjustable tape feed
- Label length setting
- Repeat printing
- Split printing
- Numbering function
- Bar code generation
- Zooming in and out

INDEX

- A**
AC adaptor8, 10, 46
Accented characters52
Alignment
 Horizontal91
 Vertical92
ALT key48
AUTO FORMATS key69
Automatic backup46
Automatic power off46
- B**
BACKSPACE key19, 63
Backup46
Bar code
 Numbering56, 102
 Settings100
 Symbols101
Batteries8, 9, 46
Blank display111
Blocks55
Bold character style83
Bottom alignment92
Boxing86, 87
- C**
CANCEL key54, 58
Cancelling
 Deleting stored text97
 Operations58
 Recalling stored text96
 Storing text95
CAPS key19, 48
Cassette8, 11
Center alignment
 Horizontal91
 Vertical92
Character sizes81
Character styles83
Character widths81
Check digit100
Cleaning
 Machine's surface8
 Print head and rollers13
CLEAR key65
CODABAR symbols102
CODE 39 symbols102
CODE key49
CODE128 symbols101
Combination character styles83
Composite characters52
CONTRAST key68
COPIES setting98
Creating
 Blocks55
 Global Formats77
 Local formats75
Cursor movement17, 60
Cursors17, 47
- D**
Default settings
 Font79
 Framing
 Global format87
 Local format86
 Global formatting77
 Horizontal alignment91
 Italics83
 Label length93
 Mirror printing90
 Size81
 Style83
 Tape feed88
 Underlining86
 Units94
 Vertical alignment92
 Vertical printing89
 Width81
Deleting
 Stored labels97
 Symbols64
 Text63, 64
 Working area text65
Diacritical marks52
Displaying
 Final layout66
 Label length67
 Units94

E		
EAN 128 symbols	101	
END key	60	
Ending a line	53	
Entering		
Capital letters	48	
Composite characters	52	
Diacritical marks	52	
Selections	54	
Symbols	48, 50	
Error messages	105–110	
F		
Failure to print	111	
Features	7	
FEED key	98	
Font	79	
Format indicators	17	
FORMAT key	24	
Format settings	26	
Framing	86, 87	
G		
Global formatting	77	
H		
HOME key	60	
Horizontal alignment	91	
I		
Incrementing	56	
Indicator		
AUTO FORMATS	69	
CAPS	48	
Fonts	79	
INS	61	
Italic	83	
Style	83	
TITLE	79	
ZOOM	66	
INSERT key	19, 61	
Instant lettering tape	12	
Italic character style	83	
J		
Joining recalled text	96	
Justifying text	91	
K		
Keyboard	6	
Keypop symbols	48	
L		
Label backing removal	12	
Label length		
Displaying	67	
Selecting	93	
Label templates	69	
LCD display	6	
Left alignment	91	
LINE OUT key	64	
Local formatting	34, 75	
M		
Malformed characters	111	
Margin width	88	
Memory		
Deleting	97	
Joining	96	
Overwriting with recalled text	96	
Recalling	95	
Storing	95	
Mirror printing	90	
Multiple blocks	37	
Multiple printing	30	
N		
NEW BLOCK key	37, 55	
New blocks	55	
Non-keytop symbols	50–51	
Normal character style	83	
Numbering	42, 56	
Bar codes	56, 102	
Symbols	56	
O		
On/Off button	17	
Outline character style	83	
Overwrite mode	19, 61	
Overwriting with recalled text	96	
P		
Pause printing	30	
Power button	17, 46	
Precautions	8	
Print head	13	

PRINT key	98
Printing	
Default settings	99
Failure	111
Malformed characters	111
Multiple copies	30
Protocols	100

R

Recalling labels	29, 95
Removing label backing	12
Repeat printing	30
Resetting the machine	46
RETURN key	53, 59
Right alignment	91
Rollers	13
Rub-on transfers	12

S

Selecting	
Character sizes	81
Character styles	83
Character widths	81
Fonts	79
Framing	86, 87
Horizontal alignment	91
Label length	93
Margin width	88
Mirror printing	90
Numbering field	56
Print settings	98
Tape feed	88
Underlining	86
Units	94
Vertical alignment	92
Vertical printing	89
SEQ. NUMBERING key	56
Shadow character style	83
SHIFT key	48
Size	81
SPACE key	18
Special printing	30, 98
Split printing	98
Storing labels	27, 95
Striped tape	111
Style	83
SYMBOL key	20, 50
Symbols	
Bar codes	101

Deleting	63, 64
Keytop	48
Non-keytop	50–51
Numbering	56

T

Tape cassettes	8, 11
Supplies	117
Tape cut pause	98
Tape cutter lever	4, 11
Tape feed	88
Tape widths	
Maximum character sizes	81
Text	
Clearing all	65
Deleting	63
Joining	96
Overwriting	61
Overwriting with recalled text	96
Recalling	95
Storing	95
TITLE fonts	79
Top alignment	92
Troubleshooting	111

U

Underlining	86
Units	94
Uppercase letters	18

V

Vertical alignment	92
Vertical printing	89
Viewing	
Final layout	66
Label length	67

W

Width	81
Working area text	
Joining	96
Overwriting with recalled text	96
WYSIWYG mode	17

Z

ZOOM key	66
----------------	----

ACCESSORIES

Obtain tape cassettes and AC adaptors from your nearest authorized dealer Brother cannot be held responsible for trouble caused by the use of unauthorized supplies. Use only Brother TZ tapes with this machine. Do not use tapes that do not have the  mark.

Stock No.	Description	QTY/ PACKAGE	PRICE
1" (24 mm) laminated tapes			
TZ-151	Black characters on clear adhesive	1	\$23.95
TZ-251	Black characters on white adhesive	1	\$23.95
TZ-451	Black characters on red adhesive	1	\$23.95
TZ-651	Black characters on yellow adhesive	1	\$23.95
TZ-252	Red characters on white adhesive	1	\$23.95
TZ-354	Gold characters on black adhesive	1	\$26.95
TZ-355	White characters on black adhesive	1	\$26.95
TZ-B51	Black characters on orange fluorescent adhesive	1	\$28.95
3/4" (18 mm) laminated tapes			
TZ-141	Black characters on clear adhesive	1	\$20.95
TZ-241	Black characters on white adhesive	1	\$20.95
TZ-242	Red characters on white adhesive	1	\$20.95
TZ-243	Blue characters on white adhesive	1	\$20.95
TZ-344	Gold characters on black adhesive	1	\$24.95
TZ-345	White characters on black adhesive	1	\$23.95
TZ-441	Black characters on red adhesive	1	\$20.95
TZ-541	Black characters on blue adhesive	1	\$20.95
TZ-545	White characters on blue adhesive	1	\$23.95
TZ-641	Black characters on yellow adhesive	1	\$20.95
TZ-741	Black characters on green adhesive	1	\$20.95
TZ-B41	Black characters on orange fluorescent adhesive	1	\$24.95
TZ-M41	Black characters on clear (mat) adhesive	1	\$20.95
TZ-L041	Instant lettering tape	1	\$20.95
1/2" (12 mm) laminated tapes			
TZ-131	Black characters on clear adhesive	1	\$16.95
TZ-231	Black characters on white adhesive	1	\$17.95
TZ-232	Red characters on white adhesive	1	\$17.95
TZ-335	White characters on black adhesive	1	\$20.95

Stock No.	Description	QTY/ PACKAGE	PRICE
3/8" (9 mm) laminated tapes			
TZ-121	Black characters on clear adhesive	1	\$14.95
TZ-221	Black characters on white adhesive	1	\$16.95
TZ-325	White characters on black adhesive	1	\$18.98
TZ-421	Black characters on red adhesive	1	\$16.95
1/4" (6 mm) laminated tapes			
TZ-111	Black characters on clear adhesive	1	\$12.95
TZ-211	Black characters on white adhesive	1	\$14.95
TZ-315	White characters on black adhesive	1	\$17.95

OPTIONS

Stock No.	Description	QTY/ PACKAGE	PRICE
AC adaptor			
AD-30	AC adaptor	1	\$21.95

SUPPLIES ORDER FORM

Dear Customer:

Please send this order form, along with proper payment, to the address below OR, Visa, MasterCard or Discover holders, call toll free, anytime, 1-800-284-4357, or fax your completed order form to 1-800-947-1445.

Stock No.	Description	Price	Quantity	Total
Subtotal				

Name: _____
 Address: _____
 City: _____
 State/Zip: _____
 Daytime Phone: _____

Accessory Subtotal: \$ _____
 AZ, CA, CT, FL, GA, IL, LA, MA, MI, MN,
 MO, NC, NJ, NV, NY, TN, TX, VA, WA
 residents add applicable sales tax \$ _____

SEND ORDER FORM TO:
 Brother International Corp.
 Attn: Consumer Accessory Div.
 P.O.Box 341332
 Bartlett, TN38184-1332

Shipping/Handling Options
 Please choose one:
 • Standard (\$5.00)
 • 2nd day air freight (\$8.75)
 Mandatory for all deliveries
 outside of the continental U.S.
 (Alaska, Hawaii, Puerto Rico,
 Virgin Islands & Canada)
 • All other overseas orders (\$25.00) \$ _____

TOTAL DUE \$ _____

Method of payment (Check one)
 Visa MasterCard Discover Check/Money Order
 Account Number _____
 Expiration Date _____
 Signature _____

*Prices subject to change without notice.



SUPPLIES ORDER FORM

Dear Customer:

Please send this order form, along with proper payment, to the address below OR, Visa, MasterCard or Discover holders, call toll free, anytime, 1-800-284-4357, or fax your completed order form to 1-800-947-1445.

Stock No.	Description	Price	Quantity	Total
Subtotal				

Name: _____
 Address: _____
 City: _____
 State/Zip: _____
 Daytime Phone: _____

Accessory Subtotal: \$ _____
 AZ, CA, CT, FL, GA, IL, LA, MA, MI, MN,
 MO, NC, NJ, NV, NY, TN, TX, VA, WA
 residents add applicable sales tax \$ _____

SEND ORDER FORM TO:
 Brother International Corp.
 Attn: Consumer Accessory Div.
 P.O.Box 341332
 Bartlett, TN38184-1332

Shipping/Handling Options
 Please choose one:
 • Standard (\$5.00)
 • 2nd day air freight (\$8.75)
 Mandatory for all deliveries
 outside of the continental U.S.
 (Alaska, Hawaii, Puerto Rico,
 Virgin Islands & Canada)
 • All other overseas orders (\$25.00) \$ _____

TOTAL DUE \$ _____

Method of payment (Check one)
 Visa MasterCard Discover Check/Money Order
 Account Number _____
 Expiration Date _____
 Signature _____

*Prices subject to change without notice.



brother[®]