

brother®

TZ
TAPE

P-touch

7500/7600

USER'S GUIDE

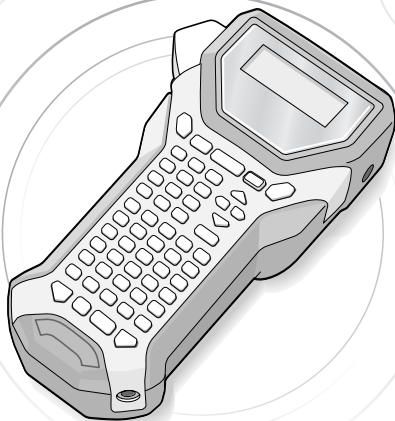

- Read this User's Guide before you start using your P-touch.
- Keep this User's Guide in a handy place for future reference.

Declaration of Conformity

We BROTHER INDUSTRIES, LTD.
15-1, Naeshiro-cho, Mizuho-ku,
Nagoya, 467-8561, Japan

declare that the Labelling System PT-7500 and PT-7600 conforms with the following normative documents:

EMC: EN55022:2006 Class B
EN55024:1998+A1:2001+A2:2003
EN61000-3-2:2006
EN61000-3-3:1995+A1:2001+A2:2005

and follows the provisions of the Electromagnetic Compatibility Directive 2004/108/EC. The optional AC adapter AD-18U and AD-18E also conforms with EN60950-1:2001+A11:2004 and follows the provisions of the Low Voltage Directive 2006/95/EC.

Issued by: BROTHER INDUSTRIES, LTD.
Printing & Solutions Company,
Quality Management Dept.

Compilation and Publication Notice

Under the supervision of Brother Industries Ltd., this manual has been compiled and published, covering the latest product's descriptions and specifications.

The contents of this manual and the specifications of this product are subject to change without notice.

Brother reserves the right to make changes without notice in the specifications and materials contained herein and shall not be responsible for any damages (including consequential) caused by reliance on the materials presented, including but not limited to typographical and other errors relating to the publication.

Trademarks

The Brother logo is a registered trademark of Brother Industries, Ltd.
Brother is a registered trademark of Brother Industries, Ltd.

© 2008 Brother Industries Ltd.

- Microsoft, Windows and Windows Vista are registered trademarks of Microsoft Corporation in the United States and other countries.
- The names of other software or products used in this document are trademarks or registered trademarks of the respective companies that developed them.



Before Using Your P-touch

Thank you for purchasing the PT-7500/7600.









Your new P-touch is an easy to operate, feature packed labelling system that makes creating professional, high quality labels a breeze. In addition to easy label creation via pre-formatted label layouts, the P-touch editing software features advanced label formatting, block formats, bar codes and auto-numbering functions.

Safety precautions

To prevent injury and damage, important notes are explained using various symbols. The symbols and their meanings are as follows:

 WARNING	Tells you what to do to avoid the risk of injury.
 CAUTION	Tells you about procedures you must follow to prevent damage to the P-touch.













The symbols used in this manual are as follows:

	Action NOT allowed.		DO NOT disassemble the product.
	DO NOT splash the product with or immerse the product in water.		DO NOT touch this part of the product.
	Mandatory action		Unplugging
	Safety alert		Alerts to the possibility of electrical shock

WARNING









Rechargeable battery pack (for PT-7600 only)

Follow these guidelines to avoid fire, heat, damage, and electric shock.

-  Do not use this P-touch with any rechargeable battery pack other than that specified.
-  To recharge the rechargeable battery pack, insert the rechargeable battery pack into the P-touch, and then use AD-18U or AD-18E designed specifically for this P-touch.
-  Do not insert or use the rechargeable battery pack in any equipment other than the P-touch. Do not directly connect it to a power supply, car cigarette lighter or electrical outlet.
-  Do not expose the rechargeable battery pack or the P-touch with the rechargeable battery pack installed to pressure, heat, electric charge or microwaves.
-  Do not place the rechargeable battery pack or the P-touch with the rechargeable battery pack installed near a fire or in a location exposed to heat or high temperatures (for example, near a flame or stove, in the sun, or in a location where the temperature is 60 °C or more, such as in a hot car).
-  Do not allow the rechargeable battery pack to get wet.
-  Do not short-circuit the terminals of the rechargeable battery pack or the P-touch with the rechargeable battery pack installed, such as with a metal object.
-  Do not pierce the external casing of the rechargeable battery pack in any way.
-  Take care to prevent damage to the rechargeable battery pack, or the P-touch with the rechargeable battery pack installed.
-  Do not disassemble or alter the rechargeable battery pack or the P-touch with the rechargeable battery pack installed.
-  Do not use a damaged or deformed rechargeable battery pack.
-  Do not use in a corrosive environment (for example, exposed to salty air or salt water, or acidic, alkaline or corrosive gas).
-  Do not insert or remove the rechargeable battery pack when the AC adapter is connected.

AC adapter







Follow these guidelines to avoid fire, damage, electric shock, or failure.

-  Use only the AC adapter (AD-18U or AD-18E) designed exclusively for your P-touch. Failure to observe this may result in an accident or damage. Brother shall not assume any responsibility for any accident or damage resulting from not using the specified AC adapter.
-  Unplug the power cord immediately and stop using the machine during an electrical storm. There may be a remote risk of electric shock from lightning.
-  Do not touch the AC adapter or power plug with wet hands.
-  Do not use the AC adapter in places of high humidity such as bathrooms.
-  Do not use a damaged power cord.
-  Do not overload the power outlet.
-  Do not place heavy objects on, damage or modify the power cord or plug. Do not forcibly bend or pull the power cord.
-  Do not drop, hit or otherwise damage the AC adapter.
-  Make sure that the plug is fully inserted in the power outlet. Do not use an outlet that is loose.

WARNING









Batteries (Alkaline/Rechargeable)

Follow these guidelines to avoid leakage, or damage to the batteries.

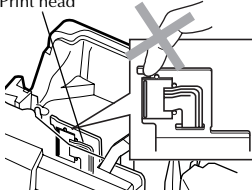
-  Do not use metallic articles, such as tweezers or a metallic pen, when exchanging the batteries.
-  Do not charge the batteries in high temperature locations.
-  Do not throw into fire, heat up, or disassemble the battery.
-  If battery fluid comes into contact with skin or clothes, wash the affected areas thoroughly with clean water. Battery fluid is harmful to skin.
-  If the batteries leak, make sure the fluid does not come into contact with your eyes, as this may result in loss of eyesight. If contact does occur, flush eyes with clean water and seek medical attention urgently.
-  If the batteries begin to emit an odour, overheat, discolour, deform, or any other change occurs during use, charging, or storage, remove the batteries immediately and discontinue use.

P-touch

Follow these guidelines to avoid fire, damage, electric shock, and choking.

-  Do not allow the P-touch to get wet in any way.
-  Do not touch any metal parts near the print head. The print head becomes very hot during use and remains very hot immediately after use. Do not touch it directly with your hands.
Print head
- 
-  Do not disassemble the P-touch. For inspection, adjustment, and repair of the P-touch, contact the retail outlet where the P-touch was purchased or your local authorized service centre.
-  Plastic bags are used in the packaging of your machine. To avoid danger of suffocation, keep these bags away from babies and children.
-  Disconnect the AC adapter and remove battery immediately and stop using when you notice abnormal odour, heat, discolouration, deformation or anything unusual while using or storing it.
-  Do not use the P-touch with a foreign object in it. If water, metallic substance or any foreign object enters the P-touch, disconnect the AC adapter and remove battery, and contact the retail outlet where the P-touch was purchased or your local authorized service centre.
-  To prevent damage, do not drop or hit the machine.
-  Do not touch the blade of the cutter unit.

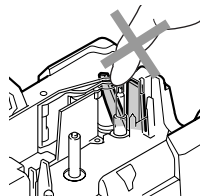



CAUTION

Tape Cutter

Follow these guidelines to avoid personal injury and damage of the P-touch.





-  Do not open the tape compartment cover when operating the cutter unit.
-  Do not apply excessive pressure to the cutter unit.

AC adapter

-  If you do not intend using the P-touch for an extended period of time, please disconnect the AC adapter from the power outlet and the P-touch to avoid battery leakage or loss of charge.
-  Always hold the plug when disconnecting the power cord from the power outlet.



Batteries

Follow these guidelines to avoid liquid leakage, heat or rupture of the batteries.

-  Do not use old and new batteries together.
-  Check that the batteries are correctly inserted.
-  Do not mix alkaline batteries with other type batteries.
-  If you do not intend using the P-touch for an extended period of time, please remove the battery to avoid battery leakage or loss of charge.
-  Do not let the batteries get wet.

P-touch



Follow these guidelines to avoid personal injury and damage of the P-touch.

-  Place the P-touch on a flat, stable surface such as a desk.
-  Do not place any heavy objects on top of the P-touch. Do not press on the LCD screen.
-  Do not leave the P-touch within reach of children with the back cover open.

Tape

-  Depending on the location, material, and environmental conditions, the label may unpeel or become irremovable, the colour of the label may change or be transferred to other objects. Before applying the label, check the environmental condition and the material.

Memory

-  Any data stored in memory will be lost due to failure or repair of the P-touch, or when the batteries expires and the power is disconnected.
-  When power is disconnected for more than two minutes, all text and format settings will be cleared. Any text files stored in the memory will also be cleared.

General Precautions

- Do not use the P-touch in any way or for any purpose not described in this guide. Doing so may result in accidents or damage to the machine.
- Do not put any foreign objects into the tape exit slot, AC adapter connector, or USB port (for PT-7600 only), etc.
- Do not touch the print head with your fingers. Use a soft wipe (e.g. a cotton swab) when cleaning the print head or the optional print head cleaning cassette (TZ-CL4) when cleaning the print head.
- Do not clean the machine with alcohol or other organic solvents. Only use a soft, dry cloth.
- Do not place the P-touch/battery in direct sunlight or rain, near heaters or other hot appliances, in any location exposed to extremely high or low temperatures (e.g. on the dashboard or in the back of your car), high humidity, or dusty locations. Standard operating temperature range: 10°C to 35°C.
- Do not leave any rubber or vinyl on the machine for an extended period of time, otherwise the machine may be stained.
- Depending on the environmental conditions and the applied settings, some characters or symbols may be difficult to read.
- Use only Brother TZ tapes with this machine. Do not use tapes that do not have the  mark.
- Do not pull or apply pressure to the tape in the cassette. Otherwise the tape cassette or P-touch may be damaged.
- Make sure that the release lever is up when closing the back cover. The back cover cannot be closed if the release lever is pressed down.
- Do not try to print labels using an empty tape cassette or without a tape cassette set in the P-touch. Doing so will damage the print head.
- Do not attempt to cut tape while printing or feeding since this will damage the tape.
- It is recommended that you use the USB cable supplied with the P-touch. Should another USB cable need to be used, ensure it is of high quality construction (for PT-7600 only).
- Be careful not to scratch the CD-ROM. Do not place the CD-ROM in any location exposed to high or low temperatures. Do not place heavy objects on the CD-ROM or bend it (for PT-7600 only).
- The software on the CD-ROM is intended for use with the P-touch and may be installed on more than one PC (for PT-7600 only).
- We strongly recommend that you read this User's Guide carefully before using your P-touch, and then keep it nearby for future reference.

Contents

Before Using Your P-touch	i
<i>Safety precautions</i>	<i>i</i>
General Precautions	v

1. Getting Started 1

Unpacking Your P-touch	1
General Description	3
<i>Top view & bottom view</i>	<i>3</i>
<i>Keyboard & LCD screen</i>	<i>4</i>
<i>Back light</i>	<i>5</i>
Power Supply	5
<i>AC Adapter</i>	<i>5</i>
<i>Batteries</i>	<i>6</i>
<i>Rechargeable battery pack (for PT-7600 only)</i>	<i>7</i>
Tape Cassettes	9
<i>Installing a tape cassette</i>	<i>9</i>
Turning the P-touch On/Off	12
Changing the Language	12

2. Label Type Modes 13

Selecting a Label Type Mode	13
Normal and Vertical Modes	13
Rotate and Rotate & Repeat Modes	14
Flag Mode	15
Port and Panel1 Modes	16
Panel2 Mode	17

3. Basic Functions 19

Performing Basic Operations	19
<i>Choosing functions, parameters, settings and groups</i>	<i>19</i>
<i>Choosing the default setting</i>	<i>19</i>
<i>Confirming a choice</i>	<i>19</i>
<i>Cancelling a choice</i>	<i>19</i>
Inputting Label Data	20
<i>Entering and editing text</i>	<i>20</i>

<i>Entering an accented character</i>	22
<i>Entering a bar code</i>	23
<i>Entering a symbol</i>	25
Formatting the Label	28
<i>Specifying a label length</i>	28
<i>Specifying a margin size</i>	28
<i>Framing the text</i>	29
<i>Specifying the character size</i>	30
<i>Specifying the character width</i>	31
<i>Specifying the character style</i>	32
<i>Using the pre-formatted Auto Format templates</i>	33
Printing Labels	34
<i>Previewing the label layout</i>	34
<i>Feeding tape</i>	35
<i>Printing a label</i>	35
<i>Using special printing functions</i>	35
Storing and Recalling Files	39
<i>Storing label text</i>	39
<i>Recalling text that has been stored</i>	40
<i>Deleting text that has been stored</i>	40

4. Machine Adjustments42

<i>Selecting how tape is fed and cut</i>	42
<i>Adjusting the display contrast</i>	42
<i>Using the Auto Reduction function</i>	43
<i>Calibrating the label length</i>	43
<i>Updating the PERSONAL symbol category</i>	44
<i>Changing the units of measure</i>	44
<i>Displaying version information</i>	44
Cleaning	45
<i>Cleaning the print head, rollers and tape cutter</i>	45

5. Using P-touch With a Computer (for PT-7600 only) ...47

Installing the Software & Printer Driver	47
<i>Introduction</i>	47
<i>System requirements</i>	48
<i>Installing P-touch Editor 5.0 and the Printer driver</i>	48
<i>Uninstalling P-touch Editor 5.0</i>	53
<i>Uninstalling / Replacing the printer driver</i>	53

Using P-touch Editor 5.0	54
<i>Starting P-touch Editor</i>	<i>55</i>
<i>Layout window</i>	<i>57</i>
<i>Starting P-touch Editor Help</i>	<i>59</i>
Transferring Data To/From a Computer	61
<i>Entering Transfer mode</i>	<i>61</i>
How to use P-touch Transfer Manager & P-touch Library	62
<i>Starting up P-touch Transfer Manager</i>	<i>62</i>
<i>Transferring label templates from the PC</i>	<i>64</i>
<i>Adding a user-defined character image to the text</i>	<i>66</i>
<i>Using template data</i>	<i>66</i>
<i>Using downloaded database data</i>	<i>68</i>
<i>Backing up label templates</i>	<i>70</i>
<i>Starting up the P-touch Library</i>	<i>72</i>
<i>Searching labels</i>	<i>72</i>

6. Appendix74

Resetting the P-touch	74
Troubleshooting	74
Error Message List	76
Machine Specifications	81
<i>Main Unit</i>	<i>81</i>
<i>Operating Environment: Windows® (for PT-7600 only)</i>	<i>83</i>
Accessories	83
Index	88

1 Getting Started

Unpacking Your P-touch

Check that the package contains the following before using your P-touch.

PT-7600

P-touch



Rechargeable battery pack (BA-7000)

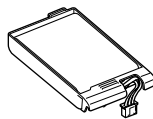

TZ tape cassette

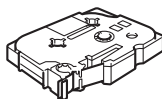

Strap belt

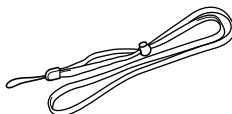

CD-ROM



User's Guide

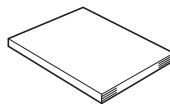

USB cable

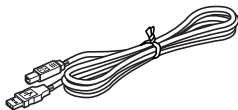

AC adapter (AD-18U or AD-18E)

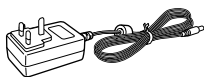

(The design of the adapter may differ by country.)

PT-7500

P-touch



Strap belt

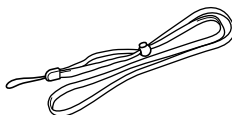

TZ tape cassette

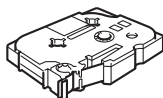

User's Guide

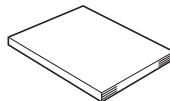

AC adapter (AD-18U or AD-18E)

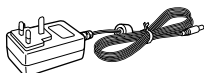

(The design of the adapter may differ by country.)

General Description

Top view & bottom view

Top view

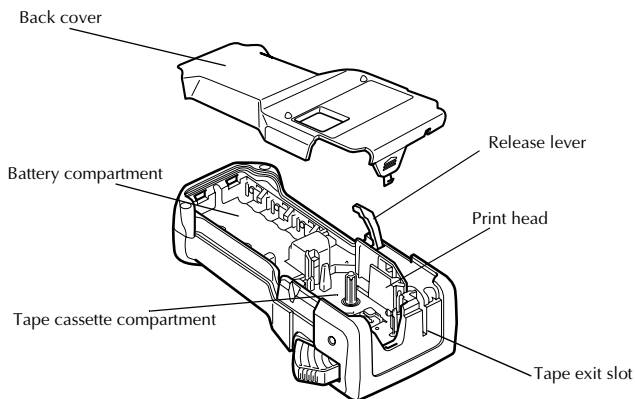
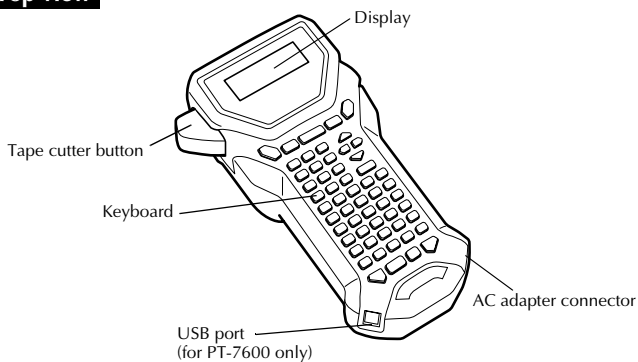

Bottom view

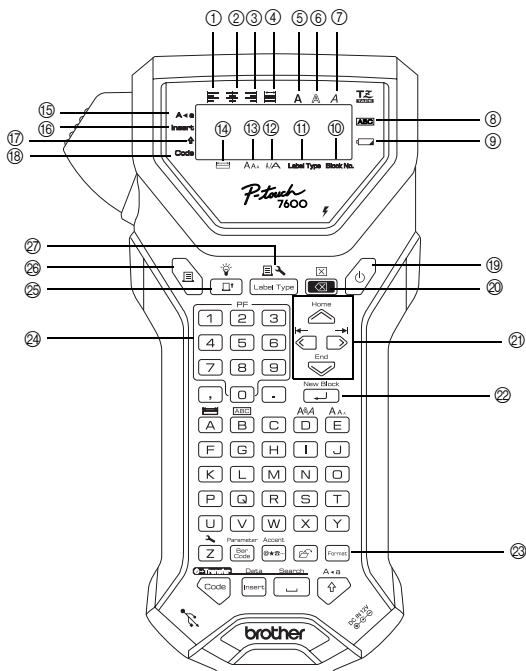

Keyboard & LCD screen

PT-7600 is shown here.



- | | |
|--------------------------------------|--|
| ① Left text alignment (page 33) | ⑮ Caps mode (page 20) |
| ② Centre text alignment (page 33) | ⑯ Insert mode (page 21) |
| ③ Right text alignment (page 33) | ⑰ Shift mode (page 20) |
| ④ Justified text alignment (page 33) | ⑱ Code mode (page 20) |
| ⑤ Bold text style (page 32) | ⑲ Power key (page 12) |
| ⑥ Outline text style (page 32) | ⑳ Backspace key (pages 19 & 22) |
| ⑦ Italic text style (page 32) | ㉑ Arrow keys (page 19) |
| ⑧ Frame (page 29) | ㉒ Return key (pages 19 & 21) |
| ⑨ Low battery indicator (page 7) | ㉓ Global format key (page 30) |
| ⑩ Block number (page 21) | ㉔ PF keys (page 33) (PT-7600) Auto Format keys (page 33) (PT-7500) |
| ⑪ Label Type setting (page 13) | ㉕ Feed key (page 35) |
| ⑫ Width setting (page 31) | ㉖ Print key (page 35) |
| ⑬ Size setting (pages 30 & 31) | ㉗ Label Type (page 13) |
| ⑭ Length setting (page 28) | |

Back light

Press  and  to turn on or turn off the back light. The back light can be used when you wish to see the display more clearly. The default setting is ON.

 Power can be saved when the back light is turned off.

Power Supply

The P-touch can be supplied with two or three power supply options.

	AC adapter (page 5)	Batteries (page 6)	Rechargeable battery pack* (page 7)
PT-7500	●	●	-
PT-7600	●	●	●

*The rechargeable battery pack is a consumable product. There is no guarantee against its deterioration during storage.

Use the power supply best suited to your needs. For details on each power supply, refer to the following description below.

AC Adapter

Connecting the AC adapter

When printing a large number of labels or labels that contain a large amount of text, it may be useful to connect the P-touch to a standard electrical outlet using the AC adapter.

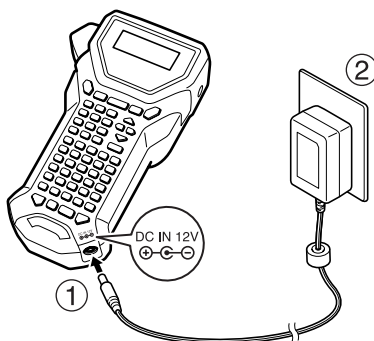

Notes on the AC adapter

- ☞ Only use the AC adapter designed exclusively for this machine.
- ☞ Disconnect the AC adapter if you do not intend to use this P-touch for an extended period of time. When the power is disconnected, all text shown in the display and stored in the memory will be lost.

Batteries

Installing the batteries

This machine has been designed to allow you to change the batteries quickly and easily. With batteries installed, this compact and portable machine can be used anywhere.

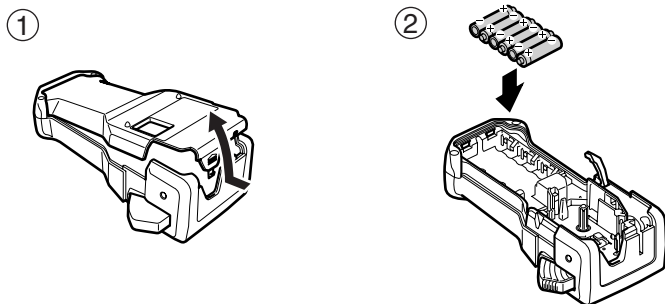

Notes on batteries

- ☞ **This P-touch requires six AA-size batteries (LR6). Rechargeable (Ni-MH) batteries can be used instead of six alkaline batteries.**
- ☞ The rechargeable batteries cannot be recharged by leaving them in the P-touch with the AC adapter connected. Instead, recharge the rechargeable batteries by using a battery charger designed specifically for the type of rechargeable batteries used. For more details on the rechargeable batteries, refer to the instructions provided with them.
- ☞ Do not use any of the following, otherwise battery leakage or damage may occur.
 - Manganese batteries
 - A combination of new and used batteries
 - A combination of batteries of different types (alkaline and Ni-MH), different manufacturers or different models
 - A combination of recharged and uncharged batteries

- ⚠ Make sure that the batteries are inserted so that their poles point in the correct direction. With batteries installed, the P-touch determines the remaining battery charge during printing and feeding. If a low battery charge is detected, the low battery indicator (🔋) comes on. When this occurs, be sure to replace the batteries. The low battery indicator may not come on in some operating conditions.
- ⚠ Before replacing the batteries, make sure that the P-touch is turned off. In addition, when replacing the batteries, insert the new ones within two minutes of removing the old ones, otherwise the text shown in the display and any text stored in the memory will be lost.
- ⚠ If you do not intend to use this P-touch for an extended period of time, remove the batteries. When the power is disconnected, all text shown in the display and stored in the memory will be lost.

Rechargeable battery pack (for PT-7600 only)

The machine has a rechargeable battery pack that allows you to use it anywhere when charged, and an AC adapter that allows you to use it while connected to an electrical outlet when the rechargeable battery pack's charge becomes low.

- ⚠ If you do not use the rechargeable battery pack frequently, you can increase its useable life by charging it every six months.

Installing the rechargeable battery pack

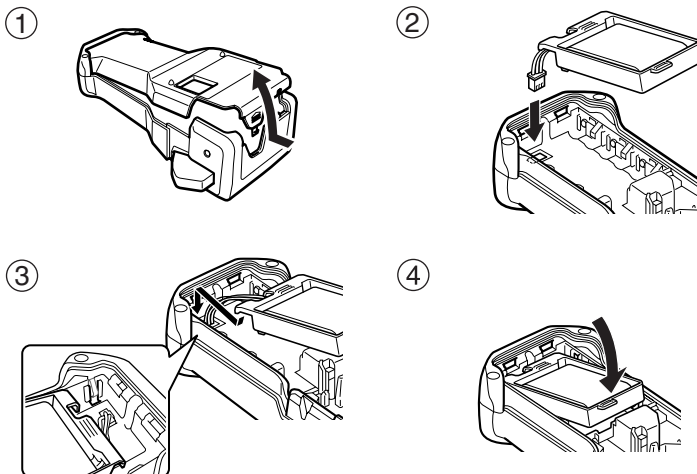

Charging the rechargeable battery pack

Insert the plug on the AC adapter cord into the connector on the machine and insert the AC adapter plug into a standard electrical outlet. While the rechargeable battery pack is charging, the charging indicator light lights up. Charging time is approx. 3 hours. The charging indicator light turns off when charging is completed.

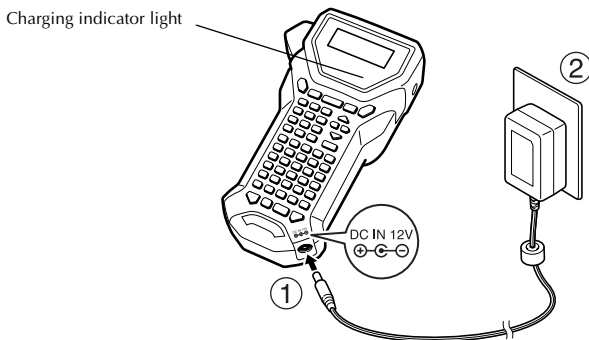

Replacing the rechargeable battery pack

If you use your P-touch frequently, you will generally need to replace the rechargeable battery pack after approximately one year. While the replacement period varies depending on the conditions of use, you should replace the pack when it shows signs of holding a reduced charge. Be sure to replace it with the specified rechargeable battery pack (BA-7000).

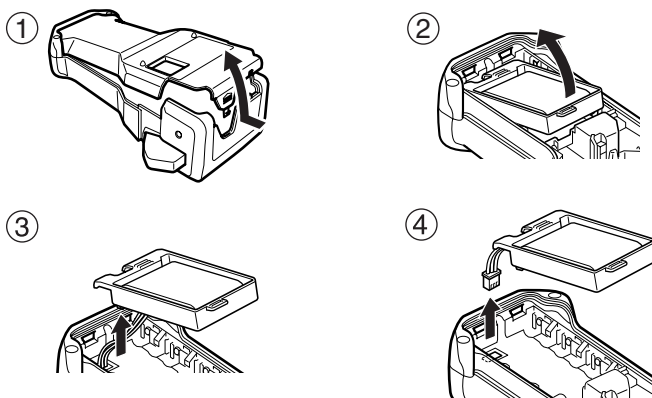

Notes on the rechargeable battery pack

- Be sure to use the suggested AC adapter (AD-18U or AD-18E)
- Connect the AC adapter directly to the P-touch to use it immediately after purchase or when the rechargeable battery pack's charge becomes low.
- Disconnect power to the P-touch when installing or removing the rechargeable battery pack.
- Be sure to charge the rechargeable battery pack before using the P-touch.
- The rechargeable battery pack may not be charged sufficiently when the power supply is less than the rated voltage.
- Be sure to charge the new rechargeable battery pack for 3 hours after replacement.
- Be sure to dispose of the expired rechargeable battery pack as directed by local regulations for the disposal of nickel metal hydride batteries.

Tape Cassettes

Installing a tape cassette

This machine has been designed to allow you to change the tape cassettes quickly and easily. TZ tape cassettes are available for this machine in a wide variety of types, colours and sizes, enabling you to make distinctive colour-coded and stylized labels.

①

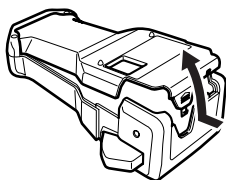

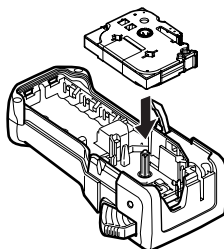

②

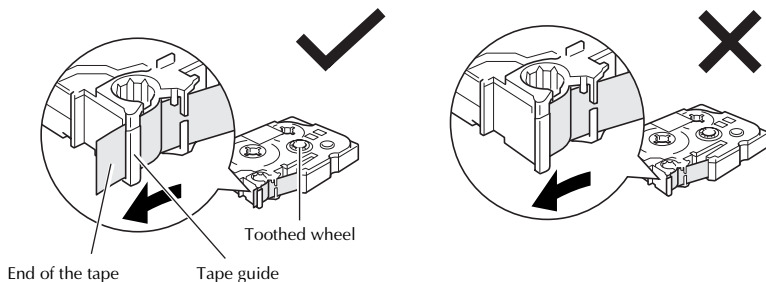

Notes on tape cassettes

- ❗ Before installing the tape cassette, make sure that the end of the tape feeds under the tape guides.
- ❗ If the tape cassette to be installed has an ink ribbon and the ink ribbon is loose, use your finger to wind the toothed wheel in the direction of the arrow on the cassette until there is no slack in the ribbon.



- ❗ When inserting the tape cassette, make sure that the inner ribbon does not catch on the corner of the metal guide.
- ❗ After installing a tape cassette, press  once to remove any slack in the tape, and then press the tape cutter button to cut off the excess tape.
- ❗ Always cut off the tape before removing it from the machine. If the tape is pulled on before being cut off, the tape cassette may be damaged.

Strong Adhesive Tape

- ❗ For textured, rough, or slipping surface, we recommend using Strong Adhesive Tape.
- ❗ **Although the instruction sheet included with the Strong Adhesive Tape cassette recommends cutting the tape with scissors, the tape cutter that this P-touch is equipped with is able to cut Strong Adhesive Tape.**

Flexible ID Tape

- For applications that require more flexible labels, such as around sharp bends and cylindrical objects, we recommend using Flexible ID Tape.
- Labels made with Flexible ID Tape are not designed for use as electrical insulation.
- When wrapping labels around cylindrical objects, the diameter of the object should be at least 3 mm, otherwise the label should be wrapped as a flag and the **FLAG** Label Type mode should be used. In addition, the overlapping ends of the label or the label flag should be at least 5 mm.
- The label may peel off cylindrical objects if the object is bent after the label is affixed.

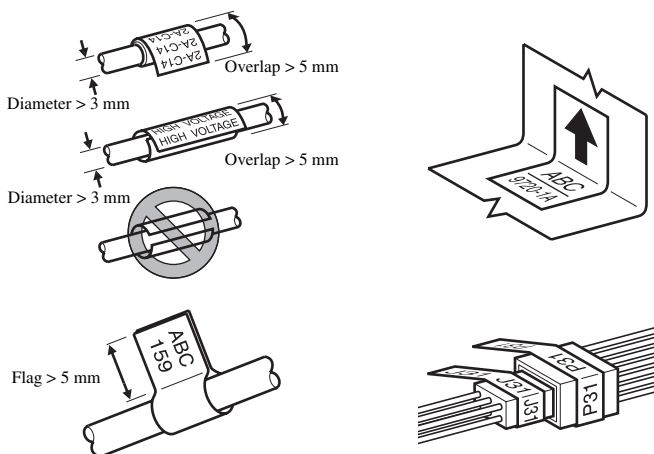

Turning the P-touch On/Off







Press  to turn on or turn off the P-touch.

If the P-touch is powered by the AC adaptor or batteries, the previous session's text is displayed when the P-touch is turned on again. This feature allows you to stop work on a label, turn off the machine, and return to it later without having to re-enter the text.

Regardless of whether the P-touch is being operated from battery or the AC adapter, the machine will automatically turn off if no key is pressed or no operation is performed for 5 minutes.

Changing the Language













The language of the menus, settings and messages can be changed by selecting **ENGLISH, FRANÇAIS, ESPAÑOL, PORTUGUÊS, DEUTSCH, NEDERLANDS, ITALIANO, DANSK, SVENSKA, NORSK, or SUOMI**. (The default setting is **ENGLISH**.)

- 1 Press , then .
- 2 Press  or  until **LANGUAGE** is displayed.
- 3 Press  or  until the desired setting is displayed, and then press .

2 Label Type Modes

Selecting a Label Type Mode

Pressing  allows you to select one of the two regular modes for designing and printing your own custom labels, or any of the six special modes available for printing labels pre-formatted for identifying patch panels, cables, connectors and other components.

- 1 Press .
- 2 Press  or  (or continue pressing ) until the desired mode is displayed. (For details on each Label Type mode, refer to the sections below.)
- 3 Press  to apply the selected Label Type mode.
 - If **NORMAL** or **VERTICAL** was selected, continue entering the label text as described in chapter 3, *Basic Functions*.
 - If **ROTATE**, **R & REP.**, **PORT**, **PANEL1**, **PANEL2** or **FLAG** was selected, continue with the following steps.
- 4 Press  or  until the desired parameter is displayed.
- 5 Press  or  until the desired setting is displayed (or use the number keys to type in the desired setting).
- 6 Press  to apply the selected settings.
- 7 Type the text for each label in a separate text block.
- 8 Print the labels.
 - To print a single copy of each label, press .
 - To print multiple copies or several copies while increasing certain characters, or to print using any other special printing function, press , then  and choose your options. (For details, refer to *Using special printing functions* on page 35.)

Normal and Vertical Modes

Labels printed using the **Normal** and **Vertical** Label Type modes can be formatted and printed to fit any need.

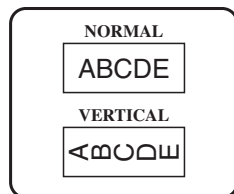

After selecting the Label Type mode **NORMAL** or **VERTICAL**, the label text can be entered, formatted, printed and cut as usual. With the **Normal** Label Type mode, the entered text is printed horizontally along the label. With the **Vertical** Label Type mode, the entered text is printed vertically along the label.

Rotate and Rotate & Repeat Modes

Labels printed using these Label Type modes can be wrapped around cables and wires to mark them. With both of these modes, the text is rotated 90° anti-clockwise and each text block printed on a separate label as shown below. With the Rotate & Repeat mode, the text is printed repeatedly along the length of the label so that it can easily be read from any angle.

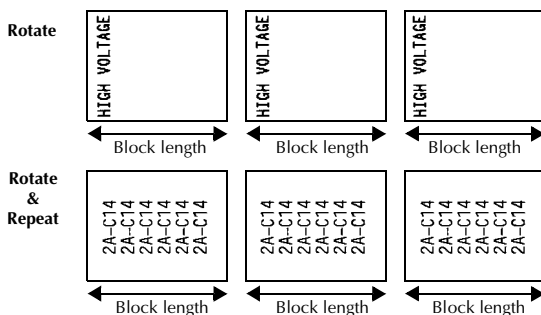
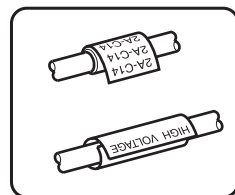

After selecting the **ROTATE** or **R & REP.** Label Type mode, specify the length of each label and a frame style if desired.

- **BL. LEN.** (block length): 20.0 to 200.0 mm
Default: 30.0 mm
- **FRAME:** **OFF**, 1, 2, 3, 4
Default: **OFF**

- ☞ A single block of text can contain a maximum of 7 text lines, and with the **R & REP.** Label Type mode, only the text lines that fit within the label are printed.
- ☞ For labels to be attached to cables and wires, we recommend using Flexible ID Tape. When wrapping Flexible ID Tape around cylindrical objects, the diameter of the object should be at least 3 mm, otherwise the **FLAG** Label Type mode should be used. In addition, the overlapping ends of the label or the flag length should be at least 5 mm.

Flag Mode

Labels printed using this Label Type mode can be wrapped around cable or wire with the ends stuck together to form a flag. With the **FLAG** Label Type mode, each block of text is printed at both ends of separate labels. The length of the unprinted part of this label is equal to the circumference of the cable or wire. In addition, the text can be printed horizontally or rotated 90°.

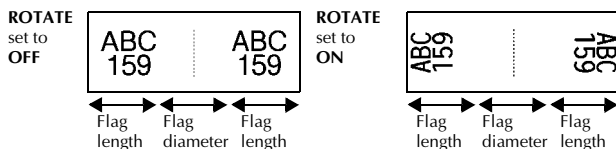
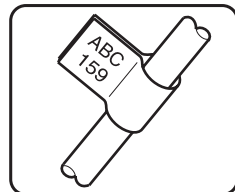

After selecting the **FLAG** Label Type mode, specify the length and diameter of the flag, a frame style if desired, and whether or not to rotate the text.

- **FLAG ϕ** (flag diameter): 0.0 to 100.0 mm
Default: 7.0 mm
- **FLAG LEN** (flag length): 10.0 to 200.0 mm
Default: 30.0 mm
- **FRAME:** OFF, 1, 2, 3, 4
Default: OFF
- **ROTATE:** OFF, ON
Default: OFF

- ☞ A single block of text can contain a maximum of 7 text lines.
- ☞ For labels to be attached to cables and wires, we recommend using Flexible ID Tape. To wrap Flexible ID Tape around cylindrical objects, use the **FLAG** Label Type mode when the diameter of the object is less than 3 mm. In addition, the flag length should be at least 5 mm.

Port and Panel1 Modes

Labels printed using these Label Type modes can be used to identify various components or panels.

With the **Port** Label Type mode, each block of the text is printed on a separate label, making these labels useful for identifying different components or ports that are not equally spaced.

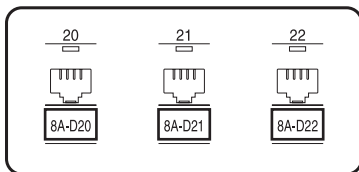

With the **Panel1** Label Type mode, all blocks of the text are evenly spaced on a single label, making this label useful for a row of equally spaced switches, fuses or connectors on a patch panel. In addition, the text blocks can be printed in the order that they were typed in or in the opposite order.

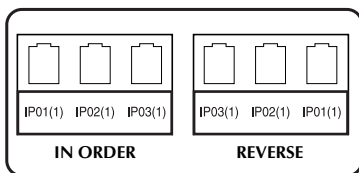

Port

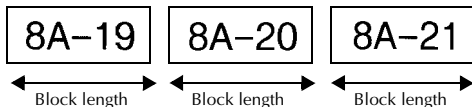

Panel1
(PRINT set to
IN ORDER)

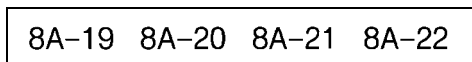

Panel1
(PRINT set
to REVERSE)

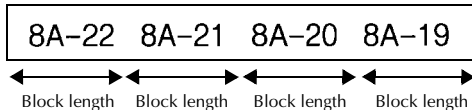

After selecting the **PORT** or **PANEL1** Label Type mode, specify the length of each text block or label, and select a frame style if desired. For the **PANEL1** Label Type mode, select whether the text blocks are printed in the order that they were typed in or in the reverse order.

- **BL. LEN.** (block length): * For the **PORT** Label Type mode:
20.0 to 200.0 mm
Default: 30.0 mm
* For the **PANEL1** Label Type mode:
6.0 to 200.0 mm
Default: 30.0 mm
- **FRAME:** * For the **PORT** Label Type mode:
OFF, 1 , 2 , 3 , 4
Default: **OFF**
* For the **PANEL1** Label Type mode:
OFF, 1 , 2 | | | | ,
3 , 4 ,
5 , 6 ,
7 , 8 , 9 ,
Default: **OFF**
- **PRINT** (print order): **IN ORDER, REVERSE**
Default: **IN ORDER**

- ☞ For these types of labels, we recommend using Strong Adhesive Tape.
- ☞ The **PRINT** parameter is only available with the **PANEL1** Label Type mode.
- ☞ By using the Numbering function with the **PANEL1** Label Type mode, a single label containing multiple blocks of ascending characters can easily be created, for example, to label patch panels as shown above. (For details on the Numbering function, refer to *Printing multiple copies with incremental characters* on page 36.)





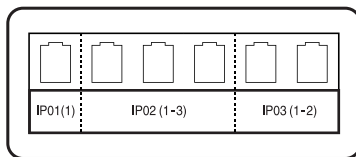



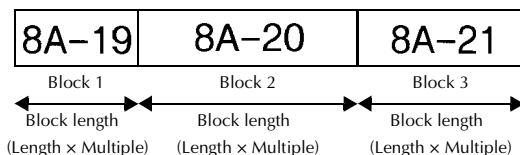











Panel2 Mode



Specifying a fixed length for each block makes this label useful for a row of switches (for example, in a switchboard) or a patch panel. In addition, the text blocks can be printed in the order that they were typed in or in the opposite order, or the text can be printed rotated 90°.



Panel2







- **BLOCK:** 1 to 50 blocks
Default: 1
- LENGTH:** 6.0 to 200.0 mm
Default: 17.5mm
- MULTIPLE:** x1 to x9
Default: 1
- **FRAME:** **OFF, 1**  **, 2**  **, 3**  **,**
4    **,** **5**    **,** **6**    **,**
7    **,** **8**    **,** **9**   
 Default: **OFF**
- **PRINT:** **IN ORDER, REVERSE**
Default: **IN ORDER**
- **ROTATE:** **OFF, ON**
Default: **OFF**

-  The number of blocks can be specified or changed only with the **BLOCK** parameter. Text blocks cannot be added or deleted in any other way.
-  If the number of blocks specified in the **PANEL2** Label Type mode is less than the number of text blocks that have already been entered, entered text blocks are deleted. If the specified number of blocks is greater than the number of entered text blocks, text blocks are added.
-  For these types of labels, we recommend using Strong Adhesive Tape.

3 Basic Functions

Performing Basic Operations

Choosing functions, parameters, settings and groups

- If “◀▶” appears, press  to select the previous item or  to select the next item.
- If “◀▶” appears, press  to select the previous item or  to select the next item.

Choosing the default setting

- To select the default setting of a function or parameter, press .

Confirming a choice

- To select an item from a list, to apply a selected setting, or to answer “yes”, press .



Cancelling a choice



- To quit a function and return to the previous display without changing the text, or to answer “no”, press .



Inputting Label Data



Entering and editing text

Entering characters

- To type a lowercase letter, a number, a comma or a period, simply press the key for that character.
- To type an uppercase letter, press  to enter Shift mode, and then press the applicable letter.
- To type uppercase letters continuously, press , then  to enter Caps mode, and then type.

 To exit Shift mode without typing a letter, press .

 To exit Caps mode, press , then .













 To type a lowercase letter in Caps mode, press , then the applicable letter.





Entering spaces

- To add a blank space to the text, press .

Moving the cursor

Move the cursor in order to review and edit the text, or you can select the various functions and settings.

- To move the cursor left, right, up or down, press , ,  or .
- To move the cursor to the beginning of the current line of text, press , then .
- To move the cursor to the end of the current line of text, press , then .
- To move the cursor to the beginning of the entered text, press , then .
- To move the cursor to the end of the entered text, press , then .

 To move the cursor several characters or lines at once, hold down , ,  or .

Adding a new line of text



- To end the current line of text and start a new one, press . “↵” appears at the end of the line.

The number of text lines that can be printed depends on the width of the tape.

Tape Width	Maximum Number of Lines That Can Be Printed
6 mm	2
9 mm	2
12 mm	3
18 mm	5
24 mm	7

The line number on the display indicates the line number of the text block.

Adding a new text block

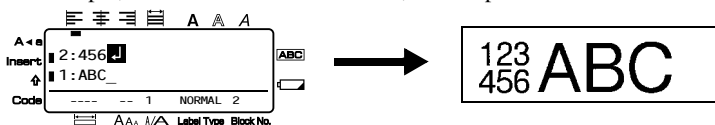

- To create a new text block so that one section of the text can have a different number of lines than another, press , then . “↵” appears at the end of the block.

For example, text entered as shown below, will be printed as follows.









- A single label can only contain a maximum of fifty text blocks.
- The number of the block that the cursor is in is indicated at the bottom of the display.
- All text blocks have the same formatting features.
- While trying to print a large amount of data at one time, some outputted labels may be blank. For example, when printing 50 records, the maximum number of characters that can be printed at one time is limited to approximately 200.

Inserting text

- To insert the text that you type at the cursor's current position, make sure that the **Insert** indicator is displayed. Otherwise, press  to enter **Insert** mode.
- To replace the text at the cursor's current position instead of inserting it, press  to exit **Insert** mode.

Deleting text





- To remove characters to the left of the cursor's current position, press  until all of the characters that you wish to delete are removed.
- To delete all of the text:
 - Press , then .
 - Press  or  to select either **TEXT ONLY** (to erase just the text) or **TEXT&FORMAT** (to erase all of the text and return all formatting functions to their default settings).
 - Press .

Entering an accented character

There are various accented characters available with the Accent function.



The following accented characters are available.

Character	Accented Characters	Character	Accented Characters
a	á à â ã ä å æ ã ç á â ã	n	ñ ñ í î
A	Á Â Ã Ä Å Æ Ā Ā Ā Ā Ā	N	Ñ Ñ Ń Ń
c	ç ċ é	o	ó ô õ ø ö õ œ ö
C	Ç Ć Ć	O	Ó Ô Õ Ø Ö Õ Œ Ö
d	ď ð đ	r	ř ř ı
D	Ď Đ	R	Ř Ř Ŗ
e	é è ê ë ě é ê ě	s	ś ś ș ș ß
E	É È Ê Ë Ě Ě Ě Ě	S	Ś Ś Ș Ș ß
g	ğ ğ	t	ı ı ı
G	Ğ Ğ	T	Ţ Ţ Ț
i	í î ï ĳ ĵ	u	ú û ü ü ü ü ü
I	Í Î Ï Ĵ ĵ	U	Ú Û Ü Ü Ü Ü Ü
k	ķ	y	ý ŷ
K	Ķ	Y	Ý Ŷ
l	ł ł ł ł	z	ž ž ž
L	Ł Ł Ł Ł	Z	Ž Ž Ž

- Press , then . The message "ACCENT a-z/A-Z?" appears.
- Press the key corresponding with the desired accented character repeatedly, until the correct character is displayed.
- Add the accented character(s) to the text.
 - To add a single accented character or the last one in a series, skip to step **5**.
 - To add a series of accented characters to the text, press , then .

4 For each additional accented character, repeat steps 2 and 3.

5 Press .

To type in an uppercase accented character, press  (or press , then  to enter Caps mode) before pressing the letter key.

Entering a bar code

The **Bar Code** function allows bar codes to be printed as part of labels.







- Since this machine is not specifically designed for special bar code label-making, some bar code readers may not be able to read the labels.
- Bar code readers may not be able to read bar codes printed with certain ink colours on certain label tape colours. For best results, print bar code labels using black on white tape.

In addition, the various bar code parameters enable you to create more customized bar codes.



Parameter	Settings
PROTOCOL	CODE 39, I-2/5, EAN13, EAN8, UPC-A, UPC-E, CODABAR, EAN128, CODE128
WIDTH (bar width)	SMALL, MEDIUM, LARGE
UNDER# (numbers printed below bar code)	ON, OFF
CHECK DIGIT	OFF, ON





- The **CHECK DIGIT** parameter is only available with the **CODE 39, I-2/5** and **CODABAR** protocols.





Setting bar code parameters

- 1 Press , then .
- 2 Press  or  until the parameter that you wish to change is displayed.
- 3 Press  or  until the desired setting is displayed.
- 4 Repeat steps 2 and 3 until all parameters are set as you wish.
- 5 Press .

Entering bar code data

- 1 Press .
- 2 Type in the new bar code data or edit the old data.
- 3 Press  to add the bar code to the text.

 To add special characters to the bar code data (only with protocols **CODE39**, **CODABAR**, **EAN128** or **CODE128**), position the cursor below the character immediately to the right of where you wish to add the special character, and then press . Press  or  until the desired control character is displayed, and then press  to add the character to the data. (Refer to the tables below for a list of the special characters that are available.)

 To change the data or **WIDTH** or **UNDER#** parameter settings of a bar code that has already been added to the text, position the cursor below the bar code mark (), and then press , then .

The following control characters can only be added to bar codes created using protocol **CODE39** or **CODABAR**.

CODE39

CODABAR

Symbol	Character	Symbol	Character	Symbol	Character	Symbol	Character
0	-	4	/	0	-	3	/
1	.	5	+	1	\$	4	.
2	(SPACE)	6	%	2	:	5	+
3	\$						





The following special characters can only be added to bar codes created using protocols EAN128 and CODE128.



Symbol	Character	Symbol	Character	Symbol	Character
0	(SPACE)	10	★	20	>
1	!	11	+	21	?
2	"	12	/	22	@
3	#	13	-	23	[
4	\$	14	.	24	\
5	%	15	/	25]
6	&	16	:	26	^
7	'	17	;	27	_
8	(18	<		
9)	19	=		

Symbol	Control Character	Symbol	Control Character	Symbol	Control Character
28	NUL	42	CR	56	ESC
29	`	43	SO	57	{
30	SOH	44	SI	58	FS
31	STX	45	DLE	59	
32	ETX	46	DC1	60	GS
33	EOT	47	DC2	61	}
34	ENQ	48	DC3	62	RS
35	ACK	49	DC4	63	~
36	BEL	50	NAK	64	US
37	BS	51	SYN	65	DEL
38	HT	52	ETB	66	FNC3
39	LF	53	CAN	67	FNC2
40	VT	54	EM	68	FNC4
41	FF	55	SUB	69	FNC1

Entering a symbol

There are 164 symbols and pictures available with the Symbol function.

- 1 Press . The last category used is displayed.
- 2 Press  or  to select the desired category.
- 3 Press  or  until the desired symbol is selected.
- 4 Add the symbol(s) to the text.



- To add a single symbol or the last one in a series, skip to step 6.
- To add a series of symbols to the text, press , then .

















































































5 For each additional symbol, repeat steps 2 through 4.





6 Press .

A symbol can also be selected by typing in the corresponding code from the table below. For example, typing “A02”, then pressing  adds “?” to the text.

The following symbols are available.

Category	Symbols									
A PUNCTUATION	.	,	?	!	”	'	:	;	-	—
	00	01	02	03	04	05	06	07	08	09
	\	/	&	¿	¡	~	§	▪		
	10	11	12	13	14	15	16	17		
B BUSINESS	@	#	%	®	©	™				
	00	01	02	03	04	05				
C MATHEMATICS	+	-	×	*	±	=	÷			
	00	01	02	03	04	05	06			
D BRACKET	()	[]	<	>	《	》		
	00	01	02	03	04	05	06	07		
E ARROW	→	←	↑	↓	➔	➠	⬆	⬇		
	00	01	02	03	04	05	06	07	08	09
F UNIT	°	\$	¥	£	€	¢	f	φ		
	00	01	02	03	04	05	06	07		
G INTERNATIONAL CHARACTERS	ā	ā	ß	Š	à	β	γ	δ	μ	Ω
	00	01	02	03	04	05	06	07	08	09
	Ð	ð	Þ	þ	ij					
	10	11	12	13	14					

Category		Symbols									
H	NUMBER	1/2	1/3	1/4	0	1	2	1	2		
		00	01	02	03	04	05	06	07		
I	PICTOGRAPH										
		00	01	02	03	04	05				
J	ELECTRICAL / ELECTRONIC										
		00	01	02	03	04	05	06	07	08	09
											
		10	11	12	13	14	15	16	17	18	19
											
		20	21	22	23	24	25	26	27	28	29
											
		30	31	32	33	34	35	36	37	38	39
											
40	41	42									
K	PROHIBITION										
		00	01	02							
L	WARNING										
		00	01	02	03	04	05	06			
M	COMMUNICATIONS										
		00	01	02	03	04	05				
N	AUDIO/VISUAL										
		00	01	02	03	04	05	06	07	08	09
											
10	11	12	13	14							







Category	Symbols			
O OTHERS				
	00	01	02	03
Z PERSONAL CATEGORY	*A maximum of 16 most recently selected symbols are automatically saved in the PERSONAL symbol category.			

Once the **PERSONAL** symbol category becomes full, newly selected symbols will overwrite older ones unless the Symbol Save function is set to **OFF**. (Refer to *Updating the PERSONAL symbol category* on page 44.)

Formatting the Label

Specifying a label length





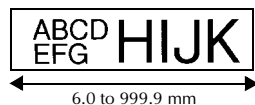

The length of the label can be specified as follows.

- Press , then .
- Press  or  until **LENGTH** is displayed.
- Press  or  until the desired label length is displayed (or use the number keys to type in the desired setting).
- Press .







Specifying a margin size

The size of the margins for the left and right sides of the text can be specified.

- Press , then .
- Press  or  until **MARGIN** is displayed.
- Press  or  until the desired margin setting is displayed (or use the number keys to type in the desired margin setting).
- Press .



Framing the text

- 1 Press , then .
- 2 Press  or  until the desired frame setting is displayed.
- 3 Press . The selected setting is applied to the entire text.

The following frame styles are available.







Frame Setting	Sample	Frame Setting	Sample
1		8	
2		9	
3		10	
4		11	
5		12	
6		13	
7		14	

Specifying the character size





The character size can be specified for all text in the label or only for the text in the line that the cursor is in.

☞ With the default character size setting **AUTO**, the largest possible text size is automatically selected depending on the width of the tape and the number of lines in the text.

Formatting the Global character size of all text

- 1 Press .
- 2 Press  or  until **G. SIZE** is displayed.
- 3 Press  or  until the desired character size setting is displayed.
- 4 Press . The selected setting is applied to the entire text.

Formatting the character size of a line

- 1 Move the cursor to the line of text whose size you wish to change.
- 2 Press , then .
- 3 Press  or  until the desired character size setting is displayed.
- 4 Press . The selected setting is only applied to the text line that the cursor is positioned in.







☞ Since the text sizes that can be printed depends on the width of the tape, the following table shows the maximum text size that can be used with each tape width.

Tape Width	Maximum Text Size
6 mm	12 points
9 mm	18 points
12 mm	24 points
18 mm	36 points
24 mm	48 points









☞ With the **AUTO** setting selected and the text in a block consisting of just one line of only uppercase letters (and no accented letters), the text is printed slightly larger than the maximum possible for the tape width.

Specifying the character width

Formatting the Global width of all text

- 1 Press .
- 2 Press  or  until **G. WIDTH** is displayed.
- 3 Press  or  until the desired character width setting is displayed.
- 4 Press . The selected setting is applied to the entire text.

Formatting the width of a line

- 1 Move the cursor to the line of text whose character width you wish to change.
- 2 Press , then  .
- 3 Press  or  until **WIDTH** is displayed.
- 4 Press  or  until the desired character width setting is displayed.
- 5 Press . The selected setting is only applied to the text line that the cursor is positioned in.







The following width sizes are available for each text size as shown.

Width Size	NORMAL	NARROW	THIN	WIDE
48 points	ABC	ABC	ABC	ABC
36 points	ABC	ABC	ABC	ABC
24 points	ABC	ABC	ABC	ABC
18 points	ABC	ABC	ABC	ABC
12 points	ABC	ABC	ABC	ABC
9 points	ABC	ABC	ABC	ABC





Width Size	NORMAL	NARROW	THIN	WIDE
6 points	ABC	ABC	ABC	ABC

Specifying the character style

Formatting the Global character style of all text

- 1 Press .
- 2 Press  or  until **G. STYLE** is displayed.
- 3 Press  or  until the desired character style setting is displayed.
- 4 Press . The selected setting is applied to the entire text.







Formatting the character style of a line

- 1 Move the cursor to the line of text whose character style you wish to change.
- 2 Press , then .
- 3 Press  or  until the desired character style setting is displayed.
- 4 Press . The selected setting is only applied to the text line that the cursor is positioned in.

The following text styles are available.

Style Setting	Sample	Style Setting	Sample
NORMAL	ABC	ITALIC	<i>ABC</i>
BOLD	ABC	I+BOLD (italic & bold)	<i>ABC</i>
OUTLINE	ABC	I+OUTL (italic & outline)	<i>ABC</i>

Specifying the alignment for all lines in the text

- 1 Press .
- 2 Press  or  until **ALIGN** is displayed.
- 3 Press  or  until the desired setting is displayed.
- 4 Press . The selected setting is applied to the entire text.



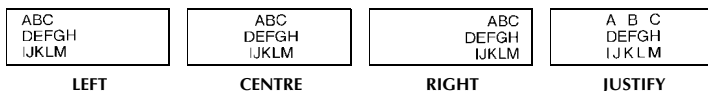

The following alignment settings are available.

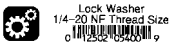

Using the pre-formatted Auto Format templates

Various pre-formatted label templates are available, enabling you to quickly and easily create labels for a variety of applications—from identifying the contents of boxes and file folders to labelling equipment and making name badges and ID tags. After simply selecting one of the ten label templates, type text into each of its fields, and then the label is ready to be printed.

The following label templates are available.

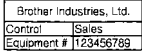
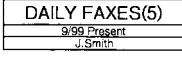
Key	Template Name	Tape Width × Label Length	Template Fields	Sample
1	BIN BOX	18 mm × 69 mm	① SYMBOL? ② TEXT1? ③ TEXT2? ④ BAR CODE?	
2	ASSET1	24 mm × 83 mm	① TEXT1? ② TEXT2? ③ BAR CODE?	
3	ASSET2	24 mm × 79 mm	① TEXT? ② BAR CODE?	
4	ASSET3	24 mm × 41 mm	① TEXT? ② BAR CODE?	
5	ASSET4	24 mm × 55 mm	① TEXT1? ② TEXT2? ③ TEXT3? ④ TEXT4? ⑤ TEXT5?	
6	ID	24 mm × 69 mm	① TEXT1? ② TEXT2? ③ TEXT3?	

Key	Template Name	Tape Width × Label Length	Template Fields	Sample
	SIGN	24 mm × 101 mm	① SYMBOL? ② TEXT1? ③ TEXT2?	NO SMOKING
	N. BADGE	18 mm × 101 mm	① NAME? ② COMPANY?	Robert Becker ABC Transport
	FILING	12 mm × 88 mm	① TITLE? ② SUB-TITLE?	August Sales Report Overseas Sales Div.
	IC CHIP	9 mm × 25 mm	① TEXT1? ② TEXT2?	01294667 ver. 1.2

- Press , then the number key where the template that you wish to use is assigned.
- Press . The first field for the selected template is displayed.
- Press or to display each field, and then type in the text.
- To print a single copy, press .
 - To print multiple copies, several copies while increasing certain characters, or a mirror image of the text, press , then . (For details, refer to *Using special printing functions* on page 35.)

☞ Accented characters (page 22), symbols (page 25) and bar codes (page 23) can be entered in the template fields.

☞ To quit using the template, display the last field, and then press . The Auto Format menu appears. Press or until **FINISH** appears, and then press .

Printing Labels

Previewing the label layout

The **Preview** function allows you to see a sample of the layout of the text.

- To use the print preview, press , then . The length of the current label is indicated in the lower-left corner of the display.

☞ To scroll the print preview left or right, press or .

☞ To return to the text, press or .

Feeding tape

- To feed out 23 mm of tape, press . The message “FEED” is displayed.
- ☞ Press to feed out any leftover printed tape after pressing to quit printing.

Printing a label

- To print out a label, press . The message “WORKING”, then “COPIES” followed by the number of the label being printed is displayed.
- ☞ To quit printing, press to turn off the P-touch.
- ☞ When setting **3** (cut pause; chain printing) or **4** (no cut pause; chain printing) is selected in the Cut function (page 42), “OK TO FEED?” will appear. Press to feed. Or press to return to the entering text mode.

Using special printing functions



Various special printing functions are available that enable you to print multiple copies of labels, print several copies while incrementing the values of certain characters, print specific sections of label text, or print label text as a mirror image.

Printing multiple copies of a label

The Repeat Printing function allows you to print up to 99 copies of the same text.

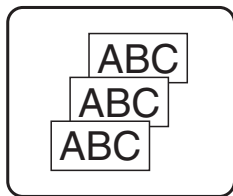
- 1 Press , then .
- 2 Press or until **COPIES** is displayed.
- 3 Press or until the desired number of copies is displayed (or use the number keys to type in the desired setting).
- 4 Press (or). **CONFIRM** appears in the Print Option menu.
- 5 Press (or) to begin printing the specified number of copies. The number of each copy is displayed while it is being printed.









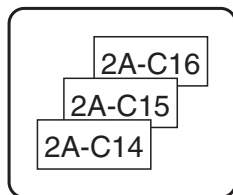















- ☞ If the Cut function is set to **1** or **3**, the message “CUT TAPE TO CONTINUE” appears after each label is printed. Press the tape cutter button to cut off the label and continue printing.
- ☞ Be sure to cut the tape within 5 minutes from the time that the message appears.
- ☞ For the different options available for cutting the tape, refer to *Selecting how tape is fed and cut* on page 42.
- ☞ To specify settings for additional Print Option functions, instead of continuing with step **5**, press  or  until **CONTINUE** is displayed in the Print Option menu, and then press .

Printing multiple copies with incremental characters

The Numbering function can be used to print several copies of the same text while incrementing the values of certain characters (letters, numbers or bar code data) after each label is printed. This type of automatic incrementation is very useful when printing serial number labels, production control labels or other labels requiring ascending codes.









- 1** Press , then .
- 2** Press  or  until **NUMBER** is displayed.
- 3** Press  or  until the desired number of copies is displayed (or use the number keys to type in the desired setting).
- 4** Press . The message “START?” appears. (To specify only the character at the cursor’s current position as the numbering field, press , and then skip to step **9**.)
- 5** Press , ,  or  until the first character that you wish to include in the numbering field is flashing.
- 6** Press . The message “END?” appears.
- 7** Press , ,  or  until the last character that you wish to include in the numbering field is flashing.
- 8** Press . **CONFIRM** appears in the Print Option menu.
- 9** Press  (or ) to begin printing the specified number of labels. The number of each copy is displayed while it is being printed.





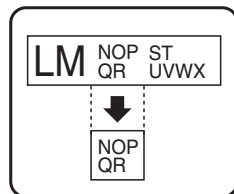

- ☞ If the Cut function is set to **1** or **3**, the message “CUT TAPE TO CONTINUE” appears after each label is printed. Press the tape cutter button to cut off the label and continue printing.
- ☞ Be sure to cut the tape within 5 minutes from the time that the message appears.
- ☞ For the different options available for cutting the tape, refer to *Selecting how tape is fed and cut* on page 42.
- ☞ Letters and numbers increase as shown below.
 0 → 1 → ...9 → 0 → ...
 A → B → ...Z → A → ...
 a → b → ...z → a → ...
 A0 → A1 → ...A9 → B0 → ...
 Spaces (shown as underlines “_” in the examples below) can be used to adjust the space between characters or to control the number of digits that are printed.
 _Z → AA → ...ZZ → AA → ...
 _9 → 10 → ...99 → 00 → ...
 1_9 → 2_0 → ...9_9 → 0_0 → ...
- ☞ Only one numbering field can be selected from any text.
- ☞ A numbering field must be located entirely within one line of text of a single block.
- ☞ A maximum of five characters can be selected for the numbering field.
- ☞ If you include a non-alphanumeric character such as a symbol in the numbering field, only the letters and numbers in the numbering field will be increased when the labels are printed, or just one label will be printed if the field only contains a non-alphanumeric character.
- ☞ To specify settings for additional Print Option functions, instead of continuing with step 9, press  or  until **CONTINUE** is displayed in the Print Option menu, and then press .
- ☞ If a bar code is selected as the numbering field in step 5, skip steps 6 and 7, and continue with step 8.

Printing a range of text blocks

The Block Printing function enables you to select the range of text blocks to print.

- 1 Press , then .
- 2 Press  or  until the first number in the range displayed below **BLOCK NO.** is flashing.
- 3 Press  or  until the desired block number is displayed (or use the number keys to type in the desired setting).











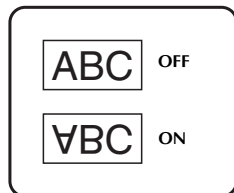

- ④ Press  so that the second number in the range displayed below **BLOCK NO.** is flashing.
- ⑤ Press  or  until the desired block number is displayed (or use the number keys to type in the desired setting).
- ⑥ Press  (or ). **CONFIRM** appears in the Print Option menu.
- ⑦ Press  (or ) to begin printing the specified number of labels. The number of each copy is displayed while it is being printed.

☞ To specify settings for additional Print Option functions, instead of continuing with step ⑦, press  or  until **CONTINUE** is displayed in the Print Option menu, and then press .



Printing mirrored labels

This function prints your label so that the text can be read from the adhesive side of the tape. If mirror-printed labels are attached to glass or some other transparent material, they can be read correctly from the opposite side.



- ① Press , then .
- ② Press  or  until **MIRROR** is displayed.
- ③ Press  or  until **ON** is displayed.
- ④ Press  (or ). **CONFIRM** appears in the Print Option menu.
- ⑤ Press  (or ) to begin printing the specified number of labels. The number of each copy is displayed while it is being printed.

☞ When using the Mirror Printing function, the text should be printed on clear tape.

☞ To specify settings for additional Print Option functions, instead of continuing with step ⑤, press  or  until **CONTINUE** is displayed in the Print Option menu, and then press .

Combining special printing functions

Many of the special printing functions can be combined, depending on various conditions, such as which Label Type mode is selected or whether a template is being used. For example, by combining the operations for the Repeat Printing function and the Numbering function to print two copies of a label with “1” selected as the numbering field and three increments, the labels shown above will be printed.

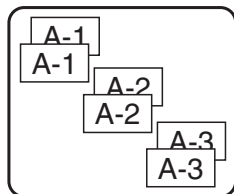







For details on the various special printing functions, refer to the corresponding section above.



Storing and Recalling Files

Frequently used label text along with its formatting can be stored in the memory and easily recalled so that it can be edited and quickly printed. When each text file is stored, it is given a number to make recalling it easier. Up to 10 text files or approximately 2,000 characters can be stored in the memory.







Since a copy of the stored text file is recalled when the Recall function is used, the text can be edited or printed without changing the originally stored file. When a file is no longer needed or more space is necessary, the Clear function can be used to delete text files.



Storing label text

- 1 Press .
- 2 Press  or  until **STORE** is displayed.
- 3 Press .
- 4 Press  or  until the file number where you wish to store the text is displayed.
- 5 Press .











- ☞ If the maximum number of characters has already been stored, the error message “MEMORY FULL!” appears in the display. If this occurs, an existing text file must be deleted before the new one can be stored.
- ☞ If a file is already stored under the selected file number, the message “OVERWRITE?” appears in the display. To overwrite the stored file with the new one, press . To go back and choose another file number without overwriting the text file, press , and then select a different file number.

Recalling text that has been stored

- 1 Press .
- 2 Press  or  until **RECALL** is displayed.
- 3 Press .
- 4 Press  or  until the file number containing the text that you wish to recall is displayed.
- 5 Press . Any text previously entered in the display is erased and the text stored under the selected file number is recalled into the display.



- ☞ To view other parts of the selected text file, press  or .

Deleting text that has been stored



- 1 Press .
- 2 Press  or  until **CLEAR** is displayed.
- 3 Press .
- 4 Press  or  until the file number containing the text that you wish to delete is displayed.
- 5 Select the file(s) to be deleted.
 - To delete a single file, skip to step 6.
 - To select multiple files, press . The current file number is highlighted. Continue selecting text files by repeating step 4, then pressing  until all files that you wish to delete are selected.
 - To delete all files, press , then .

6 Press . The message “OK TO CLEAR?” (or “CLEAR ALL?” if all files were selected) appears.

7 Press . The text stored in the selected files is deleted.

 If you do not wish to delete the selected text file(s), press  instead of  in step 7.

 To view other parts of the selected text file, press  or .

 To remove a text file from those that are to be deleted, display the text file, and then press  so that the file number is no longer highlighted.

4 Machine Adjustments

Various functions are available for changing and adjusting the operation of the P-touch.

Selecting how tape is fed and cut







The **Cut** function enables you to specify how the tape is fed out after it is printed. The settings of the Cut function consist of combinations of two different cut methods:

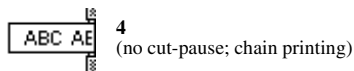
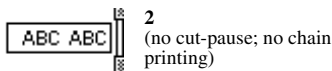
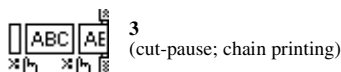
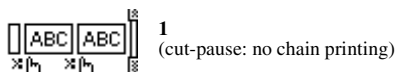

cut-pause (where the machine stops printing so the label can be cut) and chain printing (where the last copy is not fed out to be cut, reducing the amount of tape that is wasted).

Chain printing is an economical function designed to help eliminate “wasted tape” at the beginning of labels. Without chain printing, the excess from the previous printing session is cut before the first label in the current session is printed. However, if a setting using chain printing is selected, the last label in the previous session remains in the machine (is not fed out), so that the next label can be printed without wasting tape. When the last label is printed, press  to feed the chain of labels, and then press the tape cutter button to cut it.

The following settings are available: (The default setting is **1**.)









- 1** Press , then .
- 2** Press  or  until **CUT** is displayed.
- 3** Press  or  until the desired setting is displayed, and then press .

 After printing with the **Cut** function set to **3** or **4**, “OK TO FEED?” will appear. Press  to feed. Press  to return the entering text mode.







Adjusting the display contrast

The display can be made lighter or darker by selecting a setting between **-2** and **+2**. (The default setting is **0**.) Select a higher value to increase the contrast (make the display darker). Select a lower value to decrease the contrast (make the display lighter).

- 1 Press , then .
- 2 Press  or  until **CONTRAST** is displayed.
- 3 Press  or  until the desired setting is displayed, and then press .

Using the Auto Reduction function

With the Auto Reduction function, you can select whether the text width (**TEXT WIDTH**) or the text size (**TEXT SIZE**) will be reduced if text that is set to the **AUTO** Size setting is too large for the specified label length. (The default setting is **TEXT SIZE**.)

- 1 Press , then .
- 2 Press  or  until **AUTO REDUCTION** is displayed.
- 3 Press  or  until the desired setting is displayed, and then press .

If **TEXT SIZE** is selected and more text is added, the character size is reduced so the text fits within the specified label length.







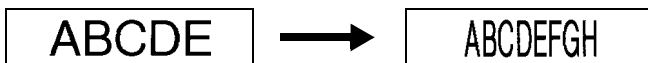

If **TEXT WIDTH** is selected and more text is added, the character width is reduced so the text fits within the specified label length.

However, after the character width is reduced to **THIN**, the character size will be reduced so the text fits within the specified label length.









Calibrating the label length

If the length of the printed label does not correspond to the length specified with the Length function, the printed label length can be recalibrated with the Length Adjust function by selecting a setting between **-5** and **+5**. (The default setting is **0**.)

- 1 Press , then .
- 2 Press  or  until **LENGTH ADJUST** is displayed.
- 3 Press  or  until the desired setting is displayed, and then press .







Updating the PERSONAL symbol category

You can specify whether symbols continue to be added to the **PERSONAL** symbol category (with the older symbols deleted) when the category becomes full (**ON**) or symbols are no longer added after the **PERSONAL** symbol category becomes full (**OFF**). (The default setting is **ON**.)

- 1 Press , then .
- 2 Press  or  until **SYMBOL UPDATE** is displayed.
- 3 Press  or  until the desired setting is displayed, and then press .







Changing the units of measure

The units used for displaying measurements can be set to millimeters (**mm**) or inches (**inch**). (The default setting is **mm**.)

- 1 Press , then .
- 2 Press  or  until **UNITS** is displayed.
- 3 Press  or  until the desired setting is displayed, and then press .

Displaying version information

This function can be used to display the version information for the P-touch software and built-in symbol set.

- 1 Press , then .
- 2 Press  or  until **VERSION INFO** is displayed.
- 3 Press  or  until the desired version information is displayed.
- 4 Press  to exit Setup mode.

Cleaning

Occasionally, certain parts of the P-touch may need to be cleaned. Dust or dirt may become attached to the P-touch's print head and rollers, particularly when the unit is used outdoors or in a very dusty environment. With use, the tape cutter may become covered with adhesive, making it difficult to cut the tape.

Cleaning the print head, rollers and tape cutter

- ⓘ Before cleaning the print head, rollers and tape cutter, press  to turn off the P-touch, and then remove the battery and disconnect the AC adapter.

WARNING

- Do not touch the print head directly with your bare hands. The print head may be hot.
- Do not touch the cutter blade directly with your bare hands.

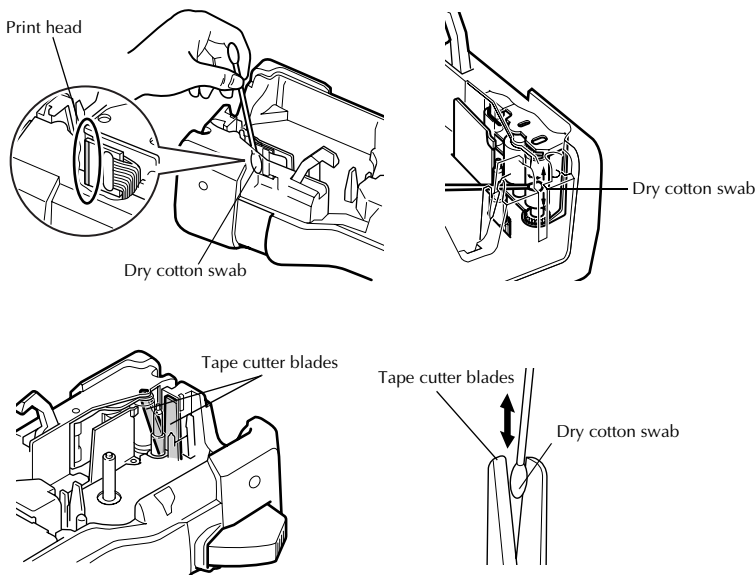

Notes on cleaning the print head & rollers

- ☞ If a blank horizontal streak appears through the label text, clean the machine's print head.
- ☞ The print head can be cleaned more easily if the optional print head cleaning cassette (TZ-CL4) is used.

Notes on cleaning the tape cutter

- ☞ If the tape cannot be cut correctly, clean the tape cutter blades.

5 *Using P-touch With a Computer* (for PT-7600 only)

This P-touch is equipped with a USB port, allowing you to connect it to a computer running Microsoft® Windows®. The enclosed CD-ROM contains P-touch Editor 5.0, which is installed together with the printer driver and P-touch Transfer Manager.

- **P-touch Editor 5.0** is a label-designing software that provides additional illustration and layout features enabling you to design more elaborate label templates and create databases. Once these label templates and databases have been created, they can be downloaded to the P-touch, where they can be used to print labels.

- ☞ **The P-touch Editor software and the printer driver must be installed before the P-touch is connected to the computer or turned on.**
- ☞ Only use the enclosed USB interface cable to connect the P-touch to the computer.
- ☞ A single computer cannot be connected to multiple P-touch machines at the same time.
- ☞ **Although the P-touch can be connected to the computer through a USB connection, label layouts created in P-touch Editor cannot be printed directly from the application.**

Installing the Software & Printer Driver

Introduction

Features

P-touch Editor	Makes it easy for anyone to create a wide variety of custom labels in complex layouts by using fonts, templates, and clip art.
Printer Driver	Lets you print labels from the connected P-touch when using P-touch Editor on your PC.

CD-ROM Precautions

- Do not scratch the CD-ROM.
- Do not subject the CD-ROM to extremely high or extremely low temperatures.
- Do not put heavy objects on the CD-ROM or apply force to the CD-ROM.
- The software contained on the CD-ROM is meant for use with your purchased machine only.
It may be installed on multiple PCs for use at an office, etc.
- **Do not connect the USB cable to your PC until the software has been installed and you are instructed to connect.**

System requirements

Before installation, check that your system configuration meets the following requirements.

Operating system	Microsoft® Windows® 2000 Professional / XP / Windows Vista®
Memory	Windows® 2000 Pro, XP: 128MB or more Windows Vista® : 512MB or more
Hard disk free space	70MB or more
Interface	USB Port (USB Specification 1.1 or 2.0 protocol)
Monitor	SVGA High Colour graphics support or higher
Other	CD-ROM drive for installation

Installing P-touch Editor 5.0 and the Printer driver

- ⓘ **Do not connect the USB cable to your PC before installing the software.**
- ⓘ You must be logged on as a user with administrator privileges to install this software.

Installing P-touch Editor 5.0

The installation procedure may change depending on the Operating System on your PC. Windows Vista® is shown here as an example.

- 1 Start your PC making sure to log on as a user with Administrator privileges.
- 2 Insert the CD-ROM into the CD-ROM drive. The P-touch Setup Screen will appear.

If the P-touch Setup Screen does not appear, from Windows Explorer double-click the My Computer icon, and then double-click the PT-7600 icon. If you wish to cancel installation in the middle of the process, click [Exit].

- 3 Select the desired language, and double click the type of setup you prefer.
Standard: All features (P-touch Editor and Printer driver) will be installed (default).
Custom: You can specify which features to install. Recommended for advanced users.



- 4 Read the licence agreement carefully. If you agree with the terms and conditions of the licence agreement, click [Yes] to continue the installation.
- 5 Type in the User Name and Company Name (if needed), and then click [Next].
- 6 Confirm the destination to install the software, and then click [Next].

If you wish to modify or change the destination, click [Browse] to choose the installation path.

- 7 Check on/off which shortcuts you wish to add, and then click [Next].
- 8 Review the settings, and then click [Next]. (To change the settings, click [Back] to go back to the appropriate window(s) and correct.)
- 9 The selected features will be installed automatically.

Installing the Printer driver

- Read the contents of the “Before installing the printer driver” dialog box, and then check [Yes, confirmed] and click [OK].



The installation procedure for the printer driver differs depending on the operating system being used.

- For Windows® 2000 Professional (page 50)
- For Windows® XP (page 51)
- For Windows Vista® (page 52)

For Windows® 2000 Professional

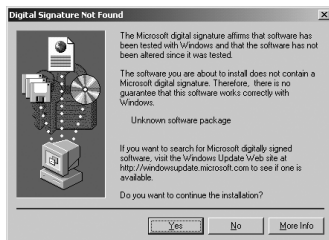
- Although a message warning that no digital signature was found appears soon after driver installation begins, click [Yes].



- When prompted, connect your P-touch to the PC by using a USB cable, and then hold down  and  to turn on the P-touch in Transfer mode.

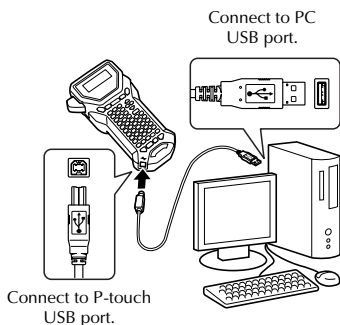

- The printer is detected, and then a message appears again, warning that no digital signature was found. Click [Yes] to install the printer driver.





- You will be prompted to register your P-touch online, click [Yes] and then click [Next]. If you have selected to register the product your default internet browser will be launched in a new window.
- Click [Finish] to complete the installation. Restart your PC if you are instructed to do so.

For Windows® XP

- Although a message warning that no digital signature was found appears soon after driver installation begins, click [Continue Anyway].



- When prompted, connect your P-touch to the PC by using a USB cable, and then hold down  and press  to turn on the P-touch in Transfer mode.

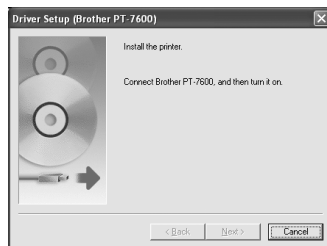
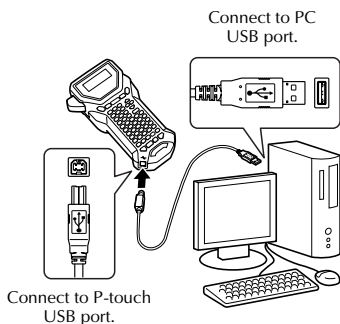

- The printer is detected, and then the “Found New Hardware Wizard” starts up. Select [No, not this time], and then click [Next]. In the dialog box for selecting the installation method, select “Install the software automatically (Recommended)”, and then click [Next].





- Again, a message appears warning that no digital signature was found. Click [Continue Anyway] to install the printer driver. When a message appears, indicating that the printer has been added, click [OK] to close the message.



- You will be prompted to register your P-touch online, click [Yes] and then click [Next]. If you have selected to register the product your default internet browser will be launched in a new window.
- Click [Finish] to complete the installation. Restart your PC if you are instructed to do so.

For Windows Vista®

- When the message confirming installation of software published by Brother appears, click [Install].
- When prompted, connect your P-touch to the PC by using a USB cable, and then hold down  and press  to turn on the P-touch in Transfer mode.

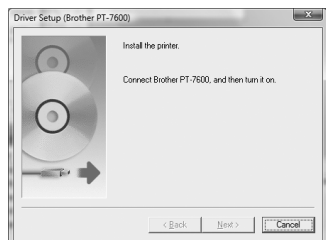

- 3 The printer is detected, and then the driver is installed.
- 4 You will be prompted to register your P-touch online, click [Yes] and then click [Next]. If you have selected to register the product your default internet browser will be launched in a new window.
- 5 Click [Finish] to complete the installation. Restart your PC if you are instructed to do so.

Uninstalling P-touch Editor 5.0

The uninstallation procedure for P-touch Editor 5.0 differs depending on the operating system being used.

For Windows® 2000 Professional/XP

- 1 Start (→ Settings) → Control Panel → Add or Remove Programs (Add/Remove Program) → Brother P-touch Editor 5.0 → Change/Remove
- 2 Select [OK] to uninstall the software.
- 3 Follow the instructions that appear on the dialog box to complete.

For Windows Vista®

- 1 Start (→ Settings) → Control Panel → Programs → Uninstall a program → Brother P-touch Editor 5.0 → Uninstall
- 2 Select [OK] to uninstall the software.
- 3 Follow the instructions that appear on the dialog box to complete.

Uninstalling / Replacing the printer driver

- 1 Insert the CD-ROM into the CD-ROM drive. (If the installation window automatically appears, click [Cancel].)
- 2 From My Computer, right click on the CD-ROM drive to open.
- 3 Double click “D_SETUP.EXE”. (If a dialog box appears asking for a desired language, select the language you wish for instructions and click [OK].)
- 4 Select whether to delete or to replace the printer driver, and then click [Next].
- 5 Follow the instructions that appear in the dialog box to complete.

Using P-touch Editor 5.0

P-touch Editor 5.0 makes it easy for anyone to design and print more complex labels, for almost any need imaginable.

See the P-touch Editor Help for samples of various kinds of labels and details on creating, printing, and saving the labels. The following is the example for Windows Vista®.

Notes on creating templates

Since some P-touch Editor 5.0 functions are not available with the P-touch machine, keep the following points in mind when using P-touch Editor 5.0 to create templates.

- ☞ Since only the Helsinki font is available on the P-touch machine, the font used to print the text may be different from the font selected for the template in P-touch Editor. In addition, since the size of all text on the P-touch machine is set to **AUTO**, the text size may automatically be reduced. We recommend using the Helsinki font installed with P-touch Editor for best results when creating labels.
- ☞ Although character styles can be applied to individual characters with P-touch Editor, styles can only be applied to a line of text with the P-touch machine. In addition, some character styles are not available on the P-touch machine.
- ☞ Unlike P-touch Editor, the P-touch machine cannot print underline or strikethrough characters.
- ☞ Only the first 999 rows of a database linked to a template are read by the P-touch machine.
- ☞ Only the first line of text typed into a database field is read by the P-touch machine. Therefore, if you wish to print from a database with more than one line of text, create the template and database with separate fields for each line of text.
- ☞ Some characters available with P-touch Editor are not available with the P-touch machine.
- ☞ Bar codes specified with settings not compatible with the P-touch bar codes settings will not print correctly.
- ☞ A template created with P-touch Editor should have a fixed length with a maximum of 1 m.
- ☞ The template and database should be created so that no more than approximately 500 characters per label will be printed.
- ☞ Fields that extend out of the print area may not print completely.
- ☞ A numbering field specified with P-touch Editor will not transfer and is not compatible with the **Numbering** function on the P-touch machine.
- ☞ Backgrounds specified with P-touch Editor are not compatible with the P-touch machine.
- ☞ Time and date objects using the “At Printing” setting on P-touch Editor will not be printed.
- ☞ The printed label may differ from the image that appears in the Preview area of Transfer Manager.

- ❗ If the number or order of fields in a database are changed and only the database (*.csv file) is transferred to update it, the database may not link correctly with the template. In addition, the first line of data in the transferred file must be recognized by the P-touch machine as “field names”, otherwise the database cannot be used to print.
- ❗ A P-touch Editor layout that uses the split printing function (enlarging the label and printing it on 2 or more labels) cannot be transferred.
- ❗ The label length settings in P-touch Editor and the P-touch machine, may differ slightly due to minor variations in mechanical operation.

Starting P-touch Editor

- 1 Click [Start]-[All Programs (Programs)]-[Brother P-touch]-[P-touch Editor 5.0].

❗ You can also start P-touch Editor using the following methods (only if you created the shortcut during installation):

- Double-click the shortcut icon on the desktop.
- Click the shortcut icon in the Quick Launch bar.

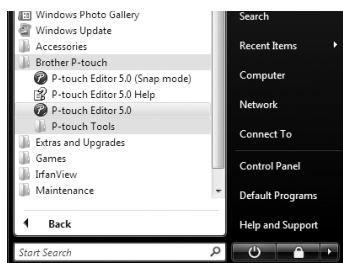

When P-touch Editor is launched, the [New/Open] dialog box appears, allowing you to choose whether you want to create a new label layout or open an existing label.

❗ To specify how P-touch Editor works when it starts, click [Tools]-[Options] to display the [Options] dialog box. In the [General] tab, you can choose the setting in the [Operations] list box in the [Startup Settings]. Normally, choose [Display New/Open Dialog Box].

- 2 Choose an option in the [New/Open] dialog box and click [OK].

- You can choose the label printer and media size.
- When you choose [Open File], the [Open] dialog box appears. You can choose and open the file you have created and stored previously.
- When you choose [View History], the [History] dialog appears. You can choose from recently created labels.

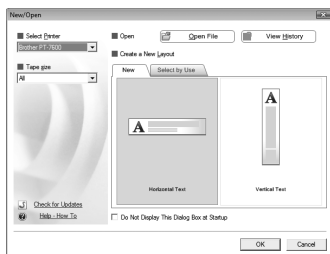

- When you choose [New], choose either vertical writing style or horizontal writing style.
- When you choose [Select by Use], you can choose by label applications.
- When you choose [Help-How To], the P-touch Editor Help appears. The Help files allow you to learn step by step how to create a label layout.
- When you choose [Check for Updates] with a computer connected to the Internet, you will be taken to the Brother Solutions Center (<http://solutions.brother.com>). Use the Brother Solutions Center to check for the latest software downloads and FAQs.

Layout window

Express Mode

This mode provides easy label creation with text and images.

The layout window consists of the following sections:

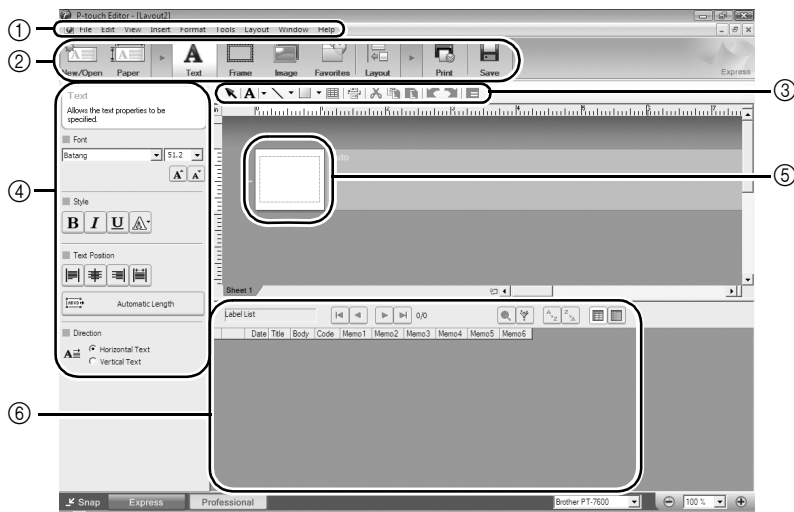

① Menu bar

Commands are categorized under each menu (File, Edit, View, and Insert, etc.) by function.

② Command bar

The command bar contains the New/Open, Paper, Text, Frame, Image, etc.

③ Draw/Edit toolbar

Provides tools for choosing an object, entering text, drawing graphics, etc.

④ Property bar

You can easily insert and format text, images, etc.

⑤ Layout window

The layout window is used to display and edit objects.

⑥ Database window

Displays a connected database.

- ☞ The [View] menu allows you to show/hide the toolbars and windows.
- ☞ See the P-touch Editor Help for details.

Professional Mode

This mode provides full-scale label creation for creating the templates.
The layout window consists of the following sections:

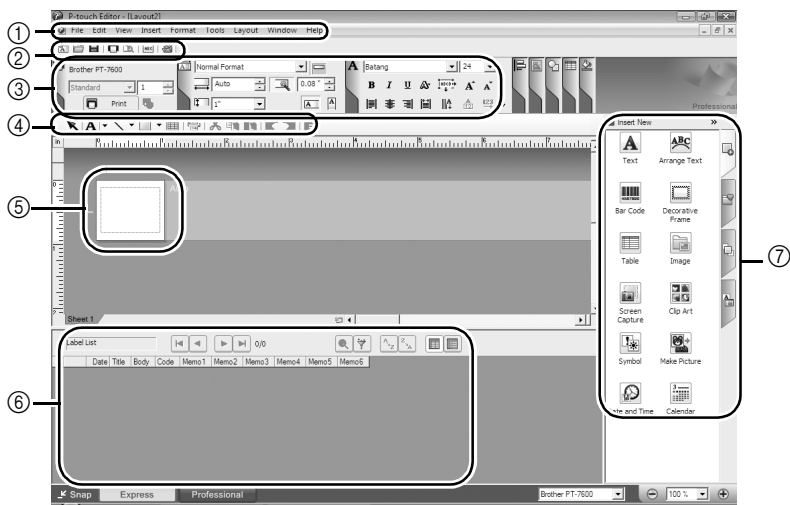

① Menu bar

Commands are categorized under each menu (File, Edit, View, and Insert, etc.) by function.

② Standard toolbar

A group of frequently used commands (New Layout, Open, Save, Print, etc.) are provided in this toolbar.

③ Property palette

The property palette contains the Print, Paper, Text, and Layout property boxes. Click on the left side of each palette to show/hide the box.

④ Draw/Edit toolbar

Provides tools for choosing an object, entering text, drawing graphics, etc.

⑤ Layout window

The layout window is used to display and edit objects.

⑥ Database window

Displays a connected database.

⑦ Side bar

By selecting the tab, you can easily insert and format text, bar codes, frames, tables, figures and arrange objects.

- ☞ The [View] menu allows you to show/hide the toolbars, palettes, and windows.
- ☞ See the P-touch Editor Help for details.

Snap Mode

With this mode, you can capture the screen, print it as image, and save it for future use. To start Snap mode, follow the steps below.

- 1 When you click [Snap Mode], the Snap mode description dialog box appears. Click [OK].

- ☞ If you put a checkmark in [Do Not Display This Dialog Again], you can go to Snap mode directly from next time.
- ☞ You can also start from [Start]-[All Programs (Programs)]-[Brother P-touch]-[P-touch Editor 5.0 (Snap mode)].

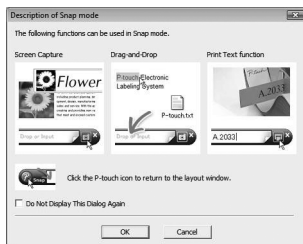

- 2 Snap mode appears.

- ☞ See the P-touch Editor Help for details.



Starting P-touch Editor Help

This section explains how to start P-touch Editor Help for Windows. The following is the example for Windows Vista®.

Starting from Start button

- 1 Click [Start]-[All Programs (or Programs)]-[Brother P-touch]-[P-touch Editor 5.0].

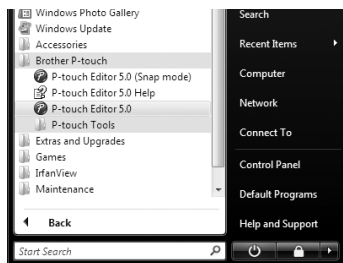

- 2 In the [New/Open] dialog, click [Help-How To].

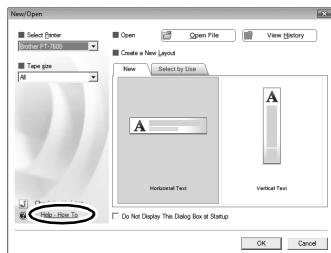

Starting from P-touch Editor

Click Help menu and choose P-touch Editor Help.

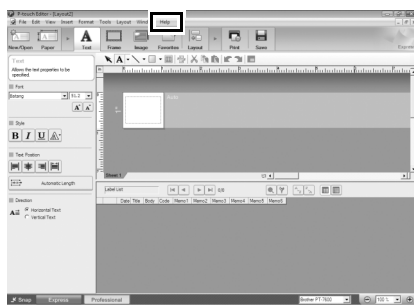

Express Mode

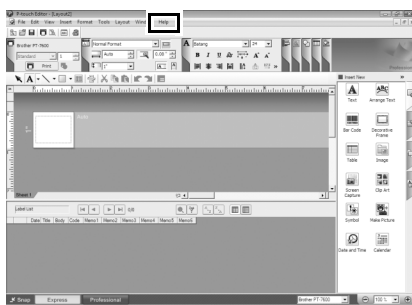

Professional Mode

Starting from Snap mode

Right click the mouse and choose P-touch Editor Help.

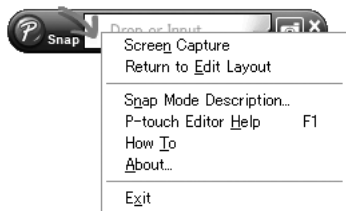

Printing the Help description

The information given in P-touch Editor Help can be printed. Use your normal printer to print the P-touch Editor Help information.

- 1 In the [Contents] tab, choose any topic you want to print.
- 2 Click  on the Toolbar.
- 3 Choose the range of topics to be printed, and click [OK].

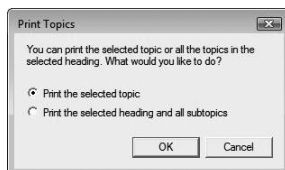

- 4 Specify the [Printer] and click [Print].

☞ Choose a normal printer that supports general paper sizes, such as A4.

Transferring Data To/From a Computer

A template, database or a user-defined character image (character not available on the P-touch) can be transferred from the computer and assigned to a PF key on the P-touch.

Entering Transfer mode

- Hold down  and press  to turn on the P-touch in Transfer mode.

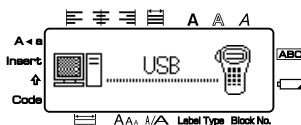

- ☞ To exit Transfer mode, press  to turn off the P-touch.
- ☞ **Be sure not to turn off the P-touch while data is being sent to it, otherwise the data will be lost.**
- ☞ Regardless of whether the P-touch is being operated from battery or the AC adapter, the machine will automatically turn off if no key is pressed or no operation is performed for 5 minutes.

How to use P-touch Transfer Manager & P-touch Library

 Although the PT-7600 can be connected to the computer through a USB connection, label layouts created in P-touch Editor cannot be printed directly from the application.

P-touch Transfer Manager: The PT-7600 can transfer templates created in P-touch Editor. Also, you can save the Label templates data from P-touch onto the computer as a back up.

P-touch Library: This application allows you to manage P-touch label templates and other data on the computer.

Starting up P-touch Transfer Manager

- 1 Click the [Start] button, then choose [All programs (Programs)] - [Brother P-touch] - [P-touch Tools] - [P-touch Transfer Manager 2.1].
P-touch Transfer Manager starts up.

Layout window

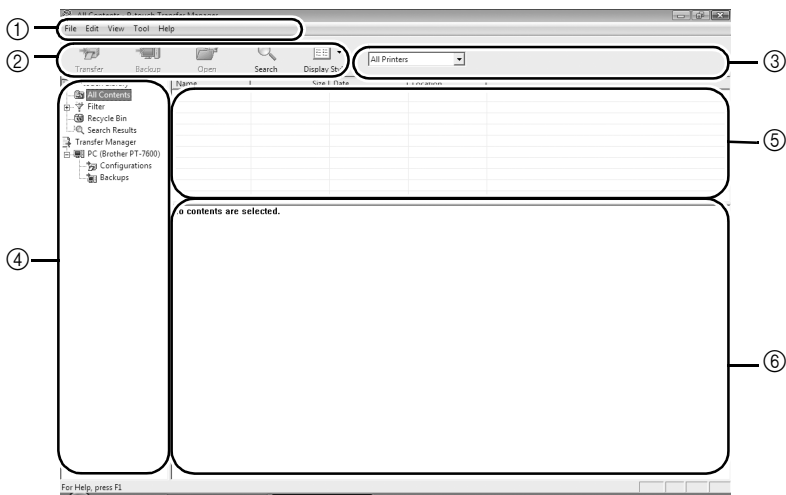

① Menu

Commands are categorized into each menu (File, Edit, View, Tool, and Help) by function.

② Toolbar

There are icons for frequently used commands. Click on one to access that command.

③ Selecting the printer model (Only for P-touch Transfer Manager)

Select the printer model to send data to. When you select a printer, only the data that can be sent to the selected printer is displayed in the list view.

④ Folder view

Displays a list of folders. When you select any folder, the data in the folder selected is displayed in the list view on the right.





⑤ List view

The data in the selected folder is displayed.

⑥ Preview

The label templates selected in the list view are displayed as a preview.

Explanations of the Icons

Icon	Button name	Function
	Transfer (Only for P-touch Transfer Manager)	Transfers the label templates and other data on your PC to the P-touch (when connecting USB interface cable).
	Backup (Only for P-touch Transfer Manager)	Backs up the data you have transferred to the P-touch using the P-touch Transfer Manager.
	Open	Edits the selected data.
	Search	Searches the data managed with the P-touch Library.
	Display Style	Changes the file display format.

Transferring label templates from the PC

- 1 Select the P-touch to transfer data to.

 Make sure that the P-touch is in Transfer mode. (For more details, refer to *Entering Transfer mode* on page 61.)

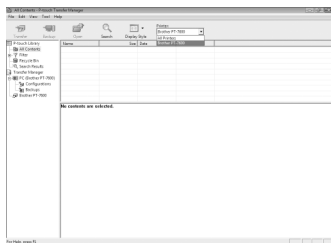

- 2 Right click the [Configurations] folder, then select [New] and create a new folder. Here, as an example, we create the folder "Transfer".

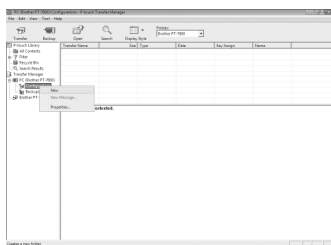

- 3 Drag the transfer data to the folder you created.
Drag the transfer data from All contents, Layouts or another folder under Filter.
When transferring multiple sets of data, you can move all the transfer data to the folder you created.

- 4 Key Assign numbers are automatically assigned to transferred data inside the folder you made in the previous step.
To change a number, right click the data name in the list view, then select the Key Assign number.

- Key Assign is necessary for transfer of data other than message texts.
- If you change the Key Assign number used for data which has already been transferred to the P-touch, the data will be overwritten. You can check the Key Assign number used for data already transferred to the P-touch by backing up the data as explained in *Backing up label templates* on page 70.
- You can click the data name for transfer data and change to a new name. The character limit is 15 words.

- 5 Select the data or folder you want to transfer, then click  .
The transfer confirmation message is displayed.

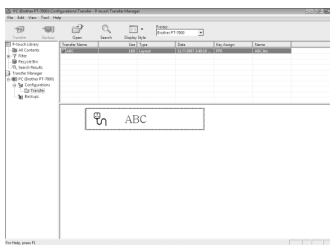
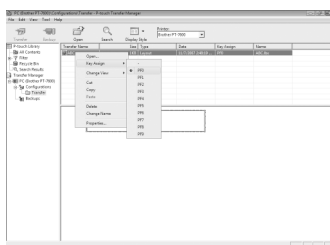
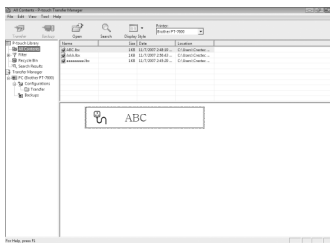

- 6 Click [OK].
The data in the folder selected in the folder view is transferred to the P-touch.

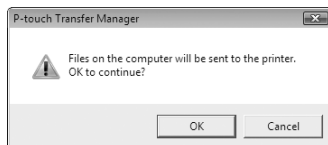

- If you have selected specific data in the list view, only that selected data is transferred to the P-touch.

Adding a user-defined character image to the text

If a user-defined character image (a bitmap character not usually available on the P-touch) is assigned to a PF key, that character can be added to any label that you create on the P-touch.

- Press , then the applicable PF key.
The character is added to the text at the cursor's position.

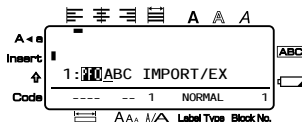

- Only a monochrome bitmap (*.bmp) file can be transferred to the P-touch.
- A high-resolution file can be cut from a file with the specifications described above.
- The downloaded image is automatically resized to the width of the tape being used.

Using template data

A label layout created with P-touch Editor (*.lhx file) can be transferred to the P-touch, where it can be used as a template for printing labels. Templates can be printed using text from either a database, or by directly typing text in.

When a database (*.mdb file created with P-touch Editor 5.0 or *.csv file) is transferred to the P-touch, data from selected records can be added to labels either using a template linked to the database or using a new template. In addition, the database data can be searched to find specific records.



- The P-touch can only contain one database at a time. However, the database can be replaced or updated.

Using a template not linked to a database







Using a template not linked to a database is the same as using any of the preset Auto Format templates. For details on using Auto Format templates, refer to *Using the pre-formatted Auto Format templates* on page 33.

Using a template linked to a database

A single record or a range of records in the database linked to the template can be printed.







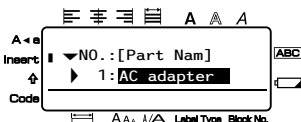





- 1 Press , then the PF key where the template that you wish to use is assigned.
- 2 Press . The database data is displayed.









To select a single database record to be printed in the template:

- 3 Press  or  to highlight the desired record, and then press .
- 4 To edit any text in the record, press  or  to display the text, and then type in the new text.
- 5 Press .



To select a range of database records to be printed in the template:







- 3 Press  or  to highlight a record, and then press .
- 4 Press , then . The message "CLEAR TEXT & PRINT DATABASE?" appears.
- 5 Press .
- 6 Press  or  until **RECORD NO.** is displayed, and then specify the desired range of records.
- 7 Press  (or ). **CONFIRM** appears in the Print Option menu.
- 8 Press  (or ) to begin printing the labels using the specified range of records.

- ☞ If the Cut function is set to **1** or **3**, the message “CUT TAPE TO CONTINUE” appears after each label is printed. Press the tape cutter button to cut off the label and continue printing.
- ☞ Be sure to cut the tape within 5 minutes from the time that the message appears.
- ☞ For the different options available for cutting the tape, refer to *Selecting how tape is fed and cut* on page 42.
- ☞ To search for a specific record while the database data is displayed (in step **2** above), refer to *Searching the database* on page 70.
- ☞ To view other fields in the record selected in step **3**, press  or .
- ☞ When editing data as described in step **4** of the procedure for printing a single database record, the database remains unchanged. When printing a range of database records, the text cannot be edited.
- ☞ To specify settings for additional Print Option functions, instead of continuing with step **8**, press  or  until **CONTINUE** is displayed in the Print Option menu, and then press . (Refer to *Printing multiple copies of a label* on page 35 and *Printing mirrored labels* on page 38.)
- ☞ To quit using the template, display the last field, and then press . The template menu appears. Press  or  until **FINISH** appears, and then press .
- ☞ While trying to print a large amount of data at one time, some outputted labels may be blank. For example, when printing 50 records, the maximum number of characters that can be printed at one time is limited to approximately 200.

Using downloaded database data

Either an *.mdb database, created with P-touch Editor 5.0, or a database converted to a *.csv file can be transferred to the P-touch. The database data can be used either with a template or added to a label created on the P-touch without using a template.













Adding database data to a label



- 1** Move the cursor to place in the text where you wish to add the database data.
- 2** Press , then .
- 3** Press  or  until the record containing the desired data is flashing.
- 4** Press  or  until the desired data is flashing.
- 5** Press . The selected data is added to the label text.



☞ To search for a specific record, refer to *Searching the database* on page 70.

Using database data in a Label Type mode

This function enables you to select the range of database fields to print.

- 1 Press , and then select the Label Type mode as described in chapter 2.
- 2 Press , then . The message “CLEAR TEXT & PRINT DATABASE?” appears.
- 3 Press .
- 4 Press  or  until **RECORD NO.** is displayed, and then specify the desired range of records.
- 5 Press  or  until **FIELD NO.** is displayed, and then specify the desired range of record fields.
- 6 Press  (or ). **CONFIRM** appears in the Print Option menu.
- 7 Press  (or ) to begin printing the labels using the specified range of records.

☞ If label text has been typed in, you will be asked to choose either **TEXT PRINT** or **DATA PRINT** when , then  is pressed. At this time, select **DATA PRINT**. If **TEXT PRINT** is selected, the special printing functions for printing multiple copies of labels (refer to page 35), printing multiple copies with incremental characters (refer to page 36), printing a range of text blocks (refer to page 37), or printing the label text as a mirror image (refer to page 38) are available.



☞ To specify settings for additional Print Option functions, instead of continuing with step 7, press  or  until **CONTINUE** is displayed in the Print Option menu, and then press . (Refer to *Printing multiple copies of a label* on page 35 and *Printing mirrored labels* on page 38.)

☞ While trying to print a large amount of data at one time, some outputted labels may be blank. For example, when printing 50 records, the maximum number of characters that can be printed at one time is limited to approximately 200.

Searching the database



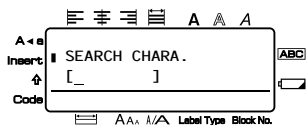

While selecting a database record to be used in a template or while selecting a database record whose data is to be added to a label, the database can be searched for records containing specific characters or records with a specific number.

To search the database for a record containing specific characters:

- 1 Press  and  until the search screen is displayed.
- 2 Type in the characters that you wish to search for.
- 3 Press . The first record after the currently selected one that contains the entered characters appears.



To display a record with a specific number:

- 1 Press  and  until the jump screen is displayed.
- 2 Press  or  until the desired record number is displayed, or use the number keys to type in the desired number.
- 3 Press . The record with the specified record number appears.

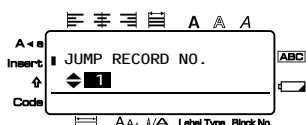

Backing up label templates

This transfers label templates and other data in the P-touch to the PC.

- ☞ Valid only when connected with the USB cable.
- ☞ Backed up data cannot be edited on the PC.
- ☞ It may not be possible to transfer backed-up data to printers of a different specification from one which the data was originally backed up from.

- 1 Connect the P-touch to the PC with the USB cable, and switch on the printer power.
The P-touch model name is displayed in the folder view.
If you select a P-touch model in the folder view, the current data transferred to the PC is displayed.

- 2 Select the P-touch to back up from, then click  .
The backup confirmation message is displayed.

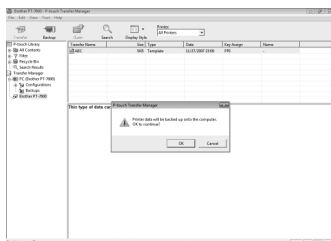

- 3 Click [OK].
A new folder with a name containing the current date is created inside the P-touch folder, and all the P-touch's data is transferred to that new folder.

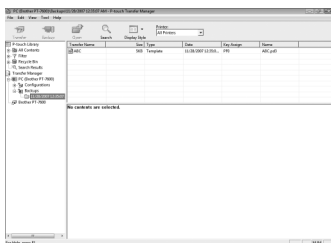

Deleting all the P-touch data

- 1 Connect the PC and the P-touch by cable and turn on the machine's power.
The P-touch model name is displayed in the folder view.
- 2 Right click the P-touch, then select [All Delete].
The confirmation message is displayed.

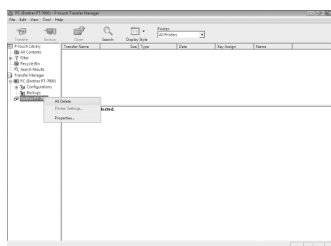

- 3 Click [OK].
All P-touch data is erased.

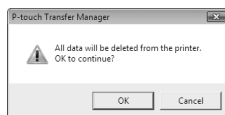

Starting up the P-touch Library

You can start up the P-touch Library and edit and print labels.

- 1 Click the [Start] button, then choose [All programs (Programs)] - [Brother P-touch] - [P-touch Tools] - [P-touch Library 2.1].
The P-touch Library starts up.

Opening and editing data

- 1 Choose the data you want to edit, then click



The application associated with the data is opened and you can edit the data.

 The application that starts up depends on the data. For example, for a P-touch template, P-touch Editor starts up.

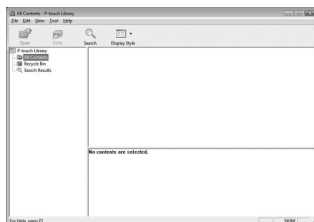

Searching labels

You can search label templates registered in the P-touch Library.

- 1 Click  .
The [Search] dialog box is displayed.

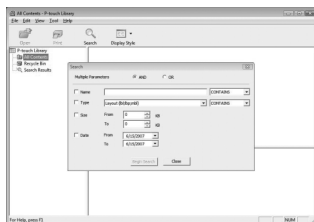

- 2 Check the items to be used as search conditions and set the search items.
The search items that can be set are as follows.

Settings	Details
Multiple Parameters	This sets the method for combining multiple search items. If you choose AND, files are searched for those that satisfy all the conditions. If you choose OR, files are searched for those that satisfy any one of the conditions.
Name	Inputs the data name to search for.
Type	Chooses the data type to search for.
Size	Sets the data size to search for.
Date	Sets the date and time at which the data to search for was last modified.

- 3 Click [Search Results].
The search is started and the search results are displayed.

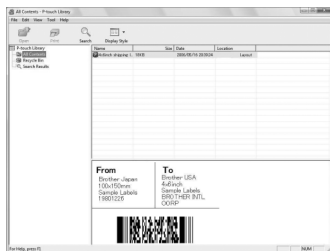







- ☞ The search results can be checked in the Search Results folder view.
- ☞ You can register the data in the P-touch Library by dragging and dropping to the All contents folder or its list view. To have label templates created with P-touch Editor automatically registered in the P-touch Library, use the following method.
 1. From the P-touch Editor menu, choose [Tools] - [Options].
 2. In the [Options] dialog box [General] tab, click [Registration Settings].
 3. Choose the timing for registering label templates created with P-touch Editor, then click [OK].

6 Appendix

Resetting the P-touch

You can reset the internal memory of your P-touch when you want to clear all saved label files, or in the event the P-touch is not working properly.

- 1 Turn off the machine and then while holding down  and , press  to turn the machine back on.
- 2 Release  and .
The P-touch turns on with the internal memory reset.

 Release  before releasing the other keys.

 All text, format settings, option settings and stored label files are cleared when you reset the P-touch. Language and unit settings will also be cleared.



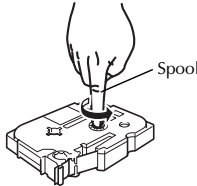

Troubleshooting



Problem	Cause	Solution
The screen 'locks', or the P-touch does not respond properly.		Refer to <i>Resetting the P-touch</i> on page 74 and reset the internal memory to the initial settings. If resetting the P-touch does not solve the problem, disconnect the AC adapter and remove the battery for more than 10 minutes.
The display remains blank after turning on the power.	Is the AC adapter connected correctly?	Check that the AC adapter designed exclusively for your P-touch is connected correctly.
	Are you using the correct AC adapter?	Make sure that you are using the AC adapter designed exclusively for your P-touch (included in package).
	Is the battery fitted correctly?	Remove and re-install the battery.
	Is the rechargeable battery pack charged sufficiently? (for PT-7600 only)	The rechargeable battery pack's charge may be low. Charge the rechargeable battery pack. (The rechargeable battery pack's charge may run low even when you are not using the P-touch.)



Problem	Cause	Solution
The label is not printed after pressing 	Has text been entered?	A label will not be printed if there is no text entered.
	Is the tape cassette installed correctly, and is there enough tape remaining?	Check that the tape cassette is installed correctly, and that there is enough tape remaining.
	Is the end of the tape bent?	If bent, cut the bent section of tape with scissors and thread the tape through the tape exit slot correctly.
	Is the tape jammed?	If jammed, remove the tape cassette, carefully pull out the jammed tape, and then cut the tape with scissors. Check that the end of the tape passes through the tape guide, and reinstall the tape cassette.
	Is the tape compartment cover open?	If so, close the tape compartment cover correctly.
The LCD messages are displayed in a foreign language.	Is the language set properly?	Refer to <i>Changing the Language</i> on page 12 and select the desired language for the LCD messages.
The label is not printed correctly.	Is the tape cassette installed correctly?	When installing a cassette, press firmly until it clicks into place.
	Is the print head clean?	If not, clean the print head using a cotton swab or optional print head cleaning cassette (TZ-CL4).
	Is the rechargeable battery pack charged sufficiently?	If the battery indicator comes on, charge the rechargeable battery pack.
The ink ribbon is separated from the ink roller.	Is the ink ribbon in the tape cassette loose, or did you pull on the label coming out of the tape exit slot?	<p>If the ink ribbon is broken replace the tape cassette. If not, leave the tape uncut and remove the tape cassette, then wind the loose ink ribbon onto the spool as shown in the figure.</p> 
The P-touch stops while printing a label.	Is there enough tape remaining in the tape cassette?	The striped tape indicates you have reached the end of the tape. Replace the tape cassette when the striped tape appears.
	Are the batteries weak and is the AC adapter disconnected?	Replace all batteries or connect the AC adapter directly to the P-touch.

Problem	Cause	Solution
Label files saved previously are now empty.	Have the batteries and AC adapter been disconnected?	All files stored in the internal memory are lost if the batteries and AC adapter are disconnected for longer than two minutes.
	Is there enough power remaining in the batteries?	All data stored in the internal memory is lost if the batteries become empty or the AC adapter is disconnected.
	Have you used the Reset function?	The resetting function clears all data stored in the internal memory, including label files.





Error Message List

Error Message	Cause	Solution
1 BLOCK LIMIT!	<ul style="list-style-type: none"> This message appears if you try to use the Numbering function when multiple blocks of text have been entered with the PANEL1 Label Type mode selected. 	<ul style="list-style-type: none"> Cancel the Numbering function. Limit the number of text blocks to 1.
CHECK # OF DIGITS ENTERED!	<ul style="list-style-type: none"> This message appears if less than the minimum one digit are entered as the bar code data. 	<ul style="list-style-type: none"> Enter a minimum of one digit before pressing .
	<ul style="list-style-type: none"> This message appears if the required number of digits are not entered in the bar code data. 	<ul style="list-style-type: none"> Input the correct number of digits or change the bar code protocol.
50 LINE LIMIT REACHED!	<ul style="list-style-type: none"> This message appears if 50 lines have already been entered when you press , then . 	<ul style="list-style-type: none"> Limit the number of lines to 50.
7 LINE LIMIT!	<ul style="list-style-type: none"> This message appears if 7 lines have already been entered in a text block when you press . 	<ul style="list-style-type: none"> Limit the number of lines in a text block to 7.
	<ul style="list-style-type: none"> This message appears if you delete , causing the number of lines in a block to exceed the 7-line limit. 	<ul style="list-style-type: none"> Adjust the number of lines so that the block will not have more than 7 lines.

Error Message	Cause	Solution
BUFFER EMPTY!	<ul style="list-style-type: none"> This message appears if no text has been typed in when you try to print or Preview function. 	<ul style="list-style-type: none"> Type in some text before trying to perform any of these operations.
BUFFER FULL!	<ul style="list-style-type: none"> This message appears if you try to add a character, a space, a new line, a new block, a symbol, an accented character or a bar code after the maximum number of characters has already been entered. 	<ul style="list-style-type: none"> Delete some existing text before trying to add any more.
TAPE CASSETTE CHANGED!	<ul style="list-style-type: none"> This message appears if the tape cassette was changed while the P-touch paused for the tape to be cut. 	<ul style="list-style-type: none"> Change the tape cassette back again.
CHECK BATTERIES!	<ul style="list-style-type: none"> This message appears if a combination of new and used batteries, a combination of batteries of different types (alkaline and Ni-MH), manufacturers or models, or a combination of recharged and uncharged batteries have been installed. 	<ul style="list-style-type: none"> Replace the batteries with six new AA batteries of the same type. If rechargeable batteries are installed, recharge all batteries.
CHECK SETTING IN LABEL TYPE MODE!	<ul style="list-style-type: none"> This message appears if you try to change the settings for the Length function or Frame function after a Label Type mode with a preset label length or frame has already been selected. 	<ul style="list-style-type: none"> Select a different Label Type mode.
CUTTER ERROR!	<ul style="list-style-type: none"> This message appears if the tape cutter button was pressed when  was pressed or the tape was being fed. 	<ul style="list-style-type: none"> Release the tape cutter button. If  was pressed, press  to feed out any printed tape. If the problem cannot be corrected, contact your service representative.
EXCEEDS PRINT COPY LIMIT!	<ul style="list-style-type: none"> This message appears if more than 1000 copies were selected with the Print Option functions. Note the number of copies plus the number of sequential labels cannot exceed 1000. 	<ul style="list-style-type: none"> Select less than 1000 copies.

Error Message	Cause	Solution
IMAGE CHARACTER SIZE ERROR!	<ul style="list-style-type: none"> This message appears if a wide user-defined character image is entered when the Vertical Label Type mode is selected. 	<ul style="list-style-type: none"> Change the Label Type mode or use a tall user-defined character image.
INPUT ABCD AT BEGIN & END!	<ul style="list-style-type: none"> This message appears if a letter between A and D has not been entered at the beginning and end of the bar code data when the CODABAR protocol is selected. 	<ul style="list-style-type: none"> Enter a letter between A and D at the beginning and end of the bar code data.
LENGTH LIMIT!	<ul style="list-style-type: none"> This message appears if you try to print or use the Preview function when the length of the text is greater than the 1 m limit. 	<ul style="list-style-type: none"> Delete some of the text.
<p>On 18 mm tape: LINE LIMIT! 5 LINES MAXIMUM</p> <p>On 12 mm tape: LINE LIMIT! 3 LINES MAXIMUM</p> <p>On 9 mm and 6 mm tape: LINE LIMIT! 2 LINES MAXIMUM</p>	<ul style="list-style-type: none"> This message appears if you try to print or use the Preview function when the number of lines in the text is greater than the maximum possible for the installed tape. 	<ul style="list-style-type: none"> Reduce the number of lines or install a wider tape.
MEMORY FULL!	<ul style="list-style-type: none"> This message appears if you try to store a text file after approximately 2000 characters have already been stored in the memory. 	<ul style="list-style-type: none"> Delete an unwanted file to make space for the new one.
NO DATABASE OR INCORRECT FORMAT	<ul style="list-style-type: none"> This message appears if no database has been downloaded to the P-touch when you press , then . 	<ul style="list-style-type: none"> Download a database.
NO FILES!	<ul style="list-style-type: none"> This message appears if no files are stored in the memory when you try to recall or delete one. 	<ul style="list-style-type: none"> Store a text file before trying to recall or delete one.
RECORD NOT FOUND!	<ul style="list-style-type: none"> This message appears when the specified text or record number cannot be found in the database. 	<ul style="list-style-type: none"> Try searching for different text or a different record number.

Error Message	Cause	Solution
SET 24mm!	<ul style="list-style-type: none"> This message appears if a 24-mm-wide tape cassette is not installed when printing an Auto Format template created for 24-mm-wide tape. 	<ul style="list-style-type: none"> Install a 24-mm-wide tape cassette.
SET 18mm!	<ul style="list-style-type: none"> This message appears if a 18-mm-wide tape cassette is not installed when printing an Auto Format template created for 18-mm-wide tape. 	<ul style="list-style-type: none"> Install a 18-mm-wide tape cassette.
SET 12mm!	<ul style="list-style-type: none"> This message appears if a 12-mm-wide tape cassette is not installed when printing an Auto Format template created for 12-mm-wide tape. 	<ul style="list-style-type: none"> Install a 12-mm-wide tape cassette.
SET 9mm!	<ul style="list-style-type: none"> This message appears if a 9-mm-wide tape cassette is not installed when printing an Auto Format template created for 9-mm-wide tape. 	<ul style="list-style-type: none"> Install a 9-mm-wide tape cassette.
SET 6mm!	<ul style="list-style-type: none"> This message appears if a 6-mm-wide tape cassette is not installed when printing an Auto Format template created for 6-mm-wide tape. 	<ul style="list-style-type: none"> Install a 6-mm-wide tape cassette.
INSERT TAPE CASSETTE!	<ul style="list-style-type: none"> This message appears if no tape cassette is installed when you try to feed the tape, print or use the Preview function. 	<ul style="list-style-type: none"> Install a tape cassette and try again.
TEXT TOO HIGH! XX BLOCK	<ul style="list-style-type: none"> This message appears if the size of the text is larger than the width of the installed tape. 	<ul style="list-style-type: none"> Reduce the size of the characters, install a tape with a greater width, or select the AUTO text size setting.
TEXT TOO LONG!	<ul style="list-style-type: none"> This message appears if the length of the text is longer than the label length that has been set with the Length function. 	<ul style="list-style-type: none"> Press  A, and then select a longer label length.
TEXT TOO LONG! XX BLOCK	<ul style="list-style-type: none"> This message appears if you try to print a label that is longer than the specified block length. 	<ul style="list-style-type: none"> Select a longer block length.

Error Message	Cause	Solution
<p style="text-align: center;">VALUE OUT OF RANGE!</p>	<ul style="list-style-type: none"> • This message appears if the value entered while setting the Margin, Length, and Block Length function is not within the allowable range. • This message appears if the specified characters cannot be found in the database. • This message appears if the values for the blocks, records or fields to be printed is not within the allowable range. 	<ul style="list-style-type: none"> • Type in a value that is within the allowable range.
<p style="text-align: center;">BAR CODE TOO LONG!</p>	<ul style="list-style-type: none"> • The message appears if the length of the bar code is longer than 22 cm when pressing . 	<ul style="list-style-type: none"> • Reduce the width of the bar code.
<p style="text-align: center;">OK TO REDUCE THE BLOCK NO.?</p>	<ul style="list-style-type: none"> • The message appears if you select the PANEL2 Label Type mode, and when the number of the desired blocks is less than that of the text mode, the number is reduced. 	<ul style="list-style-type: none"> • Press  to reduce. Press  to set the same or the more numbers of the blocks.
<p style="text-align: center;">BLOCK NO. CHANGE CLEAR TEXT?</p>	<ul style="list-style-type: none"> • The message appears when changing from a different Label Type mode to the PANEL2 Label Type mode and the current block number is different from the previously used block number. 	<ul style="list-style-type: none"> • Press  to use the PANEL2 Label Type mode. All text is cleared. • Press  to select a different Label Type mode.

Machine Specifications

Main Unit

Item	Specification
Input Device	Keyboard (56 key)

Display

LCD	16 characters x 2 lines (132 dot x 48 dot) * Line indicator and 15 characters = 16 characters
LCD Contrast	5 levels (+2, +1, 0, -1, -2)
Back light	Yes

Printing

Print method	Thermal printer
Print head	128 dot / 180 dpi
Print height	18.1 mm max. (when using 24 mm tape)
Print speed	10 mm / sec.
Tape cassette	Standard TZ tape cassette (6, 9, 12, 18, 24 mm widths)
Tape cutter	Manual
No. of lines	24 mm tape: 1 - 7 lines; 18 mm tape: 1 - 5 lines; 12 mm tape: 1 - 3 lines; 9 mm tape: 1 - 2 lines; 6 mm tape: 1 - 2 lines
Print direction	Horizontal, Vertical
Continuous printing	1 ~ 99 labels
Numbering printing	1 ~ 99 labels
Print preview	Yes

Characters

Internal character set	Total of 373 characters (62 alphanumeric, 164 symbols, 147 accented characters.)
Text buffer	Maximum 512 characters.
Fonts	Helsinki
Character size	Auto, 48 pt, 36 pt, 24 pt, 18 pt, 12 pt, 9 pt, 6 pt
Character style	Normal, Bold, Outline, Italic, Italic Bold, Italic Outline
Character width	Normal, Narrow, Thin, Wide
Text alignment	Left, Centre, Right, Justify

Item	Specification
Memory	
Memory size	Maximum 2000 characters
Other Features	
Frame	15 frame patterns
Auto-Format	Templates: 10
PC Interface (for PT-7600 only)	Yes (Transfer Only)
Transfer Function (for PT-7600 only)	Download Templates and Image Characters (Max.10) Download Database x1
Label Type	Normal, Vertical, Rotate, Rotate & Repeat, Port, Panel1, Panel2, Flag
Power Supply	
Power supply	AC adapter (AD-18U or AD-18E) Six AA-size alkaline batteries (LR6) Six AA-size rechargeable battery Ni-MH rechargeable battery pack (BA-7000) (for PT-7600 only)
Auto Power-off	5 minutes
Size	
Dimensions	134 mm (W) x 235 mm (D) x 78 mm (H)
Weight	635 g (without tape cassette and battery)
Other	
Operating temperature / humidity	10 ~ 35°C / 20 ~ 80% humidity (without condensation)

Operating Environment: Windows® (for PT-7600 only)

Item	Specification
OS	Microsoft® Windows® 2000 Professional/XP/ Windows Vista®
Memory	Windows® 2000 Pro, XP: 128MB or more required Windows Vista®: 512MB or more
Hard disk	70MB or more required
Monitor	SVGA High colour graphics support or higher
Interface	USB Port (USB specification 1.1 or 2.0 protocol)
Other	CD-ROM drive for installation

Accessories

● Supplies

Obtain tape cassettes from your nearest authorised dealer.

Use only Brother TZ tapes with this machine. **Brother cannot be held responsible for any problems caused by the use of unauthorised supplies.** Do not use tapes that do not have the  mark. Tape supply may differ by country.

Laminated tapes (length: 8 m)

The surface of laminated tapes is protected by a transparent film. This prevents characters from smudging or being erased if the label becomes wet.

Stock No.	Description
24 mm	
TZ-151	Black characters on clear tape
TZ-152	Red characters on clear tape
TZ-153	Blue characters on clear tape
TZ-155	White characters on clear tape
TZ-251	Black characters on white tape
TZ-252	Red characters on white tape
TZ-253	Blue characters on white tape
TZ-354	Gold characters on black tape
TZ-355	White characters on black tape
TZ-451	Black characters on red tape
TZ-455	White characters on red tape
TZ-551	Black characters on blue tape
TZ-555	White characters on blue tape
TZ-651	Black characters on yellow tape

Stock No.	Description
TZ-655	White characters on orange tape
TZ-751	Black characters on green tape
TZ-755	White characters on green tape
TZ-951	Black characters on silver tape
TZ-M951	Black characters on silver (matt) tape
TZ-B51	Black characters on fluorescent orange tape
TZ-C51	Black characters on fluorescent yellow tape
TZ-D51	Black characters on fluorescent green tape
TZ-M51	Black characters on clear (matt) tape
18 mm	
TZ-141	Black characters on clear tape
TZ-241	Black characters on white tape
TZ-242	Red characters on white tape
TZ-243	Blue characters on white tape
TZ-344	Gold characters on black tape
TZ-145	White characters on clear tape
TZ-345	White characters on black tape
TZ-441	Black characters on red tape
TZ-541	Black characters on blue tape
TZ-641	Black characters on yellow tape
TZ-741	Black characters on green tape
12 mm	
TZ-131	Black characters on clear tape
TZ-132	Red characters on clear tape
TZ-133	Blue characters on clear tape
TZ-135	White characters on clear tape
TZ-231	Black characters on white tape
TZ-232	Red characters on white tape
TZ-233	Blue characters on white tape
TZ-334	Gold characters on black tape
TZ-335	White characters on black tape
TZ-431	Black characters on red tape
TZ-435	White characters on red tape
TZ-531	Black characters on blue tape
TZ-535	White characters on blue tape
TZ-631	Black characters on yellow tape
TZ-635	White characters on orange tape
TZ-731	Black characters on green tape
TZ-735	White characters on green tape
TZ-931	Black characters on silver tape
TZ-M931	Black characters on silver (matt) tape
TZ-B31	Black characters on fluorescent orange tape (length: 5 m)
TZ-C31	Black characters on fluorescent yellow tape (length: 5 m)

Stock No.	Description
TZ-D31	Black characters on fluorescent green tape (length: 5 m)
TZ-M31	Black characters on clear (matt) tape
9 mm	
TZ-121	Black characters on clear tape
TZ-122	Red characters on clear tape
TZ-123	Blue characters on clear tape
TZ-221	Black characters on white tape
TZ-222	Red characters on white tape
TZ-223	Blue characters on white tape
TZ-324	Gold characters on black tape
TZ-325	White characters on black tape
TZ-421	Black characters on red tape
TZ-521	Black characters on blue tape
TZ-621	Black characters on yellow tape
TZ-721	Black characters on green tape
TZ-M21	Black characters on clear (matt) tape
6 mm	
TZ-111	Black characters on clear tape
TZ-211	Black characters on white tape
TZ-315	White characters on black tape
TZ-611	Black characters on yellow tape

Non-laminated tapes (length: 8 m)

Stock No.	Description
24 mm	
TZ-N251	Black characters on white tape
18 mm	
TZ-N241	Black characters on white tape
TZ-N641	Black characters on yellow tape
12 mm	
TZ-N231	Black characters on white tape
TZ-N631	Black characters on yellow tape
9 mm	
TZ-N221	Black characters on white tape
6 mm	
TZ-N211	Black characters on white tape

Strong adhesive tapes (length: 8 m)

Laminated tapes with stronger adhesive, ideal for rough surfaces or harsh environments.

Stock No.	Description
24 mm	
TZ-S151	Black characters on clear tape
TZ-S251	Black characters on white tape
TZ-S651	Black characters on yellow tape
18 mm	
TZ-S141	Black characters on clear tape
TZ-S241	Black characters on white tape
TZ-S641	Black characters on yellow tape
12 mm	
TZ-S131	Black characters on clear tape
TZ-S231	Black characters on white tape
TZ-S631	Black characters on yellow tape
9 mm	
TZ-S121	Black characters on clear tape
TZ-S221	Black characters on white tape
TZ-S621	Black characters on yellow tape
6 mm	
TZ-S111	Black characters on clear tape
TZ-S211	Black characters on white tape
TZ-S611	Black characters on yellow tape

Flexible ID tapes (length: 8 m)

Flexible laminated tapes ideal for labelling network cables, electrical wires, etc.

Stock No.	Description
24 mm	
TZ-FX151	Black characters on clear tape
TZ-FX251	Black characters on white tape
TZ-FZ651	Black characters on yellow tape
18 mm	
TZ-FX141	Black characters on clear tape
TZ-FX241	Black characters on white tape
TZ-FX641	Black characters on yellow tape
12 mm	
TZ-FX131	Black characters on clear tape
TZ-FX231	Black characters on white tape
TZ-FX631	Black characters on yellow tape

Stock No.	Description
9 mm	
TZ-FX121	Black characters on clear tape
TZ-FX221	Black characters on white tape
TZ-FX621	Black characters on yellow tape
6 mm	
TZ-FX111	Black characters on clear tape
TZ-FX211	Black characters on white tape
TZ-FX611	Black characters on yellow tape

Security tape (length: 8 m)

This tape leaves a checkered pattern when removed.

Stock No.	Description
18 mm	
TZ-SE4	Black characters on white tape

Fabric tape (length: 3 m)

These fabric labels can be affixed to other fabrics by using an iron.

Stock No.	Description
18 mm	
TZ-FA4B	Blue characters on white tape
12 mm	
TZ-FA3	Blue characters on white tape

Print head cleaning cassette

Cassette tape for cleaning the print head of your P-touch.

Stock No.	Description
18 mm	
TZ-CL4	Print head cleaning cassette (cleans approx. 100 times)

Index

- A**
- AC adapter 5
 - Accent function 22
 - alignment 33
 - arrow keys..... 4, 19, 20
 - Auto Format function 33
 - Auto Reduction function 43
- B**
- backspace key..... 4, 19, 22
 - bar code
 - special characters 24
 - Bar Code function 23
 - block number..... 4
 - block range 37
 - bold text style..... 32
 - indicator 4
- C**
- cancelling 19
 - Caps indicator 4
 - Caps mode 20
 - centre text alignment..... 33
 - indicator 4
 - chain printing..... 42
 - character
 - size..... 30
 - style..... 32
 - width..... 31
 - choosing 19
 - default setting 19
 - cleaning
 - print head..... 45
 - rollers 45
 - tape cutter 45
 - Clear function 22
 - Code indicator 4
 - confirming..... 19
- Contrast function..... 42
 - copies 35
 - cursor..... 20
 - Cut function 42
 - cut-pause 42
- D**
- database record range 67
 - databases 67, 68
 - Label Type mode..... 69
 - searching..... 70
 - default setting..... 19
 - deleting
 - memory files..... 40
 - text 22
 - display 4
 - contrast 42
- E**
- error messages..... 76
- F**
- Feed key..... 4, 35
 - Flag mode 15
 - flexible ID tape..... 11
 - Format key 30, 31, 32
 - formatting..... 30, 31, 32
 - Frame function 29
 - frame indicator..... 4
- G**
- global format key 4
 - global formatting
 - character size 30
 - character style 32
 - character width 31

I	
indicators	4
block number	4
bold text style	4
Caps	4
centre text alignment	4
Code	4
frame	4
Insert	4
italic text style	4
justified text alignment	4
Label Type setting.....	4
left text alignment.....	4
length	4
low battery	4
outline text style	4
right text alignment.....	4
Shift.....	4
size.....	4
width.....	4
Insert indicator	4
Insert key.....	21
installing	
P-touch Editor.....	47
italic text style	32
indicator	4
J	
justified text alignment	33
indicator	4
K	
keyboard	4
L	
label margins.....	28
Label Type key	4
Label Type mode.....	13
databases	69
Label Type setting indicator.....	4
LCD screen	4
left text alignment.....	33
indicator.....	4
length adjustment.....	43
Length function	28
length indicator	4
local formatting	
character size	30
character style	32
character width	31
low battery indicator	4
lowercase letters.....	20
M	
Margin function.....	28
Memory key	39
mirror printing.....	38
N	
New Block function	21
Normal mode.....	13
Numbering function	36
numbers	20
O	
outline text style	32
indicator.....	4
P	
Panel1 mode	16
Panel2 mode	17
PERSONAL symbol category	28
setup	44
PF keys.....	4
Port Block mode.....	16
Port mode	16
power key	4, 12
preview	34
print head.....	45
Print key.....	4, 35
printing	
database record range	67
text block range.....	37

problems	74
P-touch Editor	
installing.....	47
starting	54
template	66

R

recalling	40
Repeat Printing function	35
return key	4, 19, 21
right text alignment	33
indicator	4
rollers.....	45
Rotate & Repeat mode.....	14
Rotate mode.....	14

S

searching.....	70
selecting.....	19, 20
default setting	19
Setup key	42
Shift indicator.....	4
Shift mode.....	20
size	30
indicator.....	4
Space key.....	19, 20
storing	39
Strong Adhesive Tape.....	10
style	32
Symbol key	25

T

tape	
cutter.....	45
templates	
Auto Format	33
P-touch Editor.....	66
text	
alignment	33
size.....	30
size adjustment.....	43
style.....	32

width.....	31
width adjustment.....	43
Transfer mode	61
troubleshooting	74

U

uppercase letters	20
user-defined character image	66

V

version	44
Vertical mode.....	13

W

width.....	31
indicator.....	4

Federal Communications Commission (FCC) Declaration of Conformity (For USA Only)

Responsible Party : Brother International Corporation
100 Somerset Corporate Boulevard
Bridgewater, NJ 08807-0911 USA
TEL : (908) 704-1700

declares that the product

Product Name : Brother P-touch Electronic Labeling System

Model Number : PT-7600

This device complies with Part 15 of the FCC Rules. Operation is subject to the following two conditions: (1) this device may not cause harmful interference, and (2) this device must accept any interference received, including interference that may cause undesired operation.

This equipment has been tested and found to comply with the limits for a Class B digital device, pursuant to Part 15 of the FCC Rules. These limits are designed to provide reasonable protection against harmful interference in a residential installation. This equipment generates, uses and can radiate radio frequency energy and, if not installed and used in accordance with the instructions, may cause harmful interference to radio communications. However, there is no guarantee that interference will not occur in a particular installation. If this equipment does cause harmful interference to radio or television reception, which can be determined by turning the equipment off and on, the user is encouraged to try to correct the interference by one or more of the following measures:

- Reorient or relocate the receiving antenna.
- Increase the separation between the equipment and receiver.
- Connect the equipment into an outlet on a circuit different from that to which the receiver is connected.
- Consult the dealer or an experienced radio/TV technician for help.

Important

- The enclosed interface cable should be used in order to ensure compliance with the limits for a Class B digital device.
- Changes or modifications not expressly approved by Brother Industries, Ltd. could void the user's authority to operate the equipment.

brother®

Printed in China
LW2458001®

