

Operation Manual

Embroidery and Sewing Machine

Product Code: 882-C50

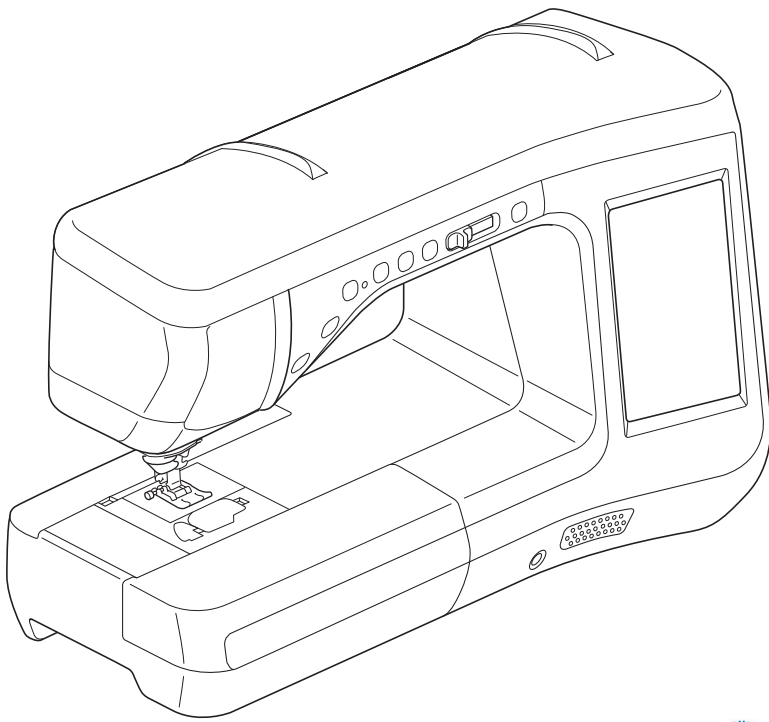

Be sure to read this document before using the machine.
We recommend that you keep this document nearby for future reference.

TRADEMARKS

IMPORTANT:

READ BEFORE DOWNLOADING, COPYING, INSTALLING OR USING.

By downloading, copying, installing or using the software you agree to this license. If you do not agree to this license, do not download, install, copy or use the software.

Intel License Agreement For Open Source Computer Vision Library

Copyright © 2000, Intel Corporation, all rights reserved. Third party copyrights are property of their respective owners.

Redistribution and use in source and binary forms, with or without modification, are permitted provided that the following conditions are met:

- Redistribution's of source code must retain the above copyright notice, this list of conditions and the following disclaimer.
- Redistribution's in binary form must reproduce the above copyright notice, this list of conditions and the following disclaimer in the documentation and/or other materials provided with the distribution.
- The name of Intel Corporation may not be used to endorse or promote products derived from this software without specific prior written permission.

This software is provided by the copyright holders and contributors "as is" and any express or implied warranties, including, but not limited to, the implied warranties of merchantability and fitness for a particular purpose are disclaimed. In no event shall Intel or contributors be liable for any direct, indirect, incidental, special, exemplary, or consequential damages (including, but not limited to, procurement of substitute goods or services; loss of use, data, or profits; or business interruption) however caused and on any theory of liability, whether in contract, strict liability, or tort (including negligence or otherwise) arising in any way out of the use of this software, even if advised of the possibility of such damage.

All information provided related to future Intel products and plans is preliminary and subject to change at any time, without notice.

SD is a registered trademark or a trademark of SD-3C, LLC.

CompactFlash is a registered trademark or a trademark of Sandisk Corporation.

Memory Stick is a registered trademark or a trademark of Sony Corporation.

SmartMedia is a registered trademark or a trademark of Toshiba Corporation.

MultiMediaCard (MMC) is a registered trademark or a trademark of Infineon Technologies AG.

xD-Picture Card is a registered trademark or a trademark of Fuji Photo Film Co. Ltd.

IBM is a registered trademark or a trademark of International Business Machines Corporation.

Microsoft, Windows and Windows Vista are registered trademarks or trademarks of Microsoft Corporation.

Each company whose software title is mentioned in this manual has a Software License Agreement specific to its proprietary programs.

All other brands and product names mentioned in this manual are registered trademarks of their respective companies. However, the explanations for markings such as ® and ™ are not clearly described within the text.

INTRODUCTION

Thank you for purchasing this machine. Before using this machine, carefully read the “IMPORTANT SAFETY INSTRUCTIONS”, and then study this manual for the correct operation of the various functions. In addition, after you have finished reading this manual, store it where it can quickly be accessed for future reference.

IMPORTANT SAFETY INSTRUCTIONS

Please read these safety instructions before attempting to use the machine.

⚠ DANGER - To reduce the risk of electrical shock

1 Always unplug the machine from the electrical outlet immediately after using, when cleaning, making any user servicing adjustments mentioned in this manual, or if you are leaving the machine unattended.

⚠ WARNING - To reduce the risk of burns, fire, electrical shock, or injury to persons.

2 Always unplug the machine from the electrical outlet when making any adjustments mentioned in the instruction manual.

- To unplug the machine, switch the machine to the symbol “O” position to turn it off, then grasp the plug and pull it out of the electrical outlet. Do not pull on the cord.
- Plug the machine directly into the electrical outlet. Do not use an extension cord.
- Always unplug your machine if the power is cut.

3 Electrical Hazards:

- This machine should be connected to an AC power source within the range indicated on the rating label. Do not connect it to a DC power source or inverter. If you are not sure what kind of power source you have, contact a qualified electrician.
- This machine is approved for use in the country of purchase only.

4 Never operate this machine if it has a damaged cord or plug, if it is not working properly, has been dropped or damaged, or water is spilled on the unit. Return the machine to the nearest authorized dealer for examination, repair, electrical or mechanical adjustment.

- While the machine is stored or in use if you notice anything unusual, such as an odor, heat, discoloration or deformation, stop using the machine immediately and unplug the power cord.
- When transporting the sewing machine, be sure to carry it by its handle. Lifting the sewing machine by any other part may damage the machine or result in the machine falling, which could cause injuries.
- When lifting the sewing machine, be careful not to make any sudden or careless movements, otherwise you may injure your back or knees.

5 Always keep your work area clear:

- Never operate the machine with any air openings blocked. Keep ventilation openings of the sewing machine and foot control free from the build up of lint, dust, and loose cloth.
- Do not store objects on the foot controller.
- Do not use extension cords. Plug the machine directly into the electrical outlet.
- Never drop or insert foreign objects in any opening.
- Do not operate where aerosol (spray) products are being used or where oxygen is being administered.
- Do not use the machine near a heat source, such as a stove or iron; otherwise, the machine, power cord or garment being sewn may ignite, resulting in fire or an electric shock.
- Do not place this sewing machine on an unstable surface, such as an unsteady or slanted table, otherwise the sewing machine may fall, resulting in injuries.

6 Special care is required when sewing:

- Always pay close attention to the needle. Do not use bent or damaged needles.
- Keep fingers away from all moving parts. Special care is required around the machine needle.
- Switch the sewing machine to the symbol "O" position to turn it off when making any adjustments in the needle area.
- Do not use a damaged or incorrect needle plate, as it could cause the needle to break.
- Do not push or pull the fabric when sewing, and follow careful instruction when free motion stitching so that you do not deflect the needle and cause it to break.

7 This machine is not a toy:

- Your close attention is necessary when the machine is used by or near children.
- The plastic bag that this sewing machine was supplied in should be kept out of the reach of children or disposed of. Never allow children to play with the bag due to the danger of suffocation.
- Do not use outdoors.

8 For a longer service life:

- When storing this machine, avoid direct sunlight and high humidity locations. Do not use or store the machine near a space heater, iron, halogen lamp, or other hot objects.
- Use only neutral soaps or detergents to clean the case. Benzene, thinner, and scouring powders can damage the case and machine, and should never be used.
- Always consult the operation manual when replacing or installing any assemblies, the presser feet, needle, or other parts to assure correct installation.

9 For repair or adjustment:

- If the light unit is damaged, it must be replaced by an authorized dealer.
- In the event a malfunction occurs or adjustment is required, first follow the troubleshooting table in the back of the operation manual to inspect and adjust the machine yourself. If the problem persists, please consult your local authorized Brother dealer.

Use this machine only for its intended use as described in the manual.

Use accessories recommended by the manufacturer as contained in this manual.

Use only the interface cable (USB cable) included with this machine.

Use only the mouse designed specifically for this machine.

The contents of this manual and specifications of this product are subject to change without notice.

For additional product information and updates, visit our website at www.brother.com

SAVE THESE INSTRUCTIONS

This machine is intended for household use.

This appliance is not intended for use by persons (including children) with reduced physical, sensory or mental capabilities, or lack of experience and knowledge, unless they have been given supervision or instruction concerning use of the appliance by a person responsible for their safety. Children should be supervised to ensure that they do not play with the appliance.

This appliance can be used by children aged from 8 years and above and persons with reduced physical, sensory or mental capabilities or lack of experience and knowledge if they have been given supervision or instruction concerning use of the appliance in a safe way and understand the hazards involved. Children shall not play with the appliance. Cleaning and user maintenance shall not be made by children without supervision.

FOR USERS IN THE UK, EIRE, MALTA AND CYPRUS ONLY

IMPORTANT

- In the event of replacing the plug fuse, use a fuse approved by ASTA to BS 1362, i.e. carrying the  mark, rating as marked on plug.
- Always replace the fuse cover. Never use plugs with the fuse cover omitted.
- If the available electrical outlet is not suitable for the plug supplied with this equipment, you should contact your authorized dealer to obtain the correct lead.

Federal Communications Commission (FCC) Declaration of Conformity (For USA Only)

Responsible Party: Brother International Corporation
200 Crossing Boulevard
P.O. Box 6911
Bridgewater, NJ 08807-0911 USA
TEL : (908) 704-1700

declares that the product

Product Name: Brother Sewing Machine
Model Number: VM5100

This device complies with Part 15 of the FCC Rules. Operation is subject to the following two conditions: (1) this device may not cause harmful interference, and (2) this device must accept any interference received, including interference that may cause undesired operation.

This equipment has been tested and found to comply with the limits for a Class B digital device, pursuant to Part 15 of the FCC Rules. These limits are designed to provide reasonable protection against harmful interference in a residential installation. This equipment generates, uses, and can radiate radio frequency energy and, if not installed and used in accordance with the instructions, may cause harmful interference to radio communications. However, there is no guarantee that interference will not occur in a particular installation. If this equipment does cause harmful interference to radio or television reception, which can be determined by turning the equipment off and on, the user is encouraged to try to correct the interference by one or more of the following measures:

- Reorient or relocate the receiving antenna.
- Increase the separation between the equipment and receiver.
- Connect the equipment into an outlet on a circuit different from that to which the receiver is connected.
- Consult the dealer or an experienced radio/TV technician for help.
- The included interface cable should be used in order to ensure compliance with the limits for a Class B digital device.
- Changes or modifications not expressly approved by Brother Industries, Ltd. could void the user's authority to operate the equipment.

WHAT YOU CAN DO WITH THIS MACHINE

B *Basic operations*

After purchasing your machine, be sure to read this section first. This section provides details on the initial setup procedures as well as descriptions of this machine's more useful functions.

Chapter 1 Getting Ready

To learn the operation of the principal parts and the screens

Page B-18

S *Sewing*

This section describes procedures for using the various utility stitches as well as other functions. It provides details on basic machine sewing in addition to the more expressive features of the machine, from sewing tubular pieces and buttonholes to sewing the character and decorative stitch patterns.

Chapter 1 Sewing Basics

To learn how to prepare for sewing and basic sewing operations

Page S-2

Chapter 2 Utility Stitches

Pre-programmed with more than 100 frequently used stitches

Page S-20

Chapter 3 Character/Decorative Stitches

The variety of stitches widen your creativity

Page S-76

Chapter 4 MY CUSTOM STITCH

Create original decorative stitches

Page S-102

E *Embroidering*

This section provides instruction to embroider designs with this machine.

Chapter 1, "Embroidery", provides details on sewing embroidery patterns stored on the machine as well as patterns that have been imported. Chapter 2, "Embroidery Edit", provides details on editing embroidery patterns to create custom embroidery.

Chapter 1 Embroidery

Maximum 30 cm x 18 cm (approx. 12 inches x 7 inches) for large embroidery designs

Page E-2

Chapter 2 Embroidery Edit

Designs can be combined, rotated or enlarged

Page E-56

A *Appendix*

This section provides important information for operating this machine.

Chapter 1 How to Create Bobbin Work

To learn how to create bobbin work

Page A-2

Chapter 2 Maintenance and Troubleshooting

Find troubleshooting tips and pointers as well as how to keep your machine in the best working condition.

Page A-18

CONTENTS

TRADEMARKS

INTRODUCTION 1
IMPORTANT SAFETY INSTRUCTIONS 1
WHAT YOU CAN DO WITH THIS MACHINE 5
NAMES OF MACHINE PARTS AND THEIR FUNCTIONS 9
 Machine 9
 Needle and Presser Foot Section 10
 Embroidery Unit 11
 Operation Buttons 11
 Using the Flat Bed Attachment 12
 Included Accessories 13
 Accessories that are Included in Some Countries or Regions 15
 Options 15

B Basic operations

Chapter1 Getting Ready 18

TURNING THE MACHINE ON/OFF 19
 Setting Your Machine for the First Time 20
LCD SCREEN 22
 Using the Machine Setting Mode Key 26
 Using the Sewing Machine Help Key 34
 Using the Operation Guide Function 35
 Using the Sewing Guide Function 36
 Using the Pattern Explanation Function 37
LOWER THREADING 38
 Winding the Bobbin 38
 Setting the Bobbin 43
 Pulling Up the Bobbin Thread 45
UPPER THREADING 46
 Upper Threading 46
 Using the Twin Needle Mode 49
 Using Threads that Unwind Quickly 51
CHANGING THE PRESSER FOOT 53
 Removing the Presser Foot 53
 Attaching the Presser Foot 53
 Attaching the Presser Foot with the Included Adapter 53
CHANGING THE NEEDLE 55
ABOUT THE NEEDLE AND FABRIC 56
 About the Needle 56
 Fabric/Thread/Needle Combinations 57
BEFORE EMBROIDERING 58
 Embroidery Step by Step 58
 Attaching the Embroidery Foot “W” 59
 Using the Optional Embroidery Foot “W+” with LED Pointer 60
 Attaching the Embroidery Unit 62
USING FUNCTIONS BY CONNECTING THE ACCESSORY TO THE MACHINE 65
 Using USB Media or Embroidery Card Reader/USB Card Writer Module* 65
 Connecting the Machine to the Computer 65
 Using a USB Mouse 66
 Using the Optional Dual Feed Foot 67

S Sewing

Chapter1 Sewing Basics 2

SEWING 3
 Sewing a Stitch 3
 Sewing Reinforcement Stitches 5
 Automatic Reinforcement Stitching 5
 Sewing Curves 7
 Changing Sewing Direction 7
 Sewing Heavyweight Fabrics 7
 Sewing Hook-and-Loop Fastener 8
 Sewing Lightweight Fabrics 9
 Sewing Stretch Fabrics 9
STITCH SETTINGS 10
 Setting the Stitch Width 10
 Setting the Stitch Length 10
 Setting the “L/R SHIFT” 11
 Setting the Thread Tension 12
USEFUL FUNCTIONS 14
 Automatic Thread Cutting 14
 Using the Knee Lifter 15
 Pivoting 15
 Automatic Fabric Sensor System (Automatic Presser Foot Pressure) 17
 Needle Position – Stitch Placement 18
 Locking the Screen 18

Chapter2 Utility Stitches 20

SELECTING UTILITY STITCHES 21
 Selecting a Stitch 21
 Saving Your Stitch Settings 22
SEWING THE STITCHES 24
 Straight Stitches 24
 Dart Seam 28
 Gathering 29
 Flat Fell Seam 29
 Pintuck 30
 Zigzag Stitches 31
 Elastic Zigzag Stitches 33
 Overcasting 33
 Quilting 35
 Blind Hem Stitches 45
 Appliqué 48
 Shelltuck Stitches 49
 Scallop Stitches 50
 Crazy Quilting 50
 Smocking Stitches 51
 Fagoting 52
 Tape or Elastic Attaching 52
 Heirloom 53
 One-step Buttonholes 55
 Darning 58
 Bar Tacks 59
 Button Sewing 61
 Eyelet 62
 Multi-directional Sewing (Straight Stitch and Zigzag Stitch) 63
 Zipper Insertion 64
STITCH SETTING CHART 67

Chapter3 Character/Decorative Stitches 76

SELECTING STITCH PATTERNS	77
Selecting Decorative Stitch Patterns/7mm Decorative Stitch Patterns/Satin Stitch Patterns/7mm Satin Stitch Patterns/Cross Stitch/Utility Decorative Stitch Patterns.....	78
Characters.....	78
SEWING STITCH PATTERNS.....	81
Sewing Attractive Finishes.....	81
Basic Sewing.....	81
Making Adjustments	82
EDITING STITCH PATTERNS	84
Changing the Size	86
Changing the Length (for 7mm Satin Stitch Patterns Only)....	86
Creating a Vertical Mirror Image.....	86
Creating a Horizontal Mirror Image	86
Sewing a Pattern Continuously.....	86
Changing Thread Density (for Satin Stitch Patterns Only)	87
Returning to the Beginning of the Pattern	87
Checking the Image	88
COMBINING STITCH PATTERNS	89
Before Combining.....	89
Combining Various Stitch Patterns	89
Combining Large and Small Stitch Patterns	90
Combining Horizontal Mirror Image Stitch Patterns	91
Combining Stitch Patterns of Different Length	91
Making Step Stitch Patterns (for 7mm Satin Stitch Patterns Only).....	92
USING THE MEMORY FUNCTION.....	94
Stitch Data Precautions	94
Saving Stitch Patterns in the Machine's Memory	95
Saving Stitch Patterns to USB Media	96
Saving Stitch Patterns in the Computer.....	97
Retrieving Stitch Patterns from the Machine's Memory.....	98
Recalling from USB Media.....	99
Recalling from the Computer	100

Chapter4 MY CUSTOM STITCH 102

DESIGNING A STITCH	103
ENTERING STITCH DATA.....	105
USING STORED CUSTOM STITCHES.....	110
Storing Custom Stitches in Your List.....	110
Retrieving Stored Stitches.....	111

E Embroidering**Chapter1 Embroidery 2**

SELECTING PATTERNS.....	3
Selecting Embroidery Patterns/Brother "Exclusives"/Floral Alphabet/Bobbin Work Patterns	4
Selecting Character Patterns	5
Selecting Frame Patterns	7
Selecting Patterns from Embroidery Cards	7
Selecting Patterns from USB Media/Computer.....	8
VIEWING THE EMBROIDERING SCREEN.....	9
PREPARING THE FABRIC	11
Attaching Iron-on Stabilizers (Backing) to the Fabric	11
Hooping the Fabric in the Embroidery Frame.....	13
Embroidering Small Fabrics or Fabric Edges	16
ATTACHING THE EMBROIDERY FRAME.....	17
CONFIRMING THE PATTERN POSITION.....	19
Checking the Pattern Position	19
Previewing the Completed Pattern	20
SEWING AN EMBROIDERY PATTERN.....	21
Embroidery Attractive Finishes	21
Sewing Embroidery Patterns.....	22
Sewing Embroidery Patterns Which Use Appliqué	23

ADJUSTMENTS DURING THE EMBROIDERY

PROCESS.....	26
If the Bobbin Runs Out of Thread	26
If the Thread Breaks During Sewing.....	27
Restarting from the Beginning.....	28
Resuming Embroidery After Turning Off the Power	28
MAKING EMBROIDERY ADJUSTMENTS.....	30
Adjusting Thread Tension	30
Adjusting the Bobbin Case (with No Color on the Screw)	31
Using the Automatic Thread Cutting Function (END COLOR TRIM)	32
Using the Thread Trimming Function (JUMP STITCH TRIM)	32
Adjusting the Embroidery Speed.....	33
Changing the Thread Color Display.....	34
Changing the "Embroidery Frame Display"	35
REVISING THE PATTERN.....	36
Moving the Pattern	36
Aligning the Pattern and the Needle	36
Changing the Size of the Pattern.....	37
Rotating the Pattern	38
Creating a Horizontal Mirror Image.....	39
Enlarging the Editing Screen	39
Changing the Density (Alphabet Character and Frame Patterns Only)	40
Changing the Colors of Alphabet Character Patterns.....	40
Embroidering Linked Characters.....	41
Uninterrupted Embroidering (Monochrome - Using a Single Color).....	43
USING THE MEMORY FUNCTION	44
Embroidery Data Precautions	44
Saving Embroidery Patterns in the Machine's Memory	45
Saving Embroidery Patterns to USB Media.....	46
Saving Embroidery Patterns in the Computer	47
Retrieving Patterns from the Machine's Memory.....	48
Recalling from USB Media	49
Recalling from the Computer.....	50
EMBROIDERY APPLICATIONS.....	51
Using a Frame Pattern to Make an Appliqué (1).....	51
Using a Frame Pattern to Make an Appliqué (2).....	52
Sewing Split Embroidery Patterns	53

Chapter2 Embroidery Edit 56

EXPLANATION OF FUNCTIONS.....	57
SELECTING PATTERNS TO EDIT	58
Selecting Embroidery Patterns/Brother "Exclusives"/Floral Alphabet Patterns/Frame/Bobbin Work Patterns.....	59
Selecting Alphabet Character Patterns	59
EDITING PATTERNS.....	61
Moving the Pattern	63
Rotating the Pattern	63
Changing the Size of the Pattern.....	63
Deleting the Pattern.....	63
Displaying Patterns in the Screen Magnified by 200%.....	63
Changing the Configuration of Character Patterns	64
Changing Character Spacing	64
Reducing Character Spacing.....	65
Separating Combined Character Patterns.....	65
Changing the Color of Each Alphabet Character in a Pattern.....	66
Embroidering Linked Characters.....	67
Changing the Thread Color	67
Creating a Custom Thread Table	68
Choosing a Color from the Custom Thread Table	71
Designing Repeated Patterns	72
Embroidering the Pattern Repeatedly	76
Duplicating a Pattern.....	78
After Editing	79
COMBINING PATTERNS.....	80
Editing Combined Patterns	80
Sewing Combined Patterns.....	83

VARIOUS EMBROIDERING FUNCTIONS..... 84
 Uninterrupted Embroidering (Monochrome - Using a Single Color)..... 84
 Basting Embroidery 84
USING THE MEMORY FUNCTION..... 85

A Appendix

Chapter1 How to Create Bobbin Work 2

ABOUT BOBBIN WORK 3
PREPARING FOR BOBBIN WORK 3
 Required Materials 3
 Upper Threading 4
 Preparing the Bobbin Thread..... 5
CREATING BOBBIN WORK (SEWING)..... 9
 Positioning the Fabric and Sewing..... 9
 Bobbin Work Free Motion Sewing..... 11
CREATING BOBBIN WORK (EMBROIDERY)..... 12
 Selecting the Pattern 12
 Start Embroidering..... 14
ADJUSTING THE THREAD TENSION 16
TROUBLESHOOTING..... 17

Chapter2 Maintenance and Troubleshooting 18

CARE AND MAINTENANCE..... 19
 Restrictions on oiling 19
 Precautions on storing the machine..... 19
 Cleaning the LCD Screen 19
 Cleaning the Machine Casing..... 19
 Cleaning the Race 19
 Cleaning the Cutter in the Bobbin Case Area..... 21
 About the Maintenance Message..... 21
ADJUSTING THE SCREEN..... 22
 Adjusting the Brightness of the Screen Display 22
 Touch Panel is Malfunctioning..... 22
TROUBLESHOOTING..... 23
 Frequent troubleshooting topics 23
 Upper thread tightened up 23
 Tangled thread on wrong side of fabric 24
 Incorrect thread tension..... 26
 Fabric is caught in the machine and cannot be removed 27
 List of Symptoms 30
ERROR MESSAGES 34
SPECIFICATIONS 37
UPGRADING YOUR MACHINE'S SOFTWARE..... 38
 Upgrade Procedure Using USB Media..... 38
 Upgrade Procedure Using Computer..... 39
INDEX 40

NAMES OF MACHINE PARTS AND THEIR FUNCTIONS

The names of the various parts of the sewing machine and their functions are described below. Before using the sewing machine, carefully read these descriptions to learn the names of the machine parts.

Machine

■ Front View

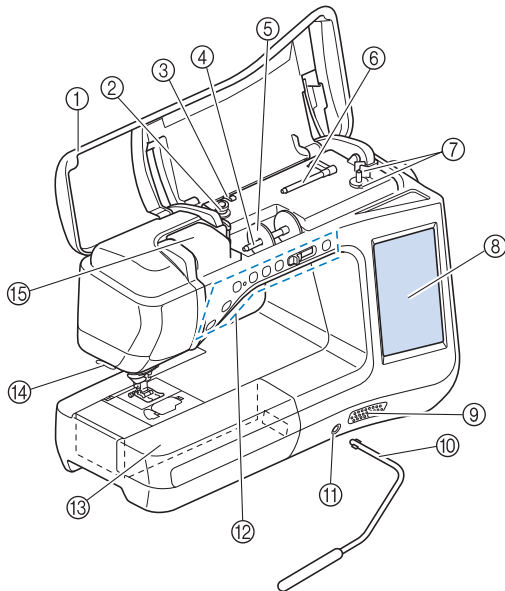

- ① **Top cover**
Open the top cover to thread the machine and wind the bobbin.
- ② **Pre-tension disk**
Pass the thread around the pre-tension disk when winding the bobbin thread. (page B-38)
- ③ **Thread guide for bobbin winding**
Pass the thread through this thread guide when winding the bobbin thread. (page B-38)
- ④ **Spool pin**
Place a spool of thread on the spool pin. (page B-46)
- ⑤ **Spool cap**
Use the spool cap to hold the spool of thread in place. (page B-46)
- ⑥ **Supplemental spool pin**
Use this spool pin to wind the bobbin thread, or to sew with the twin needle. (page B-38, B-49)
- ⑦ **Bobbin winder**
Use the bobbin winder when winding the bobbin. (page B-38)
- ⑧ **LCD (liquid crystal display)**
Settings for the selected stitch and error messages appear in the LCD. (page B-22)
- ⑨ **Speaker**
- ⑩ **Knee lifter**
Use the knee lifter to raise and lower the presser foot. (page S-15)
- ⑪ **Knee lifter slot**
Insert the knee lifter into the slot. (page S-15)
- ⑫ **Operation buttons (7 buttons) and sewing speed controller**
Use these buttons and the slide to operate the sewing machine. (page B-11)
- ⑬ **Flat bed attachment with accessory compartment**
Store presser feet and bobbins in the accessory compartment of the flat bed attachment. When sewing cylindrical pieces, remove the flat bed attachment. (page B-12)
- ⑭ **Thread cutter**
Pass the threads through the thread cutter to cut them. (page B-48)
- ⑮ **Thread guide plate**
Pass the thread around the thread guide plate when threading upper thread. (page B-46)

■ Right-side/Rear View

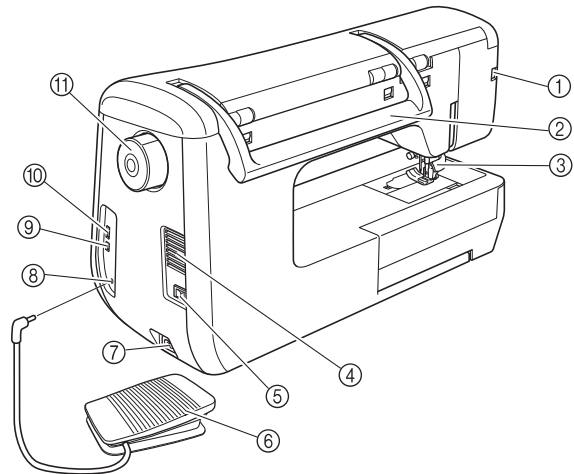

- ① **Connector for the optional presser foot**
Connect the dual feed foot or embroidery foot with LED pointer. (page B-60, B-67)
- ② **Handle**
Carry the sewing machine by its handle when transporting the machine.
- ③ **Presser foot lever**
Raise and lower the presser foot lever to raise and lower the presser foot. (page B-53)
- ④ **Air vent**
The air vent allows the air surrounding the motor to circulate. Do not cover the air vent while the sewing machine is being used.
- ⑤ **Main power switch**
Use the main power switch to turn the sewing machine ON and OFF. (page B-19)
- ⑥ **Foot controller**
Depress the foot controller to control the speed of the machine. (page S-4)
- ⑦ **Power cord receptacle**
Insert the power cord into the machine receptacle. (page B-19)
- ⑧ **Foot controller jack**
Insert the foot controller plug into its jack on the machine. (page S-4)
- ⑨ **USB port for computer**
In order to import/export patterns between a computer and the machine, plug the USB cable into the USB port. (page B-65, S-97, E-47)
- ⑩ **USB port for mouse/media (USB 2.0)**
In order to send patterns from/to USB media, plug the USB media directly into the USB port. (page B-65, S-96, E-46)
Connect the USB mouse to operate with mouse. (page B-66)
- ⑪ **Handwheel**
Rotate the handwheel toward you (counterclockwise) to raise and lower the needle. The wheel should be turned toward the front of the machine.

Needle and Presser Foot Section

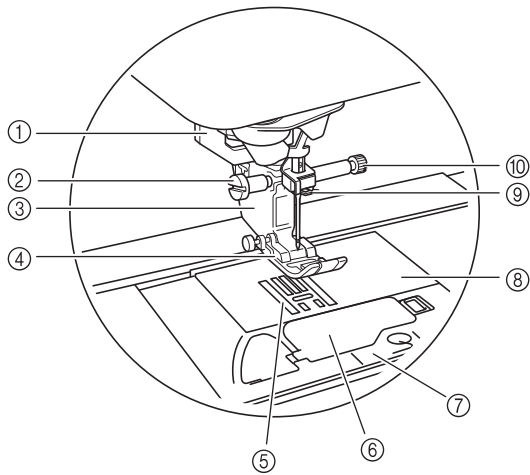

- ① **Buttonhole lever**
The buttonhole lever is used with the one-step buttonhole foot to create buttonholes. (page S-55)
- ② **Presser foot holder screw**
Use the presser foot holder screw to hold the presser foot in place. (page B-53, B-59)
- ③ **Presser foot holder**
The presser foot is attached to the presser foot holder. (page B-53)
- ④ **Presser foot**
The presser foot consistently applies pressure to the fabric as sewing takes place. Attach the appropriate presser foot for the selected stitch. (page B-53)
- ⑤ **Feed dogs**
The feed dogs feed the fabric in the sewing direction.
- ⑥ **Bobbin cover**
Open the bobbin cover to set the bobbin. (page B-43, S-32)
- ⑦ **Needle plate cover**
Remove the needle plate cover to clean the race. (page S-26, E-22)
- ⑧ **Needle plate**
The needle plate is marked with guides to help sew straight seams. (page S-26)
- ⑨ **Needle bar thread guide**
Pass the upper thread through the needle bar thread guide. (page B-46)
- ⑩ **Needle clamp screw**
Use the needle clamp screw to hold the needle in place. (page B-53)

Measurements on the needle plate, bobbin cover (with mark) and needle plate cover

The measurements on the bobbin cover are references for patterns with a middle (center) needle position. The measurements on the needle plate and the needle plate cover are references for stitches with a left needle position.

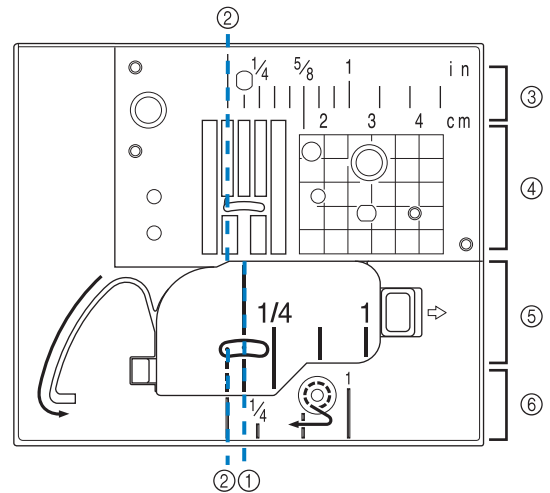

- ① **For stitches with a middle (center) needle position**
- ② **For stitches with a left needle position**
- ③ **Left needle position on the needle plate <inch>**
- ④ **Left needle position on the needle plate <cm>**
- ⑤ **Middle (center) needle position on the bobbin cover (with mark) <inch>**
- ⑥ **Left needle position on the needle plate cover <inch>**

Embroidery Unit

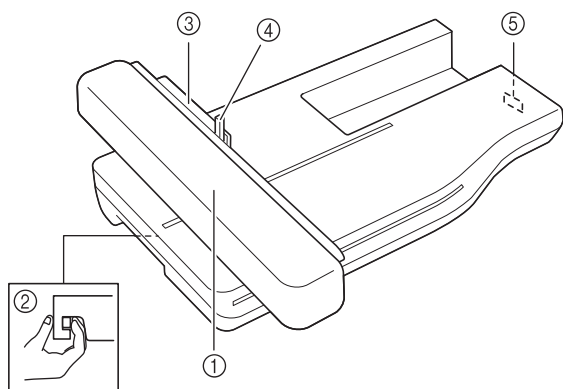







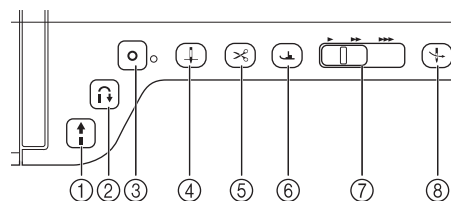

- ① **Carriage**
The carriage moves the embroidery frame automatically when embroidering. (page B-62)
- ② **Release button (located under the embroidery unit)**
Press the release button to remove the embroidery unit. (page B-62)
- ③ **Embroidery frame holder**
Insert the embroidery frame into the embroidery frame holder to hold the frame in place. (page E-17)
- ④ **Frame-securing lever**
Press the frame-securing lever down to secure the embroidery frame. (page E-17)
- ⑤ **Embroidery unit connection**
Insert the embroidery unit connection into the connection port when attaching the embroidery unit. (page B-62)

⚠ CAUTION

- Before inserting or removing the embroidery unit, turn the main power to OFF.
- After the embroidery frame is set in the frame holder, be sure the frame-securing lever is correctly lowered.

Operation Buttons



- ① **“Start/Stop” button** 
Press this button and the machine will sew a few stitches at a slow speed and then begin sewing at the speed set by the sewing speed controller. Press the button again to stop the machine. Hold the button in to sew at the machine’s slowest speed. The button changes color according to the machine’s operation mode.
Green: The machine is ready to sew or is sewing.
Red: The machine cannot sew.
- ② **“Reverse Stitch” button** 
For straight, zigzag, and elastic zigzag stitch patterns that take reverse stitches, the machine will sew reverse stitches at low speed only while holding down the “Reverse Stitch” button. The stitches are sewn in the opposite position. For other stitches, use this button to sew reinforcement stitches at the beginning and end of sewing. Press and hold this button, and the machine sews 3 stitches in the same spot and stops automatically. (see page S-5)
- ③ **“Reinforcement Stitch” button** 
Use this button to sew a single stitch repeatedly and tie-off. For character/decorative stitches, press this button to end with a full stitch instead of at a mid-point. The LED light beside this button lights up while the machine is sewing a full motif, and automatically turns off when the sewing is stopped. (see page S-5)
- ④ **“Needle Position” button** 
Use this button when changing sewing direction or for detailed sewing in small areas. Press this button to raise or lower the needle position. With this button, you can lower and raise the needle to sew a single stitch.
- ⑤ **“Thread Cutter” button** 
Press this button after sewing to automatically trim the excess thread.
- ⑥ **“Presser Foot Lifter” button** 
Press this button to lower the presser foot and apply pressure to the fabric. Press this button again to raise the presser foot.
- ⑦ **Sewing Speed controller** 
Use this controller to adjust the sewing speed. Move the slide to the left to sew at slower speeds. Move the slide to the right to sew at higher speeds. Beginners should sew at a slow speed.
- ⑧ **“Automatic Threading” button** 
Use this button to automatically thread the needle.

⚠ CAUTION

- Do not press the thread cutter button after the threads have been cut. The needle may break and threads may become tangled, or damage to the machine may occur.

Using the Flat Bed Attachment

Pull the top of the flat bed attachment to open the accessory compartment.

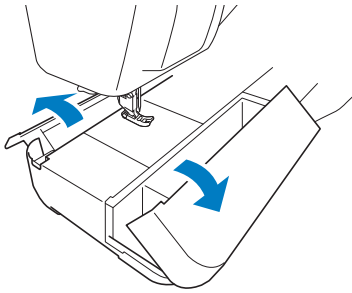

A presser foot storage tray is stored in the accessory compartment of the flat bed attachment.

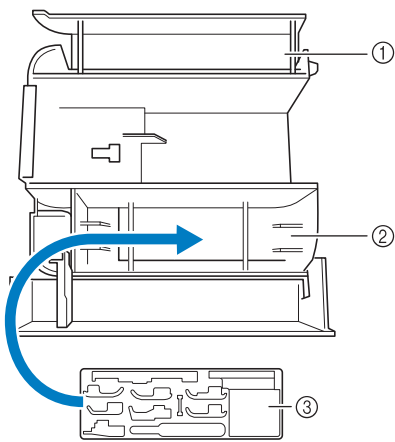

- ① Storage space of the flat bed attachment
- ② Presser foot storage space of the flat bed attachment
- ③ Presser foot storage tray
There are also storage spaces for optional presser feet, such as the vertical stitch alignment foot "V".

Included Accessories

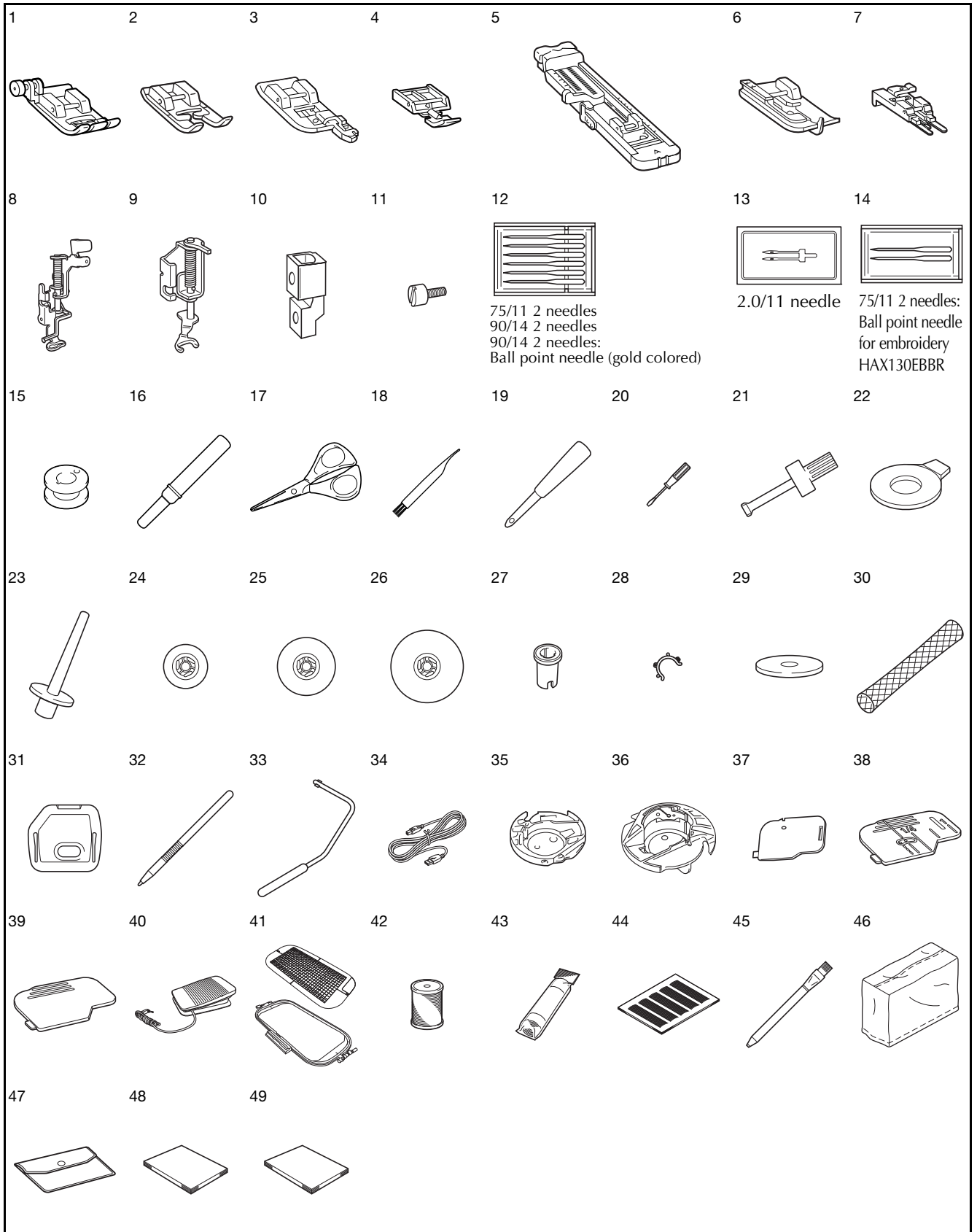

No.	Part Name	Part Code	
		Americas	Others
1	Zigzag foot "J" (on machine)	XF3022-001	
2	Monogramming foot "N"	X53840-351	
3	Overcasting foot "G"	XC3098-051	
4	Zipper foot "I"	X59370-051	
5	Buttonhole foot "A"	X57789-251	
6	Blind stitch foot "R"	X56409-051	
7	Button fitting foot "M"	130489-001	
8	Embroidery foot "W"	XF4012-001	
9	Free motion open toe quilting foot "O"	XF4873-001	
10	Adapter	XF3613-001	
11	Screw (small)	XA4813-051	
12	Needle set*1	X58358-051	
13	Twin needle*2	X59296-151	
14	Ball point needle set*3	XD0705-051	
15	Bobbin × 10 (One is on machine.)	SA156	SFB: XA5539-151
16	Seam ripper	XF4967-001	
17	Scissors	XC1807-121	
18	Cleaning brush	X59476-051	
19	Eyelet punch	XZ5051-001	
20	Screwdriver (small)	X55468-051	
21	Screwdriver (large)	XC4237-021	
22	Disc-shaped screwdriver	XC1074-051	
23	Vertical spool pin	XC8619-052	
24	Spool cap (small)	130013-154	
25	Spool cap (medium) × 2 (One is on machine.)	X55260-153	
26	Spool cap (large)	130012-054	
27	Spool cap (special)	XA5752-121	
28	Bobbin clip × 10	XE3060-001	
29	Spool felt (on machine)	X57045-051	
30	Spool net × 2	XA5523-050	
31	Embroidery needle plate cover	XE5131-001	
32	Touch pen (stylus)	XA9940-051	
33	Knee lifter	XA6941-052	
34	USB cable	XD0745-051	
35	Alternate bobbin case (no color on the screw)	XC8167-551	
36	Bobbin case (gray, for bobbin work)	XE8298-001	
37	Cord guide bobbin cover (with single hole)	XE8991-101	
38	Bobbin cover (with mark)	XF0750-101	
39	Bobbin cover (on machine)	XE8992-101	
40	Foot controller	XD0501-151(EU area) XC8816-051 (other area)	
41	Embroidery frame set (extra large) H 30 cm × W 18 cm (H 12 inches × W 7 inches)	SA440	EF76: XC8482-152
42	Embroidery bobbin thread	SA-EBT	XC6283-001
43	Stabilizer material	SA519	BM3: XE0806-001
44	Grid sheet set	SA507	GS3: X81277-151
45	Chalk pencil	XE8568-001	
46	Dust cover	VM5100 : XF4569-001 V5 : XF4113-001	
47	Accessory bag	XC4487-021	
48	Operation manual	This manual	
49	Quick Reference Guide	XF6503-001	XF3617-001

- *1 75/11 2 needles
90/14 2 needles
90/14 2 needles: Ball point needle (gold colored)
- *2 2.0/11 needle
- *3 75/11 2 needles:
Ball point needle for embroidery
HAX130EBBR



Memo

- Foot controller: Model T
This foot controller can be used on the machine with product code 882-C50. The product code is mentioned on the machine rating plate.
- Always use accessories recommended for this machine.
- Placing bobbin clips on bobbins helps prevent the thread from unwinding from the bobbin. In addition, snapping bobbin clips together allows the bobbins to be conveniently stored and prevents them from rolling around if they are dropped.

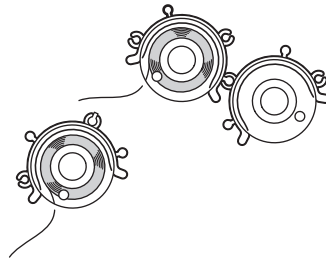

Accessories that are Included in Some Countries or Regions

If these accessories are not included with your machine, these are available as optional accessories.

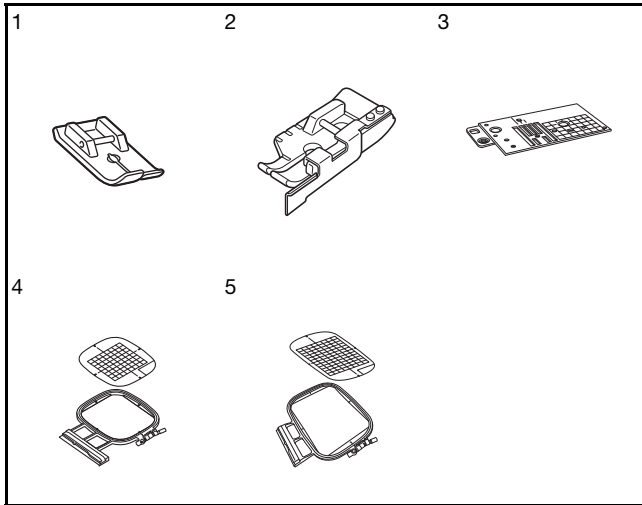

No.	Part Name	Part Code	
		Americas	Others
1	Straight stitch foot	SA167	F042N: XC1973-052
2	1/4" quilting foot with guide	SA185	F057: XC7416-252
3	Straight stitch needle plate	XF3076-001	
4	Embroidery frame set (medium) H 10 cm x W 10 cm (H 4 inches x W 4 inches)	SA438	EF74: XC8480-152
5	Embroidery frame set (large) H 18 cm x W 13 cm (H 7 inches x W 5 inches)	SA439	EF75: XC8481-152

Options

The following are available as optional accessories to be purchased separately from your authorized Brother dealer.

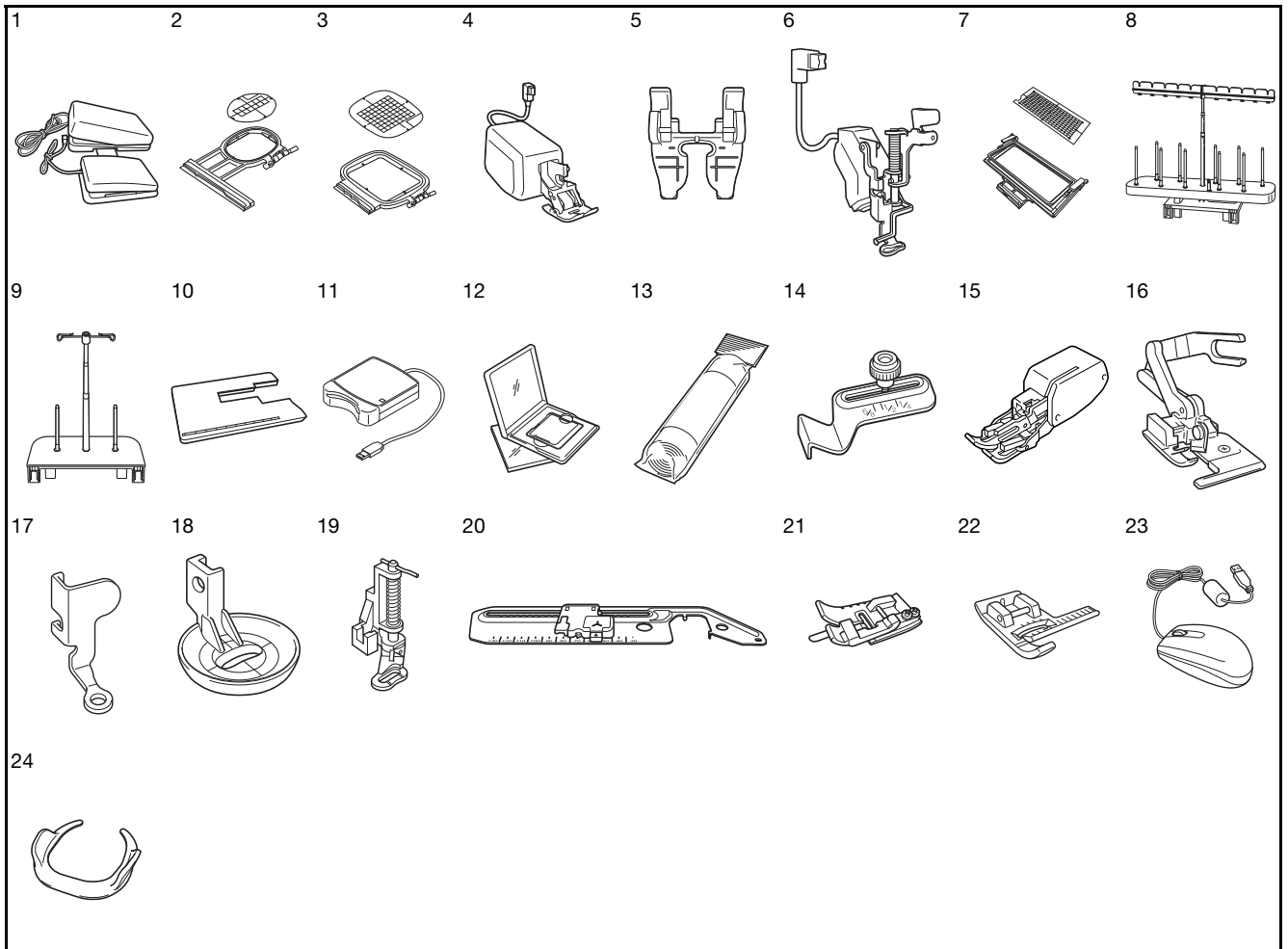

No.	Part Name	Part Code	
		Americas	Others
1	Multi-function foot controller	SAMFFC (USA) SAMFFCC (Canada)	MFFC1: XF4159-001 MFFC1OC: XF4471-001 (Australia)
2	Embroidery frame set (small) H 2 cm x W 6 cm (H 1 inch x W 2-1/2 inches)	SA437	EF73: XC8479-152
3	Square embroidery frame H 15 cm x W 15 cm (H 6 inches x W 6 inches)	SA448 (USA) SA448C (Canada)	SEF150: XF4163-001
4	Dual feed foot	SA196 (USA) SA196C (Canada)	DF1: XF4166-001 (EU area) DF1AP: XF6843-001 (other area)
5	Open toe for dual feed foot	SA195	F070: XF6096-001
6	Embroidery foot "W+" with LED pointer	SA197 (USA) SA197C (Canada)	FLED1: XF4168-001 (EU area) FLED1AP: XF6845-001 (other area)
7	Border embroidery frame H 30 cm x W 10 cm (H 12 inches x W 4 inches)	SABF6200D1 (USA) SABF6200D1C (Canada)	BF3: XF4170-001
8	10 spool stand	SA561 (USA) SA561C (Canada)	TS5: XF4175-001
9	King spool thread stand	SA562 (USA) SA562C (Canada)	TS6: XF4180-001
10	Wide table	SAWT6200D (USA) SAWT6200DC (Canada)	WT10: XF4184-001
11	Embroidery card Reader	SAECRI	
12	Embroidery card	-	
13	Stabilizer material	SA519	BM3: XE0806-001
	Water soluble stabilizer	SA520	BM5: XE0615-001
14	Seam guide	SA538	SG1: XC8483-052
15	Walking foot	SA140	F033N: XC2214-052
16	Side cutter foot	SA177	F054: XC3879-152
17	Free motion quilting foot "C"	XF4737-001	
18	Free motion echo quilting foot "E"	XE0766-001	
19	Free-motion quilting foot	SA129	F005N: XC1948-052
20	Circular attachment	SACIRC1	CIRC1: XE3527-001
21	Stitch in the ditch foot	SA191	F065: XF2339-001
22	Vertical stitching alignment foot "V"	SA189	F063: XE5224-001
23	USB mouse	XE5334-101	
24	Free motion guide grip	SAFMGRIP	FMG2: XF6266-001 (EU area) FMG2AP: XF6267-001 (other area)



Memo

- All specifications are correct at the time of printing. Please be aware that some specifications may change without notice.



Note

- Embroidery cards purchased in foreign countries may not work with your machine.
- Visit your dealer or nearest authorized Brother dealer for a complete listing of optional accessories and embroidery cards available for your machine.

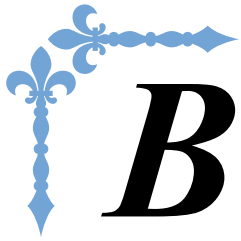

Basic operations

This section provides details on the initial setup procedures as well as descriptions of this machine's more useful functions.

Page number starts with "B" in this section.

Chapter1 Getting Ready	B-18
-------------------------------------	-------------

B *Basic operations*

Chapter 1 Getting Ready

TURNING THE MACHINE ON/OFF	19
Setting Your Machine for the First Time	20
LCD SCREEN	22
■ Home Page Screen	22
■ Utility Stitch Screen	23
■ Key Functions	24
Using the Machine Setting Mode Key	26
■ Selecting the “Eco Mode” or “Shutoff Support Mode”	30
■ Changing the Pointer Shape When a USB Mouse Is Used	30
■ Selecting the Initial Screen Display	30
■ Choosing the Display Language	31
■ Changing the Background Colors of the Embroidery Patterns	31
■ Specifying the Size of Pattern Thumbnails	32
■ Saving a Settings Screen Image to USB Media	33
Using the Sewing Machine Help Key	34
Using the Operation Guide Function	35
Using the Sewing Guide Function	36
Using the Pattern Explanation Function	37
LOWER THREADING	38
Winding the Bobbin	38
■ Using the Supplemental Spool Pin	38
■ Using the Spool Pin	41
■ Untangling Thread from Beneath the Bobbin Winder Seat	42
Setting the Bobbin	43
Pulling Up the Bobbin Thread	45
UPPER THREADING	46
Upper Threading	46
Using the Twin Needle Mode	49
Using Threads that Unwind Quickly	51
■ Using the Spool Net	51
■ Using the Vertical Spool Pin	52
CHANGING THE PRESSER FOOT	53
Removing the Presser Foot	53
Attaching the Presser Foot	53
Attaching the Presser Foot with the Included Adapter	53
■ Attaching the Walking foot	54
CHANGING THE NEEDLE	55
ABOUT THE NEEDLE AND FABRIC	56
About the Needle	56
Fabric/Thread/Needle Combinations	57
BEFORE EMBROIDERING	58
Embroidery Step by Step	58
Attaching the Embroidery Foot “W”	59
Using the Optional Embroidery Foot “W+” with LED Pointer	60
■ Attaching the Embroidery Foot “W+” with LED Pointer	60
■ Checking the Needle Drop Point With the Embroidery Foot “W+” with LED Pointer	61
■ Adjusting the LED Pointer	61
■ Adjusting the Brightness of the LED Pointer	62
Attaching the Embroidery Unit	62
■ About the Embroidery Unit	62
■ Removing the Embroidery Unit	63
USING FUNCTIONS BY CONNECTING THE ACCESSORY TO THE MACHINE	65
Using USB Media or Embroidery Card Reader/ USB Card Writer Module*	65
Connecting the Machine to the Computer	65
Using a USB Mouse	66
■ Clicking a Key	66
■ Changing Pages	66
Using the Optional Dual Feed Foot	67
■ Attaching the Dual Feed Foot	67
■ Attaching/detaching toe	67
■ Using the Dual Feed Position Lever	68
■ Adjusting the Amount of Fabric Feeding of the Dual Feed Foot	68

TURNING THE MACHINE ON/OFF

WARNING

- Use only regular household electricity for the power source. Using other power sources may result in fire, electric shock, or damage to the machine.
- Make sure that the plugs on the power cord are firmly inserted into the electrical outlet and the power cord receptacle on the machine.
- Do not insert the plug on the power cord into an electrical outlet that is in poor condition.
- Turn the main power to OFF and remove the plug in the following circumstances:
 - When you are away from the machine
 - After using the machine
 - When the power fails during use
 - When the machine does not operate correctly due to a bad connection or a disconnection
 - During electrical storms

CAUTION

- Use only the power cord included with this machine.
- Do not use extension cords or multi-plug adapters with many other appliances plugged in to them. Fire or electric shock may result.
- Do not touch the plug with wet hands. Electric shock may result.
- When unplugging the machine, always turn the main power to OFF first. Always grasp the plug to remove it from the outlet. Pulling on the cord may damage the cord, or lead to fire or electric shock.
- Do not allow the power cord to be cut, damaged, modified, forcefully bent, pulled, twisted, or bundled. Do not place heavy objects on the cord. Do not subject the cord to heat. These things may damage the cord, or cause fire or electric shock. If the cord or plug is damaged, take the machine to your authorized dealer for repairs before continuing use.
- Unplug the power cord if the machine is not to be used for a long period of time. Otherwise, a fire may result.
- When leaving the machine unattended, either the main switch of the machine should be turned to OFF or the plug must be removed from the socket-outlet.
- When servicing the machine or when removing covers, the machine must be unplugged.
- For USA only
This appliance has a polarized plug (one blade wider than the other). To reduce the risk of electrical shock, this plug is intended to fit in a polarized outlet only one way. If the plug does not fit fully in the outlet, reverse the plug. If it still does not fit, contact a qualified electrician to install the proper outlet. Do not modify the plug in any way.

- 1 Insert the power supply cord into the power cord receptacle, then insert the plug into a wall outlet.

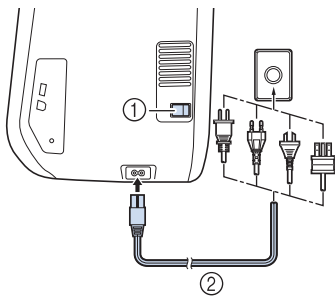

- ① Main power switch
- ② Power supply cord

- 2 Turn the main power switch to "I" to turn on the machine.

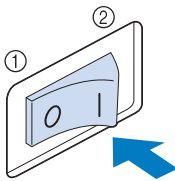

- ① OFF
- ② ON



Note

- When the straight stitch needle plate is on the machine, the needle will automatically move to the middle position.



Memo

- When the machine is turned on, the needle and the feed dogs will make sound when they move; this is not a malfunction.

- 3 When the machine is turned on, the opening movie is played. Touch anywhere on the screen to display the Home page screen.

CAUTION

- Only touch the screen with your finger or the included touch pen. Do not use a sharp pencil, screwdriver, or other hard or sharp object. It is not necessary to press hard on the screen. Pressing too hard or using a sharp object may damage the screen.

- 4 Turn the main power switch to "O" to turn off the machine.



Memo

- If the machine is turned off in the middle of sewing in the "Sewing" function, the operation will not continued after turning the power on again.

Setting Your Machine for the First Time

When you first turn on the machine, set the language and time/date to your language and local time/date. Follow the procedure below when the settings screen appears automatically.

- 1 Press and to set your local language.

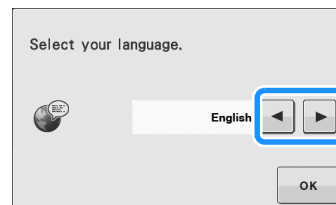

- 2 Press .

- 3 The message screen, confirming if you want to set time/date, appears. To set the time/date, press ; to cancel the setting, press .

→ The screen to set time/date appears.

4 Press **-** or **+** to set time/date.

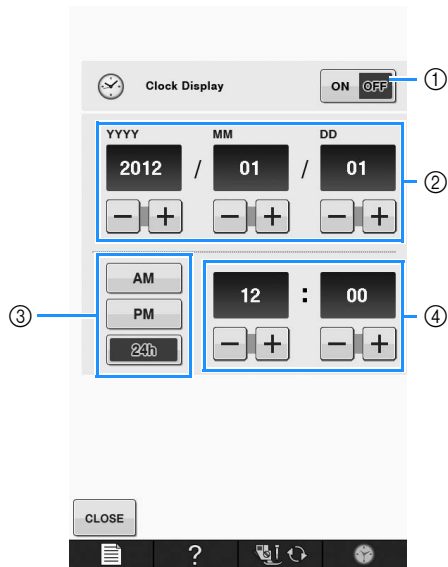

- ① Press to display the time on the screen.
- ② Set the year (YYYY), month (MM) and date (DD).
- ③ Select whether 24h or 12h setting to display.
- ④ Set the current time.

5 Press **CLOSE** to start using your machine.

→ The clock starts from 0 second of the time you set.



Note

- The time/date you set may be cleared, if you don't turn on the machine for a certain period.



LCD SCREEN

⚠ CAUTION

- Only touch the screen with your finger or the included touch pen. Do not use a sharp pencil, screwdriver, or other hard or sharp object. It is not necessary to press hard on the screen. Pressing too hard or using a sharp object may damage the screen.

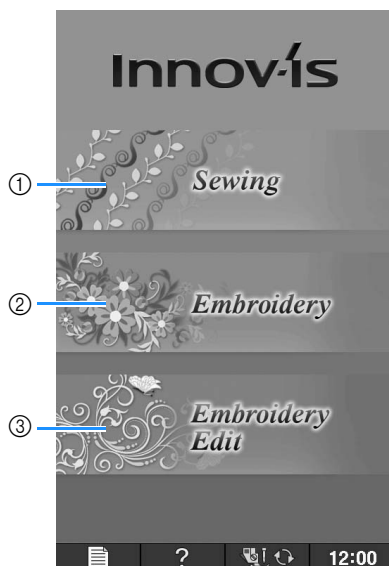
■ Home Page Screen



No.	Display	Key Name	Explanation	Page
①		"Sewing" key	Press this key to sew utility stitches or character or decorative stitch patterns.	See the "Key Functions" table. B-24
②		"Embroidery" key	Attach the embroidery unit and press this key to embroider patterns.	E-3
③		"Embroidery Edit" key	Press this key to combine embroidery patterns. With the "Embroidery Edit" functions, you can also create original embroidery patterns or frame patterns.	E-57

Utility Stitch Screen

Press a key with your finger to select the stitch pattern, to select a machine function, or to select an operation indicated on the key. When the key display is light gray, the function is not currently available.

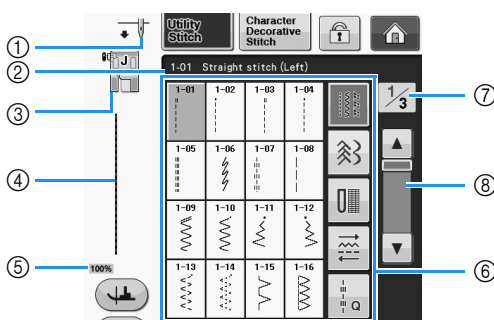





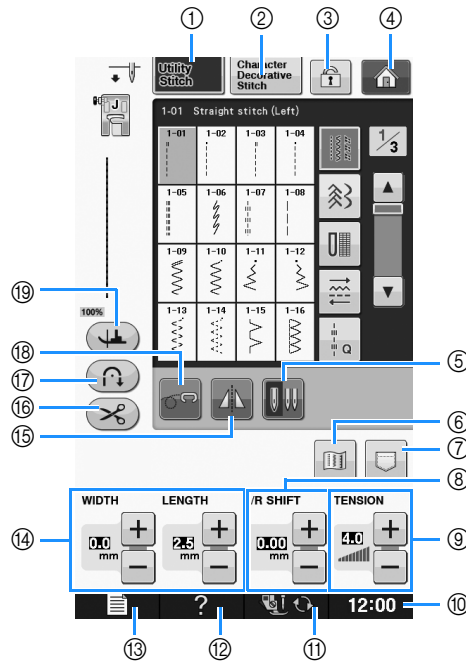

No.	Display	Key Name	Explanation	Page
①		Needle position setting display	Shows single or twin needle mode setting, and the needle stop position. Single needle/down position Single needle/up position Twin needle/down position Twin needle/up position	-
②		Selected stitch display	Shows the name and code number of the selected stitch.	S-3
③		Presser foot display	Shows the presser foot code. Attach the presser foot indicated in this display before sewing.	B-53
④		Stitch preview	Shows a preview of the selected stitch. When shown at 100%, the stitch appears in the screen at nearly its actual size.	S-21
⑤		Pattern display size	Shows the approximate size of the pattern selected. 100% : Nearly the same size as the sewn pattern 50% : 1/2 the size of the sewn pattern 25% : 1/4 the size of the sewn pattern * The actual size of the sewn pattern may differ depending on the type of fabric and thread that is used.	S-21
⑥		Stitch selection screen	Press the key for the pattern you want to sew. Use to change to different stitch groups.	S-21
⑦		Page display	Shows additional pages that can be displayed.	-
⑧		Scroll key	Press or , to move one page at a time, or touch anywhere on the bar to jump ahead for additional pages of stitches.	-

* All key functions of the LCD are explained in the "Key Functions" table on the following page.

■ Key Functions







No.	Display	Key Name	Explanation	Page
①		“Utility Stitch” key	Press this key to select a straight stitch, zigzag stitch, buttonhole, blind hem stitch, or other stitches commonly used in garment construction.	S-21
②		“Character/ Decorative Stitch” key	Press this key to select character or decorative stitch patterns.	S-77
③		Screen lock key	Press this key to lock the screen. When the screen is locked, the various settings, such as the stitch width and stitch length, are locked and cannot be changed. Press this key again to unlock the settings.	S-18
④		Home page screen key	Press this key anytime it is displayed to return to the home page screen and select a different category - “Sewing”, “Embroidery” or “Embroidery Edit”.	B-22
⑤		Needle mode selection key (Single/Double)	Press this key to select twin needle sewing mode. The sewing mode changes between single needle mode and twin needle mode each time you press the key. If the key display is light gray, the selected stitch pattern cannot be sewn in the twin needle mode.	B-49
⑥		Image key	Press this key to display an enlarged image of the selected stitch pattern.	S-22
⑦		Machine’s memory key	Press this key to select from 3 memory functions; retrieving, storing or reset.	S-22, S-95, S-97
⑧		“L/R SHIFT” key	Shows the tendency of Left/Right of the center line of the original zigzag stitch currently selected stitch pattern.	S-11
⑨		Thread tension key	Shows the automatic thread tension setting of the currently selected stitch pattern. You can use the plus and minus keys to change the thread tension settings.	S-12
⑩		Clock key	Press this key to set the clock to your local time.	B-20
⑪		Presser foot/Needle exchange key	Press this key before changing the needle, the presser foot, etc. This key locks all key and button functions to prevent operation of the machine.	B-53 to B-55
⑫		Sewing machine help key	Press this key to see explanations on how to use the machine.	B-34
⑬		Machine setting mode key	Press this key to change the needle stop position, change the volume of operation sound, adjust the pattern or screen, and change other machine settings.	B-26
⑭		Stitch width and stitch length key	Shows the zigzag width and stitch length settings of the currently selected stitch pattern. You can use the plus and minus keys to adjust the zigzag width and stitch length settings.	S-10

No.	Display	Key Name	Explanation	Page
15		Mirror image key	Press this key to create a mirror image of the selected stitch pattern. If the key display is light gray, a mirror image of the selected stitch pattern cannot be sewn.	S-21
16		Automatic thread cutting key	Press this key to set the automatic thread cutting function. Set the automatic thread cutting function before sewing to have the machine automatically sew reinforcement stitches at the beginning and end of sewing (depending on the pattern, the machine may sew reverse stitches) and trim the threads after sewing.	S-14
17		Automatic reverse/reinforcement stitch key	Press this key to use the automatic reverse/reinforcement stitching setting. If you select this setting before sewing, the machine will automatically sew reverse stitches or reinforcement stitches depending on the pattern, at the beginning and end of sewing.	S-5
18		Free motion mode key	Press this key to enter free motion sewing mode. The presser foot is raised to an appropriate height and the feed dog is lowered for free motion quilting.	S-40
19		Pivot key	<p>Press this key to select the pivot setting. When the pivot setting is selected, stopping the machine lowers the needle and slightly raises the presser foot automatically. In addition, when sewing is restarted, the presser foot is automatically lowered.</p> <ul style="list-style-type: none"> • If this key appears as , the pivot function cannot be used. • Be sure the needle position on page B-27 of Machine Settings is set to the down position. 	S-15

For additional operational information, refer to page reference number listed above.

Using the Machine Setting Mode Key

Press  to change the default machine settings (needle stop position, embroidery speed, opening display, etc.). To display the different settings screens, press  for “Sewing settings”,  for “General settings” or  for “Embroidery settings”.

Memo

- Press  or  next to the page numbers, to display a different settings screen.

Sewing settings

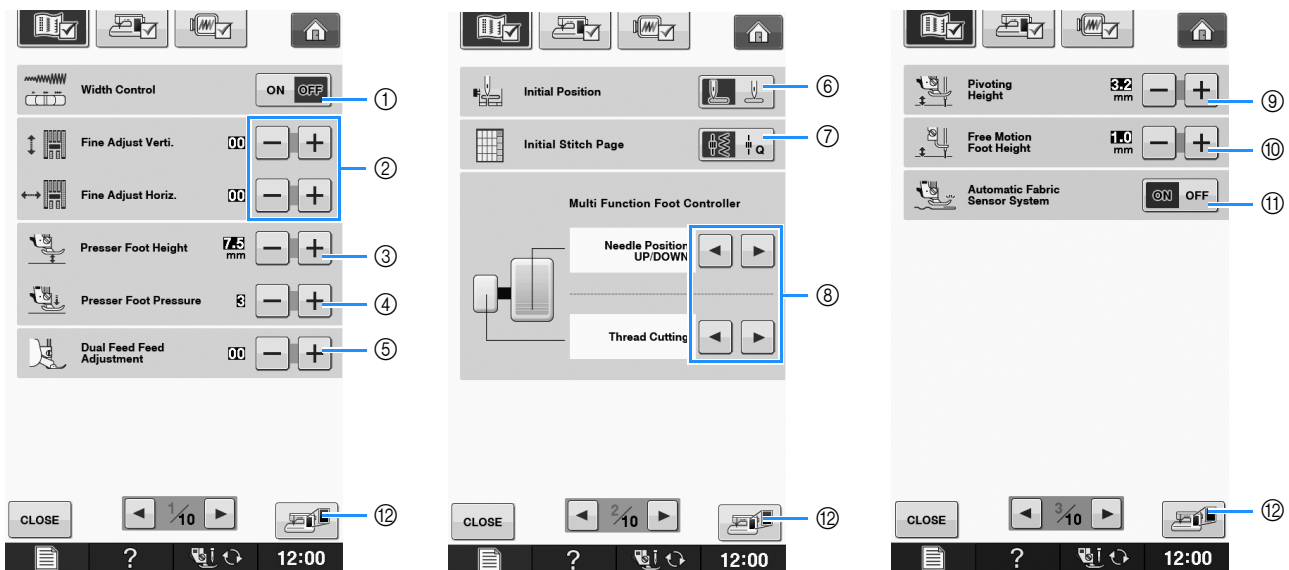

- ① Select whether to use the sewing speed controller to determine the zigzag width (see page S-39).
- ② Make adjustments to character or decorative stitch patterns (see page S-82).
- ③ Adjust the presser foot height. (Select the height of the presser foot when the presser foot is raised.)
- ④ Adjust the presser foot pressure. (The higher the number, the greater the pressure will be. Set the pressure at “3” for normal sewing.) (see page S-17)
If the dual feed foot is installed and its roller is lowered, the pressure setting is fixed at “2” and cannot be changed.
- ⑤ Fine tune the feed of the dual feed foot (see page B-67).
- ⑥ Select whether “1-01 Straight stitch (Left)” or “1-03 Straight stitch (Middle)” is the utility stitch that is automatically selected when the machine is turned on. (see page S-21)
- ⑦ Select whether “Utility Stitch” or “Quilt Stitch” displayed first on the stitch selection screen when the “Sewing” is selected.
- ⑧ You can activate this setting after connecting the optional multi-function foot controller. (These settings are not operable unless the optional multi-function foot controller is attached to the machine.)
- ⑨ Change the height of the presser foot when sewing is stopped when the pivot setting is selected (see page S-15). Adjust the presser foot to one of the three heights (3.2 mm, 5.0 mm and 7.5 mm). (see page S-15)
- ⑩ Change the height of the presser foot when the machine is set to free motion sewing mode (see page S-40).
- ⑪ When set to “ON”, the thickness of the fabric is automatically detected by an internal sensor while sewing. This enables the fabric to be fed smoothly (see pages S-8 and S-17).
- ⑫ Press  to save the current settings screen image to USB media (see page B-33)

General settings

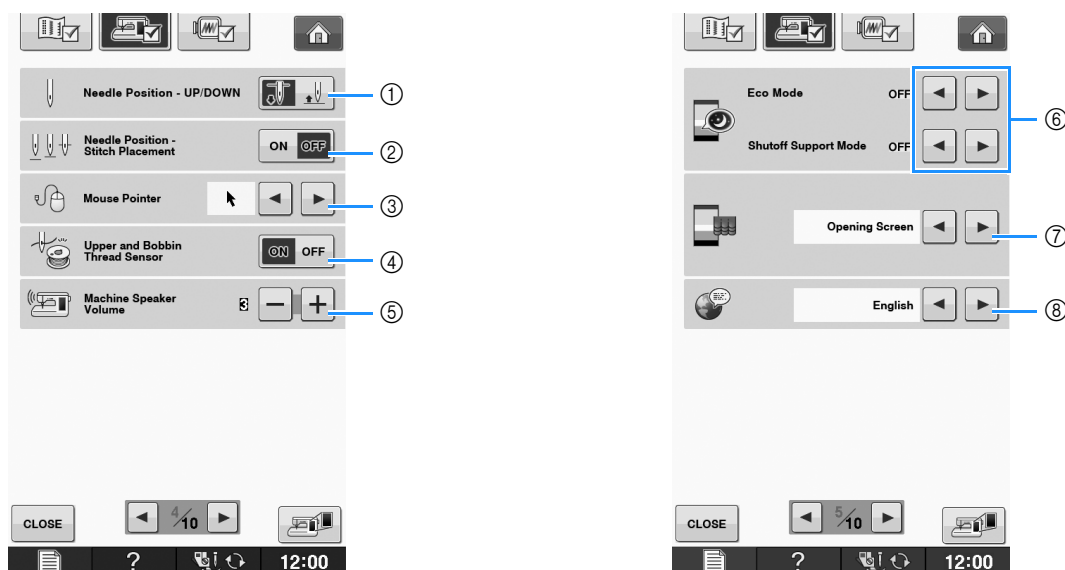

- ① Select the needle stop position (the needle position when the machine is not operating) to be up or down. Select the down position when using the pivot key. (see page S-15)
- ② Select the operation of the “Needle Position – Stitch Placement” button from the following two sequences (see page S-18).
Each press of the “Needle Position – Stitch Placement” button:
“ON” – raises the needle, stops it at a nearly lowered position, then lowers it
“OFF” – raises the needle, then lowers it
- ③ Change the shape of the pointer when a USB mouse is used (see page B-30).
- ④ Turn the “Upper and Bobbin Thread Sensor” “ON” or “OFF”. If it is turned “OFF”, the machine can be used without thread. (see page S-4, E-26)

! CAUTION

- If “Upper and Bobbin Thread Sensor” is set to “OFF”, remove the upper thread. If the machine is used with the upper thread threaded, the machine will not be able to detect if the thread has become tangled. Continuing to use the machine with tangled thread may cause damage.

- ⑤ Change the speaker volume. Increase the number for louder volume, decrease for softer volume.
- ⑥ Select to save the machine power by setting the “Eco Mode” or the “Shutoff Support Mode” (see page B-30).
- ⑦ Select the initial screen that is displayed when the machine is turned on (see page B-30).
- ⑧ Change the display language (see page B-31).

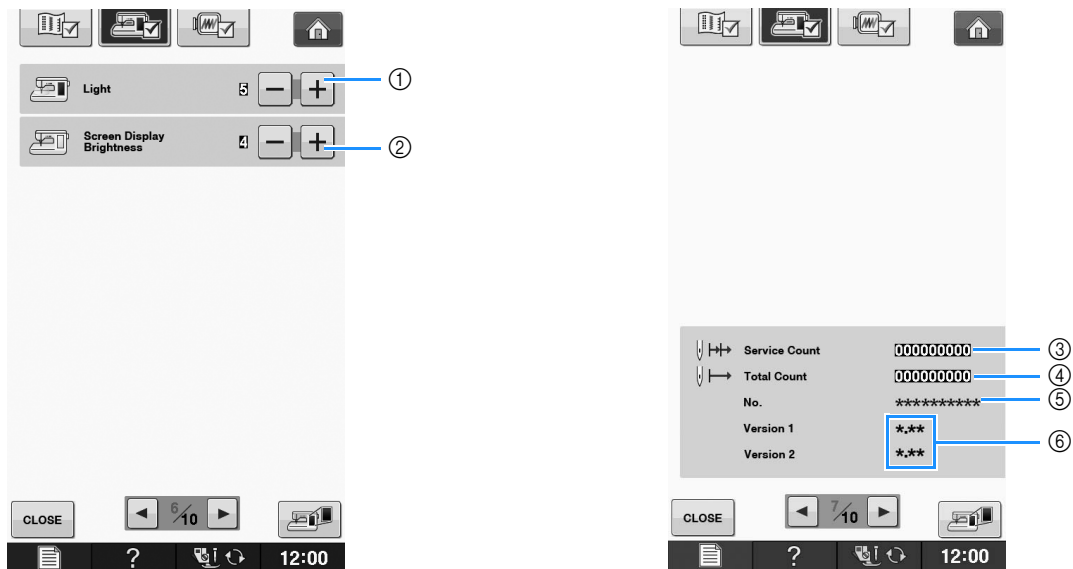

- ① Change the brightness of the needle area and work area lights.
- ② Change the screen display brightness (see page A-22).
- ③ Display the service count which is a reminder to take your machine in for regular servicing. (Contact your authorized dealer for details.)
- ④ Display the total number of stitches sewn on this machine.
- ⑤ The “No.” is the internal machine number for the embroidery and sewing machine.
- ⑥ Display the program version. “Version 1” shows the program version of the LCD panel, “Version 2” shows the program version of the machine.

Memo

- The latest version of software is installed in your machine. Check with your local authorized Brother dealer or at “ <http://solutions.brother.com> ” for available updates (see page A-38).

Embroidery settings

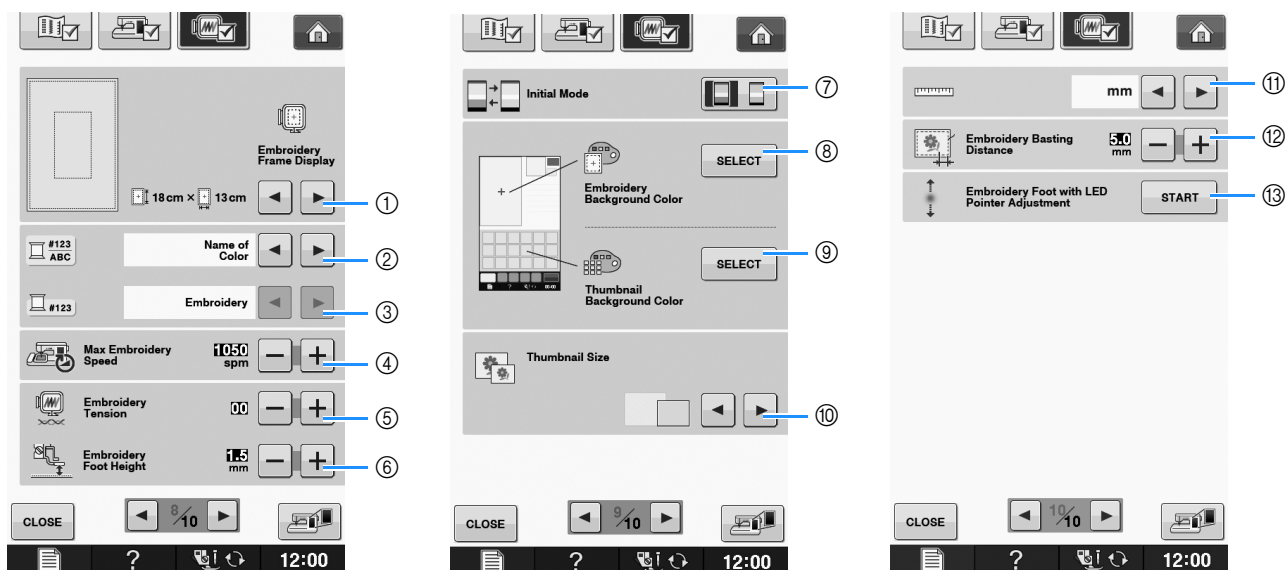

- ① Select from among 16 embroidery frame displays (see page E-35).
- ② Change the thread color display on the “Embroidery” screen; thread number, color name (see page E-34).
- ③ When the thread number “#123” is selected, select from six thread brands (see page E-34).
- ④ Adjust the maximum embroidery speed setting (see page E-33).
- ⑤ Adjust the upper thread tension for embroidering (see page E-30).
- ⑥ Select the height of the embroidery foot during embroidering (see page E-11).
- ⑦ Change the initial mode of the display (Embroidery/Embroidery Edit) (see page E-4).
- ⑧ Change the color of the background for the embroidery display area (see page B-31).
- ⑨ Change the color of the background for the thumbnail area (see page B-31).
- ⑩ Press to specify the size of pattern thumbnails (see page B-32).
- ⑪ Change the display units (mm/inch).
- ⑫ Adjust the distance between the pattern and the basting stitching (see page E-84).
- ⑬ Adjusting the position and brightness of the embroidery foot “W+” with LED pointer (see page B-61).

■ Selecting the “Eco Mode” or “Shutoff Support Mode”

You can save the machine power by setting the eco mode or the shutoff support mode.

If you leave the machine without using for a specified period of time, the machine enters in one of these modes.

“Eco Mode”;





Machine will enter a sleep mode. Touch the screen or press the “Start/Stop” button to continue sewing.

“Shutoff Support Mode”;

Machine will enter lower power modes after set period of time. Turn machine off and then back on to restart sewing.

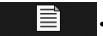
Condition	Eco Mode	Shutoff Support Mode
Available time	OFF, 1 - 120 (minute)	OFF, 1 - 12 (hour)
“Start/Stop” button	Green flashing	Green slow flashing
Suspended function	Machine light, Screen display, LED pointer	All functions
After recovering	The machine starts from the previous operation.	You need to turn off the machine.

Press the “Start/Stop” button or touch the screen display to recover from these modes.

- 1 Press . → The settings screen appears.
- 2 Press . → The General settings screen appears.
- 3 Display page 5 of the General settings screen.
- 4 Use  or  to select the time until entering the mode.

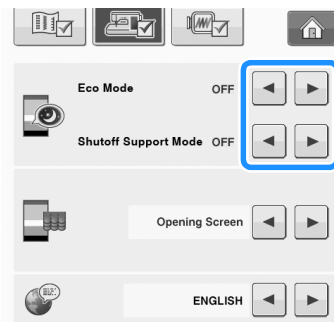

Note







- If you turn off the machine while the machine is in the “Eco Mode” or the “Shutoff Support Mode”, wait for about 5 seconds before turning on the machine again.

■ Changing the Pointer Shape When a USB Mouse Is Used

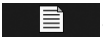
In the settings screen, the shape can be selected for the pointer that appears when a USB mouse is connected. Depending upon the background color, select the desired shape from the three that are available.

Memo

- For details on changing the background color, refer to “Changing the Background Colors of the Embroidery Patterns” on page B-31.

- 1 Press . → The settings screen appears.
- 2 Press . → The General settings screen appears.
- 3 Display page 4 of the General settings screen.
- 4 Use  or  to choose the pointer shape from the three settings available (,  and ).

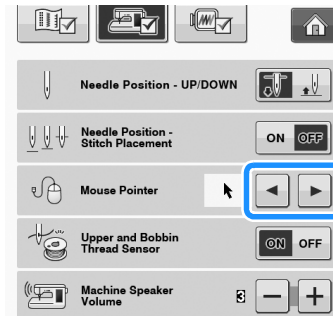



- 5 Press  to return to the original screen.

Memo

- The setting remains selected even if the machine is turned off.

■ Selecting the Initial Screen Display

The Initial screen that appears on the machine can be changed.

- 1 Press . → The settings screen appears.
- 2 Press . → The General settings screen appears.
- 3 Display page 5 of the General settings screen.

- 4 Use ◀ or ▶ to select the setting for the initial screen display.

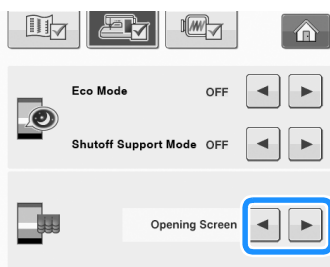

- * **Opening Screen:** When the machine is turned on, the home page screen appears after the opening movie screen is touched.
- * **Home Page:** When the machine is turned on, the home page screen appears.
- * **Sewing/Embroidery Screen:** When the machine is turned on, the “Embroidery” screen appears if the embroidery unit is attached to the machine, or the sewing screen appears if the embroidery unit is not attached to the machine.

- 5 Press **CLOSE** to return to the original screen.

■ Choosing the Display Language

- 1 Press .
→ The settings screen appears.
- 2 Press .
→ The General settings screen appears.
- 3 Display page 5 of the General settings screen.
- 4 Use ◀ and ▶ to choose the display language.

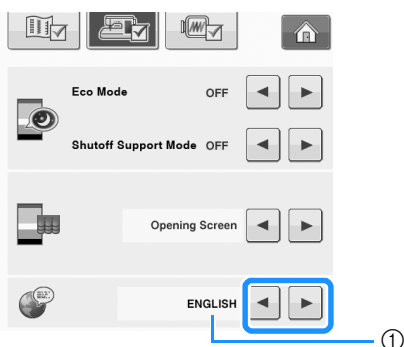

① Display language

- 5 Press **CLOSE** to return to the original screen.

■ Changing the Background Colors of the Embroidery Patterns

In the settings screen, the background colors can be changed for the embroidery pattern and pattern thumbnails. Depending on the pattern color, select the desired background color from the 66 settings available. Different background colors can be selected for the embroidery pattern and pattern thumbnails.

- 1 Press .
→ The settings screen appears.
- 2 Press .
→ The Embroidery settings screen appears.



Memo

- When using the “Embroidery” or “Embroidery Edit”, touch to directly access the Embroidery settings screen.

- 3 Display page 9 of the Embroidery settings screen.

- 4 Press **SELECT**.

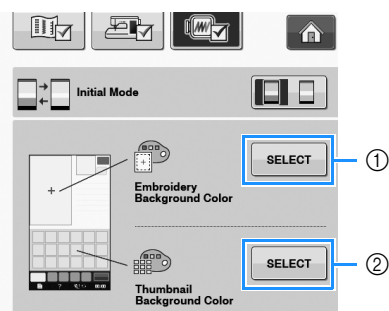

- ① Embroidery pattern background
- ② Pattern thumbnails background

- Select the background color from the 66 available settings.

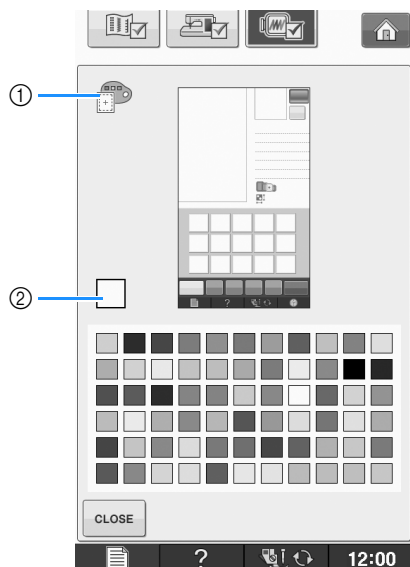

- Embroidery pattern background
- Selected color

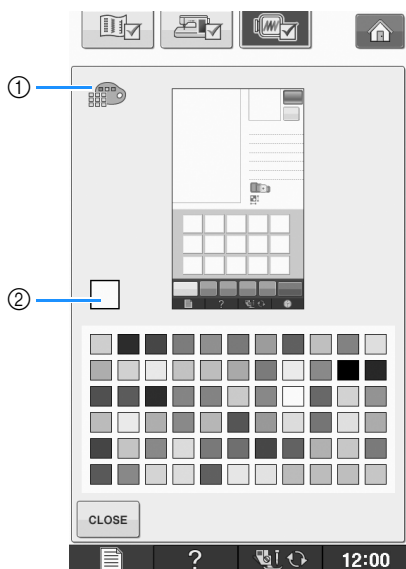

- Pattern thumbnails background
- Selected color

- Press **CLOSE** to return to the original screen.



Memo

- The setting remains selected even if the machine is turned off.

Specifying the Size of Pattern Thumbnails

The thumbnails for selecting an embroidery pattern can be set to be displayed at the smaller size or a larger size. The larger size is 1.5 times the smaller size.

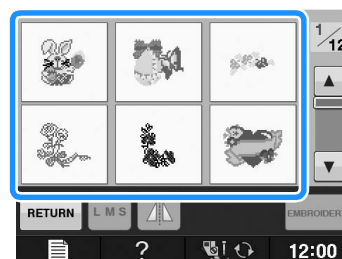
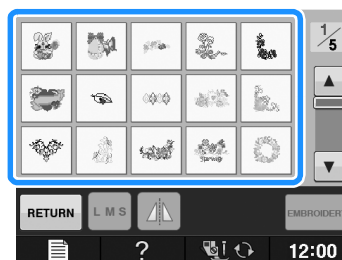

- Press **[List Icon]**.
→ The settings screen appears.
- Press **[Embroidery Icon]**.
→ The Embroidery settings screen appears.
- Display page 9 of the Embroidery settings screen.

- 4 Press ◀ or ▶ to select the desired thumbnail size.

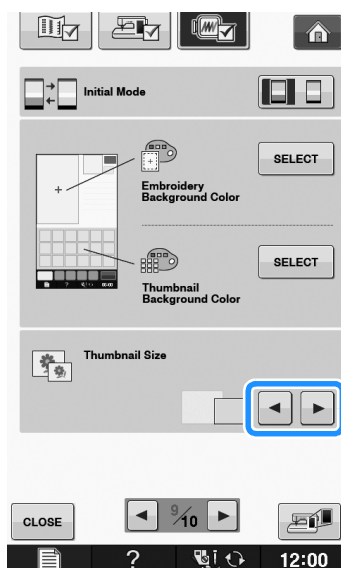

Note

- When thumbnail size setting has been changed the pattern selection screen will not immediately reflect the chosen size. To view the patterns with the new thumbnail size, return to the category selection screen, and then select the pattern category again.

■ Saving a Settings Screen Image to USB Media

An image of the settings screen can be saved as a BMP file.

A maximum of 100 images can be saved on a single USB media at one time.

- 1 Insert the USB media into the USB port on the right side of the machine.

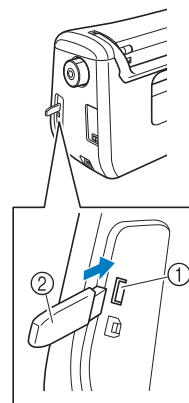

- ① USB port for mouse/media (USB 2.0)
② USB media

- 2 Press .

→ The settings screen appears. Select the settings screen page, make the changes that you want, and then save the screen image.

- 3 Press .

→ The image file will be saved to the USB media.

- 4 Remove the USB media, and then for future reference, check the saved image using a computer.

The files for Settings screen images are saved with the name "S##.BMP".

- * "###" in the name "S##.BMP" will automatically be replaced with a number between S00 and S99.



Note

- If 100 image files have already been saved on the USB media, the following message appears. In this case, delete a file from the USB media or use different USB media.

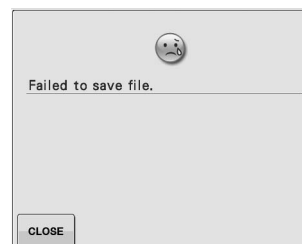

Using the Sewing Machine Help Key

Press  to open the sewing machine help screen. Three functions are available from the screen shown below.

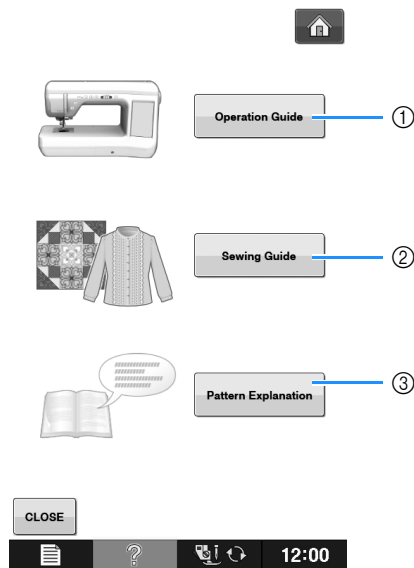

- ① Press this key to see explanation for upper threading, winding the bobbin, changing the presser foot, preparing to embroider a pattern, and how to use the machine (see page B-35).
- ② Press this key to select utility stitches when you are not sure which stitch to use or how to sew the stitch (see page B-36).
- ③ Press this key to see an explanation of the stitch selected (see page B-37).

Using the Operation Guide Function

Press **Operation Guide** to open the screen shown below. Six categories are displayed at the top of the screen. Press a key to see more information about that category.

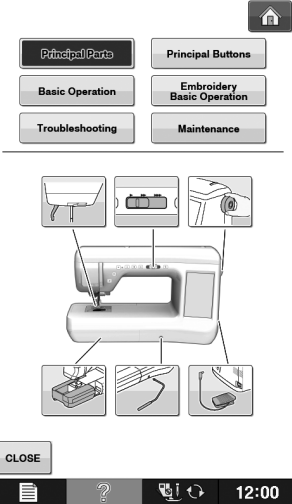
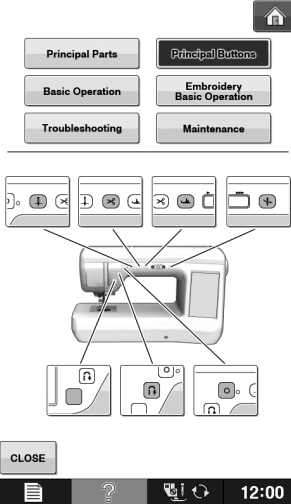
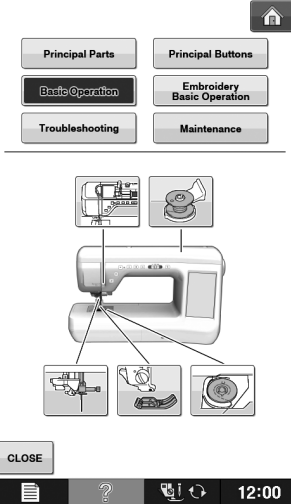
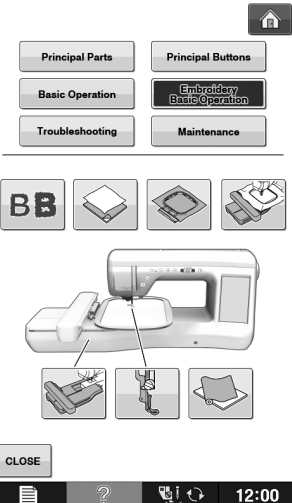
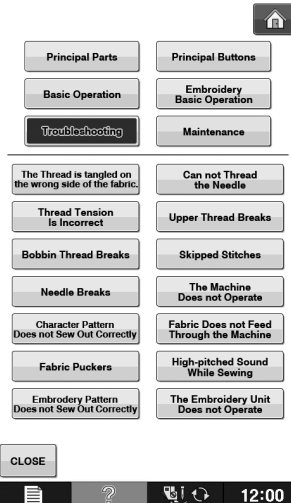
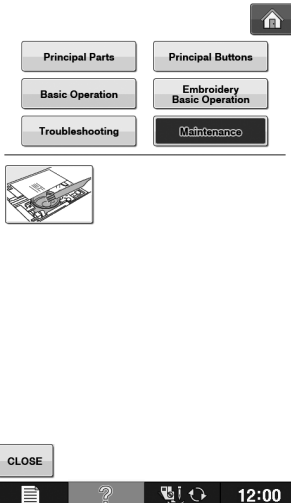
 <p>Principal Parts displays information about the main parts of the machine and their functions. This is the first screen displayed when you press Operation Guide.</p>	 <p>Principal Buttons displays information about the operation buttons.</p>	 <p>Basic Operation displays information about threading the machine, changing presser feet, etc. Some of the functions are described in the movies. Watch these movies for a better understanding of the functions. Certain individual threading screens are animated.</p>
 <p>Embroidery Basic Operation displays information about attaching the embroidery unit, preparing fabric for embroidering, etc.</p>	 <p>Troubleshooting displays troubleshooting information.</p>	 <p>Maintenance displays information about cleaning the machine, etc.</p>

Example: Displaying information about upper threading

1 Press **?**.

2 Press **Operation Guide**.



3 Press **Basic Operation**.

→ The lower half of the screen will change.

4 Press **(upper threading)**.

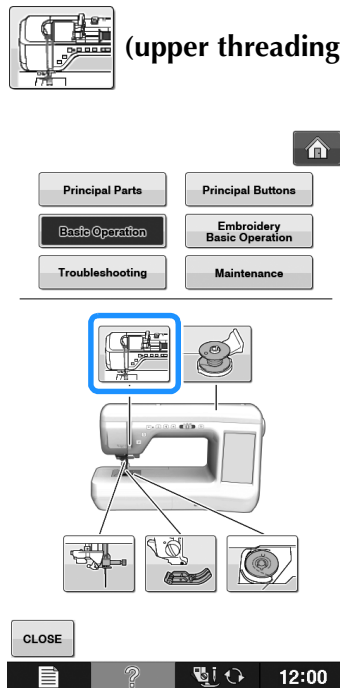

→ The screen shows instructions for threading the machine.

5 Read the instructions.

* To view video, press **video icon** of the displayed instructions.

Press **back** under movie to go back to the beginning. Press **pause** to pause. Press **play** to restart after pause. Press **CLOSE** to close out the movie.

* Press **next** to view the next page.

* Press **previous** to view the previous page.

6 Press **CLOSE** to return to the original screen.

Using the Sewing Guide Function

The sewing guide function can be used to select patterns from the Utility Stitch screen. Use this function when you are not sure which stitch to use for your application, or to get advice about sewing particular stitches. For example, if you want to sew overcasting, but you do not know which stitch to use or how to sew the stitch, you can use this screen to get advice. We recommend that beginners use this method to select stitches.

1 Enter Utility Stitch category from the home page.

2 Press **?**.

3 Press **Sewing Guide**.

→ The advice screen is displayed.

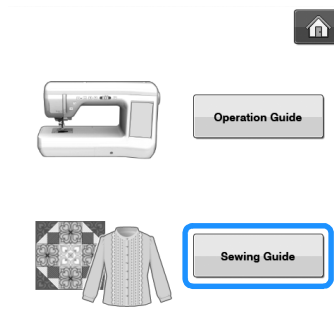



4 Press the key of the category whose sewing instructions you wish to view.

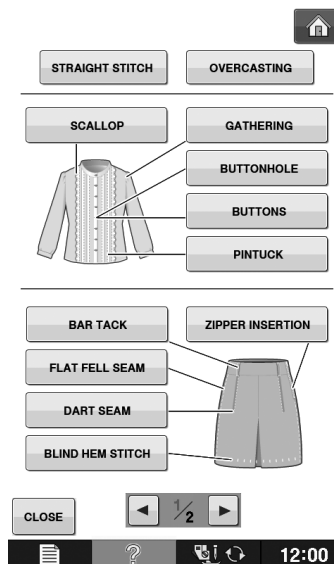

* Press **CLOSE** to return to the original screen.



5 Read the explanations and select the appropriate stitch.

- The screen displays directions for sewing the selected stitch. Follow the directions to sew the stitch.
- * Press  to view the next page.
- * Press  to view the previous page.

Using the Pattern Explanation Function

If you want to know more about the uses of a stitch pattern, select the pattern and press  and then  to see an explanation of the stitch selection.



Note

- With the pattern explanation function, descriptions can be displayed for the patterns available on the Utility Stitch and Character/Decorative Stitch screens.
- Descriptions are displayed for each pattern in the Utility Stitch screen. Description for the Character/Decorative Stitch category is also displayed.
- If the  key appears in gray, the pattern explanation function cannot be used.

Example: Displaying information about 

1 Press .

2 Press .

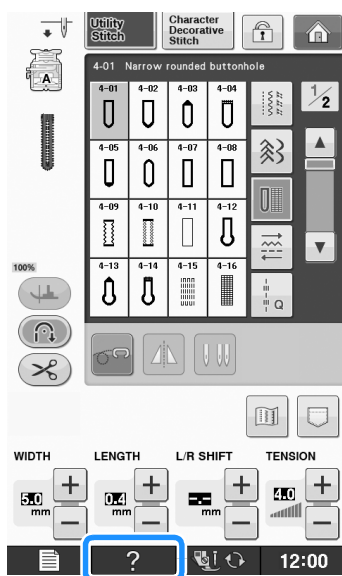

3 Press .

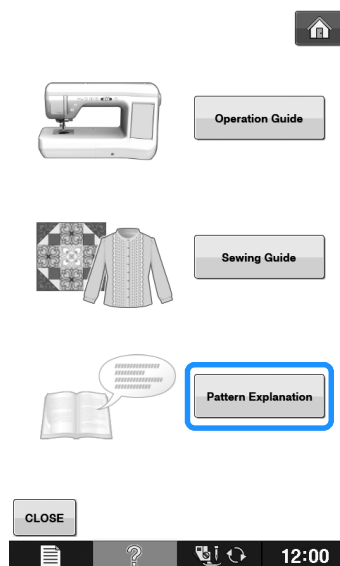

→ The screen shows information.

4 Press  to return to the original screen.



Memo

- The settings remain displayed to allow you to fine tune the stitch.

LOWER THREADING

Winding the Bobbin

Press **?** → **Operation Guide** → **Basic Operation** →



in this order to display a video

example of bobbin winding on the LCD (see page B-37). Follow the steps explained below to complete the operation.

⚠ CAUTION

- The included bobbin was designed specifically for this sewing machine. If bobbins from other models are used, the machine will not operate correctly. Use only the included bobbin or bobbins of the same type (part code: SA156, (SFB: XA5539-151)).

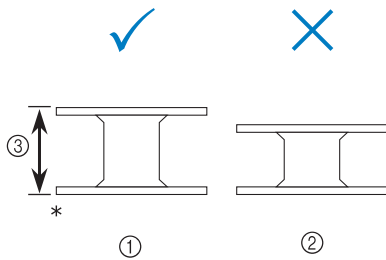

- * Actual size
- ① This model
- ② Other models
- ③ 11.5 mm (approx. 7/16 inch)

■ Using the Supplemental Spool Pin

With this machine, you can wind the bobbin without unthreading the machine. While using the main spool pin to sew, you can conveniently wind the bobbin using the supplemental spool pin.

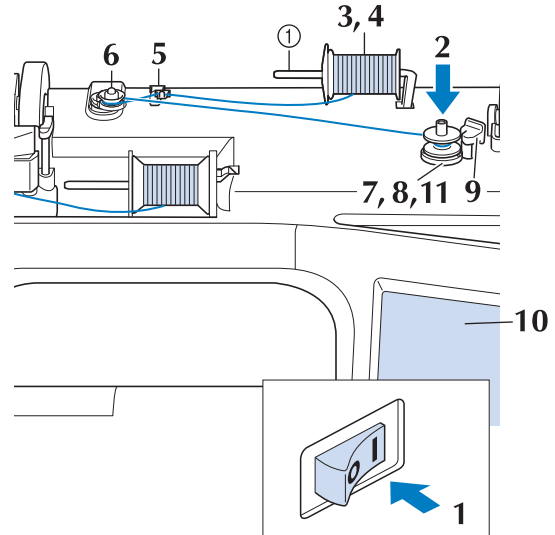

① Supplemental spool pin

- 1 Turn the main power to ON and open the top cover.
- 2 Align the groove in the bobbin with the spring on the bobbin winder shaft, and set the bobbin on the shaft.

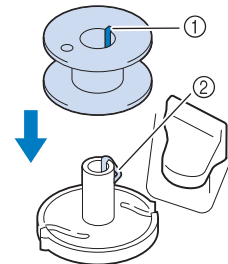

- ① Groove in the bobbin
- ② Spring on the shaft

- 3** Set the supplemental spool pin in the “up” position.

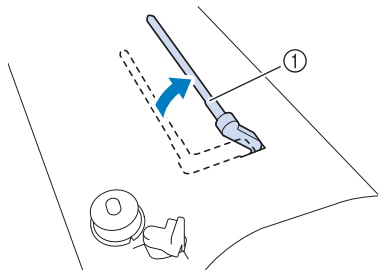

① Supplemental spool pin

- 4** Place the spool of thread on the supplemental spool pin, so that thread unrolls from the front. Push the spool cap onto the spool pin as far as possible to secure the thread spool.

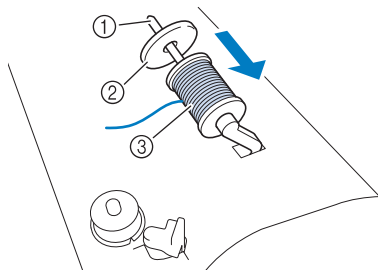

① Spool pin
② Spool cap
③ Thread spool

⚠ CAUTION

- If the thread spool and/or spool cap are set incorrectly, the thread may tangle on the spool pin and cause the needle to break.
- Use the spool cap (large, medium, small or mini insert) that is closest in size to the thread spool. If a spool cap smaller than the thread spool is used, the thread may become caught in the slit on the end of the spool and cause the needle to break.

📖 Memo

- When sewing with fine, cross-wound thread, use the small spool cap, and leave a small space between the cap and the thread spool.

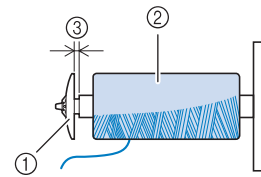

① Spool cap (small)
② Thread spool (cross-wound thread)
③ Space

- If a spool of thread whose core is 12 mm (1/2 inch) in diameter and 75 mm (3 inches) high is inserted on the spool pin, use the special spool cap.

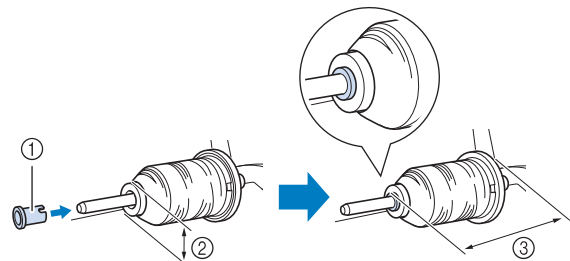

① Spool cap (special)
② 12 mm (1/2 inch)
③ 75 mm (3 inches)

- 5** With your right hand, hold the thread near the thread spool. With your left hand, hold the end of the thread, and use both hands to pass the thread through the thread guide.

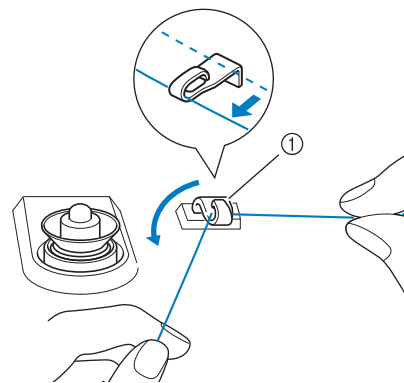

① Thread guide

- 6** Pass the thread around the pre-tension disk making sure that the thread is under the pre-tension disk.

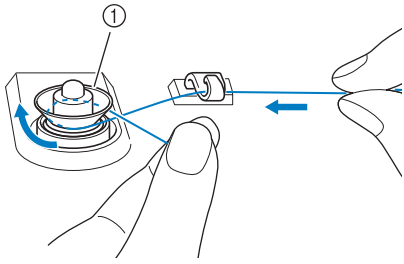

- ① Pre-tension disk
→ Make sure that the thread passes under the pre-tension disk.

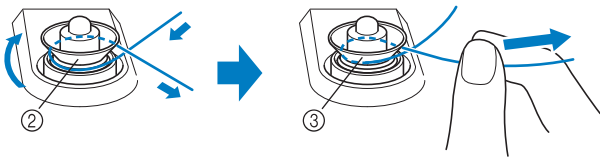

- ② Pre-tension disk
③ Pull it in as far as possible.
→ Check to make sure thread is securely set between pre-tension disks.

- 7** Wind the thread clockwise around the bobbin 5-6 Times.

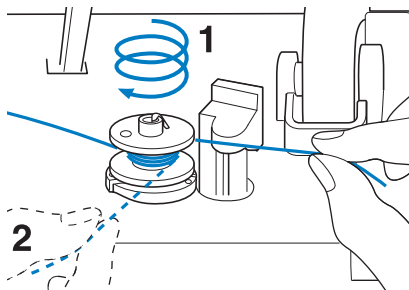

- 8** Pass the end of the thread through the guide slit in the bobbin winder seat, and pull the thread to the right to cut the thread with the cutter.

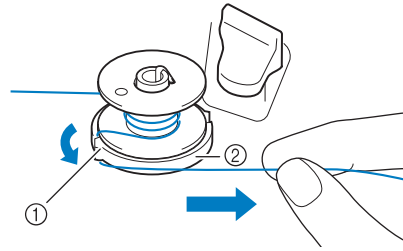

- ① Guide slit (with built-in cutter)
② Bobbin winder seat

⚠ CAUTION

- Be sure to follow the process described. If the thread is not cut with the cutter, and the bobbin is wound, when the thread runs low it may tangle around the bobbin and cause the needle to break.

- 9** Set the bobbin winding switch to the left, until it clicks into place.

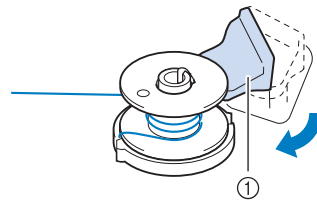

- ① Bobbin winding switch

Memo

- Sliding the bobbin winding switch to the left switches the machine into bobbin winding mode.

→ The bobbin winding window appears.

10 Press **START**.

→ Bobbin winding starts automatically. The bobbin stops rotating when bobbin winding is completed. The bobbin winding switch will automatically return to its original position.

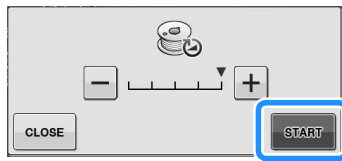
**Note**

- **START** changes to **STOP** while the bobbin is winding.
- Stay near the machine while winding the bobbin to make sure the bobbin thread is being wound correctly. If the bobbin thread is wound incorrectly, press **STOP** immediately to stop the bobbin winding.
- The sound of winding the bobbin with stiff thread, such as nylon thread for quilting, may be different from the one produced when winding normal thread; however, this is not a sign of a malfunction.

Memo

- You can change the winding speed by pressing **-** (to decrease) or **+** (to increase) in the bobbin winding window.

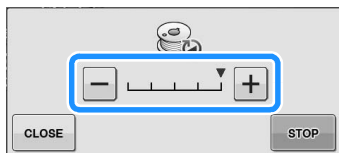

- Press **CLOSE** to minimize the bobbin winding window. Then, you can perform other operations, such as selecting a stitch or adjusting the thread tension, while the bobbin is being wound.
- Press  (in top right of the LCD screen) to display the bobbin winding window again.

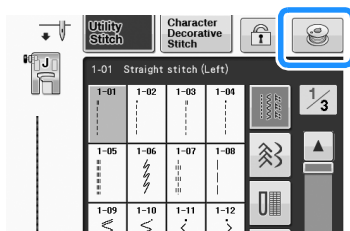
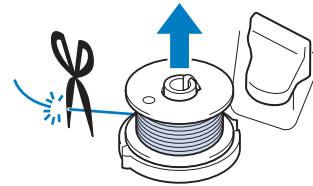
**11** Cut the thread with scissors and remove the bobbin.**Memo**

- When removing the bobbin, do not pull on the bobbin winder seat. Doing so could loosen or remove the bobbin winder seat, and could result in damage to the machine.

CAUTION

- Setting the bobbin improperly may cause the thread tension to loosen, breaking the needle and possibly resulting in injury.

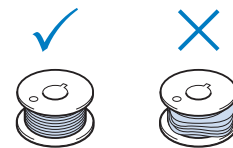
**Using the Spool Pin**

You can use the main spool pin to wind the bobbin before sewing. You cannot use this spool pin to wind the bobbin while sewing.

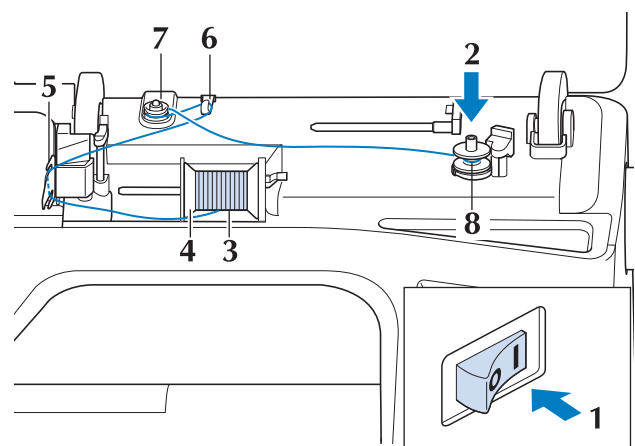

- 1 Turn the main power to ON and open the top cover.
- 2 Align the groove in the bobbin with the spring on the bobbin winder shaft, and set the bobbin on the shaft.

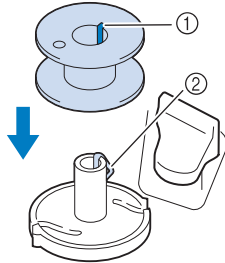

- ① Groove in the bobbin
- ② Spring on the shaft

- 3 Pivot the spool pin so that it angles upward. Set the thread spool on the spool pin so that the thread unwinds from the front of the spool.

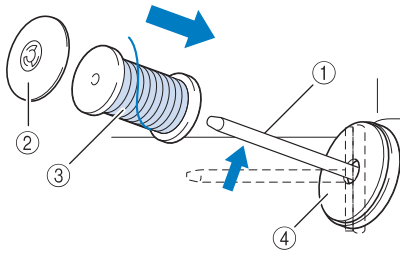

- ① Spool pin
- ② Spool cap
- ③ Thread spool
- ④ Spool felt

- 4 Push the spool cap onto the spool pin as far as possible, then return the spool pin to its original position.
- 5 While holding the thread with both hands, pull the thread up from under the thread guide plate.

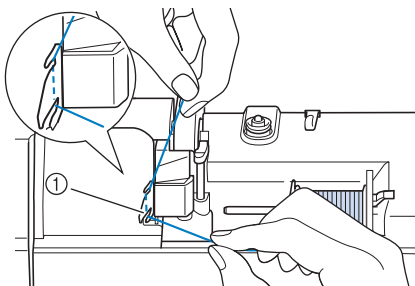

- ① Thread guide plate

- 6 Pass the thread through the thread guide.

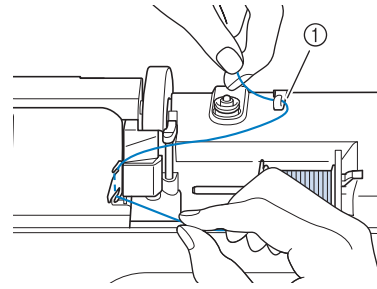

- ① Thread guide

- 7 Pass the thread around the pre-tension disk making sure that the thread is under the pre-tension disk.

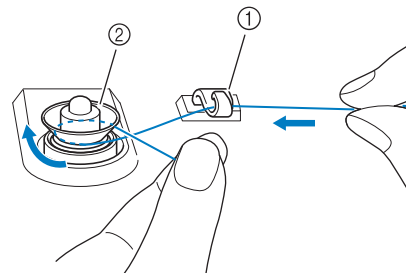

- ① Thread guide
- ② Pre-tension disk

- 8 Follow steps 7 through 11 on page B-40 through B-41.

■ Untangling Thread from Beneath the Bobbin Winder Seat

If the bobbin winding starts when the thread is not passed through the pre-tension disk correctly, the thread may become tangled beneath the bobbin winder seat.

Wind off the thread according to the following procedure.

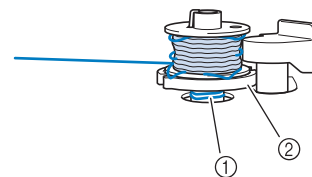

- ① Thread
- ② Bobbin winder seat

⚠ CAUTION

- Do not remove the bobbin winder seat even if the thread becomes tangled under the bobbin winder seat. It may result in injuries.

- 1 If the thread becomes tangled under the bobbin winder seat, press **STOP** once to stop the bobbin winding.

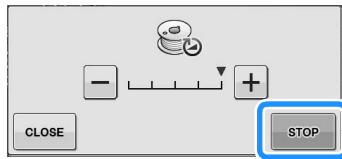

- 2 Cut the thread with scissors near the pre-tension disk.

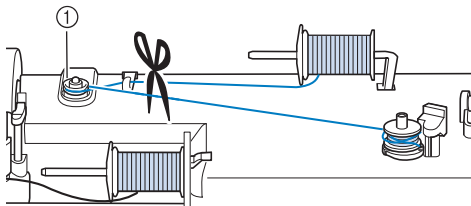

① Pre-tension disk

- 3 Push the bobbin winder switch to the right, and then raise the bobbin at least 10 cm (4 inches) from the shaft.

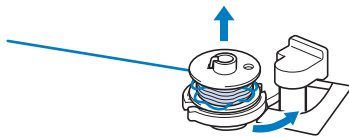

- 4 Cut the thread near the bobbin and hold the thread end with your left hand. Unwind the thread clockwise near the bobbin winder seat with your right hand as shown below.

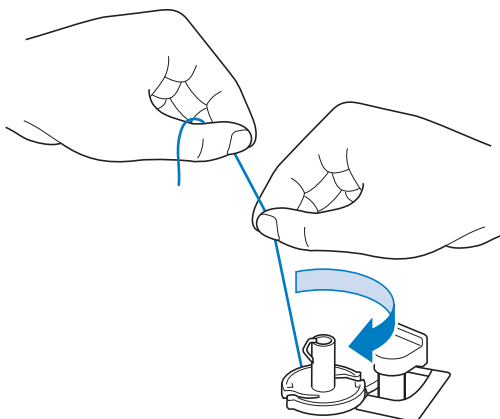

- 5 Wind the bobbin again.



Note

- Make sure that the thread passes through the pre-tension disk correctly (page B-40).

Setting the Bobbin

Press **?** → **Operation Guide** → **Basic Operation** →

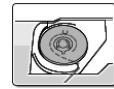

→ in this order to display a video

example of the operation on the LCD (see page B-37). Follow the steps explained below to complete the operation.

CAUTION

- Use a bobbin thread that has been correctly wound. Otherwise, the needle may break or the thread tension will be incorrect.

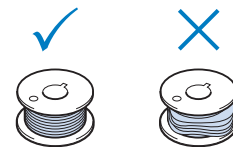

- The included bobbin was designed specifically for this sewing machine. If bobbins from other models are used, the machine will not operate correctly. Use only the included bobbin or bobbins of the same type (part code: SA156, (SFB: XA5539-151)).

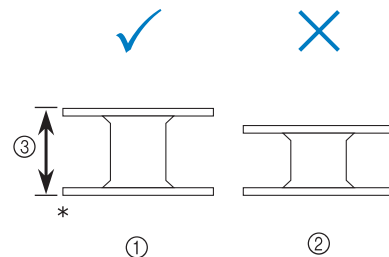

* Actual size

① This model

② Other models

③ 11.5 mm (approx. 7/16 inch)

- Before inserting or changing the bobbin, be sure to press **LOCK** in the LCD to lock all keys and buttons, otherwise injuries may occur if the "Start/Stop" button or any other button is pressed and the machine starts sewing.

- 1 Press **LOCK** to lock all keys and buttons.

* If the message "OK to automatically lower the presser foot?" appears on the LCD screen, press OK to continue.

→ The entire screen becomes white, and all keys and operation buttons are locked.

2 Slide the bobbin cover latch to the right.

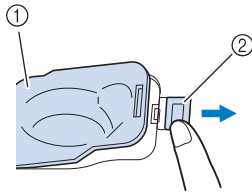

- ① Bobbin cover
- ② Latch
- The bobbin cover opens.

3 Remove the bobbin cover.

4 Insert the bobbin with your right hand so that the end of the thread is on the left, and then, after pulling the thread firmly around the tab with your left hand as shown, lightly pull the thread to guide it through the slit.

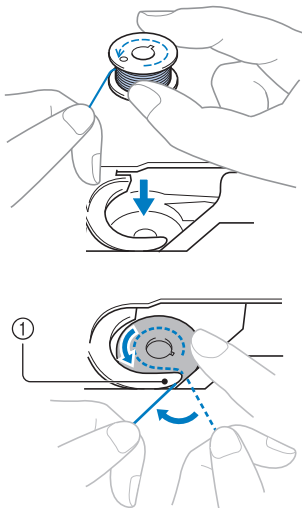

- ① Tab
- * Be sure to insert the bobbin correctly.

⚠ CAUTION

- Be sure to install the bobbin so that the thread unwinds in the correct direction, otherwise the thread may break or the thread tension will be incorrect.

📖 Memo

- The order that the bobbin thread should be passed through the bobbin case is indicated by marks around the bobbin case. Be sure to thread the machine as indicated.

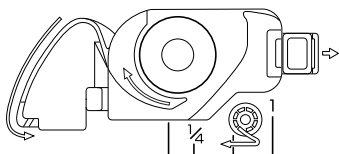

5 While lightly holding down bobbin with your right hand as shown, guide the thread through the slit (① and ②).

- * At this time, check that the bobbin easily rotates counterclockwise.

Then, pull the thread toward you to cut it with the cutter (③).

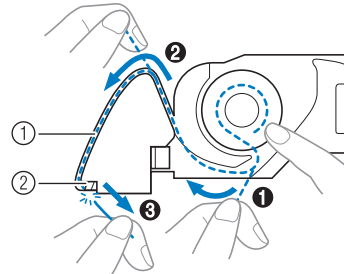

- ① Slit
- ② Cutter (Cut the thread with the cutter.)
- The cutter cuts the thread.

Make sure that the thread is correctly passed through the flat spring of the bobbin case. If it is not inserted correctly, reinstall the thread.

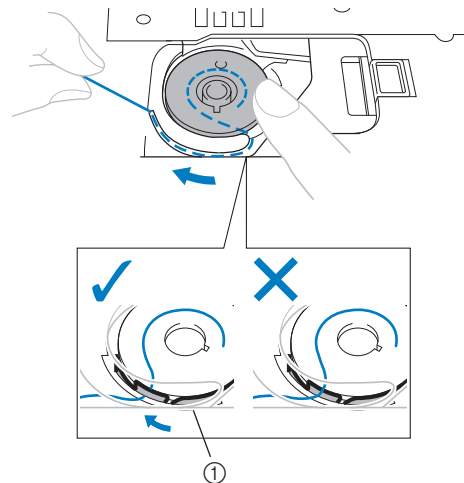



- ① Flat spring

⚠ CAUTION

- Be sure to hold down the bobbin with your finger and unwind the bobbin thread correctly. Otherwise, the thread may break or the thread tension will be incorrect.

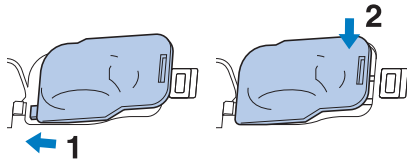
- 6** Insert the tab in the lower-left corner of the bobbin cover (1), and then lightly press down on the right side to close the cover (2).



- 7** Press  to unlock all keys and buttons.

Pulling Up the Bobbin Thread

There may be some sewing applications where you want to pull up the bobbin thread; for example, when making gathers, darts, or doing free motion quilting or embroidery.

Memo

- You can pull up the bobbin thread after threading the upper thread (“UPPER THREADING” on page B-46).

- 1** Guide the bobbin thread through the groove, following the arrow in the illustration.

- * Do not cut the thread with the cutter.
- * Do not replace the bobbin cover.

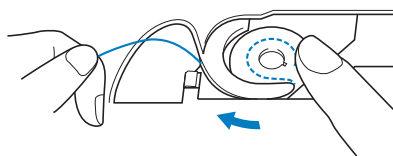

- 2** While holding the upper thread, press the “Needle Position” button to lower the needle.

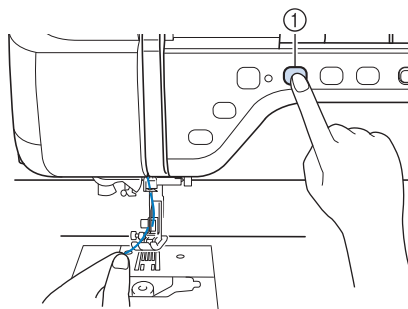

① “Needle Position” button

- 3** Press the “Needle Position” button to raise the needle.

- 4** Press  to lock all keys and buttons.

- 5** Gently pull the upper thread. A loop of the bobbin thread will come out of the hole in the needle plate.

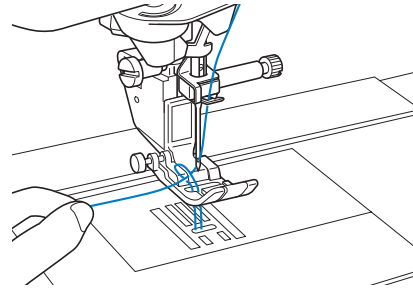

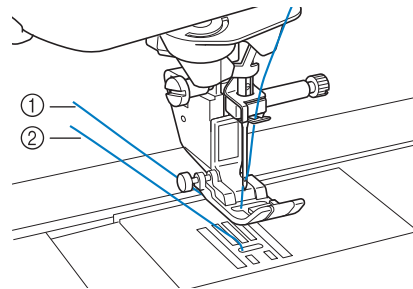

- 6** Pull up the bobbin thread, pass it under the presser foot and pull it about 100 mm (approx. 4 inches) toward the back of the machine, making it even with the upper thread.



- ① Upper thread
- ② Bobbin thread

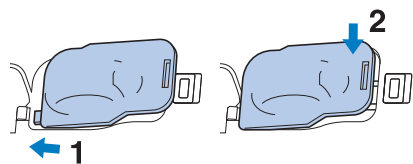

- 7** Replace the bobbin cover.



- 8** Press  to unlock all keys and buttons.

UPPER THREADING

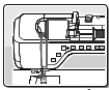
Upper Threading

Press **?** → **Operation Guide** → **Basic Operation** →  →  in this order to display a video example of the operation on the LCD (see page B-37). Follow the steps explained below to complete the operation.

⚠ CAUTION

- Be sure to thread the machine properly. Improper threading can cause the thread to tangle and break the needle, leading to injury.
- When using the walking foot, the side cutter or accessories not included with this machine, attach the accessory to the machine after threading the machine.



Memo

- The automatic threading function can be used with sewing machine needle sizes 75/11 through 100/16.
- Thread such as transparent nylon monofilament thread and thread with a thickness of 130/20 or thicker cannot be used with the automatic threading function.
- The automatic threading function cannot be used with the wing needle or the twin needle.

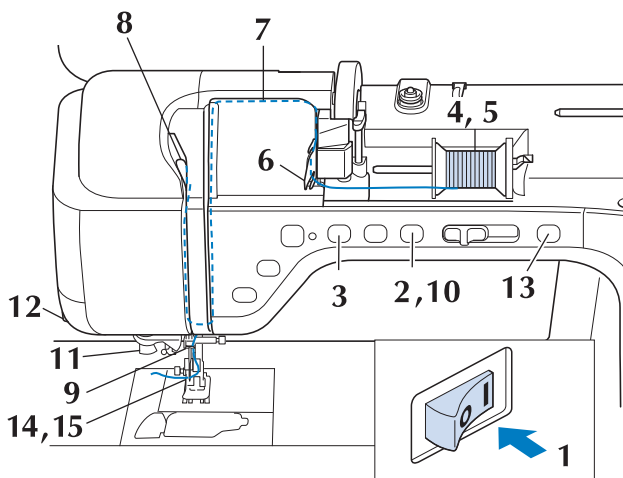

1 Turn the main power to ON.

2 Press the “Presser Foot Lifter” button to raise the presser foot.

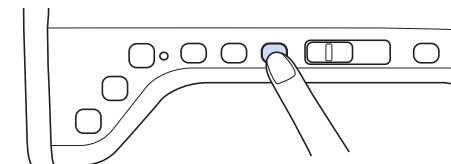

→ The upper thread shutter opens so the machine can be threaded.

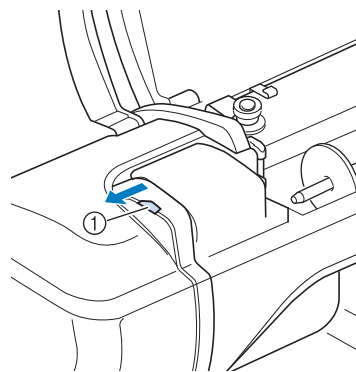

① Upper thread shutter



Memo

- This machine is equipped with an upper thread shutter, allowing you to check that the upper threading is performed correctly.

3 Press the “Needle Position” button to raise the needle.

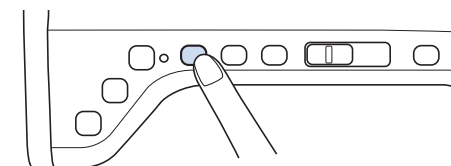

Note

- If you try to thread the needle automatically without raising the needle, the thread may not thread correctly.

- 4** Pivot the spool pin so that it angles upward. Set the thread spool on the spool pin so that the thread unwinds from the front of the spool.

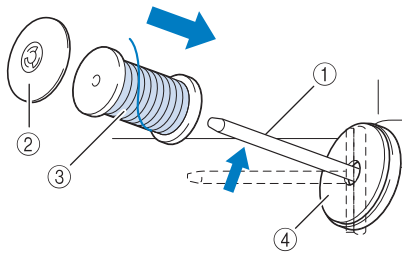

- ① Spool pin
- ② Spool cap
- ③ Thread spool
- ④ Spool felt

- 5** Push the spool cap onto the spool pin as far as possible, then return the spool pin to its original position.

⚠ CAUTION

- If the thread spool and/or spool cap are set incorrectly, the thread may tangle on the spool pin and cause the needle to break.
- Use the spool cap (large, medium, or small) that is closest in size to the thread spool. If a spool cap smaller than the thread spool is used, the thread may become caught in the slit on the end of the spool and cause the needle to break.

📖 Memo

- When sewing with fine, cross-wound thread, use the small spool cap, and leave a small space between the cap and the thread spool.

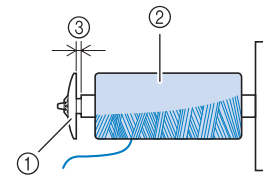

- ① Spool cap (small)
- ② Thread spool (cross-wound thread)
- ③ Space

- If a spool of thread whose core is 12 mm (1/2 inch) in diameter and 75 mm (3 inches) high inserted onto the spool pin, use the special spool cap.

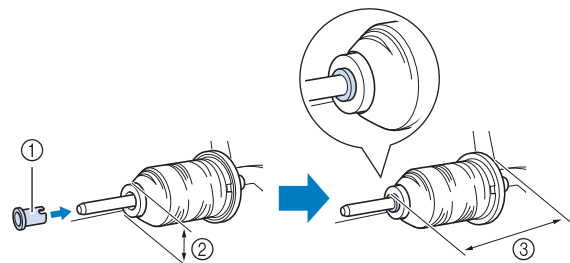

- ① Spool cap (special)
- ② 12 mm (1/2 inch)
- ③ 75 mm (3 inches)

- 6** While holding the thread with both hands, pull the thread up from under the thread guide plate.

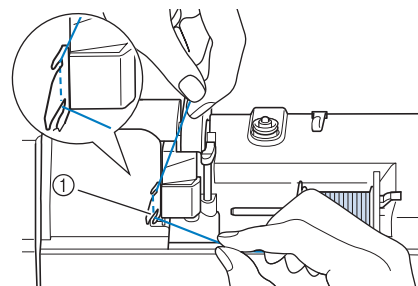

- ① Thread guide plate

- 7** While holding the thread in your right hand, pass the thread through the thread guide in the direction indicated.

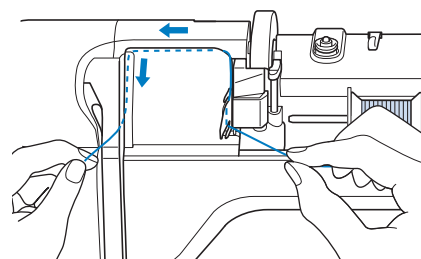

- 8** Guide the thread down, up, then down through the groove, as shown in the illustration.

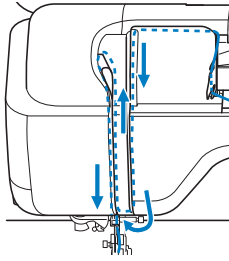

Memo

- Look in the upper groove area to check if the thread catches on the take-up lever visible inside the upper groove area.

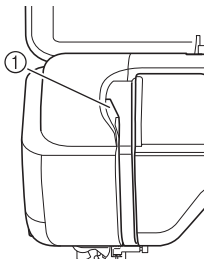

① Look in the upper groove area

- 9** Pass the thread through the needle bar thread guide (marked “6”) by holding the thread with both hands and guiding it as shown in the illustration.

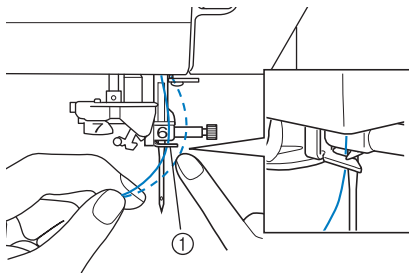

① Needle bar thread guide

- 10** Press the “Presser Foot Lifter” button to lower presser foot.

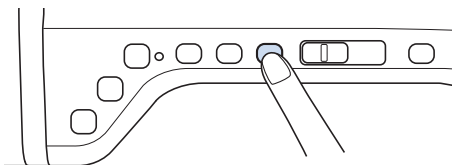

- 11** Pass the thread through the thread guide disks (marked “7”). Make sure that the thread passes through the groove in the thread guide.

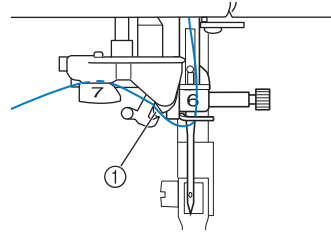

① Groove in thread guide

- 12** Pull the thread up through the thread cutter to cut the thread, as shown in the illustration.

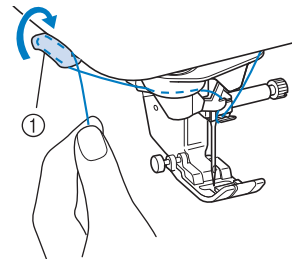

① Thread cutter



Note

- When using thread that quickly winds off the spool, such as metallic thread, it may be difficult to thread the needle if the thread is cut. Therefore, instead of using the thread cutter, pull out about 80 mm (approx. 3 inches) of thread after passing it through the thread guide disks (marked “7”).

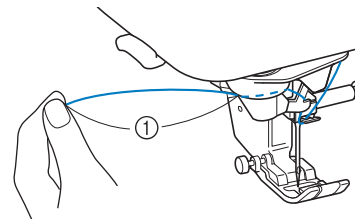

① 80 mm (approx. 3 inches) or more

- 13** Press the “Automatic Threading” button to have the machine automatically thread the needle.

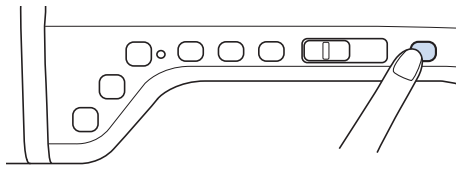

→ The thread passes through the eye of the needle.



Memo

- When the “Automatic Threading” button is pressed, the presser foot will be automatically lowered. After threading is finished, the presser foot moves back to the position before the “Automatic Threading” button was pressed.

- 14** Carefully pull the end of the thread that was passed through the eye of the needle.

- * If a loop was formed in the thread passed through the eye of the needle, carefully pull on the loop of thread through to the back of the needle.

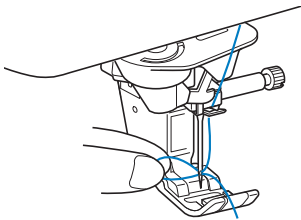

Note

- Pulling the loop of thread gently will avoid needle breakage.

- 15** Pull out about 5 cm (approx. 2 inches) of the thread, and then pass it under the presser foot toward the rear of the machine.

→ Raise the presser foot lever if the presser foot is lowered.

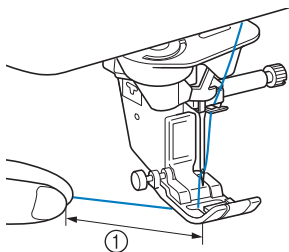

① About 5 cm (approx. 2 inches)



Memo

- If the needle could not be threaded or the thread was not passed through the needle bar thread guides, perform the procedure again starting from step ③. Then, pass the thread through the eye of the needle after step ⑨.



Note

- Some needles cannot be threaded with the needle threader. In this case, instead of using the needle threader after passing the thread through the needle bar thread guide (marked “6”), manually pass the thread through the eye of the needle from the front to the back.

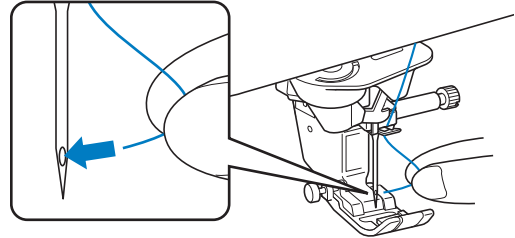

Using the Twin Needle Mode

The twin needle can only be used for patterns that show  after being selected. Before you select a stitch pattern, make sure the stitch can be sewn in the twin needle mode (refer to the “STITCH SETTING CHART” on page S-67).

⚠ CAUTION

- Twin needle (part code X59296-151) is recommended for this machine. Contact your authorized dealer for replacement needles (size 2.0/11 is recommended).
- Be sure to set the twin needle mode when using the twin needle. Using the twin needle while the machine is in single needle mode could cause the needle to break, resulting in damage.
- Do not sew with bent needles. The needle could break and cause injury.
- When using the twin needle, it is recommended to use presser foot “J”.
- When the twin needle is used, bunched stitches may occur depending on the types of fabric and thread that are used. Use monogramming foot “N” for decorative stitches.
- Before changing the needle or threading the machine, be sure to press  on the LCD screen to lock all keys and buttons, otherwise injuries may occur if the “Start/Stop” button or any other button is pressed and the machine starts sewing.

- 1 Press  to lock all keys and buttons and install the twin needle ("CHANGING THE NEEDLE" on page B-55).

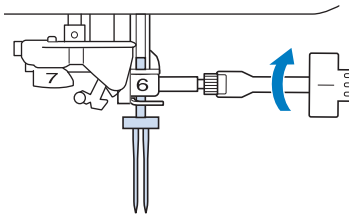

- 2 Thread the machine for the first needle according to the procedure for threading a single needle ("Upper Threading" on page B-46).

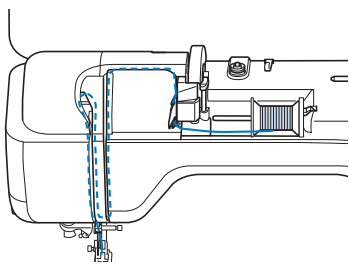

- 3 Pass the thread through the needle bar thread guides on the needle bar, then thread the needle on the left side manually.

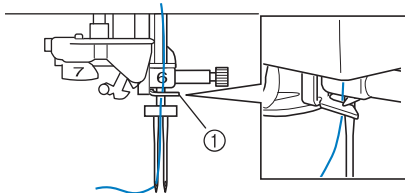

① Needle bar thread guide



Note

- The "Automatic Threading" button cannot be used. Manually thread the twin needle from front to back. Using the "Automatic Threading" button may result in damage to the machine.

- 4 Pull up the supplemental spool pin and set it in the up position.

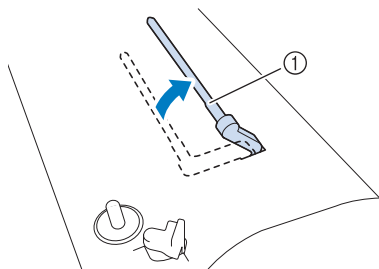

① Supplemental spool pin

- 5 Place the additional spool of thread on the supplemental spool pin, so that the thread unwinds from the front. Push the spool cap onto the spool pin as far as possible to secure the thread spool.

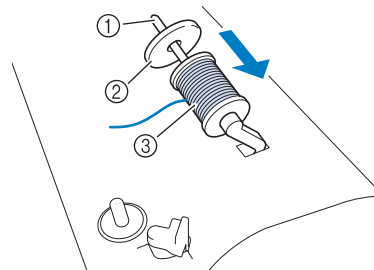

- ① Spool pin
- ② Spool cap
- ③ Thread spool

- 6 Hold the thread from the spool with both hands, and place the thread in the thread guide.

* Do not place the thread in the pre-tension disks.

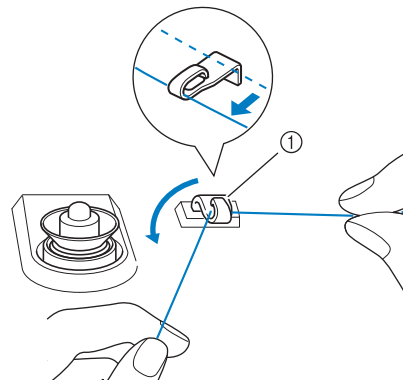

① Thread guide

- 7 While holding the thread from the spool, pull the thread through the lower notch in the thread guide plate, then through the upper notch. Hold the end of the thread with your left hand, and then guide the thread through the groove, following the arrows in the illustration.

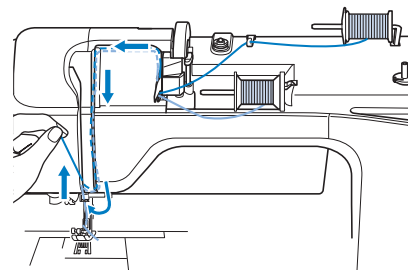

- 8** Continue threading however do not pass the thread in the needle bar thread guide "6" on the needle bar. Thread the needle on the right side.

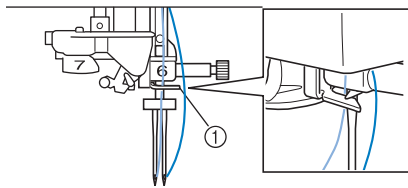

① Needle bar thread guide

- 9** Press to unlock all keys and buttons.

- 10** Select a stitch pattern. (Example:)

* Refer to the "STITCH SETTING CHART" on page S-67 for the proper stitch to use with presser foot "J".

→ The selected stitch is displayed.



Note

- If the key is light gray after selecting the stitch, the selected stitch cannot be sewn in the twin needle mode.

- 11** Press to select the twin needle mode.

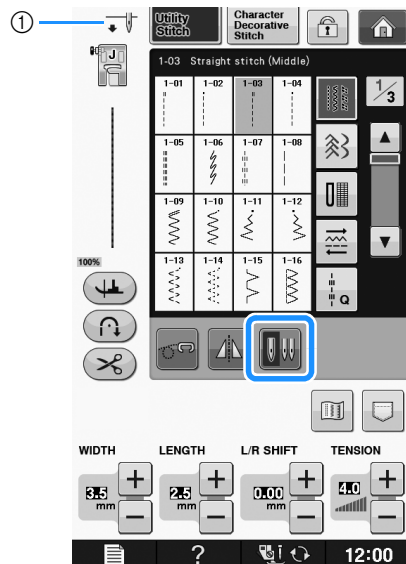

① Single needle/twin needle setting

→ appears.

CAUTION

- Be sure to set the twin needle mode when using the twin needle. Using the twin needle while the machine is in single needle mode could cause the needle to break, resulting in damage.

- 12** Start sewing.

Sample of Twin Needle Sewing

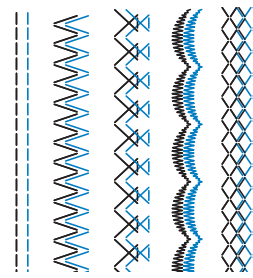

Memo

- To change direction when sewing with the twin needle, raise the needle from the fabric, raise the presser foot lever, and then turn the fabric.

Using Threads that Unwind Quickly

Using the Spool Net

If using transparent nylon monofilament thread, metallic thread, or other strong thread, place the included spool net over the spool before using it. When using specialty threads, threading must be done manually.

If the spool net is too long, fold it once to match it to the spool size before placing it over the spool.

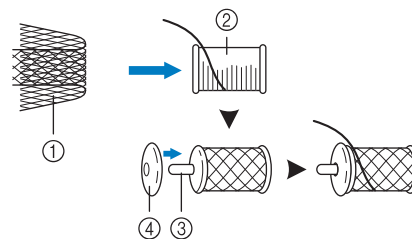

- ① Spool net
- ② Thread spool
- ③ Spool pin
- ④ Spool cap



Memo

- When threading the spool with the spool net on, make sure that 5 cm - 6 cm (approx. 2 inches - 2-1/2 inches) of thread are pulled out.
- It may be necessary to adjust the thread tension when using the spool net.

■ Using the Vertical Spool Pin

Use the vertical spool pin when using an irregularly shaped thread spool, and when sewing or embroidering with metallic thread.

1 Insert the vertical spool pin onto the bobbin winder shaft.

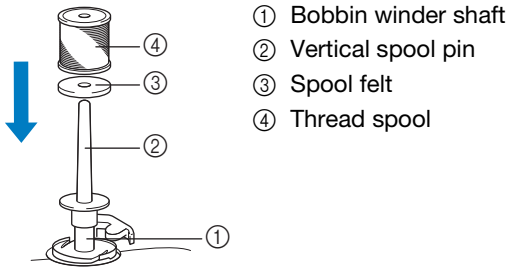

2 Install the spool felt and the thread spool in that order, and then thread the upper thread.





Memo

- When setting the thread spool, set it so that the thread winds off from the front of the spool.
- If using metallic thread, we recommend that you use a 90/14 home sewing machine needle.
- This method keeps the thread from twisting as it comes off the spool pin.

CHANGING THE PRESSER FOOT

⚠ CAUTION

- Always press  on the screen to lock all keys and buttons before changing the presser foot. If  is not pressed and the “Start/Stop” button or another button is pressed, the machine will start and may cause injury.
- Always use the correct presser foot for the selected stitch pattern. If the wrong presser foot is used, the needle may strike the presser foot and bend or break, and may cause injury.
- Only use presser feet made for this machine. Using other presser feet may lead to accident or injury.

Removing the Presser Foot

- 1 Press the “Needle Position” button to raise the needle.

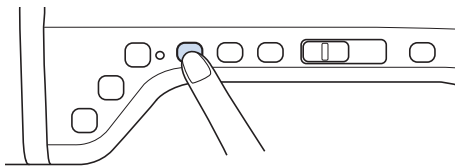

- 2 Press  to lock all keys and buttons.

- * If the message “OK to automatically lower the presser foot?” appears on the LCD screen, press OK to continue.
- The entire screen becomes white, and all keys and operation buttons are locked.

- 3 Raise the presser foot lever.

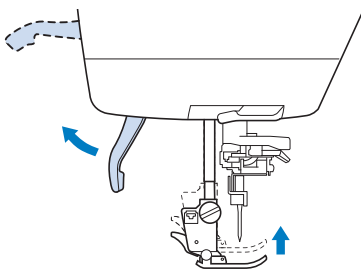

- 4 Press the black button on the presser foot holder and remove the presser foot.

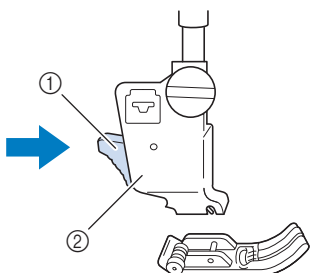

- ① Black button
- ② Presser foot holder

Attaching the Presser Foot

⚠ CAUTION

- Make sure that the presser foot is installed in the correct direction, otherwise the needle may strike the presser foot, breaking the needle and causing injuries.

- 1 Place the new presser foot under the holder, aligning the foot pin with the notch in the holder. Lower the presser foot lever so that the presser foot pin snaps into the notch in the holder.

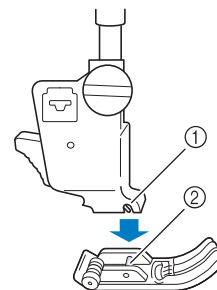

- ① Notch
- ② Pin

- 2 Press  to unlock all keys and buttons.

- 3 Raise the presser foot lever.

Attaching the Presser Foot with the Included Adapter

You can attach the optional presser feet using the included adapter and small screw. For example, the walking foot, the free motion echo quilting foot “E”, the free motion quilting foot and so on.

Following procedure shows how to attach the walking foot as an example.

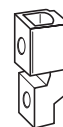

■ Attaching the Walking foot

The walking foot holds the fabric between the presser foot and the feed dogs to feed the fabric. This enables you to have better fabric control when sewing difficult fabrics (such as quilted fabrics or velvet) or fabrics that slip easily (such as vinyl, leather, or synthetic leather).

- 1 Follow the steps in “Removing the Presser Foot” in the previous page.
- 2 Loosen the screw of the presser foot holder to remove the presser foot holder.

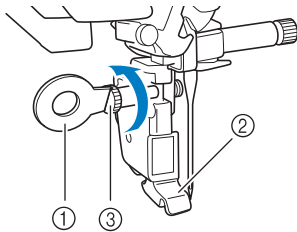

- ① Disc-shaped screwdriver
- ② Presser foot holder
- ③ Presser foot holder screw

- 3 Remove the screw of the presser foot completely from the presser foot shaft.

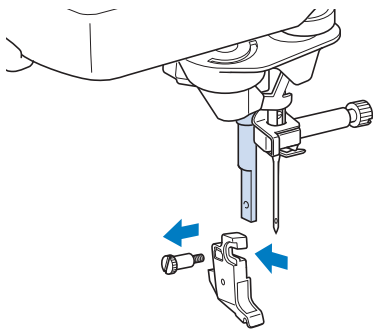

- 4 Set the adapter on the presser foot bar, aligning the flat side of the adapter opening with the flat side of the presser bar. Push it up as far as possible, and then tighten the screw securely with the screwdriver.

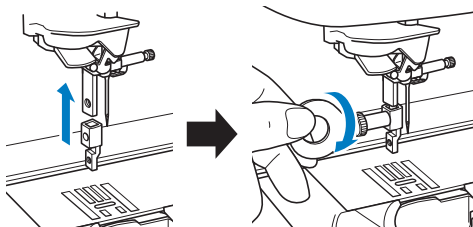

- 5 Turn a supplied small screw 2 or 3 times with your hand.

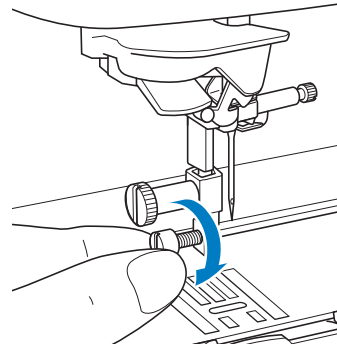

- 6 Set the operation lever of the walking foot so that the needle clamp screw is set between the forks. Position the shank of the walking foot on the adapter attached to the presser foot bar.

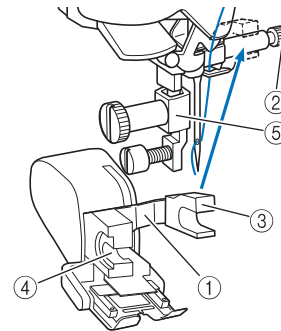

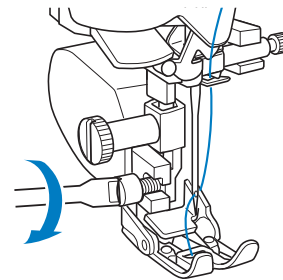

- ① Operation lever
- ② Needle clamp screw
- ③ Fork
- ④ Walking foot shank
- ⑤ Adapter

- 7 Lower the presser foot lever. Tighten the small screw securely with a large screwdriver.



CHANGING THE NEEDLE

⚠ CAUTION

- Always press  on the screen to lock all keys and buttons before changing the needle. If  is not pressed and the Start/Stop button or another operation button is pressed accidentally, the machine will start and injury may result.
- Use only sewing machine needles made for home use. Other needles may bend or break and may cause injury.
- Never sew with a bent needle. A bent needle will easily break and may cause injury.

Memo

- To check the needle correctly, place the flat side of the needle on a flat surface. Check the needle from the top and the sides. Throw away any bent needles.

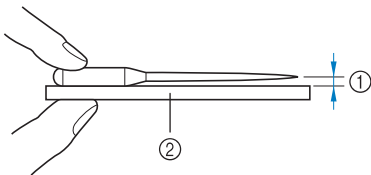

- ① Parallel space
② Level surface (bobbin cover, glass, etc.)

- 1** Press the “Needle Position” button to raise the needle.

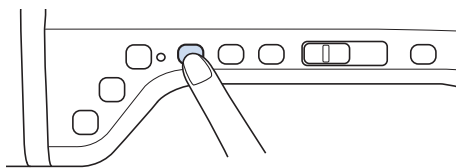

- 2** Press  to lock all keys and buttons.

- * If the message “OK to automatically lower the presser foot?” appears on the LCD screen, press OK to continue.
- The entire screen becomes white, and all keys and operation buttons are locked.

Note

- Before replacing the needle, cover the hole in the needle plate with fabric or paper to prevent the needle from falling into the machine.

- 3** Use the screwdriver to turn the screw toward the front of the machine and loosen the screw. Remove the needle.

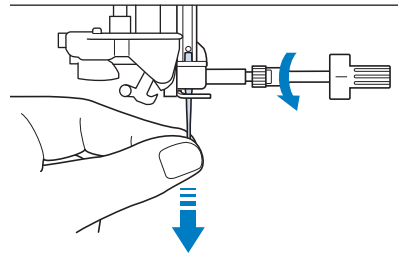

Note

- Do not apply pressure to the needle clamp screw. Doing so may damage the needle or machine.

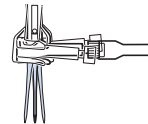

- 4** With the flat side of the needle facing the back, insert the new needle all the way to the top of the needle stopper (viewing window) in the needle clamp. Use a screwdriver to securely tighten the needle clamp screw.

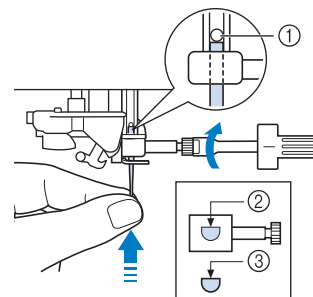

- ① Needle stopper
② Hole for setting the needle
③ Flat side of needle

⚠ CAUTION

- Be sure to push in the needle until it touches the stopper, and securely tighten the needle clamp screw with a screwdriver. If the needle is not completely inserted or the needle clamp screw is loose, the needle may break or the machine may be damaged.

- 5** Press  to unlock all keys and buttons.

ABOUT THE NEEDLE AND FABRIC

About the Needle

The sewing machine needle is probably the most important part of the sewing machine. Choosing the proper needle for your sewing project will result in a beautiful finish and fewer problems. Below are some things to keep in mind about needles.

- The smaller the needle number, the finer the needle. As the numbers increase, the needles get thicker.
- Use fine needles with lightweight fabrics, and thicker needles with heavyweight fabrics.
- To avoid skipped stitches, use ball point needle (golden colored) 90/14 with stretch fabrics.
- To avoid skipped stitches, use ball point needle (golden colored) 90/14 when sewing character or decorative stitches.
- Use needle 75/11 for embroidery. Use ball point needle 75/11 for embroidering patterns with short jump stitches such as alphabet characters when the thread trimming function is turned on.
- It is recommended that a 90/14 needle should be used when embroidering on heavyweight fabrics or stabilizing products (for example, denim, puffy foam, etc.). A 75/11 needle may bend or break, which could result in injury.



Note

- Never use a thread of weight 20 or lower. It may cause malfunctions.

Fabric/Thread/Needle Combinations

The following table provides information concerning the appropriate thread and needle for various fabrics. Please refer to this table when selecting a thread and needle for the fabric you wish to use.

Fabric type/Application		Thread		Size of needle
		Type	Size	
Medium weight fabrics	Broadcloth	Cotton thread	60 - 90	75/11 - 90/14
	Taffeta	Synthetic thread		
	Flannel, Gabardine	Silk thread	50	
Thin fabrics	Lawn	Cotton thread	60 - 90	65/9 - 75/11
	Georgette	Synthetic thread		
	Challis, Satin	Silk thread	50	
Thick fabrics	Denim	Cotton thread	30	90/14 - 100/16
			50	
	Corduroy	Synthetic thread	50 - 60	
	Tweed	Silk thread		
Stretch fabrics	Jersey	Thread for knits	50 - 60	Ball point needle (gold colored) 75/11 - 90/14
	Tricot			
Easily frayed fabrics		Cotton thread	50 - 90	65/9 - 90/14
		Synthetic thread		
		Silk thread	50	
For top-stitching		Synthetic thread	30	100/16
		Silk thread	50 - 60	90/14 - 100/16



Memo

- For transparent monofilament nylon thread, always use needle sizes 90/14 or 100/16. The same thread is usually used for the bobbin thread and upper thread.

⚠ CAUTION

- Be sure to follow the needle, thread, and fabric combinations listed in the table. Using an improper combination, especially a heavyweight fabric (i.e., denim) with a small needle (i.e., 65/9 - 75/11), may cause the needle to bend or break, and lead to injury. Also, the seam may be uneven, the fabric may pucker, or the machine may skip stitches.

BEFORE EMBROIDERING

Embroidery Step by Step

Follow the steps below to prepare the machine for embroidery.

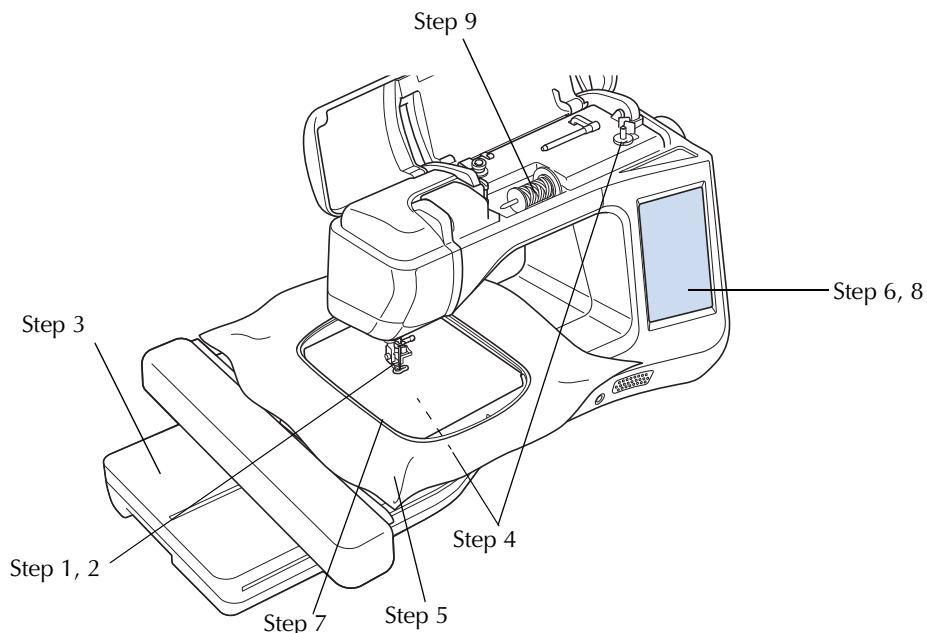

Step #	Aim	Action	Page
1	Presser foot attachment	Attach embroidery foot "W" or "W+".	B-59
2	Checking the needle	Use needle 75/11 for embroidery. *	B-56
3	Embroidery unit attachment	Attach the embroidery unit.	B-62
4	Bobbin thread setup	For the bobbin thread, wind embroidery bobbin thread and set it in place.	B-38
5	Fabric preparation	Attach a stabilizer material to the fabric, and hoop it in the embroidery frame.	E-11 to E-16
6	Pattern selection	Turn the main power to ON, and select an embroidery pattern.	E-3
7	Embroidery frame attachment	Attach the embroidery frame to the embroidery unit.	E-17
8	Checking the layout	Check and adjust the size and position of the embroidery.	E-19
9	Embroidery thread setup	Set up embroidery thread according to the pattern.	E-21

* It is recommended that a 90/14 needle should be used when embroidering on heavy weight fabrics or stabilizing products (for example; denim, puffy foam, etc.). Ball point needle (golden colored) 90/14 is not recommended for embroidery.

Attaching the Embroidery Foot “W”

⚠ CAUTION

- When attaching a presser foot, always press  on the screen to lock all keys and buttons. You may accidentally press the “Start/Stop” button and possibly cause injury.
- Be sure to use embroidery foot when doing embroidery. Using another presser foot may cause the needle to strike the presser foot, causing the needle to bend or break and possibly cause injury.

- 1** Press the “Needle Position” button to raise the needle.

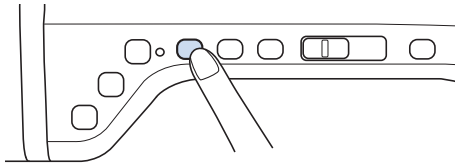

- 2** Press  to lock all keys and buttons.

→ The entire screen becomes white, and all keys and operation buttons are locked.

⚠ CAUTION

- When attaching a presser foot, always press  on the screen to lock all keys and buttons. You may accidentally press the “Start/Stop” button and possibly cause injury.

- 3** Raise the presser foot lever.

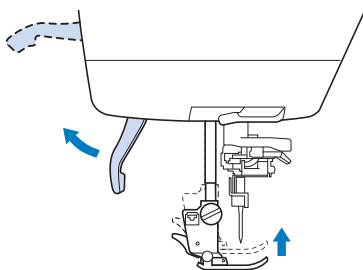

- 4** Push the black button on the presser foot holder and remove the presser foot.

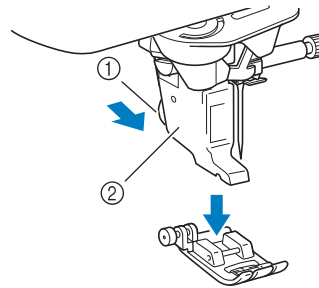

- ① Black button
 - ② Presser foot holder
- Remove the presser foot from the presser foot holder.

- 5** Use the included screwdriver to loosen the screw of the presser foot holder, then remove the presser foot holder.

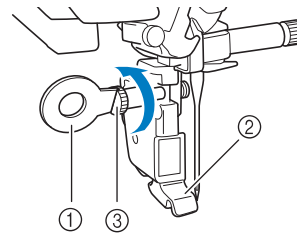

- ① Screwdriver
 - ② Presser foot holder
 - ③ Presser foot holder screw
- Remove the presser foot holder.

- 6** Position the embroidery foot “W” on the presser foot bar by aligning the notch of the presser foot to the large screw.

Side view

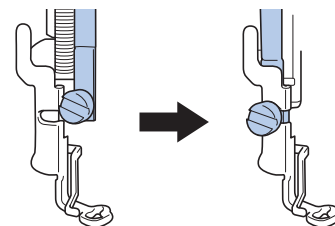

- 7 Hold the embroidery foot in place with your right hand, and then use the included screwdriver to securely tighten the presser foot holder screw.

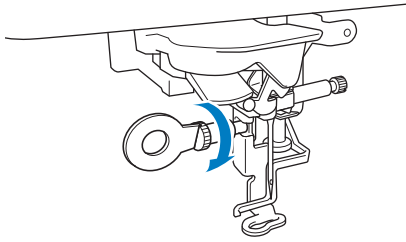

⚠ CAUTION

- Use the included screwdriver to firmly tighten the screw of the embroidery foot. If the screw is loose, the needle may strike the presser foot and possibly cause injury.

- 8 Press to unlock all keys and buttons.

→ All keys and operation buttons are unlocked, and the previous screen is displayed.

Using the Optional Embroidery Foot “W+” with LED Pointer

By plugging in the connector on the back of your machine, the embroidering needle drop point will be indicated on the fabric, allowing you to accurately position the pattern.

■ Attaching the Embroidery Foot “W+” with LED Pointer

⚠ CAUTION

- When attaching a presser foot, always press on the screen to lock all keys and buttons. You may accidentally press the “Start/Stop” button and possibly cause injury.
- Be sure to use embroidery foot when doing embroidery. Using another presser foot may cause the needle to strike the presser foot, causing the needle to bend or break and possibly cause injury.

- 1 Follow the steps from 1 to 5 of “Attaching the Embroidery Foot “W+” on page B-59.

- 2 Position the embroidery foot “W+” with LED pointer on the presser foot bar by aligning the notch of the presser foot to the large screw.

Side view

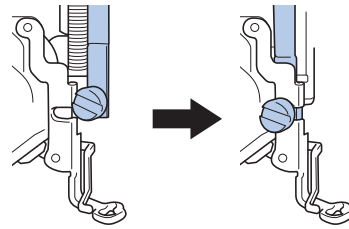

- 3 Hold the embroidery foot in place with your right hand, and then use the included screwdriver to securely tighten the presser foot holder screw.

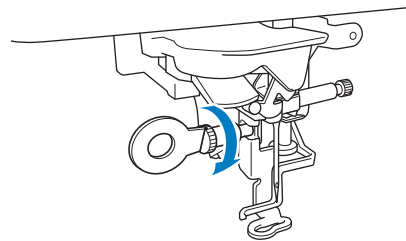

⚠ CAUTION

- Use the included screwdriver to firmly tighten the screw of the embroidery foot. If the screw is loose, the needle may strike the presser foot and possibly cause injury.

- 4 Plug the connector of the embroidery foot “W+” with LED pointer into the jack on the back of your machine.

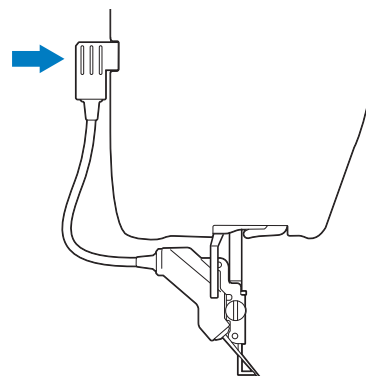

- 5 Press to unlock all keys and buttons.

→ All keys and operation buttons are unlocked, and the previous screen is displayed.

■ Checking the Needle Drop Point With the Embroidery Foot “W+” with LED Pointer

Before beginning to embroider when using the embroidery foot “W+” with LED pointer, carefully read the procedures described in the “Embroidery” and “Embroidery Edit” chapters.

- 1 After the embroidery frame is attached, press  in the embroidery screen.

→ The LED pointer indicates the needle drop point.



Memo

- When the LED pointer is turned on, the presser foot height is automatically adjusted according to the fabric thickness.
- If  is pressed again, the fabric thickness is remeasured and the presser foot is set to the optimum height.

* The LED pointer turns off automatically by lowering the presser foot or returning to the previous page.

Note

- With thick elastic fabric, the position will be misaligned only at raised parts in the fabric. In this case, manually adjust the position according to the thickness of the fabric.
- With fabric that has a very uneven surface such as quilting, the position is not correctly aligned. In this case, the pointer indication should be used only as a reference.

■ Adjusting the LED Pointer

Adjust the LED pointer if it indicates a point different than the actual needle drop point.

Before adjusting the LED pointer, mark the actual needle drop point on the fabric to be embroidered, and then hoop the fabric and attach the embroidery frame.

Note

- As a default, some keys mentioned in the following procedures appear in light gray and are not available. To enable the keys for specifying the settings, attach embroidery foot “W+” with LED pointer to the machine. The keys are enabled after the embroidery foot is detected.

- 1 Press .

→ The settings screen appears.

- 2 Press .

→ The Embroidery settings screen appears.

Memo

- When using the “Embroidery” or “Embroidery Edit”, touch  to directly access the Embroidery settings screen.

- 3 Display page 10 of the Embroidery settings screen.

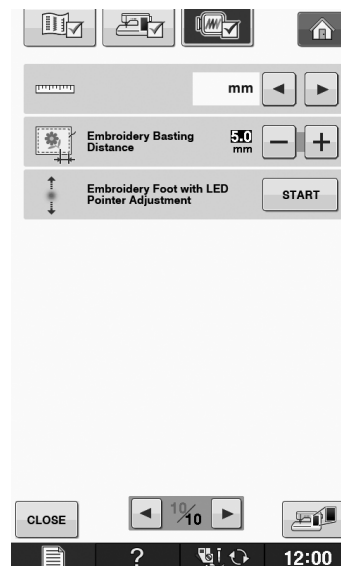

- 4** Press **START**.
 → The Embroidery Foot “W+” with LED Pointer Adjustment screen appears.

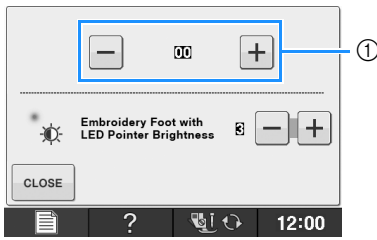

① LED pointer adjustment



Note

- The specified setting is saved in the machine’s memory. This is useful for positioning during continuous embroidering.
- For normal use, return the setting to “00”.

- 5** Use **-** or **+** to adjust the LED pointer so that it indicates the actual needle drop point.

- 6** Press **CLOSE** twice to return to the original screen.

Adjusting the Brightness of the LED Pointer

- 1** Follow the steps from **1** to **4** to display the embroidery foot with LED pointer adjust screen.

- 2** Use **-** or **+** to adjust the brightness of the LED pointer.

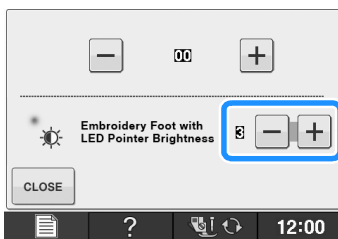

- 3** Press **CLOSE** twice to return to the original screen.

Attaching the Embroidery Unit



About the Embroidery Unit

CAUTION

- Do not move the machine with the embroidery unit attached. The embroidery unit could fall off and cause injury.
- Keep your hands and foreign objects away from the embroidery carriage and frame when the machine is embroidering. Otherwise, injury may result.
- To avoid distorting your embroidery design, do not touch the embroidery carriage and frame when the machine is embroidering.



Note

- You can also sew utility/decorative stitches with the embroidery unit attached. Touch  and . The feed dog will automatically raise for utility and decorative stitching.
- Be sure to turn off the power before installing the embroidery unit. Otherwise, the machine may be damaged.
- Do not touch the inner connector of the embroidery unit. The pins on the embroidery unit connection may be damaged.
- Do not apply strong force to the embroidery unit carriage or pick up the unit by the carriage. Otherwise, the embroidery unit may be damaged.
- Store the embroidery unit in the proper storage case.

- 1** Turn the main power to OFF, and remove the flat bed attachment.

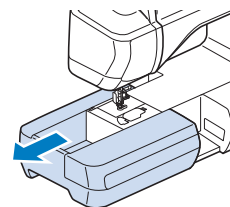

- 2** Insert the embroidery unit connection into the machine connection port. The spring hinge on the connection port cover will allow easy access to the port. Push lightly on the connection port cover until the unit clicks into place.

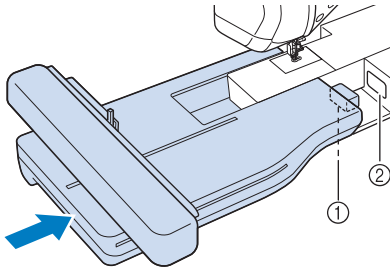

- ① Embroidery unit connection
② Machine connection port

**Note**

- Be sure there is no gap between the embroidery unit and the sewing machine. If there is a gap, the embroidery patterns will not embroider with the correct registration.
- Do not push on the carriage when installing the embroidery unit onto the machine. Moving the carriage may damage the embroidery unit.

- 3** Turn the main power to ON.

→ The following message will appear.

- 4** Press **OK**.

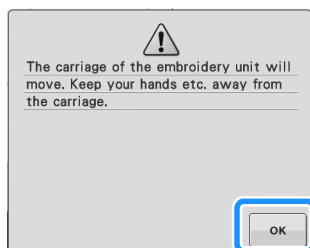

→ The carriage will move to the initialization position.

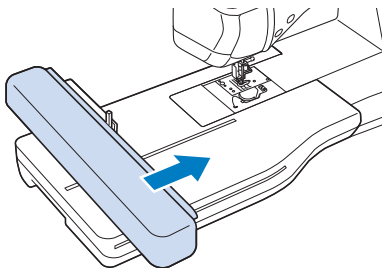
**Note**

- Either "Embroidery" screen or "Embroidery Edit" screen appears, depending on the setting selected in the settings screen.

Removing the Embroidery Unit

- 1** Press either  or , then press



→ The carriage will move to the removal position.

CAUTION

- Always remove the embroidery frame before pressing . Otherwise, the frame may strike the embroidery foot, and possibly cause injury.
- The embroidery unit will not fit in the storage case if this step is not done.

- 2** Turn the main power to OFF.

**Note**

- Be sure to turn off the machine before removing the embroidery unit, otherwise damage to the machine may result.

- 3** Hold down the release button, and pull the embroidery unit away from the machine.

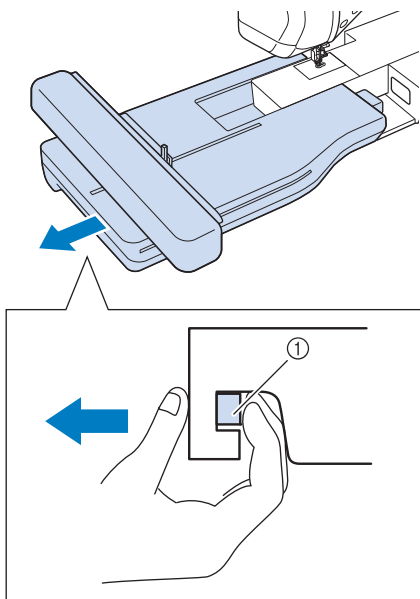

① Release button

⚠ CAUTION

- Do not carry the embroidery unit by holding the release button compartment.

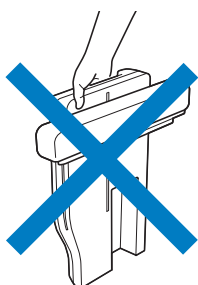

USING FUNCTIONS BY CONNECTING THE ACCESSORY TO THE MACHINE

Using USB Media or Embroidery Card Reader/USB Card Writer Module*

* If you have purchased the PE-DESIGN Ver5 or later, PE-DESIGN NEXT, PE-DESIGN Lite, PED-BASIC or PE-DESIGN PLUS, you can plug the included USB card writer module into the machine as an embroidery card reader, and recall patterns.

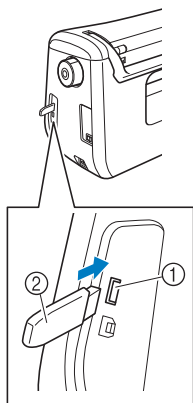

- ① USB port for mouse/media (USB 2.0)
- ② USB media

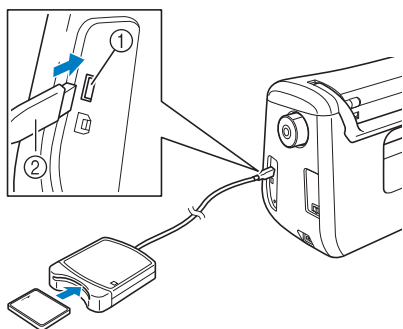

- ① USB port for mouse/media (USB 2.0)
- ② Embroidery card Reader/USB card writer module*



Note

- Use only an embroidery card reader designed for this machine. Using an unauthorized embroidery card reader may cause your machine to operate incorrectly.
- Embroidery patterns cannot be saved from the machine to an embroidery card inserted into a connected USB card writer module.



Memo

- USB media is widely used, however some USB media may not be usable with this machine. Please visit our website for more details.
- Depending on the type of USB media being used, either directly plug the USB device into the machine's USB port or plug the USB media Reader/Writer into the machine's USB port.

Connecting the Machine to the Computer

Using the included USB cable, the sewing machine can be connected to your computer.

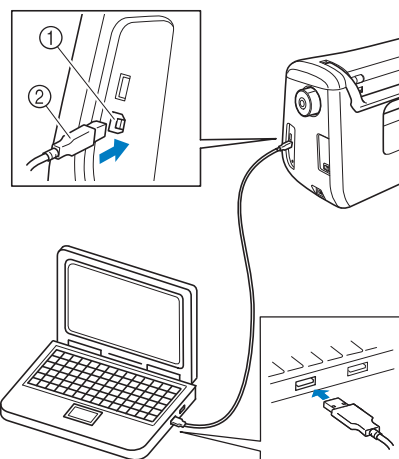

- ① USB port for computer
- ② USB cable connector



Note

- The connectors on the USB cable can only be inserted into a port in one direction. If it is difficult to insert the connector, do not insert it with force. Check the orientation of the connector.
- For details on the position of the USB port on the computer (or USB hub), refer to the instruction manual for the corresponding equipment.

Using a USB Mouse

The USB mouse, connected to the sewing machine, can be used to perform a variety of operations in the screens.



Note

- If a mouse other than the optional USB mouse is used, it may not perform as described in this Operation Manual.

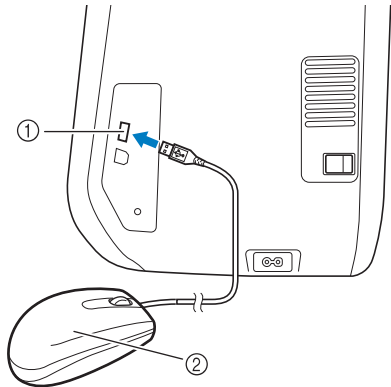

- ① USB port for mouse/media (USB 2.0)
- ② USB mouse



Note

- Do not perform operations with the mouse at the same time that you are touching the screen with your finger or the included touch pen.
- A USB mouse can be connected or disconnected at any time.
- Only the left mouse button and its wheel can be used to perform operations. No other buttons can be used.
- The mouse pointer does not appear in the opening screen.

Clicking a Key

When the mouse is connected, the pointer appears on the screen. Move the mouse to position the pointer over the desired key, and then click the left mouse button.



Memo

- Double-clicking has no effect.

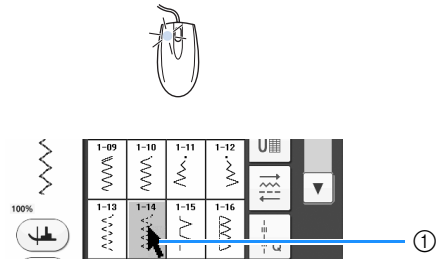

- ① Pointer

Changing Pages

Rotate the mouse wheel to switch through the tabs of the pattern selection screens.



Memo

- If page numbers and a vertical scroll bar for additional pages are displayed, rotate the mouse wheel or click the left mouse button with the pointer on ◀ / ▶ or ▲ / ▼ to display the previous or next page.

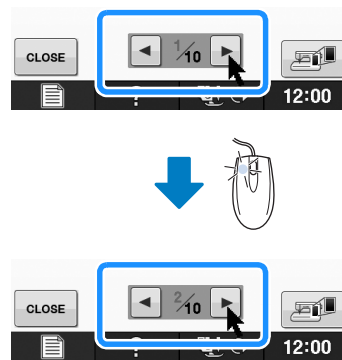

Using the Optional Dual Feed Foot

Dual feed foot enables you to have best fabric control when sewing difficult fabrics that slip easily, such as quilted fabrics or fabrics that tend to stick to the bottom of a presser foot, such as vinyl, leather or synthetic leather.



Note

- When sewing with the dual feed foot, sew at medium to low speeds.



Memo

- When selecting stitches to be used with the dual feed foot, only the stitches that can be used will be activated on the display.
- When sewing fabric that easily sticks together, a more attractive finish can be achieved by basting the beginning of sewing.

■ Attaching the Dual Feed Foot

- 1 Follow the steps from 1 to 5 of “Attaching the Embroidery Foot “W”” on page B-59.
- 2 Position the dual feed foot to the presser foot bar by aligning the notch of the dual feed foot to the large screw.

Side view

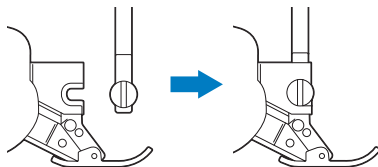

- 3 Hold the dual feed foot in place with your right hand, then using the included screwdriver securely tighten the large screw.

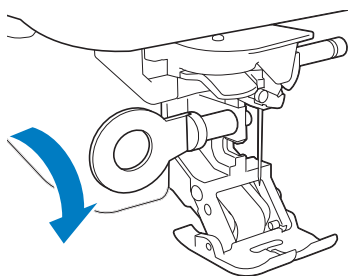

⚠ CAUTION

- Use the included screwdriver to firmly tighten the screw. If the screw is loose, the needle may strike the presser foot and possibly cause injury.

- 4 Plug the connector of the dual feed foot into the jack on the back of your machine.

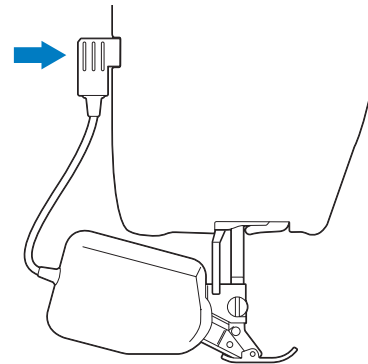

- 5 Press  to unlock all keys and buttons.

→ All keys and operation buttons are unlocked, and the previous screen is displayed.

■ Attaching/detaching toe

Attach the toe by aligning the pins with the notches and snap it into place.

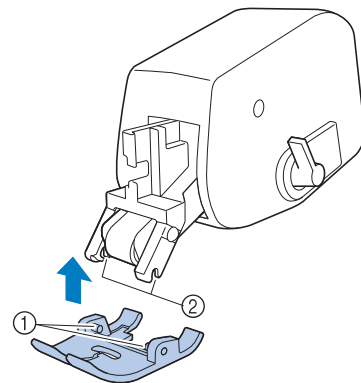

- ① Pins
- ② Notches

If you push down on the front part of the dual feed foot, the toe of the dual feed foot will snap off.

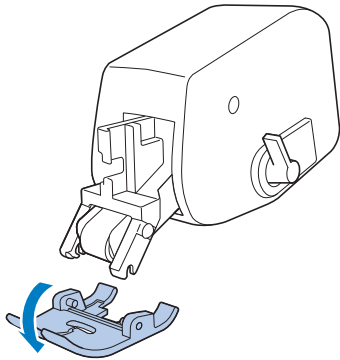

■ Using the Dual Feed Position Lever

When the feed position lever is up, the black roller belt on the dual feed is not engaged.

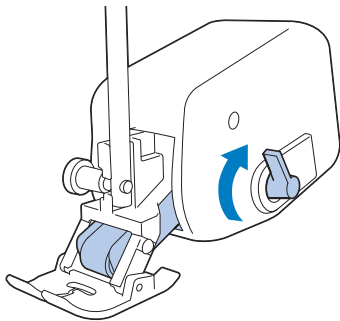

When the feed position lever is down, the black roller belt on the dual feed is engaged.

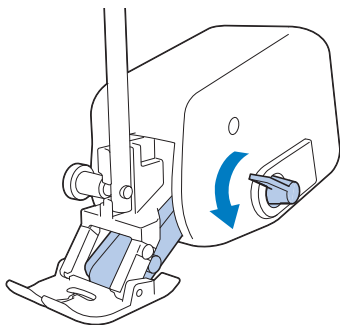

Note

- Do not operate the lever while sewing.







■ Adjusting the Amount of Fabric Feeding of the Dual Feed Foot

The dual feed mechanism pulls the top fabric according to the set stitch length. With troublesome fabrics, fine tune the set length, by changing the dual feed feed adjustment in the settings screen.



Note

- As a default, some keys mentioned in the following procedures appear in light gray and are not available. To enable the keys for specifying the settings, attach the dual feed foot to the machine. The keys are enabled after the dual feed foot is detected.

- 1 Press .
 - The settings screen appears.
- 2 Press .
 - The Sewing settings screen appears.
- 3 Display page 1 of the Sewing settings screen.
- 4 Use  or  to increase or decrease the feeding of the top fabric.
 - * Select "00" for sewing in most cases.
 - * If the feed amount for the top fabric is too little, causing the fabric to be longer than the bottom fabric, press  to increase the feed amount for the top fabric.
 - * If the feed amount for the top fabric is too much, causing the fabric to be shorter than the bottom fabric, press  to decrease the feed amount for the top fabric.

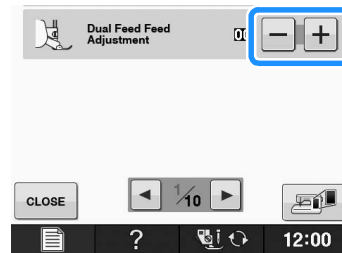

- 5 Press  to return to the original screen.



Sewing

This section describes procedures for using the various utility stitches as well as other functions. It provides details on basic sewing in addition to the more expressive features of the machine, from sewing tubular pieces and buttonholes to sewing the character and decorative stitch patterns.

Page number starts with "S" in this section.

The screen display and machine illustration may vary slightly, depending on the countries or regions.

Chapter1 Sewing Basics	S-2
Chapter2 Utility Stitches	S-20
Chapter3 Character/Decorative Stitches	S-76
Chapter4 MY CUSTOM STITCH	S-102

Chapter 1

Sewing Basics

SEWING	3
Sewing a Stitch	3
■ Using the Foot Controller	4
Sewing Reinforcement Stitches	5
Automatic Reinforcement Stitching	5
Sewing Curves	7
Changing Sewing Direction	7
■ Sewing a Seam Allowance of 0.5 cm or Less	7
Sewing Heavyweight Fabrics	7
■ If the Fabric does not Fit under the Presser Foot.....	8
■ If the Fabric does not Feed.....	8
Sewing Hook-and-Loop Fastener	8
Sewing Lightweight Fabrics	9
Sewing Stretch Fabrics.....	9
STITCH SETTINGS	10
Setting the Stitch Width.....	10
Setting the Stitch Length	10
Setting the “L/R SHIFT”	11
Setting the Thread Tension	12
■ Proper Thread Tension	12
■ Upper Thread is Too Tight	12
■ Upper Thread is Too Loose	13
USEFUL FUNCTIONS	14
Automatic Thread Cutting	14
Using the Knee Lifter	15
Pivoting.....	15
Automatic Fabric Sensor System (Automatic Presser Foot Pressure)	17
Needle Position – Stitch Placement	18
Locking the Screen	18

SEWING

⚠ CAUTION

- To avoid injury, pay special attention to the needle while the machine is in operation. Keep your hands away from moving parts while the machine is in operation.
- Do not stretch or pull the fabric during sewing. Doing so may lead to injury.
- Do not use bent or broken needles. Doing so may lead to injury.
- Do not attempt to sew over basting pins or other objects during sewing. Otherwise, the needle may break and cause injury.
- If stitches become bunched, lengthen the stitch length setting before continuing sewing. Otherwise, the needle may break and cause injury.

Sewing a Stitch

- 1 Turn the main power to ON and display the utility stitches, and push the “Needle Position” button to raise the needle.
- 2 Press the key of the stitch you want to sew.

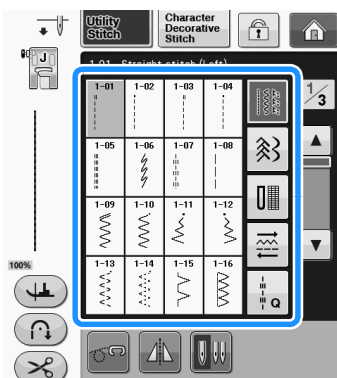

→ The symbol of the correct presser foot will be displayed in the upper left corner of the LCD screen.

- 3 Install the presser foot (“CHANGING THE PRESSER FOOT” of “Basic operations”).

⚠ CAUTION

- Always use the correct presser foot. If the wrong presser foot is used, the needle may strike the presser foot and bend or break, possibly resulting in injury. Refer to page S-67 for presser foot recommendations.

- 4 Set the fabric under the presser foot. Hold the fabric and thread in your left hand, and rotate the handwheel to set the needle in the sewing start position.

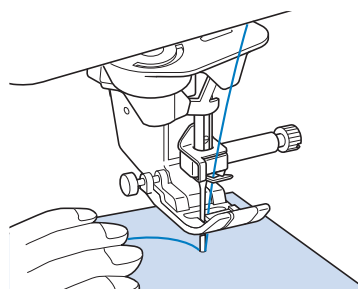
**Memo**

- The black button on the left side of presser foot “J” should be pressed only if the fabric does not feed or when sewing thick seams (see page S-8). Normally, you can sew without pressing the black button.

- 5 Lower the presser foot.
 - * You do not have to pull up the bobbin thread.
- 6 Adjust the sewing speed with the speed control slide.
 - * You can use this slide to adjust sewing speed during sewing.

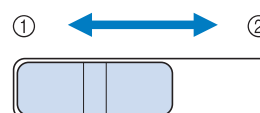

- ① Slow
- ② Fast

7 Press the “Start/Stop” button to start sewing.

* Guide the fabric lightly by hand.

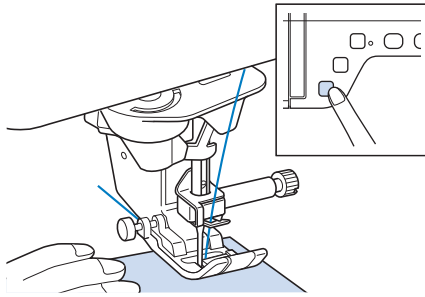

Memo

- When the foot controller is being used, you cannot start sewing by pressing the “Start/Stop” button.

8 Press the “Start/Stop” button again to stop sewing.

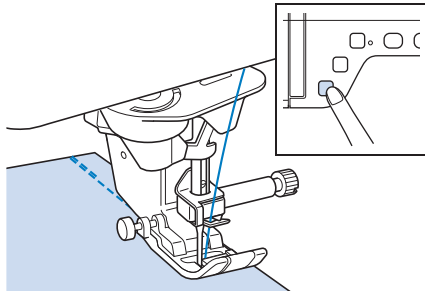

9 Press the “Thread Cutter” button to trim the upper and lower threads.

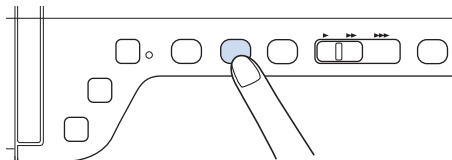

→ The needle will return to the up position automatically.

⚠ CAUTION

- Do not press the “Thread Cutter” button after the threads have been cut. Doing so could tangle the thread or break the needle and damage the machine.
- Do not press the “Thread Cutter” button when there is no fabric set in the machine or during machine operation. The thread may tangle, possibly resulting in damage.



Note

- When cutting thread thicker than #30, nylon monofilament thread, or other decorative threads, use the thread cutter on the side of the machine.

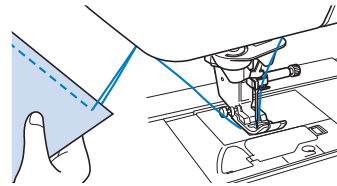

10 When the needle has stopped moving, raise the presser foot and remove the fabric.



Memo

- This machine is equipped with a bobbin thread sensor that warns you when the bobbin thread is almost empty. When the bobbin thread is nearly empty, the machine automatically stops. However, if the “Start/Stop” button is pressed, a few stitches can be sewn. When the warning displays, re-thread the machine immediately.

■ Using the Foot Controller

You can also use the foot controller to start and stop sewing.

⚠ CAUTION

- Do not allow fabric pieces and dust to collect in the foot controller. Doing so could cause a fire or an electric shock.



Memo

- When the foot controller is being used, you cannot start sewing by pressing the “Start/Stop” button.
- (For embroidery and sewing machine only)
- The foot controller cannot be used when embroidering.
 - The foot controller can be used for sewing utility and decorative stitches when the embroidery unit is attached.

- 1** Insert the foot controller plug into its jack on the machine.

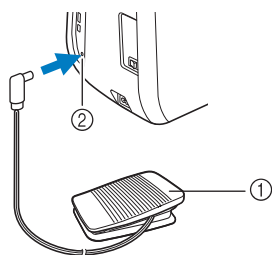

- ① Foot controller
② Foot controller jack

- 2** Slowly depress the foot controller to start sewing.

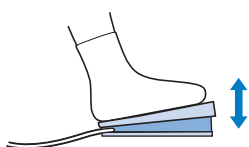

Memo

- The speed that is set using the sewing speed controller is the foot controller's maximum sewing speed.

- 3** Release the foot controller to stop the machine.

Sewing Reinforcement Stitches

Reverse/reinforcement stitches are generally necessary at the beginning and end of sewing. You can use the "Reverse Stitch" button to sew reverse/reinforcement stitches.

When you keep pressing the "Reinforcement Stitch" button, the machine will sew reinforcement stitch at that point 3 to 5 stitches, and then stop.

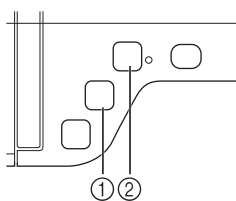

- ① "Reverse Stitch" button
② "Reinforcement Stitch" button

If the automatic reinforcement stitch is selected on the screen, reverse stitches (or reinforcement stitches) will be sewn automatically at the beginning of sewing when the "Start/Stop" button is pressed. Press the "Reverse Stitch" button or "Reinforcement Stitch" button to sew reverse stitches or reinforcement stitches automatically at the end of sewing.

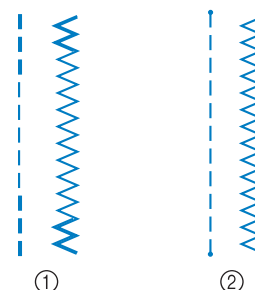

- ① Reverse stitch
② Reinforcement stitch

The operation performed when the button is pressed differs depending on the selected pattern. (Refer to the table in "Automatic Reinforcement Stitching" on page S-5.)

Memo

- When you press the "Reinforcement Stitch" button while sewing character/decorative stitch pattern, you can end sewing with a full stitch instead of at a mid-point.
- The green light on the right of the "Reinforcement Stitch" button lights up while the machine is sewing a full motif, and it automatically turns off when the sewing is stopped.

Automatic Reinforcement Stitching

After selecting a stitch pattern, turn on the automatic reinforcement stitching function before sewing, and the machine will automatically sew reinforcement stitches (or reverse stitches, depending on the stitch pattern) at the beginning and end of sewing.

- 1** Select a stitch pattern.

2 Press  to set the automatic reinforcement stitching function.

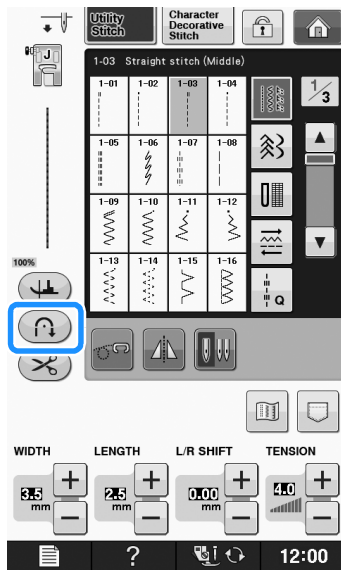

→ The key will display as .

Memo

- Some stitches, such as buttonholes and bar tacks, require reinforcement stitches at the beginning of sewing. If you select one of these stitches, the machine will automatically turn on this function (the key appears as  when the stitch is selected).

3 Set the fabric in the start position and start sewing.

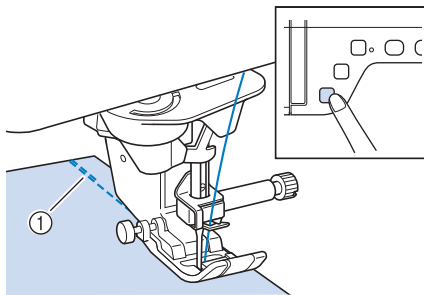

① Reverse stitches (or reinforcement stitches)
→ The machine will automatically sew reverse stitches (or reinforcement stitches) and then continue sewing.

Memo

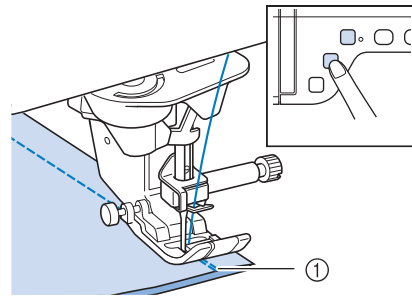

- If you press the “Start/Stop” button to pause sewing, press it again to continue. The machine will not sew reverse/reinforcement stitches again.

4 Press the “Reverse Stitch” button or “Reinforcement Stitch” button.















① Reverse stitches (or reinforcement stitches)
→ The machine will sew reverse stitches (or reinforcement stitches) and stop.

Memo

- To turn off the automatic reinforcement stitching function, press  again, so it appears as .

The operation performed when the button is pressed differs depending on the selected pattern. Refer to the following table for details on the operation that is performed when the button is pressed.

	“Reverse Stitch” button 	“Reinforcement Stitch” button 
Utility Stitch +  1-01 1-03 1-05	Machine starts sewing the stitches and only sews reverse stitches while holding the “Reverse Stitch” button.	Machine starts sewing the stitches and sews 3 - 5 reinforcement stitches while holding the “Reinforcement Stitch” button.
Utility Stitch +  1-02 1-04 1-10	Machine starts sewing the stitches and only sews reverse stitches while holding the “Reverse Stitch” button.	Machine starts sewing the stitches and sews 3 - 5 reinforcement stitches while holding the “Reinforcement Stitch” button.
Utility Stitch +  1-01 1-03 1-09	Machine sews reverse stitches at the beginning and end of sewing.	Machine sews reverse stitches at the beginning and reinforcement stitches at the end of sewing.
Utility Stitch +  1-02 1-04 1-10	Machine sews reinforcement stitches at the beginning and reverse stitches at the end of sewing.	Machine sews reinforcement stitches at the beginning and end of sewing.

	“Reverse Stitch” button 	“Reinforcement Stitch” button 
 + 	Machine starts sewing and then sews reinforcement stitches while holding the “Reverse Stitch” button.	Machine starts sewing at the beginning, then completes the pattern and sews reinforcement stitches at the end of sewing.
 + 	Machine sews reinforcement stitches at the beginning and sews reinforcement stitches when the “Reverse Stitch” button is touched.	Machine sews reinforcement stitches at the beginning, then completes the pattern and sews reinforcement stitches at the end of sewing.

Sewing Curves

Sew slowly while keeping the seam parallel with the fabric edge as you guide the fabric around the curve.

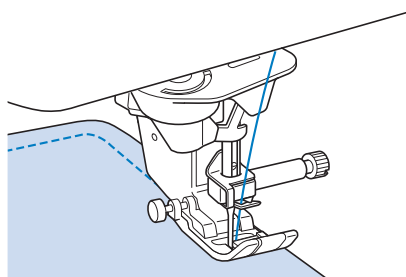

Changing Sewing Direction

Stop the machine. Leave the needle in the fabric, and press the “Presser Foot Lifter” button to raise the presser foot. Using the needle as a pivot, turn the fabric so that you can sew in the new direction. Press the “Presser Foot Lifter” button to lower the presser foot and start sewing.

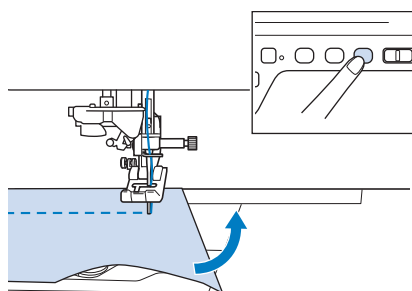

The pivot setting is useful when changing the sewing direction. When the machine is stopped at the corner of the fabric, the machine stops with the needle in the fabric and the presser foot is automatically raised so the fabric can easily be rotated (“Pivoting” on page S-15).

■ Sewing a Seam Allowance of 0.5 cm or Less

Baste the corner before sewing, and then, after changing the sewing direction at the corner, pull the basting thread toward the back while sewing.

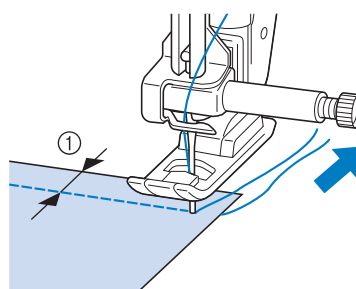

① 5 mm (approx. 3/16 inch)

Sewing Heavyweight Fabrics

The sewing machine can sew fabrics up to 6 mm (approx. 1/4 inch) thick. If the thickness of a seam causes sewing to occur at an angle, help guide the fabric by hand and sew on the downward slope.

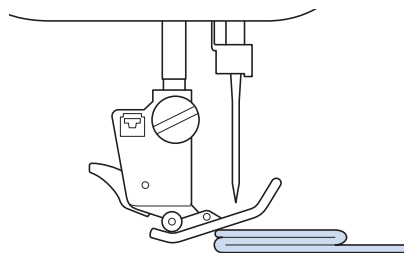

⚠ CAUTION

- Do not forcefully push fabrics more than 6 mm (approx. 1/4 inch) thick through the sewing machine. This may cause the needle to break and cause injury.
- Thicker fabrics require a larger needle (“CHANGING THE NEEDLE” of “Basic operations”).

■ If the Fabric does not Fit under the Presser Foot

If the presser foot is in the up position, and you are sewing heavyweight or multiple layers of fabric which do not fit easily under the presser foot, use the presser foot lever to raise the presser foot to its highest position. The fabric will now fit under the presser foot.

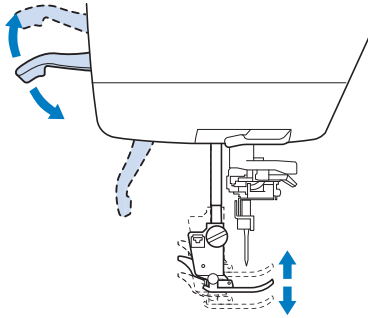

Memo

- You cannot use the presser foot lever after the presser foot has been raised using the “Presser Foot Lifter” button.

■ If the Fabric does not Feed

If the fabric does not feed when starting to sew or when sewing thick seams, press the black button on the left side of presser foot “J”.

1 Raise the presser foot.

2 While keeping the black button on the left side of presser foot “J” pressed in, press the “Presser Foot Lifter” button to lower the presser foot.

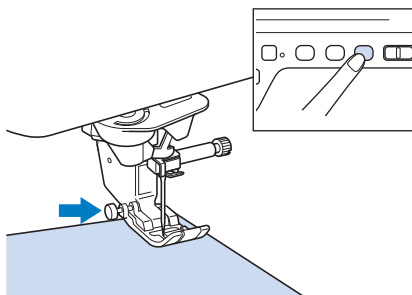

3 Release the black button.

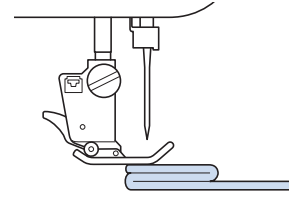

→ The presser foot remains level, enabling the fabric to be fed.

Memo

- Once the trouble spot has been passed, the foot will return to its normal position.
- When “Automatic Fabric Sensor System” (Automatic Presser Foot Pressure) in the machine settings screen is set to “ON”, the thickness of the fabric is automatically detected by the internal sensor so the fabric can be fed smoothly for best sewing results. (see page S-17 for details.)

Sewing Hook-and-Loop Fastener

CAUTION

- Do not use adhesive backed hook-and-loop fastener designed for sewing. If the adhesive sticks to the needle or the bobbin hook race, it may cause malfunction.
- If the hook-and-loop fastener is sewn with a fine needle (65/9-75/11), the needle may bend or break.

Note

- Before starting to sew, baste the fabric and hook-and-loop fastener together.

Make sure that the needle passes through the hook-and-loop fastener by rotating the handwheel and lower the needle into the hook-and-loop fastener before sewing. Sew the edge of the hook-and-loop fastener at a slow speed. If the needle does not pass through the hook-and-loop fastener, replace the needle with the needle for thick fabrics (“Fabric/Thread/Needle Combinations” of “Basic operations”).

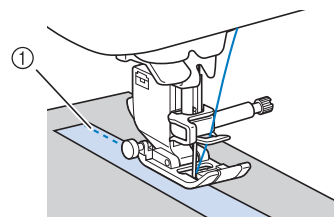

① Edge of the hook-and-loop fastener

Sewing Lightweight Fabrics

Place thin paper or tear away embroidery stabilizer under thin fabrics to make sewing easier. Gently tear off the paper or the stabilizer after sewing.

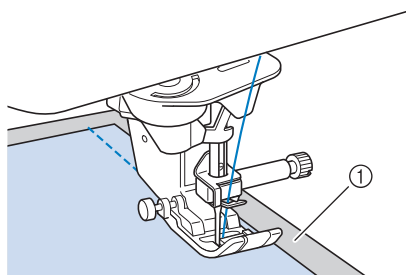

① Thin paper

Sewing Stretch Fabrics

First, baste together the pieces of fabric, and then sew without stretching the fabric.

In addition, a better result can be achieved by using thread for knits or a stretch stitch.



Memo

- For best results when sewing stretch fabrics, decrease the pressure of the presser foot (“Using the Machine Setting Mode Key” of “Basic operations”).

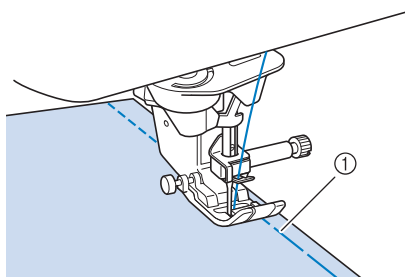

① Basting stitching

STITCH SETTINGS

When you select a stitch, your machine automatically selects the appropriate stitch width, stitch length, “L/R SHIFT”, and upper thread tension. However, if needed, you can change any of the individual settings.



Note

- Settings for some stitches cannot be changed (refer to the “STITCH SETTING CHART” on page S-67).
- If you turn off the machine or select another stitch without saving stitch setting changes (“Saving Your Stitch Settings” on page S-22), the stitch settings will return to their default settings.

Setting the Stitch Width

Follow the steps below when you want to change the zigzag stitch pattern width.



Memo

- For an alternate method of changing the stitch width using the speed controller, see page S-39.

Example:

Press **-** to narrow the zigzag stitch pattern width.

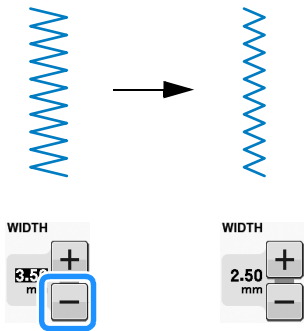

→ The value in the display gets smaller.

Press **+** to widen the zigzag stitch pattern width.

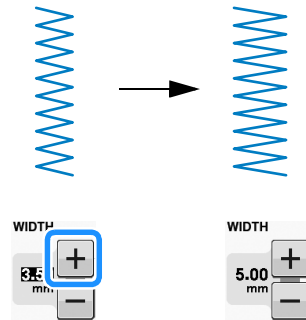

→ The value in the display gets bigger.



Memo

- Press **RESET** after pressing **□** to return to the original setting.



Note

- After adjusting the stitch width, slowly rotate the handwheel toward you (counterclockwise) and check that the needle does not touch the presser foot. If the needle hits the presser foot, the needle may bend or break.

Setting the Stitch Length

Follow the steps below when you want to change the stitch pattern length.



Example:

Press **-** to shorten the stitch length.

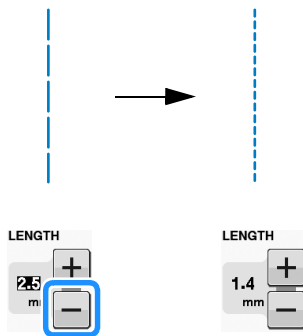

→ The value in the display gets smaller.

Press **+** to lengthen the stitch length.

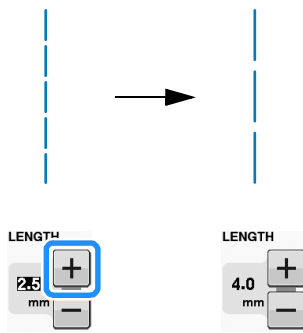

→ The value in the display gets bigger.

Memo

- Press **MEMO** to check changes made to the stitch.
- Press **RESET** after pressing **MEMO** to return to the original setting.

CAUTION

- If the stitches get bunched together, lengthen the stitch length and continue sewing. Do not continue sewing without lengthening the stitch length. Otherwise, the needle may break and cause injury.

Setting the “L/R SHIFT”

Follow the steps below when you want to change the placement of the zigzag stitch pattern by moving it left and right.

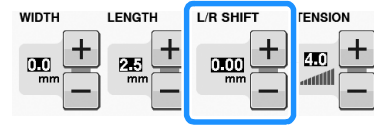

Example:

Press **-** to shift the pattern to the left.

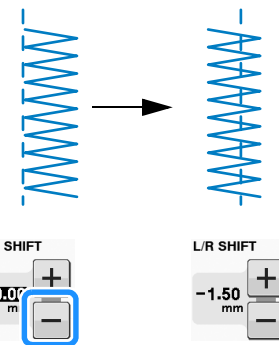

→ The value in the display appears with a minus sign.

Press **+** to shift the pattern to the right side of the left needle position.

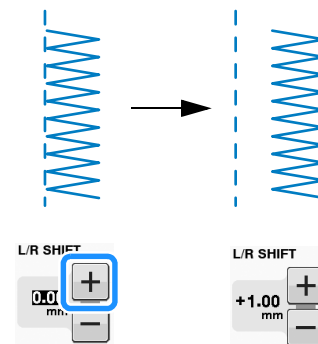

→ The value in the display appears with a plus sign.

Memo

- Press **RESET** after pressing **MEMO** to return to the original setting.

Note

- After adjusting the “L/R SHIFT”, slowly rotate the handwheel toward you (counterclockwise) and check that the needle does not touch the presser foot. If the needle hits the presser foot, the needle may bend or break.

Setting the Thread Tension

You may need to change the thread tension, depending on the fabric and thread being used. Follow the steps below to make any necessary changes.

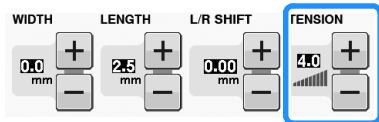

■ Proper Thread Tension

The upper thread and the bobbin thread should cross near the center of the fabric. Only the upper thread should be visible from the right side of the fabric, and only the bobbin thread should be visible from the wrong side of the fabric.

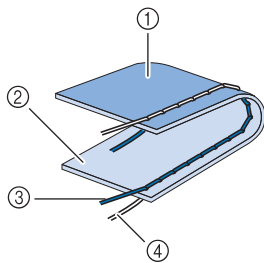

- ① Wrong side
- ② Surface
- ③ Upper thread
- ④ Bobbin thread

■ Upper Thread is Too Tight

If the bobbin thread is visible on the right side of the fabric, the upper thread is too tight.



Note

- If the bobbin thread was incorrectly threaded, the upper thread may appear to be too tight. In this case, refer to “Setting the Bobbin” of “Basic operations” and rethread the bobbin thread.

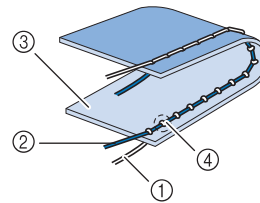

- ① Bobbin thread
- ② Upper thread
- ③ Surface
- ④ Locks appear on surface of fabric

Press , to loosen the upper thread.



Memo

- When you finish sewing, remove the bobbin cover and then make sure that the thread is shown as below. If the thread is not shown as below, the thread is not inserted through the tension-adjusting spring of the bobbin case correctly. Reinsert the thread correctly. For details, refer to “Setting the Bobbin” of “Basic operations”.

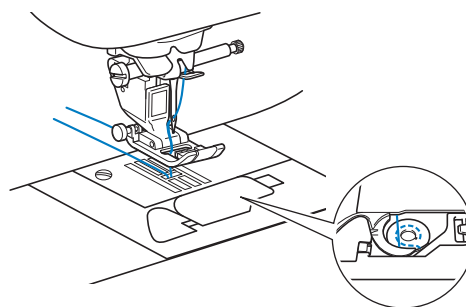

■ Upper Thread is Too Loose

If the upper thread is visible from the wrong side of the fabric, the upper thread is too loose.



Note

- If the upper thread was incorrectly threaded, the upper thread may appear to be too loose. In this case, refer to “Upper Threading” of “Basic operations” and rethread the upper thread.

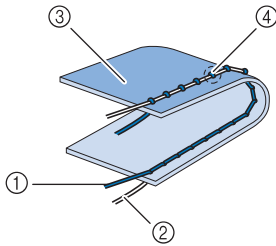



- ① Upper thread
- ② Bobbin thread
- ③ Wrong side
- ④ Locks appear on wrong side of fabric

Press  , to tighten the upper thread.



Memo

- Press  after pressing  to return to the original setting.

USEFUL FUNCTIONS

Automatic Thread Cutting

After selecting a stitch pattern, turn on the automatic thread cutting function before sewing, and the machine will automatically sew reinforcement stitches (or reverse stitches, depending on the stitch pattern) at the beginning and end of sewing, and trim the threads at the end of sewing. This function is useful when sewing buttonholes and bar tacks.

1 Select a stitch pattern.

2 Press  to set the automatic thread cutting function.

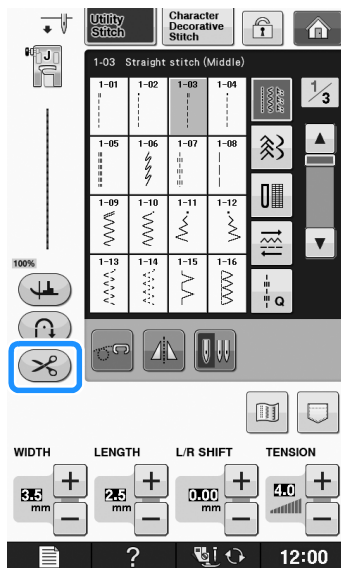

→ The key will display as .

3 Set the fabric in the start position and start sewing.

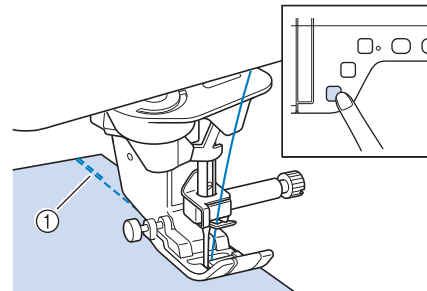

① Reverse stitches (or reinforcement stitches)
→ The machine will automatically sew reverse stitches (or reinforcement stitches) and then continue sewing.



Memo

- If you press the “Start/Stop” button to pause sewing, press the same button again to continue. The beginning reverse/reinforcement stitches will not be sewn again.

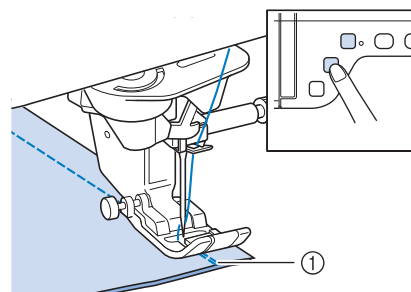

4 Press the “Reverse Stitch” button or “Reinforcement Stitch” button.



① Reverse stitches (or reinforcement stitches)
→ The machine will sew reverse stitches (or reinforcement stitches), then trim the thread.



Memo

- To turn off the automatic thread cutting function, press  again, so it appears as .

Using the Knee Lifter

Using the knee lifter, you can raise and lower the presser foot with your knee, leaving both hands free to handle the fabric.

- 1 **Align the tabs on the knee lifter with the notches in the knee lifter slot on the front of the machine. Insert the knee lifter bar as far as possible.**

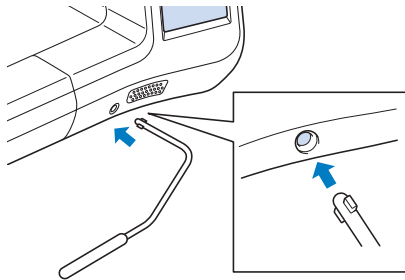

⚠ CAUTION

- Only change position of the knee lifter handle when knee lifter is not on the machine, otherwise the presser foot will go up, and then the knee lifter may damage the mounting slot on front of the machine.

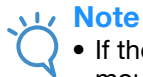

Note

- If the knee lifter bar is not pushed into the mounting slot as far as possible, it may come out during use.

- 2 **Use your knee to move the knee lifter bar to the right in order to raise the presser foot. Release the knee lifter to lower the presser foot.**

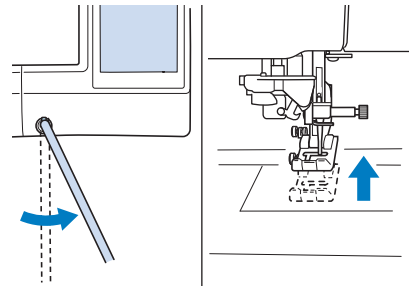

⚠ CAUTION

- Be sure to keep your knee away from the knee lifter during sewing. If the knee lifter is pushed during machine operation, the needle may break or the thread tension may loosen.



Memo

- When the presser foot is in the up position, move the knee lifter to the far right and then release to return the presser foot to the down position.



Pivoting

If the pivot setting is selected, the machine stops with the needle lowered (in the fabric) and the presser foot is automatically raised to an appropriate height when the "Start/Stop" button is pressed. When the "Start/Stop" button is pressed again, the presser foot is automatically lowered and sewing continues. This function is useful for stopping the machine to rotate the fabric.

⚠ CAUTION





- When the pivot setting is selected, the machine starts when the "Start/Stop" button is pressed or the foot controller is pressed down even if the presser foot has been raised. Be sure to keep your hands and other items away from the needle, otherwise injuries may occur.

Memo

- When the pivot setting is selected, the height of the presser foot when sewing is stopped can be changed according to the type of fabric being sewn. Press  to display "Pivoting Height" in the settings screen. Press  or  to select one of the three heights (3.2 mm, 5.0 mm or 7.5 mm). To raise the presser foot further, increase the setting. (Normally, 3.2 mm is set.)



Note

- The "Needle Position - UP/DOWN" in the settings screen, must be set in the down position  for the pivot function to be used. When "Needle Position - UP/DOWN" is set in the raised position,  appears as light gray and cannot be used.
- The pivot function can only be used with stitches where presser foot J or N is indicated in the upper-left corner of the screen. If any other stitch is selected,  appears as light gray and is not available.
- Use the "Presser Foot Lifter" button to make sure the presser foot is lowered, and then press the "Start/Stop" button to continue sewing.
- If the pivot setting is selected,  and  beside "Presser Foot Height" in the settings screen are not available and the setting cannot be changed.

1 Select a stitch.

2 Press  to select the pivot setting.

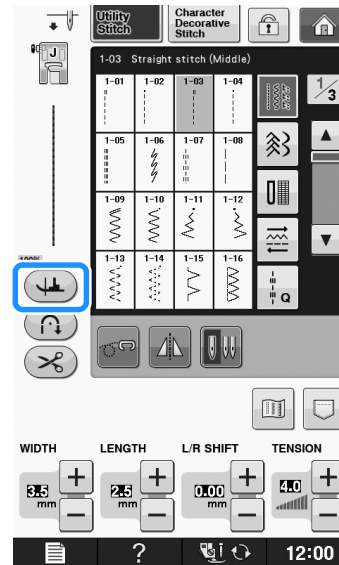

→ The key appears as .

3 Place the fabric under the presser foot with the needle at the starting point of the stitching, and then press the "Start/Stop" button. The machine will begin sewing.

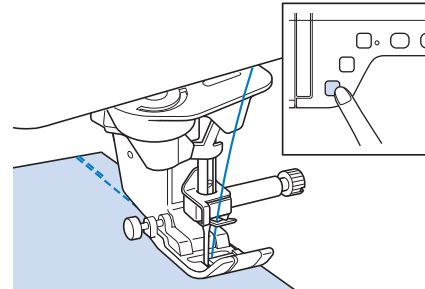

Memo

- If you press the "Start/Stop" button to pause sewing, press it again to continue, reverse stitches (or reinforcement stitches) will not be sewn.

- 4** Press the “Start/Stop” button to stop the machine at the point where the sewing direction changes.

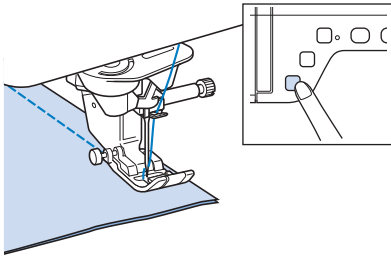

→ The machine stops with the needle in the fabric, and the presser foot is raised.

- 5** Rotate the fabric, and then press the “Start/Stop” button.

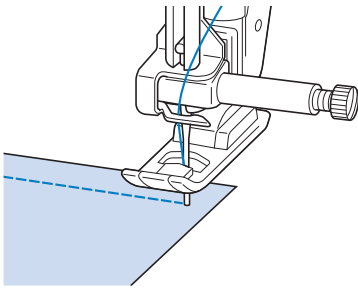

→ The presser foot is automatically lowered, and sewing continues.

Automatic Fabric Sensor System (Automatic Presser Foot Pressure)

The thickness of the fabric is automatically detected and the presser foot pressure is automatically adjusted with an internal sensor while sewing, to insure that your fabric is fed smoothly. The fabric sensor system works continuously while sewing. This function is useful for sewing over thick seams (see page S-8), or quilting (see page S-35).

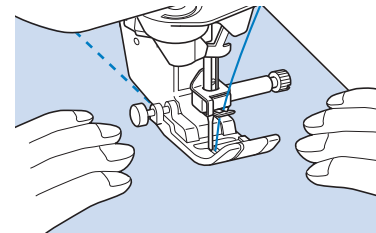
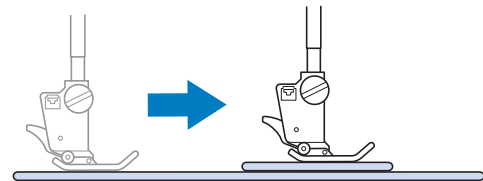

- 1** Press  to display “Automatic Fabric Sensor System” in the settings screen.
- 2** Set “Automatic Fabric Sensor System” to “ON”.

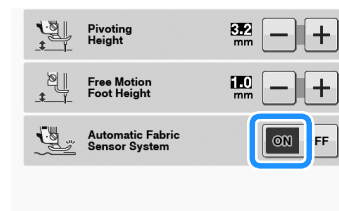

- 3** Press  to return to the original screen.

Needle Position – Stitch Placement

When the “Needle Position – Stitch Placement” is on, the needle will be partially lowered for precise stitch placement and then press the “Needle Position” button again to lower the needle completely. Each press of the “Needle Position” button changes the needle to the next position. When the “Needle Position – Stitch Placement” is turned off, each press of the “Needle Position” button simply raises and then lowers the needle.

- ① Pointing needle mode is “ON”
- ② Pointing needle mode is “OFF”

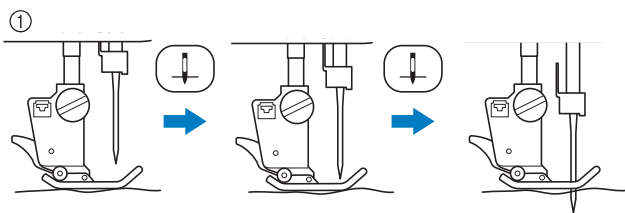

* When the needle is nearly lowered by pressing the “Needle Position” button, the feed dogs are lowered. At this time, the fabric can be shifted to finely adjust the needle drop position.

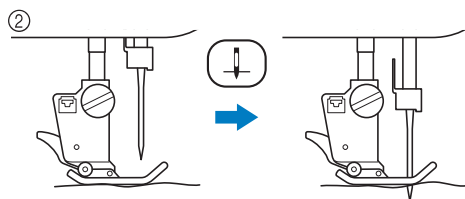

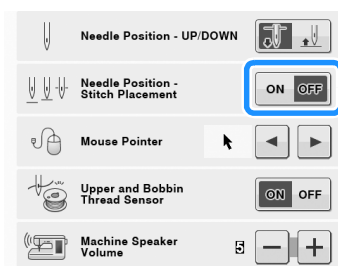

- 1 Press  to display “Needle Position – Stitch Placement” in the settings screen.
- 2 Set “Needle Position – Stitch Placement” to “ON” or “OFF”.





- 3 Press  to return to the original screen.

Locking the Screen

If the screen is locked before starting to sew, the various settings such as the stitch width and stitch length are locked and cannot be changed. This prevents screen settings from accidentally being changed or the machine from being stopped while large pieces of fabric or projects are being sewn. The screen can be locked when sewing utility stitches and character decorative stitches.

- 1 Select a stitch pattern.
- 2 If necessary, adjust any settings such as the stitch width and stitch length.
- 3 Press  to lock the screen settings.
→ The key appears as .
- 4 Sew your project.
- 5 When you are finished sewing, press  again to unlock the screen settings.

⚠ CAUTION

- If the screen is locked () , unlock the screen by pressing  . While the screen is locked, no other key can be operated.
- The settings are unlocked when the machine is turned off and on.

S
1

Sewing Basics

Chapter 2

Utility Stitches

SELECTING UTILITY STITCHES 21

Selecting a Stitch	21
■ Using the Mirror Image Key	21
■ Using the Image Key	22
Saving Your Stitch Settings	22
■ Saving Settings	22
■ Retrieving Saved Settings	23

SEWING THE STITCHES 24

Straight Stitches	24
■ Changing the Needle Position (Left or Middle Needle Position Stitches Only)	25
■ Aligning the Fabric with a Mark on the Needle Plate or Bobbin Cover (with Mark)	26
■ Using the Straight Stitch Needle Plate and the Straight Stitch Foot	26
■ Basting	28
Dart Seam	28
Gathering	29
Flat Fell Seam	29
Pintuck	30
Zigzag Stitches	31
■ Overcasting (Using a Zigzag Stitch)	31
■ Appliqué (Using a Zigzag Stitch)	31
■ Patchwork (for Crazy Quilt)	32
■ Sewing Curves (Using a Zigzag Stitch)	32
■ Cord Guide Bobbin Cover (Using a Zigzag Stitch)	32
Elastic Zigzag Stitches	33
■ Tape Attaching	33
■ Overcasting	33
Overcasting	33
■ Overcasting Using Presser Foot "G"	33
■ Overcasting Using Presser Foot "J"	34
Quilting	35
■ Piecing	36
■ Piecing Using the 1/4" Quilting Foot with Guide (optional with some models)	37
■ Appliqué	38
■ Quilting	38
■ Quilting with Satin Stitches	39
■ Free Motion Quilting	40
■ Echo Quilting Using the Free Motion Echo Quilting Foot "E" (optional with some models)	43
Blind Hem Stitches	45
■ If the Needle Catches Too Much of the Hem Fold	47
■ If the Needle does not Catch the Hem Fold	47
Appliqué	48
■ Appliqué Sharp Curves	48
■ Appliqué Corners	49
Shelltuck Stitches	49
Scallop Stitches	50
Crazy Quilting	50
Smocking Stitches	51
Fagoting	52
Tape or Elastic Attaching	52
Heirloom	53
■ Hemstitching (1)	53
■ Hemstitching (2) (Drawn Work (1))	54
■ Hemstitching (3) (Drawn Work (2))	54

One-step Buttonholes	55
■ Sewing Stretch Fabrics	57
■ Odd Shaped Buttons/Buttons that do Not Fit into the Button Holder Plate	58
Darning	58
Bar Tacks	59
■ Bar Tacks on Thick Fabrics	61
Button Sewing	61
■ Attaching 4 Hole Buttons	62
■ Attaching a Shank to the Button	62
Eyelet	62
Multi-directional Sewing (Straight Stitch and Zigzag Stitch) ...	63
Zipper Insertion	64
■ Centered Zipper	64
■ Inserting a Side Zipper	65
STITCH SETTING CHART	67

SELECTING UTILITY STITCHES



Selecting a Stitch

There are 5 categories of Utility Stitches.

- 1 Turn the main power to ON and display the utility stitches.

→ Either "1-01 Straight stitch (Left)" or "1-03 Straight stitch (Middle)" is selected, depending on the setting selected in the settings screen.

- 2 Use  to select the category you want.

- * Press  to view the next page.
- * Press  to view previous page.

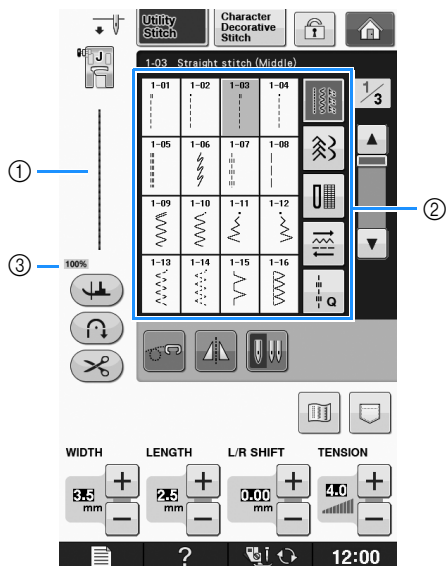

- ① Preview of the selected stitch
- ② Stitch selection screen
- ③ Percentage size of view

- 3 Press the key of the stitch you want to sew.



Memo

- For details on each stitch, refer to the "STITCH SETTING CHART" on page S-67.

Using the Mirror Image Key

Depending on the type of utility stitch you select, you may be able to sew a horizontal mirror image of the stitch.

If  is lit when you select a stitch, it will be possible to make a mirror image of the stitch.



Note

- If  is light gray after you select a stitch, you cannot create a horizontal mirror image of the selected stitch due to the type of stitch or type of presser foot recommended (this is true of buttonholes, multi-directional sewing, and others).



Press  to create a horizontal mirror image of the selected stitch.

The key will display as .



Using the Image Key

You can display an image of the selected stitch. You can check and change the colors of the image of the screen.

- 1 Press .
 - An image of the selected stitch is displayed.
- 2 Press  to change the thread color of the stitch on the screen.
 - * Press  to display an enlarged image of the stitch.

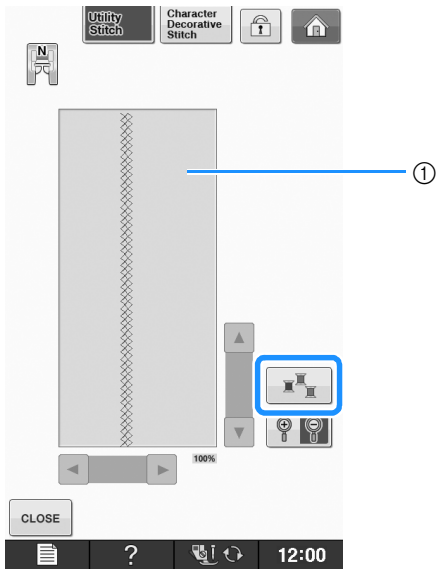

① Stitch screen

Memo

- The color changes every time you press .

Note

- If stitches are wider or larger than display, press darkened arrows to move the stitch pattern for better visibility.

- 3 Press  to return to the original screen.

Saving Your Stitch Settings

The settings for the zigzag stitch width, stitch length, thread tension, automatic thread cutting, automatic reinforcement stitching, etc., are preset in the machine for each stitch. However, if you have specific settings that you wish to reuse later for a stitch, you can change the settings so that they can be saved for that stitch. Five sets of settings can be saved for a single stitch.

Saving Settings

- 1 Select a stitch. (Example: )
- 2 Specify your preferred settings.

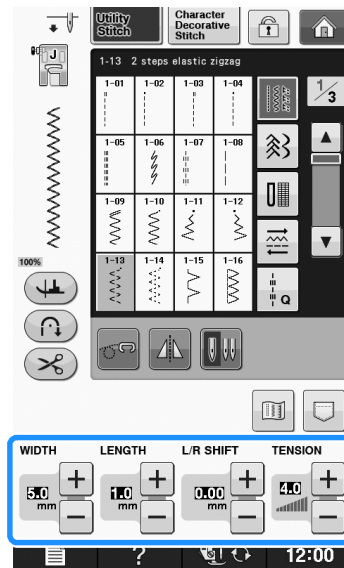

- 3 Press .
 - The memory function screen appears.

- 4 Press .

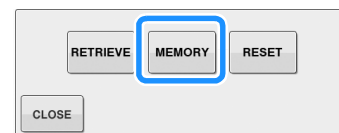

→ The settings are saved. Press  to return to the original screen.

Memo

- If you try to save settings when there are already 5 sets of settings saved for a stitch, the message “The pockets are full. Delete a pattern.” will appear. Close the message and delete a setting referring to page S-23.

Retrieving Saved Settings

1 Select a stitch.

Memo

- When a stitch is selected, the last settings retrieved are displayed. The last settings retrieved are retained even if the machine was turned off or a different stitch was selected.

2 Press .

→ The memory function screen appears.

3 Press .

4 Press the numbered key of the settings to be retrieved.

- * Press  to return to the original screen without retrieving settings.

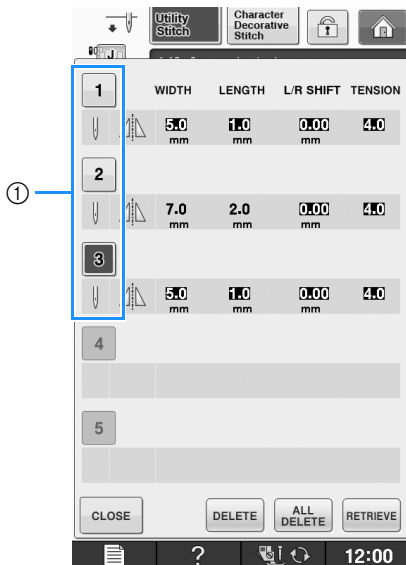







① Numbered keys

5 Press .

→ The selected settings are retrieved. Press  to return to the original screen.

















Memo

- To save new settings when there are already 5 sets of settings saved for a stitch, press  in the memory function screen. Press the numbered key of the setting to be deleted. Press  and then . Press  and then . The new setting will be saved in place of the recently deleted setting.
- You can delete all the saved settings by pressing .

SEWING THE STITCHES

Straight Stitches

See page S-67 for the detailed information of stitches.

Stitch	Stitch name	Presser foot
	Straight stitch (Left)	
	Straight stitch (Left)	
	Straight stitch (Middle)	
	Straight stitch (Middle)	
	Triple stretch stitch	
	Stem stitch	
	Decorative stitch	
	Basting stitch	

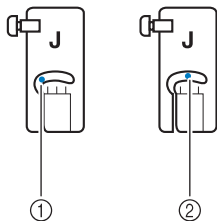

- ① Left needle position
- ② Middle needle position

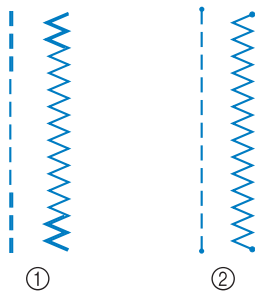

- ① Reverse stitch
- ② Reinforcement stitch



Memo

- Refer to “Sewing Reinforcement Stitches” on page S-5 for the detailed information of reverse stitches and reinforcement stitches.

1 Select a stitch.

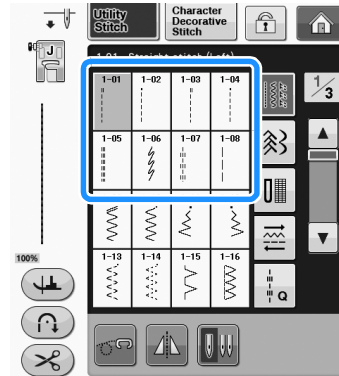

2 Attach presser foot “J”.

* Attach presser foot “N” when you select  .

3 Hold the thread tail and fabric with your left hand, and rotate the handwheel with your right hand to insert the needle into the fabric.

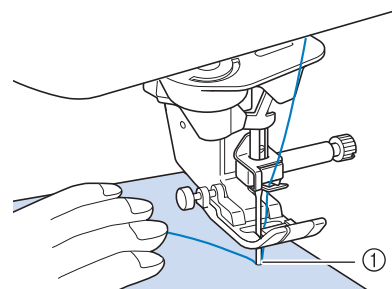

- ① Sewing start position

4 Lower the presser foot, and hold the “Reverse Stitch” or “Reinforcement Stitch” button to sew 3-4 stitches.

→ The machine sews reverse stitches (or reinforcement stitches).

- 5** Press the “Start/Stop” button to sew forward.

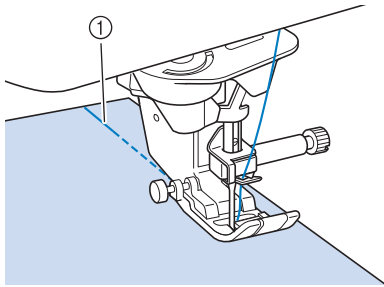

- ① Reverse stitches
→ The machine will begin sewing slowly.

⚠ CAUTION

- Be sure the needle does not strike a basting pin, or any other objects, during sewing. The thread could tangle or the needle could break, causing injury.

- 6** When sewing is completed, hold the “Reverse Stitch” button or “Reinforcement Stitch” button to sew 3-4 reverse stitches (or reinforcement stitches) at the end of the seam.

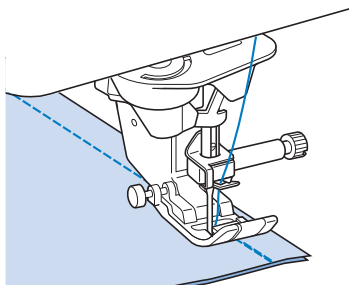

- 7** After sewing, press the “Thread Cutter” button to trim the threads.

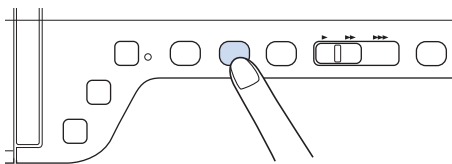

Memo

- When the automatic thread cutting and automatic reinforcement stitch keys on the screen are selected, reverse stitches (or reinforcement stitches) will be sewn automatically at the beginning of sewing when the “Start/Stop” button is pressed. Press the “Reverse Stitch” or “Reinforcement Stitch” button to sew reverse stitches (or reinforcement stitches) and trim the thread automatically at the end of sewing.

■ Changing the Needle Position (Left or Middle Needle Position Stitches Only)

When you select left or middle needle position stitches, you can use **−** and **+** in the stitch width display to change the position of the needle. Match the distance from the right edge of the presser foot to the needle with the stitch width, then align the edge of the presser foot with the edge of the fabric during sewing for an attractive finish.

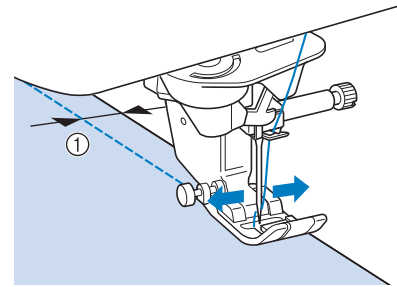

- ① Stitch width

Example: Left/Middle needle position stitches

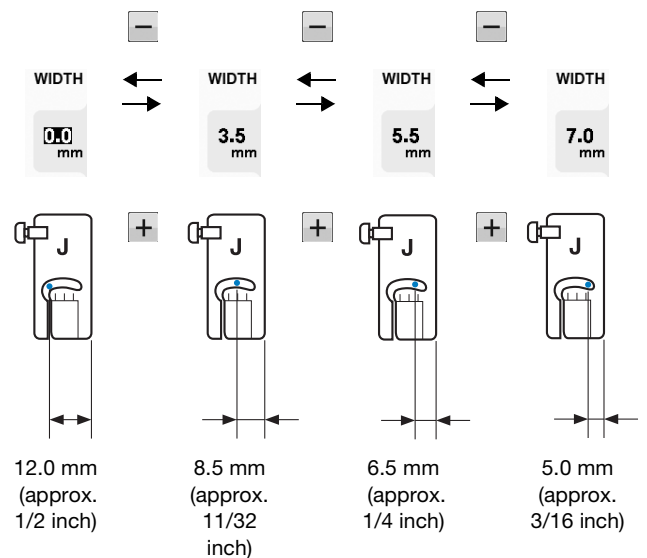

■ Aligning the Fabric with a Mark on the Needle Plate or Bobbin Cover (with Mark)

While sewing, align the edge of the fabric with the 16 mm (approx. 5/8 inch) mark on the needle plate or bobbin cover (with mark) depending on the needle position (left or middle (center) needle position stitches only).

For stitches with a left needle position (Stitch width: 0.0 mm)

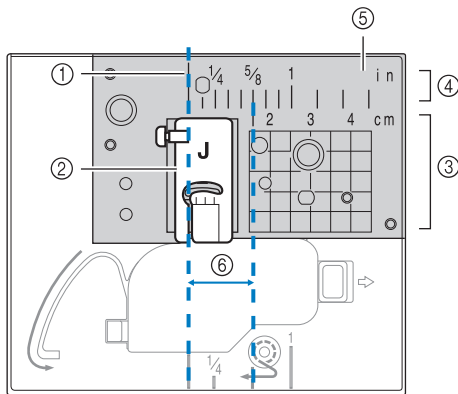

- ① Seam
- ② Presser foot
- ③ Centimeters
- ④ Inches
- ⑤ Needle plate
- ⑥ 16 mm (5/8 inch)

For stitches with a middle (center) needle position (Stitch width: 3.5 mm)

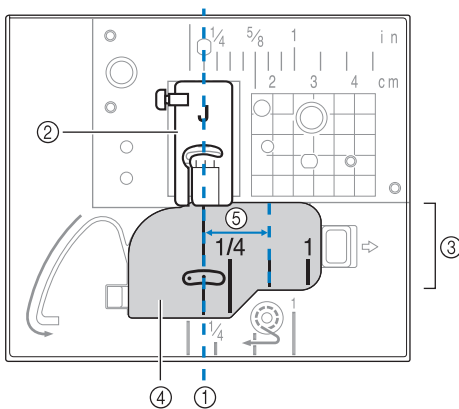

- ① Seam
- ② Presser foot
- ③ Inches
- ④ Bobbin cover (with mark)
- ⑤ 16 mm (5/8 inch)

■ Using the Straight Stitch Needle Plate and the Straight Stitch Foot

The straight stitch needle plate and the straight stitch foot can only be used for straight stitches (middle needle position stitches). Use the straight stitch needle plate and the straight stitch foot when sewing thin fabrics or when sewing small pieces which tend to sink into the hole of the regular needle plate during sewing. The straight stitch foot is perfect to reduce puckering on lightweight fabrics. The small opening on the foot provides support for the fabric as the needle travels through the fabric.

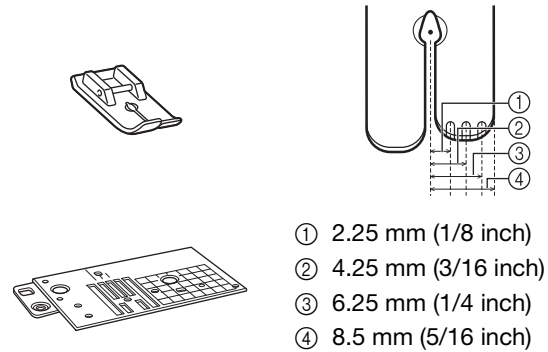

- ① 2.25 mm (1/8 inch)
- ② 4.25 mm (3/16 inch)
- ③ 6.25 mm (1/4 inch)
- ④ 8.5 mm (5/16 inch)

⚠ CAUTION

- Always use the straight stitch foot in combination with the straight stitch needle plate.

- 1 Press the “Needle Position” button to raise the needle and turn the main power to OFF or press to unlock all keys and buttons.
- 2 Remove the needle and the presser foot holder (“CHANGING THE NEEDLE” of “Basic operations”).
- 3 Remove the flat bed attachment.
- 4 Grasp both sides of the needle plate cover, and then slide it toward you.

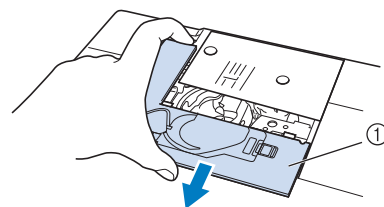

- ① Needle plate cover

- 5** Grasp the bobbin case, and then pull it out.

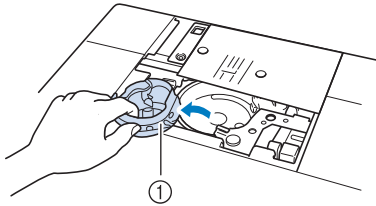

① Bobbin case

- 6** Use the disc-shaped screwdriver included with the machine to unscrew and remove the regular needle plate.

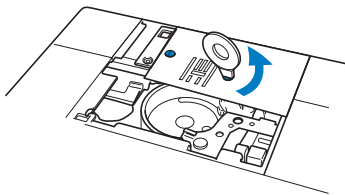

- 7** Set the straight stitch needle plate in place and use the disc-shaped screwdriver to tighten the plate.

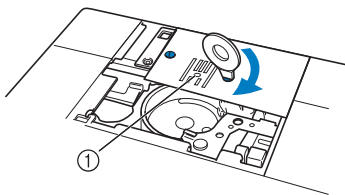

① Round hole



Note

- Align the two screw holes on the needle plate with the two holes on the machine. Use the disc-shaped screwdriver included with the machine to secure the screws in the needle plate.

- 8** Insert the bobbin case in its original position, and then attach the needle plate cover.
- 9** After reinstalling the needle plate cover, select any of the straight stitches.



Memo

- When using the straight stitch needle plate, all straight stitches become middle needle position stitches. You cannot change the needle position using the width display.
- Always secure the needle plate before inserting the bobbin case into its original position.
- “L/R SHIFT” does not work when straight stitch needle plate is on the machine.

⚠ CAUTION

- Selecting other stitches will cause an error message to be displayed.
- Slowly rotate the handwheel toward you (counterclockwise) before sewing and make sure that the needle is not contacting the straight stitch foot and straight stitch needle plate.

- 10** Insert needle and attach the straight stitch foot.

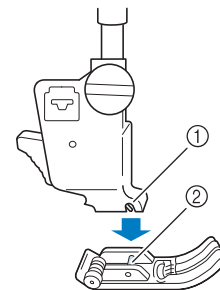

- ① Notch
② Pin

- 11** Start sewing.

- After sewing, make sure to remove the straight stitch needle plate and the straight stitch foot, and reinstall the regular needle plate, the needle plate cover and the presser foot “J”.



Memo

- To prevent puckering on fine fabrics, use a fine needle, size 75/11, and a short stitch length. For heavier fabrics, use a heavier needle, size 90/14, and longer stitches.

■ Basting

- 1 Select  and attach presser foot "J".
- 2 Press the "Reverse Stitch" button to sew reinforcement stitches, then continue sewing.

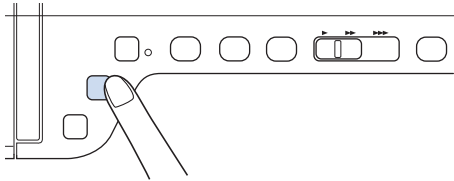

Memo

- When you use the basting stitch for gathering, do not use a reinforcement stitch at the beginning; you should lift the presser foot, rotate the handwheel toward you (counterclockwise), pull up the bobbin thread and pull a length of top and bobbin thread out from the rear of the machine.
- You can set the stitch length between 5 mm (approx. 3/16 inch) and 30 mm (approx. 1-3/16 inches)

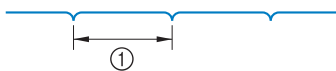

- ① Between 5 mm (approx. 3/16 inch) and 30 mm (approx. 1-3/16 inches)

- 3 Sew while keeping the fabric straight.

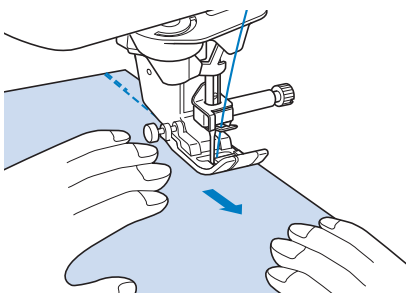

- 4 End the basting with reinforcement stitches.

Dart Seam

- 1 Select  and attach presser foot "J".
- 2 Sew a reverse stitch at the beginning of the dart and then sew from the wide end to the other end without stretching the fabric.

- * If automatic reinforcement stitching is preset, a reinforcement stitch will automatically be sewn at the beginning of sewing.

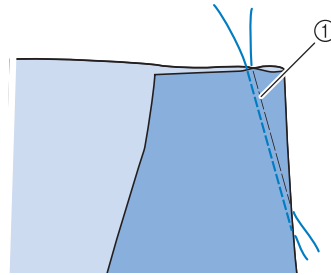

- ① Basting

- 3 Cut the thread at the end leaving 50 mm (approx. 2 inches), and then tie both ends together.

- * Do not sew a reverse stitch at the end.

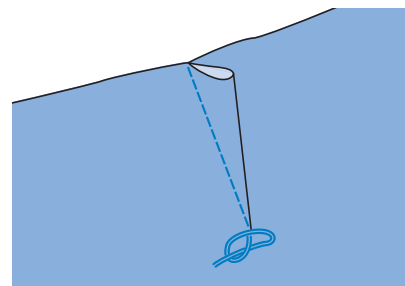

- 4 Insert the ends of the thread into the dart with a hand sewing needle.

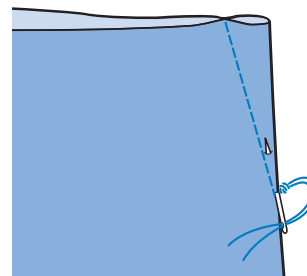

- 5 Iron the dart to one side so that it is flat.

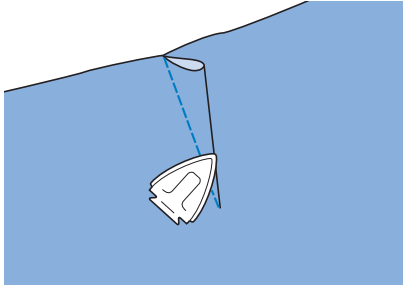

Gathering

Use on waists of skirts, sleeves of shirts, etc.

- 1 Select a straight stitch and attach presser foot "J".

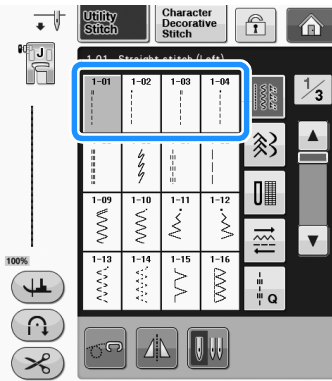

- 2 Set the stitch length to 4.0 mm (approx. 3/16 inch) and the thread tension to approximately 2.0 (weaker tension).

* If you press **Sewing Guide** after pressing **?** and then **GATHERING**, the stitch length will be set automatically to 4.0 mm (approx. 3/16 inch) and the thread tension will be automatically set to 2.0.

- 3 Pull the bobbin and upper threads out by 50 mm (approx. 2 inches) ("Pulling Up the Bobbin Thread" of "Basic operations").

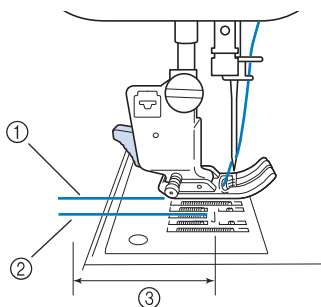

- ① Upper thread
② Bobbin thread
③ About 50 mm (approx. 2 inches)

- 4 Sew two rows of straight stitches parallel to the seam line, then trim excess thread leaving 50 mm (approx. 2 inches).

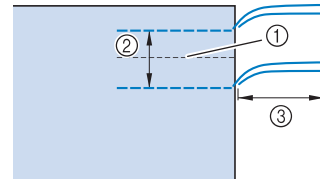

- ① Seam line
② 10 mm to 15 mm (approx. 3/8 inch to 9/16 inch)
③ About 50 mm (approx. 2 inches)

- 5 Pull the bobbin threads to obtain the desired amount of gather, then tie the threads.

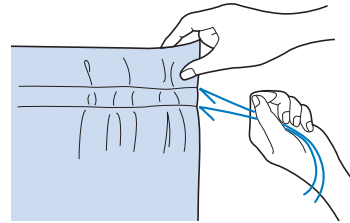

- 6 Smooth the gathers by ironing them.

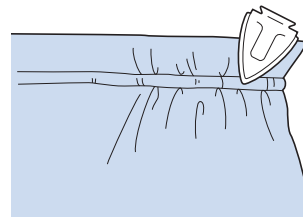

- 7 Sew on the seam line and remove the basting stitch.

Flat Fell Seam

Use for reinforcing seams and finishing edges neatly.

- 1 Select **1-03** and attach presser foot "J".

- 2 Sew the finish line, then cut half of the seam allowance from the side on which the flat fell seam will lie.

* When the automatic thread cutting and automatic reinforcement stitching are preset, reinforcement stitches will be sewn automatically at the beginning of sewing. Press the "Reverse Stitch" button to sew a

reinforcement stitch and trim the thread automatically at the end of sewing.

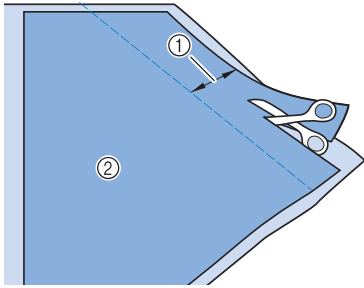

- ① About 12 mm (approx. 1/2 inch)
- ② Wrong side

3 Spread the fabric out along the finish line.

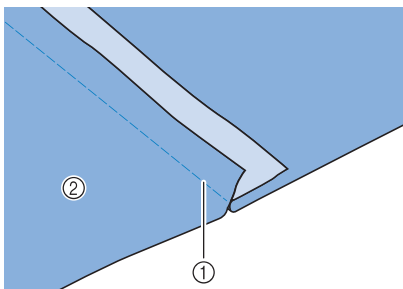

- ① Finish line
- ② Wrong side

4 Lay both seam allowances on the side of the shorter seam (cut seam) and iron them.

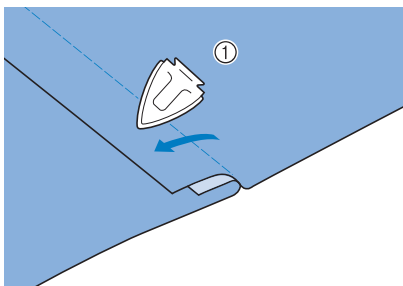

- ① Wrong side

5 Fold the longer seam allowance around the shorter one, and sew the edge of the fold.

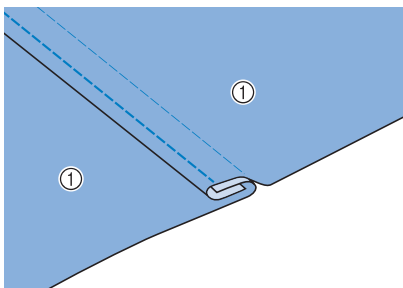

- ① Wrong side

Finished flat fell seam

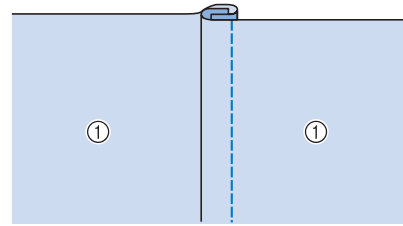

- ① Surface

Pintuck

1 Mark along the folds on the wrong side of the fabric.

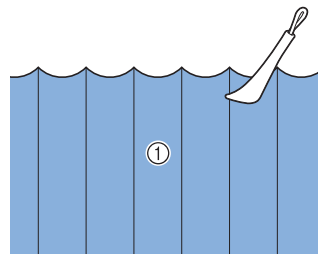

- ① Wrong side

2 Turn the fabric and iron the folded parts only.

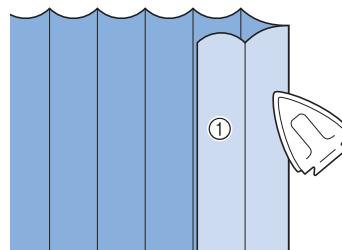

- ① Surface

3 Select  and attach presser foot "1".

4 Sew a straight stitch along the fold.

* When the automatic thread cutting and automatic reinforcement stitching are preset, reinforcement stitches will be sewn automatically at the beginning of sewing. Press the "Reverse Stitch" button to sew a reinforcement stitch and trim the thread automatically at the end of sewing.

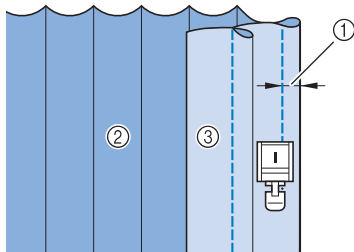

- ① Width for pintuck
- ② Wrong side
- ③ Surface

5 Iron the folds in the same direction.

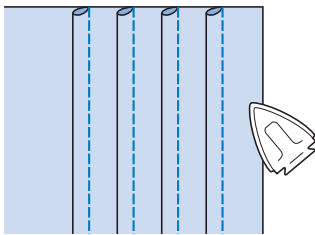

Zigzag Stitches

Zigzag stitches are useful for overcasting, appliqué, patchwork and many other applications.

Select a stitch, and attach presser foot "J".

See page S-5 for the detailed information of reverse stitches and reinforcement stitches.

See page S-67 for the detailed information of stitches.

Stitch	Stitch name	Presser foot
	Zigzag stitch	
	Zigzag stitch	
	Zigzag stitch (Right)	
	Zigzag stitch (Left)	

1 Select a stitch.

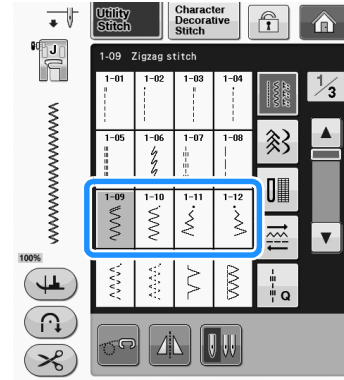

2 Attach presser foot "J".

Overcasting (Using a Zigzag Stitch)

Sew the overcasting along the edge of the fabric while positioning the right-hand side needle drop point just outside the edge of the fabric.

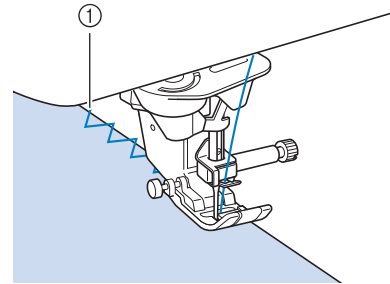

- ① Needle drop position

Appliqué (Using a Zigzag Stitch)

Attach the appliqué material using a temporary spray adhesive or basting, and then sew it.

* Sew a zigzag stitch while positioning the right-hand side needle drop point just outside the edge of the fabric.

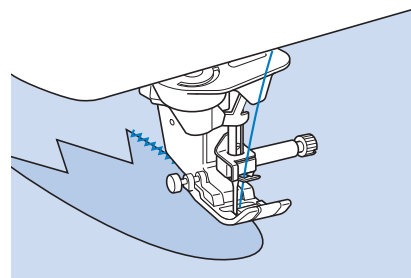

■ Patchwork (for Crazy Quilt)

Turn back the desired width of fabric and position it over the lower fabric, then sew so that the stitch bridges both pieces of fabric.

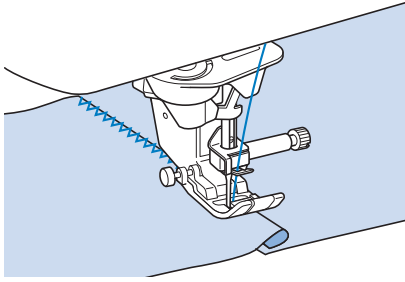

■ Sewing Curves (Using a Zigzag Stitch)

Shorten the stitch length setting to obtain a fine stitch. Sew slowly, keeping the seams parallel with the fabric edge as you guide the fabric around the curve.

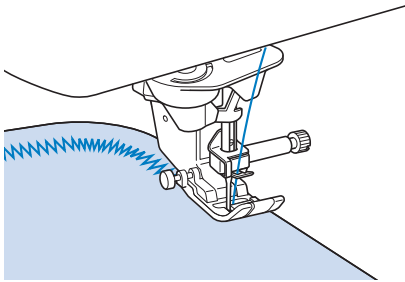

■ Cord Guide Bobbin Cover (Using a Zigzag Stitch)

- 1 Remove the bobbin cover from the machine (“Setting the Bobbin” of “Basic operations”).
- 2 Thread the gimp thread through the hole in the cord guide bobbin cover from top to bottom. Position the thread in the notch at the back of the cord guide bobbin cover.

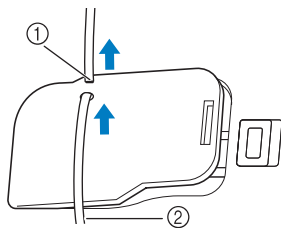

- ① Notch
- ② Gimp thread

- 3 Snap the cord guide bobbin cover into place, making sure that the gimp thread can be fed freely.

* Make sure there are no restrictions when feeding the thread.

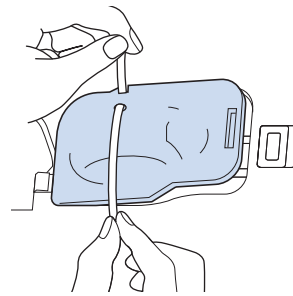

- 4 Set the zigzag width from 2.0 mm - 2.5 mm (approx. 1/16 inch - 3/32 inch).
- 5 Attach presser foot “N”.
- 6 Position the fabric right side up on top of the cord and place the cord to the rear of the machine under the presser foot.

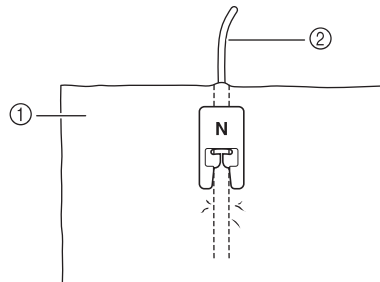

- ① Fabric (right side)
- ② Gimp thread



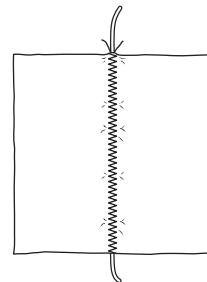

- 7 Lower the presser foot and start sewing to make a decorative finish.



Elastic Zigzag Stitches

Use elastic zigzag stitches for tape attaching, overcasting, darning, or a wide variety of other uses.

See page S-67 for the detailed information of stitches.

Stitch	Stitch name	Presser foot
	2 steps elastic zigzag	
	3 steps elastic zigzag	

1 Select a stitch.

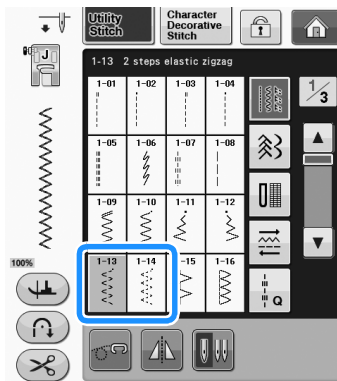

2 Attach presser foot "J".

■ Tape Attaching

Stretch the tape flat. While stretching the tape flat, sew the tape to the fabric.

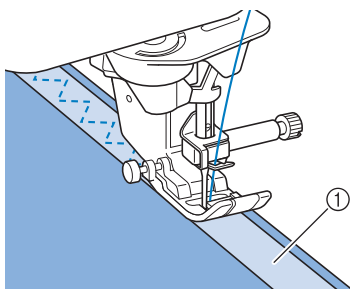

① Tape

■ Overcasting



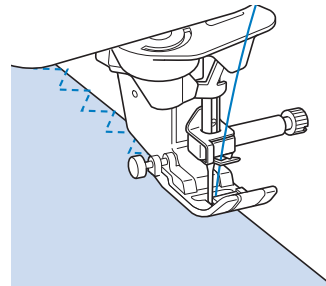



Use this stitch to sew overcasting on the edge of stretch fabrics. Sew the overcasting along the edge of the fabric while positioning the right-hand side needle drop point just outside the edge of the fabric.



Overcasting

Use for the edge of seams in skirts or trousers, and the edge of all cuttings. Use presser foot "G", presser foot "J", or the optional side cutter attachment depending on the kind of overcasting stitch you select.

■ Overcasting Using Presser Foot "G"

Stitch	Stitch name	Presser foot
	Overcasting stitch	
	Overcasting stitch	
	Overcasting stitch	

1 Select a stitch and attach presser foot “G”.

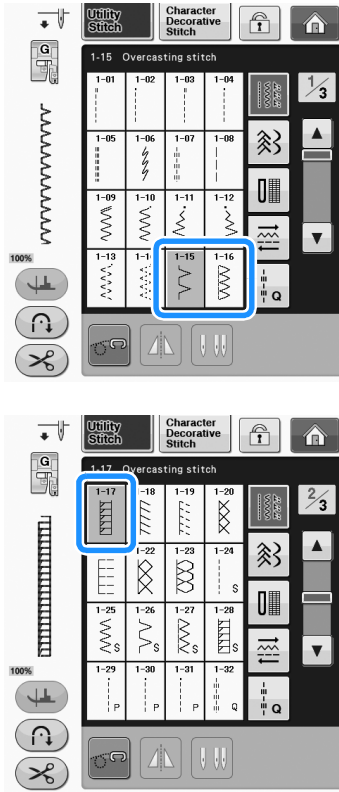

2 Lower the presser foot so that the presser foot guide is set flush against the edge of the fabric.

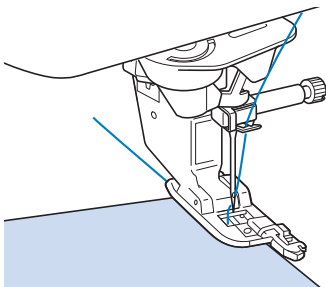

3 Sew along the presser foot guide.

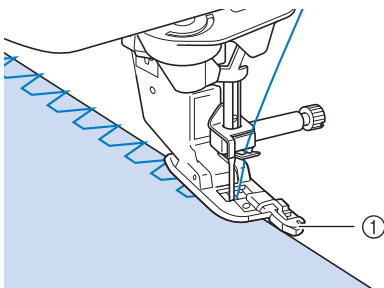

① Guide

CAUTION

- After the stitch width is adjusted, rotate the handwheel toward you (counterclockwise). Check that the needle does not touch the presser foot. If the needle hits the presser foot, the needle may break and cause injury.

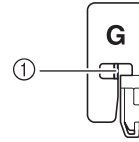

- ① The needle should not touch the center bar
- If the presser foot is raised to its highest level, the needle may strike the presser foot.

Overcasting Using Presser Foot “J”

See page S-67 for the detailed information of stitches.

Stitch	Stitch name	Presser foot
	Overcasting stitch	
	Overcasting stitch	
	Overcasting stitch	
	Overcasting stitch	
	Single diamond overcast	
	Single diamond overcast	

1 Select a stitch and attach presser foot “J”.

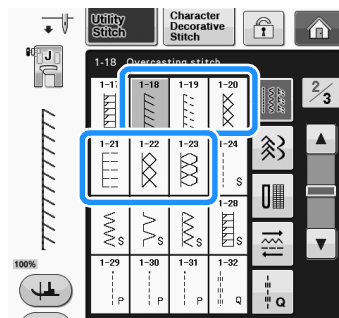

2 Sew with the needle dropping slightly off the edge of the fabric.

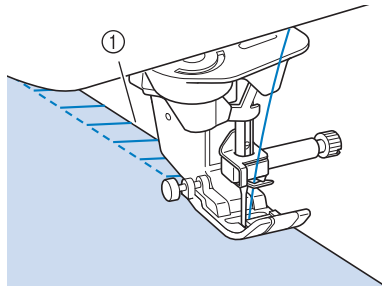

① Needle drop position



Note

- Use the “L/R SHIFT” setting for fine tuning the placement of the stitch. Be sure to sew trial stitches using the same conditions as the real sewing.













































Quilting

You can make beautiful quilts quickly and easily with this machine. When making a quilt, you will find it convenient to use the knee lifter and foot controller to free your hands for other tasks (“Using the Foot Controller” on page S-4 and /or “Using the Knee Lifter” on page S-15). The 30 quilting stitches Q-01 through Q-30 and the utility stitches with “P” or “Q” indicated on their key are useful for quilting. The “P” or “Q” at the bottom of the key display indicates that these stitches are intended for (“Q”) quilting and (“P”) piecing.

See page S-67 for the detailed information of stitches.

Stitch	Stitch name	Presser foot	
	Piecing stitch (Middle)		
	Piecing stitch (Right)		
	Piecing stitch (Left)		
	Hand-look quilting (Middle)		
	Basting stitch (Middle)		

Stitch	Stitch name	Presser foot	
	Stem stitch		
	Quilting appliqué zigzag stitch		
	Zigzag stitch (Right)		
	Zigzag stitch (Left)		
	2 steps elastic zigzag		
	3 steps elastic zigzag		
	Quilting appliqué stitch		
	Shell tuck edge		
	Blanket stitch		
	Quilting stippling		
	Overcasting stitch		
	Tape attaching		
	Serpentine stitch		
	Feather stitch		
	Fagoting cross stitch		
	Couching stitch		
	Patchwork double overlock stitch		
	Smocking stitch		

Stitch	Stitch name	Presser foot	
			
	Rick-rack stitch		
	Decorative stitch		
	Decorative stitch		
	Hemstitching		
	Hemstitching		
	Single diamond overcast		
	Overcasting stitch		
	Piecing stitch (Right)		
	Piecing stitch (Middle)		
	Piecing stitch (Left)		
	Hand-look quilting		
	Quilting appliqué zigzag stitch		
	Quilting appliqué stitch		
	Quilting stippling		

Memo



- When a stitch pattern in the Quilting Stitches category (Q-02 through Q-30) is selected, a finer stitch width can be set than is available with stitch patterns in other categories. For example: Stitch Q-03 has 57 needle positions and stitch Q-19 has 29 width selections.



Note
 • The width range of stitch setting is only available in the Quilting stitch “Q” quilting category.

Piecing

Sewing two pieces of fabric together is called piecing. When cutting pieces for quilt blocks, make sure the seam allowance is 6.5 mm (approx. 1/4 inch).

1 Select  or  and attach presser foot “J”.

2 Align the edge of the fabric with the edge of the presser foot, and start sewing.

- * To sew a 6.5 mm (approx. 1/4 inch) seam allowance along the right edge of the presser foot with  selected, the width should be set to 5.50 mm (approx. 7/32 inch).

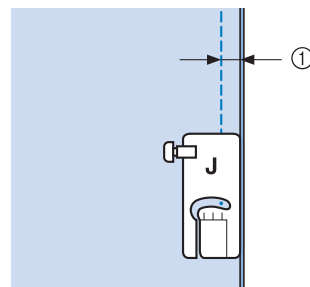

① 6.5 mm (approx. 1/4 inch)

- * To sew a 6.5 mm (approx. 1/4 inch) seam allowance along the left edge of the presser foot with  selected, the width should be set to 1.50 mm (approx. 1/32 inch).

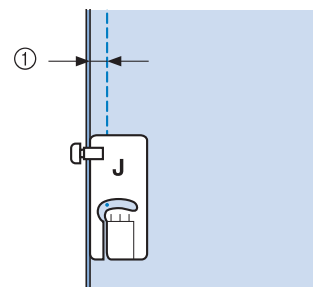

① 6.5 mm (approx. 1/4 inch)

- * To change the needle position, use **+** or **-** in the width display.



 **Memo**

- Using a straight stitch (middle needle position) makes it easier to sew smoothly (see page S-24).
- For models equipped with the guideline marker: In the case Q-01 (center, at width 3.5 mm) is selected, if the guideline marker is set at 10.0 mm (3.5 mm plus 6.5 mm, close to 1/4 inch), you can sew piecing with referring the guideline marker.

■ Piecing Using the 1/4" Quilting Foot with Guide (optional with some models)

This quilting foot can sew an accurate 1/4 inch or 1/8 inch seam allowance.

It can be used for piecing together a quilt or for topstitching.

- 1 Press , and then attach the 1/4" quilting foot with guide.

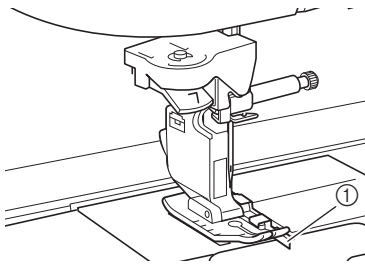

- 1 Guide

- 2 Use the guide and marks on the presser foot to sew accurate seam allowances.

Piecing a 1/4 inch seam allowance

Sew keeping the edge of the fabrics against the guide.

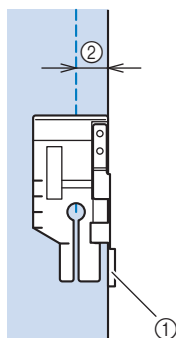

- 1 Guide
- 2 1/4 inch

 **Memo**

- For accurate fabric placement, refer to "Aligning the Fabric with a Mark on the Needle Plate or Bobbin Cover (with Mark)" on page S-26.

Creating an accurate seam allowance

Use the mark on the foot to begin, end, or pivot 1/4 inch from edge of fabric.

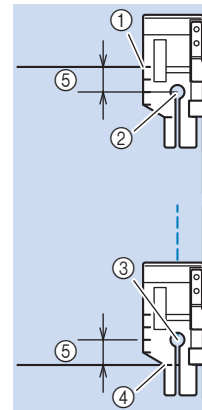

- 1 Align this mark with edge of fabric to begin.
- 2 Beginning of stitching
- 3 End of stitching
- 4 Opposite edge of fabric to end or pivot
- 5 1/4 inch

 **Memo**

- For details on pivoting, refer to "Pivoting" on page S-15.

Topstitching quilting, 1/8 inch

Sew with the edge of the fabric aligned with the left side of the presser foot end.

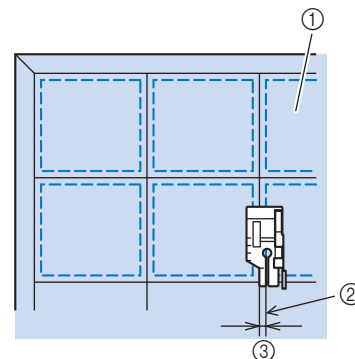

- 1 Surface of fabric
- 2 Seam
- 3 1/8 inch

■ Appliqué

- 1 Trace the pattern onto the appliqué fabric and then cut around it, leaving a 3 mm to 5 mm (approx. 1/8 inch to 3/16 inch) seam allowance.

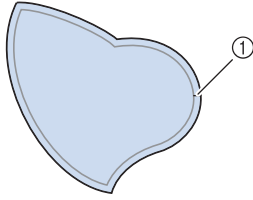

① Seam allowance: 3 mm to 5 mm (approx. 1/8 inch to 3/16 inch)

- 2 Place a piece of stabilizer cut to the finished size of the appliqué design onto the fabric, and then fold over the seam margin using an iron. Clip curves when necessary.

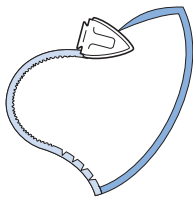

- 3 Turn the appliqué over, and attach the stabilizer with basting pins or a basting stitch.

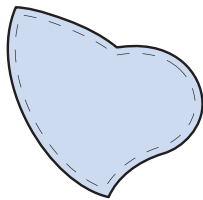

- 4 Select  and attach presser foot "J".

- 5 Use the quilting appliqué stitch to attach the appliqué. Sew around the edge while dropping the needle as close to the edge as possible.

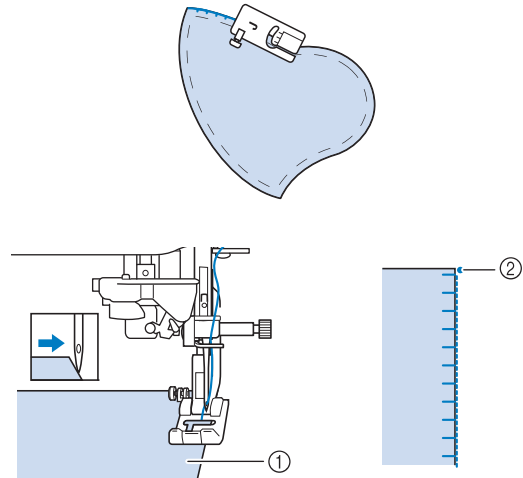

- ① Appliqué
② Needle drop position

⚠ CAUTION

- Be careful that the needle does not strike a basting pin during sewing. Striking a pin can cause the needle to break, resulting in injury.

You can use the appliqué technique to attach appliqué designs like the three pictured below.

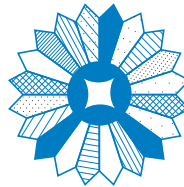

①

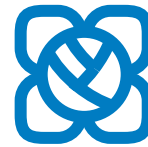

②





③

- ① Dresden plate
② Stained glass
③ Sunbonnet sue

■ Quilting

Sewing the quilt top, batting, and backing together is called quilting. You can sew the quilt with the optional walking foot to keep the quilt top, batting, and backing from sliding. The walking foot has a set of feed dogs that move together with the feed dogs in the needle plate during sewing.

- 1 Select ,  or .

- 2 Attach the walking foot. ("CHANGING THE PRESSER FOOT" of "Basic operations")

- 3 Place one hand on each side of the presser foot to hold the fabric secure while sewing.

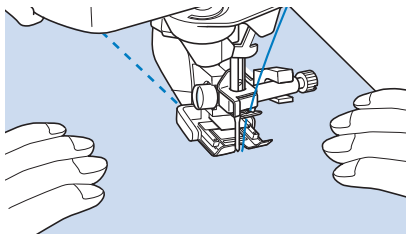



Memo

- Sew at slow to medium speed.
- Do not sew in reverse or use stitches that require side ways or reverse feeding. Always check to be sure that your quilting surface is securely basted before beginning to sew. Specialized machine quilt needles and threads are also available for machine quilting.

■ Quilting with Satin Stitches

For better fabric control, use the foot controller to sew with satin stitches. Set the speed control slide to control the stitch width to make subtle changes in the stitch width during sewing.

- 1 Attach the foot controller (see page S-4).
- 2 Select  and attach presser foot "J".
- 3 Press  in the length display to shorten the stitch length.

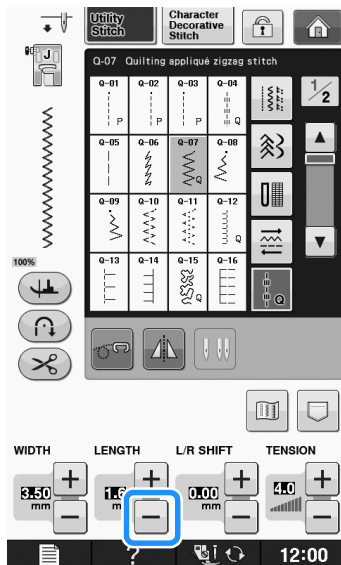

Memo

- The setting will vary according to the kind of fabric and the thickness of the thread, but a length of 0.3 mm to 0.5 mm (approx. 1/64 inch to 1/32 inch) is best for satin stitches.

- 4 Press  to use the speed control slide to control the stitch width.
- 5 Set the "Width Control" to "ON".

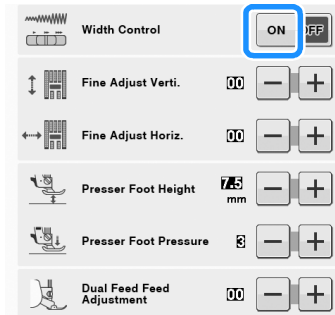

Memo

- You can use the speed control slide to adjust the stitch width. Use the foot controller to adjust the sewing speed.

- 6 Press .

→ The display will return to the original screen.

- 7 Start sewing.

- * You can adjust the stitch width during sewing by moving the stitch width controller. Slide the lever to the left, and the stitch width becomes narrower. Slide it to the right, the stitch width becomes wider. The size of the width changes equally on both sides of the middle needle position.

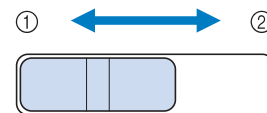

- ① narrower
- ② wider

Example: Changing the width

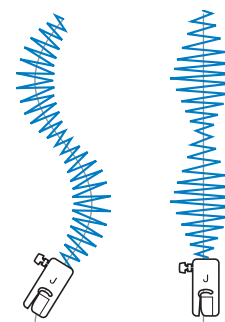

- 8 When you are finished sewing, set the "Width Control" back to "OFF".

Free Motion Quilting

With free motion quilting, the feed dogs can be lowered by pressing , so that the fabric can be moved freely in any direction. In this mode, the presser foot is raised to the necessary height for free motion sewing. We recommend attaching the foot controller and sewing at a consistent speed. You can adjust the sewing speed with the speed control slide on the machine.

CAUTION

- With free motion quilting, control the feeding speed of the fabric to match the sewing speed. If the fabric is moved faster than the sewing speed, the needle may break or other damage may result.



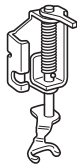

Using free motion open toe quilting foot "O"

The free motion open toe quilting foot "O" is used for free motion quilting with zigzag or decorative stitches or for free motion quilting of straight lines on fabric with an uneven thickness. Various stitches can be sewn using free motion open toe quilting foot "O". For details on the stitches that can be used, refer to the "STITCH SETTING CHART" on page S-67.



Free motion open toe quilting foot "O"

Memo

- When starting to sew, the internal sensor detects the thickness of the fabric, and the quilting foot is raised to the height specified in the machine settings screen. Press  to display "Free Motion Foot Height" of the settings screen. Press  or  to select the height that the quilting foot is raised above the fabric. Increase the setting by pressing , for example, when sewing very stretchy fabric, so that it is easier to sew.



- In order to sew with a balanced tension, it may be necessary to adjust the upper thread tension (see page S-12). Test with a sample piece of quilting fabric.

- Press  to set the machine to free motion sewing mode.

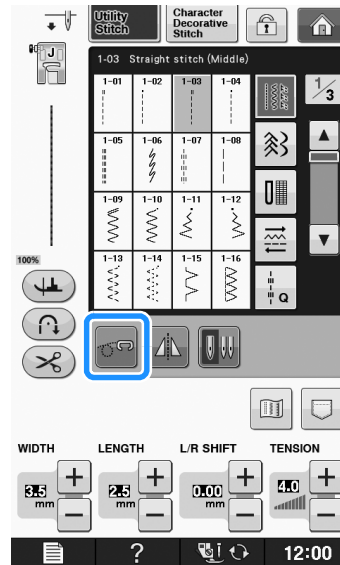

→ The key appears as , the quilting foot is raised to the necessary height, and then the feed dogs are lowered for free motion sewing.

- Select a stitch.
- Remove the presser foot holder.

- 4** Attach free motion open toe quilting foot “O” by positioning the pin of the quilting foot above the needle clamp screw and aligning the lower-left of the quilting foot and the presser bar.

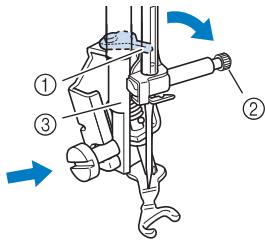

- ① pin
② Needle clamp screw
③ Presser bar

**Note**

- Make sure that the quilting foot is not slanted.

- 5** Hold the quilting foot in place with your right hand, and tighten the presser foot holder screw using the disc-shaped screwdriver with your left hand.

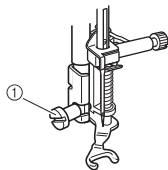

- ① Presser foot holder screw

CAUTION

- Be sure to securely tighten the screws with the included screwdriver. Otherwise, the needle may touch the quilting foot, causing it to bend or break.

- 6** Use both hands to stretch the fabric taut, and then move the fabric at a consistent pace in order to sew uniform stitches roughly 2.0 mm - 2.5 mm (approx. 1/16 inch - 3/32 inch) in length.

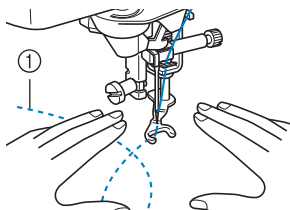

- ① Stitch

- 7** Press  to cancel the free motion sewing mode.

→ Rotate the handwheel toward you (counterclockwise) to raise the feed dogs.

**Memo**

- Do not be discouraged with your initial results. The technique requires practice.

Using free motion quilting foot “C” (optional with some models)

Use the free motion quilting foot “C” with straight stitch needle plate for free motion sewing.







Free motion quilting foot “C”

CAUTION

- When using free motion quilting foot “C”, be sure to use the straight stitch needle plate and sew with the needle in middle (center) needle position. If the needle is moved to any position other than the middle (center) needle position, the needle may break, which may result in injuries.

**Memo**

- When starting to sew, the internal sensor detects the thickness of the fabric, and the quilting foot is raised to the height specified in the machine settings screen. Press  to display “Free Motion Foot Height” of the settings screen. Press  or  to select the height that the quilting foot is raised above the fabric. Increase the setting by pressing , for example, when sewing very stretchy fabric, so that it is easier to sew.

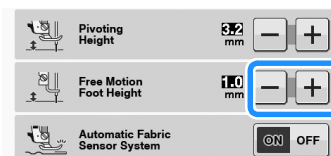

- In order to sew with a balanced tension, it may be necessary to adjust the upper thread tension. Test with a sample piece of fabric that is similar to your chosen fabric.

- 1 Attach the straight stitch needle plate (see page S-26).

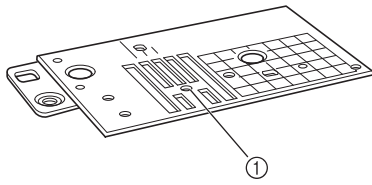

① Round hole

Memo

- Notice this needle plate has a round hole for the needle.

- 2 Select or .

- 3 Press to set the machine to free motion sewing mode.

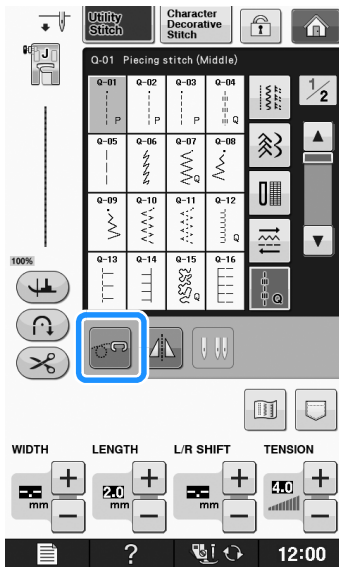

→ The key appears as , the quilting foot is raised to the necessary height, and then the feed dogs are lowered for free motion sewing.

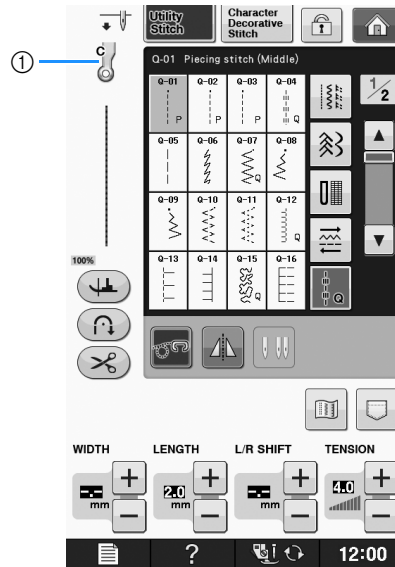

- ① Free motion quilting foot “C”
→ When stitch Q-01 or 1-30 is selected, free motion quilting foot “C” is indicated in the upper-left corner of the screen.

- 4 Attach free motion quilting foot “C” at the front with the presser foot holder screw aligned with the notch in the quilting foot.

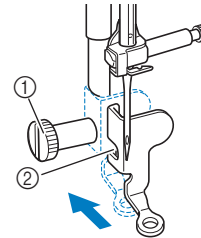

- ① Presser foot holder screw
- ② Notch

Note

- Make sure that the quilting foot is attached properly and not slanted.

- 5** Hold the quilting foot in place with your right hand, and tighten the presser foot holder screw using the screwdriver with your left hand.

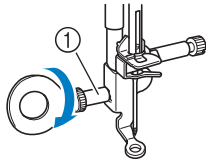

① Presser foot holder screw

⚠ CAUTION

- Be sure to securely tighten the screws with the included screwdriver. Otherwise, the needle may touch the quilting foot, causing it to bend or break.

- 6** Use both hands to stretch the fabric taut, and then move the fabric at a consistent pace in order to sew uniform stitches roughly 2.0 mm - 2.5 mm (approx. 1/16 inch - 3/32 inch) in length.

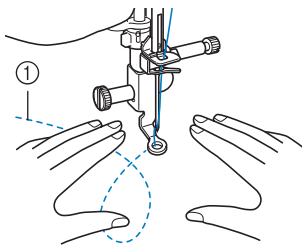

① Stitch

- 7** Press  to cancel the free motion sewing mode.

→ Rotate the handwheel toward you (counterclockwise) to raise the feed dogs.

- 8** After sewing, make sure to remove the straight stitch needle plate and presser foot “C”, and reinstall the regular needle plate and the needle plate cover.



Note

- Free motion open toe quilting foot “O” can also be used with the straight stitch needle plate. We recommend using free motion open toe quilting foot “O” with free motion sewing of fabrics of uneven thicknesses.
- When using the straight stitch needle plate, all straight stitches become middle needle position stitches. You cannot change the needle position using the width display.



Memo

- Normally, the feed dogs are raised for regular sewing.
- Do not be discouraged with your initial results. The technique requires practice.

■ Echo Quilting Using the Free Motion Echo Quilting Foot “E” (optional with some models)

Sewing quilting lines at equal distances around a motif is called echo quilting. The quilting lines, which appear as ripples echoing away from the motif, are the distinguishing characteristic of this quilting style. Use the free motion echo quilting foot “E” for echo quilting. Using the measurement on the presser foot as a guide, sew around the motif at a fixed interval. We recommend attaching the foot controller and sewing at a consistent speed.

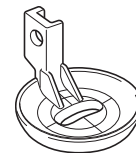

Free motion echo quilting foot “E” measurement

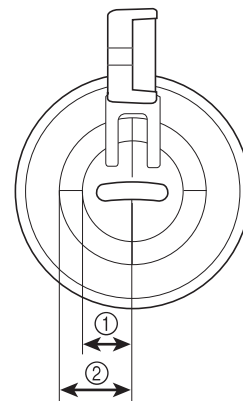





- ① 6.4 mm (approx. 1/4 inch)
② 9.5 mm (approx. 3/8 inch)

CAUTION

- With free motion quilting, control the feeding speed of the fabric to match the sewing speed. If the fabric is moved faster than the sewing speed, the needle may break or other damage may result.

Memo

- When starting to sew, the internal sensor detects the thickness of the fabric, and the quilting foot is raised to the height specified in the machine settings screen. Press  to display “Free Motion Foot Height” of the settings screen (see page S-15). Press  or  to select the height that the quilting foot is raised above the fabric. Increase the setting by pressing , for example, when sewing very soft fabric, so that it is easier to sew.



- In order to sew with a balanced tension, it may be necessary to adjust the upper thread tension (see page S-12). Test with a sample piece of quilting fabric.

1 Select .

2 Press  to set the machine to free motion sewing mode.

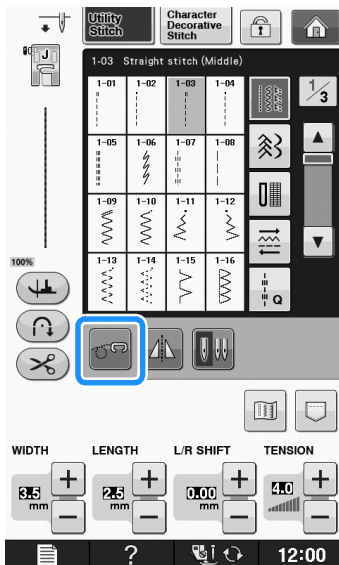

→ The key appears as , the quilting foot is raised to the necessary height, then the feed dogs are lowered for free motion sewing.

3 Attach the adapter (“CHANGING THE PRESSER FOOT” of “Basic operations”).

4 Attach the free motion echo quilting foot “E” on the left side of the adapter with the holes in the quilting foot and adapter aligned.

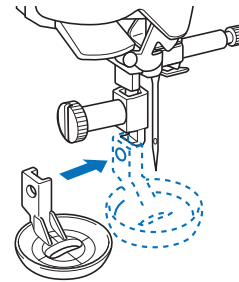

5 Tighten the screw with the included screwdriver.

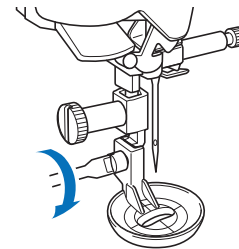
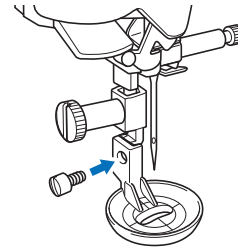

CAUTION

- Be sure to securely tighten the screws with the included screwdriver. Otherwise, the needle may touch the quilting foot, causing it to bend or break.

- 6** Using the measurement on the quilting foot as a guide, sew around the motif.

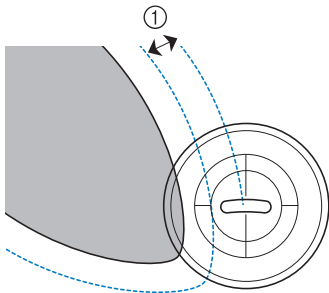
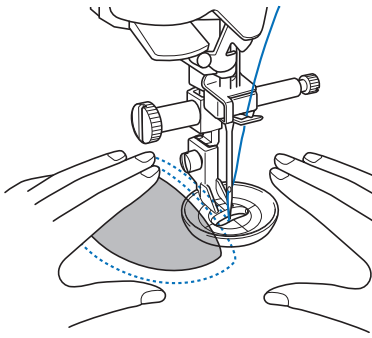

① 6.4 mm (approx. 1/4 inch)

Finished project

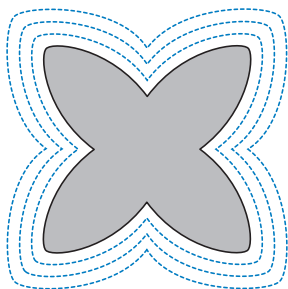





- 7** Press  to cancel the free motion sewing mode.

→ Rotate the handwheel toward you (counterclockwise) to raise the feed dogs.

Blind Hem Stitches

Secure the bottoms of skirts and pants with a blind hem. Two stitches are available for blind hem stitching.

Stitch	Stitch name	Presser foot
	Blind hem stitch	
	Blind hem stitch stretch	

Memo

- When the size of cylindrical pieces is too small to slide onto the arm or the length is too short, the fabric will not feed and desired results may not be achieved.

- 1** Turn the skirt or pants wrong side out.

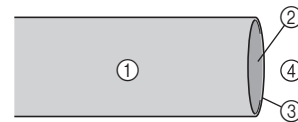

- ① Wrong side of fabric
- ② Right side of fabric
- ③ Edge of fabric
- ④ Bottom side

- 2** Fold the fabric along the desired edge of the hem, and press.

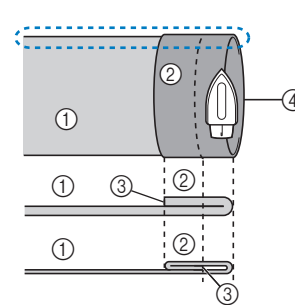

- ① Wrong side of fabric
- ② Right side of fabric
- ③ Edge of fabric
- ④ Desired edge of hem

<Thick fabric>

<Normal fabric>

<Seen  from the side>

3 Use a chalk to mark on the fabric about 5 mm (3/16 inch) from the edge of the fabric, and then baste it.

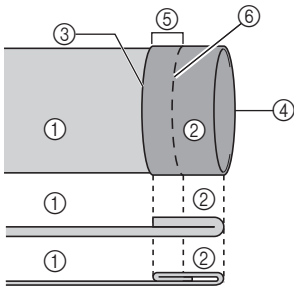

- ① Wrong side of fabric
- ② Right side of fabric
- ③ Edge of fabric
- ④ Desired edge of hem
- ⑤ 5 mm (3/16 inch)
- ⑥ Basting

<Thick fabric>
<Normal fabric>

<Seen from the side>

4 Fold back the fabric inside along the basting.

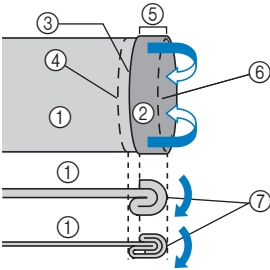

- ① Wrong side of fabric
- ② Right side of fabric
- ③ Edge of fabric
- ④ Desired edge of hem
- ⑤ 5 mm (3/16 inch)
- ⑥ Basting
- ⑦ Basting point

<Thick fabric>
<Normal fabric>

<Seen from the side>

5 Unfold the edge of fabric, and position the fabric with the wrong side facing up.

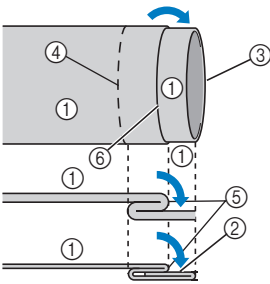



- ① Wrong side of fabric
- ② Right side of fabric
- ③ Edge of fabric
- ④ Desired edge of hem
- ⑤ Basting point
- ⑥ Basting

<Thick fabric>
<Normal fabric>

<Seen from the side>

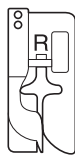
6 Attach blind hem foot "R".



7 Select  or .

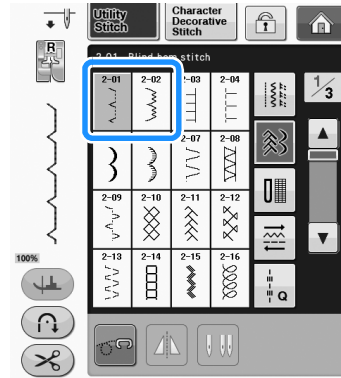

8 Remove the flat bed attachment to use the free-arm.

9 Slide the item that you wish to sew onto the free arm, make sure that the fabric feeds correctly, and then start sewing.

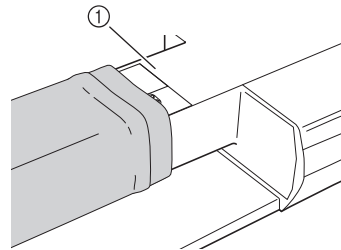

① Free arm

10 Position the fabric with the edge of the folded hem against the guide of the presser foot, and then lower the presser foot lever.

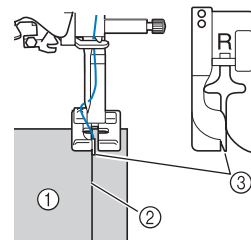

- ① Wrong side of fabric
- ② Fold of hem
- ③ Guide

11 Adjust the stitch width until the needle slightly catches the fold of the hem.

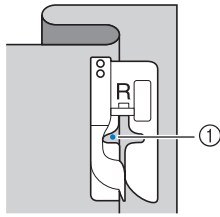

① Needle drop point

When you change the needle drop point, raise the needle, and then change the stitch width.

<Stitch width>

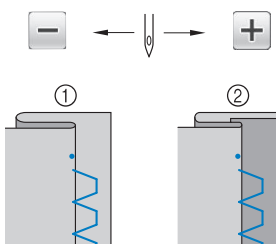

① Thick fabric

② Normal fabric



Memo

- Blind hem stitches cannot be sewn if the left needle drop point does not catch the fold. If the needle catches too much of the fold, the fabric cannot be unfolded and the seam appearing on the right side of the fabric will be very large, leaving an unattractive finish. If you experience either of these cases, follow the instructions below to solve the problem.

■ If the Needle Catches Too Much of the Hem Fold

The needle is too far to the left.

Press **+** to decrease the stitch width so that the needle slightly catches the fold of the hem.



<Thick fabric>

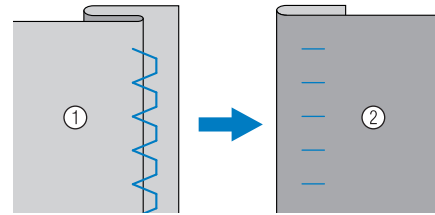

<Normal fabric>

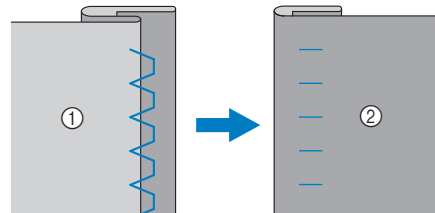

① Wrong side of fabric

② Right side of fabric

■ If the Needle does not Catch the Hem Fold

The needle is too far to the right.

Press **-** to increase the stitch width so that the needle slightly catches the fold of the hem.



<Thick fabric>

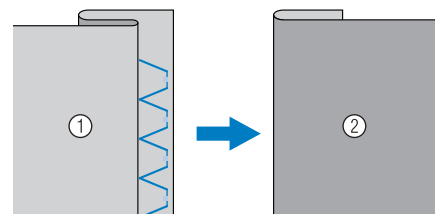

<Normal fabric>

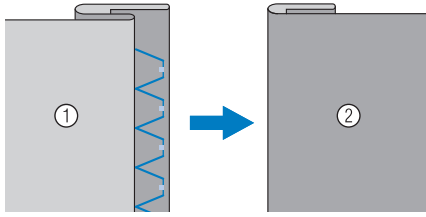

- ① Wrong side of fabric
- ② Right side of fabric

12 Sew with the fold of the hem against the presser foot guide.

13 Remove the basting stitching and reverse the fabric.

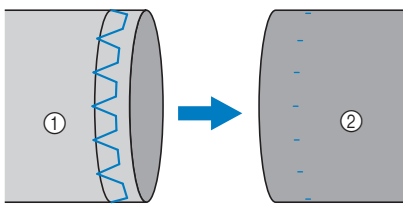

- ① Wrong side of fabric
- ② Right side of fabric



Appliqué

1 Use a temporary spray adhesive, fabric glue or a basting stitch to attach the appliqué to the fabric.

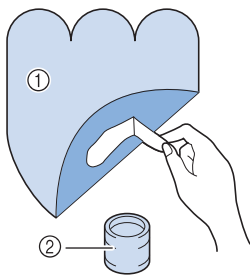
* This will keep the fabric from moving during sewing.



- ① Appliqué
- ② Fabric glue

2 Select  **or**  .

* Adjust the stitch length and width to correspond to the appliqué shape, size, and quality of material (see page S-10).

Memo

- For details on each stitch, refer to the “STITCH SETTING CHART” on page S-67.

3 Attach presser foot “J”. Check that the needle drops slightly off the edge of the appliqué, then start sewing.

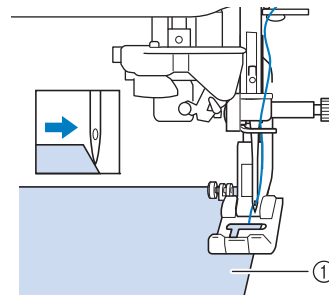

- ① Appliqué material

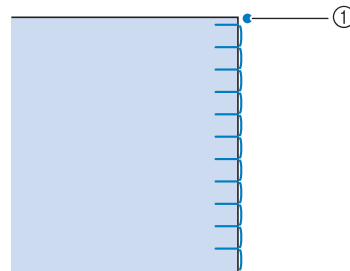

- ① Needle drop position

■ Appliqué Sharp Curves

Stop the machine with the needle in the fabric outside the appliqué. Raise the presser foot and turn the fabric a little bit at a time while sewing for an attractive finish to the seam.

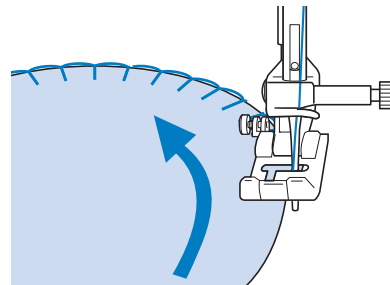

■ Appliqué Corners

Stop the machine with the needle in the right position of the outside (or inside) corner of the appliqué. Raise the presser foot and pivot the fabric to align the fabric edge. Lower the presser foot and continue stitching.

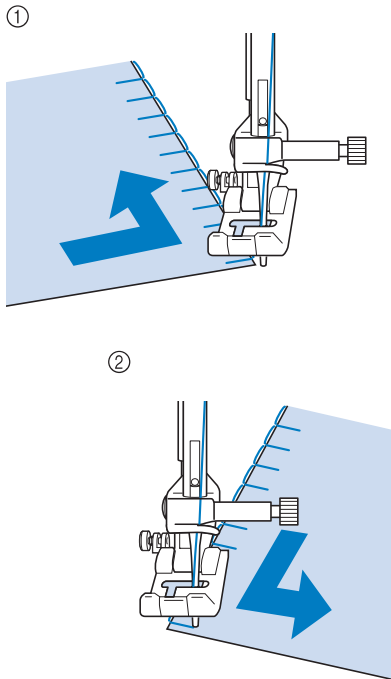

- ① Outside corner
- ② Inside corner

Memo

- Placing a lightweight tear away stabilizer beneath the stitching area will improve the stitch placement along the edge of the appliqué fabric.

Shelltuck Stitches

Shelltuck stitches give an attractive appearance of shells along the curve of a collar. This stitch pattern can be used for edging the neckline or sleeves of dresses and blouses.

- 1 Select  .

Memo

- For details on each stitch, refer to the “STITCH SETTING CHART” on page S-67.

- 2 Increase the upper thread tension for an attractive scallop finish to the shelltuck stitches (see page S-12).

Memo

- If the upper thread tension is too weak, the shelltuck stitches will not scallop.

- 3 To make rows of shell tuck stitches, fold the fabric in half along the bias.

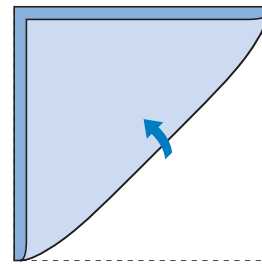

Memo

- Use a thin fabric.

- 4 Attach presser foot “J”. Set the needle drop point slightly off the edge of the fabric, and start sewing.

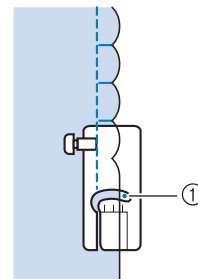
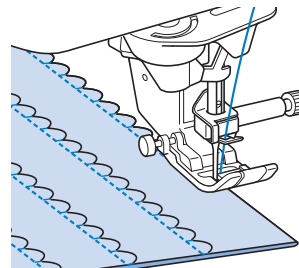

- ① Needle drop position

- 5** Unfold the fabric, and iron the tucks to one side.

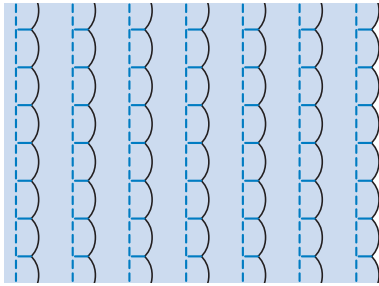

Memo

- To make shell tucks at the edge of a collar or neckline, follow the pattern's instructions and then use this stitch to make a decorative finish on the collar or neckline.

Scallop Stitches

This wave-shaped satin stitch is called the scallop stitch. Use this stitch to decorate the edges of blouse collars and handkerchiefs or use it as a hem accent.

Memo

- A temporary spray adhesive may be necessary for lightweight fabrics. Test sew the fabric before sewing a project.

- 1** Select $\left. \begin{array}{c} 2-05 \\ \} \end{array} \right\}$.

Memo

- For details on each stitch, refer to the "STITCH SETTING CHART" on page S-67.

- 2** Attach presser foot "N". Sew scallop stitches along the edge of the fabric.

* Do not sew directly on the edge of the fabric.

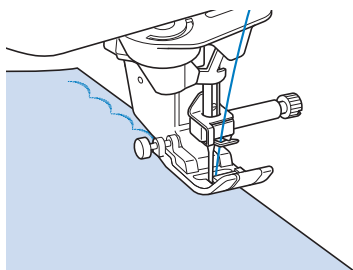

- 3** Trim along the seam, making sure not to cut the stitches.

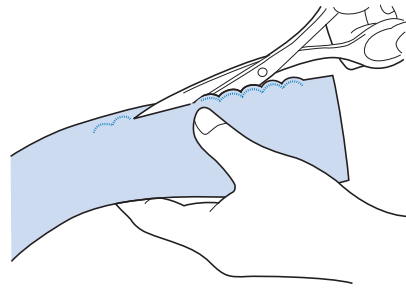

Memo

- Use a seam sealant to secure the edges of the scallop stitches.

Crazy Quilting

For a decorative look called "Crazy Quilting", the following stitches can be sewn on top of a pressed seam allowance.

- 1** Select a straight stitch and attach presser foot "J".
- 2** With the right sides facing each other, sew two pieces of fabric together, and then press open the seam allowance.

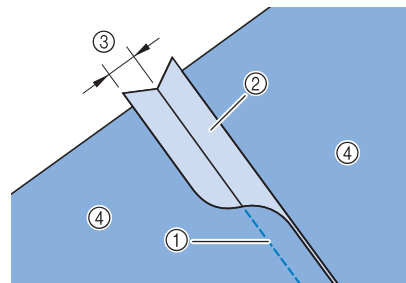

- ① Straight stitch
- ② Seam margins
- ③ 6.5 mm (approx. 1/4 inch)
- ④ Wrong side

- 3** Select a stitch for top stitching.

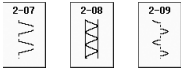

- 4** Place the fabric right side up in the machine, and center the presser foot over the seam when sewing.

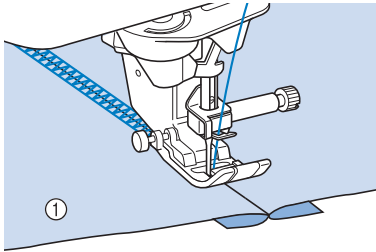

① Right side of fabric

Smocking Stitches

Use smocking stitches for decorative sewing on clothes, etc.

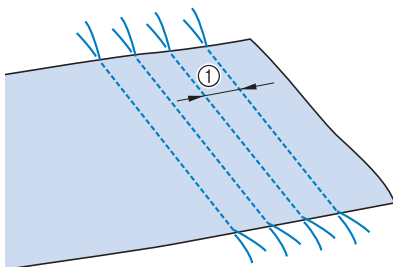

- 1** Select a straight stitch and attach presser foot "J".
- 2** Set the stitch length to 4.0 mm (approx. 3/16 inch) and loosen the upper thread tension to approximately 2.0 (see "Setting the Stitch Length" on page S-10 and "Setting the Thread Tension" on page S-12).
- 3** Pull the bobbin and upper threads out by 50 mm (approx. 2 inches).
- 4** Sew the seams, leaving approximately 10 mm (approx. 3/8 inch) between the seams, then trim excess thread, leaving 50 mm (approx. 2 inches).

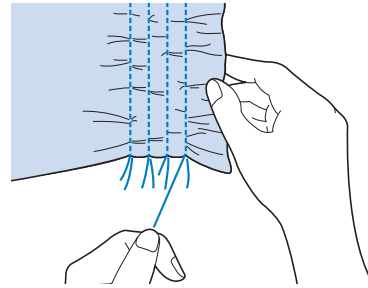

① Approximately 10 mm (approx. 3/8 inch)

- 5** Pull the bobbin threads to obtain the desired amount of gather, and then smooth the gathers by ironing them.



- 6** Select  or .



Memo

- For details on each stitch, refer to the "STITCH SETTING CHART" on page S-67.

- 7** Sew the spaces between the straight seams.

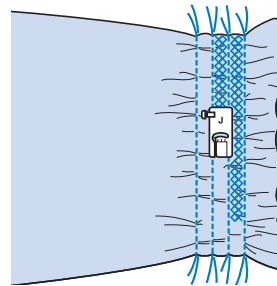

- 8** Pull out the straight stitch threads.

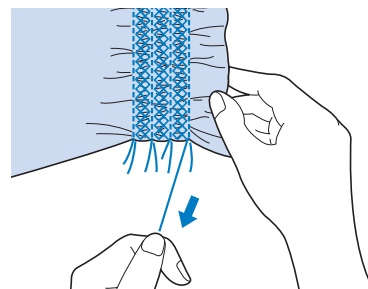

Fagoting



When there is a space between two fabrics with thread sewn over the space to join the fabrics together, it is called fagoting. Use this stitch when sewing blouses or children's clothes.

- 1 Baste two pieces of fabric onto thin paper, leaving a space of 4 mm (approx. 3/16 inch) between the fabrics.

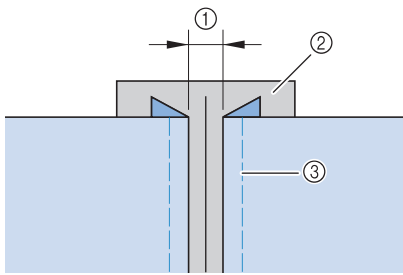
* If you draw a line down the middle of the thin paper or water-soluble stabilizer, sewing is easier.



- ① 4.0 mm (approx. 3/16 inch)
- ② Paper
- ③ Basting stitches

- 2 Select  or .

Memo

- For details on each stitch, refer to the "STITCH SETTING CHART" on page S-67.

- 3 Attach presser foot "J". Align the center of the presser foot with the middle of the space between the fabrics and begin sewing.

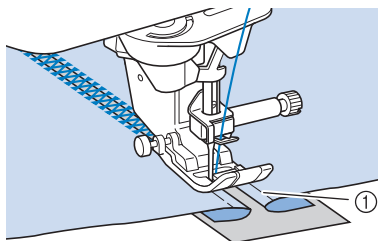

- ① Basting stitches

Memo



- Use a thick thread.

- 4 When sewing is finished, gently tear the paper away.

Tape or Elastic Attaching

- 1 Select a straight stitch and attach presser foot "J".
- 2 Set the stitch length to 4.0 mm (approx. 3/16 inch), and loosen the upper thread tension to 2.0 (see "Setting the Stitch Length" on page S-10 and "Setting the Thread Tension" on page S-12).

Memo

- Be sure that neither automatic reinforcement  nor automatic thread cutting  is selected.

- 3 Sew two rows of straight stitches on the right side of the fabric, then pull the bobbin thread to create the necessary gather.

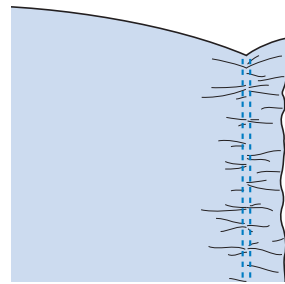



Memo

- Before sewing the straight stitch, rotate the handwheel toward you (counterclockwise) and pull up the bobbin thread. Holding the top and bobbin thread, pull a length of thread out from the rear of the machine. (Be sure that the presser foot is raised.)

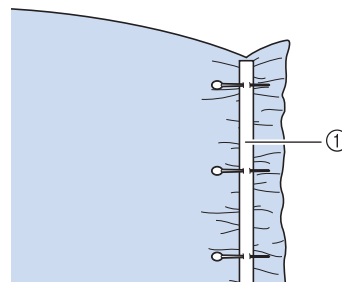
- 4 Place the tape over the gather, and hold it in place with basting pins.



- ① Tape

- 5 Select  or .

Memo

- For details on each stitch, refer to the “STITCH SETTING CHART” on page S-67.

- 6 Sew over the tape (or elastic).

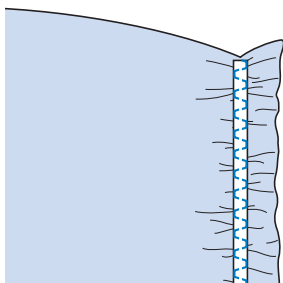
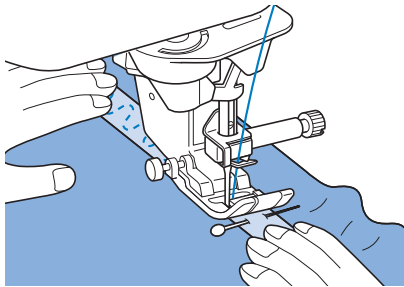

CAUTION

- Be sure the needle does not strike a basting pin, or any other objects, during sewing. The thread could tangle or the needle could break, causing injury.

- 7 Pull out the straight stitch threads.

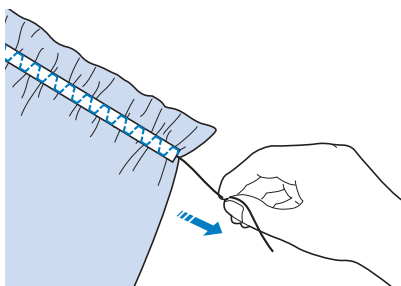

Heirloom

Hemstitching (1)

Use for sewing tablecloths, decorative hems, and decorative stitching on shirt fronts.

Memo

- Use a light to medium weight homespun fabric with a little stiffness.

- 1 Insert a type 130/705H, size 100/16 Wing needle.

- * This specialty sewing needle is not furnished with your machine. Must be purchased separately.

CAUTION

- The “Automatic Threading” button cannot be used. Thread the wing needle by hand, from front to back. Using the “Automatic Threading” button may result in damage to the machine.
- A more attractive finish can be obtained if you use a “130/705H Wing” needle when sewing these patterns. If using a wing needle and the stitch width has been set manually, check that the needle will not touch the presser foot by carefully rotating the handwheel toward you (counterclockwise) before starting to sew.

- 2 Select a stitch and attach presser foot “N”.

- * Select any stitch between 3-01 and 3-22.

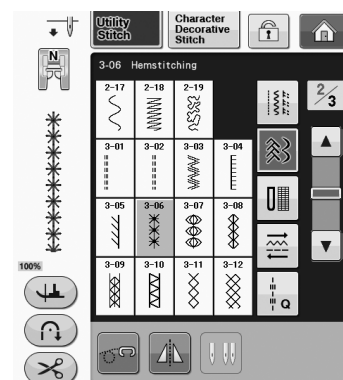

Memo

- For details on each stitch, refer to the “STITCH SETTING CHART” on page S-67.

3 Start sewing.

Example: Illustration of finished product

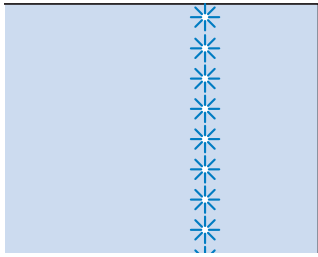

■ Hemstitching (2) (Drawn Work (1))

1 Pull out several threads from one area on a piece of fabric to open the area.

* Pull out 5 or 6 threads to leave a 3 mm (approx. 1/8 inch) area open.

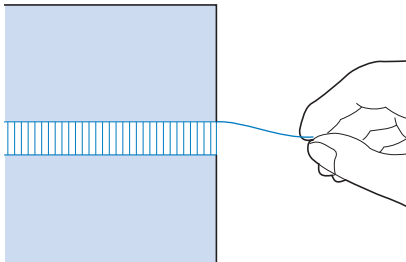

Memo

• Loosely woven fabrics work best for this.

2 Select .

Memo

• For details on each stitch, refer to the “STITCH SETTING CHART” on page S-67.

3 Attach presser foot “N”. With the right side of the fabric facing up, sew one edge of the open area.

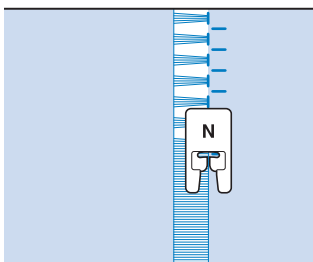

4 Press  to create a mirror image of the stitch.

5 Match beginning needle drop points on the opposite edge of the open area to keep the stitching symmetrical.

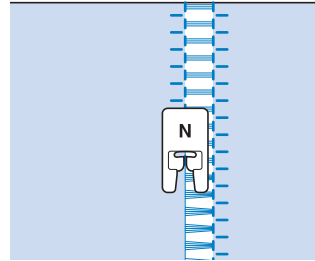

■ Hemstitching (3) (Drawn Work (2))

1 Pull out several threads from both sides of the 4 mm (approx. 3/16 inch) area which are not yet open.

* Pull out four threads, leave five threads, and then pull out four threads. The width of five threads is approximately 4 mm (approx. 3/16 inch) or less.

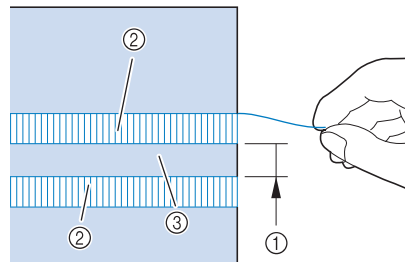

- ① Approx. 4 mm (approx. 3/16 inch) or less
- ② Four threads (pull out)
- ③ Five threads (leave)

2 Select .

Memo

• For details on each stitch, refer to the “STITCH SETTING CHART” on page S-67.

3 Sew the decorative stitch in the center of the five threads created above.

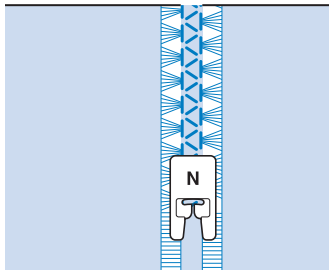

Memo

- A wing needle can be used for Hemstitching (3).

One-step Buttonholes

With one-step buttonholes, you can make buttonholes appropriate to the size of your button.

See page S-67 for the detailed information of stitches.

Stitch	Stitch name	Presser foot
	Narrow rounded buttonhole	
	Wide round ended buttonhole	
	Tapered round ended buttonhole	
	Round ended buttonhole	
	Round ended buttonhole	
	Round double ended buttonhole	
	Narrow squared buttonhole	
	Wide squared buttonhole	
	Stretch buttonhole	
	Heirloom buttonhole	

Stitch	Stitch name	Presser foot
	Bound buttonhole	
	Keyhole buttonhole	
	Tapered keyhole buttonhole	
	Keyhole buttonhole	

One-step buttonholes are sewn from the front of the presser foot to the back, as shown below.

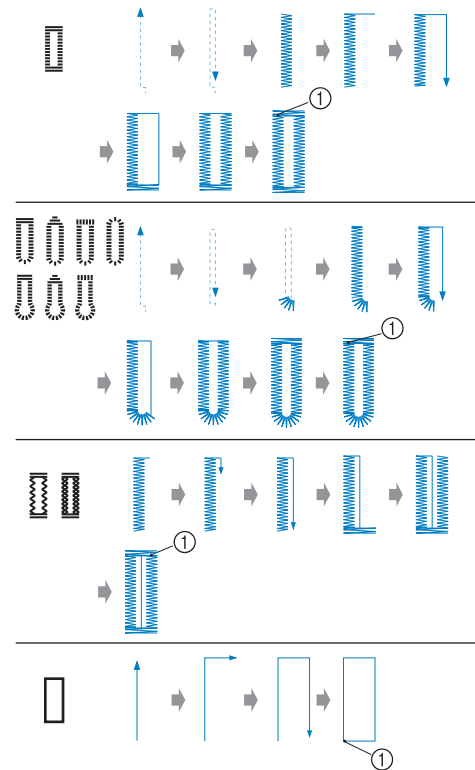

① Reinforcement stitching

- 1 Select a buttonhole stitch, and attach buttonhole foot "A".
- 2 Mark the position and length of the buttonhole on the fabric.

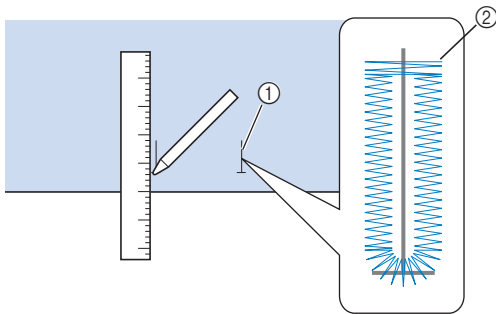

- ① Marks on fabric
- ② Buttonhole sewing

Memo

• The maximum buttonhole length is about 28 mm (approx. 1-1/16 inches) (diameter + thickness of the button).

- 3 Pull out the button holder plate on the presser foot, and insert the button that will be put through the buttonhole. Then tighten the button holder plate around the button.

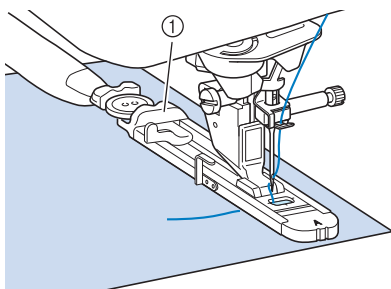

- ① Button holder plate

Memo

• The size of the buttonhole is determined by the size of the button in the button holder plate.

- 4 Align the presser foot with the mark on the fabric, and lower the presser foot.

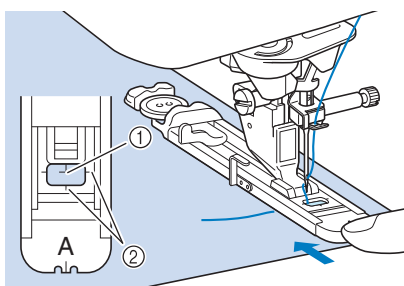

- ① Mark on the fabric
- ② Marks on the presser foot

Note

- Pass the thread underneath the presser foot.
- Slide the outside frame of the buttonhole foot backward as far as possible as shown in the illustration, making sure that there is no gap behind the part of the foot marked "A". If the buttonhole foot is not slid back as far as possible, the buttonhole will not be sewn at the correct size.

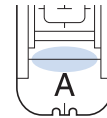

- 5 Lower the buttonhole lever so that it is positioned behind the metal bracket on the buttonhole foot.

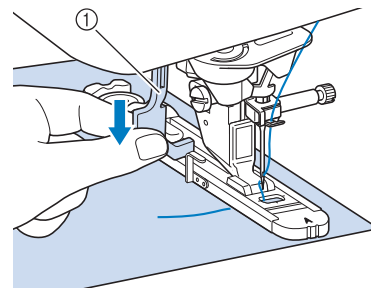

- ① Buttonhole lever

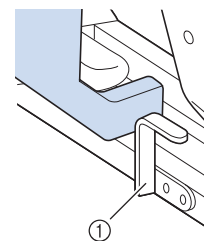

- ① Metal bracket

- 6 Gently hold the end of the upper thread, and then start sewing.

* Feed the fabric carefully by hand while the buttonhole is sewn.

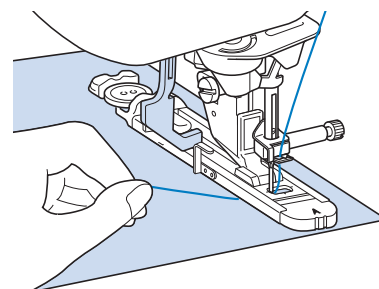

→ Once sewing is completed, the machine automatically sews reinforcement stitches, and then stops.

Memo

- If automatic thread cutting is turned on before you start sewing, both threads are automatically cut after the reinforcement stitches are sewn. If the fabric does not feed (for example, because it is too thick), increase the stitch length setting.

- 7 Insert a pin along the inside of one of the bar tacks, and then insert the seam ripper into the center of the buttonhole and cut towards the pin.

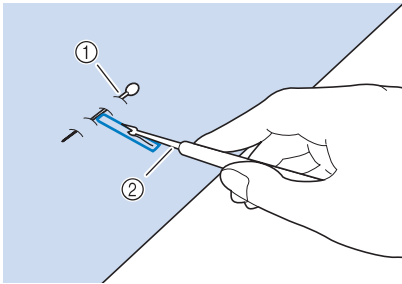

- ① Basting pin
- ② Seam ripper

CAUTION

- When using the seam ripper to open the buttonhole, do not put your hand or finger in the path of the ripper. The ripper may slip and cause injury. Do not use the seam ripper in any other way than how it is intended.

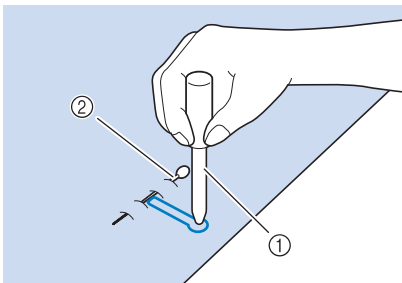

Memo

- For keyhole buttonholes, use the eyelet punch to make a hole in the rounded end of the buttonhole. Then insert a pin along the inside of one of the bar tacks, insert a seam ripper into the hole made with the eyelet punch, and cut towards the pin.



- ① Eyelet punch
- ② Basting pin

■ Sewing Stretch Fabrics

When sewing on stretch fabric with  or , sew the buttonhole stitches over a gimp thread.

- 1 Hook the gimp thread onto the back of presser foot "A". Insert the ends into the grooves at the front of the presser foot, and then temporarily tie them there.

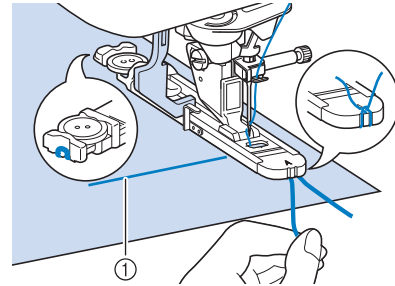

- ① Upper thread

- 2 Lower the presser foot and start sewing.

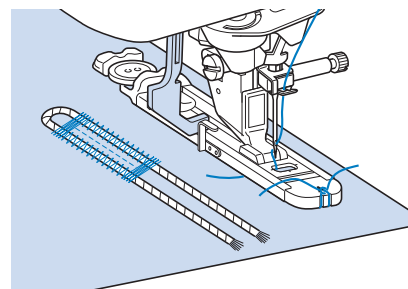

Memo

- Set the width of the satin stitches to the width of the gimp thread, and set the buttonhole width to be 2-3 times the width of the gimp thread.

- 3 Once sewing is completed, gently pull the gimp thread to remove any slack, and trim off any excess.

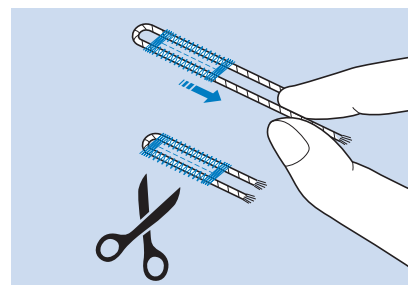

Memo

- After using the seam ripper to cut open the threads over the buttonhole, trim off the threads.

■ Odd Shaped Buttons/Buttons that do Not Fit into the Button Holder Plate

Use the markings on the presser foot scale to set the size of the buttonhole. One mark on the presser foot scale equals 5 mm (approx. 3/16 inch).

Add the button diameter and thickness together, and then set the plate at the calculated value.

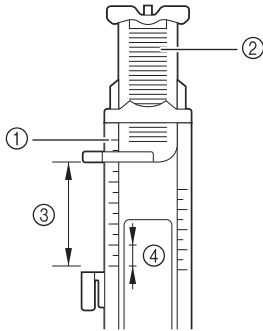

- ① Presser foot scale
- ② Button holder plate
- ③ Completed measurement of diameter + thickness
- ④ 5 mm (approx. 3/16 inch)

Memo

- For example, for a button with a diameter of 15 mm (approx. 9/16 inch) and a thickness of 10 mm (approx. 3/8 inch), the scale should be set at 25 mm (approx. 1 inch).

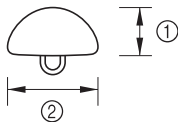





- ① 10 mm (approx. 3/8 inch)
- ② 15 mm (approx. 9/16 inch)

Darning

Use darning stitches for mending and other applications.

See page S-67 for the detailed information of stitches.

Stitch	Stitch name	Presser foot
	Darning	
	Darning	

Darning is performed by sewing from the front of the presser foot to the back as shown below.

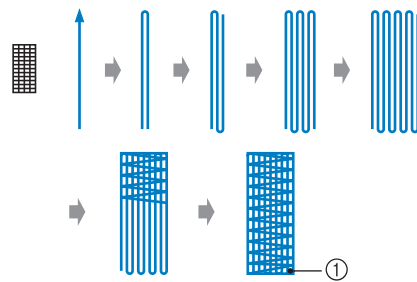
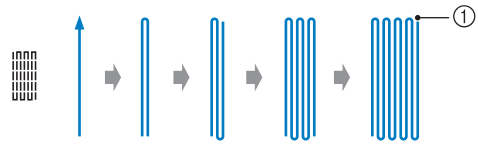

- ① Reinforcement stitches

- 1** Select a stitch, and attach buttonhole foot "A".
- 2** Set the scale to the desired length of the darning.

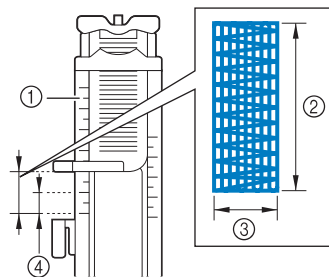

- ① Presser foot scale
- ② Completed length measurement
- ③ Width 7 mm (approx. 1/4 inch)
- ④ 5 mm (approx. 3/16 inch)

Memo

- The maximum length for darning is 28 mm (approx. 1-1/16 inches).

- 3** Check that the needle drops at the desired position and lower the presser foot, making sure the upper thread passes underneath the buttonhole foot.

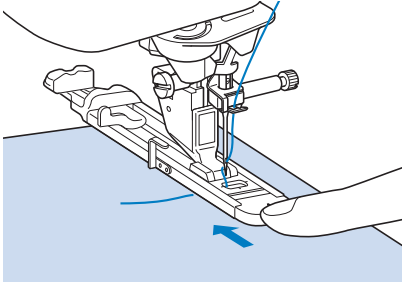
**Note**

- Pass the thread underneath the presser foot.
- Set the presser foot so that there is no gap behind the section marked with an "A" (the shaded area in the illustration below). If there is a gap, the size of the darning will not be correct.

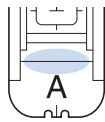

- 4** Lower the buttonhole lever so that it is positioned behind the metal bracket on the buttonhole foot.

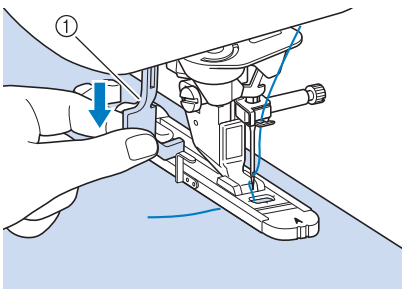

① Buttonhole lever

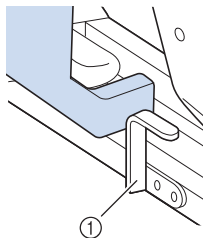

① Metal bracket

- 5** Gently hold the end of the upper thread, and then press the "Start/Stop" button to start the machine.

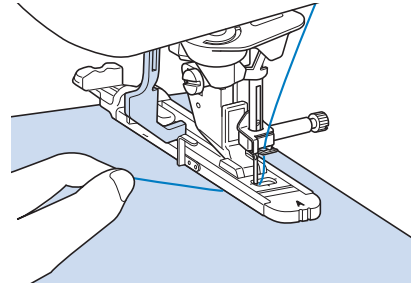

→ Once sewing is completed, the machine automatically sews reinforcement stitches, and then stops.



**Memo**

- If automatic thread cutting is turned on before you start sewing, both threads are automatically cut after the reinforcement stitches are sewn. If the fabric does not feed (for example, because it is too thick), increase the stitch length setting.

Bar Tacks

Use bar tacks to reinforce areas that will be subject to strain, such as pocket corners.

See page S-67 for the detailed information of stitches.

Stitch	Stitch name	Presser foot
	Bar tack	

- 1** Select  .
- 2** Attach buttonhole foot "A" and set the scale to the length of the bar tack you wish to sew.

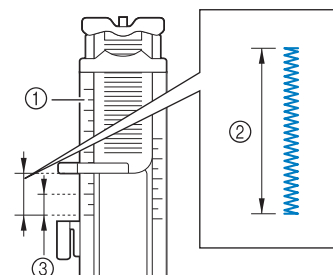

- ① Presser foot scale
 ② Completed length measurement
 ③ 5 mm (approx. 3/16 inch)

Memo

- Bar tacks can be between 5 mm (approx. 3/16 inch) and 28 mm (approx. 1-1/16 inches). Bar tacks are usually between 5 mm (approx. 3/16 inch) and 10 mm (approx. 3/8 inch).

3 Set the fabric so that the pocket moves toward you during sewing.

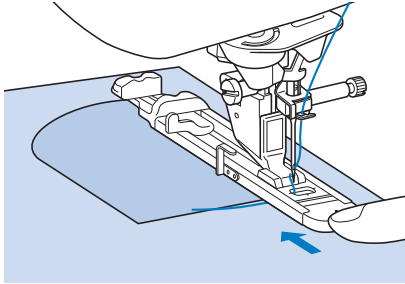

Note

- Pass the thread underneath the presser foot.
- Slide the outside frame of the buttonhole foot backward as far as possible as shown in the illustration, making sure that there is no gap behind the part of the foot marked "A". If the buttonhole foot is not slid back as far as possible, the bar tack will not be sewn to the correct size.

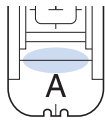

4 Check the first needle drop point and lower the presser foot.

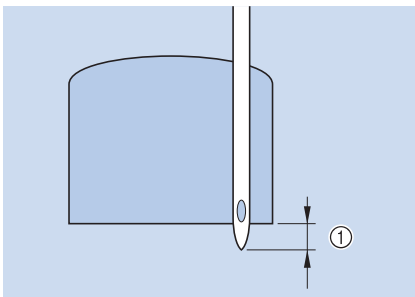

① 2 mm (approx. 1/16 inch)

5 Lower the buttonhole lever so that it is positioned behind the metal bracket on the buttonhole foot.

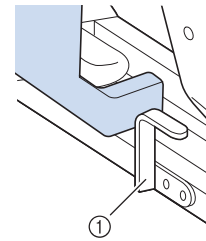
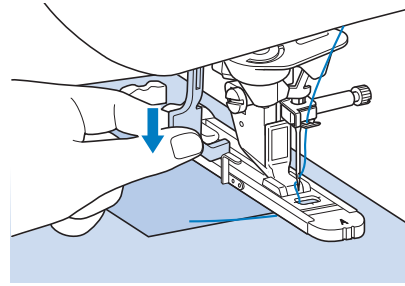

① Metal bracket

6 Gently hold the end of the upper thread and begin sewing.

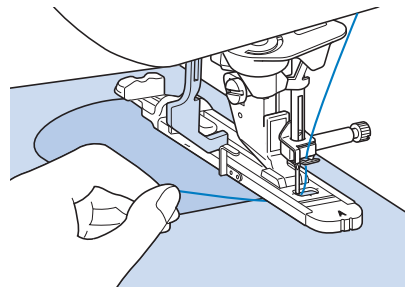

→ When sewing is completed, the machine will sew reinforcement stitches and stop automatically.

■ Bar Tacks on Thick Fabrics

Place a piece of folded fabric or cardboard beside the fabric being sewn to level the buttonhole foot and allow for easier and even feeding.

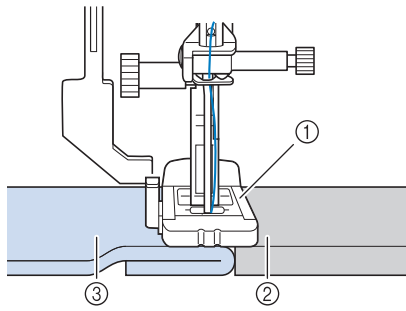

- ① Presser foot
- ② Thick paper
- ③ Fabric



Memo

- If automatic thread cutting is turned on before you start sewing, both threads are automatically cut after the reinforcement stitches are sewn. If the fabric does not feed (for example, because it is too thick), increase the stitch length setting.

Button Sewing

Buttons with 2 or 4 holes can be attached, using the machine.

See page S-67 for the detailed information of stitches.

Stitch	Stitch name	Presser foot
4-18 ⊖	Button sewing	



Note

- Do not use the automatic thread cutting function when sewing buttons. Otherwise, you will lose the thread ends.

- 1 Select .

→ The feed dogs are lowered automatically.

- 2 Raise the presser foot.

- 3 Attach button sewing foot “M”, slide the button along the metal plate and into the presser foot, and lower the presser foot.

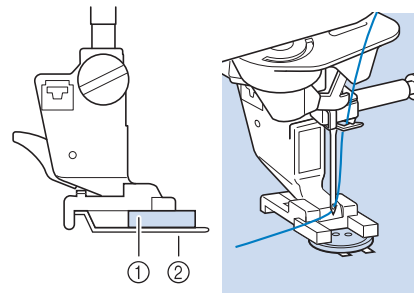

- ① Button
- ② Metal plate

- 4 Rotate the handwheel toward you (counterclockwise) to check that the needle goes into each hole correctly.

- * If the needle does not reach the holes on the left side, adjust the stitch width.
- * To attach the button more securely, repeat the process.

- 5 Gently hold the end of the upper thread and start sewing.

→ The machine stops automatically when sewing is finished.

⚠ CAUTION

- Make sure the needle does not strike the button during sewing. The needle may break and cause injury.

- 6 From the wrong side of the fabric, pull the end of the bobbin thread to pull the upper thread through to the wrong side of the fabric. Tie the two thread ends together and cut the threads.

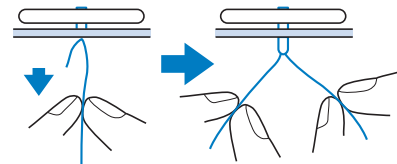

- 7 After the button is attached, select another stitch and rotate the handwheel toward you (counterclockwise) to raise the feed dogs.

■ Attaching 4 Hole Buttons

Sew the two holes closest to you. Then raise the presser foot and move the fabric so that the needle goes into the next two holes, and sew them in the same way.

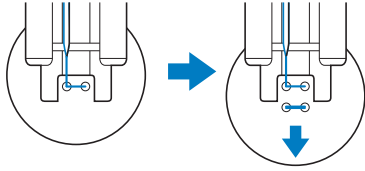

■ Attaching a Shank to the Button

- 1 Pull the shank lever toward you before sewing.

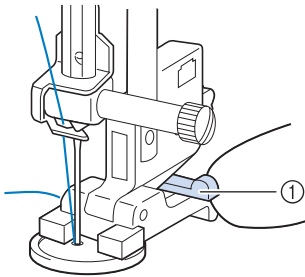

① Shank lever

- 2 Pull the two ends of the upper thread between the button and the fabric, wind them around the shank, and then tie them firmly together.

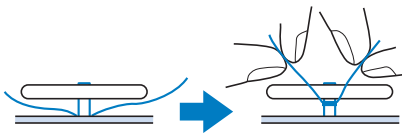

- 3 Tie the ends of the bobbin thread from the beginning and end of sewing together on the wrong side of the fabric.



Note

- When sewing is completed, be sure to select the other stitch and rotate the handwheel toward you (counterclockwise) to raise the feed dogs.

- 4 Cut off any excess thread.

Eyelet

Use this stitch for making belt holes and other similar applications.

See page S-67 for the detailed information of stitches.

Stitch	Stitch name	Presser foot
4-19 ○	Eyelet	

- 1 Select .

- 2 Use or in either the stitch width display or the stitch length display to choose the size of the eyelet.

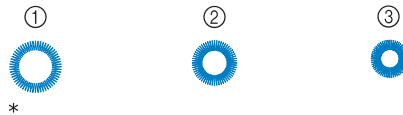

* Actual size

- ① Large 7 mm (approx. 1/4 inch)
- ② Medium 6 mm (approx. 15/64 inch)
- ③ Small 5 mm (approx. 3/16 inch)

- 3 Attach monogramming foot “N”, then rotate the handwheel toward you (counterclockwise) to check the needle drop position.

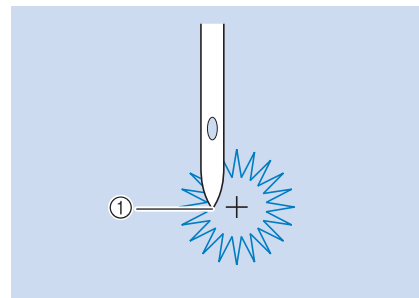

① Needle drop position

- 4 Lower the presser foot and start sewing.

→ When sewing is finished, the machine sews reinforcement stitches and stops automatically.



Note

- If the stitch pattern comes out poorly, make adjustments to “SEWING STITCH PATTERNS” on page S-81.

- 5 Use the eyelet punch to make a hole in the center of the stitching.

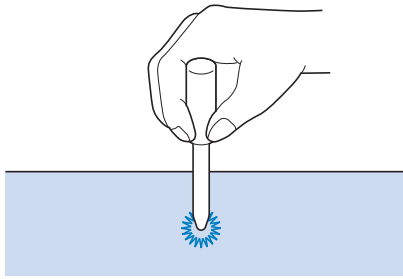

Multi-directional Sewing (Straight Stitch and Zigzag Stitch)

Use these stitch patterns to attach patches or emblems to pant legs, shirt sleeves, etc.

- 1 Remove the flat bed attachment to use the free-arm.

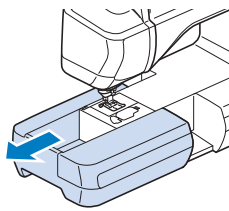

Memo

- Insert the tubular piece of fabric onto the free-arm, and then sew in the order shown in the illustration.

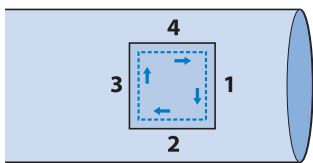

- 2 Select  and attach monogramming foot "N".

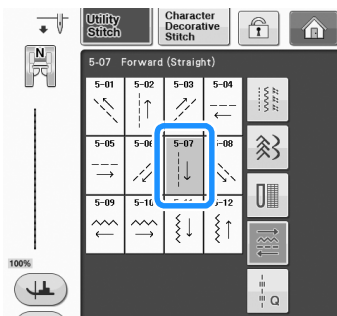

Memo

- For details on each stitch, refer to the "STITCH SETTING CHART" on page S-67.

- 3 Set the needle in the fabric at the sewing start point, and sew seam "1" as shown.

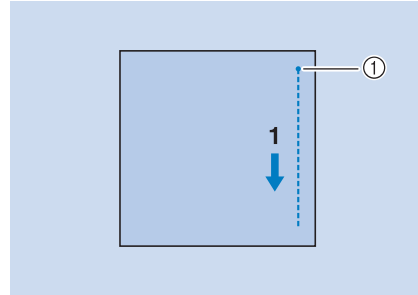

- ① Start Point

- 4 Select  and sew seam "2" as shown.

- * The fabric will move sideways, guide the fabric by hand to keep sewing straight.

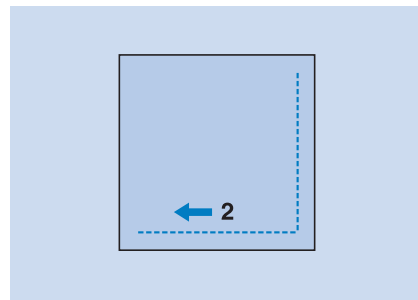

- 5 Select  and sew seam "3" as shown.

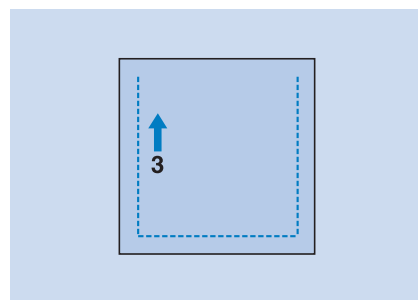

- The fabric feeds forward while stitching backward.

6 Select  and sew seam "4" as shown.

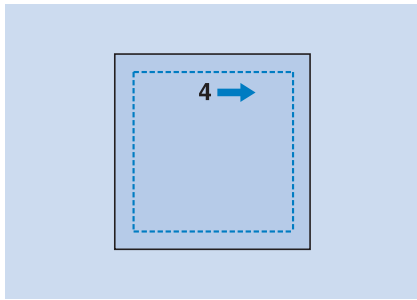

→ The seam will be connected to the starting point of seam 1.

Zipper Insertion

Centered Zipper

Use for bags and other such applications.

1 Select .

Memo

- For details on each stitch, refer to the "STITCH SETTING CHART" on page S-67.

Note

- Make sure you sew using the middle needle position.

2 Attach presser foot "J" and sew straight stitches up to the zipper opening. Change to a basting stitch (see page S-28) and sew to the top of the fabric.

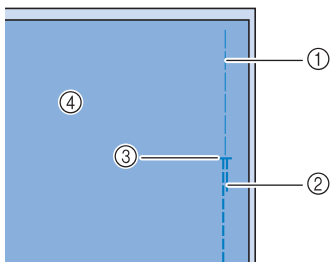

- ① Basting stitches
- ② Reverse stitches
- ③ End of zipper opening
- ④ Wrong side

3 Press the seam allowance open and attach the zipper with a basting stitch in the middle of each side of the zipper tape.

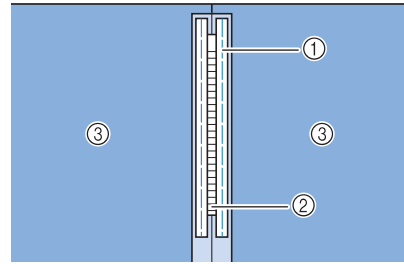

- ① Basting stitches
- ② Zipper
- ③ Wrong side

4 Remove presser foot "J". Align the right side of the pin in zipper foot "I" with the presser foot holder, and attach the zipper foot.

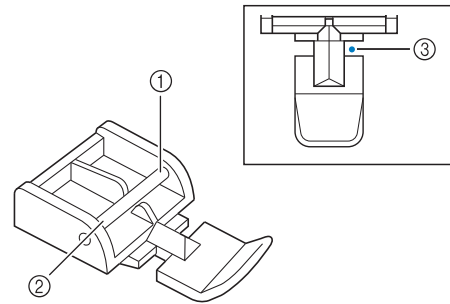

- ① Right
- ② Left
- ③ Needle drop position

CAUTION

- When using zipper foot "I", make sure the straight stitch, middle needle position is selected. Rotate the handwheel toward you (counterclockwise) to make sure the needle does not strike the presser foot. If another stitch is selected, the needle will strike the presser foot, causing the needle to break and possibly causing injury.

- 5** Topstitch 7 mm to 10 mm (approx. 1/4 inch to 3/8 inch) from the seamed edge of the fabric, then remove the basting.

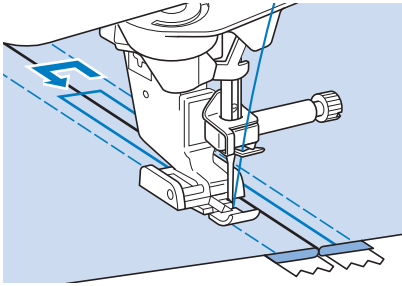

⚠ CAUTION

- Make sure the needle does not strike the zipper during sewing. If the needle strikes the zipper, the needle may break, leading to injury.

■ Inserting a Side Zipper

Use for side zippers in skirts or dresses.

- 1** Select .



Note

- Make sure you sew using the middle needle position.

- 2** Attach presser foot “J” and sew straight stitches up to the zipper opening. Change to a basting stitch and sew to the top of the fabric.

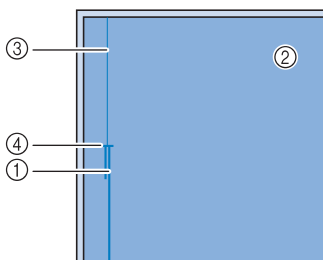

- ① Reverse stitches
- ② Wrong side of fabric
- ③ Basting stitches
- ④ End of zipper opening

- 3** Press the seam allowance open and align the folded hem along the teeth of the zipper, while maintaining 3 mm (approx. 1/8 inch) of sewing space.

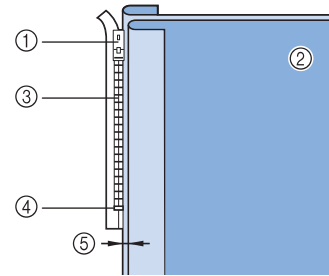

- ① Zipper pull tab
- ② Wrong side of fabric
- ③ Zipper teeth
- ④ End of zipper opening
- ⑤ 3 mm (approx. 1/8 inch)

- 4** Remove presser foot “J”.

- 5** Align the right side of the pin in zipper foot “I” with the presser foot holder, and attach the presser foot.

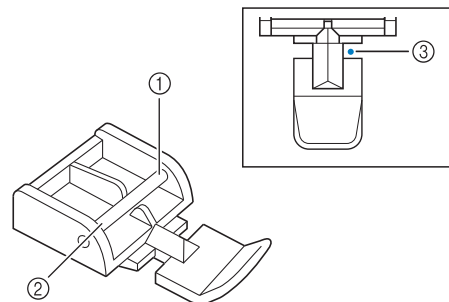

- ① Right
- ② Left
- ③ Needle drop position

⚠ CAUTION

- When using zipper foot “I”, make sure the straight stitch, middle needle position is selected. Rotate the handwheel toward you (counterclockwise) to make sure the needle does not strike the presser foot. If another stitch is selected, the needle will strike the presser foot, causing the needle to break and possibly causing injury.

- 6** Set the presser foot in the 3 mm (approx. 1/8 inch) margin.

7 Starting from the end of the zipper opening, sew to a point about 50 mm (approx. 2 inches) from the edge of the fabric, then stop the machine.

8 Pull down the zipper slider, then continue sewing to the edge of the fabric.

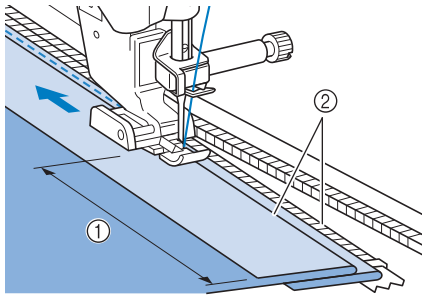

- ① 50 mm (approx. 2 inches)
- ② 3 mm (approx. 1/8 inch)

⚠ CAUTION

- Make sure the needle does not strike the zipper during sewing. If the needle strikes the zipper, the needle may break, leading to injury.

9 Close the zipper, turn the fabric over, and sew a basting stitch.

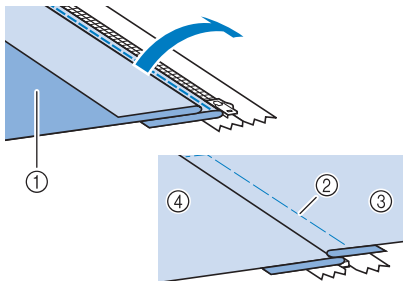

- ① Front of the skirt (wrong side of fabric)
- ② Basting stitches
- ③ Front of the skirt (right side of fabric)
- ④ Back of the skirt (right side of fabric)

10 Remove the presser foot, and reattach it so that the left side of the pin is attached to the presser foot holder.

- * When sewing the left side of the zipper, the needle should drop on the right side of the presser foot. When sewing the right side of the zipper, the needle should drop on the left side of the presser foot.

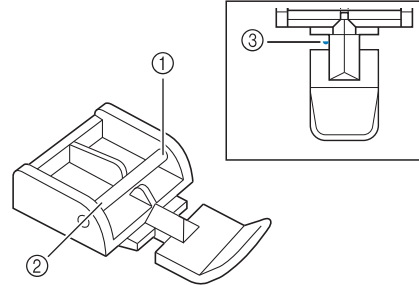

- ① Right
- ② Left
- ③ Needle drop position

11 Set the fabric so that the left edge of the presser foot touches the edge of the zipper teeth.

12 Sew reverse stitches at the top of the zipper, then continue sewing.

13 Stop sewing about 50 mm (approx. 2 inches) from the edge of the fabric, leave the needle in the fabric, and remove the basting stitches.



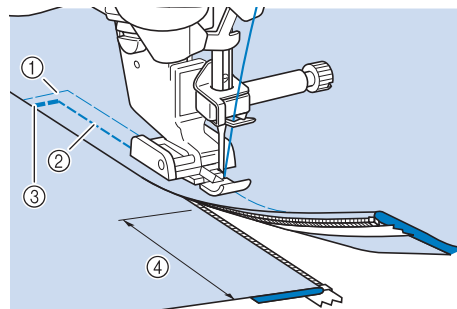











































14 Open the zipper and sew the rest of the seam.



















































- ① Basting stitches
- ② 7 mm to 10 mm (approx. 1/4 inch to 3/8 inch)
- ③ Reverse stitches
- ④ 50 mm (approx. 2 inches)























































STITCH SETTING CHART

The following chart shows information for each utility stitch concerning applications, stitch lengths, stitch widths, and whether or not the twin needle mode can be used.

























































Stitch	Stitch name	Presser foot		Applications	Stitch width [mm (inch)]		Stitch length [mm (inch)]		Twin needle
					Auto.	Manual	Auto.	Manual	
	Straight stitch (Left)			General sewing, gather, pintuck, etc.	0.0 (0)	0.0 - 7.0 (0 - 1/4)	2.5 (3/32)	0.2 - 5.0 (1/64 - 3/16)	OK (J)
	Straight stitch (Left)			General sewing, gather, pintuck, etc.	0.0 (0)	0.0 - 7.0 (0 - 1/4)	2.5 (3/32)	0.2 - 5.0 (1/64 - 3/16)	OK (J)
	Straight stitch (Middle)			General sewing, gather, pintuck, etc.	3.5 (1/8)	0.0 - 7.0 (0 - 1/4)	2.5 (3/32)	0.2 - 5.0 (1/64 - 3/16)	OK (J)
	Straight stitch (Middle)			General sewing, gather, pintuck, etc.	3.5 (1/8)	0.0 - 7.0 (0 - 1/4)	2.5 (3/32)	0.2 - 5.0 (1/64 - 3/16)	OK (J)
	Triple stretch stitch			General sewing for reinforcement and decorative topstitching	0.0 (0)	0.0 - 7.0 (0 - 1/4)	2.5 (3/32)	0.4 - 5.0 (1/64 - 3/16)	OK (J)
	Stem stitch			Reinforced stitching, sewing and decorative applications	1.0 (1/16)	0.0 - 7.0 (0 - 1/4)	2.5 (3/32)	0.4 - 5.0 (1/64 - 3/16)	OK (J)
	Decorative stitch			Decorative stitching, top stitching	0.0 (0)	0.0 - 7.0 (0 - 1/4)	2.5 (3/32)	0.4 - 5.0 (1/64 - 3/16)	OK (J)
	Basting stitch			Basting	0.0 (0)	0.0 - 7.0 (0 - 1/4)	20 (3/4)	5 - 30 (3/16 - 1-3/16)	NO
	Zigzag stitch			For overcasting, mending.	3.5 (1/8)	0.0 - 7.0 (0 - 1/4)	1.4 (1/16)	0.0 - 5.0 (0 - 3/16)	OK (J)
	Zigzag stitch			For overcasting, mending.	3.5 (1/8)	0.0 - 7.0 (0 - 1/4)	1.4 (1/16)	0.0 - 5.0 (0 - 3/16)	OK (J)
	Zigzag stitch (Right)			Start from right needle position, zigzag sew at left.	3.5 (1/8)	2.5 - 5.0 (3/32 - 3/16)	1.4 (1/16)	0.3 - 5.0 (1/64 - 3/16)	OK (J)
	Zigzag stitch (Left)			Start from left needle position, zigzag sew at right.	3.5 (1/8)	2.5 - 5.0 (3/32 - 3/16)	1.4 (1/16)	0.3 - 5.0 (1/64 - 3/16)	OK (J)
	2 steps elastic zigzag			Overcasting (medium weight and stretch fabrics), tape and elastic	5.0 (3/16)	0.0 - 7.0 (0 - 1/4)	1.0 (1/16)	0.2 - 5.0 (1/64 - 3/16)	OK (J)
	3 steps elastic zigzag			Overcasting (medium, heavyweight and stretch fabrics), tape and elastic	5.0 (3/16)	0.0 - 7.0 (0 - 1/4)	1.0 (1/16)	0.2 - 5.0 (1/64 - 3/16)	OK (J)
	Overcasting stitch			Reinforcing of light and medium weight fabrics	3.5 (1/8)	2.5 - 5.0 (3/32 - 3/16)	2.0 (1/16)	0.4 - 5.0 (1/64 - 3/16)	NO













































STITCH SETTING CHART

















































Stitch	Stitch name	Presser foot		Applications	Stitch width [mm (inch)]		Stitch length [mm (inch)]		Twin needle
					Auto.	Manual	Auto.	Manual	
	Overcasting stitch			Reinforcing of heavyweight fabric	5.0 (3/16)	2.5 - 5.0 (3/32 - 3/16)	2.5 (3/32)	0.4 - 5.0 (1/64 - 3/16)	NO
	Overcasting stitch			Reinforcing of medium, heavyweight and easily friable fabrics or decorative stitching.	5.0 (3/16)	3.5 - 5.0 (1/8 - 3/16)	2.5 (3/32)	0.4 - 5.0 (1/64 - 3/16)	NO
	Overcasting stitch			Reinforced seaming of stretch fabric	5.0 (3/16)	0.0 - 7.0 (0 - 1/4)	2.5 (3/32)	0.4 - 5.0 (1/64 - 3/16)	OK (J)
	Overcasting stitch			Reinforcing of medium stretch fabric and heavyweight fabric, decorative stitching	5.0 (3/16)	0.0 - 7.0 (0 - 1/4)	2.5 (3/32)	0.4 - 5.0 (1/64 - 3/16)	OK (J)
	Overcasting stitch			Reinforcement of stretch fabric or decorative stitching	4.0 (3/16)	0.0 - 7.0 (0 - 1/4)	4.0 (3/16)	0.4 - 5.0 (1/64 - 3/16)	OK (J)
	Overcasting stitch			Stretch knit seam	5.0 (3/16)	0.0 - 7.0 (0 - 1/4)	4.0 (3/16)	0.4 - 5.0 (1/64 - 3/16)	NO
	Single diamond overcast			Reinforcement and seaming stretch fabric	6.0 (15/64)	0.0 - 7.0 (0 - 1/4)	3.0 (1/8)	0.4 - 5.0 (1/64 - 3/16)	OK (J)
	Single diamond overcast			Reinforcement of stretch fabric	6.0 (15/64)	0.0 - 7.0 (0 - 1/4)	1.8 (1/16)	0.4 - 5.0 (1/64 - 3/16)	OK (J)
	With side cutter			Straight stitch while cutting fabrics	0.0 (0)	0.0 - 2.5 (0 - 3/32)	2.5 (3/32)	0.2 - 5.0 (1/64 - 3/16)	NO
	With side cutter			Zigzag stitch while cutting fabrics	3.5 (1/8)	3.5 - 5.0 (1/8 - 3/16)	1.4 (1/16)	0.0 - 5.0 (0 - 3/16)	NO
	With side cutter			Overcasting stitch while cutting fabrics	3.5 (1/8)	3.5 - 5.0 (1/8 - 3/16)	2.0 (1/16)	0.4 - 5.0 (1/64 - 3/16)	NO
	With side cutter			Overcasting stitch while cutting fabrics	5.0 (3/16)	3.5 - 5.0 (1/8 - 3/16)	2.5 (3/32)	0.4 - 5.0 (1/64 - 3/16)	NO
	With side cutter			Overcasting stitch while cutting fabrics	5.0 (3/16)	3.5 - 5.0 (1/8 - 3/16)	2.5 (3/32)	0.4 - 5.0 (1/64 - 3/16)	NO
	Piecing stitch (Right)			Piecing/patchwork 6.5 mm (approx. 1/4 inch) left seam allowance	5.5 (7/32)	0.0 - 7.0 (0 - 1/4)	2.0 (1/16)	0.2 - 5.0 (1/64 - 3/16)	NO
	Piecing stitch (Middle)			Piecing/patchwork	—	—	2.0 (1/16)	0.2 - 5.0 (1/64 - 3/16)	NO
	Piecing stitch (Left)			Piecing/patchwork 6.5 mm (approx. 1/4 inch) left seam allowance	1.5 (1/16)	0.0 - 7.0 (0 - 1/4)	2.0 (1/16)	0.2 - 5.0 (1/64 - 3/16)	NO
	Hand-look quilting			Quilting stitch made to look like hand quilting stitch	0.0 (0)	0.0 - 7.0 (0 - 1/4)	2.5 (3/32)	0.4 - 5.0 (1/64 - 3/16)	NO
	Quilting appliqué zigzag stitch			Zigzag stitch for quilting and sewing on appliqué quilt pieces	3.5 (1/8)	0.0 - 7.0 (0 - 1/4)	1.4 (1/16)	0.0 - 5.0 (0 - 3/16)	NO

























































Stitch	Stitch name	Presser foot		Applications	Stitch width [mm (inch)]		Stitch length [mm (inch)]		Twin needle
					Auto.	Manual	Auto.	Manual	
	Quilting appliqué stitch			Quilting stitch for invisible appliqué or attaching binding	1.5 (1/16)	0.0 - 7.0 (0 - 1/4)	1.8 (1/16)	0.4 - 5.0 (1/64 - 3/16)	NO
	Quilting stippling			Background quilting	7.0 (1/4)	0.0 - 7.0 (0 - 1/4)	1.6 (1/16)	0.4 - 5.0 (1/64 - 3/16)	NO
	Blind hem stitch			Hemming woven fabrics	00	3← - →3	2.0 (1/16)	0.4 - 5.0 (1/64 - 3/16)	NO
	Blind hem stitch stretch			Hemming stretch fabric	00	3← - →3	2.0 (1/16)	0.4 - 5.0 (1/64 - 3/16)	NO
	Blanket stitch			Appliqués, decorative blanket stitch	3.5 (1/8)	0.0 - 7.0 (0 - 1/4)	2.5 (3/32)	0.4 - 5.0 (1/64 - 3/16)	OK (J)
	Shell tuck edge			Shell tuck edge finish on fabrics	4.0 (3/16)	0.0 - 7.0 (0 - 1/4)	2.5 (3/32)	0.2 - 5.0 (1/64 - 3/16)	OK (J)
	Satin scallop stitch			Decorating collar of blouse, edge of handkerchief	5.0 (3/16)	0.0 - 7.0 (0 - 1/4)	0.5 (1/32)	0.1 - 5.0 (1/64 - 3/16)	OK (J)
	Scallop stitch			Decorating collar of blouse, edge of handkerchief	7.0 (1/4)	0.0 - 7.0 (0 - 1/4)	1.4 (1/16)	0.4 - 5.0 (1/64 - 3/16)	NO
	Patchwork join stitch			Patchwork stitches, decorative stitching	4.0 (3/16)	0.0 - 7.0 (0 - 1/4)	1.2 (1/16)	0.2 - 5.0 (1/64 - 3/16)	OK (J)
	Patchwork double overlock stitch			Patchwork stitches, decorative stitching	5.0 (3/16)	0.0 - 7.0 (0 - 1/4)	2.5 (3/32)	0.4 - 5.0 (1/64 - 3/16)	OK (J)
	Couching stitch			Decorative stitching, attaching cord and couching	5.0 (3/16)	0.0 - 7.0 (0 - 1/4)	1.2 (1/16)	0.2 - 5.0 (1/64 - 3/16)	OK (J)
	Smocking stitch			Smocking, decorative stitching	5.0 (3/16)	0.0 - 7.0 (0 - 1/4)	1.6 (1/16)	0.4 - 5.0 (1/64 - 3/16)	OK (J)
	Feather stitch			Fagoting, decorative stitching	5.0 (3/16)	0.0 - 7.0 (0 - 1/4)	2.5 (3/32)	0.4 - 5.0 (1/64 - 3/16)	OK (J)
	Fagoting cross stitch			Fagoting, bridging and decorative stitching	5.0 (3/16)	0.0 - 7.0 (0 - 1/4)	2.5 (3/32)	0.4 - 5.0 (1/64 - 3/16)	OK (J)
	Tape attaching			Attaching tape to seam in stretch fabric	4.0 (3/16)	0.0 - 7.0 (0 - 1/4)	1.0 (1/16)	0.2 - 5.0 (1/64 - 3/16)	OK (J)
	Ladder stitch			Decorative stitching	4.0 (3/16)	0.0 - 7.0 (0 - 1/4)	3.0 (1/8)	0.4 - 5.0 (1/64 - 3/16)	NO
	Rick-rack stitch			Decorative top stitching	4.0 (3/16)	0.0 - 7.0 (0 - 1/4)	2.5 (3/32)	0.4 - 5.0 (1/64 - 3/16)	OK (J)
	Decorative stitch			Decorative stitching	5.5 (7/32)	0.0 - 7.0 (0 - 1/4)	1.6 (1/16)	0.4 - 5.0 (1/64 - 3/16)	OK (J)

STITCH SETTING CHART













































Stitch	Stitch name	Presser foot		Applications	Stitch width [mm (inch)]		Stitch length [mm (inch)]		Twin needle
					Auto.	Manual	Auto.	Manual	
	Serpentine stitch			Decorative stitching and attaching elastic	5.0 (3/16)	0.0 - 7.0 (0 - 1/4)	1.0 (1/16)	0.2 - 5.0 (1/64 - 3/16)	OK (J)
	Decorative stitch			Decorative stitching and appliqué	6.0 (15/64)	0.0 - 7.0 (0 - 1/4)	1.0 (1/16)	0.2 - 5.0 (1/64 - 3/16)	OK (J)
	Decorative stippling stitch			Decorative stitching	7.0 (1/4)	0.0 - 7.0 (0 - 1/4)	1.6 (1/16)	0.4 - 5.0 (1/64 - 3/16)	NO
	Hemstitching			Decorative hems, triple straight at left	1.0 (1/16)	0.0 - 7.0 (0 - 1/4)	2.5 (3/32)	0.4 - 5.0 (1/64 - 3/16)	OK (J)
	Hemstitching			Decorative hems, triple straight at center	3.5 (1/8)	0.0 - 7.0 (0 - 1/4)	2.5 (3/32)	0.4 - 5.0 (1/64 - 3/16)	OK (J)
	Hemstitching zigzag			Decorative hems, top stitching	6.0 (15/64)	0.0 - 7.0 (0 - 1/4)	3.0 (1/8)	0.4 - 5.0 (1/64 - 3/16)	OK (J)
	Hemstitching			Decorative hems, lace attaching pin stitch	3.5 (1/8)	0.0 - 7.0 (0 - 1/4)	2.5 (3/32)	0.4 - 5.0 (1/64 - 3/16)	NO
	Hemstitching			Decorative hems	3.0 (1/8)	0.0 - 7.0 (0 - 1/4)	3.5 (1/8)	0.4 - 5.0 (1/64 - 3/16)	NO
	Hemstitching			Decorative hems daisy stitch	6.0 (15/64)	0.0 - 7.0 (0 - 1/4)	3.0 (1/8)	0.4 - 5.0 (1/64 - 3/16)	NO
	Hemstitching			Heirloom, decorative hems	5.0 (3/16)	0.0 - 7.0 (0 - 1/4)	3.5 (1/8)	0.4 - 5.0 (1/64 - 3/16)	NO
	Hemstitching			Heirloom, decorative hems	5.0 (3/16)	0.0 - 7.0 (0 - 1/4)	3.5 (1/8)	0.4 - 5.0 (1/64 - 3/16)	NO
	Hemstitching			Heirloom, decorative hems	5.0 (3/16)	0.0 - 7.0 (0 - 1/4)	3.5 (1/8)	0.4 - 5.0 (1/64 - 3/16)	OK (J)
	Hemstitching			Heirloom, decorative hems	5.0 (3/16)	0.0 - 7.0 (0 - 1/4)	4.0 (3/16)	0.4 - 5.0 (1/64 - 3/16)	OK (J)
	Hemstitching			Heirloom, decorative hems	4.0 (3/16)	0.0 - 7.0 (0 - 1/4)	2.5 (3/32)	0.4 - 5.0 (1/64 - 3/16)	OK (J)
	Honeycomb stitch			Heirloom, decorative hems	5.0 (3/16)	0.0 - 7.0 (0 - 1/4)	2.5 (3/32)	0.4 - 5.0 (1/64 - 3/16)	OK (J)
	Honeycomb stitch			Heirloom, decorative hems	6.0 (15/64)	0.0 - 7.0 (0 - 1/4)	3.5 (1/8)	0.4 - 5.0 (1/64 - 3/16)	OK (J)
	Hemstitching			Heirloom, decorative hems	6.0 (15/64)	0.0 - 7.0 (0 - 1/4)	1.6 (1/16)	0.4 - 5.0 (1/64 - 3/16)	OK (J)
	Hemstitching			Heirloom, decorative hems	6.0 (15/64)	0.0 - 7.0 (0 - 1/4)	3.0 (1/8)	0.4 - 5.0 (1/64 - 3/16)	NO

Stitch	Stitch name	Presser foot		Applications	Stitch width [mm (inch)]		Stitch length [mm (inch)]		Twin needle
					Auto.	Manual	Auto.	Manual	
	Hemstitching			Heirloom, decorative hems	6.0 (15/64)	0.0 - 7.0 (0 - 1/4)	4.0 (3/16)	0.4 - 5.0 (1/64 - 3/16)	OK (J)
	Hemstitching			Heirloom, decorative hems	4.0 (3/16)	0.0 - 7.0 (0 - 1/4)	2.5 (3/32)	0.4 - 5.0 (1/64 - 3/16)	NO
	Hemstitching			Heirloom, decorative hems	5.0 (3/16)	0.0 - 7.0 (0 - 1/4)	2.0 (1/16)	0.4 - 5.0 (1/64 - 3/16)	OK (J)
	Hemstitching			Decorative hems and bridging stitch	6.0 (15/64)	0.0 - 7.0 (0 - 1/4)	2.0 (1/16)	0.4 - 5.0 (1/64 - 3/16)	OK (J)
	Hemstitching			Decorative hems. Fagoting, attaching ribbon	5.0 (3/16)	0.0 - 7.0 (0 - 1/4)	3.0 (1/8)	0.4 - 5.0 (1/64 - 3/16)	OK (J)
	Hemstitching			Decorative hems, smocking	6.0 (15/64)	0.0 - 7.0 (0 - 1/4)	1.6 (1/16)	0.4 - 5.0 (1/64 - 3/16)	NO
	Hemstitching			Decorative hems, smocking	5.0 (3/16)	0.0 - 7.0 (0 - 1/4)	1.6 (1/16)	0.4 - 5.0 (1/64 - 3/16)	NO
	Narrow rounded buttonhole			Buttonhole on light to medium weight fabrics	5.0 (3/16)	3.0 - 5.0 (1/8 - 3/16)	0.4 (1/64)	0.2 - 1.0 (1/64 - 1/16)	NO
	Wide round ended buttonhole			Buttonholes with extra space for larger buttons	5.5 (7/32)	3.5 - 5.5 (1/8 - 7/32)	0.4 (1/64)	0.2 - 1.0 (1/64 - 1/16)	NO
	Tapered round ended buttonhole			Reinforced waist tapered buttonholes	5.0 (3/16)	3.0 - 5.0 (1/8 - 3/16)	0.4 (1/64)	0.2 - 1.0 (1/64 - 1/16)	NO
	Round ended buttonhole			Buttonholes with vertical bar tack in heavyweight fabrics	5.0 (3/16)	3.0 - 5.0 (1/8 - 3/16)	0.4 (1/64)	0.2 - 1.0 (1/64 - 1/16)	NO
	Round ended buttonhole			Buttonholes with bar tack	5.0 (3/16)	3.0 - 5.0 (1/8 - 3/16)	0.4 (1/64)	0.2 - 1.0 (1/64 - 1/16)	NO
	Round double ended buttonhole			Buttonholes for fine, medium to heavyweight fabrics	5.0 (3/16)	3.0 - 5.0 (1/8 - 3/16)	0.4 (1/64)	0.2 - 1.0 (1/64 - 1/16)	NO
	Narrow squared buttonhole			Buttonholes for light to medium weight fabrics	5.0 (3/16)	3.0 - 5.0 (1/8 - 3/16)	0.4 (1/64)	0.2 - 1.0 (1/64 - 1/16)	NO
	Wide squared buttonhole			Buttonholes with extra space for larger decorative buttons	5.5 (7/32)	3.5 - 5.5 (1/8 - 7/32)	0.4 (1/64)	0.2 - 1.0 (1/64 - 1/16)	NO
	Stretch buttonhole			Buttonholes for stretch or woven fabrics	6.0 (15/64)	3.0 - 6.0 (1/8 - 15/64)	1.0 (1/16)	0.5 - 2.0 (1/32 - 1/16)	NO
	Heirloom buttonhole			Buttonholes for heirloom and stretch fabrics	6.0 (15/64)	3.0 - 6.0 (1/8 - 15/64)	1.5 (1/16)	1.0 - 3.0 (1/16 - 1/8)	NO
	Bound buttonhole			The first step in making bound buttonholes	5.0 (3/16)	0.0 - 6.0 (0 - 15/64)	2.0 (1/16)	0.2 - 4.0 (1/64 - 3/16)	NO

Stitch	Stitch name	Presser foot		Applications	Stitch width [mm (inch)]		Stitch length [mm (inch)]		Twin needle
					Auto.	Manual	Auto.	Manual	
	Keyhole buttonhole			Buttonholes in heavyweight or thick fabrics for larger flat buttons	7.0 (1/4)	3.0 - 7.0 (1/8 - 1/4)	0.5 (1/32)	0.3 - 1.0 (1/64 - 1/16)	NO
	Tapered keyhole buttonhole			Buttonholes in medium to heavy weight fabrics for larger flat buttons	7.0 (1/4)	3.0 - 7.0 (1/8 - 1/4)	0.5 (1/32)	0.3 - 1.0 (1/64 - 1/16)	NO
	Keyhole buttonhole			Buttonholes with vertical bar tack for reinforcement in heavyweight or thick fabrics	7.0 (1/4)	3.0 - 7.0 (1/8 - 1/4)	0.5 (1/32)	0.3 - 1.0 (1/64 - 1/16)	NO
	Darning			Darning of medium weight fabric	7.0 (1/4)	2.5 - 7.0 (3/32 - 1/4)	2.0 (1/16)	0.4 - 2.5 (1/64 - 3/32)	NO
	Darning			Darning of heavyweight fabric	7.0 (1/4)	2.5 - 7.0 (3/32 - 1/4)	2.0 (1/16)	0.4 - 2.5 (1/64 - 3/32)	NO
	Bar tack			Reinforcement at opening of pocket, etc.	2.0 (1/16)	1.0 - 3.0 (1/16 - 1/8)	0.4 (1/64)	0.3 - 1.0 (1/64 - 1/16)	NO
	Button sewing			Attaching buttons	3.5 (1/8)	2.5 - 4.5 (3/32 - 3/16)	—	—	NO
	Eyelet			For making eyelets, holes on belts, etc.	7.0 (1/4)	7.0 6.0 5.0 (1/4 15/64 3/16)	7.0 (1/4)	7.0 6.0 5.0 (1/4 15/64 3/16)	NO
	Diagonally left up (Straight)			For attaching appliqué on tubular pieces of fabric and mitering corners	—	—	—	—	NO
	Reverse (Straight)			For attaching appliqué on tubular pieces of fabric and mitering corners	—	—	—	—	NO
	Diagonally right up (Straight)			For attaching appliqué on tubular pieces of fabric and mitering corners	—	—	—	—	NO
	Sideways to left (Straight)			For attaching appliqué on tubular pieces of fabric	—	—	—	—	NO
	Sideways to right (Straight)			For attaching appliqué on tubular pieces of fabric	—	—	—	—	NO
	Diagonally left down (Straight)			For attaching appliqué on tubular pieces of fabric and mitering corners	—	—	—	—	NO
	Forward (Straight)			For attaching appliqué on tubular pieces of fabric and mitering corners	—	—	—	—	NO
	Diagonally right down (Straight)			For attaching appliqué on tubular pieces of fabric and mitering corners	—	—	—	—	NO
	Sideways to left (Zigzag)			For attaching appliqué on tubular pieces of fabric	—	—	—	—	NO
	Sideways to right (Zigzag)			For attaching appliqué on tubular pieces of fabric	—	—	—	—	NO

Stitch	Stitch name	Presser foot		Applications	Stitch width [mm (inch)]		Stitch length [mm (inch)]		Twin needle
					Auto.	Manual	Auto.	Manual	
	Forward (Zigzag)			For attaching appliqué on tubular pieces of fabric and mitering corners	—	—	—	—	NO
	Reverse (Zigzag)			For attaching appliqué on tubular pieces of fabric and mitering corners	—	—	—	—	NO
	Piecing stitch (Middle)			Piecework/patchwork	—	—	2.0 (1/16)	0.2 - 5.0 (1/64 - 3/16)	NO
	Piecing stitch (Right)			Piecework/patchwork 6.5 mm (approx. 1/4 inch) right seam allowance	5.50 (7/32)	0.00 - 7.00 (0 - 1/4)	2.0 (1/16)	0.2 - 5.0 (1/64 - 3/16)	NO
	Piecing stitch (Left)			Piecework/patchwork 6.5 mm (approx. 1/4 inch) left seam allowance	1.50 (1/16)	0.00 - 7.00 (0 - 1/4)	2.0 (1/16)	0.2 - 5.0 (1/64 - 3/16)	NO
	Hand-look quilting			Quilting stitch made to look like hand quilting stitch	3.50 (1/8)	0.00 - 7.00 (0 - 1/4)	2.5 (3/32)	0.4 - 5.0 (1/64 - 3/16)	NO
	Basting stitch			Basting	3.50 (1/8)	0.00 - 7.00 (0 - 1/4)	20 (3/4)	5 - 30 (3/16 - 1-3/16)	NO
	Stem stitch			Reinforced stitching, sewing and decorative applications	1.00 (1/16)	0.00 - 7.00 (0 - 1/4)	2.5 (3/32)	0.4 - 5.0 (1/64 - 3/16)	NO
	Quilting appliqué zigzag stitch			Zigzag stitch for quilting and sewing on appliqué quilt pieces	3.50 (1/8)	0.00 - 7.00 (0 - 1/4)	1.6 (1/16)	0.0 - 5.0 (0 - 3/16)	NO
	Zigzag stitch (Right)			Start from right needle position, zigzag sew at left	3.50 (1/8)	2.50 - 5.00 (3/32 - 3/16)	1.6 (1/16)	0.3 - 5.0 (1/64 - 3/16)	NO
	Zigzag stitch (Left)			Start from left needle position, zigzag sew at right	3.50 (1/8)	2.50 - 5.00 (3/32 - 3/16)	1.6 (1/16)	0.3 - 5.0 (1/64 - 3/16)	NO
	2 steps elastic zigzag			Overcasting (medium weight and stretch fabrics), tape and elastic	5.00 (3/16)	0.00 - 7.00 (0 - 1/4)	1.0 (1/16)	0.2 - 5.0 (1/64 - 3/16)	NO
	3 steps elastic zigzag			Overcasting (medium, heavyweight and stretch fabrics), tape and elastic	5.00 (3/16)	0.00 - 7.00 (0 - 1/4)	1.0 (1/16)	0.2 - 5.0 (1/64 - 3/16)	NO
	Quilting appliqué stitch			Quilting stitch for invisible appliqué or attaching binding	2.00 (1/16)	0.00 - 7.00 (0 - 1/4)	2.0 (1/16)	0.4 - 5.0 (1/64 - 3/16)	NO
	Shell tuck edge			Shell tuck edge finish on fabrics	4.00 (3/16)	0.00 - 7.00 (0 - 1/4)	2.5 (3/32)	0.2 - 5.0 (1/64 - 3/16)	NO
	Blanket stitch			Appliqués, decorative blanket stitch	3.50 (1/8)	0.00 - 7.00 (0 - 1/4)	2.5 (3/32)	0.4 - 5.0 (1/64 - 3/16)	NO
	Quilting stippling			Background quilting	7.00 (1/4)	0.00 - 7.00 (0 - 1/4)	1.6 (1/16)	0.4 - 5.0 (1/64 - 3/16)	NO
	Overcasting stitch			Stretch knit seam	5.00 (3/16)	0.00 - 7.00 (0 - 1/4)	4.0 (3/16)	0.4 - 5.0 (1/64 - 3/16)	NO

STITCH SETTING CHART

Stitch	Stitch name	Presser foot		Applications	Stitch width [mm (inch)]		Stitch length [mm (inch)]		Twin needle
					Auto.	Manual	Auto.	Manual	
	Tape attaching			Attaching tape to seam in stretch fabric	5.50 (7/32)	0.00 - 7.00 (0 - 1/4)	1.4 (1/16)	0.2 - 5.0 (1/64 - 3/16)	NO
	Serpentine stitch			Decorative stitching and attaching elastic	5.00 (3/16)	0.00 - 7.00 (0 - 1/4)	2.0 (1/16)	0.2 - 5.0 (1/64 - 3/16)	NO
	Feather stitch			Fagoting, decorative stitching	5.00 (3/16)	0.00 - 7.00 (0 - 1/4)	2.5 (3/32)	0.4 - 5.0 (1/64 - 3/16)	NO
	Fagoting cross stitch			Fagoting, bridging and decorative stitching	5.00 (3/16)	0.00 - 7.00 (0 - 1/4)	2.5 (3/32)	0.4 - 5.0 (1/64 - 3/16)	NO
	Couching stitch			Decorative stitching, attaching cord and couching	5.00 (3/16)	0.00 - 7.00 (0 - 1/4)	1.2 (1/16)	0.2 - 5.0 (1/64 - 3/16)	NO
	Patchwork double overlock stitch			Patchwork stitches, decorative stitching	5.00 (3/16)	0.00 - 7.00 (0 - 1/4)	2.5 (3/32)	0.4 - 5.0 (1/64 - 3/16)	NO
	Smocking stitch			Smocking, decorative stitching	5.00 (3/16)	0.00 - 7.00 (0 - 1/4)	1.6 (1/16)	0.4 - 5.0 (1/64 - 3/16)	NO
	Rick-rack stitch			Decorative top stitching	4.00 (3/16)	0.00 - 7.00 (0 - 1/4)	2.5 (3/32)	0.4 - 5.0 (1/64 - 3/16)	NO
	Decorative stitch			Decorative stitching and appliqué	6.00 (15/64)	0.00 - 7.00 (0 - 1/4)	1.0 (1/16)	0.2 - 5.0 (1/64 - 3/16)	NO
	Decorative stitch			Decorative stitching	5.50 (7/32)	0.00 - 7.00 (0 - 1/4)	1.6 (1/16)	0.4 - 5.0 (1/64 - 3/16)	NO
	Hemstitching			Heirloom, decorative hems	5.00 (3/16)	0.00 - 7.00 (0 - 1/4)	2.0 (1/16)	0.4 - 5.0 (1/64 - 3/16)	NO
	Hemstitching			Decorative hems and bridging stitch	6.00 (15/64)	0.00 - 7.00 (0 - 1/4)	2.0 (1/16)	0.4 - 5.0 (1/64 - 3/16)	NO
	Single diamond overcast			Reinforcement and seaming stretch fabric	6.00 (15/64)	0.00 - 7.00 (0 - 1/4)	3.0 (1/8)	0.4 - 5.0 (1/64 - 3/16)	NO
	Overcasting stitch			Reinforcement of stretch fabric or decorative stitching	4.00 (3/16)	0.00 - 7.00 (0 - 1/4)	4.0 (3/16)	0.4 - 5.0 (1/64 - 3/16)	NO

Chapter 3

Character/Decorative Stitches

SELECTING STITCH PATTERNS	77
Selecting Decorative Stitch Patterns/7mm Decorative Stitch Patterns/Satin Stitch Patterns/7mm Satin Stitch Patterns/Cross Stitch/Utility Decorative Stitch Patterns	78
Characters	78
■ Deleting Characters	79
■ Adjusting the Character Spacing	80
SEWING STITCH PATTERNS	81
Sewing Attractive Finishes	81
Basic Sewing	81
Making Adjustments	82
EDITING STITCH PATTERNS	84
■ Key Functions.....	84
Changing the Size	86
Changing the Length (for 7mm Satin Stitch Patterns Only)	86
Creating a Vertical Mirror Image	86
Creating a Horizontal Mirror Image	86
Sewing a Pattern Continuously	86
Changing Thread Density (for Satin Stitch Patterns Only)	87
Returning to the Beginning of the Pattern.....	87
Checking the Image	88
COMBINING STITCH PATTERNS	89
Before Combining	89
Combining Various Stitch Patterns	89
Combining Large and Small Stitch Patterns	90
Combining Horizontal Mirror Image Stitch Patterns	91
Combining Stitch Patterns of Different Length	91
Making Step Stitch Patterns (for 7mm Satin Stitch Patterns Only)	92
■ More Examples.....	93
USING THE MEMORY FUNCTION	94
Stitch Data Precautions	94
■ Types of Stitch Data that can be Used	94
■ Types of USB Devices/Media that can be Used.....	94
■ Computers and Operating Systems with the Following Specifications can be Used.....	94
■ Precautions on Using the Computer to Create and Save Data	94
Saving Stitch Patterns in the Machine's Memory	95
■ If the Memory is Full	95
Saving Stitch Patterns to USB Media.....	96
Saving Stitch Patterns in the Computer.....	97
Retrieving Stitch Patterns from the Machine's Memory	98
Recalling from USB Media	99
Recalling from the Computer	100

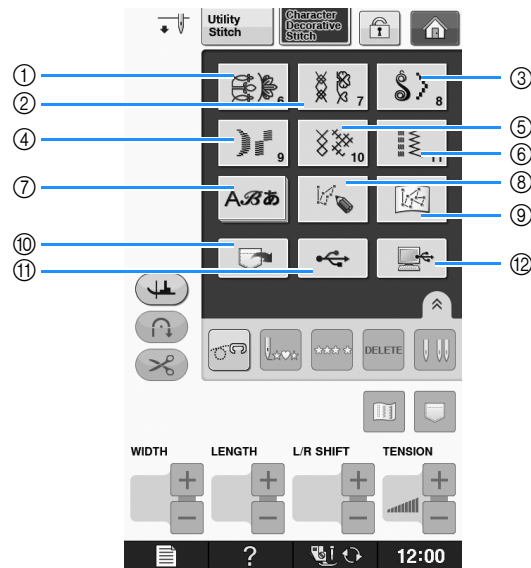

SELECTING STITCH PATTERNS

Press  to display the screen below. There are 7 categories of Character/Decorative stitch patterns.



- ① Decorative stitch patterns
- ② 7mm decorative stitch patterns. You can set stitch length and width.
- ③ Satin stitch patterns
- ④ 7mm satin stitch patterns. You can set stitch length and width.
- ⑤ Cross stitch
- ⑥ Utility decorative stitch patterns
- ⑦ Characters (Gothic font, Handwriting font, Outline, Cyrillic font, Japanese font)
- ⑧ Press this key to create your own stitches with the "MY CUSTOM STITCH" function (see page S-102)
- ⑨ Patterns stored in "MY CUSTOM STITCH" (see page S-102)
- ⑩ Patterns saved in the machine's memory (see page S-98)
- ⑪ Patterns saved in USB media (see page S-99)
- ⑫ Patterns saved on the computer (see page S-100)

Note

- If the screen is locked (), unlock the screen by pressing  . While the screen is locked, no other key can be operated.

Selecting Decorative Stitch Patterns/7mm Decorative Stitch Patterns/Satin Stitch Patterns/7mm Satin Stitch Patterns/Cross Stitch/Utility Decorative Stitch Patterns

- 1 Select the category of the pattern you want to sew.
- 2 Press the key of the stitch pattern you want to sew.
 - * Press to view the next page.
 - * Press to view the previous page.
 - * Touch the bar that appears between and to leap multiple pages at one time.
 - * To select a different stitch pattern, press . When the current stitch pattern is erased, select the new stitch pattern.

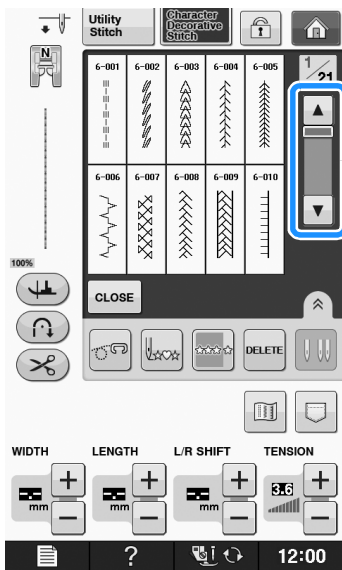

→ The selected pattern is displayed.

Characters

Example: Entering "Blue Sky".

- 1 Press .



- 2 Press , , , or to select a font.

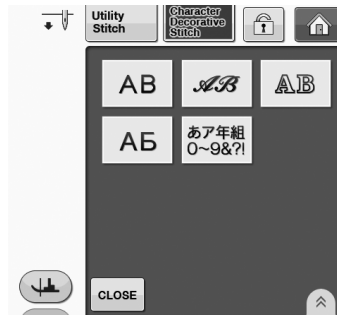

Memo

- There are four fonts for alphabet character stitching, and a font for Japanese character stitching. Refer to the Quick Reference Guide for the details about the different font selections available.

- 3 Press a tab to change the selection screens.

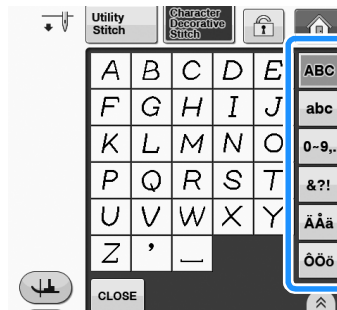

4 Press **ABC** and then enter "B".

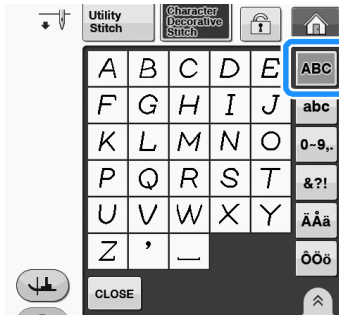

5 Press **abc** and then enter "lue".

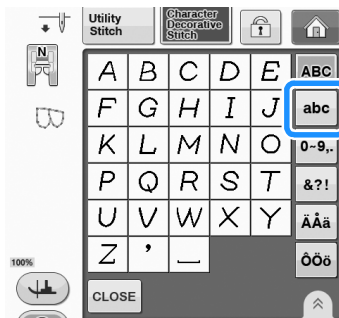

6 Press **[]** to enter a space.

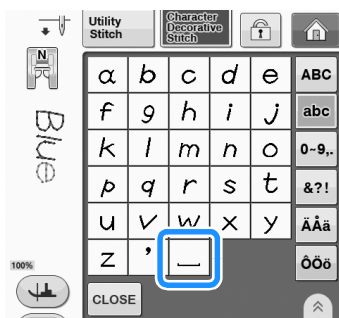

7 Press **ABC** again and enter "S".

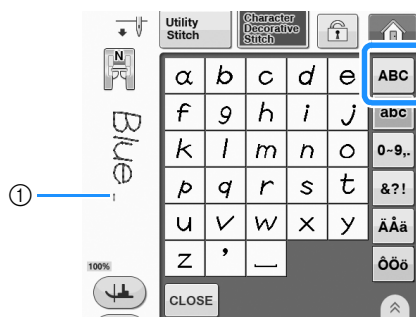

① Space is a jumping stitch
* Remove the jumping stitches after sewing.

8 Press **abc** and then enter "ky".

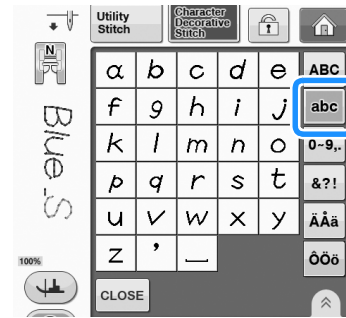

* If you want to continue entering characters in a different font, press **CLOSE**, and then repeat from step 2.

■ Deleting Characters

1 Press **DELETE** to delete the last character.

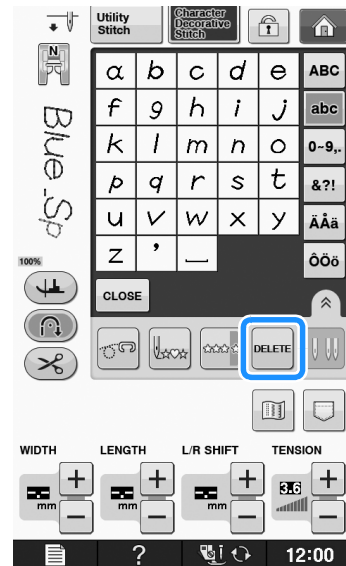

Memo

- Characters are deleted individually starting with the last character entered.

2 Select the correct character.

* Continually press **DELETE** and all characters will be deleted.

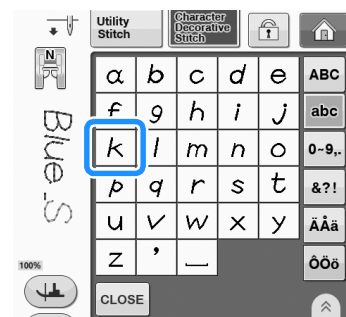

■ Adjusting the Character Spacing



The space between the characters can be adjusted.

1 Press .

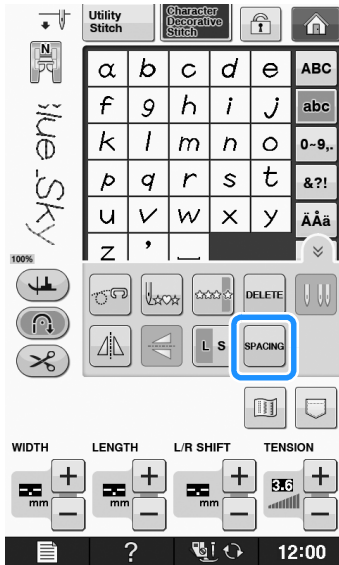

* Press  to display  on the screen.

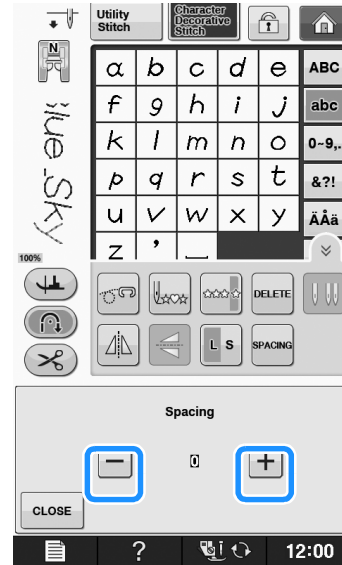

→ The character spacing window appears.

2 Press  or  to adjust character spacing.



* Press  to increase the character spacing and press  to decrease the character spacing.

Example:

* Each setting equals a specific distance between characters.



Value	mm
0	0
1	0.18
2	0.36
3	0.54
4	0.72
5	0.9
6	1.08
7	1.26
8	1.44
9	1.62
10	1.8

Memo

- The default setting is “0”. No number less than “0” can be set.
- Changing character spacing by this method, pertains to all characters. Spacing changes are valid not only while entering characters but also before and after the entering of characters.

SEWING STITCH PATTERNS

Sewing Attractive Finishes

To achieve attractive results when sewing character/decorative stitches, check the table below for the proper fabric/thread/needle combinations.



Note

- Other factors, such as fabric thickness, stabilizer material, etc., also have an effect on the stitch, so you should always sew a few trial stitches before beginning your project.
- When sewing satin stitch patterns, there may be shrinking or bunching of stitches, so be sure to attach a stabilizer material.
- Guide the fabric with your hand to keep the fabric feeding straight and even during sewing.

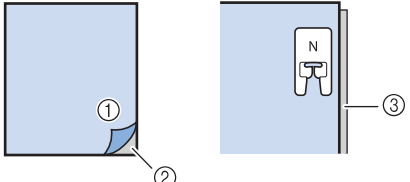
Fabric	When sewing on stretch fabrics, lightweight fabrics, or fabrics with coarse weaves, attach stabilizer on the wrong side of the fabric. If you do not wish to do so, place the fabric on a thin paper such as tracing paper.  ① Fabric ② Stabilizer ③ Thin paper
Thread	#50 - #60
Needle	With lightweight, regular, or stretch fabrics: the Ball point needle (golden colored) 90/14 With heavyweight fabrics: home sewing machine needle 90/14
Presser foot	Monogramming foot "N". Using another presser foot may give inferior results.

Basic Sewing

- 1 Select a stitch pattern.
- 2 Attach monogramming foot "N".
- 3 Place the fabric under the presser foot, pull the upper thread out to the side, and then lower the presser foot.

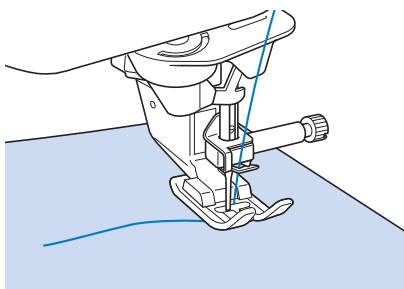

- 4 Press the "Start/Stop" button to start sewing.

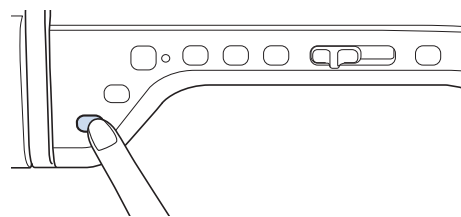

⚠ CAUTION

- When sewing 7 mm satin stitch patterns and the stitches are bunched, lengthen the stitch length. If you continue sewing when the stitches are bunched, the needle may bend or break ("Setting the Stitch Length" on page S-10).

Memo

- If the fabric is pulled or pushed during sewing, the pattern may not turn out correctly. Also, depending on the pattern, there may be movement to the left and right as well as front and back. Guide the fabric with your hand to keep the fabric feeding straight and even during sewing.

5 Press the “Start/Stop” button to stop sewing.

6 Press the “Reverse Stitch” button or “Reinforcement Stitch” button to sew reinforcement stitches.

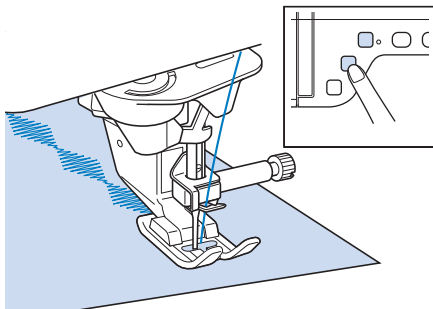

Memo

- When sewing character stitches, the machine automatically sews reinforcement stitches at the beginning and end of each character.

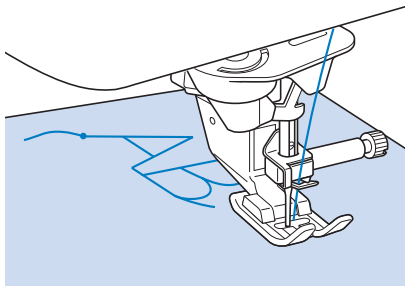

- When sewing is completed, trim any excess thread between letters.

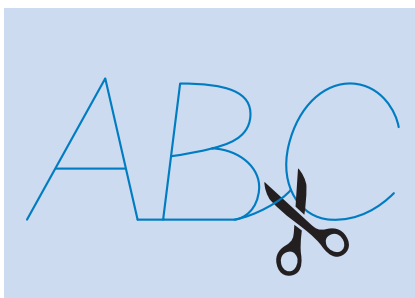



Note

- When sewing some patterns, the needle will temporarily pause in the raised position while the fabric is fed due to the operation of the needle bar separation mechanism which is used in this machine. At such times, a clicking sound different from the sound generated during sewing will be heard. This sound is normal and is not the sign of a malfunction.

Making Adjustments

Your stitch pattern may sometimes turn out poorly, depending on the type or thickness of fabric, the stabilizer material used, sewing speed, etc. If your sewing does not turn out well, sew trial stitches using the same conditions as the real sewing, and adjust the stitch pattern as explained below. If the pattern does not turn out well even after making

adjustments based on the  pattern, make adjustments for each pattern individually.

1 Press  and select  on 19/21.

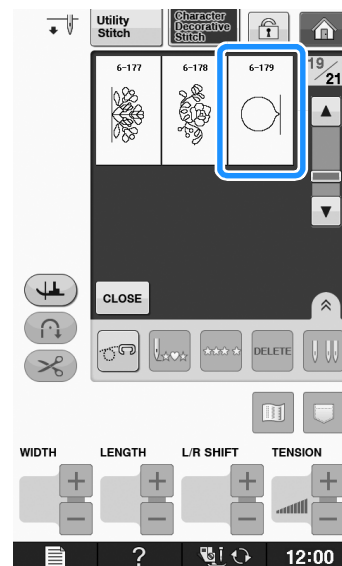

- 2** Attach monogramming foot “N” and sew the pattern.

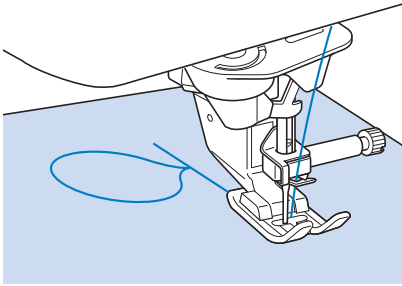

- 3** Compare the finished pattern to the illustration of the correct pattern below.

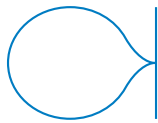

- 4** Press , and then adjust the pattern with the “Fine Adjust Verti.” or “Fine Adjust Horiz.” displays.

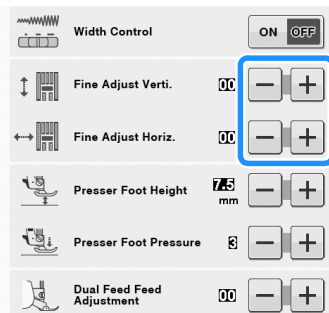

- * If the pattern is bunched:

Press  in the “Fine Adjust Verti.” display.

→ The displayed value increases each time the button is pressed and the pattern will lengthen.

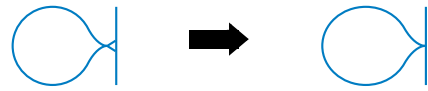

- * If the pattern has gaps:

Press  in the “Fine Adjust Verti.” display.

→ The displayed value decreases each time the button is pressed and the pattern will shorten.



- * If the pattern is skewed to the left:

Press  in the “Fine Adjust Horiz.” display.

→ The displayed value increases each time the button is pressed and the pattern will slide to the right.

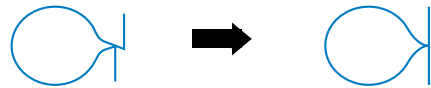

- * If the pattern is skewed to the right:

Press  in the “Fine Adjust Horiz.” display.

→ The displayed value decreases each time the button is pressed and the pattern will slide to the left.

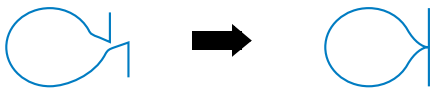

- 5** Sew the stitch pattern again.

- * If the stitch pattern still comes out poorly, make adjustments again. Adjust until the stitch pattern comes out correctly.



Memo

- You can sew with the setting screen on the display.

- 6** Press  to return to the original screen.

EDITING STITCH PATTERNS

Key Functions

You can create just the finish you want using the editing functions. Make patterns larger or smaller, make mirror images, etc.



Note

- Some editing functions cannot be used with certain stitch patterns. Only the functions for the displayed keys are available when a pattern is selected.

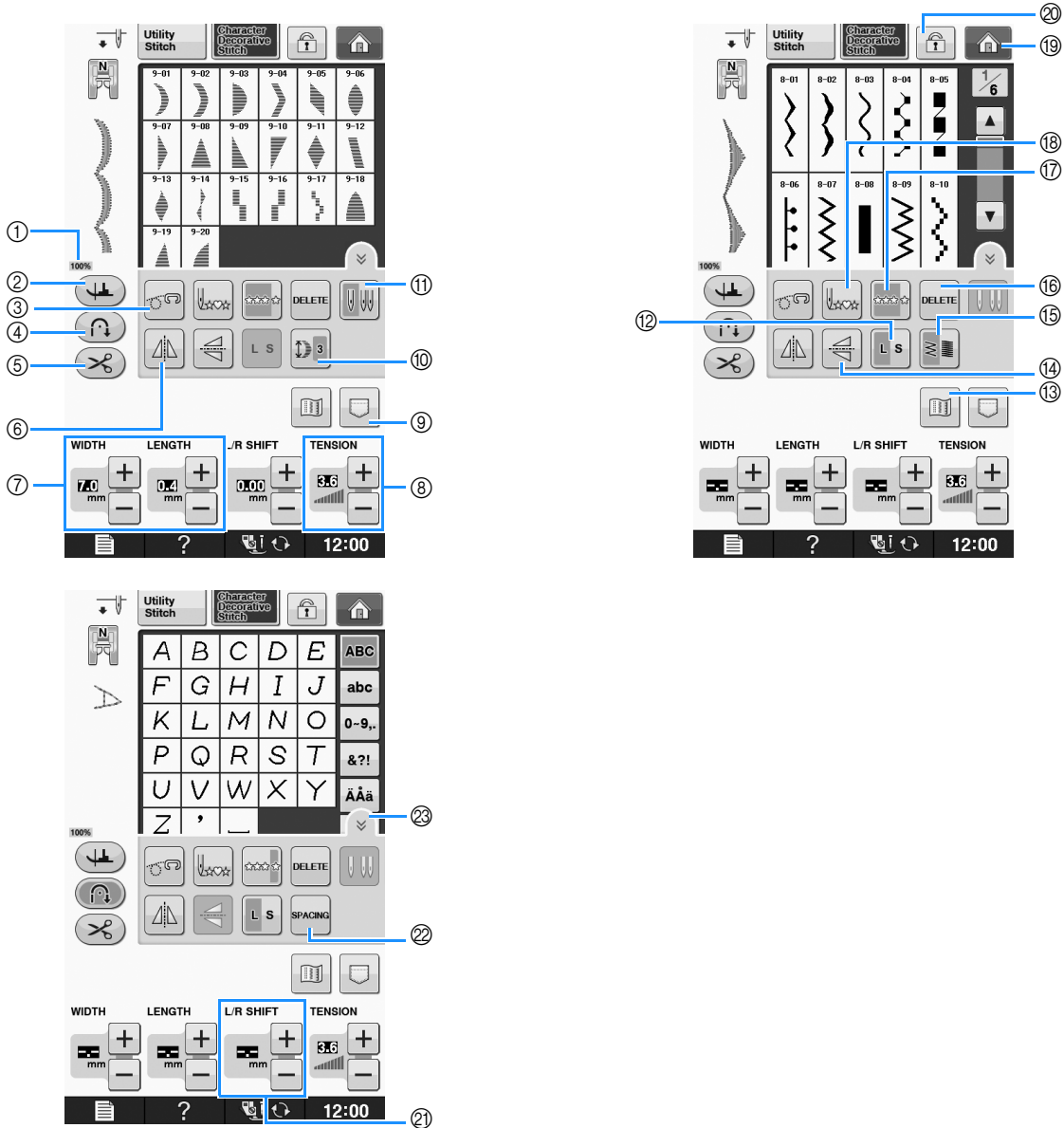

No.	Display	Key Name	Explanation	Page
①	100%	Pattern display size	Show the approximate size of the pattern selected. 100% : Nearly the same size as the sewn pattern 50% : 1/2 the size of the sewn pattern 25% : 1/4 the size of the sewn pattern * The actual size of the sewn pattern may differ depending on the type of fabric and thread that is used.	S-21

No.	Display	Key Name	Explanation	Page
②		Pivot key	Press this key to select the pivot setting. When the pivot setting is selected, stopping the machine lowers the needle and slightly raises the presser foot automatically. In addition, when sewing is restarted, the presser foot is automatically lowered. <ul style="list-style-type: none"> • If this key appears as , the pivot function cannot be used. • Be sure the “Needle Position - UP/DOWN” of Machine Settings is set to the down position. 	S-15
③		Free motion mode key	Press this key to enter free motion sewing mode. The feed dog is lowered and presser foot is raised to a height appropriate for free motion quilting.	S-40
④		Automatic reinforcement stitch key	Press this key to turn on the automatic reinforcement stitching mode.	S-5
⑤		Automatic thread cutting key	Press this key to turn on the automatic thread cutting mode.	S-14
⑥		Horizontal mirror image key	After selecting the stitch pattern, use this key to create a horizontal mirror image of the stitch pattern.	S-86
⑦		Stitch width and stitch length key	Shows the stitch width and stitch length of the selected stitch pattern. The machine default settings are highlighted.	S-10 to S-12
⑧		Thread tension key	Shows the thread tension setting for the selected stitch pattern. The machine default settings are highlighted	S-12
⑨		Memory key	Use this key to save stitch pattern combinations.	S-95 to S-96
⑩		Elongation key	When 7mm satin stitch patterns are selected, press this key to choose from 5 automatic length settings, without changing the stitch zigzag width or stitch length settings.	S-86
⑪		Needle mode selection key (Single/Double)	Press this key to choose single needle sewing or twin needle sewing.	“Basic operations”
⑫		Size selection key	Use this key to select the size of the stitch pattern (large, small).	S-86
⑬		Image key	Press this key to display an enlarged image of the selected stitch pattern.	S-88
⑭		Vertical mirror image key	After selecting the stitch pattern, use this key to create a vertical mirror image of the stitch pattern.	S-86
⑮		Thread density key	After selecting the stitch pattern, use this key to change the thread density of the pattern.	S-87
⑯		Delete key	When you make a mistake selecting a stitch pattern, use this key to delete the mistake. When you make a mistake in combining stitch patterns, use this key to delete stitch patterns.	S-78, S-79
⑰		Single/Repeat sewing key	Press this key to choose single stitches or continuous stitches.	S-86
⑱		Back to beginning key	When sewing is stopped, press this key to return to the beginning of the pattern.	S-87
⑲		Home page screen key	(For embroidery and sewing machine only) Press this key to return to the home page screen.	-
⑳		Screen lock key	Press this key to lock the screen. When the screen is locked, the various settings, such as the stitch width and stitch length, are locked and cannot be changed. Press this key again to unlock the settings.	S-18
㉑		“L/R SHIFT” key	Press to shift the stitch pattern to the right or press to shift the pattern to the left. This feature is not available on all patterns. Only those applicable will be shifted. The machine default setting is highlighted.	S-11
㉒		Character spacing key	Press this key to change the spacing of character patterns.	S-80
㉓		Function page key	Press this key to show all the functions available in this screen.	S-80

Changing the Size

Select a stitch pattern, then press **L S** to change the size of the stitch pattern. The stitch pattern will be sewn in the size highlighted on the key.



Memo

- If you continue entering stitch patterns after changing the size, those patterns will also be sewn in that size.
- You cannot change the size of combined stitch patterns once the stitch pattern is entered.

Actual Stitch Pattern Size

* The size differs depending on the fabric and threads.

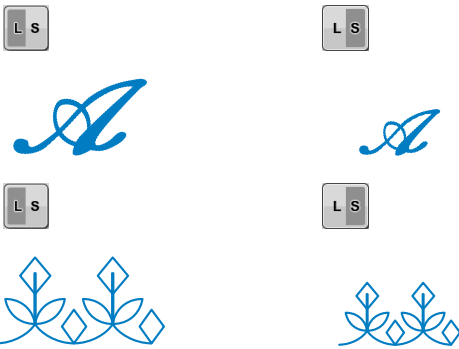

Changing the Length (for 7mm Satin Stitch Patterns Only)

When 7mm satin stitch patterns are selected, press **↕ 3** to choose from 5 automatic length settings, without changing the stitch zigzag width or stitch length settings.

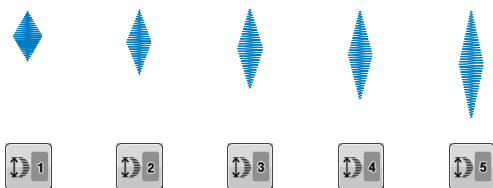

Creating a Vertical Mirror Image

To create a vertical mirror image, select a stitch pattern then press .

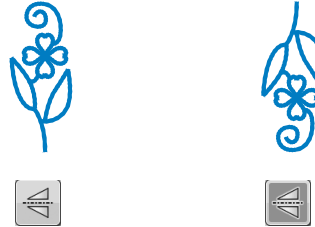
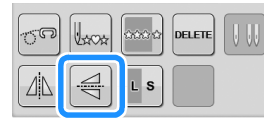

Creating a Horizontal Mirror Image

To create a horizontal mirror image, select a stitch pattern then press .

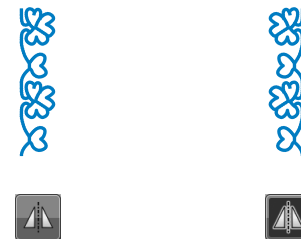

Sewing a Pattern Continuously

Press  to select continuous sewing or single stitch sewing.

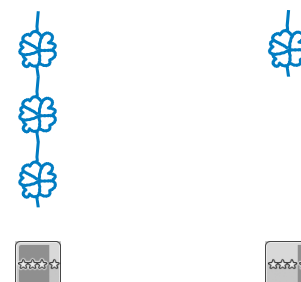

Memo



- To finish a complete motif while sewing the pattern continuously, you can press the  key while sewing. The machine will automatically stop when the motif is finished.

Changing Thread Density (for Satin Stitch Patterns Only)

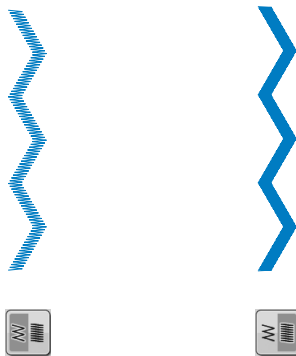
After selecting a satin stitch pattern, press  to select your preferred thread density.



CAUTION

- If the stitches bunch when thread density is changed to , return the thread density to . If you continue sewing when the stitches are bunched, the needle may bend or break.

Memo

- Even if you select a new pattern after changing the thread density, the thread density remains the same until you change it.
- You cannot change thread density for a combined pattern after additional patterns are added.

Returning to the Beginning of the Pattern

When sewing character/decorative stitches, you can return to the beginning of the pattern after trial sewing or when the stitching is sewn incorrectly.

- 1 Press the “Start/Stop” button to stop the machine, and then press .

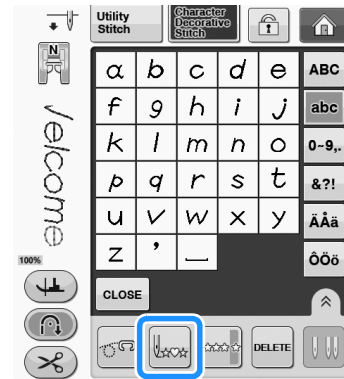

→ Sewing returns to the beginning of the selected pattern (“W”) from the point where sewing was stopped.

Memo

- If this key is pressed when sewing is stopped, patterns can be added at the end of a combined stitch pattern. (In this example, “!” is added.)

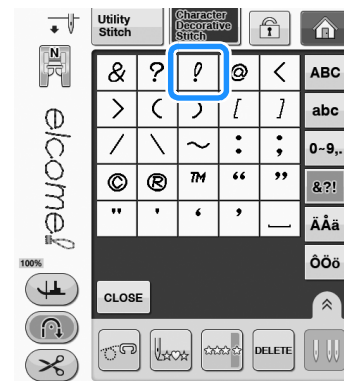

- 2 Press the “Start/Stop” button to continue sewing.

Checking the Image

You can display an approximate size image of the selected stitch pattern. You can also check and change the colors of the image on the screen.

1 Press .

→ An image of the selected pattern is displayed.

2 Press  to change the thread color in the image to red, blue, or black.

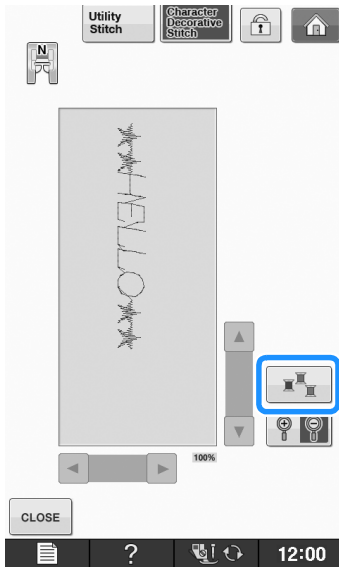

→ The color changes every time you press the button.

3 Press  to display the enlarged image.

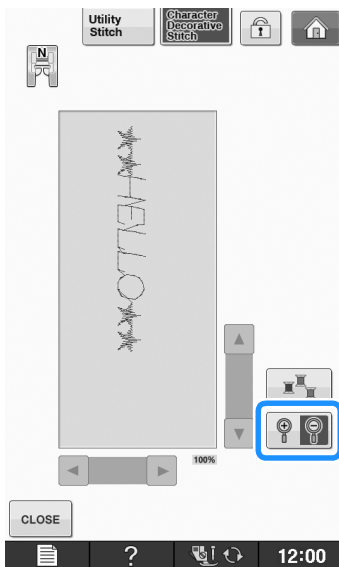

4 Use  to view any part of the image that extends out of the viewable display area.

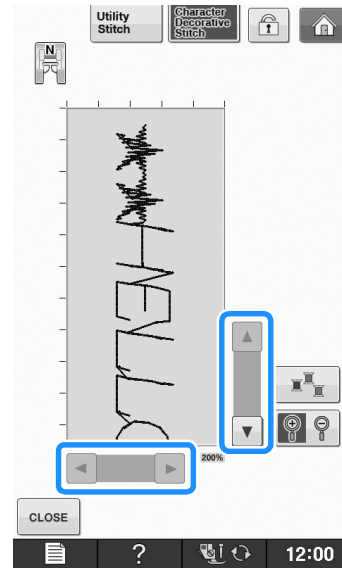

5 Press  to return to the original screen.

Memo

- You can also sew from this screen when the presser foot symbol is displayed.
- Image of some patterns will display in default size only.

COMBINING STITCH PATTERNS

You can combine many varieties of stitch patterns, such as character stitches, cross stitches, satin stitches, or stitches you design with “MY CUSTOM STITCH” function (see page S-102 for information about “MY CUSTOM STITCH”). You can also combine stitch patterns of different sizes, mirror image stitch patterns and others.

Before Combining

Single stitch sewing is automatically selected for sewing combined patterns. If you want to sew the pattern continuously, press  after finishing the stitch pattern combination.

When changing sizes, creating mirror images, or making other adjustments to a combined stitch pattern, be sure to edit the selected stitch pattern before selecting the next one. You cannot edit a stitch pattern once the next stitch pattern is selected.

Combining Various Stitch Patterns

Example:



1 Press .



2 Select .

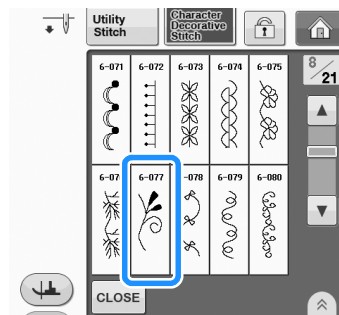

3 Press .

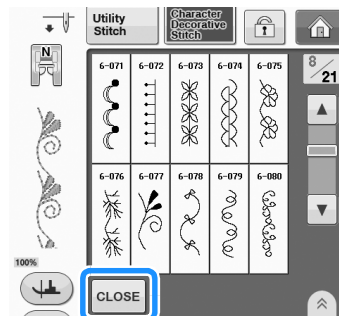



→ The display returns to the stitch selection screen.

4 Press .

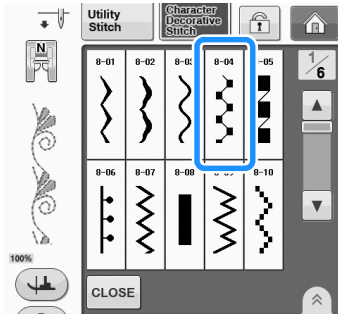

5 Select .



6 Press  to sew the pattern continuously.

7 Press .

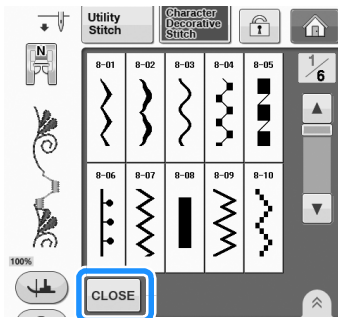

Memo

- Patterns are deleted individually starting with the last pattern entered by pressing





Combining Large and Small Stitch Patterns

Example:

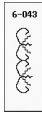

1 Press .

→ The large size stitch will be selected.

2 Press  again, then press  to select the small size.

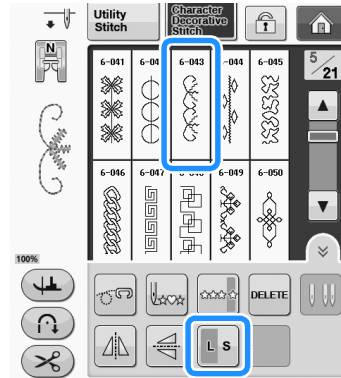

→ The pattern is displayed in a smaller size.

3 Press  to sew continuously.

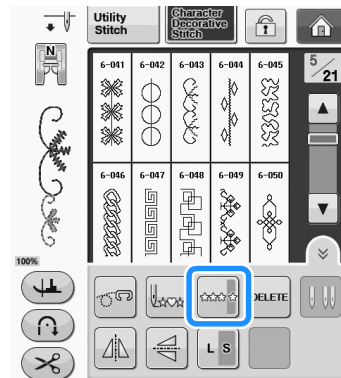



→ The entered pattern is repeated.

Combining Horizontal Mirror Image Stitch Patterns

Example:



1 Press  .

2 Press  again, then press  .

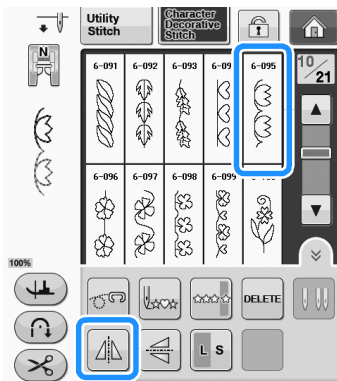

→ The pattern is flipped along a vertical axis.

3 Press  .

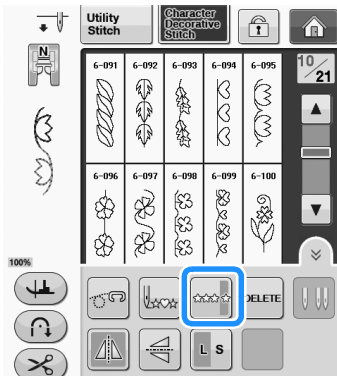



→ The entered pattern is repeated.



Combining Stitch Patterns of Different Length

Example:



1 Press  , then press  once.

→ The length of the image is set to  .

2 Select  again, then press  3 times.

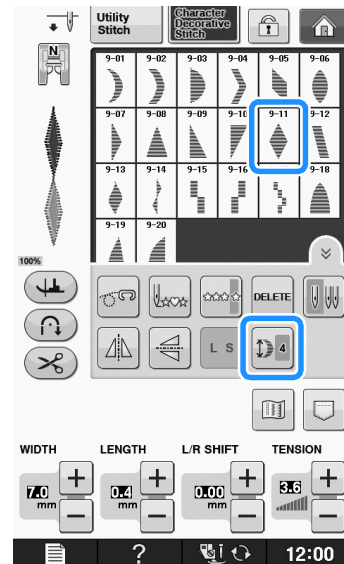

→ The length of the image is set to  .

3 Press .

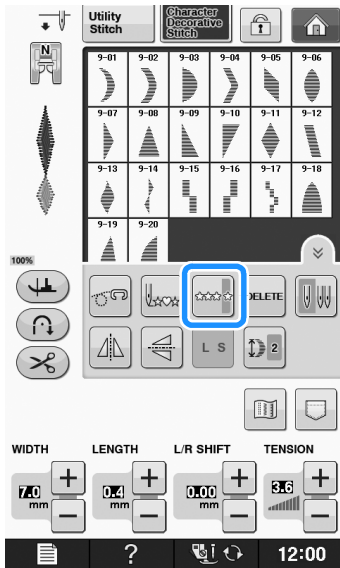



→ The entered pattern is repeated.

Making Step Stitch Patterns (for 7mm Satin Stitch Patterns Only)

You can use the   keys with 7mm satin stitch patterns to create a step effect.

Stitch patterns sewn so that they create a step effect are called step stitch patterns.

- * Press  to move the stitch pattern a distance equal to half of the stitch pattern's size to the left.
- * Press  to move the stitch pattern a distance equal to half of the stitch pattern's size to the right.

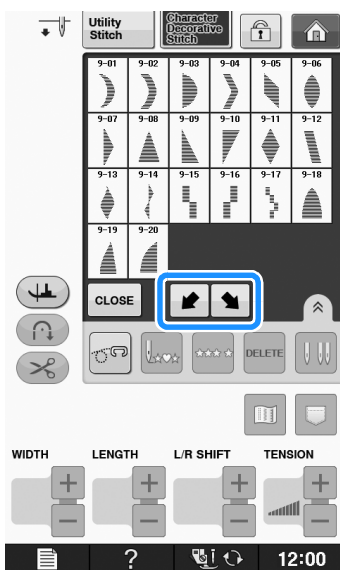

Example:



1 Press .

2 Press .



→ The next stitch pattern will move to the right.

3 Press  again.

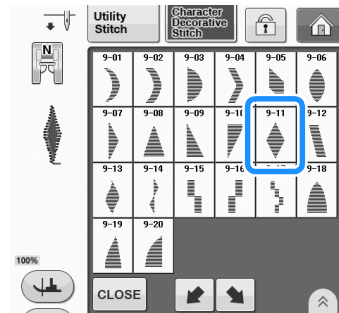

4 Press .



→ The next stitch pattern will move to the left.

5 Press 

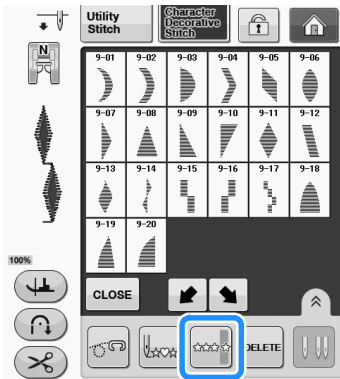

→ The entered pattern is repeated.

More Examples

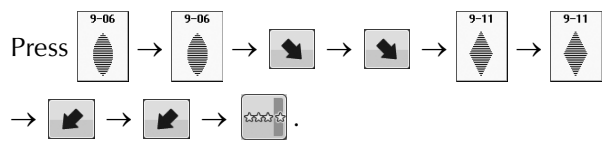
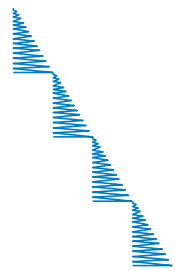
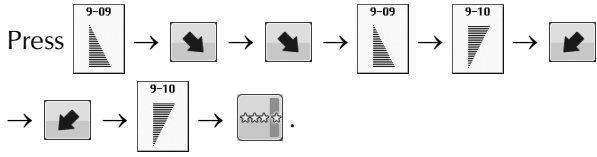
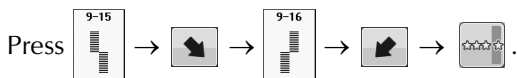

USING THE MEMORY FUNCTION

Stitch Data Precautions

Observe the following precautions when using stitch data other than that created and saved in this machine.

■ Types of Stitch Data that can be Used

- In the Character/Decorative Stitch memory, “.pmv”, “.pmx” and “.pmu” stitch data files can be used with this machine. “.pmu” stitch data files can be retrieved; however, when the machine is used to save the file, it is saved as a “.pmv” stitch data file. Using data other than that created using this machine or the machine which create “.pmu” data file, may cause the machine to malfunction.

■ Types of USB Devices/Media that can be Used

Stitch data can be saved to or recalled from USB external media. Use external media that meets the following specifications.

- USB Flash drive (USB Flash memory)
- USB Floppy disk drive

Stitch data can be recalled only from;

- USB CD-ROM, CD-R, CD-RW drives

You can also use the following types of media with the USB Memory Card Reader/USB card writer module.

- Secure Digital (SD) Card
- CompactFlash
- Memory Stick
- Smart Media
- Multi Media Card (MMC)
- xD-Picture Card



Note

- Some USB media may not be usable with this machine. Please visit our website for more details.
- The access lamp will begin blinking after inserting USB Devices/Media, and it will take about 5 to 6 seconds to recognize the Devices/Media. (Time will differ depending on the USB Device/Media).

- To create file folders, use a computer.

■ Computers and Operating Systems with the Following Specifications can be Used

- Compatible models:
IBM PC with a USB port as standard equipment
IBM PC-compatible computer equipped with a USB port as standard equipment
- Compatible operating systems:
Microsoft Windows XP, Windows Vista, Windows 7, Windows 8

■ Precautions on Using the Computer to Create and Save Data

- If the name of the stitch data file/folder cannot be identified, for example, because the name contains special characters, the file/folder is not displayed. If this occurs, change the name of the file/folder. We recommend using the 26 letters of the alphabet (uppercase and lowercase), the numbers 0 through 9, “-”, and “_”.
- Stitch data in a folder created in USB media can be retrieved.
- Do not create folders in “Removable Disk” on a computer. If stitch data is stored in a folder in “Removable Disk”, that stitch data cannot be retrieved by the machine.

Saving Stitch Patterns in the Machine's Memory

You can save often used stitch patterns in the machine's memory. A total of about 511 KB of stitch patterns can be saved in the machine's memory.



Note

- Do not turn the main power to OFF while the "Saving" screen is displayed. You will lose the stitch pattern you are saving.



Memo

- It takes a few seconds to save a stitch pattern.
- See page S-98 for information on retrieving a saved stitch pattern.

1 Press .

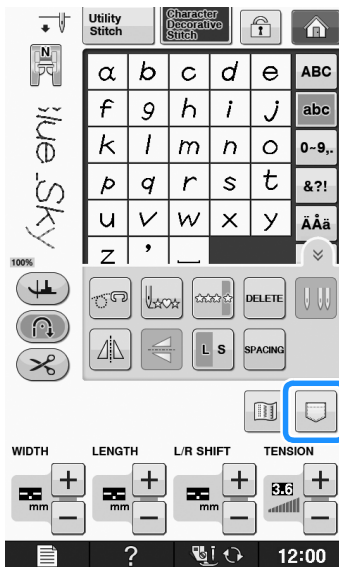

2 Press .

- Press to return to the original screen without saving.



→ The "Saving" screen is displayed. When the pattern is saved, the display returns to the original screen automatically.

If the Memory is Full

If the following screen appears while you are trying to save a pattern on the machine's memory, the memory is too full to hold the currently selected stitch pattern. To save the stitch pattern in the machine's memory, you have to delete a previously saved stitch pattern.

1 Press .

- Press to return to the original screen without saving.

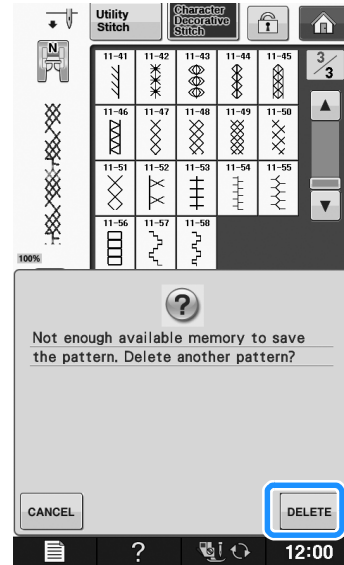

2 Choose a stitch pattern to delete.

- Press if you decide not to delete the stitch pattern.

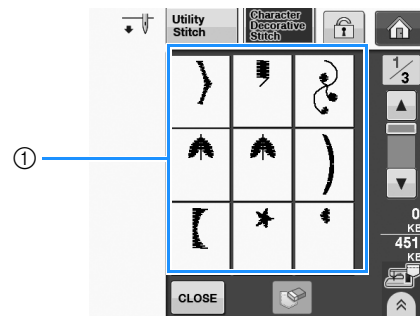

① Pockets holding saved stitch patterns

3 Press .

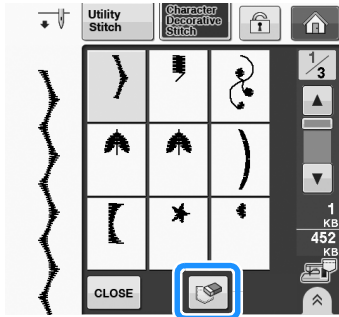

→ A confirmation message appears.

4 Press .

* If you decide not to delete the stitch pattern, press

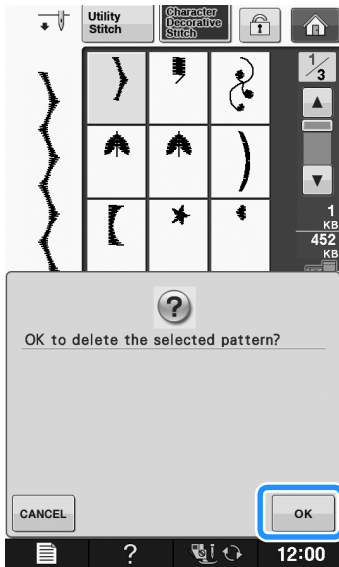

→ The machine deletes the stitch pattern, then automatically saves the new stitch pattern.

Saving Stitch Patterns to USB Media

When sending stitch patterns from the machine to USB media, plug the USB media into the machine's top USB port.

Memo

- USB media is commercially available, but some USB media may not be usable with this machine. Please visit our website for more details.
- Depending on the type of USB media being used, either directly plug the USB device into the machine's USB port or plug the USB media Reader/Writer into the machine's USB port.
- The USB media can be inserted or removed at any time except when saving or deleting.

1 Press .



- 2** Insert the USB media into the USB port on the machine.

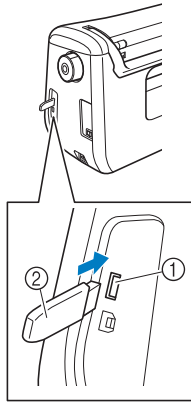

- ① USB port for mouse/media (USB 2.0)
- ② USB media



Note

- The processing speed may vary by quantity of data.

- 3** Press  .

- * Press  to return to the original screen without saving.



→ The "Saving" screen is displayed. When the pattern is saved, the display returns to the original screen automatically.



Note

- Do not insert or remove USB media while "Saving" screen is displayed. You will lose some or all of the pattern you are saving.

Saving Stitch Patterns in the Computer

Using the included USB cable, the machine can be connected to your computer, and the stitch patterns can be temporarily retrieved from and saved in the "Removable Disk" folder in your computer. A total of about 772 KB of stitch patterns can be saved in the "Removable Disk", but the saved stitch patterns are deleted when the machine is turned OFF.



Note

- Do not turn the main power to OFF while the "Saving" screen is displayed. You will lose the stitch pattern you are saving.

- 1** Plug the USB cable connector into the corresponding USB ports for the computer and for the machine.

- 2** Turn on your computer and select "Computer (My computer)".

- * The USB cable can be plugged into the USB ports on the computer and machine whether or not they are turned on.

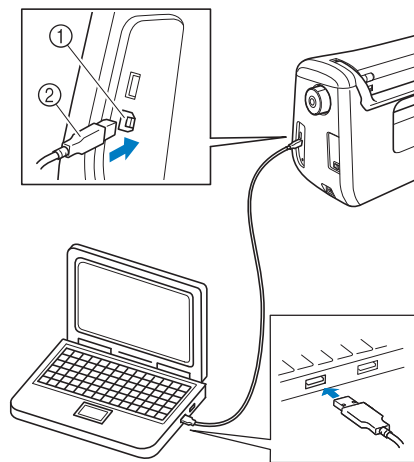

- ① USB port for computer
- ② USB cable connector
- The "Removable Disk" icon will appear in "Computer (My computer)" on the computer.



Note

- The connectors on the USB cable can only be inserted into a port in one direction. If it is difficult to insert the connector, do not insert it with force and check the orientation of the connector.
- For details on the position of the USB port on the computer (or USB hub), refer to the instruction manual for the corresponding equipment.

3 Press .

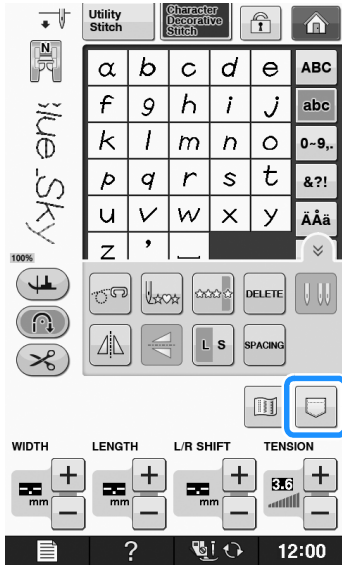

4 Press .

* Press  to return to the original screen without saving.

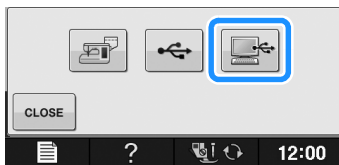

→ The stitch pattern will be temporarily saved to "Removable Disk" under "Computer (My computer)".

5 Select the stitch pattern's .pmv file and copy the file to the computer.

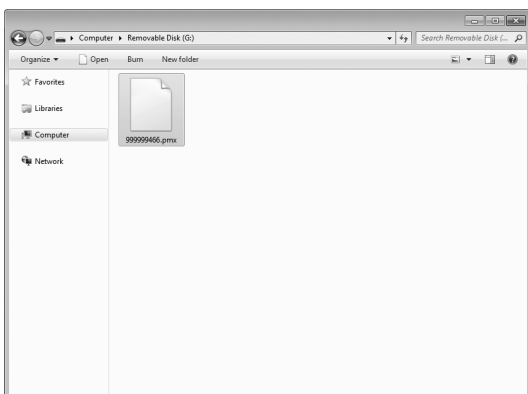

Note

- Do not turn off the machine while the "Saving" screen is showing. You may lose the data.

Retrieving Stitch Patterns from the Machine's Memory

1 Press .



→ The pocket selection screen appears.

2 Choose a stitch pattern to retrieve.

- * If the entire saved stitch pattern is not displayed, press the thumbnail.
- * Press  to return to the original screen without saving.

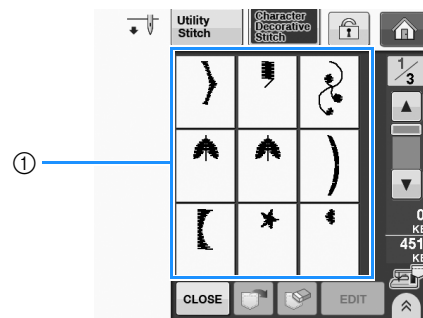

① Saved stitch patterns

3 Press .

* Press  to delete the stitch pattern.

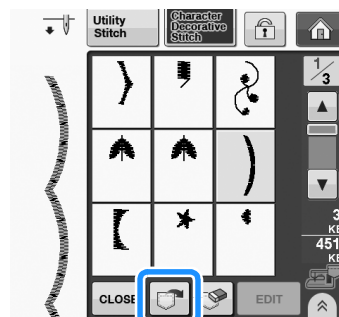

→ The selected stitch pattern is retrieved and the sewing screen will be displayed.

Recalling from USB Media

You can recall a specific stitch pattern from either direct USB media or a folder in the USB media. If the stitch pattern is in a folder, check each folder to find the stitch pattern.

- 1 Insert the USB Media into the USB port on the machine (see page S-96).

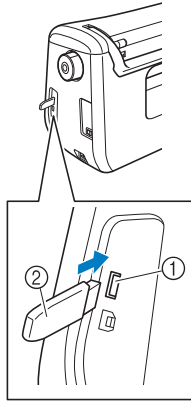

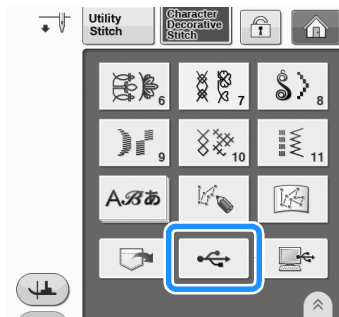

- 1 USB port for mouse/media (USB 2.0)
- 2 USB media

- 2 Press .



→ Stitch patterns and a folder in a top folder are displayed.

- 3 Press  when there is a subfolder to sort two or more stitch patterns to USB media, the stitch pattern in the subfolder is displayed.

* Press  to return to the original screen without recalling.

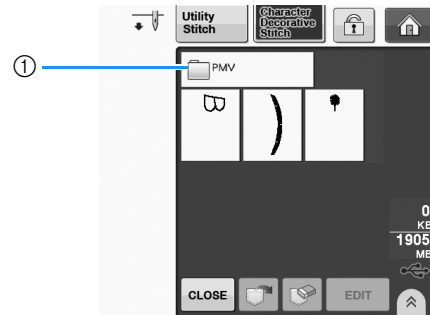

→ Stitch patterns and a subfolder within a folder are displayed. Select the folder to display the patterns in it.

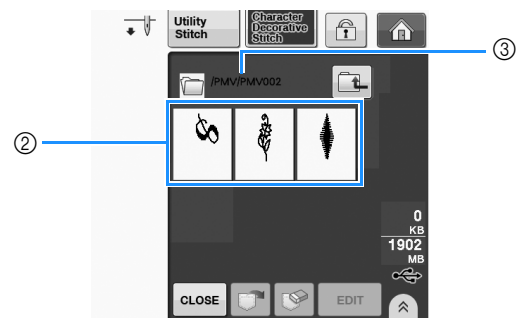

- 1 Folder name
- 2 Stitch patterns in a folder show only the first pattern of any combined patterns.
- 3 Path

* Press  to return to the previous folder.

* Use the computer to create folders. Folders cannot be created with the machine.

- 4 Press the key of the stitch pattern you want to recall.

5 Press .

* Press  to delete the stitch pattern. The pattern will be deleted from the USB media.

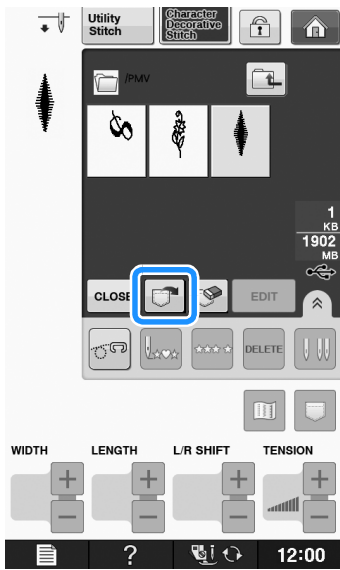

→ The selected stitch pattern is recalled and the sewing screen will be displayed.

Recalling from the Computer

- 1** Plug the USB cable connector into the corresponding USB ports for the computer and for the machine (see page S-97).
- 2** On the computer, open “Computer (My computer)” then go to “Removable Disk”.

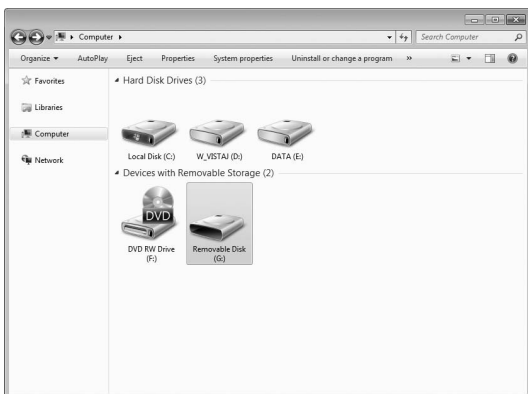

3 Move/copy the pattern data to “Removable Disk”.

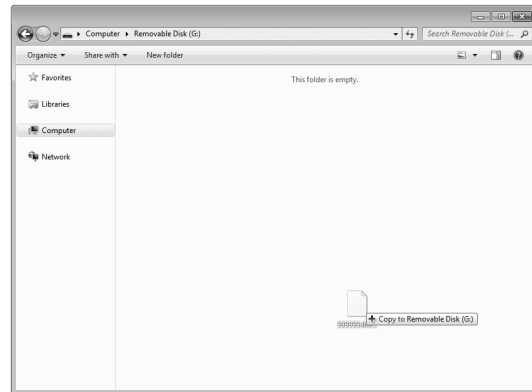

→ Stitch pattern data in “Removable Disk” is written to the machine.



Note

- While data is being written, do not disconnect the USB cable.
- Do not create folders within “Removable Disk”. Since folders are not displayed, stitch pattern data within folders cannot be recalled.

4 Press .

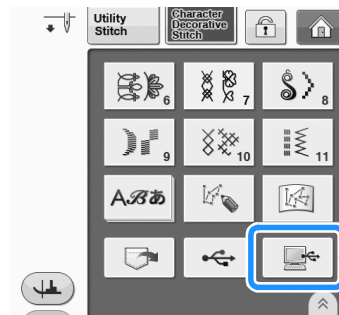

→ The stitch patterns in the computer are displayed on the selection screen.

5 Press the key of the stitch pattern you want to recall.

* Press **CLOSE** to return to the original screen without recalling.

6 Press .

- * Press  to delete the stitch pattern.
The pattern will be deleted from the “Removable Disk” folder in your computer.

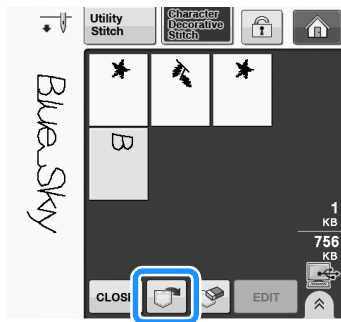

- The selected stitch pattern is recalled and the sewing screen will be displayed.



Note

- The pattern recalled from the computer is only temporarily written to the machine. It is erased from the machine when the machine is turned off. If you wish to keep the stitch pattern, store it in the machine (“Saving Stitch Patterns in the Machine’s Memory” on page S-95).

Chapter 4

MY CUSTOM STITCH

DESIGNING A STITCH.....	103
ENTERING STITCH DATA	105
■ Key Functions.....	105
■ Moving a Point	107
■ Moving Part or All of the Design	108
■ Inserting New Points	109
USING STORED CUSTOM STITCHES.....	110
Storing Custom Stitches in Your List	110
■ If the Memory is Full	110
Retrieving Stored Stitches	111

DESIGNING A STITCH

By using the “MY CUSTOM STITCH” function, you can register stitches you have created yourself. You can also sew designs combining “MY CUSTOM STITCH” creations with built-in characters (see page S-89).

Memo

- Stitches that you create with “MY CUSTOM STITCH” can be a maximum of 7 mm (approx. 9/32 inch) wide and 37 mm (approx. 1-1/3 inches) long.
- Stitches can be designed more easily with “MY CUSTOM STITCH” if you first draw the stitch on the included grid sheet.

1 Draw the stitch design on the grid sheet (part code SA507, GS3:X81277-151).

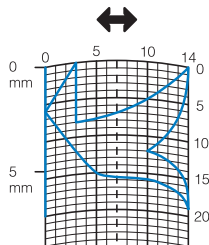

Memo

- Simplify the design so that it can be sewn as a continuous line. For a more attractive stitch, close the design by intersecting lines.

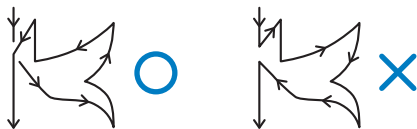

If the design is to be repeated and linked, the start point and end point of the design should be at the same height.



2 Decide the spacing of the stitch.

- * By adjusting the spacing of a stitch, you can create various patterns with one stitch.

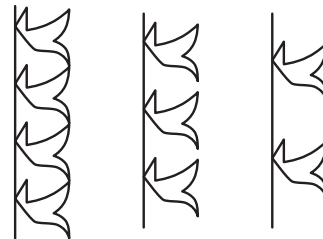
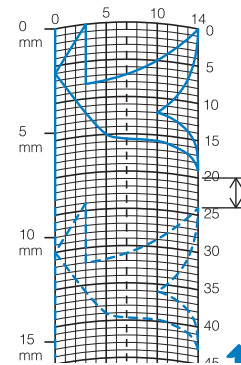

3 Place points where the pattern intersects with the grid, and connect all the points with a line.

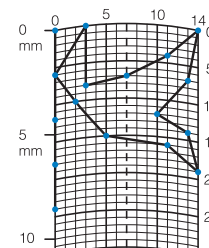

4 Determine the x and y coordinates of each of the marked points.

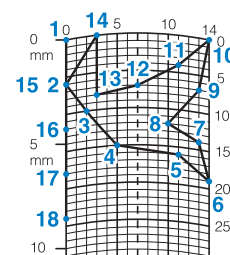

Memo

- This will determine the stitch design that will be sewn.

Examples of Custom Stitches

	Stitch	1	2	3	4	5	6	7	8	9	10	11	12	13	14	15
	↕	0	12	18	22	23	21	17	14	12	9	6	3	1	3	6
	↔	0	0	3	6	10	13	14	13	11	13	14	13	10	6	3
	Stitch	16	17	18	19	20	21	22	23	24	25	26	27	28	29	30
	↕	12	41	43	40	41	38	35	32	30	32	35	41	45	47	44
	↔	0	0	4	7	11	13	14	13	10	6	3	0	0	4	7
	Stitch	31	32	33	34	35	36	37	38	39	40	41	42	43	44	45
	↕	45	47	50	54	56	55	51	45	70						
↔	11	13	14	13	10	6	3	0	0							

	Stitch	1	2	3	4	5	6	7	8	9	10	11	12	13	14	15
	↕	0	30	32	32	32	33	35	35	37	35	32	30	30	29	26
	↔	0	0	1	7	10	12	11	8	12	14	14	11	5	3	8
	Stitch	16	17	18	19	20	21	22	23	24	25	26	27	28	29	30
	↕	24	18	13	12	13	10	12	8	12	7	12	6	10	5	10
	↔	10	13	14	14	12	11	10	9	8	6	6	3	2	0	2
	Stitch	31	32	33	34	35	36	37	38	39	40	41	42	43	44	45
	↕	16	19	23	22	17	22	23	19	42						
↔	1	0	0	6	10	6	0	0	0							



	Stitch	1	2	3	4	5	6	7	8	9	10	11	12	13	14	15
	↕	0	3	5	8	12	17	20	24	27	29	31	32	30	27	24
	↔	0	5	8	11	13	14	14	13	12	11	9	6	3	1	0
	Stitch	16	17	18	19	20	21	22	23	24	25	26	27	28	29	30
	↕	21	18	16	15	15	16	18	21	25	28	33	37	41	43	44
	↔	0	1	3	5	8	10	12	13	14	14	13	11	8	5	0
	Stitch	31	32	33	34	35	36	37	38	39	40	41	42	43	44	45
	↕															
↔																





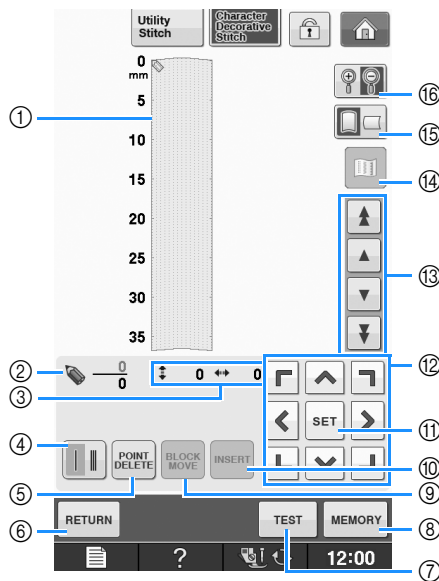









	Stitch	1	2	3	4	5	6	7	8	9	10	11	12	13	14	15
	↕	0	5	4	5	8	7	8	11	11	11	16	11	7	4	0
	↔	7	7	3	7	7	0	7	7	3	7	7	3	0	3	7
	Stitch	16	17	18	19	20	21	22	23	24	25	26	27	28	29	30
	↕	4	7	11	16	21	20	21	24	23	24	27	27	27	32	27
	↔	11	14	11	7	7	11	7	7	14	7	7	11	7	7	11
	Stitch	31	32	33	34	35	36	37	38	39	40	41	42	43	44	45
	↕	23	20	16	20	23	27	32								
↔	14	11	7	3	0	3	7									

ENTERING STITCH DATA

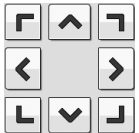
Key Functions





- ① This area displays the stitch being created.
- ② Displays the number of the present set point over the total number of points in the stitch.
- ③ Displays the y-coordinate of  over the x-coordinate of .

No.	Display	Key Name	Explanation	Page
④		Single/triple stitching key	Press this key to select whether one or three stitches will be sewn between two points.	S-106
⑤		Point delete key	Press this key to delete a selected point.	S-107
⑥		Return key	Press this key to exit the entering stitch data screen.	—
⑦		Test key	Press this key to sew a test of the stitch.	S-107, S-110
⑧		“MY CUSTOM STITCH” memory key	Press this key to store the stitch being created.	S-110
⑨		Block move key	Press this key to group points together and move them together.	S-108
⑩		Insert key	Press this key to insert new points on the stitch design.	S-109
⑪		Set key	Press this key to set a point on the stitch design.	S-106 to S-108
⑫		Arrow keys	Use these keys to move  over the display area.	S-106 to S-109
⑬		Point-to-point key	Use these keys to move  from point to point on the stitch, or to the first or last point entered on the stitch.	S-107 to S-109
⑭		Image key	Press this key to view an image of the stitch.	S-107
⑮		Grid direction key	Press this key to change the direction of the grid sheet.	S-106
⑯		Enlarger key	Press this key to see an enlarged version of the stitch being created.	S-106

1 Press  .

2 Press  .



3 Use  to move  to the coordinates of the first point on the grid sheet.

* Press  to change the direction of the grid sheet.

* Press  to enlarge the image of the stitch being created.

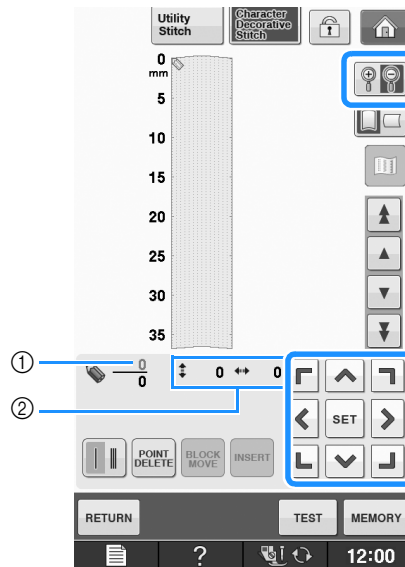

① Currently selected point/Total number of points
 ② Coordinates of 

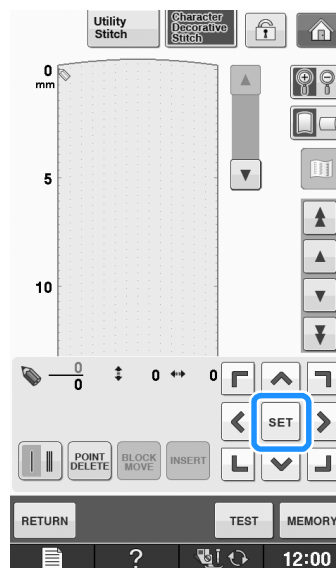

4 Press  to add the point indicated by  .

* To insert coordinates with the touch pen, move the tip of the pen to a desired point. Once you release the pen from the screen a point will be entered into the graph at those coordinates. The number of the currently selected points along with the total number of points will be displayed.





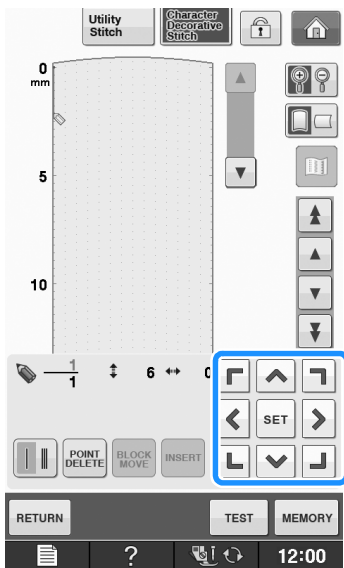

5 Select whether one stitch or three stitches will be sewn between the first two points.

* To sew three stitches, press the key so that it appears as  .

6 Use  to move  to the second point and press  .



7 Repeat the steps above for each point that you have drawn on the grid sheet until the stitch design is drawn on the screen as a continuous line.

- * Press  to delete a selected point entered.
- * Press  to sew a test-run of the stitch.
- * Press  to return to the original screen.
- * Press  to view an image of the stitch.

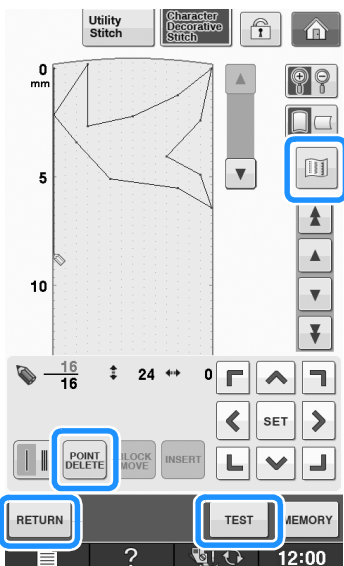

 **Memo**



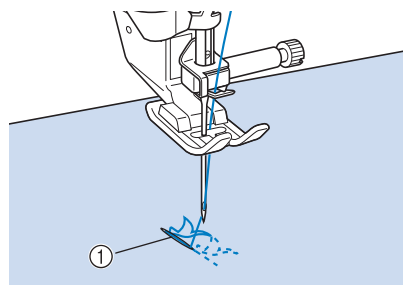

- If you have entered points that are too close together, the fabric may not feed properly. Edit the stitch data to leave a larger space between points.
- If the stitch design is to be repeated and linked, make sure that linking stitches are added so that the stitch designs will not overlap.



- ① Linking stitches
 - You can touch on the grid sheet to set the point, or you can also use a USB mouse.

■ Moving a Point

1 Press  or  to move  to the point that you want to move.

- * To move  to the first point, press  .
- * To move  to the last point, press  .

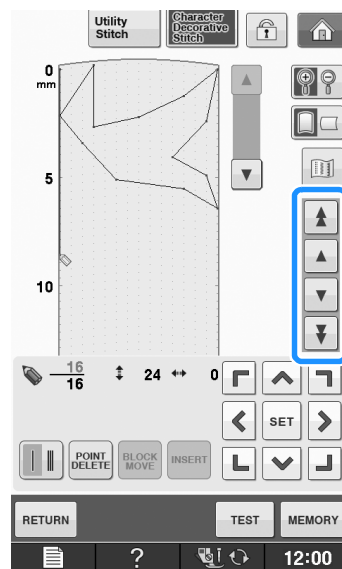



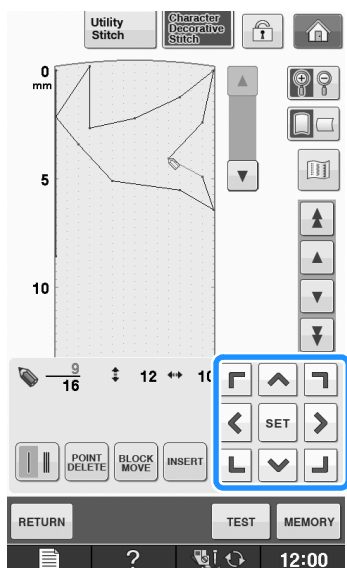

2 Use  to move the point.





* You can also move  by using the touch pen.

■ Moving Part or All of the Design

1 Press  or  to move  to the first point of the section that you want to move.

* To move  to the first point, press .

* To move  to the last point, press .

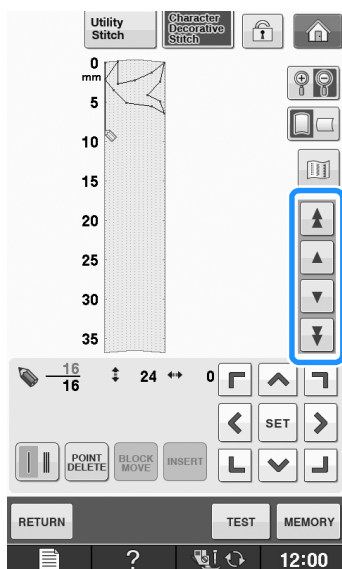

2 Press .

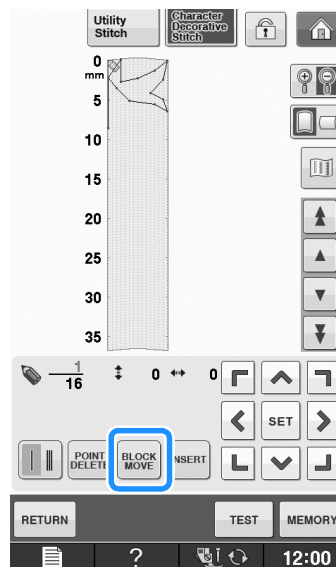

→ The selected point and all points that were entered after it are selected.

3 Press  or  to move the section.

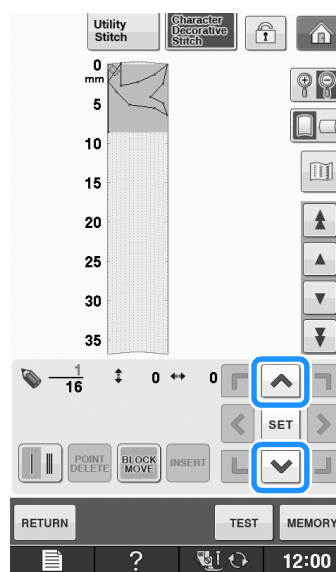

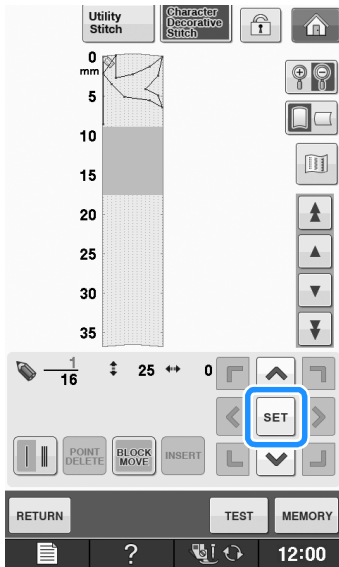

4 Press **SET**.



→ The section will be moved.

■ Inserting New Points

1 Press **▲** or **▼** to move  to a place on the design where you want to add a new point.

- * To move  to the first point, press **▲**.
- * To move  to the last point, press **▼**.

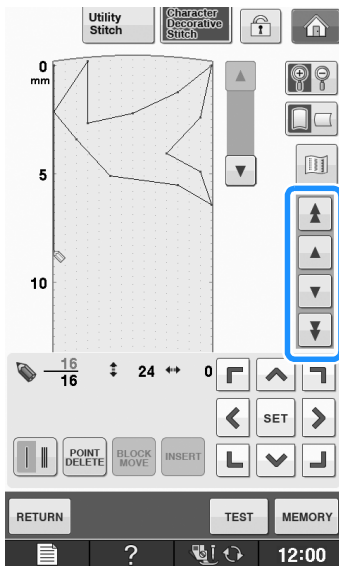

2 Press **INSERT**.

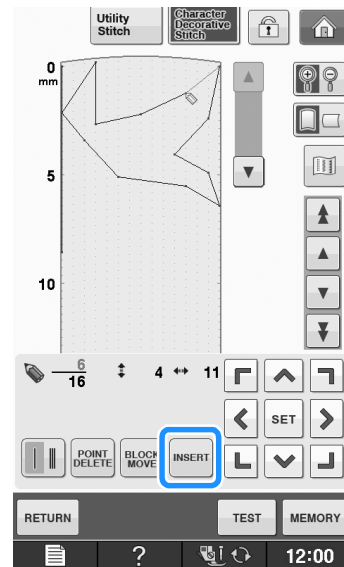

→ A new point is entered and  moves to it.

3 Use  to move the point.

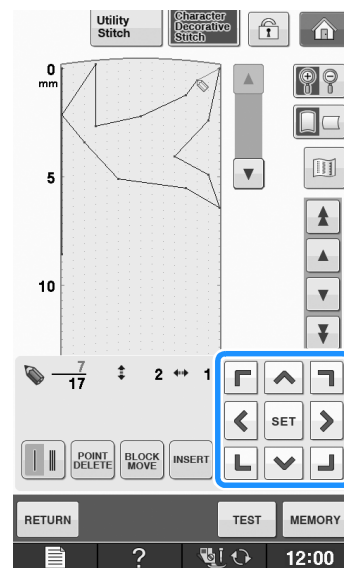

* You can also move  by using the touch pen.

USING STORED CUSTOM STITCHES

Storing Custom Stitches in Your List

Stitch patterns created using the “MY CUSTOM STITCH” function can be stored for later use. Once you finish entering the stitch data, press **MEMORY**. The “Saving” message appears and the stitch will be stored.

Before storing a stitch, press **TEST** to sew a test-run of the stitch.

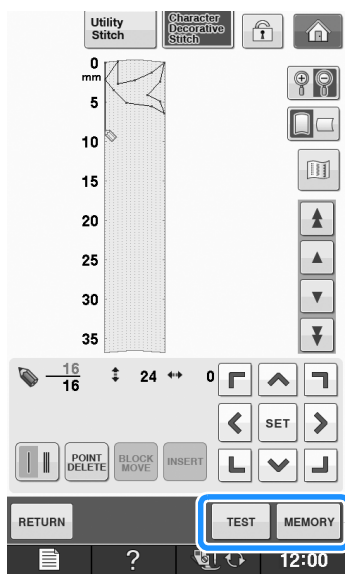

Memo

- Storing a stitch pattern takes a few seconds.
- For details on retrieving a stored stitch pattern, see page S-111.

Note

- Do not turn off the machine while the “Saving” message is displayed, otherwise the stitch pattern data being saved may be lost.

■ If the Memory is Full

If the following message appears after **MEMORY** is pressed, the stitch pattern cannot be stored because either the machine’s memory is full or the stitch pattern being stored is larger than the amount of space available in the memory. To be able to store the stitch pattern in the machine’s memory, a previously stored stitch pattern must be deleted.

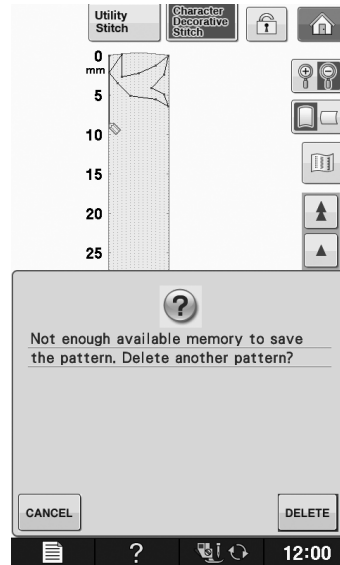

Note

- To save custom stitches to USB media or in the computer, follow the previously described procedure to store the custom stitch, and then press **MEMORY** to select the stitch (see the following “Retrieving Stored Stitches” section). Press **MEMORY** to save the stitch to USB media or in the computer. (For details, “Saving Stitch Patterns to USB Media” on page S-96 or “Saving Stitch Patterns in the Computer” on page S-97.)

Retrieving Stored Stitches

1 Press .



→ A list of stored stitch patterns is displayed.

2 Select the stitch pattern.

* Press **CLOSE** to return to the previous screen without retrieving.

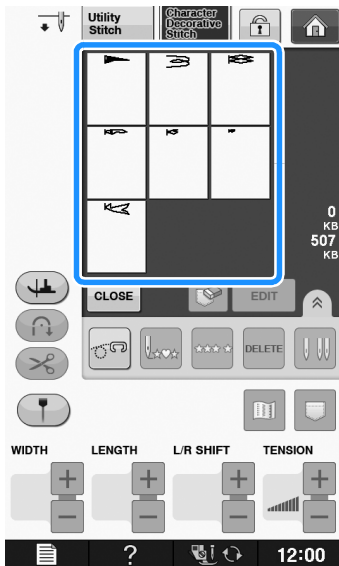

3 Press **CLOSE**.

- * To delete the stored stitch pattern, press .
- * To edit the stored stitch pattern, press **EDIT**.

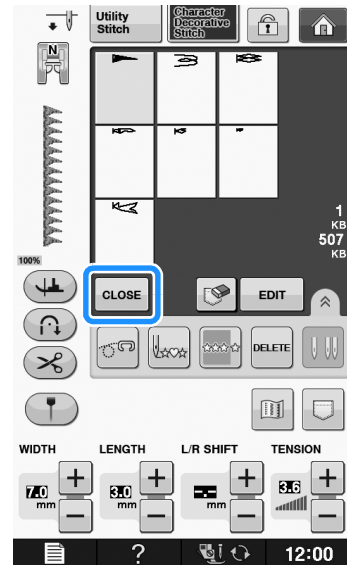



Embroidering

This section provides instruction to embroider designs with this machine.
Page number starts with “E” in this section.

The screen display and machine illustration may vary slightly, depending on the countries or regions.

Chapter1 Embroidery	E-2
Chapter2 Embroidery Edit	E-56

E Embroidering

Chapter 1 Embroidery

SELECTING PATTERNS	3
■ Copyright Information	3
Selecting Embroidery Patterns/Brother "Exclusives"/Floral Alphabet/Bobbin Work Patterns	4
Selecting Character Patterns	5
Selecting Frame Patterns	7
Selecting Patterns from Embroidery Cards	7
■ About Embroidery Card Reader (Sold Separately) and USB Card Writer Module*	7
■ About Embroidery Cards (Sold Separately)	7
Selecting Patterns from USB Media/Computer	8
VIEWING THE EMBROIDERING SCREEN	9
■ Key Functions	10
PREPARING THE FABRIC	11
Attaching Iron-on Stabilizers (Backing) to the Fabric	11
Hooping the Fabric in the Embroidery Frame	13
■ Types of Embroidery Frames	13
■ Inserting the Fabric	14
■ Using the Embroidery Sheet	15
Embroidering Small Fabrics or Fabric Edges	16
■ Embroidering Small Fabrics	16
■ Embroidering Edges or Corners	16
■ Embroidering Ribbons or Tape	16
ATTACHING THE EMBROIDERY FRAME	17
■ Removing the Embroidery Frame	17
CONFIRMING THE PATTERN POSITION	19
Checking the Pattern Position	19
Previewing the Completed Pattern	20
■ Frame sizes displayed on screen	20
SEWING AN EMBROIDERY PATTERN	21
Embroidery Attractive Finishes	21
■ Embroidery Needle Plate Cover	22
Sewing Embroidery Patterns	22
Sewing Embroidery Patterns Which Use Appliqué	23
ADJUSTMENTS DURING THE EMBROIDERY PROCESS	26
If the Bobbin Runs Out of Thread	26
If the Thread Breaks During Sewing	27
Restarting from the Beginning	28
Resuming Embroidery After Turning Off the Power	28
MAKING EMBROIDERY ADJUSTMENTS	30
Adjusting Thread Tension	30
■ Correct Thread Tension	30
■ Upper Thread is Too Tight	30
■ Upper Thread is Too Loose	30
Adjusting the Bobbin Case (with No Color on the Screw)	31
■ Correct Tension	31
■ Bobbin Thread is Too Loose	31
■ Bobbin Thread is Too Tight	32
Using the Automatic Thread Cutting Function (END COLOR TRIM)	32
Using the Thread Trimming Function (JUMP STITCH TRIM)	32
■ Selecting the Length of Jump Stitch Not to Trim	33
Adjusting the Embroidery Speed	33
Changing the Thread Color Display	34
Changing the "Embroidery Frame Display"	35
REVISING THE PATTERN	36
Moving the Pattern	36
Aligning the Pattern and the Needle	36
Changing the Size of the Pattern	37
Rotating the Pattern	38
Creating a Horizontal Mirror Image	39
Enlarging the Editing Screen	39
Changing the Density (Alphabet Character and Frame Patterns Only)	40
Changing the Colors of Alphabet Character Patterns	40
Embroidering Linked Characters	41
Uninterrupted Embroidering (Monochrome - Using a Single Color)	43
USING THE MEMORY FUNCTION	44
Embroidery Data Precautions	44
■ Types of Embroidery Data that can be Used	44
■ Types of USB Devices/Media that can be Used	44
■ Computers and Operating Systems with the Following Specifications can be Used	44
■ Precautions on Using the Computer to Create and Save Data	44
■ Tajima (.dst) Embroidery Data	45
Saving Embroidery Patterns in the Machine's Memory	45
■ If the Memory is Full	45
Saving Embroidery Patterns to USB Media	46
Saving Embroidery Patterns in the Computer	47
Retrieving Patterns from the Machine's Memory	48
Recalling from USB Media	49
Recalling from the Computer	50
EMBROIDERY APPLICATIONS	51
Using a Frame Pattern to Make an Appliqué (1)	51
Using a Frame Pattern to Make an Appliqué (2)	52
Sewing Split Embroidery Patterns	53

SELECTING PATTERNS

■ Copyright Information

The patterns stored in the machine and embroidery cards are intended for private use only. Any public or commercial use of copyrighted patterns is an infringement of copyright law and is strictly prohibited.

There are many character and decorative embroidery patterns stored in the machine's memory (see the "Quick Reference Guide" for a full summary of patterns in the machine's memory). You can also use patterns from the embroidery cards (sold separately).

Once the machine has finished the initialization and the carriage has moved to the start position, the pattern type selection screen will display.

If another screen is displayed, press , then  to display the screen below.

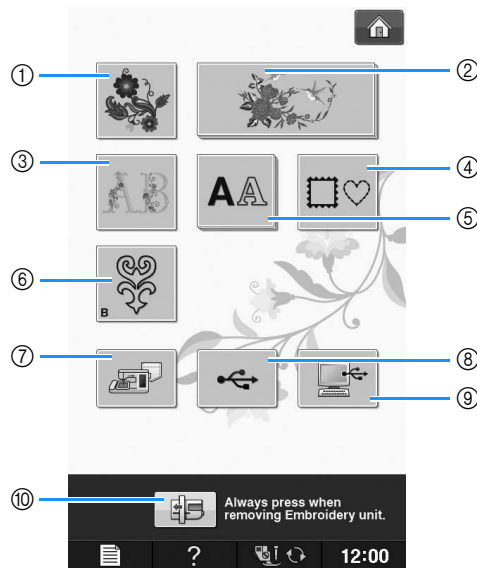

There are 6 categories of patterns in this machine.



- ① Embroidery patterns
- ② Brother "Exclusives"
- ③ Floral alphabet patterns
- ④ Frame patterns
- ⑤ Character patterns
- ⑥ Bobbin work patterns (see "Appendix")
- ⑦ Patterns saved in the machine's memory (see page E-48)
- ⑧ Patterns saved in USB media (see page E-49)
- ⑨ Patterns saved on the computer (see page E-50)
- ⑩ Press this key to position the embroidery unit for storage

Memo

- A key that appears stacked, such as

 and , indicates that there are sub-categories, which must be selected before a pattern selection screen appears.

Selecting Embroidery Patterns/Brother "Exclusives"/Floral Alphabet/Bobbin Work Patterns

1 Touch the key of the category of the pattern you want to embroider.

* Refer to "How to Create Bobbin Work" of "Appendix" about the bobbin work patterns.



2 Press the key of the pattern you want to embroider.

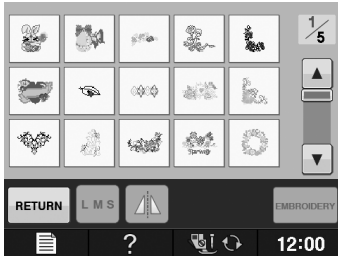

* Press to view the next page.
 * Press to view the previous page.
 → The selected pattern is displayed.

3 Press to create a mirror image of the pattern as needed.

* If a mistake has been made when selecting the pattern, press the key of the pattern you want to embroider and the new selection appears.

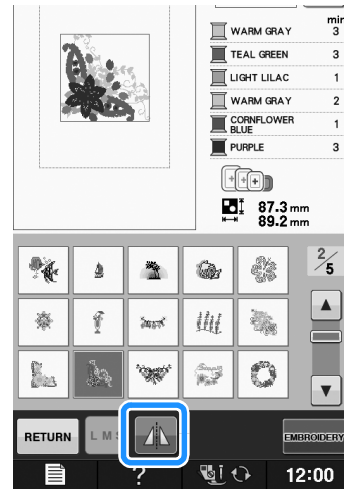

4 Press .

→ The embroidery screen is displayed.

5 Proceed to "VIEWING THE EMBROIDERING SCREEN" on page E-9 to embroider the pattern.

* To return to the previous screen to select another pattern, press .

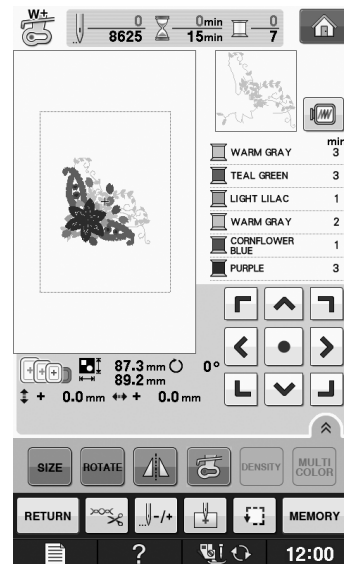

Selecting Character Patterns

Example: Entering "We Fly".

1 Press **AA**.

2 Press the key of the font you want to embroider.

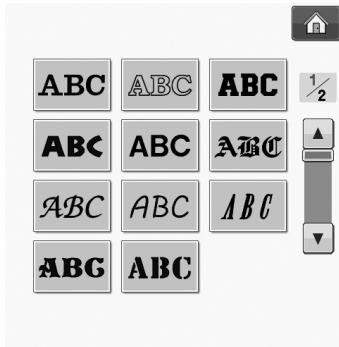

3 Press to change the selection screens.



4 Press **ABC** and then enter "W".



- * If you want to change the size of a character, select the character and then press **LMS** to change the size. The size changes each time you press the key, from large to medium to small.
- * If you make a mistake, press **DELETE** to erase the mistake.
- * If the pattern is too small to see clearly, you can use the **CHECK** key to check it.

Memo

- If you continue adding characters after changing the size, the new characters will be entered in the new size.
- You cannot change the size of the entered characters after combining character stitch patterns.

5 Press **abc** and enter "e".

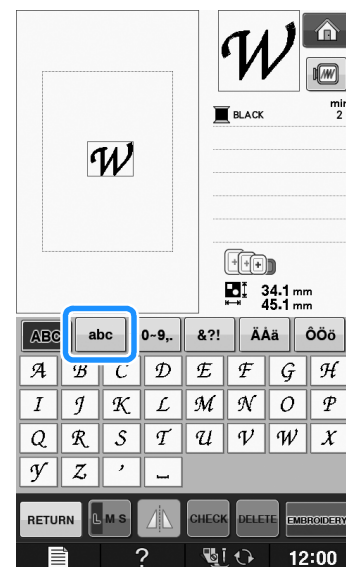

6 Press **_** to enter a space.



7 Press **ABC** again and enter "F".



8 Press **abc** and then enter "ly".



9 Press **EMBROIDERY**.



→ The embroidery screen is displayed.

10 Proceed to "VIEWING THE EMBROIDERING SCREEN" on page E-9 to embroider the pattern.

* To return to the previous screen to select another pattern, press **RETURN**.

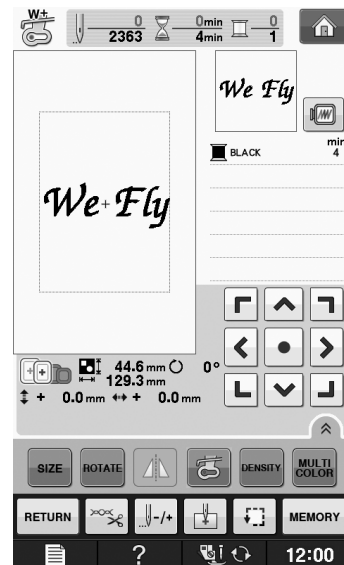

Selecting Frame Patterns

1 Press .

2 Press the key of the frame shape you want to embroider in the top part of the screen.

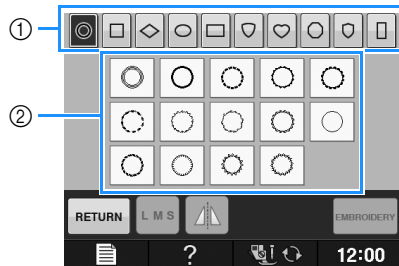

① Frame shapes

② Frame patterns

→ Various frame patterns are displayed at the bottom part of the screen.

3 Press the key of the frame pattern you want to embroider.

* If you make a mistake selecting the pattern, press the key of the pattern you want to embroider.

→ The selected pattern is displayed on the screen.

4 Press .

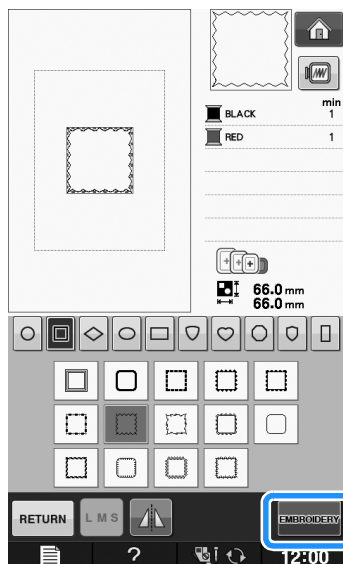

→ The embroidery screen is displayed.

5 Proceed to “VIEWING THE EMBROIDERING SCREEN” on page E-9 to embroider the pattern.

* To return to the previous screen to select another pattern, press .

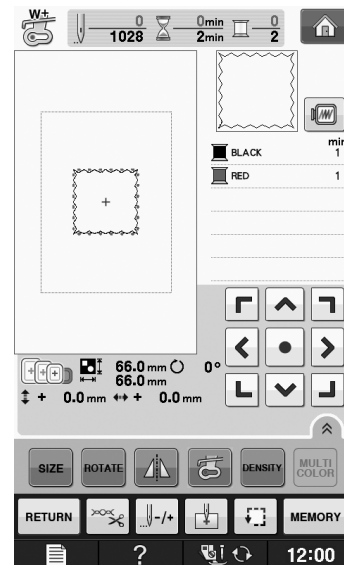

Selecting Patterns from Embroidery Cards

■ About Embroidery Card Reader (Sold Separately) and USB Card Writer Module*

- Use only an embroidery card Reader designed for this machine. Using an unauthorized embroidery card Reader may cause your machine to operate incorrectly.
- * If you have purchased the PE-DESIGN Ver5 or later, PE-DESIGN NEXT, PE-DESIGN Lite, PED-BASIC or PE-DESIGN PLUS, you can plug the included USB card writer module into the machine as an embroidery card reader, and recall patterns.



Note

- Embroidery patterns cannot be saved from the machine to an embroidery card inserted into a connected USB card writer module*.

■ About Embroidery Cards (Sold Separately)

- Use only embroidery cards manufactured for this machine. Using unauthorized cards may cause your machine to operate incorrectly.
- Embroidery cards sold in foreign countries cannot be used with this machine.
- Store embroidery cards in the hard case.

- 1 Plug the optional embroidery card Reader/USB card writer module into the USB port on the machine.

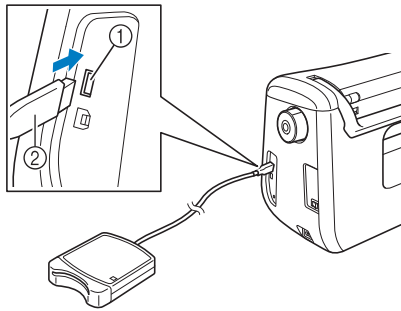

- ① USB port for mouse/media (USB 2.0)
- ② Embroidery card Reader/USB card writer module

- 2 Insert the card completely into the card Reader/USB card writer module.

* Insert the embroidery card so that the end with a printed arrow is facing up.

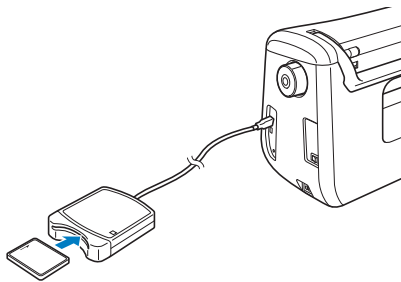

Note

- Two embroidery USB card Readers/USB card writer module cannot be used with this machine at the same time. If two embroidery USB card Readers/USB card writer module are inserted, only the embroidery USB card Reader/USB card writer module inserted first is detected.

- 3 Press the key of the USB port.

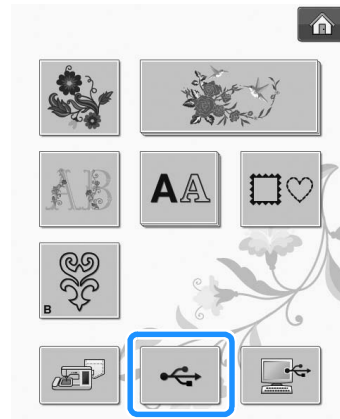

→ The patterns on the embroidery card are displayed on the selection screen.

- 4 Follow the steps on page E-4 to select a pattern.

Selecting Patterns from USB Media/Computer

To recall patterns from the computer or USB media, see pages E-49 to E-50.

VIEWING THE EMBROIDERING SCREEN

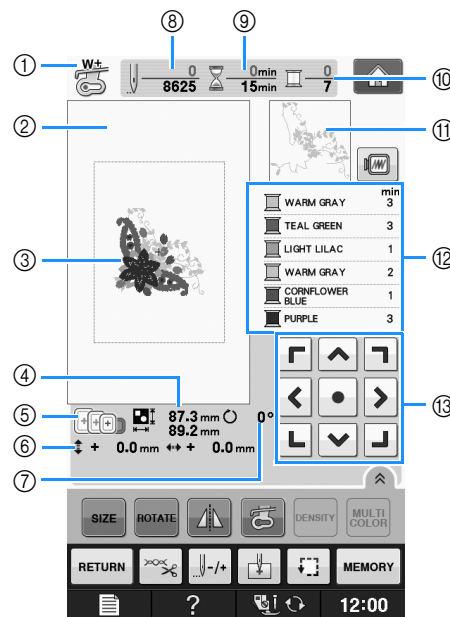

- ① Shows the presser foot code.
Attach embroidery foot “W+” or “W” for all embroidery projects. When the foot presser symbol is displayed on the screen, you are able to sew.
 - ② Shows the boundary for embroidering with the extra large frame (30 cm × 18 cm (approx. 12 inches × 7 inches)).
 - ③ Shows a preview of the selected pattern.
 - ④ Shows the size of the selected pattern.
 - ⑤ Shows the embroidery frames that can be used for the selected pattern. Be sure to use the proper frame (see page E-13).
 - ⑥ Shows how far the sewing position is from the center (when you move the sewing position).
 - ⑦ Shows the degree of rotation of the pattern.
 - ⑧ Shows how many stitches are in the selected pattern and how many stitches have been sewn so far.
 - ⑨ Shows the time necessary to sew the pattern, and the time already spent sewing the pattern (not including time for changing and automatically trimming the thread).
 - ⑩ Shows the number of colors in the selected pattern, and the number of the color currently being sewn.
 - ⑪ Shows the part of the embroidery that will be sewn with the first thread color.
 - ⑫ Shows the order for thread color changes and the embroidering time for each thread color.
- * The displayed time is the approximate time that will be required. The actual embroidering time may be longer than the displayed time, depending on the embroidery frame that is used. In addition, the amount of time required to change thread colors is not included.

**Note**

- There is an explanation of additional key functions on the next page.

■ Key Functions

Using these keys, you can change the size of the pattern, rotate the pattern, etc.

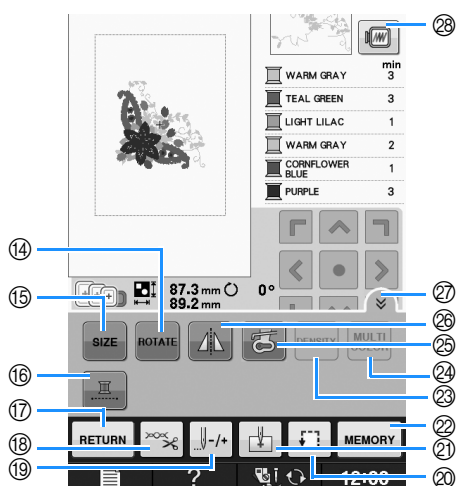

Note

- Some operations or functions are not available for certain patterns. If the key display is light gray, you cannot use that function or operation with the selected pattern.

No.	Display	Key Name	Explanation	Page
13		Arrow keys (● Center key)	Press an arrow key to move the pattern in the direction shown by the arrow. (Press the Center key to return the pattern to the center of the embroidery area.)	E-36
14		Rotate key	Press this key to rotate the pattern. You can rotate a pattern one degree, 10 degrees or 90 degrees at a time.	E-38
15		Size key	Press this key to change the size of the pattern.	E-37
16		Uninterrupted embroidery key	Press this key to embroider the selected pattern with a single color.	E-43
17		Return key	Press this key to return to the pattern type selection screen.	—
18		Cut/Tension key	Press this key to specify automatic thread cutting, thread trimming or the thread tension. For embroidery, these functions are set automatically.	E-32 to E-32
19		Forward/Back key	Press this key to move the needle forward or back in the pattern; useful if the thread breaks while sewing or if you want to start again from the beginning.	E-27 to E-29
20		Trial key	Press this key to check the position of the pattern. The embroidery frame moves to the desired position so you can check that there is enough space to sew the pattern.	E-19
21		Starting point key	Press this key to move the needle start position to align the needle with the pattern position.	E-36
22		Memory key	Press this key to save a pattern in the machine's memory, USB media or a computer.	E-45 to E-47
23		Density key	Press this key to change the density of alphabet character or frame patterns.	E-40
24		Multi color key	Press this key to change the color of each letter when sewing alphabet character patterns.	E-40
25		Embroidery LED foot key	Press this key to turn on the LED pointer.	"Basic operations"
26		Horizontal mirror image key	Press this key to create a horizontal mirror image of the pattern.	E-39
27		Function page key	Press this key to show all the keys in this screen.	E-40
28		Image key	Press this key for a preview of the sewn image.	E-20



PREPARING THE FABRIC

⚠ CAUTION

- Use fabrics with a thickness of less than 3 mm (approx. 1/8 inch). Using fabrics thicker than 3 mm (approx. 1/8 inch) may cause the needle to break.
- When using layers with thicker batting etc., you can sew more attractive embroidery by adjusting the embroidery presser foot height in the embroidery settings screen (see below).
- In the case of thick terry cloth towels we recommend that you place a piece of water soluble stabilizer on the top surface of the towel. This will help to reduce the nap of the toweling and result in more attractive embroidery.



Note

- Press . In the “Embroidery Foot Height” display, use  and  in the settings screen. Adjust the presser foot height for thick or puffy fabrics.

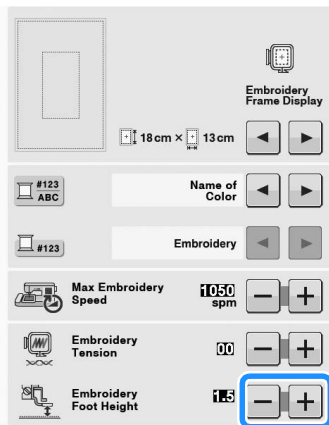

- To increase the space between the presser foot and the needle plate, set the embroidery foot height to a larger number, 1.5 mm setting is used for most embroidery.

Attaching Iron-on Stabilizers (Backing) to the Fabric

For best results in your embroidery projects, always use stabilizer material for embroidery. Follow the package instructions for the stabilizer being used.

When using fabrics that cannot be ironed (such as towel or fabrics that have loops which expand when ironed) or in places where ironing is difficult, position the stabilizer material under the fabric without fusing it, then position the fabric and stabilizer in the embroidery frame, or check with your authorized dealer for the correct stabilizer to use.

⚠ CAUTION

- Always use a stabilizer material for embroidery when sewing stretch fabrics, lightweight fabrics, fabrics with a coarse weave, or fabrics which cause pattern shrinkage. Otherwise, the needle may break and cause injury. Not using a stabilizer material may result in a poor finish to your project.

1

- Use a piece of stabilizer which is larger than the embroidery frame being used.

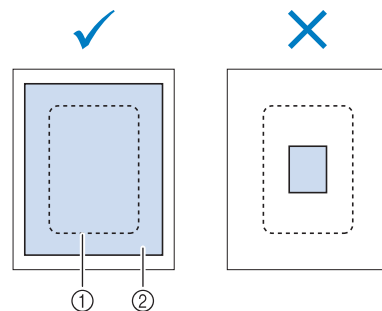

- ① Size of the embroidery frame
- ② Iron-on stabilizer (backing)

2 Iron the iron-on stabilizer material to the wrong side of the fabric.

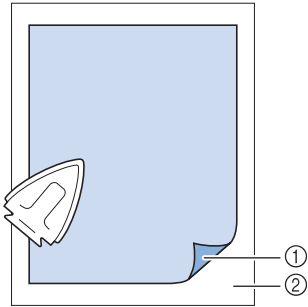

- ① Fusible side of stabilizer
- ② Fabric (wrong side)



 **Memo**

- When embroidering on thin fabrics such as organdy or lawn, or on napped fabrics such as towel or corduroy, use water soluble stabilizer (sold separately) for best results. The water soluble stabilizer material will dissolve completely in water, giving the project a more attractive finish.

Hooping the Fabric in the Embroidery Frame

Types of Embroidery Frames

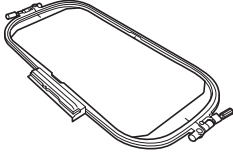
The types and numbers of supplied embroidery frame are differs depending on the countries and regions.

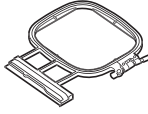
Extra Large	Large	Medium
		
Embroidery field 30 cm × 18 cm (approx. 12 inches × 7 inches)	Embroidery field 18 cm × 13 cm (approx. 7 inches × 5 inches)	Embroidery field 10 cm × 10 cm (approx. 4 inches × 4 inches)
Use when embroidering connected or combined characters or patterns, or when embroidering large patterns.	Use when embroidering patterns between 10 cm × 10 cm (approx. 4 inches × 4 inches) and 18 cm × 13 cm (approx. 7 inches × 5 inches).	Use when embroidering patterns under 10 cm × 10 cm (approx. 4 inches × 4 inches).

Other optional embroidery frames can be used. When choosing frames that do not appear on the screen, be sure to check the design size of the embroidery field of the optional frame. Check with your authorized dealer for frame compatibility.

Select a frame that matches the pattern size. Included frame options are displayed on the LCD.

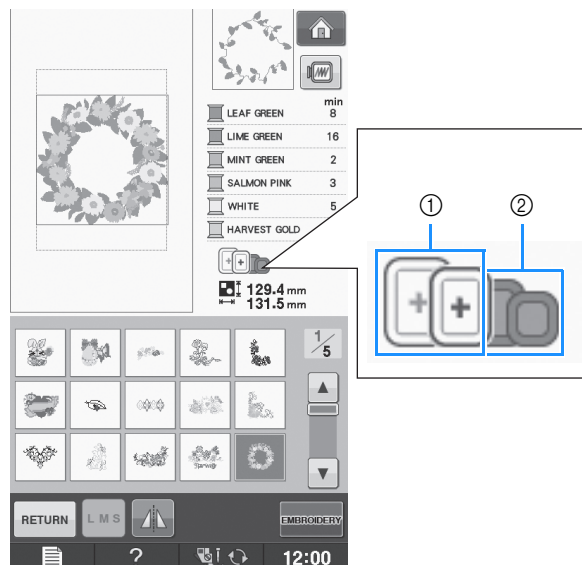

- ① Highlighted: Can be used
- ② Shaded: Cannot be used

CAUTION

- If you use a frame that is too small, the presser foot may strike the frame during sewing and cause injury.

■ Inserting the Fabric



Note

• If the fabric is not securely held in the embroidery frame, the embroidery design will sew out poorly. Insert the fabric on a level surface, and gently stretch the fabric taut in the frame. Follow the steps below to insert the fabric correctly.

- 1 Lift-up and loosen the frame adjustment screw and remove the inner frame.**

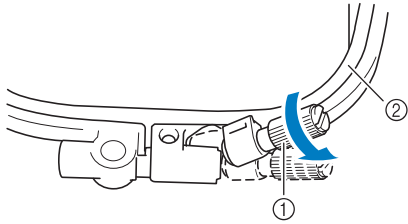

- ① Frame adjustment screw
- ② Inner frame

- 2 Lay the fabric right side up on top of the outer frame.**

Re-insert the inner frame making sure to align the inner frame's \triangle with the outer frame's ∇ .

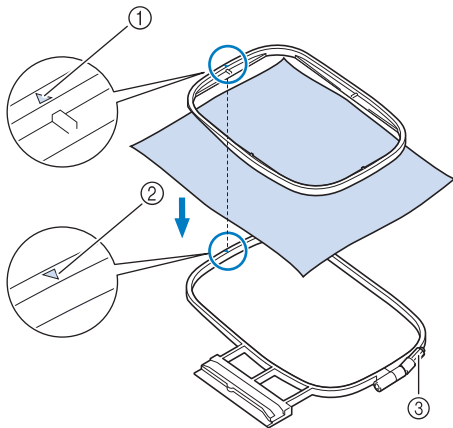

- ① Inner frame's \triangle
- ② Outer frame's ∇
- ③ Frame adjustment screw

- 3 Slightly tighten the frame adjustment screw, and then remove the slack in the fabric by pulling on the edges and corners. Do not loosen the screw.**

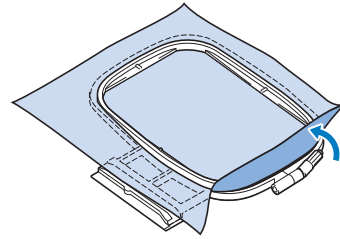

- 4 Gently stretch the fabric taut, and tighten the frame adjustment screw to keep the fabric from loosening after stretching.**

* After stretching the fabric, make sure the fabric is taut.

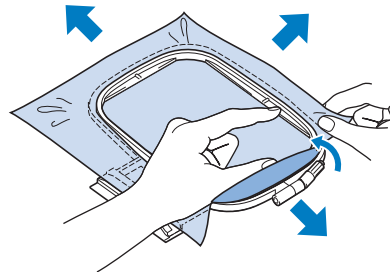

* Make sure the inside and outside frames are even before you start embroidering.

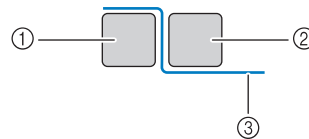

- ① Outer frame
- ② Inner frame
- ③ Fabric



Memo

• Stretch the fabric from all four corners and all four edges. While stretching the fabric, tighten the frame adjustment screw.

- 5** Return the frame adjustment screw to its initial position.

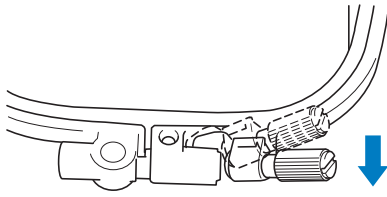

Memo

- You can use the included screwdriver when you loosen or tighten the frame adjustment screw.

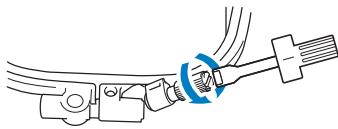

Using the Embroidery Sheet

When you want to embroider the pattern in a particular place, use the embroidery sheet with the frame.

- 1** With a chalk pencil, mark the area of the fabric you want to embroider.

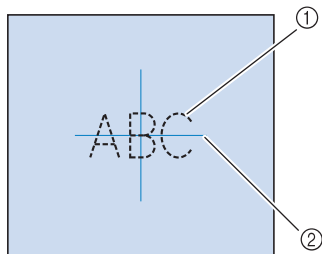

- ① Embroidery pattern
- ② Mark

- 2** Place the embroidery sheet on the inner frame. Align the guide lines on the embroidery sheet with the mark you made on the fabric.

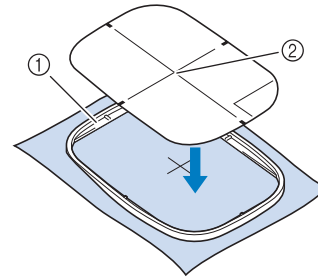

- ① Inner frame
- ② Guide line

- 3** Gently stretch the fabric so there are no folds or wrinkles, and press the inner frame into the outer frame.

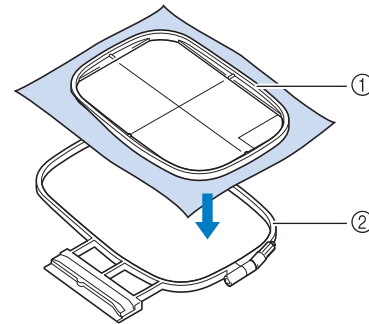

- ① Inner frame
- ② Outer frame

- 4** Remove the embroidery sheet.

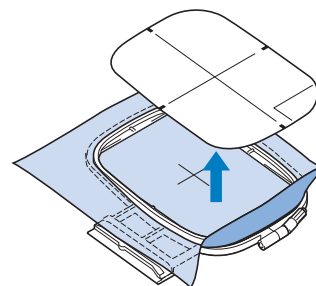

Embroidering Small Fabrics or Fabric Edges

Use an embroidery stabilizer to provide extra support. After embroidering, remove the stabilizer carefully. Attach the stabilizer as shown in the following examples. We recommend using a stabilizer for embroidery.

Embroidering Small Fabrics

Use a temporary spray adhesive to adhere the small piece of fabric to the larger piece in the frame. If you do not wish to use a temporary spray adhesive, attach the stabilizer with a basting stitch.

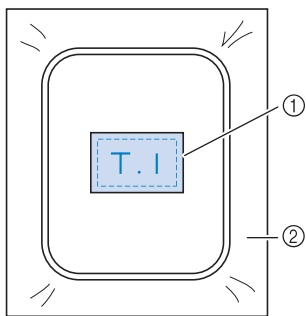

- ① Fabric
- ② Stabilizer

Embroidering Edges or Corners

Use a temporary spray adhesive to adhere the small piece of fabric to the larger piece in the frame. If you do not wish to use a temporary spray adhesive, attach the stabilizer with a basting stitch.

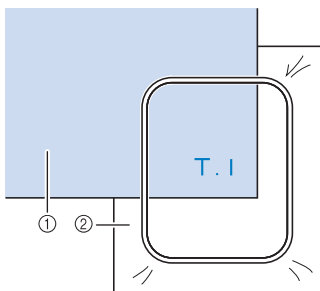

- ① Fabric
- ② Stabilizer

Embroidering Ribbons or Tape

Secure with double-sided tape or a temporary spray adhesive.

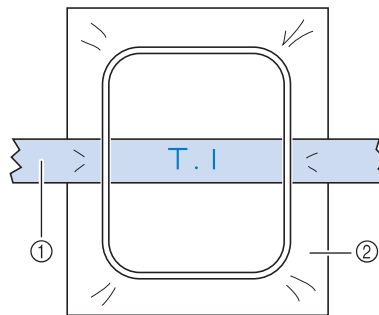

- ① Ribbon or tape
- ② Stabilizer

ATTACHING THE EMBROIDERY FRAME



Note

- Wind and insert the bobbin before attaching the embroidery frame.

- 1 Press the “Presser Foot Lifter” button to raise the presser foot.
- 2 Align the embroidery frame guide with the right edge of the embroidery frame holder.

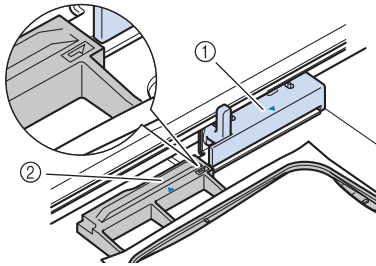

- ① Embroidery frame holder
- ② Embroidery frame guide

- 3 Slide the embroidery frame into the holder, making sure to align the embroidery frame's \triangle with the holder's ∇ .

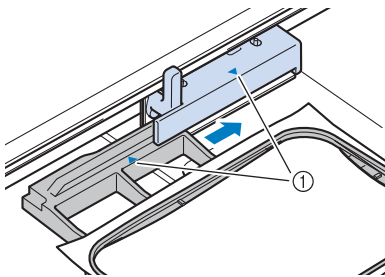

- ① Arrow mark

- 4 Lower the frame-securing lever to be level with the frame to secure the embroidery frame in the embroidery frame holder.

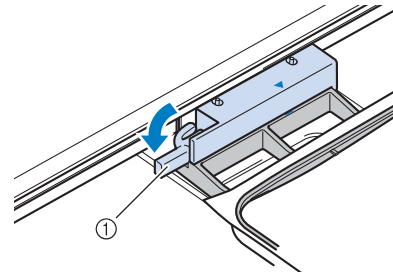

- ① Frame-securing lever

CAUTION

- If the frame-securing lever is not lowered, the following message appears. You cannot start sewing until you lower the frame-securing lever.

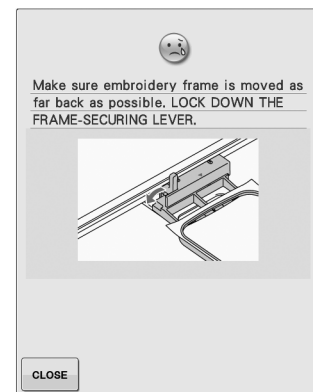

Removing the Embroidery Frame

- 1 Raise the frame-securing lever.

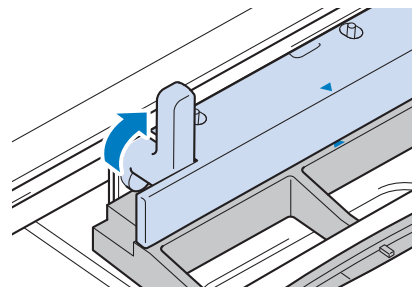

2 Pull the embroidery frame toward you.

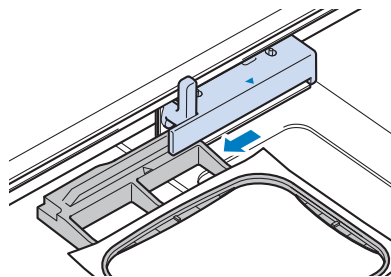

CONFIRMING THE PATTERN POSITION

The pattern is normally positioned in the center of the embroidery frame. If the pattern needs to be repositioned for better placement on the garment, you can check the layout before starting embroidery.

Checking the Pattern Position

The embroidery frame moves and shows the pattern position. Watch the frame closely to make sure the pattern will be sewn in the right place.

1 Press .

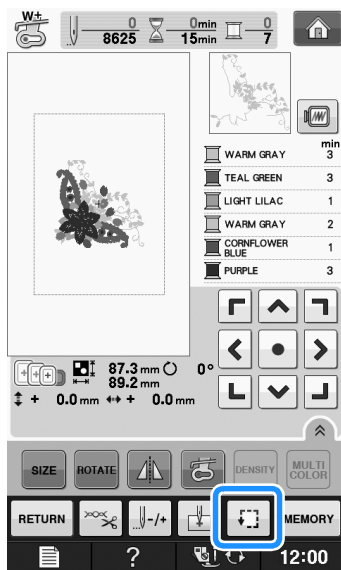

→ The following screen is displayed.

2 From , press the key for the position that you want to check.

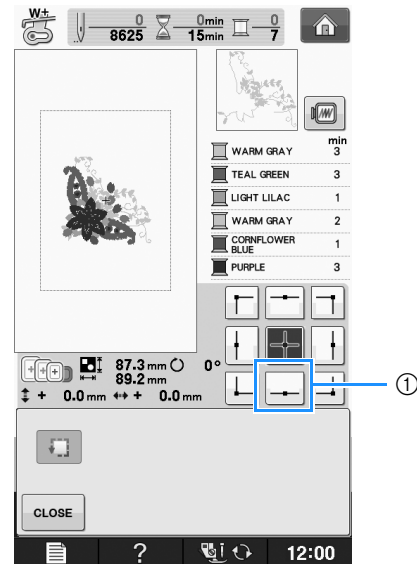

① Selected position

→ The needle will move to the selected position on the pattern.



Memo

- To see the entire embroidering area, press . The embroidery frame moves and shows the embroidering area.

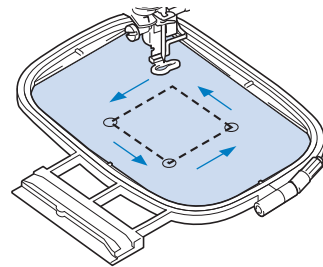

CAUTION

- Make sure the needle is up when the embroidery frame is moving. If the needle is down, it could break and result in injury.

3 Press .

Previewing the Completed Pattern

1 Press .

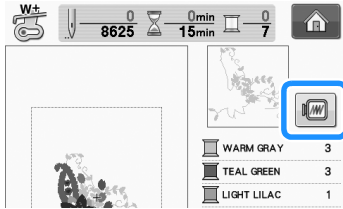





→ An image of the pattern as it will be embroidered appears.

2 Press  to select the frame used in the preview.

- * Frames displayed in light gray cannot be selected.
- * Press  to enlarge the image of the pattern.
- * The pattern can be sewn as it appears in the following display.



Frame sizes displayed on screen

Icon	Name
Embroidering area	
	Extra large embroidery frame
	H 30 cm × W 18 cm (H 11-3/4 inches × W 7-1/8 inches)
	Large embroidery frame (optional with some models)
	H 18 cm × W 13 cm (H 7-1/8 inches × W 5-1/8 inches)
	Medium embroidery frame (optional with some models)
	H 10 cm × W 10 cm (H 4 inches × W 4 inches)
	Small embroidery frame (optional)
	H 2 cm × W 6 cm (H 3/4 inch × W 2-3/8 inches)



Memo

- You can begin sewing from this screen by pressing the “Start/Stop” button.

3 Press  to return to the original screen.

SEWING AN EMBROIDERY PATTERN

Embroidery Attractive Finishes

There are many factors that go into beautiful embroidery. Using the appropriate stabilizer (see page E-11) and hooping the fabric in the frame (see page E-13) are two important factors mentioned earlier. Another important point is the appropriateness of the needle and thread being used. See the explanation of threads below.

Thread	Upper thread	Use embroidery thread intended for use with this machine. Other embroidery threads may not yield optimum results.
	Bobbin thread	Use embroidery bobbin thread intended for use with this machine.



Memo

- If you use threads other than those listed above, the embroidery may not sew out correctly.

You can adjust thread tension with the screw on the bobbin case. Included bobbin case varies depending on the type of machine. See the explanation of bobbin case types below.

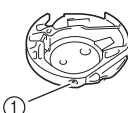
Bobbin case (for the embroidery and sewing machine) 	Standard bobbin case (green marking on the screw) originally installed in the machine has a green marking on the screw. Do not adjust green marked screw.
	Alternate bobbin case (no color on the screw) is set with tighter tension for embroidery with different weights of bobbin threads and a variety of embroidery techniques. This bobbin case is identified with a dark colored mark on the inside of the bobbin cavity. The screw on this case can be adjusted if necessary (see page E-31).

- ① Standard bobbin case (green marking on the screw)
Alternate bobbin case (no color on the screw)

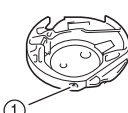
Bobbin case (for the embroidery machine) 	The bobbin case (no color on the screw) is installed in the machine. We recommend using the included embroidery bobbin thread. The screw on this case can be adjusted if necessary (see page E-31).
--	---

- ① Bobbin case (no color on the screw)

See "Cleaning the Race" of "Appendix" for how to remove the bobbin case.

⚠ CAUTION

- When embroidering on large garments (especially jackets or other heavy fabrics), do not let the fabric hang over the table. Otherwise, the embroidery unit cannot move freely and the embroidery frame may strike the needle, causing the needle to bend or break and possibly cause injury. Place the fabric so that it does not hang off the table or hold the fabric to keep it from dragging.



Note

- Before embroidering, check that there is enough thread in the bobbin. If you start to sew your embroidery project without enough thread in the bobbin, you will need to rewind the bobbin in the middle of the embroidery pattern.
- Do not leave objects in the range of motion of the embroidery frame. The frame may strike the object and cause a poor finish to the embroidery pattern.
- When embroidering on large garments (especially jackets or other heavy fabrics), do not let the fabric hang over the table. Otherwise, the embroidery unit cannot move freely, and the pattern may not turn out as planned.

Embroidery Needle Plate Cover

Under some conditions, based on the type of fabric, stabilizer, or thread being used, there may be some looping in the upper thread. In this case, attach the included embroidery needle plate cover to the needle plate. Attach the cover by inserting the two projections on the underside of the cover into the notches on the needle plate as shown below.

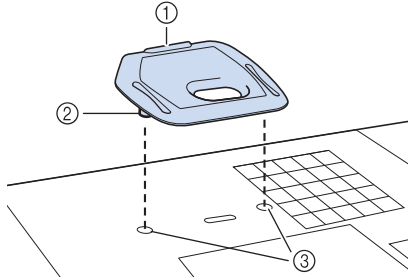

- ① Groove
- ② Projection
- ③ Notch

To remove the embroidery needle plate cover, place your fingernail in the groove and lift the plate out.

CAUTION

- Push the embroidery needle plate cover as far as possible to attach it. If the embroidery needle plate cover is not securely attached, it may cause the needle to break.

Note

- Do not use the embroidery needle plate cover for any applications other than embroidery.

Sewing Embroidery Patterns

Example:

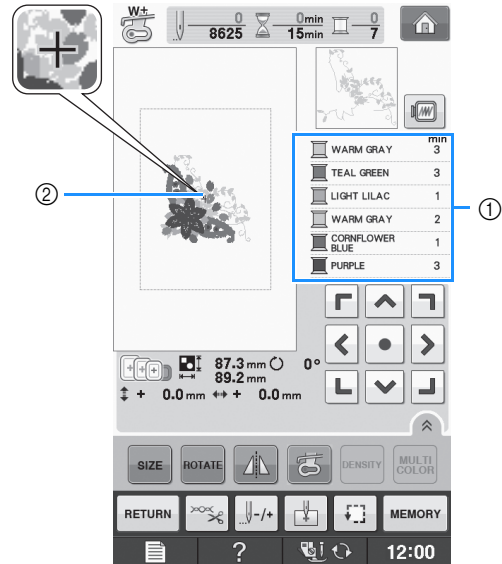

- ① Embroidery color order
- ② Cursor

Memo

- The [+] cursor moves over the pattern, showing which part of the pattern is being sewn.

- 1 Thread the machine with thread for the first color, pass the thread through the hole in embroidery foot, pull out some thread to give it some slack, and then lightly hold the end of the thread in your left hand.

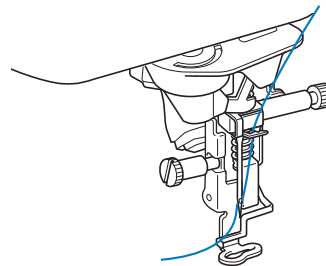

2 Lower the presser foot, then press the “Start/Stop” button to start embroidering. After 5-6 stitches, press the “Start/Stop” button again to stop the machine.

3 Trim the excess thread at the end of the seam. If the end of the seam is under the presser foot, raise the presser foot, then trim the excess thread.

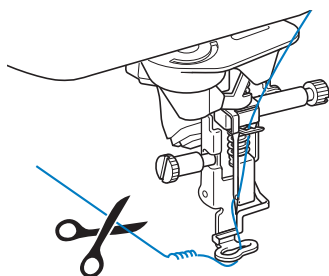

4 Press the “Start/Stop” button to start embroidering.

→ When the first color is completely sewn, the machine will automatically trim the threads and stop. The presser foot will then automatically be raised. On the embroidery color order display, the next color will move to the top.

Memo

- If there is thread left over from the beginning of sewing, it may be sewn over as you continue embroidering the pattern, making it very difficult to deal with the thread after the pattern is finished. Trim the threads at the beginning of each thread change.

5 Remove the thread for the first color from the machine. Thread the machine with the next color.

6 Repeat the same steps for embroidering the remaining colors.

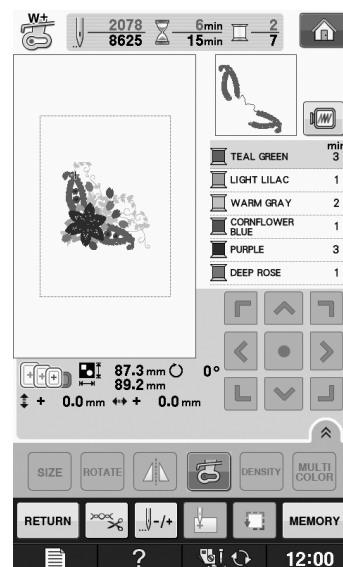

→ When the last color is sewn, “Finished sewing” will appear on the display. Press , and the display will return to the original screen.

Memo



- The Thread Trimming Function is originally set to trim excess thread jumps (threads linking parts of the pattern, etc.). Depending on the type of thread and fabric that are used, an end of upper thread may remain on the surface of the fabric at the beginning of the stitching. After embroidering is finished, cut off this excess thread. If the setting has been turned off, trim the excess thread jumps using scissors after the pattern is finished. See page E-32 for information on the thread trimming function.

Sewing Embroidery Patterns Which Use Appliqué

There are some patterns which call for an appliqué inside the pattern. Prepare the base fabric and the appliqué fabric (appliqué piece).

When sewing an embroidery pattern with an appliqué, the color sewing order display shows “APPLIQUE MATERIAL”, “APPLIQUE POSITION”, “APPLIQUE”, and then the sewing order of the colors around the appliqué.

Memo

- Depending on the thread color display setting, the display may show  >, , or .

1 Attach an iron-on stabilizer to the wrong side of the appliqué material.

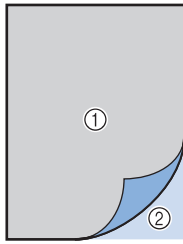

- ① Appliqué material (cotton, felt, etc.)
- ② Iron-on stabilizer

2 Place the appliqué material into the embroidery frame, and then press the “Start/Stop” button to sew the outline of the appliqué.

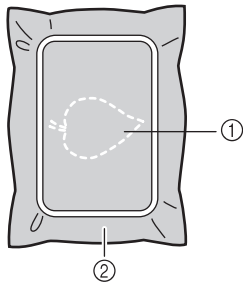

- ① Outline of appliqué
- ② Appliqué material

Memo

- The embroidery procedure is the same as the basic procedure explained on page E-22.

→ The machine will sew around the outline of the appliqué pieces and will then stop.

3 Remove the appliqué material from the embroidery frame, and then cut carefully along the stitching. After cutting, remove all of the stitching thread carefully.

- * Carefully cut out the pattern on the outline you just sewed. Do not cut inside the stitching line, as the appliqué fabric will not be caught by the appliqué stitch.

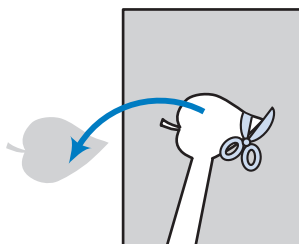

4 Place the base material into the embroidery frame.

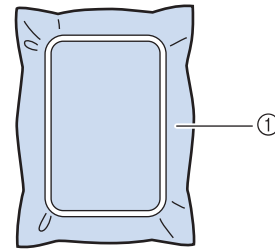

- ① Base material

5 Press the “Start/Stop” button to sew the position of the appliqué.

- * Use the same thread color you plan to use when attaching the appliqué in step 7.

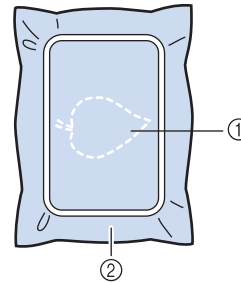

- ① Position of appliqué
- ② Base material

→ The machine will sew around the position of the appliqué and will then stop.

6 Apply a thin layer of adhesive or spray adhesive to the back of the appliqué piece and attach it to the appliqué position so that it follows the seam of the outline.

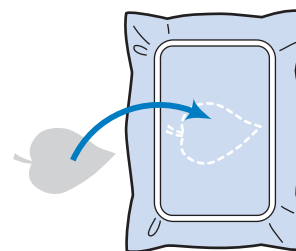

Memo

- If the appliqué material is a lightweight fabric, you may want to use a fusible web on the back to stabilize the fabric and for appliqué placement. Fuse appliqué in place with an iron. Do not remove fabric from the frame to iron the appliqué material.

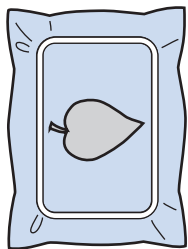
7 Press the “Start/Stop” button.**Memo**

- Some patterns may not show all three appliqué steps. Sometimes the “APPLIQUE” step will be shown as a color.

→ The appliqué will then be completed.

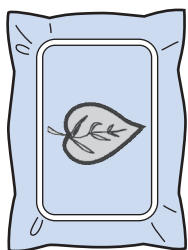
8 Change the upper thread and then carry out the rest of the embroidering.**Memo**

- Some glue may get onto the presser foot, needle, and needle plate at this time. Finish embroidering the appliqué pattern and then clean away the glue.
- For best sewing results clip all threads between color steps.



ADJUSTMENTS DURING THE EMBROIDERY PROCESS



Note

- Be careful not to bump the embroidery unit carriage or the presser foot when removing or attaching the embroidery frame. Otherwise, the pattern will not embroider correctly.

If the Bobbin Runs Out of Thread

When the bobbin begins to run out of thread during embroidering, the machine will stop and the message below will appear. Press  and follow the directions below to rethread the lower threading. If very little sewing remains, you can embroider 10 final stitches without rethreading the machine by pressing . The machine will stop after sewing the 10 stitches.

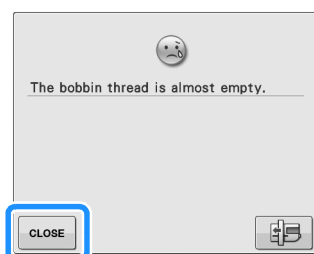

Note

- If “Upper and Bobbin Thread Sensor” in the settings screen of the machine setting mode is set to “OFF”, the message shown above does not appear.

1 Press .

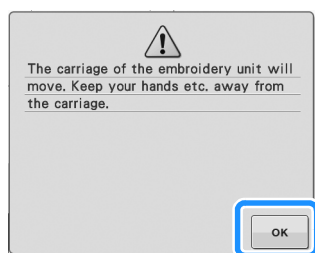

→ After the thread is automatically cut, the carriage will move.

2 Unlock the frame-securing lever and remove the embroidery frame.

- * Be careful not to apply strong force to the fabric at this time. Otherwise, the fabric may loosen in the frame.

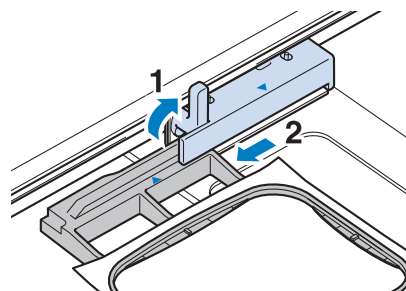

3 Insert a wound bobbin into the machine. (see “Setting the Bobbin” of “Basic operations”.)

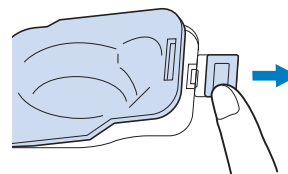

4 Press .

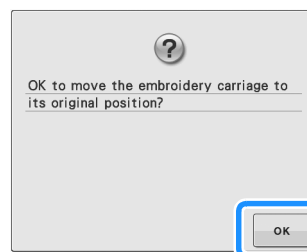



→ The carriage will return to its original position.





5 Attach the embroidery frame.



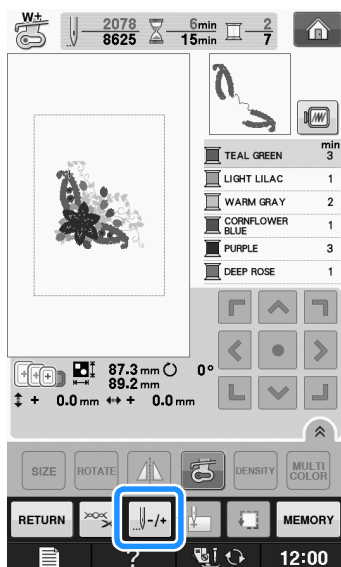

6 To return to the spot in the pattern where you stopped sewing, follow steps **3** through **6** in the next section.

If the Thread Breaks During Sewing

- 1 Press the “Start/Stop” button to stop the machine.
- 2 If the upper thread is broken, redo the upper threading. If the bobbin thread is broken, press  and follow the directions in steps 1 through 5 from the previous section to reset the bobbin.
- 3 Press .



- 4 Press , , , or  to move the needle back the correct number of stitches before the spot where the thread broke.

- * If you cannot move back to the spot where the thread broke, press  to select the color and move to the beginning position of that color, then use , , , or  to move ahead to slightly before where the thread broke.

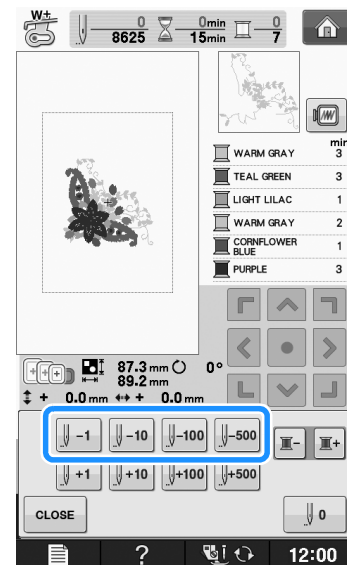

- 5 Press  to return to the original screen.
- 6 Press the “Presser Foot Lifter” button to lower the presser foot, and press the “Start/Stop” button to continue sewing.

Restarting from the Beginning

- 1 Press .

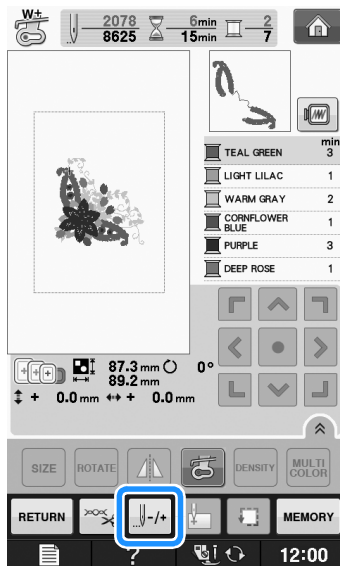

- 2 Press .

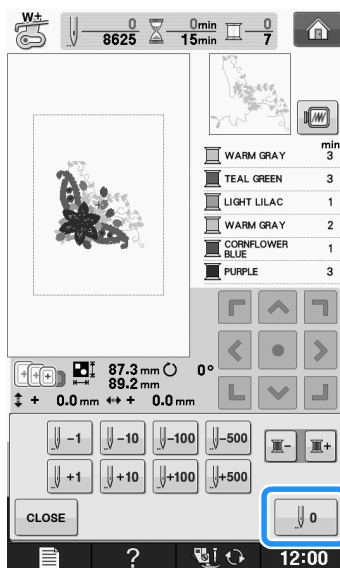

→ The embroidery frame moves, returning the needle to the pattern's beginning position.

- 3 Press the "Presser Foot Lifter" button to lower the presser foot and start sewing.

Resuming Embroidery After Turning Off the Power

The current color and stitch number are saved when embroidery is stopped. The next time the machine is turned on, you have the option to continue or delete the pattern.

Memo

- Even if the power goes out in the middle of embroidery, the machine returns to the point where embroidery was stopped when the machine is turned on again.

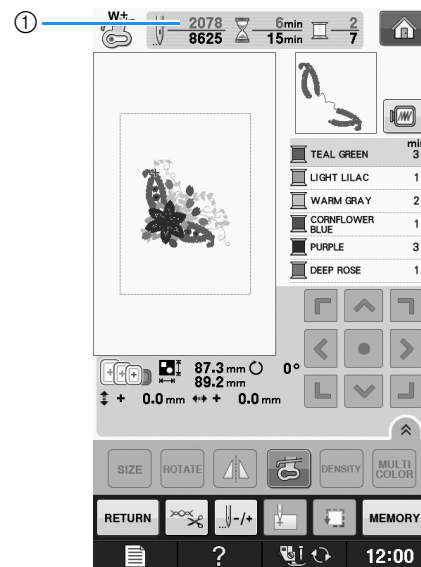

- ① Current stitch number when embroidery was stopped

Note

- Do not remove the embroidery unit or the memory will no longer remember your design.

- 1 Turn the main power to ON.
- 2 Follow the instructions shown on the screen and remove the embroidery frame.

→ The following message will appear.

3 Attach the embroidery frame and press

OK

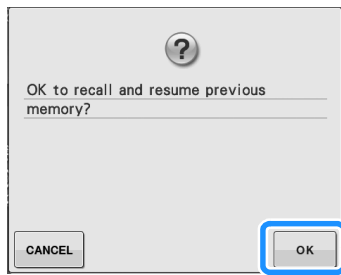

→ The previous embroidery screen displayed before the machine was turned off appears.

Memo

- If you want to start a new embroidery pattern, press **CANCEL** so the pattern selection screen appears.

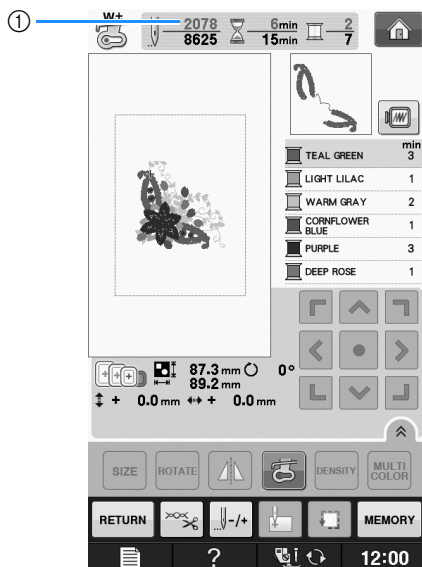
4 Continue embroidering.

① Stitch number when embroidery is resumed

MAKING EMBROIDERY ADJUSTMENTS

Adjusting Thread Tension

When embroidering, the thread tension should be set so that the upper thread can slightly be seen on the wrong side of the fabric.

Correct Thread Tension

The pattern can be seen from the wrong side of the fabric. If the thread tension is not set correctly, the pattern will not finish well. The fabric may pucker or the thread may break.



- ① Right side
- ② Wrong side

Follow the operations described below to adjust thread tension according to the situation.



Note

- If the thread tension setting is made extremely weak, the machine may stop during sewing. This is not the sign of a malfunction. Increase the thread tension slightly, and begin sewing again.



Memo

- If you turn the main power to OFF or select a different pattern, the thread tension will reset to the automatic setting.
- When you retrieve a saved pattern, the thread tension setting will be the same as when the pattern was saved.

Upper Thread is Too Tight

The tension of the upper thread is too tight, resulting in the bobbin thread being visible from the right side of the fabric.



Note

- If the bobbin thread was incorrectly threaded, the upper thread may be too tight. In this case, refer to “Setting the Bobbin” of “Basic operations” and rethread the bobbin thread.

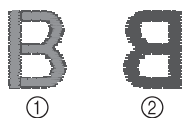

- ① Right side
- ② Wrong side

1 Press .

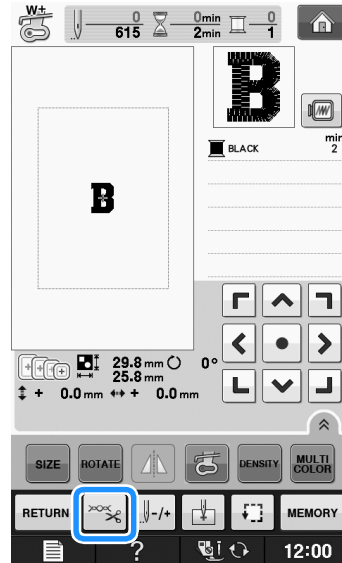

2 Press to weaken the upper thread tension. (The tension number will decrease.)

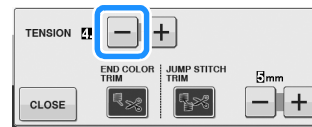

3 Press .

Upper Thread is Too Loose

The tension of the upper thread is too loose, resulting in a loose upper thread, loose thread locks, or loops appearing on the right side of the fabric.



Note

- If the upper thread was incorrectly threaded, the upper thread may be too loose. In this case, refer to “Upper Threading” of “Basic operations” and rethread the upper thread.



- ① Right side
- ② Wrong side

1 Press .

- 2 Press **+** to tighten the upper thread tension. (The tension number will increase.)

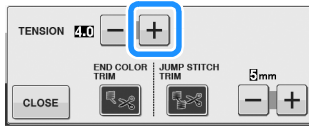

- 3 Press **CLOSE**.



Note

• With “Embroidery Tension” on the setting screen, the tension of the upper thread can be adjusted for embroidering. The selected setting will be applied to all patterns. When embroidering, if the overall tension of the upper thread is too tight or too loose, adjust it from the setting screen. Press **+** to tighten the upper thread tension and press **-** to loosen the upper tension. If an individual embroidery pattern needs additional fine tuning, refer to “Adjusting Thread Tension” on page E-30.

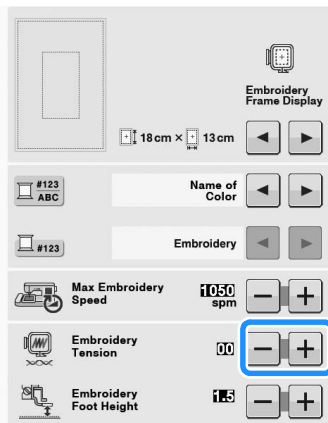

Adjusting the Bobbin Case (with No Color on the Screw)

The bobbin case (with no color on the screw) can be adjusted when bobbin tension changes are required to accommodate different bobbin threads. See “Embroidery Attractive Finishes” on page E-21.

To adjust the bobbin tension for embroidery function, using the bobbin case (with no color on the screw), turn the slotted-head screw (-) with a (small) screwdriver.

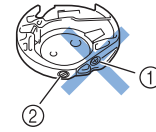

- ① Do not turn a phillips screw (+).
- ② Adjust with a screwdriver (small).

Correct Tension

Upper thread slightly appears on the wrong side of fabric.



- ① Right side
- ② Wrong side

Bobbin Thread is Too Loose

Bobbin thread appears slightly on the right side of fabric.

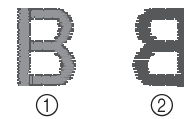

- ① Right side
- ② Wrong side

If this occurs, turn the slotted-head screw (-) clockwise, being careful not to over-tighten the screw, approximately 30-45 degrees to increase bobbin tension.

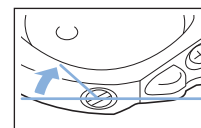

■ Bobbin Thread is Too Tight

Upper thread on the right side of fabric seems to be lifting/looping and bobbin thread is not seen on the wrong side of fabric.



- ① Right side
- ② Wrong side

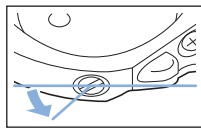

If this occurs, turn the slotted-head screw (-) counterclockwise, being careful not to over-loosen the screw, approximately 30-45 degrees to decrease bobbin tension.



⚠ CAUTION

- When adjusting the bobbin case, be sure to remove the bobbin from the bobbin case.
- DO NOT adjust the position of the phillips (+) screw on the bobbin case as this may result in damage to the bobbin case, rendering it unusable.
- If the slotted-head screw (-) is difficult to turn, do not use force. Turning the screw too much or providing force in either (rotational) direction may cause damage to the bobbin case. Should damage occur, the bobbin case may not maintain proper tension.

Using the Automatic Thread Cutting Function (END COLOR TRIM)

The automatic thread cutting function  will cut the thread at the end of sewing each color. This function is initially turned on. To turn this function off, press  key and then . This function can be turned on or off during embroidering.

- * This setting returns to its default  when the machine is turned off.

1 Press .

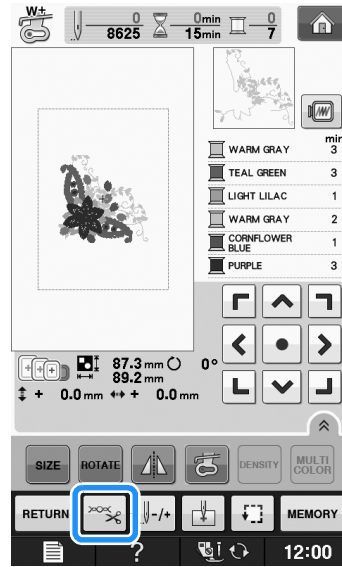



2 Press  to turn off the automatic thread cutting function.



→ The key will display as .

- * When one color thread is sewn, the machine will stop without cutting the thread.

Using the Thread Trimming Function (JUMP STITCH TRIM)

The thread trimming function  will automatically trim any excess thread jumps within the color. This function is initially turned on. To turn this function off, press  key and then . This function can be turned on or off during embroidering.

- * Your customized setting remains after turning the machine off and on.

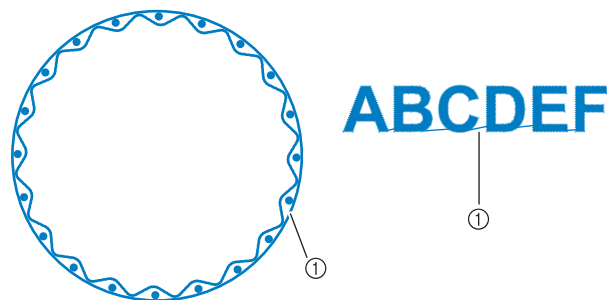

① Jump stitch

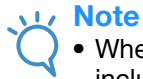

Note

- When this function is turned on, use the included ball point needle 75/11 for embroidering patterns with short jump stitches such as alphabet characters. Using other needles may cause the thread to break.

1 Press .

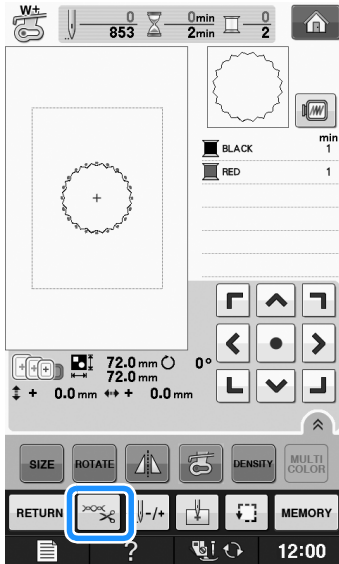

2 Press  to turn off the thread trimming function.



→ The key will display as 



- * The machine will not trim the thread before moving to the next stitching.

■ Selecting the Length of Jump Stitch Not to Trim

When the thread trimming function  is turned on, you can select the length of the jump stitch not to trim the thread. This function can be turned on or off during embroidering.

Select a setting from 5 mm to 50 mm in 5 mm increments.

- * Your customized setting remains after turning the machine off and on.

Press  or  to select the length of jump stitch.

For example: Press  to select 25 mm (1 inch) and the machine will not trim a jump stitch of 25 mm or less before moving to the next stitching.

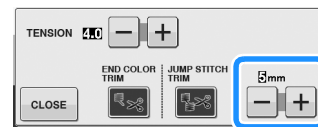



Note

- If design has many trims it is recommended to select a higher jump stitch trim setting in order to reduce the amount of excess tails on backside of fabric.
- The higher number of the jump stitch length selected, the fewer number of times the machine will trim. In this case, more jump stitches remain on the surface of the fabric.

Adjusting the Embroidery Speed

1 Press .

2 In the “Max Embroidery Speed” display, use

  to change the maximum embroidery speed.

- * You can choose from 3 different speed levels, 350 spm, 600 spm or 1050 spm.

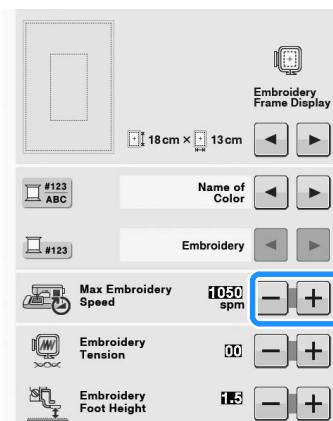

Memo

- “spm” is the number of stitches sewn in one minute.
- Decrease the sewing speed when embroidering on thin, thick, or heavy fabrics.
- The sewing speed can be changed after an embroidery has been started.
- The maximum sewing speed setting does not change until a new setting is selected. The setting specified before the main power is set to OFF remains selected the next time that the machine is turned on.
- Decrease the sewing speed to 600 spm when using a speciality thread like a metallic thread.
- While selecting the bobbin work pattern, the embroidery speed recommendation is set at “100 spm”; however you can choose from 100 spm, 200 spm or 350 spm.

3 Press .



Changing the Thread Color Display

You can display the name of the thread colors or embroidery thread number.



Memo

- Colors on the screen may vary slightly from actual spool colors.

1 Press .

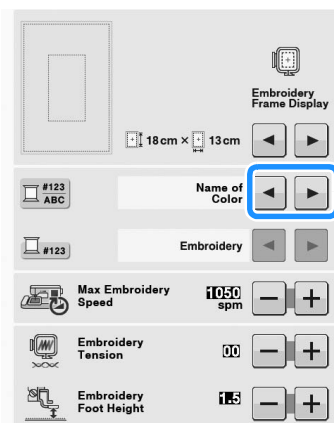

2 In the “Thread Color Display”, use   to display the name of the thread colors or the embroidery thread number.

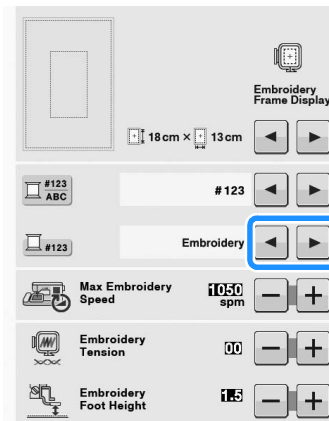

3 When the thread number **#123** is displayed, use   to select from six embroidery thread brands pictured below.



EMBROIDERY / POLYESTER THREAD#

-  509 Embroidery
-  804 Embroidery
-  085 Embroidery



COUNTRY/COTTON THREAD#*

-  463 Country
-  604 Country
-  155 Country



MADEIRA /POLYESTER THREAD#

-  1749 Madeira Poly
-  1630 Madeira Poly
-  1921 Madeira Poly



MADEIRA RAYON THREAD#

-  1050 Madeira Rayon
-  1261 Madeira Rayon
-  1108 Madeira Rayon

SULKY THREAD#

-  1510 Sulky
-  1193 Sulky
-  1224 Sulky

ROBISON-ANTON/POLYESTER THREAD#



-  5514 R-A Poly
-  5586 R-A Poly
-  5523 R-A Poly

* Depending on the country or area, cotton-like polyester thread is sold.

4 Press .

Changing the “Embroidery Frame Display”

1 Press .

2 In the “Embroidery Frame Display”, use   to change the embroidery frame display mode.

* There are 16 choices.

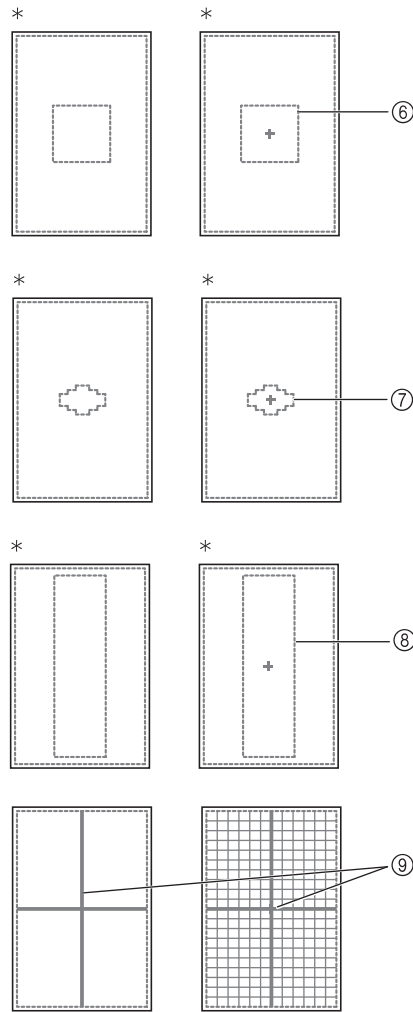
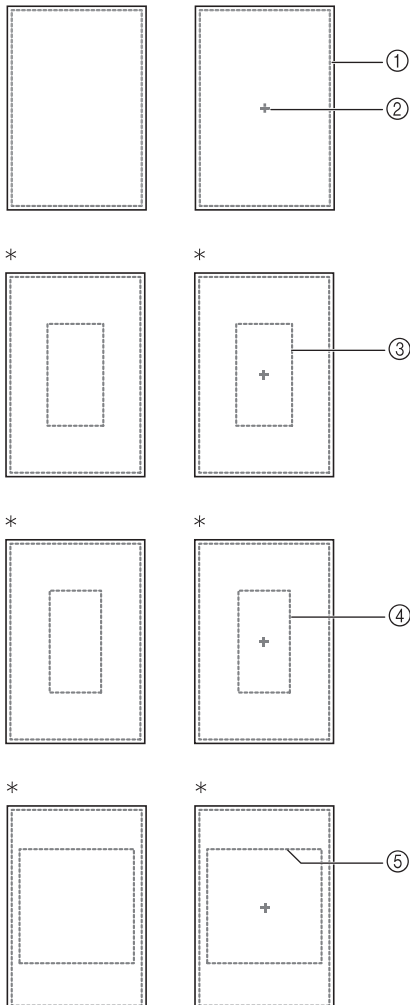
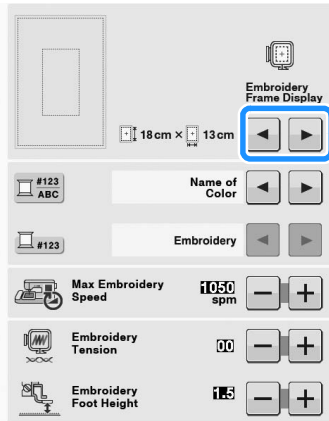

* For the optional embroidery frame.

- ① Extra large frame embroidering area
30 cm x 18 cm (11-3/4 inches x 7-1/8 inches)
- ② Center mark
- ③ Large frame embroidering area
18 cm x 13 cm (7-1/8 inches x 5-1/8 inches)
- ④ Embroidering area for optional border embroidery frame
18 cm x 10 cm (7-1/8 inches x 4 inches)
- ⑤ Embroidery area for optional quilt embroidery frame
15 cm x 15 cm (6 inches x 6 inches)
- ⑥ Medium frame embroidering area
10 cm x 10 cm (4 inches x 4 inches)
- ⑦ Embroidery area for optional small embroidery frame
2 cm x 6 cm (3/4 inch x 2-3/8 inches)
- ⑧ Embroidering area for optional border embroidery frame
30 cm x 10 cm (11-3/4 inches x 4 inches)
- ⑨ Grid lines

3 Press .

REVISING THE PATTERN

⚠ CAUTION

- When you have revised the pattern, check the display of available embroidery frames and use an appropriate frame. If you use an embroidery frame not displayed as available for use, the presser foot may strike the frame and possibly cause injury.

Moving the Pattern

Use  to move the pattern in the direction shown by the arrow.

Press  to center the pattern.

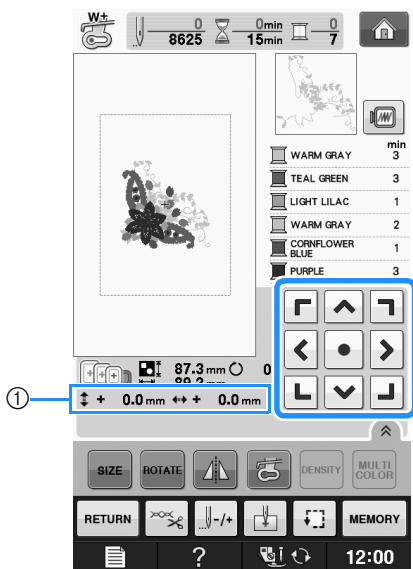

① Distance from the center

The pattern can also be moved by dragging it.

If a USB mouse is connected, move the mouse to position the pointer on the desired pattern, and then select and drag the pattern. The pattern can also be dragged by selecting it directly in the screen with your finger or the touch pen.

Memo

- Patterns cannot be moved in screens where

 does not appear.

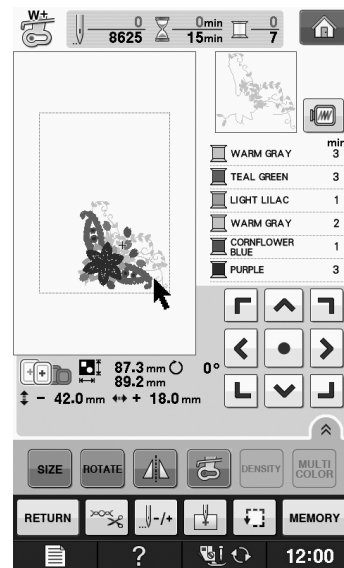

Aligning the Pattern and the Needle

Example: Aligning the lower left side of a pattern and the needle

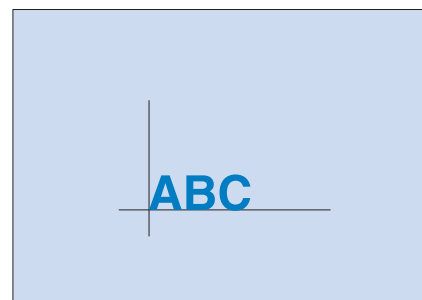

- 1 Mark the embroidery start position on the fabric, as shown.

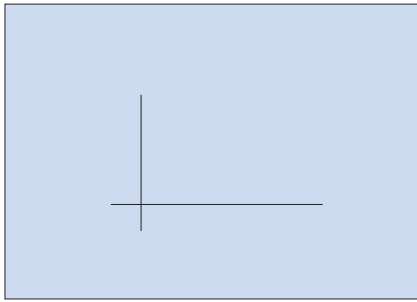

- 2 Press .

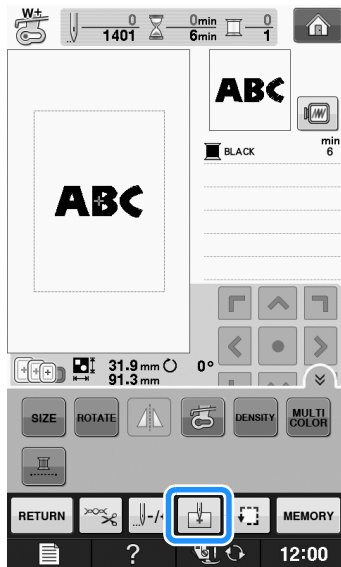

- 3 Press .

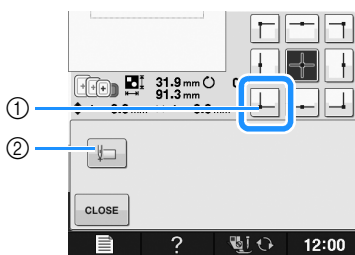

- 1 Start position
 - 2 This key is used for aligning linked characters (see page E-41).
- The needle position moves to the bottom left corner of the pattern (the embroidery frame moves so that the needle is positioned correctly).

- 4 Press .

- 5 Use  to align the needle and the mark on the fabric, and begin embroidering the pattern.

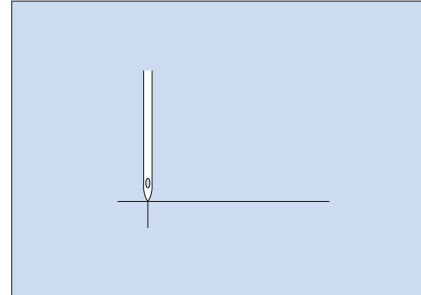





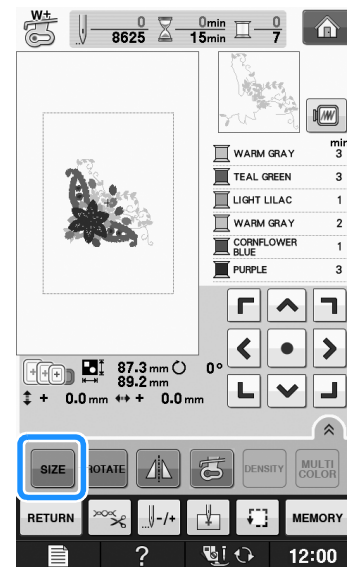

Changing the Size of the Pattern

- 1 Press .



- 2 Select the direction in which to change the size.

- * Press  to enlarge the pattern proportionately.
- * Press  to shrink the pattern proportionately.
- * Press  to stretch the pattern horizontally.
- * Press  to compact the pattern horizontally.
- * Press  to stretch the pattern vertically.
- * Press  to compact the pattern vertically.
- * Press  to return the pattern to its original appearance.

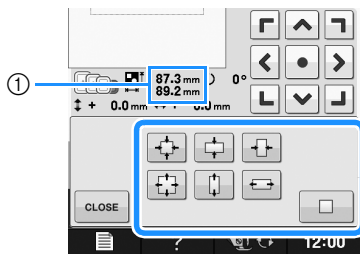

① Size of the pattern

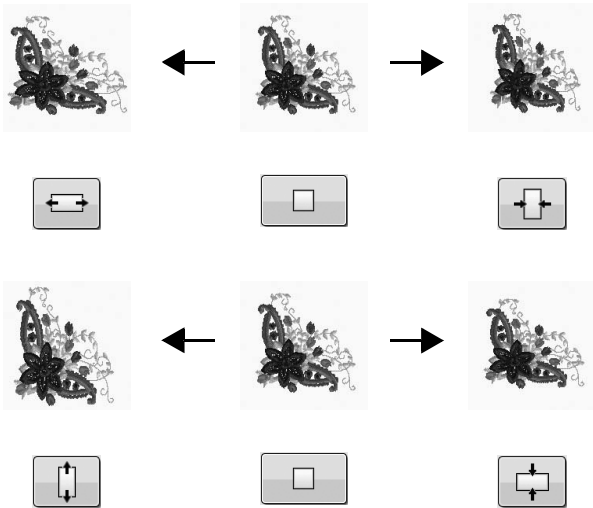

Memo

- Some patterns or characters can be enlarged more than others.
- Some patterns or characters can be enlarged to a greater degree if they are rotated 90 degrees.
- You can change the size of the pattern by rotating the mouse wheel. Rotate the mouse wheel away from you to shrink the pattern. Rotate the mouse wheel toward you to enlarge the pattern.

3 Press **CLOSE** to return to the original screen.

Rotating the Pattern

1 Press **ROTATE**.

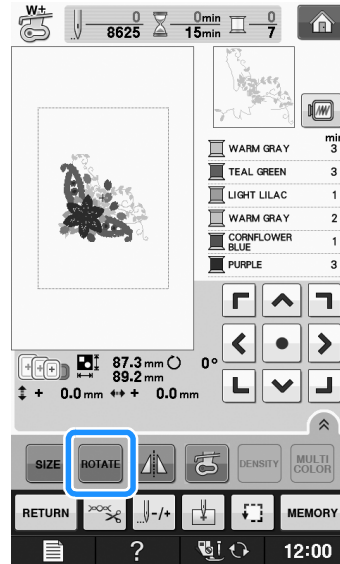

2 Select the angle of rotation for the pattern.

- * Press **90°** to rotate the pattern 90 degrees to the left.
- * Press **90°** to rotate the pattern 90 degrees to the right.
- * Press **10°** to rotate the pattern 10 degrees to the left.
- * Press **10°** to rotate the pattern 10 degrees to the right.
- * Press **1°** to rotate the pattern 1 degree to the left.
- * Press **1°** to rotate the pattern 1 degree to the right.
- * Press **RESET** to return the pattern to its original position.

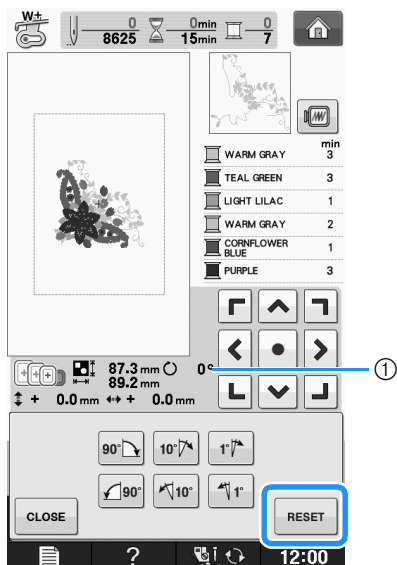

① Degree of rotation



Memo

- You can rotate the pattern by rotating the mouse wheel. Rotate the mouse wheel away from you to rotate the pattern 10 degrees to the left. Rotate the mouse wheel toward you to rotate the pattern 10 degrees to the right.

3 Press **CLOSE** to return to the original screen.

Creating a Horizontal Mirror Image

Press so it appears as to create a horizontal mirror image of the selected pattern.
Press again to return the pattern to normal.

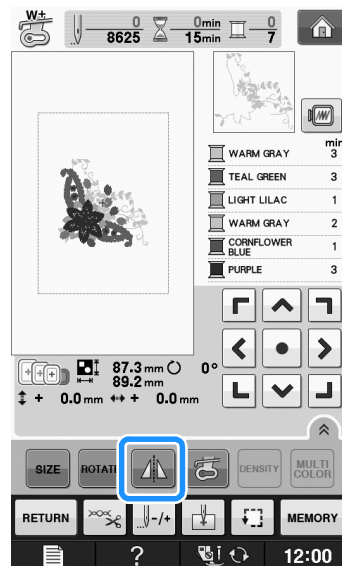

Enlarging the Editing Screen

Enlarge the editing screen by pressing .



Press to close the enlarged screen.



Changing the Density (Alphabet Character and Frame Patterns Only)

The thread density for some alphabet character and frame patterns can be changed.

A setting between 80% and 120% in 5% increments can be specified.

1 Press .

* Press  to display all the function keys on the screen.

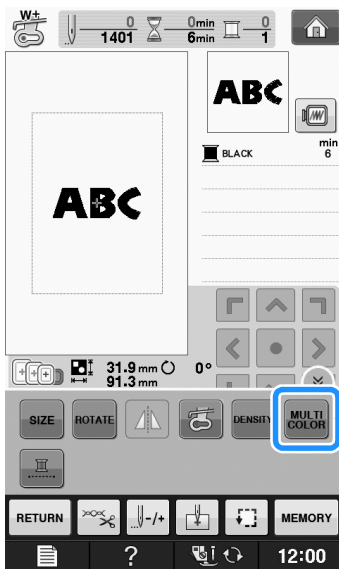

2 Change the density.

* Press  to make the pattern less dense.

* Press  to make the pattern more dense.

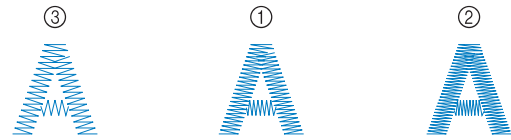
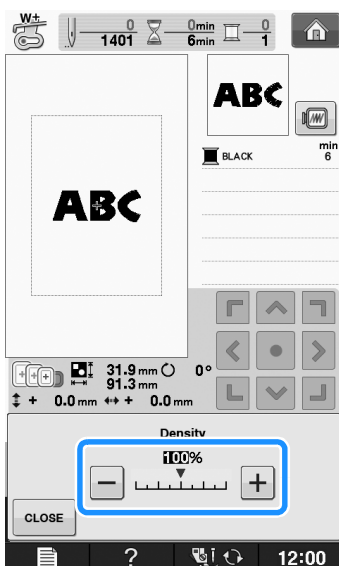



- ① Normal
- ② Fine (stitches closer together)
- ③ Coarse (stitches farther apart)

→ The pattern density changes each time you press a button.

3 Press  to return to the pattern selection screen.

Changing the Colors of Alphabet Character Patterns

Combined alphabet character patterns can be sewn with each letter in a different color. If "MULTI COLOR" is set, the machine stops after each character is sewn so that the thread can be changed to a different color.

1 Press  so that it appears as .

* Press  to display all the function keys on the screen.

* Press the key again to return to the original setting.

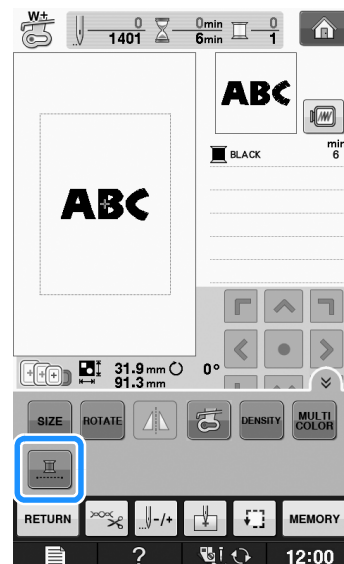

- 2 After a character is sewn, change the thread color, and then sew the next character.

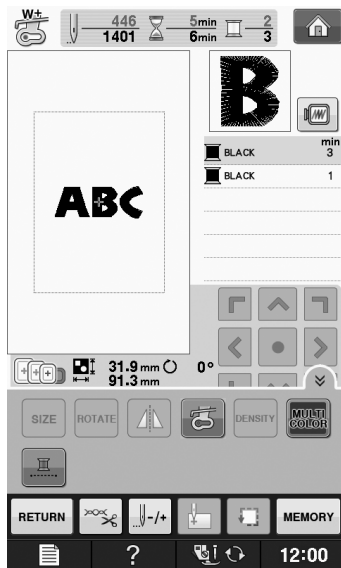

- 2 Press .

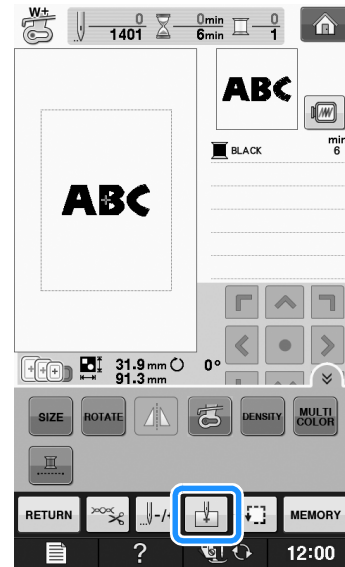

Embroidering Linked Characters

Follow the procedure described below to embroider linked characters in a single row when the entire pattern extends beyond the embroidery frame.

Example: Linking "DEF" to the characters "ABC"

A B C D E F

- 1 Select the character patterns for "ABC".



Note

- For details on selecting character patterns, refer to "Selecting Character Patterns" on page E-5.

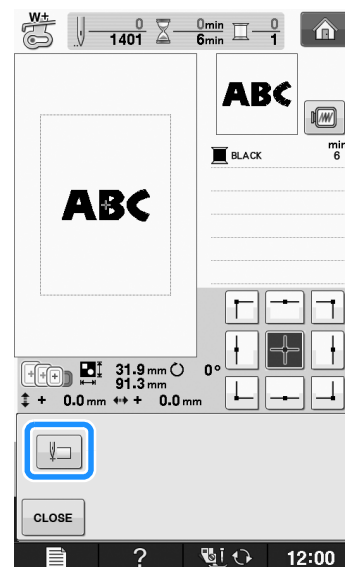

- 3 Press .



→ The needle is positioned in the lower-left corner of the pattern. The embroidery frame moves so that the needle is positioned correctly.





Note

- To cancel the starting point setting and return the starting point to the center of the pattern, press .
- Use  to select a different starting point for embroidering.

4 Press  .

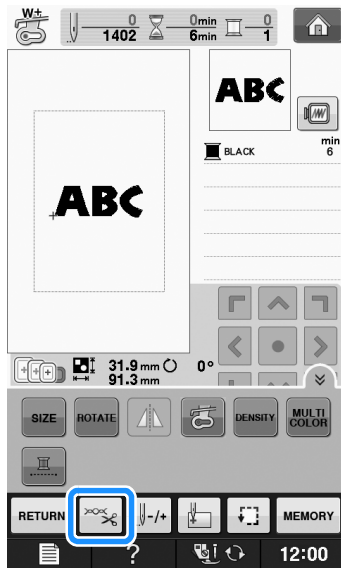
5 Press  .



6 Press  to turn off the thread cutting function and then press  .

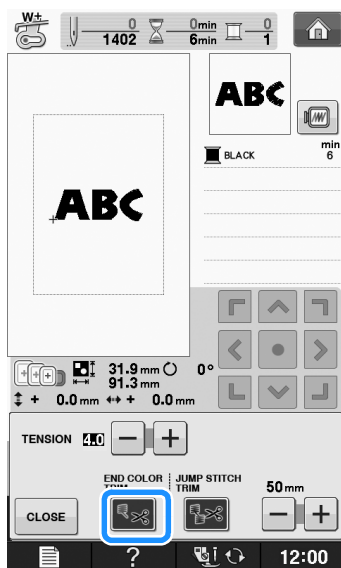

7 Press the "Start/Stop" button.

8 After the characters are embroidered, cut the threads to a generous length, remove the embroidery frame, and then attach the embroidery frame again so that the remaining characters ("DEF") can be embroidered.

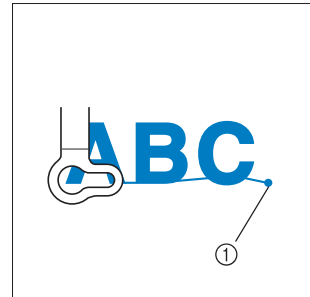

① End of the embroidering

9 As in step ①, select the character patterns for "DEF".

10 Press  .

11 Press  .

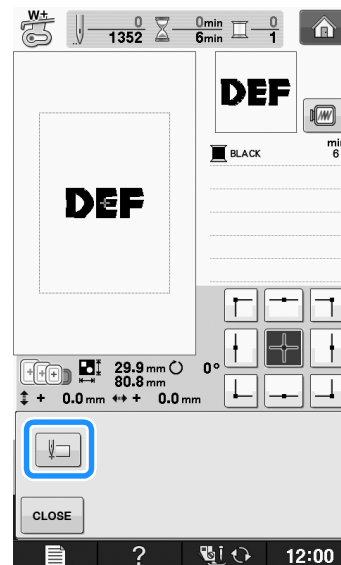

→ The needle is positioned in the lower-left corner of the pattern. The embroidery frame moves so that the needle is positioned correctly.

12 Press  .

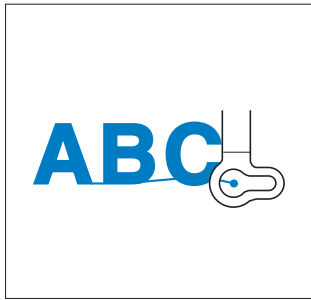

- 13 Use  to align the needle with the end of embroidering for the previous pattern.



- 14 Press the “Start/Stop” button to begin embroidering the remaining character patterns.



Uninterrupted Embroidering (Monochrome - Using a Single Color)

A selected pattern can be stitched out in one color instead of multicolor. The machine will hesitate but not stop between color steps, and then continue till the pattern is completed. Press  for the multicolor steps to become shaded and the selected pattern will embroider in a single color, instead of changing the thread while embroidering. Press  again to return to the pattern’s original settings.

- * Press  to display all the function keys on the screen.

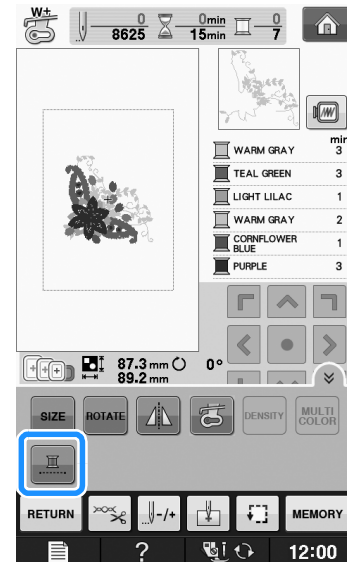

→ The thread color displayed on the screen will be grayed out.

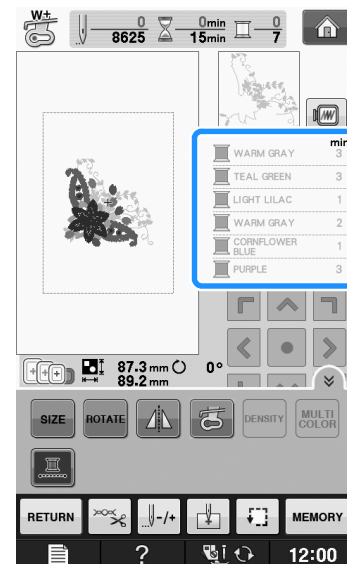

Memo

- Even if uninterrupted embroidering  has been set, the automatic thread cutting function and the thread trimming function can be used (see page E-32).

USING THE MEMORY FUNCTION

Embroidery Data Precautions

Observe the following precautions when using embroidery data other than that created and saved in this machine.

CAUTION

- When using embroidery data other than our original patterns, the thread or needle may break when sewing with a stitch density that is too fine or when sewing three or more overlapping stitches. In that case, use one of our original data design systems to edit the embroidery data.

■ Types of Embroidery Data that can be Used

- Only .pes, .phc, and .dst embroidery data files can be used with this machine. Using data other than that saved using our data design systems or machines may cause the embroidery machine to malfunction.

■ Types of USB Devices/Media that can be Used

Stitch data can be saved to or recalled from USB media. Use media that meets the following specifications.

- USB Flash drive (USB Flash memory)
- USB Floppy disk drive

Stitch data can be recalled only.

- USB CD-ROM, CD-R, CD-RW drives

You can also use the following types of media with the USB Memory Card Reader/USB card writer module.

- Secure Digital (SD) Card
- CompactFlash
- Memory Stick
- Smart Media
- Multi Media Card (MMC)
- XD-Picture Card



Note

- The processing speed may vary by quantity of data stored.
- Some USB media may not be usable with this machine. Please visit our website for more details.
- The access lamp will begin blinking after inserting USB devices/media, and it will take about 5 to 6 seconds to recognize the devices/media. (Time will differ depending on the USB device/media).



Memo

- To create file folders, use a computer.
- Letters and numerals can be used in the file names. In addition, if the file name contains no more than eight characters, the entire file name will appear on the screen. If the file name is more than eight characters long, only the first six characters followed by “~” and a number appear as the file name.

■ Computers and Operating Systems with the Following Specifications can be Used

- Compatible models:
IBM PC with a USB port as standard equipment
IBM PC-compatible computer equipped with a USB port as standard equipment
- Compatible operating systems:
Microsoft Windows XP, Windows Vista, Windows 7, Windows 8

■ Precautions on Using the Computer to Create and Save Data

- If the name of the embroidery data file/folder cannot be identified, for example, because the name contains special characters, the file/folder is not displayed. If this occurs, change the name of the file/folder. We recommend using the 26 letters of the alphabet (uppercase and lowercase), the numbers 0 through 9, “-”, and “_”.
- If embroidery data larger than 30 cm × 18 cm (approx. 12 inches × 7 inches) is selected, a message is shown asking if you wish to rotate the pattern 90 degrees. Even after being rotated 90 degrees, embroidery data larger than 30 cm × 18 cm (approx. 12 inches × 7 inches) cannot be used. (All designs must be within the 30 cm × 18 cm (approx. 12 inches × 7 inches) design field size.)
- .pes files saved with the number of stitches or the number of colors exceeding the specified limits cannot be displayed. The combined design can not exceed a maximum number of 500,000 stitches or a maximum number of 125 color changes (Above numbers are approximate, depending on the overall size of the design). Use one of our design software programs to edit the embroidery pattern so that it meets these specifications.
- Embroidery data stored in a folder created in USB media can be retrieved.

- Do not create folders in “Removable Disk” on a computer. If embroidery data is stored in a folder in “Removable Disk”, that embroidery data cannot be retrieved by the machine.
- Even if the embroidery unit is not attached, the machine will recognize embroidery data.

■ Tajima (.dst) Embroidery Data

- .dst data is displayed in the pattern list screen by file name (the actual image cannot be displayed). Only the first eight characters of the file name can be displayed.
- Since Tajima (.dst) data does not contain specific thread color information, it is displayed with our default thread color sequence. Check the preview and change the thread colors as desired.

Saving Embroidery Patterns in the Machine’s Memory

You can save embroidery patterns that you have customized and will use often; for example, your name, patterns that have been rotated or had the size changed, patterns that have had the sewing position changed, etc. A total of about 1 MB of patterns can be saved in the machine's memory.



Note

- Do not turn the main power to OFF while the “Saving” screen is displayed. You will lose the pattern you are saving.



Memo

- It takes a few seconds to save a pattern to the machine’s memory.
- See page E-48 for information on retrieving a saved pattern.

- 1 Press **MEMORY** when the pattern you want to save is in the embroidery screen.

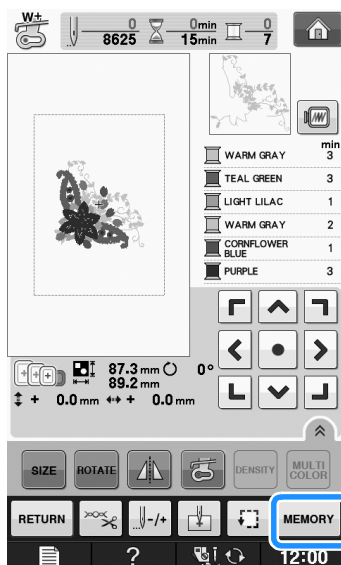

- 2 Press .

- * Press **CLOSE** to return to the original screen without saving.

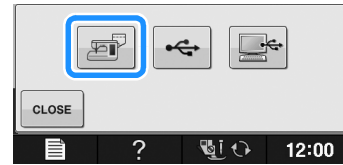

→ The “Saving” screen is displayed. When the pattern is saved, the display returns to the original screen automatically.

■ If the Memory is Full

If the screen below displays, either the maximum number of patterns have been saved or the pattern you want to save takes a lot of memory, and the machine cannot save it. If you delete a previously saved pattern, you can save the current pattern.

- 1 Press **OK** .

- * Press **CANCEL** to return to the original screen without saving.

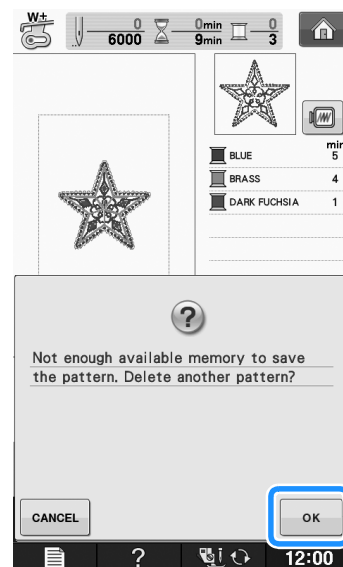

→ The machine displays the patterns currently saved.

2 Select the pattern you want to delete.

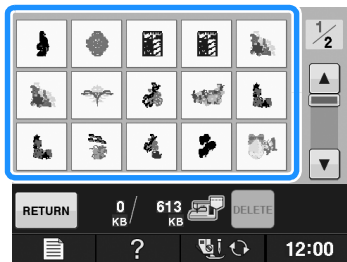

3 Press **DELETE**.

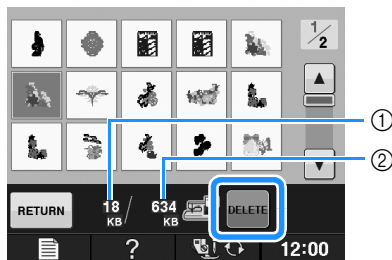

- ① Amount of memory used by the pattern to be deleted
- ② Amount of memory needed to save the current pattern

4 Press **OK**.

* If you decide not to delete the pattern, press **CANCEL**.

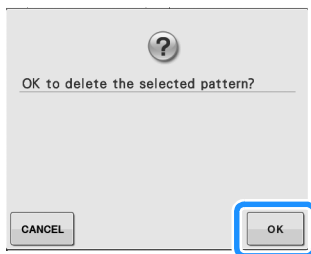

→ The “Saving” screen displays. When the pattern is saved, the display returns to the original screen automatically.



Note

- Do not turn the main power to OFF while the “Saving” screen is displayed. You will lose the pattern you are saving.

Memo

- If there is enough memory available after deleting the pattern, the pattern you want to save will be saved automatically. If there is not enough memory available after deleting the pattern, repeat the steps above to delete another pattern from the machine’s memory.
- It takes a few seconds to save a pattern.
- See page E-48 for more information about retrieving saved patterns.

Saving Embroidery Patterns to USB Media

When sending embroidery patterns from the machine to USB media, plug the USB media into the machine’s USB port.

Memo

- USB media is commercially available, but some USB media may not be usable with this machine. Please visit our website for more details.
- Depending on the type of USB media being used, either directly plug the USB device into the machine’s USB port or plug the USB media Reader/Writer into the machine’s USB port.
- The USB media can be inserted or removed at any time except while saving or deleting a pattern.

1 Press **MEMORY** when the pattern you want to save is in the embroidery screen.

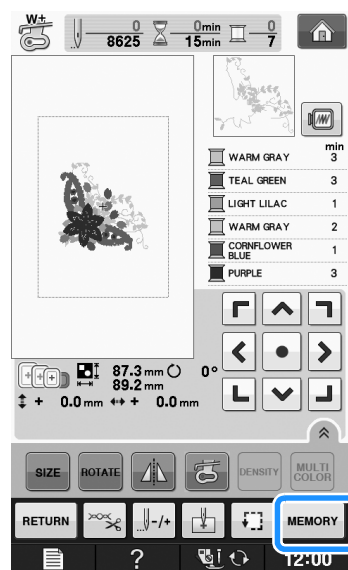

- 2 Insert the USB media into the USB port on the machine.

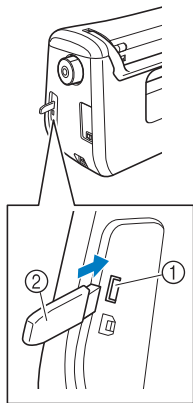

- ① USB port for mouse/media (USB 2.0)
- ② USB media



Note

- The processing speed may vary by quantity of data.
- Do not insert anything other than USB media into the USB media port. Otherwise, the USB media drive may be damaged.

- 3 Press  .

- * Press  to return to the original screen without saving.



→ The "Saving" screen is displayed. When the pattern is saved, the display returns to the original screen automatically.



Note

- Do not insert or remove USB media while "Saving" screen is displayed. You will lose some or all of the pattern you are saving.

Saving Embroidery Patterns in the Computer

Using the included USB cable, the machine can be connected to your computer, and the embroidery patterns can be temporarily retrieved from and saved in the "Removable Disk" folder in your computer. A total of about 772 KB of embroidery patterns can be saved in the "Removable Disk", but the saved embroidery patterns are deleted when the machine is turned OFF.



Note

- Do not turn the main power to OFF while the "Saving" screen is displayed. You will lose the pattern you are saving.

- 1 Plug the USB cable connector into the corresponding USB ports for the computer and for the machine.
- 2 Turn on your computer and select "Computer (My computer)".

- * The USB cable can be plugged into the USB ports on the computer and embroidery machine whether or not they are turned on.

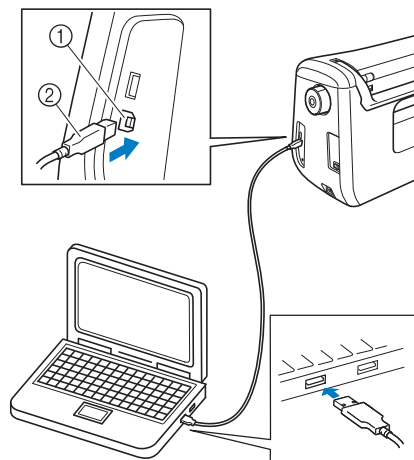

- ① USB port for computer
- ② USB cable connector
- The "Removable Disk" icon will appear in "Computer (My computer)" on the computer.



Note

- The connectors on the USB cable can only be inserted into a port in one direction. If it is difficult to insert the connector, do not insert it with force. Check the orientation of the connector.
- For details on the position of the USB port on the computer (or USB hub), refer to the instruction manual for the corresponding equipment.

3 Press **MEMORY** when the pattern you want to save is in the embroidery screen.

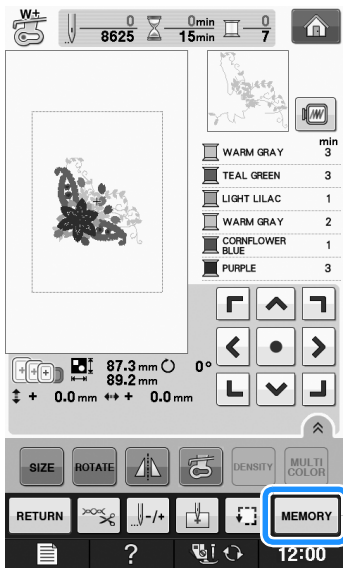

4 Press .

* Press **CLOSE** to return to the original screen without saving.

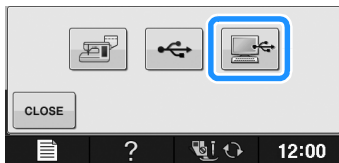

→ The pattern will be temporarily saved to "Removable Disk" under "Computer (My computer)".

5 Select the pattern's .phc file in "Removable Disk" and copy the file to the computer.

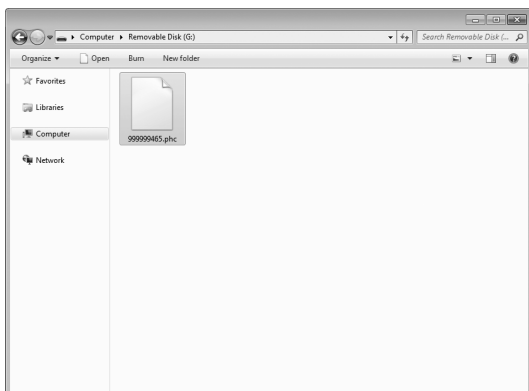

Retrieving Patterns from the Machine's Memory

1 Press .

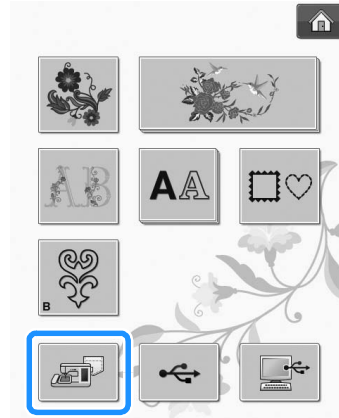

→ The machine displays the patterns currently in the memory.

2 Press the key of the pattern you want to retrieve.

* Press **RETURN** to return to the original screen.

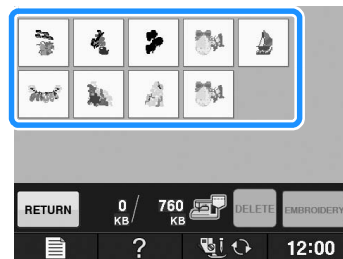

3 Press **EMBROIDERY**.

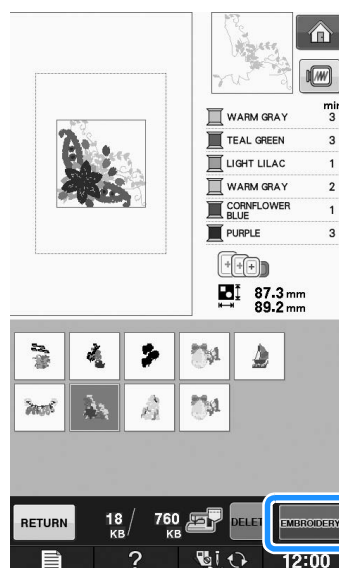

→ The embroidery screen is displayed.

Recalling from USB Media

You can recall a specific embroidery pattern from either direct USB media or a folder in the USB media. If the pattern is in a folder, check each folder to find the embroidery pattern.



Note

- The processing speed may vary by quantity of data.

- 1 Insert the USB media into the USB port on the machine (see page E-46).

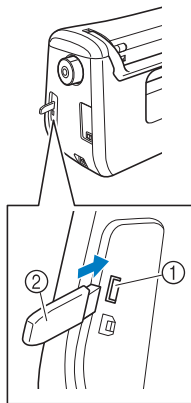



- ① USB port for mouse/media (USB 2.0)
- ② USB media

- 2 Press .



→ Embroidery patterns and a folder in a top folder are displayed.

- 3 Press  when there is a subfolder to sort two or more stitch patterns to USB media, the embroidery pattern in the subfolder is displayed.

- * Press  to return to the original screen without recalling.

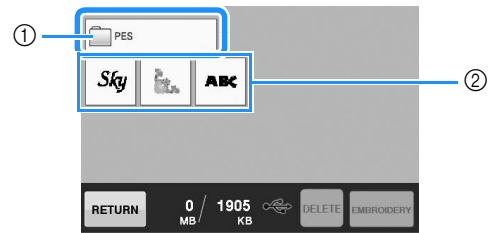

- ① Folder name
- ② Embroidery patterns in USB media
- ③ Path
- * The path to shows the current folder at the top of the list. Embroidery patterns and subfolders within a folder are displayed.
- * Press  to return to the previous folder.
- * Use the computer to create folders. Folders cannot be created with the machine.

- 4 Press the key of the pattern you want to retrieve.

- * Press  to return to the original screen.

- 5 Press .

- * Press  to delete the pattern. The pattern will be deleted from the USB media.

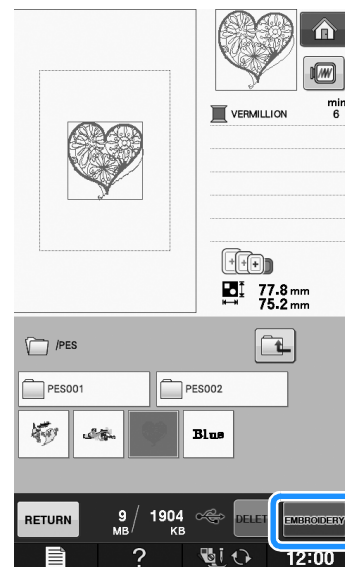

→ The embroidery screen is displayed.

Recalling from the Computer

- 1 Plug the USB cable connector into the corresponding USB ports for the computer and for the machine (see page E-47).
- 2 On the computer, open “Computer (My computer)” then go to “Removable Disk”.

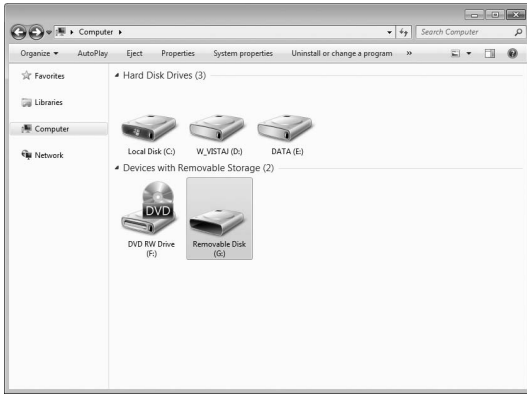

- 3 Move/copy the pattern data to “Removable Disk”.

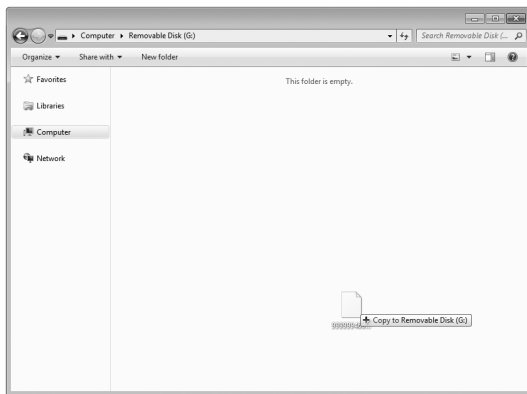

→ Pattern data in “Removable Disk” is written to the machine.

Note

- While data is being written, do not disconnect the USB cable.
- Do not create folders within “Removable Disk”. Since folders are not displayed, stitch pattern data within folders cannot be recalled.

- 4 Press .



→ The patterns in the computer are displayed on the selection screen.

- 5 Press the key of the pattern you want to recall.

* Press  to return to the original screen.



- 6 Press .



→ The embroidery screen is displayed.

EMBROIDERY APPLICATIONS

Using a Frame Pattern to Make an Appliqué (1)

You can use framed patterns of the same size and shape to create an appliqué. Embroider one pattern with a straight stitch and one pattern with a satin stitch.

- 1 Select a straight stitch frame pattern. Embroider the pattern onto the appliqué material, then cut neatly around the outside of the shape.

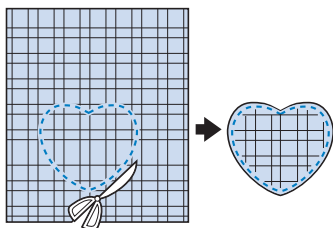
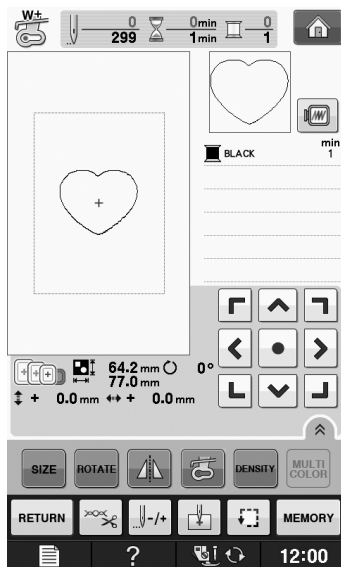

- 2 Embroider the same pattern from step 1 onto the base fabric.

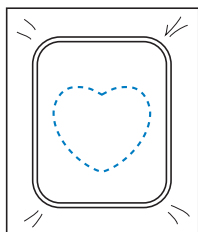

- 3 Apply a thin layer of fabric glue or a temporary spray adhesive to the rear of the appliqué created in step 1. Attach the appliqué to the base fabric matching the shapes.

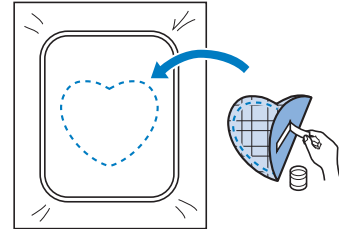

- 4 Select the satin stitch frame pattern of the same shape as the appliqué. Embroider over the appliqué and base fabric from step 3 to create the appliqué.

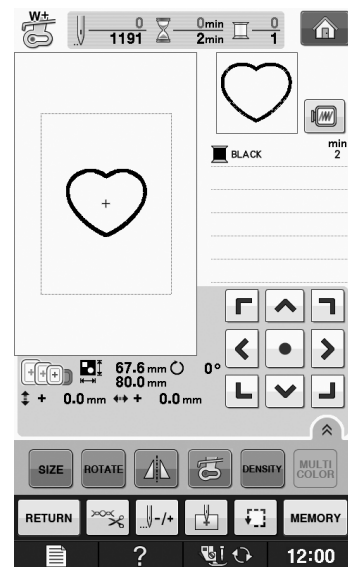

Note

- If you change the size or position of the patterns when selecting them, make a note of the size and location.

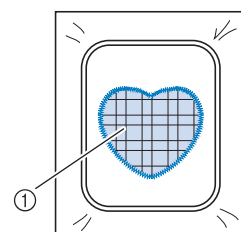

① Appliqué material

Using a Frame Pattern to Make an Appliqué (2)

This is a second method to make appliqué using embroidery patterns. You do not have to change the fabric in the embroidery frame using this method. Embroider one pattern with a straight stitch and one pattern with a satin stitch.

- 1 Select a straight stitch frame pattern, and embroider the pattern onto the base fabric.

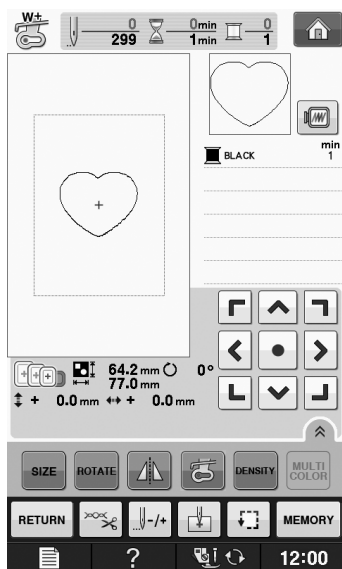

- 2 Place the appliqué fabric over the pattern embroidered in step 1.

* Be sure that the appliqué fabric completely covers the stitched line.

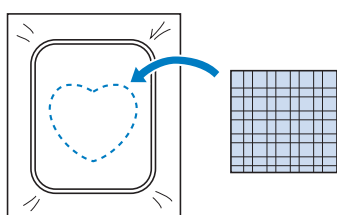

- 3 Embroider the same pattern on the appliqué fabric.

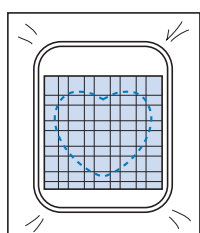

- 4 Remove the embroidery frame from the embroidery unit, and cut around the outside of the stitches.

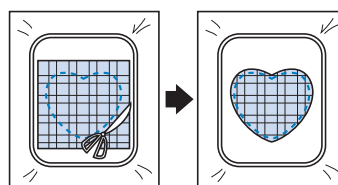

Note

- Do not remove the fabric from the embroidery frame to cut it. Also, do not pull or push on the fabric. Otherwise, the fabric may loosen in the frame.

- 5 Select the satin stitch frame pattern of the same shape as the appliqué.

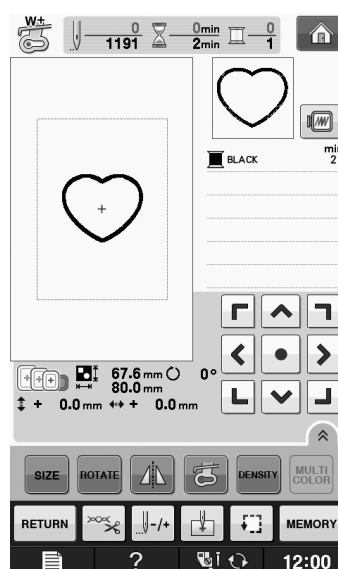

Note

- Do not change the size or position of the pattern.
- If you change the size or position of the patterns when selecting them, make a note of the size and location.

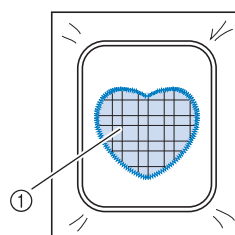

① Appliqué material

- 6** Reattach the embroidery frame to the embroidery unit, and embroider the satin stitch pattern to create an appliqué.

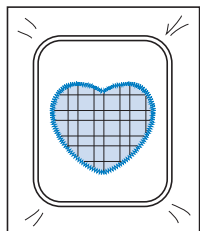

Sewing Split Embroidery Patterns

Split embroidery patterns created with PE-DESIGN Ver.7 or later, or PE-DESIGN NEXT can be sewn. With split embroidery patterns, embroidery designs larger than the embroidery hoop are divided into multiple sections, which combine to create a single pattern after each section is sewn.

For details on creating split embroidery patterns and for more detailed sewing instructions, refer to the Instruction manual included with PE-DESIGN Ver.7 or later, or PE-DESIGN NEXT.

The following procedure describes how to read the split embroidery pattern shown below from USB media and embroider it.

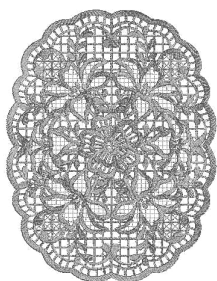

- 1** Connect to the machine the media containing the created split embroidery pattern, and then select the split embroidery pattern to be embroidered.

- * For details on recalling patterns, refer to “Selecting Patterns from Embroidery Cards” on page E-7, “Recalling from USB Media” on page E-49, or “Recalling from the Computer” on page E-50.

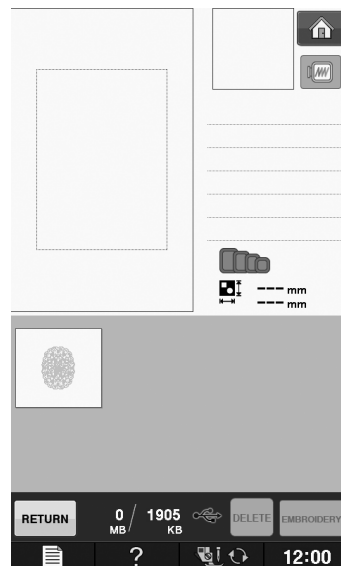

- A screen appears so that a section of the split embroidery pattern can be selected.

- 2** Select section **Aa** to be embroidered.

- * Select the sections in alphabetical order.
- * A maximum of 12 sections can be displayed in one page. If there are 13 or more sections in the pattern, press **▲** or **▼** to display the previous or next page.

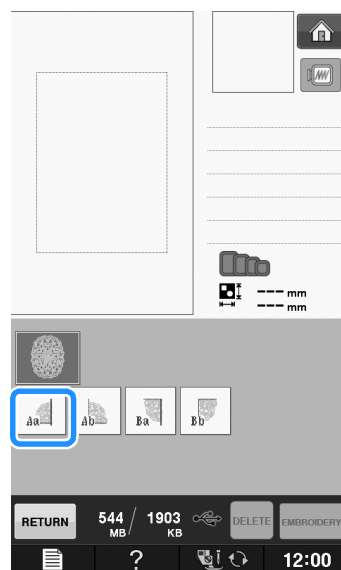

3 Press **EMBROIDERY**.

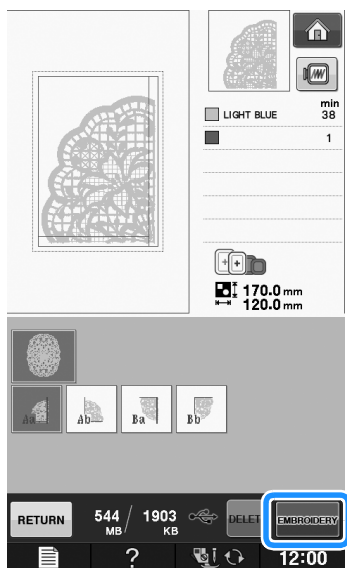

4 If necessary, edit the pattern.

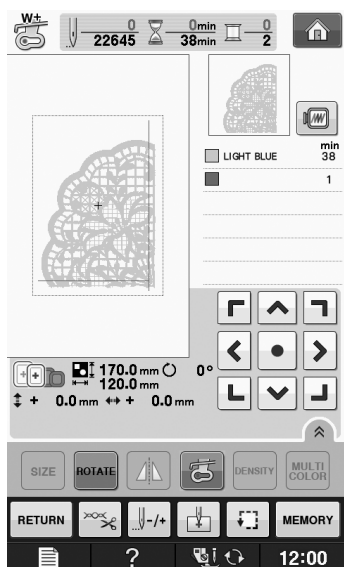

* For details, refer to “REVISING THE PATTERN” on page E-36.



Memo

- The pattern can be rotated 90° to either the left or right when **ROTATE** is pressed.

5 Press the “Start/Stop” button to embroider the pattern section.

6 When embroidering is finished, the following screen appears. Press **OK**.

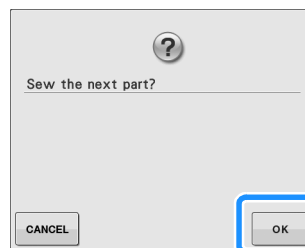

→ A screen appears so that a section of the split embroidery pattern can be selected.

7 Repeat steps **2** through **6** to embroider the remaining sections of the pattern.



Chapter 2

Embroidery Edit

EXPLANATION OF FUNCTIONS.....	57
SELECTING PATTERNS TO EDIT	58
Selecting Embroidery Patterns/Brother "Exclusives"/Floral Alphabet Patterns/Frame/Bobbin Work Patterns	59
Selecting Alphabet Character Patterns.....	59
EDITING PATTERNS.....	61
■ Key Functions.....	62
Moving the Pattern	63
Rotating the Pattern.....	63
Changing the Size of the Pattern.....	63
Deleting the Pattern	63
Displaying Patterns in the Screen Magnified by 200%	63
Changing the Configuration of Character Patterns	64
Changing Character Spacing.....	64
Reducing Character Spacing	65
Separating Combined Character Patterns	65
Changing the Color of Each Alphabet Character in a Pattern ..	66
Embroidering Linked Characters.....	67
Changing the Thread Color	67
Creating a Custom Thread Table.....	68
■ Adding a Color to the Custom Thread Table from the List	69
■ Saving the Custom Thread Table to USB media	70
■ Recalling the Custom Thread Table data from USB media	70
Choosing a Color from the Custom Thread Table	71
Designing Repeated Patterns	72
■ Sewing Repeated Patterns	72
■ Repeating One Element of a Repeated Pattern.....	74
■ Color Sorting Repeated Patterns	75
■ Assigning Thread Marks	75
Embroidering the Pattern Repeatedly	76
Duplicating a Pattern.....	78
After Editing.....	79
COMBINING PATTERNS	80
Editing Combined Patterns.....	80
■ Selecting combined embroidery patterns.....	82
Sewing Combined Patterns	83
VARIOUS EMBROIDERING FUNCTIONS	84
Uninterrupted Embroidering (Monochrome - Using a Single Color).....	84
Basting Embroidery.....	84
USING THE MEMORY FUNCTION	85

EXPLANATION OF FUNCTIONS

With the “Embroidery Edit” functions, you can combine embroidery patterns and character patterns, change the size of patterns, rotate patterns, and perform many other editing functions. This machine can perform the 9 functions listed below.

■ Combine Patterns

You can easily create combinations of embroidery patterns, frame patterns, character patterns, patterns from the machine’s memory, patterns from separately sold embroidery cards, and many other patterns.

■ Move Patterns

Within the 30 cm × 18 cm (approx. 12 inches × 7 inches) wide embroidery area, you can change the position of patterns, and check the position on the LCD.

■ Rotate Patterns

You can rotate patterns one degree, ten degrees or ninety degrees at a time.

■ Enlarge or Reduce Patterns

You can make patterns larger or smaller.

- This function is not available for some patterns.

■ Create Mirror Images

You can create horizontal mirror images.

- This function is not available for some patterns.

■ Change Alphabet Character Spacing

You can increase or decrease the spacing between characters in combined patterns.

■ Change Alphabet Character Appearance/Layout

You can change the layout of the characters to a curved line, diagonal, etc. There are 6 choices total.

■ Change the Thread Colors of Patterns



You can change the thread colors of the pattern to your favorite colors.

■ Creating a Repeating Pattern

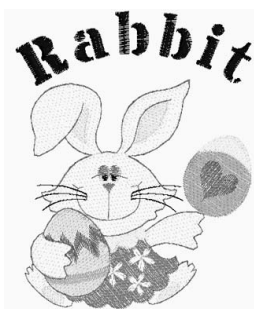
You can add copies of a pattern to create a pattern that repeats in a vertical or horizontal direction.



SELECTING PATTERNS TO EDIT

Prepare the machine for embroidery according to the instructions on “BEFORE EMBROIDERING” of “Basic operations”, and press , then  to display the screen below.

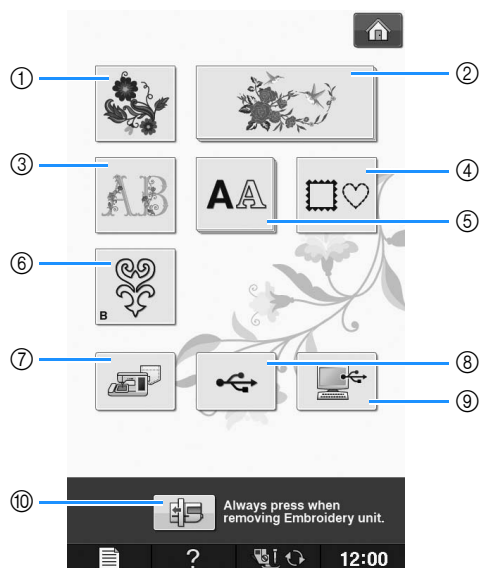

- ① Embroidery patterns
- ② Brother “Exclusives”
- ③ Floral alphabet patterns
- ④ Frame patterns
- ⑤ Character patterns
- ⑥ Bobbin work patterns (see “Appendix”)
- ⑦ Patterns saved in the machine’s memory (see page E-48)
- ⑧ Patterns saved in USB media (see page E-49)
- ⑨ Patterns saved on the computer (see page E-50)
- ⑩ Press this key to position the embroidery unit for storage.



Memo

- See included “Quick Reference Guide” for more information on each category’s selection screen.

Selecting Embroidery Patterns/Brother "Exclusives"/Floral Alphabet Patterns/Frame/Bobbin Work Patterns

- 1 Select the category of the pattern.
 - * Refer to "How to Create Bobbin Work" of "Appendix" about the bobbin work patterns.
- 2 Press the key of the pattern you want to edit.
 - * See page E-4 and E-7 for more information on selecting patterns.
 - The pattern is displayed in the top part of the screen.
- 3 Press **SET**.

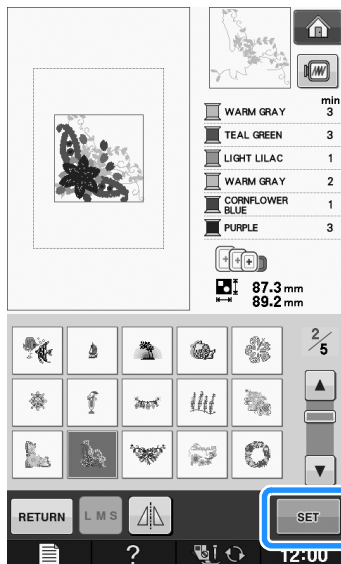

→ The pattern selected for editing is outlined in red on the "Embroidery Edit" display.

- 4 Proceed to "EDITING PATTERNS" on page E-61 to edit the pattern.

Selecting Alphabet Character Patterns

When you select character patterns from the "Embroidery Edit" screen, you can edit the appearance of the pattern at the same time.

- 1 Press **AA**.



- 2 Select the font, then enter the characters. (Example: A B C)

* See page E-5 for more information about selecting characters.

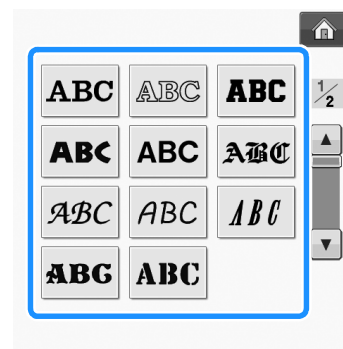



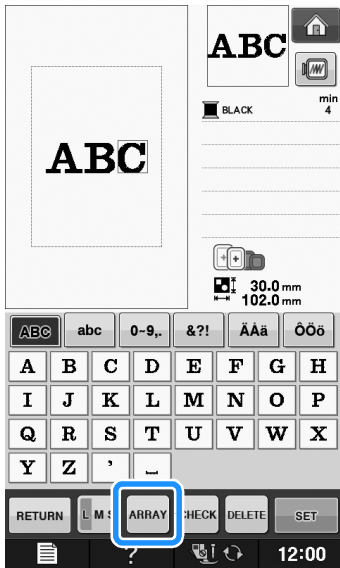

3 Press **ARRAY** to change the layout of the pattern.

* If the characters are too small to see, press **CHECK** to view a display of all entered characters.







4 Select the layout. (Example: )

When selecting an arc, use  and  to change the degree of the arc.

- * Press  to make the arc flatter.
- * Press  to make the arc rounder.

Memo

- When selecting ,  and  change to  and . You can increase or decrease the incline.

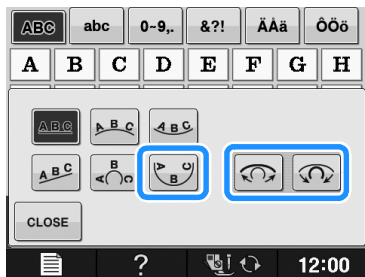

5 Press **CLOSE** to return to the original screen.

6 After you finish your selections, press

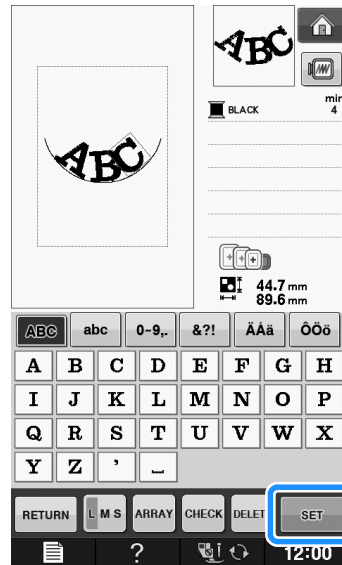

→ The “Embroidery Edit” screen will appear.

7 Proceed to “EDITING PATTERNS” on page E-61 to edit the pattern.

EDITING PATTERNS

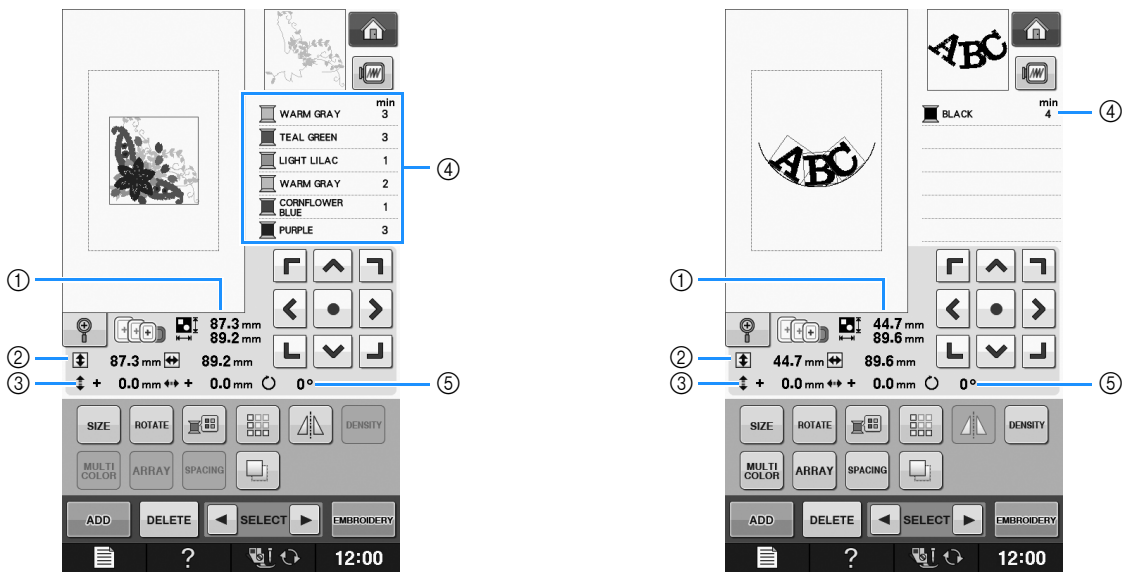

- ① Shows the size of the entire combined pattern.
- ② Shows the size of the pattern currently selected.
- ③ Shows the distance from the center of the frame.
- ④ Shows the color sequence and times of each step of the pattern currently selected.
- ⑤ Shows the degree of rotation for the pattern.

 **Memo**

- If a key display is light gray, you cannot use that function with the selected pattern.

■ Key Functions

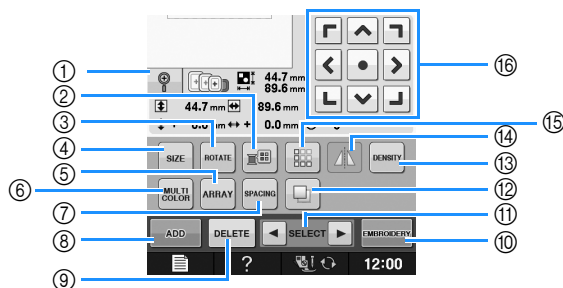

No.	Display	Key Name	Explanation	Page
①		Magnify key	Press this key to magnify the pattern by 200% in the screen.	E-63
②		Thread palette key	Press this key to change the colors of the displayed pattern.	E-67
③		Rotate key	Press this key to rotate the pattern. You can rotate a pattern one degree, ten degrees or ninety degrees at a time.	E-38
④		Size key	Press this key to change the size of the pattern. Patterns can be enlarged or reduced.	E-37
⑤		Array key	Press this key to change the configuration of a character pattern.	E-64
⑥		Multi color key	Press this key to change the color of individual characters in a pattern.	E-66
⑦		Character spacing key	Press this key to change the spacing of character patterns.	E-64
⑧		Add key	Press this key to add another pattern to the editing pattern.	E-79
⑨		Delete key	Press this key to delete the selected pattern (the pattern outlined by the red box).	E-63
⑩		"Embroidery" key	Press this key to call up the "Embroidery" screen.	E-79
⑪		Pattern select key	When a combined pattern is selected, use these keys to select a part of the pattern to edit.	E-64
⑫		Duplicate key	Press this key to duplicate a pattern.	E-78
⑬		Density key	Press this key to change the density of frame patterns or character patterns.	E-40
⑭		Horizontal mirror image key	Press this key to make a horizontal mirror image of the selected pattern.	E-39
⑮		Border key	Press this key to make and edit a repeating pattern.	E-72
⑯	 (Center key)	Arrow keys	Press these keys to move the pattern in the direction indicated by the arrow on the key. (Press to return the pattern to its original position.)	E-36

Moving the Pattern

For details on moving the pattern, refer to “Moving the Pattern” on page E-36.

Rotating the Pattern

For details on rotating the pattern, refer to “Rotating the Pattern” on page E-38.

Changing the Size of the Pattern

For details on changing the size of the pattern, refer to “Changing the Size of the Pattern” on page E-37.

Deleting the Pattern

Press **DELETE** to delete the pattern from the screen.

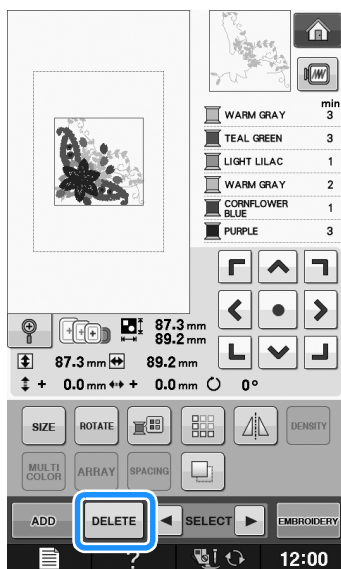

Displaying Patterns in the Screen Magnified by 200%

1 Press .

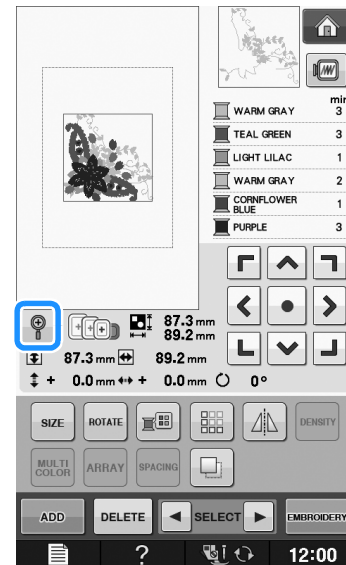

→ The pattern is magnified by 200%.

2 Check the displayed pattern.

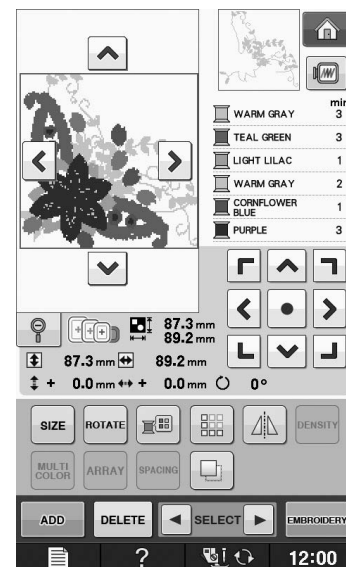

→ Use to scroll through the display in any direction.

3 To display the pattern back to the normal size (100%), press .

Changing the Configuration of Character Patterns

1 Press **ARRAY**.

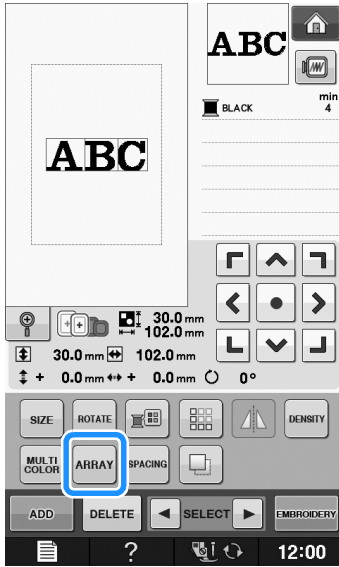

2 Press the key of the layout you want to embroider.

* See page E-60 for more information about layout types.

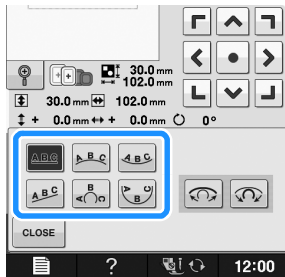

→ The display will show the selected layout.

3 Press **CLOSE**.

Changing Character Spacing

1 Press **SPACING**.

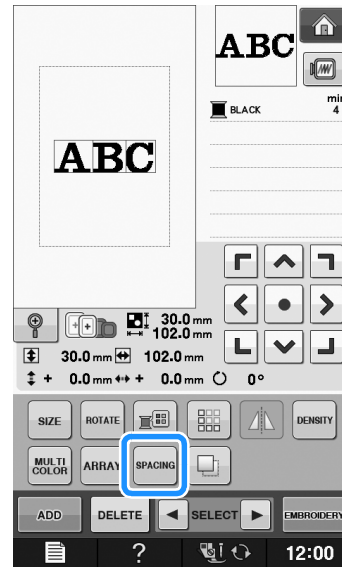

2 Use **A B C** to change the spacing.

- * Press **←ABC→** to increase the character spacing.
- * Press **→ABC←** to decrease the character spacing.
- * Press **A B C** to return the pattern to its original appearance.

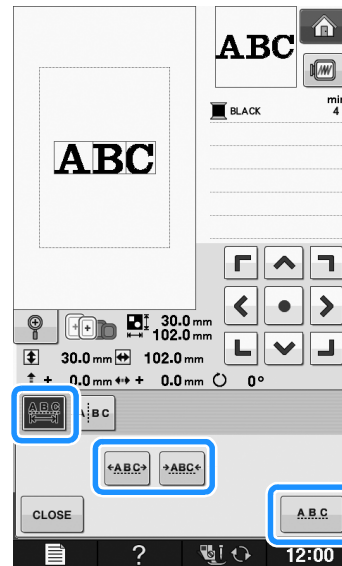

A B C ↔ ABC

←ABC→

→ABC←

3 Press **CLOSE** to return to the original screen.

Reducing Character Spacing

The spacing between characters can be reduced to 50% of the narrowest character in the group.



Note

- It is not recommended to edit data and transfer to other or older version machines. Same features do not apply in other machines, so problems may occur.
- Character spacing can be reduced only when characters are arranged normally on a straight line.

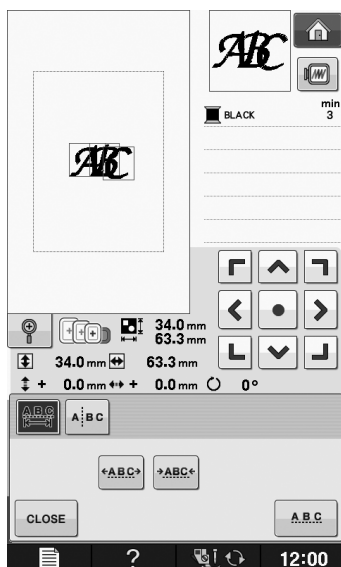
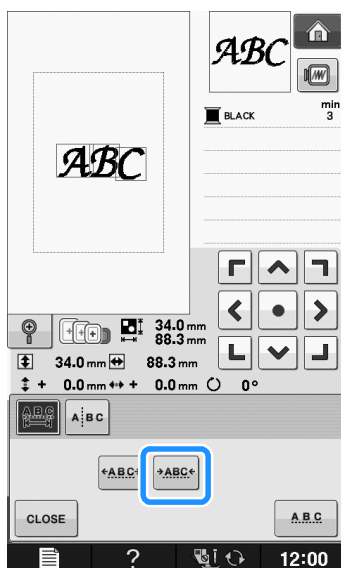

Separating Combined Character Patterns

Combined character patterns can be separated to adjust the character spacing or to separately edit the patterns after all characters have been entered.

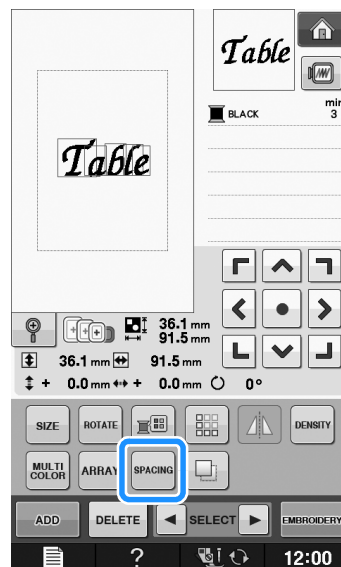

1 Press  .



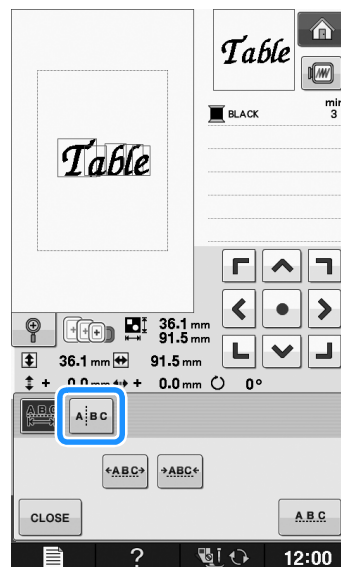

2 Press  .





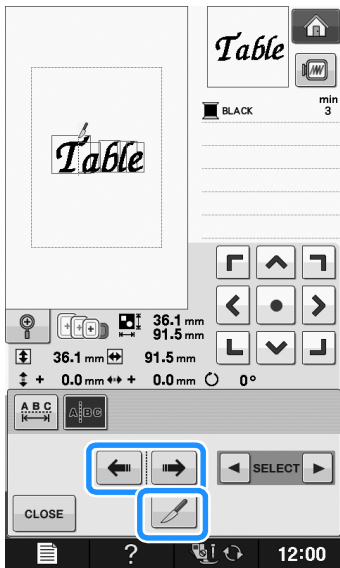



→ The key appears as  .

- 3 Use   to select where the pattern is to be separated, and then press  to separate it. For this example, the pattern will be separated between “T” and “a”.



Note
 • A separated character pattern cannot be combined again.

- 4 Use   to select a pattern, and then use     to adjust the character spacing.

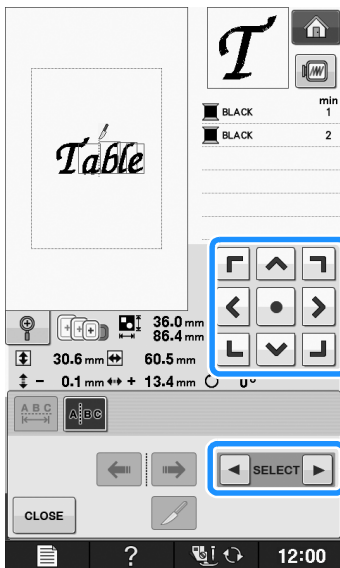

- 5 Press .

Changing the Color of Each Alphabet Character in a Pattern

- 1 Press  so you can assign a thread color to each character.

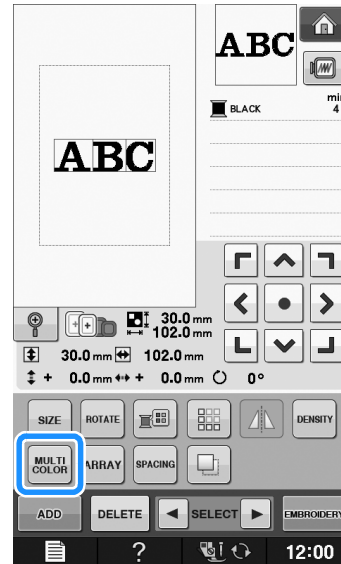

- 2 Change the thread to sew each character in a different color.

* Press  to change the colors in the sewing order.

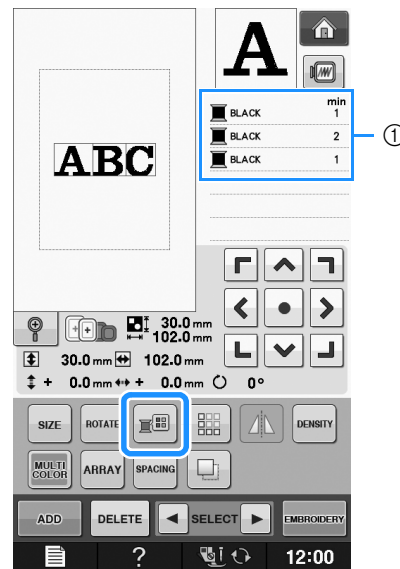

① Color for each character

Embroidering Linked Characters

You can embroider linked characters exemplified below, in a single row when the pattern extends beyond the embroidery frame.

For details on embroidering linked characters, refer to “Embroidering Linked Characters” on page E-41.

Example: Linking “DEF” to the characters “ABC”

A B C D E F



Changing the Thread Color

You can change the thread color by moving the color to be changed to the top of the sewing order and selecting a new color from the thread colors in the machine.

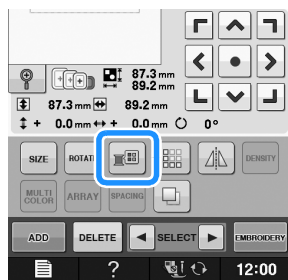
1 In the pattern editing screen, press .



→ The thread color palette screen displays.

2 Press  or  to put the color you want to change at the top of the sewing order.

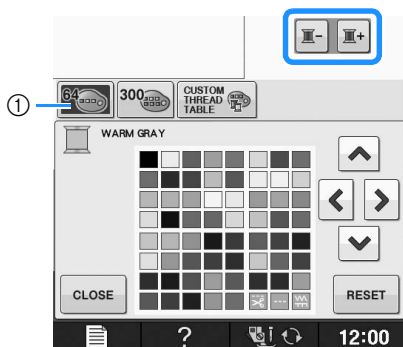

① 64 Embroidery threads table

3 Press , , , or  to choose a new color from the color palette.

- * To return to the original color, press . If multiple colors have been changed, this command will return all colors to their original colors.
- * You can select colors from the color palette by directly touching the color selection with the touch pen.

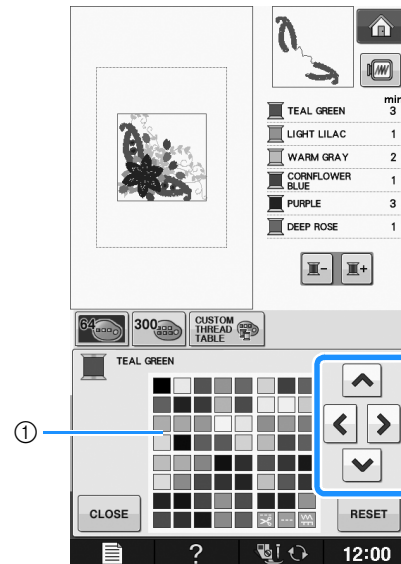

① Color palette

→ The selected color appears at the top of the sewing order.

4 Press .

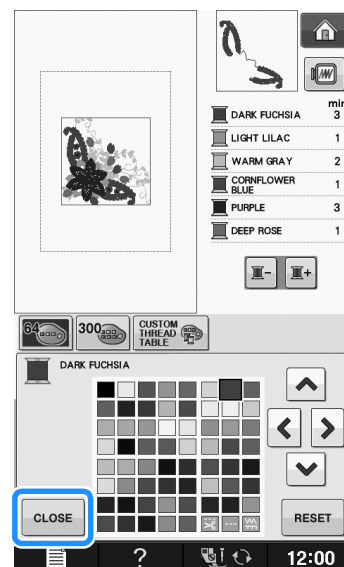

→ The display shows the changed colors.

Memo

- To select a color from the Custom Thread Table, “Choosing a Color from the Custom Thread Table” on page E-71.

Creating a Custom Thread Table

You can create a custom thread table containing the thread colors that you most often use. You can select thread colors from the machine's extensive list of thread colors from nine different thread brands. You can select any color and move the color to your custom thread table.



Note

- Some machines may already have an additional 300 Robison-Anton thread colors contained in the custom thread table. 300 Robison-Anton thread colors table data can be downloaded from our website “ <http://solutions.brother.com> ”.

1 In the pattern editing screen, press and then press .

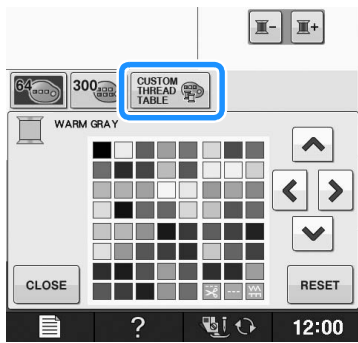

2 Use to choose where to add a color on the custom thread table.

- * You can choose colors from the custom thread table by directly touching the screen with the touch pen.
- * You can scroll through 100 colors at a time using and on the custom thread table.

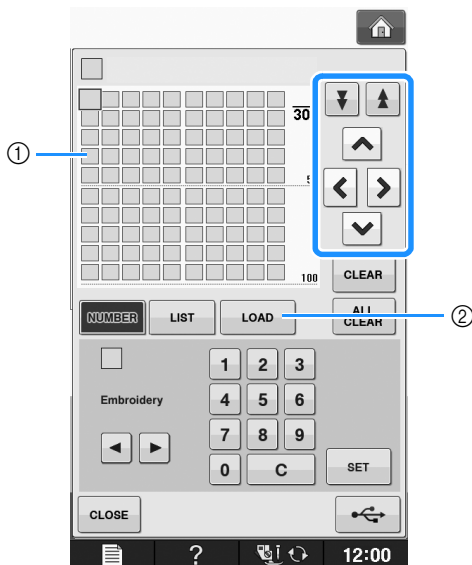

- ① Custom thread table
- ② Press to recall the custom thread table data (See page E-70)

3 Use to select one of the thread brands in the machine.

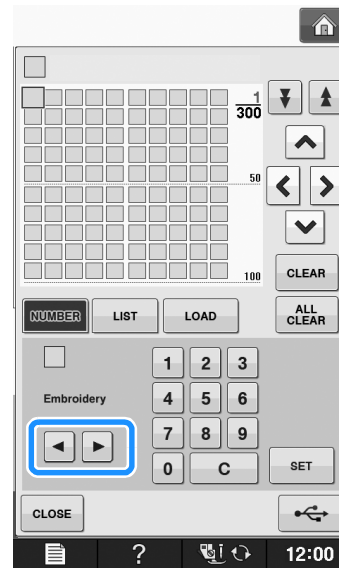

4 Use to enter a color's 4-digit number.

- * If you make a mistake, press to erase the entered number, and then enter the correct number.

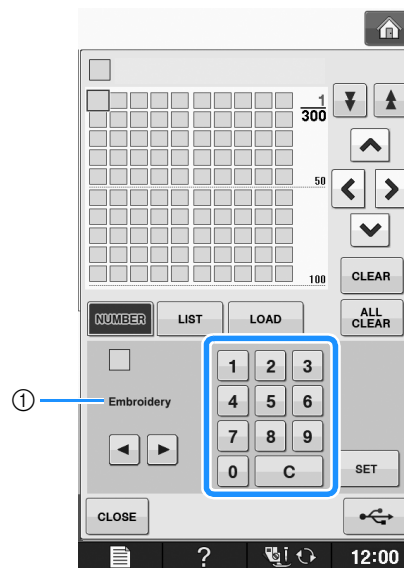

- ① Thread brand

5 Press **SET** .

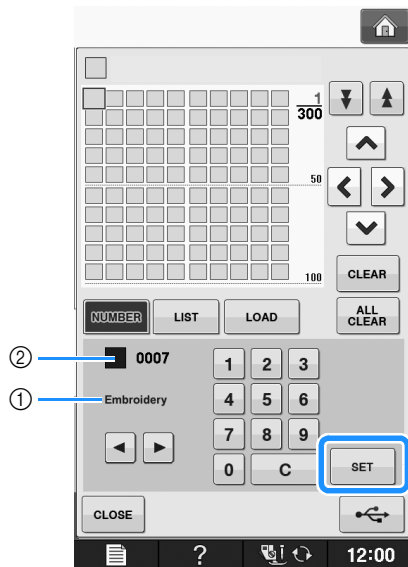

- ① Thread brand
 - ② Entered thread color number
- The selected thread color is set in the custom thread table.



Note

- If **SET** is not pressed, the thread color number will not be changed.

6 Repeat the previous steps until all desired thread colors are specified.

- * To delete a specified color from the palette, select the color to be deleted, and then press **CLEAR** .
- * To delete all the specified color from the palette, press **ALL CLEAR** .

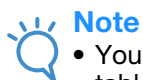

Note

- You can save the created custom thread table data. Refer to “Saving the Custom Thread Table to USB media” on page E-70 for the detailed procedure.

7 Press **CLOSE** to return to the original screen.

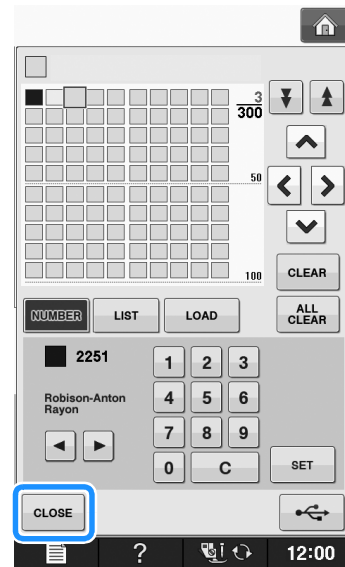

■ Adding a Color to the Custom Thread Table from the List

1 Repeat the previous steps **1** through **3** on page E-68.

2 Press **LIST** to display the thread list.

3 Use **▲** **▼** to select a thread color.

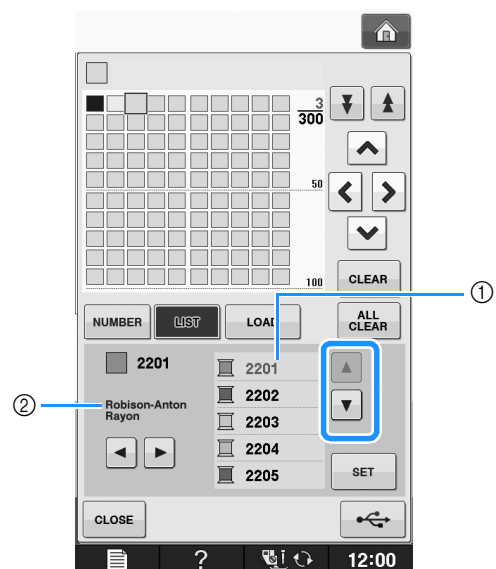

- ① Thread list
- ② Thread brand

4 Press **SET** .

5 Repeat the previous steps until all desired thread colors are specified.

- * To delete a specified color from the palette, select the color to be deleted, and then press **CLEAR**.
- * To delete all the specified color from the palette, press **ALL CLEAR**.

6 Press **CLOSE to return to the original screen.**

■ Saving the Custom Thread Table to USB media

You can save a custom thread table data file to USB media.



Note

- Custom thread table data can only be saved to USB media. You cannot save the data in the machine's memory or in the computer.
- Custom thread table data is saved as “.pcp” data file.

1 Press **TABLE and then press **CUSTOM THREAD TABLE**.**

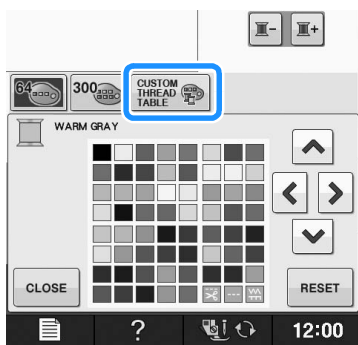

2 Set your desired colors in the custom thread table according to the procedure in “Creating a Custom Thread Table” on page E-68.

3 Insert the USB media into the USB port on the machine.

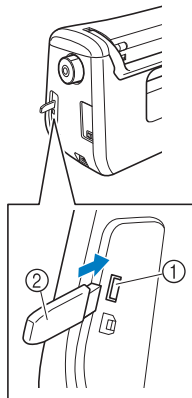

- ① USB port for mouse/media (USB 2.0)
- ② USB media

4 Press **USB.**

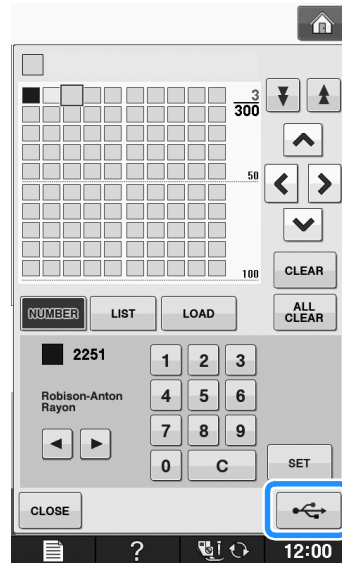

→ The “Saving” screen is displayed. When the data is saved, the display returns to the original screen automatically.



Note

- Do not insert or remove USB media while “Saving” screen is displayed. You will lose some or all of the data you are saving.

■ Recalling the Custom Thread Table data from USB media

You can recall a custom thread table data from USB media.





Note

- Do not store two or more “.pcp” data file in USB media. You can only recall one custom thread table data at a time.

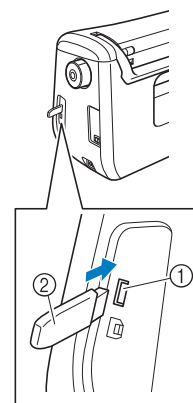
1 Insert the USB media containing the custom thread table data into the USB port.



- ① USB port for mouse/media (USB 2.0)
- ② USB media

2 Press  and then press .

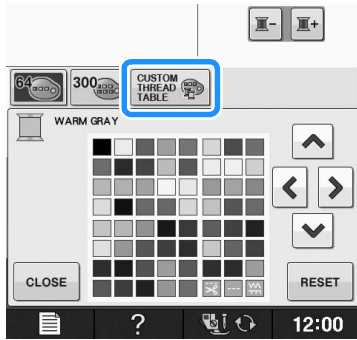

3 Press .

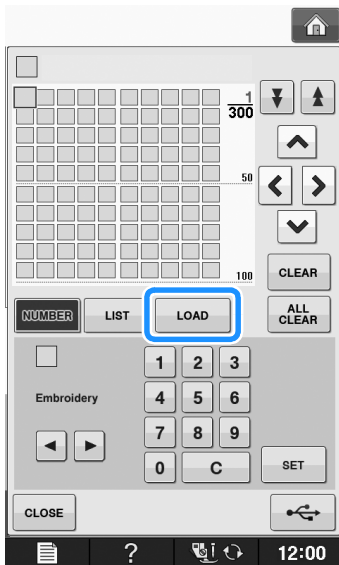

→ The “Saving” screen is displayed. When the data is loaded to the machine, the display returns to the original screen automatically.



Note

- Do not insert or remove USB media while “Saving” screen is displayed. You will lose some or all of the data you are saving.

4 The recalled custom thread table is displayed on the screen.



Choosing a Color from the Custom Thread Table

You can select a color from the up to 300 thread colors you have set in the custom thread table.

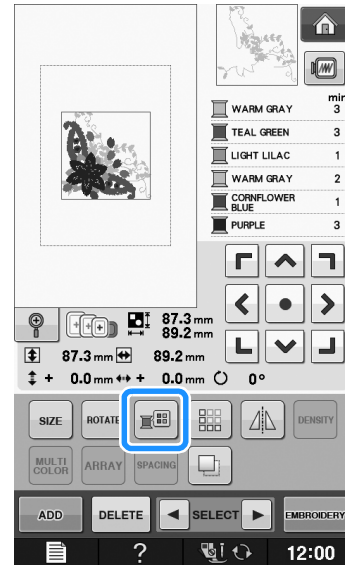
1 Press .



→ The thread color palette screen displays.

2 Press  or  to put the color you want to change at the top of the sewing order.

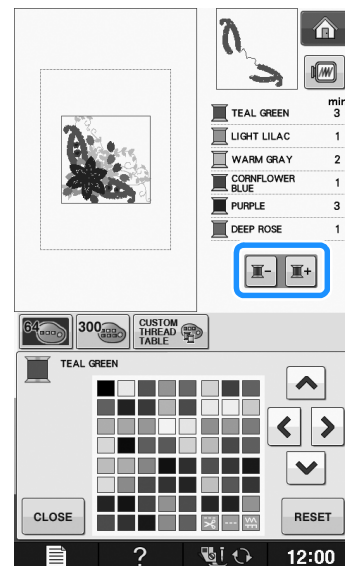

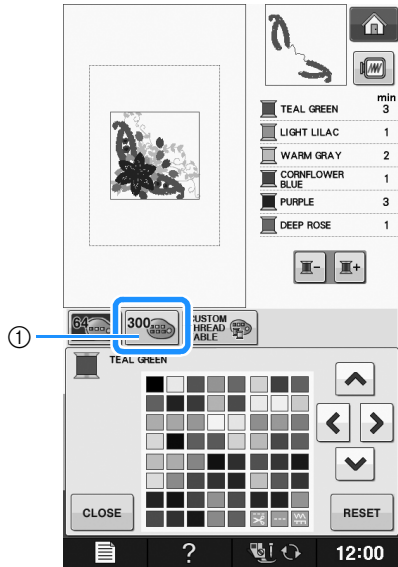

3 Press  .



① Custom thread change key
→ The custom thread table will appear.

4 Press     to choose a new color from the custom thread table.

- * Use  and  to scroll through the custom thread table.
- * Press  to return to the original color.
- * You can choose colors from the custom thread table by directly touching the screen with the touch pen.

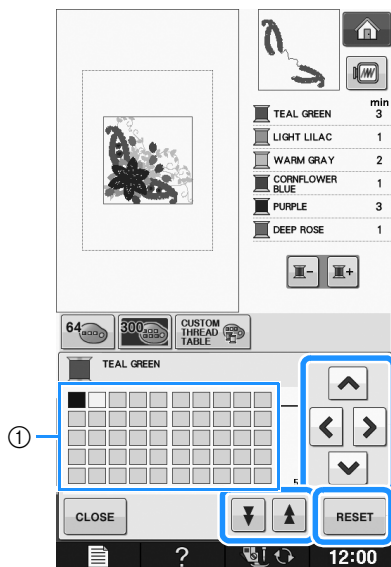

① Custom thread table
→ The display shows the changed colors.

5 Press  .

Designing Repeated Patterns

■ Sewing Repeated Patterns

Using the border function, you can create stitches using repeated patterns. You can also adjust the spacing of the patterns within a repeated pattern stitch.

1 Select a pattern, and then press  .

2 Press  .

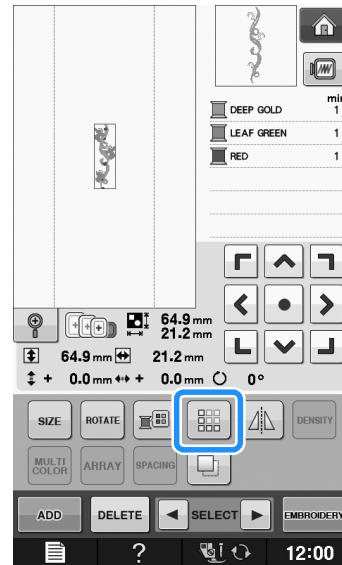



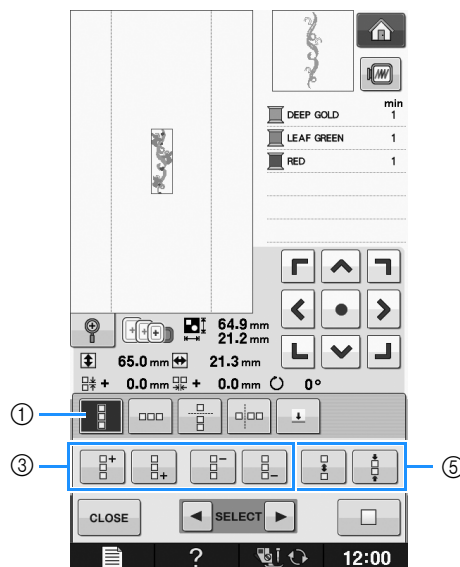

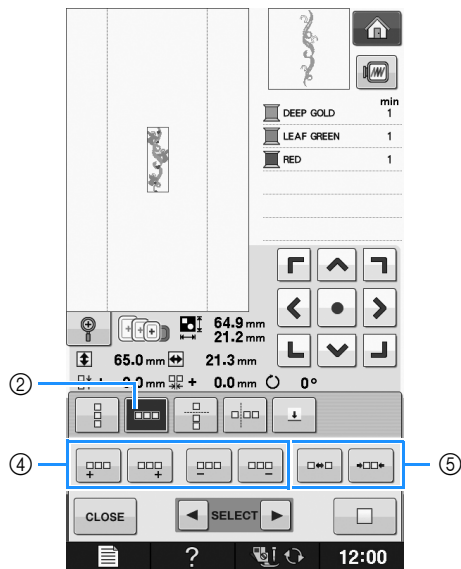
3 Select the direction in which the pattern will be repeated.







- ① Vertical direction
 - ② Horizontal direction
 - ③ Repeating and deleting vertical keys
 - ④ Repeating and deleting horizontal keys
 - ⑤ Spacing keys
- The pattern direction indicator will change depending on the direction selected.

4 Use  to repeat the pattern on top and  to repeat the pattern at the bottom.

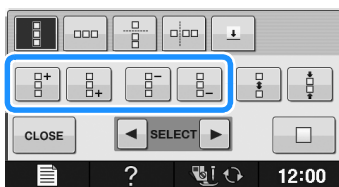
- * To delete the top pattern, press .
- * To delete the bottom pattern, press .



5 Adjust the spacing of the repeated pattern.

- * To widen spacing, press .
- * To tighten spacing, press .

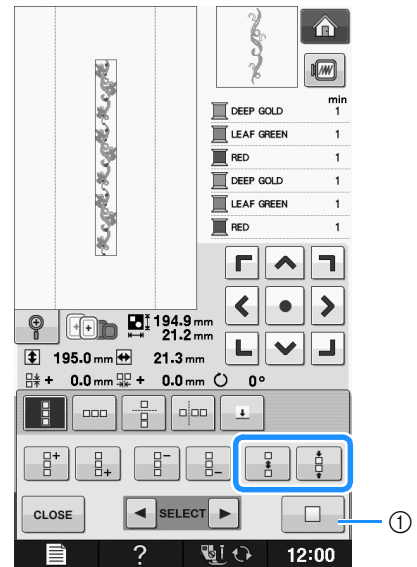

- ① Press  to change a repeated pattern back to one single pattern.

 **Memo**

- You can only adjust the spacing of patterns included in the red frame.

6 Complete repeated patterns by repeating steps ③ through ⑤.

7 Press  to finish repeating.

 **Memo**

- When there are two or more patterns, all patterns will be grouped together as one pattern in the red frame.

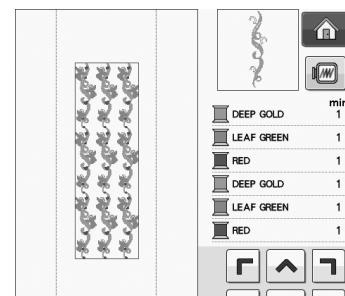



- When changing the direction in which the pattern will be repeated, all of the patterns in the red frame will automatically be grouped as one repeating unit. Press  to change a repeated pattern back to one single pattern. See the following section on how to repeat one element of a repeated pattern.

■ Repeating One Element of a Repeated Pattern

By using the Cut function, you can select one element of a repeated pattern and repeat only that single element. This function allows you to design complex repeated patterns.

1 Choose the direction in which the repeated pattern will be cut.

- * Press  to cut horizontally.
- * Press  to cut vertically.

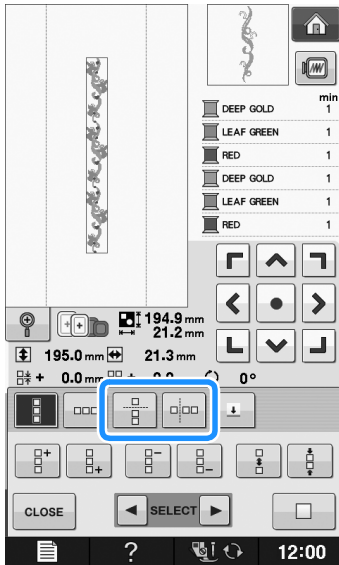

→ The pattern direction indicator will change depending on the direction selected.

2 Use and to select the cut line.

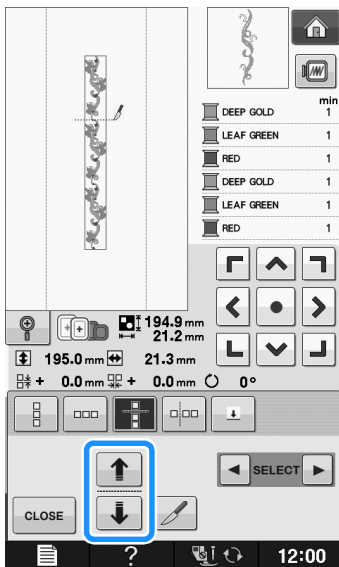

→ The cut line will move.

3 Press .

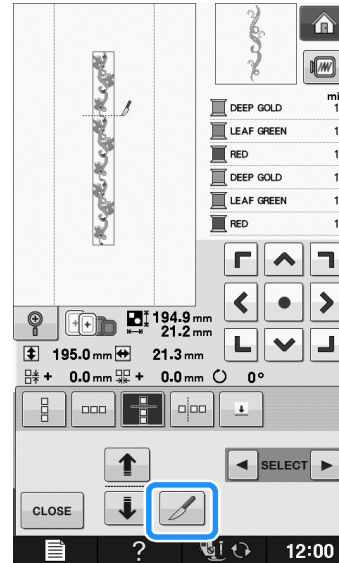

→ The repeated pattern will be divided into separate elements.

4 Press .

5 Use and to select the element to repeat.

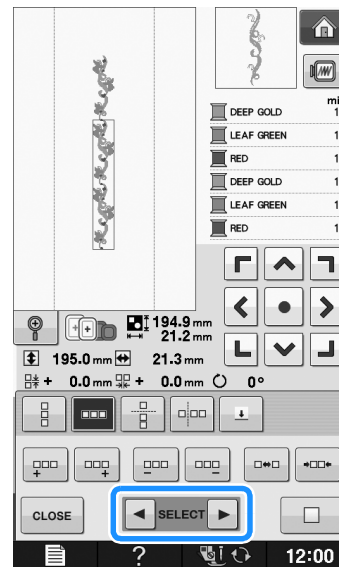

6 Repeat the selected element.

7 Press **CLOSE** to finish repeating.

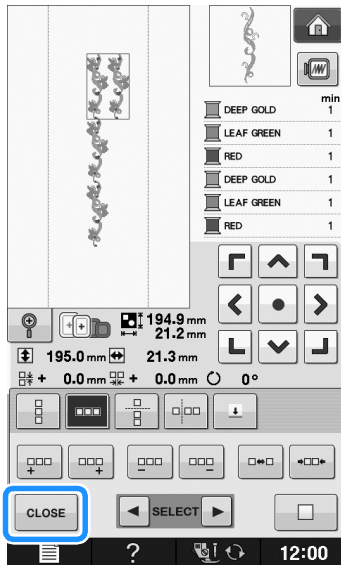

Note

- Once you have cut a repeated pattern into separate elements, you cannot return to the original repeated pattern.
- Each element can be edited separately in the edit screen. See “Selecting combined embroidery patterns” on page E-82.

Color Sorting Repeated Patterns

Press **EMBROIDERY** to automatically change the sewing order of colors in combined border embroidery patterns so that the same color can be continuously sewn. This allows you to continue sewing without repeatedly changing the upper thread or changing the sewing order manually.

Memo

- In combined stitch patterns that contain two or more border patterns or other patterns combined with border patterns, the sewing order of only the border patterns is changed.
- When a group of two or more patterns using border patterns is repeated, the sewing order is changed so that the same color can be sewn continuously in each pattern.

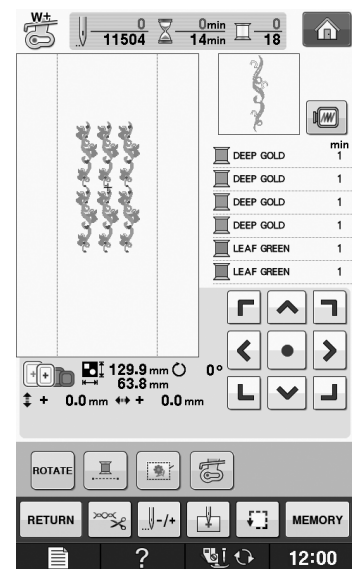
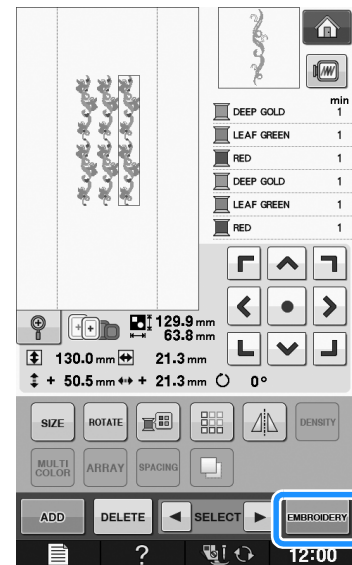

Assigning Thread Marks

By sewing thread marks, you can easily align patterns when embroidering a series. When sewing is finished on a pattern, a thread mark in the shape of an arrow will be sewn using the final thread. When sewing a series of patterns, use the point of this arrow for positioning the following designs to be sewn.



Memo

- When repeatedly sewing individual patterns, thread marks can be sewn around the perimeter of the pattern only.

1 Press .

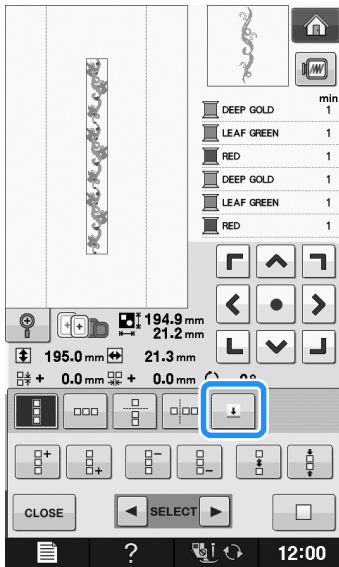



2 Press .

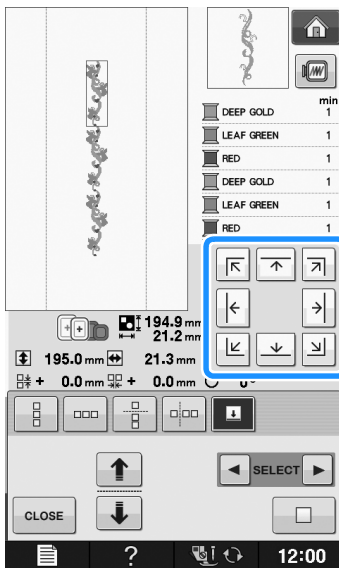

3 Press   to select the thread mark to be sewn.



 **Memo**

- When there are two or more elements, use  and  or  and  to select a pattern that you want to assign a thread mark(s) to.

4 Press .

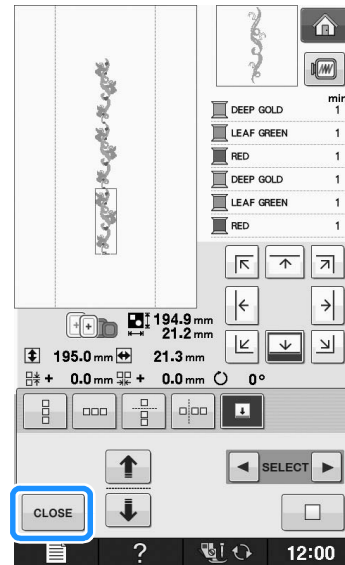

Embroidering the Pattern Repeatedly

After creating the repeated pattern, rehoop the embroidery frame and keep sewing for the next pattern.

 **Memo**

- The optional border frame allows you to easily rehoop the fabric without removing the embroidery frame from the machine.

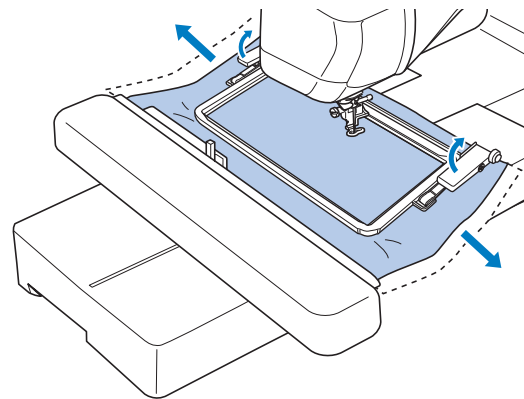

1 Create the repeated pattern with the thread mark at the center of the end of the pattern.

* Refer to "Assigning Thread Marks" on page E-75.

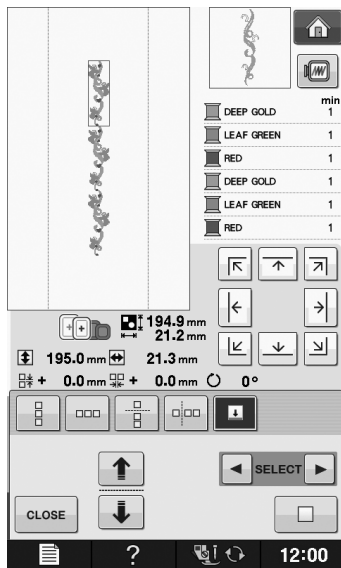

2 Press **CLOSE, then **EMBROIDERY**.**

3 Press the "Start/Stop" button to begin embroidering.

→ When embroidering is finished, the thread mark is sewn with the last thread color.



4 Remove the embroidery frame.

5 Rehoop the fabric in the embroidery frame.



Note

• Adjust the position of the fabric so that the embroidering area for the next pattern is within the embroidering area of the embroidery sheet.

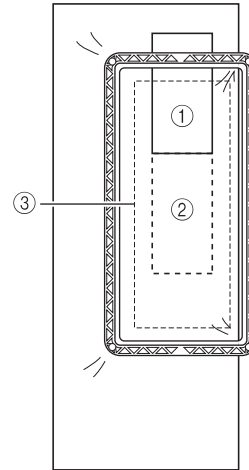

- ① Pattern embroidered first
- ② Position of pattern to be embroidered next
- ③ Embroidering area of embroidery sheet

6 Attach the embroidery frame to the machine, and then touch .

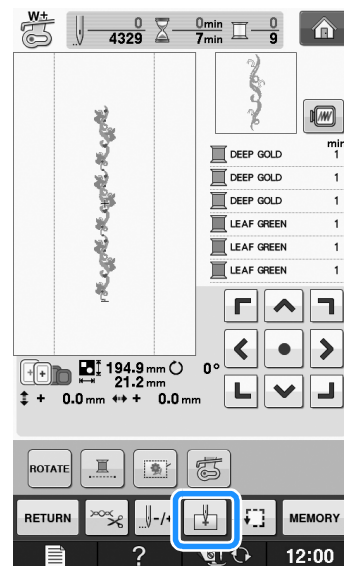

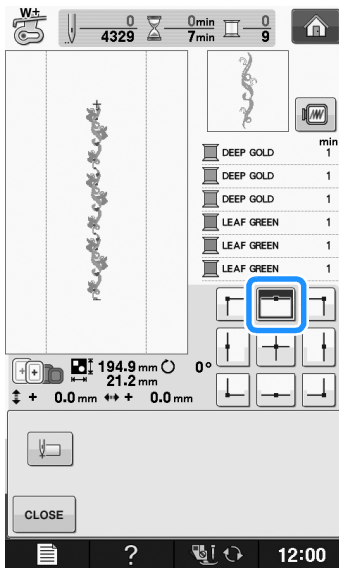

- 7** Touch  to set the starting point to the center top of the pattern.

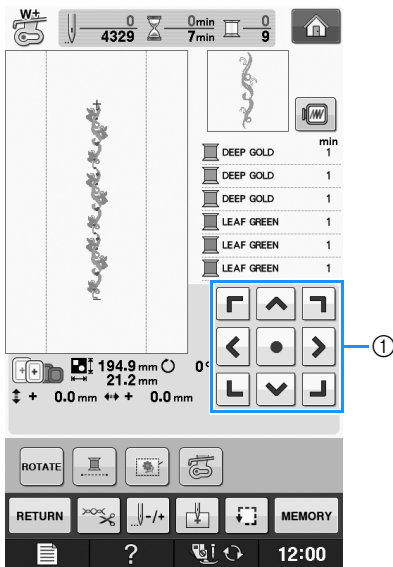

- 8** Touch .

- 9** Press the positioning keys to move the embroidery frame until the starting point is aligned with the thread mark on the fabric.



- ① Positioning keys
 * Press  to check the embroidering position.

- 10** Remove the thread mark.

- 11** Press the “Start/Stop” button to begin embroidering.

Duplicating a Pattern

- 1** Press .

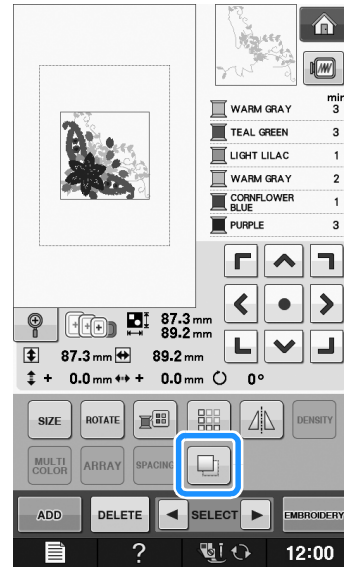

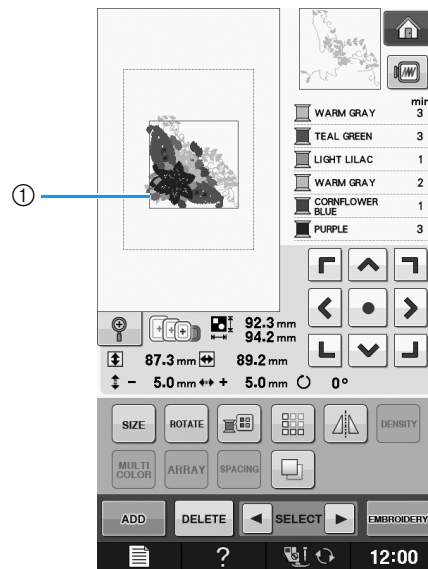

→ The duplicate is positioned over the original pattern.



- ① Duplicated pattern

Note

- If multiple patterns are displayed in the screen, only the pattern selected using  and  is duplicated.
- Move and edit each duplicated pattern individually.

After Editing

1 Press **EMBROIDERY**.

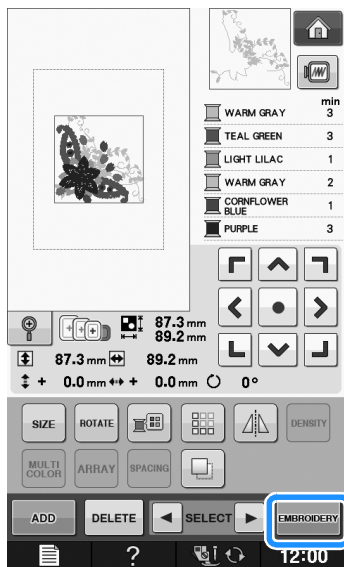

- * To combine the pattern with other patterns, select **ADD** (see page E-80).
- * See page E-21 for more information about sewing patterns.



Memo

- If you want to return to the edit screen after pressing **EMBROIDERY**, press **RETURN**.

COMBINING PATTERNS

Editing Combined Patterns

Example: Combining alphabet characters with an embroidery pattern and editing



1 Press  to select an embroidery pattern.

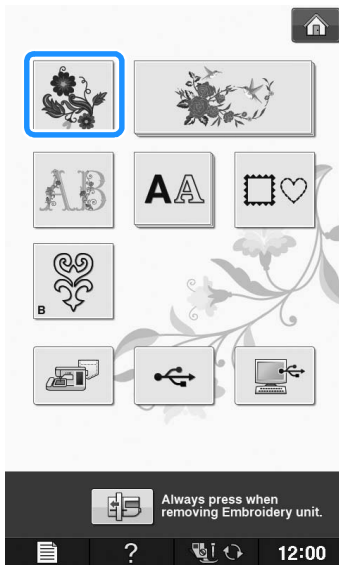

2 Select  .

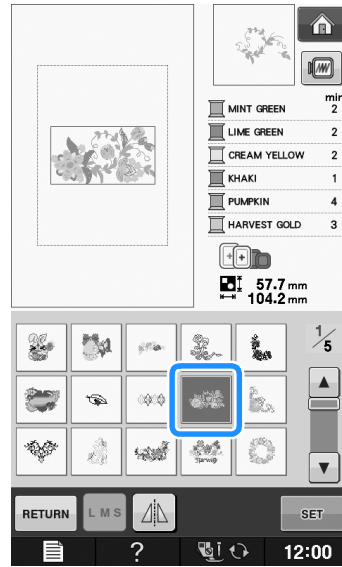

3 Press  .

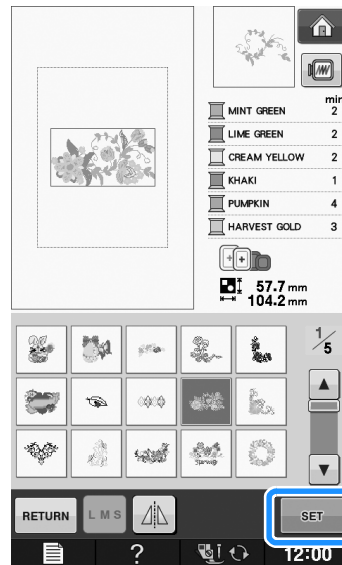

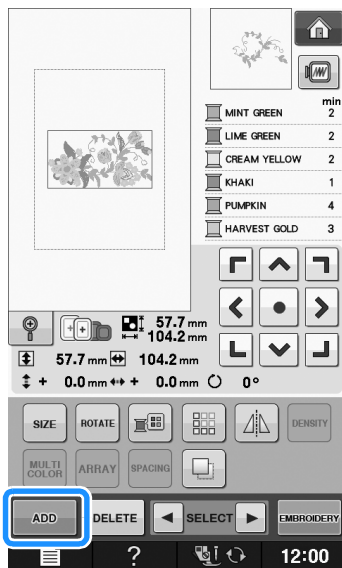
4 Press **ADD**.5 Press **AA** to enter the alphabet characters.

* Press **RETURN** to return to the previous screen.

6 Select **ABC** and enter "Flower".

* After selecting **F**, press **abc** to change the character case, then enter the remaining characters.

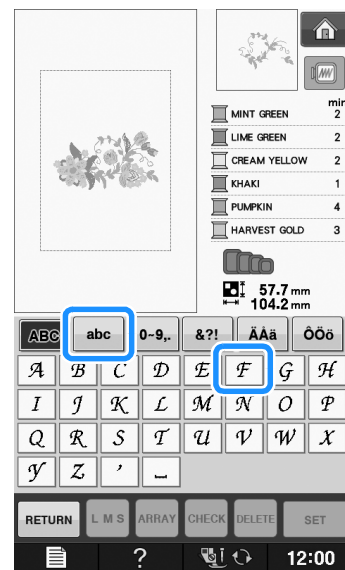

→ The characters you enter will be displayed in the center of the display.

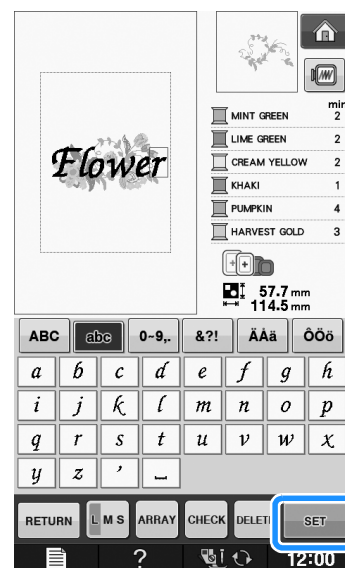
7 Press **SET**.8 Use **← ↑ → ↓** to move the characters.

* With a USB mouse, your finger or the touch pen, drag the characters to move them.

9 Press **ARRAY** to change the layout of the characters. Press **CLOSE**.

* See page E-64 for more information about changing the layout.

10 Press  to change the color of the characters.

* See page E-67 for more information about changing the color.

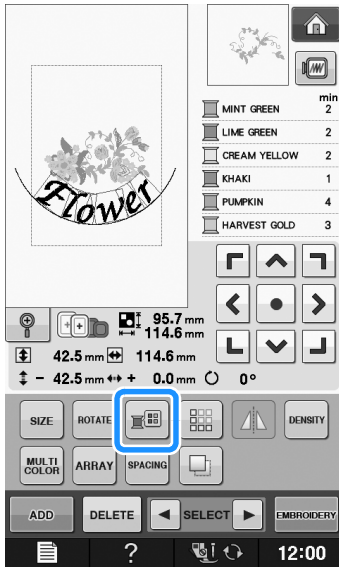

11 When all editing is finished, press .

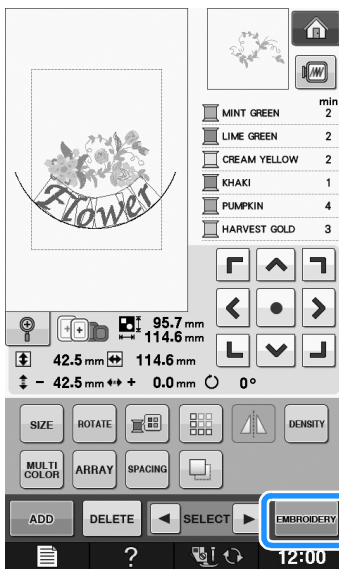

■ Selecting combined embroidery patterns

If multiple patterns have been combined, use



 to select the pattern to be edited. If a USB mouse is connected, the pattern can be selected by clicking it. Move the mouse to position the pointer over the desired pattern, and then click the left mouse button. In addition, patterns can be selected by directly touching the screen with your finger or touch pen.

 **Memo**

- Use  to select patterns that are overlapping and cannot be selected by clicking them or by touching the screen.

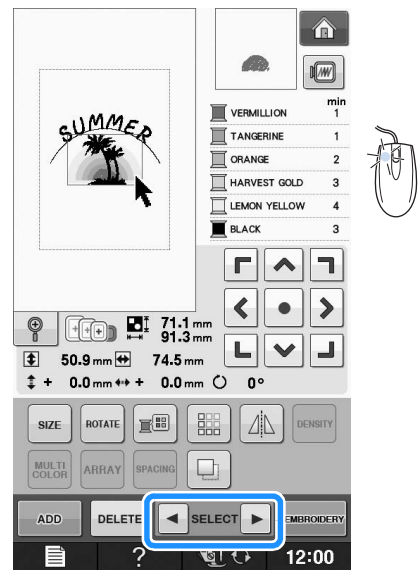
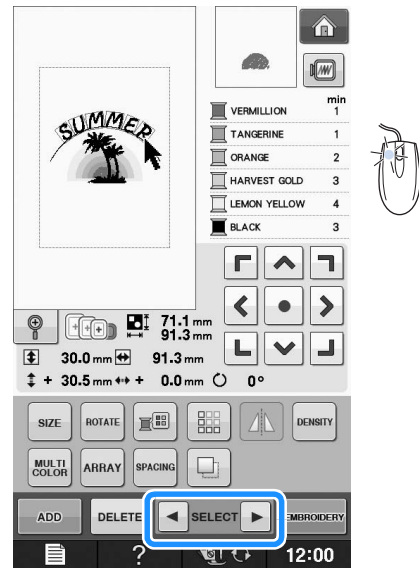

Sewing Combined Patterns

Combined patterns will be embroidered in the order they were entered. In this example, the embroidery order will be as follows:



Note

- Follow the directions in “Sewing Embroidery Patterns” on page E-22.

1 Embroider  by following the color order on the right side of the display.

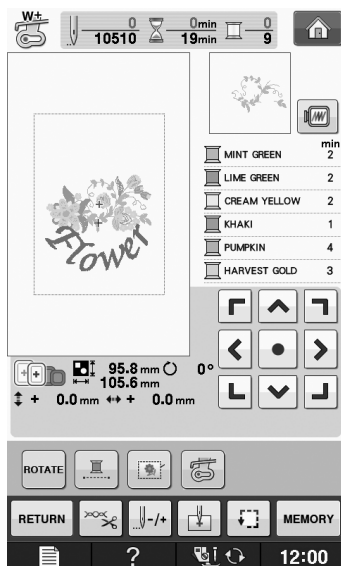

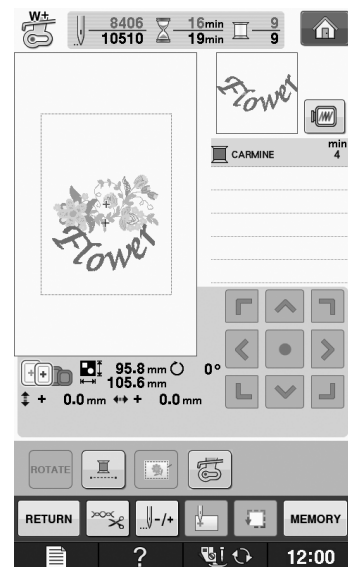

→ After the flowers are embroidered, the [+] cursor will move to the “Flower” part of the pattern.

2 Embroider .



VARIOUS EMBROIDERING FUNCTIONS

Uninterrupted Embroidering (Monochrome - Using a Single Color)

A selected pattern can be stitched out in one color instead of multicolor. The machine will hesitate but not stop between color steps, and then continue till the pattern is completed. Press  for the multicolor steps to become shaded and the selected pattern will embroider in a single color, instead of changing the thread while embroidering. Press  again to return to the pattern's original settings.

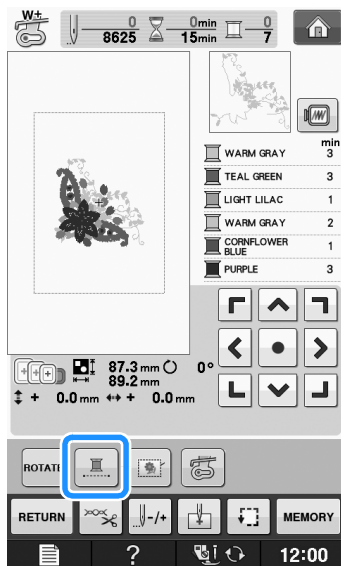

Basting Embroidery



Before embroidering, basting stitches can be sewn along the outline of the pattern. This is useful for embroidering fabric that cannot have stabilizer material affixed with an iron or adhesive. By stitching stabilizer material to the fabric, shrinkage of the stitching or misaligned pattern can be minimized.



Note

- It is recommended to finish combining and editing the pattern before selecting the basting setting. If the pattern is edited after selecting the basting setting, the basting and pattern may become misaligned, and the basting under the pattern may be difficult to remove after embroidering is complete.

1 Press .

2 In the "Embroidery Basting Distance" display, use  and  to specify the distance from the pattern to the basting stitching.

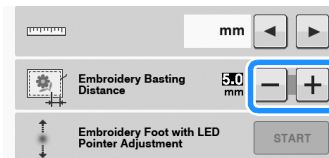

Memo

- The higher the setting, the farther the basting is from the pattern.
- The setting remains selected even if the machine is turned off.

3 Press  to return to the previous screen.

4 Press .

5 Press  to select the basting setting.

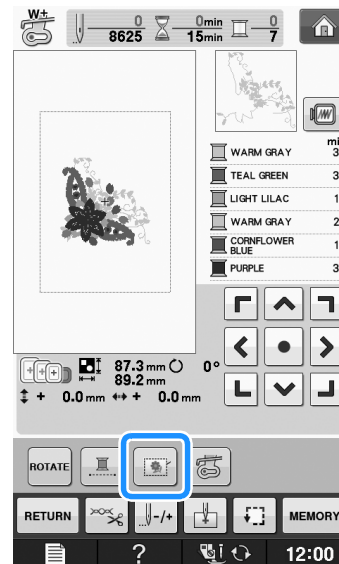

Note

- When  is pressed, the pattern is moved to the center. After selecting the basting setting, move the pattern to the desired position.

**Memo**

- To cancel the setting, press .

→ Basting is added to the beginning of the sewing order.

6

Press the “Start/Stop” button to begin embroidering.

7

When embroidering is finished, remove the basting stitching.

**E
2**

Embroidery Edit

USING THE MEMORY FUNCTION

In the same way as embroidery patterns in Chapter 1, you can save and retrieve edited embroidery patterns to and from the machine’s memory, a personal computer, or USB media. Refer to the relevant sections in Chapter 1 on saving and retrieving embroidery patterns and follow the same procedures in order to save and retrieve edited embroidery patterns.

See page E-44 for more information about the memory function.



Appendix

This section provides important information for operating this machine. Please read this section to find troubleshooting tips and pointers as well as how to keep your machine in the best working order.

Page number starts with “A” in this section.

The screen display and machine illustration may vary slightly, depending on the countries or regions.

Chapter1 How to Create Bobbin Work A-2

Chapter2 Maintenance and Troubleshooting..... A-18

Chapter 1

How to Create Bobbin Work

ABOUT BOBBIN WORK.....	3
PREPARING FOR BOBBIN WORK.....	3
Required Materials.....	3
■ Bobbin case and bobbin cover	3
■ Lower thread.....	4
■ Upper thread	4
■ Needle	4
■ Presser foot	4
■ Fabric.....	4
Upper Threading.....	4
Preparing the Bobbin Thread	5
■ When tension is applied to the bobbin thread.....	6
■ When tension is not applied to the bobbin thread	7
CREATING BOBBIN WORK (SEWING)	9
Positioning the Fabric and Sewing	9
■ Finishing the thread ends	11
Bobbin Work Free Motion Sewing	11
CREATING BOBBIN WORK (EMBROIDERY)	12
Selecting the Pattern	12
Start Embroidering.....	14
ADJUSTING THE THREAD TENSION	16
■ Adjusting the upper thread tension	16
■ Adjusting the tension of the bobbin thread	16
TROUBLESHOOTING	17
■ The thread was accidentally cut automatically and the bobbin thread is caught inside the machine	17
■ Correcting bobbin work tension	17
■ The bobbin thread catches on the tension spring of the bobbin case.....	17

ABOUT BOBBIN WORK

Beautiful embroidery work, with a three-dimensional appearance, can be created by winding the bobbin with medium to heavy weight thread or ribbon, which is too thick to be threaded through the machine's needle. The decorative thread or ribbon will stitch out on the underneath side of fabric while sewing with the fabric wrong side facing up.

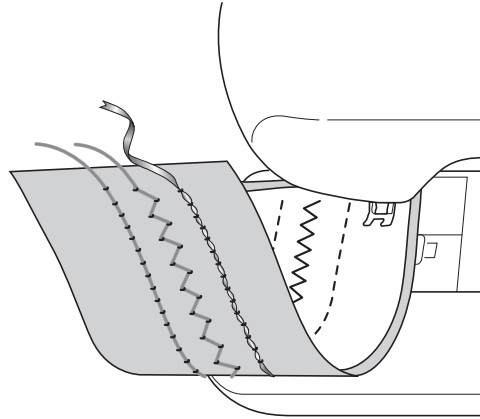

1. Utility stitches

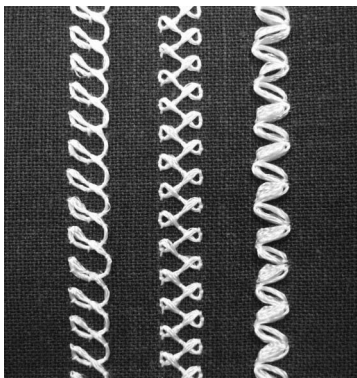

2. Decorative stitches

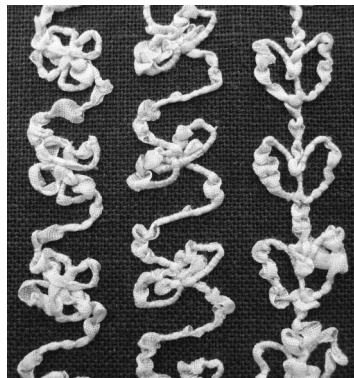

3. Free motion sewing

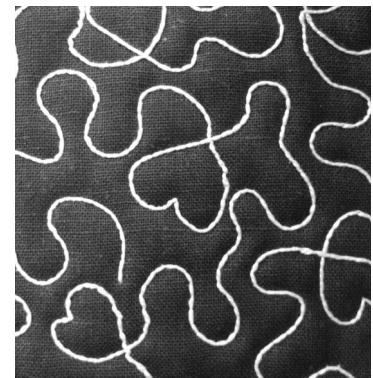

Bobbin work embroidery is sewn using the bobbin work patterns included with this machine.

PREPARING FOR BOBBIN WORK

Required Materials

■ Bobbin case and bobbin cover

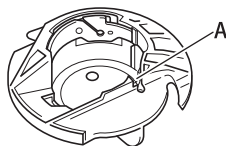

- ① Bobbin case (gray)
There is a notch at the location indicated by the letter "A".

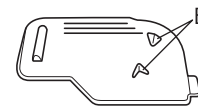

- ① Bobbin cover
There are two small v-shaped tabs on the back of the bobbin cover as indicated by the letter "B". The tabs help hold the bobbin in place so it does not lift up while thick thread is being pulled through.

■ Lower thread

We recommend the following types of threads for bobbin work.



No.5 or finer hand embroidery thread or decorative thread



Flexible woven ribbon
(When embroidering: approx. 2 mm (approx. 5/64 inch) is recommended)

<Sewing only>



Fine embroidery ribbon (silk or silk-like material) (3.5 mm (approx. 1/8 inch) or less is recommended)

* When wide ribbon or heavy weight threads are being used, we recommend test sewing with and without bobbin case tension being applied to see which gives the best stitching results. If wide ribbon such as 3.5 mm (approx. 1/8 inch) is to be used, we recommend that bobbin case tension not be applied. Refer to page A-7 for more detailed instructions.



Note

- Do not use thread heavier than No.5 hand embroidery thread.
- Some threads may not be appropriate for bobbin work. Be sure to sew trial stitches before sewing on your project.

■ Upper thread

Sewing machine embroidery thread (polyester thread) or monofilament (transparent nylon) thread. If you do not wish for the upper thread to be visible, we recommend using transparent nylon monofilament thread or polyester light weight thread (50 wt. or above) that is the same color as the lower thread.

■ Needle

Use a needle appropriate for the upper thread and fabric being used. Refer to "Fabric/Thread/Needle Combinations" on page B-57 and "Embroidery Step by Step" on page B-58.

■ Presser foot

Utility stitches or decorative stitches:
Monogramming foot "N"



Free motion sewing:
Free motion open toe quilting foot "O"

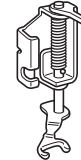

Embroidery foot "W" or embroidery foot with LED pointer "W+"

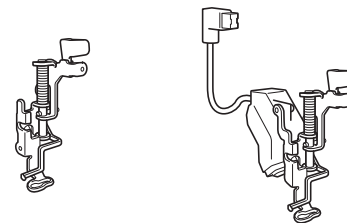

■ Fabric

Be sure to sew trial stitches on a piece of scrap fabric, which includes the same threads and fabric as what is being used in your project.



Note

- The sewing results may be affected by the type of fabric used. Before sewing your project, be sure to sew trial stitches on a piece of scrap fabric that is the same as the fabric used in the project.

Upper Threading

1 Install a needle appropriate for the upper thread and fabric to be used.

For details on installing the needle, refer to "CHANGING THE NEEDLE" on page B-55.

2 Attach the presser foot.

3 Thread the machine with the upper thread.

For details on threading the machine, refer to "Upper Threading" on page B-46.

Preparing the Bobbin Thread

In order to create bobbin work, the bobbin case must be replaced with the one for bobbin work.

Before creating bobbin work, clean the bobbin case and the race.

- 1 Raise the needle and presser foot, and then turn off the machine.
- 2 Remove the flat bed attachment or embroidery unit.
- 3 Grasp both sides of the needle plate cover, and then slide it toward you to remove it.

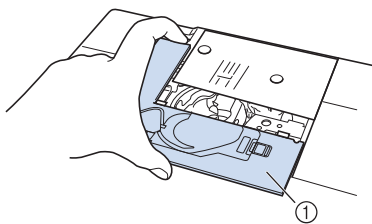

① Needle plate cover

- 4 Remove the bobbin case.

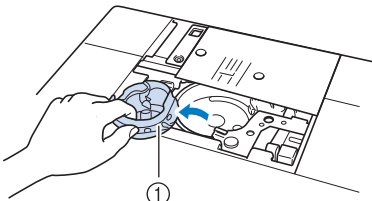

① Bobbin case

- 5 Use the cleaning brush included with the machine or a vacuum cleaner to remove any lint and dust from the race and its surrounding area.

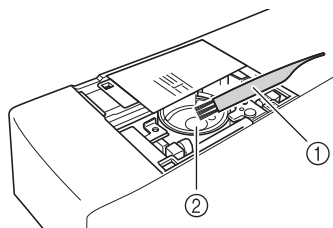

① Cleaning brush
② Race

- 6 Wipe the bobbin case (gray) with a soft lint free cloth to clean it.
- 7 Insert the bobbin case so that the ▲ mark on the bobbin case aligns with the ● mark on the machine.

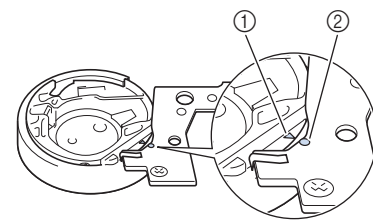
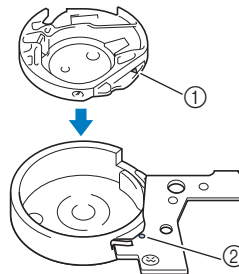

* Align the ▲ and ● marks.

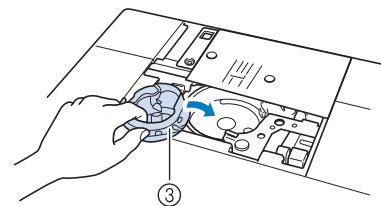

① ▲ mark
② ● mark
③ Bobbin case



Note

- The bobbin case (gray) cannot be used for sewing in any way other than bobbin work. After sewing bobbin work, refer back to the steps in “Preparing the Bobbin Thread” on page A-5 for removing and cleaning the bobbin case (gray), and then reinstall the standard bobbin case.

CAUTION

- Be sure to use the bobbin case (gray) when creating bobbin work. Using any other bobbin case may result in the thread becoming tangled or damage to the machine.
- Make sure that the bobbin case is correctly installed. If the bobbin case is incorrectly installed, the thread may become tangled or the machine may be damaged.

- 8 Wind a decorative thread around the bobbin by hand. After winding the bobbin so it is filled as shown below (about 80%), cut the thread.



For precautions on winding the bobbin for embroidering, refer to step 2 of "Selecting the Pattern" on page A-12.

CAUTION

- Be sure to use the machine's included bobbin or one designed specifically for this machine. Using any other bobbin may result in damage or injuries.

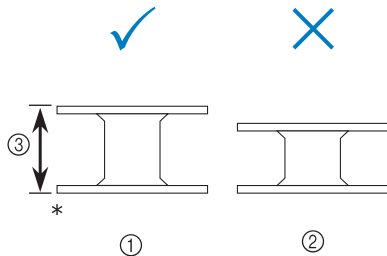

- * Actual size
- ① This model
- ② Other models
- ③ 11.5 mm (approx. 7/16 inch)

Note

- Slowly and evenly wind the thread around the bobbin.
- For best results, wind the bobbin so the thread is snug and not twisted.

- 9 Using scissors carefully trim the thread tail as close to the bobbin as possible.

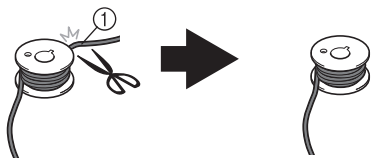

① Beginning of wound thread

CAUTION

- If thread extends beyond the top of the bobbin too much, the thread may become tangled or the needle may break.

- 10 Install the bobbin wound with thread.

Whether or not tension should be applied to the bobbin thread depends on the type of thread being used.

When tension is applied to the bobbin thread

Insert bobbin into bobbin case so the thread unwinds from the left side. Then correctly pass the thread through the tension spring as shown below.

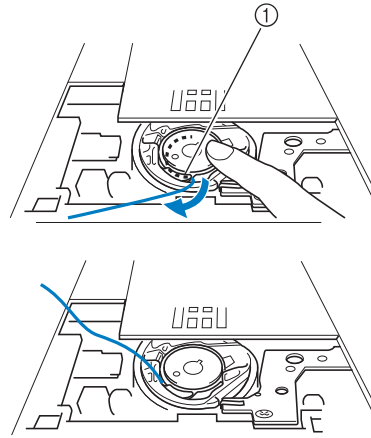

① Tension spring

CAUTION

- When winding the bobbin, make sure the thread is not frayed. Sewing with frayed thread may result in the thread catching on the tension spring of the bobbin case, the thread completely becoming tangled or damage to the machine.
- Do not guide the bobbin thread through the groove in the needle plate cover, otherwise the lower threading cannot be done correctly.

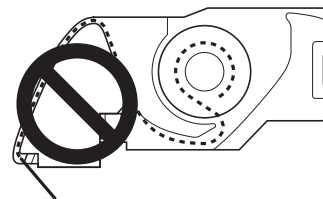

■ When tension is not applied to the bobbin thread

If the bobbin thread in the trial stitching is too tight and adjusting the bobbin case tension does not help, do not pass the thread through the tension spring.

Hold the bobbin with your left hand so the thread unwinds from the right side and hold the end of the thread with your right hand.

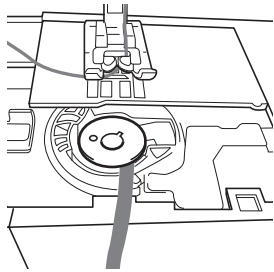
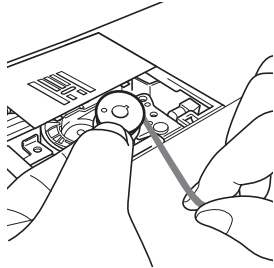

11 Pull out about 8 cm (approx. 3 inches) of bobbin thread.

12 Lightly hold the end of the upper thread while turning the handwheel toward you (counterclockwise) until the mark on the handwheel aligns with the center top of machine.

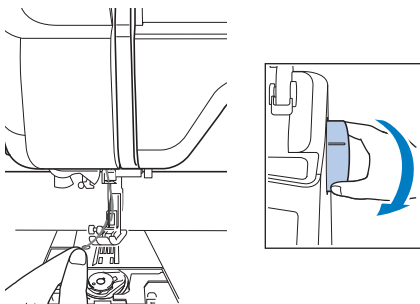

13 Gently pull the upper thread to bring the bobbin thread up through the needle plate.

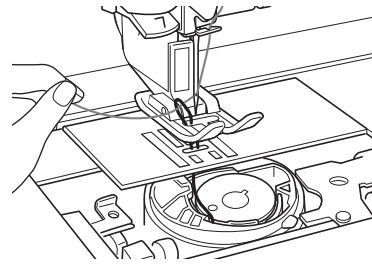

→ A loop of the bobbin thread comes out through the hole in the needle plate.

14 Insert tweezers through bobbin thread loop and pull bobbin thread above the needle plate.

15 Align the upper thread and bobbin thread, and then pull out about 10 cm (approx. 4 inches) of the threads and pass them under the presser foot toward the rear of the machine.

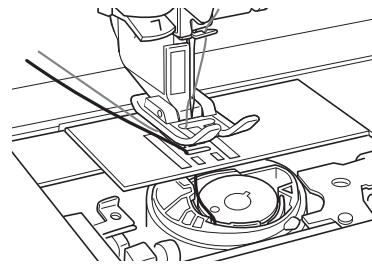

16 Install the needle plate cover and bobbin cover with tabs.

For details on installing the needle plate cover, refer to “Cleaning the Race” on page A-19.

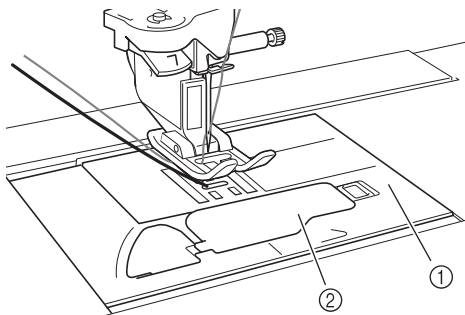

- ① Bobbin cover
- ② Bobbin cover with tabs

⚠ CAUTION

- When creating bobbin work, use the bobbin cover with tabs, otherwise the thread may become tangled or the needle may break.

Note

- When installing the needle plate cover, do not allow it to pinch the thread.

17 Install the flat bed attachment or embroidery unit.

Note

- When installing the flat bed attachment or embroidery unit, do not allow it to pinch the thread.
- When the bobbin thread is replaced with a new one, be sure to repeat the procedure from ①, otherwise the lower threading will not be done correctly.

→ This completes the upper and lower threading.

Note

- If utility stitches are to be used, refer to “CREATING BOBBIN WORK (SEWING)” on page A-9. If embroidery patterns are to be used, refer to “CREATING BOBBIN WORK (EMBROIDERY)” on page A-12.

CREATING BOBBIN WORK (SEWING)

Positioning the Fabric and Sewing

Note

- Recommended stitches for bobbin work are open “airy” type stitches.
- Be sure to sew trial stitches using same fabric and threads as project in order to check the sewing results.
- The bobbin thread may become tangled due to the type of pattern and thread that are being used. Since this may cause the needle to break, immediately stop sewing if this occurs. Turn off the machine and cut out the tangled thread with scissors. Then, clean the race and bobbin case as described in “Fabric is caught in the machine and cannot be removed” on page A-27.

- 1 Turn on the machine.
- 2 Select a stitch in the Utility and Decorative Stitches mode. For this example, press 

Memo

- For best results, select a longer stitch length and a wider stitch width. Depending on the selected stitch, it may not be possible to change the stitch length and stitch width settings.



- Depending on the fabric, bunched stitches may result. We recommend selecting a simple stitch and sewing trial stitches to check the sewing results.

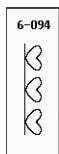
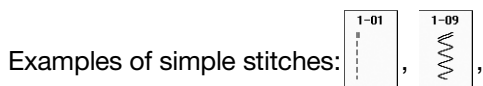

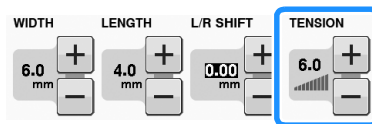

- 3 Increase the upper thread tension. Upper thread tension setting between 6 and 8 is recommended for bobbin work.
For details on adjusting the upper thread tension, refer to “Setting the Thread Tension” of “Sewing”.



Note

- Before sewing, check that there is enough thread in the bobbin.

- 4 Make sure the automatic thread cutting () and automatic reinforcement stitching () have been turned off.

CAUTION

- Before sewing, make sure the automatic thread cutting has been turned off. If sewing is started with automatic thread cutting turned on, the thread may become tangled or the machine may be damaged.

- 5 Place stabilizer on top (wrong side) of the fabric.

Note

- Type and weight of stabilizer will depend on fabric and thread being used.

- 6 If thread is too thick to pull through fabric to machine surface use an awl to punch a small hole in the fabric at the beginning of stitching so the bobbin thread can be fed through the opening.

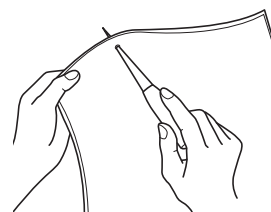

- 7 Press  to lock all keys and buttons.
→ The screen changes, and all keys and operation buttons are locked.

8 Use the presser foot lever to raise the presser foot.

9 With the wrong side facing up, place the fabric under the presser foot.

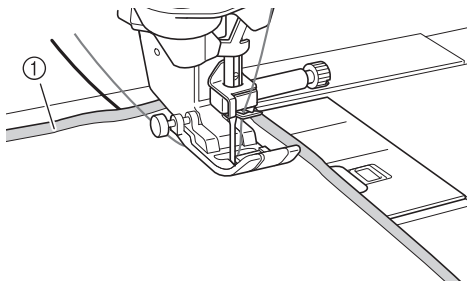

① Wrong side of fabric

10 Turn the handwheel toward you (counterclockwise) to feed the needle into the fabric or punched hole. Position the upper thread over the presser foot and lightly hold, and then lower the presser foot lever.

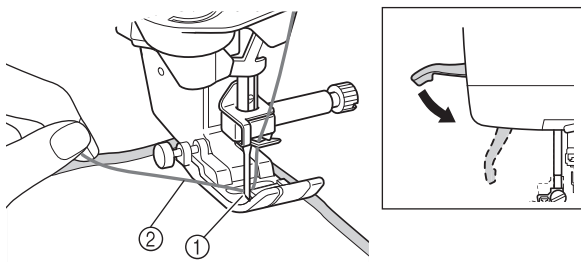

① Punched hole
② Upper thread over the presser foot

11 Pulling the upper thread gently, turn the handwheel toward you (counterclockwise) until the mark on the handwheel aligns with the center top of machine.

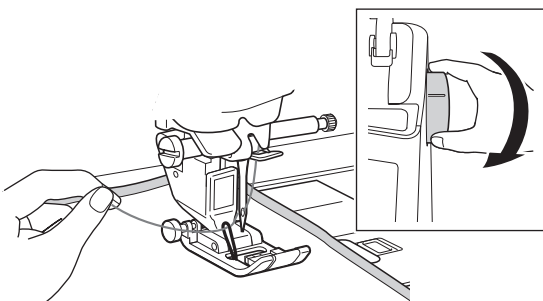

→ A loop of the bobbin thread comes out through the hole in the fabric.



Note

• If the bobbin thread does not come up, hold the upper thread as shown below to pull up the bobbin thread.

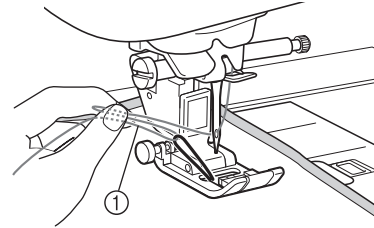

① Upper thread

12 Raise the presser foot lever, and then use tweezers to pull up the bobbin thread and bring the end of the thread to the top of the fabric.



Note

• Pull the thread while holding down the fabric so it does not move out of place.

13 Align the upper thread and bobbin thread, and then pass them under the presser foot toward the rear of the machine.

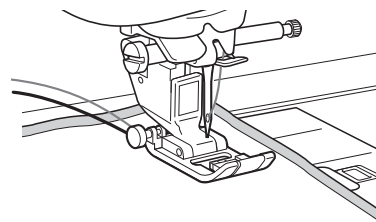

14 While gently holding threads at the rear of the machine, turn the handwheel to feed the needle into the fabric or punched hole again, and then lower the presser foot lever.

15 Press  at lower right of LCD screen to unlock all keys and buttons.

→ All keys and operation buttons are unlocked, and the previous screen is displayed.

16 Select a low speed, gently hold the threads behind the presser foot and start sewing. Threads can be released after several stitches have been made.

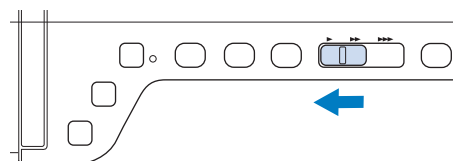

- 17** When you have reached the end of the stitching area, stop the machine.

**Note**

- Do not sew reverse/reinforcement stitches at the end of the stitching, otherwise the threads may become tangled or the needle may break. In addition, it will be difficult to pull the bobbin thread up to the wrong side of the fabric.

- 18** Raise the needle and presser foot.

- 19** Leaving about 10 cm (approx. 4 inches) of thread at the ends, use scissors to cut the threads.

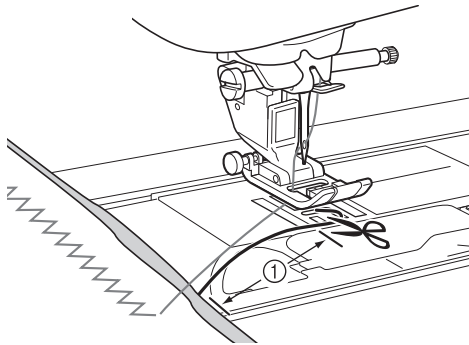

① 10 cm (approx. 4 inches)

**Note**

- Do not press the "Thread Cutter" button to cut the threads, otherwise the machine may be damaged.

■ Finishing the thread ends

- 1** At the end of the stitching, use a hand sewing needle to bring the bobbin thread up to the wrong side of the fabric.

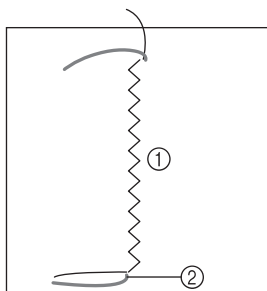

① Wrong side of fabric
② Bobbin thread

**Note**

- If it is difficult to place bobbin thread through the eye of a hand sewing needle, use a ribbon embroidery needle to pull the thread up to the wrong side of the fabric. Otherwise, use an awl to pull up the bobbin thread.

- 2** Working from the wrong side of the fabric, tie the bobbin and upper threads together by hand. Cut away excess threads with scissors.

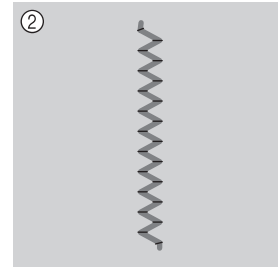
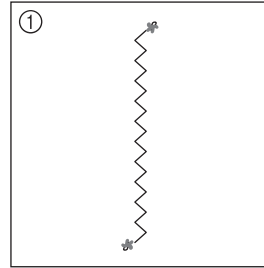

① Wrong side of fabric
② Right side of fabric

**Note**

- To ensure threads do not come undone after being tied place a drop of fabric glue on knots.

- 3** If the desired results could not be achieved, adjust the tension of the bobbin thread and of the upper thread, and then try sewing the stitching again.

For more details, refer to "ADJUSTING THE THREAD TENSION" on page A-16.

Bobbin Work Free Motion Sewing

If so desired, use a template or draw your design on the stabilizer to allow for ease of stitching. Remember, your stitches with your decorative thread will be on the underneath side of your fabric and the stabilizer will be on the top of the wrong side of your fabric.

- * For information about using free motion open toe quilting foot "O" refer to "Free Motion Quilting" on page S-40.

CREATING BOBBIN WORK (EMBROIDERY)

Selecting the Pattern



Note

- Prepare the machine for bobbin work as described in “PREPARING FOR BOBBIN WORK” on page A-3.

1 Attach the embroidery foot and the embroidery unit.

2 Install a bobbin wound with an adequate amount of thread for pattern.



Note

- For an estimated length of bobbin thread required for each pattern, refer to the “Quick Reference Guide” included with the machine. Be sure to use a bobbin wound with enough thread. If the bobbin runs out of thread while sewing, the embroidery cannot be completed.
- Depending on the thread thickness, it may not be possible to wind the bobbin with the necessary length of thread. In this case, try winding the bobbin again, or use a lighter weight thread.

3 Pull up the bobbin thread above the needle plate.

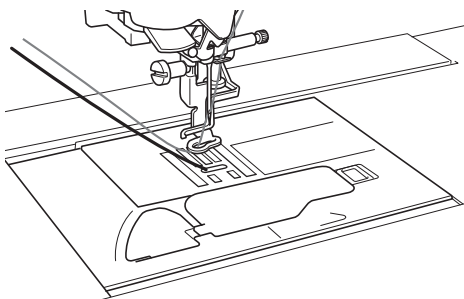

4 Turn on the machine.

5 Press  .

→ The carriage will move to the initialization position.

6 To select a bobbin work embroidery pattern, press  (Embroidery).



Note

- Embroidery patterns for bobbin work “B” cannot be used in the “Embroidery Edit” screen ().

7 Press , then select one of the bobbin work embroidery patterns.

Embroidery patterns for bobbin work appear with the letter “B” in the lower-left corner of the key.

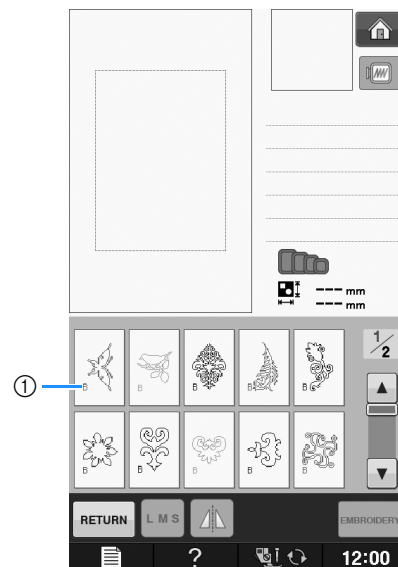

① “B” mark

→ Regardless of the setting that had been selected, the automatic thread cutting function is turned off.

→ When a bobbin work embroidery pattern is selected the embroidery sewing speed can only be adjusted from 100 spm to a maximum of 350 spm.



Note

- The beginning and end of stitching are specified for bobbin work patterns. They cannot be used for normal embroidering.
- Recommended default setting for bobbin work embroidery is 100 spm.

⚠ CAUTION

- When sewing bobbin work, be sure to select an embroidery pattern for bobbin work. If any other type of pattern is selected, the machine may be damaged.



Note

- Bobbin work embroidery sewing speed defaults to 100 spm when a bobbin work embroidery pattern is selected. The Settings screen will only allow speed to be adjusted from 100 spm to a maximum sewing speed of 350 spm.



Memo

- When an embroidery pattern for bobbin work is selected, the automatic thread cutting function is turned off. Afterward, if a pattern other than one for bobbin work is selected, the automatic thread cutting function is returned to the setting that was selected before the embroidery pattern for bobbin work was chosen.

8

Press **EMBROIDERY**.

→ The sewing screen is displayed.

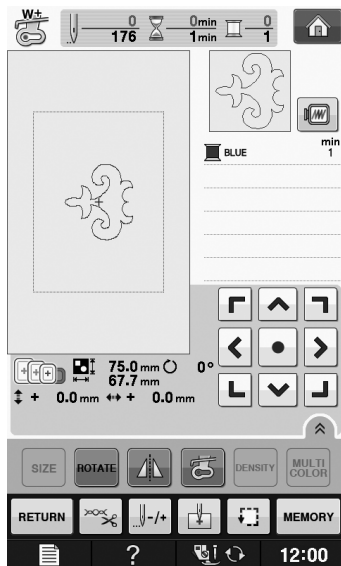

Note

- Since bobbin work is sewn from the wrong side of the fabric, the pattern shown in the screen appears as a mirror image of the final sewn embroidery. If necessary, flip the image to preview it. In addition, when sewing with the thread colors shown in the embroidery screen, select a bobbin thread that matches what is shown in the screen.

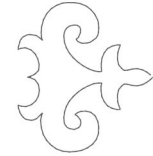
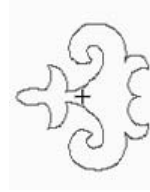

① Image shown in screen ② Sewn embroidery (Right side of fabric)



Memo

- With embroidery patterns for bobbin work, the size and thread density cannot be changed. In addition, the automatic thread cutting function cannot be turned on.

9

Press **TENSION**, and then adjust the tension of the upper thread.

For details on adjusting the tension of the upper thread, refer to “Adjusting Thread Tension” on page E-30.

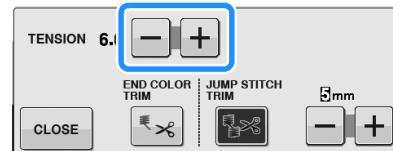

Memo

- We recommend a setting between 6 and 8 for the upper thread tension.

Start Embroidering

- 1 Hoop the fabric so the right side of the fabric is facing down with the stabilizer lying on the top. Use an embroidery frame that fits the size of the pattern and then attach the frame to the machine. These patterns are embroidered from the wrong side of the fabric so technically you are working in “reverse” of normal embroidering.

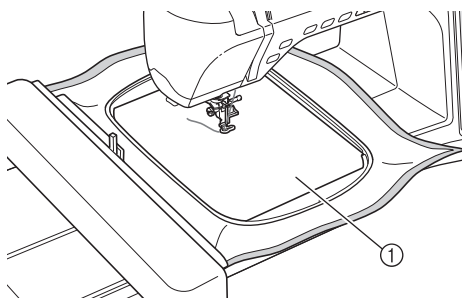

① Wrong side of fabric

⚠ CAUTION

- Always use a stabilizer material for embroidery. Otherwise, the needle may break and cause injuries. Not using a stabilizer material may result in a poor finish to your project.

- 2 Press **CLOSE**.
- 3 Press **LOCK** to lock all keys and buttons.
→ The screen changes, and all keys and operation buttons are locked.
- 4 Using the presser foot lever, raise the presser foot.
- 5 To bring the bobbin thread above the fabric, rotate the handwheel counterclockwise while holding the upper thread.

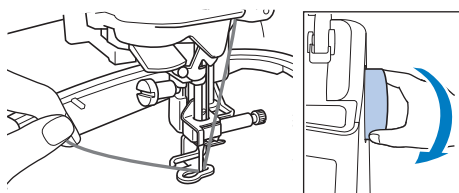

- 6 As shown below, pull the upper thread to pull the bobbin thread up through the fabric.

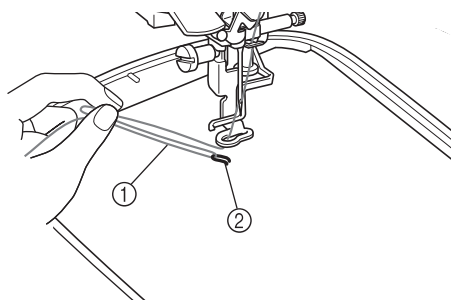

- ① Upper thread
- ② Bobbin thread



Memo

- If the bobbin thread cannot be pulled up, use an awl to create small hole to help pull bobbin thread to surface.

- 7 Press **UNLOCK** to unlock all keys and buttons.
- 8 Lower the presser foot.
- 9 It is necessary to move to the beginning of stitching so press **START**, and then press **+1**.

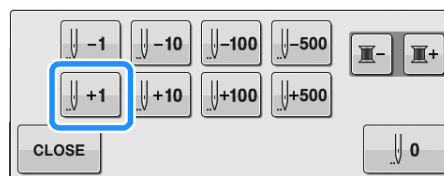

- The embroidery frame moves to the beginning of stitching.

- 10 While holding both the upper thread and the bobbin thread, sew a section of the pattern.

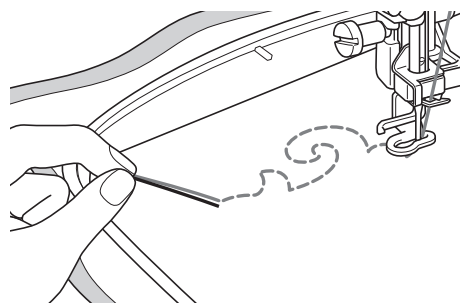

- 11** Stop the machine, and then tie the upper thread and the bobbin thread together to secure the threads.

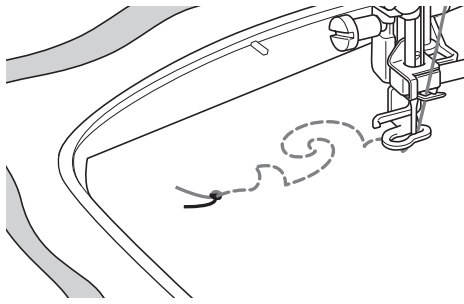

- 12** Start sewing again to finish the pattern.

- 13** Raise the needle and presser foot, remove the embroidery frame, and then cut the upper thread and the bobbin thread.

When cutting the threads, be sure to leave an adequate length of thread so they can be properly secured.

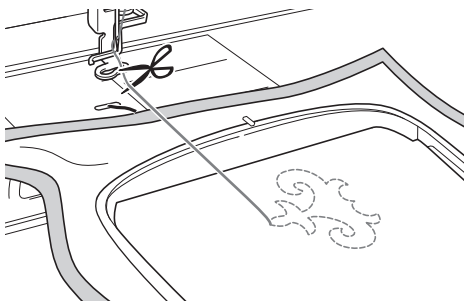

- 14** Using a hand sewing needle such as a ribbon embroidering needle, pull the bobbin thread to the top (wrong side) of the fabric, and then tie the upper thread and the bobbin thread together.

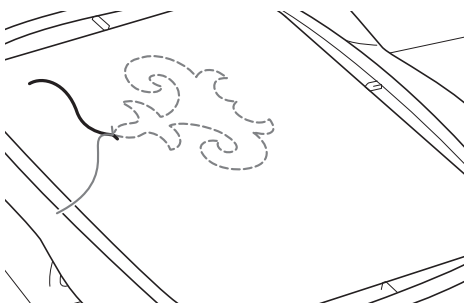

Memo

- If there is a gap between the start point and end point of the pattern, leave an adequate length of thread, cut the threads, and remove the fabric from the machine. Use a ribbon embroidering needle to hand sew stitches to connect the starting and ending points.

- 15** Remove the fabric from the embroidery frame, and check the finished embroidery.

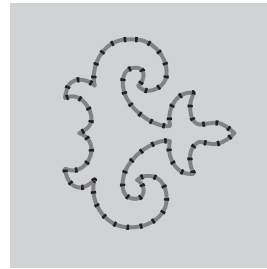

① Right side of fabric

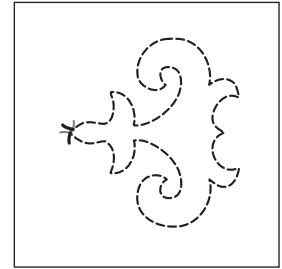

② Wrong side of fabric

- 16** If the desired results could not be achieved, adjust the tension of the bobbin thread and the upper thread, and then try sewing the pattern again.

For more details, refer to "ADJUSTING THE THREAD TENSION" on page A-16.

Memo

- Check bobbin after each bobbin work embroidery pattern is sewn to make sure there is adequate bobbin thread for the next pattern.
- While selecting the bobbin work pattern, the embroidery speed value is set to "100 spm". Refer to "Adjusting the Embroidery Speed" on page E-33 to change the embroidery speed.

ADJUSTING THE THREAD TENSION

After sewing trial stitches and checking the sewing results, adjust the thread tensions if necessary. After adjusting the tensions, be sure to sew trial stitches again in order to check the sewing results.

■ Adjusting the upper thread tension

We recommend a setting between 6 and 8 for the upper thread tension when sewing bobbin work. Refer to “Adjusting Thread Tension” on page E-30.

■ Adjusting the tension of the bobbin thread

If the desired stitching cannot be achieved after adjusting the upper thread tension, adjust the tension of the bobbin thread. The tension of the bobbin thread can be adjusted by turning the slotted-head (-) screw on the bobbin case (gray) for bobbin work.

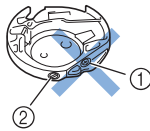

- ① Do not turn the phillips screw (+).
- ② Adjust with a small screwdriver.

To increase the tension of the bobbin thread, turn the slotted-head (-) screw 30° to 45° clockwise.

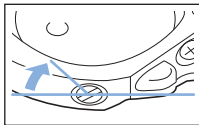

To decrease the tension of the bobbin thread, turn the slotted-head (-) screw 30° to 45° counterclockwise.

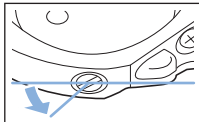

Note

- Turning the screw on the bobbin case (gray) may push up the spring plate, as shown below. If this occurs, gently press down the spring plate with a screwdriver so it is lower than the top surface of the bobbin case (gray), and then insert the bobbin case into the machine.

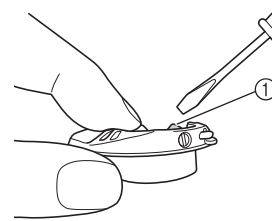

- ① Spring plate

⚠ CAUTION

- **DO NOT** adjust the position of the phillips (+) screw on the bobbin case (gray) as this may result in damage to the bobbin case, rendering it useless.
- If the slotted-head screw (-) is difficult to turn, do not use force. Turning the screw too much or providing force in either (rotational) direction may cause damage to the bobbin case. Should damage occur, the bobbin case may not maintain proper tension.



Note

- If the bobbin thread tension is tight, the thread cannot be passed through the tension spring when the bobbin is installed in the bobbin case. (Refer to “When tension is not applied to the bobbin thread” on page A-7.)

TROUBLESHOOTING

Several solutions for minor problems are described below. If the problem persists, contact your dealer or nearest authorized Brother dealer.

■ The thread was accidentally cut automatically and the bobbin thread is caught inside the machine

- 1 Cut the thread near the fabric above the needle plate, and then remove the fabric.

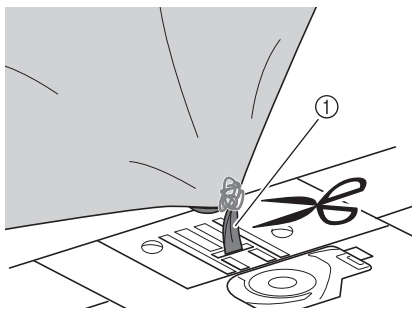

① Thread



Note

- If an embroidery pattern was sewn, remove the embroidery frame.

- 2 Remove the bobbin, and then hold it out toward the left side of the machine.

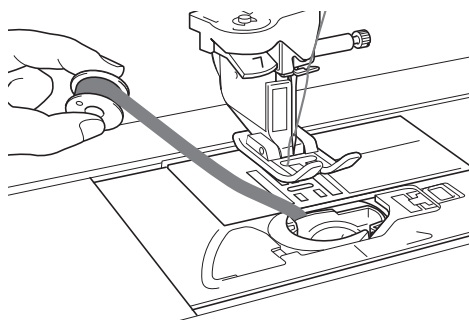

- 3 Lower the presser foot.

- 4 Apply slight tension on bobbin thread by holding thread out to the left side of presser foot. Press the "Thread Cutter" button again.

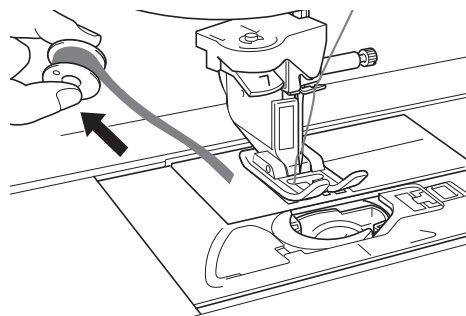

⚠ CAUTION

- Do not pull on the thread with excessive force, otherwise the machine may be damaged.

■ Correcting bobbin work tension

- * If the top thread shows on the bobbin side of the fabric, increase the upper tension (Refer to "ADJUSTING THE THREAD TENSION" on page A-16).
- * If the top thread still shows on the bobbin side of the fabric, reduce the tension of the bobbin thread or bypass the bobbin tension. (Refer to "ADJUSTING THE THREAD TENSION" on page A-16.)
- * Some bobbin threads are too coarse to pass through to wrong side of fabric. In this case, be sure to color match top thread with bobbin threads.

Example: Decorative Stitch

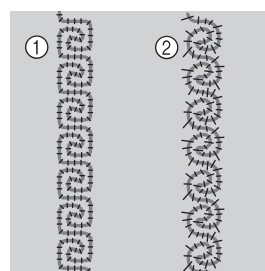

- ① Correct tension
- ② The upper thread tension is too loose, or the bobbin thread tension is too tight.

■ The bobbin thread catches on the tension spring of the bobbin case

Sew with no tension applied to the bobbin thread. (Refer to "When tension is not applied to the bobbin thread" on page A-7.)

Chapter 2

Maintenance and Troubleshooting

CARE AND MAINTENANCE	19
Restrictions on oiling	19
Precautions on storing the machine	19
Cleaning the LCD Screen	19
Cleaning the Machine Casing	19
Cleaning the Race	19
Cleaning the Cutter in the Bobbin Case Area	21
About the Maintenance Message	21
ADJUSTING THE SCREEN	22
Adjusting the Brightness of the Screen Display	22
Touch Panel is Malfunctioning	22
TROUBLESHOOTING	23
Frequent troubleshooting topics	23
Upper thread tightened up	23
■ Symptom	23
■ Cause	23
■ Remedy/check details	23
Tangled thread on wrong side of fabric	24
■ Symptom	24
■ Cause	24
■ Remedy/check details	24
Incorrect thread tension	26
■ Symptoms	26
■ Cause/Remedy	26
Fabric is caught in the machine and cannot be removed	27
■ Removing the fabric from the machine	27
■ Checking machine operations	29
List of Symptoms	30
ERROR MESSAGES	34
SPECIFICATIONS	37
UPGRADING YOUR MACHINE'S SOFTWARE	38
Upgrade Procedure Using USB Media	38
Upgrade Procedure Using Computer	39
INDEX	40

CARE AND MAINTENANCE

⚠ CAUTION

- Be sure to unplug the machine before cleaning it. Otherwise, electric shock or injury may result.

Restrictions on oiling

In order to prevent damaging this machine, it must not be oiled by the user. This machine was manufactured with the necessary amount of oil applied to ensure correct operation, making periodic oiling unnecessary.

If problems occur, such as difficulty turning the handwheel or an unusual noise, immediately stop using the machine, and contact your authorized dealer or the nearest authorized service center.

Precautions on storing the machine

Do not store the machine in any of the locations described below, otherwise damage to the machine may result, for example, rust caused by condensation.

- * Exposed to extremely high temperatures
- * Exposed to extremely low temperatures
- * Exposed to extreme temperature changes
- * Exposed to high humidity or steam
- * Near a flame, heater or air conditioner
- * Outdoors or exposed to direct sunlight
- * Exposed to extremely dusty or oily environments



Note

- In order to extend the life of this machine, periodically turn it on and use it. Storing this machine for an extended period of time without using it may reduce its efficiency.

Cleaning the LCD Screen

If the screen is dirty, gently wipe it with a soft, dry cloth. Do not use organic solvents or detergents.



Note

- Do not wipe the LCD screen with a damp cloth.



Memo

- Occasionally, condensation may form on the LCD screen or it may become fogged up; however, this is not a malfunction. After a while, the cloudiness will disappear.

Cleaning the Machine Casing

If the surface of the machine is dirty, lightly soak a cloth in a neutral detergent, squeeze it out firmly, and then wipe the surface. Then wipe again with a dry cloth.

Cleaning the Race

If dust or bits of dirt collect in the race or bobbin case, the machine will not run well, and the bobbin thread detection function may not operate. Keep the machine clean for best results.

- 1 Press the "Needle Position" button to raise the needle.
- 2 Turn the main power to OFF.
- 3 Remove the needle, presser foot, and presser foot holder (see page B-53 through B-55).
- 4 Remove the flat bed attachment or the embroidery unit if either is attached.
- 5 Grasp both sides of the needle plate cover, and then slide it toward you.

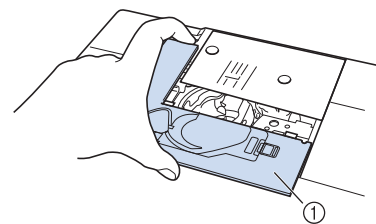

① Needle plate cover

→ The needle plate cover is removed.

- 6 Grasp the bobbin case, and then pull it out.

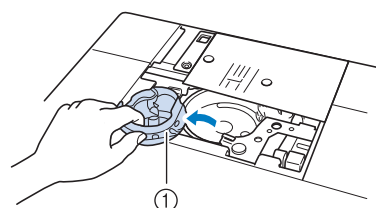

① Bobbin case

- 7** Use the cleaning brush or a vacuum cleaner to remove any lint and dust from the race and bobbin thread sensor and the surrounding area.

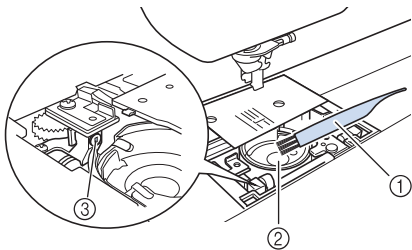

- ① Cleaning brush
- ② Race
- ③ Bobbin thread sensor



Note

- Do not apply oil to the bobbin case.
- If lint or dust collects on the bobbin thread sensor, the sensor may not operate correctly.

- 8** Insert the bobbin case so that the ▲ mark on the bobbin case aligns with the ● mark on the machine.

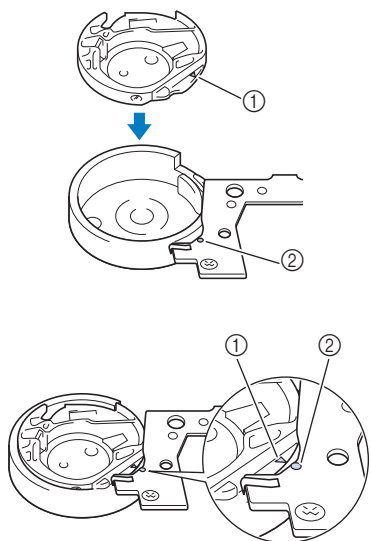

* Align the ▲ and ● marks.

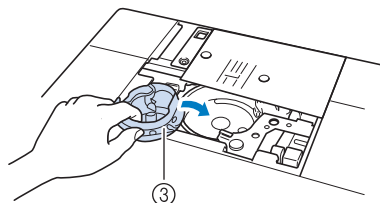

- ① ▲ mark
- ② ● mark
- ③ Bobbin case

* Make sure that the indicated points are aligned before installing the bobbin case.

⚠ CAUTION

- Never use a bobbin case that is scratched; otherwise, the upper thread may become tangled, the needle may break, or sewing performance may suffer. For a new bobbin case (part code: XE5342-101 (green marking on the screw), XC8167-551 (no color on the screw), XE8298-001 (gray, for bobbin work)), contact your dealer or nearest authorized dealer.
- Make sure that you fit the bobbin case properly, otherwise the needle may break.

- 9** Insert the tabs on the needle plate cover into the needle plate, and then slide the cover back on.

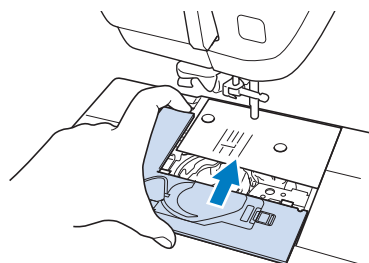

Note

- If the needle plate has been removed it is especially important to reinstall the needle plate and tighten the screws prior to installing the bobbin case.

Cleaning the Cutter in the Bobbin Case Area

The cutter below the needle plate should be cleaned. If dust or lint accumulate on the cutter, it will be difficult to cut the thread when the “Thread Cutter” button is pressed or the automatic thread cutting function is used. Clean the cutter when the thread is not easily cut.

- 1 Follow steps 1 through 5 in “Cleaning the Race” to remove the needle plate cover.
- 2 Use the screwdriver included with the machine to unscrew and remove the needle plate.

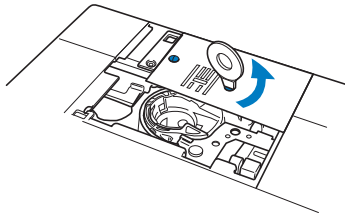

- 3 Use the cleaning brush or a vacuum cleaner to remove any lint and dust from the cutter in the bobbin case area.

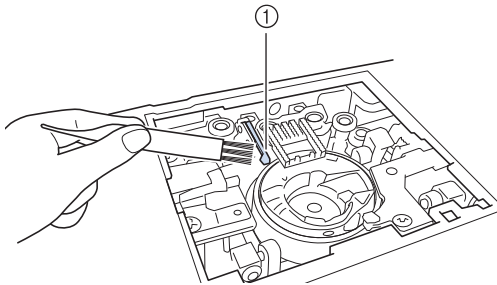

① Cutter

⚠ CAUTION

- Do not touch the cutter, otherwise injuries may result.

- 4 Use the screwdriver included with the machine to screw and attach the needle plate.

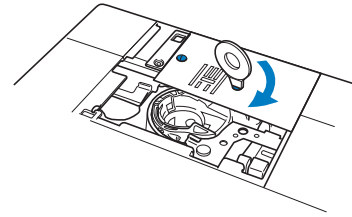

- 5 Insert the tabs on the needle plate cover into the needle plate, and then slide the cover back on.

About the Maintenance Message

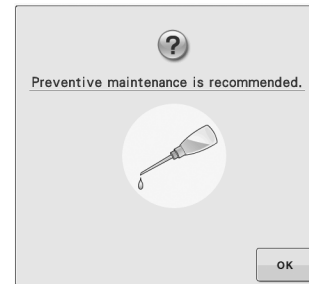





Once this message appears, it is recommended to take your machine to an authorized dealer or nearest authorized service center for a regular maintenance check. Although this message will disappear and the machine will continue to function once you press **OK**, the message will display several more times until the appropriate maintenance is performed. Please take the time to arrange the maintenance your machine requires once this message appears. Such steps will help to ensure you receive continued, uninterrupted hours of machine operation for the future.

ADJUSTING THE SCREEN

Adjusting the Brightness of the Screen Display

If the screen does not look very clear under certain situation, you can adjust the brightness of the screen display.

- 1 Press .
 - The settings screen appears.
- 2 Press .
 - The General settings screen appears.
- 3 Display page 6 of the General settings screen.
- 4 Press  or  to adjust the brightness of the screen display.



* The screen appears dim as the number on the settings screen decreases. The screen appears brighter as the number increases.

Touch Panel is Malfunctioning

If the screen does not respond correctly when you touch a key (the machine does not perform the operation or performs a different operation), follow the steps below to make the proper adjustments.

- 1 Holding your finger on the screen, turn the main power switch to OFF and back to ON.

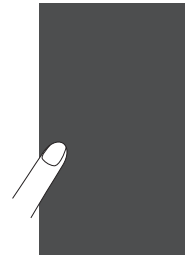

→ The touch panel adjustment screen is displayed.

- 2 Using the included touch pen, lightly touch the center of each +, in order from 1 to 5.



Note

- Only use the included touch pen to touch the screen. Do not use a mechanical pencil, pin, or other sharp object. Do not press too hard on the screen. Otherwise, damage may result.

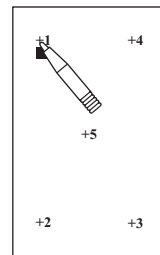

- 3 Turn the main power to OFF, then turn it back to ON.



Note

- If you finish the screen adjustment and the screen still does not respond, or if you cannot do the adjustment, contact your authorized dealer.

TROUBLESHOOTING

If the machine stops operating correctly, check the following possible problems before requesting service. You can solve most problems by yourself. If you need additional help, the Brother Solutions Center offers the latest FAQs and troubleshooting tips. Visit us at "<http://solutions.brother.com>".

If the problem persists, contact your dealer or the nearest authorized service center.

Frequent troubleshooting topics

Detailed causes and remedies for common troubleshooting topics are described below. Be sure to refer to this before contacting your dealer.

■ Upper thread tightened up	page A-23
■ Tangled thread on wrong side of fabric	page A-24
■ Incorrect thread tension	page A-26
■ Fabric is caught in the machine and cannot be removed	page A-27

Upper thread tightened up

■ Symptom

- * The upper thread appears as a single continuous line.
- * The lower thread is visible from the upper side of the fabric. (Refer to the illustration below.)
- * The upper thread has tightened up, and comes out when pulled.
- * The upper thread has tightened up, and wrinkles appear in the fabric.
- * The upper thread tension is tight, and the results do not change even after the thread tension is adjusted.

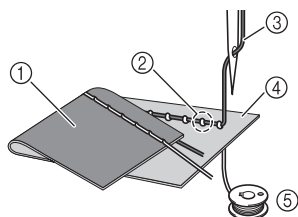

- ① Lower side of fabric
- ② Lower thread visible from upper side of fabric
- ③ Upper thread
- ④ Upper side of fabric
- ⑤ Lower thread

■ Cause

Incorrect lower threading

If the lower thread is incorrectly threaded, instead of the appropriate tension being applied to the lower thread, it is pulled through the fabric when the upper thread is pulled up. For this reason, the thread is visible from the upper side of the fabric.

■ Remedy/check details

Correctly install the lower thread.

- 1 Turn off the sewing machine.
- 2 Remove the bobbin from the bobbin case.
- 3 Place the bobbin in the bobbin case so that the thread unwinds in the correct direction.
 - * Hold the bobbin with your right hand with the thread unwinding to the left, and hold the end of the thread with your left hand. Then, with your right hand, place the bobbin in the bobbin case.

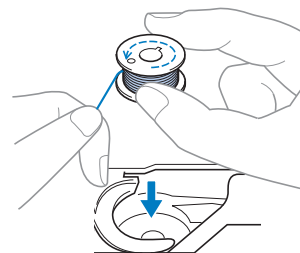

If the bobbin is inserted with the thread unwinding in the wrong direction, sewing will be done with an incorrect thread tension.

4 While holding the bobbin in place with your finger, pass the thread through the slit in the needle plate.

- * Hold down the bobbin with your right hand, and then pull the end of the thread around the tab with your left hand.

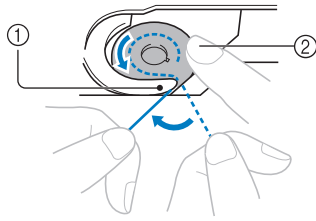

- ① Tab
- ② Hold down the bobbin with your right hand.

Pull the thread to pass it through the slit in the needle plate, then cut it with the cutter.

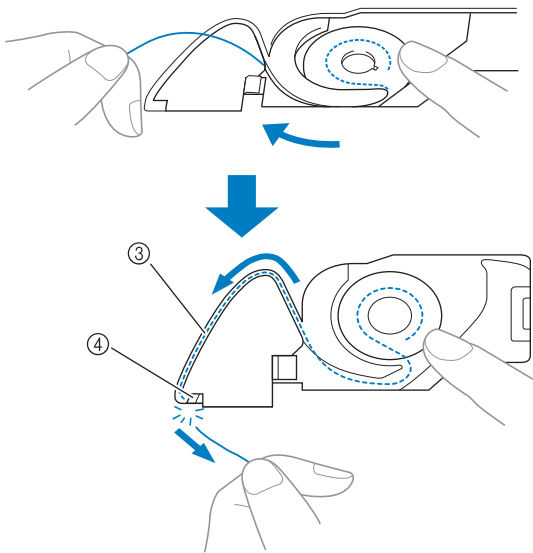

- ③ Slit
- ④ Cutter

Sewing with the correct thread tension is possible after the bobbin has been correctly installed in the bobbin case.

Tangled thread on wrong side of fabric

Symptom

- * The thread becomes tangled on the lower side of the fabric.

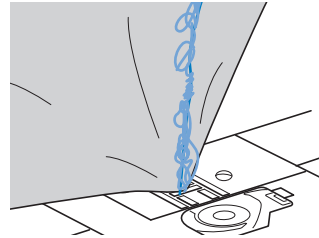

- * After starting sewing, a rattling noise is made and sewing cannot continue.
- * Looking under the fabric, there is tangled thread in the bobbin case.

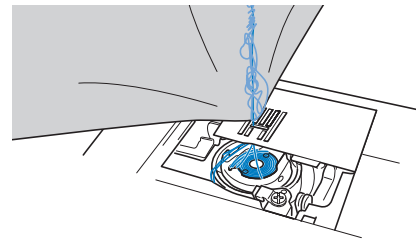

Cause

Incorrect upper threading

If the upper thread is incorrectly threaded, the upper thread passed through the fabric cannot be firmly pulled up and the upper thread becomes tangled in the bobbin case, causing a rattling noise.

Remedy/check details

Remove the tangled thread, and then correct the upper threading.

1 Remove the tangled thread. If it cannot be removed, cut the thread with scissors.

- * Refer to "Cleaning the Race" in "CARE AND MAINTENANCE" on page A-19.

2 Remove the upper thread from the machine.

3 Refer to the following steps to correct the upper threading.

- * If the bobbin was removed from the bobbin case, refer to "LOWER THREADING" on page B-38 and "Remedy/check details" in the section "Upper thread tightened up" on page A-23 to correctly install the bobbin.

- 4** Raise the presser foot using the presser foot lever.

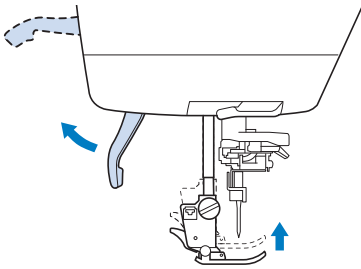

* If the presser foot is not raised, the sewing machine cannot be threaded correctly.

- 5** Raise the needle by turning the handwheel toward you (counterclockwise) so that the mark on the wheel points up, or press "Needle Position" button once or twice to raise the needle.

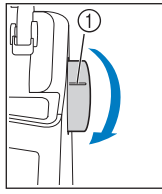

or

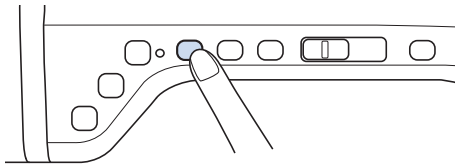

① Mark

- 6** While holding the thread with both hands, pull the thread up from under the thread guide plate.

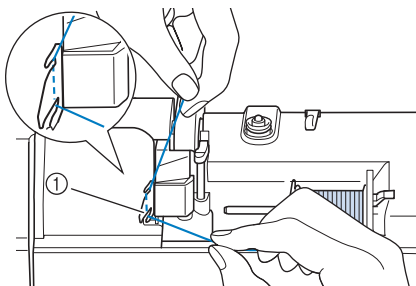

① Thread guide plate

- 7** While holding the thread in your right hand, pass the thread through the thread guide in the direction indicated.

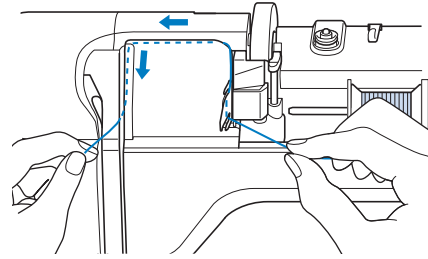

- 8** Guide the thread down, up, then down through the groove, as shown in the illustration.

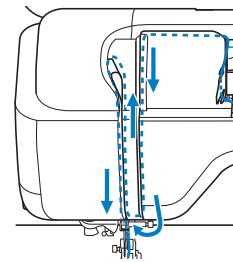

Memo

- Look in the upper groove area to check if the thread catches on the take-up lever visible inside the upper groove area.

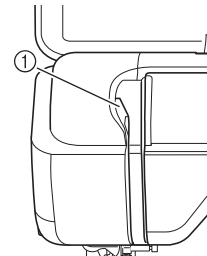

① Look in the upper groove area

- 9** Pass the thread through the needle bar thread guide (marked "6") by holding the thread with both hands and guiding it as shown in the illustration.

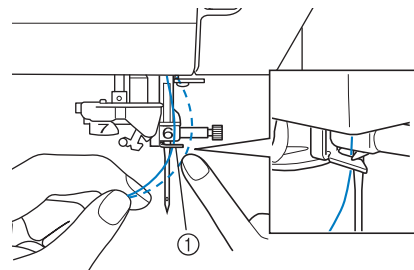

① Needle bar thread guide

- 10** Thread the needle according to steps **10** and **15** in "Upper Threading" on page B-46.

Incorrect thread tension

■ Symptoms

- Symptom 1: The lower thread is visible from the upper side of the fabric.
- Symptom 2: The upper thread appears as a straight line on the upper side of the fabric.
- Symptom 3: The upper thread is visible from the lower side of the fabric.
- Symptom 4: The lower thread appears as a straight line on the lower side of the fabric.
- Symptom 5: The stitching on the lower side of the fabric is loose or has slack.

□ Symptom 1/2

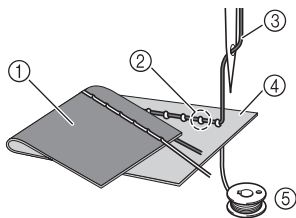

□ Symptom 3/4

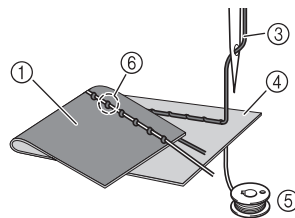

- ① Lower side of fabric
- ② Lower thread visible on upper side of fabric
- ③ Upper thread
- ④ Upper side of fabric
- ⑤ Lower thread
- ⑥ Upper thread visible from lower side of fabric

■ Cause/Remedy

□ Cause 1

The machine is not correctly threaded.

<With symptoms 1 and 2 described above>

The lower threading is incorrect.

Adjust the upper thread tension and then refer to “Upper Thread is Too Tight” on page S-12.

<With symptoms 3 through 5 described above>

The upper threading is incorrect.

Adjust the upper thread tension and then refer to “Tangled thread on wrong side of fabric” on page A-24 to correct the upper threading.

□ Cause 2

A needle and thread appropriate for the fabric are not being used.

The sewing machine needle that should be used depends on the type of fabric sewn and the thread thickness. If a needle and thread appropriate for the fabric are not being used, the thread tension will not be adjusted correctly, causing wrinkles in the fabric or skipped stitches.

- * Refer to “Fabric/Thread/Needle Combinations” on page B-57 to check that a needle and thread appropriate for the fabric that is being used.

□ Cause 3

An appropriate upper tension is not selected.

Adjust the upper thread tension to select an appropriate thread tension.

The appropriate thread tension differs according to the type of fabric and thread being used.

- * Adjust the thread tension while test sewing on a piece of scrap fabric that is the same as that used in your project.



Note

- If the upper threading and lower threading are incorrect, the thread tension cannot be adjusted correctly, even by adjusting the upper thread tension. Check the upper threading and lower threading first, and then adjust the thread tension.

- * When the lower thread is visible on the upper side of the fabric. Set the upper thread tension to a lower number. (Loosen the thread tension.)
- * When the upper thread is visible on the lower side of the fabric. Set the upper thread tension to a higher number. (Tighten the thread tension.)



Fabric is caught in the machine and cannot be removed

If the fabric is caught in the sewing machine and cannot be removed, the thread may have become tangled under the needle plate. Follow the procedure described below to remove the fabric from the machine. If the operation could not be completed according to the procedure, instead of attempting to complete it forcefully, contact your dealer or nearest authorized service center.

■ Removing the fabric from the machine

1 Immediately stop the sewing machine.

2 Turn off the sewing machine.

3 Remove the needle.

If the needle is lowered into the fabric, turn the handwheel away from you (clockwise) to raise the needle out of the fabric, and then remove the needle.

* Refer to "CHANGING THE NEEDLE" on page B-55.

4 Remove the presser foot and presser foot holder.

* Refer to "CHANGING THE PRESSER FOOT" on page B-53.

5 Lift up the fabric and cut the threads below it.

If the fabric can be removed, remove it. Continue with the following steps to clean the race.

6 Remove the needle plate cover.

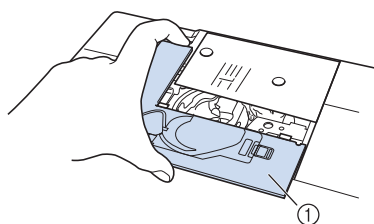

① Needle plate cover

7 Cut out the tangled threads, and then remove the bobbin.

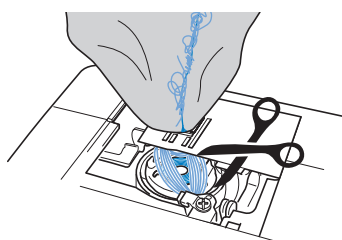

8 Remove the bobbin case.

If threads remain in the bobbin case, remove them.

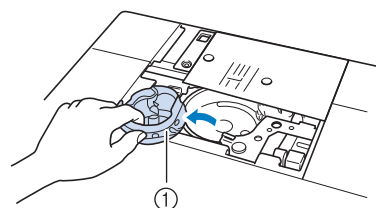

① Bobbin case

9 Use the cleaning brush or a vacuum cleaner to remove any dust or loose threads from the race and its surrounding area.

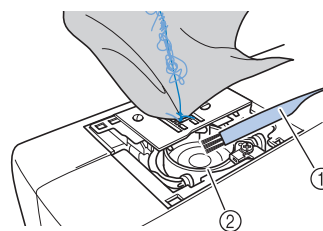

① Cleaning brush

② Race

If the fabric could be removed

Continue with step **16**.

If the fabric could not be removed

Continue with step **10**.

10 Use the enclosed disc-shaped screwdriver to loosen the two screws on the needle plate.

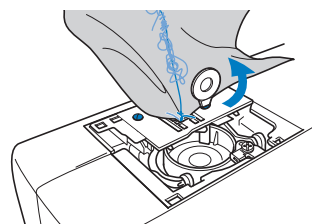

Note

- Be careful not to drop the removed screws in the machine.

- 11** Slightly lift up the needle plate, cut any tangled threads, and then remove the needle plate.

Remove the fabric and threads from the needle plate.

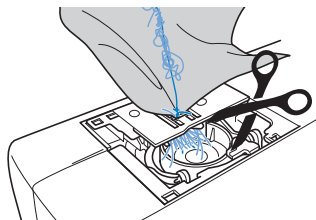

If the fabric cannot be removed, even after completing these steps, contact your dealer or nearest authorized service center.

- 12** Remove any threads in the race and around the feed dogs.

- 13** Turn the handwheel to raise the feed dogs.

- 14** Align the two screw holes in the needle plate with the two holes at the needle plate mounting base, and then fit the needle plate onto the machine.

- 15** Lightly finger-tighten the screw on the right side of the needle plate. Then, use the disc-shaped screwdriver to firmly tighten the screw on the left side. Finally, firmly tighten the screw on the right side.

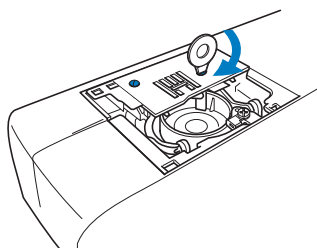

Turn the handwheel to check that the feed dogs move smoothly and do not contact the edges of the slots in the needle plate.

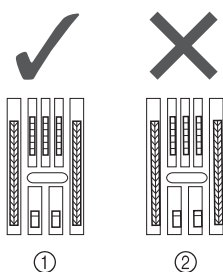

- ① Correct position of feed dogs
② Incorrect position of feed dogs



Note

- Be careful not to drop the removed screws in the machine.

- 16** Insert the bobbin case so that the ▲ mark on the bobbin case aligns with the ● mark on the machine.

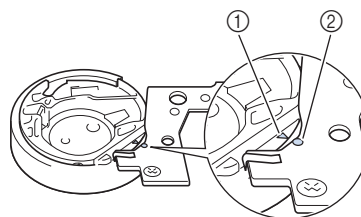
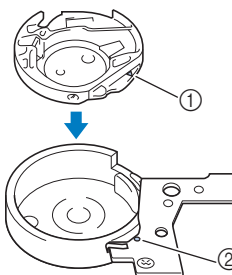

* Align the ▲ and ● marks.

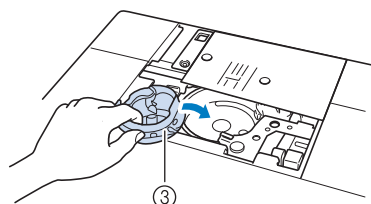

- ① ▲ mark
② ● mark
③ Bobbin case

* Make sure that the indicated points are aligned before installing the bobbin case.

CAUTION

- Never use a bobbin case that is scratched; otherwise, the upper thread may become tangled, the needle may break, or sewing performance may suffer. For a new bobbin case (part code: XE5342-101 (green marking on the screw), XC8167-551 (no color on the screw), XE8298-001 (gray, for bobbin work)), contact your nearest authorized dealer.
- Make sure that you fit the bobbin case properly, otherwise the needle may break.

- 17** Insert the tabs on the needle plate cover into the needle plate, and then slide the cover back on.

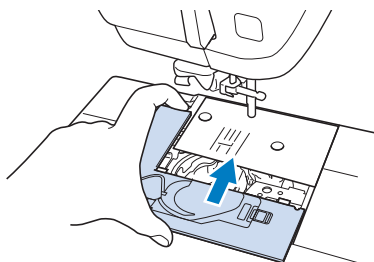
**Note**

- If the needle plate has been removed it is especially important to reinstall the needle plate and tighten the screws prior to installing the bobbin case.

- 18** Check the condition of the needle, and then install it.

If the needle is in a poor condition, for example, if it is bent, be sure to install a new needle.

- * Refer to "CHANGING THE NEEDLE" on page B-55.

⚠ CAUTION

- Never use bent needles. Bent needles can easily break, possibly resulting in injuries.

**Note**

- After completing this procedure, continue with the following procedure in "Checking machine operations" to check that the machine is operating correctly.

**Memo**

- Since the needle may have been damaged when the fabric was caught in the machine, we recommend replacing it with a new one.

■ Checking machine operations

If the needle plate has been removed, check machine operations to confirm that installation has been completed correctly.

- 1** Turn on the machine.

- 2** Select .

**Note**

- Do not yet install the presser foot and thread.

- 3** Slowly turn the handwheel toward you (counterclockwise), and look from all sides to check that the needle falls at the center of the hole in the needle plate.

If the needle contacts the needle plate, remove the needle plate, and then install it again, starting with step 13 in "Removing the fabric from the machine" on page A-28.

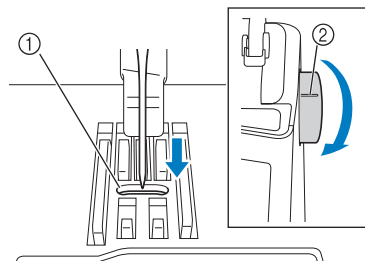

- ① Hole in the needle plate
② Handwheel

- 4** Select zigzag stitch . At this time, increase the stitch length and width to their maximum settings.

- 5** Slowly turn the handwheel toward you (counterclockwise) and check that the needle bar and feed dogs operate correctly.

If the needle or feed dogs contact the needle plate, the machine may be malfunctioning; therefore, contact your dealer or nearest authorized service center.

- 6** Turn off the machine, and then install the bobbin and presser foot.

- * Refer to "Setting the Bobbin" and "CHANGING THE PRESSER FOOT" on page B-53.

- 7** Correctly thread the machine.

- * For details on the machine, refer to "Upper Threading" on page B-46.

**Note**

- The thread may have become tangled as a result of incorrect upper threading. Make sure that the machine is correctly threaded.

- 8** Perform trial sewing with normal fabric.





**Note**

- Incorrect sewing may be the result of incorrect upper threading or sewing thin fabrics. If there are poor results from the trial sewing, check the upper threading or the type of fabric being used.

List of Symptoms

Problem	Cause	Solution	Page
The thread is tangled on the wrong side of the fabric.	Upper threading is incorrect.	Check the steps for threading the machine and rethread the machine.	B-46
	Using improper needle or thread for the selected fabric.	Check the "Fabric/Thread/Needle Combinations" chart.	B-57
The upper thread is too tight.	The bobbin thread is incorrectly installed.	Correctly install the bobbin thread.	B-43
Cannot thread the needle	Needle is not in the correct position.	Press the "Needle Position" button to raise the needle.	B-11
	Needle is installed incorrectly.	Reinstall the needle correctly.	B-55
	Needle is turned, bent or the point is dull.	Replace the needle.	B-55
Cannot lower the presser foot with the presser foot lever	Presser foot was raised using the "Presser Foot Lifter" button.	Press the "Presser Foot Lifter" button to lower the presser foot.	B-11
Thread tension is incorrect	Upper threading is incorrect.	Check the steps for threading the machine and rethread the machine.	B-46
	Bobbin is set incorrectly.	Reset the bobbin. (If needle plate was removed, reinstall needle plate and tighten screws prior to installing bobbin case.)	B-43
	Using improper needle or thread for the selected fabric.	Check the "Fabric/Thread/Needle Combination" chart.	B-57
	Presser foot holder is not attached correctly.	Reattach the presser foot holder correctly.	B-53
	Thread tension is set incorrectly.	Adjust the thread tension.	S-12, E-30
	Bobbin thread is incorrectly wound.	Use a correctly wound bobbin.	B-38
	Needle is turned, bent or the point is dull.	Replace the needle.	B-55
Upper thread breaks	Machine is not threaded correctly (used the wrong spool cap, spool cap is loose, the thread did not catch the needle bar threader, etc.)	Rethread the machine correctly.	B-46
	Needle is turned, bent or the point is dull.	Replace the needle.	B-55
	There are scratches on the bobbin case.	Replace the bobbin case, or consult your authorized dealer.	A-19
	Upper thread tension is too strong.	Adjust the thread tension.	S-12, E-30
	Using improper needle or thread for the selected fabric.	Check the "Fabric/Thread/Needle Combinations" chart.	B-57
	Thread is twisted.	Use scissors, etc., to cut the twisted thread and remove it from the race, etc.	—
	There are scratches near the hole of the needle plate.	Replace the needle plate, or consult your authorized dealer.	S-26
	There are scratches near the hole in the presser foot.	Replace the presser foot, or consult your authorized dealer.	B-53
	Needle is installed incorrectly.	Reinstall the needle correctly.	B-55
	Thread is knotted or tangled.	Rethread upper and lower thread.	B-43, B-46
	A bobbin designed specifically for this machine is not used.	Incorrect bobbins will not work properly. Only use a bobbin designed specifically for this machine.	B-43
Bobbin thread breaks	Bobbin is set incorrectly.	Reset the bobbin thread correctly.	B-43
	There are scratches on the bobbin or it doesn't rotate properly.	Replace the bobbin.	B-43
	Thread is twisted.	Use scissors, etc. to cut the twisted thread and remove it from the race, etc.	—
	A bobbin designed specifically for this machine is not used.	Incorrect bobbins will not work properly. Only use a bobbin designed specifically for this machine.	B-43
Bobbin thread does not wind neatly on the bobbin.	The thread is not passed through the bobbin winding thread guide correctly.	Correctly pass the thread through the bobbin winding thread guide.	B-39
	Bobbin spins slowly.	Press [+] in the bobbin winding window to increase the bobbin winding speed.	B-41
	The thread that was pulled out was not wound onto the bobbin correctly.	Wind the thread that was pulled off around the bobbin 5 or 6 times clockwise.	B-40

Problem	Cause	Solution	Page
Skipped stitches	Needle is turned, bent or the point is dull.	Replace the needle.	B-55
	Using improper needle or thread for the selected fabric.	Check the "Fabric/Thread/Needle Combination" chart.	B-57
	Machine is threaded incorrectly.	Check the steps for threading the machine and rethread it correctly.	B-46
	Dust or lint has collected under the needle plate.	Remove the dust or lint with the brush.	A-19
	Needle is installed incorrectly.	Reinstall the needle correctly.	B-55
	Needle is defective.	Replace the needle.	B-55
	Thin or stretch fabrics are being sewn.	Sew with one sheet of thin paper under the fabric.	S-9
Needle breaks	Needle is installed incorrectly.	Reinstall the needle correctly.	B-55
	Needle clamp screw is not tightened.	Tighten the needle clamp screw.	B-55
	Needle is turned or bent.	Replace the needle.	B-55
	Using improper needle or thread for the selected fabric.	Check the needle and fabric combination.	B-56, E-21
	Wrong presser foot was used.	Use the recommended presser foot.	S-67
	Upper thread tension is too strong.	Adjust the thread tension setting.	S-12, E-30
	Fabric is pulled during sewing.	Do not pull the fabric during sewing.	—
	Spool cap is set incorrectly.	Check the method for attaching the spool cap, then reattach the spool cap.	B-46
	There are scratches around the holes in the needle plate.	Replace the needle plate, or consult your authorized dealer.	A-19
	There are scratches around the hole(s) in the presser foot.	Replace the presser foot, or consult your authorized dealer.	B-53
	There are scratches on the bobbin case.	Replace the bobbin case, or consult your authorized dealer.	A-19
	Needle is defective.	Replace the needle.	B-55
	Upper threading is incorrect.	Check the steps for threading the machine and rethread the machine.	B-46
	Bobbin is set incorrectly.	Reset the bobbin thread correctly.	B-43
	Presser foot is attached incorrectly.	Attach the presser foot correctly.	B-53
	Screw of the presser foot holder is loose.	Securely tighten the screw of the presser foot.	B-53
	Fabric is too thick.	Use fabric that the needle can pierce when the handwheel is turned.	S-7
	Fabric is fed forcefully when sewing thick fabric or thick seams.	Allow the fabric to be fed without being forcefully pushed.	
	Stitch length is too short.	Adjust the stitch length.	S-10
	Stabilizer is not attached to fabric being embroidered.	Attach stabilizer.	S-81, E-11
Bobbin thread is incorrectly wound.	Use a correctly wound bobbin.	B-38	
Fabric does not feed through the machine	Feed dogs are set in the down position.	Press  , and then turn the handwheel to raise the feed dogs.	S-40
	Stitches are too close together.	Lengthen the stitch length setting.	S-10
	Wrong presser foot was used.	Use the correct presser foot.	S-67
	Needle is turned, bent or the point is dull.	Replace the needle.	B-55
	Thread is entangled.	Cut the entangled thread and remove it from the race.	A-27
Fabric puckers	There is a mistake in the upper or bobbin threading.	Check the steps for threading the machine and rethread it correctly.	B-43, B-46
	Thread tension is set incorrectly.	Adjust the thread tension.	S-12, E-30
	Stitches are too long when sewing thin fabrics.	Shorten the stitch length.	S-10
	Needle is turned, bent or the point is dull.	Replace the needle.	B-55
	Spool cap is set incorrectly.	Check the method for attaching the spool cap, then reattach the spool cap.	B-46
	Wrong presser foot.	Use the correct presser foot.	S-67

Problem	Cause	Solution	Page
High-pitched sound while sewing	Dust or lint is caught in the feed dogs.	Remove the dust or lint.	A-19
	Pieces of thread are caught in the race.	Clean the race.	A-19
	Upper threading is incorrect.	Check the steps for threading the machine and rethread the machine.	B-46
	There are scratches on the bobbin case.	Replace the bobbin case, or consult your authorized dealer.	A-19
	A bobbin designed specifically for this machine is not used.	Incorrect bobbins will not work properly. Only use a bobbin designed specifically for this machine.	B-43
Character pattern does not turn out	Wrong presser foot was used.	Attach the correct presser foot.	S-67
	Pattern adjustment settings were set incorrectly.	Revise the pattern adjustment settings.	S-82
	Did not use a stabilizer material on thin fabrics or stretch fabrics.	Attach a stabilizer material.	S-81
	Thread tension is set incorrectly.	Adjust the thread tension.	S-12, E-30
	Fabric was pulled, pushed or fed at an angle while it was being sewn.	Sew while guiding the fabric with your hands so that the fabric is fed in a straight line.	S-3
Machine does not operate	There is no pattern selected.	Select a pattern.	S-21, S-77, E-3, E-58
	“Start/Stop” button was not pushed.	Press the “Start/Stop” button.	B-11
	Main power switch is not turned on.	Turn the main power to ON.	B-19
	Presser foot is not lowered.	Lower the presser foot.	B-11
	“Start/Stop” button was pushed with the foot controller attached.	Remove the foot controller, or use the foot controller to operate the machine.	S-4
	The “Start/Stop” button was pressed while the machine is set for the sewing speed controller to control the zigzag stitch width.	Use the foot controller instead of the “Start/Stop” button to operate the machine, or set the “Width Control” to “OFF” in the settings screen.	B-26, S-4
Nothing happens, even if the LCD display is pressed	All keys and buttons have been locked by  .	Press  to unlock all keys and buttons.	B-53, B-55
	The screen has been locked.	Press either of the following keys to unlock the screen.  	—
The fabric feeds in the opposite direction.	The feed mechanism is damaged.	Contact your dealer or the nearest authorized service center.	—
The LCD screen is fogged up.	Condensation has formed on the LCD screen.	After a while, the cloudiness will disappear.	—
Embroidery pattern does not sew out correctly	Thread is twisted.	Use scissors, etc., to cut the twisted thread and remove it from the race, etc.	A-27
	Fabric was not inserted into the frame correctly (fabric was loose, etc.).	If the fabric is not stretched tight in the frame, the pattern may turn out poorly or there may be shrinkage of the pattern. Set the fabric into the frame correctly.	E-14
	Stabilizing material was not attached.	Always use stabilizing material, especially with stretch fabrics, lightweight fabrics, fabrics with a coarse weave, or fabrics that often cause pattern shrinkage. See your authorized dealer for the proper stabilizer.	E-11
	There was an object placed near the machine, and the carriage or embroidery frame hit the object during sewing.	If the frame bumps something during sewing, the pattern will turn out poorly. Do not place anything in the area where the frame may bump it during sewing.	E-21
	Fabric outside the frame edges interferes with the sewing arm, so the embroidery unit cannot move.	Reinsert the fabric in the embroidery frame so that the excess fabric is away from the sewing arm, and rotate the pattern 180 degrees.	E-14
	Fabric is too heavy, so the embroidery unit cannot move freely.	Place a large thick book or similar object under the arm head to lightly lift the heavy side and keep it level.	—

Problem	Cause	Solution	Page
Embroidery pattern does not sew out correctly	Fabric is hanging off the table.	If the fabric is hanging off the table during embroidery, the embroidery unit will not move freely. Place the fabric so that it does not hang off the table or hold the fabric to keep it from dragging.	E-21
	Fabric is snagged or caught on something.	Stop the machine and place the fabric so that it does not get caught or snagged.	—
	Embroidery frame was removed during sewing (for example, to reset the bobbin). The presser foot was bumped or moved while removing or attaching the embroidery frame, or the embroidery unit was moved.	If the presser foot is bumped or the embroidery unit is moved during sewing, the pattern will not turn out. Be careful when removing or reattaching the embroidery frame during sewing.	E-26
	Stabilizer is incorrectly attached, for example, it is smaller than the embroidery frame.	Attach the stabilizer correctly.	E-11
Loops appear on the surface of the fabric when embroidering	The thread tension is incorrectly set.	Adjust the thread tension.	E-30 to E-32
	The tension of the upper thread is incorrectly set for the combination of the fabric, thread and pattern being used.	Use the embroidery needle plate cover.	E-22
	The combination of the bobbin case and bobbin thread is incorrect.	Change the bobbin case or bobbin thread so that the correct combination is used.	E-21
Embroidery unit does not operate	There is no pattern selected.	Select a pattern.	E-3, E-58
	Main power switch is not turned on.	Turn the main power to ON.	B-19
	Embroidery unit is not attached correctly.	Reattach the embroidery unit correctly.	B-62
	Embroidery frame was attached before the unit was initialized.	Perform the initialization process correctly.	B-62
Pointer of the optional embroidery foot "W+" with LED pointer does not indicate the position correctly	With thick elastic fabric, the position will be misaligned only at raised parts in the fabric.	Manually adjust the position according to the thickness of the fabric.	B-61
	With fabric having a very uneven surface, the position is not correctly aligned.	The pointer indication should be used only as a reference.	B-61

CAUTION

- This machine is equipped with a thread detection device. If the "Start/Stop" button is pushed before the upper threading is done, the machine will not operate properly. Also, depending on the pattern selected, the machine may feed the fabric even if the needle is raised. This is due to the needle bar release mechanism. At these times, the machine will make a sound different from what is made during normal sewing. This is not the sign of a malfunction.
- If the power is disconnected during sewing:
Turn the main power to OFF and unplug the machine.
If you restart the machine, follow the instructions for operating the machine correctly.





















ERROR MESSAGES























If the machine is not properly set and the “Start/Stop” button or the “Reverse Stitch” button is pressed, or if the operation procedure is incorrect, the machine does not start. An alarm sounds and an error message is displayed on the LCD. If an error message displays, follow the instructions in the message.











Below is an explanation of error messages. Refer to these when necessary (if you press  or do the operation correctly while the error message is displayed, the message disappears).

CAUTION

- **Be sure to rethread the machine. If you press the “Start/Stop” button without rethreading the machine, the thread tension may be wrong or the needle may break and cause injury.**

Marks	Error Messages	Cause/Solution
	A malfunction occurred. Turn the machine off, then on again.	This message is displayed if some malfunction occurs.
	Attach the embroidery frame.	This message is displayed when the machine is ready to sew an embroidery pattern, and the “Start/Stop” button is pushed while the embroidery frame is not attached.
	Can not change the configuration of the characters	This message is displayed when there are too many characters and the curved character configuration is impossible.
	Check and rethread the upper thread.	This message is displayed when the upper thread is broken or not threaded correctly, and the “Start/Stop” button or the “Reverse Stitch” button is pressed.
	Data volume is too large for this pattern.	This message is displayed when the patterns you are editing take up too much memory, or if you are editing too many patterns for the memory.
	Failed to save file.	This message appears when you try to save more than 100 settings screen image files in the USB media. In this case, delete a file from the USB media or use different USB media. (see page B-33)
	In twin needle mode, the automatic needle threading button cannot be used.	This message is displayed when the automatic needle threading button is pushed while twin needle sewing is set.
	Lower the buttonhole lever.	This message is displayed when the buttonhole lever is up, a buttonhole stitch is selected, and the “Start/Stop” button or “Reverse Stitch” button is pushed.
	Lower the presser foot lever.	This message is displayed when the “Presser Foot Lifter” button is pushed while the presser foot lever is raised/the needle is lowered.
	Not enough available memory to save the pattern. Delete another pattern?	This message is displayed when the memory is full and the stitch or pattern cannot be saved.
	OK to automatically lower the presser foot?	This message is displayed when  is pressed (the presser foot is raised).
	OK to delete the selected pattern?	This message is displayed when, after selecting a pattern,  or  is pressed and the pattern is about to be deleted.
	OK to delete the setting?	This message appears when  or  is pressed to delete the settings for a utility stitch. To delete the selected settings, press  .
	OK to recall and resume previous memory?	This message appears if the machine is turned off while sewing, then turned on again. Press  to return the machine to the condition (pattern position and number of stitches) when it was turned off. Follow the procedure described in “If the Thread Breaks During Sewing” on page E-27 to align the needle position and sew the remainder of the pattern.

Marks	Error Messages	Cause/Solution
	Preventive maintenance is recommended.	This message is displayed when the machine needs to be maintained. (see page A-19)
	Raise the buttonhole lever.	This message is displayed when the buttonhole lever is down, a stitch other than a buttonhole is selected, and the "Start/Stop" button or the "Reverse Stitch" button is pushed.
	Remove Dual Feed module from the machine.	This message appears when you try to start embroidering with the optional dual feed foot attached to the machine. Remove the dual feed foot before entering the embroidery mode. (see page B-67)
	Remove Embroidery foot with LED pointer from the machine.	This message appears when you try to start sewing utility/decorative stitch or character pattern using the optional embroidery foot with the LED pointer attached to the machine. Remove the embroidery foot with the LED pointer before entering the sewing mode. (see page B-60)
	Retrieving the pattern. Wait a moment.	This message is displayed when the machine is retrieving a previously saved pattern while in "Embroidery Edit" mode.
	Set the clock.	This message appears when the time/date is not set. Set time/date. (see page B-20)
	The bobbin thread is almost empty.	This message is displayed when the bobbin thread is running out.
	The bobbin winder safety device has activated. Is the thread tangled?	This message is displayed when the bobbin is being wound, and the motor locks because the thread is tangled, etc.
	The carriage of the embroidery unit will move. Keep your hands etc. away from the carriage.	This message appears before embroidery unit moves.
	The pockets are full. Delete a pattern.	This message is displayed when the memory is full and a pattern must be deleted.
	The safety device has been activated. Is the thread tangled? Is the needle bent?	This message is displayed when the motor locks due to tangled thread or for other reasons related to thread delivery.
	The shutoff support mode has been activated. Turn off the machine.	This message appears when the machine is in the shutoff support mode. Turn off the machine once to start the machine again. (see page B-30)
	The "Start/Stop" button does not operate with the foot controller attached. Remove the foot controller.	This message is displayed when the "Start/Stop" button is pushed to sew Utility stitches or Character/Decorative stitches while the foot controller is connected. (This message does not appear when embroidering).
	The upper thread may not be threaded correctly. Thread the upper thread from the beginning.	This message is displayed when it seems that the upper thread has not been threaded correctly.
	The USB media was changed. Do not change the USB media while it is being read.	This message is displayed when you attempt to select a pattern after the USB media in which the pattern is saved has been changed.
	There is no needle plate cover. Attach a needle plate cover.	This message is displayed when the needle plate cover is not attached.
	This file cannot be used.	This message appears if the file format is incompatible with this machine. Check the list of compatible file formats. (see page S-94)
	This file exceeds the data capacity and cannot be used. Use a suitable size file.	This message is displayed when the file size exceeds the data capacity of the machine. Confirm the file size and format. (see page S-95)
	This key cannot be used at this time.	This message is displayed when you press  in the screen other than the Utility Stitch, or press  in the screen other than the Utility Stitch or Character/Decorative Stitch.
	This key does not operate when the needle is down. Raise the needle and press the key again.	This message is displayed when a key on the LCD display is touched while the needle is in the down position.
	This pattern cannot be sewn with this mode.	This message is displayed when the selected stitch is not available for the specific function.

Marks	Error Messages	Cause/Solution
	This stitch is not "Dual Feed Mode" compatible.	This message appears when the optional dual feed foot cannot be used with the current stitch. Select other stitch. (see page B-67)
	This USB media cannot be used.	This message is displayed when you try to use incompatible media.
	This USB media is incompatible.	This message is displayed when you try to use incompatible USB media. For a list of compatible USB media, visit " http://solutions.brother.com ".
	To thread the needle, please remove the fabric from under the presser foot.	This message is displayed if you press the "Automatic Threading" button while the dual feed foot is attached and the presser foot height is 3 mm (1/8 inches) or higher. Remove the fabric, and then press the "Automatic Threading" button again.
	Transmitting by USB	This message is displayed while the USB media is transmitting.
	Turn off the power and replace the needle plate.	This message is displayed when you try to sew with a stitch other than a middle needle position stitch while the single-hole needle plate is installed. This message is displayed when the needle plate is removed with the machine on or when the machine is turned on and "Embroidery" or "Embroidery Edit" mode is selected (see page B-22).
	USB media error	This message is displayed when an error occurs with the USB media.
	USB media is not loaded. Load USB media.	This message is displayed when you try to recall or save a pattern while no USB media is loaded.
	Use the presser foot lifter button to lower the presser foot.	This message is displayed when a button, such as the "Start/Stop" button, is pushed while the presser foot is raised.
	When the speed controller is set to control the zigzag stitch width, the "Start/Stop" button does not operate.	This message is displayed when the speed control lever is set to control the zigzag stitch width, and the "Start/Stop" button is pushed. Use the foot controller to operate the machine.

SPECIFICATIONS

	Item	Specification
Sewing Machine and Accessories (Box 1 of 2)	Dimensions of machine	Approx. 57.1 cm (W) × 33.2 cm (H) × 28.4 cm (D) (approx. 22-1/2 inches (W) × 13-1/16 inches (H) × 11-3/16 inches (D))
	Dimensions of box	Approx. 68.5 cm (W) × 55.0 cm (H) × 37.7 cm (D) (approx. 26-15/16 inches (W) × 21-5/8 inches (H) × 14-13/16 inches (D))
	Weight of machine	Approx. 15.3 kg (approx. 33.7 lb)
	Weight of box (for shipping)	Approx. 20.5 kg (approx. 45.2 lb)
	Sewing speed	70 to 1050 stitches per minute
	Needles	Home sewing machine needles (HA × 130)
Embroidery Unit (Box 2 of 2)	Dimensions of embroidery unit	Approx. 54.5 cm (W) × 13.0 cm (H) × 46.4 cm (D) (approx. 21-7/16 inches (W) × 5-1/8 inch (H) × 18-1/4 inches (D))
	Dimensions of machine with embroidery unit attached	Approx. 81.5 cm (W) × 33.2 cm (H) × 46.4 cm (D) (approx. 32-1/16 inches (W) × 13-1/16 inch (H) × 18-1/4 inches (D))
	Dimensions of box	Approx. 68.5 cm (W) × 55.0 cm (H) × 18.8 cm (D) (approx. 26-15/16 inches (W) × 21-11/16 inch (H) × 7-7/16 inches (D))
	Weight of embroidery unit	Approx. 3.9 kg (approx. 8.5 lb)
	Weight of box (for shipping)	Approx. 6.0 kg (approx. 13.2 lb)
Total Shipping Weight (Combination of all 2 boxes complete)		Approx. 29.5 kg (approx. 65.0 lb)

* Please be aware that some specifications may change without notice.

UPGRADING YOUR MACHINE'S SOFTWARE

You can use USB media or a computer to upgrade software for your sewing machine. When an upgrade program is available on "<http://solutions.brother.com>", please download the files following the instructions on the website and steps below.



Note

- When using USB media to upgrade the software, check that no data other than the upgrade file is saved on the USB media being used before starting to upgrade.

Upgrade Procedure Using USB Media

- 1** While pressing the "Automatic Threading" button, turn the main power to ON.

→ The following screen will appear on the LCD.

- 2** Press  .

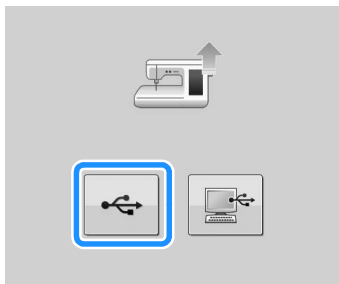

- 3** Insert the USB media into the USB port for media/mouse on the machine. The media device should only contain the upgrade file.

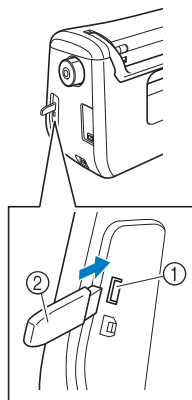

- ① USB port for mouse/media (USB 2.0)
- ② USB media



Note

- The access lamp will begin blinking after inserting USB media, and it will take about 5 to 6 seconds to recognize the media. (Time will differ depending on the USB media).

- 4** Press  .

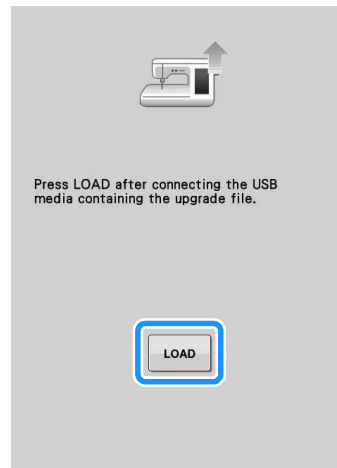

→ The upgrade file is loaded.



Note

- If an error occurs, a red text error message will appear. When the installation is performed successfully, following message will appear.



- 5** Remove the USB media, and turn the machine off and on again.

Upgrade Procedure Using Computer



Note

- Do not connect any additional USB media devices to your computer when using the USB cable.

- While pressing the "Automatic Threading" button, turn the main power to ON.

→ The following screen will appear on the LCD.

- Press .

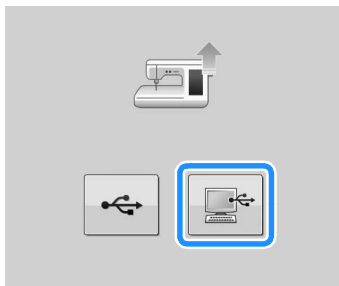

- Plug the USB cable connector into the corresponding USB ports for the computer and for the machine.

→ "Removable Disk" will appear in "Computer (My computer)".

- Copy the upgrade file to "Removable Disk".

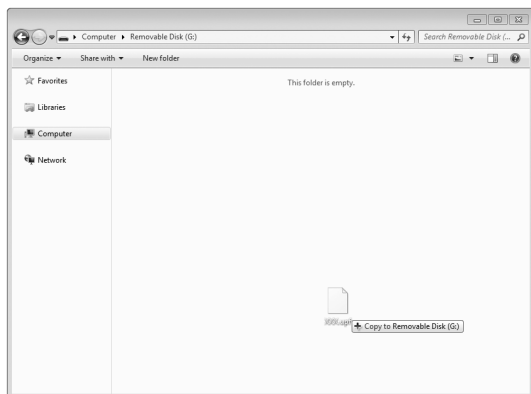

→ The following message will appear.



- When the message disappears, press

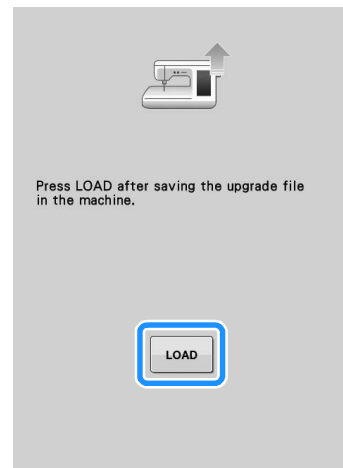

→ The upgrade file is loaded.



Note

- If an error occurs, a red text error message will appear. When the installation is performed successfully, following message will appear.



- Unplug the USB cable, and turn the machine off and on again.

INDEX

A

Accessories	
included accessories	B-12
options	B-15
Accessory compartment	B-12
Adapter	B-54
Adjusting the LED pointer	B-61
Air vent	B-9
Aligning the position	E-36
Alphabet characters	
character/decorative stitches	S-78
embroidery	E-5
embroidery edit	E-59
Appliqué	S-48
embroidery patterns	E-23
quilting	S-38
using a zigzag stitch	S-31
using an embroidery frame pattern	E-51
Array key	E-60, E-64
Arrow keys	S-106, E-36, E-81
Automatic fabric sensor system	S-17
Automatic reinforcement stitch key	S-6
Automatic thread cutting key	S-14
Automatic Threading button	B-11, B-46

B

Back to beginning key	S-87
Ball point needle 75/11	B-57, E-33
Bar tacks	S-60
Basting	S-28
Blind hem stitches	S-45
Block move key	S-108
Bobbin	
pulling up the bobbin thread	B-45
runs out of thread	E-26
setting	B-43
winding	B-38
Bobbin case	
bobbin case	E-21
cleaning	A-19
Bobbin clip	B-14
Bobbin cover	B-10, B-44
Bobbin holder (switch)	B-40
Bobbin winder	B-9
Bobbin work	A-2
Border key	E-72, E-76
Button sewing	S-61
4 hole buttons	S-62
shank	S-62
Buttonhole lever	B-10, S-56, S-59
Buttonholes	
odd-shaped/buttons that do not fit the button holder plate	S-58
one-step	S-55

C

Character spacing key	E-64
Character/Decorative Stitches	
adjustments	S-82
combining	S-89
editing	S-84
key functions	S-84
retrieving	S-98, S-99
saving	S-95, S-96, S-97
selecting	S-77
sewing	S-81
Cleaning	

LCD screen	A-19
machine casing	A-19
race	A-19
Combining Patterns	
character/decorative stitches	S-89
embroidery edit	E-80
Cord guide bobbin cover	S-32
Crazy quilt	S-32
Custom Thread Table	E-68, E-71
Cut/Tension key	E-30

D

Darning	S-58
Dart seam	S-28
Density key	E-40
Dual feed foot	B-67

E

Eco mode	B-30
Editing	
character/decorative stitches	S-84
embroidery	E-36
embroidery edit	E-61
MY CUSTOM STITCH	S-105
Elastic zigzag stitches	S-33
Elongation key	S-86
Embroidery	
adjusting the speed	E-33
automatic thread cutting function (END COLOR TRIM)	E-32
edges or corners	E-16
key functions	E-10
restarting from the beginning	E-28
resuming embroidery after turning off the power	E-28
ribbons or tape	E-16
selecting patterns	E-3
small fabrics	E-16
thread color display	E-34
thread trimming function (JUMP STITCH TRIM)	E-32
Embroidery card	E-7
Embroidery card reader	E-7
Embroidery edit	
changing the thread color	E-67
combined patterns	E-80, E-83
custom thread table	E-68, E-71
explanation of functions	E-57
key functions	E-62
repeated patterns	E-72
Embroidery foot with LED pointer	B-60
Embroidery frame display	E-35
Embroidery frames	
attaching	E-17
inserting fabric	E-14
removing	E-17
types	E-13
using the embroidery sheet	E-15
Embroidery key	E-79
Embroidery needle plate cover	E-22
Embroidery patterns	
aligning the position	E-36
checking the position	E-19
combining	E-80
duplicating	E-78
editing	E-61
linked characters	E-41
patterns which use appliqué	E-23
retrieving	E-48, E-49
revising	E-36

saving E-45, E-46, E-47
 selecting E-3, E-58
 sewing E-21
 using a frame pattern to make an appliqué E-51, E-52
 Embroidery sheet E-15
 Embroidery unit B-11, B-62
 carriage B-11
 Enlarger key S-106
 Error messages A-34
 Eyelet S-62

F

Fabrics
 fabric/thread/needle combinations B-57
 sewing heavyweight fabrics S-7
 sewing lightweight fabrics S-9
 sewing stretch fabrics S-9, S-57
 Fagoting S-52
 Feed dogs B-10, S-40
 Flat bed attachment B-9, B-62
 Flat fell Seam S-29
 Foot controller B-9, S-4
 Forward/Back key E-27, E-28
 Free motion quilting
 free motion echo quilting foot "E" S-43
 free motion open toe quilting foot "O" S-40
 free motion quilting foot "C" S-41
 Free motion sewing mode S-40

G

Gathering S-29
 Grid direction key S-106

H

Handle B-9
 Handwheel B-9
 Heirloom S-53
 Hemstitching
 daisy stitch S-53
 drawn work S-54
 Home page screen B-22

I

Image key S-22, S-88, S-107, E-20
 Insert key S-109

K

Key functions
 character/decorative stitches S-84
 embroidery E-10
 embroidery edit E-62
 MY CUSTOM STITCH S-105
 utility stitches B-24
 Knee lifter B-9, S-15

L

L/R SHIFT S-11
 LCD screen B-9, B-22
 cleaning A-19
 locking S-18
 Lower threading
 pulling up the bobbin thread B-45
 setting the bobbin B-43
 winding the bobbin B-38

M

Machine operation mode key A-23

Main power switch B-9, B-19
 Mirror image key S-21, S-86, E-39
 Multi color key E-40, E-66
 Multi-directional sewing S-63
 MY CUSTOM STITCH
 designing S-103
 entering data S-105
 key functions S-105
 retrieving S-111
 saving S-110
 storing in your list S-110

N

Needle
 changing the needle B-55
 changing the needle position S-25
 fabric/thread/needle combinations B-57
 mode B-22
 twin needle B-49
 Needle bar thread guides B-10, B-50
 Needle clamp screw B-10
 Needle mode selection key B-49
 Needle plate B-10
 Needle position S-18, S-25
 Needle Position button B-11

O

Operation buttons B-9, B-11
 Overcasting S-31, S-33

P

Patchwork S-32
 Piecing S-36
 1/4" quilting foot with guide S-37
 Pintuck S-30
 Pivoting S-15
 Point delete key S-107
 Power cord B-20
 Power cord receptacle B-9
 Presser foot
 adapter B-53
 attaching B-53
 pressure S-17
 removing B-53
 types S-67
 Presser foot code E-9
 Presser foot holder B-10, B-53
 Presser foot holder screw B-10
 Presser foot lever B-9, S-8
 Presser Foot Lifter button B-11
 Presser foot/
 Needle exchange key B-45, B-50, B-53, B-55, B-59
 Pre-tension disk B-9, B-40, B-42

Q

Quilting S-35
 free motion S-40
 with satin stitches S-39

R

Race A-19
 Reinforcement Stitch button B-11, S-5
 Repeated patterns E-72
 Retrieving
 character/decorative stitch patterns S-98
 computer S-100, E-50
 embroidery patterns E-48
 machine's memory S-98, E-48
 MY CUSTOM STITCH designs S-111

stitch settings	S-23
USB media	S-99, E-49
utility stitches	S-23
Reverse Stitch button	B-11, S-5
Reverse/Reinforcement stitches	S-5
Rotate key	E-38, E-63

S

Satin stitches	S-39, S-87
Saving	
character/decorative stitches	S-95
computer	S-97, E-47
embroidery patterns	E-45
machine's memory	S-95, E-45
MY CUSTOM STITCH designs	S-110
stitch settings	S-22
USB media	S-96, E-46
utility stitches	S-22
Scallop stitches	S-50
Screen brightness	A-22
Set key	S-106
Settings	
automatic reinforcement stitching	S-5
automatic thread cutting	S-14, E-32
display language	B-31
embroidery settings	B-29
general settings	B-27
machine setting mode key	B-26, E-33, E-68
sewing settings	B-26
stitch length	S-10
stitch width	S-10
thread tension	S-12, E-30
thread trimming	E-32
Sewing machine help key	B-34
Sewing speed controller (speed control slide)	B-9, B-11, S-3
Sewing type selection key	B-36
Shelltuck stitches	S-49
Shutoff support mode	B-30
Single/Repeat sewing key	S-86
Single/Triple stitching key	S-106
Size key	E-37, E-63
Size selection key	S-86
Smocking stitches	S-51
Speaker	B-27
Special spool cap	B-39
Specifications	A-37
Spool cap	B-9
Spool net	B-51
Spool pin	B-9
Stabilizer	E-11
Start/Stop button	B-11
Starting point key	E-37
Step stitch patterns	S-92
Stitch setting chart	S-67
Straight stitch foot	S-26
Straight stitch needle plate	S-26
Straight stitches	S-24
Supplemental spool pin	B-9, B-38, B-50

T

Tape attaching	S-33
Tape or elastic attaching	S-52
Test key	S-107, S-110
Thread	
fabric/thread/needle combinations	B-57
thread tension	S-12, E-30
Thread color display	E-34
Thread cutter	B-9, S-4
Thread Cutter button	B-11
Thread density key	S-87
Thread guide	B-9, B-39, B-42, B-50
Thread guide plate	B-9, B-42, B-46

Thread marks	E-75
Thread palette key	E-66, E-67, E-71
Top cover	B-9
Top stitching	S-50
Touch pen	S-106, E-67, A-22
Trial key	E-19
Troubleshooting	A-23
Twin needle	B-49

U

Uninterrupted embroidering	E-43
Upgrading	A-38
Upper threading	
twin needle mode	B-49
using the "Automatic Threading" button	B-46
using the spool net	B-51
USB cable	B-65, S-97, E-47, E-50, A-39
USB media	
recalling	S-99, E-49
saving	S-96, E-46
usable	S-94, E-44
USB mouse	B-30, B-66
USB port connector	
for computer	B-9, S-97, E-47
for mouse/media	S-96, E-46
Utility stitches	
key functions	B-24
pattern explanation key	B-37
retrieving	S-23
saving	S-22
selecting	S-21
sewing type selection key	B-36
stitch setting chart	S-67

W

Walking foot	B-53
--------------------	------

Z

Zigzag stitches	S-31
Zipper insertion	
centered	S-64
side	S-65

Please visit us at <http://solutions.brother.com> where you can get product support and answers to frequently asked questions (FAQs).

English
882-C50
Printed in Taiwan



XF6500-001