

Before you can use the DCP, you must set up the hardware and install the driver. To help you get started in setting up the machine and installing the driver and software, please read this "Setup Guide" and follow the simple instructions.

Step 1



Setting Up the Machine



Step 2



Installing the Driver & Software



Setup is Complete!

For the latest drivers and to find the best solution for your problem or question, access the Brother Solutions Center directly from the driver or go to <http://solutions.brother.com>. Keep this "Quick Setup Guide", User's Guide and supplied CD-ROM in a convenient place for quick and easy reference at all times.

Setting Up
the Machine

Windows®
USB

Windows®
Parallel

Windows
NT® 4.0
Parallel

Installing the Driver & Software

Windows®
Network



Macintosh®
USB

Macintosh®
Network

For
Administrators

Getting Started

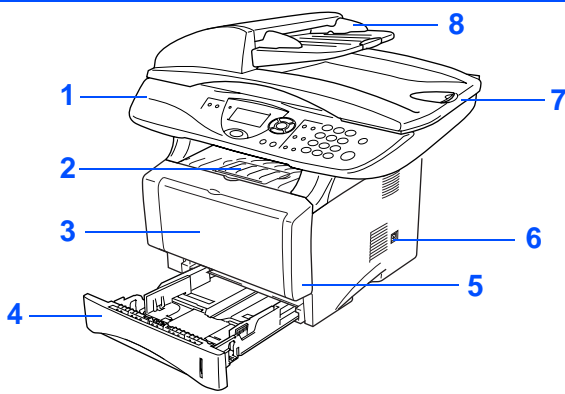
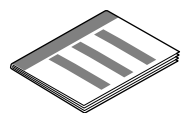
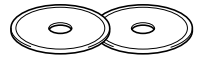
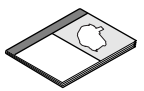
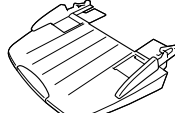
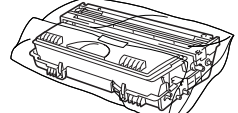
Carton Components

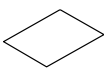
<p>DCP</p>  <p>1. Control Panel 2. Face-down Output Tray Support Flap with Extension (Support Flap) 3. (For DCP-8020) Manual Feed Tray (For DCP-8025D) Multi-purpose Tray (MP Tray) 4. Paper Tray 5. Front Cover 6. Power Switch 7. Document Cover 8. Automatic Document Feeder (ADF)</p>		 <p>Quick Setup Guide</p>	
		 <p>CD-ROMs For Windows® For Macintosh®</p>	
		 <p>User's Guide</p>	
 <p>ADF Support</p>	 <p>Drum Unit Assembly (including Toner Cartridge)</p>	 <p>AC Power Cord</p>	 <p>Accessory Order Form (USA/Canada only)</p>

Carton components may differ from one country to another.
Save all packing materials and the carton.



- *The interface cable is not a standard accessory. Please purchase the appropriate interface cable for the interface you intend to use (Parallel or USB).*
- *For Parallel use a bi-directional shield interface cable that is IEEE 1284-compliant, and not longer than 6 feet (2 meters).*
- *For USB use a Hi-Speed USB 2.0 interface cable that is not longer than 6 feet (2 meters).*
- *Please make sure that you use a Hi-Speed USB 2.0 certified cable if your computer uses a Hi-Speed USB 2.0 interface.*
- *Even if your computer has a USB 1.1 interface, you can connect the DCP.*

Control Panel

DCP-8020 and DCP-8025D have similar control panel keys.

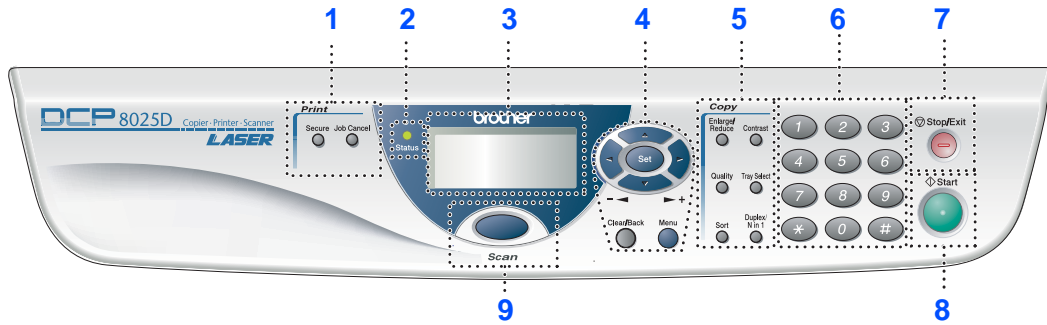

1. Print keys	4. Navigation keys	7. Stop/Exit
2. Status LED (Light-Emitting Diode)	5. Copy keys (Temporary Settings)	8. Start
3. 5-Line Liquid Crystal Display (LCD)	6. Numeric keys	9. Scan key



For the details of the control panel, see "Control panel overview" in Chapter 1 of the User's Guide.

Warning

When you move the DCP, grasp the side handholds that are under the scanner. Do NOT carry the DCP by holding it at the bottom.

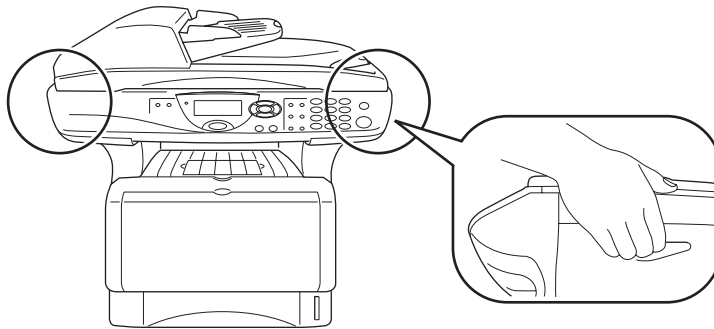





 <p>Warning</p>		 <p>Hint</p>	 <p>User's Guide</p>
<p>Indicates warnings that must be observed to prevent possible personal injury.</p>	<p>Indicates cautions that must be observed to use the DCP properly or to prevent damage to the DCP.</p>	<p>Indicates notes and useful tips to remember when using the DCP.</p>	<p>Indicates reference to the User's Guide.</p>

Table of Contents

Step 1

Setting Up the Machine

1. Install the Automatic Document Feed (ADF) Support	2
2. Install the Drum Unit Assembly	2
3. Load Paper in the Paper Tray	3
4. Release the Scanner Lock.....	4
5. Install Power Cord.....	5
6. Selecting Your Language (Canada Only).....	5

Step 2

Installing the Driver & Software

Windows®

Supplied CD-ROM (MFL-Pro Suite).....	6
For USB Interface Cable Users (For Windows® 98/98SE/Me/2000 Professional/XP).....	8
■ For Windows® 98/98SE/Me Users Only	11
■ For Windows® 2000 Professional Users Only.....	13
■ For Windows® XP Users Only	17
For Parallel Interface Cable Users (For Windows® 95/98/98SE/Me/2000 Professional/XP).....	20
■ For Windows® 95/98/98SE/Me Users Only	23
■ For Windows® 2000 Professional Users Only.....	24
■ For Windows® XP Users Only	28
For Windows NT® Workstation Version 4.0 Users	31
For Network Interface Cable Users (For Windows® 95/98/98SE/Me/NT/2000 Professional/XP).....	34

Macintosh®

For USB Interface Cable Users.....	38
■ For Mac® OS 8.6 to 9.2	38
■ For Mac® OS X 10.1/10.2.1 or greater.....	40
For Network Interface Cable Users	42
■ For Mac® OS 8.6 to 9.2	42
■ For Mac® OS X 10.1/10.2.1 or greater.....	44

■ For Administrators

Network User's Guide Chapter Map (NC-9100h)	46
Installing the BRAdmin Professional Configuration Utility (Windows® Users Only)	47
Web BRAdmin (Windows® Users Only)	47
Setting your IP Address, Subnet Mask and Gateway using BRAdmin Professional (Windows® Users Only).....	48
Options.....	49
Replacement Consumables.....	49

Step 1

Setting Up the Machine

1 Install the Automatic Document Feed (ADF) Support



Do NOT connect the interface cable. Connecting the interface cable is done when installing the driver.

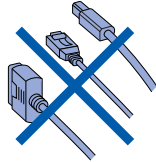

- 1 Open the ADF cover.

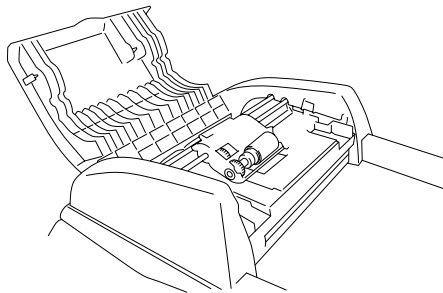
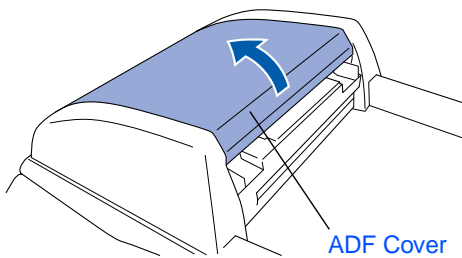

- 2 Slide ADF support into the groove on ADF.

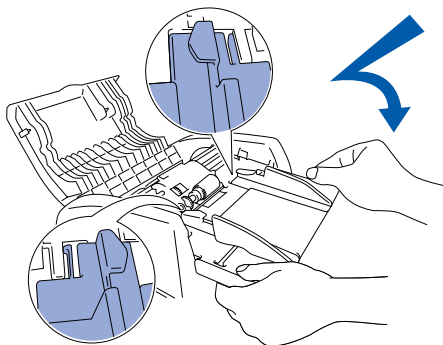

- 3 Close the ADF cover.

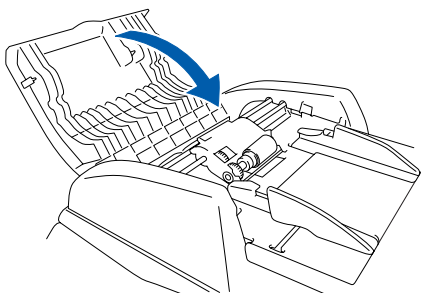

2 Install the Drum Unit Assembly

- 1 Open the front cover by pressing the front cover release button.

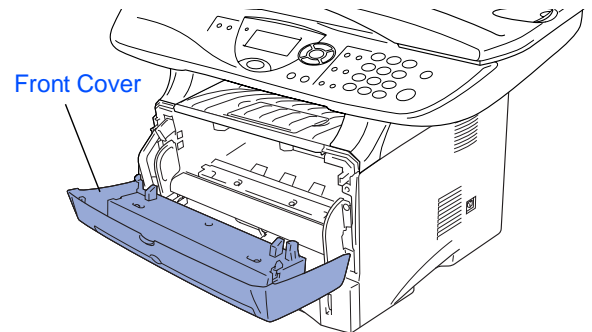
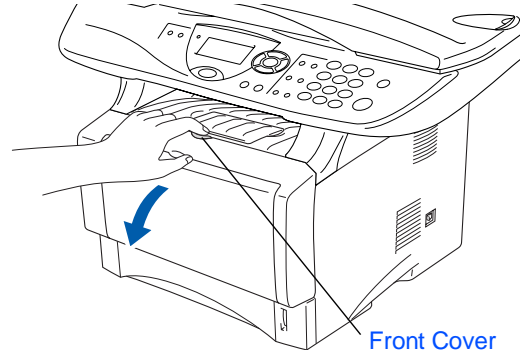

- 2 Unpack the drum unit assembly. Remove the protective part.

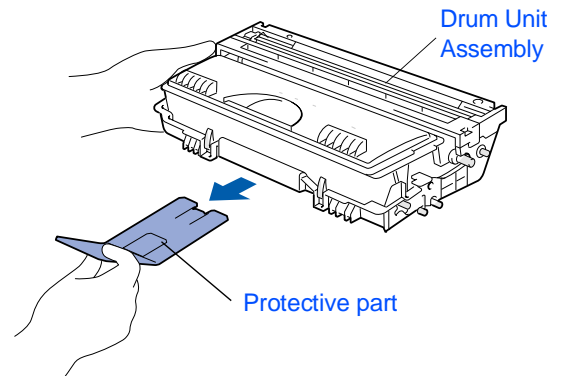

- Rock it from side to side several times to distribute the toner evenly inside the assembly.

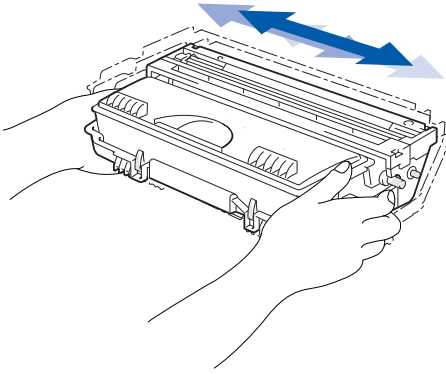

- Push the drum unit assembly into the machine (until it snaps into place).

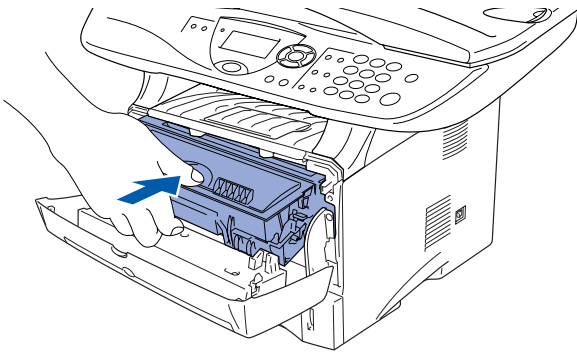

- Close the front cover of the machine.

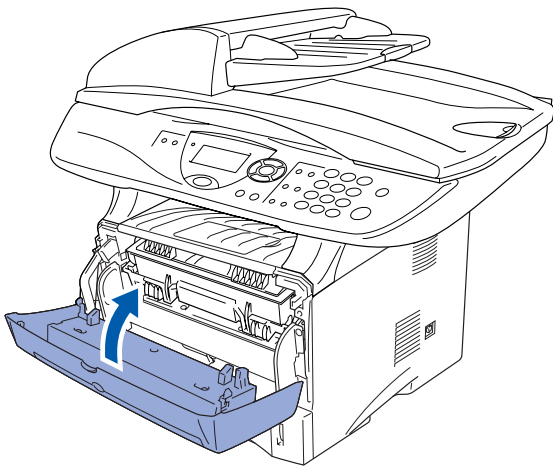

3 Load Paper in the Paper Tray

- Pull the paper tray completely out of the machine.

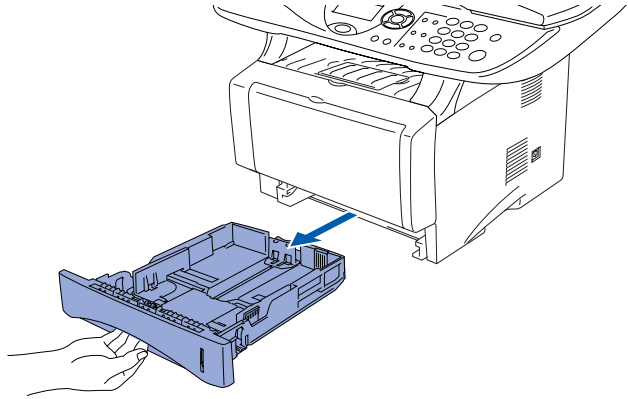

- While pressing the paper guide release lever, slide the adjusters to fit the paper size. Check that the guides are firmly in the slots on the tray.

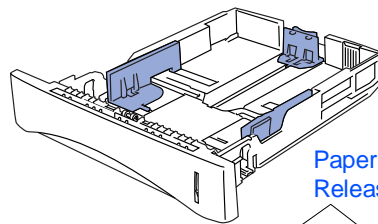

Paper Guide Release Lever

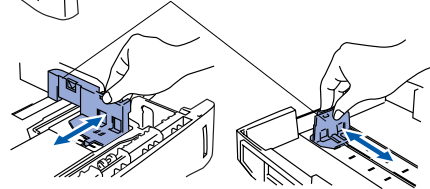

For Legal size paper, press the universal guide release button and pull out the rear of the paper tray.

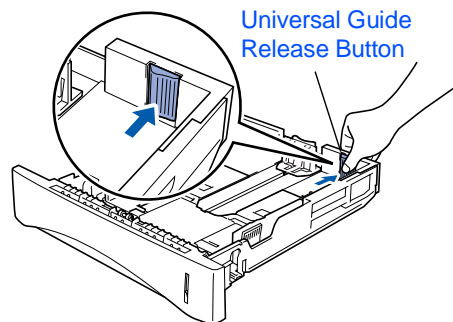

Universal Guide Release Button

Step 1

Setting Up the Machine

- 3 Fan the stack of paper well to avoid paper jams and misfeeds.

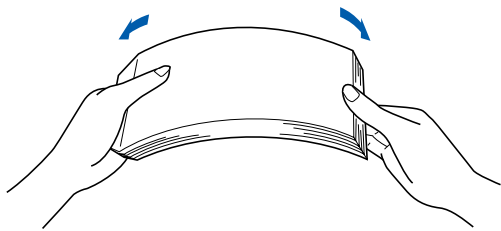

- 4 Put paper in the paper tray. Check that the paper is flat in the tray and below the maximum paper mark.

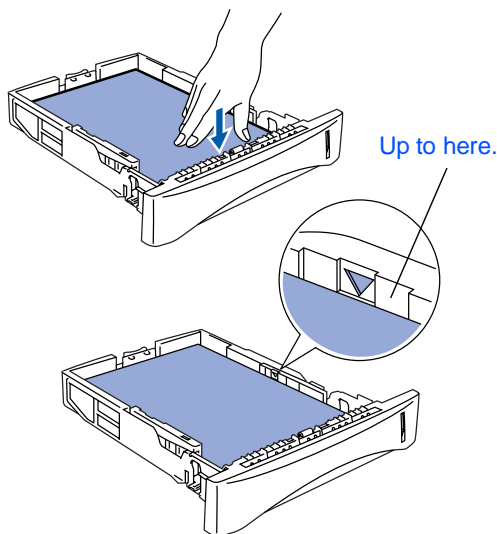

- 5 Put the paper tray firmly back in the machine and unfold the Support flap before you use the machine.

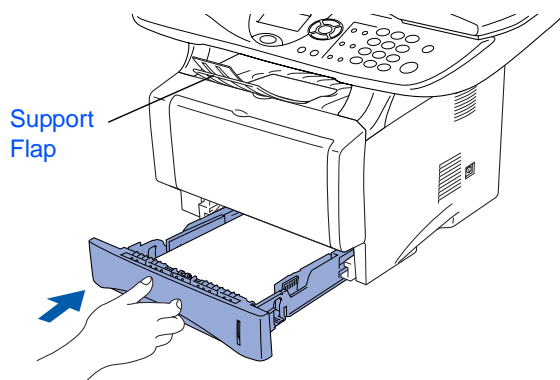

For details on supported paper specifications, see "Paper" in Chapter 2 of the User's Guide.

4 Release the Scanner Lock

- 1 Push the lever up to unlock the scanner. (The gray scanner lock lever is located at the back left under side of the document cover.)

Scanner Lock Lever

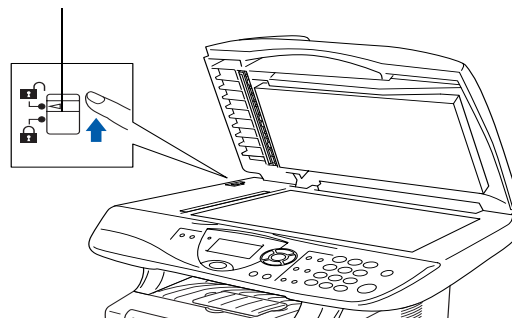

5 Install Power Cord

 Do not connect the Parallel or USB cable yet.

- 1 Make sure that the power switch is off. Connect the AC power cord to the machine.

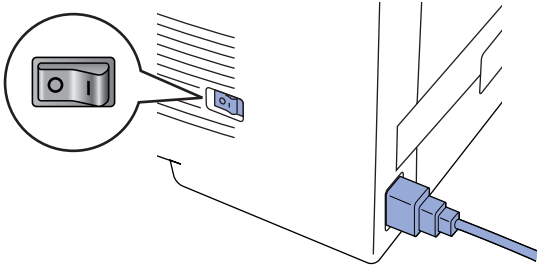



- 2 Plug the AC power cord into an AC outlet. Turn the power switch on.



If **Check Scan Lock** appears on the LCD, immediately release the scanner lock and press **Stop/Exit**.

6 Selecting Your Language (Canada Only)

- 1 Press the **Menu** key.
- 2 Press the **1** key.
- 3 Press the **0** key.
- 4 Select your language (ENGLISH or FRENCH) by using  or , and then press the **Set** key.

```
10.Local Language
▲ English *
▼ French
Select ▲▼ & Set
```

- 5 Press the **Stop/Exit** key.

Go to Next page to install the driver

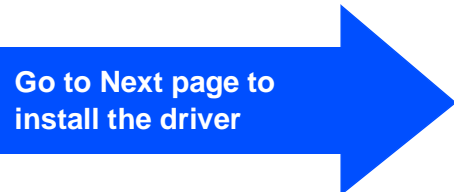

Supplied CD-ROM (MFL-Pro Suite)

You can find a variety of information on the CD-ROM.

Windows®



Install Software

You can install printer, scanner drivers and the various utility items, including PaperPort® and TextBridge® OCR.



On-Line Registration

You will be pointed to the Brother Product Registration Web Page for quick registration of your DCP.



Documentation

View the User's Guide and other documentation in PDF format. (Viewer included)



Brother Support

You can access the Brother Solutions Center which is a Web site offering information about your Brother product including FAQs, User's Guides, Driver updates and Tips for using your machine.



Help

Helpful hints.

Macintosh®



Start Here

You can install the printer driver, scanner driver, and Presto! PageManager® for OS 8.6 - 9.2



Documentation

View the User's Guide and other documentations in PDF format.



Start Here OS X

You can install the printer driver, scanner driver, and Presto! PageManager® for Mac OS 10.1/10.2.1 or greater (Scanning is not supported in OS 10.1).



Brother Solutions Center

You can access the Brother Solutions Center which is a Web site offering information about your Brother product including FAQs, User's Guides, Driver updates and Tips for using your machine.



ReadMe!

You can get important information and troubleshooting tips.



On-Line Registration

You will be pointed to the Brother Product Registration Web Page for quick registration of your DCP.



Follow the instructions on this page for your operating system and interface cable.

Setting Up
the Machine

Windows®



USB Interface Cable Users Go to page 8
(For Windows® 98/98SE/Me/2000 Professional/XP)

Windows®
USB



Parallel Interface Cable Users..... Go to page 20
(For Windows® 95/98/98SE/Me/2000 Professional/XP)

Windows®
Parallel



Windows NT® Workstation Version 4.0 Users... Go to page 31
(For Parallel Interface Cable Users)

Windows
NT® 4.0
Parallel



Network Interface Cable Users Go to page 34
(For Windows® 95/98/98SE/Me/NT/2000 Professional/XP)

Windows®
Network

Macintosh®



USB Interface Cable Users
■ For Mac® OS 8.6 to 9.2 Go to page 38
■ For Mac® OS X 10.1/10.2.1 or greater Go to page 40

Macintosh®
USB



Network Interface Cable Users
■ For Mac® OS 8.6 to 9.2 Go to page 42
■ For Mac® OS X 10.1/10.2.1 or greater Go to page 44

Macintosh®
Network

For Administrators..... Go to page 46

For
Administrators

Step 2

Installing the Driver & Software



For USB Interface Cable Users

(For Windows® 98/98SE/Me/2000 Professional/XP)

Make sure that you have completed the instructions from Step 1 “Setting Up the Machine” on pages 2 - 5.

- 1 Switch off and unplug the DCP from the AC outlet and disconnect it from your computer, if you already connected an interface cable.

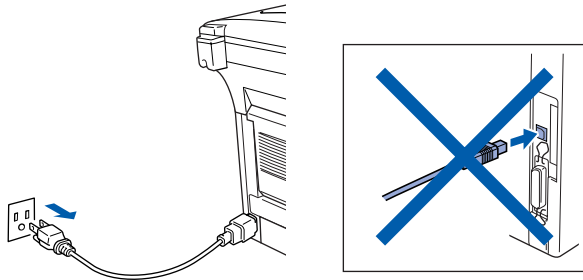

- 2 Turn on your computer. (For Windows® 2000 Professional/XP, you must be logged on as the administrator.)
- 3 Insert the supplied CD-ROM for Windows® into your CD-ROM drive. If the model name screen appears, select your machine. If the language screen appears, select your language.



- 4 The CD-ROM main menu will appear. Click **Install Software**.



If this window does not appear, use Windows® Explore to run the **setup.exe** program from the root directory of the Brother CD-ROM.

- 5 Click **MFL-Pro Suite** in Main Application.



MFL-Pro Suite includes Printer Driver, Scanner Driver, ScanSoft® PaperPort®, ScanSoft® TextBridge® and True Type fonts. PaperPort® is a document management application for viewing scanned documents. ScanSoft® TextBridge®, which is integrated into PaperPort®, is an OCR application that converts an image into text and inserts it into your default word processor.

- 6 Click **Install**.

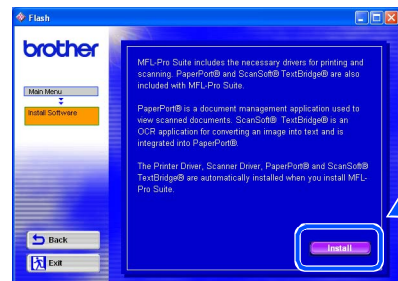

If you see the following screen, click **OK** to install the Windows® updates. After the updates are installed your PC may restart. Note: If it does the installation will automatically continue.

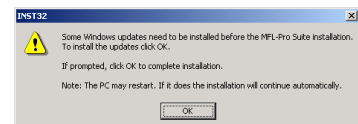

If the installation does not continue automatically, please open the installer menu again by double-clicking the **setup.exe** program from the root directory of the Brother CD-ROM, and continue from Step 4.

- 7 When the PaperPort® 8.0 SE Setup window is displayed, click **Next**.

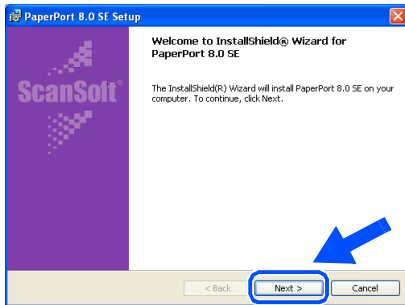

- 8 After reading and accepting the ScanSoft® License Agreement, enter your user information and click **Next**.

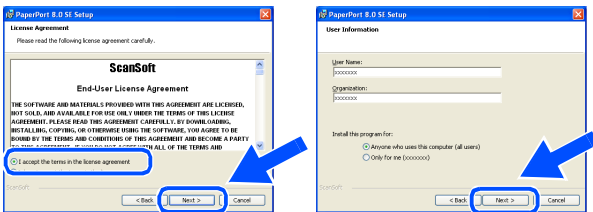

- 9 Select **Typical** and click **Next**.

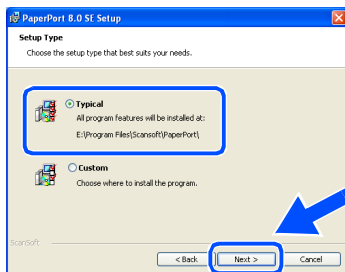

- 10 Click **Install** and PaperPort® will start installing on your computer.

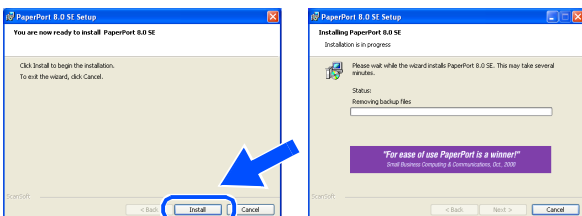

- 11 When the ScanSoft® Registration screen is displayed, make your selection and follow the on-screen instructions.

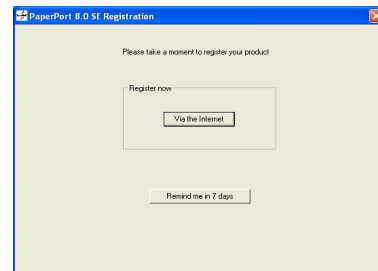

- 12 Click **Finish** to complete installation.

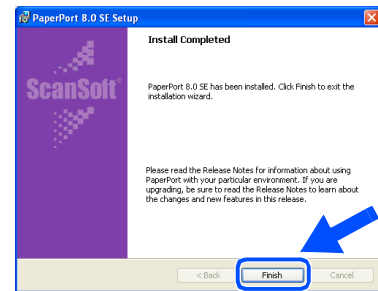

- 13 When the Brother MFL-Pro Suite Installation window appears, click **Next**.

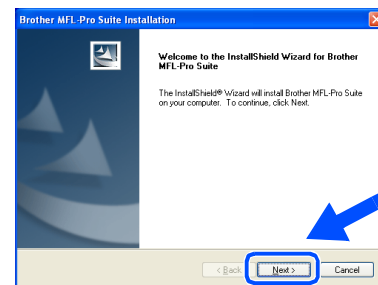

If an error message appears at this point in the installation process, or if you have previously installed the MFL-Pro Suite, you will first have to uninstall it. From the **Start** menu, select **Programs, Brother, Brother MFL-Pro Suite, Uninstall**, and then follow the instructions on the screen.

Continued ...

Step 2

Installing the Driver & Software



For USB Interface Cable Users

(For Windows® 98/98SE/Me/2000 Professional/XP)

- 14 When the Brother Software License Agreement window appears, click **Yes**.

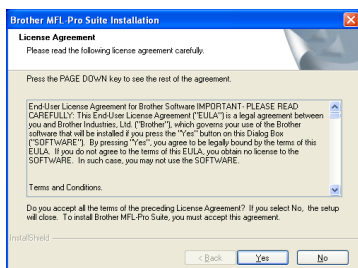

- 15 Select **Local Interface**, and then click **Next**.

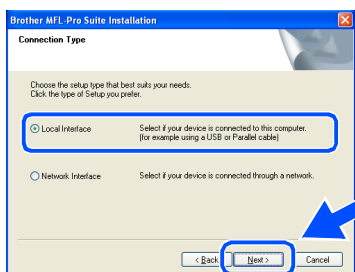

- 16 Select **Standard**, and then click **Next**.
The application files will be copied and installed to your computer.

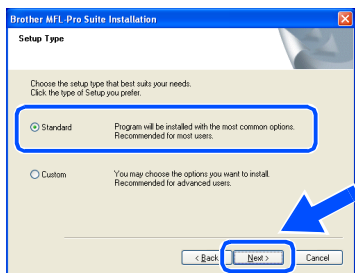

If you want to install the PS driver, select **Custom** and then follow the on-screen instructions. When the **Select Components** screen appears, check **PS Printer Driver**, and then continue following the on-screen instructions.



Windows® 98/98SE/Me Users

→ Go to page 11

Windows® 2000 Professional Users

→ Go to page 13

Windows® XP Users

→ Go to page 17

For Windows® 98/98SE/Me Users Only

Make sure that you followed the instructions in 1 to 16 on pages 8 - 10.

- 17 When this screen appears, connect the USB interface cable to your PC, and then connect it to the DCP. Turn on the DCP by plugging in the power cord. Turn the power switch on.

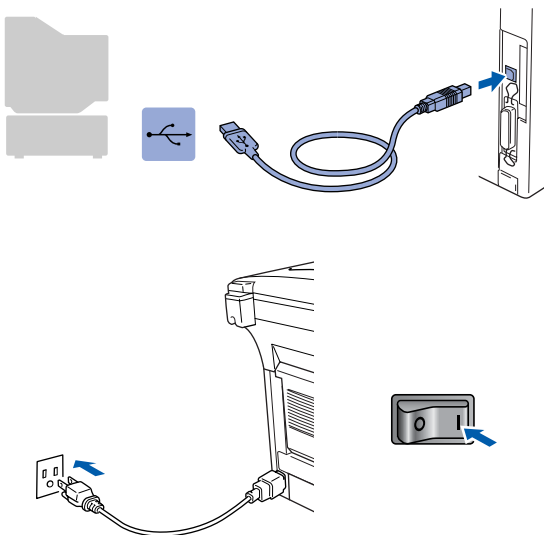
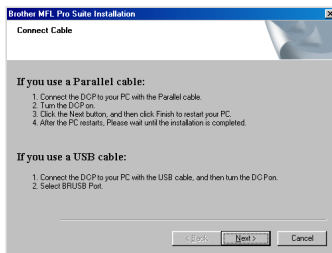

It will take a few seconds for the installation screen to appear. The installation of the Brother drivers will automatically start. Follow the instructions on the screen.

- 18 Select **BRUSB: USB Printer Port**, and then click **Next**.

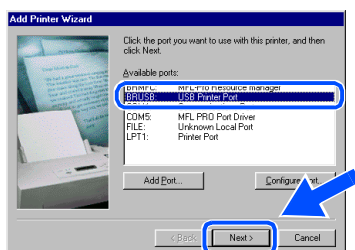

- 19 Accept the default Printer name by selecting **Yes**, and then click **Next**.

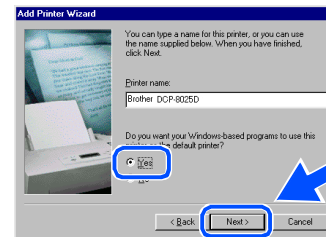

- 20 Select **Yes (recommended)**, and then click **Finish**. A test page will be printed so you can check the print quality.

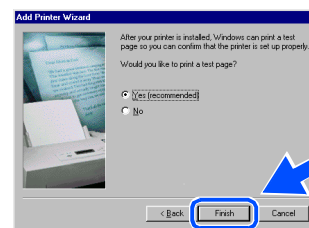

- 21 If the test page is printed correctly, click **Yes**. If you click **No**, follow the prompts on the screen to correct the problem.

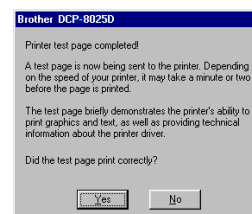

If the **README.WRI** file shown in step 22 appears, close the **README.WRI** file and then click **Finish** after printing the test page.

Continued ...

Step 2

Installing the Driver & Software



For USB Interface Cable Users

(For Windows® 98/98SE/Me/2000 Professional/XP)

- 22 The README.WRI file will be displayed. Please read this file for troubleshooting information and then close the file to continue installation.

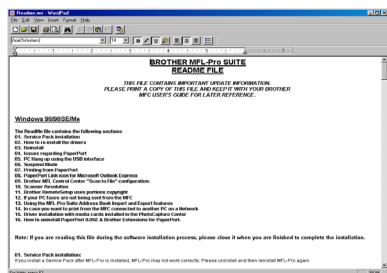

- 23 Click **Finish** to restart your computer.

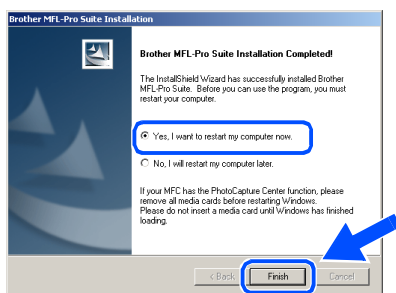

- 24 After the computer restarts, click **Yes** to have the Control Center load each time Windows® is started. The Control Center will appear as an icon in the task tray. If you click **No** the Scan keys on the DCP will be disabled.

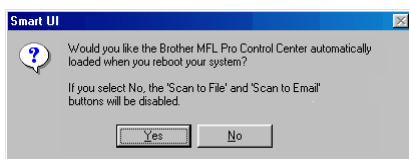

Even if you select **NO**, you will be able to launch the Brother Control Center later to use the **Scan** key by double clicking the Smart UI icon on the desktop. This loads the Brother Control Center to the task tray. See *AutoLoad the Brother Control Center*, Chapter 15 in the Documentation (User's Guide) located on the CD-ROM.

- OK!** The Brother Printer and Scanner drivers have been installed and the installation is now complete.

For Windows® 2000 Professional Users Only

Make sure that you followed the instructions in 1 to 16 on pages 8 - 10.

- 17 When this screen appears, connect the USB interface cable to your PC, and then connect it to the DCP. Turn on the DCP by plugging in the power cord. Turn the Power Switch on.

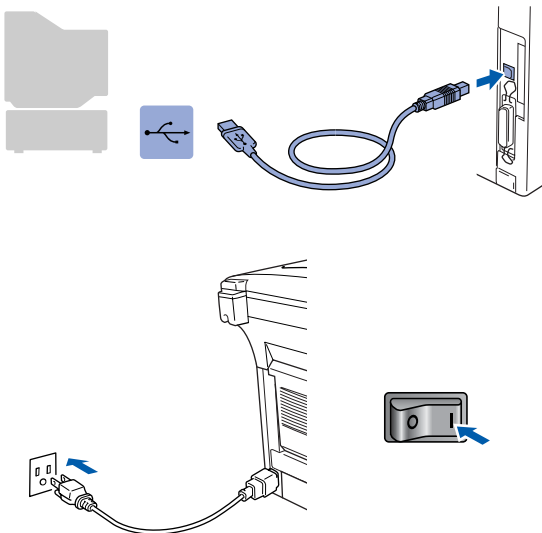
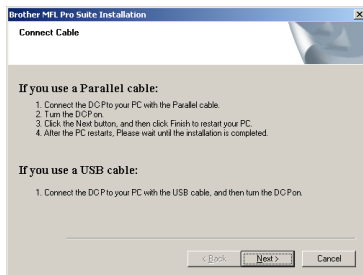

It will take a few seconds for the installation screen to appear.

The installation of the Brother drivers will automatically start. Follow the instructions on the screen.

- 18 If the **Digital Signature Not Found** dialog boxes appear, click **Yes** to install the driver.

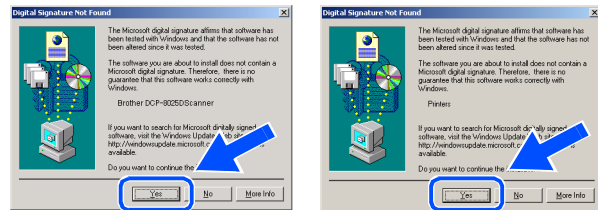

- 19 The README.WRI file will be displayed. Please read this file for troubleshooting information and then close the file to continue installation.

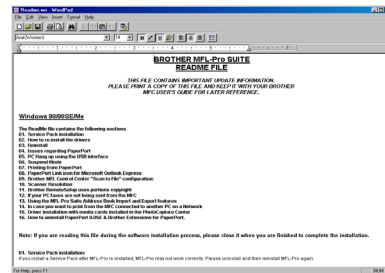

- 20 Click **Finish** to restart your computer.

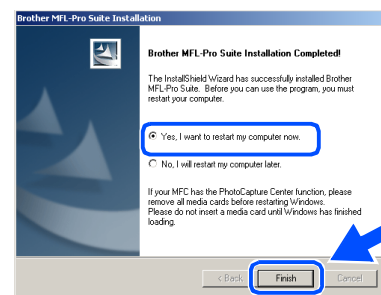

Continued ...



For USB Interface Cable Users

(For Windows® 98/98SE/Me/2000 Professional/XP)

- 21 After the computer restarts, click **Yes** to have the Control Center load each time Windows® is started. The Control Center will appear as an icon in the task tray. If you click **No** the Scan keys on the DCP will be disabled.

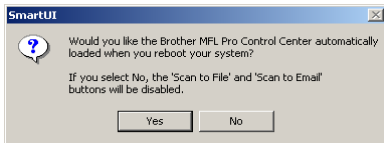

Even if you select **NO**, later you will be able to launch the Brother Control Center to use the **Scan** key by double clicking the Smart UI icon on the desktop. This loads the Brother Control Center to the task tray. See *AutoLoad the Brother Control Center*, Chapter 15 in the Documentation (User's Guide) located on the CD-ROM.



A Basic Universal printer driver was installed with the MFL-PRO Software Suite which is certified for use with Windows® operating systems.

Brother also offers a full featured printer driver (Native driver) that includes more features than the Basic Universal driver. However, this driver does not include a Windows® certificate. To install the Brother Native driver proceed to step 22.



For details on what features are available see chapter 7 of the User's Guide.

Brother Native driver Installation

- 22 Click **Start** and select **Settings** and then **Pointers**. Click on **Add a printer** and the Add Printer Wizard will start. When this screen appears, click **Next**.

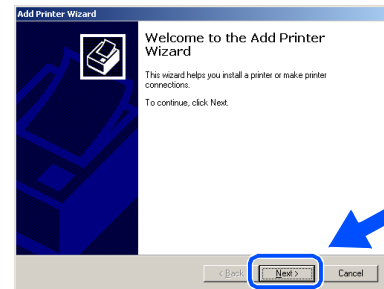

- 23 Un-check the **Automatically detect and install my Plug and Play printer** selection and then click **Next**.

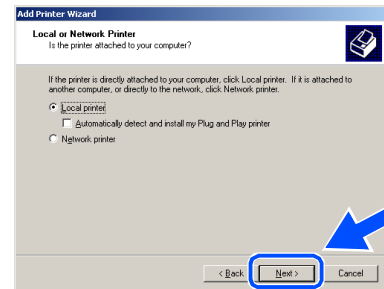

- 24 Select **USBXXX** from the pull down window for the Printer Port Selection and then click **Next**.

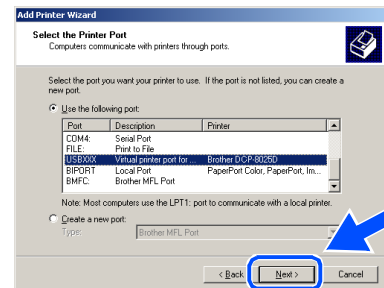

- 25 Click on **Have Disk**.

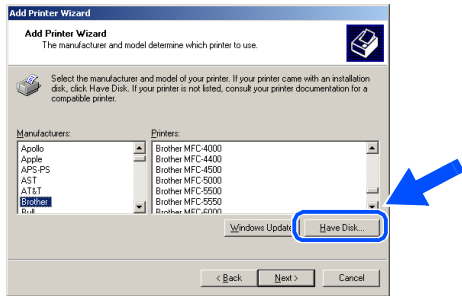

- 26 Browse the CD-ROM and highlight your language folder and click **Open**. Highlight the **W2K** folder and click **Open**. Highlight the **Addprt** folder and click **Open**.

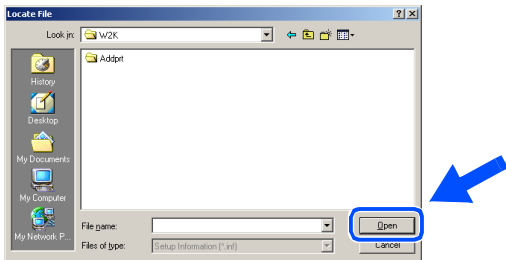

- 27 Click **Open**.

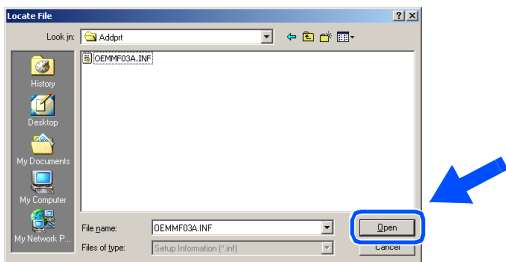

- 28 Make sure **X:\ENGIW2K\Addprt** is displayed in the window and click **OK** (X:\ is the drive letter of your CD-ROM).

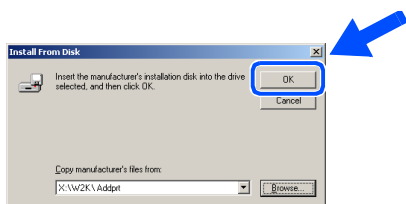

- 29 Highlight the model you are installing from the list of machines and click **Next**.

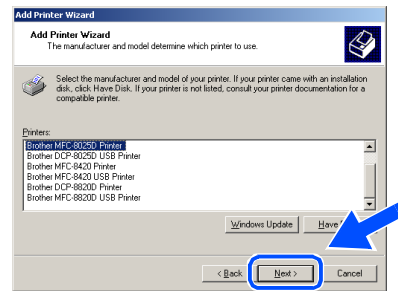

 Make sure you select a USB printer.

- 30 The model you are installing will be listed in the window. Select **Yes** or **No** if you want this driver to be your default printer.

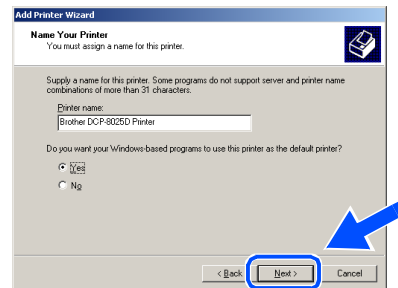

- 31 If this screen appears, select **Do not share this printer** and **Next**.

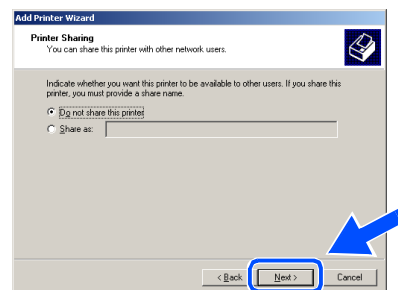

Continued ... 

Step 2

Installing the Driver & Software



For USB Interface Cable Users

(For Windows® 98/98SE/Me/2000 Professional/XP)

32 Select **Yes** and **Next** to print a test page.

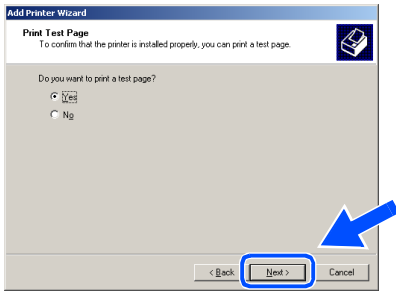

35 If the test page printed, click **OK**.

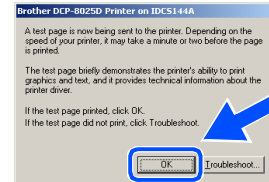

33 When this screen appears, click **Finish**.

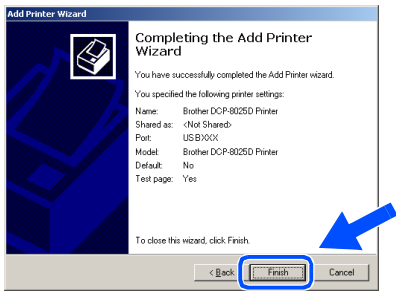

There will be two Brother printer drivers listed in the Printers selection. The driver with "Printer" after the model name (ex. Brother DCP-8025D Printer) is the Brother Native Driver.



The Brother Native Drivers have been installed and the installation is now complete.

34 If the Digital Signature Not Found dialog box appears, click **Yes**.

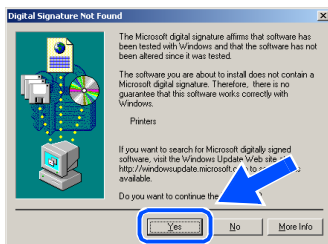

For Windows® XP Users Only

Make sure that you followed the instructions in 1 to 16 on pages 8 - 10.

- 17 When this screen appears, connect the USB interface cable to your PC, and then connect it to the DCP. Turn on the DCP by plugging in the power cord. Turn the power switch on.

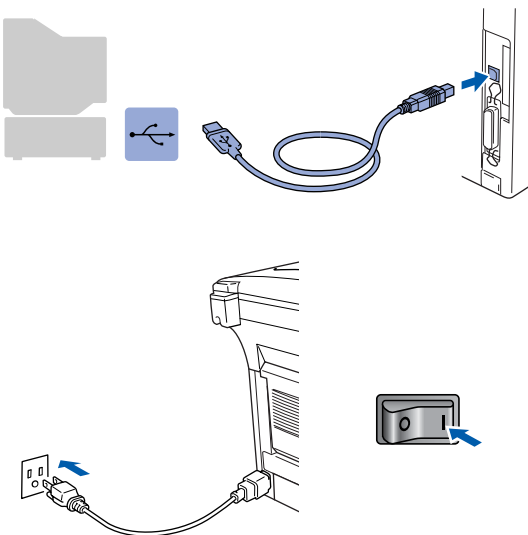
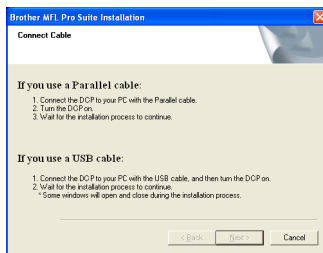

It will take a few seconds for the installation screen to appear. The installation of the Brother drivers will automatically start. The screens appear one after another, please wait for a while.

- 18 The README.WRI file will be displayed. Please read this file for troubleshooting information and then close the file to continue installation.

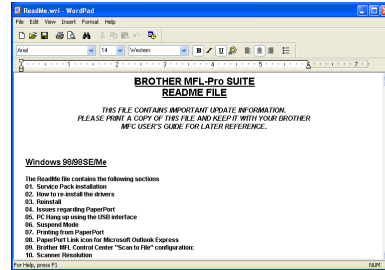

- 19 Click **Finish** to restart your computer.

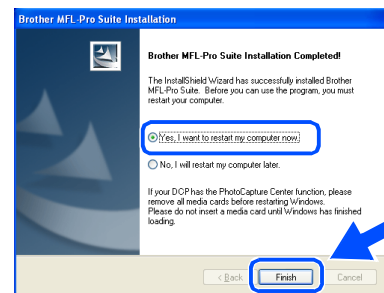

- OK! A Basic Universal printer driver was installed with the MFL-PRO Software Suite which is certified for use with Windows® operating systems.

Brother also offers a full featured printer driver (Native driver) that includes more features than the Basic Universal driver. However, this driver does not include a Windows® certificate. To install the Brother Native driver proceed to step 20.



For details on what features are available see chapter 7 of the User's Guide.

Continued ...

Step 2

Installing the Driver & Software



For USB Interface Cable Users

(For Windows® 98/98SE/Me/2000 Professional/XP)

Brother Native driver Installation

- 20 Click **Start** and select **Printers and Faxes**. Click on **Add a printer** and the Add Printer Wizard will start. When this screen appears, click **Next**.

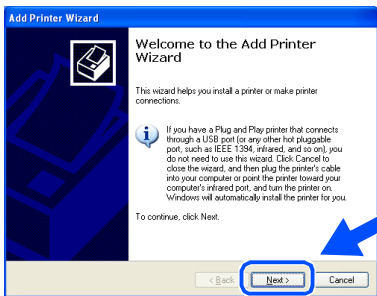

- 21 Un-check the **Automatically detect and install my Plug and Play printer** selection and then click **Next**.

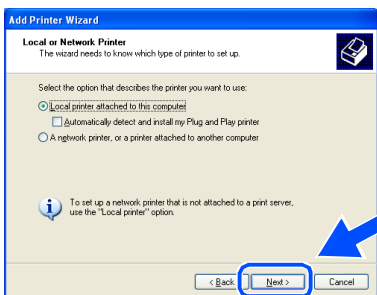

- 22 Select **USBXXX** from the pull down window for the Printer Port Selection and then click **Next**.

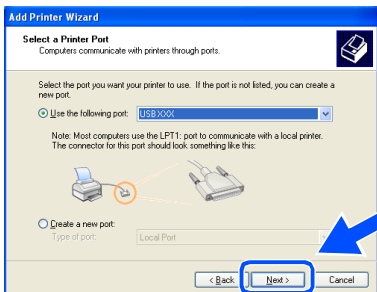

- 23 Click on **Have Disk**.

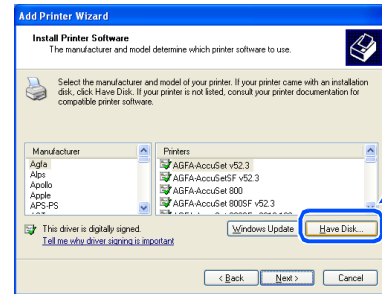

- 24 Browse the CD-ROM and highlight your language folder and click **Open**. Highlight the **WXP** folder and click **Open**. Highlight the **Addprt** folder and click **Open**.

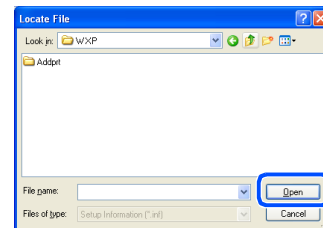

- 25 Click **Open**.

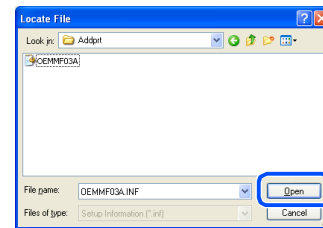

- 26 Make sure **X:\ENG\WXP\Addprt** is displayed in the window and click **OK** (X:\ is the drive letter of your CD-ROM).

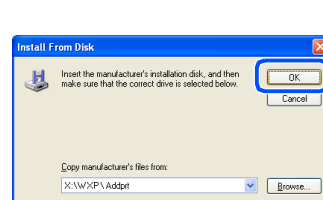

- 27 Highlight the model you are installing from the list of machines and click **Next**.

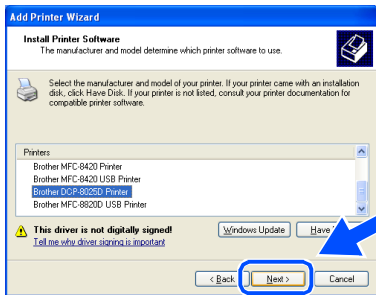

Make sure you select a USB printer.

- 28 The model you are installing will be listed in the window. Select **Yes** or **No** if you want this driver to be your default printer.

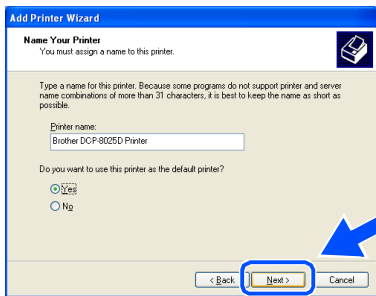

- 29 If this screen appears, select **Do not share this printer** and **Next**.

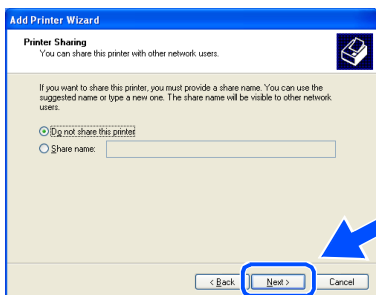

- 30 Select **Yes** and **Next** to print a test page.

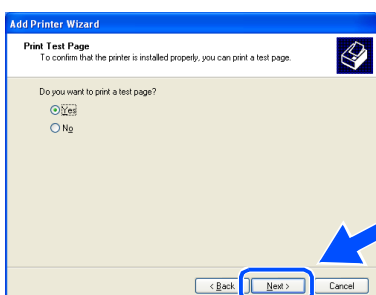

- 31 When this screen appears, click **Finish**.

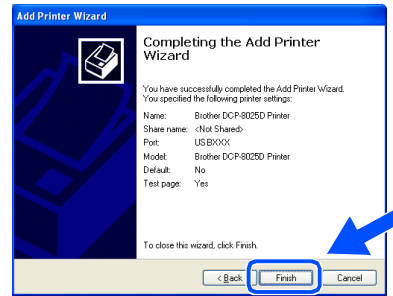

- 32 When the Windows Logo testing screen appears, click **Continue Anyway**.

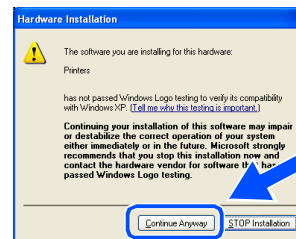

There will be two Brother printer drivers listed in the Printers selection. The driver with "Printer" after the model name (ex. Brother DCP-8025D Printer) is the Brother Native Driver.

- OK!** The Brother Native Drivers have been installed and the installation is now complete.

For Parallel Interface Cable Users (For Windows® 95/98/98SE/Me/2000 Professional/XP)

Make sure that you have completed the instructions from Step 1 “Setting Up the Machine” on pages 2 - 5.

- 1 Switch off and unplug the DCP from the AC outlet and disconnect it from your computer, if you already connected an interface cable.

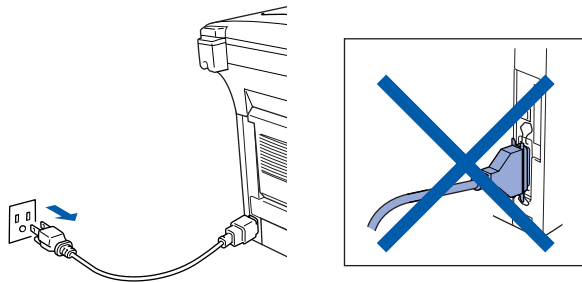

- 2 Turn on your computer. (For Windows® 2000 Professional/XP, you must be logged on as the administrator.)
- 3 Insert the supplied CD-ROM for Windows® into your CD-ROM drive. If the model name screen appears select your machine. If the language screen appears, select your language.



- 4 The CD-ROM main menu will appear. Click **Install Software**.



If this window does not appear, use Windows® Explore to run the **setup.exe** program from the root directory of the Brother CD-ROM.

- 5 Click **MFL-Pro Suite** in Main Application.



MFL-Pro Suite includes Printer Driver, Scanner Driver, ScanSoft® PaperPort®, ScanSoft® TextBridge® and True Type fonts. PaperPort® is a document management application for viewing scanned documents. ScanSoft® TextBridge®, which is integrated into PaperPort®, is an OCR application that converts an image into text and inserts it into your default word processor.

- 6 Click **Install**.

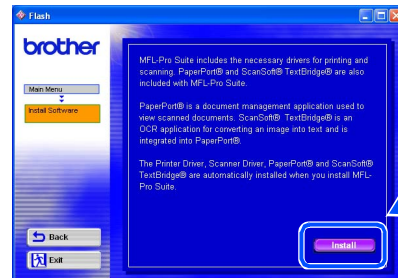

If you see the following screen, click **OK** to install the Windows® updates. After the updates are installed your PC may restart. Note: If it does the installation will automatically continue.

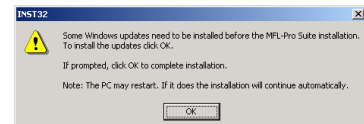

If the installation does not continue automatically, please open the installer menu again by double-clicking the **setup.exe** program from the root directory of the Brother CD-ROM, and continue from Step 4.

- 7 When the PaperPort® 8.0 SE Setup window is displayed, click **Next**.

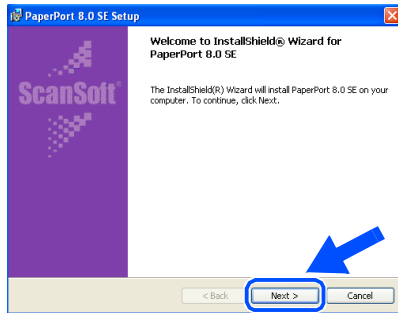

- 8 After reading and accepting the ScanSoft® License Agreement, enter your user information and click **Next**.

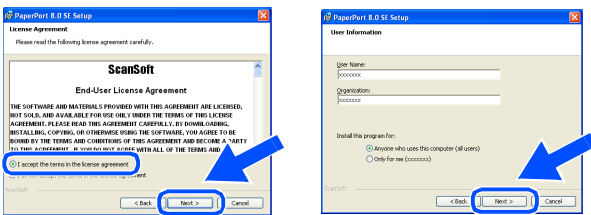

- 9 Select **Typical** and click **Next**.

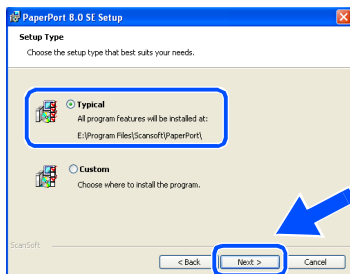

- 10 Click **Install** and PaperPort® will start installing on your computer.

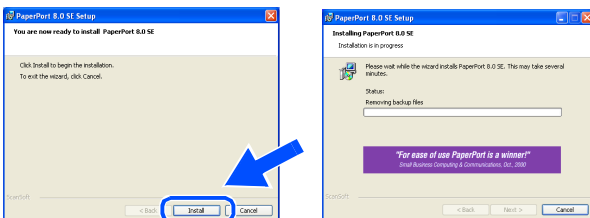

- 11 When the ScanSoft® Registration screen is displayed, make your selection and follow the on screen instructions.

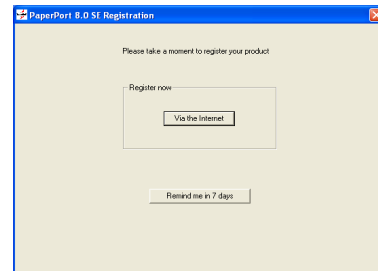

- 12 Click **Finish** to complete installation.

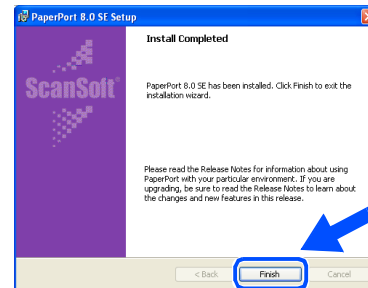

- 13 When the Brother MFL-Pro Suite Installation window appears, click **Next**.

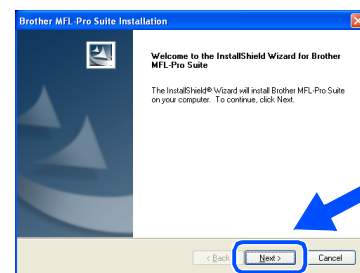

If an error message appears at this point in the installation process, or if you have previously installed the MFL-Pro Suite, you will first have to uninstall it. From the **Start** menu, select **Programs, Brother, Brother MFL-Pro Suite, Uninstall**, and then follow the instructions on the screen.

Continued ...

For Parallel Interface Cable Users (For Windows® 95/98/98SE/Me/2000 Professional/XP)

- 14 When the Brother Software License Agreement window appears, click **Yes**.

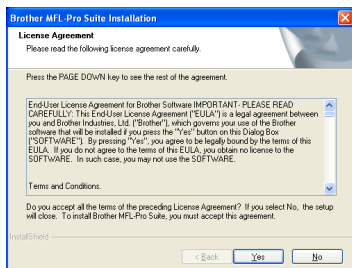

- 15 Select **Local Interface**, and then click **Next**.

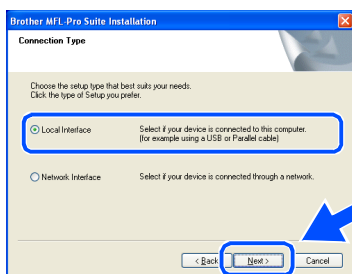

- 16 Select **Standard**, and then click **Next**.
The application files will be copied to your computer.

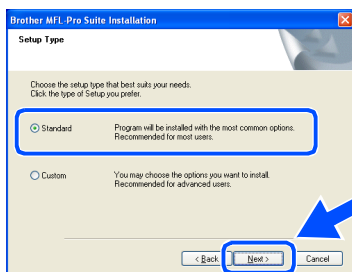

If you want to install the PS driver, select **Custom** and then follow the on-screen instructions. When the **Select Components** screen appears, check **PS Printer Driver**, and then continue following the on-screen instructions.

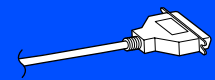

Windows® 95/98/98SE/Me Users
→ Go to page 23
Windows® 2000 Professional Users
→ Go to page 24
Windows® XP Users
→ Go to page 28

For Windows® 95/98/98SE/Me Users Only

Make sure that you followed the instructions in ① to ⑬ on pages 20 - 22.

- ⑰ When this screen appears, connect the parallel interface cable to your PC, and then connect it to the DCP. Turn on the DCP by plugging in the power cord. Turn the power switch on.

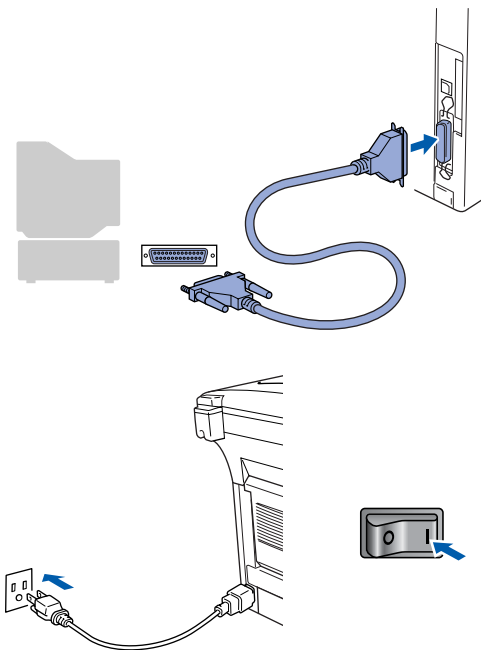
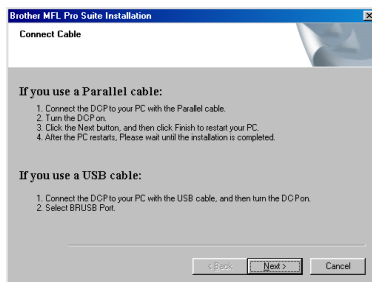

- ⑱ Click **Next**.

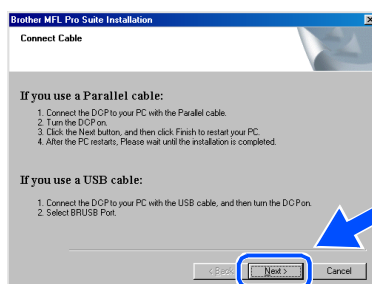

- ⑲ The README.WRI file will be displayed. Please read this file for troubleshooting information and then close the file to continue installation.

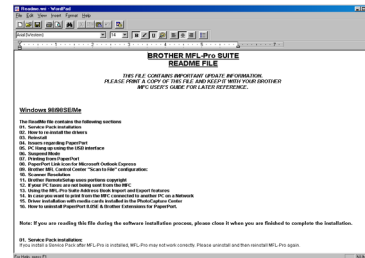

- ⑳ Click **Finish** to restart your computer.

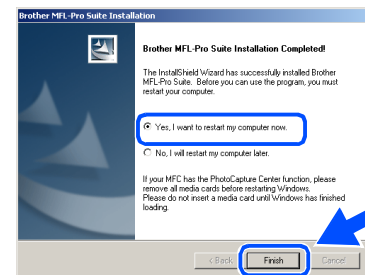

- ㉑ After the computer restarts, the installation of the Brother driver will automatically start. Follow the instructions on the screen.
- ㉒ Click **Yes** to have the Brother MFL-Pro Control Center load each time Windows® is started. The Control Center will appear as an icon in the task tray. If you click **No** the Scan keys on the DCP will be disabled.

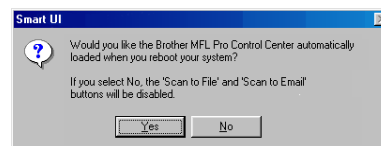

Even if you select **NO**, you will be able to launch the Brother Control Center later to use the **Scan** key by double clicking the Smart UI icon on the desktop. This loads the Brother Control Center to the task tray. See *AutoLoad the Brother Control Center, Chapter 15 in the Documentation (User's Guide) located on the CD-ROM.*

- OK! The Brother Printer and Scanner drivers have been installed and the installation is now complete.

For Parallel Interface Cable Users (For Windows® 95/98/98SE/Me/2000 Professional/XP)

For Windows® 2000 Professional Users Only

Make sure that you followed the instructions in 1 to 16 on pages 20 - 22.

- 17 When this screen appears, connect the parallel interface cable to your PC, and then connect it to the DCP. Turn on the DCP by plugging in the power cord. Turn the power switch on.

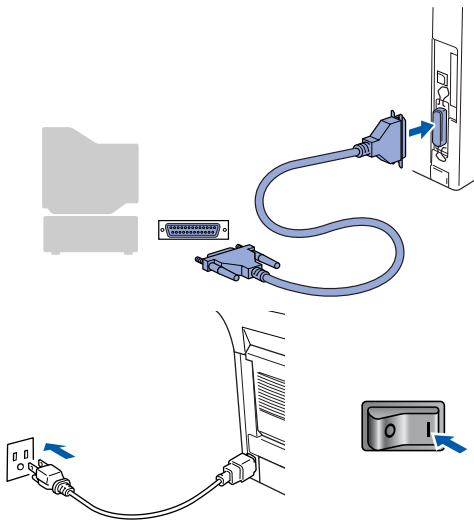
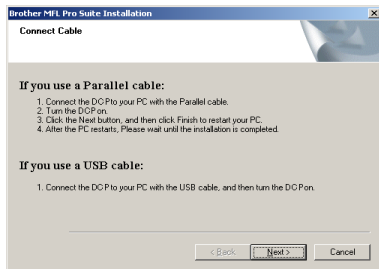

- 18 Click the **Next**.

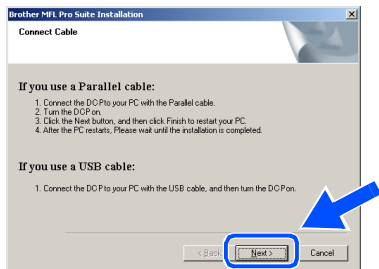

- 19 The README.WRI file will be displayed. Please read this file for troubleshooting information and then close the file to continue installation.

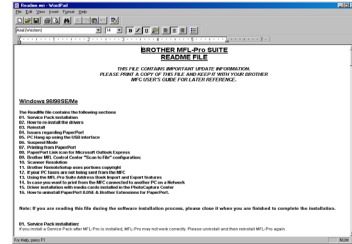

- 20 Click **Finish** to restart your computer.

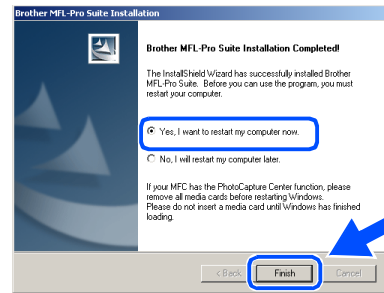

- 21 After the computer restarts, the installation of the Brother drivers will automatically start. Follow the instructions on the screen.

- 22 If the **Digital Signature Not Found** dialog boxes appear, click **Yes** to install the driver.

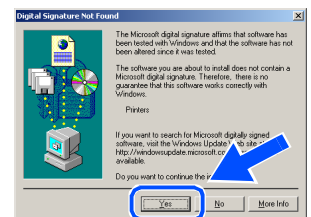
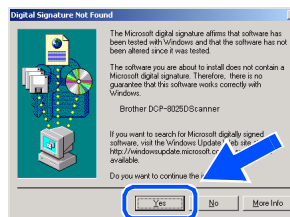

- 23 Click **Yes** to have the Control Center loaded each time Windows® is started. The Control Center will appear as an icon in the task tray. If you click **No** the Scan keys on the DCP will be disabled.

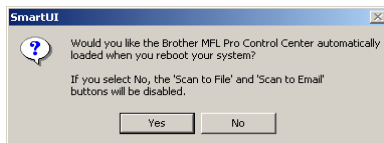

Even if you select **NO**, later you will be able to launch the Brother Control Center to use the **Scan** key by double clicking the Smart UI icon on the desktop. This loads the Brother Control Center to the task tray. See *AutoLoad the Brother Control Center, Chapter 15 in the Documentation (User's Guide) located on the CD-ROM.*

- OK!** A Basic Universal printer driver was installed with the MFL-PRO Software Suite which is certified for use with Windows® operating systems.

Brother also offers a full featured printer driver (Native driver) that includes more features than the Basic Universal driver. However, this driver does not include a Windows® certificate. To install the Brother Native driver proceed to step 24.



For details on what features are available see chapter 7 of the User's Guide.

Brother Native driver Installation

- 24 Click **Start** and select **Settings** and then **Printers**. Click on **Add a printer** and the Add Printer Wizard will start. When this screen appears, click **Next**.



- 25 Un-check the **Automatically detect and install my Plug and Play printer** selection and then click **Next**.

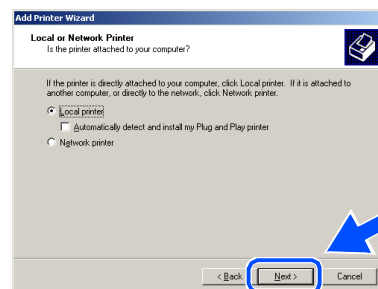

- 26 Select **BMFC (Brother MFL Port)** from the pull down window for the Printer Port Selection and then click **Next**.

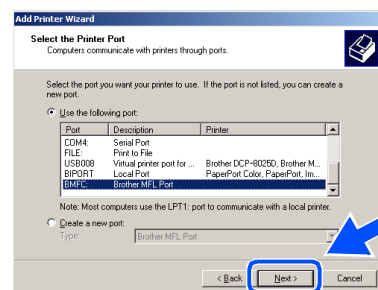

Continued ...

Step 2

Installing the Driver & Software

For Parallel Interface Cable Users (For Windows® 95/98/98SE/Me/2000 Professional/XP)

27 Click on **Have Disk**.

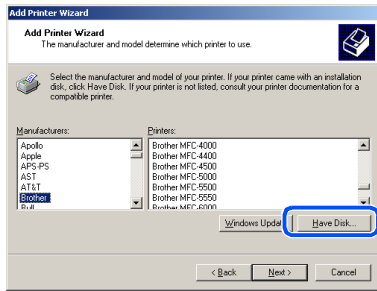

28 Browse the CD-ROM and highlight your language folder and click **Open**. Highlight the **W2K** folder and click **Open**. Highlight the **Addprt** folder and click **Open**.

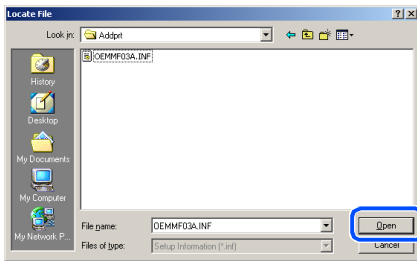

29 Click **Open**.

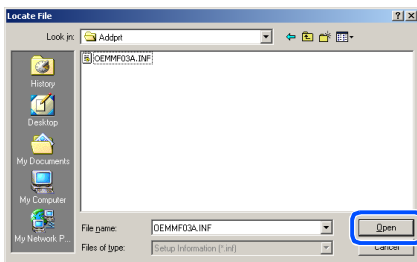

30 Make sure **X:\ENGL\W2K\Addprt** is displayed in the window and click **OK** (X:\ is the drive letter of your CD-ROM).

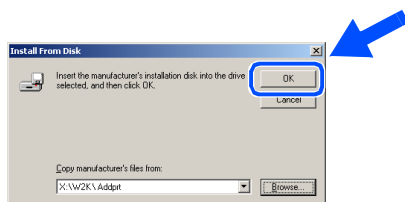

31 Highlight the model you are installing from the list of machines and click **Next**.

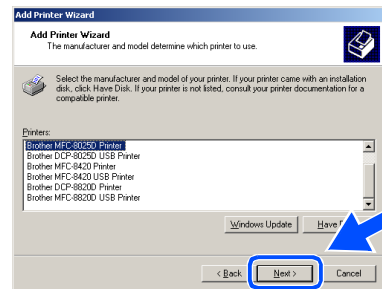

 Make sure you do not select a USB printer.

32 The model you are installing will be listed in the window. Select **Yes** or **No** if you want this driver to be your default printer.

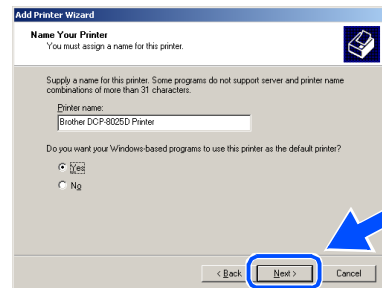

33 If this screen appears, select **Do not share this printer** and **Next**.

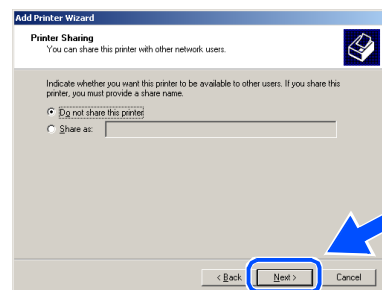

- 34 Select **Yes** and **Next** to print a test page.

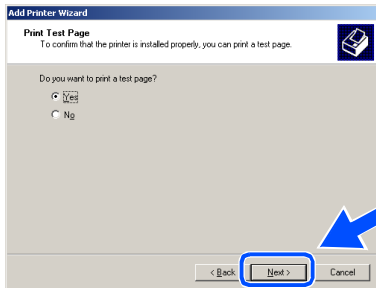

- 35 When this screen appears, click **Finish**.

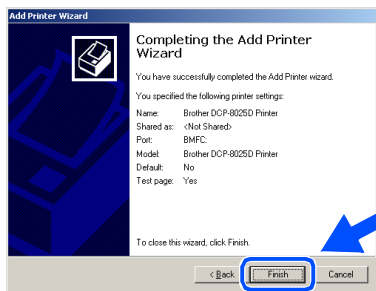

- 36 If the Digital Signature Not Found dialog box appears, click **Yes**.

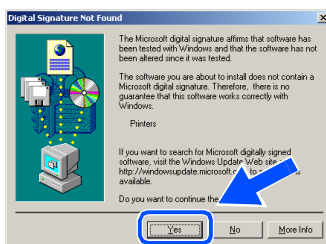

- 37 If the test page printed, click **OK**.

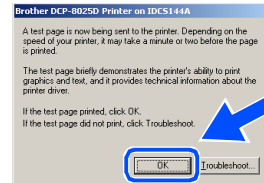

There will be two Brother printer drivers listed in the Printers selection. The driver with "Printer" after the model name (ex. Brother DCP-8025D Printer) is the Brother Native Driver.

- OK!** The Brother Native Drivers have been installed and the installation is now complete.

For Parallel Interface Cable Users (For Windows® 95/98/98SE/Me/2000 Professional/XP)

For Windows® XP Users Only

Make sure that you followed the instructions in 1 to 16 on pages 20 - 22.

- 17 When this screen appears, connect the parallel interface cable to your PC, and then connect it to the DCP. Turn on the DCP by plugging in the power cord. Turn the power switch on.

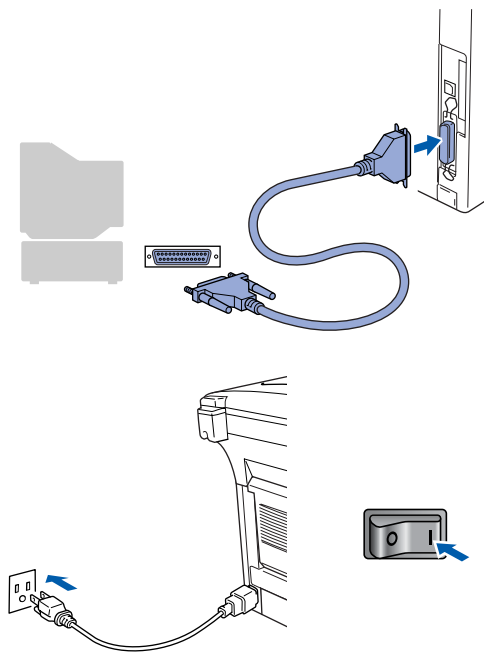
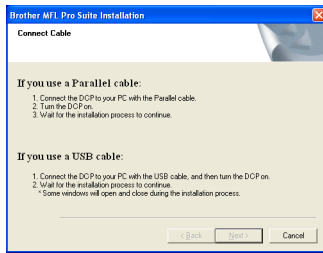

The installation of the Brother drivers will automatically start. The screens appear one after another, please wait for a while.

- 18 The README.WRI file will be displayed. Please read this file for troubleshooting information and then close the file to continue installation.

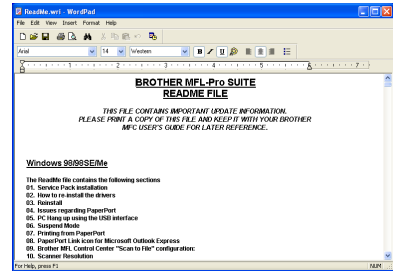

- 19 When the following screen appears, click **Finish** and wait as the PC restarts Windows and continues the installation.

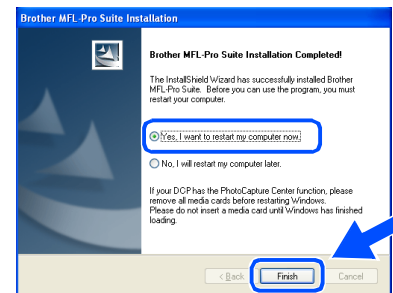

- OK!** A Basic Universal printer driver was installed with the MFL-PRO Software Suite which is certified for use with Windows® operating systems.

Brother also offers a full featured printer driver (Native driver) that includes more features than the Basic Universal driver. However, this driver does not include a Windows® certificate. To install the Brother Native driver proceed to step 20.



For details on what features are available see chapter 7 of the User's Guide.

Brother Native driver Installation

- 20 Click **Start** and select **Printers and Faxes**. Click on **Add a printer** and the Add Printer Wizard will start. When this screen appears, click **Next**.

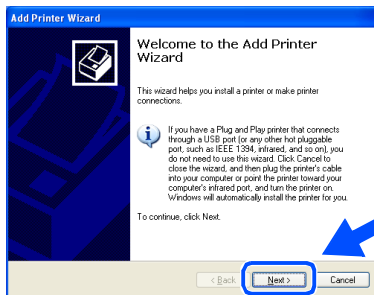

- 21 Un-check the **Automatically detect and install my Plug and Play printer** selection and then click **Next**.

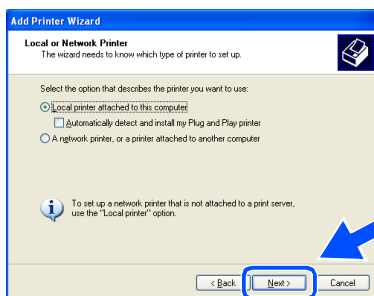

- 22 Select **BMFC (Brother MFL Port)** from the pull down window for the Printer Port Selection and then click **Next**.

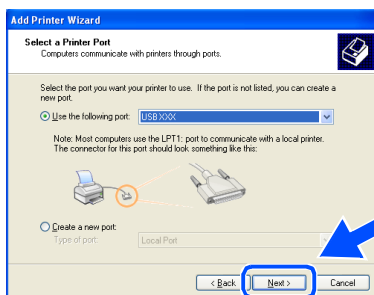

- 23 Click on **Have Disk**.

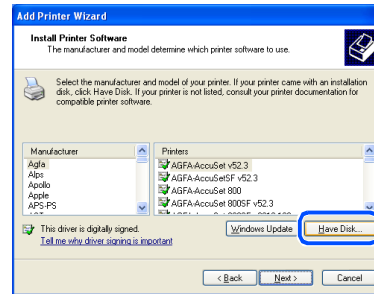

- 24 Browse the CD-ROM and highlight your language folder and click **Open**. Highlight the **WXP** folder and click **Open**. Highlight the **Addprt** folder and click **Open**.

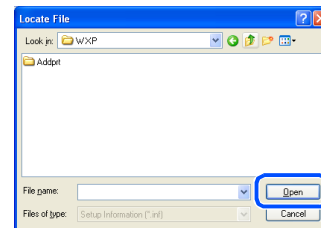

- 25 Click **Open**.

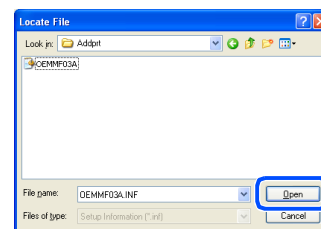

- 26 Make sure **X:\ENG\WXP\Addprt** is displayed in the window and click **OK** (X:\ is the drive letter of your CD-ROM).

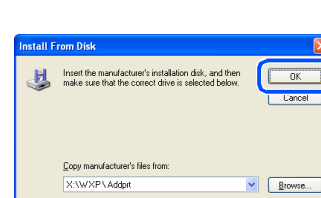

Continued ...

Step 2

Installing the Driver & Software

For Parallel Interface Cable Users (For Windows® 95/98/98SE/Me/2000 Professional/XP)

- 27 Highlight the model you are installing from the list of machines and click **Next**.

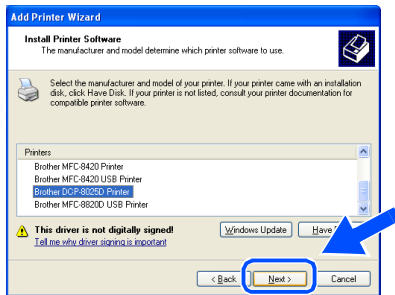

Make sure you do not select a USB printer.

- 28 The model you are installing will be listed in the window. Select **Yes** or **No** if you want this driver to be your default printer.

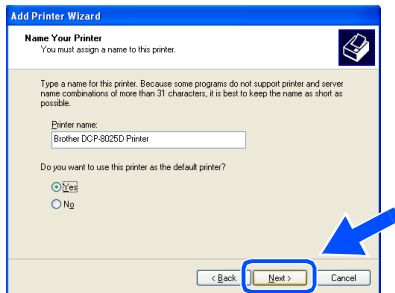

- 29 If this screen appears, select **Do not share this printer** and **Next**.

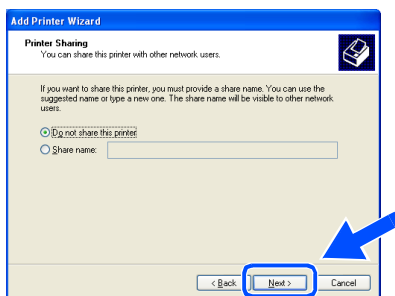

- 30 Select **Yes** and **Next** to print a test page.

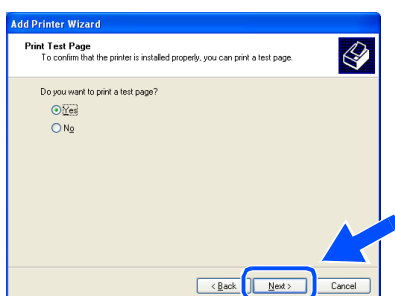

- 31 When this screen appears, click **Finish**.

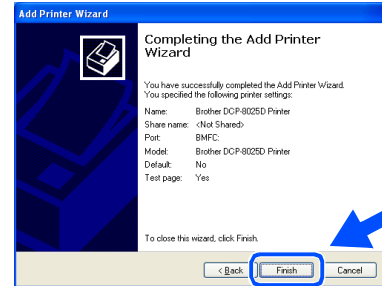

- 32 When the Windows Logo testing screen appears, click **Continue Anyway**.

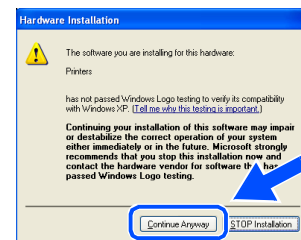

There will be two Brother printer drivers listed in the Printers selection. The driver with "Printer" after the model name (ex. Brother DCP-8025D Printer) is the Brother Native Driver.

- OK!** The Brother Native Drivers have been installed and the installation is now complete.

For Windows NT® Workstation Version 4.0 Users

Make sure that you followed the instructions from Step 1 “Setting Up the Machine” on pages 2 - 5.

- 1 Turn on your computer. You must be logged on as the Administrator.
- 2 Connect the parallel interface cable to your computer, and then connect it to the DCP.

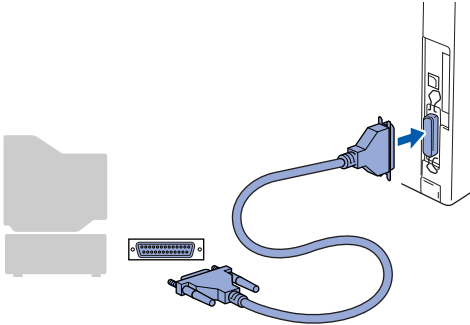

- 3 Make sure you turn on the DCP by plugging in the power cord, and turning Power Switch on.

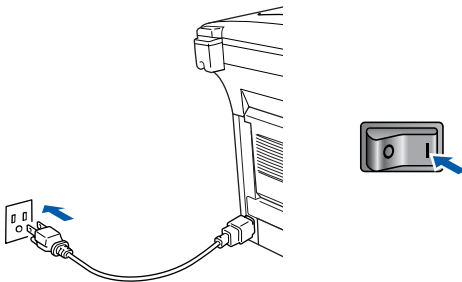

- 4 Insert the Supplied CD-ROM for Windows® into your CD-ROM drive. If the model name screen appears, select your machine. If the language screen appears, select your language.



- 5 The CD-ROM main menu will appear. Click **Install Software**.



If this window does not appear, use Windows® Explore to run the **setup.exe** program from the root directory of the Brother CD-ROM.

- 6 Click **MFL-Pro Suite** in Main Application.

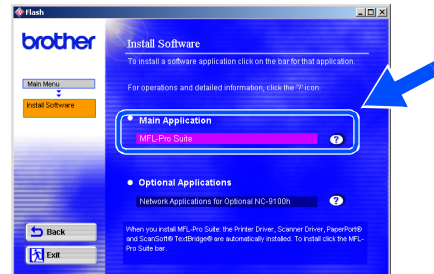

MFL-Pro Suite includes Printer Driver, Scanner Driver, ScanSoft® PaperPort®, ScanSoft® TextBridge® and True Type fonts. PaperPort® is a document management application for viewing scanned documents. ScanSoft® TextBridge®, which is integrated into PaperPort®, is an OCR application that converts an image into text and inserts it into your default word processor.

- 7 Click **Install**.

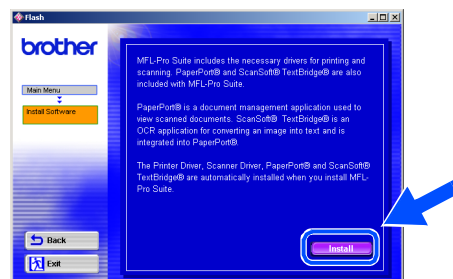

If you see the following screen, click **OK** to install the Windows® updates. After the updates are installed your PC may restart. Note: If it does the installation will automatically continue.

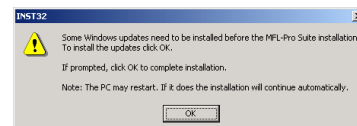

If the installation does not continue automatically, please open the installer menu again by double-clicking the **setup.exe** program on the Brother CD-ROM, and continue from Step 5.

Continued ...

Step 2

Installing the Driver & Software



For Windows NT® Workstation Version 4.0 Users

- 8 When the PaperPort® 8.0 SE Setup window is displayed, click **Next**.

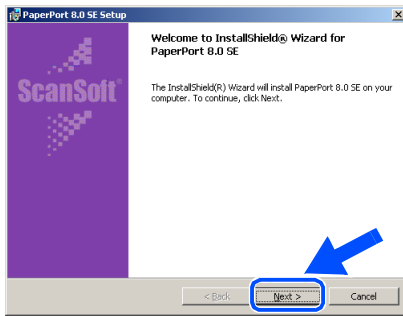

- 12 When the ScanSoft® Registration screen is displayed, make your selection and follow the on screen instructions.

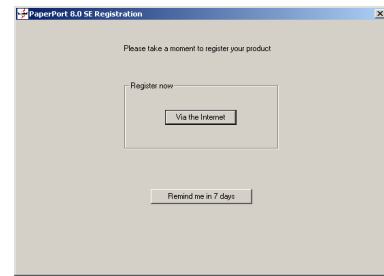

- 9 After reading and accepting the ScanSoft® License Agreement, enter your user information and click **Next**.

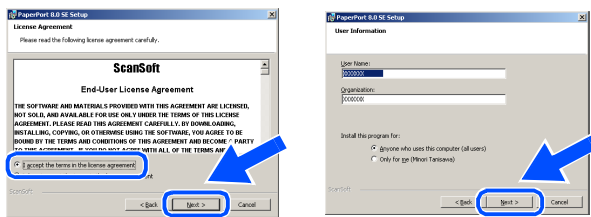

- 13 Click **Finish** to complete installation.

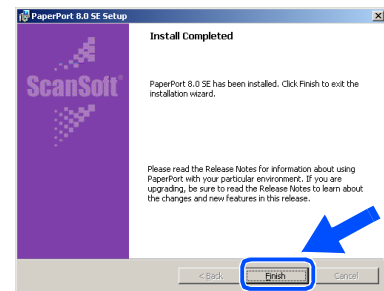

- 10 Select **Typical** and click **Next**.

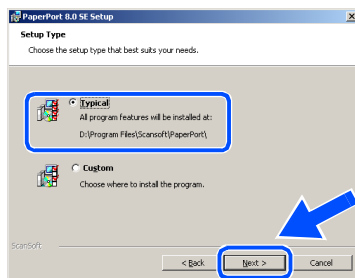

- 14 When the Brother MFL-Pro Suite Installation window appears, click **Next**.

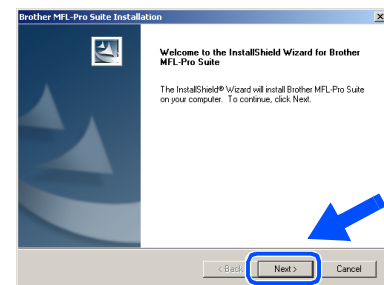

- 11 Click **Install** and PaperPort® will start installing on your computer.

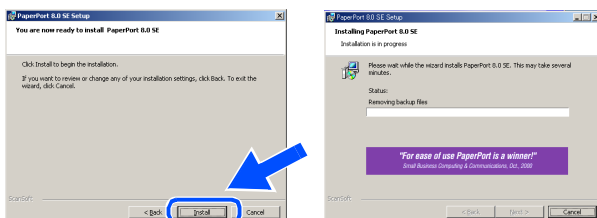

If an error message appears at this point in the installation process, or you have previously installed MFL-Pro Suite, you will first have to uninstall it. From the **Start** menu, select **Programs, Brother, Brother MFL-Pro Suite, Uninstall**, and then follow the instructions on the screen.

- 15 When the Brother Software License Agreement window appears, click **Yes** if you agree to it and go to next screen.

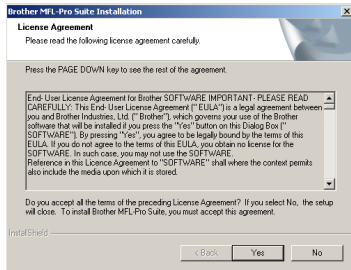

- 16 Select **Local Interface**, and then click **Next**.

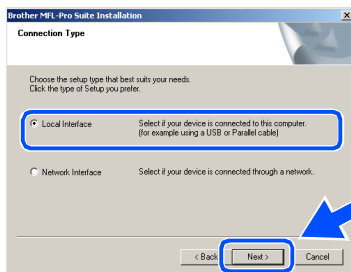

- 17 When the Setup Type window appears, select **Standard**, and then click **Next**.

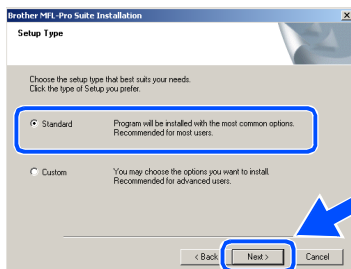

If you want to install the PS driver, select **Custom** and then follow the on-screen instructions. When the **Select Components** screen appears, check **PS Printer Driver**, and then continue following the on-screen instructions.

- 18 The README.WRI file will be displayed. Please read this file for troubleshooting information and then close the file to continue installation.

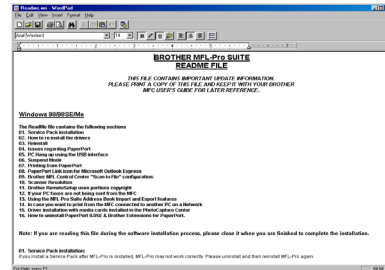

- 19 Click **Finish** restart your computer.

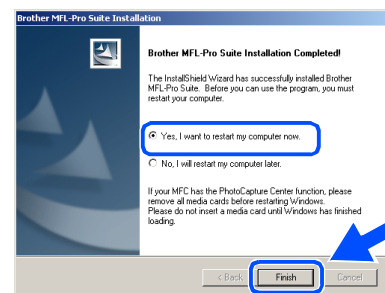

- 20 After the computer restarts, click **Yes** to have the Control Center load each time Windows® is started. The Control Center will appear as an icon in the task tray. If you click **No** the Scan keys on the DCP will be disabled.

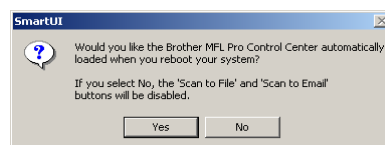

Even if you select **NO**, you will be able to launch the Brother Control Center later to use the **Scan** key by double clicking the Smart UI icon on the desktop. This loads the Brother Control Center to the task tray. See *AutoLoad the Brother Control Center*, Chapter 15 in the Documentation (User's Guide) located on the CD-ROM.

- OK!** The Brother Printer and Scanner drivers have been installed and the installation is now complete.

For Network Interface Cable Users (For Windows® 95/98/98SE/Me/NT/2000 Professional/XP)

Make sure that you have completed the instructions from Step 1 “Setting Up the Machine” on pages 2 - 5.

- 1 Make sure that the NC-9100h (Network Print/Fax Server) is installed into the DCP. (See *Optional accessories in Chapter 15 of the User's Guide.*)

- 2 Connect the network cable to the DCP, and then connect it to a free port on your hub. Turn on the DCP by plugging in the power cord. Turn the Power Switch on.

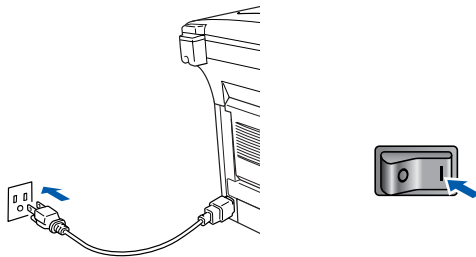
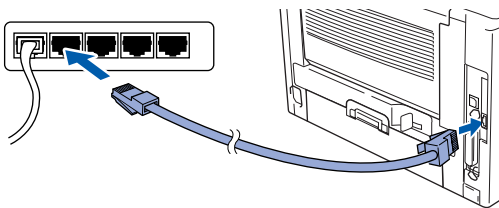

- 3 Turn on your computer. (For Windows® 2000 Professional/XP, you must be logged on as the administrator.)

- 4 Insert the supplied CD-ROM for Windows® into your CD-ROM drive. If the model name screen appears, select your machine. If the language screen appears select your language.



- 5 The CD-ROM main menu will appear. Click **Install Software**.



If this window does not appear, use Windows® Explore to run the **setup.exe** program from the root directory of the Brother CD-ROM.

- 6 Click **MFL-Pro Suite** in Main Application.



MFL-Pro Suite includes Printer Driver, Scanner Driver, ScanSoft® PaperPort®, ScanSoft® TextBridge® and True Type fonts. PaperPort® is a document management application for viewing scanned documents. ScanSoft® TextBridge®, which is integrated into PaperPort®, is an OCR application that converts an image into text and inserts it into your default word processor.

- 7 Click **Install**.



If you see the following screen, click **OK** to install the Windows® updates. After the updates are installed your PC may restart. Note: If it does the installation will automatically continue.

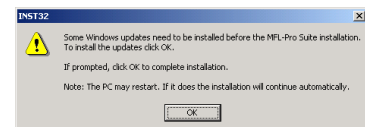

If the installation does not continue automatically, please open the installer menu again by double-clicking the **setup.exe** program from the root directory of the Brother CD-ROM, and continue from Step 4.

- 8 When the PaperPort® 8.0 SE Setup window is displayed, click **Next**.

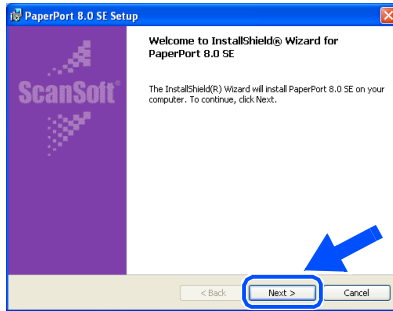

- 9 After reading and accepting the ScanSoft® License Agreement, enter your user information and click **Next**.

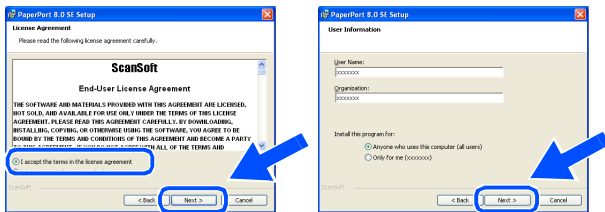

- 10 Select **Typical** and click **Next**.

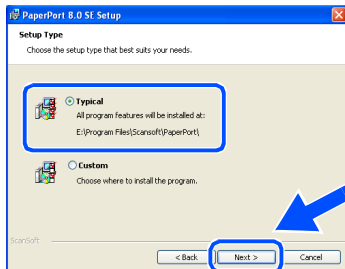

- 11 Click **Install** and PaperPort® will start installing on your computer.

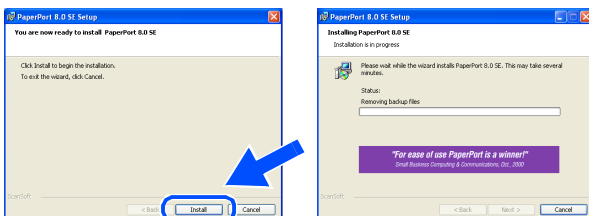

- 12 When the ScanSoft® Registration screen is displayed, make your selection and follow the on screen instructions.



- 13 Click **Finish** to complete installation.

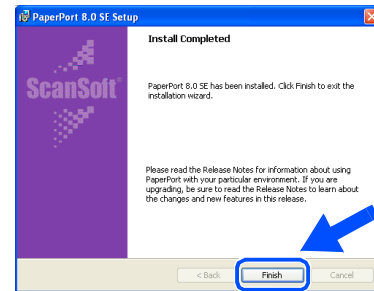

- 14 When the Brother MFL-Pro Suite Installation window appears, click **Next**.



If an error message appears at this point in the installation process, or if you have previously installed the MFL-Pro Suite, you will first have to uninstall it. From the **Start** menu, select **Programs, Brother, Brother MFL-Pro Suite, Uninstall**, and then follow the instructions on the screen.

Continued ...

Step 2

Installing the Driver & Software

For Network Interface Cable Users (For Windows® 95/98/98SE/Me/NT/2000 Professional/XP)

- 15 When the Brother Software License Agreement window appears, click **Yes**.

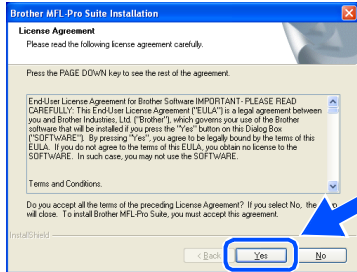

- 16 Select **Network Interface**, and then click **Next**.

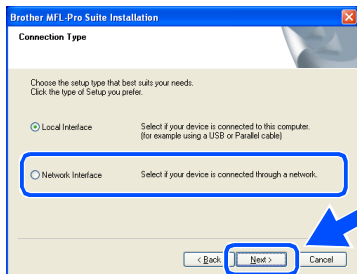

- 17 Select **Standard**, and then click **Next**. The application files will be copied to your computer.

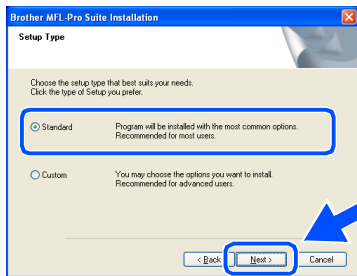

If you want to install the PS driver, select **Custom** and then follow the on-screen instructions. When the **Select Components** screen appears, check **PS Printer Driver**, and then continue following the on-screen instructions.

- 18 Select **Search the network for devices and choose from a list of discovered devices**, and then click **Next**.

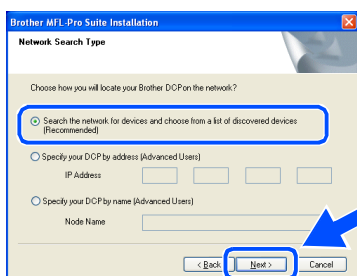

If you see the following screen, click **OK**.



- 19 If the DCP is un-configured for your network:

Select the un-configured device from the list and then click **Next**. → Go to 20

If the DCP is configured for your network:

Select the DCP from the list and then click **Next**. → Go to 23

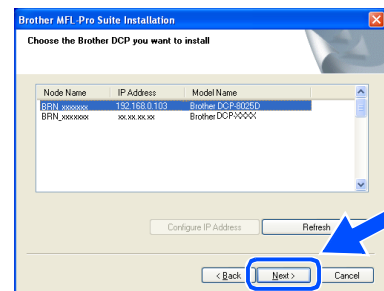

- 20 Click **Configure IP Address**.

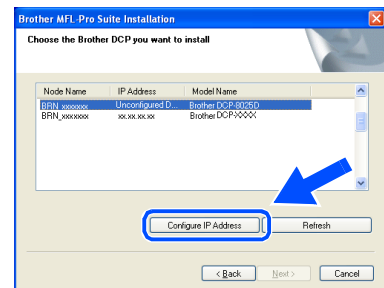

- 21 Enter the proper IP Address information for your network, and then click **OK**.

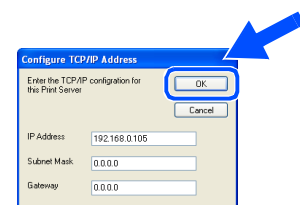

(e.g. Enter 192.168.0.105 IP Address)

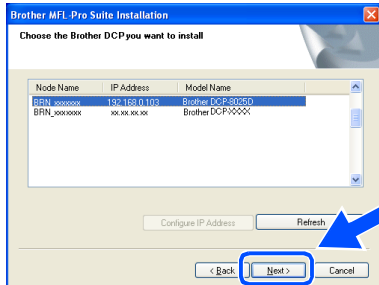
22 Click **Next**.

 See the *For Administrator* section of this guide or the *NC-9100h User's Guide* located on the CD-ROM for more network configuration information.

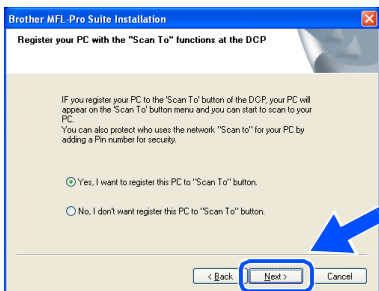
23 Windows® 95/NT Users → Go to **25**
Windows® 98/Me/2000/XP Users:
Select yes and then click **Next**.**24** Click **Next** or enter the name you want displayed on the LCD for your PC and then click **Next**.
The default name is the name of your PC.

 You can avoid receiving unwanted documents by setting a 4-digit PIN Number.

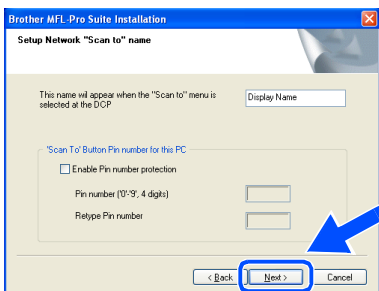
**For Windows® 98/Me/2000/XP Users Only**

Please wait for the window to open.

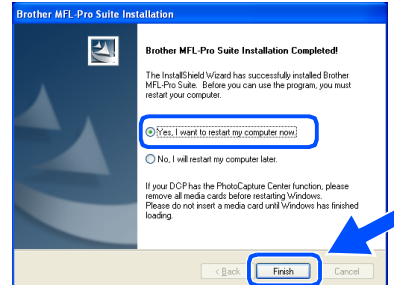
25 Click **Finish** restart your computer.

Windows® 95/98/98SE/Me/NT/2000 Users follow step **26**.

 The Network Scanning feature is not supported in Windows® 95 or NT.

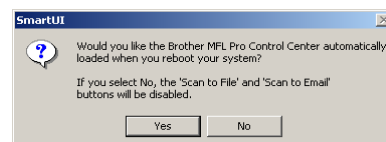
OK! For Windows® XP Users Only
The Brother Printer and Scanner drivers have been installed and the installation is now complete.**26** After the computer restarts, click **Yes** to have the Control Center load each time Windows® is started. The Control Center will appear as an icon in the task tray. If you click **No** the Scan keys on the DCP will be disabled.

 Even if you select **NO**, later you will be able to launch the Brother Control Center to use the **Scan** key by double clicking the Smart UI icon on the desktop. This loads the Brother Control Center to the task tray. See *AutoLoad the Brother Control Center, Chapter 15 in the Documentation (User's Guide)* located on the CD-ROM.

OK! For Windows® 98/Me/2000 Users
The Brother Printer and Scanner drivers have been installed and the installation is now complete.

For Windows® 95/NT Users
The Brother Printer driver has been installed and the installation is now complete.

For USB Interface Cable Users

For Mac[®] OS 8.6 to 9.2

Make sure that you have completed the instructions from Step 1 “Setting Up the Machine” on pages 2 - 5.

- 1 Switch off and unplug the DCP from the AC outlet and disconnect it from your Macintosh if you already connected an interface cable.

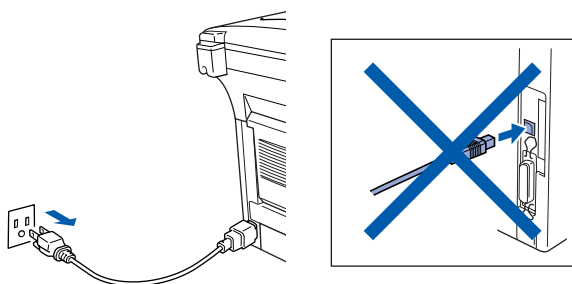

- 2 Turn on your Macintosh[®].
- 3 Insert the supplied CD-ROM for Macintosh[®] into your CD-ROM drive.



- 4 Double-click the **Start Here** icon to install the printer and scanner drivers. If the language screen appears, select your language.

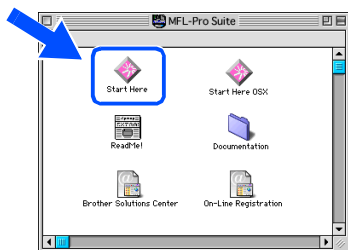

- 5 Click the **MFL-Pro Suite** for your country to install.

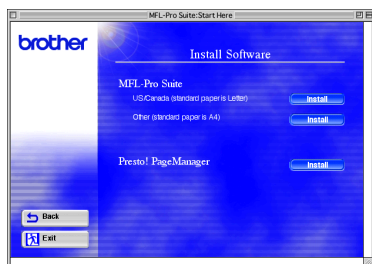

- 6 Select **USB Interface**, and then click **Install**.
- 7 After the installation is completed, restart your Macintosh[®].
- 8 Connect the USB interface cable to your Macintosh[®], and then connect it to the DCP.

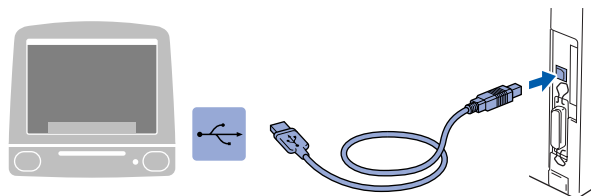

Do not connect the DCP to a USB port on a keyboard or a non powered USB hub.

- 9 Turn on the DCP by plugging in the power cord. Turn the Power Switch on.

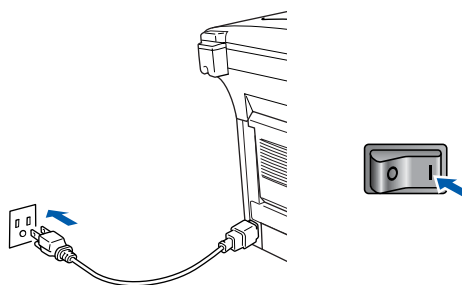

- 10 From the Apple[®] menu, open the **Chooser**.

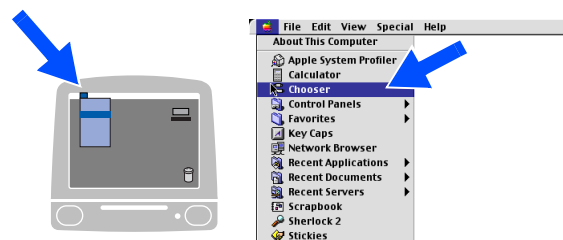

- 11 Click the **Brother Laser** icon you installed. On the right side of the **Chooser**, select the printer to which you want to print. Close the **Chooser**.

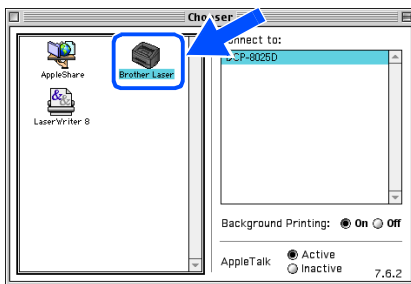

- OK! **The Brother Printer and Scanner drivers have been installed.**

- 12 To install Presto! PageManager®, click the **Presto! PageManager®** icon and follow on the Screen instructions.

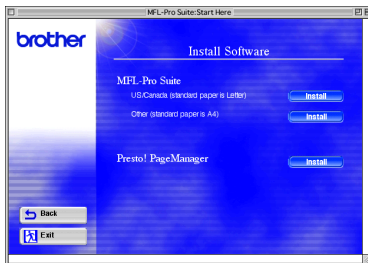

You can easily scan, share and organize photos and documents using Presto! PageManager®.

- OK! **Presto! PageManager® has been installed and the installation is now complete.**

For USB Interface Cable Users

For Mac[®] OS X 10.1/10.2.1 or greater

Make sure that you have completed the instructions from Step 1 “Setting Up the Machine” on pages 2 - 5.

- 1 Switch off and unplug the DCP from the AC outlet and disconnect it from your Macintosh if you already connected an interface cable.

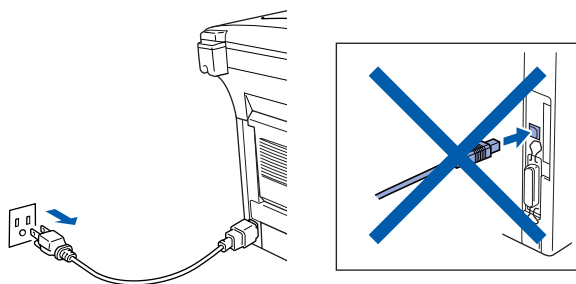

- 7 Connect the USB interface cable to your Macintosh[®], and then connect it to the DCP.

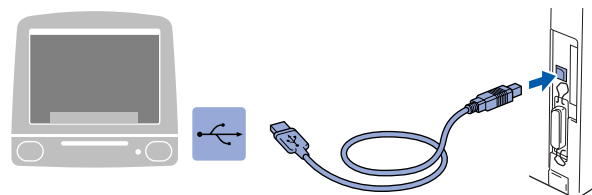

Do not connect the DCP to a USB port on a keyboard or a non powered USB hub.

- 2 Turn on your Macintosh[®].
- 3 Insert the supplied CD-ROM for Macintosh[®] into your CD-ROM drive.



- 4 Double-click the **Start Here OS X** icon to install the printer driver and Scanner driver. If the language screen appears, select your language.



- 8 Turn on the DCP by plugging in the power cord. Turn the Power Switch on.

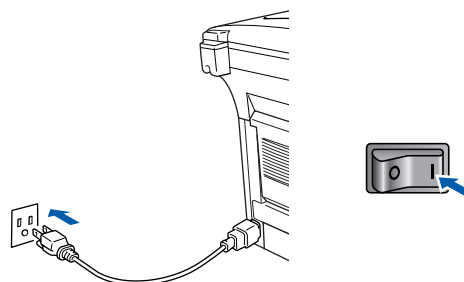

- 5 Click the **MFL-Pro Suite** to install.

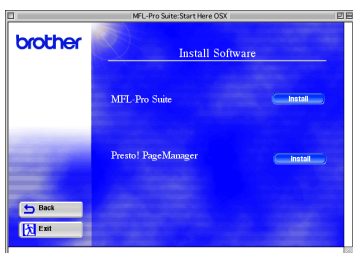

- 9 Select **Applications** from the **Go** menu.

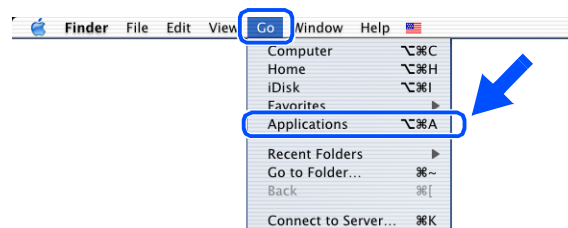

- 6 Select **USB Interface**, and then click **Install**.

- 10 Open the **Utilities** folder.



- 11 Open the **Printer Center** icon.

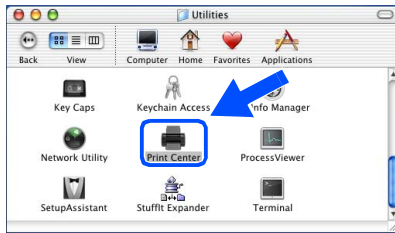

- 12 Click **Add Printer...**

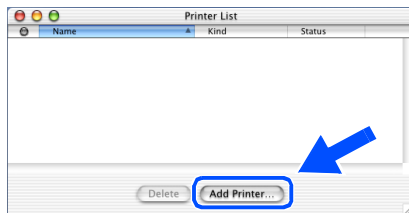

- 13 Select **USB**.

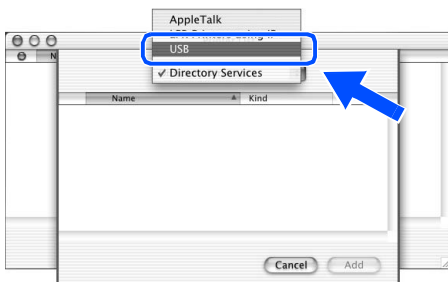

- 14 Select **DCP-8020/8025D**, and then click **Add**.

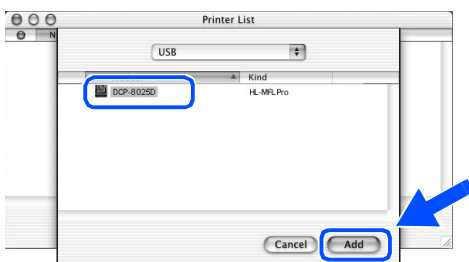

- 15 Select **Quit Printer Center** from the **Printer Center** menu.

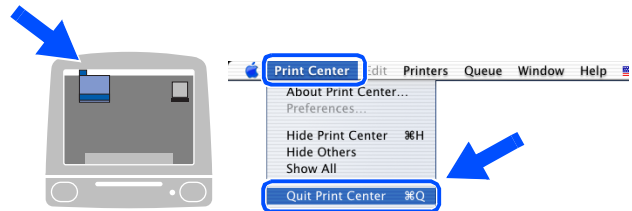

- OK! The **Brother Printer driver** and **Scanner driver** have been installed and the installation is now complete.

- 16 To install **Presto! PageManager®**, click the **Presto! PageManager®** icon and follow on the Screen instructions.

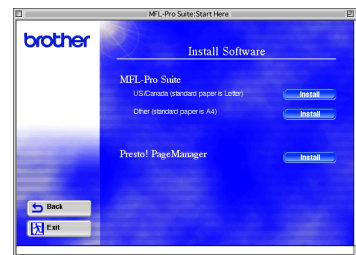

You can easily scan, share and organize photos and documents using **Presto! PageManager®**.

- OK! **Presto! PageManager®** has been installed and the installation is now complete.

For Network Interface Cable Users

For Mac[®] OS 8.6 to 9.2

Make sure that you have completed the instructions from Step 1 “Setting Up the Machine” on pages 2 - 5.

- 1 Make sure that the NC-9100h (Network Print/Fax Server) is installed into the DCP. (See *Optional accessories in Chapter 15 of the User's Guide.*)
- 2 Switch off and unplug the DCP from the AC outlet and disconnect it from your Macintosh if you already connected an interface cable.

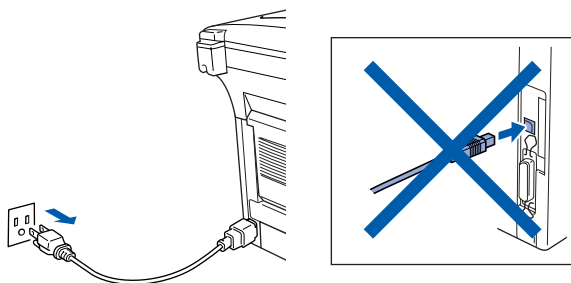

- 3 Turn on your Macintosh[®].
- 4 Insert the supplied CD-ROM for Macintosh[®] into your CD-ROM drive.



- 5 Double-click the **Start Here** icon to install the printer and scanner drivers. If the language screen appears, select your language.

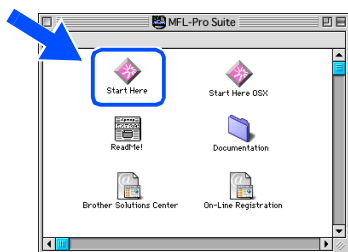

- 6 Click the **MFL-Pro Suite** for your country to install.

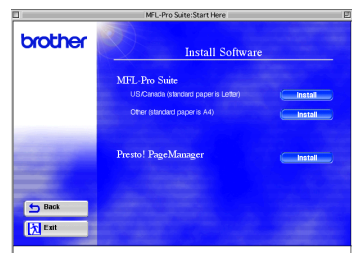

- 7 Select **Network Interface**, and then click **Install**.
- 8 After the installation is completed, restart your Macintosh[®].
- 9 Connect the network interface cable to the printer, and then connect it to a free port on your hub.

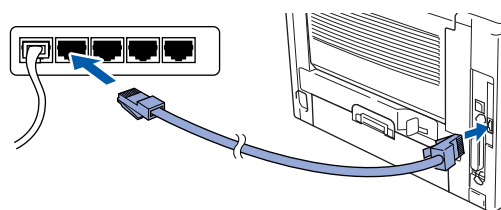

- 10 Turn on the DCP by plugging in the power cord. Turn the Power Switch on.

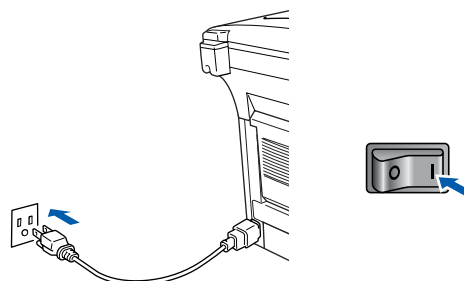

- 11 Open the **Chooser** from the **Apple** menu.



- 12 Click the **Brother Laser (AT)** icon, and then select **BRN_XXXXXX_P1**.¹
Close the **Chooser**.

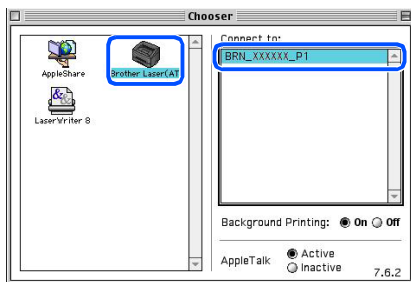

- 1 *xxxxxx are the last six digits of the Ethernet address.*

 *Network User's Guide Chapter 7 on the CD-ROM.*

- OK!** The setup is now complete.

For Network Interface Cable Users

For Mac[®] OS X 10.1/10.2.1 or greater

Make sure that you have completed the instructions from Step 1 “Setting Up the Machine” on pages 2 - 5.

- 1 Make sure that the NC-9100h (Network Print/Fax Server) is installed into the DCP. (See *Optional accessories in Chapter 15 of the User's Guide.*)
- 2 Switch off and unplug the DCP from the AC outlet and disconnect it from your Macintosh if you already connected an interface cable.

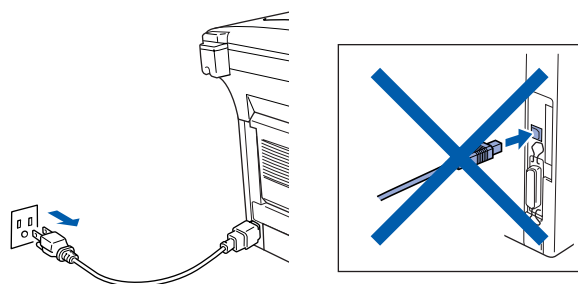

- 3 Turn on your Macintosh[®].
- 4 Insert the supplied CD-ROM for Macintosh[®] into your CD-ROM drive.



- 5 Double-click the **Start Here OS X** folder to install the printer driver. If the language screen appears, select your language.



- 6 Click the **MFL-Pro Suite** to install.



- 7 Select **Network Interface**, and then click **Install**.

- 8 Connect the network interface cable to the printer, and then connect it to a free port on your hub.

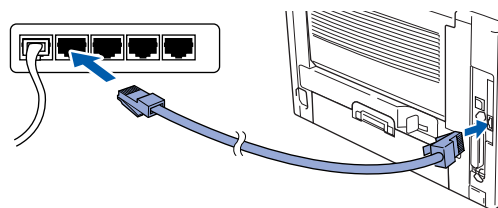

- 9 Turn on the DCP by plugging in the power cord. Turn the Power Switch on.

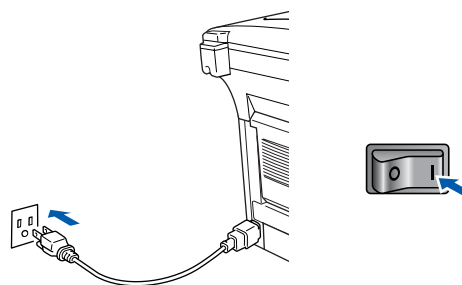

- 10 Select **Applications** from the **Go** menu.

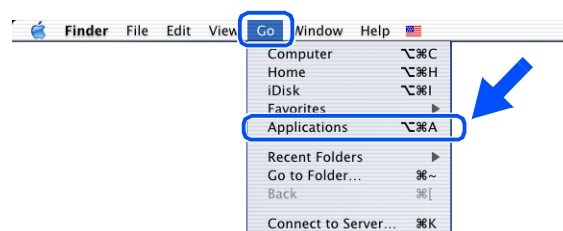

- 11 Open the **Utilities** folder.

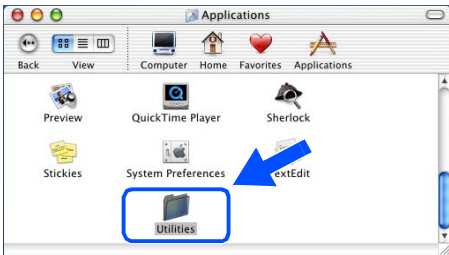

- 12 Open the **Print Center** icon.

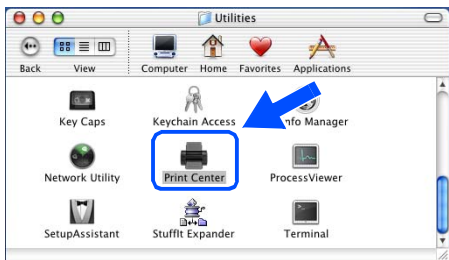

- 13 Click the **Add Printer...** button.

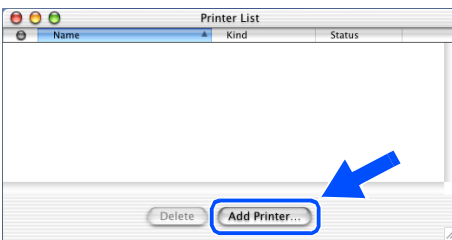

- 14 Select **AppleTalk**.

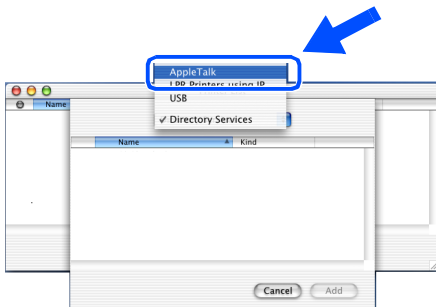

- 15 Select **BRN_XXXXXX_P1**¹, and then click the **Add** button.

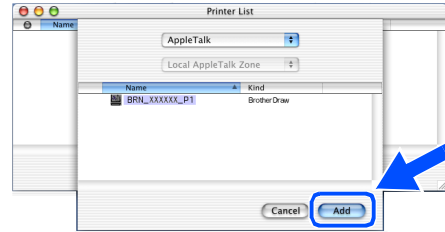

1 xxxxxx are the last six digits of the Ethernet address.



Network User's Guide Chapter 7 on the CD-ROM.

- 16 Select **Quit Printer Center** from the **Printer Center** menu.

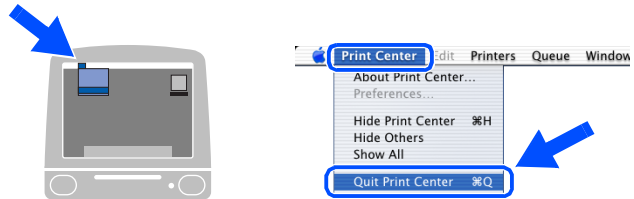

OK! The setup is now complete.



For users of Mac® OS 10.2.2 or greater Please see Network User's Guide Chapter 7 on the CD-ROM for information about using Rendezvous.

■ For Administrators

This section is for using the printer on a network. An administrator should set up the printer using the following steps.

Network User's Guide Chapter Map (NC-9100h)

Windows®



Macintosh®



Windows® 95/98/ME	Peer-to-Peer	TCP/IP	Chapter 3	Peer-to-Peer Printing
		NetBIOS	Chapter 4	NetBIOS Peer-to-Peer Printing
	Brother Internet Print	TCP/IP	Chapter 5	Configuring Internet Print for Windows®
	Netware	IPX/SPX	Chapter 6	Novell Netware Printing
Windows NT®	Peer-to-Peer	TCP/IP	Chapter 2	TCP/IP Printing
		NetBIOS	Chapter 4	NetBIOS Peer-to-Peer Printing
		DLC/LLC	Chapter 8	DLC Printing
	Brother Internet Print (NT® 4.0 only)	TCP/IP	Chapter 5	Configuring Internet Print for Windows®
Netware	IPX/SPX	Chapter 6	Novell Netware Printing	
Windows® 2000/XP	Peer-to-Peer (Windows® 2000 only)	TCP/IP	Chapter 2	TCP/IP Printing
		NetBIOS	Chapter 4	NetBIOS Peer-to-Peer Printing
		DLC/LLC	Chapter 8	DLC Printing
	IPP (Internet Printing Protocol)	TCP/IP	Chapter 2	TCP/IP Printing
	Brother Internet Print	TCP/IP	Chapter 5	Configuring Internet Print for Windows®
Netware	IPX/SPX	Chapter 6	Novell Netware Printing	
UNIX/Linux		TCP/IP	Chapter 1	UNIX Printing
Macintosh®		AppleTalk	Chapter 7	Apple talk (Ether Talk TCP/IP Printing)
		TCP/IP	Chapter 7	Apple talk (Ether Talk TCP/IP Printing)
		Rendezvous	Chapter 7	Rendezvous Printing
OS2 Warp Server LAN Server		TCP/IP	Chapter 2	TCP/IP Printing
		NetBIOS	Chapter 4	NetBIOS Peer-to-Peer Printing

Installing the BRAdmin Professional Configuration Utility (Windows® Users Only)

The BRAdmin Professional software utility is designed to manage your Brother network connected devices such as network-ready printers and/or network-ready Multifunction devices in a Local Area Network (LAN) environment.

BRAdmin Professional can also be used to manage devices from other manufacturers whose products support SNMP (Simple Network Management Protocol).

For more information on BRAdmin Professional go to <http://solutions.brother.com>

- 1 Insert the supplied CD-ROM for Windows® into your CD-ROM drive. The opening screen will appear automatically. Follow the on-screen instructions.

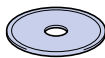

- 2 Click the **Install Software** icon on the menu screen.



- 3 Click Network Applications for Optional NC-9100h.



- 4 Click **BRAdmin Professional** and follow the on-screen instructions.

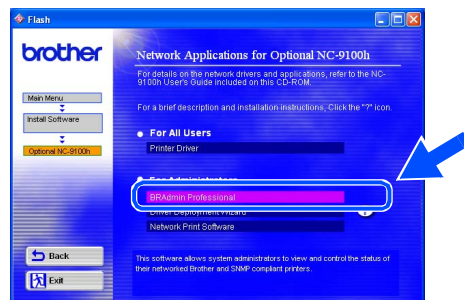

Web BRAdmin (Windows® Users Only)

Brother has also developed Web BRAdmin, an enterprise network software utility that enables management of Brother and other SNMP compliant devices in larger LAN/WAN environments.

This software is Web server based and requires the installation of Microsoft's Internet Information Server and Sun's Java client software. To learn more about the Web BRAdmin software or to download it, please go to <http://solutions.brother.com/webbradmin>

Setting your IP Address, Subnet Mask and Gateway using BRAdmin Professional (Windows® Users Only)

- 1 Start BRAdmin Professional, and select **TCP/IP**.

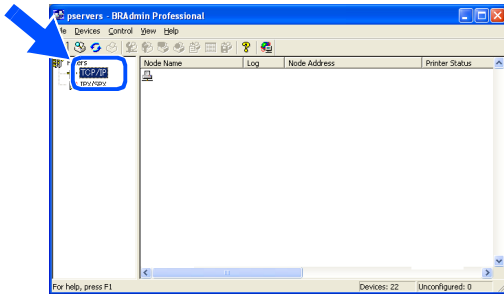

- 3 Double-click the new device.

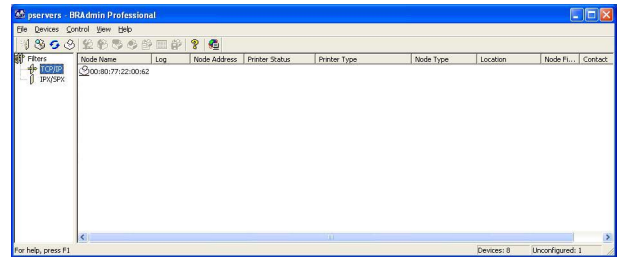

- 2 Select **Search Active Devices** from the **Devices** menu. BRAdmin will search for new devices automatically.

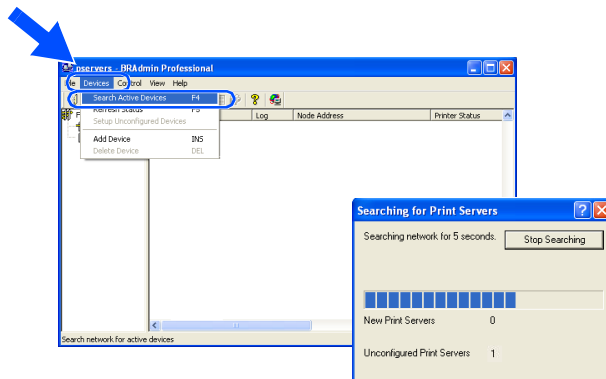

- 4 Enter the **IP Address**, **Subnet Mask** and **Gateway**, and then click the **OK** button.

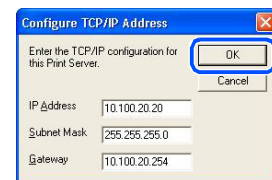

- 5 The address information will be saved to the printer.

Options

The DCP has the following optional accessories. You can expand the capabilities of the DCP by adding these items.

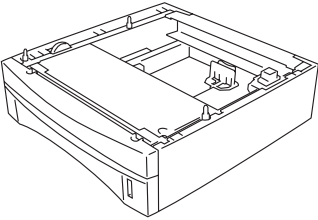
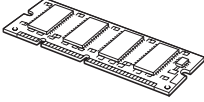
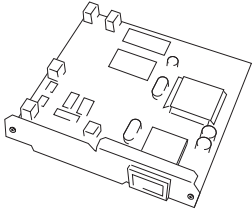
Lower Tray Unit	DIMM Memory	Network Print/Fax Server
LT-5000		NC-9100h
 <p>The second lower paper tray expands input capacity by up to an additional 250 sheets for a total input capacity up to 500 sheets.</p>	 <p>For more details, see "Memory Board" in Chapter 15 (User's Guide). (Not available from Brother)</p>	 <p>The optional Network Print Server (NC-9100h) transforms your DCP into a Network Multi Function Center, offering Network Printing and Network Scanning capability.</p>

Replacement Consumables

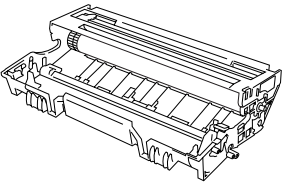
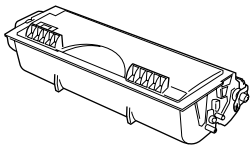
Drum Unit	Toner
DR-500	TN-530/TN-560
 <p>Up to 20,000 A4/Letter pages @ 5% coverage</p>	 <p>TN-530: Up to 3,300 A4/Letter pages @ 5% coverage TN-560: Up to 6,500 A4/Letter pages @ 5% coverage</p>

Setting Up
the Machine

Windows®
USB

Windows®
Parallel

Windows
NT® 4.0
Parallel

Windows®
Network

Macintosh®
USB

Macintosh®
Network

For
Administrators

Trademarks

The Brother logo is a registered trademark of Brother Industries, Ltd.

Brother is a registered trademark of Brother Industries, Ltd.

Multi-Function Link is a registered trademark of Brother International Corporation.

© Copyright 2003 Brother Industries, Ltd. All rights reserved.

Windows, Microsoft and MS-DOS are registered trademarks of Microsoft in the U.S. and other countries.

Macintosh is a registered trademark of Apple Computer, Inc.

PaperPort and TextBridge are registered trademarks of ScanSoft, Inc.

Presto! PageManager is a registered trademark of NewSoft Technology Corporation.

Each company whose software title is mentioned in this manual has a Software License Agreement specific to its proprietary programs.

All other brand and product names mentioned in this manual are registered trademarks of their respective companies.

Compilation and Publication

Under the supervision of Brother Industries Ltd., this manual has been compiled and published, covering the latest product descriptions and specifications.

The contents of this manual and the specifications of this product are subject to change without notice.

Brother reserves the right to make changes without notice in the specifications and materials contained herein and shall not be responsible for any damages (including consequential) caused by reliance on the materials presented, including but not limited to typographical and other errors relating to the publication.

This product is designed for use in a Professional Environment.

brother®

USA