

DCP-9045CDN

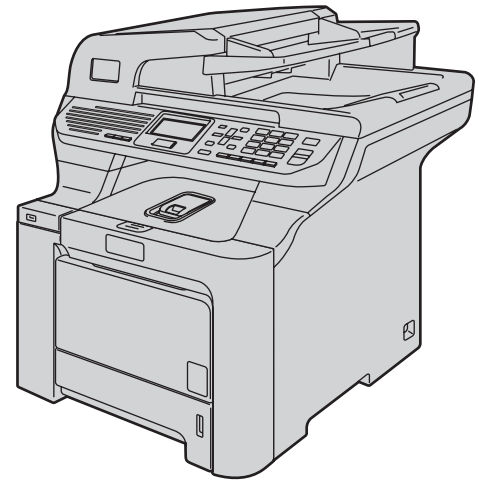

Before you can use the machine, you must set up the hardware and install the driver. Please read this 'Quick Setup Guide' for proper set up and installation instructions.

STEP 1

Setting Up the Machine





**STEP 2**

Installing the Driver & Software

Setup is Complete!

Keep this 'Quick Setup Guide' and the supplied CD-ROM in a convenient place for quick and easy reference at all times.

Symbols used in this guide

 Warning	 Caution	 Improper Setup
Warnings tell you what to do to prevent possible personal injury.	Cautions specify procedures you must follow or avoid to prevent possible damage to the printer or other objects.	Improper Setup icons alert you to devices and operations that are not compatible with the machine.
 Note	 User's Guide, Software User's Guide or Network User's Guide	
Notes tell you how you should respond to a situation that may arise or give tips about how the current operation works with other features.	Indicates reference to the User's Guide, Software User's Guide or Network User's Guide which is on the CD-ROM we have supplied.	

Getting Started

Carton components	2
Control panel	3

STEP 1 – Setting Up the Machine

Remove the packing materials from the machine	4
Installing the toner cartridges	5
Load paper in the paper tray	6
Release the Scanner Lock	7
Install the power cord	7
Setting the date and time	8
Selecting your language (Canada only)	9
Setting the LCD contrast	9

STEP 2 – Installing the Driver & Software

Windows®

For USB Interface Cable Users (For Windows® 2000 Professional/XP/ XP Professional x64 Edition/Windows Vista™)	12
For Network Interface Users (For Windows® 2000 Professional/XP/ XP Professional x64 Edition/Windows Vista™)	15
For Windows Server® 2003, see the Network User's Guide on the CD-ROM. Firewall settings	18

Macintosh®

For USB Interface Cable Users	20
For Mac OS® X 10.2.4 or greater	20
For Network Interface Users	22
For Mac OS® X 10.2.4 or greater	22

For Network Users

BRAdmin Light utility (For Windows® users)	25
Installing the BRAdmin Light configuration utility	25
Setting your IP address, Subnet Mask and Gateway using BRAdmin Light	25
BRAdmin Light utility (For Mac OS® X users)	26
Setting your IP address, Subnet Mask and Gateway using BRAdmin Light	26
Web Based Management (web browser)	27
Restoring the network settings to factory default	27

Consumables and Options

Options	28
Consumables	28

Carton components

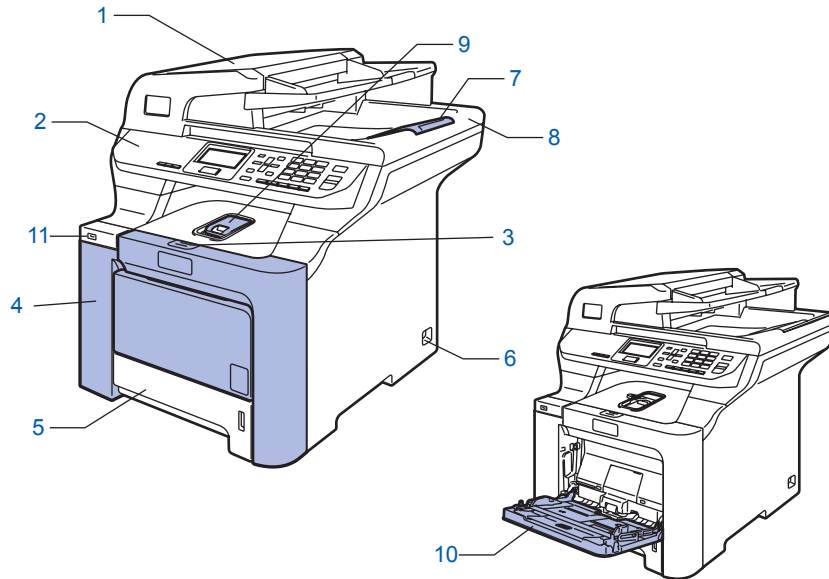

Carton components may vary from one country to another.

Save all packing materials and the printer carton in case for any reason you must ship your printer.

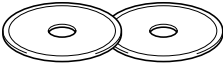

- 1 Automatic Document Feeder (ADF)
- 2 Control Panel
- 3 Front Cover Release Button
- 4 Front Cover
- 5 Paper Tray

- 6 Power Switch
- 7 ADF Document Output Support Flap
- 8 Document Cover
- 9 Face-down Output Tray Support
- 10 Multi-purpose tray (MP tray)
- 11 USB direct interface

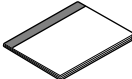
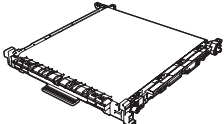
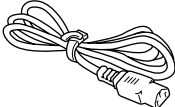
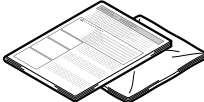
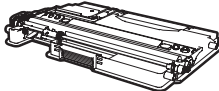
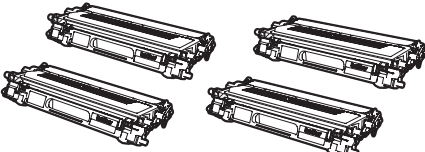
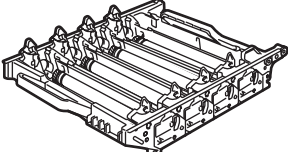
 <p>CD-ROMs For Windows® For Macintosh®</p>	 <p>Quick Setup Guide</p>	 <p>User's Guide</p>	 <p>Belt Unit (pre-installed)</p>
 <p>AC Power Cord</p>	 <p>Insertion Sheet and Plastic bag for repacking</p>	 <p>Waste Toner Box (pre-installed)</p>	
 <p>Toner cartridges (Black, Cyan, Magenta and Yellow)</p>		 <p>Drum Unit (pre-installed)</p>	

The interface cable is not a standard accessory. Please purchase the appropriate interface cable for the interface you intend to use (USB or Network). Do NOT connect the interface cable at this time. Connecting the interface cable is done during the software installation process.

■ **USB interface cable**

Please make sure you use a USB 2.0 interface cable that is no longer than 6 feet (2 meters). When you use a USB cable, make sure you connect it to the USB port of your computer and not to a USB port on a keyboard or non-powered USB hub.

■ **Network cable**

Use a straight-through Category5 (or greater) twisted-pair cable for 10BASE-T or 100BASE-TX Fast Ethernet Network.

Control panel

DCP-9045CDN

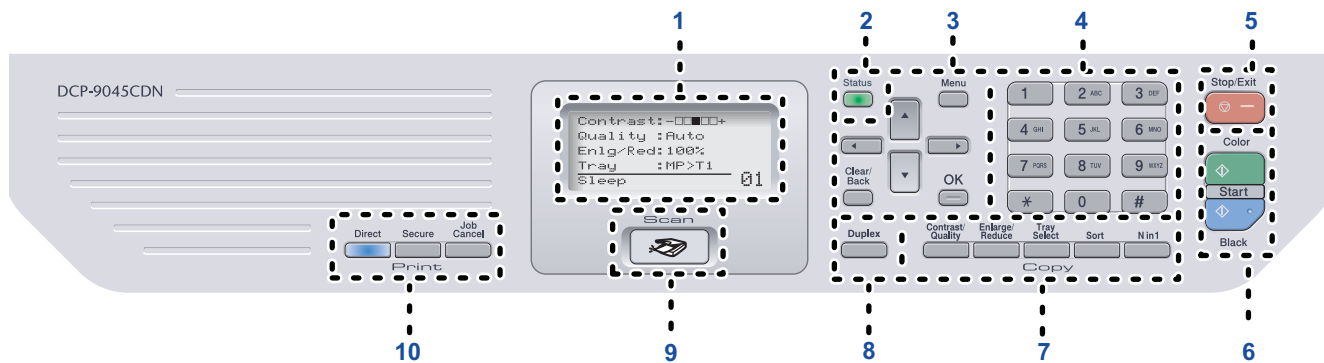

- | | |
|--------------------------------|--------------|
| 1 LCD (Liquid Crystal Display) | 6 Start keys |
| 2 Status LED | 7 Copy keys |
| 3 Menu keys | 8 Duplex |
| 4 Numeric keys | 9 Scan key |
| 5 Stop/Exit key | 10 Print key |

 For the details of the control panel, see "Control panel overview" in Chapter 1 of the User's Guide.

Note

This machine is heavy and weighs 83.2 lb (37.8 kg). To prevent injuries use at least two people to lift the machine. Be careful not to pinch your fingers when you set the machine back down.

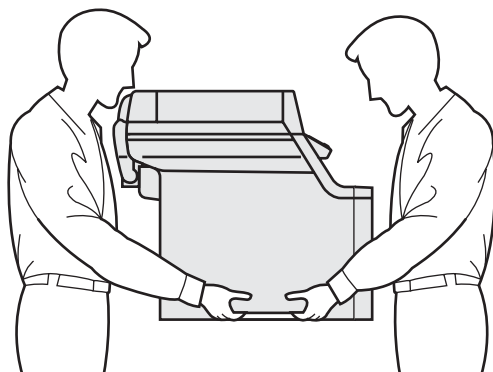

1 Remove the packing materials from the machine

Important

Save all packing materials and the carton in case you have to ship your machine.

⊘ Improper Setup

DO NOT plug in the AC power cord yet.

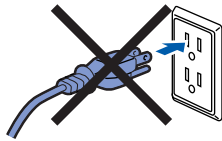

1 Remove the packing tape from the outside of the machine.

2 Press the front cover release button and open the front cover.

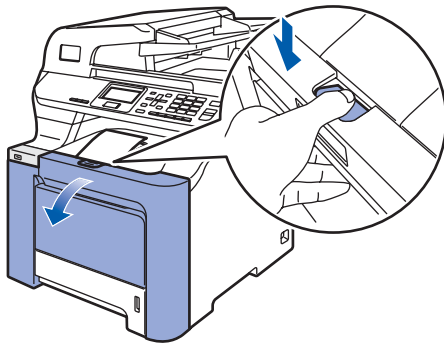

3 Remove the four pieces of orange packing material as shown in the illustration below.

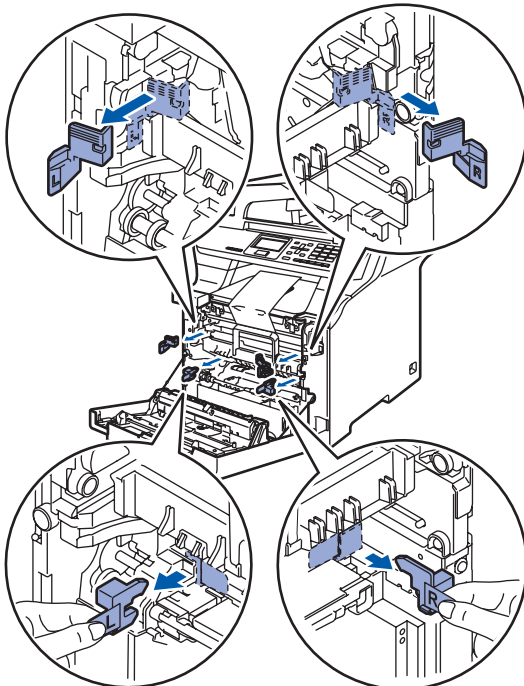

4 Hold the green handle of the drum unit. Lift the drum unit up and then pull it out until it stops.

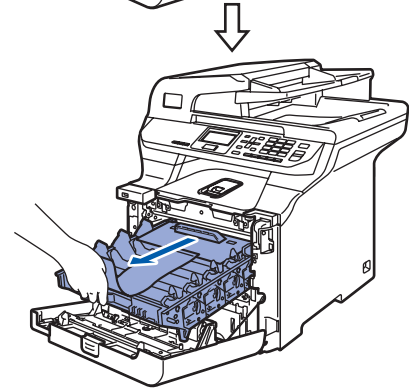
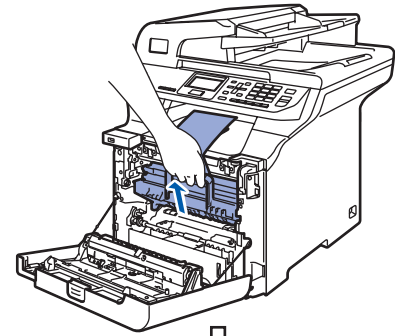

5 Remove the orange packing material as shown in the illustration below.

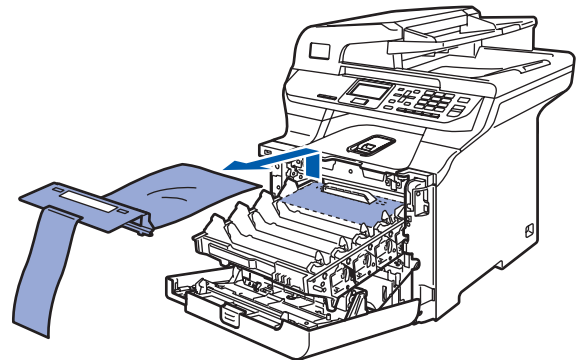

2 Installing the toner cartridges

- 1** Unpack the toner cartridges and rock each toner cartridge from side to side 5 to 6 times.

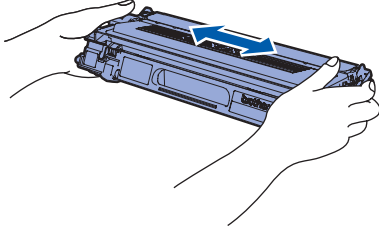

- 2** Pull off the protective cover.

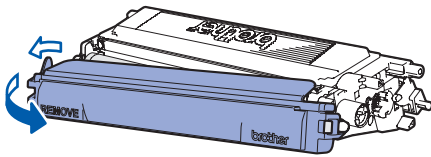

- 3** Hold the handle of the toner cartridge and slide it into the drum unit. Make sure that you match the toner cartridge color to the same color label on the drum unit, and make sure that you fold down the toner cartridge handle (1) once the toner cartridge is in place.

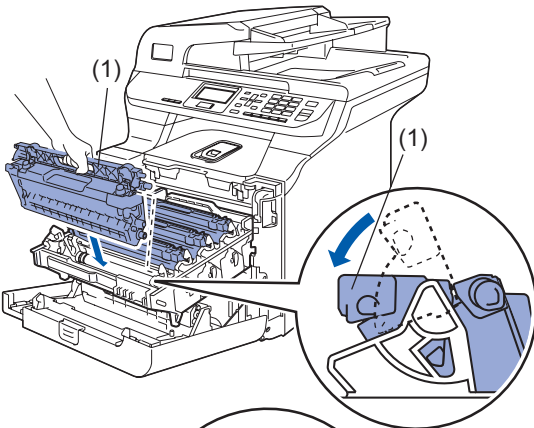

1
2
3
4

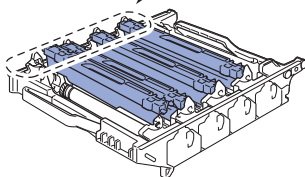

- 1 C — Cyan
- 2 M — Magenta
- 3 Y — Yellow
- 4 K — Black

- 4** Repeat steps **1** through **3** for the remaining toner cartridges.

- 5** Put the drum unit back into the machine.

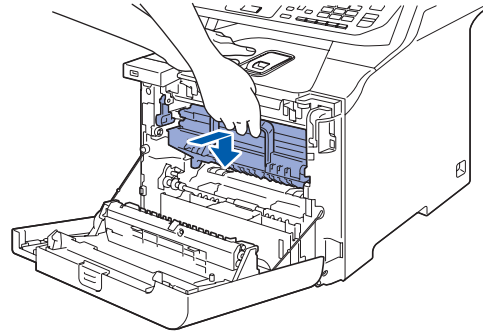

- 6** Close the front cover of the machine.

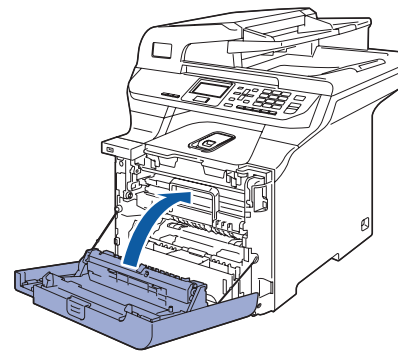

3 Load paper in the paper tray

- 1 Pull the paper tray completely out of the machine.

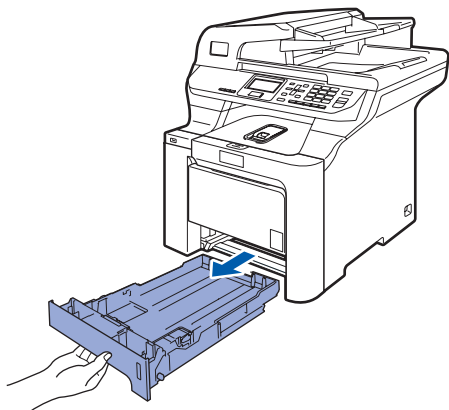

- 2 While pressing the green paper-guide release lever (1), slide the paper guides to fit the paper size. Make sure that the guides are firmly in the slots.

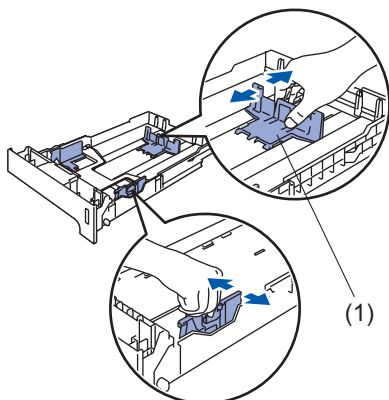

- 3 Fan the stack of paper well to avoid paper jams and misfeeds.

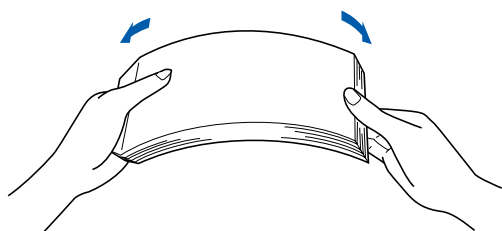

- 4 Put paper in the paper tray. Make sure that the paper is flat in the tray and below the maximum paper mark.

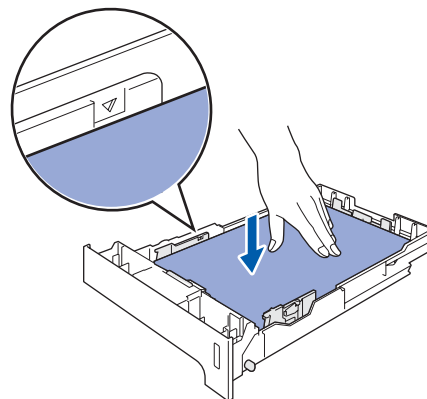

- 5 Put the paper tray firmly back into the machine.

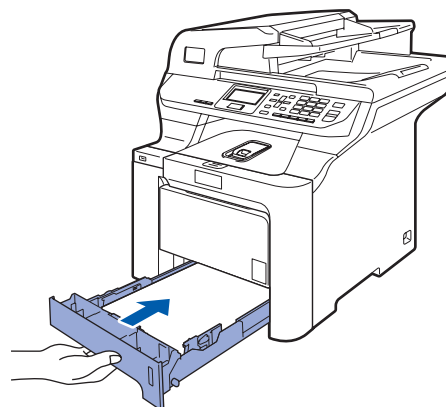

4 Release the Scanner Lock

- 1 Push the lever (1) in the direction shown to unlock the scanner.
(The gray scanner lock lever is located at the back left side, under the document cover (2).)

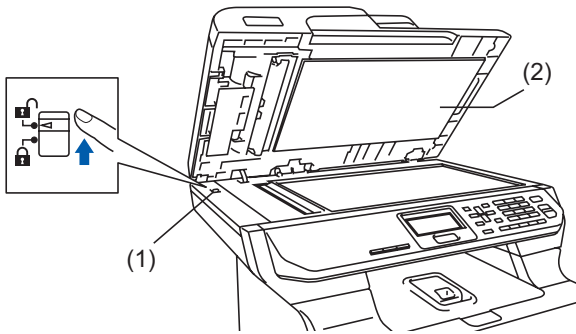

5 Install the power cord

- 1 Make sure that the machine's power switch is off. Remove the label covering the AC power inlet.

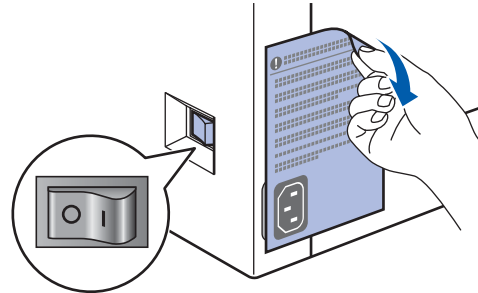

- 2 Connect the AC power cord to the machine.

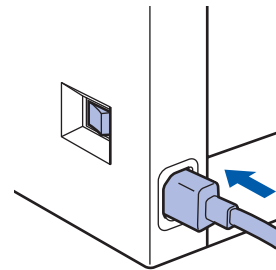

- 3 Plug the AC power cord into an AC outlet. Turn the power switch on.

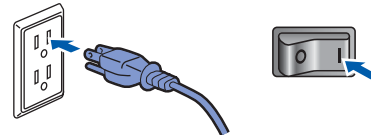

6 Setting the date and time

- 1 Press **Menu**.
- 2 Press **6**.
- 3 Press **1**.
- 4 Enter the last two digits of the year on the numeric keys, and then press **OK**.

61.Date&Time 03/25/2007
Year:2007
Enter & OK Key

(e.g. Enter **0, 7** for 2007.)

- 5 Enter the two digits for the month on the numeric keys, and then press **OK**.

61.Date&Time XX/XX/2007
Month:03
Enter & OK Key

(e.g. Enter **0, 3** for March.)

- 6 Enter the two digits for the day on the numeric keys, and then press **OK**.

61.Date&Time 03/XX/2007
Day:25
Enter & OK Key

(e.g. Enter **2, 5**.)

- 7 Enter the time in 24-hour format on the numeric keys, and then press **OK**.

61.Date&Time 03/25/2007
Time:15:25
Enter & OK Key

(e.g. Enter **1, 5, 2, 5** for 3:25 P.M.)



- 8 Press **Stop/Exit**.



Note

*If you make a mistake, press **Stop/Exit** to start from step 1.*

7 Selecting your language (Canada only)

- 1 Press **Menu**.
- 2 Press **1**.
- 3 Press **0**.
- 4 Select your language (English or Français) by using  or , and then press **OK**.
- 5 Press **Stop/Exit**.

8 Setting the LCD contrast

You can change the contrast to help the LCD look lighter or darker.

- 1 Press **Menu**.
- 2 Press **1**.
- 3 Press **7**.
- 4 Press  to increase the contrast.

—OR—
Press  to decrease the contrast.
Press **OK**.
- 5 Press **Stop/Exit**.

Supplied CD-ROM 'MFL-Pro Suite'

Windows®



Install MFL-Pro Suite

You can install the MFL-Pro Suite software and multifunction drivers.



Install Other Drivers or Utilities

You can install additional MFL-Pro Suite software utilities.



Documentation

View the User's Guide, Software User's Guide and Network User's Guide in HTML format. You can also view the manuals in PDF format by accessing the Brother Solutions Center. (Internet access required) The Software User's Guide and Network User's Guide include instructions for features available when connected to a computer. (eg. printing, scanning and networking details)



On-Line Registration

Register your machine from the Brother Product Registration Page.



Brother Support

View contact information for Brother Customer Service and how to find a Brother Authorized Service Center. For Supplies Information, visit our site for original/genuine Brother supplies at <http://www.brother.com/original/>.



Repair MFL-Pro Suite (For USB users only)

If an error occurred during the installation of the MFL-Pro Suite, use this selection to automatically repair and re-install the MFL-Pro Suite.



Note

MFL-Pro Suite includes the Printer Driver, Scanner Driver, Brother ControlCenter3, ScanSoft™ PaperPort™ 11SE with OCR by NUANCE™. ScanSoft™ PaperPort™ 11SE is a document management application for scanning and viewing documents.

Macintosh®



Start Here OSX

You can install the MFL-Pro Suite that includes the printer driver, scanner driver and the Brother ControlCenter2 and BRAdmin Light for Mac OS® X 10.2.4 or greater.



Documentation

View the User's Guide, Software User's Guide and Network User's Guide in HTML format. You can also view the manuals in PDF format by accessing the Brother Solutions Center. (Internet access required) The Software User's Guide and Network User's Guide include instructions for features available when connected to a computer. (eg. printing, scanning and networking details)



Brother Solutions Center

Access the Brother Solutions Center for FAQs, User's Guide, driver updates and tips for using your machine. (Internet access required)



Presto! PageManager

You can install Presto!® PageManager® to add OCR capability to the Brother ControlCenter2 and easily scan, share and organize photos and documents.



On-Line Registration

Register your machine from the Brother Product Registration Page.



Utilities

You can find the following additional Utilities from this folder.

- Presto!® PageManager® Uninstaller
- BRAdmin Light

STEP 2

Installing the Driver & Software

Follow the instructions on this page for your operating system and interface.
For the latest drivers, documentation, and to find the best solution for your problem, access the Brother Solutions Center directly from the CD-ROM / Driver or visit <http://solutions.brother.com>.

Windows®



For USB Interface Cable Users 12



For Network Interface Users 15
For Windows Server® 2003, see Chapter 5 of the Network User's Guide

Macintosh®



For USB Interface Cable Users 20



For Network Interface Users 22

The screens for Windows® in this Quick Setup Guide are based on Windows® XP.
The screens for Mac OS® X in this Quick Setup Guide are based on Mac OS® X 10.4.

For USB Interface Cable Users (For Windows® 2000 Professional/XP/ XP Professional x64 Edition/Windows Vista™)

Important

Make sure that you have finished the instructions from step 1 *Setting Up the Machine* on pages 4 through 9.

Note

- Please close any applications running before installing the MFL-Pro Suite.
- The supplied CD-ROM includes ScanSoft™ PaperPort™ 11SE. This installer supports Windows® 2000 (SP4 or greater), XP (SP2 or greater), XP Professional x64 Edition and Windows Vista™ only. Please update to the latest Windows® Service Pack before installing MFL-Pro Suite.

- 1 Turn off and unplug the machine from the AC outlet and disconnect it from your computer, if you already connected an interface cable.

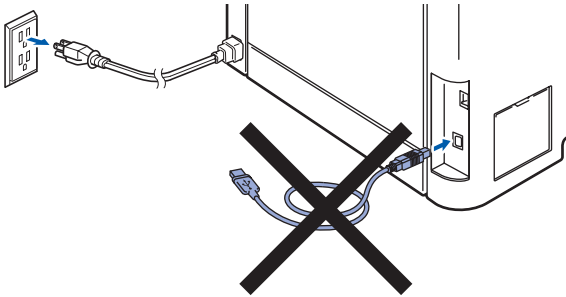

- 2 Turn on your computer. (You must be logged on with administrator rights.)

- 3 Put the supplied CD-ROM for Windows® into your CD-ROM drive. If the model name screen appears, choose your machine. If the language screen appears, choose your language.

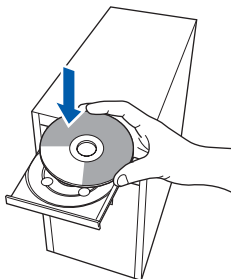

- 4 The CD-ROM main menu will appear. Click **Install MFL-Pro Suite**.



Note

- If this window does not appear, use Windows® Explorer to run the **start.exe** program from the root folder of the Brother CD-ROM.
- For Windows Vista™, when the User Account Control screen appears, click **Allow**.

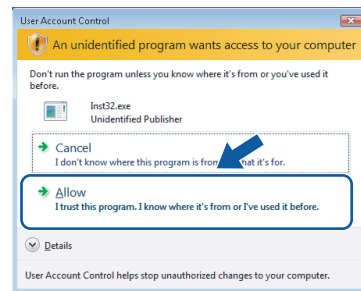

- 5 After reading and accepting the ScanSoft™ PaperPort™ 11SE License Agreement, click **Yes**.

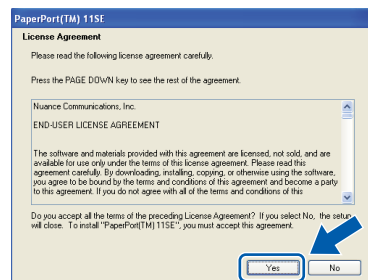

The installation of ScanSoft™ PaperPort™ 11SE will automatically start and is followed by the installation of MFL-Pro Suite.

- 6** When the Brother MFL-Pro Suite Software License Agreement window appears, click **Yes** if you agree to the Software License Agreement.

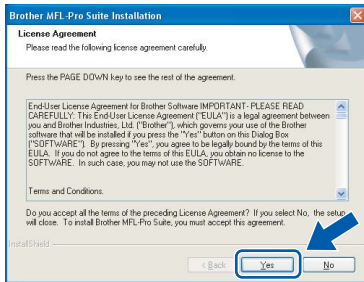

- 7** Choose **Local Connection**, and then click **Next**. The installation will continue.

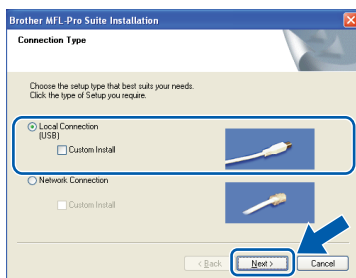

Note

If you want to install the PS driver (Brother's BR-Script Driver), choose **Custom Install** and then follow the on-screen instructions. When the **Select Features** screen appears, check **PS Printer Driver**, and then continue following the on-screen instructions.

- 8** When this screen appears, connect the USB interface cable to your PC, and then connect it to the machine.

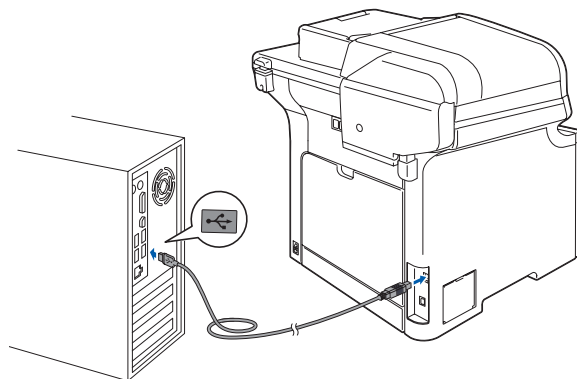

Improper Setup

DO NOT connect the machine to a USB port on a keyboard or a non-powered USB hub. Brother recommends that you connect the machine directly to your computer.

- 9** Plug the AC power cord into an AC outlet. Turn the power switch on.

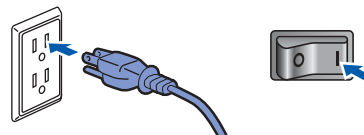

The installation of the Brother drivers will automatically start. **The installation screens appear one after another, please wait for a while.**

Improper Setup

DO NOT try to cancel any of the screens during this installation.

- 10** When the On-Line Registration screen is displayed, make your selection and follow the on-screen instructions.

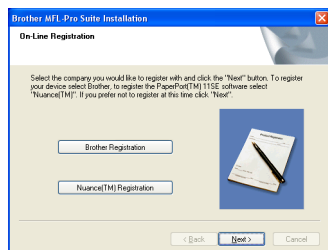

- 11** Click **Finish** to restart your computer. (You must be logged on with Administrator rights.)

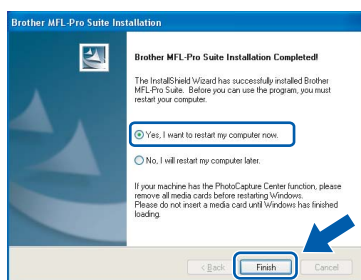

Note

After restarting the computer, the **Installation Diagnostics** will run automatically. If the installation is unsuccessful, the installation results window will be shown. If the **Installation Diagnostics** shows a failure, please follow the on-screen instruction or read on-line help and FAQs in **Start/All Programs/Brother/DCP-XXXX**.



The MFL-Pro Suite (including printer driver and scanner driver) has been installed and the installation is now complete.

For Network Interface Users (For Windows® 2000 Professional/XP/ XP Professional x64 Edition/Windows Vista™)

Important

Make sure that you have finished the instructions from step 1 *Setting Up the Machine* on pages 4 through 9.



Note

The supplied CD-ROM includes ScanSoft™ PaperPort™ 11SE. This installer supports Windows® 2000 (SP4 or greater), XP (SP2 or greater), XP Professional x64 Edition and Windows Vista™ only. Please update to the latest Windows® Service Pack before installing MFL-Pro Suite.

- 1 Turn off and unplug the machine from the AC outlet.
- 2 Connect the network interface cable to the machine, and then connect it to your network.

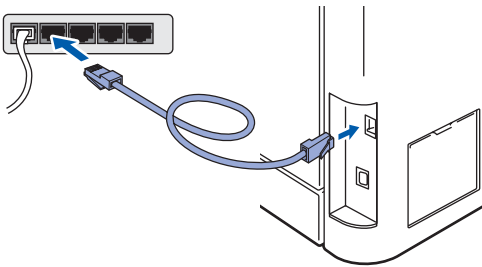

- 3 Plug the AC power cord into an AC outlet. Turn the power switch on.

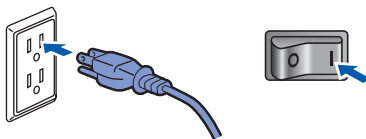

- 4 Turn on your computer. (You must be logged on with Administrator rights.) Close any applications running before installing the MFL-Pro Suite.



Note

Before installation, if you are using personal firewall software, disable it. After the installation, restart your personal firewall software.

- 5 Put the supplied CD-ROM into your CD-ROM drive. If the model name screen appears, choose your machine. If the language screen appears, choose your language.

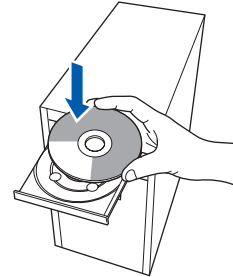

- 6 The CD-ROM main menu will appear. Click **Install MFL-Pro Suite**.



Note

- If this window does not appear, use Windows® Explorer to run the **start.exe** program from the root folder of the Brother CD-ROM.
- For Windows Vista™, when the User Account Control screen appears, click **Allow**.

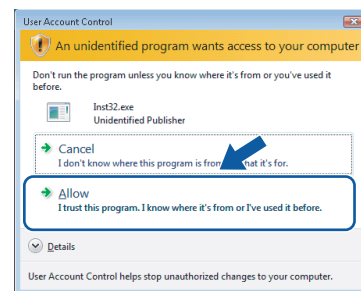

- 7 After reading and accepting the ScanSoft™ PaperPort™ 11SE License Agreement, click **Yes**.

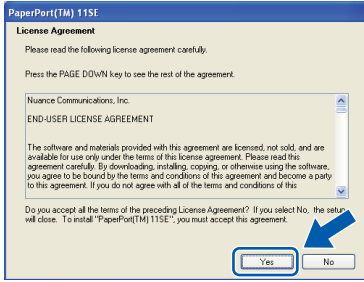

The installation of ScanSoft™ PaperPort™ 11SE will automatically start and is followed by the installation of MFL-Pro Suite.

- 8 When the Brother MFL-Pro Suite Software License Agreement window appears, click **Yes** if you agree to the Software License Agreement.

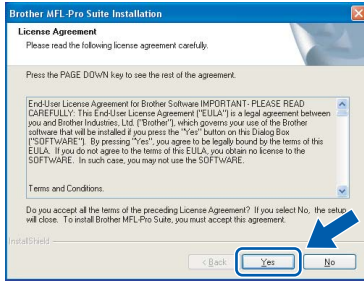

- 9 Choose **Network Connection**, and then click **Next**.

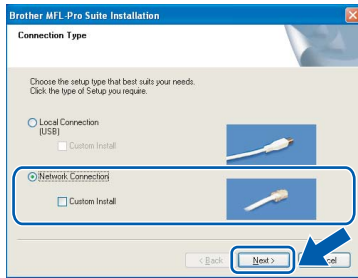

Note

If you want to install the PS driver (Brother's BR-Script Driver), choose **Custom Install** and then follow the on-screen instructions. When the **Select Features** screen appears, check **PS Printer Driver**, and then continue following the on-screen instructions.

- 10 If the machine is configured for your network, choose the machine from the list, and then click **Next**. This window will not appear if there is only one machine connected on the network, it will be chosen automatically.

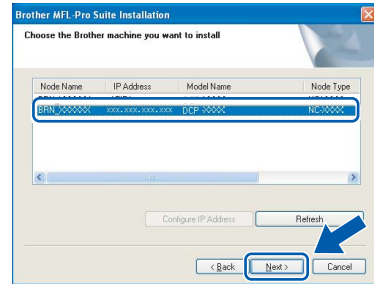

If your machine shows **APIPA** in the **IP Address** field, click **Configure IP Address** and enter an **IP address** for your machine that is suitable for your network.

Note

If the machine is not yet configured for use on your network, the following screen appears.



Click **OK**. The **Configure IP Address** window will appear. Enter an **IP address** for your machine that is suitable for your network by following the on-screen instructions.

- 11 The installation of the Brother drivers will automatically start. **The installation screens appear one after another, please wait for a while.**

Improper Setup

DO NOT try to cancel any of the screens during this installation.

Note

For Windows Vista™, when this screen appears, click the check box and click **Install**.

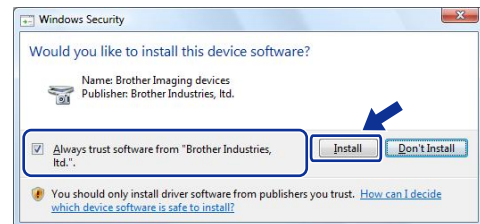

- 12** When the Brother and ScanSoft on-line Registration screen is displayed, make your selection and follow the on-screen instructions.

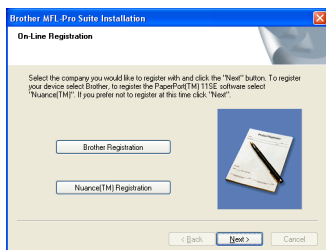

- 13** Click **Finish** to restart your computer. (You must be logged on with Administrator rights.)

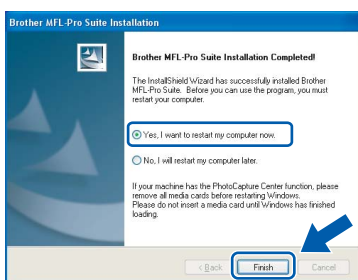

The MFL-Pro Suite has been installed and the installation is now complete.

Note

- MFL-Pro Suite includes the Network Printer Driver, Network Scanner Driver, Brother ControlCenter3, ScanSoft™ PaperPort™ 11SE. ScanSoft™ PaperPort™ 11SE is a document management application for viewing scanned documents.
- After restarting the computer, the **Installation Diagnostics** will run automatically. If the installation is unsuccessful, the installation results window will be shown. If the **Diagnostics** shows a failure, please follow the on-screen instructions or read the on-line help and FAQ's in **Start/All Programs/Brother/DCP-XXXX**.
- Once you are sure that you can print after the installation, restart your Firewall software.
- Firewall settings on your PC may reject the necessary network connection for Network Scanning. Follow the instructions on the following page to configure your Windows® Firewall. If you are using personal firewall software, see the User's Guide for your software or contact the software manufacturer.

Firewall settings

Firewall settings on your PC may reject the necessary network connection for Network Scanning and Printing. If you are using the Windows® Firewall follow the instructions for Windows® XP SP2 or Windows Vista™. If you are using personal firewall software, see the User's Guide for your software or contact the software manufacturer.

■ For Windows® XP SP2 users:

- 1 Click the **Start** button, **Control Panel**, **Network and Internet Connections** and then **Windows Firewall**.
Make sure that Windows Firewall on the **General** tab is set to On.
- 2 Click the **Advanced** tab and **Settings...** button.

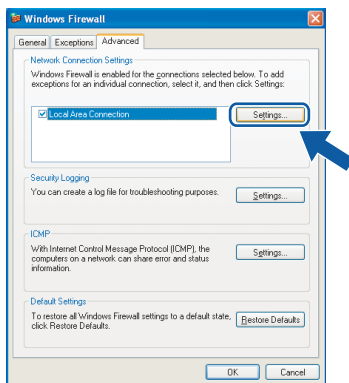

- 3 Click the **Add** button.
- 4 Add port **54925** for network scanning by entering the information below:
 1. In **Description of service:**
- Enter any description, for example "Brother Scanner".
 2. In **Name or IP address (for example 192.168.0.12) of the computer hosting this service on your network:**
- Enter "Localhost".
 3. In **External Port Number for this service:**
- Enter "**54925**".
 4. In **Internal Port number for this service:**
- Enter "**54925**".
 5. Make sure **UDP** is selected.
 6. Click **OK**.

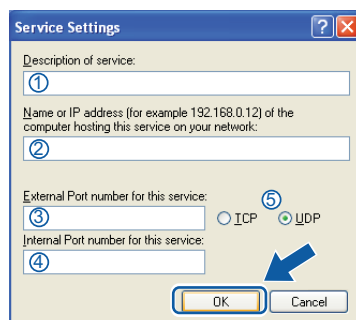

- 5 Click the **Add** button.
- 6 If you still have trouble with your network connection, click the **Add** button.
- 7 Add port **137** for network scanning and Network printing by entering the information below:
 1. In **Description of service:**
- Enter any description, for example "Brother Network Print".
 2. In **Name or IP address (for example 192.168.0.12) of the computer hosting this service on your network:**
- Enter "Localhost".
 3. In **External Port Number for this service:**
- Enter "**137**".
 4. In **Internal Port number for this service:**
- Enter "**137**".
 5. Make sure **UDP** is selected.
 6. Click **OK**.
- 8 Make sure that the new settings are added and checked, and then click **OK**.

■ For Windows Vista™ users:

1 Click the **Start** button, **Control Panel**, **Network and Internet**, **Windows Firewall** and click **change settings**.

2 When the **User Account Control** screen appears, do the following.

■ For Users who have administrator rights: Click **Continue**.

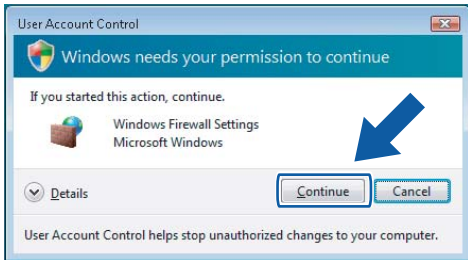

■ Users who do not have administrator rights: Enter the administrator password and click **OK**.

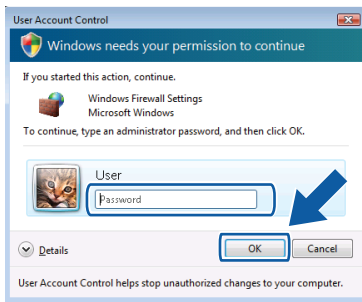

3 Make sure that Windows Firewall on the **General** tab is set to On.

4 Click the **Exceptions** tab.

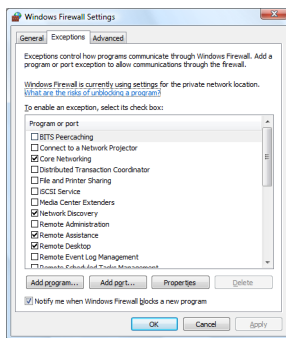

5 Click the **Add port...** button.

6 To add port **54925** for network scanning, enter the information below:

1. In **Name**: Enter any description, for example "Brother Scanner".
2. In **Port number**: Enter "**54925**".
3. Make sure **UDP** is selected. Then, click **OK**.

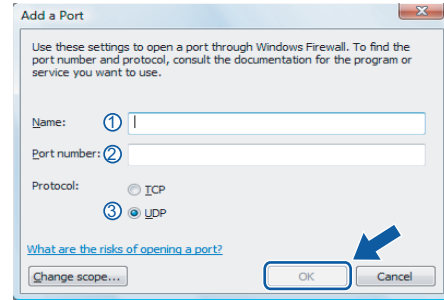

7 Click the **Add port...** button.

8 Make sure that the new setting is added and is checked, and then click **OK**.

9 If you still have trouble with your network connection such as Network Scanning or Printing, check the **File and Printer Sharing** box in the Exceptions tab and then click **OK**.

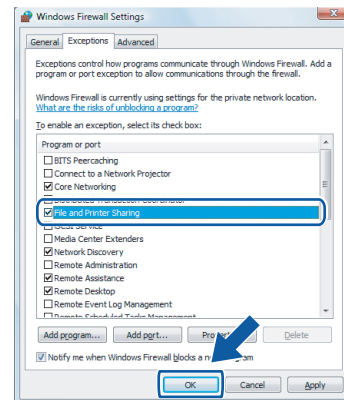

For USB Interface Cable Users

For Mac OS® X 10.2.4 or greater

Important

Make sure that you have finished the instructions from step 1 *Setting Up the Machine* on pages 4 through 9.



Note

For Mac OS® X 10.2.0 to 10.2.3 users, upgrade to Mac OS® X 10.2.4 or greater. (For the latest information for Mac OS® X, visit <http://solutions.brother.com>)

1

Connect the USB interface cable to your computer, and then connect it to the machine.

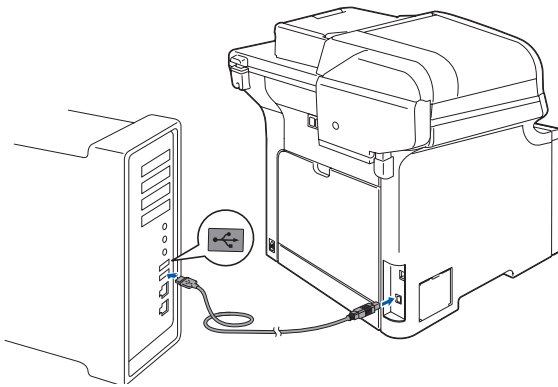

⊘ Improper Setup

DO NOT connect the machine to a USB port on a keyboard or a non-powered USB hub. Brother recommends that you connect the machine directly to your computer.



Note

Make sure that the machine is turned on by connecting the power cord.

2

Turn on your Macintosh®.

3

Put the supplied CD-ROM into your CD-ROM drive.

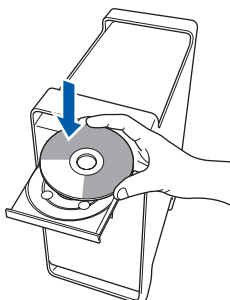

4

Double-click the **Start Here OSX** icon to install. Follow the on-screen instructions.



Please wait, it will take a few seconds for the software to install. After the installation, click **Restart** to finish installing the software.



Note

Please see the *Software User's Guide* on the CD-ROM to install the PS driver.

5

The Brother software will search for the Brother device. During this time the following screen will appear.

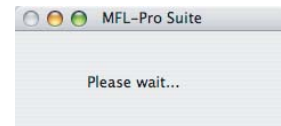

6

When this screen appears, click **OK**.

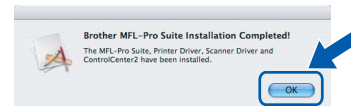

For Mac OS® X 10.3.x or greater users: The MFL-Pro Suite, Brother printer driver, scanner driver and Brother ControlCenter2 have been installed and the installation is now complete. Go to step 11.

7 For Mac OS® X 10.2.4 to 10.2.8 users:
Click **Add**.

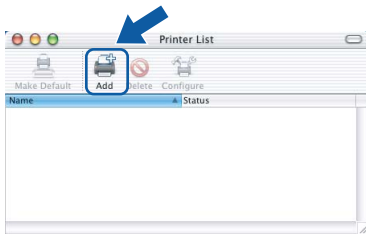

8 Choose **USB**.

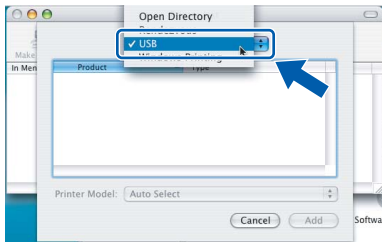

9 Choose your model name, and then click **Add**.

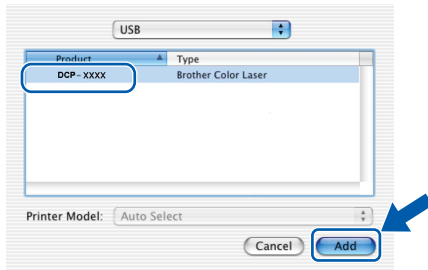

10 Click **Print Center**, then **Quit Print Center**.

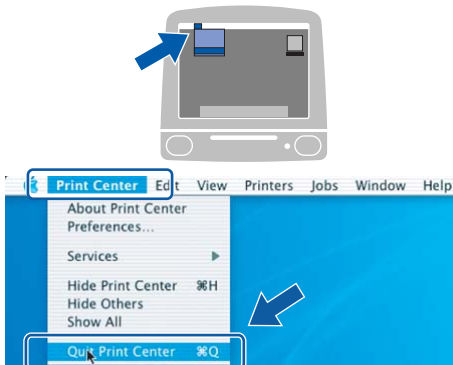

OK! The MFL-Pro Suite, Brother printer driver, scanner driver and Brother ControlCenter2 have been installed and the installation is now complete.

11 To install Presto!® PageManager®, double-click the **Presto! PageManager** icon and follow the on-screen instructions.

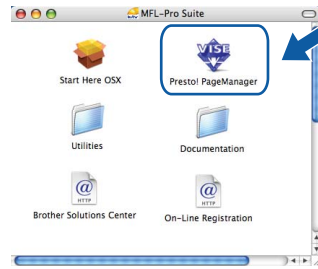

Note

When Presto!® PageManager® is installed OCR capability is added to the Brother ControlCenter2. You can easily scan, share and organize photos and documents using Presto!® PageManager®.

OK!

Presto!® PageManager® has been installed and the installation is now complete.

For Network Interface Users

For Mac OS® X 10.2.4 or greater

Important

Make sure that you have finished the instructions from step 1 *Setting Up the Machine* on pages 4 through 9.

- 1 Connect the network interface cable to the machine, and then connect it to your network.

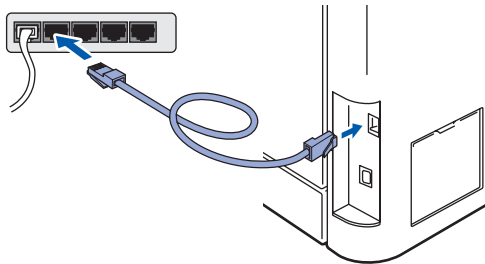

Note

Make sure that the machine is turned on by connecting the power cord.

- 2 Turn on your Macintosh®.
- 3 Put the supplied CD-ROM into your CD-ROM drive.

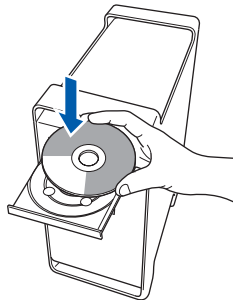

4

Double-click the **Start Here OSX** icon to install. Follow the on-screen instructions.



Please wait, it will take a few seconds for the software to install. After the installation, click **Restart** to finish installing the software.



Note

Please see the *Network User's Guide on the CD-ROM* to install the PS driver.

- 5** The Brother software will search for the Brother device. During this time the following screen will appear.

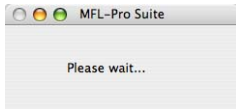

Note

- If the machine is configured for your network, choose the machine from the list, and then click **OK**. This window will not appear if there is only one machine connected on the network, it will be chosen automatically. Go to step **6**.

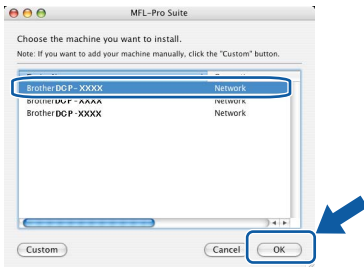

- If this screen appears click **OK**.



Enter a name for your Macintosh® in **Display Name** up to 15 characters long and click **OK**. Go to step **6**.

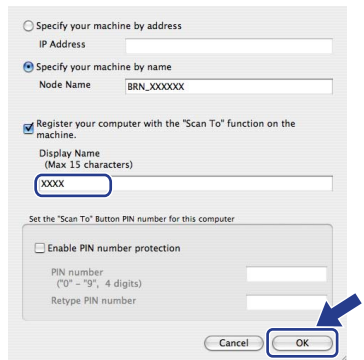

- If you want to use the machine's Scan key to scan over the network you must check the **Register your computer with the "Scan To" function on the machine** box.
- The name you enter will appear on the machine's LCD when you press the **Scan** key and choose a scan option. (For more information, see *Network Scanning in the Software User's Guide on the CD-ROM*.)

- 6** When this screen appears, click **OK**.

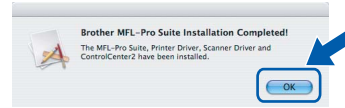

- OK!** For Mac OS® X 10.3.x or greater users: The MFL-Pro Suite, Brother printer driver, scanner driver and Brother ControlCenter2 have been installed and the installation is now complete. Go to step **11**.

- 7** For Mac OS® X 10.2.4 to 10.2.8 users: Click **Add**.

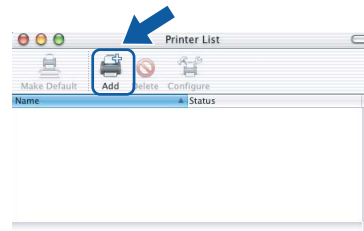

- 8** For Mac OS® X 10.2.4 to 10.2.8 users: Make the selection shown below.

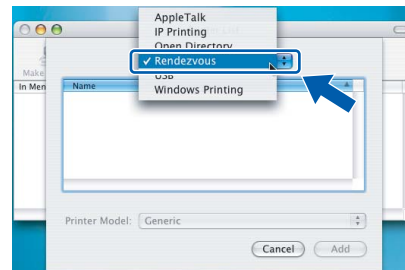

- 9** Choose your model name, and then click **Add**.

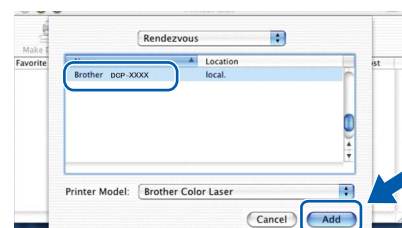

- 10** Click **Print Center**, then **Quit Print Center**.

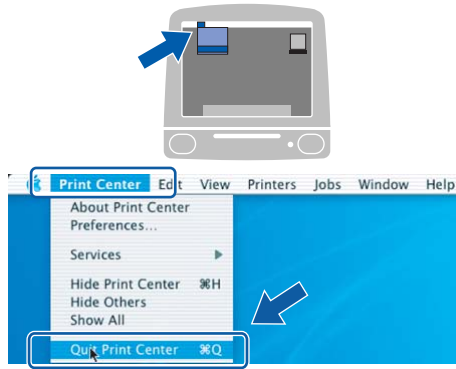

- OK!** The **MFL-Pro Suite**, **Brother printer driver**, **scanner driver** and **Brother ControlCenter2** have been installed and the installation is now complete.

- 11** To install **Presto!® PageManager®**, double-click the **Presto! PageManager** icon and follow the on-screen instructions.

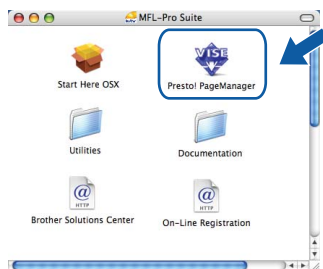

Note

*When **Presto!® PageManager®** is installed OCR capability is added to the **Brother ControlCenter2**. You can easily scan, share and organize photos and documents using **Presto!® PageManager®**.*

- OK!** **Presto!® PageManager®** has been installed and the installation is now complete.

BRAdmin Light utility (For Windows[®] users)

The BRAdmin Light is a utility for initial setup of Brother network connected devices. It also can search for Brother products on your network, view the status and configure basic network settings, such as IP address. For more information on BRAdmin Light, visit us at <http://solutions.brother.com>.



If you require more advanced printer management, use the latest Brother BRAdmin Professional utility version that is available as a download from <http://solutions.brother.com>.

Installing the BRAdmin Light configuration utility



The default password for the print server is 'access'. You can use BRAdmin Light to change this password.

- 1 Click **Install Other Drivers or Utilities** on the menu screen.

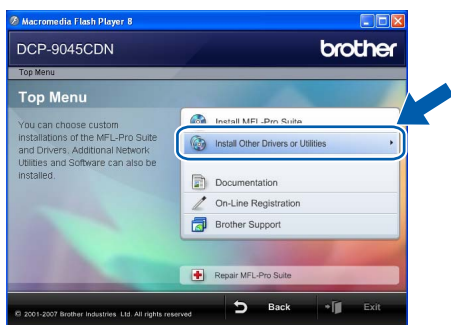

- 2 Click **BRAdmin Light** and follow the on-screen instructions.

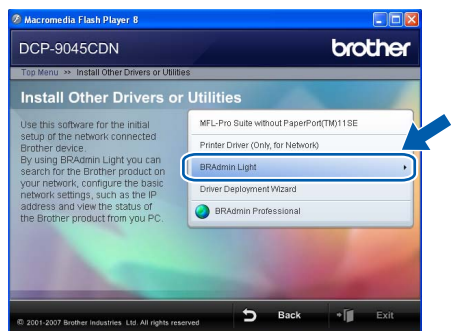

Setting your IP address, Subnet Mask and Gateway using BRAdmin Light



If you have a DHCP/BOOTP/RARP server in your network, you don't have to do the following operation. The print server will automatically obtain its own IP address.

- 1 Start BRAdmin Light. It will search for new devices automatically.

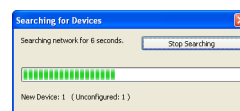

- 2 Double-click the unconfigured device.

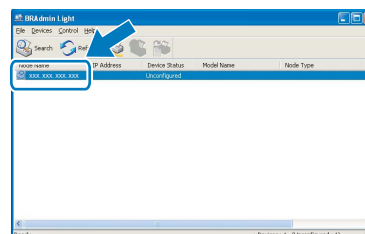

- 3 Choose **STATIC** for the **Boot Method**. Enter the **IP Address**, **Subnet Mask** and **Gateway**, and then click **OK**.

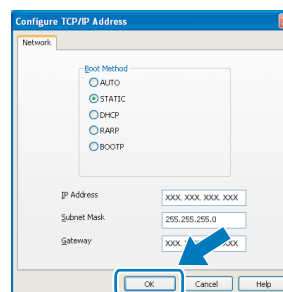

- 4 The address information will be saved to the machine.

BRAdmin Light utility (For Mac OS® X users)

The BRAdmin Light is a utility for initial setup of Brother network connected devices. It also can search for Brother products on your network, view the status and configure basic network settings, such as IP address from a computer running Mac OS® X 10.2.4 or greater.

The BRAdmin Light software will be installed automatically when you install the printer driver. If you have already installed the printer driver, you don't have to install it again. For more information on BRAdmin Light, visit us at <http://solutions.brother.com>.

Setting your IP address, Subnet Mask and Gateway using BRAdmin Light

Note

- If you have a DHCP/BOOTP/RARP server in your network, you don't have to do the following operation. The print server will automatically obtain its own IP address.
- Make sure that version 1.4.1_07 or later of Java™ client software is installed on your computer.
- The default password for the print server is 'access'. You can use BRAdmin Light to change this password.

- 1 Double-click the **Macintosh HD** icon on your desktop.

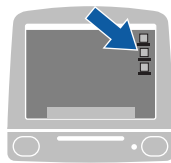

- 2 Choose **Library**, **Printers**, **Brother** and then **Utilities**.

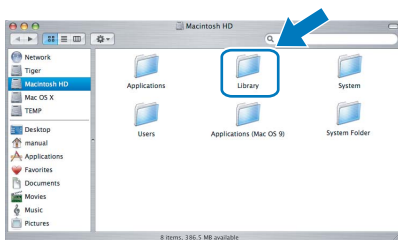

- 3 Double-click the file **BRAdmin Light.jar** and run the software. BRAdmin Light will then search for new devices automatically.

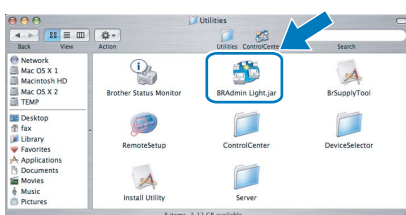

- 4 Double-click the unconfigured device.

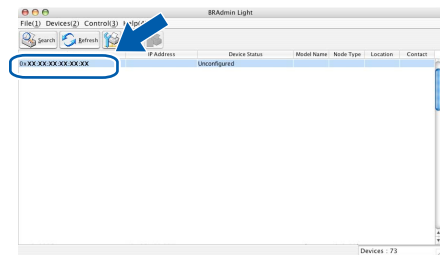

- 5 Choose **STATIC** for the **Boot Method**. Enter the **IP Address**, **Subnet Mask** and **Gateway**, and then click **OK**.

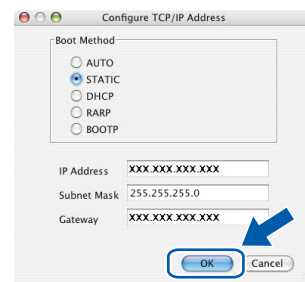

- 6 The address information will be saved to the machine.

Web Based Management (web browser)

The Brother print server is equipped with a web server that allows you to monitor its status or change some of its configuration settings, using HTTP (Hyper Text Transfer Protocol).

Note

- The User Name is **'admin'** and the default password is **'access'**. You can use a web browser to change this password.
- We recommend Microsoft Internet Explorer 6.0[®] (or higher) or Firefox[®] 1.0 (or higher) for Windows[®] and Safari[™] 1.0 for Macintosh[®]. Please also make sure that JavaScript and cookies are always enabled in whichever browser you use. We recommend you upgrade to Safari[™] 1.2 or higher to enable JavaScript. To use a web browser, you will need to know the IP address of the print server.

- 1 Open your browser.
- 2 Type `http://printer_ip_address /` into your browser (Where "printer_ip_address" is the IP address of the printer or the print server name).
 - For example: `http://192.168.1.2/`

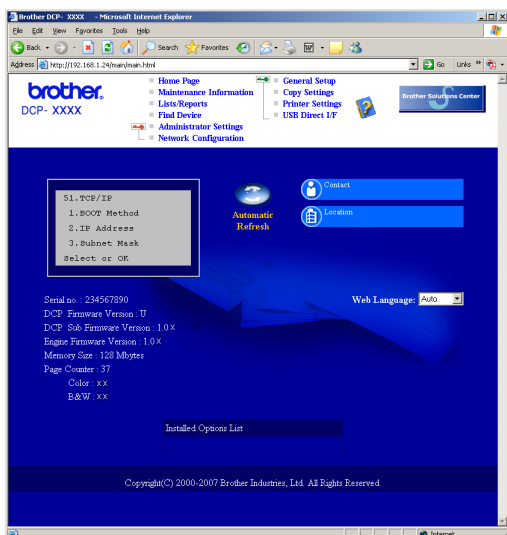

See Chapter 2 of the Network User's Guide on the CD-ROM.

Restoring the network settings to factory default

To restore all network settings of the internal Print/Scan server to factory default, please follow the steps below.

- 1 Make sure the machine is not in use, then disconnect all the cables from the machine (except power cable).
- 2 Press **Menu, 5, 0**.
- 3 Press **1** to select **Reset**.
- 4 Press **1** to select **Yes**.
- 5 The machine will restart. Re-connect cables once this is complete.

Consumables and Options

Options

The machine has the following optional accessories. You can expand the capabilities of the machine by adding these items.

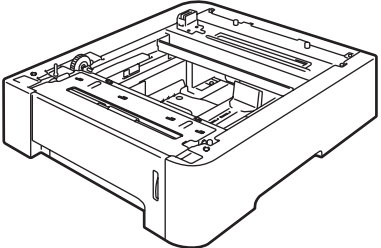
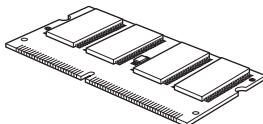
Lower Tray Unit	DIMM Memory
<p align="center">LT-100CL</p>	
 <p>The lower paper tray unit can hold up to 500 sheets of paper. When the lower tray unit is installed, the machine expands total input capacity up to 800 sheets.</p>	 <p>You can expand the memory by installing a (144-pin SO-DIMM) memory module. (See the User's Guide for details.)</p>

Consumables

When the time comes to replace consumable items, an error message will be indicated on the LCD. For more information about the consumables for your machine, visit us at <http://solutions.brother.com> or contact your local Brother reseller.

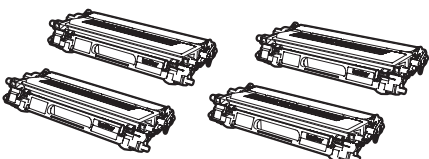
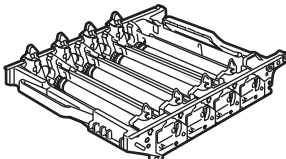
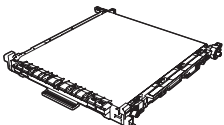
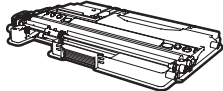
Toner Cartridge	Drum Unit
<p><Standard Toner> TN-110C/TN-110M/TN-110Y/TN-110BK <High-Yield Toner>TN-115C/TN-115M/TN-115Y/TN-115BK</p>	<p align="center">DR-110CL</p>
	
<p align="center">Belt Unit (BU-100CL)</p>	<p align="center">Waste Toner Box (WT-100CL)</p>
	

Trademarks

The Brother logo is a registered trademark of Brother Industries, Ltd.

Brother is a registered trademark of Brother Industries, Ltd.

Multi-Function Link is a registered trademark of Brother International Corporation.

Microsoft, Windows and Windows Server are registered trademarks of Microsoft Corporation in the United States and other countries.

Windows Vista is either a registered trademark or a trademark of Microsoft Corporation in the United States and other countries.

Macintosh and True Type are registered trademarks of Apple Inc.

Postscript and Postscript 3 are registered trademarks or trademarks of Adobe Systems Incorporated.

Nuance, the Nuance logo, PaperPort and ScanSoft are trademarks or registered trademarks of Nuance Communications, Inc. or its affiliates in the United States and / or other countries.

Presto! PageManager is a registered trademark of NewSoft Technology Corporation.

Each company whose software title is mentioned in this manual has a Software License Agreement specific to its proprietary programs.

All other brand and product names mentioned in this manual are trademarks or registered trademarks of their respective companies.

Compilation and Publication

Under the supervision of Brother Industries Ltd., this manual has been compiled and published, covering the latest product descriptions and specifications.

The contents of this manual and the specifications of this product are subject to change without notice.

Brother reserves the right to make changes without notice in the specifications and materials contained herein and shall not be responsible for any damages (including consequential) caused by reliance on the materials presented, including but not limited to typographical and other errors relating to the publication.

This product is designed for use in a Professional Environment.

brother®

USA/CAN