

# User's Guide

# EM-630 CM-2000

ELECTRONIC TYPEWRITER

US English

**brother**®

US ENGINEERING

# Brother EM-630/CM-2000 Electronic Typewriter

Please record in the blank space below the MODEL NO. and SERIAL NO. of this typewriter. The MODEL NO. and SERIAL NO. are located on the back of the typewriter.

MODEL NO.: \_\_\_\_\_ SERIAL NO.: \_\_\_\_\_

Please keep these numbers in a safe place for future reference.

## FCC NOTICE

This equipment generates and uses radio frequency energy and if not installed and used properly, that is, in strict accordance with the manufacturer's instructions, may cause interference to radio and television reception. It has been type tested and found to comply with the limits for a class B computing device in accordance with the specifications in Subpart J of Part 15 of FCC Rules, which are designed to provide reasonable protection against such interference in a residential installation. However, there is no guarantee that such interference to radio or television reception, which can be determined by turning the equipment on and off, will be avoided. The user is encouraged to try to correct the interference by one or more of the following measures:

- Reorient the receiving antenna
- Relocate the computer with respect to the receiver
- Move the computer away from the receiver
- Plug the computer into a different outlet so that the computer and receiver are on different branch circuits. If necessary, the user should consult the dealer or an experienced radio/television technician for additional suggestions. The user may find the following booklet prepared by the Federal Communications Commission helpful: "How to Identify and Resolve Radio-TV Interference Problems". This booklet is available from the US Government Printing Office, Washington, D.C., 20402, Stock No. 004-000-00345-4.

THE EQUIPMENT MUST BE INSTALLED NEAR THE SOCKET OUTLET, WHICH MUST BE  
EASILY ACCESSIBLE.

# Table of Contents

<b>GENERAL VIEW .....</b>	<b>5</b>
<b>CM2000 KEYBOARD LAYOUT .....</b>	<b>6</b>
<b>GETTING STARTED .....</b>	<b>1-1</b>
<b>Getting to Know Your Typewriter .....</b>	<b>1-1</b>
<b>Quick Reference Guide .....</b>	<b>1-1</b>
Key Functions .....	1-1
<b>About your Typewriter .....</b>	<b>1-4</b>
<b>About This User Guide .....</b>	<b>1-4</b>
<b>MENU ITEMS .....</b>	<b>1-5</b>
<b>SETTING UP THE TYPEWRITER .....</b>	<b>1-6</b>
<b>Paper Supporter .....</b>	<b>1-6</b>
Support arm .....	1-6
<b>Acoustic Cover .....</b>	<b>1-7</b>
Margin scale .....	1-7
Glare Screen .....	1-7
<b>Top Cover .....</b>	<b>1-8</b>
Opening the top cover .....	1-8
Closing the top cover .....	1-8
<b>Cassette Daisy Wheel .....</b>	<b>1-9</b>
Removing the cassette daisy wheel ....	1-9
Inserting the new cassette daisy wheel .....	1-10
<b>Cassette Ribbon .....</b>	<b>1-10</b>
Removing the old cassette ribbon ....	1-10
Inserting the new cassette ribbon ....	1-11
<b>Correction Tape .....</b>	<b>1-12</b>
Removing the old correction tape ...	1-12
Installing the new correction tape ....	1-13
<b>Switching The Machine On And Off ..</b>	<b>1-14</b>
Loading Paper .....	1-15
<b>Automatic Paper Insertion .....</b>	<b>1-16</b>
<b>Manual Paper Adjustment .....</b>	<b>1-17</b>
<b>Paper Thickness Control .....</b>	<b>1-18</b>
<b>Self-Demonstration .....</b>	<b>1-18</b>
<b>Multilingual Keyboards .....</b>	<b>1-19</b>
<b>THE DISK DRIVE .....</b>	<b>2-1</b>
<b>What is a Disk Drive? .....</b>	<b>2-1</b>
<b>What is a File? .....</b>	<b>2-2</b>
Types Of Disk Your Machine Can Use .....	2-2
<b>Inserting and Removing a Floppy Disk</b>	<b>2-3</b>
<b>Initializing New Disks .....</b>	<b>2-4</b>
<b>Caring for Your Disks .....</b>	<b>2-5</b>
Write-Protecting Your Disks .....	2-6
<b>Backing up a Disk .....</b>	<b>2-6</b>
<b>Disk Error Messages .....</b>	<b>2-7</b>
<b>BASIC TYPING .....</b>	<b>3-1</b>
<b>The Keyboard .....</b>	<b>3-1</b>
<b>ALT and CODE Keys .....</b>	<b>3-1</b>
<b>Typewriter Operation .....</b>	<b>3-2</b>
Selecting TW Operation .....	3-2
<b>Moving Around The Page .....</b>	<b>3-3</b>
<b>Carrier Return .....</b>	<b>3-3</b>
<b>Tab Key .....</b>	<b>3-3</b>
<b>Index and Reverse Index .....</b>	<b>3-3</b>
Micro Index/Reverse Index.....	3-4
<b>Cursor Keys .....</b>	<b>3-4</b>
<b>Backspacing .....</b>	<b>3-4</b>
Simple backspace .....	3-4
Express backspace .....	3-5
Micro backspace .....	3-5
<b>Relocation .....</b>	<b>3-5</b>
<b>Status Indicators .....</b>	<b>3-6</b>
<b>Changing Settings .....</b>	<b>3-6</b>
<b>Status Indicators .....</b>	<b>3-7</b>
<b>SELECTING TYPING MODE .....</b>	<b>4-1</b>
<b>Normal (Manual Carrier Return) .....</b>	<b>4-1</b>
<b>The Hot Zone .....</b>	<b>4-2</b>
<b>Automatic Carrier Return .....</b>	<b>4-2</b>

**Typing On The Display** ..... 4-3

**Line-By-Line** ..... 4-3

    Ending A Line ..... 4-4

**Permanent Spaces and Hyphens** ..... 4-5

**Justified Typing** ..... 4-5

    Left aligned ..... 4-5

    Justified ..... 4-5

**SETTING THE LINE FORMAT** ..... 5-1

**Line Format Memory** ..... 5-1

**Selecting A Line Format** ..... 5-1

**Format Memory Reset** ..... 5-2

**Changing A Line Format** ..... 5-2

**Setting Line Spacing** ..... 5-3

**Setting Typing Pitch** ..... 5-3

**Margins And Page Length** ..... 5-4

    Preset Margins ..... 5-4

    Margin Release ..... 5-5

    Setting Margins ..... 5-5

    Setting Left Margin ..... 5-5

    Setting Right Margin ..... 5-5

**Setting Start Position (Top Margin)** .... 5-6

**Setting End Position (Page Length)** .... 5-6

**Setting And Using Tabs** ..... 5-7

    Normal tabs ..... 5-7

    Decimal Tabs ..... 5-8

    Using Decimal Tabs ..... 5-8

    Tab Clear ..... 5-9

    Auto tab set ..... 5-9

    All Tab Clear ..... 5-9

**Setting The Hot Zone** ..... 5-10

**TEXT ALIGNMENT IN TW MODE** .... 6-1

**Indentation** ..... 6-1

    Line Indentation ..... 6-1

    Paragraph Indentation ..... 6-1

    Indent Clear ..... 6-2

**Centering** ..... 6-3

    Centering Between Margins ..... 6-3

    Centering Between Tabs ..... 6-3

    Centering At The Carrier Position ..... 6-4

**Right Margin Flush** ..... 6-4

**TEXT ATTRIBUTES** ..... 7-1

**Shift And Caps Keys** ..... 7-1

    Shift ..... 7-1

    Shift lock ..... 7-2

    Caps ..... 7-2

**Bold Text** ..... 7-3

**Automatic Underline** ..... 7-3

**Continuous Underline** ..... 7-4

**Word-By-Word Underline** ..... 7-4

**Expanded Typing** ..... 7-4

**Subscript And Superscript** ..... 7-5

    Subscript ..... 7-5

    Superscript ..... 7-5

**Dead Keys** ..... 7-7

**Superimposed Characters** ..... 7-7

    Extra Characters ..... 7-7

**Setting Impact** ..... 7-8

**Selecting Keyboard** ..... 7-8

    1 (Standard) ..... 7-8

    2 (International) ..... 7-8

    3 (Symbol) ..... 7-9

**MAKING CORRECTIONS** ..... 8-1

**Corrections In NORMAL And AUTO mode** ..... 8-1

    Character Correction ..... 8-1

**Word Out** ..... 8-2

**Line Out** ..... 8-3

**Insertions And Deletions** ..... 8-4

    Insertions ..... 8-4

    Deletions ..... 8-5

**Relocation** ..... 8-6

**Manual Correction** ..... 8-7

**Corrections In L/L, JUSTIFY And WP Modes** ..... 8-8

    Inserting Or Overwriting Text ..... 8-8

    Inserting Text ..... 8-8

**Overwriting Text** ..... 8-9

**Deleting Incorrect Text** ..... 8-10

**Backspace Or Character Correction** .8-10

**Deleting A Word** ..... 8-11

**Deleting A Line** ..... 8-12

**FRAMING AND LINE DRAWING ..... 9-1**

- Horizontal Line Drawing ..... 9-1
- Vertical Line Drawing ..... 9-2
- Drawing A Rectangular Frame ..... 9-3
- Drawing A Tabular Grid ..... 9-4
- Frames With Complex Shapes ..... 9-5

**BASIC WORDPROCESSING ..... 10-1**

**Advantages Of Wordprocessors ..... 10-1**

**Using the Wordprocessor ..... 10-1**

**Selecting WP Mode ..... 10-2**

**Printing Mode ..... 10-3**

**Non-Printing Mode ..... 10-3**

**Creating Or Editing A Document ..... 10-4**

**Saving Your Document ..... 10-4**

**Auto Save ..... 10-6**

**Recovering An Auto Save File ..... 10-6**

**The Wordprocessor Screen ..... 10-6**

**Moving Around The Page ..... 10-7**

Moving Up And Down The Page .... 10-7

Moving Across The Page ..... 10-7

**Layout Indicators ..... 10-8**

**Typing In WP Mode ..... 10-10**

Word Wrap ..... 10-10

Adding Text To A File In Printing

Mode ..... 10-11

Switching Back To TW Mode

Or MAIN MENU ..... 10-11

**FORMATTING YOUR DOCUMENT 11-1**

**Justification In WP Mode ..... 11-1**

**The Format Menu ..... 11-2**

Changing The Format ..... 11-3

Selecting A Format ..... 11-4

Deleting A Format ..... 11-4

Checking The Format And Status ... 11-5

**Page Format ..... 11-5**

**Setting The Paper Size ..... 11-6**

Entering Header Or Footer Text..... 11-7

**Page Breaks ..... 11-8**

**Using GO TO ..... 11-9**

**TEXT ALIGNMENT IN WP MODE .. 12-1**

**Line Indentation ..... 12-1**

**Paragraph Indentation ..... 12-1**

**Centering In WP Mode ..... 12-2**

Centering Between The Margins ..... 12-2

Centering Between Tabs ..... 12-2

**Right Margin Flush ..... 12-3**

Inserting Alignment Markers After

Typing ..... 12-3

Hyphenation In WP Mode ..... 12-3

**Permanent Spaces In WP Mode ..... 12-5**

**BLOCK OPERATIONS ..... 13-1**

**Copying A Block ..... 13-1**

**Temporary Memory ..... 13-3**

Copying Text From Temporary

Memory ..... 13-4

**Moving A Block ..... 13-4**

**Deleting A Block ..... 13-5**

**Block Functions And Formatting ..... 13-5**

**SEARCHING AND REPLACING**

**TEXT ..... 14-1**

**Search ..... 14-1**

**Search And Replace ..... 14-3**

Defining A Search String ..... 14-5

Hyphen Scan ..... 14-6

**ABBREVIATED PHRASES ..... 15-1**

**Maintaining Your Phrase Files ..... 15-2**

**Adding Or Editing An Abbreviated**

**Phrase ..... 15-2**

**Deleting A Phrase ..... 15-4**

**Deleting all Phrases ..... 15-5**

Loading A Phrase File ..... 15-5

Saving A Phrase File ..... 15-6

**Using Abbreviated Phrases ..... 15-6**

Using Phrases In Display Typing

Modes ..... 15-6

Using Phrases In NORMAL And

AUTO Modes ..... 15-8

**PRINTING YOUR DOCUMENT ..... 16-1**

**Printing The Current Page ..... 16-1**

**Printing The Whole Document ..... 16-2**

<b>Stop Codes .....</b>	<b>16-5</b>
Inserting Text At A Stop Code .....	16-5
<b>SPELLING CHECKER .....</b>	<b>17-1</b>
Using The Spelling Checker In	
TW Mode .....	17-2
<b>Find Mode .....</b>	<b>17-3</b>
<b>Adding A Word .....</b>	<b>17-5</b>
<b>One Word Spelling Check (TW) .....</b>	<b>17-5</b>
Redundancy Check .....	17-5
<b>Using The Spelling Checker In</b>	
<b>WP Mode .....</b>	<b>17-6</b>
<b>Checking The Whole Document .....</b>	<b>17-7</b>
<b>One Word Spelling Check (WP) .....</b>	<b>17-7</b>
<b>Using the Spell Checker in WP</b>	
<b>Printing Mode .....</b>	<b>17-7</b>
<b>Maintaining The User Dictionary .....</b>	<b>17-8</b>
<b>Deleting Words From The User</b>	
<b>Dictionary .....</b>	<b>17-8</b>
<b>Deleting All Words .....</b>	<b>17-9</b>
<b>Loading A User Dictionary .....</b>	<b>17-9</b>
<b>Saving A User Dictionary .....</b>	<b>17-10</b>
<b>FORM TYPING .....</b>	<b>18-1</b>
Creating A Form Typing File .....	18-1
<b>Filling In A Form .....</b>	<b>18-5</b>
<b>Changing A Form .....</b>	<b>18-6</b>
<b>Switching Back To TW Mode Or Main</b>	
<b>Menu .....</b>	<b>18-9</b>
<b>ORGANIZING YOUR FILES .....</b>	<b>19-1</b>
<b>File Management Menu .....</b>	<b>19-1</b>
<b>The File Management Menu .....</b>	<b>19-3</b>
<b>Copying A File .....</b>	<b>19-3</b>
<b>Deleting A File .....</b>	<b>19-5</b>
<b>Renaming A File .....</b>	<b>19-5</b>
<b>File Conversion .....</b>	<b>19-6</b>
<b>Deleting All Files .....</b>	<b>19-8</b>
<b>Switching Back To TW Mode Or</b>	
<b>Main Menu .....</b>	<b>19-9</b>
<b>APPENDIX .....</b>	<b>20-1</b>

<b>MAINTENANCE AND</b>	
<b>TROUBLESHOOTING .....</b>	<b>20-1</b>
<b>Maintenance .....</b>	<b>20-1</b>
Environment .....	20-1
Cleaning .....	20-1
Supplies .....	20-2
<b>Troubleshooting .....</b>	<b>20-3</b>
<b>SPECIFICATIONS .....</b>	<b>20-4</b>
<b>EXTRA CHARACTERS AND</b>	
<b>SYMBOL KEYBOARD .....</b>	<b>20-5</b>
<b>Additional and Alternate</b>	
<b>Characters .....</b>	<b>20-5</b>
<b>Keyboard 3 (Symbol Keyboard) .....</b>	<b>20-6</b>
<b>MULTILINGUAL KEYBOARDS .....</b>	<b>20-6</b>
<b>Daisy Wheel Codes for Multilingual</b>	
<b>Keyboards .....</b>	<b>20-6</b>
<b>INDEX .....</b>	<b>i</b>

# General View

## PRINTER CARRIER

Printing mechanism that holds the ribbon cassette, daisy wheel, and correction tape. It moves back and forth along the platen.

## PAPER GUIDE

Moves for paper alignment.

## PAPER SUPPORTER

Holds paper for insertion.

## SUPPORT ARM

Supports long sheets of paper.

## GLARE SCREEN

Shades acoustic cover to minimise reflections.

## ACOUSTIC COVER

Suppresses printing noise and protects from dust, and has margin and tab reference scale for convenience.

## PAPER RELEASE LEVER

Unlocks the platen to adjust paper position.

## TOP COVER

Protects print carrier.

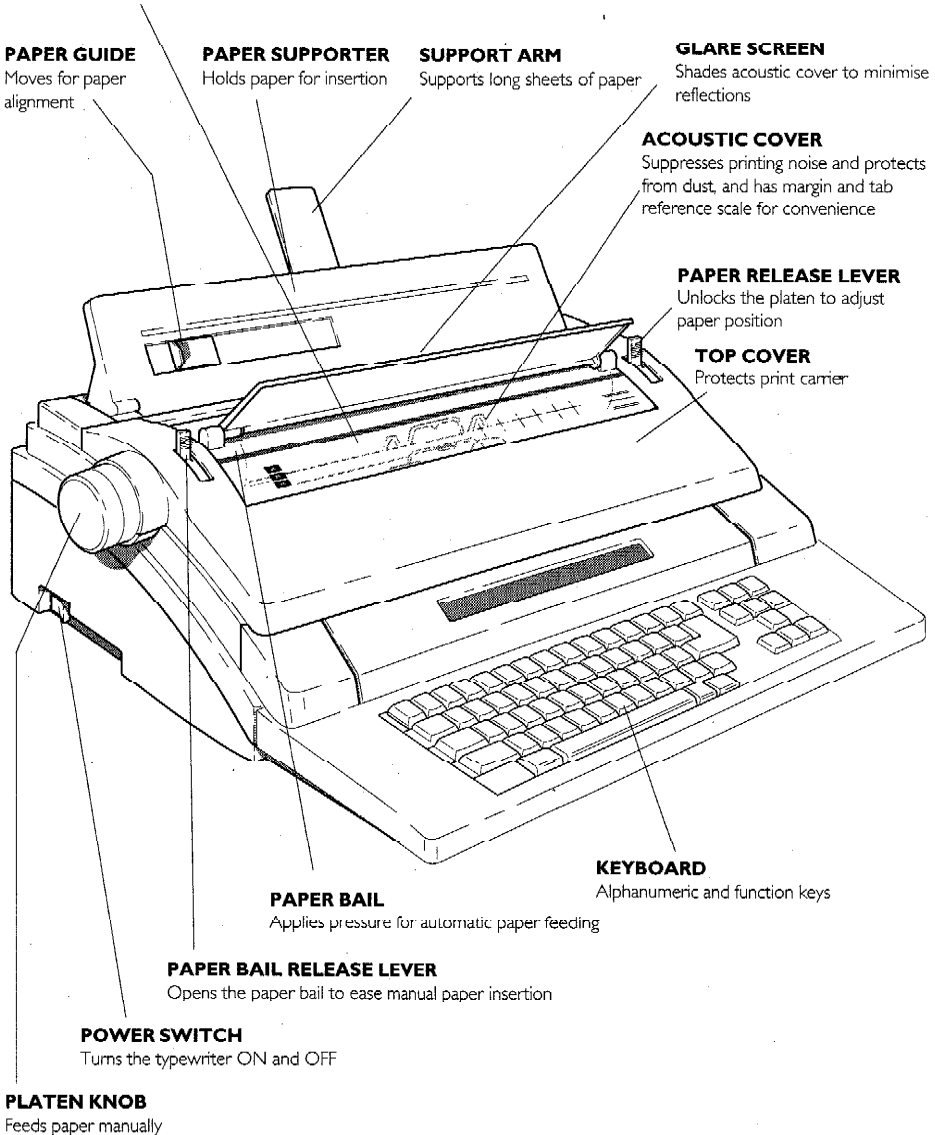

## TOP COVER

Protects print carrier.

## KEYBOARD

Alphanumeric and function keys.

## PAPER BAIL

Applies pressure for automatic paper feeding.

## PAPER BAIL RELEASE LEVER

Opens the paper bail to ease manual paper insertion.

## POWER SWITCH

Turns the typewriter ON and OFF.

## PLATEN KNOB

Feeds paper manually.

# Keyboard Layout

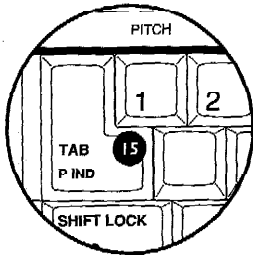

Alternative Style  
Tab Key

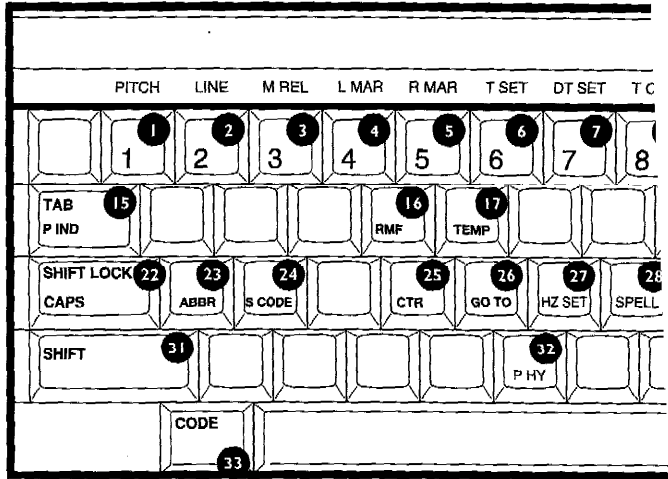

## FUNCTION KEYS

KEY NO.	LEGEND	NAME	FUNCTION			
1*	PITCH	Typing Pitch	Sets 10, 12, 15 or P5 pitch	21	RETURN	Carriage Return
2*	LINE	Line Spacing	Sets 1, 1.5 or 2 line spacing			
3*	M REL	Margin Release	Releases margin stops	21*	IND CLR	Indent Clear
4*	L MAR	Left Margin	Sets the left margin	22		Shift Lock
5*	R MAR	Right Margin	Sets the right margin	22*	CAPS	Caps
6*	T SET	Tab Set	Sets a tab stop	23*	ABBR	ABBR
7*	DT SET	Decimal Tab Set	Sets a decimal tab	24*	S CODE	STOP CODF
8*	T CLR	Tab Clear	Clears a tab	25*	CTR	Centring
9*	UNDLN	Underline	Switches underline on/off	26*	GO TO	GO TO
10*	BOLD	Bold	Turns bold printing on/off			
11*	EXPAND	Expand	Switches expanded typing on/off	27*	HZ SET	Hot Zone Set
12^	IMPACT	Impact	Sets typing impact	28*	SPELL	Spelling Check
13	BKSP	Backspace	Moves the carriage one space left			
13*	BS I	Micro Backspace	Backspaces 1/120 inch	29^	KB	Keyboard
14	RELOC	Relocate	Returns typing carriage after corrections	30*	L IND	Line Indent
14*	EXPR	Express Backspace	Returns carriage to left margin	31		Shift
15	TAB	Tab	Moves carriage to next tab position			
15*	P IND	Paragraph Indent	Turns on paragraph indent mode	32*	P HY	Permanent Hyphen
16*	RMF	Right Margin Flush	Turns on right margin flush printing	33	CODE	Code
17*	TEMP	TEMP	Copies text to/from temporary memory			
18*	INSERT	INSERT	Turns text insertion on/off	34		Spacebar
19*	OPERATE	OPERATE	Selects typewriter mode	35	CORRECT	Character Correct
			NORMAL,AUTO,U/L,JST	35*	CORRECT	Manual Correct
				36	WORD OUT	Word Out
29	PRINT	Print	Prints multilingual keyboard layouts	36*	LINE OUT	Line Out



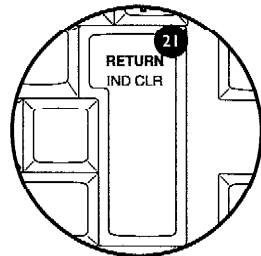
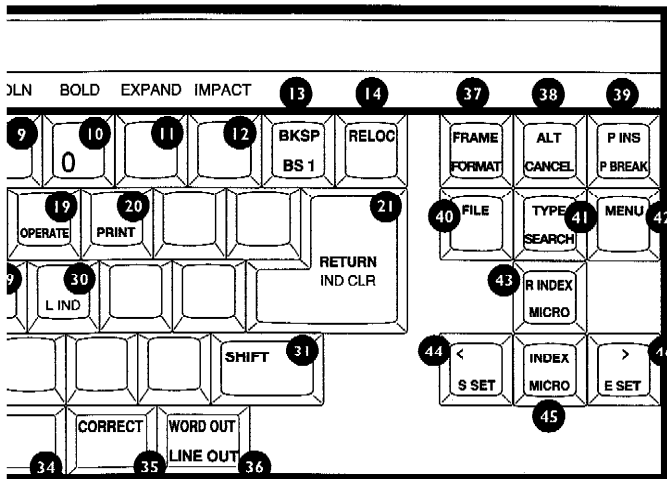

**Alternative Style  
Return Key**

Returns the printing carriage to the left margin and advances one line	37	FRAME	Framing	Starts or ends text framing
	37^	FORMAT	Line Format	Selects a stored line format
Turns off paragraph indent mode	38	ALT	Alternate Function	Used to display and set functions indicated with ^
Locks shift mode on	38*	CANCEL	Cancel	Used to abandon many operations
Turns caps on or off	39	P INS	Paper Insert	Used for automatic paper insertion
Inserts an abbreviated phrase	39*	P BREAK	Page break	Inserts a page break
Inserts a stop code in the text	40	FILE	FILE	Saves a wordprocessor file
Turns centring mode on	41	TYPE	TYPE	Switches between TW and WP mode
Goes to selected page or finds mis-spelt words	41*	SEARCH	SFARCH	Searches for specified text in WP mode
Sets the width of the hot zone	42	MENU	MENU	Calls up menu options
Turns the spelling checker on or off	43	R INDEX	Reverse Index	Moves the paper down 1/12 inch
Selects keyboard I, II or III	43*	MICRO	Micro Reverse Index	Moves the paper down 1/48 inch
Moves the carriage five spaces right	44	←	Left Cursor	Moves the typing carriage one space left
Selects shift mode or cancels shift lock	44*	S SET	Start Set	Sets the top margin
Prints a permanent hyphen	45	INDEX	Index	Moves the paper up 1/12 inch
Used to display and set functions indicated with *	45*	MICRO	Micro Index	Moves the paper up 1/48 inch
Moves the carriage one space right	46	→	Right Cursor	Moves the carriage one space right
Automatically deletes a character	46*	E SET	End Set	Sets the bottom margin
Used for manual correction				
Automatically deletes a word				
Automatically deletes a line of text				

**Notes:**

1. Functions marked \* are used with the CODE key.
2. Functions marked ^ are used with the ALT key.



# GETTING STARTED





















## Getting To Know Your Typewriter



*This section gives you a quick guide to the function keys and menus of your typewriter*



### Quick Reference Guide

The most frequently used functions of your typewriter are activated by special keys. Other functions are called up by pressing the **[MENU]** key, when the display screen will show a list of choices. The quick reference guide gives a brief description of these key functions and menus. Some of these functions may be unfamiliar at this stage, but more detailed descriptions are given in other sections of the User Guide. See also the keyboard layout on pages 6 and 7.



### Key Functions

	+		Sets typing pitch (10/12/15/PS)		+		Tab set
	+		Sets line spacing (1/1.5/2)		+		Decimal tab set
	+		Margin release		+		Tab clear
	+		Left margin set		+		Turns underlined text on or off
	+		Right margin set		+		Turns bold text on or off

 +  Turns expanded text on or off

 +  Sets typing impact (Light/Medium/Heavy)

 Backspaces one character

 +  Backspaces 1/120 inch

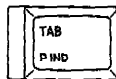

 Relocates the carrier to the end of the typing line

 +  Moves the carrier to the left margin

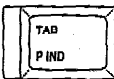

 Moves to the next tab position



 +  Indents a paragraph

 +  Turns on right margin flush typing

 +  Saves text to temporary memory

 +  Turns text insertion on or off

 +  Sets typing mode (Normal/Auto/Line-By-Line/)

 +  Prints the keyboard layout in SET UP mode, or the current page of a WP document

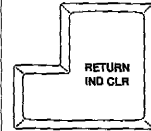

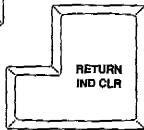
 Carrier return

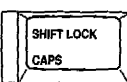

 +  Clears paragraph indent.



 +  Inserts an abbreviated phrase in the text



 +  Locks keyboard in caps mode



 +  Inserts a stop code in the text

 +  Turns on centered typing

 +  Jumps to a selected page number or finds a mis-spelt word

 +  Sets the hot zone (3 to 12 characters)



 +  Turns spelling checker on or off

 +  Selects keyboard (Standard/International/Symbol)

 +  Indents the line five spaces

 Types upper case characters and punctuation marks

 Locks the keyboard in shift mode



 +  Inserts a permanent hyphen

**[SPACE]** Moves carrier right one character



 Automatic character deletion

 +  Manual character deletion

 Automatic word deletion



 +  Automatic line deletion

 Frame and line drawing

 +  Selects a line format

 +  Used to abandon an operation

 Automatic paper insertion

 +  Inserts a page break

 Saves a wordprocessor or form typing file

 Switches between typewriter and wordprocessor

 +  Searches for specified text in WP mode

 Calls up menu items (see next page)

 Moves paper down by 1/12 inch

 Moves paper up by 1/12 inch

 +  Moves paper down by 1/48 inch

 +  Moves paper up by 1/12 inch

 Moves carrier or cursor left one space

 Moves carrier or cursor right one space

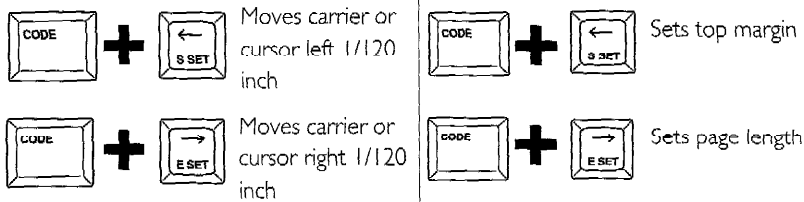
**Note!**

Keys shown with the [ALT] key also work with the [CODE] key, but keys shown with the [CODE] key do not work with the [ALT] key.

## About your Typewriter

Your Brother typewriter is actually two machines in one. It's a powerful typewriter with all the features you expect from a Brother machine. There's also a display typing mode that allows you to see each line of text and correct it before printing. Your typewriter is also a wordprocessor that allows you to create and edit entire documents before printing them. You can switch between wordprocessing and ordinary typing at the push of a button, so if you are in the middle of wordprocessing a document and need to type a short memo or address an envelope, it's no problem. Just switch to typewriter mode, do your typing, and switch straight back to your wordprocessor document at the point where you left off.

There's also a form typing mode that makes it easy to fill in pre-printed forms, and the file management feature allows you to organize your wordprocessor documents.

## About This User Guide

This guide is divided into five main sections. These describe, getting started, typewriter operation, wordprocessor operation, form typing and file management. These sections are identified by the words **GETTING STARTED**, **TW**, **WP**, **FORM TYPING** or **FILE MANAGEMENT** at the edge of each page.

Because your machine can work as a typewriter or as a wordprocessor, some features described in the typewriter section are applicable to the wordprocessor, and vice versa. These sections have **TW/WP** at the edge of the each page.

# Menu Items

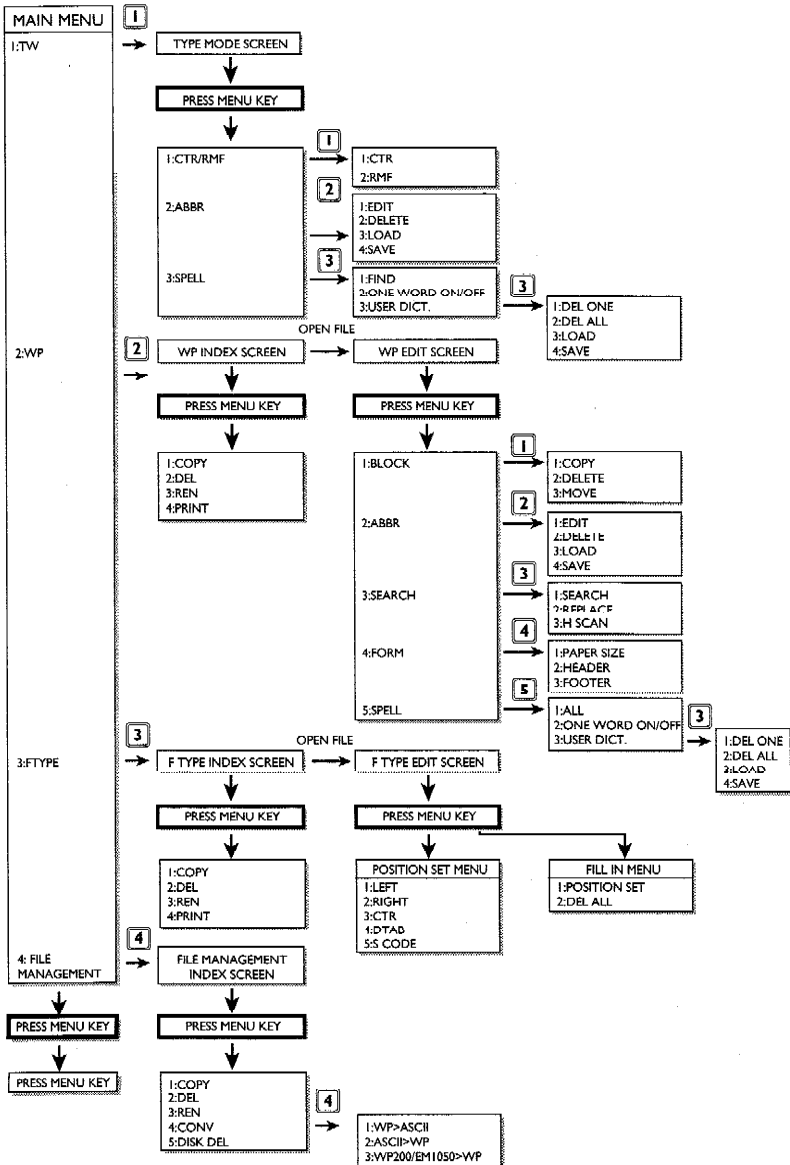

# Setting up the Typewriter

*This section tells you how to set up your typewriter for typing. If you didn't remove the yellow packing pieces and fit the paper supporter when you unpacked the typewriter, now is the time to do it before you attempt to power up the machine.*

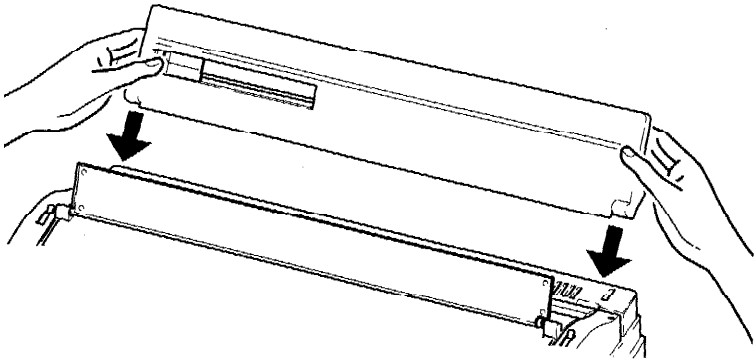

## Paper Supporter

The paper supporter is used to check and adjust the position of the paper.

Attach the paper supporter by inserting the tabs into the holes provided on the top of the typewriter.

The sliding paper guide can be used to adjust the position of the left edge of the paper, relative to the extreme left position of the print carrier, which is indicated by the '0' mark on the embossed scale.

## Support arm

The support arm can be folded out to provide additional support to long sheets of paper.



**Note:**

Should you need to move your typewriter, we suggest that you remove the paper supporter first to avoid the risk of damage.

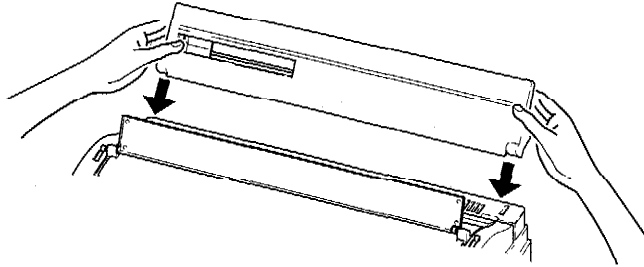

## Acoustic Cover

The acoustic cover suppresses the noise created by the typing carrier and prevents dust from entering the typewriter. Electronic typewriters really dislike dust, so make sure that the acoustic cover of your typewriter is always closed.

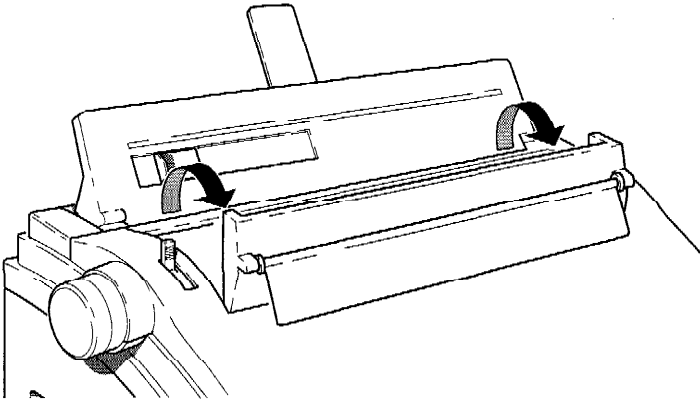

## Margin scale

The margin scale is embossed on the acoustic cover. It shows the three pitch scales (for 10, 12 and 15 characters per inch), the left and right margins, the tab stop positions and the position of the carrier.

## Glare Screen

The glare screen can be adjusted to shade the acoustic cover in order to reduce reflections.

## Top Cover

### Opening the top cover

In order to insert a new cassette daisy wheel, cassette ribbon or spool of correction tape, first place the top cover of the typewriter to the upright position. Do this by placing both hands on either end of the cover and lifting it upwards until it stands by itself.

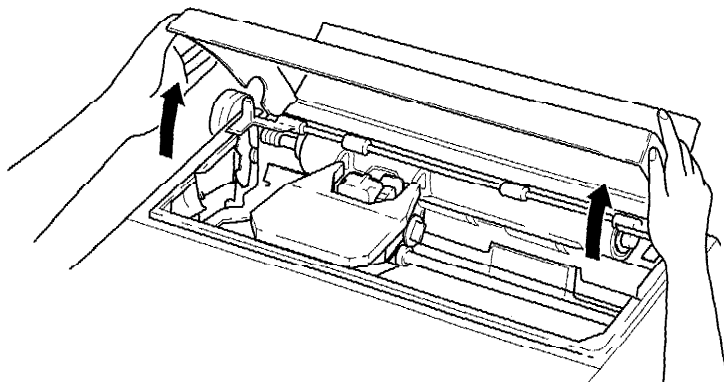

#### Notes:

1. The keyboard locks up when the cover is raised, and typing is not possible until it is closed again.
2. Opening the top cover has no effect on margin settings, tab settings or the correction memory, all of which are retained without change.
3. While the cover is open, the message:



will appear in the display.

### Closing the top cover

After inserting the cassette daisy wheel, cassette ribbon or spool of correction tape, close the top cover by replacing it to its original position. Ensure that it is firmly in place after closing.

#### Note:

If the top cover is closed with the unit switched **ON**, the carrier will automatically travel to the left edge, then return to its previous position.

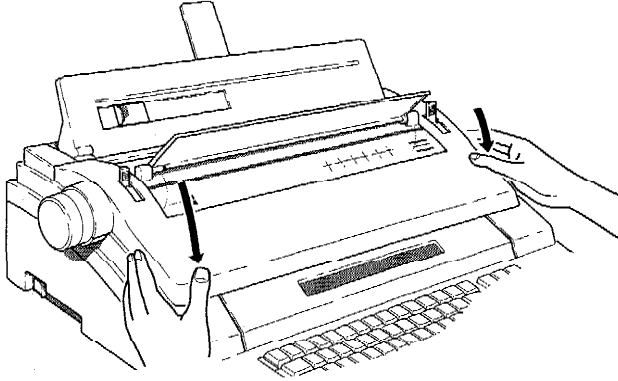

## Cassette Daisy Wheel

Brother's slip-in, slip-out cassette daisy wheels are known the world over for their beautiful true letter quality type print. Here's your chance to discover it for yourself.

Your typewriter comes with a cassette daisy wheel already installed. You may, at some point, wish to exchange it for one with a different typeface, or to place a new one in. With the Brother typewriter, this is a very simple task.

### Removing the cassette daisy wheel

To remove the cassette daisy wheel, pull the locking lever towards you to release it, then grasp the 'ear' of the cassette daisy wheel between your thumb and forefinger and simply pull it out.

**Note:**

The cassette ribbon need not be removed in order to remove the cassette daisy wheel.

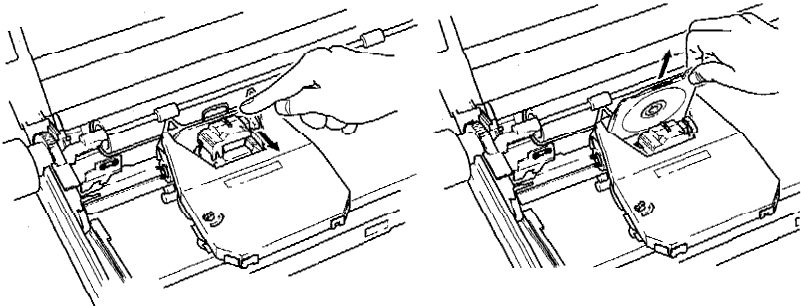

## Inserting the new cassette daisy wheel

Grasping the 'ear' of the new cassette daisy wheel, slip it into the cassette guide slot and slide it in as far as it will go.

Now press the locking lever back toward the platen until it clicks into place. Do not force the lever. If you have any difficulty, recheck the cassette daisy wheel to ensure that it is properly set and try again.

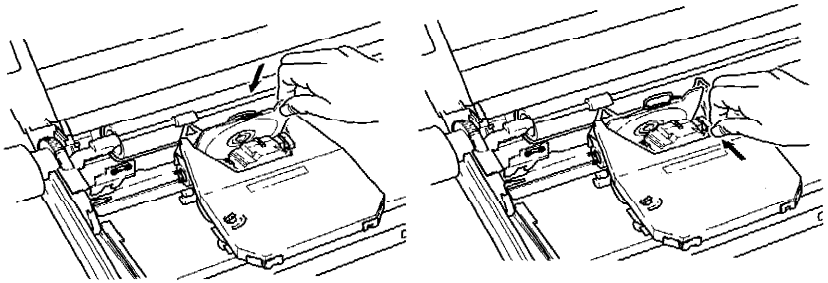

### Notes:

1. Be sure that the 'ear' of the cassette daisy wheel is to the right during insertion. Putting it in backwards can damage both the cassette daisy wheel and the motor mechanism.
2. If the cassette daisy wheel is not properly locked into position, characters will not be properly typed.
3. There is a wide selection of Brother cassette daisy wheels available.

## Cassette Ribbon

The wide range of Brother cassette ribbons available have two unique features in common: they are clean and troublefree. Clean means that the ink goes where it is supposed to go, on the paper, and not on your hands!

### Removing the old cassette ribbon

First, use the [SPACEBAR] or [BKSP] key to move the carrier to the center of the platen. To remove the cassette ribbon, hold the cassette with both hands and raise the front end (that near to the platen). Then, when the ribbon is clear, simply lift the cassette up and out.

2. Brother cassette ribbons are available in four different types:

Correctable film ribbon (standard with this model)

One-time film ribbon

Multistrike film ribbon

Nylon ribbon

The correctable film ribbon is also available in red, blue, green and brown.

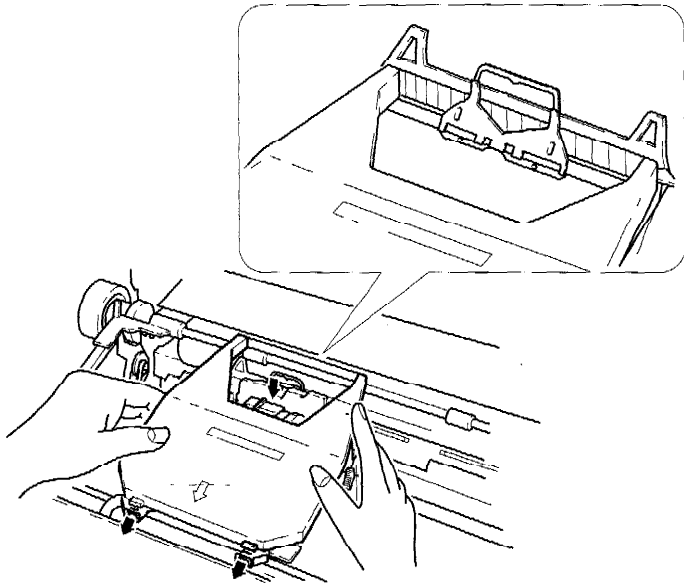

## Correction Tape

The correction tape guarantees a faultless document every time. What's more, the bottom of your typewriter will never be full of pieces of old correction paper and lumps of dried up correction fluid!

### Removing the old correction tape

If you need to replace the correction tape, first make sure that the carrier is in the center of the platen by using the **[SPACEBAR]** or **[BKSP]** key. Then remove the cassette ribbon.

Now just pull out the left and right spools of the old correction tape from the carrier.

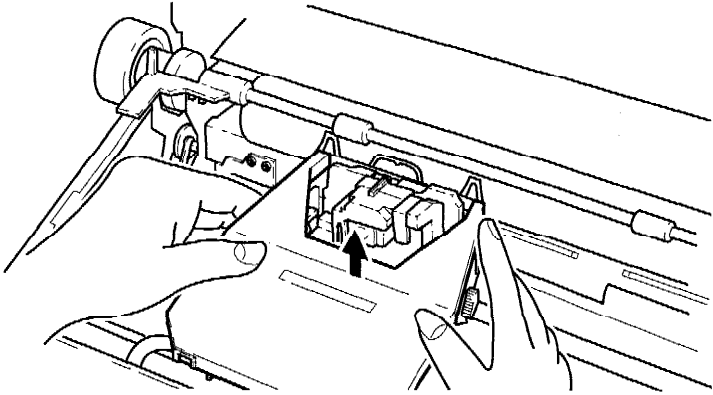

## Inserting the new cassette ribbon

Remove the stopper from the new cassette ribbon and turn the ribbon feed knob counterclockwise to tighten the ribbon.

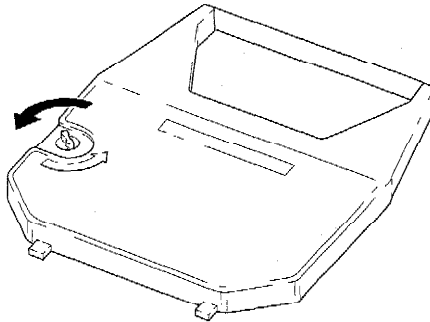

Now locate the lugs on the back edge of the cassette into the locating holes in the cassette ribbon table, and slide the ribbon between the ribbon guides.

With the ribbon set between the ribbon guides, press the cassette down until it locks into place. Turn the ribbon feed knob again slightly anticlockwise to tighten the ribbon.

### Notes:

1. A window is provided in the cassette to allow you to check on the remaining amount of ribbon.

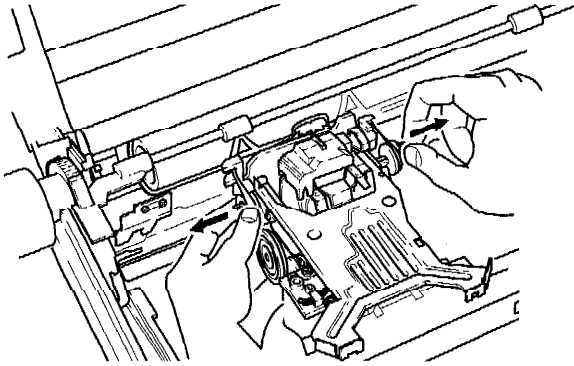

## Installing the new correction tape

First install the left spool, then thread the tape across the left and right guide rollers and install the right spool. Make sure that the active (non-shiny) side of the correction tape is facing towards the platen.

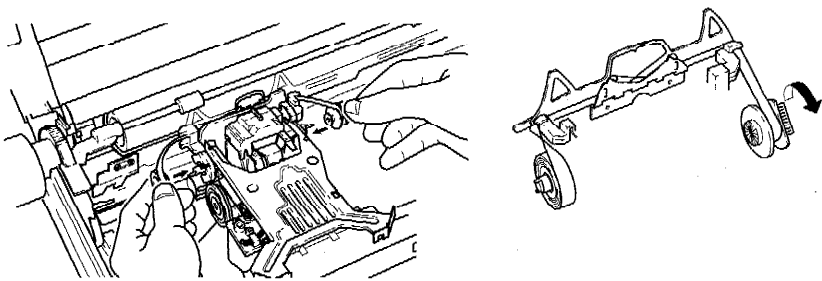

Take up the slack by turning the right spool counterclockwise until the white portion of the tape begins to wind onto the right spool.

### Note:

Brother correction tapes are available in two types:

**Liftoff correction tape** (standard with this typewriter)

This is used together with the correctable film ribbon.

**Coverup correction tape**

This is used together with the multi-strike film ribbon, one-time film ribbon or the nylon ribbon.

## Switching The Machine On And Off

Before switching on for the first time, check that there is no floppy disk in the disk drive on the right-hand side of the machine, as this can complicate matters. If there is a disk in the drive, press the rectangular button to eject it.

Use of the disk drive will be discussed later.

The power switch is located on the left hand side of the machine near the back. To switch on, press the side of the switch marked **I - ON** so that the red bar on the switch is visible. To switch off, press the side of the switch marked **O - OFF**.

When you first switch on your typewriter, the machine will initialize itself. The carrier will move to the extreme left position, then to the left margin, and the daisywheel will rotate, then stop. During this time the display will show the message:



```
WORKING...
```

After this the **MAIN MENU** screen appears.



```
<<MAIN MENU>>  
1:TW 2:WP 3:F TYPE 4:FILE MANAGEMENT
```

This gives you the four operating options of your typewriter:

You can select these options in one of two ways:

1. Use the left and right cursor keys ( $\leftarrow$  and  $\rightarrow$ ) to move the rectangular cursor symbol ( $\blacksquare$ ) to the option you wish to choose. Then press the **[RETURN]** key to confirm the selection.
2. Use the shortcut of pressing the number key corresponding to the option you wish to select. There is no need to press the **[RETURN]** key after pressing the number key, the machine will go straight into the option you selected.

The  $\leftarrow$  and  $\rightarrow$  keys can be used in almost all operations of the machine, for selecting options and moving left and right across the display.



You will probably want to use cursor selection until you become familiar with the machine, to reduce the possibility of mistakes, but for conciseness we shall always refer to selection by number.

Selecting **TW** lets your machine operate as a normal typewriter, but with the useful option of typing each line of text on the liquid crystal display screen, for correction before printing.

**WP** is the wordprocessor mode. When you select the wordprocessor mode, the text you type will be displayed on the liquid crystal screen, and you can correct mistakes, insert and delete words, and perform many other editing functions, to make sure that your document is perfect before you actually print it on paper.

You can also save your documents as files on the floppy disk and recall them at any later time.

**F TYPE** selects the Form Typing mode, which you will find a great time-saver if you frequently have to fill in pre-printed forms. Once you have set up the typewriter for a particular form, you will be able to type in the blank spaces on the form and, when you have finished typing in one space, the printing carrier will automatically move to the beginning of the next space.

**FILE MANAGEMENT** is the mode you will select when you want to carry out operations on the document files you have stored on a floppy disk, such as copying, renaming, deleting and so on.

It's easy to switch between the various operating modes of your typewriter. If you are in **WP**, **F TYPE** or **FILE MANAGEMENT** mode, and need to do some quick typing such as a short memo or envelope, you can simply press the **[TYPE]** key to jump into **TW** mode. After doing your typing, press the **[TYPE]** key again to jump back to what you were doing at the point where you left off.

If you are in **TW**, **WP**, **F TYPE** or **FILE MANAGEMENT** mode, and want to quit it completely and select another mode, simply press the **[FILE]** key. This will allow you to save your work, then return you to the **MAIN MENU**, from which you can select a different option.

## Loading Paper

After switching on the machine, you are ready to insert a sheet of paper and set up your typewriter ready for typing.

## Automatic Paper Insertion

Inserting a sheet of paper into a typewriter has never been simpler; just three easy steps and you're off! Most types of smooth finish paper can be used with your typewriter. Rag content and other types of rough paper, however, are not recommended.

First, ensure that the power switch is **ON**, and that the **PAPER RELEASE LEVER** is set to the back position.

Place the paper guide in the desired position, then, holding the sheet as straight as possible, insert the paper into the slot behind the paper rest with the left edge against the paper guide.

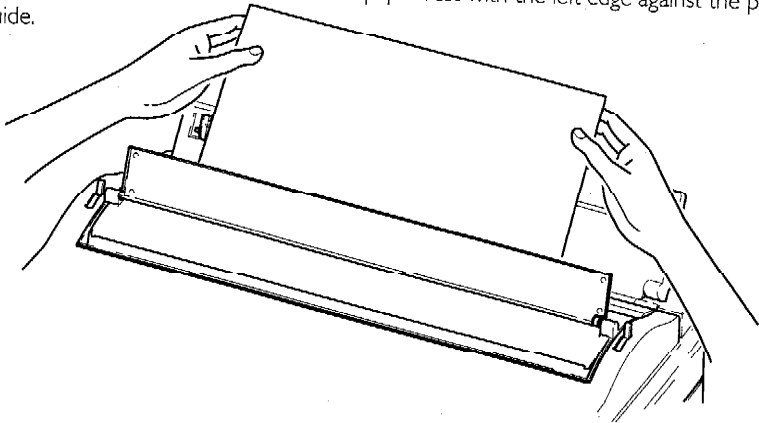

Now press [**P INS**]. The carrier will first move to the left end of the platen and then back to the center of the margin scale, the paper bail will lift, and the platen will rotate to feed in the sheet of paper automatically.

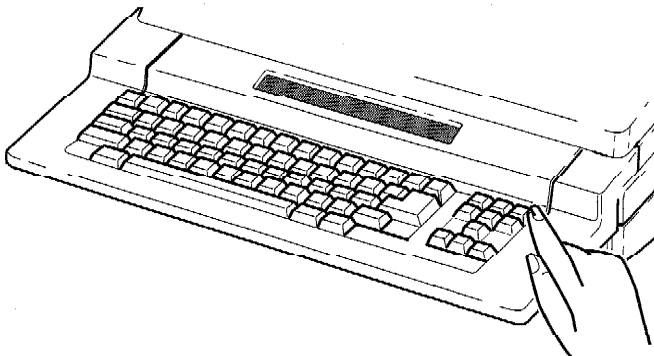

After the paper has been inserted, press **[RETURN]** to move the carrier to the left margin position. When you are in normal typing mode, you will be prompted to do this.

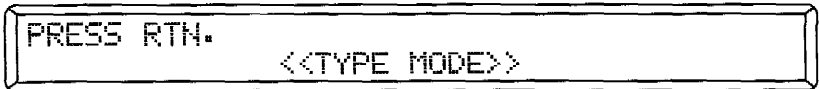

### Notes!

1. The distance the paper is fed in will determine the position of the first typing line in relation to the top edge of the paper (the top margin). You can adjust this using the **START SET** function, as described later. The factory setting of the top margin is one inch.
3. If the paper is crooked or not properly aligned after automatic insertion, it may be adjusted manually. First turn the platen or use **[INDEX]** to feed more paper through, then pull the paper release lever forward. This will lift the paper bail and release the paper so that it may be moved manually. Align the paper until it is straight, then return the paper release lever to its back position and turn the platen knob or use **[INDEX]** and **[R INDEX]** to return the paper to the position where you wish to begin typing. For finer adjustment, use these keys with the **[CODE]** key held down.

## Manual Paper Adjustment

If the paper is crooked or not properly aligned after automatic insertion, it may be adjusted manually. First pull the paper bail lever forward to raise the paper bail and avoid it catching on the paper. Turn the platen knob or use **[INDEX]** to feed more paper through, then pull the paper release lever forward. This will lift the paper bail and release the paper so that it may be moved manually. Align the paper until it is straight, then return the paper release lever to its back position and turn the platen knob or use **[INDEX]** and **[R INDEX]** to return the paper to the position where you wish to begin typing. For finer adjustment, use these keys with the **[CODE]** key held down.

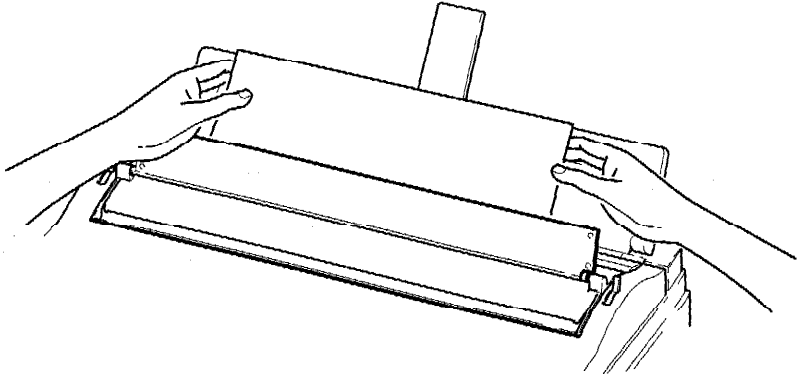

## Paper Thickness Control

The paper thickness control is located on the right side of the cassette ribbon table.

The lever is normally pushed right down in its standard position. Pulling up the lever increases the space between the carrier print head and the platen, thus enabling you to insert thicker paper and envelopes.

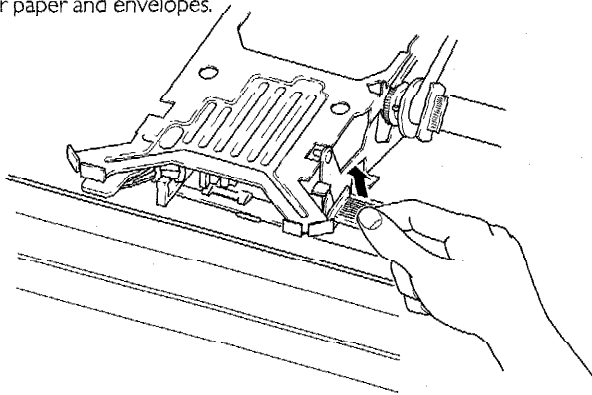

## Self-Demonstration

Your typewriter has a built-in self demonstration that tells you about the many advanced features of your machine.

To activate the self-demonstration:

1. Make sure that your machine is switched on, with a daisy wheel and cassette ribbon fitted, and that the MAIN MENU is in the display.
2. Press the **MENU** key. The following message will appear on the display:

```
▶ MENU
1: SET UP 2: SELF DEMO
```

3. Press the **[2]** key to select **SELF DEMO**. The following message will appear:

```
▲ INSERT PAPER AND PRESS RTN.
```

4. Insert a sheet of paper, as described earlier, and press **[RETURN]**.

The following message will appear, and the self-demonstration will begin to print.

```
▲ PRESS CANCEL FOR MAIN MENU
<<SELF DEMO>>
```

If you wish to cancel the self-demonstration before it has finished, hold down the **[CODE]** key and press the **[CANCEL]** key.

## Multilingual Keyboards

If you wish to type in some foreign languages, for example Turkish, you may find that the English daisy wheel does not contain all the required characters, and for languages with non-Latin characters such as Greek the character set is completely different.

Of course, you can simply put a foreign language daisy wheel in your typewriter, but you may find the results are not very good.

Firstly, the keyboard layout may not be the same as it would be on the proper foreign language keyboard.

Secondly, when you type a character using an English daisy wheel, the printing impact is set to suit that particular character, so that the print density remains even. (For example, a small character such as a full stop needs less impact than a capital B).

If you use a foreign language daisy wheel, the typewriter does not know the correct typing impacts for the characters on that daisy wheel, and some characters may appear darker than others.

Fortunately, the multilingual keyboard feature of your typewriter allows you to get the best results when you use foreign language daisy wheels.

To select a different keyboard language:

1. With the main menu on the screen, press the **[MENU]** key.

The following menu will appear:

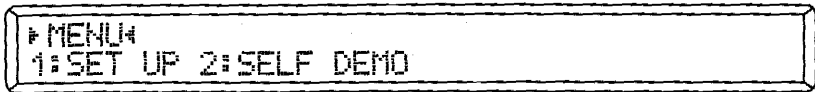

2. Press **[1]** to select **SETUP**.

The following message will appear:

The first item in the display is shown as asterisks, because it is the default value, which is

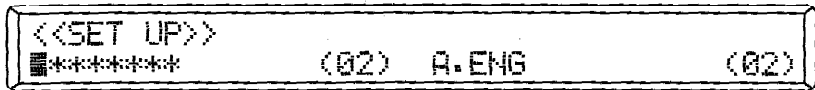

different for each country. (e.g UK English for the United Kingdom).

To see other options, you can use **[INDEX]** and **[R INDEX]** to scroll the display up and down, and **←** and **→** to select either the left or right hand option in the display.

*****	(02)	A. ENG	(02)
J. ENG	(05)	GERMAN	(08)
ENG	(14)	CAN	(16)
FRENCH	(20)	L. SPA	(27)
TURKISH	(29)	S. AFR	(31)
DUTCH	(32)	SWISS(KB1)	(36)
SWISS(KB2)	(36)	GREEK(KB2)	(42)
ITALIAN	(52)	LATIN	(53)
FIN/SWE	(60)	POR	(64)
POR(BRAZIL)	(64)	NOR/DAN(NOR)	(70)
NOR/DAN(DAN)	(70)	ICE	(74)
S-SPAIN	(76)		

The two digit number alongside the language selection is the keyboard and daisy wheel code for that language. For example, the keyboard code for Dutch is 32, and all Dutch daisy wheels are labelled 32 or 32F, depending on whether the daisy wheel has the vertical bar (|) framing character or not. A complete listing of multilingual keyboards, by language, is given in Appendix B.

When you have selected the keyboard layout you want, press **[RETURN]** to confirm the selection and return to the **MAIN MENU**.

Press **[CODE] + [PRINT]** to print out a map of the foreign language keyboard layout. You must have the foreign language daisy wheel installed to do this.

To return to the **MAIN MENU** without changing the keyboard code, press **[CODE] + [CANCEL]**.

#### **Note!**

1. The machine returns to the default keyboard setting each time it is switched off. If you want to use another keyboard you must set it up each time the machine is switched on.





# The Disk Drive

## What is a Disk Drive?

While your typewriter is switched on, the machine can store up to 32,400 characters of text in its internal memory, but there are two disadvantages to this. Firstly, the stored text would be lost if the machine was switched off, and secondly, once the memory became full you would not be able to store any more text.

To allow you to save unlimited amounts of text, your typewriter is equipped with a floppy disk drive. This is located in the right-hand side of your typewriter.

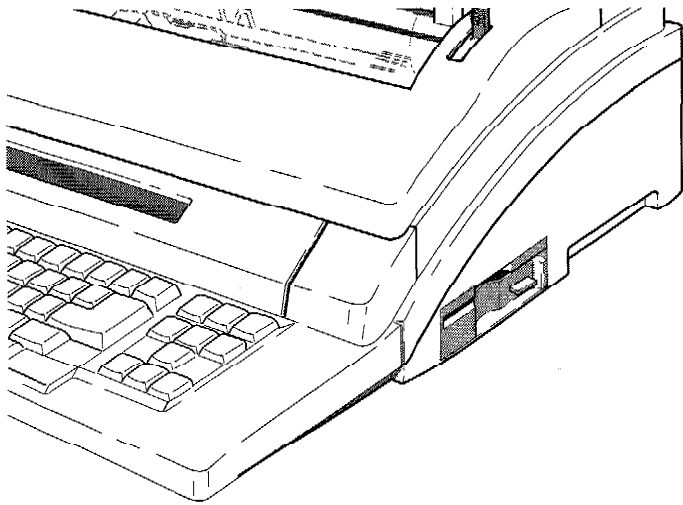

The floppy disk drive allows you to transfer your document from the machine's memory and record it on a rotating disk made of a magnetic material similar to audio and video cassette tapes.

Once you have saved a document on a disk, it will remember the document even if the power is switched off. Furthermore, if a floppy disk becomes full and can hold no more information, you can remove it from the disk drive and replace it with a blank one. You can also use a disk from your typewriter (and the documents on it) in some other Brother wordprocessors or an IBM compatible personal computer.

## What is a File?

A floppy disk records documents as a sequence of coded data in the form of magnetic signals on the disk's surface. The collection of data that makes up a particular document is known as a **FILE**. Since there may be many different documents saved on a floppy disk, each one must be given a **FILE NAME** so that you can see what files are on the disk, and retrieve the one you want without having to read every one on the disk.

A file name consists of up to 8 characters, followed by a 3 character code called the file name extension. The extension is used by your machine to identify what kind of file this is. For example, **TEXTFILE.WPT** is a Brother wordprocessor file.

When you are giving your files names, you do not need to worry about the extension, it is added automatically by your typewriter. The only characters that are allowed in file names are letters A to Z, numbers 0 to 9 and the hyphen (-). Your typewriter does not distinguish between upper and lower case letters in file names, and letter input will be converted to upper case.

If you try to input an invalid character, or type more than 8 characters in the file name, a warning beep will sound.

When you have to carry out operations that involve loading files into memory, a list of files will appear on the screen. These screens are known as index screens.

File names should be chosen so that you can easily find the document you want on the disk. You may wish to use names that are mnemonics, or arranged in alphabetical or numerical order.

## Types Of Disk Your Machine Can Use

This machine accepts only the following types of 3.5 inch floppy disks:

MF 2DD (Double Sided/Double Density/Double Track)

Your machine cannot use high density ("HD") floppy disks, so be sure to purchase only double density double track ("DD") disks. It is recommended that you use Brother brand disks.

## Inserting and Removing a Floppy Disk

Insert the floppy disk as shown in the illustration. You will feel some resistance if you try to insert the disk the other way around.

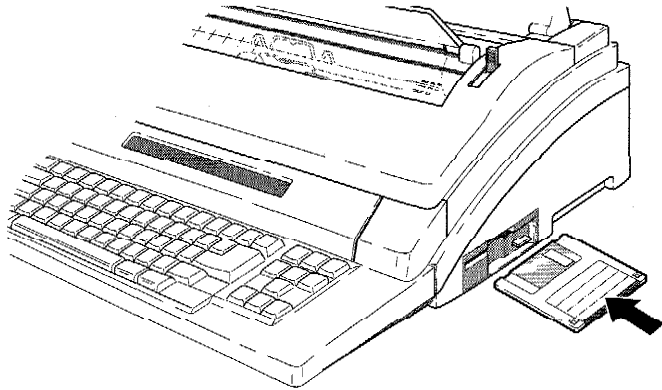

To remove the disk, simply press the eject button .

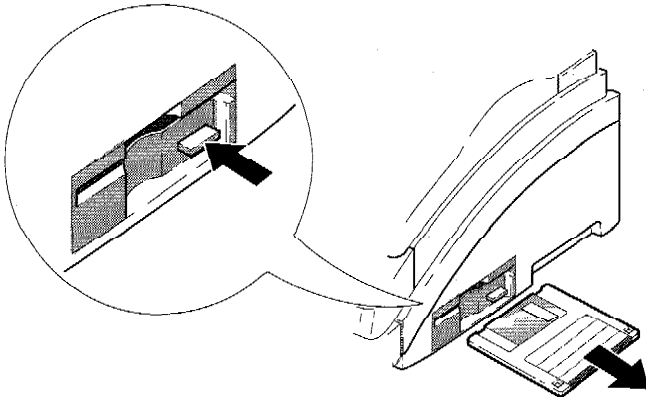

**CAUTION!** The floppy disk may be inserted and removed when the power is either on or off. It may also be left in the drive while transporting the machine. However, you should never insert or remove it while a message indicates that a disk operation is in progress, for example:

```
PLEASE WAIT....
```

## Initializing New Disks

A new floppy disk can be used by a system only after being "formatted" - that is, initialised by the system for specific use by that system.

Whenever you carry out an operation for which your typewriter needs to use the disk drive, such as saving document, the typewriter first checks that there is a disk in the drive. If there is not, the following message will appear in the display:

```
INSERT DISK AND PRESS RTN.
```

You should insert a disk and press the **[RETURN]** key .

If there is a disk in the drive, the disk format is checked. If the disk is unformatted or has a different format, the following prompt appears:

```
INITIALIZE? Y/N
```

Press **[Y]** to initialize the disk, or **[N]** to abandon the procedure. Initialization of the disk will take a few minutes.

- **WARNING!** - Initializing a disk erases any data that might be on it. If you initialize a disk from a personal computer, for example, the files will be completely destroyed. Once the disk has been initialized, however, it will be in the proper format for use with your typewriter.

- The disk which comes with this machine is not initialized.

**Note!**

Your typewriter can read disks that have been initialized on IBM-compatible personal computers and other wordprocessors that use the same disk format. However, it can use only certain types of files created on those machines.

If you ask your typewriter to use an incompatible type of file, it will give the following warning:

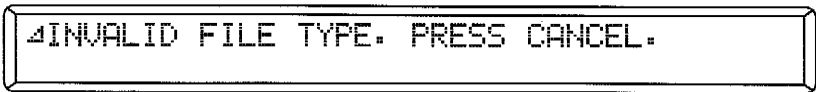

Hold down the [CODE] key and press the [CANCEL] key to abandon this operation.

## Caring for Your Disks

Although 3.5-inch floppy disks are rugged and the system has incorporated in it every reasonable precaution to prevent inadvertent erasure, accidents will happen. New disks frequently come with cards or labels listing some of the things that can go wrong; for example:

Mechanical damage due to heat, dust, dropping, crushing, spilled liquids, etc.

Electrical damage due to exposure to magnetic fields. These are generated, not just by magnets, but also by electrical and electronic equipment such as loudspeakers, television sets and computer monitors, and many other types of equipment.

**DON'T**

- leave your disks lying around where they may become dirty or damaged.
- leave your disks lying on or near electrical or electronic equipment.
- open the shutter of the disk and never touch the surface directly.
- use magnetic materials near the disk.
- expose the disk to extremely high or low temperatures.

**DO**

Store your disks in the original manufacturer's carton or in a dustproof disk storage case.

## Write-Protecting Your Disks

All 3.5-inch floppy disks have a switch that protects their contents from accidental erasure. When the switch is in its **READ ONLY** position, you can read information from a disk, but you cannot erase old information or store new information on the disk. Put the switch in the **READ ONLY** position to protect a disk containing valuable information.

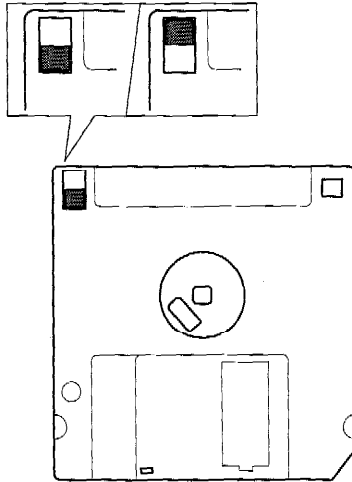

### Note!

If your typewriter tries to store information on a write-protected disk, for example, saving a document, the following message will appear:

```
WRITE PROTECTED DISK.  
MOVE PROTECT TAB, PRESS RTN TO RETRY.
```

## Backing up a Disk

The best insurance against losing important data is to make backups (duplicate copies) of your files. You can do this with the **COPY** function, as explained in the section on **FILE MANAGEMENT**.

## Disk Error Messages

During disk operations, you may see the following warning messages:

```
ΔDISK FULL.  
INSERT NEW DISK AND PRESS RTN.
```

This means the disk can hold no more data. Replace it with a disk that has some space remaining.

```
ΔTOO MANY FILES ON DISK.  
INSERT NEW DISK AND PRESS RTN.
```

The maximum number of files allowed on a disk is 112, even if the disk is not full. Replace it with a disk that has some space remaining and contains less than 112 files.

```
ΔUNIDENTIFIED DISK ERROR.  
INSERT NEW DISK AND PRESS RTN.
```

Your machine thinks that the disk may be faulty - replace it. If the problem persists, consult your dealer.





# TYPEWRITER

## Basic Typing

*This section tells you how to use your machine in the typewriter or **TW** mode. In this section you will learn how to do basic typing and use the many useful features of the machine.*

*Don't be afraid to experiment. Whatever keys you press, you cannot damage the machine, and the worst that can happen is that you may waste some paper.*

### The Keyboard

Your typewriter's keyboard has a full set of character keys for typing alphabetic and numeric characters, symbols and punctuation marks. It also has a number of keys for calling up the many functions of the typewriter, the use of which will be discussed. A diagram of the keyboard, with a brief description of each function key, appears on pages 6 and 7.

### ALT and CODE Keys

Many keys of the typewriter have text or symbols for secondary functions printed on them in green.

These functions are selected by first holding down the **[CODE]** key, then pressing the key for the function.

Some of these functions can also be selected using the **[ALT]** key. The use of the **[CODE]** and **[ALT]** keys in relation to specific functions will be discussed later. Note that keys shown as being used with the **[ALT]** key can also be used with the **[CODE]** key, but keys shown as being used with the **[CODE]** key will not work with the **[ALT]** key.

### Important Notes!

1. For conciseness, once the function of a key has been explained, we shall use the symbol for the function, for example [BKSP] for **BACKSPACE**. When referring to the secondary function of the key, we shall use the symbol for the secondary function, for example [BS I] for **MICRO BACKSPACE**. When referring to functions used with the [CODE] or [ALT] keys, we shall say "press [CODE] + [BS I]" to mean "hold down the [CODE] key, then press the [BS I] key". for example.
2. When the flashing cursor symbol is over a character, the display alternates between the cursor and the character, e.g. █ → B → █. As it is not possible to show this alternation in the diagrams, the cursor symbol will, in general, be shown instead of the character, except where it is more important to see the text.

## Typewriter Operation

When using your typewriter in **TW** mode, you can use it like an ordinary typewriter, with each character being printed as it is typed. Alternatively, you can type a line of text on the display, and only print it after you have checked and corrected it. In this section we will look at these different modes of operation, but first, you need to select typewriter mode.

### Selecting TW Operation

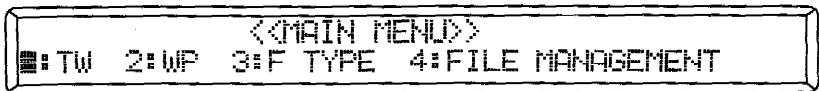

The machine should be switched on, with the **MAIN MENU** in the display.

To select typewriter operation, press [1]. If the machine has not been used before, the following message should appear.

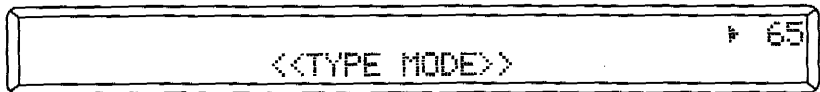

The number in the top right-hand corner of the display tells you how many characters remain between the current carriage position and the right margin. It will decrement by one for every space that the carriage moves to the right, and is useful for setting tabs as well as telling you how many characters remain on the current line.

The left and right margins are factory set to 10 and 75, so this number will be 65 if the machine has not been used before. If the machine has been used before and the margins have been changed, this number may be different.

If the machine has been used before, you may see the display "AUT" on the top line of the display. Alternatively, "L-L" or "JST" may appear in this position, in which case the bottom line of the display will be blank. These display messages have to do with the four operating modes of the typewriter, which will be discussed later.

## Moving Around The Page

Your typewriter has keys that let you move the carriage accurately to any part of the page and back to your original typing position, without having to make any time-consuming manual adjustments of the platen.

### Carrier Return

The [RETURN] key advances the paper by one line, depending on the line space setting, and returns the print carriage to the left margin.

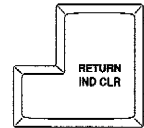

### Tab Key

The tab key moves the carriage to the right by one tab position each time it is pressed, the distance depending on what tabs have been set.

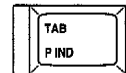

## Index and Reverse Index



The index and reverse index keys are used for vertical adjustment of the paper, and for shifting the paper up and down by 1/12 inch for typing subscripts and superscripts.

The [INDEX] key moves the paper up by 1/12 inch (moves down the page) each time it is pressed.

The [R INDEX] key moves the paper down by 1/12 inch (moves up the page) each time it is pressed.

If [INDEX] or [R INDEX] are held down for more than 0.5 seconds, the paper will move continuously until the key is released.

**Note!**

When typing on the display in **TW** or **WP** (non-printing) mode, **[INDEX]** and **[R INDEX]** are used for scrolling the display up and down.

**Micro Index/Reverse Index**

If **[INDEX]** and **[R INDEX]** are pressed while holding down **[CODE]**, the up or down movement is 1/48 inch.

**Cursor Keys**



The left and right cursor keys - ← and → move the carriage left or right by one character. If ← or → is held down for more than 0.5 seconds, the carriage will move continuously until the key is released. If the cursor keys are used with the **[CODE]** key held down, the carriage movement is 1/120 inch.

However, when typing on the display **[CODE]** + ← and **[CODE]** + → move the cursor symbol (␣) to the beginning or end of the line respectively.

**Backspacing**

You may wish to move the carriage back over text you have already typed for a variety of reasons; for example, to manually underline text, or when making corrections.

Your typewriter has three different backspace functions.

**Simple backspace**



Press the **[BKSP]** key to move the carriage to the left one space at a time. Holding down **[BKSP]** for more than 0.5 seconds moves the carriage continuously to the left.

**Note!**

It may appear that **[BKSP]** duplicates the function of ←, but when typing on the display in **TW** or **WP** mode, ← merely moves the cursor to the left, whereas **[BKSP]** moves the cursor to the left and deletes the text that has been typed.

## Express backspace

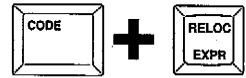

Holding down [CODE] and pressing the **EXPRESS BACKSPACE** key - [EXPR] will bring the carriage immediately back to the left margin. When typing on the display, [CODE] + [EXPR] moves the cursor symbol to the beginning of the line.

## Micro backspace

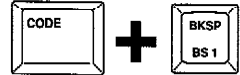

Holding down [CODE] and pressing the **MICRO BACKSPACE** key - [BS 1] will move the carriage to the left by 1/120 of an inch. As the distance backspaced remains constant at 1/120 of an inch regardless of the typing pitch being used, backspacing in this case varies by pitch as shown in the following table:

Pitch	Spacing
10	1/12 of a character pitch
12	1/10 of a character pitch
15	1/8 of a character pitch
PS	1/10 of a character pitch (nominal)

This function is useful in numerous different ways, including positioning a character or word when the paper has been reinserted into the typewriter, or for typing a character or word into a limited space on the document. See "Insertions And Deletions" in the next section for more information.

## Relocation



If you break off typing and move the carriage back along the typing line, using the cursor and backspace keys, to make a correction, for example, your typewriter remembers where the carriage was when you left off typing.

When you finish making corrections, the [RELOC] key returns the carriage back to your original typing position.

### Note!

Relocation is possible only while making corrections on the current typing line, or the previous line.

## Status Indicators

Before you start typing, you will probably want to set up your typewriter with the correct margins, tabs, line spacing and typing pitch, so that the layout of your document is correct when you print it. You may also wish to switch on (or off) text attributes such as bold, underline and expanded printing.

Before you can change any of the items above, you need to know what the current settings are. The most frequently used status indicators are shown permanently on the top line of the display, for example:



The others status indicators can be displayed by pressing the [ALT] key, when the following display will appear:

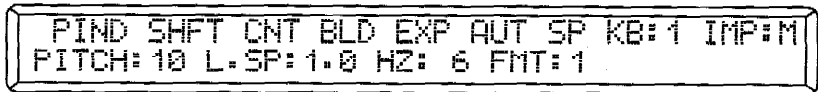

Don't worry if the display is not exactly like the examples shown above, since the actual indications will depend on how the machine is set up. Some of the indications may be different from those shown in the above example, and some of the indications on the top line of the display may be blank, indicating that a function is turned off.

Each of the above indicators shows the current status of a text attribute such as bold and underline, and layout or format attributes, for example typing pitch and line spacing. At this stage you probably won't know what many of these indicators mean. A brief glossary is given in the table below, and all the functions will be explained in detail later.

If no indication appears in a particular position in the display, the function is turned off, apart from the typing mode, where no display means normal typing mode.

## Changing Settings

Those functions permanently shown on the top line of the display (apart from [SHIFT] and [SHIFT LOCK]) are changed by holding down the [CODE] key and pressing the key for the function to be changed. Some of these functions are simply toggled on or off each

time the function key is pressed. Others cycle through a number of different settings as the function key is pressed repeatedly.

Those functions that are only displayed when the [ALT] key is pressed can be changed by pressing the key for the function while the [ALT] key is held down. These functions selected also work with the [CODE] key, but the [ALT] key allows the status of the function to be viewed before pressing the key to change it, whereas the [CODE] key does not display the function until the function key is pressed, which also changes the setting.

### Note!

The status of tabs and margins is not shown on the display. These have to be set using the counter in the top right corner of the display.

## STATUS INDICATORS

FUNCTION DESCRIPTION	DISPLAY	FUNCTION KEY(S)
Paragraph indent mode OFF	NONE	[CODE] + [P IND]
Paragraph indent mode ON	PIND	
Shift, Shift Lock and CAPS all OFF	NONE	[SHIFT] and [CODE] + [CAPS]
Caps Lock ON	CAPS	[CODE] + [CAPS]
Shift key held down	SHFT	[SHIFT]
Shift lock ON	SHFT	[SHIFT LOCK] (overrides CAPS)
Underline OFF	NONE	[ALT] + [UNDLN]
Continuous Underline	ENT	
Word-by-word underline	WRD	
Bold printing OFF	NONE	[ALT] + [BOLD]
Bold printing ON	BLD	
Expanded printing OFF	NONE	[ALT] + [EXPAND]
Expanded printing ON	EXP	

Normal typing mode	NONE	[ALT] + [OPERATE]
Auto carriage return mode	AUT	
Line-by-line typing mode	L/L	
Justified typing mode	JUST	
Spelling checker OFF	NONE	[ALT] + [SPELL]
Spelling checker ON	SP	
Keyboard 1	KB: 1	[ALT] + [KB]
Keyboard 2	KB: 2	
Keyboard 3	KB: 3	
Typing impact Low	IMP:L	[ALT] + [IMPACT]
Typing impact Medium	IMP:M	
Typing impact High	IMP:H	
Typing pitch 10	PITCH: 10	[ALT] + [PITCH]
Typing pitch 12	PITCH: 12	
Typing pitch 15	PITCH: 15	
Proportional spacing	PITCH: PS	
Single line spacing	L.SP: 1.0	[ALT] + [LINE]
1 1/2 line spacing	L.SP: 1.5	
Double line spacing	L.SP: 2.0	
Hot zone (3 to 12 characters)	HZ: (3 to 12)	[ALT] + [HZ SET]
Current format number (1 to 5)	FMT: (1 to 5)	[ALT] + [FORMAT]

**Note!**

Keys shown with [ALT] key will also work with the [CODE] key, but keys shown with [CODE] key do not work with the [ALT] key.



# Selecting Typing Mode

## Selecting Typing Mode



When used in TW mode, your typewriter has four distinct modes of operation:

- Normal operation (manual carrier return)
- Automatic carrier return
- Display typing (line-by-line, left aligned)
- Display typing (line-by-line, justified)

The typing mode is selected by holding down **[ALT]** and pressing the **[OPERATE]** key.

Each time **[OPERATE]** is pressed, the typing mode indication will change in the following sequence:

NORMAL (no display) → FJT → L/L → JST → NORMAL

## Normal (Manual Carrier Return)

In normal typing mode, your typewriter prints each character as it is typed. Carrier return is accomplished manually, by pressing **[RETURN]** at the end of each line.

Pressing **[RETURN]** advances the paper by the number of lines set with **[LINE]** (1, 1.5 or 2) and returns the carrier to the left margin.

The many features of this new Brother typewriter **[RETURN]**  
make typing really easy. **[RETURN]**  
you can produce professional looking documents in a **[RETURN]**  
fraction of the time.

To select normal operation, hold down **[ALT]** and press **[OPERATE]** until the typing mode indication is blank.

## The Hot Zone



The hot zone is an area that begins before the right margin and extends up to the right margin. You can set the start of the hot zone to be between 3 and 12 characters before the right margin. This is independent of the typing pitch, so if you set the hot zone to 5 characters in 10 pitch, it will still be 5 characters if you change to 15 pitch.

The hot zone helps you to keep your typed lines neatly within the margins by giving you a warning when you are getting close to the right margin. When the carrier enters the hot zone, the beeper will sound. You then have the remainder of the hot zone in which to finish off your line by ending a word and pressing **[RETURN]**, or by splitting a word with a hyphen and pressing **[RETURN]**. If you do not press **[RETURN]** before the right margin is reached, the carrier will lock and no further typing is possible until either **[RETURN]** or **[CODE] + [M REL]** is pressed.

If the word you are currently typing cannot be hyphenated and is too long to fit on the line, you may wish to delete the portion of it you have already typed by pressing the **WORD OUT** key - .

Alternatively, you can release the right margin by holding down **[CODE]** and pressing the margin release key **[M REL]**, in order to fit the word on the line. Of course, the word will then extend beyond the right margin.

The hot zone is set by pressing **[ALT] + [HZ SET]**. This is described in more detail in the section on setting the line format.

The default setting of the hot zone is 6.

## Automatic Carrier Return

Automatic carrier return saves you having to press the **[RETURN]** key every time you reach the end of a line. This function works by automatically performing a carrier returning whenever you end a word by pressing **[SPACE]** or split a word by pressing the hyphen key while the carrier is in the hot zone. The carrier will also return if you press the **[RETURN]** key at any time.

To turn on the automatic carrier return mode, hold down the **[ALT]** key and press the **[OPERATE]** key until the typing mode indication changes to **AUT**.

The many features of this new Brother typewriter **[SPACE]**  
 make typing really easy. **[RETURN]**  
 You can produce professional looking documents in **[SPACE]**  
 a fraction of the time.

**Notes:**

1. If you type up to the right margin with no spaces or hyphens in the hot zone, the beeper will sound, the carrier will stop at the right margin and will not return automatically. Press the [RETURN] key or [SPACE] to return the carrier or [CODE] + [M REL] to continue typing past the right margin.
2. You cannot type a hyphen at the right margin position to break a word and return the carrier. If you have reached the right margin position and wish to hyphenate a word, you can either use [CODE] + [M REL] to continue typing past the right margin, or delete some characters using the character correction key [CORRECT], then type in the hyphen.

## Typing On The Display

The normal and auto carrier return modes are fine for experienced touch typists who rarely make mistakes, but less skilled typists will find the two display typing modes very helpful, since you can see your text on the display before you print it, and correct it if necessary.

When you type on the display, the carrier moves across the paper so that you can see where your text will be printed, but it is not printed until a whole line has been typed. There are two different modes for display typing, **LINE-BY-LINE** and **JUSTIFY**.

## Line-By-Line

To select line-by-line typing, hold down the [ALT] key and press the [OPERATE] key until L/L appears in the display.



In the line-by-line typing mode, the text is not printed as you type it, but is displayed on the screen.

Depending on the margins you have set and the typing pitch, the entire line of text may be too long to fit on the display, which is only 40 characters wide. In this case, when the text reaches a point five characters from the right-hand side of the display it will scroll to the left.

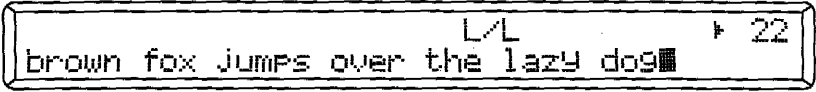

You can move back along the line using the left cursor key - ←, and view the text that is off the left side of the display.

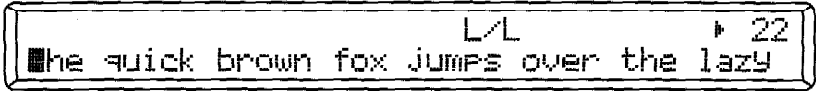

Do not try to use the backspace key - [BKSP] to move to the left, as this will delete the text you just typed.

Similarly, to move to the right-hand end of the text line, press the right cursor key →.

To move quickly to the beginning of the line, press [CODE] + [EXPR] or [CODE] + ←.

To move quickly to the end of the line, press [RELOC] or [CODE] + →.

### Ending A Line

When the text reaches the hot zone, the beeper will sound. If you end a word with a space, split a word with a hyphen, or press [RETURN], the carrier will return and the text will be printed.

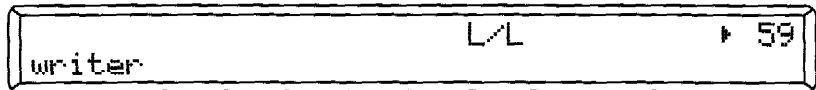
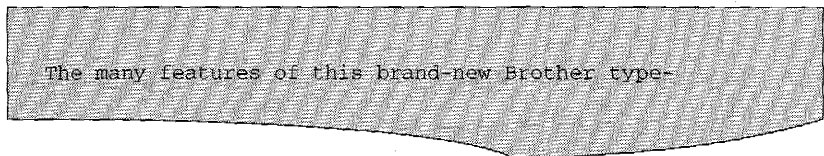

Hyphens typed in the hot zone are shown dotted (·) on the display to distinguish them from normal hyphens (-), but they print out the same.

## Permanent Spaces and Hyphens



In some cases you may wish to finish a word within the hot zone and type another short word on the same line, or you may have a hyphenated phrase such as mother-in-law that you do not want to split over two lines.

In this case you can use the permanent space or hyphen function.

To type a permanent space or hyphen, hold down the [CODE] key and press either the [SPACE] or the [PHY] key. Your space or hyphen will be typed without the carrier returning, and it will not return until you type a normal space or hyphen.

When you type a permanent space on the display, it is shown differently to distinguish it from a normal space.

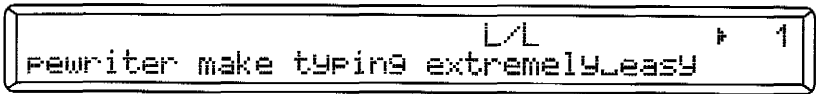

permanent space

## Justified Typing

The justified typing mode is similar to the line-by-line mode, except that the text is evenly justified between the margins when it is printed, instead of left-aligned.

### Left-aligned

Your Brother typewriter is actually three machines in one. It's a powerful typewriter with all the features you expect from a Brother machine. There's also a display typing mode that allows you to see each line of text and correct it before printing.

### Justified

Your Brother typewriter is actually three machines in one. It's a powerful typewriter with all the features you expect from a Brother machine. There's also a display typing mode that allows you to see each line of text and correct it before printing.

Justified typing is turned on by holding down the [ALT] key and pressing the [OPERATE] key until JST appears in the display.

Justified text that has too few words on a line will not look good, as there will be large gaps between words. (Typographers call this a loose line).

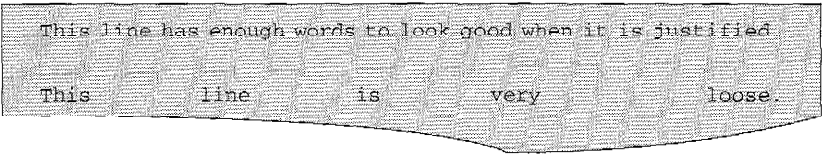

Also, text such as an address may require to be left-aligned.

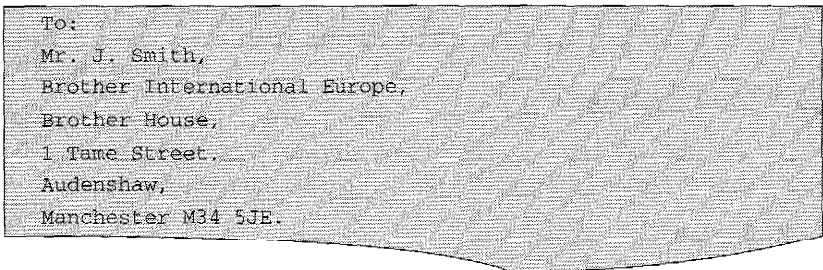

In order to avoid loose lines, and to allow left-alignment of text that requires it, your typewriter will justify text only if it extends into the hot zone, and the line is ended by a space or hyphen.

If the line is ended by a carrier return inside the hot zone, or before the hot zone is reached, the line will be printed left-aligned.

# Setting the Line Format

*Your typewriter has a number of functions that affect the overall layout and appearance of your document. These are shown in the table below, together with their factory settings.*

Line Spacing	Single
Typing Pitch	10 characters per inch
Hot Zone	6 characters
Left Margin	10 columns in from left
Right Margin	75 columns in from left
Tabs	Every 10 columns
Top Margin (Start Position)	1 inch
Page Length (End Position)	Not set

These settings are known collectively as the **LINE FORMAT**.

## Line Format Memory

If you frequently have to type different types of document, it can be tedious and time-consuming to change the line format manually every time you have a different job to do.

Fortunately, your typewriter makes changing the line format easy, by having five memories in which line format information can be saved. The contents of all five line format memories are factory set to the values given in the table above, but you can change them to suit your own requirements.

## Selecting A Line Format



To select a line format, hold down **[ALT]** and press the **[FORMAT]** key.

Each time you press the **[FORMAT]** key, the **FMT** display on the status screen will change in the sequence: 1→2→3→4→5→1.

When the machine is first used, all five format memories are the same, so the format functions displayed on the status screen will not change. Once you have changed the contents of the format memories you will see these functions change as you cycle through the five format memories.

The format memories are backed up. This means that the format information is not lost when the machine is switched off. Also, when you switch the machine on again, the selected format will be the one that you were using when you switched the machine off.

## Format Memory Reset



The format memories in your machine are factory set with the values mentioned earlier, but it is quite likely that you will change them while using the machine. Should you wish to restore the factory settings at any time, you can do this quite simply.

1. Select the format number you wish to restore to factory settings, using **[ALT] + [FORMAT]**.
2. Hold down the **[ALT]** key and press the **[CORRECT]** key.
3. The format memory will be restored to factory settings, and the following message will be displayed:

▲FORMAT IS CHANGED TO DEFAULT SETTING.

## Changing A Line Format

Changing the contents of a line format memory to suit your own requirements is very simple. Every time you make a change to one of the line format functions, the change is automatically saved in the format memory that you currently have selected.

If you have some work that requires frequent format changes, and other work that requires pre-defined formats, it's a good idea to use format memory 1 as your "scratch" format memory and reserve the other four memories for your fixed formats.

How to change the various functions that make up the line format information is described below.



**Note!**

Margins, tabs and the hot zone cannot be changed in line-by-line or justified typing modes. You must select **NORMAL** or **AUTO** modes when setting these items.

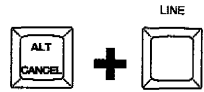
**Setting Line Spacing**

Your typewriter offers you three choices of line spacing: single line spacing, one and a half line spacing, and double line spacing. To select the desired line spacing, hold down **[ALT]** and press the **[LINE]** key. Each time **[LINE]** is pressed, the **L-SP** display will change in the following sequence:

1.0 → 1.5 → 2.0 → 1.0

Single line spacing places 1/6 inch of space between lines.

One and a half line spacing places 1/4 inch of space between lines.

Double line spacing places 1/3 inch of space between lines.

**Note!**

The factory setting of line spacing is 1.0.

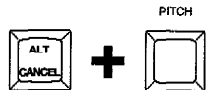
**Setting Typing Pitch**

Your typewriter offers you four choices of pitch:

**Pica, or 10** pitch (10 characters per inch)

**Elite or 12** pitch (12 characters per inch)

**Micron or 15** pitch (15 characters per inch)

**PS** or Proportional Spacing

10, 12 and 15 pitch are fixed pitches, i.e. the print carrier advances a fixed distance after typing any character. With proportional spacing, the distance the carrier advances after typing a character depends on the actual character width. Therefore, the number of characters per line in PS depends on what characters are typed, since you can get more l's on a line than M's.

For the purposes of setting margins and tabs, the nominal or average character spacing of PS can be taken as 12 pitch.

To select the desired pitch, hold down **[ALT]** and press the **[PITCH]** key. Each time **[PITCH]** is pressed, the **PITCH** display will change in the following sequence:

10 → 12 → 15 → PS → 10

10 pitch allows 120 characters to be typed per line.

12 pitch allows 144 characters to be typed per line.

15 pitch allows 180 characters to be typed per line.

The maximum characters per line in PS pitch is variable.

**Note!**

The factory setting of pitch is 10.

## Margins And Page Length

The margin settings of the typewriter allow you to determine the overall layout of the page. Left and right margins define the overall width of the text and its horizontal position on the page. Top margin (START SET) determines the vertical position of the text relative to the top edge of the page, and page length (END SET) determines the overall height of the text.

### Preset Margins

When you first switch on your typewriter, the margins have been preset at the factory in 10 pitch and for single line spacing. If you change either of these, the preset margins will vary, depending on the typing pitch and line spacing, as shown in the following table .

Pitch	Left margin	Right margin
10	10	75
12	12	90
15	15	112
Line Spacing	Top Margin	Page Length
1.0	6	Not set
1.5	1	Not set
2.0	3	Not set

## Margin Release

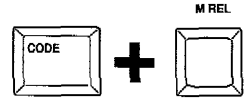

The print carrier will normally not move outside the margins. However, on occasion, you may wish to type outside the margins. It will also be necessary to move the carrier past the margins if you want to set margins outside the ones currently set.

To move to the left of the left margin:

1. Use **[BKSP]** or **←** to move to the left margin.
2. Hold down **[CODE]** and press the **MARGIN RELEASE** key - **[M REL]** and then continue to press **[BKSP]**, **←** or **→** until the carrier reaches the place where you wish to begin typing or set a new left margin

Similarly to move past the right margin, press **[M REL]** when the margin is reached, then continue typing.

## Setting Margins

If you do not wish to use the standard margins, you can set your own margins very easily.

### Setting Left Margin



To set a new left margin:

1. Move the carrier to the new left margin position using **[SPACE]**, **→**, **[BKSP]** and **←** keys as necessary. If the new margin position is to the left of the old margin, you will need to use **[CODE]** + **[M REL]** before you can move outside the old margin.
2. Hold down the **[CODE]** key and press the **LEFT MARGIN** key - **[L MAR]**. The left margin is now set.

### Setting Right Margin

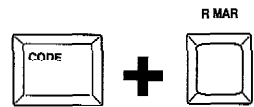

To set a new right margin:

1. Move the carrier to the new right margin position using **[SPACE]**, **→**, **[BKSP]** and **←** as necessary.
2. Press the **RIGHT MARGIN** key - **[R MAR]**. The right margin is now set.

If you wish to move beyond the existing right margin to set a new one, use **[CODE]** + **[M REL]** then **[SPACE]** or **→**. If you use **[SPACE]**, you should first ensure that the machine is in **NORMAL** typing mode, since you cannot use **[SPACE]** to move beyond the right margin in **AUTO**, **LINE-BY-LINE** or **JUSTIFY** modes, as the carrier will return if **[SPACE]** is pressed in the hot zone.

The minimum width between left and right margins depends on the typing pitch, as shown in the following table.

Pitch	Min Margin Width	Expand mode
10	20 characters	10 characters
12	24 characters	12 characters
15	30 characters	15 characters

## Setting Start Position (Top Margin)

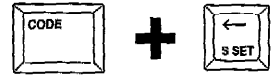

Automatic paper insertion normally sets the paper so that typing will start approximately one inch (25.4 mm) from the top of the page. However, you can change this position using the **START SET** function, so that auto-insertion will set the paper to a start position anywhere between one and six inches (25.4 and 152.4 mm) from the top of the page.

To set the start position:

1. Insert a sheet of paper and press the **[P INS]** key to auto-insert the page.  
The display will show the message: **▲PRESS R.TN.**

However, if you wish to set the start position you should not press **[RETURN]** at this stage.

2. Use **[INDEX]** and **[R INDEX]** to adjust the position of the page to where you wish to begin typing.
3. Hold down **[CODE]** and press the **START SET** key - **[S SET]** to save that setting as the start line.

## Setting End Position (Page Length)

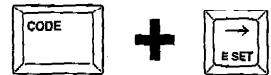

The appearance of multi-page documents is enhanced if the text ends at the same position on each page. Your typewriter allows you to set the page length using the **END SET** function, so that you cannot type below the end position.

To set the end position:

1. First insert the paper as above, using the **[P INS]** key. Do not press **[RETURN]**.
2. Use **[INDEX]** and **[R INDEX]** to adjust the paper to the desired end position.
3. Hold down **[CODE]** and press the **END SET** key - **[E SET]** to set the end position.

**Notes!**

1. There must be at least 5 lines between the start position and the end position.
2. The end position cannot be more than 16.5 inches or 419.1 mm from the top of the page.
3. The start and end positions are measured absolutely from the top edge of the page and are completely independent of each other. Changing start position does not affect end position, and vice versa.
4. When the carrier reaches the end of the page the following message will appear



If you wish to type an extra line, press the **[CORRECT]** key and continue typing.

If you wish to cancel the current page end setting, press **[CODE] + [E SET]** when the page end is reached.

**Setting And Using Tabs**

Tabs allow you to move the typing position quickly and automatically to a preset position. As their name suggests, they are useful for typing tables, and are also used for indenting paragraphs.

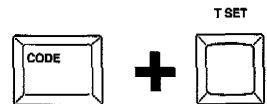
**Normal tabs**

Normal tabs are left-aligned, i.e. the first letter of the text is aligned to the tab stop.

To set a normal tab:

1. Move the carrier to the position at which a tab is required.
2. Hold down **[CODE]** and press the **TAB SET** key - **[T SET]**.
3. To use the tab stop, press the **TAB** key - **[TAB]**, and the carrier will move to the tab position automatically.

### Notes!

1. When a tab is to be set in the same position as a decimal tab (see below), the decimal tab in that position will be changed to a normal tab when **[T SET]** is pressed.
2. Tab positions are set according to the absolute position of the carrier (in units of 1/120 in.) based on the left edge, so they do not change even when the margins or pitch have been changed.
3. A maximum of 30 tabs, including decimal tabs, can be set on your typewriter

## Decimal Tabs

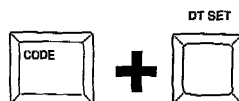

This function allows you to type columns of numbers aligned on a decimal point, or on the space after the last digit in the case of numbers that do not have a fractional component (integers).

If you have text that needs to be right-aligned to a tab instead of left-aligned (i.e. aligned on the last letter of the text instead of the first letter), you can use a decimal tab for this purpose.

To set a decimal tab:

1. Move the carrier to the position at which a decimal tab is required.
2. Hold down **[CODE]** and press the **DECIMAL TAB SET** key- **[DT SET]**. To move the carrier to the decimal tab stop, press **[TAB]**.

### Notes!

1. When a decimal tab is set in the same position as a normal tab, the normal tab in that position will be changed to a decimal tab when **[CODE]** + **[DT SET]** are pressed.
2. Decimal tab positions are set according to the absolute position of the carrier (in units of 1/120 in.) based on the left edge, so they do not change even when the margins or pitch have been changed.
3. A maximum of 30 decimal tabs, including normal tabs, can be set on your typewriter.

## Using Decimal Tabs

Typing text at a decimal tab is different from typing at a normal tab. Since text at a decimal tab is aligned on the decimal point or the space after an integer number, your typewriter needs to know where this appears before it can print the text.

When you use the **[TAB]** key to move to a decimal tab stop, the message: **DECIMAL TAB** will appear on the top line of the display.

If your number has an integer part before the decimal point, type this in. Each character you type will appear on the display, and the carrier will move one space to the left.

If your number has a decimal point, type this. The integer part of the number and the decimal point will be printed. You can then type the fractional part of the number, which will be printed after the decimal point in the normal way.

If the number is an integer, press **[TAB]** to print the number and move to the next tab position, or **[RETURN]** to print the number and end the line.

## Tab Clear

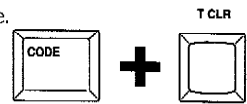

To clear a normal or decimal tab:

1. Move the carrier to the position of that tab using **[TAB]**.
2. Hold down **[CODE]** and press the **TAB CLEAR** key - **[T CLR]**.

## Auto tab set

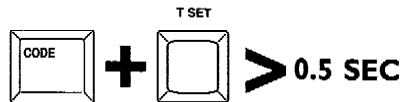

If **[CODE]** + **[T SET]** is pressed for more than half a second, tabs will be set every 10 columns from the current left margin position and the following message will appear:

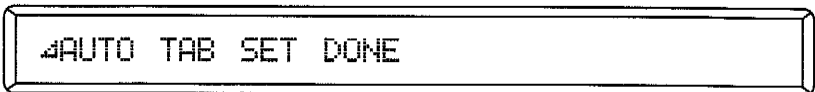

### Note!

All tab set does not work with decimal tabs.

## All Tab Clear

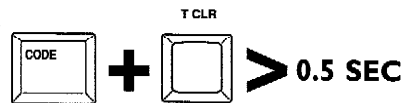

If **[CODE]** + **[T CLR]** is pressed for more than half a second, all tabs will be cleared, and the following message will appear:

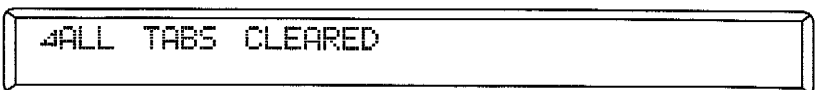

**Note!**

If you have selected paragraph indent mode (as described later) and subsequently clear the paragraph indent tab, the tab will be cleared but the typewriter will remain in paragraph indent mode until it is cancelled by holding down [CODE] and pressing [RETURN].

## Setting The Hot Zone



Use of the hot zone was discussed in the section on selecting typing mode.

To set the hot zone, hold down [ALT] and press the [HZ SET] key until the required setting appears in the display. Each time you press [HZ], the hot zone indication will change in the sequence:

6 → 7 → 8 → 9 → 10 → 11 → 12 → 3 → 4 → 5 → 6

**Note!**

The default setting of the hot zone is 6 characters.



# Text Alignment in TW Mode

The overall layout of your page is determined by the margins, line spacing and typing pitch. Text is normally printed left-aligned or justified, depending on which typing mode is selected. In addition, you may wish to change the layout of the text locally, by right or left aligning it, by centering, or by indenting lines and paragraphs.

## Indentation

Your typewriter can perform both line indentation and paragraph indentation.

### Line Indentation

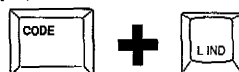

The line indentation function allows you to indent the first line of your paragraphs in one step without spacing or setting a tab. With the carrier at the left margin, hold down the [CODE] key and press the [L IND] key. The carrier will automatically move over five spaces and wait for you to begin typing. Each time you press the [L IND] key, the carrier will move 5 spaces to the right.

#### Note!

When typing on the display, line indent is indicated by five permanent spaces.



### Paragraph Indentation



The paragraph indent function will indent an entire paragraph to the position of the next tab, without you having to use the [TAB] key at the beginning of each line, so you must have at least one tab set to use this function.

To indent a paragraph, hold down the **[CODE]** key and press the **[P IND]** key. The **P IND** indicator will appear in the display, and the carrier will move over to the first tab and wait for you to begin typing. If you want to indent to a tab other than the first tab, continue to press **[CODE] + [P IND]** until the tab is reached, then begin typing.

Thereafter, whenever the carrier return is pressed, the carrier will return to that tab position rather than the left margin.

If you want a subsequent paragraph to be indented even further to the right, hold down the **[CODE]** key and press the **[P IND]** key again.

The number of different paragraph indents you can have is limited only by the number of tabs and the space between the margins.

This paragraph demonstrates line indentation. As you can see, only the first line of this paragraph is indented, and all subsequent lines are aligned to the left margin.

This paragraph demonstrates paragraph indentation. As you can see, the whole of this paragraph is indented to the first tab position.

This paragraph also demonstrates paragraph indentation. As you can see, the whole of this paragraph is indented to the second tab position.

### Notes!

1. If you want to type to the left of the paragraph indent point during the paragraph indent mode, simply use **[BKSP]**, **←** or **[CODE] + [EXPR]** to move the carrier to the place where you want to begin typing. To get back to the paragraph indent point after typing, press the **[RETURN]** key.

### Indent Clear

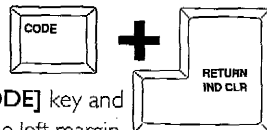

To clear the paragraph indent mode, hold down the **[CODE]** key and press the **[IND CLR]** key. The carrier will now return to the left margin.

## Centering

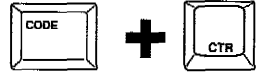

Your typewriter allows you to type three different kinds of centered text:

- centered between the margins.
- centered between adjacent tabs.
- centered around the current position of the carrier.

### Centering Between Margins

To type text centered between margins:

1. Return the carrier to the left margin.
2. Hold down the **[CODE]** key and press the **[CTR]** key. The message **CENTERING** will appear on the top line of the display, and the carrier will move to a position midway between the left and right margins and place the machine in the centering mode.
3. Type in your text. When you type, the characters will not be printed on the page, but will appear on the display, and the carrier will move half a space to the left for every character and space you type. In the expand mode the carrier moves one full space to the left for every character and space you type.
4. When you have finished typing the line, press the **[RETURN]** key to print the line and perform a carrier return. After printing, the machine will leave the centering mode.
5. Centering can also be selected by pressing the **MENU** key, pressing **[1]** to select **CTR/RMF** and pressing **[1]** again to select **CTR**.

### Centering Between Tabs

Centering between tabs allows you to create tables in which the items in a column are aligned centrally above one another, instead of left-aligned, right aligned, or decimal aligned.

To center between tabs:

1. Use the **[TAB]** key to move the carrier to a tab position.
2. Hold down the **[CODE]** key and press the **[CTR]** key, or select centering using the **[MENU]** key.
3. Type in the text as before.
4. Press **[TAB]** to print the text and move to the next tab, or **[RETURN]** to print the text and perform a carrier return. The text will be centered about a point midway between the tab and the next tab to the right.

**Notes!**

1. You cannot center between the left margin and a tab, because centering carried out with the carrier at the left margin is assumed to be centering between margins.
2. You can create as many columns of tab-centered text as you like, up to the limit of 30 tab positions. However, if you try to type text whose width exceeds the distance between the adjacent tabs, the beeper will sound and no further typing will be possible. This prevents the possibility of columns overlapping.

**Centering At The Carrier Position**

To center text around the current carrier position:

1. Move the carrier to the required position.
2. Hold down the [CODE] key and press the [CTR] key, or select centering using the [MENU] key..
3. Type in the text as before and press [TAB] or [RETURN] to print it. It will be centered around the current carrier position.

**Notes!**

1. You cannot center text around the current carrier position at the left margin, or if there is a tab at that position.
2. Text typed on the display in centering mode can be corrected in the same way as normal display typing.
3. To leave the centering mode before any data has been input, pressing [CODE] + [CANCEL] or [CODE] + [CTR] keys will release your typewriter from the centering mode.

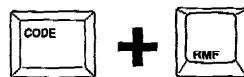
**Right Margin Flush**

Right margin flush automatically aligns text flush with the right margin. To type text right margin flush:

1. Hold down the [CODE] key and press the [RMF] key while the carrier is anywhere to the left of the right margin. The message **RIGHT MARGIN FLUSH** will appear on the top line of the display, and the carrier will move to the right margin.
2. Type in the text. When you type, the characters will not be printed but will appear on the display, and the carrier will move one space to the left for every character you subsequently type (two in the expanded mode).

3. When you have finished typing the line, press the **[TAB]** key or **[RETURN]** key to print the line and perform a carrier return. After printing, the machine will leave the right margin flush mode.

**Notes!**

1. Text typed on the display in right margin flush mode can be corrected in the same way as normal display typing.
2. To leave the right margin flush mode before anything has been typed, pressing **[CODE] + [CANCEL]** or **[CODE] + [RMF]** keys will release your typewriter from the right margin flush mode and relocate the carrier to its previous position.
3. Right margin flush can also be selected by pressing the **MENU** key, pressing **[1]** to select **CTR/RMF** and **[2]** to select **RMF**.



# Text Attributes

*Formatting and text alignment functions change the overall layout of text on the page. This section looks at keys that are used to change the appearance of the actual characters typed. Most of these functions operate in a similar way in WP mode as when typing on the display in TW mode.*

## Shift And Caps Keys

Your typewriter normally prints lower case letters and numerals, plus the punctuation marks and symbols shown on the lower part of other keys. However, you will often want to type upper case letters (for beginning a sentence etc.) and the symbols shown on the upper part of other keys.

The [SHIFT], [SHIFT LOCK] and [CAPS] keys allow you to do this.

### Shift



There are two shift keys, one on each side of the keyboard. If you hold down either of the [SHIFT] keys, you may type upper case letters and the upper characters shown on other keys. Releasing this key automatically returns the keyboard to the lower case mode. The shift keys are generally used if you only want to capitalise the first letter of a word, or for inserting punctuation marks and other symbols.



## Shift lock

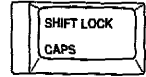

The **SHIFT** function can be locked on by pressing the **[SHIFT LOCK]** key. To return to lower case typing, press either of the **[SHIFT]** keys. In this case, whatever key you press, it will be the upper character on the key that is printed.



TW/WP

## Caps

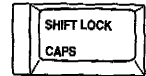

If you want to type upper case letters but want the lower characters on other keys (e.g. numerals), hold down the **[CODE]** key and press the **[CAPS]** key. To return the keyboard to normal mode, press **[CODE]** + **[CAPS]** again.

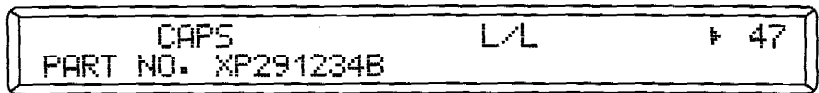

While the keyboard is in **CAPS** mode you can still access the upper characters on non-letter keys by pressing the **[SHIFT]** key or the **[SHIFT LOCK]** key, because the **SHIFT** mode overrides the **CAPS** mode.

Some keys have characters printed on them in green. These characters are printed by holding down the **[CODE]** key and pressing the appropriate character key. A table of these characters is also given in the Appendix at the back of this manual.



## Bold Text

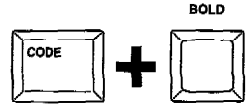

Place your typewriter in the bold typing mode by holding down the [CODE] key and pressing the [BOLD] key until **BLD** appears in the display. All characters subsequently typed will be printed in bold.

Holding down the [ALT] key and pressing the [BOLD] key once again will clear the bold function and return the typewriter to the normal mode.

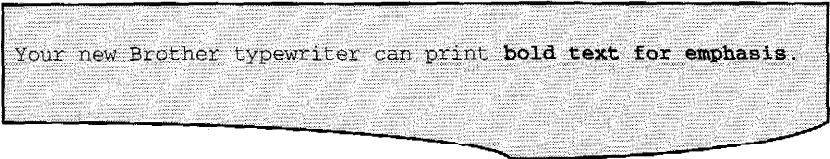

### Notes!

1. The bold function can be performed in the centring, right margin flush, and decimal tab modes.
2. When typing on the display, bold text is indicated by the bold marker alternating with the typed text.

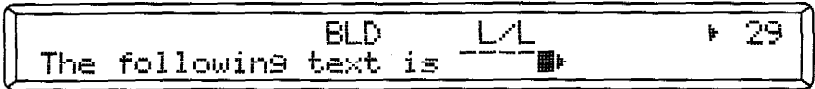

↑  
↓  
bold

## Automatic Underline

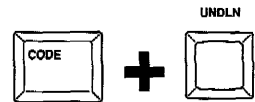

Your typewriter can underline text automatically as you type it, either with a continuous line or word-by-word.

Holding down the [ALT] key and pressing the [UNDLN] key repeatedly cycles through the underline setting in the sequence:-

OFF (no display) → CNT → WRD → OFF

## Continuous Underline

To switch on continuous underlining, hold down the [ALT] key and press the [UNDLN] key until CNT appears in the display. While your typewriter is in this mode, all characters and spaces typed will be underlined.

To cancel continuous underline mode, hold down the [ALT] key and press the [UNDLN] key until there is no underline indicator in the display.

## Word-By-Word Underline

Word-by-word underlining underlines all characters except spaces. To switch on word-by-word underlining, hold down the [ALT] key and press the [UNDLN] key twice, until WRD appears in the display.

To cancel the word-by-word underline mode, hold down the [ALT] key and press the [UNDLN] key once, so that the underline indicator disappears from the display.

TW/WP

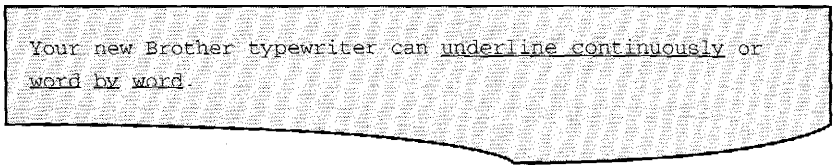

### Notes!

1. The auto underline function can be performed in the centring, right margin flush, and decimal tab modes.
2. When typing on the display, underlined text is indicated by the underline marker alternating with the underlined text.

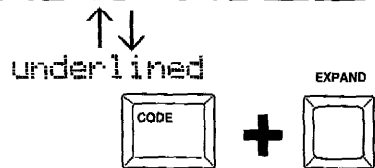
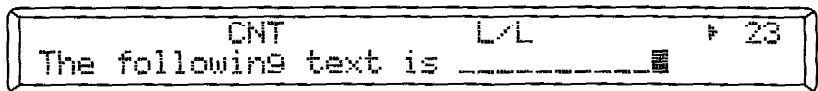

## Expanded Typing

The expand function adds an extra space after each character typed in any pitch. To place your typewriter in the expand mode, hold down the [ALT] key and press the [EXPAND] key, so that EXP appears in the display.

To cancel expanded printing, hold down the **[ALT]** key and press the **[EXPAND]** key once more, so that the **EXP** indicator disappears from the display.

Your typewriter can print expanded text.

### Note!

When typing on the display in **EXPAND** mode, the extra spaces are shown as permanent spaces.



## Subscript And Superscript

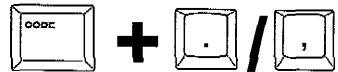

If you have to type mathematical or scientific documents, you may find the need for subscript and superscript characters. These can easily be typed, either on paper or on the display.

### Subscript

To type subscript text, press **[CODE] + [.]** to enter subscript mode. The typing line will move down by 1/12 inch (i.e. the paper will move up).

Type the subscript text, then press **[CODE] + [.]** again to return to normal typing.

### Superscript

Superscript is the reverse of subscript. Press **[CODE] + [,]**, and the typing line will move up by 1/12 inch (i.e. the paper will move down).

Type the superscript text, then press **[CODE] + [,]** to return to normal typing.

With subscript and superscript you can type  $H_2O$  or  $2^3$ .

**Notes!**

1. When typing on the display, the shape of the cursor changes to ■ for superscript and ▣ for subscript. Superscript and subscript text already typed are indicated by the subscript or superscript marker alternating with the text.

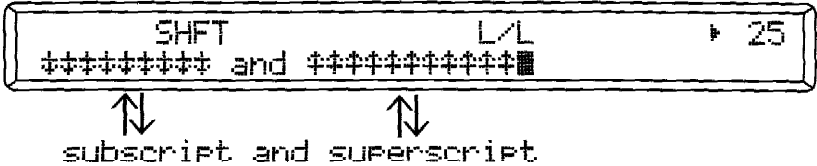

2. In **NORMAL** and **AUTO** typing modes you can have two levels of subscript or superscript by pressing [CODE] + [,] or [CODE] + [.] twice.



You cannot do this in the display typing modes, since only one level of subscript can be shown on the display.

3. Subscript and superscript text can also be bold, underlined and/or expanded.
4. The index and reverse index keys [R INDEX] or [INDEX] are not normally used for subscript and superscript, since holding them down can move the paper continuously. However, if you want the displacement of subscript or superscript characters to be less than 1/12 inch, use them with the [CODE] key ([CODE] + [R INDEX] or [CODE] + [INDEX]) and the vertical movement of the carrier is only 1/48 inch. This does not work when typing on the display.
5. If use of the [R INDEX] or [INDEX] keys moves the platen up or down by more than 1/4 inch, the line correction memory is cleared, since the typewriter cannot return the paper accurately back to its original position for automatic correction.

## Dead Keys

Dead keys are used for diacritical marks (e.g. accents) that may be placed over typed characters. The carrier does not move when a dead key is pressed, so the character beneath the accent can be typed without having to backspace. When a dead key is pressed in the underline mode, the dead key character will not be underlined.

### Note!

When typing on the display, the dead character alternates with the base character. For example `même` is displayed as:

`meme` → `m~me` → `meme`

## Superimposed Characters

On some occasions you may wish to superimpose two characters. For example, you may wish to type a hyphen through a 7 to make a continental-style 7.

It's fairly obvious that you can do this in NORMAL and AUTO modes by backspacing and typing the hyphen on top of the 7.

However, if you try to do this when typing on the display, backspacing deletes the 7.

To get around this:

1. Type the 7.
2. Hold down [CODE] and press [BKSP]. The 7 is not deleted.
3. Type the hyphen.

The 7 and the hyphen will alternate in the display, and both of them will be printed.

`7` → `-` → `7`

## Extra Characters

The extra characters printed in green on the bottom half of some of the keys are typed by holding down the [CODE] key and pressing those keys.

A list of characters accessed by the code key is given in the Appendix.

## Setting Impact

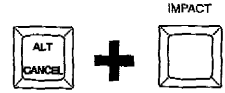

Typing impact may be adjusted according to the quality and thickness of the paper you wish to use, or to the number of carbon copies you are making.

Select the desired impact force by holding down the [ALT] key and pressing [IMPACT] until the required impact setting appears in the display. Each time [IMPACT] is pressed, the IMP display changes in the sequence:

IMP:M → H → L → M

### Notes!

1. Your typewriter is able to make up to 4 carbon copies in addition to the original document.
2. The default setting of impact is Medium.

TW/WP

## Selecting Keyboard



A Prestige 1012 daisy wheel is supplied with your typewriter. However, a wide range of other daisy wheels is available for your typewriter. As well as having different typefaces, some of these daisy wheels have different sets of characters to suit different applications. Your typewriter has three keyboard settings that can be changed at the press of a key to allow it to work properly with commonly-used types of daisy wheel.

For users who frequently wish to type in foreign languages, a wider range of multilingual keyboard settings is available through the SET UP menu, to allow your typewriter to work with many different foreign daisy wheels.

### 1 (Standard)

This is the keyboard that you will probably use most of the time with "ENGLISH" daisy wheels. When an English daisy wheel is used with keyboard 1, the characters shown on the left side of the keytop are printed.

### 2 (International)

This keyboard should be used when an optional "INTERNATIONAL" daisy wheel has been inserted. You may have noticed that some of the keytops have characters printed on the right side as well as on the left. When an international daisy wheel is used and keyboard 2 is selected, these characters are printed instead of the characters shown on the left side of the keytop. A complete table of these extra characters is given in the Appendix.

### 3 (Symbol)

This keyboard is for when you need to type mathematical formulae or equations that require special symbols, using the optional "SYMBOL" daisy wheel. The symbol keyboard layout is shown in Appendix A.

To select the desired keyboard, hold down **[ALT]** and press the **[KB]** key, until the required keyboard setting appears in the display. Each time you press **[KB]**, the KB display will change in the sequence:

KB: 1 → 2 → 3 → 1

**Note!**

The default keyboard setting is keyboard 1.





# Making Corrections

*Making corrections on your typewriter has never been easier. Your typewriter has a two-line correction memory that stores all the characters typed on the current and previous lines in TW mode. This allows you automatically to delete a character, a word, or a whole line of incorrect text, and replace it with correct text. In WP mode you can correct any part of your document.*

Similar correction functions are available in both **TW** and **WP** modes, though the exact way they operate depends on which mode you are using.

If you are typing on the display or using **WP** mode, you can make your corrections before even committing the text to paper. If you are typing in **NORMAL** or **AUTO** modes, you can automatically remove incorrect text with the correction tape, before typing in the correct text.

## Corrections In **NORMAL** And **AUTO** mode

In **NORMAL** and **AUTO** modes, text is printed as you type it, so if you make any mistakes you must remove the old text with the correction ribbon before typing in the new text.

### Character Correction



To correct a character automatically:

1. Use [SPACE], [BKSP], ← or →, [INDEX] or [R INDEX] as required, to move the carriage directly over the incorrect character.

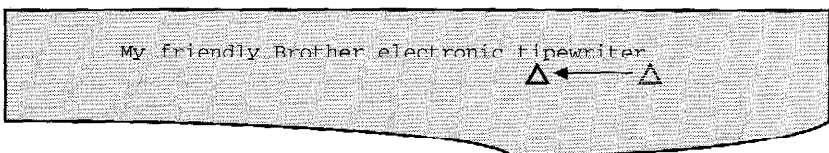

2. Press [CORRECT].

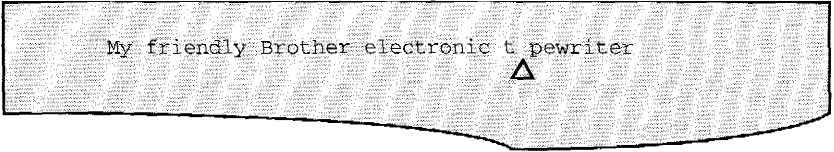

3. If you wish to erase more characters to the left of the one you just erased, press [CORRECT] again.
4. You may type the correct character, or move on as necessary.

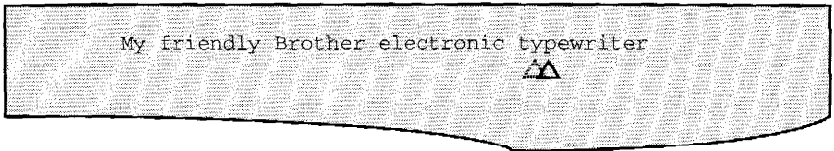

TW/WP

### Notes!

1. The automatic correction function works on bold, subscript, superscript, dead and underlined characters.
2. If you superimpose two characters for any reason, the automatic character correction works only on the second character. The first character should be corrected manually.

## Word Out



The word out function will remove a whole or partial word from your document. To remove a word:

1. Position the carriage on the last character of the word that you wish to delete, or the space after it. If you wish to delete only part of a word, position the carriage on the last character to be deleted.

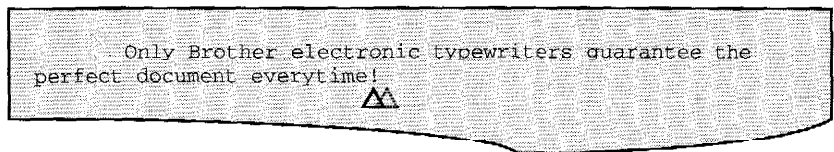

2. Press **[WORD OUT]**. The character at the current carriage position, and everything to the left of it will be erased, until a space between words is reached.

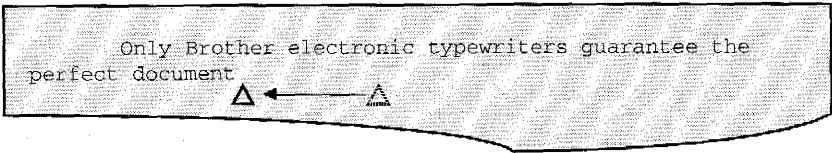

After erasing the word, the carriage will remain at the position of the last character erased, and await your corrected input.

## Line Out

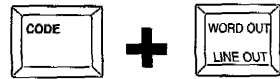

This function allows you to erase all or part of the current or previous typing line. To erase a line:

1. Position the carriage at the end of the line, or on the last character to be erased.

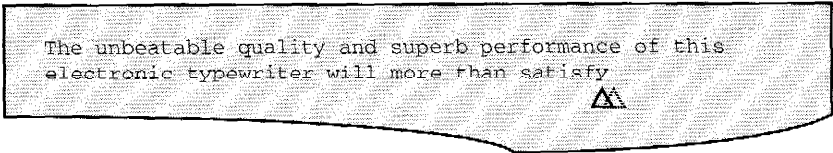

2. Hold down **[CODE]** and press **[LINE OUT]**.

The character at the current carriage position, and everything to the left of it, will be erased.

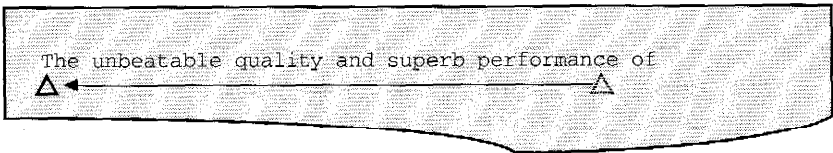

## Insertions And Deletions



Instead of replacing incorrect characters or words with ones having the same number of characters, you may wish to insert extra characters, or delete them, or replace entire words with new ones having more or less characters.

In this case you may find that there is too little space available to make the correction without running into the next word, or too much space so that a big gap is left.

Micro-spacing and backspacing [CODE] + →, [CODE] + ←, [CODE] + [BS I], allow fine adjustment of the spacing of your corrections, so it is not apparent that insertions or deletions have been made.

### Insertions

If you try to insert an extra character into a word, you will be left with no space between it and the next word. You can even this up by moving the whole word half a space to the left, as follows:

1. Use word out to delete the incorrect word.

This electronic typewriter is real typng happiness!



Press [WORD OUT].

This electronic typewriter is real happiness!



2. Hold down [CODE] and press [BS I] or ←. Each time [BS I] is pressed, the carriage moves 1/120 inch to the left. If you move the carriage too far you can use [CODE] + → for fine movement of the carriage to the right.

This electronic typewriter is real  happiness!

The number of times you need to press [BS 1] for a half space depends on the typing pitch.

Pitch	No. of presses
10	6
12 or PS	5
15	4

You may now type in the correct word.

This electronic typewriter is real typing  happiness!

TW/WP

## Deletions

If you try to delete a character from a word, you will be left with an extra space after the word, you can even this up using [BS 1] so that you have one-and-a-half spaces on either side of the word, as follows:

1. Use word out to delete the incorrect word.

This electronic typewriter is reall typing happiness!  ← 

Press [WORD OUT].

This electronic typewriter is  ←  typing happiness!

2. Press [CODE] + → several times to move the carriage half a space to the right. Each time you press [CODE] + →, the carriage will move 1/120 inch to the right.

This electronic typewriter is  typing happiness!

3. Type in the correct word.

This electronic typewriter is real  typing happiness!

The above examples only show the insertion or deletion of a single character. If you wish to insert or delete more than one character, or replace several words with other words, you can use the same principle by deleting several words and using micro-spacing to expand or reduce the spaces between the replacement words.

## Relocation



After finishing your corrections, press [RELOC] to return to your original typing position.

This electronic typewriter is real typing happiness!  \_\_\_\_\_ 

## Manual Correction

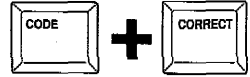

You can only perform automatic correction on the current typing line and the previous line. Manual correction may be performed at any place on the page, as follows:

1. Move the carriage to the character to be corrected using [INDEX], [R INDEX], [SPACEBAR], [BKSP] → or ← as necessary.

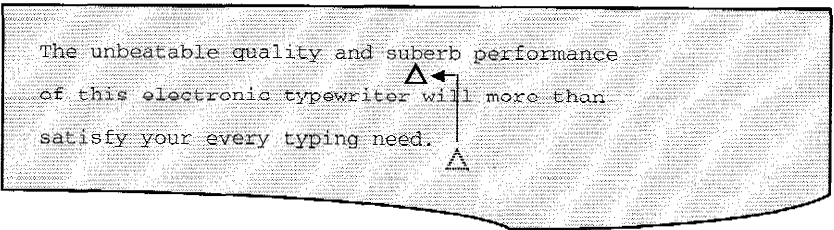

2. Hold down [CODE] and press [CORRECT]. Then press the key for the incorrect character.

That character will be erased and the carriage will remain in that position for you to type in a new character, or move on, as necessary.

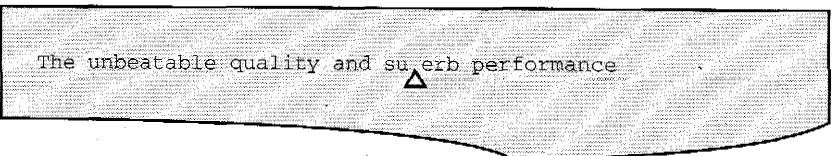

3. Type in the correct character.

The unbeatable quality and superb performance



If you want to correct another character, you must move to that character and use [CODE] + [CORRECT] again.

If you want to make insertions or deletions using manual correction, you can delete entire words, character by character, and adjust the spacing of the new words using micro-spacing, as with automatic correction.

4. After finishing your corrections, use [INDEX], [R INDEX], [SPACEBAR] and [BKSP], as required, to return to your original typing position.

**Notes!**

1. If [SPACE] is pressed after [CORRECT] has been pressed, the correction function is cleared and the carriage will move to the right one space.
2. You cannot use [RELOC] to return to your original typing position after making manual corrections.

TW/WP

## Corrections in L/L, JUSTIFY And WP Modes

When typing on the display, correction is done on the display before the line is printed. In WP mode you can, of course, correct any part of the document at any time.

### Inserting Or Overwriting Text

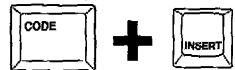

When inserting extra characters or words in display typing, you don't need to worry about making space on the page for the new words, just turn on the **INSERT** function.

When replacing text with new text, you don't have to erase the old text first, you can simply overwrite it if the **INSERT** function is turned off.

### Inserting Text

If you miss out some words or characters it's very easy to insert them as follows:

1. Make sure that **INSERT** is turned on by pressing [CODE] + [INSERT]. The cursor will change from ■ to □, to indicate that insert is turned on.



2. Move the cursor to the position at which you wish to insert the text, and begin typing. The text to the right of the cursor will be pushed along the line as the new text is inserted.

The quick brown  jumps over the lazy dog

Type "[SPACE]fox "

The quick brown fox  jumps over the lazy

### Notes!

1. In **L/L**, **JUSTIFY** and **WP** printing modes, if inserting text pushes the end of the line up to the right margin, the beeper will sound, the keyboard will lock and you cannot type in any more text. Press **[RETURN]** to print the line as it is, or delete some text from the end of the line to make room for more insertions.
2. In **WP** non-printing mode, you can insert as much text as you like.

TW/WP

## Overwriting Text

If you want to overwrite some incorrect text, make sure that the **INSERT** mode is turned off. The cursor change to a solid block. Position the cursor at the position where you wish to overwrite and begin typing. The character(s) beneath the cursor will be replaced with the new character(s) that you type.

The quick brown  en jumps over the lazy

Type "fox"



The quick brown fox jumps over the lazy

**Notes!**

1. If the new text is shorter than the text you are overwriting, you will have to delete any remaining characters of the old text.
2. If the new text is longer than the text you are overwriting, turn on **INSERT** when you get to the end of the old text to insert the remainder of the new text.

## Deleting Incorrect Text

Like **NORMAL** and **AUTO** typing modes, there are three basic ways in which you can delete incorrect text. The only difference is that you do it on the display instead of on paper.

The correction keys work slightly differently from the **NORMAL** and **AUTO** modes. When you press one of the correction keys, the character beneath the cursor position is not deleted, so you must always position the cursor one character to the right of the last character you wish to delete.

TWMP

## Backspace Or Character Correction



When typing on the display, there is really no difference between these two operations. The backspace key also acts as a delete key.

Use the cursor keys to position the cursor one space to the right of the character you wish to delete. Press **[BKSP]** or **[CORRECT]** and the character to the left of the cursor will be deleted. Press **[BKSP]** or **[CORRECT]** again to delete further characters.



The quick brown fox jumps over the lazy

Press **[BKSP]** or **[CORRECT]**.

The quick brown fo jumps over the lazy

You may now type in the correct character(s). (Make sure **INSERT** mode is turned on).

The quick brown fox jumps over the lazy

## Deleting A Word



1. Move the cursor to the space after the last character of the word you wish to delete.

The quick black fox jumps over the lazy

2. Press **[WORD OUT]**. The word will be deleted.

The quick fox jumps over the lazy dog

3. If you want to insert a new word, simply type it in. (Make sure insert mode is turned on).

The quick brown fox jumps over the lazy

4. If you don't want to insert a new word, press **[CORRECT]** or **[BKSP]** to delete the extra space.

If you position the cursor part way through a word, that portion of the word to the left of the cursor will be deleted.

The many useful picDures of this new

Press [WORD OUT].

The many useful Dures of this new

Type in the correct text:

The many useful feaDures of this new

## Deleting A Line



To delete a line or part of a line, position the cursor at the point where you wish the deletion to begin, hold down [CODE] and press [LINE OUT]. Everything on the line to the left of the cursor will be deleted.

The quick brownDfox jumps over the lazy

Press [CODE] + [LINE OUT].

Dfox jumps over the lazy dog

# Framing and Line Drawing

The framing and line drawing function on your typewriter allows you to draw horizontal and vertical lines, and to draw rectangular boxes and tabular grids around text.

## Note!

Framing only works in **NORMAL** or **AUTO** typing modes, not in the display typing modes.

## Horizontal Line Drawing



To draw a horizontal line:

1. Position the carriage where you want the left-hand end of the line to be (A). You can use [SPACE], [TAB], [BKSP], [CODE]+[BS I], ←, →, [CODE]+ ←, [CODE]+ →, [RETURN], [INDEX], [R INDEX], [CODE]+ [INDEX], [CODE]+ [R INDEX], as required, to position it precisely.
2. Press the [FRAME] key. The message **ΔFRAMING** will appear in the display.
3. Move the carriage to the point where you want the right-hand end of the line to be (B), using [SPACE], [TAB], [BKSP], [CODE]+[BS I], ←, →, [CODE]+ ←, [CODE]+ →, as required.
4. Press the [FRAME] key again.

The message: **ΔFRAMING, PRESS RTN TO PRINT** will appear in the display.

5. Press the [RETURN] key and the line will be printed. The carriage will then return to its original position.

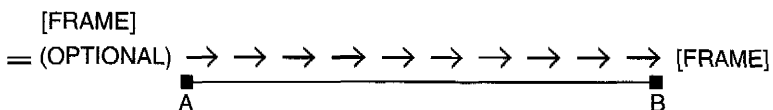

**Note:**

You can draw a double horizontal line if you have keyboard 2 selected and an International daisy wheel fitted, which has the ledger line symbol (=).

You can also draw double lines if you have keyboard 3 selected and a Symbol daisy wheel fitted.

Immediately after pressing the [FRAME] key for the first time, press [=] before moving the carriage to the right. When you press the [FRAME] key again, followed by the [RETURN] key, the line will be printed double.

## Vertical Line Drawing



To draw a vertical line:

1. Position the carriage where you want the top of the line to start (A), using the above keys as required.
2. Press the [FRAME] key. The message ~~FRAMING~~ will appear in the display.
3. Move the carriage to the point where you want the bottom of the line (B), using [[INDEX], [R INDEX], [CODE] + [INDEX], [CODE] + [R INDEX]], as required, to position it precisely.
4. Press the [FRAME] key again, then the [RETURN] key, as before. The line will be printed, and the carriage will then return to its original position.

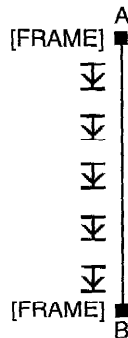

## Drawing A Rectangular Frame



Drawing a simple frame is almost as easy as drawing a line. All you have to do is tell your typewriter where the top-left and bottom right corners of the frame are, and it will do the rest.

1. Begin in the same way as for drawing a line, by moving the carriage to the point where you want the top left corner of the frame (A), and pressing the **[FRAME]** key.

As with drawing a horizontal line, if you want the top line of the frame to be a double line, press **[==]**.

2. Now move the carriage down and to the right, to the point where you want the bottom right corner of the frame (B). In the example, the carriage is shown as moving down first, then to the right, but in fact you can move the carriage down and right in any sequence of steps.

If you want the bottom line of the frame to be a double line, press **[==]**.

3. Press the **[FRAME]** key, followed by the **[RETURN]** key, as before. The frame will be printed, and the carriage will return to the top left-hand corner of the frame.

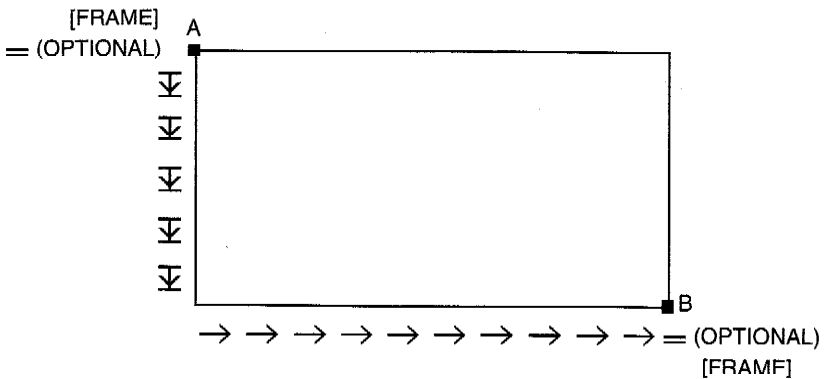

## Drawing A Tabular Grid



In order to draw a tabular grid, your typewriter needs to know, not only the position of the top left and bottom right corners of the frame, but also where the internal, horizontal and vertical lines of the grid will be.

1. Begin in the same way as for drawing a simple frame, by moving the carriage to the point where you want the top left corner of the frame (A), and pressing the [FRAME] key.  
If you want the top line of the frame to be a double line, press [SHIFT] + ==.
2. Now move the carriage down to the position of the first, internal, horizontal line of the grid, (B) and press [SHIFT] + \_ (underline) for a single line, or [SHIFT] + == for a double line.
3. Repeat this procedure for all the horizontal lines of the grid.
4. Now move the carriage right, to the position of the first, internal, vertical line of the grid (E), and press the key for the vertical framing character (|).
5. Repeat the procedure for every (internal) vertical line in the grid.
6. Now move the carriage to the bottom right-hand corner of the grid, and press the [FRAME] key, followed by the [RETURN] key, as before.

The grid will be printed, and the carriage will return to the top left-hand corner of the grid.

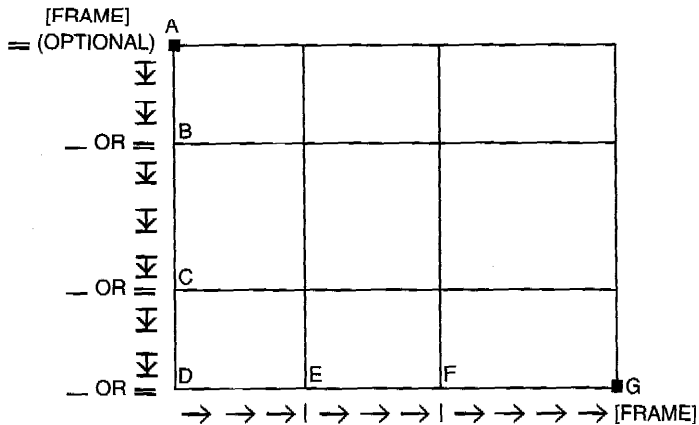



**Notes!**

1. The above examples show only one way to draw frames and tabular grids. If you find it more convenient, you can move the carriage to the right first and define the vertical lines, before moving the carriage down and defining the horizontal lines.
2. The maximum number of horizontal lines in a grid is limited to 70. If you try to set more than this, the beeper will sound.
3. The maximum number of vertical lines in a grid is limited to 30. If you try to set more than this, the beeper will sound.
4. You must use daisywheels with the vertical bar (|) symbol for framing, otherwise vertical lines will be printed as periods.
5. You must use keyboard 2 and an International daisy wheel, or keyboard 3 and a symbol daisy wheel, if you want to use the double ledger line (==) for horizontal lines.
6. Framing only works when the default keyboard is selected for keyboard 1. If you have selected a foreign language keyboard for Keyboard 1 using **SET UP**, framing will not work at all.

**Frames With Complex Shapes**

You may want to draw frames whose shape is not rectangular, or grids where the horizontal and vertical lines do not extend all the way to the edges. For example, you may want a table to have a rectangular box the full width of the table across the top, to accommodate the title.

You can do this by building up the frame as a combination of several smaller frames.



# WORDPROCESSOR

## Basic Wordprocessing

*Although your Brother typewriter can function as an ordinary typewriter, once you have used its wordprocessing features you will probably never want to use it any other way, except for typing very short documents and envelopes.*

### Advantages Of Wordprocessors

You have already seen the advantages of the Line-by-line and Justify modes, which allow you to view and correct a line of text on the screen before you print it.

The wordprocessor mode allows you to create and edit, not just one line of text, but an entire document using the display screen, without doing any printing. Only when the document has been edited and corrected to your satisfaction do you need to commit it to paper.

You can also save documents as files on floppy disk, and re-use or edit them later. A more detailed explanation of files and use of the disk drive is given in the chapter on **File Management**. If you have not used a machine with a disk drive before, we suggest you read that chapter first.

### Using the Wordprocessor

If you are used to using an ordinary typewriter and have never used a wordprocessor, it may take you a little time to become familiar with the wordprocessor features of your Brother typewriter.

However, once you see how easy it is to create perfect documents before committing them to paper, you probably won't want to use your typewriter any other way.

As with using your typewriter in the **TW** mode, don't be afraid to experiment. You cannot damage the typewriter by pressing the wrong keys. The worst that can happen is that you may waste some paper or delete some files from the disk.

## Selecting WP Mode

To use your typewriter as a word processor

1. It's a good idea to have a disk in the disk drive, for saving your document on later. However, you can use the wordprocessor without a disk in the drive.

If the disk has not been used before, you may get the following message:

```
ΔINITIALIZE? Y/N
```

Press **[Y]** to initialize the disk. This may take a few minutes.

2. Press the **[2]** key to select **WP** from the **MAIN MENU** screen.

```
<<MAIN MENU>>  
1:TW 2:WP 3:F TYPE 4:FILE MANAGEMENT
```

The following WP index screen will appear:

```
<<WP INDEX>>                REMAIN: 726.0K  
■NEWFILE-N                    *NEWFILE-P
```

This screen tells you how many thousand (K) characters of space are left on the disk, and gives you the option of creating a new file in either printing or non-printing mode. (**NEWFILE.P** or **NEWFILE.N**)

**NEWFILE** is simply a blank file in which you can create a new document. When saving your document after creating it, you will need to give it a different file name.

## Printing Mode

Printing mode is almost identical to typing on the display in **TW** mode. You type, correct and print your document one line at a time, and the only difference is that what you print is also stored in memory, so that you can save the document on disk and use it again.

### Note!

In printing mode, it is not possible to go back and edit a previous line of text once it has been printed. If you want to do this, you must save the file and recall it from disk in **EDIT** mode.

## Non-Printing Mode

For most word processor work you will probably want to use non-printing mode. In non-printing mode you create the entire document before you print it. You can move backwards and forwards through the document as you wish, editing and making corrections.

If the disk has been used before and there are files already on it, you can view these by using the cursor keys to scroll the display.

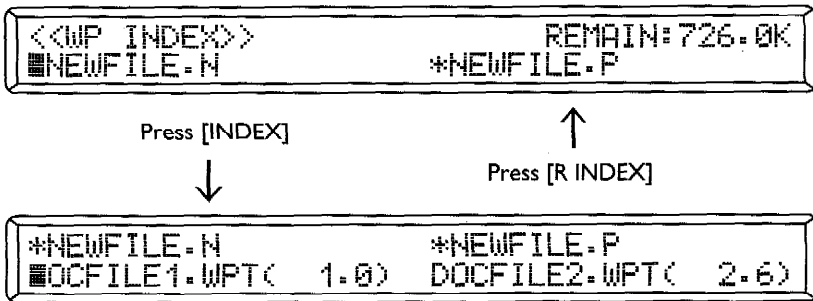

The first 8 characters are the file name, and the 3 characters after the point are called the filename extension, which tells the typewriter what kind of files these are. The file name and its extension are simply a label that allow you, and the typewriter, to find and identify your documents on the disk.

File names with an extension **.WPT** are Brother wordprocessor files.

## Creating Or Editing A Document

To begin a new document file, position the cursor on **NEWFILE.P** or **NEWFILE.N**. If you wish to edit an existing document, position the cursor on the file name of that document. Now press the **[RETURN]** key, and the following display will appear:

```
*NEWFILE.N                                REMAIN:32.4K  
┌ ────
```

If you chose to edit an existing file, the name of that file will appear in the top left corner of the display, if not **\*NEWFILE** will appear in the display. The memory indicator in the top right corner of the display now shows the number of characters remaining in the typewriter's memory (not on the disk). The maximum number of characters you can have in a single file is around 32400.

You may now begin typing.

```
*NEWFILE.N                                REMAIN:32.4K  
┌ The quick brown fox jumps over ────
```

## Saving Your Document

When you have finished creating your document, you may wish to save it on disk.

So far you haven't got much of a document to save, but it's a good idea to learn how to do it now.

To save your document:

1. Press the **[FILE]** key, and the following message will appear:

```
┌PRESS RTN- TO SAVE, CORRECT TO ABANDON
```

2. Press the **[RETURN]** key to confirm that you wish to save the document.

Alternatively, you may decide that the document is not worth saving. For example, a short note that you have printed and no longer need.

If you decide that you do not wish to save the document, press the [CORRECT] key to abandon it and return to the WP INDEX screen.

If you press [RETURN], the following message will appear:

```

┌TYPE FILENAME AND PRESS RTN.
FILENAME: █ .WPT
  
```

3. Type in the file name under which you wish to save your document.

The filename can be up to 8 characters long, and only letters and numerals are valid. All letters typed will appear as upper case, even if you type in lower case, for example:

```

┌TYPE FILENAME AND PRESS RTN.
FILENAME: FOX123█ .WPT
  
```

4. Press [RETURN].

The following message will appear:

```

┌PLEASE WAIT....
FILENAME: FOX123█ .WPT
  
```

If a file with the same name already exists on the disk (which will always be the case when editing an existing file), a warning message will appear:

```

┌FILEN EXISTS. PRESS RTN TO OVERWRITE
FILENAME: FOX123█ .WPT
  
```

Press [RETURN] if you wish to replace the existing file. Otherwise, type in a different file name and press [RETURN].

After the file has been saved, the display will return to the WP INDEX screen, so that you can create a new file or choose a different one to edit.

## Auto Save

The document you are creating or editing remains in your typewriter's memory only as long as the power is switched on. However, power failures can occur, and it can be very frustrating if you lose several hours' work when workmen dig through a cable outside your home or office.

To minimize losses during power failures, your typewriter has an auto save function that saves your document as an **AUTO SAVE FILE** on disk after every 2000 characters that you type. This means that the most text you can lose is 1999 characters, which is typically less than half a page (depending on margins, pitch and line spacing).

When you save the document in the normal way, the auto save file is deleted.

## Recovering An Auto Save File

When you switch on your typewriter with a disk inserted in the drive, it checks if there is an **AUTO SAVE FILE** on the disk. If there is, the following message appears:



```
^POWER FAILURE...RECOVER AUTO SAVE FILE?  
PRESS RTN OR CANCEL.
```

If you press **[RETURN]**, the **AUTO SAVE FILE** will be loaded into memory, and you can edit if required, then save it as a normal file.

If you press **[CODE] + [CANCEL]**, the auto save file will be deleted.

## The Wordprocessor Screen

The previous section showed you how to select **WP** mode, create a simple, one-line document and save it. When you start to create longer documents, you will need to know how to find your way around the document.

You can think of the machine's memory as a large page on which your document is typed, and the display screen as a (small) window which gives you a view onto part of that page.



Of course, the document can be many lines long, and up to 180 characters wide (in 15 pitch typing), whereas your display screen is only 2 lines high and 40 characters wide. Therefore, you will need to move the screen window up and down, and possibly from side-to-side, in order to view all of the document two lines (or part lines) at a time.

## Moving Around The Page

To move the display window around you will use the cursor keys ( $\leftarrow$   $\rightarrow$  [R INDEX][INDEX]).

In the section on the **TW** mode, you already learned how to use the  $\leftarrow$  and  $\rightarrow$  keys to move the cursor left and right along the line in the Line-by-line and Justify modes, and how the display will scroll to left and right if the text is too long to fit in the display.

The only difference in the **WP** mode is that the display can show two lines of text at once, the line you are working on and the line above it.

The bottom line of the display is the active line on which you will type and edit text. You can move the cursor along the bottom line and scroll this line of text to left and right.

## Moving Up And Down The Page

In the **WP** mode, you will also use the [R INDEX] and [INDEX] keys to move up and down the page. When you press the [INDEX] key to move down the page, the bottom line of text moves up to the top line of the display, and the line below (that you couldn't see) appears on the bottom line. Similarly, when you press the [R INDEX] key to move up the page, the top line of text moves down to the bottom line, and line above that (which you couldn't see) appears on the top line.

## Moving Across The Page

To move across the page without changing the text, you use the left and right cursor keys  $\leftarrow$  and  $\rightarrow$ .

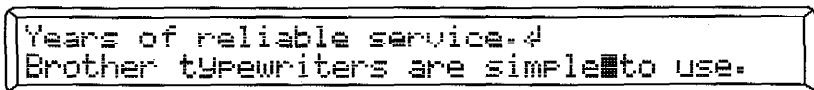

```
Years of reliable service.␣
Brother typewriters are simple to use.
```

When you press the  $\leftarrow$  key, the cursor (█) will move to the left of the screen.

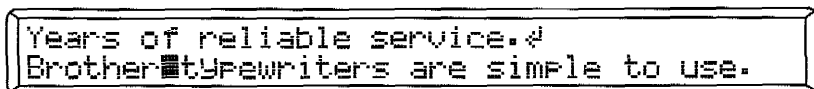

```
Years of reliable service.␣
Brother█typewriters are simple to use.
```

If there is undisplayed text off the left of the screen, the display will scroll to the right when the cursor reaches a point five characters from the left edge of the screen.

```
Years of reliable service.↵  
Broth■er typewriters are simple to use.
```

Press ←.

```
Years of reliable service.↵  
Broth■er typewriters are simple to use.
```

When you press the → key, the cursor will move to the right of the screen.

When the cursor reaches a position five characters before the right-hand edge of the screen, the display will scroll to the left.

```
Give you many years of reliable service  
soon find that Brother typewriters■are s
```

Press →.

```
You many years of reliable service.↵  
find that Brother typewriters ■re simpl
```

## Layout Indicators

You can lay out your document on the screen in **WP** mode, using all the same functions as in typewriter mode. To help you do this, there are a number of special characters that will appear in the text when you perform different functions. Some of these have already been used in **TW** mode. They are briefly described in the following table, and more detailed explanations are given later in the text.

INDICATOR	MEANING
↵	A paragraph end or carriage return indicator. This appears when you press the [RETURN] key and indicates the end of a paragraph.
↵	Indent clear. This appears when you press [CODE] + [RETURN] in paragraph indent mode, and indicates the end of paragraph indent mode*.
¶	Paragraph Indent. This appears at the beginning of a paragraph when you press [CODE] + [P IND] and indicates the start of paragraph indentation.
+	Normal Tab Marker. Indicates that the following text is aligned to a tab.
␣	Right Aligned Indicator. Indicates that the following text is right aligned.
␣	Centered Marker. Indicates that the following text is centered between the margins.
␣	Tab Centered Marker. Indicates that the following text is centered between tabs.
≡	Stop Code. Stops printing of a document at the point where the stop code is inserted in the text, allowing you to insert additional text before continuing.
⏏	Page Break Marker. Indicates the position of a page break.
␣	Permanent Space.
␣	Line Indent. Shown as five permanent spaces.
⊕ and ⊖	Subscript and Superscript indicators. Alternate with the text to be sub- or superscript. e.g. "H <sub>2</sub> O and 2 <sup>3</sup> " is shown as: H2O and 23 → H⊕O and 2⊖ → H2O and 23
␣	Bold Indicator. Alternates with the text to be bold e.g. Page is shown as: Page → ␣ → Page

INDICATOR	MEANING
_	Underline. Alternates with the text to be underlined e.g. <u>Page</u> is shown as <b>Page</b> → _____ → <b>Page</b>
...	Ghost Hyphen. A hyphen typed in the hot zone to hyphenate a word and force a line break is a ghost hyphen. It will disappear if reformatting allows the whole word to fit on one line.
¶	A format change marker. This indicates a change in formatting, and indicates the position of hidden code characters that define paragraph formatting (margins, tabs, pitch, line spacing, hot zone, justification). A format change marker can only appear at the beginning of a paragraph, and affects that paragraph and all subsequent paragraphs until a new format marker is reached.

**Note!**

A paragraph is defined as a block of text which starts after a [¶] or [↵] at the end of the previous paragraph, or a page break, and whose end is similarly defined.

## Typing In WP Mode

Typing in **WP** mode is similar to typing on the display in **TW** mode, except that you can type many lines of text and edit them before printing. The main difference is what happens when you reach the end of a line.

## Word Wrap

The word wrap function allows you to type continuously without worrying about what happens when you reach the end of a line. If you type a space or hyphen in the hot zone, then the cursor will move to the beginning of a new line. This is similar to auto carriage return in **AUTO**, **L/L** and **JUSTIFY** typing modes.

However, even if you type a word that would extend right across the hot zone and beyond the right margin, you do not need to worry about pressing the hyphen key or carriage return to split the word. The entire word will be moved automatically to the beginning of the next line.

## Adding Text To A File In Printing Mode

When you select an existing file for editing, it is normally edited in non-printing mode. It is not possible to edit a file in printing mode, but you can add text to the end of a file and print the new text at the same time. This can be useful if you want to add a postscript to a letter, for example. You can print the postscript at the bottom of the letter and add the extra text to the file at the same time.

To add text to an existing file in printing mode:

1. Make sure the page to which you wish to add the text is correctly positioned in the typewriter.
2. Select the file to be edited from the **WP INDEX** screen.
3. Press **[CODE] + FILE**. The cursor will move to the end of the text, and you can type in and print your additional text in exactly the same way as **NEWFILE.P** mode.

When you save the file, the text you added will also be saved.

## Switching Back To TW Mode Or MAIN MENU

If you are in the middle of wordprocessing a document and want to type something else such as an envelope or a short memo, you don't have to abandon what you are doing. Simply press the **[TYPE]** key to switch to **TW** mode, do your typing, then press the **[TYPE]** key again to switch back to **WP** mode at the point where you left off.

If you want to quit wordprocessing and select another option, you can switch back to the **MAIN MENU** from the **WP INDEX** screen by pressing the **[FILE]** key. If you wish to switch back to the **MAIN MENU** while creating or editing a document, you must first save your file as discussed before, as you cannot select form typing or file management with a document still open. After saving the file, press the **[FILE]** key again to return to the **MAIN MENU**.

### Note!

1. You cannot use **[TYPE]** to switch from **TW** mode to **WP** mode unless **WP** mode has already been selected from the **MAIN MENU**.



# Formatting Your Document

*Before you start creating your document, you may wish to set various format functions, such as margins and tabs, to define the overall layout of your document.*

*However, you do not have to do this, as you can re-format all or part of the document later before printing. In many cases you may find it more convenient to type in the text first, and worry about creating an attractive layout later.*

When using your machine as a typewriter, you learned how to set margins, tabs, and other formatting items, to define the layout of your documents. In typewriter or WP printing mode you can change these as often as you wish (each line if you like) as you type a document, and the new format you set cannot affect what has previously been printed.

In the non-printing **WP** mode, the situation is a little different. Since you create the document before printing it, any format changes you make must be stored in the document so that your text prints out with the correct layout. Whenever you make a format change in WP mode, a marker [P ] is inserted at the beginning of the paragraph in the extreme left hand position on the display. This indicates the position of hidden code characters (not shown on the screen), that define the formatting for that entire paragraph, and all subsequent paragraphs until the format is changed again. You cannot move the cursor to this position.

## **Justification In WP Mode**

In **TW** or **WP** printing mode, each line of text is justified as it is printed, if justification is switched on.

In **WP** non-printing mode, since text is not printed as it is typed, the status of justification must be stored in the format marker like any other formatting information.

If you turn on the justify function, each line of text will be justified on-screen when the cursor moves onto the next line. If you do not have the justify function turned on, your text will be left-aligned.

**Note!**

Lines ended by pressing the **[RETURN]** key are not justified.

## The Format Menu

Format changes in **WP** mode are made using the **FORMAT MENU**. This allows you to:

- select a new format from one of the five format memories, although you cannot change the contents of these memories in **WP** mode, only in **TW** mode.
- change the information contained in an existing format marker, or create a new one.
- delete an existing format marker, in which case the paragraph takes the format of the preceding paragraph.

**Note!**

A paragraph is defined as a block of text whose start is defined by a carriage return (↵), an indent clear symbol (⇐), or a page break symbol (⌘), and whose end is similarly defined, for example:

```
Your new Brother typewriter.↵  
This block of text between two carriage  
returns is a paragraph.↵
```

A format marker only appears at the beginning of the first line of a paragraph and defines the formatting for the whole paragraph. A format marker cannot appear in the middle of a paragraph.

To change the formatting of a paragraph or paragraphs, you can select one of the five stored formats from memory. You can also change the contents of a format marker, or delete a format marker from a paragraph, so that it reverts to the format of the previous paragraph.



When you first select the W/P mode, the selected format will be the one that you last used. If you wish to choose a different format, change the format memory, or delete a format marker, proceed as follows:

1. First make sure that the cursor is positioned on the first character of the paragraph where you wish to make the format change. If you want to change or delete an existing format, there should be a format marker on this line.
2. Hold down the **[ALT]** key and press the **[FORMAT]** key.

The following menu will appear.

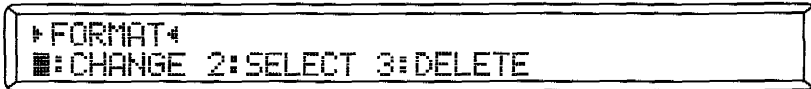

This menu gives you the option of changing the currently selected format, choosing a different format, or deleting the format.

## Changing The Format

To change the current format:

1. Press the **[I]** key, and the following message will appear:



You can set margins and tabs in exactly the same way as in the typewriter mode, by moving the carriage with **[SPACE]** and **[BKSP]** keys and using the **[L MAR]**, **[R MAR]**, **[M REL]**, **[T SET]**, and **[DT SET]** keys.

Similarly, you can set the typing pitch, line spacing, hot zone and justification, using **[CODE]** plus the appropriate function key.

When you have finished changing the format, press the **[RETURN]** key, and the display will return to the W/P editing screen. If there was an existing format marker at the beginning of the paragraph, its contents will have been changed. If there was no format marker, a new one will be inserted.

## Selecting A Format

To select a preset format from one of the five format memories:

1. Press the [2] key and the following message will appear.

```
▶MOVE █ TO SELECT. PRESS RTN-  
FORMAT: █ 2 3 4 5
```

Use the cursor keys to select the format that you want, then press the [RETURN] key. If there was an existing format marker at the beginning of the paragraph, its contents will be replaced by the contents of the format memory. If there was no format marker a new one will be inserted.

### Note!

Justification information is not stored in the line format memories. If you wish to set justification on or off you should do this using the **CHANGE** option either before or after selecting the new format.

## Deleting A Format

If you want to delete a format:

1. Position the cursor on the line where the format marker which is to be deleted appears.
2. Press [ALT] + [FORMAT] to select the **FORMAT MENU**.
3. Press the [3] key followed by the [RETURN] key to select **DELETE** from the **FORMAT MENU**.

The following message will appear:

```
▶DELETE FORMAT CODE Y/N?  
▶█he many features of this new Brother t
```

Press the [Y] key to delete the format marker, or the [N] key to cancel the operation.

When a format marker is deleted, all paragraphs controlled by it will assume the format of the previous paragraph.

**Note!**

You cannot delete the first format marker in a document, since the first paragraph must always have a format marker.

**Checking The Format And Status**

You can check the formatting of a paragraph and the machine status at any time by pressing the **[ALT]** key, when the following display will appear.

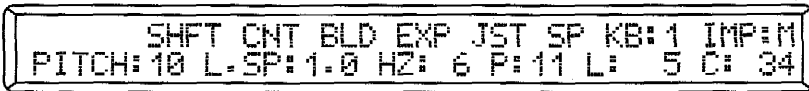

This display shows the status of various functions, in the same way as in **TW** mode. However, the pitch, line spacing, hot zone and justification indicators show you the contents of the format marker for the current paragraph. If you move the cursor to a paragraph with a different format and press **[ALT]** again, some of these indicators may change.

The status screen also shows the position of the cursor in the document, giving page number (P), line (L) and column (C).

**Page Format**

The page format function allows you to define the overall layout of the page.

You can define:

- Paper size
- Header and footer text to be printed at the top and bottom of each page, with automatic page numbering.
- Top margin between the top of the page and the header.
- Top space between the header and the beginning of the text.
- Bottom space between the bottom of the text and the footer.
- Bottom margin between the footer and the bottom of the paper.

To define the page format:

1. Press the [MENU] key to get the WP MENU.



2. Press [4] to select the FORM MENU.

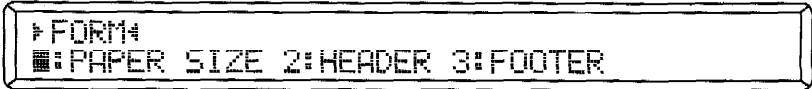

You now have the choice of setting the paper size and top/bottom margins, or entering a header or footer text.

## Setting The Paper Size

To set the paper size and margins:

1. Press [1].



2. Enter the length of the paper in lines (0 to 999), then use the [INDEX] and [R INDEX] keys to view the following items.

```

TOP MARGIN:      6
(HEADER         0)
TOP SPACE:       0
BOTTOM SPACE:    0
(FOOTER         0)
BOTTOM MARGIN:   6

```

The numbers shown are the default settings. They may be different if the page format of the document has been set previously.

You can enter values from 0 to 99 lines for everything except the header, footer, and the text area. The header and footer are either 0 or 1 line depending on whether header/footer text is entered or not, and the area available for text is calculated automatically from the other settings.

If the total value of:

top margin + header + top space + bottom space + footer + bottom margin  
exceeds the page length, the following error message will appear:



3. When you have finished press **[RETURN]** to save the setting and return to the **WP** edit screen.

## Entering Header Or Footer Text

To enter a header or footer text:

1. Press either **[2]** or **[3]** to select **HEADER** or **FOOTER** from the **FORM MENU**. Thereafter the procedure is the same for both.

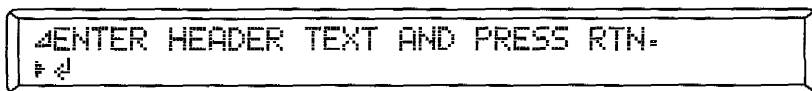

2. Type in the header or the footer text and press **[RETURN]**.

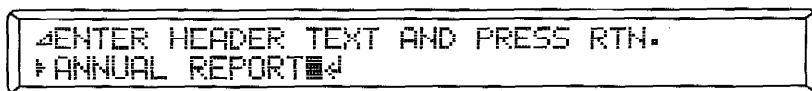

3. If you want the header or footer to include a page number that increments automatically, include the page number from which you wish the auto-numbering to begin, inside double quotation marks, as part of the header or footer text, e.g.

```
ENTER HEADER TEXT AND PRESS RTN.  
Monthly Report May 1993 - PAGE "31"
```

The quotation marks are not printed.

The page numbering can begin with any number from 0 to 9999. This can be useful if you are typing a document with several chapters stored in several WVP files, and you want chapter 2 to begin at page 31, for example.

You can also mix left aligned text and right margin flush text to create attractive headers and footers, for example:

```
ENTER HEADER TEXT AND PRESS RTN.  
Brother Annual Report - Page "31"
```

Brother Annual Report Page 31

## Page Breaks

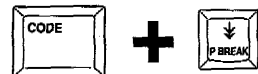

The page format menu sets up automatic page breaks at regular intervals in the text, depending on the text area set. However, you may want to force a page break at a particular point in your text before the normal page end, for example, if you have just finished a chapter and wish to begin a new one.

In this case you can insert a page break marker (↵) by holding down the [CODE] key and pressing the [P BREAK] key.

The page break marker will appear at the end of the last line on the page, and a continuous line will appear all the way across the top of the display on the following page (this line is not printed on the paper).

many useful features.  
 typewriters are simple to use.▸

-----  
 █

**Note!**

Page break also ends a paragraph, so if you want to insert a page break at the end of a paragraph, use **[CODE] + [P BREAK]** to end the paragraph instead of **[RETURN]**. If you add a page break after a carriage return you will get an extra blank line at the bottom of the page.

**Using GO TO**

The **GO TO** key provides an easy way to jump to a different page in a multi-page document. To use the **GO TO** function:

1. Press **[CODE] + [GO TO]**. The following message will appear.

▴TYPE NUMBER AND PRESS RTN.  
 PAGE: █

2. Type in the page number that you wish to jump to, and press **[RETURN]**.

The display will jump to the start of that page. The default value is 1, so if you want to jump to the start of the document, simply press **[RETURN]** without typing a number.

If you want to jump to the last page of the document, but cannot remember the number of pages, simply type in 999 or any number greater than the number of pages, and the display will jump to the start of the last page.





# Text Alignment in WP Mode

*Text alignment in WP mode works in a similar way to TW mode. The default alignment of text in a paragraph can be left aligned or justified dependent on whether justification is switched on, while centering and right margin flush can be applied to text on a line-by-line basis using [CODE] + [L IND], [CODE] + [CTR] or [CODE] + [RMF], just as in TW mode.*

The difference in text alignment between WP and TW modes is that in TW mode the text is printed as, or immediately after, it is typed, so the fact that it was indented, centered or right margin flush does not have to be remembered later. In WP (non-printing) mode your document is not printed until after it is created, so special markers are inserted in the file to tell the machine (and remind you) what the alignment is. Left alignment or justification forms part of the formatting information that determines overall paragraph alignment, while centering and right-margin flush markers are inserted in the text.

## Line Indentation

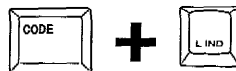

Line indentation in **WP** mode works exactly the same as in **TW** mode. The indentation is indicated by five permanent spaces.

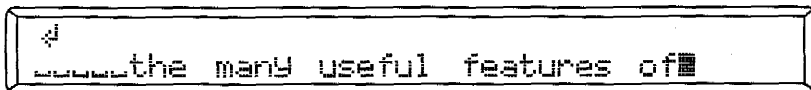

## Paragraph Indentation



Paragraph indentation in **WP** mode is indicated by a paragraph indent marker at the start of the indented paragraph.



Paragraph indentation is ended using [CODE] + [IND CLR] and is indicated by an indent clear marker instead of the usual carriage return symbol.

```
pewriter make typing really easy.¶
```

## Centering In WP Mode

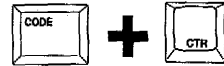

Text can be centered between the margins, at the current cursor position, or between tabs.

### Centering Between The Margins

To center text between the margins:

1. Make sure the cursor is on the left margin, hold down the [CODE] key and press [CTR].

The centering marker  $\bar{C}$  will appear, and you can type your text, which will be centered as it is typed.

### Centering Between Tabs

To center text between tabs:

1. Press the [TAB] key one or more times, to move the cursor to the required tab position.
2. Hold down the [CODE] key and press the [CTR] key.

The centering marker  $\bar{T}$  will appear, to indicate centering between tabs, and you can type your text, which will be centered about a point halfway between the current tab position and the next tab.

#### Notes!

1. If the text is longer than the distance between the two tabs, the beeper will sound.
2. You cannot center between the left margin and the first tab position, since centering selected at the left margin is automatically assumed to be between the margins.
3. You cannot center about the current cursor position, unlike centering about current carriage position in TW mode.

## Right Margin Flush

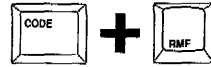

To align text to the right margin:

1. Hold down the [CODE] key and press the [RMF] key.

The right margin flush marker ¶ will appear, and you can type in your text, which will be aligned to the right margin on the screen.

## Inserting Alignment Markers After Typing

You can insert alignment markers for centering or right margin flush after you have typed your text. It is quite possible to have text left-aligned, centered between tabs and right margin flush on the same line.

## Hyphenation In WP Mode

Hyphens typed in TW mode only affect the current typing line, and have no effect after it has been printed. In WP mode, a word that you hyphenated at the end of a line may not need hyphenation if you re-format the document. Different types of wordprocessors handle hyphenation of words in different ways, so it is important to understand how hyphenation works in your Brother wordprocessor.

Typing a hyphen in the hot zone in WP (non-printing) mode automatically ends the line and moves the cursor to a new line, just like in TW mode. Such hyphens are known as ghost hyphens and are indicated as dotted (···). If subsequent text editing moves a hyphenated word out of the hot zone, the hyphen will disappear and the two halves of the word will join together.

Certain phrases such as "mother-in-law" always require hyphens and should not be split over two lines. These type of hyphens are known as "permanent" or "non-breaking" hyphens, since they will not disappear during re-formatting and do not cause a line break. A permanent hyphen is treated just like any other character that forms part of a word.

A word containing a permanent hyphen will not split at the hyphen, but will always wrap to the next line if it reaches the right margin.

All hyphens typed outside the hot zone are permanent, but if you wish to type a permanent hyphen in the hot zone you must hold down the [CODE] key and press the [PHY] key.

Examples:

If you do not use a permanent hyphen you can get:

```
s not get on well with his mother...
in-law
```

This may become:

after reformatting

```
John does not get on well with his
motherin-law
```

If you use permanent hyphens you won't get the phrase split over two lines.

```
s not get on well with his mother
```

Type [CODE] + [P HY]

```
s not get on well with his mother-
```

A permanent hyphen in the hot zone does not cause a line break.

Type "in"

```
not get on well with his mother-i
```

When the text reaches the right margin the whole word moves to the next line.

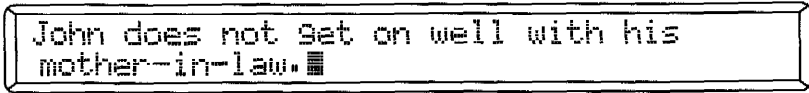

John does not get on well with his  
mother-in-law. █

## Permanent Spaces In WP Mode

A permanent space works just like a permanent hyphen, or any other character. It is typed using [CODE] + [SPACE].



# Block Operations

*Block operations allow you to perform a number of different operations on any chosen area of text, which can be as small as a single character or as large as the entire document. Block operations are one of the most powerful features of the WP (non-printing) mode.*

Using block operations, you can:

- move a block of text to a different part of the document.
- copy a block of text one or more times to a different part of the document, or even to a different document.
- delete a block of text.

## Copying A Block

To copy a block of text to a different location within the document:

1. Position the cursor on the first character of the block you wish to copy.



```
many years of reliable service.
My new Brother electronic typewriter is
```

2. Press the [MENU] key to bring up the WP MENU.



```
▶ MENU
■:BLOCK 2:ABBR 3:SEARCH 4:FORM 5:SPELL
```

3. Press the [1] key to select block operations, and the BLOCK menu will appear.



4. Press the [1] key to select copy, and the following message will appear:

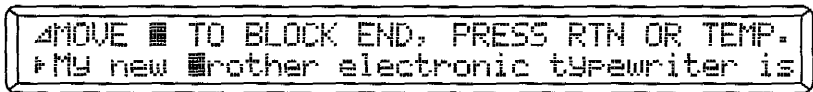

**Shortcut Hint!**

You can bypass steps 2, 3 and 4 by pressing [CODE] + [C] to go straight to the above message.

5. Move the cursor to the end of the block. As you do so, the block will be highlighted.

**Note!**

The block includes only those characters under the flashing checkerboard pattern. It does not include the character under the cursor.



6. When the block has been highlighted, press the [RETURN] key if you wish to copy the block to another part of this document.

The following message will appear:





7. Move the cursor to the position at which you wish the text block to be inserted.

**Note!**

The last character of the block will be inserted one character to the left of the cursor position.

```
will find it very easy to use.↵
This ␣wewriter has many useful features
```

8. Now press the [RETURN] key. The text will be inserted.

```
will find it very easy to use.↵
This Brother electronic ␣wewriter has
```

**Notes!**

1. The block is always inserted into the text, even if insert mode is turned off, so it will never overwrite text at the destination position.
2. Since copying increases the size of your document, you may run out of memory if the memory is nearly full, and the following message will appear:

```
␣MEMORY FULL.
```

## Temporary Memory

You can think of the temporary memory as a clipboard on which you can place text for later use. Temporary memory is useful if you want to copy a block of text from one document and use it later in another document, or if you want to copy the same block of text to several different places in a document. (The normal copy function only allows you to make one copy).

To copy text to temporary memory, after you have highlighted the block, press [CODE] + [TEMP] instead of [RETURN]. The text will be copied to temporary memory and can be retrieved for later use in this or another document.

## Copying Text From Temporary Memory

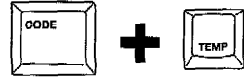

To copy text from temporary memory into a document:

1. Position the cursor at the place where you wish the text to be inserted.

```
will find it very easy to use.¶
This ■pewriter has many useful features
```

2. Hold down the [CODE] key and press the [TEMP] key. The following message will be displayed.

```
¶TO RECALL TEMPORARY FILE PRESS RTN.
This ■pewriter has many useful feature
```

3. Press the [RETURN] key. The text from temporary memory will be inserted at the cursor position.

```
will find it very easy to use.¶
This new Brother electronic ■pewriter h
```

### Notes!

1. You can copy the same block of text from the temporary memory as many times as you wish. It will remain in the temporary memory until it is replaced with a new block of text.
2. Up to 4000 characters can be stored in temporary memory.

## Moving A Block

The procedure for moving a block of text is almost identical to that for copying, except that you select **MOVE** instead of **COPY** from the **BLOCK** menu. As a shortcut, you can press [CODE] + [E], instead of going through the menu, to select the block move function.

After selecting the **MOVE** function from the **BLOCK** menu, the sequence of operations is exactly the same. The only difference is that the **COPY** function leaves the original text where it is, but the **MOVE** function deletes the text from its original location and moves it to the new location.

### Notes!

1. The block is always inserted into the text, even if insert mode is turned off, so it will never overwrite text at the destination position.
2. The temporary memory option is not available in the **MOVE** function. You can only copy text to temporary memory, not move it.

## Deleting A Block

Selecting a block of text to be deleted is just the same as selecting a block to be move or copied, except that **DELETE** is selected from the **BLOCK MENU** instead of **COPY** or **MOVE**. As a shortcut, you can press **[CODE] + [D]**, instead of going through the menu, to select the block delete function.

After selecting the block to delete, you will be asked for confirmation, to minimize the possibility of a mistake:



```

DELETE? Y/N
This ***** [ ] Wpewriter
  
```

Press **[Y]** to confirm the deletion or **[N]** to abort the operation.

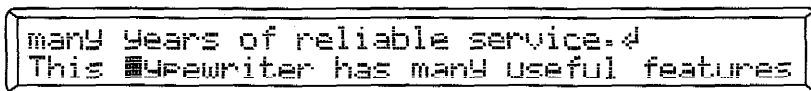

```

many years of reliable service.
This ***** [ ] Wpewriter has many useful features
  
```

## Block Functions And Formatting

When carrying out block operations, any format code contained in a block is copied, moved or deleted with it. This can affect the appearance of the text at the original location of the text, and at the destination.

A format code is a marker **[\*]** that appears at the beginning of a paragraph.

It indicates the position of code characters hidden in the text (not shown on screen) that define paragraph formatting. A format marker applies to all paragraphs that follow it until a new format code appears.

If a format marker is removed from a location by using **MOVE** or **DEL**, the paragraph(s) that followed that marker will adopt the formatting of the previous paragraph.

```
»The many useful features of Your
new Brother electronic typewriter
will enable You to produce error-
free, professional-looking
documents in a fraction of the
time.¶
Here's a short demonstration.¶
»Your new Brother type-
writer offers features
such as block copy,
move and delete,
spelling checker,
search and replace
functions, and many
more.¶
```

If we remove the words "Here's a short demonstration," and "Your new", we also remove the format code for the last paragraph. What's left of this paragraph will adopt the formatting of the previous paragraph.

```
»The many useful features of Your
new Brother electronic typewriter
will enable You to produce error-
free, professional-looking
documents in a fraction of the
time.¶
Brother typewriter offer features
such as block copy, move and
delete, spelling checker, search
and replace functions, and many
more.¶
```

If a block of text containing no format codes is moved or copied to a new location, it will take its format from the format code that precedes it at the new location.

```

    ▶ The many useful features of Your
      new Brother electronic typewriter
      will enable You to produce error-
      free, Professional-looking
      documents in a fraction of the
      time.␣
      Here's a short demonstration.␣
  ▶ Your new Brother type-
    writer offers features
    such as block copy,
    move and delete,
    spelling checker,
    search and replace
    functions, and many
    more.␣
  
```

If the words "Here's a short demonstration." are moved as shown, they will adopt the format of the previous paragraph.

```

    ▶ The many useful features of Your
      new Brother electronic typewriter
      will enable you to produce error-
      free, Professional-looking
      documents in a fraction of the
      time.␣
  ▶ Your new Brother type-
    writer offers features
    such as block copy,
    move and delete,
    spelling checker,
    search and replace
    functions, and many
    more.␣
    Here's a short
    demonstration.␣
  
```

Note that removing "Here's a short demonstration." from its original location had no effect, because it did not contain any format codes.

Things are a little more complicated at the new location when moving or copying a block of text that contains format codes.

1. Any part of the block not preceded by a format marker will adopt the attributes of the preceding paragraph at the new location, just like "Here's a short demonstration." in the previous example.
2. Similarly, text at the new location after the point at which the block is inserted will adopt the format defined by the last format code in the block, unless already preceded by another format code.
3. Format codes within the block, except the last one, affect only text within the block.

# Searching And Replacing Text

*The search and replace function allows you to scan through the document for occurrences of a particular piece of text. You can also replace the text with a different piece of text.*

## Search

To search for a particular piece of text, proceed as follows:

1. First position the cursor at the point where you wish the search to begin. That portion of the document before the cursor will not be searched, so if you wish to search the entire document, you must position the cursor at the start of the text.

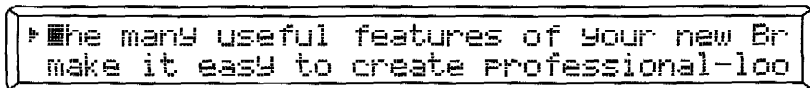

▶ The many useful features of your new Br  
make it easy to create professional-look

2. Press the [MENU] key to select the WP menu.



▶ MENU  
■: BLOCK 2: ABBR 3: SEARCH 4: FORM 5: SPELL

3. Press the [3] key to call up the SEARCH menu.

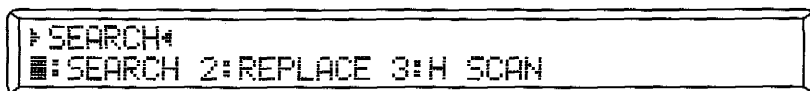

▶ SEARCH  
■: SEARCH 2: REPLACE 3: H SCAN

4. Press the [1] key to select **SEARCH**. You will then be prompted to type in the search string.

```
ΔTYPE WORD(S).  PRESS RTN TO START.  
SEARCH: █
```

5. Type in the text for which you wish to search and press [RETURN].

```
ΔTYPE WORD(S).  PRESS RTN TO START.  
SEARCH: features█
```

6. The wordprocessor will now search for the first occurrence of the text. While the search is going on, the following message will be displayed:

```
ΔWORKING....
```

7. When the search text is found, it will be highlighted and the following message will appear:

```
▶█:NEXT 2:EDIT  
The many useful ██████████ of your new Br
```

8. If you wish to make changes to the text, press the [2] key to edit. This will return you to normal typing mode at the point where the search text was found.

If you wish to search for further occurrences of the text after editing, you can begin from step 2. Since the search string is held in memory until you type in a new one, you will not have to type it in again.

If you do not wish to edit the text at this point, but wish to look for other occurrences of the search text, press the [1] key to skip to the next occurrence of the search text.



If you wish to abandon the operation, press [CODE] + [CANCEL].

9. When no more occurrences of the search text are found, the following message will appear.

```

┌WORD(S) NOT FOUND.
└

```

### Note!

As a shortcut you can press [CODE] + [SEARCH] instead of using the menu.

## Search And Replace

As well as searching for a particular piece of text, you also have the option to replace it with a different text string. Replacing text is carried out as follows:

1. First position the cursor at the position from which you wish to begin searching. If you wish to search the whole document, position the cursor at the start of the text.
2. Call up the **SEARCH** menu as before, then press [2] to select **REPLACE** from the **SEARCH** menu. You will be prompted to enter the search string as before.

```

┌TYPE WORD(S). PRESS RTN TO START.
SEARCH :
└

```

3. Type in the search word(s), then press [RETURN].

```

┌TYPE WORD(S). PRESS RTN TO START.
SEARCH : features
└

```

You will now be prompted to enter the word(s) with which they are to be replaced.

```

┌TYPE WORDS(S). PRESS RTN TO START.
REPLACE :
└

```

4. Type in the text which is to replace the search text.

```
△TYPE WORD(S). PRESS RTN TO START.  
REPLACE: functions
```

5. You will now be given the choice of replacing all occurrences of the search text automatically (global replacement), or one-by-one under your control.

```
△GLOBAL? Y/N  
REPLACE: functions
```

If you press [Y], every occurrence of the search text will be replaced.

The search will stop at the end of the document, with the following message:

```
△GLOBAL REPLACE COMPLETED.  
and this is the end of the document.
```

If you press [N] the search will stop at the first occurrence of the search text, and you will be given the following options.

```
▶ █:NEXT 2:EDIT 3:REPLACE  
The many useful██████████ of this new Br
```

To replace this occurrence of the search text before searching for the next one, press [3]. To skip to the next occurrence of the search text without replacing, press [1]. To leave the REPLACE operation and edit the text, press the [2] key. To abandon the replace operation altogether, press [CODE] + [CANCEL].

If you select EDIT or CANCEL by mistake, or you want to search for more occurrences of the text after editing, you can re-start the procedure from step 2. Since the search and replace text are held in memory until you type in new ones, you will not have to re-type them.

When no more occurrences of the search text are found, the following message will appear:

```

┌WORD(S) NOT FOUND.
└

```

## Defining A Search String

Take great care when typing in your search string, especially in **REPLACE** mode, or the results may not be what you expect. The search function looks for an exact match with the characters you type, and the following points should be noted.

1. The string input area initially appears on the screen as a continuous underline. Everything you type in this area, including spaces at the beginning and end, is considered as part of the search string.

For example, if you type:

```

┌TYPE WORD(S). PRESS RTN TO START-
SEARCH:The quick brown fox
└

```

(with two spaces between quick and brown)

The search will not find:

```

┌
└The quick brown fox
└

```

2. The search function distinguishes between upper and lower case characters, so if you type in DOG it will not find Dog or dog.
3. The search string cannot contain text attributes such as bold, underline, subscript and superscript so, for example, it cannot distinguish between A3, A<sub>3</sub>, A<sup>3</sup>, A3 or A3, it will find them all if they occur.
3. The search function will find any occurrence of a word, even if it is part of another word.

For example, if you specify the search string "hat", it will find "chat", "chatter", and any word containing the letters "hat".

This can produce unexpected results in **REPLACE** mode. For example, if you replace "hat" with "cap", you may end up with "ccapt", "ccapter", and so on.

To avoid this problem, if the search string is a whole word or string of words, put a space at the beginning and end, e.g. "\_hat\_".

Now the search function will only find the word "hat". It will not find "chat" or "chatter" because the string "hat" within these words does not have a space before and after it.

## Hyphen Scan

Problems can arise with the word wrap function if the distance between the margins is small, or when typing in languages such as German, which can have very long words. Since the word wrap function automatically transfers any word that exceeds the right margin onto the next line, excessively long blank spaces may appear, resulting in a poor layout.

The hyphen scan function automatically detects a space that is wider than the hot zone, and gives you the option of splitting long words between two lines.

The hyphen scan function means that, when you first type your text, you do not have to worry about hyphenating words to make the layout look good, apart from any permanent hyphens that may be required. You can use the hyphen scan later to tidy up the layout.

To use the hyphen scan:

1. Position the cursor at the beginning of the section that you wish to scan. If you wish to scan the whole document, position the cursor at the start of the document.
2. Call up the **SEARCH** menu as before, then press the **[3]** key to select **H SCAN**.

The hyphen scan function will search through the text until it finds a blank space wider than the current width of the hot zone.

While it is searching, the following message is displayed:

```
WORKING . . .
```

In the following example, the text with the loose line is the following:

```
My brand new Brother electronic  
typewriter has many useful features
```

This is set with 40 characters between margins and a hot zone of 6 characters, so the word "typewriter" will not fit on the top line, making this line loose.

When a loose line is found, the following message will appear, together with the following line of text.

```
1:NEXT 2:EDIT 3:H SCAN
ty*****er has many useful features.
```

You will notice that a section of the text is highlighted.

The text to the right of the highlighted area is that part of the word that cannot fit on the previous line because it would extend beyond the right margin.

The highlighted area and everything to the left of it could fit on the previous line if the word was hyphenated. The highlighted portion of the word is that part that would be within the hot zone if moved to the previous line.

3. If you wish to hyphenate the word, press [3]. The following message will appear.

```
4POSITION ■ AND PRESS RTN. TO HYPHENATE.
ty*****er has many useful features.
```

4. Position the cursor on the character where you wish to break the word. In this case the word typewriter should obviously be hyphenated as type-writer, so position the cursor on the "w".

```
4POSITION ■ AND PRESS RTN. TO HYPHENATE.
ty**■*****er has many useful features.
```

4. Press [RETURN]. Everything before this character will be moved to the previous line. (You won't actually see this screen because the hyphen scan will continue).

```
My brand new Brother electronic type-
writer has many useful features.
```

When the end of the document is reached, the following message is displayed:

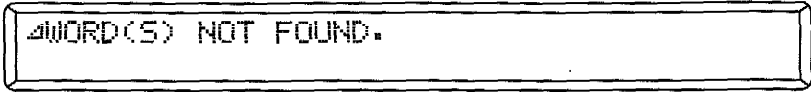

In order to keep the same hyphenation rules as normal typing, the hyphen scan only allows you to hyphenate words within the highlighted area. Obviously, you cannot hyphenate the word at a position to the right of the highlighted area, because that would extend beyond the right margin.

Similarly, in normal typing, the word wrap function will not split a word at a position to the left of the highlighted area, since typing a hyphen at a position to the left of the hot zone will not cause a carriage return, unless you break the line manually by pressing the **[RETURN]** key.

You may find there is no convenient place within the highlighted area at which to split the word. In this case you may choose not to hyphenate it, by pressing **[1]** to continue the hyphen scan, or you may decide to edit the line manually by pressing **[2]**. In this case you must insert a hyphen manually and press the **[RETURN]** key to break the line.

Note that hyphens generated during a hyphen scan are ghost hyphens, and will disappear if subsequent text editing or re-formatting means that the whole word will fit on the previous line. Editing or re-formatting after a hyphen scan can also introduce loose lines, so hyphen scan should be the last thing you do before printing your document.

# Abbreviated Phrases

*If you have long phrases that you frequently have to type, you can store these in memory and call them up later by typing a short abbreviation.*

For example, you could store "Brother Industries Ltd." as "BIL".

To use abbreviated phrases, you first have to create them and add them to the abbreviated phrase memory. You can edit phrases once they have been stored in memory and delete phrases you no longer need to make space for new ones in memory. You can also store the contents of your phrase memory as an abbreviated phrase file on disk for later use. All these operations can be carried out in either **TW** or **WP** mode.

## **Important Note!**

1. The phrase memory is backed up by an internal battery, so it will be kept in memory even when the machine is switched off.
2. If you are starting to create a collection of abbreviated phrases from scratch and intend to save them on disk, you should have an initialized disk on which you wish to save the phrase file inserted in the disk drive. This may be the disk on which you store your documents, or you can keep a separate disk for the phrase file. Any other phrase file that is already in the machine's memory must be deleted, or your words will be added to this phrase file.
3. You can have only one phrase file on any disk. Therefore, if you want several phrase files for different purposes, you must store each one on a separate disk.
4. If you save a phrase file from memory onto a disk that already contains a phrase file, the existing phrase file will be overwritten and lost.
5. If you want to add phrases to a phrase file you already have stored on disk, you must first load it into memory, as you cannot add phrases to the file on the disk.

## Maintaining Your Phrase Files

Creation and maintenance of your phrase memory and phrase files on disk is done from the **ABBR** menu in either **TW** mode or **WP** mode.

To call up the **ABBR** menu from **TW** mode or from the **WP** edit screen:

1. Press the **[MENU]** key to call up the **TW** menu or **WP** main menu.



```
▶ MENU*  
1:CTR/RMF 2:ABBR 3:SPELL
```

or



```
▶ MENU*  
1:BLOCK 2:ABBR 3:SEARCH 4:FORM 5:SPELL
```

2. Press the **[2]** key to call up the **ABBR** menu.



```
▶ ABBR*  
1:EDIT 2:DELETE 3:LOAD 4:SAVE
```

You can now carry out any of the phrase maintenance operations listed in this menu.

## Adding Or Editing An Abbreviated Phrase

1. Press the **[1]** key to choose **EDIT** from the **ABBR** menu. If there are already phrases in the memory, the following message will appear, together with the first phrase in alphabetical order.

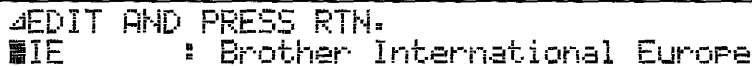

```
◀EDIT AND PRESS RTN.  
■IE : Brother International Europe
```



- To see other abbreviated phrases in the list, use the [INDEX] and [R INDEX] keys to scroll up and down.

You can use the ← and → keys to move between the abbreviated phrase name on the left of the display and the phrase data on the right, and you can edit these as you wish.

When you reach the bottom of the list, there is a screen where you can add new phrases to the list. If there are no phrases in memory, this screen will appear as soon as you select EDIT.

```

ΔTYPE PHRASE DATA AND PRESS RTN.
█          :
```

- If you want to add a new phrase to the list, type in the name for the abbreviated phrase.

```

ΔTYPE PHRASE DATA AND PRESS RTN.
BIL█          :
```

- Press → to move to the right.

```

ΔTYPE PHRASE DATA AND PRESS RTN.
BIL      █:█
```

- Type in the full text of the phrase.

```

ΔTYPE PHRASE DATA AND PRESS RTN.
BIL      :Brother Industries Ltd.█
```

- If you want to add another phrase, press [INDEX] again, and repeat the procedure.
- After you have finished adding and/or editing phrases, press [RETURN] to store the phrases in memory and return to normal typing.

If you try to add a phrase when there is insufficient space left in memory, you will get the following error message:

```
4PHRASE MEMORY FULL
```

Before you can add any more phrases, you must delete some from the memory.

**Note!**

1. Phrases are stored in alphabetical order by name.
2. Phrase names can be up to 8 characters long, and the only characters used should be letters, numbers and periods.
3. Phrase text can be up to 67 characters long, and up to 30 phrases can be stored, provided the capacity of the phrase memory is not exceeded.

## Deleting A Phrase

If the phrase memory becomes full, you may wish to clear out some phrases you no longer use to make room for new ones.

To delete a phrase:

1. Call up the **ABBR** menu, then press [2] to select **DELETE**.

After you press [2], the following message will appear:

```
▶DELETE▶
1:DEL ONE 2:DEL ALL
```

2. If you wish to delete a selected phrase, press [1]. The following message will appear:

```
▶SELECT WITH █, PRESS RTN TO DELETE.
█IE      : Brother International europe
```

3. Use [INDEX] and [R INDEX] to select the phrase you wish to delete, and press [RETURN].

```
▶SELECT WITH █, PRESS RTN TO DELETE.
█IG      : Brother International Germany
```

To avoid mistakes you will be asked to confirm the deletion.



```
DELETE? Y/N
```

4. Press [Y] to confirm the deletion or [N] to abandon the deletion.
5. Repeat the procedure for any other phrases you wish to delete.

## Deleting All Phrases

1. If you wish to delete the entire phrase memory, press [2] to select **DEL ALL** from the **DELETE** menu. To avoid mistakes you will be asked to confirm the deletion, as before.
2. Press [Y] to confirm the deletion or [N] to abandon the deletion.

## Loading A Phrase File

To load a phrase file from the disk:

1. Make sure the disk containing the phrase file is inserted in the disk drive.
2. Call up the **ABBR** menu, then press [3] to select **LOAD**.

The phrase file will automatically be loaded into the memory.

3. If a phrase file already exists in memory, the following warning will appear:



```
PHRASE MEMORY FILE ALREADY EXISTS.  
PRESS RTN TO OVERWRITE.
```

4. Press [RETURN] to replace the contents of the phrase memory with the phrase file from the disk. If you do not wish to lose the existing phrase memory, press [CODE] + [CANCEL]. You can then save the phrase memory as a phrase file on a different disk.
5. If there is no disk in the drive, or the disk does not contain an abbreviated phrase file, the following message will appear:

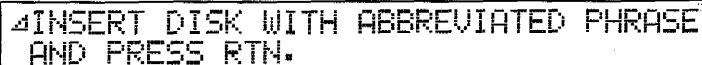

```
INSERT DISK WITH ABBREVIATED PHRASE  
AND PRESS RTN.
```

## Saving A Phrase File

To save a phrase file onto disk:

1. make sure an initialised disk, on which you want to save the phrase file, is inserted in the disk drive.
2. Call up the **ABBR** menu, then press **[4]** to select **SAVE**.

```

┌PRESS RTN TO SAVE.

```

Press **[RETURN]** to save the file on disk.

If a phrase file already exists on the disk, the following warning will appear:

```

┌PHRASE MEMORY FILE ALREADY EXISTS.
  PRESS RTN TO OVERWRITE.

```

4. Press **[RETURN]** to replace the phrase file on disk with the contents of the phrase memory. If you do not wish to lose the existing phrase file, press **[CODE]** + **[CANCEL]**. You can then save the phrase memory as a phrase file on a different disk.

## Using Abbreviated Phrases

Use of abbreviated phrases differs slightly, depending on whether you are using your typewriter in **NORMAL**, **AUTO**, **LINE-BY-LINE**, **JUSTIFY**, **WP** printing or non-printing modes.

### Using Phrases In Display Typing Modes

To use an abbreviated phrase whilst you are typing text in the **LINE-BY-LINE**, **JUSTIFY**, or **WP** modes, type in the abbreviated phrase at the required point in the text.

```

our meeting at BIL█

```

TW/WP

Now hold down the [CODE] key and press the [ABBR] key.

The abbreviated phrase will be replaced by the full text.

```
meeting at Brother Industries Ltd. █
```

In WP mode, if the abbreviated phrase makes the text too long to fit on a line, it will wrap onto the next line.

```
This is a message from BIL █
```

Press [CODE] + [ABBR]

```
This is a message from Brother  
Industries Ltd. █
```

In LINE-BY-LINE, JUSTIFY and WP printing modes, if the abbreviated phrase makes the text too long to fit on the typing line, the following message will appear:

```
WORD TOO LONG. █
```

You can also convert an abbreviated phrase to the full text after you have typed it.

```
made by BIL in the UK. █
```

1. Position the cursor anywhere in the abbreviated phrase.

```
made by BIL in the UK. █
```

2. Press [CODE] + [ABBR].

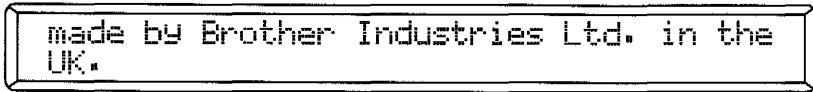

made by Brother Industries Ltd. in the  
UK.

3. The phrase is replaced by the full text.

### Using Phrases In NORMAL And AUTO Modes

If you want to use an abbreviated phrase in **NORMAL** or **AUTO** mode, the procedure is slightly different. You cannot type in the abbreviated phrase first, because it will immediately be printed in its abbreviated form. You must tell the typewriter to expect an abbreviated phrase input before you type the phrase, as follows:

Suppose you have typed:

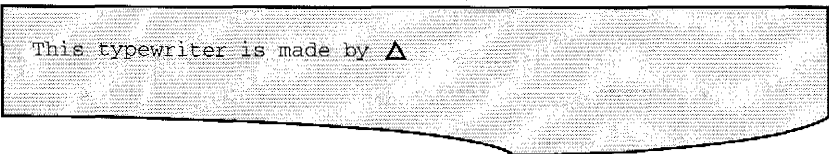

This typewriter is made by Δ

1. Press [CODE] + [ABBR]. The following message will appear:



ΔTYPE PHRASE NAME AND PRESS RTN.

2. Type in the abbreviated phrase and press [RETURN].

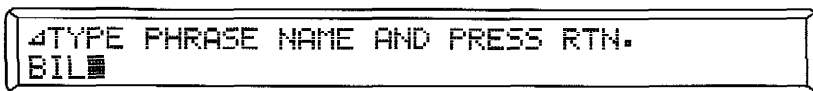

ΔTYPE PHRASE NAME AND PRESS RTN.  
BIL

3. The full text will be printed



This typewriter is made by Brother Industries Ltd.

4. If the phrase is too long to fit on the line, the following message will appear:



WORD TOO LONG.

**Note!**

When using abbreviated phrases in any typing mode, if the selected phrase does not exist, the following warning will appear:

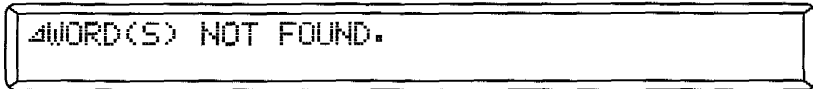

WORD(S) NOT FOUND.

TW/MP





# Printing Your Document

*There are two ways of printing your document. You can print it page-by-page as you create it, or you can print the whole file after it has been finished and saved.*

## Printing The Current Page

To print the current page of the document:

1. Hold down the **[CODE]** key and press the **[PRINT]** key.

The following message will appear:



ΔINSERT PAPER AND PRESS RTN.

2. Insert a sheet of paper using the **[P INS]** key. After inserting it, you can also adjust its position if required using **[INDEX]** and **[R INDEX]**.
3. Press **[RETURN]**. the following message will appear:



ΔPRINTING. PRESS SPACE TO PAUSE.

4. You can pause the print at any time by pressing the **[SPACEBAR]**.

```
▲PRINT PAUSED.  PRESS SPACE TO CONTINUE.
```

5. Press the [SPACEBAR] again to resume printing.

**Note!**

If the keyboard or typing pitch is changed anywhere on the page, printing will pause at that point and you will be prompted to change the daisywheel, for example:

```
▲CHANGE TO KB:2 15 WHEEL AND PRESS RTN.
```

After changing the daisywheel, press [RETURN] to resume printing.

## Printing The Whole Document

Before printing an entire document, you first have to save it as described earlier.

After you have saved the document, the display will return to the WP INDEX screen.

```
<<WP INDEX>>                REMAIN:722.9K  
■NEWFILE.N                   *NEWFILE.P
```

To print a document:

1. Use the cursor keys to select the document you wish to print.

```
*NEWFILE.N                   *NEWFILE.P  
■DOCFILE1.WPT( 2.2)         DOCFILE2.WPT( 4.3)
```

2. Press the [MENU] key to call up the DOCUMENT MENU.

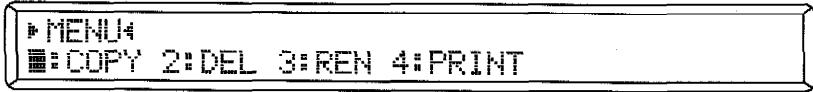

This menu allows you to copy, delete, rename or print a document.

The procedures for copying, deleting and renaming are identical to those in the **FILE MANAGE** menu described elsewhere and will not be repeated here. They are duplicated within the wordprocessor for convenience, so that you do not have to exit the wordprocessor and call up the **FILE MANAGE** menu when you want to copy, delete or rename a document.

3. Press the [4] key to call up the **PRINT MENU**.



4. Type in the page number of the document from which you wish printing to start, from 1 to 999. The default value is 1.
5. Use the [R INDEX] and [INDEX] keys to view the following items.

```

END PAGE           999
  
```

6. Type in the page number at which you wish printing to end, from 1 to 999. This must be greater than the starting page number. If you leave it set at the default value of 999, all pages of the document will be printed.

```

NUMBER OF COPIES   1
  
```

7. Type in the number of copies you wish to print, from 1 to 99.

```

HEADER PRINT       YES
  
```

8. Use the [SPACEBAR] to toggle between printing (YES) and not printing (NO) the header text.

FOOTER PRINT                      YES

9. Use the [SPACEBAR] to toggle between printing and not printing the footer text.

PAUSE FOR KB CHANGE      YES

10. Use the [SPACEBAR] to select YES if you wish printing to stop at places where you changed the keyboard or typing pitch, to allow a change of daisy wheel.

FORM FEED                      AUTO

12. Use the [SPACEBAR] to select AUTO if you want the each page of the document to be ejected automatically. If MANUAL is selected, the carriage will remain at the end of the last line of the each page after printing.

13. After setting all the items in the print menu, press the [RETURN] key. The following message will appear:

▲INSERT PAPER AND PRESS RTN.

14. Insert a sheet of paper and press [RETURN]. Printing will begin. You will see the same display messages as for single page printing, but you will also be prompted to insert a new sheet of paper after each page is printed, if the document has more than one page.

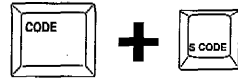

## Stop Codes

Stop codes are used to stop printing of a document at a particular point so that text can be inserted, for example, customizing a standard letter by inserting the addressee's name into it.

A stop code can be inserted at any point in the text by holding down the [CODE] key and pressing the [S CODE] key, when a stop code symbol (⊞) will appear in the text.

When using stop codes, take care that the layout of the document is such that it can accommodate the insertion of varying lengths of text at the stop code, without spoiling the appearance of the document during printing.

For example, if you have a 1 page document into which you wish to insert an address, make sure that there is enough space on the page to accommodate all the lines of the address without the document becoming a two page document.

### Inserting Text At A Stop Code

When printing stops at a stop code, the following message will appear:



You can type in your text on the page, then press [CODE] + [PRINT] to resume printing.



If the typewriter is set to L/L or JUSTIFY mode, you can type in the text on the display, and print it a line at a time.



# Spelling Checker

## Spelling Checker



*The spelling checker allows you to check your typing for spelling and typographical errors, and also for redundancy (a word typed twice). It has a main dictionary of 87,000 words and a user dictionary to which you can add up to 203 words of your own, depending on the word length.*

The spelling checker can be used in either **TW** or **WP** modes, and the operation varies only slightly depending on which mode you are using.

The user dictionary is backed up by an internal battery, and remains in memory even if the machine is switched off.

A user dictionary created in the **WP** mode can also be used in the **TW** mode, and vice versa.

You can also store the contents of your user dictionary as a file on disk for later use.

### Important Notes

1. If you wish to use a user dictionary that is saved on disk, you must load it into memory before using the spelling checker.
2. If you want to add words to a user dictionary you already have stored on disk, you must first load it into memory, as you cannot add words to the file on the disk. After adding the new words you should save the modified user dictionary on disk.
4. If you are starting to create a new user dictionary from scratch and intend to save it on disk, you should have an initialized disk on which you wish to save the user dictionary file inserted in the disk drive. This may be the disk on which you store your documents, or you can keep a separate disk for the dictionary file. Any other user dictionary that is already in the machine's memory must be deleted, or your words will be added to this dictionary.
5. You can have only one user dictionary on a disk. Therefore, if you want several user dictionaries for different purposes, you must store each one on a separate disk.

- If you save a user dictionary file from memory onto a disk that already contains a dictionary file, the existing user dictionary file will be overwritten and lost.

## Using The Spelling Checker In TW Mode

The spelling checker has two modes of operation. **ONE WORD** mode checks the spelling of each word as it is typed, when you end the word with a space or hyphen. **FIND** mode allows you to check the spelling of an entire line.

The spelling checker can be accessed via the **SPELL** menu. To call up the **SPELL** menu:

- Press the **[MENU]** key to call up the main **MENU**.



- Press **[3]** to call up the **SPELL** menu.



- Press **[1]** or **[2]** to select **FIND** or **ONE WORD** mode.

On-line spell checking checks the spelling of each word as it is typed.

If you are a fast touch typist, you may find that this interrupts your typing rhythm, so you can use the spell checker selectively in **FIND** mode to check all or part of the current typing line.

### Notes!

- As a short-cut you can turn on the **ONE WORD** spelling checker, by holding down **[ALT]** and pressing **[SPELL]** until **SP** appears in the display.
- As a short-cut to activate the **FIND** mode after typing all or part of a line of text, hold down **[CODE]** and press **[GOTO]**.



## Find Mode

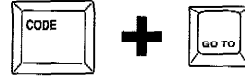

If you want to check the spelling of a line of typing, you must press **[CODE] + [GOTO]** or select **FIND** from the menu before the end of the line. Once the carriage has moved to the next line, the spelling of that line cannot be checked.

When a suspect word is found, the typing carriage will move to the space after the suspect word, so that you can delete it using **WORD OUT** if required.

If you are typing in **NORMAL** or **AUTO** mode, the suspect word will appear in the display, and the top line of the display will show the following options:

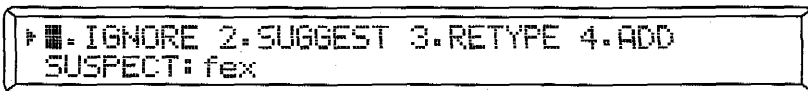

If you are typing on the display, the word will be highlighted in context, as follows:

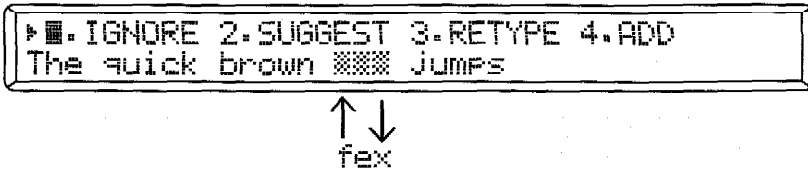

If you do not wish to change the word, press **[1]** to select **IGNORE**. The spelling checker will continue to check the rest of the line.

If you want a suggestion for the correct spelling of the word, press **[2]** for this option.

You will see a display similar to the following, depending on the mis-spelled word.



If you wish to accept one of these suggestions, select it using the cursor keys, then press **[RETURN]**.

The mis-spelled word will be replaced by the suggestion.

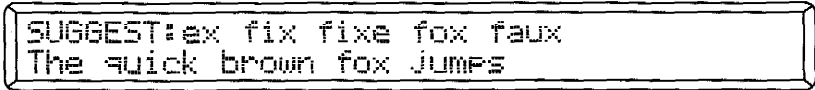

If you do not like any of the suggestions offered, press [CODE] + [CANCEL] to return to the previous menu.

If you want to type in the word yourself, select RETYPE. The following display will appear.

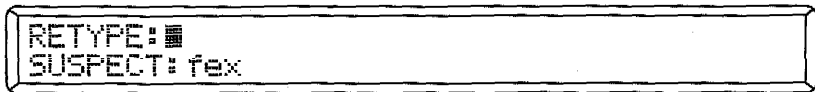

Type in the correct word, then press [RETURN]. The mis-spelled word will be replaced with the one you typed.

If you want to edit the existing word rather than re-typing it completely, press [INDEX] or [R INDEX] to display the word on the top line.



**Notes!**

1. If you are typing in **NORMAL** or **AUTO** mode, the mis-spelled word will be erased from the paper when you select **SUGGEST** or **RETYPE**. If the word you re-type or select from the suggestions is too long to fit in the space left by the erasure, the following message will appear:



2. If the word you re-type or select from the suggestions is shorter than the erased word, there will be extra space on the right of the replacement word.

## Adding A Word

The word identified as suspect may not be mis-spelled. It may be a name such as the name of your company, or a technical or other specialist word that you use frequently. If this is the case, you may choose to add it to the user dictionary, so that it will not be identified as mis-spelled in future.

Press [4] to select **ADD** from the menu options.

The following message will appear:

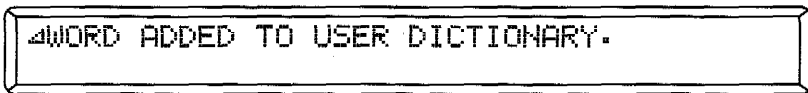

When you have dealt with the first suspect word, the spelling checker will move onto the next suspect word on a line, and you will be given the choice of correction options as above.

When no more suspect words are found, the following message will appear:



## One Word Spelling Checker

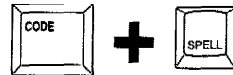

When the spell checker is used in **ONE WORD** mode and **NORMAL** or **AUTO** typing, the beeper will sound when a suspect word is found.

When typing on the display, the suspect word is highlighted.

You have the same correction options in **ONE WORD** mode as in **FIND** mode.

## Redundancy Check

In addition to checking the spelling of words, the spelling checker also carries out a redundancy check to make sure that you have not typed the same word twice in succession. When you type the same word twice in succession, such as "fox fox", the second word will be highlighted as redundant.

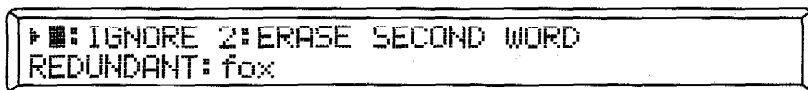

When typing on the display, both words in the suspected redundant pair will be highlighted.



Press [1] to ignore the redundancy or [2] to erase the second word.

**Notes!**

1. The spelling checker will identify as suspect any word that is not in the main or user dictionaries,
2. It will not identify numbers, or combinations of numbers separated by punctuation marks, such as dates. It will, however, identify as suspect any combination of numbers and alphabetic characters, such as part codes and serial numbers.

For example, it will not identify 28/12/93 as suspect, but it will identify XZ1234A as suspect.

3. The redundancy checker will only identify two identical words separated by a single space. It will not identify words separated by more than one space or by any other symbol.

For example, it will correctly ignore "ha-ha" or "bye-bye", but it will identify valid word pairs such as "had had", as redundant.

## Using The Spelling Checker In WP Mode

Use of the spelling checker in WP non-printing mode, when creating or editing a document, is very similar to using it in the TW display typing modes, except that you can check the whole document for spelling mistakes instead of a single word or line.

To use the spelling checker:

1. Press the [MENU] key to bring up the WP MAIN MENU.

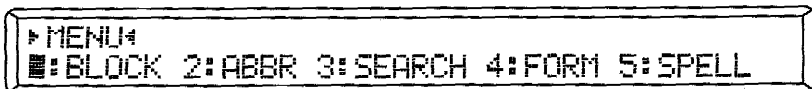

2. Press the [5] key to select **SPELL** from the **WP MAIN MENU**.



The spell check menu gives you the option of checking the whole document after it has been typed, or one word at a time as you type it (on-line spelling check).

## Checking The Whole Document

To check the whole document, press [1] to select **ALL** from the **SPELL** menu.

The spelling checker will go through the document starting at the current cursor position. If you want to check the whole document, position the cursor at the start of the first line.

Operation of the **WP** spelling checker in **ALL** mode is very similar to operation of the **TW** spelling checker in **FIND** mode, except that the whole document can be checked instead of one line of text.

Any word that is not in the main dictionary or the user dictionary will be highlighted as suspect, and the options for dealing with a suspect word are identical to those when using the spelling checker in **TW** mode. As each suspect word is found, you will be offered the option of ignoring it, asking for a spelling suggestion, re-typing it, or adding the word to the user dictionary.

## One Word Spelling Check

The **ONE WORD** spelling checker can be turned on or off the same way as in **TW** mode, from the menu or by pressing [ALT] + [SPELL]. The operation of the **ONE WORD** spelling checker is identical to the **ONE WORD** spelling checker when typing on the display in **TW** mode.

## Using the Spell Checker in WP Printing Mode

As the document is printed line-by-line in **WP** printing (\*NEWFILE.P) mode, it is pointless to check the entire document after it has been created, since it has already been printed. Therefore, the only spelling checker option that can be used in **WP** printing mode is **ONE WORD**.

## Maintaining The User Dictionary

The capacity of the user dictionary in memory is limited to around 203 words, so its a good idea to delete words you no longer need. You may also wish to save the user dictionary on disk, or load a dictionary into memory from disk.

To maintain the user dictionary in either **TW** or **WP** mode, call up the **SPELL** menu, then press **[3]** to select **USER DICT**. The following display will appear.

```

USER DICT.4
■:DEL ONE 2:DEL ALL 3:LOAD 4:SAVE
  
```

## Deleting Words From The User Dictionary

To delete a word from the user dictionary, call up the **USER DICT**. menu as above, then press **[1]** to select **DEL ONE**. The following message will appear:

```

SELECT WITH ■, PRESS RETURN TO DELETE.
ardvark
  
```

The first word in your user dictionary will appear on the screen. To see other words, use **[INDEX]** and **[R INDEX]** to scroll the display.

Pressing **[RFLOC]** will take you immediately to the end of the user dictionary.

Pressing **[EXPR]** will take you immediately to the beginning of the user dictionary.

To move quickly to a particular letter in the user dictionary, press **[CODE] + [GO TO]**, then the letter.

When the word you wish to delete is in the display, press the **[RETURN]** key.

To avoid the possibility of a mistake, you will be asked to confirm the deletion.

```

DELETE WORD FROM USER DICTIONARY? Y/N
ardvark
  
```

Press **[Y]** to confirm the deletion or **[N]** to abandon the deletion.

Repeat the above procedure for all words you wish to delete from the user dictionary. When you have finished, press [CODE] + [CANCEL] to return to normal typing.

## Deleting All Words

The **DEL ALL** function deletes all words from the user dictionary currently loaded into memory. It has no effect on the user dictionary stored on disk.

**DEL ALL** should be used if you have a user dictionary loaded into memory, and you wish to delete it so that you can begin a new one.

To delete all words from the user dictionary, press [2] to select **DEL ALL** from the **USER DICT.** menu.

The following message will appear:

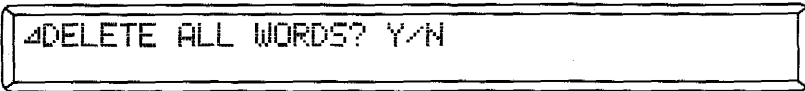

Press [Y] to delete all words from the user dictionary, or [N] to cancel the deletion.

## Loading A User Dictionary

If you have a user dictionary previously save on disk and want to add to it, you should load the existing dictionary before you start spell checking.

To load a user dictionary:

1. Make sure the disk containing the user dictionary is inserted in the disk drive.
2. Call up the **USER DICT.** menu, then press [3] to select **LOAD**.

The user dictionary will be loaded.

If a user dictionary has already been loaded from disk, or you have added words to the user dictionary memory during spell checking, the following warning will appear:



Pressing **[RETURN]** will load the user dictionary from disk into memory and overwrite the user dictionary that is already there. If you do not wish to do this, press **[CODE]** + **[CANCEL]**.

### Notes!

1. You can only have one user dictionary on a disk. If you need several user dictionaries for different purposes, they must be on different disks.
2. Loading a user dictionary from disk overwrites any user dictionary already in memory. Make sure that any user dictionary you wish to use and/or modify has been loaded before starting the spelling check. After completing the spelling check and adding new words to the user dictionary, save the new version on disk.

## Saving A User Dictionary

If you have added words to the user dictionary in memory, you may wish to save it on disk.

To save a user dictionary on disk:

1. make sure the disk on which you wish to save the dictionary is inserted in the disk drive.
2. Call up the **USER DICT.** menu, then press **[4]** to select **SAVE**. The following message will appear:

A rectangular box with a double-line border containing the text "PRESS RTN TO SAVE." in a monospaced font.

3. Press **[RETURN]** to save the user dictionary.

If a user dictionary already exists on the disk, the following warning will appear:

A rectangular box with a double-line border containing the text "USER DICTIONARY EXISTS. PRESS RTN TO OVERWRITE." in a monospaced font.

Press **[RETURN]** to overwrite the existing dictionary, or **[CODE]** + **[CANCEL]** to abandon the operation.



**Notes!**

1. You can only have one user dictionary on a disk. If you need several user dictionaries for different purposes, they must be on different disks.
2. Saving a user dictionary onto a disk overwrites any user dictionary on that disk. If you want to add words to an existing user dictionary on disk rather than replacing it with a new one, make sure it has been loaded before starting the spelling check. After completing the spelling check and adding new words to the user dictionary, save the new version on disk.



# FORM TYPING

## Form Typing

The form typing function makes it easy to fill in pre-printed forms. Instead of having to move the carriage manually to each item of the form every time you fill in a form, you only need to do it once. The moves you made can then be saved in a form typing file. Next time you have to fill in the same kind of form, the carriage will move automatically to the correct position for each item, and you only have to type in the text.

If you have to fill in a number of forms on which some of the information is always the same, you can also store this information in your form typing file, to save having to re-type it every time.

### Creating A Form Typing File

To create a form typing file:

1. It's a good idea to have an initialized disk in the disk drive, on which to save your form once you have designed it.
2. Press [3] to select F TYPE from the MAIN MENU screen.

```

      <<MAIN MENU>>
■:TW  2:WP  3:F TYPE  4:FILE MANAGEMENT

```

The FORM TYPING INDEX screen will appear.

```

<<F TYPE INDEX>>          REMAIN:713.7K
■NEWFILE                 FORMNO1 .FTP( 0.2)

```

If there are existing form files on the disk, they will be displayed with the extension .FTP.

You can scroll the display to show other files by using the cursor keys.

3. To create a new form, position the cursor on \*NEWFILE and press [RETURN].

The following message will be displayed:

```
ΔINSERT PAPER AND PRESS RTN.
```

4. Insert a blank form into the typewriter, and press [RETURN]. The following message will be displayed:

```
ΔMOVE CARRIAGE AND PRESS RTN.  
ITEM 1: (0,48) LEFT
```

5. Using [BKSP], ←, →, [INDEX], [R INDEX] (with [CODE] for micro adjustment) and [SPACE], as required, position the carrier where you want to type the first item on the form.

**Note!**

Don't try to use the [RETURN] key to move the carrier, as this is used to confirm that you have finished adjusting the position.

You can choose the alignment of the text as follows:

[CODE] + [T SET] - Left-aligned on a tab at the selected position. This is the default.

[CODE] + [DT SET] - Aligned on a decimal tab at the selected position.

[CODE] + [CTR] - Centred about the selected position.

[CODE] + [RMF] - Right aligned to a tab at the current position.

[CODE] + [S CODE] - Stop code.

You can also press the [MENU] key to access the POSITION SET menu for these items.

After selecting the print position and alignment for the first item, press [RETURN].

The following message will be displayed. This is the fill-in data screen:

```
ITEM 1 NAME:  
DATA: ■
```

6. You don't have to type in anything at this stage, but if you wish you can type in some dummy text, to get an idea of what the form will look like when it is filled in. The maximum allowed length of any data is 120 characters.

```
ITEM 1 NAME:
DATA:October 14th 1994█
```

7. You can give each item of data a name to help when filling in the form. The name will not be printed out.

To do this, use **[R INDEX]** to move to the top line of the display, then fill in the name. The maximum length for a name is 8 characters.

```
ITEM 1 NAME:Date█
DATA:October 14th 1994
```

8. Now press **[INDEX]** to move back to the bottom line.

To move onto the next item on the form do one of the following.

If the next item is on the line below the item just completed:

- press **[RETURN]** to print the text you just typed and move the carriage down one line and immediately below the item just typed.
- press **[CODE] + [RETURN]** to move the carriage down without printing.

If the next item is on the same line as the one just completed:

- press **[TAB]** to print the text and stop on the same line.
- press **[CODE] + [TAB]** to move the carriage without printing.

You can also scroll up and down through the fill-in data screens of each item in the form using **[CODE] + [INDEX]** or **[CODE] + [R INDEX]**.

9. Repeat steps 5 to 8 for every item on the form. The maximum number of items allowed on a form is 80.
10. When you have completed every item on the form, you are ready to save the form typing file. If you want the form to be blank when you use it in future, you should delete any dummy text before saving the file. To do this, press the **MENU** key, and the following display will appear:

```
▶FILL IN▶  
1:POSITION SET 2:DEL ALL<FILL IN>
```

11. Press [2] to delete any text that was typed on the **DATA** line of any item. (Item names will not be deleted).
10. When you have finished, press the [FILE] key, and the following message will be displayed:

```
▶PRESS RTN TO SAVE, CORRECT TO ABANDON.▶
```

11. Press [RETURN] to save the file, or [CORRECT] to abandon the operation and return to the **F TYPE INDEX** screen.

If you press [RETURN], the following message will appear.

```
▶TYPE FILENAME AND PRESS RTN.  
FILENAME: ■ .FTP
```

12. Type in a name for the form.

```
▶TYPE FILENAME AND PRESS RTN.  
FILENAME: FORMNO2 ■ .FTP
```

13. Press [RETURN] to save the file. If there is already a file with the same name on the disk, the following message will appear.

```
▶FILE EXISTS. PRESS RTN. TO OVERWRITE.  
FILENAME: FORMNO2 ■ .FTP
```

14. If you want to replace the existing file, simply press [RETURN] again. Otherwise type in a different file name and press [RETURN].

## Filling In A Form

1. To fill in a form, you must first select the file name of the form you wish to fill in from the **F TYPE INDEX** screen, by selecting it with the cursor keys and pressing **[RETURN]**.

The following message will appear.

```
▯INSERT PAPER AND PRESS RTN.▯
```

2. Insert the blank form that you wish to complete, and press **[RETURN]**.

The paper will be fed in to the position at which the first item on the form is to be printed, and the following message will be displayed.

```
▯POSITION OK? USE CURSOR TO CHANGE.▯  
ITEM 1:Date ( 54, 48) LEFT
```

If the paper is not adjusted correctly, this screen gives you the option of adjusting the entire form up, down, left or right on the paper, for this printout of the form only.

Do not confuse this screen with setting the position of item 1 when creating a form

3. Use the cursor keys to adjust the paper position if necessary, and press **[RETURN]**.

The following message will be displayed (for example):

```
▯ITEM 1 NAME:Date▯  
DATA: ■
```

4. Fill in the data for this item.

You may find that the form file has previously been filled in, or still contains dummy data from when you designed the form. You can overwrite the data with **INSERT** turned off, or delete it using **[CODE] + [LINE OUT]**. Alternatively, you can delete all the data from the file using the **DEL ALL** option of the **FILL IN** menu, but do not do this after you have started to fill in the form, or all your filled-in data will be deleted.

5. When you have finished with this item, press [RETURN] or [TAB] to print the item and move on to the next item.

If you wish to move onto the next item without printing this item, press [CODE] + [RETURN] or [CODE] + [TAB].

6. When all items on the form have been filled in and printed, press [FILE]. (not [RETURN], see Note on page 18-8).

The following message will be displayed.

```
▲PRESS RTN. TO SAVE, CORRECT TO ABANDON.
```

7. If you want to save the completed form as a file for archiving purposes or for future use, press [RETURN]. Otherwise press [CORRECT] to abandon the operation.

If you press [RETURN] the following message will appear, since this form typing file already exists on the disk:

```
▲FILE EXISTS. PRESS RTN. TO OVERWRITE.  
FILENAME: FORMNO2.FTP
```

Type in a new name for the file and press [RETURN] or, if you simply wish to overwrite the existing form file with the filled-in form, just press [RETURN].

## Changing A Form

You may find that you wish to change an existing form file for a variety of reasons. For example, you may wish to modify it to create a new form. You may wish to change the name of an item in the form. You may find that the print position of some items on the form is not correct, or you may wish to enter some common text that will be used on a number of forms.



To change a form:

1. Select the form to be changed from the **F TYPE** index screen.

```

┌POSITION OK? USE CURSOR TO CHANGE.
└ITEM 1:Date ( 54, 48) LEFT
  
```

2. Don't be confused by this screen. Remember, it adjusts the position of the entire form on the paper for one printout only. Ignore it and press **[RETURN]**.

```

ITEM 1 NAME:Date
DATA: June 11th 1993
  
```

3. If you want to enter or change the data on this line, you can do so.

```

ITEM 1 NAME:Date
DATA:March 14th 1994
  
```

4. If you want to change the name of item 1, move the cursor to the top line and edit the text.

```

ITEM 1 NAME:DATE
DATA:March 14th 1994
  
```

5. If you want to change the position of this item, press the **MENU** key.

```

▶FILL IN*
1:POSITION SET 2:DEL ALL<FILL IN>
  
```

6. Press **[I]** to edit the position of item 1.

```
▲MOVE CARRIAGE AND PRESS RTN.  
ITEM 1:DATE ( 54, 48) LEFT
```

5. Move the carriage to the new position for item 1 and press **[RETURN]**. The display will return to the data screen.

```
ITEM 1 NAME:DATE  
DATA:March 14th 1994
```

6. If you have finished editing the name and data of item 1, press **[RETURN]** to move onto the next item.
7. When you have finished changing all the existing items, you can save the file in the usual way by pressing the **[FILE]** key. However, if you want to add an extra item or items to the end of the form, press **[CODE] + [FILE]** after the last item, and a new item will appear for you to edit.

You can only change the position and data of existing items, and add new items to the end of the file. You cannot insert extra items between existing ones in the sequence of items. Of course, using the cursor keys, it is possible to position additional items so that they are printed anywhere on the form, but they will still be the last items to be filled in and printed when filling in the form.

**Note!**

If you press **[RETURN]** after editing or filling in the last item on the form, the following message will appear:

```
▲MAX NUMBER OF ITEMS EXCEEDED.  
PRESS RTN TO RESTART.
```

Press **[RETURN]** if you wish to abandon the operation.

Press **[CODE] + [FILE]** if you wish to add extra items to the form.

Press **[CODE] + [R INDEX]** if you wish to return to the last item on the form.

## Switching Back To TW Mode Or Main Menu

If you are in the middle of form typing and want to type something else such as an envelope or a short memo, you don't have to abandon what you are doing. Simply press the **[TYPE]** key to switch to **TW** mode, do your typing, then press the **[TYPE]** key again to switch back to form typing mode at the point where you left off.

If you want to quit form typing and select a different option, you can switch back to the **MAIN MENU** from the **F TYPE INDEX** screen by pressing the **[FILE]** key. If you wish to switch back to the **MAIN MENU** while creating or editing a form, you must first save your file as discussed before, as you cannot select **WP** or **FILE MANAGEMENT** with a document still open. After saving the file, press the **[FILE]** key again to return to the **MAIN MENU**.

### Note!

1. You cannot use **[TYPE]** to switch from **TW** mode to **F TYPE** mode unless **F TYPE** mode has already been selected from the **MAIN MENU**.



# FILE MANAGEMENT

## Organizing Your Files

*This section tells you how to use the floppy disk drive on your typewriter, how to copy, rename, and delete your documents, and how to convert them to and from formats used by other wordprocessors.*

### File Management Menu

The **FILE MANAGEMENT** menu allows you to organise the data on your disks, in a similar way to a paper filing system.

You can:

- copy individual document files from one disk to another.
- delete files that you no longer need from the disk.
- rename files.
- convert files to/from other wordprocessor formats.
- delete all files from the disk.

To select file management:

1. First make sure you have a disk containing your files inserted into the disk drive.
2. Make sure the main menu is displayed on the screen.



Press the **[4]** key to select file management.

When you select the file management option, you will see this display.

```

<<FILE MANAGEMENT>>          REMAIN:317.4K
■DOCFILE1.WPT( 3.2)  DOCFILE2.WPT( 1.3)
  
```

This is the file management index screen. It shows the amount of space remaining on the disk in thousands of characters, and the names of your files that are stored on the disk, together with amount of disk space taken up by the files.

The names of the files, will, of course, not be "DOCFILE1 and 2", but the names you have given to your files.

Since the display has only two lines, you can only see two file names at the moment (assuming there are at least two files on the disk). To see the names of other files on the disk, use **[R INDEX]** and **[INDEX]** to scroll the display.

```

DOCFILE1.WPT( 3.2)  DOCFILE2.WPT( 1.3)
■DOCFILE3.WPT( 3.2)  DOCFILE4.WPT( 1.3)
  
```

The letters ".WPT" after the file name are called the **FILE NAME EXTENSION**, and mean that these are Brother wordprocessor files that can be read by your typewriter.

Other types of files that might be on the disk are:

Form typing files:

**FILENAME.FTP**

Brother wordprocessor files from CE/EM1050:

**FILENAME (NO EXTENSION)**

ASCII text files produced on a personal computer,

which can be converted to .WPT files:

**FILENAME.TXT**

There may also be a user dictionary file and an abbreviated phrase file on the disk, but these are "hidden files" and cannot be seen on the **FILE MANAGEMENT** index screen.

If the disk has previously been used on a personal computer, there may also be other files on it that cannot be read by your typewriter.

## The File Management Menu

All file management operations begin by choosing a file from the file management index screen, and selecting the **FILE MANAGEMENT** menu.

- Using the cursor keys, select a file from the list.

```

DOCFILE1.WPT( 3.2)  DOCFILE2.WPT( 1.3)
DOCFILE3.WPT( 2.2)  █DOCFILE4.WPT( 1.8)
  
```

- Press the **[MENU]** key.

The following menu screen will appear:

```

▶ MENU4
█: COPY 2: DEL 3: REN 4: CONU 5: DISK DEL
  
```

## Copying A File

To copy the selected file:

- Press the **[1]** key. The file will be read into the typewriter's memory, and the following message will appear.

```

▲INSERT DESTINATION DISK AND PRESS RTN.
DOCFILE3.WPT( 3.2)  █DOCFILE4.WPT( 1.3)
  
```

- If you want to copy the file onto a different disk, remove the disk containing the original file and insert a different one, then press the **[RETURN]** key.

You can also copy the file to a different file name on the same disk. This can be useful if you wish to edit a copy of a document without altering the original. If you wish to do this, do not change the disk, just press the **[RETURN]** key.

The following message will appear:

```
△TYPE FILENAME AND PRESS RTN.  
FILENAME: DOCFILE1■WPT
```

3. If you want to change the name of the file, type in the new file name. You must do this if you are copying the file onto the same disk.
4. Press the [RETURN] key.

The following message will appear:

```
△PLEASE WAIT.....
```

When the file has been copied, the display will return to the file management index screen.

```
<<FILE MANAGEMENT>>          REMAIN: 317.4K  
■DOCFILE1.WPT( 3.2)  DOCFILE2.WPT( 1.3)
```

If a file with the same name already exists on the destination disk, a warning message will appear:

```
△FILE EXISTS.  PRESS RTN TO OVERWRITE.  
FILENAME: DOCFILE1■WPT
```

If you wish to replace the file with a new one, press the [RETURN] key to overwrite it. If you do not wish to overwrite the file, you can type in a different file name

```
△TYPE FILENAME AND PRESS RTN.  
FILENAME: NEWNAME■.WPT
```



## Deleting A File

To delete the selected file from the disk:

1. Call up **FILE MANAGEMENT** menu as before, then press the [2] key to select **DEL** from the menu.

The following message will appear:

```

┌DELETE? Y/N
│DOCFILE3.WPT( 3.2)  █DOCFILE4.WPT( 1.3)
└

```

Press the [Y] key if you wish to delete the file, or the [N] key if you do not wish to delete the file.

After deleting the file (or not) the display will return to the file management index screen.

## Renaming A File

To rename a file:

1. Call up **FILE MANAGEMENT** menu as before, then press the [3] key to select **REN** from the menu. The following message will appear:

```

┌TYPE FILENAME AND PRESS RTN.
│FILENAME:DOCFILE4█.WPT
└

```

2. Type in the new file name and press [RETURN].

```

┌TYPE FILENAME AND PRESS RTN.
│FILENAME:NEWNAME█.WPT
└

```

The file will be renamed and the display will return to the file management index screen.

If a file with the new name is already on the disk, the following message will appear:

```

FILE EXISTS.  PRESS RTN TO OVERWRITE.
FILENAME: NEWNAME.WPT
  
```

Type in a different file name and press [RETURN].

```

FILE EXISTS.  PRESS RTN TO OVERWRITE.
FILENAME: NEWNAME2.WPT
  
```

## File Conversion

File conversion allows you to convert files produced on your typewriter into ASCII text files that can be read by most wordprocessors for IBM-compatible personal computers. You can also convert ASCII files produced on a personal computer word processor and files produced by a Brother CE/EM-1050 wordprocessor, so that they can be read by your typewriter.

(ASCII stands for American Standard Code for Information Interchange, and is a standard defining the binary codes that represent alphanumeric and other characters).

To convert a file from one format to another:

1. Call up **FILE MANAGEMENT** menu as before, then press the [4] key to select **CONV** from the menu. The following message will appear:

```

MENU
1: WP 2: ASCII 3: WP 4: WP200/EM1050
  
```

Press [1], [2] or [3] to select the type of conversion you wish to perform, for example [2] for ASCII to WP. Thereafter the procedure is identical for each type of conversion.

An index of the type of files valid for that conversion will be displayed.

```

<<CONVERT INDEX>>          REMAIN: 700.4K
1: XTFILE1.TXT( 2.2)  TXTFILE2.TXT( 1.4)
  
```

Use the cursor keys to select the file you wish to convert.

```

TXTFILE1.TXT( 2.2)  TXTFILE2.TXT( 1.4)
█XTFILE3.TXT( 3.2)  TXTFILE4.TXT( 1.1)
  
```

Press **[RETURN]** and the following message will appear:

```

▲INSERT DESTINATION DISK AND PRESS RTN.
█XTFILE3.TXT( 3.2)  TXTFILE4.TXT( 1.1)
  
```

If you wish to save the converted file on a different disk, change the disk and press **[RETURN]**. If you wish to save the converted file on the same disk, simply press **[RETURN]**.

You will be asked to type the name for the converted file. The default is just the original file name with a different extension.

```

▲TYPE FILENAME AND PRESS RETURN.
FILENAME:TXTFILE1.WPT
  
```

Type in the new file name and press **[RETURN]**, or simply press **[RETURN]** if you want to keep the original filename.

The file will be converted and saved on the disk.

If a file with the same name and extension already exists on the disk, the following message will appear:

```

▲FILE EXISTS. PRESS RTN TO OVERWRITE.
FILENAME:TXTFILE1.TXT
  
```

Press **[RETURN]** if you wish to replace the existing file, otherwise type in a different file name and press **[RETURN]**.

### Warning!

If you are converting a file from a disk used on a WVP200/EM1050 machine, you must always save the converted file onto a different disk, initialized on your typewriter, because disks from these machines have a different format. Your typewriter can read a file from a WVP200/EM1050 disk but it cannot save a file onto one. If you try to save your converted file onto a WVP200/EM1050 disk, your typewriter will ask you to change the disk for a correct one.

## Deleting All Files

There may be occasions when the documents and other files stored on your disk are no longer needed, and you wish to re-use the disk for new files. Deleting files one at a time can be tedious, so the **DISK DEL** option allows you to delete everything on the disk.

To delete everything from the disk, you do not need to select a file from the file management index screen.

1. Call up the **FILE MANAGEMENT** menu, then press the **[5]** key to select **DISK DEL** from the menu.

The following message will appear:

```
DELETE ALL FILES ON THIS DISK? Y/N
```

2. Press the **[Y]** key to delete the disk or the **[N]** key to abandon the operation.

The following message will appear:

```
PLEASE WAIT....
```

When the disk has been deleted (or not), the display will return to the **FILE MANAGEMENT** index screen.

### Note!

**DISK DEL** will delete all files on the disk, including the user dictionary, abbreviated phrase file and other files that cannot be read by your typewriter or viewed in the **FILE MANAGEMENT** index screen.

## Switching Back To TW Mode Or Main Menu

If you are in the middle of organizing your files and want to type something such as an envelope or a short memo, you don't have to abandon what you are doing. Simply press the [TYPE] key to switch to **TW** mode, do your typing, then press the [TYPE] key again to switch back to **FILE MANAGEMENT** mode at the point where you left off.

If you want to quit **FILE MANAGEMENT** completely and select a different option, press the [FILE] key to return to the **MAIN MENU**.

### Note!

1. You cannot use [TYPE] to switch from **TW** mode to **FILE MANAGEMENT** mode unless **FILE MANAGEMENT** mode has already been selected from the **MAIN MENU**.



# APPENDIX

## Maintenance and Troubleshooting

*Your Brother electronic typewriter has been precision manufactured to give you years of trouble-free use with the minimum of routine maintenance. In the unlikely event that your typewriter fails to work correctly, the troubleshooting guide will help you to find the cause of the problem. If the steps suggested in the troubleshooting guide fail to cure the problem, please do not attempt to repair the typewriter yourself. Instead, please contact your nearest Brother dealer.*

### **Maintenance**

#### **Environment**

Your typewriter dislikes direct sunlight, excessive heat from heaters or radiators, dust and humidity.

Keep it in a cool dry, dust-free environment, and keep it covered when not in use. Do not obstruct the ventilation slots at the back of the typewriter, and do not cover them with a dust cover when the power is switched on.

You should mount the typewriter on a flat, stable surface, with easy access to a power socket.

#### **Cleaning**

The keyboard and print mechanism of your typewriter dislike dirt and foreign objects such as pins, paperclips, food and hair.

Maintenance simply consists of keeping your typewriter clean inside and outside, removing any foreign debris, and keeping the machine covered when not in use.

You should clean the typewriter with a soft cloth, and you may clean the keyboard with a proprietary keyboard cleaner, used sparingly. You should not use water, alcohol, thinners or any other solvents.

Do not attempt to push anything into the ventilation slots at the back of the typewriter, or into any other openings in the case.

## Supplies

For best results, use only Brother branded cassette daisy wheels, cassette ribbons and correction tapes.

After all, only the best is good enough for your Brother typewriter!



## Troubleshooting

PROBLEM	POSSIBLE CAUSE	ACTION
1. Nothing works	<ol style="list-style-type: none"> <li>1. Typewriter not plugged in</li> <li>2. Typewriter not switched on</li> <li>3. Cover not properly closed</li> </ol>	<p>Plug it in!</p> <p>Switch it on!</p> <p>Close it!</p>
2. It still doesn't work!	<ol style="list-style-type: none"> <li>1. Mains socket not working</li> <li>2. Blown fuse in plug</li> </ol>	<p>Check using another appliance</p> <p>Check and replace if necessary. Contact your dealer if problem recurs</p>
3. Characters do not print or are faint	<ol style="list-style-type: none"> <li>1. Daisy wheel inserted incorrectly</li> <li>2. Cassette ribbon has run out</li> <li>3. Cassette ribbon inserted incorrectly</li> <li>4. Impact setting too light</li> <li>5. Paper thickness lever in up position</li> </ol>	<p>Re-insert correctly</p> <p>Replace</p> <p>Re-insert correctly</p> <p>Change setting Push it down</p>
4. Characters are missing	<ol style="list-style-type: none"> <li>1. Daisy wheel has broken petal</li> </ol>	<p>Replace daisy wheel</p>
5. Correction does not work	<ol style="list-style-type: none"> <li>1. Correction tape has run out</li> <li>2. Correction tape installed incorrectly or back to front</li> <li>3. Wrong type of correction tape</li> </ol>	<p>Replace</p> <p>Re-install correctly</p> <p>Use correct type to suit the cassette ribbon</p>
6. Display Message ▲RAM DOWN.	<ol style="list-style-type: none"> <li>1. RAM memory fault</li> </ol>	<p>Consult your dealer</p>
7. Display Message ▲ROM DOWN.	<ol style="list-style-type: none"> <li>2. Program ROM fault</li> </ol>	<p>Consult your dealer</p>
8. Display Message ▲CHECK PRINTER.	<ol style="list-style-type: none"> <li>3. Faulty print mechanism</li> </ol>	<p>Consult your dealer</p>

# Specifications

Printing Method	Cassette daisy wheel (96 characters)
Printing Speed	20 characters per second
Typing Pitches	10 (maximum 120 characters per line) 12 (maximum 144 characters per line) 15 (maximum 180 characters per line) PS (proportional spacing)
Line Spacing	Single (6 lines per inch) 1 1/2 (4 lines per inch) Double (3 lines per inch)
Paper Capacity	393.7 mm (15.5 inches)
Typing Capacity	304.8 mm (12 inches)
Correction Memory	Two lines
Copy Capacity	Original + 4 copies
Cassette ribbon	Correctable film ribbon (standard equipment) One-time film ribbon Multi-strike film ribbon Nylon ribbon
Correction tape	Lift-off correction tape (standard equipment) Cover-up correction tape
Power Consumption	60 W
Dimensions	500 mm (W) x 428 mm (D) x 150 mm (H) 19.68 in (W) x 16.85 in (D) x 5.9 in (H)
Weight	9 kg

Specifications are subject to change without notice.

# Extra Characters and Symbol Keyboard

## Additional and Alternate Characters

Key/Key Combination	Keyboard 1	Keyboard 2
[CODE] + U	>	
[CODE] + V	³	ç
[CODE] + W	<	*
[CODE] + X	²	¥
[CODE] + Y	¶	#
[CODE] + Z	§	ß
±	±	°
[SHIFT] + ±	^	=
[SHIFT] + 2	@	"
[SHIFT] + 3	#	/
[SHIFT] + 5	%	£
[SHIFT] + 6	¢	—
[SHIFT] + 8	*	'
[SHIFT] + -	_	%
1/2	1/2	'
[SHIFT] + 1/2	1/4	"
]	]	`
[SHIFT] + ]	[	
[SHIFT] + ;	:	Ñ
'	'	í
[SHIFT] + '	"	¿
[SHIFT] + ,	,	?
/	/	;
[SHIFT] + /	?	

## Keyboard 3 (Symbol Keyboard)

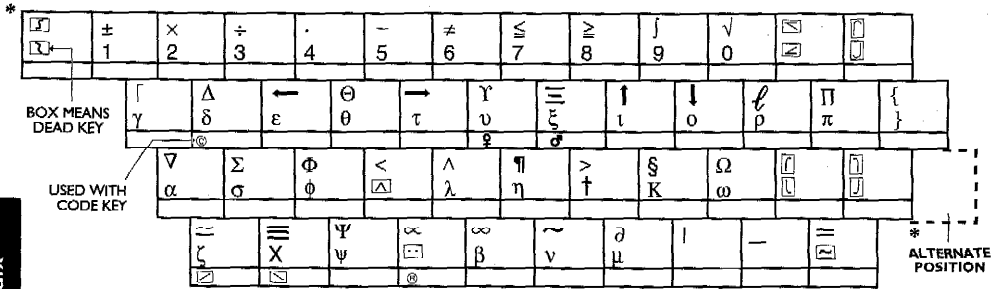

## Daisy Wheel Codes for Multilingual Keyboards

### Language

American English I (with < )  
 Brazilian (Portuguese)  
 Canadian French  
 Danish  
 Dutch  
 English  
 French  
 German  
 Greek  
 Icelandic  
 Italian  
 Japanese English (with •)  
 Latin  
 Latin American Spanish  
 Norwegian  
 Portuguese  
 South African  
 Spanish  
 Swedish  
 Swiss (French/German)  
 Turkish

### Daisy Wheel Label

A. ENG 02  
 POR 64  
 CAN 16  
 NOR/DAN 70  
 DUTCH 32  
 ENG 14  
 FRENCH 20  
 GERMAN 08  
 GREEK 42  
 ICE 74  
 ITALIAN 52  
 J. ENG 05  
 LATIN 53  
 L. SPA 27  
 NOR/DAN 70  
 POR 64  
 S. AFR 31  
 S-SPAI 76  
 FIN/SWE 60  
 SWISS 36  
 TURKISH 29

# Index



- A**
- Abbreviated Phrases ..... 15-1
  - About This User Guide ..... 1-4
  - About your Typewriter ..... 1-4
  - Acoustic Cover ..... 1-7
  - Adding A Word ..... 17-5
  - Adding Or Editing An Abbreviated Phrase ..... 15-2
  - Adding Text To A File In Printing Mode ..... 10-11
  - Advantages Of Wordprocessors ..... 1-11
  - All Tab Clear ..... 9-10
  - ALT and CODE Keys ..... 1-8
  - Auto Save ..... 6-11
  - Auto tab set ..... 9-10
  - Automatic Carrier Return ..... 2-6
  - Automatic Paper Insertion .. 16-21
  - Automatic Underline ..... 7-3
- B**
- Backing up a Disk ..... 2-7
  - Backspace Or Character Correction ..... 10-12
  - Backspacing ..... 4-8
  - Basic Typing ..... 3-1
  - Basic Wordprocessing ..... 10-1
  - Block Functions And Formatting ..... 13-5
  - Block Operations ..... 13-1
  - Bold Text ..... 7-2
- C**
- Caps ..... 7-2
  - Caring for Your Disks ..... 2-5
  - Carrier Return ..... 3-8
  - Cassette Daisy Wheel ..... 1-9
  - Cassette Ribbon ..... 1-10
  - Centering ..... 6-3
  - Centering At The Carrier Position ..... 6-3
  - Centering Between Margins ..... 3-5
  - Centering Between Tabs ..... 3-5
  - Centering In WP Mode ..... 2-5
  - Changing A Form ..... 6-9
  - Changing A Line Format ..... 2-10
  - Changing Settings ..... 6-8
  - Changing The Format ..... 11-3
  - Character Correction ..... 1-12
  - Checking The Format And Status ..... 11-5
  - Checking The Whole Document ..... 17-7
  - Closing the top cover ..... 1-8
  - Continuous Underline ..... 7-3
  - Copying A Block ..... 13-1
  - Copying A File ..... 19-6
  - Copying Text From Temporary Memory ..... 13-4
  - Correction Tape ..... 1-12
  - Corrections in L/L, JUSTIFY And WP Modes ..... 8-12
  - Corrections In NORMAL And AUTO mode ..... 1-12
  - Creating A Form Typing File ..... 1-9
  - Creating Or Editing A Document ..... 4-11
  - Cursor Keys ..... 4-8

**D**

Dead Keys ..... 7-6  
 Decimal Tabs ..... 8-10  
 Defining A Search String ..... 14-5  
 Deleting A Block ..... 13-5  
 Deleting A File ..... 19-5  
 Deleting A Format ..... 11-4  
 Deleting A Line ..... 8-12  
 Deleting A Phrase ..... 15-4  
 Deleting A Word ..... 11-12  
 Deleting All Files ..... 19-8  
 Deleting All Phrases ..... 15-5  
 Deleting All Words ..... 17-9  
 Deleting Incorrect Text ..... 10-12  
 Deleting Words From The User  
 Dictionary ..... 17-8  
 Deletions ..... 8-5  
 Drawing A Rectangular Frame ... 9-3  
 Drawing A Tabular Grid ..... 9-4

**E**

Ending A Line ..... 4-6  
 Entering Header Or Footer  
 Text ..... 11-7  
 Expanded Typing ..... 7-4  
 Express backspace ..... 5-8  
 Extra Characters ..... 7-7

**F**

File Conversion ..... 19-6  
 FILE MANAGEMENT ..... 19-1  
 File Management Menu ..... 19-1  
 Filling In A Form ..... 5-9  
 Find Mode ..... 17-3  
 Form Typing ..... 18-1  
 Format Memory Reset ..... 2-10  
 Formatting Your Document ..... 11-1  
 Framing and Line Drawing ..... 9-1  
 FUNCTION KEYS ..... 1-1

**G**

GETTING STARTED ..... 1-1  
 Glare Screen ..... 1-7

**H**

Horizontal Line Drawing ..... 9-1  
 Hyphen Scan ..... 14-6

**I**

Indent Clear ..... 2-5  
 Indentation ..... 1-5  
 Index and Reverse Index ..... 3-8  
 Initializing New Disks ..... 2-4  
 Inserting and Removing a Floppy  
 Disk ..... 2-3  
 Inserting Or Overwriting  
 Text ..... 8-12  
 Inserting Text ..... 8-12  
 Inserting Text At A Stop Code 16-5  
 Inserting the new cassette daisy  
 wheel ..... 1-10  
 Inserting the new cassette  
 ribbon ..... 1-11  
 Insertions ..... 8-5  
 Insertions And Deletions ..... 8-4  
 Installing the new correction  
 tape ..... 1-13

**J**

Justification In WVP Mode ..... 11-1  
 Justified ..... 5 6  
 Justified Typing ..... 5-6

**L**

Layout Indicators ..... 8-11  
 Left-aligned ..... 5-6  
 Line Format Memory ..... 1 10  
 Line Indentation ..... 1-5  
 Line Out ..... 3-12  
 Line-By-Line ..... 3-6  
 Loading A Phrase File ..... 15-5  
 Loading A User  
 Dictionary ..... 17-9  
 Loading Paper ..... 1-15

**M**

- Maintaining The User
  - Dictionary ..... 17-8
- Maintaining Your Phrase Files .... 15-2
- Making Corrections ..... 8-1
- Manual Correction ..... 7-12
- Manual Paper Adjustment ..... 17-21
- Margin Release ..... 5-10
- Margin scale ..... 1-7
- Margins And Page Length ..... 4-10
- Menu Items ..... 1-5
- Micro backspace ..... 5-8
- Micro Index/Reverse Index ..... 4-8
- Moving A Block ..... 13-4
- Moving Across The Page ..... 7-11
- Moving Around The Page
  - ..... 3-8, 7-11
- Moving Up And Down The
  - Page ..... 7-11
- Multilingual Keyboards ..... 19-21

**N**

- Non-Printing Mode ..... 3-11
- Normal (Manual Carrier
  - Return) ..... 1-6
- Normal tabs ..... 7-10

**O**

- One Word Spelling Check ..... 17-5
- Opening the top cover ..... 1-8
- Organizing Your Files ..... 19-1
- Overwriting Text ..... 9-12

**P**

- Page Breaks ..... 11-8
- Page Format ..... 11-5
- Paper Supporter ..... 1-6
- Paper Thickness Control ..... 1-18
- Paragraph Indentation ..... 1-5
- Permanent Spaces and
  - Hyphens ..... 5-6
- Permanent Spaces In W/P Mode ..... 5

- Preset Margins ..... 4-10
- Printing Mode ..... 3-11
- Printing The Current Page ..... 1-5
- Printing The Whole
  - Document ..... 2-5
  - Printing Your Document ..... 16-1

**R**

- Recovering An Auto Save File ..... 6-11
- Redundancy Check ..... 17-5
- Relocation ..... 6-12, 5-8
- Removing the cassette daisy
  - wheel ..... 1-9
- Removing the old cassette
  - ribbon ..... 1-10
- Removing the old correction
  - tape ..... 1-12
- Renaming A File ..... 19-5
- Right Margin Flush ..... 4-5, 3-5

**S**

- Saving A Phrase File ..... 15-6
- Saving A User Dictionary ..... 17-10
- Saving Your Document ..... 10-4
- Search ..... 14-1
- Search And Replace ..... 14-3
- Searching And Replacing
  - Text ..... 14-1
- Selecting A Format ..... 11-4
- Selecting A Line Format ..... 1-10
- Selecting Keyboard ..... 7-8
- Selecting TW Operation ..... 2-8
- Selecting Typing Mode ..... 1-6
- Selecting W/P Mode ..... 2-11
- Self-Demonstration ..... 1-18
- Setting And Using Tabs ..... 7-10
- Setting Fnd Position
  - (Page Length) ..... 6-10
- Setting Impact ..... 7-8
- Setting Left Margin ..... 5-10
- Setting Line Spacing ..... 3-10

- Setting Margins ..... 5-10
- Setting Right Margin ..... 5-10
- Setting Start Position  
(Top Margin) ..... 6-10
- Setting The Hot Zone ..... 10
- Setting the Line Format ..... 1
- Setting The Paper Size ..... 11-62
- Setting Typing Pitch ..... 3-10
- Setting up the Typewriter ..... 6-7
- Setting Up Your Typewriter ..... 1
- Shift ..... 7-1
- Shift And Caps Keys ..... 7-1
- Shift lock ..... 7-2
- Simple backspace ..... 4-8
- Spelling Checker ..... 17-1
- STATUS INDICATORS ..... 7-8
- Status Indicators ..... 6-8
- Stop Codes ..... 5
- Subscript ..... 7-5
- Subscript And Superscript ..... 7-5
- Superimposed Characters ..... 7-7
- Superscript ..... 7-5
- Support arm ..... 6-7
- Switching Back To TW Mode Or  
MAIN MENU ..... 18-9
- Switching The Machine On And  
Off ..... 14-1
- T**
- Tab Clear ..... 9-10
- Tab Key ..... 3-8
- Temporary Memory ..... 13-3
- Text Alignment in TW Mode ..... 6-1
- Text Alignment in WP Mode ... 12-1
- Text Attributes ..... 7-1
- The Disk Drive ..... 2-1
- The File Management  
Menu ..... 19-3
- The Format Menu ..... 11-2
- The Hot Zone ..... 4-2
- The Keyboard ..... 1-8
- The Wordprocessor Screen ..... 10-6
- Top Cover ..... 1-8
- Types Of Disk Your Machine Can  
Use ..... 2-2
- Typewriter Operation ..... 3-2
- Typing In WP Mode ..... 10-10
- U**
- Using Abbreviated Phrases ..... 15-6
- Using Decimal Tabs ..... 5-8
- Using GO TO ..... 11-9
- Using Phrases In Display Typing  
Modes ..... 15-6
- Using Phrases In NORMAL And  
AUTO Modes ..... 15-8
- Using the Spell Checker in WP  
Printing Mode ..... 17-7
- Using The Spelling Checker In TW  
Mode ..... 17-2
- Using The Spelling Checker In WP  
Mode ..... 17-6
- Using the Wordprocessor ..... 10-1
- V**
- Vertical Line Drawing ..... 9-2
- W**
- What is a Disk Drive? ..... 2-1
- What is a File? ..... 2-2
- Word Out ..... 8-2
- Word Wrap ..... 10-10
- Word-By-Word Underline ..... 7-4
- Write-Protecting Your Disks ..... 2-6



# IMPORTANT!

REMOVE THE PACKING PIECES AS SHOWN BEFORE USING THE TYPEWRITER

