

MFC-8870DW

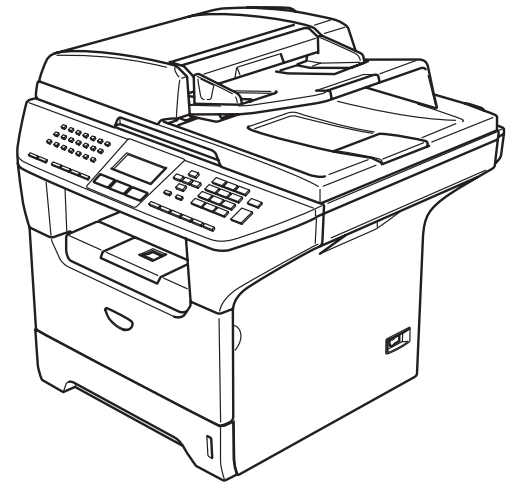

Before you can use the machine, you must set up the hardware and install the driver. Please read this 'Quick Setup Guide' for proper set up and installation instructions.

STEP 1

Setting Up the Machine







STEP 2

Installing the Driver & Software

Setup is Complete!

Keep this 'Quick Setup Guide' and the supplied CD-ROM in a convenient place for quick and easy reference at all times.

Symbols used in this guide

 Warning	 Caution	 Improper Setup
Warnings tell you what to do to prevent possible personal injury.	Cautions specify procedures you must follow or avoid to prevent possible damage to the machine or other objects.	Improper Setup icons alert you to devices and operations that are not compatible with the machine.
 Note	 User's Guide, Software Guide or Network User's Guide	
Notes tell you how you should respond to a situation that may arise or give tips about how the current operation works with other features.	Indicates reference to the User's Guide or Network User's Guide which is on the CD-ROM we have supplied.	

Getting Started

Carton components	2
Control panel	3

STEP 1 – Setting Up the Machine

Install the drum and toner cartridge unit assembly	4
Load paper in the paper tray	5
Release the scanner lock	6
Install the power cord and phone line	6
Setting the date and time	8
Setting your station ID	9
Tone and pulse dialling mode	10
Setting the phone line type	10
Selecting a receive mode	11
Setting the LCD contrast	11

STEP 2 – Installing the Driver & Software

Windows®

For USB Interface Cable Users (For Windows® 98/98SE/Me/2000 Professional/XP/XP Professional x64 Edition)	14
For Parallel Interface Cable Users (For Windows® 98/98SE/Me/2000 Professional/XP/XP Professional x64 Edition)	17
For Windows NT® Workstation Version 4.0 Users (For Parallel Interface Cable Users)	20
For Wired Network Interface Users (For Windows® 98/98SE/Me/NT/2000 Professional/XP/XP Professional x64 Edition)	22
For Wireless Network Users (For Windows® 98/98SE/Me/NT/2000 Professional/XP/XP Professional x64 Edition in infrastructure mode)	25

Macintosh®

For USB Interface Cable Users	32
For Mac OS® 10.2.4 or greater	32
For Mac OS® 9.1 to 9.2	35
For Wired Network Interface Users	37
For Mac OS® X 10.2.4 or greater	37
For Mac OS® 9.1 to 9.2	40
For Wireless Network Users (For Mac OS® X 10.2.4 or greater only)	42

For Network Users

Installing the BRAdmin Professional configuration utility (For Windows® users)	50
Setting your IP address, Subnet Mask and Gateway using BRAdmin Professional (For Windows® users)	51
BRAdmin Light configuration utility (For Mac OS® X users)	52
How to set the machine's network settings to wireless LAN or wired LAN	53
Restoring the network settings to factory default	53

Options and Consumables

Options	54
Consumables	54



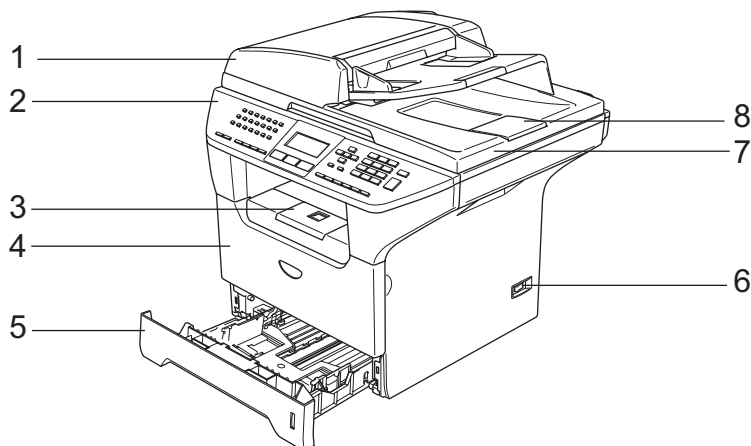

Carton components

Carton components may vary from one country to another.

Save all packing materials and the carton in case for any reason you must ship your machine.

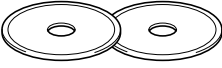

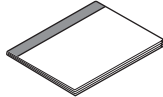
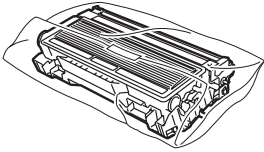
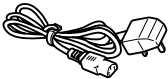
- | | |
|---|------------------------------------|
| 1 Automatic Document Feeder (ADF) | 5 Paper Tray |
| 2 Control Panel | 6 Power Switch |
| 3 Face-down Output Tray Support Flap (Support Flap) | 7 Document Cover |
| 4 Front Cover | 8 ADF Document Output Support Flap |

 <p>CD-ROMs For Windows® For Macintosh®</p>	 <p>Quick Setup Guide</p>	 <p>User's Guide</p>
 <p>Drum and Toner Cartridge Unit Assembly</p>	 <p>AC Power Cord</p>	 <p>Telephone line Cord</p>

The interface cable is not a standard accessory. Please purchase the appropriate interface cable for the interface you intend to use (Parallel, USB or Network).

Do NOT connect the interface cable at this time. Connecting the interface cable is done during the software installation process.

- USB interface cable
Please make sure you use a USB 2.0 interface cable that is no longer than 2.0 meters.
When you use a USB cable, make sure you connect it to the USB port of your computer and not to a USB port on a keyboard or non-powered USB hub.
- Parallel interface cable
Please make sure you use a Parallel interface cable that is no longer than 2.0 meters.
Use a shielded interface cable that is IEEE 1284-compliant.
- Network cable
Use a straight-through Category5 (or greater) twisted-pair cable for 10BASE-T or 100Base-TX Fast Ethernet Network.

Control panel

MFC-8870DW

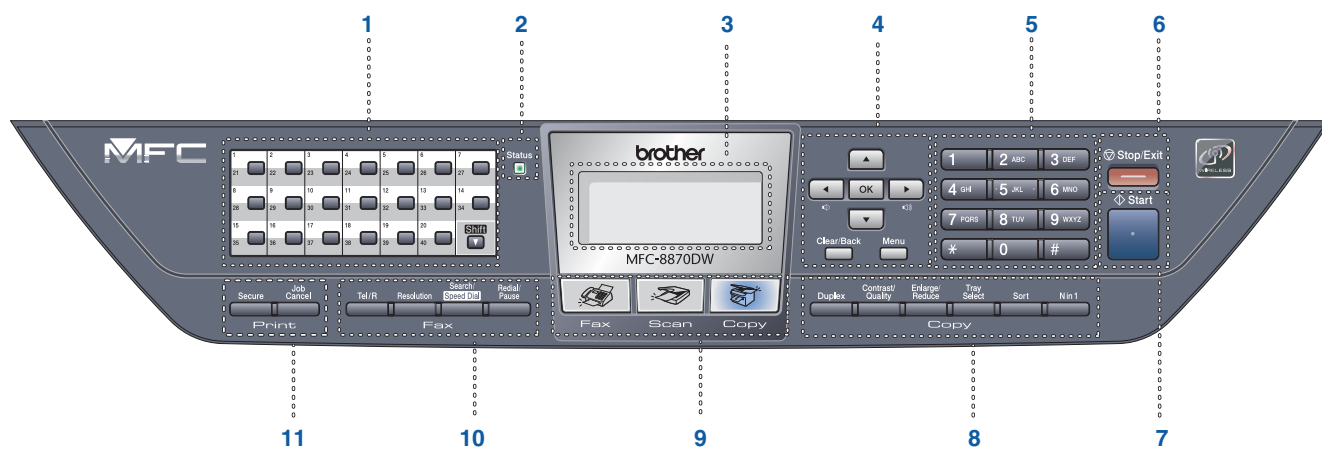

- | | |
|--------------------------------|---------------------------|
| 1 One Touch keys | 7 Start key |
| 2 Status LED | 8 Copy keys |
| 3 LCD (Liquid Crystal Display) | 9 Mode keys |
| 4 Menu keys | 10 Fax and telephone keys |
| 5 Dial Pad | 11 Print keys |
| 6 Stop/Exit key | |

 For the details of the control panel, see "Control panel overview" in Chapter 1 of the User's Guide.

Note

When you move the machine, grasp the side handholds that are under the scanner. Do NOT carry the machine by holding it at the bottom.

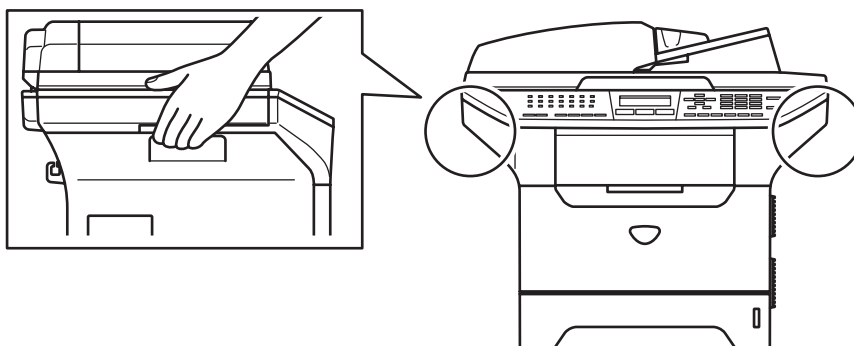

1 Install the drum and toner cartridge unit assembly

⊘ Improper Setup

DO NOT connect the interface cable.
Connecting the interface cable is done during the software installation process.

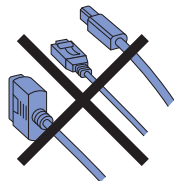

- 1** Open the front cover by pressing the front cover release button (1).

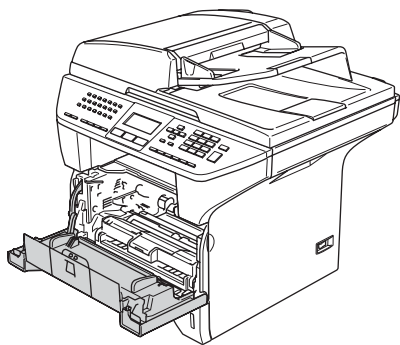
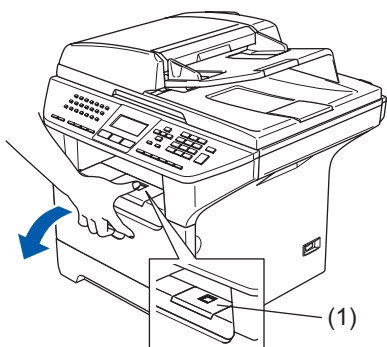

- 2** Unpack the drum and toner cartridge unit assembly.

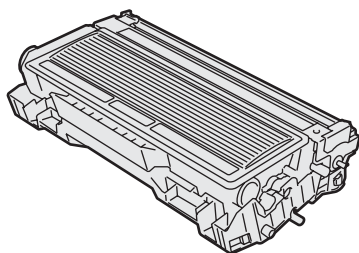

- 3** Gently rock it from side to side several times to distribute the toner evenly inside the assembly.

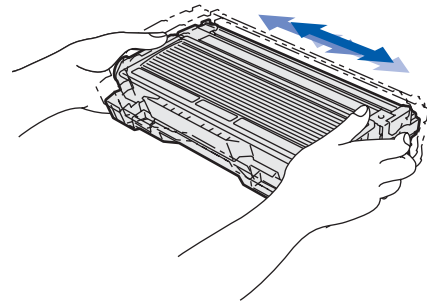

- 4** Put the drum unit assembly into the machine until it clicks into place.

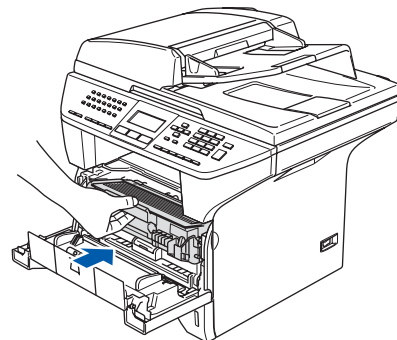

- 5** Close the front cover of the machine.

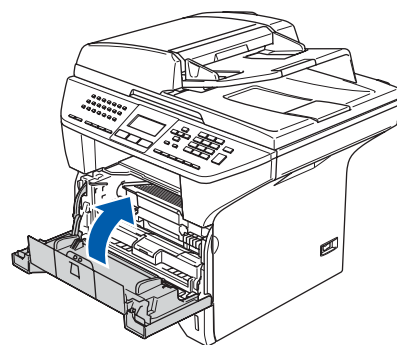

2 Load paper in the paper tray

- 1** Pull the paper tray completely out of the machine.

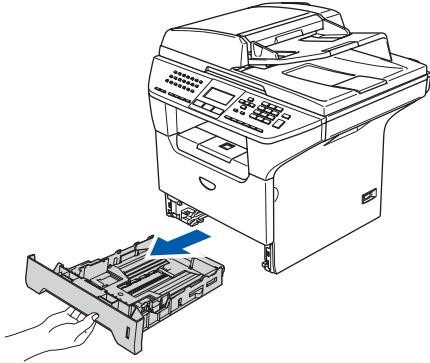

- 2** While pressing the blue paper guide release lever (1), slide the adjusters to fit the paper size. Check that the guides are firmly in the slots.

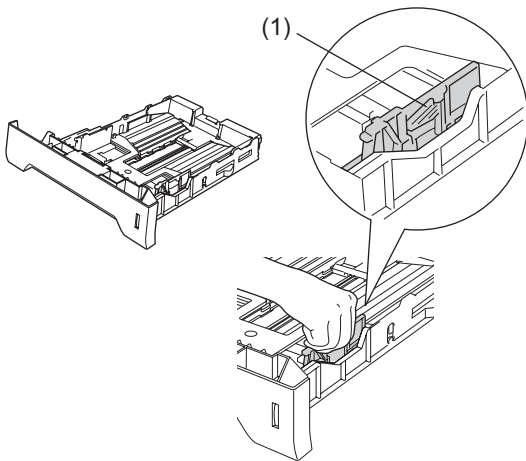

- 3** Fan the stack of paper well to avoid paper jams and misfeeds.

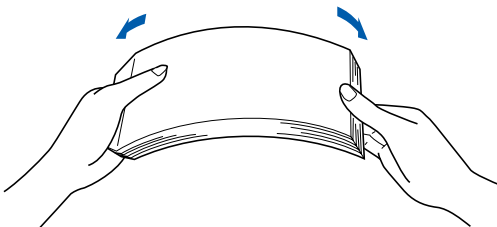

- 4** Put paper in the paper tray. Check that the paper is flat in the tray and below the maximum paper mark (1).

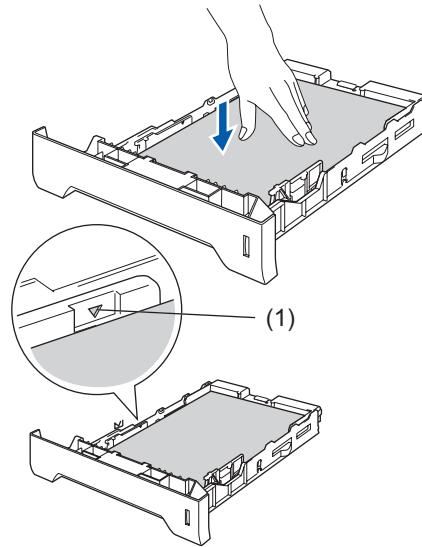

- 5** Put the paper tray firmly back into the machine and unfold the output tray support flap (1) before you use the machine.

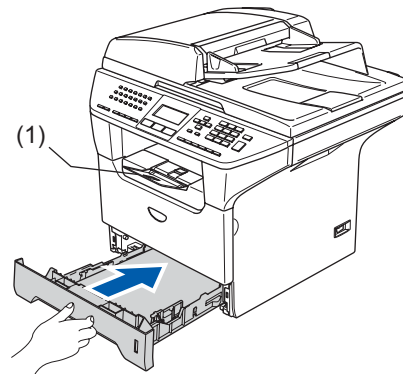

Note

For details on supported paper specifications, see "Acceptable paper and other media" in Chapter 2 of the User's Guide.

3 Release the scanner lock

- 1 Push the lever (1) in the direction shown to unlock the scanner.
(The grey scanner lock lever is located at the back left side, under the document cover (2).)

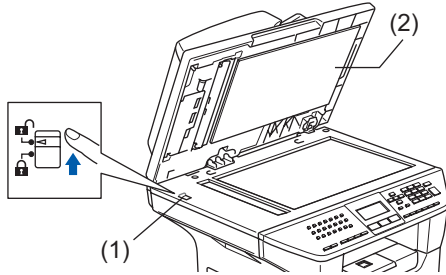

4 Install the power cord and phone line

- 1 Make sure that the machine power switch is off. Connect the AC power cord to the machine.

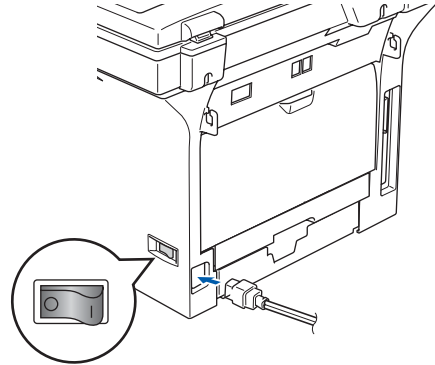

- 2 Plug the AC power cord into an AC outlet. Turn the power switch on.



Note

*If **Scanner Locked** appears on the LCD, immediately release the scanner lock and press **Stop/Exit**. (See "3. Release the scanner lock".)*

- 3 Connect one end of the telephone line cord to the socket on the machine marked **LINE** and the other end to a modular wall socket.

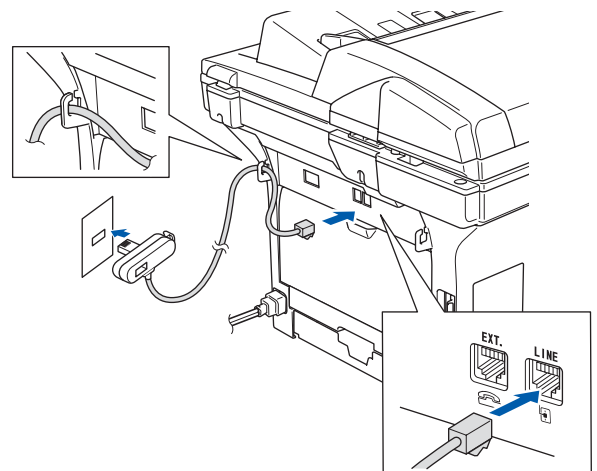

Warning

- The machine must be fitted with an earthed plug.
- Since the machine is grounded through the power outlet, you can protect yourself from potentially hazardous electrical conditions on the telephone network by keeping the power cord connected to your machine when you connect it to a telephone line. Similarly, you can protect yourself when you want to move your machine by disconnecting the telephone line first and then the power cord.

Note

If you are sharing one phone line with an external telephone, connect it as shown below.

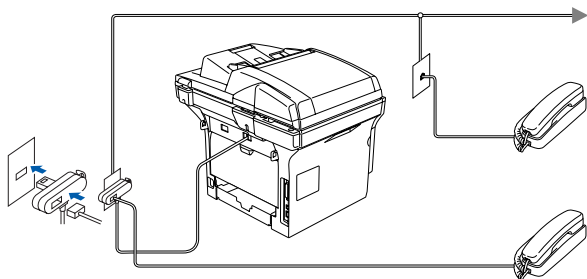

Note

If you are sharing one phone line with an external telephone answering device, connect it as shown below.

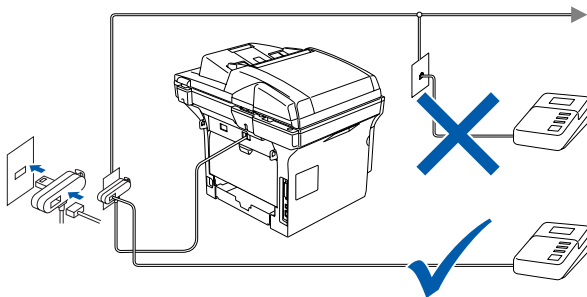

*Please set the receive mode to
External TAD.*

*For more details, see "Connecting an
external TAD" in Chapter 7 of the User's
Guide.*

5 Setting the date and time

The machine displays the date and time, and if you setup the station ID, the date and time will print on every fax you send.

- 1 Press **Menu**.
- 2 Press **0**.
- 3 Press **2**.
- 4 Enter the last two digits of the year on the dial pad, and then press **OK**.

02.Date/Time XX/03/2006
Year:2006
Enter & OK Key

(e.g. Enter **0, 6** for 2006.)

- 5 Enter the two digits for the month on the dial pad, and then press **OK**.

02.Date/Time XX/XX/2006
Month:03
Enter & OK Key

(e.g. Enter **0, 3** for March.)

- 6 Enter the two digits for the day on the dial pad, and then press **OK**.

02.Date/Time XX/03/2006
Day:25
Enter & OK Key

(e.g. Enter **2, 5**.)

- 7 Enter the time in 24-hour format on the dial pad, and then press **OK**.

02.Date/Time 25/03/2006
Time:15:25
Enter & OK Key

(e.g. Enter **1, 5, 2, 5** for 3:25 P.M.)

- 8 Press **Stop/Exit**.



Note

*If you make a mistake, press **Stop/Exit** to start from step 1.*

6 Setting your station ID

You should store your name and fax number to be printed on all fax pages that you send.

- 1 Press **Menu**.
- 2 Press **0**.
- 3 Press **3**.
- 4 Enter your fax number (up to 20 digits) on the dial pad, and then press **OK**. To enter a "+" for international dialling codes, press *****. For example, to enter the UK dialling code "+44", press *****, **4**, **4**, and then rest of your number.

```

03.Station ID
          Fax:
Enter & OK Key
    
```

- 5 Enter your telephone number (up to 20 digits) on the dial pad, and then press **OK**. (If your telephone number and fax number are the same, enter the same number again.)

```

03.Station ID
Fax:+44XXXXXXXXX
          Tel:
Enter & OK Key
    
```

- 6 Use the dial pad to enter your name (up to 20 characters), and then press **OK**.

```

03.Station ID
Fax:+44XXXXXXXXX
Tel:+44XXXXXXXXX
          Name:
Enter & OK Key
    
```

Press key	One time	Two times	Three times	Four times
2	A	B	C	2
3	D	E	F	3
4	G	H	I	4
5	J	K	L	5
6	M	N	O	6
7	P	Q	R	S
8	T	U	V	8
9	W	X	Y	Z





For more details, see "Entering Text" in Chapter D of the User's Guide.

7

Press **Stop/Exit**.





Note

- Refer to the following chart for entering your name.
- If you need to enter a character that is on the same key as the previous character, press  to move the cursor to the right.
- If you entered a letter incorrectly and want to change it, press  to move the cursor under the incorrect character, press **Clear/Back**.



7 Tone and pulse dialling mode

Your machine comes set for Tone dialling service. If you have Pulse dialling service (rotary), you need to change the dialling mode.

- 1 Press **Menu**.
- 2 Press **0**.
- 3 Press **4**.
- 4 Press  or  to choose Pulse (or Tone). Press **OK**.
- 5 Press **Stop/Exit**.

8 Setting the phone line type

If you are connecting the machine to a line that features a PABX (PBX) or ISDN to send and receive faxes, it is necessary to change the Phone Line Type accordingly by completing the following steps.

- 1 Press **Menu**.
- 2 Press **0**.
- 3 Press **6**.
- 4 Press  or  to choose the mode. Press **OK**.

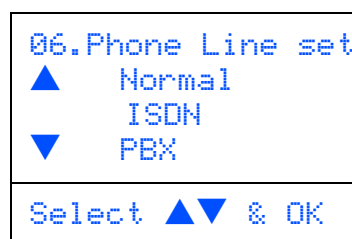

- 5 Press **Stop/Exit**.

PABX (PBX) and TRANSFER

The machine is initially set to Normal, which lets the machine connect to a standard PSTN (Public Switched Telephone Network) line. However, many offices use a central telephone system or Private Automatic Branch Exchange (PABX). Your machine can be connected to most types of PABX (PBX). The machine's recall feature supports timed break recall only (TBR). TBR will work with most PABX (PBX) systems allowing you to gain access to an outside line, or transfer calls to another extension. The feature works when **Tel/R** is pressed.

Note



You can program a **Tel/R** key press as part of a number stored in a One-Touch or Speed-Dial location. When programming the One-Touch or Speed-Dial number (**Menu, 2, 3, 1** or **2, 3, 2**) press **Tel/R** first (the screen displays "!"), then enter the telephone number. If you do this, you do not need to press **Tel/R** each time before you dial using a One-Touch or Speed-Dial location. (See "Storing numbers" in Chapter 8 of the User's Guide.) However, if PBX is not selected in the Phone Line Type setting, you cannot use the One-Touch or Speed-Dial number that **Tel/R** press is programmed into.

9 Selecting a receive mode

There are four possible receive modes: Fax Only, Fax/Tel, Manual and External TAD.

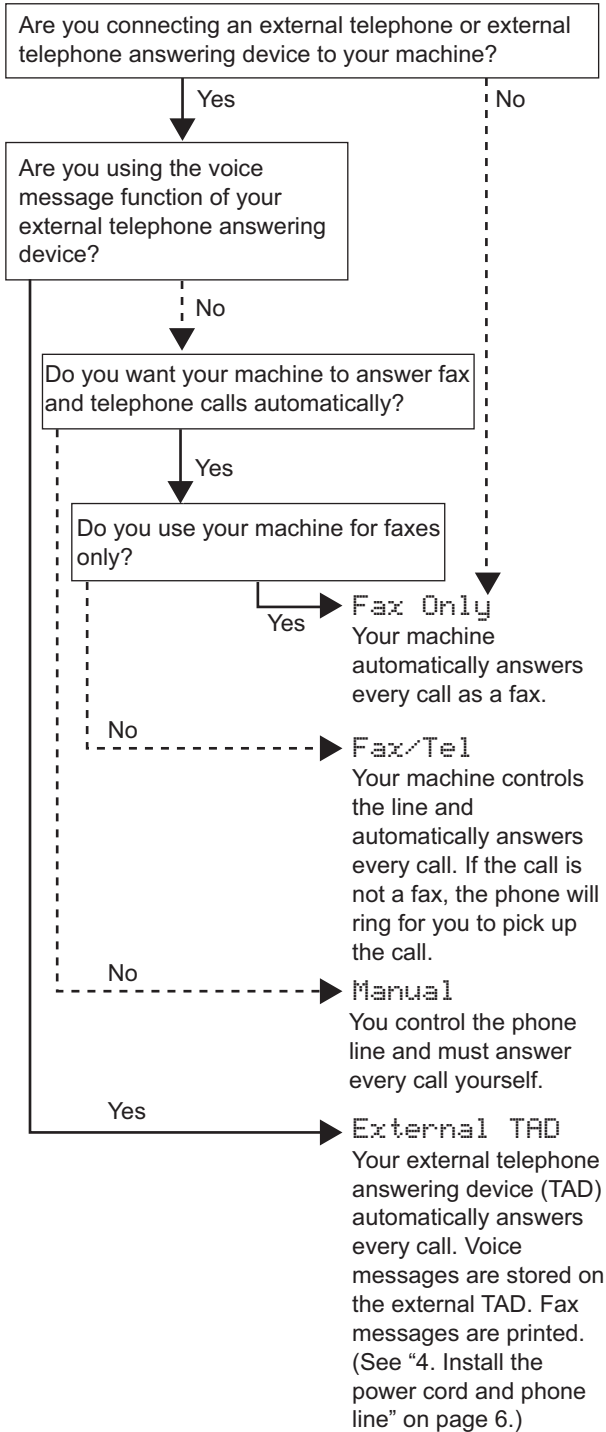
Choose the Receive Mode which best suits your needs.





- 1 Press **Menu**.
- 2 Press **0**.
- 3 Press **1**.
- 4 Press  or  to select the mode. Press **OK**.
- 5 Press **Stop/Exit**.



For more details, see "Receiving a fax" in Chapter 6 of the User's Guide.

10 Setting the LCD contrast

You can change the contrast to help the LCD look lighter or darker.

- 1 Press **Menu**.
- 2 Press **1**.
- 3 Press **8**.
- 4 Press  to increase the contrast.
—OR—
Press  to decrease the contrast. Press **OK**.
- 5 Press **Stop/Exit**.

Now go to

the next page to install the driver and software.

Supplied CD-ROM 'MFL-Pro Suite'

Windows®



Install MFL-Pro Suite

You can install the MFL-Pro Suite software and multifunction drivers.

Install Other Drivers or Utilities

You can install additional MFL-Pro Suite software utilities.

Documentation

View the User's Guide and other documents in PDF format (Viewer included). The User's Guide on the CD-ROM includes the Software and Network User's Guides for features available when connected to a computer (e.g. printing and scanning).

On-Line Registration

You will be pointed to the Brother Product Registration Web Page for quick registration of your machine.

Brother Solutions Center

You can access the Brother Solutions Center which is a Web site offering information about your Brother product including FAQs, User's Guides, driver updates and tips for using your machine.

Repair MFL-Pro Suite

(For USB and Parallel cable users only)

If an error occurred during the installation of the MFL-Pro Suite, use this selection to automatically repair and re-install the MFL-Pro Suite.

Note

MFL-Pro Suite includes Printer Driver, Scanner Driver, Brother ControlCenter2, ScanSoft® PaperPort® SE with OCR and True Type® fonts. PaperPort® SE is a document management application for viewing scanned documents.

Macintosh®

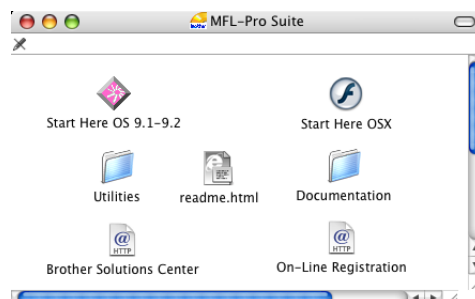

Start Here OS 9.1-9.2

You can install the printer driver, scanner driver and Presto!® PageManager® for Mac OS® 9.1-9.2.

Start Here OSX

You can install the MFL-Pro Suite that includes the printer driver, scanner driver and the Brother ControlCenter2 for Mac OS® 10.2.4 or greater. You can also install Presto!® PageManager® to add OCR capability to the Brother ControlCenter2 and easily scan, share and organize photos and documents.

readme.html

You can get important information and troubleshooting tips.

Documentation

View the User's Guide and other documents in PDF format. The User's Guide on the CD-ROM includes the Software and Network User's Guides for features available when connected to a computer (e.g. printing and scanning).

Brother Solutions Center

You can access the Brother Solutions Center which is a Web site offering information about your Brother product including FAQs, User's Guides, driver updates and tips for using your machine.

On-Line Registration

You will be pointed to the Brother Product Registration Web Page for quick registration of your machine.

Utilities

You can use additional Utilities in this folder.

STEP 2

Installing the Driver & Software

Follow the instructions on this page for your operating system and interface.
For the latest drivers and documentations and to find the best solution for your problem or question, access the Brother Solutions Center directly from the driver or visit <http://solutions.brother.com>.

Windows®



For USB Interface Cable Users
(For Windows® 98/98SE/Me/2000 Professional/XP/XP Professional x64 Edition).... 14



For Parallel Interface Cable Users
(For Windows® 98/98SE/Me/2000 Professional/XP/XP Professional x64 Edition).... 17



For Windows NT® Workstation Version 4.0 Users
(For Parallel Interface Cable Users) 20



For Wired Network Interface Users
(For Windows® 98/98SE/Me/NT/2000 Professional/XP/XP Professional x64 Edition).... 22



For Wireless Network Users (For Windows® 98/98SE/Me/NT/2000 Professional/XP/XP Professional x64 Edition in infrastructure mode) 25
For other setup methods supported, see the Network User's Guide on the CD-ROM for installation details.

Macintosh®



For USB Interface Cable Users..... 32
■ For Mac OS® 10.2.4 or greater 32
■ For Mac OS® 9.1 to 9.2 35



For Wired Network Interface Users 37
■ For Mac OS® X 10.2.4 or greater..... 37
■ For Mac OS® 9.1 to 9.2 40



For Wireless Network Users (For Mac OS® X 10.2.4 or greater only)..... 42
For other setup methods supported, see the Network User's Guide on the CD-ROM for installation details.

For USB Interface Cable Users (For Windows® 98/98SE/Me/2000 Professional/XP/ XP Professional x64 Edition)

Important

Make sure that you have finished the instructions from step 1 *Setting Up the Machine* on page 4 to 11.

Note

Please close any applications running before installing the MFL-Pro Suite.

- 1 Turn off and unplug the machine from the AC outlet and disconnect it from your computer, if you already connected an interface cable.

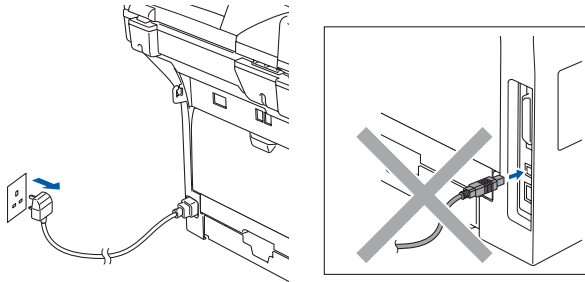

- 2 Turn on your computer. (For Windows® 2000 Professional/XP/XP Professional x64 Edition, you must be logged on with Administrator rights.)

- 3 Put the supplied CD-ROM for Windows® into your CD-ROM drive. If the model name screen appears, choose your machine. If the language screen appears, choose your language.



- 4 The CD-ROM main menu will appear. Click **Install MFL-Pro Suite**.



Note

If this window does not appear, use Windows® Explorer to run the **setup.exe** program from the root folder of the Brother CD-ROM.

- 5 Choose **Local Connection**, and then click **Next**. The installation will continue.

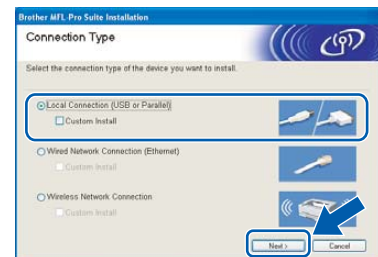

Note

If you want to install the PS driver (Brother's BR-Script Driver), choose **Custom Install** and then follow the on-screen instructions. When the **Select Components** screen appears, check **PS Printer Driver**, and then continue following the on-screen instructions

- 6** After reading and accepting the ScanSoft® PaperPort® SE License Agreement, click **Yes**.

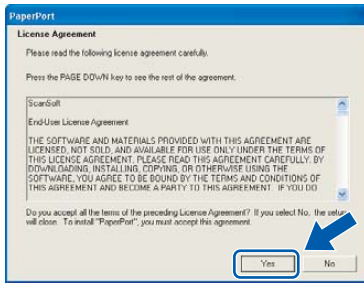

The installation of PaperPort® SE will automatically start and is followed by the installation of MFL-Pro Suite.

- 7** When the Brother MFL-Pro Suite Software License Agreement window appears, click **Yes** if you agree to the Software Licence Agreement.

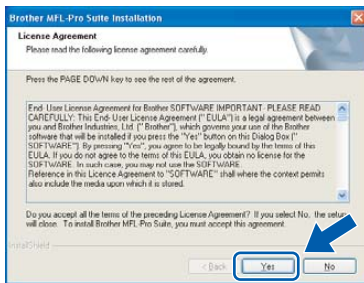

- 8** When this screen appears, connect the USB interface cable to your PC, and then connect it to the machine.
(For Windows® XP/XP Professional x64 Edition)

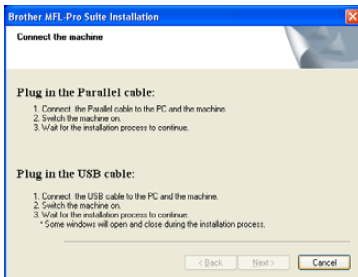

(For Windows® 98/98SE/Me/2000)

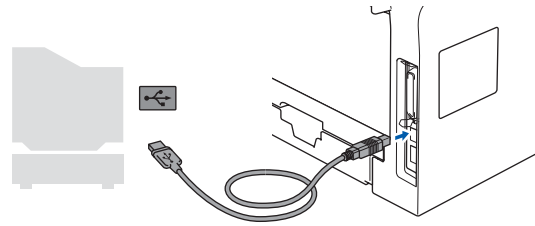
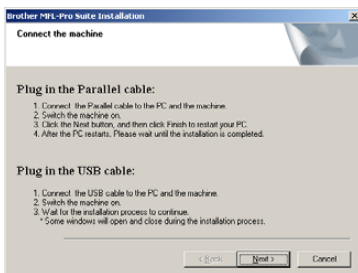

Improper Setup

DO NOT connect the machine to a USB port on a keyboard or a non-powered USB hub. Brother recommends that you connect the machine directly to your computer.

- 9** Plug in the power cord and turn on the machine.

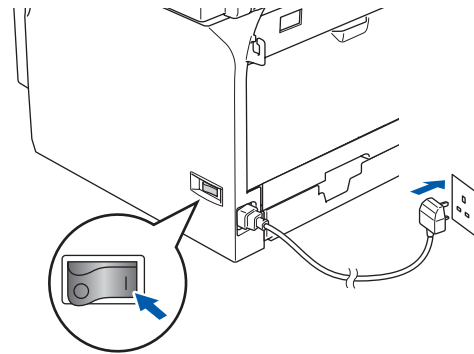

Improper Setup

DO NOT try to cancel any of the screens during this installation.

- 10** When the On-Line Registration screen is displayed, make your selection and follow the on-screen instructions.

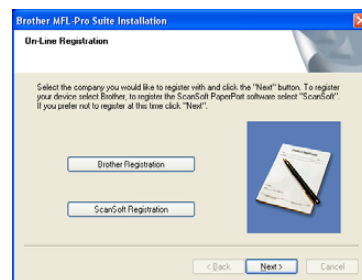

- 11** Click **Finish** to restart your computer.
(After restarting the computer, for Windows® 2000 Professional/XP/XP Professional x64 Edition, you must be logged on with Administrator rights.)

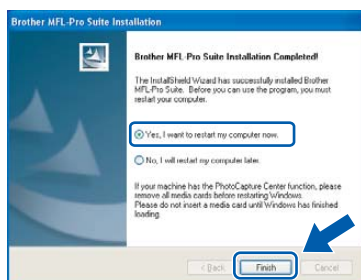

 **Note**

After restarting the computer, the **Installation Diagnostics** will run automatically. If the installation is unsuccessful, the installation results window will be shown. If the **Installation Diagnostics** shows a failure, please follow the on-screen instruction or read on-line help and FAQs in **Start/All Programs (Programs)/Brother/MFL-Pro Suite MFC-XXXX** (where XXXX is your model name).

-  **The MFL-Pro Suite (including printer driver and scanner driver) has been installed and the installation is now complete.**

For Parallel Interface Cable Users (For Windows® 98/98SE/Me/2000 Professional/XP/ XP Professional x64 Edition)

Important

Make sure that you have finished the instructions from step 1 *Setting Up the Machine* on page 4 to 11.

Note

Please close any applications running before installing the MFL-Pro Suite.

- 1 Turn off and unplug the machine from the AC outlet and disconnect it from your computer, if you already connected an interface cable.

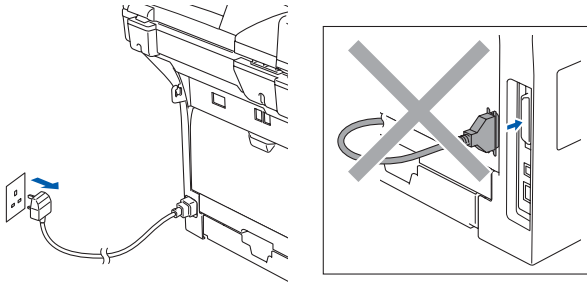

- 2 Turn on your computer. (For Windows® 2000 Professional/XP/XP Professional x64 Edition, you must be logged on with Administrator rights.)

- 3 Put the supplied CD-ROM for Windows® into your CD-ROM drive. If the model name screen appears, choose your machine. If the language screen appears, choose your language.



- 4 The CD-ROM main menu will appear. Click **Install MFL-Pro Suite**.



Note

If this window does not appear, use Windows® Explorer to run the **setup.exe** program from the root folder of the Brother CD-ROM.

- 5 Choose **Local Connection**, and then click **Next**. The installation will continue.



Note

If you want to install the PS driver (Brother's BR-Script Driver), choose **Custom Install** and then follow the on-screen instructions. When the **Select Components** screen appears, check **PS Printer Driver**, and then continue following the on-screen instructions.

- 6 After reading and accepting the ScanSoft® PaperPort® SE License Agreement, click **Yes**.

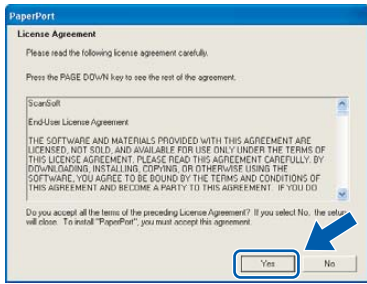

The installation of PaperPort® SE will automatically start and is followed by the installation of MFL-Pro Suite.

- 7 When the Brother MFL-Pro Suite Software License Agreement window appears, click **Yes** if you agree to the Software Licence Agreement.

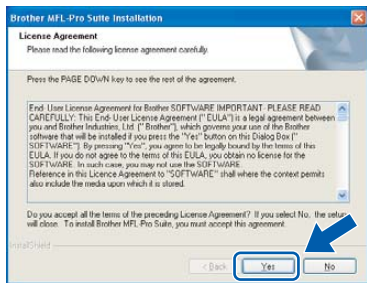

- 8 When this screen appears, connect the Parallel interface cable to your PC, and then connect it to the machine.
(For Windows® XP/XP Professional x64 Edition)

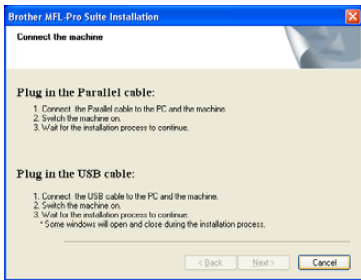

(For Windows® 98/98SE/Me/2000)

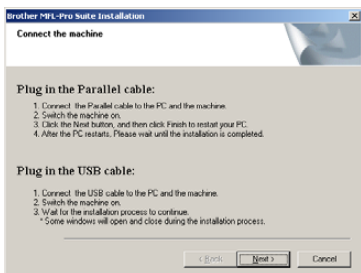

Improper Setup

DO NOT plug in the power cord before connecting the parallel interface cable. It may cause damage to your machine.

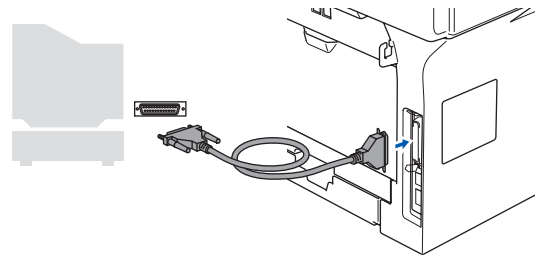

Note

Brother recommends that you connect the machine directly to your computer.

- 9 Plug in the power cord and turn on the machine.

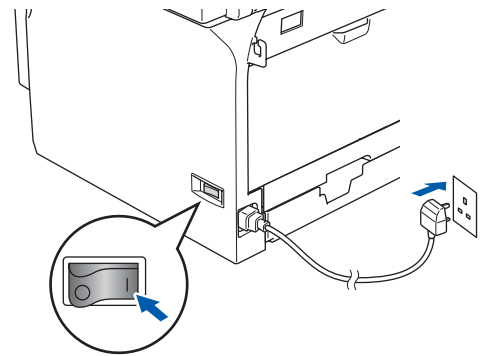

Improper Setup

DO NOT try to cancel any of the screens during this installation.

10 For Windows® 98/98SE/Me/2000 Professional users, click **Next**.

For Windows® XP/XP Professional x64 Edition users, wait for a while since the installation of the Brother drivers will automatically start. The screens appear one after another.

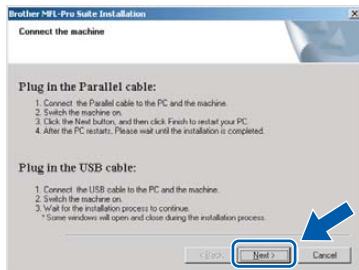

11 When the On-Line Registration screen is displayed, make your selection and follow the on-screen instructions.

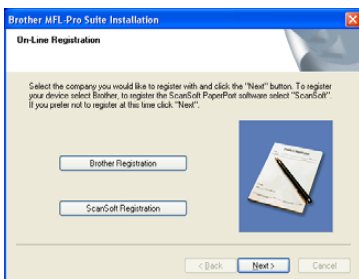

12 When the following screen appears, click **Finish** and wait as the PC restarts Windows® and continues the installation.

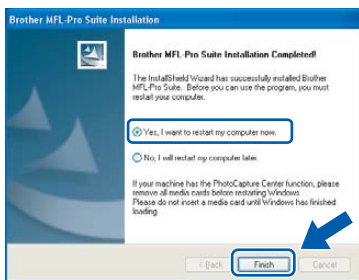

13 After the computer restarts, the installation of the Brother drivers will automatically start. Follow the instructions on the screen. (For Windows® 2000 Professional/XP/XP Professional x64 Edition, you must be logged on with Administrator rights.)

Note

After restarting the computer, the **Installation Diagnostics** will run automatically. If the installation is unsuccessful, the installation results window will be shown. If the **Installation Diagnostics** shows a failure, please follow the on-screen instruction or read on-line help and FAQs in **Start/All Programs (Programs)/Brother/MFL-Pro Suite MFC-XXXX** (where XXXX is your model name).



The MFL-Pro Suite (including printer driver and scanner driver) has been installed and the installation is now complete.

For Windows NT® Workstation Version 4.0 Users (For Parallel Interface Cable Users)

Important

Make sure that you have finished the instructions from step 1 *Setting Up the Machine* on page 4 to 11.



Note

Please close any applications running before installing the MFL-Pro Suite.

- 1 Turn off and unplug the machine from the AC outlet
- 2 Turn on your computer. You must be logged on with Administrator rights.

⊘ Improper Setup

DO NOT plug in the power cord before connecting the parallel interface cable. It may cause damage to your machine.

- 3 Connect the parallel interface cable to your computer, and then connect it to the machine.

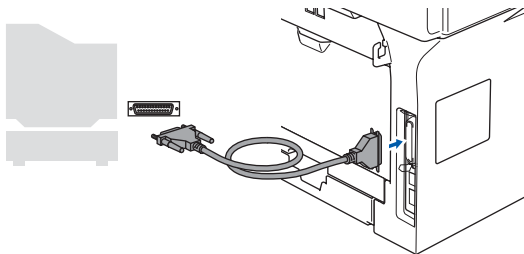

Note

Brother recommends that you connect the machine directly to your computer.

4

Plug in the power cord and turn on the machine.

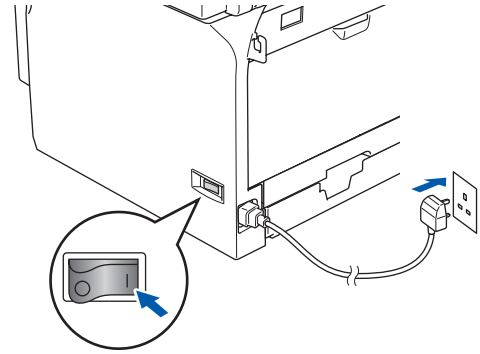

5

Put the supplied CD-ROM for Windows® into your CD-ROM drive. If the model name screen appears, choose your machine. If the language screen appears, choose your language.



6

The CD-ROM main menu will appear. Click **Install MFL-Pro Suite**.



Note

If this window does not appear, use Windows® Explorer to run the **setup.exe** program from the root folder of the Brother CD-ROM.

- 7** Choose **Local Connection**, and then click **Next**. The installation will continue.

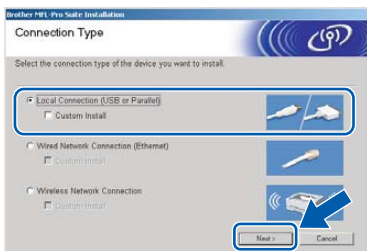

- 10** When the On-Line Registration screen is displayed, make your selection and follow the on-screen instructions.

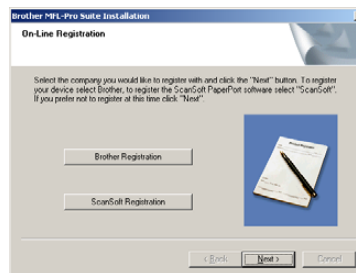

Note

If you want to install the PS driver (Brother's BR-Script Driver), choose **Custom Install** and then follow the on-screen instructions. When the **Select Components** screen appears, check **PS Printer Driver**, and then continue following the on-screen instructions.

- 11** Click **Finish** and wait as the PC restarts, Windows® and continues the installation. (You must be logged on with Administrator rights.)

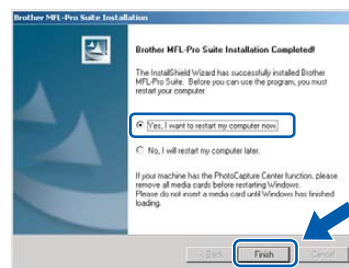

- 8** After reading and accepting the ScanSoft® PaperPort® SE License Agreement, click **Yes**.

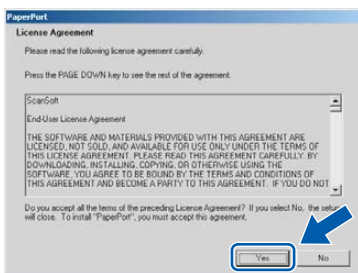

The installation of PaperPort® SE will automatically start and is followed by the installation of MFL-Pro Suite.

- 9** When the Brother MFL-Pro Suite Software License Agreement window appears, click **Yes** if you agree to the Software Licence Agreement.

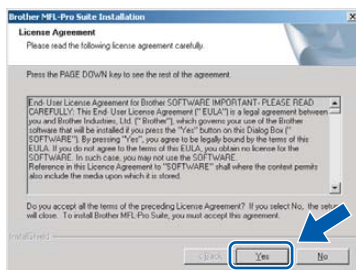

Note

After restarting the computer, the **Installation Diagnostics** will run automatically. If the installation is unsuccessful, the installation results window will be shown. If the **Installation Diagnostics** shows a failure, please follow the on-screen instruction or read on-line help and FAQs in **Start/Programs/Brother/MFL-Pro Suite MFC-XXXX** (where XXXX is your model name).



The MFL-Pro Suite (including printer driver and scanner driver) has been installed and the installation is now complete.

Windows NT® Parallel

For Wired Network Interface Users (For Windows® 98/98SE/Me/NT/2000 Professional/XP/ XP Professional x64 Edition)

Important

Make sure that you have finished the instructions from step 1 *Setting Up the Machine* on page 4 to 11.

- 1 Turn off and unplug the machine from the AC outlet.
- 2 Connect the network interface cable to the machine, and then connect it to a free port on your hub.

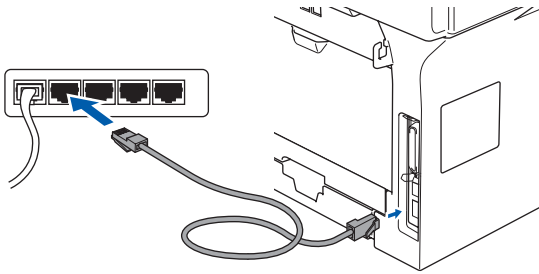

- 3 Plug in the power cord and turn on the machine.

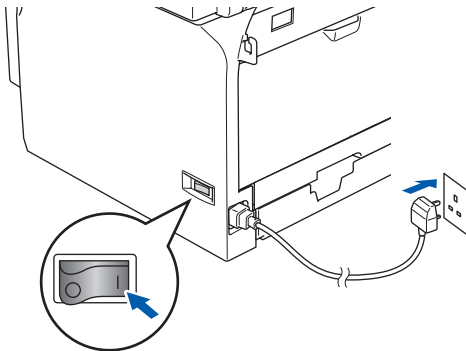

- 4 Turn on your computer.
(For Windows® 2000 Professional/XP/XP Professional x64 Edition/Windows NT® 4.0, you must be logged on with Administrator rights.)
Close any applications running before installing the MFL-Pro Suite.



Note

Before installation, if you are using personal firewall software, disable it. Once you are sure that you can print after the installation, restart your personal firewall software.

- 5 Put the supplied CD-ROM into your CD-ROM drive. If the model name screen appears, choose your machine. If the language screen appears, choose your language.



- 6 The CD-ROM main menu will appear. Click **Install MFL-Pro Suite**.



Note

If this window does not appear, use Windows® Explorer to run the **setup.exe** program from the root folder of the Brother CD-ROM.

- 7** Choose **Wired Network Connection**, and then click **Next**.

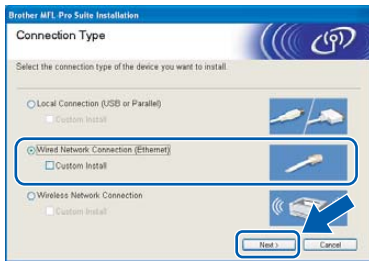

Note If you want to install the PS driver (Brother's BR-Script Driver), choose **Custom Install** and then follow the on-screen instructions. When the **Select Components** screen appears, check **PS Printer Driver**, and then continue following the on-screen instructions.

- 8** After reading and accepting the ScanSoft® PaperPort® SE License Agreement, click **Yes**.

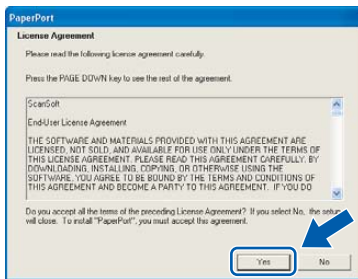

The installation of PaperPort® SE will automatically start and is followed by the installation of MFL-Pro Suite.

- 9** When the Brother MFL-Pro Suite Software License Agreement window appears, click **Yes** if you agree to the Software License Agreement.

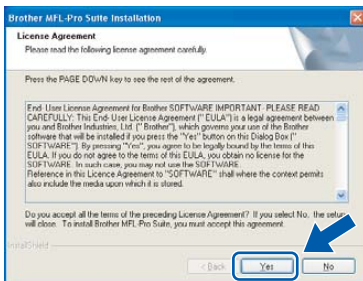

- 10** The installation of the Brother drivers will automatically start. **The installation screens appear one after another. Please wait, it will take a few seconds for all screens to appear.**

Improper Setup

DO NOT try to cancel any of the screens during this installation.

- 11** If the machine is configured for your network, choose the machine from the list, and then click **Next**.

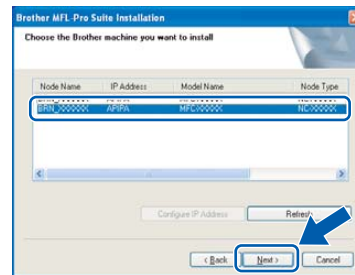

Note This window will not appear if there is only one machine connected on the network, it will be chosen automatically.

- 12** If the machine is not yet configured for use on your network, the following screen appears.

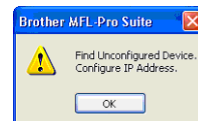

Click **OK**.

The **Configure IP Address** window will appear. Enter an IP address for your machine that is suitable for your network by following the on-screen instructions.

- 13** When the Brother and ScanSoft on-line Registration screen is displayed, make your selection and follow the on-screen instructions.

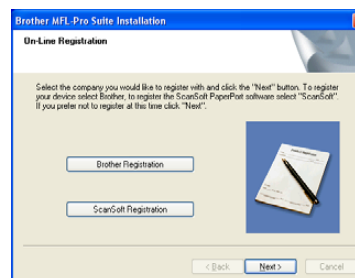

- 14** Click **Finish** to restart your computer.
(For Windows® 2000 Professional/XP/XP Professional x64 Edition, you must be logged on with Administrator rights.)

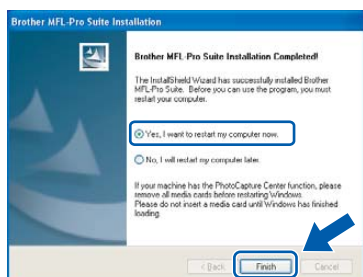

- OK!** The MFL-Pro Suite (including network printer driver and network scanner driver) has been installed and the installation is now complete.



Note

After restarting the computer, the **Installation Diagnostics** will run automatically. If the installation is unsuccessful, the installation results window will be shown. If the **Installation Diagnostics** shows a failure, please follow the on-screen instruction or read on-line help and FAQs in **Start/All Programs (Programs)/Brother/MFL-Pro Suite MFC-XXXX** (where XXXX is your model name).



Note

- For network installations, the **Repair MFL-Pro Suite** selection from the main menu is not supported.
- Network Scanning, Network Remote Setup, Network PC-FAX Receiving are not supported in Windows NT® 4.0.
- For configuration of advanced network functions such as LDAP, Scan to FTP and Fax to Server, see the Software and Network User's Guides located on the CD-ROM.

For Wireless Network Users

(For Windows® 98/98SE/Me/NT/2000 Professional/XP/XP Professional x64 Edition in infrastructure mode)

Using the SecureEasySetup™ software to configure your machine for a wireless network

The SecureEasySetup™ software allows you to configure the wireless network easier than configuring it manually. By pushing a button on the wireless router or access point, you can complete setup and secure the wireless network. Your router or access point must also support SecureEasySetup™. See the user's guide for your wireless LAN router or access point for instructions to configure your machine for a wireless network. If your wireless router or access point does not support SecureEasySetup™ go to the next page for installation instructions.

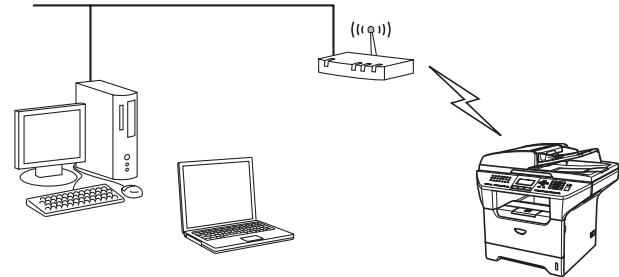

Note

Routers or access points that support SecureEasySetup™ have the SecureEasySetup™ symbol as shown below.



- 1 Plug in the power cord and turn on the machine.

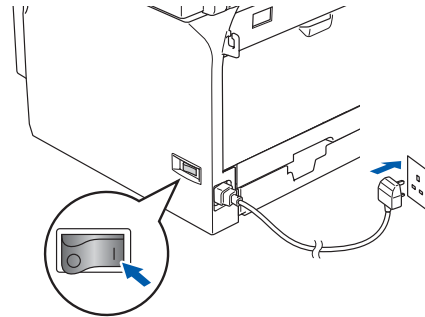

Improper Setup

If you have previously configured the wireless settings of the machine you must reset the network (LAN) settings before you can configure the wireless settings again. Press **Menu, 6, 2, 4** (or **Menu, 6, 0, 1**) and then press **1** to accept the change. The machine will restart automatically.

- 2 Place the Brother machine close to the SecureEasySetup™ router or access point (less than 5 m/16 feet).
- 3 Push the SecureEasySetup™ button on your wireless router or access point. See the user's guide for your wireless router or access point for instructions.
- 4 Press **Menu, 6, 2, 2, 2** on the control panel of the Brother machine.

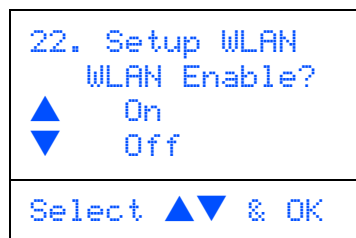

Press **▲** or **▼** to choose **On** (or **Off**), then press **OK**. The wired network interface will become inactive with this setting.

- 5** The wireless network connection status using the SecureEasySetup™ software will be displayed: `Connecting WLAN`, `Connected` or `Connection Error`.

`Connecting WLAN` is displayed when the print server is trying to make connections to your router or access point. Wait till either `Connected` or `Connection Error` is displayed.

`Connected` is displayed when the print server is successfully connected to your router or access point. You can now use your machine in a wireless network.

`Connection Error` is displayed when the print server has not successfully connected to your router or access point. Try starting from step 2 again. If the same message is displayed again, reset the print server back to the default factory settings and try again.
(See *Restoring the network settings to factory default* on page 53.)

-  **Wireless setup is now complete. To install the MFL-Pro suite, continue to step 14 on page 29.**

Using the Setup Wizard from the control panel LAN menu for wireless network configuration

Important

Make sure that you have finished the instructions from step 1 *Setting Up the Machine* on page 4 to 11.

These instructions will install your Brother machine in a typical small office or home wireless network environment in infrastructure mode, using a wireless router or access point that uses DHCP to assign IP addresses.

If you want to setup your machine in any other wireless environment you can find instructions in the Network User's Guide on the CD-ROM.

You can view the Network User's Guide by following the instructions below.

- 1 Turn on your PC. Insert the Brother CD-ROM labeled Windows® into your CD-ROM drive.
- 2 If the model name screen appears, click your model name.
- 3 If the language screen appears, click your language. The CD-ROM main menu will appear.
- 4 Click **Documentation**.
- 5 Click the **User's Guide**.
- 6 Click the **Network User's Guide**.



Note

If the window does not appear, use Windows® Explorer to run the setup.exe program from the root directory of the Brother CD-ROM.

To achieve optimum results with normal every day document printing, place the Brother machine as close to the network access point (router) as possible with minimal obstructions. Large objects and walls between the two devices as well as interference from other electronic devices can affect the data transfer speed of your documents.

First you must configure the wireless network settings of your machine to communicate with your network access point (router). After the machine is configured to communicate with your access point computers on your network will have access to the machine. To use the machine from these computers, you will need to install the MFL-Pro Software Suite. The following steps will guide you through the configuration and installation process.



- 1 Write down the wireless network settings of your access point or wireless router.

SSID (Service Set ID or Network name)

WEP Key (if needed)

WPA/WPA2-PSK (if needed)

The WEP key is for 64bit encrypted networks or 128 bit encrypted networks and can contain both numbers and letters. If you do not know this information you should see the documentation provided with your access point or wireless router. This key is a 64-bit or 128-bit value that must be entered in an ASCII or HEXADECIMAL format.

For example:

- 64 bit ASCII: Uses 5 text characters.
e.g. "Hello" (this is case sensitive)
- 64 bit Hexadecimal: Uses 10 digits of hexadecimal data.
e.g. "71f2234aba"
- 128 bit ASCII: Uses 13 text characters.
e.g. "Wirelesscomms" (this is case sensitive)
- 128 bit Hexadecimal: Uses 26 digits of hexadecimal data.
e.g. "71f2234ab56cd709e5412aa3ba"

WPA-PSK enables a Protected Access Pre-shared key that allows the Brother wireless machine to associate with access points using TKIP and AES encryption. WPA-PSK uses a Pre-Shared Key that is more than 7 and less than 64 characters in length. See Chapter 3 of the Network User's Guide for more details.

- 2** Plug in the power cord and turn on the machine.

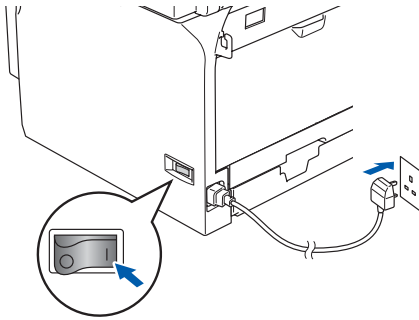

⊘ Improper Setup

If you have previously configured the wireless settings of the machine you must reset the network (LAN) settings before you can configure the wireless settings again. Press Menu, 6, 2, 4 (or Menu, 6, 0) and then press 1 to accept the change.

- 3** On your machine, press Menu, 6, 2, 2, 1.

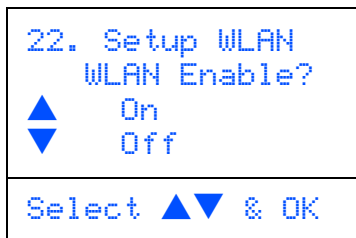

Press or to choose On (or Off), then press OK. The wired network interface will become inactive with this setting.

- 4** The machine will search for available SSIDs. If a list of SSIDs is displayed, use the or keys to choose the SSID you wrote down in step 1, then press OK. Go to step 8.



Note

It will take a few tens of seconds to display a list of available SSIDs.

If your access point is set to not broadcast the SSID you will have to manually add the SSID name. Go to step 5.

- 5** Select <NEW SSID> using or and press OK. Go to step 6.

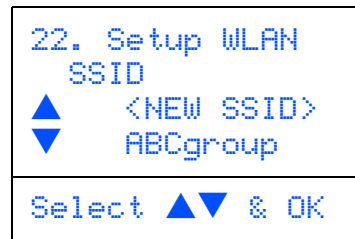

- 6** Enter the SSID you wrote down in step 1. For information how to type text, see “Entering Text” in Chapter D of the User’s Guide.

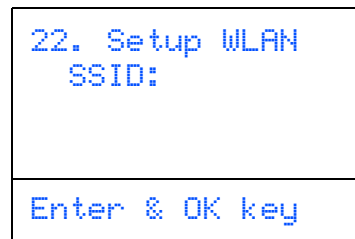

- 7** Press or to choose Infrastructure, then press OK.

- 8** Use the , and OK keys to choose one of the options below: If your network is configured for Authentication and Encryption you must match the settings used for your network.

No Authentication or Encryption: Choose Open system, press OK then choose None for Encryption Type and press OK. Then press or to choose 1.Yes and press OK to apply your settings. Go to step 12.

No Authentication with WEP Encryption: Choose Open system, press OK then use the or to choose WEP for the Encryption Type and press OK. Go to step 9.

Authentication with WEP Encryption: Choose Shared Key, press OK. Go to step 9.

Authentication with WPA-PSK (TKIP or AES Encryption): Choose WPA/WPA2-PSK, press OK. Go to step 10.

Authentication with LEAP: Choose LEAP, press OK. Go to step 11.

- 9** Choose the appropriate key number and press **OK**.

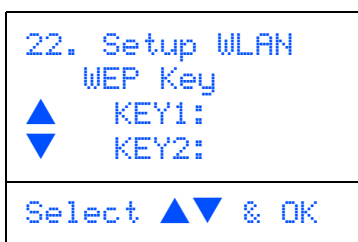

Enter the WEP key you wrote down in step 1 using the dial pad. You can use the and keys to move the cursor. For example, to enter the letter a, press the **2** key on the dial pad once. To enter the number 3, press the **3** key on the dial pad seven times. The letters appear in this order: lower case, upper case, numbers and then special letters.

Press **OK** when you have entered all the characters, then choose **1. Yes** and press **OK** to apply your settings. Go to step 12.

Most access points and routers can store more than one key, but they will only use one at any time for authentication and encryption.

- 10** Press or to choose **TKIP** or **AES** for **Encryption Type** and press **OK**. Enter the WPA-PSK Pass you wrote down in step 1 using the dial pad. You can use the and keys to move the cursor. For example, to enter the letter a, press the **2** key on the dial pad once. To enter the number 3, press the **3** key on your dial pad seven times.

Press **OK** when you have entered all the characters, then choose **1. Yes** and press **OK** to apply your settings. Go to step 12.

- 11** Enter the user and press **OK**. You can use and keys to move the cursor. For example, to enter the letter a, press the **2** key on the dial pad once.

Enter the password and press **OK**, and then choose **1. Yes** and press **OK** to apply your settings. Go to step 12.

- 12** Your machine will now try to connect to your wireless network using the information you have entered. If successful, **Connected** will appear briefly on the LCD.

Connection Error is displayed when the print server has not successfully connected to your router or access point. Try starting from step 3 again. If the same message is displayed again, reset the print server back to the default factory settings and try again. (See *Restoring the network settings to factory default* on page 53.)

- 13** The machine will automatically acquire the correct TCP/IP address information from your access point (router) if DHCP is enabled (DHCP is normally enabled as default for most access point routers).

If your access point does not have DHCP enabled you will need to manually configure the IP address, subnet mask and gateway of the machine to suit your network. See the Network User's Guide for details.

- OK!** **Wireless setup is now complete. To install the MFL-Pro Software suite, continue to step 14.**

- 14** Turn on your computer. (For Windows® 2000 Professional/XP/XP Professional x64 Edition, you must be logged on with Administrator rights.) Close any applications running before installing the MFL-Pro Suite.



Note

Before installation, if you are using personal firewall software or the built in Windows® XP firewall, disable it. Once you are sure that you can print after the installation, re-enable your firewall.

- 15** Put the supplied CD-ROM into your CD-ROM drive. If the model name screen appears, choose your machine. If the language screen appears, choose your language.



16 The CD-ROM main menu will appear. Click **Install MFL-Pro Suite**.



Note

If this window does not appear, use Windows® Explorer to run the **setup.exe** program from the root folder of the Brother CD-ROM.

17 Choose **Wireless Network Connection**, and then click **Next**.



18 Click on the **Checked and confirmed** check box, and then click **Next**.

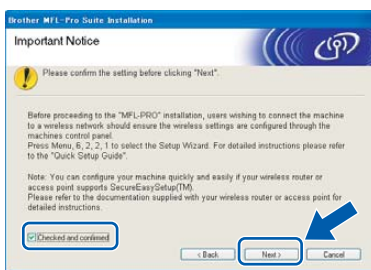

19 After reading and accepting the ScanSoft® PaperPort® SE License Agreement, click **Yes**.

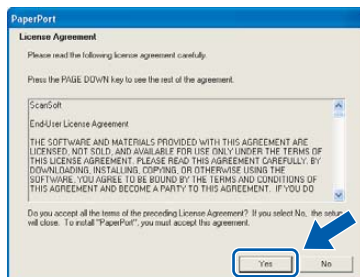

20 The installation of PaperPort® SE will automatically start and is followed by the installation of MFL-Pro Suite.

21 When the Brother MFL-Pro Suite Software License Agreement window appears, click **Yes** if you agree to the Software License Agreement.

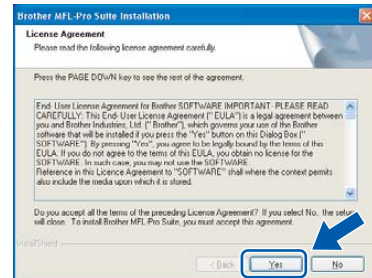

22 The installation of the Brother drivers will automatically start. **The installation screens appear one after another, please wait for a while.**

Improper Setup

- **DO NOT** try to cancel any of the screens during this installation.
- If your wireless settings fail, an error message will appear during the installation of MFL-Pro Suite and the installation will be terminated. If you encounter this failure, please go to step 3 and setup the wireless connection again.

23 Choose the machine from the list, and then click **Next**.

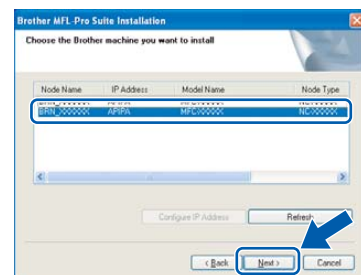

Note

This window will not appear if there is only one machine connected on the network as it will be chosen automatically.

- 24** When the Brother and ScanSoft on-line Registration screen is displayed, make your selection and follow the on-screen instructions.

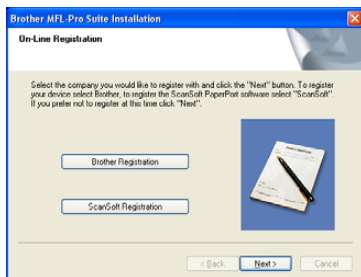

- 25** Click **Finish** to restart your computer.
(For Windows® 2000 Professional/XP/XP Professional x64 Edition, you must be logged on with Administrator rights.)



Note

After restarting the computer, the **Installation Diagnostics** will run automatically. If the installation is unsuccessful, the installation results window will be shown. If the **Installation Diagnostics** shows a failure, please follow the on-screen instruction or read on-line help and FAQs in **Start/All Programs (Programs)/Brother/MFL-Pro Suite MFC-XXXX** (where XXXX is your model name).



The MFL-Pro Suite (including network printer driver and network scanner driver) have been installed and the installation is now complete.

For USB Interface Cable Users

For Mac OS® 10.2.4 or greater

Important

Make sure that you have finished the instructions from Step 1 *Setting Up the Machine* on page 4 to 11.

Note

For Mac OS® X 10.2.0 to 10.2.3 user, upgrade to Mac OS® X 10.2.4 or greater.

(For the latest information for Mac OS® X, visit <http://solutions.brother.com>)

- 1 Turn off and unplug the machine from the AC outlet and disconnect it from your Macintosh®, if you already connected an interface cable.

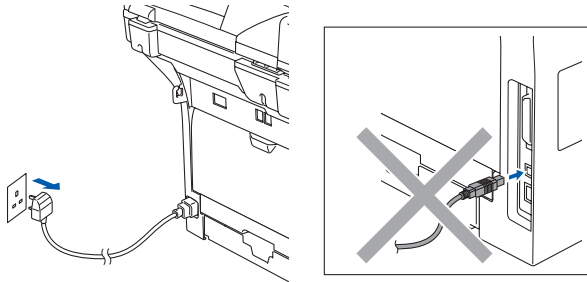

- 2 Turn on your Macintosh®.
- 3 Put the supplied CD-ROM into your CD-ROM drive.



- 4 Double-click the **Start Here OSX** icon to install the printer and scanner drivers. If the language screen appears, choose your language.

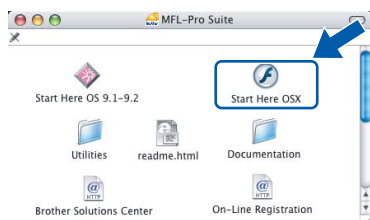

- 5 Click **MFL-Pro Suite** to install.

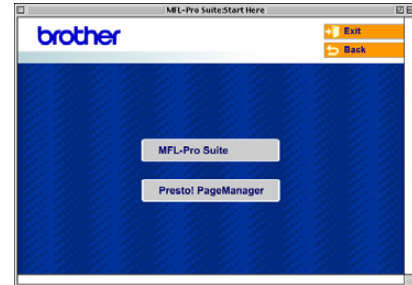

- 6 Choose **Local Connection**, and then click **Next**. Follow the on-screen instruction, and restart your Macintosh®.

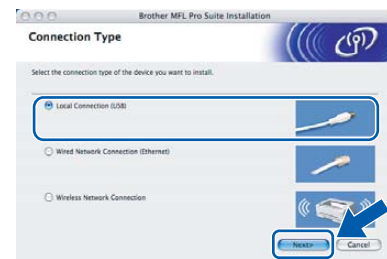

- 7 After the **DeviceSelector** window appears connect the USB interface cable to your Macintosh and then to the machine.



Note

The **DeviceSelector** window will not appear if you have connected a USB interface cable to the machine before restarting your Macintosh® or if you are overwriting a previously installed version of the Brother Software. If you encounter this problem continue with the installation but skip step 9. You should choose your Brother machine from the Model pop-up menu in the main screen of ControlCenter2. For details, see the Software User's Guide on the CD-ROM.

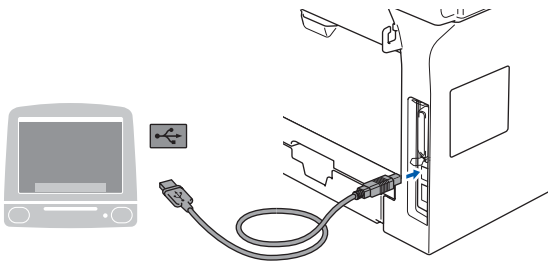

⊘ Improper Setup

DO NOT connect the machine to a USB port on a keyboard or a non-powered USB hub.

- 8** Plug in the power cord and turn on the machine.

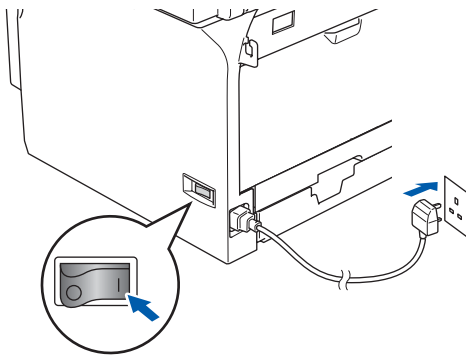

- 9** Choose **USB** and then click **OK**.

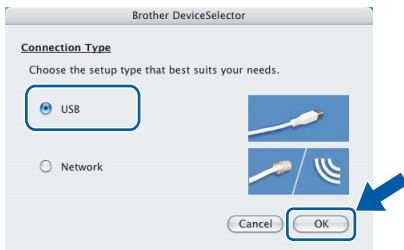

- 10** Click **Go**, then **Applications**.

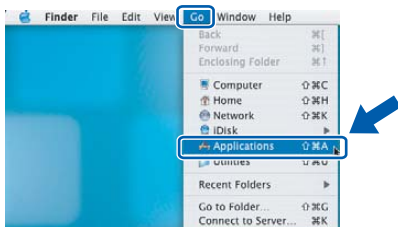

- 11** Double-click the **Utilities** folder.

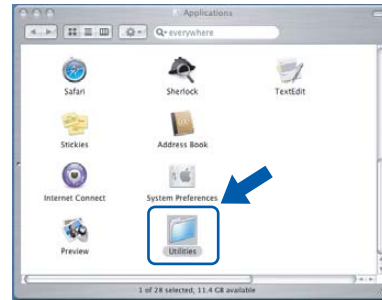

- 12** Double-click the **Printer Setup Utility** icon.

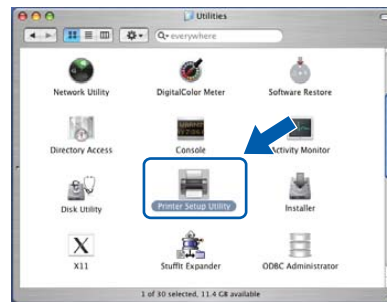

Note

For Mac OS® X 10.2.x users, open **Print Center** icon.

- 13** Click **Add**.

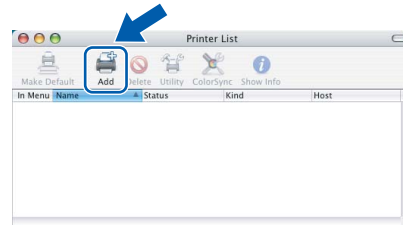

For Mac OS® X 10.2.4 to 10.3.x users
→Go to step 14.

For Mac OS® X 10.4 users→Go to step 15.

- 14** Choose **USB**.

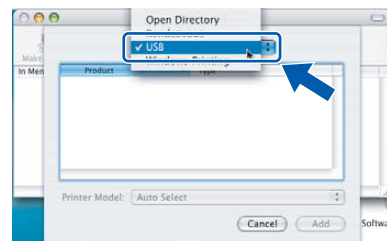

- 15** Choose your model name, and then click **Add**.
For Mac OS® X 10.2.4 to 10.3.x users

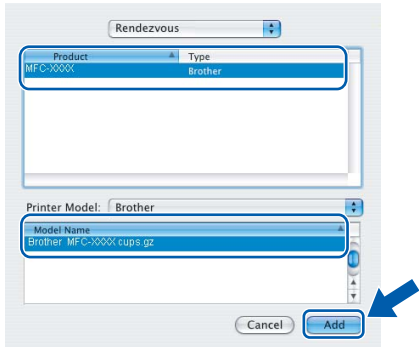

For Mac OS® X 10.4 or greater users

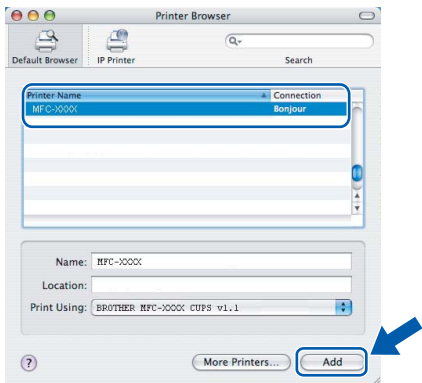

- 16** Click **Printer Setup Utility**, then choose **Quit Printer Setup Utility**.

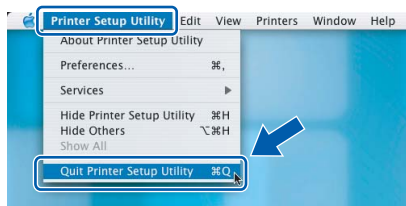
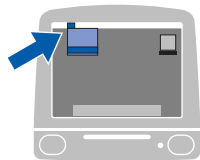

- OK!** The MFL-Pro Suite, drivers and Brother ControlCenter2 have been installed.

- 17** To install Presto!® PageManager®, click the **Presto! PageManager** icon and follow the on-screen instructions.



Note

When Presto!® PageManager® is installed OCR capability is added to the Brother ControlCenter2. You can easily scan, share and organize photos and documents using Presto!® PageManager®.

- OK!** Presto!® PageManager® has been installed and the installation is now complete.

For Mac OS® 9.1 to 9.2

Important

Make sure that you have finished the instructions from step 1 *Setting Up the Machine* on page 4 to 11.

- 1 Turn off and unplug the machine from the AC outlet and disconnect it from your Macintosh®, if you already connected an interface cable.

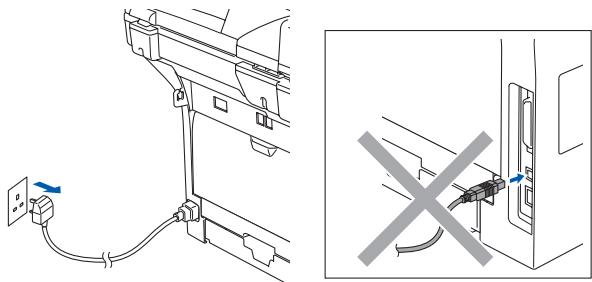

- 2 Turn on your Macintosh®.
- 3 Put the supplied CD-ROM into your CD-ROM drive.



- 4 Double-click the **Start Here 9.1-9.2** icon to install the printer and scanner drivers. If the language screen appears, choose your language.

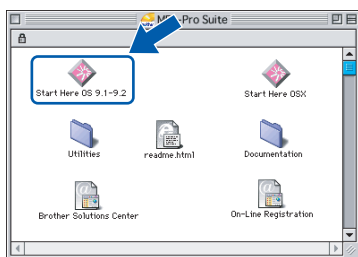

- 5 Click **MFL-Pro Suite** to install.



- 6 Follow the on-screen instructions, and restart your Macintosh®.

- 7 Connect the USB interface cable to your Macintosh®, and then connect it to the machine.

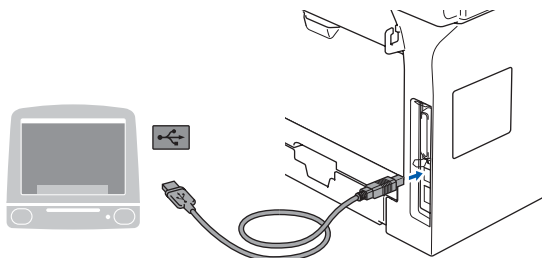

⊘ Improper Setup

DO NOT connect the machine to a USB port on a keyboard or a non-powered USB hub.

- 8 Plug in the power cord and turn on the machine.

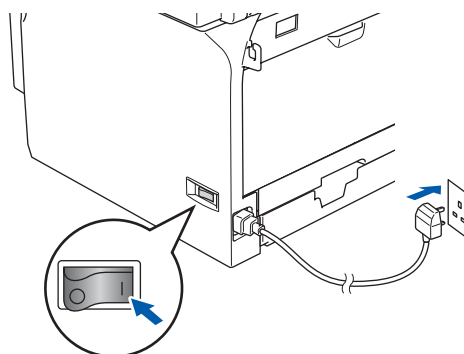

- 9 From the Apple® menu, click the **Chooser**.

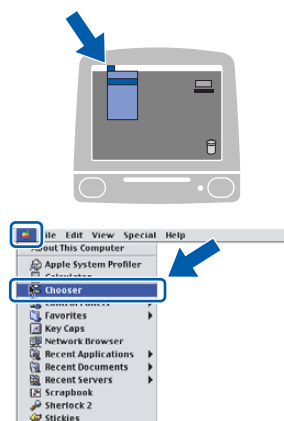

- 10** Click the **Brother Laser** icon.
On the right side of the **Chooser**, choose the machine to which you want to print.
Close the **Chooser**.

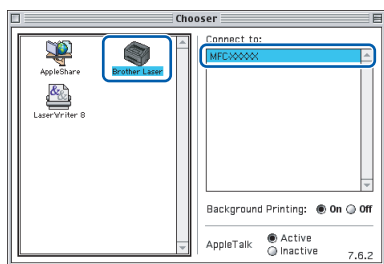

- OK!** The Brother printer driver and scanner driver have been installed.

**Note**

ControlCenter2 is not supported in Mac OS® 9.x.

- 11** To install Presto!® PageManager®, click the **Presto! PageManager** icon and follow the on-screen instructions.

**Note**

You can easily scan, share and organize photos and documents using Presto!® PageManager®.

- OK!** Presto!® PageManager® has been installed and the installation is now complete.

For Wired Network Interface Users

For Mac OS® X 10.2.4 or greater

Important

Make sure that you have finished the instructions from step 1 *Setting Up the Machine* on page 4 to 11.

- 1 Switch off the machine, then disconnect the machine from the power socket and from the network.

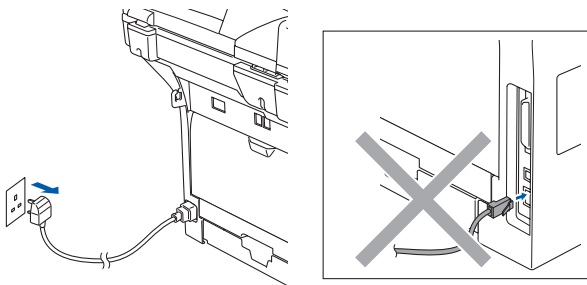

- 2 Turn on your Macintosh®.
- 3 Put the supplied CD-ROM into your CD-ROM drive.

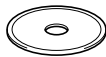

- 4 Double-click the **Start Here OSX** icon to install the drivers and MFL-Pro Suite. If the language screen appears, choose your language.



- 5 Click **MFL-Pro Suite** to install.



- 6 Choose **Wired Network Connection**, and then click **Next**. Follow the on-screen instructions, and restart your Macintosh®.



- 7 After the **DeviceSelector** window appears, connect the network interface cable to your Macintosh® and then to the machine.



Note

The **DeviceSelector** window will not appear if you have also connected a USB interface cable to the machine before restarting your Macintosh® or if you are overwriting a previously installed version of the Brother Software. If you encounter this problem continue but skip steps 9 to 12. After the software installation is completed you should choose your Brother machine from the Model pull-down list in the main screen of ControlCenter2. For details, see Chapter 10 in the Software User's Guide on the CD-ROM.

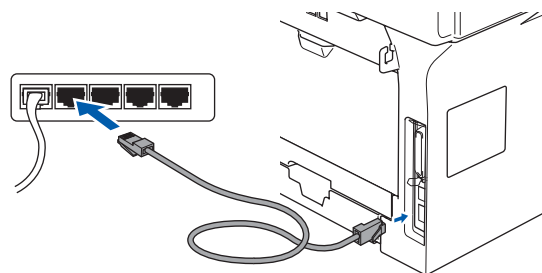

- 8** Plug in the power cord and turn on the machine.

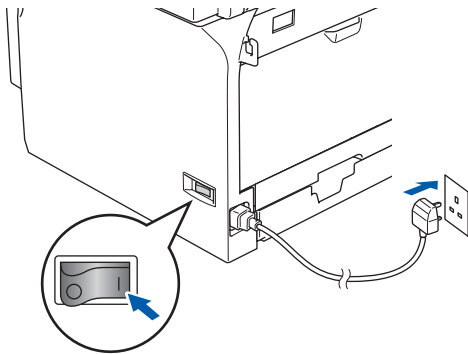

- 9** Choose **Network** and then click **OK**.

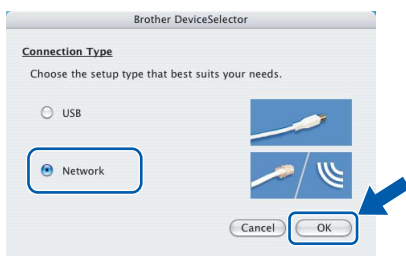

- 10** If you want to use the machine's **Scan** key to scan over the network you must check the **Register your computer with the "Scan To" functions at the machine box**. You must also enter a name for your Macintosh® in **Display Name**. The name you enter will appear on the machine's LCD when you press the **Scan** key and choose a scan option. You can enter any name up to 15 characters long. (For more information on network scanning, see *Chapter 11 of the Software User's Guide on the CD-ROM*.)



- 11** Click **Browse**.

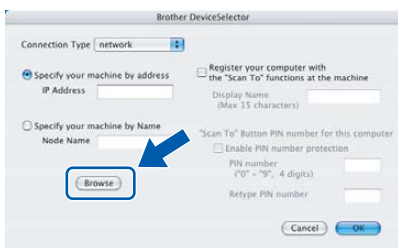

- 12** Choose your model name, and then click **OK**. Click **OK** again to close the **DeviceSelector**.

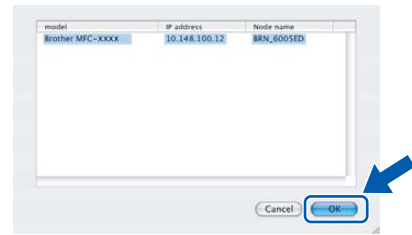

- 13** Click **Go**, then **Applications**.

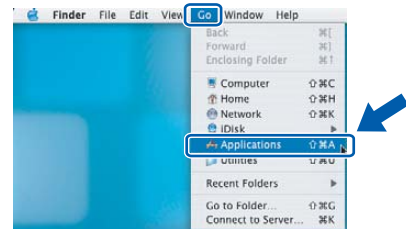

- 14** Double-click the **Utilities** folder.

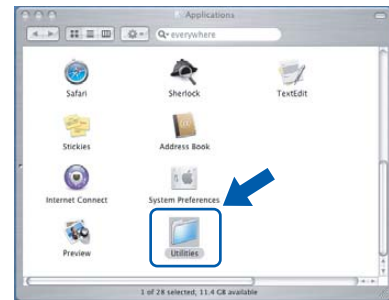

- 15** Double-click the **Printer Setup Utility** icon.



Note

For Mac OS® X 10.2.x users, open **Print Center** icon.

16 Click **Add**.

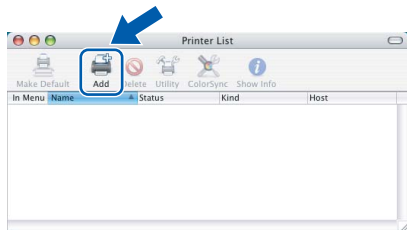

17 Make the selection shown below.

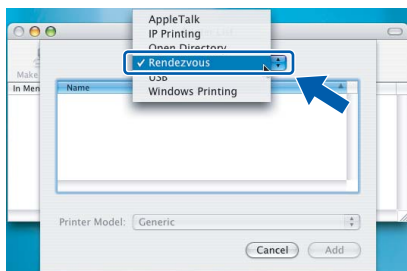

Note

For Mac OS® X 10.4 users, go to step 18.

18 Choose your model name and then click **Add**.

For Mac OS® X 10.2.4 to 10.3.x users

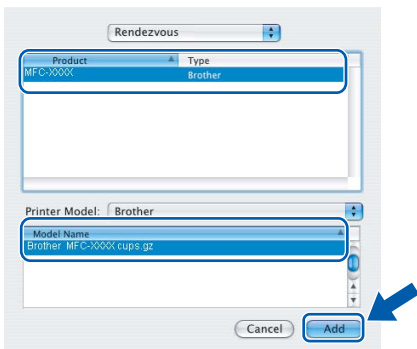

For Mac OS® X 10.4 or greater users

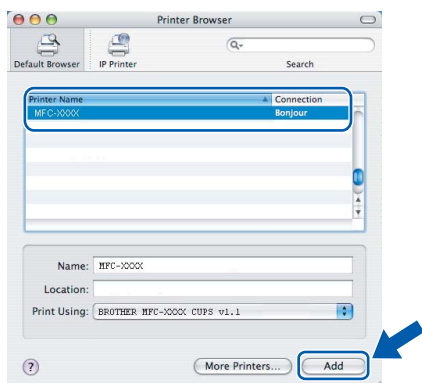

19 Click **Printer Setup Utility**, then **Quit Printer Setup Utility**.

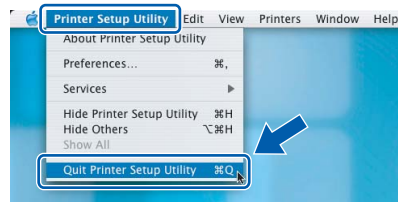
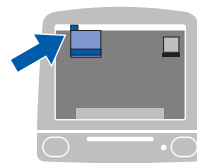

OK!

The MFL-Pro Suite, Printer Driver, Scanner Driver and ControlCenter2 have been installed.



For configuration of advanced network functions such as LDAP, Scan to FTP and Fax to Server, see the Software and Network User's Guides located on the CD-ROM.

20 To install Presto!® PageManager®, click the **Presto! PageManager** icon and follow the on-screen instructions.

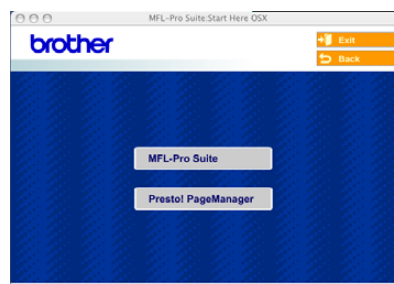

Note

When Presto!® PageManager® is installed OCR capability is added to the Brother ControlCenter2. You can also easily scan, share, and organize photos and documents using Presto!® PageManager®.

OK!

Presto!® PageManager® has been installed and the installation is now complete.

For Mac OS® 9.1 to 9.2

Important

Make sure that you have finished the instructions from step 1 *Setting Up the Machine* on page 4 to 11.

- 1 Switch off the machine, then disconnect the machine from the power socket and from the network,

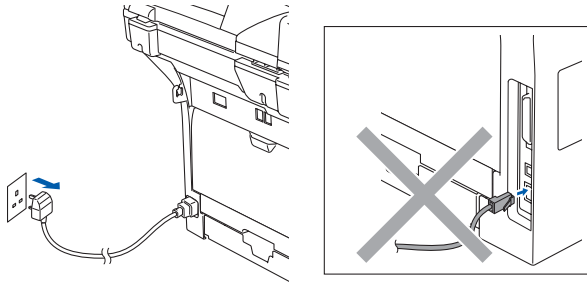

- 2 Turn on your Macintosh®.
- 3 Put the supplied CD-ROM into your CD-ROM drive.



- 4 Double-click the **Start Here OS 9.1-9.2** icon to install the printer and scanner drivers. If the language screen appears, choose your language.

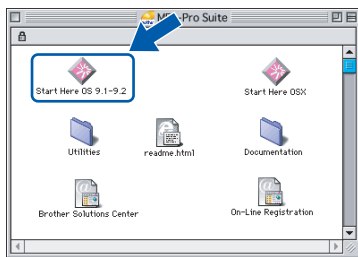

- 5 Click **MFL-Pro Suite** to install.



- 6 Follow the on-screen instructions, and restart your Macintosh®.
- 7 Connect the network interface cable to the machine, and then connect it to a free port on your hub.

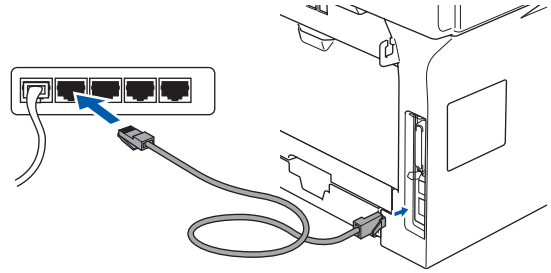

- 8 Plug in the power cord and turn on the machine.

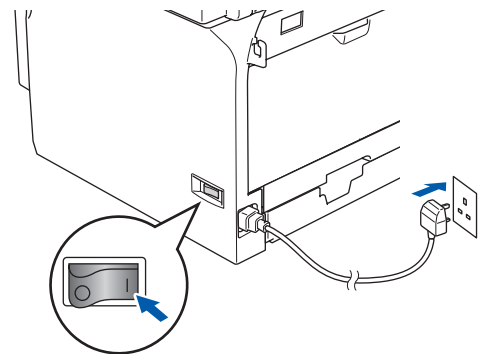

- 9 From the Apple® menu, click **Chooser**.

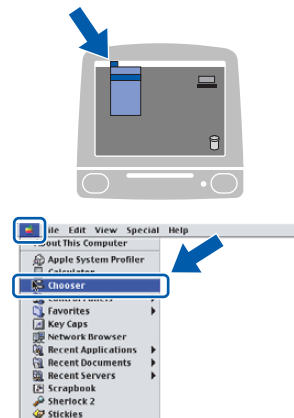

- 10** Click the **Brother Laser** icon, and then choose **BRN_XXXXXX**.
Close the **Chooser**.

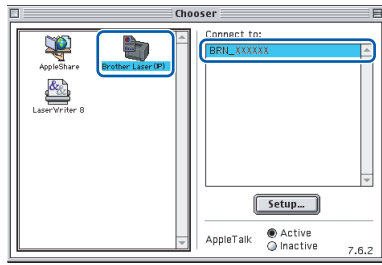
**Note**

where xxxxxx are the last six digits of the Ethernet address.



The Printer Driver has been installed.

**Note**

ControlCenter2 is not supported in Mac OS® 9.x.

- 11** To install Presto!® PageManager®, click the **Presto! PageManager** icon and follow the on-screen instructions.

**Note**

You can easily scan, share, and organize photos and documents using Presto!® PageManager®.



Presto!® PageManager® has been installed and the installation is now complete.

For Wireless Network Users (For Mac OS® X 10.2.4 or greater only)

Using the SecureEasySetup™ software to configure your machine for a wireless network

The SecureEasySetup™ software allows you to configure the wireless network easier than configuring it manually. By pushing a button on the wireless router or access point, you can complete setup and secure the wireless network. Your router or access point must also support SecureEasySetup™. See the user's guide for your wireless LAN router or access point for instructions to configure your machine for a wireless network. If your wireless router or access point does not support SecureEasySetup™ go to the next page for installation instructions.

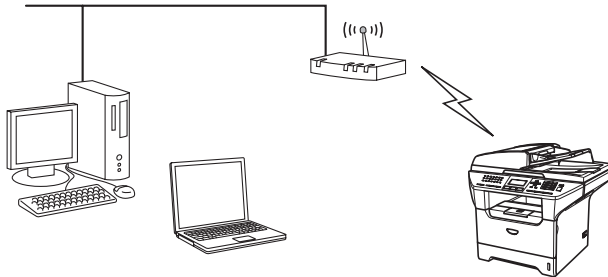

Note

Routers or access points that support SecureEasySetup™ have the SecureEasySetup™ symbol as shown below.



- 1 Plug in the power cord and turn on the machine.

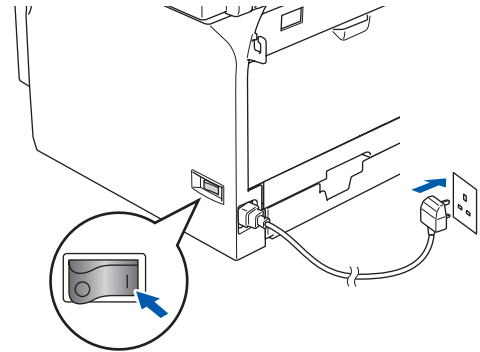

⊘ Improper Setup

If you have previously configured the wireless settings of the machine you must reset the network (LAN) settings before you can configure the wireless settings again. Press **Menu, 6, 2, 4** (or **Menu, 6, 0, 1**) and then press **1** to accept the change. The machine will restart automatically.

- 2 Place the Brother machine close to the SecureEasySetup™ router or access point (less than 50 m/16 feet).
- 3 Push the SecureEasySetup™ button on your wireless router or access point. See the user's guide for your wireless router or access point for instructions.
- 4 Press **Menu, 6, 2, 2, 2** on the control panel of the Brother machine.

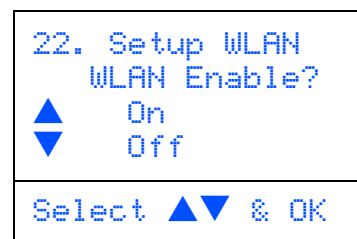

Press or to choose On (or Off), then press **OK**. The wired network interface will become inactive with this setting.

- 5** The wireless network connection status using the SecureEasySetup™ software will be displayed: `Connecting WLAN`, `Connected` or `Connection Error`.

`Connecting WLAN` is displayed when the print server is trying to make connections to your router or access point. Wait till either `Connected` or `Connection Error` is displayed.

`Connected` is displayed when the print server is successfully connected to your router or access point. You can now use your machine in a wireless network.

`Connection Error` is displayed when the print server has not successfully connected to your router or access point. Try starting from step **2** again. If the same message is displayed again, reset the print server back to the default factory settings and try again.
(See *Restoring the network settings to factory default* on page 53.)



Wireless setup is now complete. To install the MFL-Pro suite, continue to step 14 on page 46.

Using the Setup Wizard from the control panel LAN menu for wireless network configuration

Important

Make sure that you have finished the instructions from step 1 *Setting Up the Machine* on page 4 to 11.

These instructions will install your Brother machine in a typical small office or home wireless network environment in infrastructure mode, using a wireless router or access point that uses DHCP to assign IP addresses.

If you want to setup your machine in any other wireless environment you can find instructions in the Network User's Guide on the CD-ROM.

You can view the Network User's Guide by following the instructions below.

- 1 Turn on your Macintosh®. Insert the Brother CD-ROM labeled Macintosh® into your CD-ROM drive.
- 2 Double-click **Documentation**.
- 3 Double-click your language folder.
- 4 Double-click the Network User's Guide.pdf.

Note

If the window does not appear, use Windows® Explorer to run the setup.exe program from the root directory of the Brother CD-ROM.

To achieve optimum results with normal every day document printing, place the Brother machine as close to the network access point (router) as possible with minimal obstructions. Large objects and walls between the two devices as well as interference from other electronic devices can affect the data transfer speed of your documents.

First you must configure the wireless network settings of your machine to communicate with your network access point (router). After the machine is configured to communicate with your access point computers on your network will have access to the machine. To use the machine from these computers, you will need to install the MFL-Pro Software Suite. The following steps will guide you through the configuration and installation process.



- 1 Write down the wireless network settings of your access point or wireless router.

SSID (Service Set ID or Network name)

WEP Key (if needed)

WPA/WPA2-PSK (if needed)

The WEP key is for 64bit encrypted networks or 128 bit encrypted networks and can contain both numbers and letters. If you do not know this information you should see the documentation provided with your access point or wireless router. This key is a 64-bit or 128-bit value that must be entered in an ASCII or HEXADECIMAL format.

For example:

- 64 bit ASCII: Uses 5 text characters.
e.g. "Hello" (this is case sensitive)
- 64 bit Hexadecimal: Uses 10 digits of hexadecimal data.
e.g. "71f2234aba"
- 128 bit ASCII: Uses 13 text characters.
e.g. "Wirelesscomms" (this is case sensitive)
- 128 bit Hexadecimal: Uses 26 digits of hexadecimal data.
e.g. "71f2234ab56cd709e5412aa3ba"

WPA-PSK enables a Protected Access Pre-shared key that allows the Brother wireless machine to associate with access points using TKIP and AES encryption. WPA-PSK uses a Pre-Shared Key that is more than 7 and less than 64 characters in length. See Chapter 3 of the Network User's Guide for more details.

- 2** Plug in the power cord and turn on the machine.

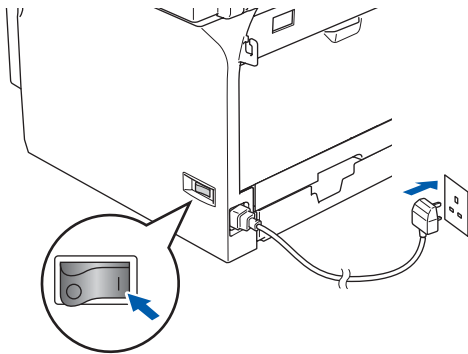

⊘ Improper Setup

If you have previously configured the wireless settings of the machine you must reset the network (LAN) settings before you can configure the wireless settings again. Press Menu, 6, 2, 4 (or Menu, 6, 0) and then press 1 to accept the change.

- 3** On your machine, press **Menu, 6, 2, 2, 1**.

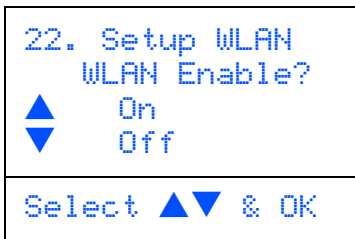

Press or to choose On (or Off), then press **OK**. The wired network interface will become inactive with this setting.

- 4** The machine will search for available SSIDs. If a list of SSIDs is displayed, use the or keys to choose the SSID you wrote down in step 1, then press **OK**. Go to step 8.



Note

It will take a few tens of seconds to display a list of available SSIDs.

If your access point is set to not broadcast the SSID you will have to manually add the SSID name. Go to step 5.

- 5** Select `<NEW SSID>` using or and press **OK**. Go to step 6.

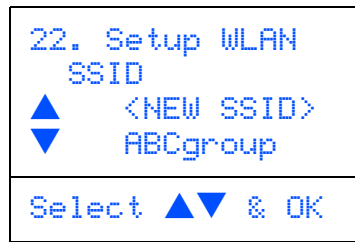

- 6** Enter the SSID you wrote down in step 1. For information how to type text, see “Entering Text” in Chapter D of the User’s Guide.

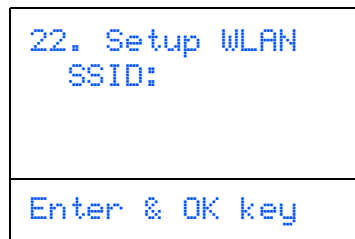

- 7** Press or to choose `Infrastructure`, then press **OK**.

- 8** Use the , and **OK** keys to choose one of the options below: If your network is configured for Authentication and Encryption you must match the settings used for your network.

No Authentication or Encryption: Choose `Open system`, press **OK** then choose `None` for `Encryption Type` and press **OK**. Then press or to choose `1.Yes` and press **OK** to apply your settings. Go to step 12.

No Authentication with WEP Encryption: Choose `Open system`, press **OK** then use the or to choose `WEP` for the `Encryption Type` and press **OK**. Go to step 9.

Authentication with WEP Encryption: Choose `Shared Key`, press **OK**. Go to step 9.

Authentication with WPA-PSK (TKIP or AES Encryption): Choose `WPA/WPA2-PSK`, press **OK**. Go to step 10.

Authentication with LEAP: Choose `LEAP`, press **OK**. Go to step 11.

- 9** Choose the appropriate key number and press **OK**.

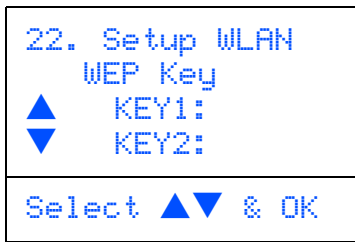

Enter the WEP key you wrote down in step 1 using the dial pad. You can use the and keys to move the cursor. For example, to enter the letter a, press the 2 key on the dial pad once. To enter the number 3, press the 3 key on the dial pad seven times. The letters appear in this order: lower case, upper case, numbers and then special letters.

Press **OK** when you have entered all the characters, then choose 1. *Yes* and press **OK** to apply your settings. Go to step 12.

Most access points and routers can store more than one key, but they will only use one at any time for authentication and encryption.

- 10** Press or to choose TKIP or AES for *Encryption Type* and press **OK**. Enter the WPA-PSK Pass you wrote down in step 1 using the dial pad. You can use the and keys to move the cursor. For example, to enter the letter a, press the 2 key on the dial pad once. To enter the number 3, press the 3 key on your dial pad seven times.

Press **OK** when you have entered all the characters, then choose 1. *Yes* and press **OK** to apply your settings. Go to step 12.

- 11** Enter the user and press **OK**. You can use and keys to move the cursor. For example, to enter the letter a, press the 2 key on the dial pad once.

Enter the password and press **OK**, and then choose 1. *Yes* and press **OK** to apply your settings. Go to step 12.

- 12** Your machine will now try to connect to your wireless network using the information you have entered. If successful, *Connected* will appear briefly on the LCD.

Connection Error is displayed when the print server has not successfully connected to your router or access point. Try starting from step 3 again. If the same message is displayed again, reset the print server back to the default factory settings and try again. (See *Restoring the network settings to factory default* on page 53.)

- 13** The machine will automatically acquire the correct TCP/IP address information from your access point (router) if DHCP is enabled (DHCP is normally enabled as default for most access point routers).

If your access point does not have DHCP enabled you will need to manually configure the IP address, subnet mask and gateway of the machine to suit your network. See the Network User's Guide for details.

- Wireless setup is now complete. To install the MFL-Pro Software suite, continue to step 14.**

- 14** Turn on your Macintosh®.

- 15** Put the supplied CD-ROM into your CD-ROM drive.



- 16** Double-click the **Start Here OSX** icon to install the drivers and MFL-Pro Suite. If the language screen appears, choose your language.



- 17** Click **MFL-Pro Suite** to install.



18 Choose **Wireless Network Connection**, and then click **Next**.

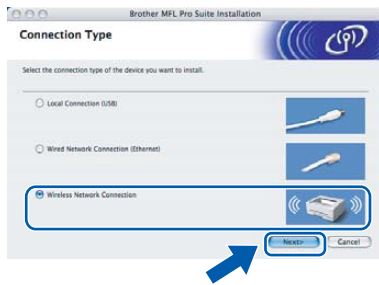

19 Click on the **Checked and confirmed** check box, and then click **Next**.

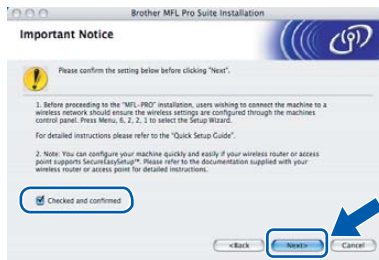

20 Follow the on-screen instructions and restart your Macintosh®.

21 When the **DeviceSelector** window appears choose **Network** and then click **OK**. The DeviceSelector window will not appear if you have also connected a USB interface cable to the machine before restarting your Macintosh or if you are overwriting a previously installed version of the Brother Software. If you encounter this problem continue but skip steps **22** through **24**. After the software installation is completed you should choose your Brother machine from the Model pop-up menu in the main screen of ControlCenter2. For details, see *Chapter 10 in the Software User's Guide on the CD-ROM*.

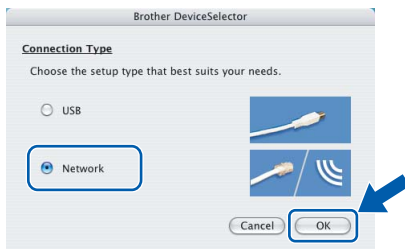

22 If you want to use the machine's **Scan** key to scan over the network you must check the **Register your computer with the "Scan To" functions at the machine** box. You must also enter a name for your Macintosh® in **Display Name**. The name you enter will appear on the machine's LCD when you press the **Scan** key and choose a scan option. You can enter any name up to 15 characters long. (For more information on network scanning, see *Chapter 11 of the Software User's Guide on the CD-ROM*.)

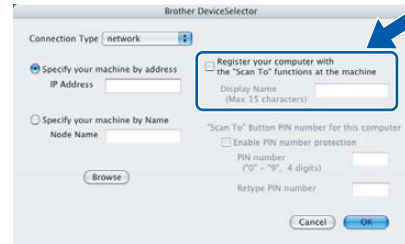

23 Click **Browse**.

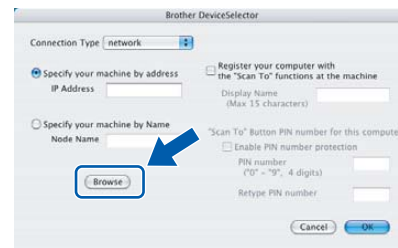

24 Choose your model name, and then click **OK**.

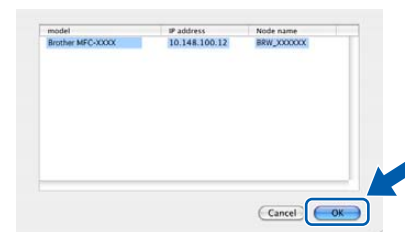

25 Click **Go**, then **Applications**.

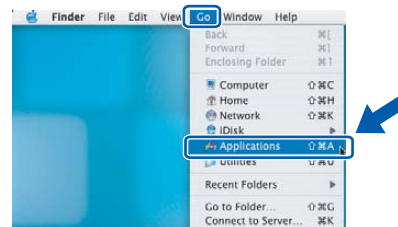

26 Double-click the **Utilities** folder.

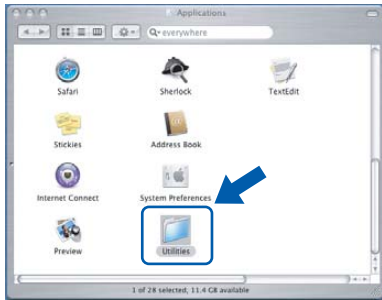

27 Double-click the **Printer Setup Utility** icon.

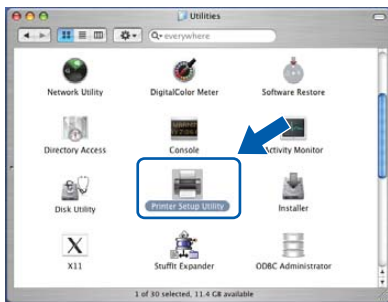

Note

For Mac OS® X 10.2.x users, open **Print Center**.

28 Click **Add**.

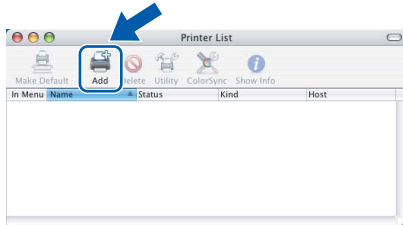

29 Make the selection shown below.

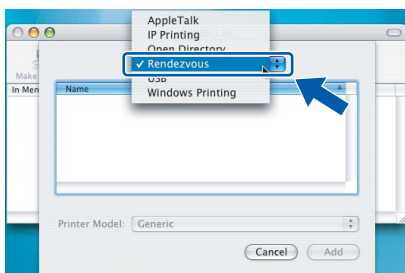

Note

For Mac OS® X 10.4 users, go to step 30.

30 Choose **Brother MFC-XXXX** (where XXXX is your model name), and then click **Add**.
For Mac OS® X 10.2.4 to 10.3.x users

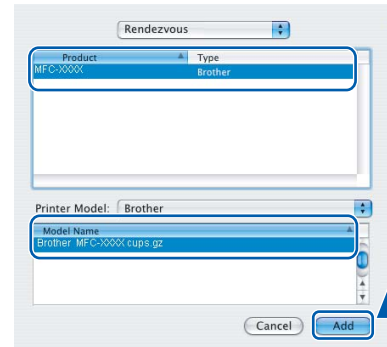

For Mac OS® X 10.4 or greater users

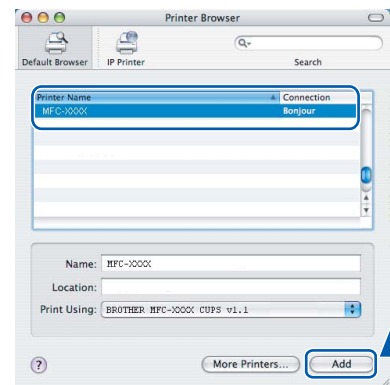

See Chapter 6 of the *Network User's Guide* on the CD-ROM.

31 Click **Printer Setup Utility**, then **Quit Printer Setup Utility**.

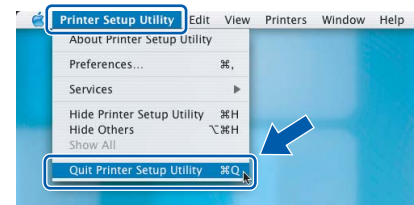
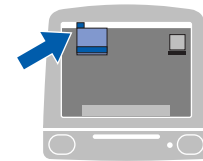

The MFL-Pro Suite, Printer Driver, Scanner Driver and ControlCenter2 have been installed.



For more information about connecting the machine to a Macintosh® network, see Chapter 6 of the *Network User's Guide* on the CD-ROM.

- 32** To install Presto!® PageManager®, click the **Presto!PageManager** icon and follow the on-screen instructions.



 **Note**

When Presto!® PageManager® is installed OCR capability is added to the Brother ControlCenter2. You can also easily scan, share, and organize photos and documents using Presto!® PageManager®.

 **Presto!® PageManager® has been installed and the installation is now complete.**

This section explains how you can configure network settings using the BRAdmin Professional Utility or how to set the machine's network settings to wireless LAN or wired LAN.

Installing the BRAdmin Professional configuration utility (For Windows® users)

The BRAdmin Professional utility for Windows® is designed to manage your Brother network connected devices such as network-ready Multifunction devices and/or network-ready printers in a Local Area Network (LAN) environment.

For more information on BRAdmin Professional and BRAdmin Light, visit <http://solutions.brother.com>

- 1 Put the supplied CD-ROM into your CD-ROM drive. The opening screen will appear automatically. Follow the on-screen instructions.



- 2 Click **Install Other Drivers or Utilities** on the main menu screen.



- 3 Click **BRAdmin Professional** and follow the on-screen instructions.



Setting your IP address, Subnet Mask and Gateway using BRAdmin Professional (For Windows® users)

- 1 Start BRAdmin Professional, and choose **TCP/IP**.

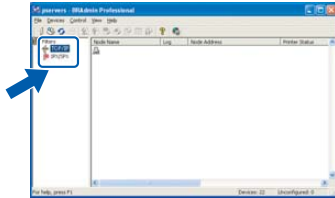

- 2 Click **Devices**, then **Search Active Devices**. BRAdmin searches for new devices automatically.

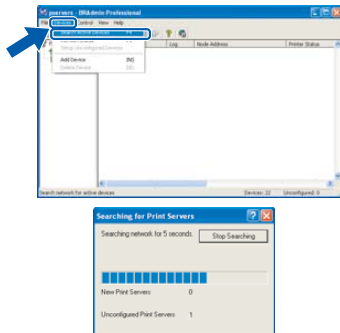

- 3 Double-click the new device.

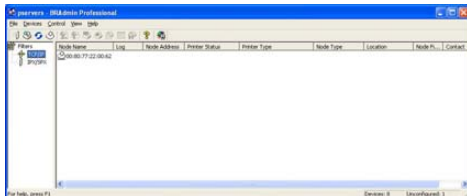

- 4 Enter the **IP Address**, **Subnet Mask** and **Gateway**, and then click **OK**.

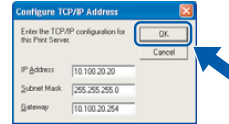

- 5 The address information will be saved to the machine.



Note

You can use the BRAdmin Professional utility to set a password. (See the Network User's Guide on the CD-ROM.)



Note

The default password for the print server is "access". You can use BRAdmin Professional or a web browser to change this password.

BRAdmin Light configuration utility (For Mac OS[®] X users)

The Brother BRAdmin Light software is a Java™ application that is designed for the Apple Mac OS[®] X environment. It supports some of the features of the Windows BRAdmin Professional software. For example, using the BRAdmin Light software, you can change some network settings on Brother's network ready printers and multifunction devices.

The BRAdmin Light software will be installed automatically when you install the MFL-Pro Suite. Please refer to Installing the driver and software in this Quick Setup Guide if you have not yet installed the MFL-Pro Suite. For more information on BRAdmin Light, visit us at <http://solutions.brother.com>.

Setting your IP address, Subnet Mask and Gateway using BRAdmin Light

Note

- If you have a DHCP/BOOTP/RARP server in your network, you don't have to do the following operation. The print server will automatically obtain its own IP address. Make sure that version 1.4.1_07 or later of Java™ client software is installed on your computer.
- The default password for the print server is "access". You can use BRAdmin Light to change this password.

- 1 Double-click the **Macintosh HD** icon on your desktop.

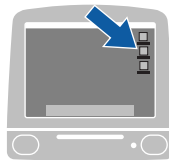

- 2 Choose **Library**, **Printers**, **Brother** and then **Utilities**.

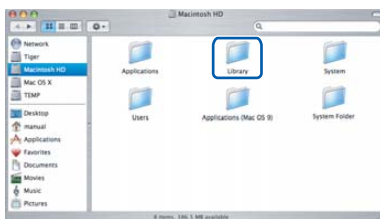

- 3 Double-click the **BRAdmin Light.jar** file. Run the BRAdmin Light software. BRAdmin Light searches new devices automatically.

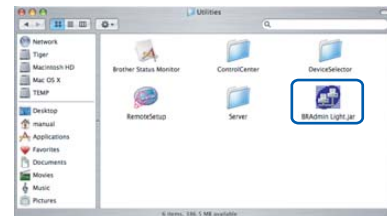

- 4 Double-click the new device.

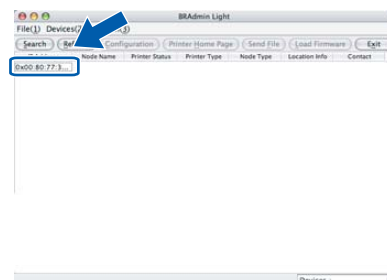

- 5 Enter the **IP Address**, **Subnet Mask** and **Gateway**, and then click **OK**.

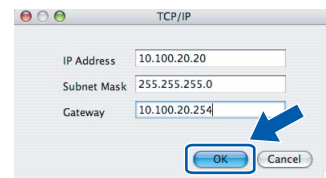



- 6 The address information will be saved to the printer.

How to set the machine's network settings to wireless LAN or wired LAN

To connect your Brother machine to a wireless or wired network you must configure the machine from the machine's control panel for the network type you are using.



For wireless LAN

On your machine, press **Menu, 6, 2, 5** then press

 or  to choose **On**, and then press **OK**.

For wired LAN

On your machine, press **Menu, 6, 1, 4** then press

 or  to choose **On**, and then press **OK**.

Note

*In case that you choose **On** for both wireless LAN and wired LAN, if the network cable is connected to the machine, the wired network interface will be active. If the cable is not connected to the machine, the wireless network interface will be active.*

Restoring the network settings to factory default

To restore all network settings of the internal Print/Scan server to factory default, please follow the steps below.

- 1** Make sure the machine is not operating, then disconnect all the cables from the machine (except power cable).
- 2** Press **Menu, 6, 0**.
- 3** Press **1** to select **Reset**.
- 4** Press **1** to select **Yes**.
- 5** The machine will restart, re-connect cables once this is complete.

Options and Consumables

Options

The machine has the following optional accessories. You can expand the capabilities of the machine by adding these items.

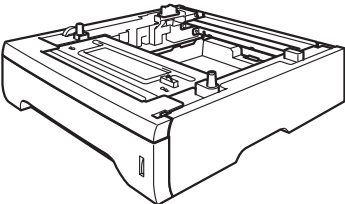
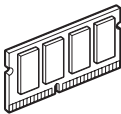
Lower Tray Unit	DIMM Memory
LT-5300	
 <p data-bbox="183 689 821 766">Second lower paper tray unit can hold up to 250 sheets of paper. When the tray is installed, the machine expands total input capacity up to 550 sheets.</p>	 <p data-bbox="845 689 1484 743">You can expand the memory by installing a (144-pin DIMM) memory module.</p>

Consumables

When the time come to replace consumables items an error message will be indicated on the LCD. For more information about the consumables for your machine, visit <http://solutions.brother.com> or contact your local Brother re-seller.

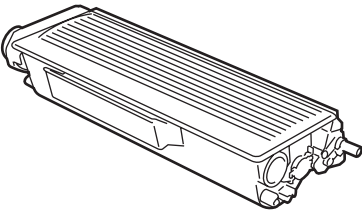
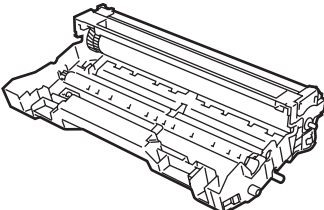
Toner Cartridge	Drum Unit
TN-3130/TN-3170	DR-3100
	

Trademarks

The Brother logo is a registered trademark of Brother Industries, Ltd.

Brother is a registered trademark of Brother Industries, Ltd.

Multi-Function Link is a registered trademark of Brother International Corporation.

Windows and Microsoft are registered trademarks of Microsoft in the U.S. and other countries.

Macintosh and True Type are registered trademarks of Apple Computer, Inc.

Postscript and Postscript 3 are registered trademarks or trademarks of Adobe Systems Incorporated.

PaperPort is a registered trademark of ScanSoft, Inc.

Presto! PageManager is a registered trademark of NewSoft Technology Corporation.

BROADCOM, SecureEasySetup, and the SecureEasySetup logo are trademarks or registered trademarks of Broadcom Corporation in the United States and/or other countries.

Each company whose software title is mentioned in this manual has a Software License Agreement specific to its proprietary programs.

All other brand and product names mentioned in this manual are trademarks or registered trademarks of their respective companies.

Compilation and Publication

Under the supervision of Brother Industries Ltd., this manual has been compiled and published, covering the latest product descriptions and specifications.

The contents of this manual and the specifications of this product are subject to change without notice.

Brother reserves the right to make changes without notice in the specifications and materials contained herein and shall not be responsible for any damages (including consequential) caused by reliance on the materials presented, including but not limited to typographical and other errors relating to the publication.

This product is designed for use in a Professional Environment.

© 2006 Brother Industries, Ltd. © 1998-2006 TROY Group, Inc. © 1983-2006 PACIFIC SOFTWARES INC. This product includes the "KASAGO TCP/IP" software developed by Elmich Systems, Inc. ALL RIGHTS RESERVED.

brother®

UK/IRE/SAF