

TZ
TAPE

P-touch

EXTRA



MODEL PT-300

USER'S GUIDE

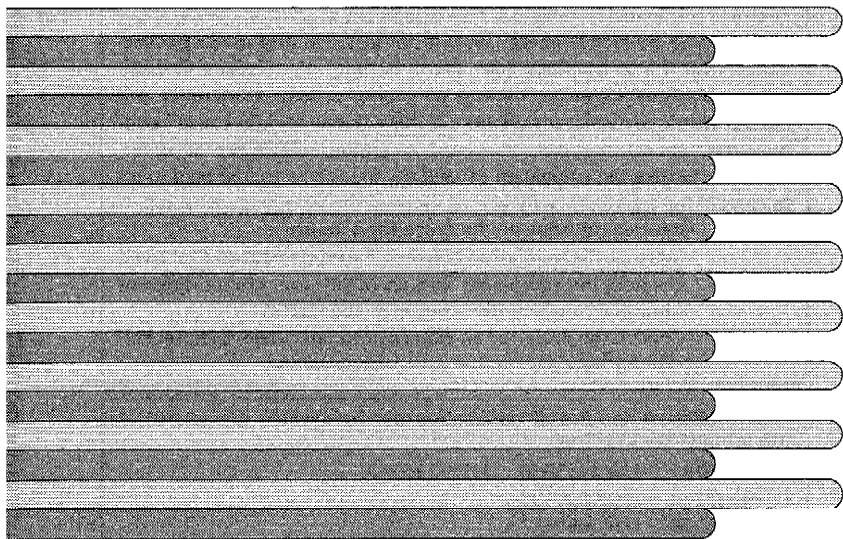

- Read this instruction before you start using your P-Touch.
- Keep this instruction in a handy place for future reference.

brother®

INTRODUCTION

This machine will help you design and print labels for any application. Extremely versatile, it can create characters of many sizes and styles. In addition, with the use of colorful tape cartridges, you can print labels with a variety of letter and background colors.

You no longer have to worry about rushing tasks that require professional-type printing. The quality and performance of this machine make it very versatile.

Although this machine is easy to use, we suggest that you read this manual carefully before starting. Please keep this manual in a handy place for future reference.

Good luck! We hope you enjoy making beautiful custom labels.

FCC NOTICE

This equipment has been tested and found to comply with the limits for a Class B digital device, pursuant to Part 15 of the FCC Rules. These limits are designed to provide reasonable protection against harmful interference in a residential installation. This equipment generates, uses, and can radiate radio frequency energy and, if not installed and used in accordance with the instructions, may cause harmful interference to radio communications. However, there is no guarantee that interference will not occur in a particular installation. If this equipment does cause harmful interference to radio or television reception, which can be determined by turning the equipment off and on, the user is encouraged to try to correct the interference by one or more of the following measures:

- Reorient or relocate the receiving antenna
- Increase the separation between the equipment and receiver.
- Connect the equipment into an outlet on a circuit different from that to which the receiver is connected.
- Consult the dealer or an experienced radio/television technician for help.

Patent numbers and patent publication numbers which are related to this product are as below:

USP4839742	USP4983058	USP5120147
USP4927278	USP5009530	
USP4976558	USP5069557	

Use only the adaptor designed exclusively for this machine. See GENERAL PRECAUTIONS on page 5.

CONTENTS

CONTENTS	1
OVERVIEW	2
GENERAL PRECAUTIONS	5
BEFORE YOU START	6
INSERTING A TAPE CASSETTE	6
INSERTING BATTERIES	7
CHANGING THE CUTTER UNIT	8
STARTING	9
CREATING A MESSAGE	10
DISPLAY	10
MOVING THE CURSOR	10
CLEARING THE DISPLAY	11
KEY OPERATIONS	12
INPUT	13
SPACE KEY	14
SYMBOLS	15
EDITING A MESSAGE	18
DELETING	18
WORD OUT	20
OVER TYPING	21
INSERTING	22
SETTING THE FORMAT	24
SIZE	24
BIG SIZE FONT	27
STYLE	28
UNDERLINE/FRAME	30
PRINTING A LABEL	32
PRINTING	32
CUTTING	33
REPEAT PRINTING	34
NUMBERING	35
MIRROR PRINTING	38
TAPE FEED	39
PHRASE MEMORY OPERATION	42
PHRASE MEMORY	42
MEMORY SIZE	42
STORING THE MESSAGE	42
RECALLING FROM PHRASE MEMORY	44
DELETING THE PHRASE MEMORY	46
MESSAGE LIST	48
TROUBLESHOOTING	49
SPECIFICATIONS	50
ACCESSORIES	51

OVERVIEW

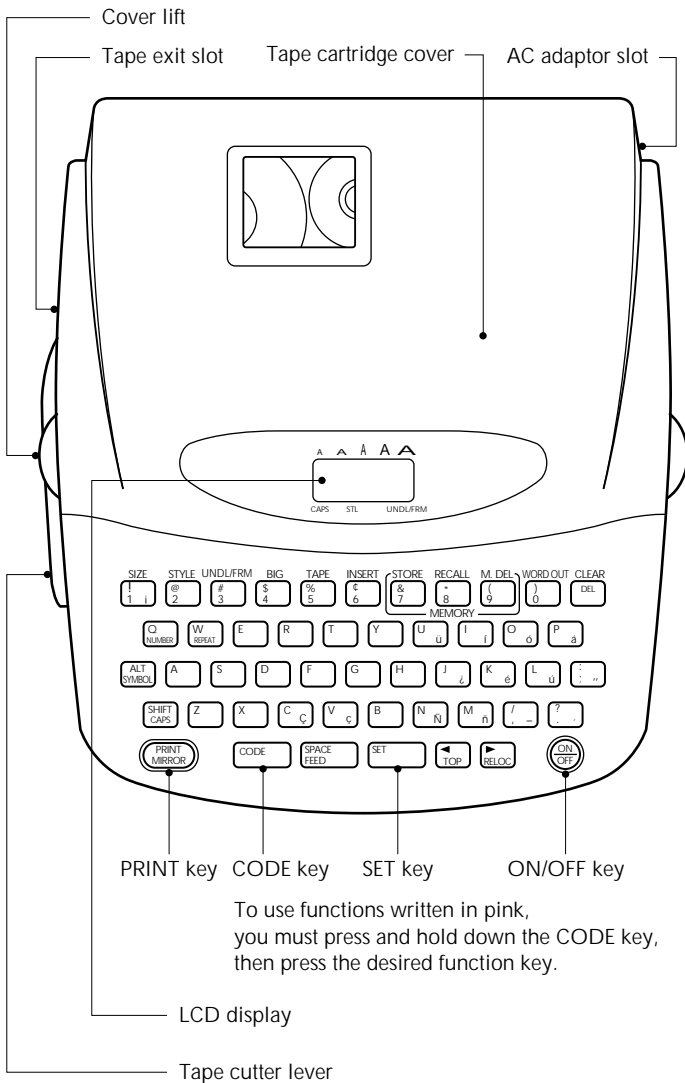

To use functions written in pink,
 you must press and hold down the CODE key,
 then press the desired function key.

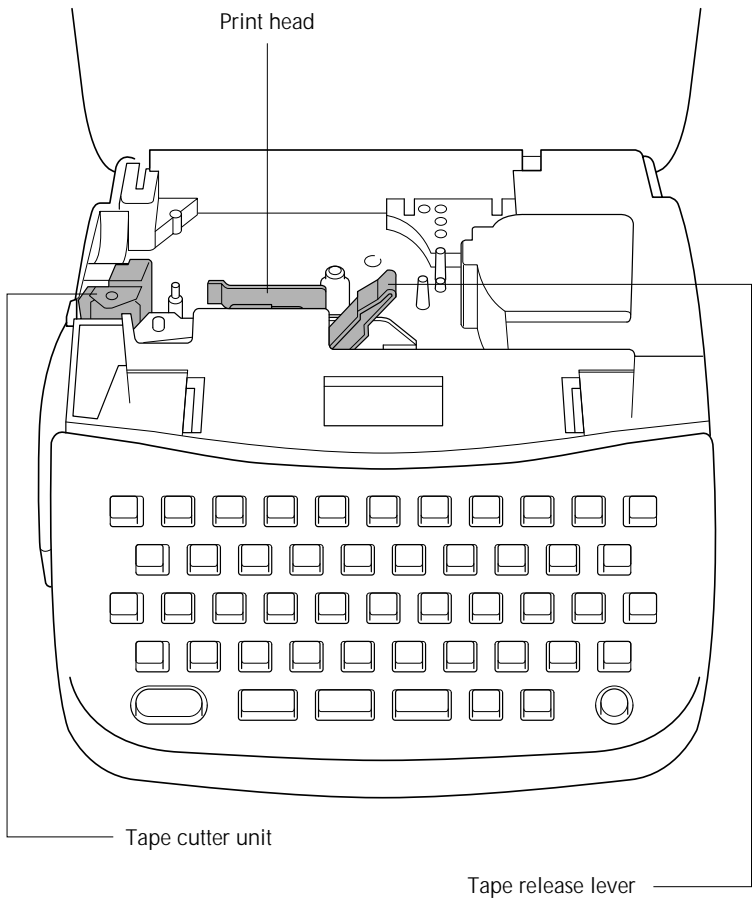

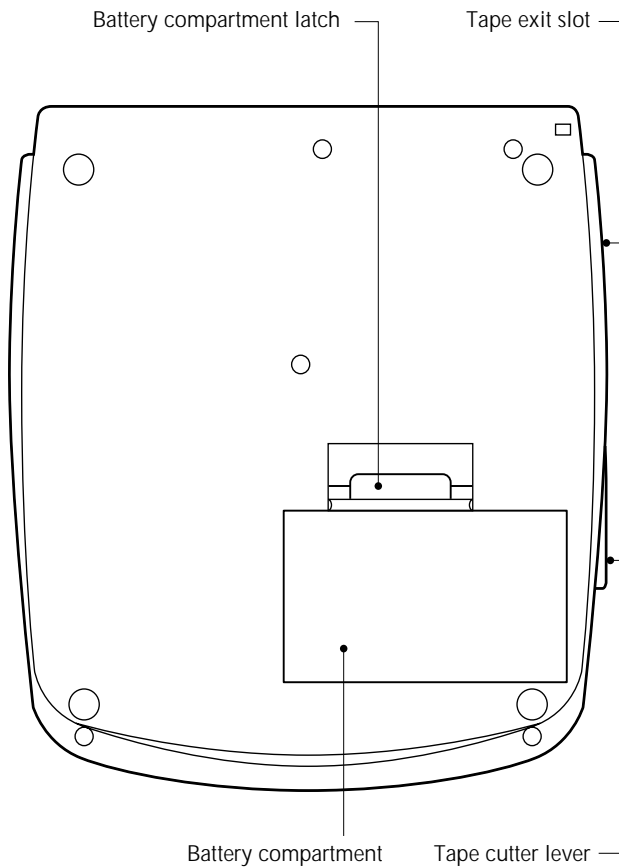

GENERAL PRECAUTIONS

- Use only Brother TZ tapes with this machine. Do not use tapes that do not have the  mark.
- Four different tape widths are available: 1/4"(6mm), 3/8"(9mm), 1/2"(12mm) and 3/4"(18mm).
- Do not pull the tape. This may damage the tape cassettes.
- Do not clean the machine with alcohol or other organic solvents. Use only a soft, dry cloth.
- Remove the batteries and/or disconnect the AC Adaptor if you do not intend to use your machine for an extended period of time.
(Note: When power is disconnected, any messages in the working area or the Message Memory area will be lost.)
- Do not put anything onto or into the machine.
- Do not expose the machine to high temperatures or high humidity. Never leave it on the dashboard or in the back of your car.
- Do not use the machine in dusty places. Keep it out of both direct sunlight and rain.
- Do not leave any rubber or vinyl on the machine for an extended period of time. Doing so may cause staining.
- After inserting a new tape cassette, advance the tape by holding down the **CODE** key and pressing the **FEED** key once.
- Do not touch the print head mechanism. If the head is touched, clean it immediately with a soft wipe (e.g.cotton swab) to avoid permanent damage.
- **Use only the AC Adaptor, MODEL AD-30 designed exclusively for this machine. Use of any adaptor will void warranty.**

BEFORE YOU START

INSERTING A TAPE CASSETTE

Brother TZ tapes are only available in the following widths for this machine:
1/4" (6mm), 3/8" (9mm), 1/2" (12mm) and 3/4" (18mm).

To insert a new tape cassette:

- (1) Lift the cassette cover so that you can reach the tape cassette easily. This will also release the installed cassette.
- (2) If there is a tape cassette already in the compartment, remove it by pulling it straight up.
- (3) Remove the stopper from a new tape cassette and if the tape is loose, use your finger to wind it in the direction of the arrow on the tape cassette until it is taut. If you are using a previous tape, ensure the tape is taut prior to inserting it into the unit.

Note: ● *Some tape cassettes are not provided with a stopper.*

- (4) Insert the tape cassette firmly into the compartment.
- (5) Shut the compartment cover.
- (6) Advance the tape by holding down the **CODE** key and pressing the **FEED** key once, then cut the tape.

Note: ● *When inserting a tape cassette, make sure that the inner ribbon does not get caught on the corner of the metal securing stand.*

- *The white lever (release lever) automatically locks when the cover is closed. If the white lever is manually operated, the cover can not be closed.*

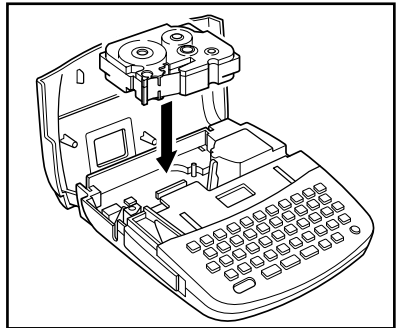
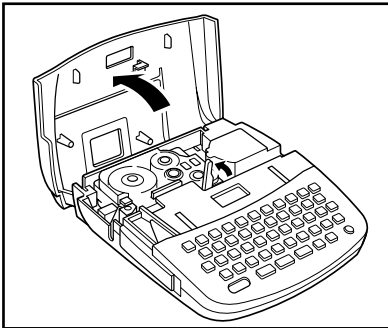

INSERTING BATTERIES

The machine uses six "AA" size (AM3, LR6, SUM-3, R6) batteries.

To insert batteries:

- (1) Turn the machine over. Remove the battery compartment cover by pinching the latch and lifting.
- (2) Follow the diagrams on the back of the compartment to insert the batteries in the proper direction.
- (3) After inserting the batteries, re-fit the battery compartment cover.

When "BATT" (Batteries Weak) is displayed, replace the six batteries.

● Alkaline batteries are recommended.

- An optional AC Adaptor is available. (Model AD-30:7V, 1.2A)

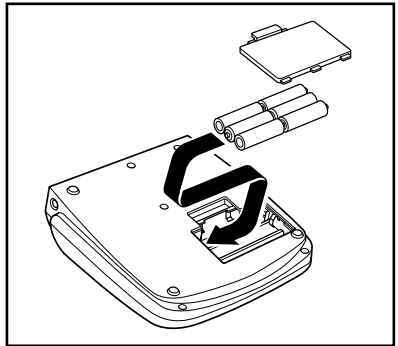
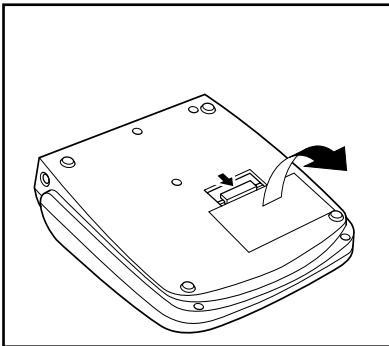

Note:

- When replacing batteries, do so in three minutes or less. Otherwise, unless an optional AC Adaptor is attached, any message in the working area or Phrase Memory will be lost.
- Note the following details when 1.2 V rechargeable NiCd batteries are used in this machine.
 - (1) "BATT" will not appear on the display when the rechargeable batteries are weak or empty. Instead, the power will turn off.
 - (2) Even after the batteries are recharged, the characters may not be printed clearly as a result of a low recharging efficiency or the operating conditions.

CHANGING THE CUTTER UNIT

When the cutter is not cutting well, replace it with a new one.

To replace a cutter with a dull or broken blade:

- (1) Open the tape cassette compartment cover and carefully remove the tape cassette if it is installed.
- (2) Grasp the cutter with your fingers and pull it out.
- (3) Grasp the new cutter with the tab on the protective film and insert the cutter into the machine.
- (4) Remove the cutter's protective film.
- (5) Insert the tape cassette, then close the tape cassette compartment cover.

WARNING: *Be very careful not to cut yourself when replacing the cutter.*

Note: *The expected life of the unit's cutter is approximately 2000 cuts.*

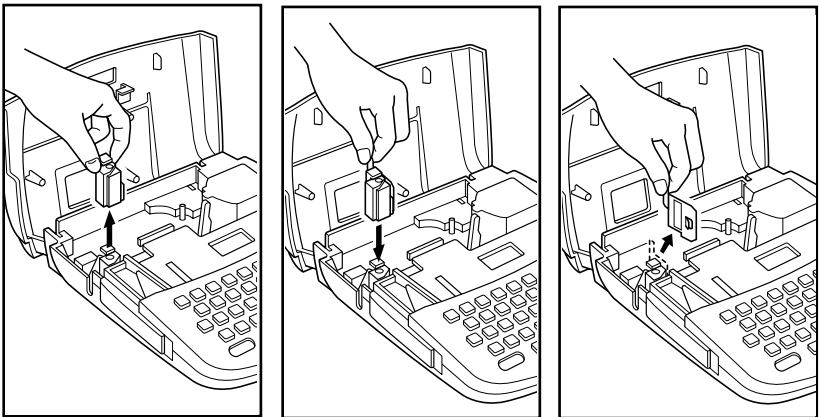

CAUTION

- When changing the cutter unit, be sure not to touch the cutter blade.
- Make sure that small children do not try to put the cutter unit in their mouths.

STARTING

To start the machine:

Press the ON/OFF key.

The machine's internal memory retains the last message created, and displays it when you turn on the machine. This feature allows you to stop work on a message, turn off the machine, and return to it later without having to re-enter the message.

The machine has an automatic power down feature. If the machine is on, but is not used for five minutes, it will automatically shut off. The message will be retained in memory until the machine is turned on again.

CREATING A MESSAGE

DISPLAY

You are now ready to create a message on the machine.

The machine's LCD display is four characters wide. Actually though, you can create messages up to 55 characters in length. The four-character display is like a window which moves across your message.

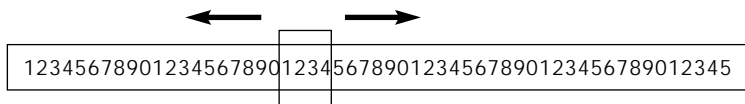

MOVING THE CURSOR

You can review and edit different parts of your message by moving the cursor backward and forward.

To move the cursor through your message:

Press the ◀ and ▶ keys to move the cursor one space at a time.

- Note:**
- Hold down the **CODE** key and press the **TOP** key to return the cursor to the beginning of the message.
 - Hold down the **CODE** key and press the **RELOC** key to advance the cursor to the end of a message.

CLEARING THE DISPLAY

Before entering a new message, you will often need to clear an old message.

To erase the previous message from the display:

Hold down the **CODE** key and press the **CLEAR** key.

Example ● Erase any message from the display by pressing

 CODE + CLEAR DEL .

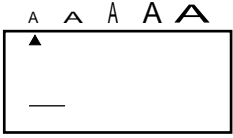

CAPS STL UNDL/FRM

In the following examples, we will work through a sample message, first creating it, then editing it, next printing it, and finally storing it in the machine's memory.

For the purpose of this example, suppose you are J. Smith, and you want to make a label with your name on it.

KEY OPERATIONS

CODE KEY

By holding down the **CODE** key and pushing the appropriate key, you can use the functions written in pink characters.

SHIFT KEY

By using the **SHIFT** key you can type capital letters, and symbols located on the upper part of keys. To type a capital "A", hold the **SHIFT** key down and push the "A" key. To type a "percent" sign "%" (located above the "5"), hold the **SHIFT** key down and push the "5" key.

CAPS KEY

By holding down the **CODE** key and pressing the **CAPS** key, you set the machine into CAPS mode. When this mode is entered, the CAPS indicator on the display turns on. In CAPS mode, capital letters can be typed simply by pressing the character keys. If number keys are pressed, numbers -- not the symbols above them -- result. For this reason, CAPS mode is particularly useful for creating messages containing many numerals and capital letters. To exit CAPS mode, hold down the **CODE** key and press the **CAPS** key.



ALT KEY

By using the **ALT** key you can type various symbols marked on the keys in green. To type a symbol located on the right side of a key, hold down the **ALT** key and press the key on which the desired symbol is marked.

INPUT

You can now use the keys to enter a message.

Example To input "Mr.":

- Press  +  to input a capital M.

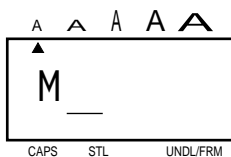

- Complete "Mr." by pressing  then .

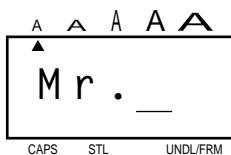

SPACE KEY

As on a typewriter, this machine's **SPACE** key lets you add a blank space into your message.

Note: The **SPACE** key and the **▶** key have different functions. The **▶** key moves the cursor forward without adding blank spaces.

Example To complete the message "Mr. J Smith":

Enter the initial "J":

- Press **SHIFT CAPS** + **J** to input a capital J.
- Add a blank space by pressing **SPACE FEED** once.

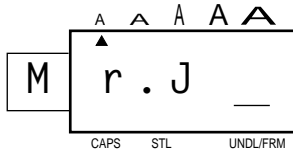

- Complete the message by entering "Smith".

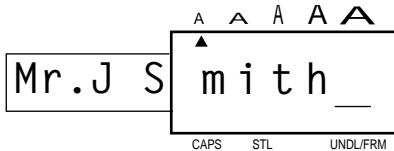

































- If you make any mistakes during this input do not worry.

Simply press **CLEAR DEL** to remove the last character, and input correctly.

SYMBOLS

In addition to the letters, symbols, and numerals on the key tops, there are 57 symbols available in Symbol Mode. These 57 additional symbols are arranged into 15 groups, corresponding to the numbers A to O on the keyboard.

Group No.	SYMBOLS	Group No.	SYMBOLS
A	Ü Æ æ §	I	   
B	+ × ÷ =	J	   
C	• ® © ™	K	   
D	[]  	L	   
E	$\frac{1}{2}$ ° ² ³	M	   
F	ª º ♥ ★	N	   
G	² ³ ⁴ 	O	
H	   		

To input a symbol that is not on the key top:

- (1) Hold down the **CODE** key and press the **SYMBOL** key to enter Symbol Mode.
- (2) The display will read: "A-O?".
- (3) Press the key of the number from A to O whose group contains the symbol you want. That letter's group of symbols will be displayed.
- (4) Move the cursor to the symbol you want.
- (5) Press the **SET** key.

Note: ● Press the **DEL** key to exit Symbol Mode.

Example First, make sure that the cursor is located at the place where you want to add a symbol. To add a telephone symbol (☎) to the message, changing the message to "Mr. J Smith ☎":

- Enter Symbol Mode by pressing CODE + ALT SYMBOL.
- The following message will be displayed:

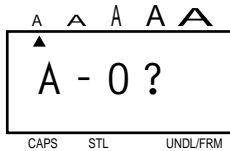

- Press the G key, as its group includes the telephone symbol.

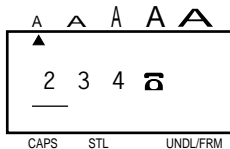

- The cursor is displayed highlighting the ☎.

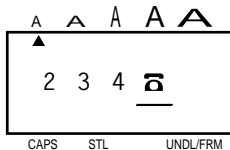

- Push to input a **ā**.

The message should now look like this:

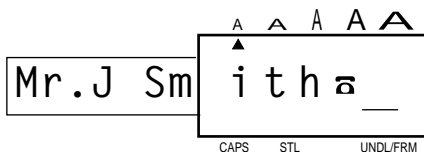

After a non-keyboard symbol has been entered, the machine automatically exits from Symbol Mode. If you wish to enter another symbol, you must re-enter Symbol Mode by holding down the **CODE** key and pressing the **SYMBOL** key.

EDITING A MESSAGE

DELETING

The **DELETE** key allows you to remove characters from your message.

To delete a character:

- (1) Using the ◀ and ▶ keys, position the cursor one space to the right of the character you want to delete.
- (2) Press the **DELETE** key.

Example To delete the ☎ from the message:

- Make sure the cursor is positioned to the right of the telephone symbol.

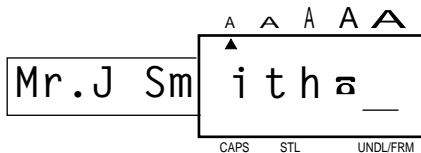

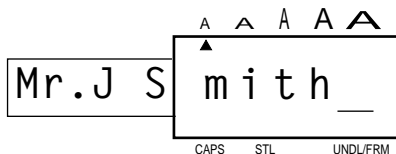

- Press to remove the ☎.



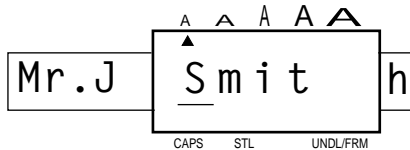

Now we will delete the blank space between the “J” and “S”:

- Press  until the cursor is positioned to the right of the blank space (under the “S”).

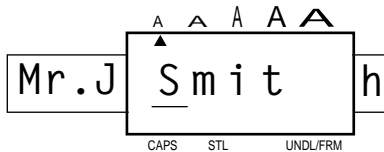

- Press  to remove the blank space.



- Press  to adjust the display in order to check that the blank space has been deleted.

WORD OUT

This function allows you to erase one word at a time, simplifying the editing of long messages.

To use the WORD OUT function:



- (1) Position the cursor to the right of the word you want to delete.
- (2) Hold down the **CODE** key and press the **WORD OUT** key.

A number or word located before the cursor and after the nearest preceding space will be deleted.

Example To delete the word "Mr." from the message:

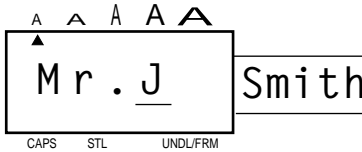
- Press  to position the cursor under "J".



- Press  +  to delete "Mr.".

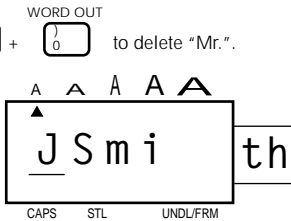

OVER TYPING

The machine normally operates in Overtyping Mode. In Overtyping Mode, you can change a character simply by typing a new one in its place.

To type over a character:

- (1) Move the cursor to the character you want to change.
- (2) Press the character or symbol you want.

The new character replaces the old one in the message.

Example To replace the lower-case letters "mith" with capital letters:

- Position the cursor under the "m".

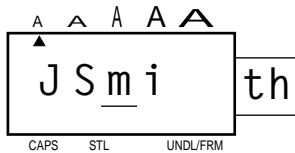

- Switch to CAPS Mode by pressing **CODE** + **SHIFT CAPS**.
The CAPS indicator will light.
- Press the **M** key.

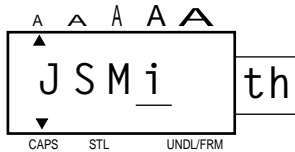

- Complete the process by typing the letters "ITH".

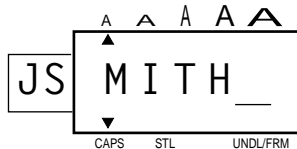

INSERTING

Sometimes you may want to insert a character into the middle of your message. To do so, you must change from Overtyping Mode to Insert Mode.

To insert characters:

- (1) Hold down the **CODE** key and press the **INSERT** key until display shows "I : ○".
- (2) Move the cursor to the position where you want to insert.
- (3) Press the keyboard character or symbol you want to add (see SYMBOLS).

All characters following the insertion will move one space to the right.

Example To insert a period into the message, changing it to "J. SMITH":

- Position the cursor under the "S".

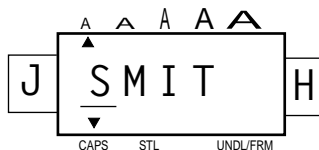

- Enter Insert Mode by pressing **CODE** + **INSERT** (⌘ 6).
- The following display appears.

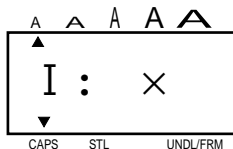

- Pressing the **INSERT** (⌘ 6) key while holding down the **CODE** key toggles between insert and overwrite mode.

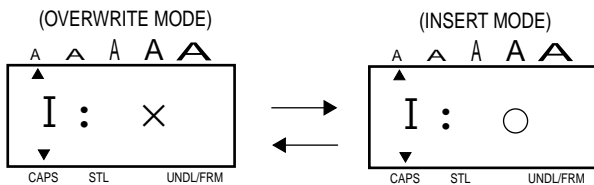

- Release the **CODE** key when the display shows "I: ○".
- Press the **?** key.

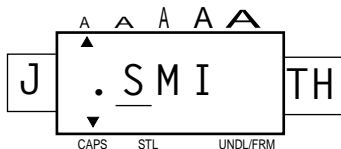

To leave INSERT Mode:

Holding down the **CODE** key press the **INSERT** key again.

SETTING THE FORMAT

You can print your completed message using a variety of different character sizes, styles, fonts, underline/frames and tape feed settings.

Choose character size, style, underline/box and tape feed before printing the label.

Note: *The type of character you choose will be used for all the characters in your message. It is not possible to have two different character sizes or styles within one message.*

SIZE

There are five different character sizes you can select for your label:

1 - Standard Size

J.SMITH

W2 - Double Width

J.SMITH

H2 - Double Height

J.SMITH

4 - Double Width & Double Height

J.SMITH

8 - 4 x Width & Double Height

J.SMITH

To choose a character size:

- (1) Holding down the **CODE** key, press the **SIZE** key to change the character size. The size indicator on the display advances in the order shown.

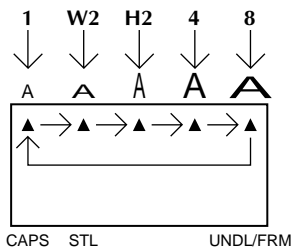

- (2) Stop pressing the **SIZE** key when your desired character size is indicated.

Example To use Double Width and Double Height (4) characters:

- Hold down and press until the size indicator is aligned with the A.

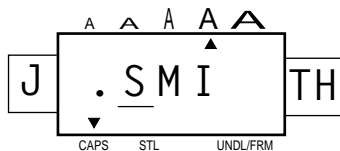

Note: When the BIG font is selected, the size is fixed to the BIG size whatever the SIZE setting.

Note: *The size of the characters that can be printed are limited by the width of the tape.*

Tape width	Possible character sizes
3/4"(18mm)	1, W2, H2, 4, 8, BIG
3/4"(12mm)	1, W2, H2, 4, 8
3/8"(9mm)	1, W2, H2, 4, 8
1/4"(6mm)	1, W2

If a character size is set which is not shown in the above table for the tape width being used and the **PRINT** key is pressed, an error message will be displayed and the label can not be printed.

BIG SIZE FONT

This machine has a BIG size font in addition to the normal font. The normal size font can be set at the standard size, W2 (double width), H2 (double height), 4 (double width & double height) and 8 (4 × width & double height). If the BIG size font is chosen, all other settings are cancelled.

J.SMITH

To choose the BIG size font:

- (1) Holding down the **CODE** key, press the **BIG** key. The display shows "NORM" or "BIG", whichever is the currently selected font size.
- (2) Pressing the **BIG** key while holding down the **CODE** key toggles the displays.
- (3) Release the **CODE** key when a desirable font size is selected on the display.

It will change as follows:

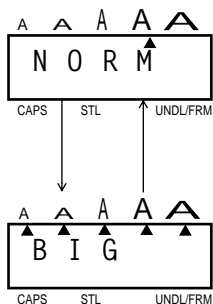

- Note:**
- When the BIG size font is selected, all lower case characters are printed in upper case, and the settings for SIZE, STYLE and UNDL/BOX are ignored.
 - The BIG size font can only be set when tape with a 3/4" (18 mm) width is used.

STYLE

There are also nine different print styles:

Normal (NORM)

J.SMITH

Italic (ITAL)

J.SMITH

Outline (OUTL)

J.SMITH

Italic + Outline (IT+O)

J.SMITH

Bold (BOLD)

J.SMITH

Italic + Bold (IT+B)

J.SMITH

Shadow (SHAD)

J.SMITH

Italic + Shadow (IT+S)

J.SMITH

Vertical (VERT)

J · S M I T H

To choose a print style for your label:

- (1) Holding down the **CODE** key, press the **STYLE** key once. The display will show the current print style.
- (2) Still holding down the **CODE** key, press the **STYLE** key again. The available print styles will appear in order as you press the **STYLE** key.
- (3) When the style you want is displayed, release the **CODE** key.

If you select a style other than Normal, the style indicator will be visible on the display.

- Note:**
- Only Normal style characters can be printed vertically.
 - Vertical printing can not be used with some tape width and character size combinations.

Example To use Outline print:

- Hold down .
- Press until the display reads "OUTL".

The style indicator turns on.

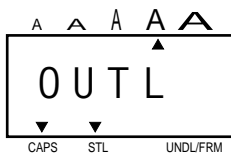

- Release .

UNDERLINE/FRAME

You can add an underline or frame text when you wish to emphasize it.

To add Underline or Box around the text.

- (1) Holding down the **CODE** key, press **UNDERLINE/FRAME** (#
3) key.
- (2) The current style will be shown on the display.
- (3) Still holding down the **CODE** key, press **UNDERLINE/FRAME** key to change the style.

It will change as follows:

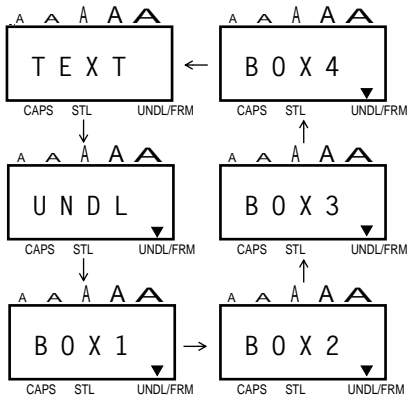

- Note:**
- Underline & Box are not available simultaneously.
 - The underline or box will not be printed when the Vertical is used.
 - Printing of the underline or frame are limited by the tape width and character size setting.

Tape width	Possible character sizes
3/4" (18 mm)	1, W2, H2, 4, 8, B , G
1/2" (12 mm)	1, W2, H2, 4, 8
3/8" (9 mm)	1, W2, H2, 4, 8
1/4" (6 mm)	X , W , Z

A triangle indicator on the display appears whether Underline or Frame is set on.

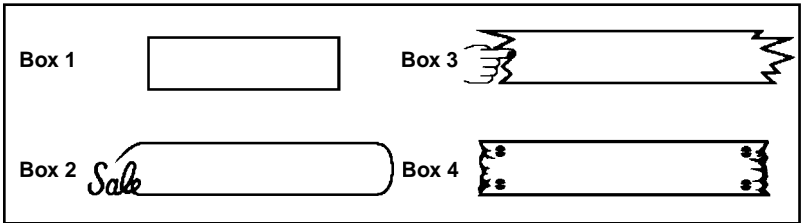

PRINTING A LABEL

PRINTING

After you have chosen the character size, print style and tape feed style, you are ready to print the label.

To print a label:

Press the **PRINT** key.

The printed label comes out of the tape exit slot on the side of the machine.

Press the **CODE + FEED** key before cutting the tape if TAPE FEED mode is set to "_", "#", "##" or "###".

Example To print the message onto a label:

- Press .

A label reading "J. SMITH" written in Double Width & Double Height Outline characters will be printed.



J.SMITH

- Note:**
- *Do not pull on the tape. This may damage the tape cassette.*
 - *Do not attempt to cut the tape during printing or feeding.*

CUTTING

To cut the tape:

Pull out the tape cutter lever on the side of the machine.

Example To cut the label:

- Pull out the tape cutter lever.

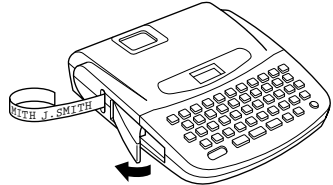

Note: *If you pull out the tape cutter lever too far, it may break.*

To attach the label:

Remove the label backing and attach the label at the desired position.

REPEAT PRINTING

The Repeat function allows you to repeatedly print the same label up to nine times.

To use the REPEAT PRINTING function:

It is recommended to set the TAPE FEED mode to "#", "##" or "###". (Please refer to page 39.)

- (1) Hold down the **CODE** key and press the **REPEAT** () key.
- (2) The following message appears on the display:

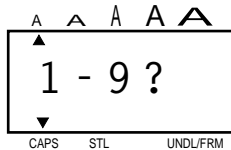

- (3) Select the number of labels you want. For example, if you want nine labels to be printed, type 9.
- (4) Press print.
Press the **CODE + FEED** keys before cutting the tape if the TAPE FEED mode is set to "-", "#", "##" or "###".

Note:

- Press  before printing; the previous screen reappears.
- A maximum of nine copies can be printed.
- Cutting is not done automatically.
- Before starting a repeat print, check that there is sufficient tape in the cartridge.
- Never try to cut the tape during printing.
- Press the **ON/OFF** key immediately if the tape runs out before all the printing is finished. (striped tape will appear.)

NUMBERING

The NUMBERING function can be used to automatically increment numbers included in otherwise identical texts. For example, when printing text with a series of dates ("JULY 4, 1962"; "JULY 5, 1962"; and "JULY 6, 1962"), the auto count function will enable printing of all three texts in a single print operation.

To use the AUTO COUNT function when printing:

It is recommended to set the TAPE FEED mode to "#", "##" or "###". (Please refer to page 39.)

- (1) Type in message to be printed.
- (2) Position the cursor beneath the number in the text to be incremented. Then hold down the **CODE** key and press the **NUMBER**  key. The display changes as follows:

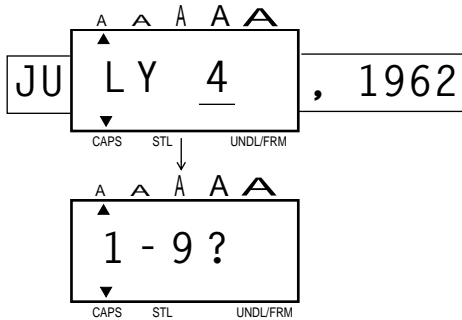

- (3) The screen will prompt the selection of the last number to be printed. (In the example described above, the last number would be 6.)
- (4) Press **PRINT** and the text will be printed out. Printing will be repeated, with the number specified incremented to the next number. This operation will continue until the last number is reached.
Press the **CODE + FEED** keys before cutting the tape if the TAPE FEED mode is set to "-", "#", "##" or "###".

- Note:**
- Before printing, you can press the **DELETE** key to erase the number you have entered. Pressing **DELETE** again will exit the NUMBERING mode.
 - The last number to be printed must be selected from within the range 1-9.
 - If you enter a number that is lower than the one originally entered in the text, printing will be disabled, and an "ERR" (ERROR) message will appear on the display if you press the **PRINT** key.

- Numbers are always incremented one at a time.
- If the battery becomes weak during a NUMBERING operation, the operation will be interrupted.

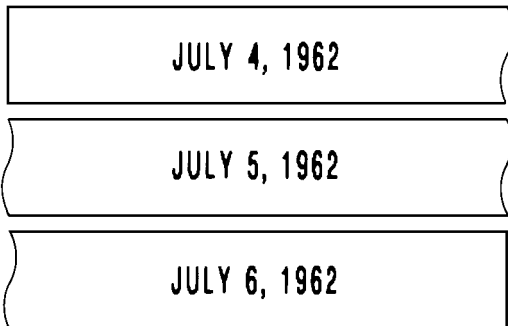

Example To use the NUMBERING function:

- Position the cursor beneath the number in the text to be incremented.

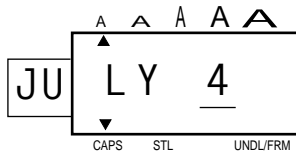

- Hold down the **CODE** key and press the **NUMBER** key. The display changes as follows:

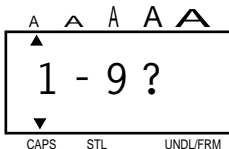

- Press numeric key "6".

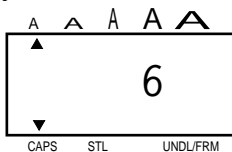

- Press **PRINT MIRROR**. Your text will be printed out.
- The number will automatically be incremented by one, and the text will be printed out again.
- The printing operation will be repeated until the number you selected as the last number has been printed out. When printing has completed, the following display appears.

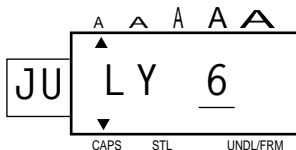

MIRROR PRINTING

For this application, tape with a clear adhesive must be used. When the mirror Printing function is used, characters are printed so as to be legible from the adhesive side of the tape. If the labels are then attached to glass or some other transparent material, they can be read correctly from the opposite side. This type of label is particularly useful for attachment to the inside of shop windows or clear notebooks, so that it can be read from the outside. For this application, transparent tape must be used.

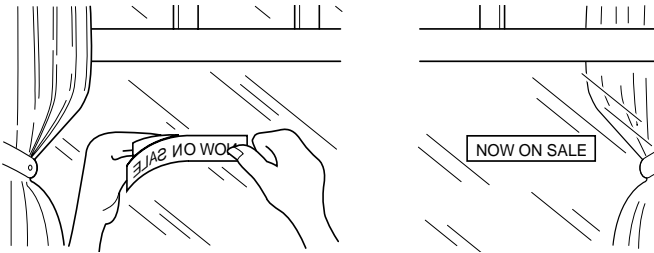

Mirror-printed labels attached inside the window can be read from the street.

To use Mirror Printing:

- (1) Holding down the **CODE** key, press the **MIRROR** () key.
- (2) The current print mode (M:○ or M:×) appears on the display.
- (3) Still holding down the **CODE** key, press the **MIRROR** key again. The display changes between the following two messages:

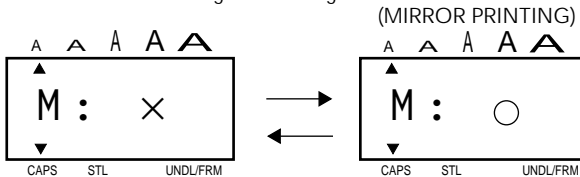

- (4) If you want to use Mirror Printing, release the **CODE** key when "M: ○" is displayed. To use regular printing, release the **CODE** key when "M: ×" is displayed.

Note: The Mirror Printing function automatically turns off when the machine is turned off. If you want to use Mirror Printing again after the power has been turned off, you must turn on the Mirror printing function again.

TAPE FEED

The tape feed function can be used to leave equal margins on the left and right sides of the label. The margins can be set to any of the following four widths: 1/6" (4mm), 1/3" (8mm), 1/2" (12mm) or 1" (24mm). When continuously printing labels, the labels can be printed without extra margins. In addition, this function is very convenient when printing more than one label with multiple styles while changing the styles each time a label is printed.

To change the TAPE FEED Mode:

- (1) Press and hold down the **CODE** key, then press the **TAPE** key.
- (2) The current feed mode appears on the display.
- (3) While still holding down the **CODE** key, press the **TAPE** key again. The display changes as shown below.

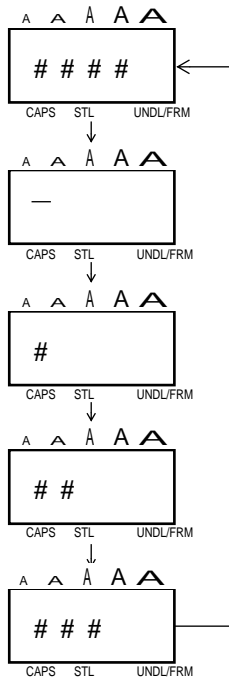

Note: When “-”, “#”, “##” or “###” is set, press **CODE** + **SPACE FEED** to feed the tape after the label is printed and before the tape is cut. If the tape is not fed before being cut, some of the printed characters may be cut off. (See the illustrations below.)

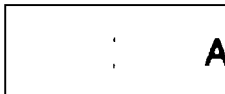

Example

- When “####” is set, the tape is automatically fed 1”(24mm) after the label is printed. If the tape is cut without being fed, a label like that shown in the illustration below is produced.

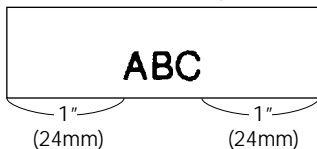

- When “-” is set, the tape is not automatically fed after the label is printed. If **CODE** + **SPACE FEED** is pressed to feed the tape and the tape is cut, a label like that shown in the illustration below is produced.

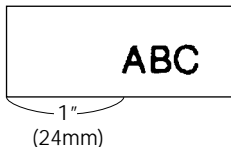

- When “#” is set, 4mm of the tape is automatically fed after the label is printed. If **CODE** + **SPACE FEED** is pressed to feed the tape and the tape is cut, a label like that shown in the illustration below is produced. Please cut the tape on the “:” mark with scissors.

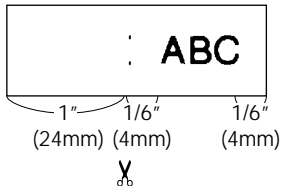

If the tape is cut at the cutline, the text is centered in the middle of the label. The tape is automatically fed 1/3"(8mm) when "## " is set, and 1/2"(12mm) when "### " is set.

- Continuous printing

When "# " is set and three labels are printed continuously, the tape is fed and a label like that shown in the illustration below is produced. If "## " or "### " is set, the labels are printed with the appropriate margin widths. Please cut the tape on the ":" mark with scissors.

1. Repeat printing (See page 34.)

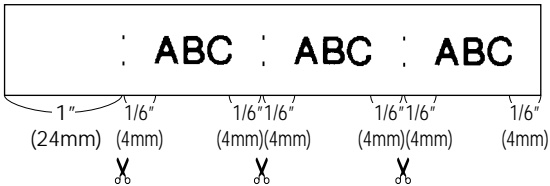

2. Numbering (See page 35.)

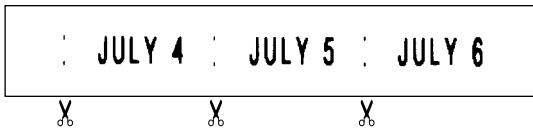

- Printing with different styles

When "- " is set, different styles can be used to print one label since the tape is not fed after a label is printed, different characters can be entered and the style can be changed. If the new label is printed, it will continue printing from the point where the first label stopped. After the whole label is printed, feed and cut the tape.



PHRASE MEMORY OPERATION

PHRASE MEMORY

You can use the Phrase Memory function to store your most frequently used messages. Text stored in the Phrase Memory will not be deleted by the usual message clear operation (**CODE + CLEAR**).

You can easily recall your message from this Phrase Memory any time you want to work with it.

MEMORY SIZE

In the Message Phrase you can store up to a total of 300 characters. These 300 characters can be divided into as many as nine areas.

The maximum capacity for any single area is 55 characters.

Note: *When replacing batteries, do so in three minutes or less. Otherwise, unless an optional AC Adaptor is attached, any message in the working area or Phrase Memory will be lost.*

STORING THE MESSAGE

To store the currently displayed message in the PHRASE MEMORY:

- (1) Type message to be stored.
- (2) Hold down the **CODE** key and press the **STORE** key.
- (3) The display will read:

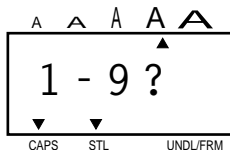

- (4) Press a key from 1 to 9 to select a storage area.
- (5) Your message is stored in the memory area you selected, and the display clears.

If the area you select is already being used, an error message will briefly appear, and then the display will again ask you to choose an area. In that event, please select a different number from 1 to 9.

If all nine areas are being used, you must clear one of them before you can store your current message.

Also, when 300 characters are already stored in the Phrase Memory and you try to store more, the message "FULL", will appear on the display. You must delete one of the memory areas before you can store your current message. See DELETING THE MESSAGE MEMORY.

Example To store the message "J. SMITH" in the Phrase Memory:

- Make sure the message is in the working area (on the display).

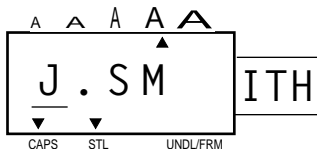

- Press + . The following guidance message appears on the display:

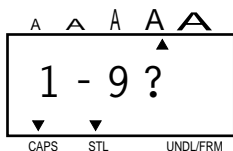

- Press a number key from 1 to 9. This time for example, press 1.

The message is stored, in the Phrase Memory.

Note: Before you enter an area number you can cancel storage by press-

ing .

RECALLING FROM PHRASE MEMORY

To recall a message stored in one of the nine PHRASE MEMORY areas:

- (1) Holding down the **CODE** key, press the **RECALL** key.
- (2) The display will read:

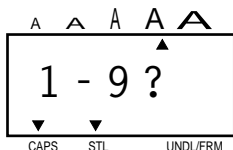

- (3) Select the number of the area you want to recall, and press it.
- (4) The key number and the beginning of the message appear on the display.
If you selected the wrong number, you can now press a new number key (1-9) to display the correct phrase.
- (5) When your desired message is on the screen, press the **SET** key.
- (6) The Phrase Memory you select is recalled into the working area for use.

- Note:**
- The character size, print style, and underline/box that are recalled are the same as those that were saved with the text.
 - When a message is recalled from the PHRASE MEMORY, any message currently on the display is cleared.

Example To recall "J. SMITH" from the Phrase Memory:

- Press + . The following guidance message appears on the display:

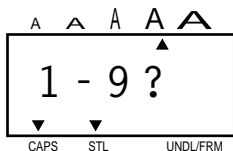

- Press 1, since you stored your message in area 1.

The stored message appears on the display, along with its area number.

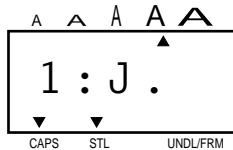

To alter recalled memory:

- Press . The message is moved to the working area and remains on the display.

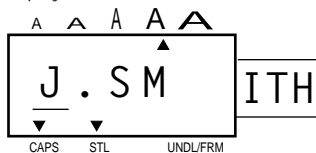

- You can see the current printing information on the display for STL, UNDL/FRM and the SIZE and BIG size settings.
- You can check the style (UNDL/FRM) by pressing the + UNDL/FRM (UNDL/FRM).
- Now you can print or edit the message.

Note: Before you press you can cancel recall by pressing



DELETING THE PHRASE MEMORY

To delete an area of PHRASE MEMORY:

- (1) Hold down the **CODE** key and press the **M.DEL** key. The following message appears on the display:

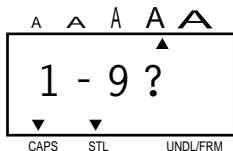

- (2) Select the number key (1-9) of the memory area you want to delete, and press it.
The key number and the beginning of the message appear on the display.
If you accidentally selected the wrong number, you can press another number key (1-9) to display the correct phrase.
- (3) When your desired message is on the screen, press the **SET** key.
- (4) The Phrase Memory area is cleared and the message previously in the working area reappears on the display.

Example To delete "J. SMITH" from the Phrase Memory:

- Press + . The following guidance appears on the display:

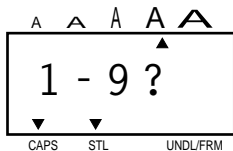

To delete Phrase Memory

- Press 1.
The stored message appears on the display.

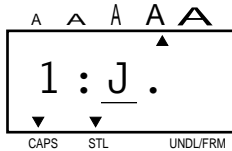

- Press . The message is deleted from the memory. The message previously in the working area (in this case, the same "J. SMITH") appears on the display.

Note: Before you press you can cancel deletion by pressing



Now you can use the cleared memory area "1" to store another message.

MESSAGE LIST

ERR	Input error. The selected tape type is incorrect.
BATT	The batteries are weak or empty.
FULL	The working area is full (max: 55 characters) or the Phrase Memory is full (see page 42).
NORM	See page 28.
OUTL	
BOLD	
SHAD	
ITAL	
IT+O	
IT+B	
IT+S	
VERT	
A-O?	
1-9?	See page 34, 35, 42, 44, 46.
BIG	The BIG size font is selected.
####	See page 39.
-	
#	
##	
###	
M: ○	Mirror printing.
M: ×	Cancels mirror printing.
TEXT	Prints without underline/frame.
UNDL	Underlines characters.
BOX 1	Frame characters.
BOX 2	
BOX 3	
BOX 4	
I: ○	Insert Mode is ON.
I: ×	Insert Mode is OFF.

TROUBLESHOOTING

Problem	What to Do
1. The display stays blank after you have turned on the machine.	<ul style="list-style-type: none">● Check the polarity of the batteries.● If the batteries are low, replace them.● Check that the adaptor is working properly.
2. The machine does not print, or the printed characters are blurred.	<ul style="list-style-type: none">● Check that the tape cassette has been inserted properly.● If the tape cassette is empty, replace it with a new one.● Check that the character size is appropriate for the width of the tape that is used.
3. The printed characters are not formed properly.	<ul style="list-style-type: none">● The batteries are probably weak. Replace them.
4. The tape cannot be cut.	<ul style="list-style-type: none">● The cutting blade is probably dull. Replace the cutter unit.
5. Striped tape appears.	<ul style="list-style-type: none">● You have reached the end of the tape. Replace it with a new tape.
6. The memory has cleared on its own.	<ul style="list-style-type: none">● The batteries are probably weak. Replace them.
7. An unprinted line appears on a label.	<ul style="list-style-type: none">● There may be some dust on the print head. Wipe the print head gently with a dry cotton swab.● If dust still remains, dip the cotton swab in isopropyl (rubbing) alcohol and wipe the print head again.

SPECIFICATIONS

Input Device:	49 keys (39 character keys and 10 function keys)
Print Speed:	10 mm/sec.
Character Size:	Standard Size (1) Double Width (W2) Double Height (H2) Double Width & Double Height (4) 4 x Width & Double Height (8) BIG SIZE (ALL INDICATORS ON, STYLE FIXED, NO UNDERLINE/FRAME)
Internal Character:	Font: HELSINKI
Print Tape:	Pressure-sensitive adhesive-based (TZ TAPE ONLY) 3/4" (18mm) (W) × 315" (8m) (L) 1/2" (12mm) (W) × 315" (8m) (L) 3/8" (9mm) (W) × 315" (8m) (L) 1/4" (6mm) (W) × 315" (8m) (L)
LCD:	7 x 5 dots 1 line x 4 columns
Power Supply:	Batteries (AA/SUM-3/AM3/R6/LR6) or optional AC Adaptor. (AD-30:7V 1.2A) Alkaline batteries are recommended. The power automatically turns off when no key is pushed for five minutes.
Dimensions:	6.85" (174mm) (W) × 7.87" (200mm) (D) × 2.36" (50mm) (H)
Weight:	1.4lb (0.65kg) (without batteries)
Memory Buffer Size:	55 characters
Phrase Memory Size:	300 characters maximum 9 available storage areas

ACCESSORIES

- **Supplies**

Obtain tape cassettes, AC Adaptors and tape cutters from your nearest authorized dealer. Brother cannot be held responsible for trouble caused by the use of unauthorized supplies.

Use only Brother TZ tapes with this machine. Do not use tapes that do not have the  mark.

Stock No.	Description	QTY/ PACKAGE	PRICE
3/4" (18mm)-wide laminated tapes			
TZ-141	Black characters on clear tape	1	\$20.99
TZ-145	White characters on clear tape	1	\$20.99
TZ-241	Black characters on white tape	1	\$20.99
TZ-242	Red characters on white tape	1	\$20.99
TZ-243	Blue characters on white tape	1	\$20.99
TZ-344	Gold characters on black tape	1	\$24.99
TZ-345	White characters on black tape	1	\$23.99
TZ-441	Black characters on red tape	1	\$20.99
TZ-541	Black characters on blue tape	1	\$20.99
TZ-545	White characters on blue tape	1	\$23.99
TZ-641	Black characters on yellow tape	1	\$20.99
TZ-741	Black characters on green tape	1	\$20.99
TZ-B41	Black characters on fluorescent orange tape	1	\$24.99
TZ-M41	Black characters on clear (matte) tape	1	\$20.99
TZ-WB41	Black characters on Bugs Bunny tape	1	\$23.99
TZ-WT41	Black characters on Taz tape	1	\$23.99
TZ-WS41	Black characters on Tweety & Sylvester tape	1	\$23.99
1/2" (12mm)-wide laminated tapes			
TZ-131	Black characters on clear tape	1	\$16.99
TZ-231	Black characters on white tape	1	\$17.99
TZ-232	Red characters on white tape	1	\$17.99
TZ-335	White characters on black tape	1	\$20.99

Stock No.	Description	QTY/ PACKAGE	PRICE
3/8" (9mm)-wide laminated tapes			
TZ-121	Black characters on clear tape	1	\$14.99
TZ-221	Black characters on white tape	1	\$16.99
TZ-325	White characters on black tape	1	\$18.99
TZ-421	Black characters on red tape	1	\$16.99
1/4" (6mm)-wide laminated tapes			
TZ-111	Black characters on clear tape	1	\$12.99
TZ-211	Black characters on white tape	1	\$14.99
TZ-315	White characters on black tape	1	\$17.99

Special tapes

Stock No.	Description	QTY/ PACKAGE	PRICE
TZ-SE4	Black characters on 3/4" (18-mm)-wide security tape	1	\$29.99
TZ-FA3	Blue characters on 1/2" (12-mm)-wide fabric tape	1	\$24.99

Stamp kit

Stock No.	Description	QTY/ PACKAGE	PRICE
SK-MB	Stamp-making kit for Medium stamp with black ink	1	\$37.99
SH-MB	Additional stamper for Medium stamp with black ink	1	\$24.99

OPTIONS

Stock No.	Description	QTY/ PACKAGE	PRICE
AD-30	AC ADAPTER	1	\$24.99
TC-9	TAPE CUTTER	1	\$9.99

Most retailers and distributors carry a full line of tape cassettes. If you wish to order accessories for your P-Touch direct from Brother, please refer to the "Accessory Order Form" or visit us on-line at "<http://www.brothermall.com>".

GUIA DEL USUARIO

INTRODUCCION

Esta máquina le ayudará a diseñar e imprimir etiquetas para cualquier aplicación.

Es muy versátil y puede utilizarse para crear caracteres de varios tamaños y estilos. Además, con el empleo de las cintas de colores, podrá imprimir las etiquetas con colores diferentes para las letras y para el fondo.

Ya no será necesario que se preocupe por las tareas que requieren una impresión tipo profesional. La calidad y rendimiento de esta máquina la convierten en una máquina muy versátil.

Aunque esta máquina es fácil de utilizar, le aconsejamos que lea atentamente este manual antes de empezar. Conserve este manual en un lugar de fácil acceso para poderlo consultar cuando sea necesario.

¡Buena suerte! Esperamos que disfrute haciendo hermosas etiquetas personales.

AVISO DE LA FCC

Este equipo ha sido probado y cumple con los límites de un aparato digital de la Clase B, siguiendo el apartado 15 de las normas de la FCC. Estos límites están pensados para proporcionar una protección razonable contra interferencias nocivas dentro de una instalación residencial. Este equipo podría interferir de forma nociva con comunicaciones por radio si no se instala y utiliza siguiendo las instrucciones. No obstante, no existe ninguna garantía de que no vayan a suceder interferencias en una instalación concreta. Si este equipo causara interferencias nocivas con la recepción de radio o televisión, lo cual puede determinarse poniendo el equipo en ON u OFF, se recomienda que el usuario intente corregir dichas interferencias mediante una de las siguientes medidas:

- Reoriente o ponga la antena receptora en otro lugar.
- Aumente la separación entre el equipo y el receptor.
- Conecte el equipo en una toma de un circuito diferente de la que esté conectada el receptor.
- Consulte a su distribuidor o a un técnico experimentado de radio/televisión.

A continuación se indican los números de patente y de publicación de patente relacionados con este producto:

USP4839742 USP4983058 USP5120147
USP4927278 USP5009530
USP4976558 USP5069557

Emplee sólo el adaptador diseñado exclusivamente para esta máquina. Vea las precauciones generales en la página 2.

ÍNDICE

PRECAUCIONES GENERALES	2
ANTES DE EMPEZAR	3
INSERCIÓN DE UN CASSETTE DE CINTA	3
INSERCIÓN DE LAS BATERÍAS	4
CAMBIO DE LA CUCHILLA	5
OPERACIONES DE LAS TECLAS	6
CREACIÓN DE UN MENSAJE	7
PANTALLA	7
DESPLAZAMIENTO DEL CURSOR	7
SIMBOLOS	8
EDICIÓN DE UN MENSAJE	9
TAMAÑO	10
ESTILO	12
SUBRAYADO/ENCUADRE	13
IMPRESIÓN Y CORTE	14
IMPRESIÓN REPETIDA	15
NUMERACIÓN	16
IMPRESIÓN INVERTIDA	17
AVANCE DE LA CINTA	18
OPERACIÓN DE LA MEMORIA DE FRASES	19
MEMORIA DE FRASES	19
LISTA DE MENSAJES	21
ACCESORIOS	22

PRECAUCIONES GENERALES

- Utilice solamente cintas TZ Brother con esta máquina. No utilice cintas que no tengan la marca .
- Las cintas están disponibles en cuatro anchuras diferentes: 1/4" (6 mm), 3/8" (9 mm), 1/2" (12 mm) y 3/4" (18 mm).
- No tire de la cinta. Si lo hiciese podría dañar los cassettes de cinta.
- No limpie el P-Touch con alcohol ni otros disolventes orgánicos. Utilice únicamente un paño suave y seco.
- Retire las baterías y/o desconecte el adaptador de CA si no va a utilizar el P-Touch por un periodo de tiempo prolongado. (Nota: Al apagar el P-Touch, se perderán los mensajes del área de trabajo del área de Mensajes de Memoria.)
- No deposite nada sobre el P-Touch ni en su interior.
- No exponga el P-Touch a temperaturas elevadas ni a altos índices de humedad. No la abandone en cualquier lugar ni lo guarde en el maletero de su automóvil.
- No utilice el P-Touch en lugares con mucho polvo. Evite la incidencia directa de la luz solar y la exposición a la lluvia.
- No deje objetos de goma o vinilo sobre el P-Touch por largo periodo de tiempo. Estos materiales podrían ocasionar oxidación.
- Después de insertar el nuevo cassette de cinta, avance la cinta pulsando las teclas **CODE** y **FEED** una vez.
- No toque el mecanismo del cabezal impresor. Si toca el cabezal, límpielo inmediatamente con un paño suave (por ejemplo, algodón) para evitar daños permanentes.
- **Utilice solamente el adaptador de CA, modelo AD-30 diseñado exclusivamente para esta máquina.**

ANTES DE EMPEZAR

INSERCIÓN DE UN CASSETTE DE CINTA

Las cintas TZ Brother están sólo disponibles en las anchuras siguientes para esta máquina: 1/4" (6 mm), 3/8" (9 mm), 1/2" (12 mm) y 3/4" (18 mm).

Para insertar un nuevo cassette de cinta:

- (1) Levante la cubierta del cassette de modo que pueda tener acceso con facilidad al cassette de cinta. De este modo también se liberará cualquier cassette que haya instalado.
- (2) Si en el compartimiento hubiera una cassette de cinta vacía, sáquela levantándola.
- (3) Extraiga el tope del cartucho de cinta nuevo, y si la cinta está floja, emplee un dedo para bobinarla en la dirección de la flecha, que hay en el cartucho de cinta, hasta que quede tensada. Si emplea una cinta que ha empleado antes, asegúrese de que la cinta esté tensada antes de insertarla en la unidad.

Nota: ● Algunos cassettes de cinta no disponen de retén.

- (4) Inserte el nueva cassette de cinta firmemente en el compartimiento.
- (5) Cierre el cubierta del compartimiento.
- (6) Avance la cinta pulsado la tecla **CODE** y luego una vez la tecla **FEED**, y corte entonces la cinta.

Nota: ● Cuando inserte un cassette de cinta, compruebe que la cinta interior no quede atrapada en el ángulo del soporte metálico de seguridad.

- La palanca blanca (palanca de liberación) se bloquea automáticamente cuando se cierra la cubierta. Si la palanca blanca es accionada manualmente, no podrá cerrarse la cubierta.

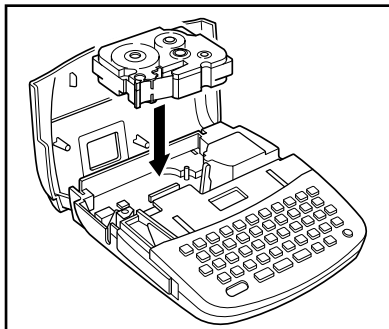
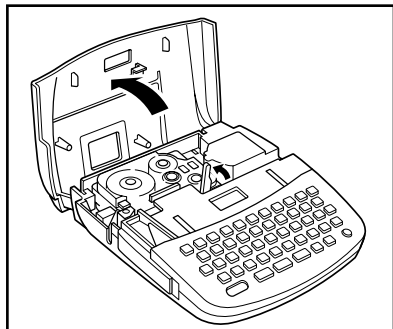

INSERCIÓN DE LAS BATERÍAS

La máquina usa seis baterías de tamaño "AA" (AM3, LR6, SUM-3, R6).

Para insertar las pilas:

- (1) Dé la vuelta al P-Touch. Retire la cubierta del compartimento de las baterías presionando el pestillo y levantando la cubierta.
- (2) Siga los diagramas del fondo del compartimento para insertar las baterías en la dirección correcta.
- (3) Una vez colocadas las baterías, vuelva a colocar la cubierta del compartimento de las baterías.

Cuando aparezca en la pantalla "BATT" (Baterías descargadas), reemplace las seis baterías.

- **Es aconsejable que utilice baterías alcalinas.**
- Existe un adaptador de CA opcional. (Modelo AD-30: 7 V, 1,2 A)

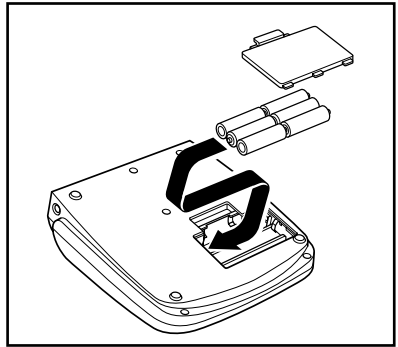
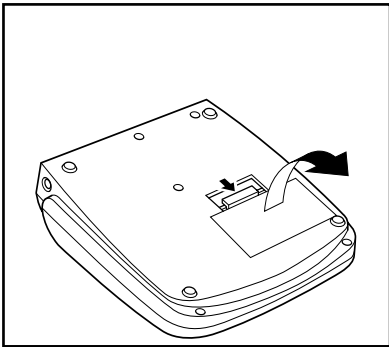

Nota:

- Cuando reemplace las baterías, hágalo en tres minutos o menos. De lo contrario, a menos que esté conectado un adaptador de alimentación de CA opcional, se perderán todos los mensajes del área de trabajo de la memoria de frases.
- Tenga presente los detalles siguientes cuando se utilicen baterías de NiCd en esta máquina.
 - (1) "BATT" no aparecerá en el visualizador cuando las baterías estén débiles o gastadas. En lugar de ello, se desconectará la alimentación.
 - (2) Incluso después de haber cargado las baterías, los caracteres pueden no imprimirse con claridad como resultado de la baja eficiencia de la carga o de las condiciones de operación.

CAMBIO DE LA CUCHILLA

Cuando la cuchilla no corte bien, reemplácela con una nueva.

Para reemplazar una cuchilla gastada o rota:

- (1) Abra la cubierta del compartimiento del cassette de cinta y saque con cuidado el cassette de cinta si estuviera instalada.
- (2) Agarre la cuchilla entre los dedos y sáquela.
- (3) Tome la cuchilla nueva con la lengüeta de la película protectora e inserte la cuchilla en la máquina.
- (4) Extraiga la película protectora de la cuchilla.
- (5) Inserte el cassette de cinta, y cierre la cubierta del compartimiento de la cassette de cinta.

ADVERTENCIA: *Tenga mucho cuidado en no cortarse cuando reemplace la cuchilla.*

Nota: *La duración aproximada de la cuchilla del P-Touch es de unos 2000 cortes.*

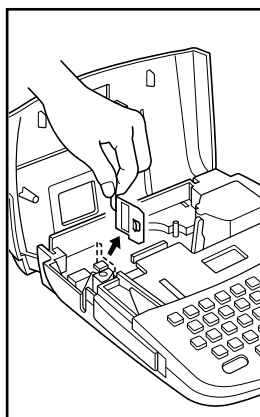
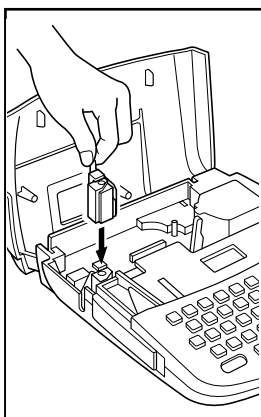
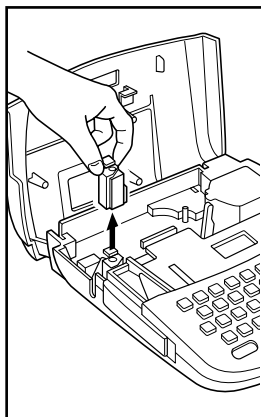

PRECAUCIÓN

- Cuando cambie la unidad de la cuchilla, cerciórese de no tocar la cuchilla de la misma.
- Cerciórese de que los niños pequeños no intenten meter la unidad de la cuchilla en su boca.

OPERACIONES DE LAS TECLAS

Tecla **CODE**

Manteniendo presionada la tecla **CODE** y pulsando la tecla adecuada, puede utilizar las funciones indicadas en caracteres de color rosa o los caracteres de color azul del de color azul de esta máquina.

Tecla **SHIFT**

Con la tecla **SHIFT** puede escribir mayúsculas, y símbolos de la parte superior de las teclas. Para escribir una "A" mayúscula, mantenga presionada la tecla **SHIFT** y pulse la tecla "A". Para escribir un signo de porcentaje (que se encuentra en la parte superior del "5"), Mantenga presionada la tecla **SHIFT** y pulse la tecla "5".

Tecla **CAPS**

Manteniendo presionada la tecla **CODE** y pulsando la tecla **CAPS**, puede conseguir que la máquina pase al modo de mayúsculas CAPS (Mayúsculas fijas/Números).

Al acceder a este modo, el indicador CAPS en la pantalla se ilumina. En el modo CAPS (Mayúsculas fijas/Números), puede escribir letras mayúsculas con sólo pulsar las teclas de los caracteres. Si pulsa teclas de números, obtendrá números y no los símbolos de la parte superior de las teclas, por tal razón el modo CAPS es particularmente útil para crear mensajes que contengan números y mayúsculas. Para abandonar el modo CAPS, mantenga presionada de nuevo la tecla **CODE** y pulse la tecla **CAPS**.

Tecla **ALT**

Utilizando la tecla **ALT**, podrá escribir varios símbolos marcados con verde en las teclas. Para escribir un símbolo que se encuentre en la parte derecha de una tecla, mantenga presionada la tecla **ALT** y pulse la tecla en la que esté marcado el símbolo deseado.

CREACION DE UN MENSAJE

PANTALLA

Una vez realizados los pasos anteriores ya puede proceder a la creación de un mensaje en el de color azul máquina.

La pantalla LCD de la máquina tiene una capacidad de 4 caracteres. No obstante, podrá crear mensajes con una longitud de hasta 55 caracteres. La pantalla de 4 caracteres actúa como una ventana que se desplaza a lo largo del mensaje.

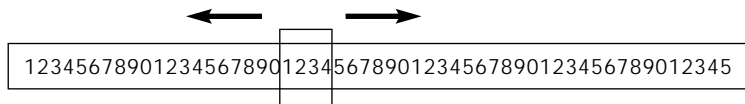

DESPLAZAMIENTO DEL CURSOR

Puede volver a visualizar y editar una parte del mensaje desplazando el cursor hacia adelante y hacia atrás.

































Para desplazar el cursor a lo largo del mensaje:

Pulse las teclas ◀ y ▶ y el cursor se desplazará de carácter en carácter.

- Nota:**
- Mantenga presionada la tecla **CODE** y la tecla **TOP** para devolver el cursor al comienzo del mensaje.
 - Mantenga presionada la tecla **CODE** y pulse la tecla **RELOC** para hacer que el cursor avance hasta el final del mensaje.

SIMBOLOS

Además de las letras, símbolos y números en la parte superior de las teclas, existen 57 símbolos en el Modo Symbol. Estos 57 símbolos adicionales están dispuestos en 15 grupos, correspondientes a los números del A al O del teclado.

N.º de grupo	SIMBOLOS	N.º de grupo	SIMBOLOS
A	Ü Æ æ §	I	   
B	+ × ÷ =	J	   
C	• ® © ™	K	   
D	[]  	L	   
E	$\frac{1}{2}$ ° ² ³	M	   
F	ª º ♥ ★	N	   
G	² ³ ⁴ 	O	
H	   		

Para entrar un símbolo que no se encuentre en la parte superior de la tecla:

- (1) Pulse la tecla **CODE** y la tecla **SYMBOL** para acceder al modo Symbol.
- (2) En la pantalla podrá leer: "A-O?".
- (3) Pulse la tecla del número de A-O cuyo grupo contenga el símbolo que desee. Se visualizará el grupo de símbolos de la letra.
- (4) Desplace el cursor hasta el símbolo que desee elegir.
- (5) Pulse la tecla **SET**.

Nota: Presione la tecla **DEL** para abandonar el modo Symbol.

EDICION DE UN MENSAJE

Para borrar un carácter:

- (1) Utilice las teclas del cursor para colocar éste un espacio a la derecha del carácter que desea borrar.
- (2) Presione la tecla **DELETE**.

Para borrar una palabra:

- (1) Coloque el cursor un espacio a la derecha de la palabra que desee borrar.
- (2) Mantenga presionada la tecla **CODE** y pulse la tecla **WORD OUT**.

Para reescribir un carácter:

- (1) Mueva el cursor hasta el carácter que desea cambiar.
- (2) Pulse la tecla correspondiente al carácter o símbolo deseado y el nuevo carácter reemplazará al viejo en el mensaje.

Para insertar caracteres:

- (1) Mantenga presionada la tecla **CODE** y pulse la tecla **INSERT** el número deseado de veces hasta que aparezca en la pantalla "I:○".
- (2) Mueva el cursor un espacio hacia la derecha de la posición en la que desee insertar un carácter.
- (3) Pulse la tecla correspondiente al carácter o símbolo que desee añadir, o elija un símbolo en el modo de símbolos. (Consulte SIMBOLOS.) Todos los caracteres siguientes se moverán hacia la derecha al ser insertados.

Para abandonar el modo de inserción:

Mantenga presionada la tecla **CODE** y pulse la tecla **INSERT** dos veces.

TAMAÑO

Para elegir el tamaño de los caracteres:

Mantenga presionada la tecla **CODE** y pulse la tecla **SIZE** el número de veces necesario hasta que en la pantalla se indique el tamaño de caracteres deseado.

- Nota:**
- *El tamaño de los caracteres que podrán imprimirse está limitado por la anchura de la cinta.*

Ancho de la cinta	Tamaños de caracteres posibles
3/4" (18 mm)	1, W2, H2, 4, 8, BIG
1/2" (12 mm)	1, W2, H2, 4, 8
3/8" (9 mm)	1, W2, H2, 4, 8
1/4" (6 mm)	1, W2

- *Si ajusta un tamaño de caracteres no mostrado en la tabla anterior y pulsa la tecla **PRINT**, se visualizará un mensaje de error y no podrá imprimirse la etiqueta.*

1:Standard Size

J.SMITH

W2:Double Width

J.SMITH

H2:Double Height

J.SMITH

4:Double Width & Double Height

J.SMITH

8:4 × Width & Double Height

J.SMITH

ESTILO

Para elegir un estilo de impresión:

Mantenga presionada la tecla **CODE** y pulse la tecla **STYLE** el número de veces necesario hasta que en la pantalla aparezca el estilo de caracteres deseado. Si selecciona un estilo que no sea **NORMAL**, en la pantalla aparecerá el indicador de tal estilo.

- Nota:**
- *Solamente podrán imprimirse verticalmente caracteres de estilo normal.*
 - *La impresión vertical no podrá utilizarse con ciertas combinaciones de anchura de cinta y tamaño de caracteres.*

NORMAL (NORM)

J.SMITH

ITALIC (ITAL)

J.SMITH

OUTLINE (OUTL)

J.SMITH

ITALIC+OUTLINE (IT + O)

J.SMITH

BOLD (BOLD)

J.SMITH

ITALIC+BOLD (IT + B)

J.SMITH

SHADOW (SHAD)

J.SMITH

ITALIC+SHADOW (IT + S)

J.SMITH

VERTICAL (VERT)

J · S M I T H

SUBRAYADO/ENCUADRE

Para añadir un subrayado o un encuadre:

Mantenga presionada la tecla **CODE** y pulse la tecla **UNDERLINE/FRAME**

UNDL/FRM



el número de veces necesario hasta que en la pantalla aparezca el estilo de subrayado/encuadre deseado. Cuando haya establecido el estilo de subrayado/encuadre, el indicador correspondiente aparecerá en la pantalla.

Nota:

- El subrayado y el encuadre no estarán disponibles simultaneamente.
- La impresión con subrayado o encuadre está limitada por la anchura de la cinta y el ajuste del tamaño de los caracteres.
- El subrayado y el recuadro no podrán imprimirse cuando se usen impresión vertical.

Ancho de la cinta	Tamaños de caracteres posibles
3/4" (18 mm)	1, W2, H2, 4, 8, BXG
1/2" (12 mm)	1, W2, H2, 4, 8
3/8" (9 mm)	1, W2, H2, 4, 8
1/4" (6 mm)	X W2

- Un subrayado o un encuadre no podrá imprimirse si el tamaño de caracteres está ajustado a uno marcado con un X y está instalada la cinta correspondiente.

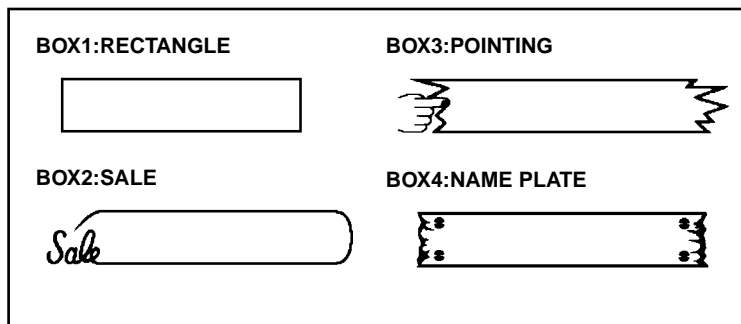

IMPRESION Y CORTE

Después de haber elegido el tamaño de los caracteres, el estilo de impresión, y el juego tipográfico, podrá imprimir la etiqueta.

Para imprimir una etiqueta:

Pulse la tecla **PRINT**.

La etiqueta impresa saldrá por la ranura de salida de la cinta de la parte lateral de la máquina.

- Nota:**
- *No tire de la cinta.*
 - *No intente cortar la cinta durante la impresión ni durante la alimentación de la misma.*

Para cortar la cinta:

Extraiga la palanca de corte de la cinta de la parte lateral de la máquina.

- Nota:**
- *No extraiga demasiado la palanca de corte de la cinta, ya que podría romperla.*

Para pegar una etiqueta:

Despegue la cinta de la parte posterior y pegue la etiqueta en la posición deseada.

IMPRESIÓN REPETIDA

Esta función le permitirá imprimir repetidamente la misma etiqueta hasta nueve veces.

Para utilizar la función de impresión repetida :

Se recomienda ajustar el modo TAPE FEED a "#", "##", o "###".

- (1) Mantenga presionada la tecla **CODE** y pulse la tecla **REPEAT** ().
- (2) Introduzca el número de veces que desee imprimir la etiqueta.
- (3) Pulse la tecla **PRINT**.

Si ha ajustado TAPE FEED a "#", "##", o "###", pulse las teclas **CODE + FEED** antes de cortar la cinta. El corte no se realiza automáticamente.

Nota:

- Para volver a la pantalla anterior, pulse **CLEAR** () antes de imprimir.
- Antes de iniciar la impresión repetida, compruebe si hay suficiente cinta en el cartucho.
- Nunca trate de cortar la cinta durante la impresión.
- Si la cinta se acaba antes de haber finalizado la impresión, pulse inmediatamente la cinta **ON/OFF**. (Aparecerá una cinta con rayas.)

NUMERACIÓN

Esta función podrá utilizarse para que aumente automáticamente el número en una serie de etiquetas impresas.

Para utilizar la función de cómputo automático :

Se recomienda ajustar el modo TAPE FEED a "#", "##", o "###".

- (1) Coloque el cursor debajo del número que desee aumentar.
- (2) Mantenga presionada la tecla **CODE** y pulse la tecla **NUMBER**. La pantalla solicitará la selección del último número a imprimir.
- (3) Introduzca un número entre 1 y 9.
- (4) Pulse **PRINT**. Las etiquetas se imprimirán y el número especificado aumentará hasta llegar al último número.

Si ha ajustado TAPE FEED a "#", "##", o "###", pulse las teclas **CODE + FEED** antes de cortar la cinta. El corte no se realiza automáticamente.

- Nota:**
- *para borrar el número que haya introducido antes de la impresión, pulse la tecla **DELETE**. Si vuelve a pulsar **DELETE**, saldrá del modo de numeración (NUMBERING).*
 - *El último número a imprimirse tendrá que seleccionarse dentro del margen 1-9.*
 - *Si introduce un número inferior al introducido originalmente en el texto, la impresión se inhabilitará, y en la pantalla aparecerá el mensaje "ERR" cuando pulse la tecla **PRINT**.*
 - *Los números aumentarán en uno cada vez.*
 - *Si las baterías se debilitan durante la operación de numeración (NUMBERING), tal operación se interrumpirá.*

IMPRESION INVERTIDA

Esta función imprimirá los caracteres de forma que podrán leerse desde el lado adhesivo de la cinta. Con esta función hay que utilizar una cinta con adhesivo transparente.

Mantenga pulsada la tecla **CODE** y presione la tecla **MIRROR** () el número de veces necesario hasta que en la pantalla aparezca "M:○".

Para volver a la impresión normal, mantenga presionada la tecla **CODE** y pulse la tecla **MIRROR** () el número de veces necesario hasta que en la pantalla aparezca "M:×".

Nota: *La función de impresión invertida se desactivará cuando desconecte la alimentación de la máquina. Si desea volver a utilizarla después de haber desconectado la alimentación, tendrá que activarla.*

AVANCE DE LA CINTA

Esta función podrá utilizarse para dejar márgenes iguales en la parte izquierda y derecha de la etiqueta. Los márgenes podrán ajustarse a cuatro anchuras: 1/6" (4 mm), 2/3" (8 mm), 1/2" (12 mm), o 1" (24 mm), cuando la alimentación de la cinta esté ajustada a "#", "##", "###", o "####", respectivamente. La cinta no se alimentará automáticamente cuando esté ajustada a "-". Cuando imprima etiquetas continuamente, podrán imprimirse sin márgenes extra. Además, esta función será muy útil para imprimir más de una etiqueta con múltiples estilos cambiando el estilo cada vez que se imprima una etiqueta.

Para cambiar el modo de alimentación de cinta :

Mantenga presionada la tecla **CODE** y pulse la tecla **TAPE** el número de veces necesario hasta que en la pantalla aparezca el modo de alimentación deseado.

- Nota:**
- Cuando haya ajustado "####", en la pantalla aparecerá el indicador de cinta. El indicador de cinta no aparecerá cuando haya ajustado "-", "#", "##", ni "###".
 - Cuando haya ajustado "-", "#", "##", o "###", pulse CODE + SPACE
FEED para alimentar la cinta después de que se haya impreso la etiqueta y antes de cortar la cinta. Si no alimenta la cinta antes de cortarla, es posible que se corten algunos de los caracteres impresos.

OPERACION DE LA MEMORIA DE FRASES

MEMORIA DE FRASES

Usted podrá utilizar la función de memoria de frases para almacenar sus mensajes utilizados con más frecuencia. Estos mensajes no se borrarán con la operación de borrado normal de mensajes (**CODE + CLEAR**).

En la memoria de frases podrá almacenar un total de 300 caracteres. Estos 300 caracteres podrán dividirse en un total de nueve áreas, y la capacidad máxima de un área es de 55 caracteres.

Nota: *Cuando reemplace las baterías, hágalo en menos de tres minutos. De lo contrario, a menos que esté conectado un adaptador de CA opcional, se perderán los mensajes del área de trabajo o de la memoria de frases.*

Para almacenar el mensaje actualmente visualizado en la memoria de frases :

- (1) Mantenga presionada la tecla **CODE** y presione la tecla **STORE**. "1-9?" aparecerá en la pantalla.
- (2) Pulse una tecla del 1 al 9 para seleccionar un área de almacenamiento. Su mensaje se almacenará en el área de la memoria seleccionada y el mensaje previamente visualizado en el área de trabajo reaparecerá en la pantalla.

Si el área seleccionada ya está utilizándose, aparecerá un mensaje de error brevemente, y después la pantalla le solicitará que elija un área. En tal caso, seleccione un número diferente entre 1 y 9.

Para invocar un mensaje almacenado en la memoria de frases :

- (1) Mantenga presionada la tecla **CODE** y pulse la tecla **RECALL**. "1-9?" aparecerá en la pantalla.
- (2) Pulse la tecla correspondiente al área que desee invocar. En la pantalla aparecerán el número de la tecla y el comienzo del mensaje. Si ha seleccionado un número erróneo, podrá presionar una nueva tecla numérica para hacer que se visualice la frase correcta.
- (3) Cuando se visualice el mensaje deseado, pulse la tecla **SET**. El mensaje actualmente visualizado se borrará y el seleccionado se invocará en el área de trabajo para su utilización.

Para borrar un área de la memoria de frases :

- (1) Mantenga presionada la tecla **CODE** y pulse la tecla **M.DEL.** "1-9?" aparecerá en la pantalla.
- (2) Pulse la tecla correspondiente al área que desee borrar. En la pantalla aparecerán el número de la tecla y el comienzo del mensaje. Si ha seleccionado un número erróneo, podrá presionar una nueva tecla numérica para hacer que se visualice la frase correcta.
- (3) Cuando se visualice el mensaje deseado, pulse la tecla **SET**.
- (4) El área de la memoria de frases se borrará y en la pantalla aparecerá el mensaje previamente visualizado en el área de trabajo.

LISTA DE MENSAJES

ERR	Error de entrada. El tipo de cinta seleccionado es incorrecto.
BATT	Las baterías están débiles o gastadas.
FULL	Memoria llena (máximo 55 caracteres) o Memoria de Frase llena (Consulte la página 19).
NORM	Consulte la página 12.
OUTL	
BOLD	
SHAD	
ITAL	
IT + O	
IT + B	
IT + S	
VERT	
A-O?	Consulte la página 8.
1-9?	Consulte la página 15, 16, 19 y 20.
BIG	La fuente del tamaño BIG está seleccionada.
####	Consulte página 18.
-	
#	
##	
###	
M: ○	Impresión en espejo
M: ×	Desactivación de la impresión en espejo
TEXT	Impresión sin subrayado/recuadro
UNDL	Subraya caracteres
BOX 1	Enmarca caracteres
BOX 2	
BOX 3	
BOX 4	
I: ○	El modo de inserción está activado.
I: ×	El modo de inserción está desactivado.

ACCESORIOS

- **Suministros**

Adquiera los cassetes de cinta, los adaptadores de CA y las cuchillas de cinta en el distribuidor autorizado más cercano. Brother no asume ningún tipo de responsabilidad por problemas causados por la utilización de suministros no autorizados.

Utilice solamente cintas TZ Brother con esta máquina. No utilice cintas que no tengan la marca .

No. de Stock	Descripción	Cantidad /Paquete	Precio
Cintas laminadas de 3/4" (18 mm)			
TZ-141	Caracteres negros sobre cinta adhesiva transparente	1	\$20.99
TZ-145	Caracteres blancos sobre cinta adhesiva transparente	1	\$20.99
TZ-241	Caracteres negros sobre cinta adhesiva blanca	1	\$20.99
TZ-242	Caracteres rojos sobre cinta adhesiva blanca	1	\$20.99
TZ-243	Caracteres azules sobre cinta adhesiva blanca	1	\$20.99
TZ-344	Caracteres dorados sobre cinta adhesiva negra	1	\$24.99
TZ-345	Caracteres blancos sobre cinta adhesiva negra	1	\$23.99
TZ-441	Caracteres negros sobre cinta adhesiva roja	1	\$20.99
TZ-541	Caracteres negros sobre cinta adhesiva azul	1	\$20.99
TZ-545	Caracteres blancos sobre cinta adhesiva azul	1	\$23.99
TZ-641	Caracteres negros sobre cinta adhesiva amarilla	1	\$20.99
TZ-741	Caracteres negros sobre cinta adhesiva verde	1	\$20.99
TZ-B41	Caracteres negros sobre cinta adhesiva naranja fluorescente	1	\$24.99
TZ-M41	Caracteres negros sobre cinta adhesiva mate	1	\$20.99
TZ-WB41	Caracteres negros sobre cinta Bugs bunny	1	\$23.99
TZ-WT41	Caracteres negros sobre cinta Taz	1	\$23.99
TZ-WS41	Caracteres negros sobre cinta Tweety & Sylvester	1	\$23.99
Cintas laminadas de 1/2" (12mm)			
TZ-131	Caracteres negros sobre cinta adhesiva transparente	1	\$16.99
TZ-231	Caracteres negros sobre cinta adhesiva blanca	1	\$17.99
TZ-232	Caracteres rojos sobre cinta adhesiva blanca	1	\$17.99
TZ-335	Caracteres blancos sobre cinta adhesiva negra	1	\$20.99

No. de Stock	Descripción	Cantidad /Paquete	Precio
Cintas laminadas de 3/8" (9mm)			
TZ-121	Caracteres negros sobre cinta adhesiva transparente	1	\$14.99
TZ-221	Caracteres negros sobre cinta adhesiva blanca	1	\$16.99
TZ-325	Caracteres blancos sobre cinta adhesiva negra	1	\$18.99
TZ-421	Caracteres negros sobre cinta adhesiva roja	1	\$16.99
Cintas laminadas de 1/4" (6mm)			
TZ-111	Caracteres negros sobre cinta adhesiva transparente	1	\$12.99
TZ-211	Caracteres negros sobre cinta adhesiva blanca	1	\$14.99
TZ-315	Caracteres blancos sobre cinta adhesiva negra	1	\$17.99

Cintas especiales

No. de Stock	Descripción	Cantidad /Paquete	Precio
TZ-SE4	Caracteres negros sobre cinta de seguridad de 3/4" (18 mm)	1	\$29.99
TZ-FA3	Caracteres azules en cintra de tela de 1/2" (12 mm) de anchura	1	\$24.99

Juego de estampas

No. de Stock	Descripción	Cantidad /Paquete	Precio
SK-MB	Juego de estampación para estampas medias con tinta negra	1	\$37.99
SH-MB	Estampador adicional para estampas medias con tinta negra	1	\$24.99

OPCIONES

No. de Stock	Descripción	Cantidad /Paquete	Precio
AD-30	ADAPTADOR DE CA	1	\$24.99
TC-9	CORTADOR DE CINTA	1	\$9.99

La mayor parte de tiendas y distribuidores tienen una línea completa de cintas-cassettes. Si desea hacer un pedido de accesorios para su P-Touch directamente a Brother, tenga la amabilidad de consultar el "Formulario de pedido de accesorios" o visítenos en línea en "<http://www.brothermall.com>".

* NOTE *

• Please read this notice carefully before starting.

To insert a new tape cartridge

- REMOVE THE STOPPER.

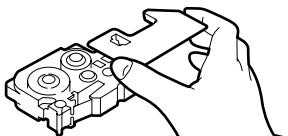

• SOME TAPE CASSETTES ARE NOT PROVIDED WITH A STOPPER.

- USE YOUR FINGER TO TIGHTEN THE RIBBON.

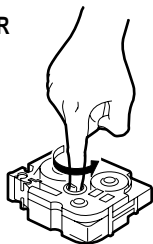

- INSTALL AND PRESS CODE+FEED.

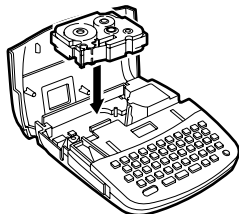

Cutting tape

- DO NOT PULL TAPE TO ADVANCE IT.

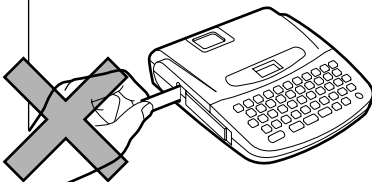

- TO CUT TAPE, USE THE BUILT-IN CUTTER LEVER. UNDER NO CIRCUMSTANCES ATTEMPT TO CUT THE TAPE WHILE PRINTING OR FEEDING.

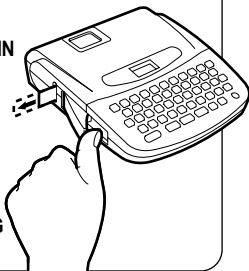

AC adaptor connection

- USE THE AC ADAPTOR DESIGNED EXCLUSIVELY FOR THIS MACHINE.

