



The 1999 Buick LeSabre Owner's Manual

1-1 Seats and Restraint Systems

This section tells you how to use your seats and safety belts properly. It also explains the “SRS” system.

2-1 Features and Controls

This section explains how to start and operate your vehicle.

3-1 Comfort Controls and Audio Systems

This section tells you how to adjust the ventilation and comfort controls and how to operate your audio system.

4-1 Your Driving and the Road

Here you'll find helpful information and tips about the road and how to drive under different conditions.

5-1 Problems on the Road

This section tells you what to do if you have a problem while driving, such as a flat tire or overheated engine, etc.

6-1 Service and Appearance Care

Here the manual tells you how to keep your vehicle running properly and looking good.

7-1 Maintenance Schedule

This section tells you when to perform vehicle maintenance and what fluids and lubricants to use.

8-1 Customer Assistance Information

This section tells you how to contact Buick for assistance and how to get service and owner publications. It also gives you information on “Reporting Safety Defects” on page 8-9.

9-1 Index

Here's an alphabetical listing of almost every subject in this manual. You can use it to quickly find something you want to read.

P40113-1-M



GENERAL MOTORS, GM, the GM Emblem, BUICK, the BUICK Emblem and the name LESABRE are registered trademarks of General Motors Corporation.

This manual includes the latest information at the time it was printed. We reserve the right to make changes in the product after that time without further notice. For vehicles first sold in Canada, substitute the name “General Motors of Canada Limited” for Buick Motor Division whenever it appears in this manual.

Please keep this manual in your vehicle, so it will be there if you ever need it when you're on the road. If you sell the vehicle, please leave this manual in it so the new owner can use it.

Litho in U.S.A.
Part No. 25685484 A First Edition



We support voluntary technician certification.

For Canadian Owners Who Prefer a French Language Manual:

Aux propriétaires canadiens: Vous pouvez vous procurer un exemplaire de ce guide en français chez votre concessionnaire ou au:

DGN Marketing Services Ltd.
1577 Meyerside Dr.
Mississauga, Ontario L5T 1B9

© Copyright General Motors Corporation 1998
All Rights Reserved

How to Use this Manual

Many people read their owner's manual from beginning to end when they first receive their new vehicle. If you do this, it will help you learn about the features and controls for your vehicle. In this manual, you'll find that pictures and words work together to explain things quickly.

Index

A good place to look for what you need is the Index in back of the manual. It's an alphabetical list of what's in the manual, and the page number where you'll find it.

Safety Warnings and Symbols

You will find a number of safety cautions in this book. We use a box and the word CAUTION to tell you about things that could hurt you if you were to ignore the warning.

CAUTION:

These mean there is something that could hurt you or other people.

In the caution area, we tell you what the hazard is. Then we tell you what to do to help avoid or reduce the hazard. Please read these cautions. If you don't, you or others could be hurt.

AM002002_INT



You will also find a circle with a slash through it in this book. This safety symbol means "Don't," "Don't do this" or "Don't let this happen."

Vehicle Damage Warnings

Also, in this book you will find these notices:

NOTICE:

These mean there is something that could damage your vehicle.

In the notice area, we tell you about something that can damage your vehicle. Many times, this damage would not be covered by your warranty, and it could be costly. But the notice will tell you what to do to help avoid the damage.

When you read other manuals, you might see CAUTION and NOTICE warnings in different colors or in different words.

You'll also see warning labels on your vehicle. They use the same words, CAUTION or NOTICE.

Vehicle Symbols

These are some of the symbols you may find on your vehicle.

For example, these symbols are used on an original battery:

CAUTION
POSSIBLE
INJURY



PROTECT
EYES BY
SHIELDING



CAUSTIC
BATTERY
ACID COULD
CAUSE
BURNS



AVOID
SPARKS OR
FLAMES



SPARK OR
FLAME
COULD
EXPLODE
BATTERY



These symbols are important for you and your passengers whenever your vehicle is driven:

DOOR LOCK
UNLOCK



FASTEN
SEAT
BELTS



POWER
WINDOW



AIR BAG



These symbols have to do with your lamps:

MASTER
LIGHTING
SWITCH



TURN
SIGNALS



PARKING
LAMPS



HAZARD
WARNING
FLASHER



DAYTIME
RUNNING
LAMPS



FOG LAMPS



These symbols are on some of your controls:

WINDSHIELD
WIPER



WINDSHIELD
WASHER



WINDSHIELD
DEFROSTER



REAR
WINDOW
DEFOGGER



VENTILATING
FAN



These symbols are used on warning and indicator lights:

ENGINE
COOLANT
TEMP



BATTERY
CHARGING
SYSTEM



BRAKE



COOLANT



ENGINE OIL
PRESSURE



ANTI-LOCK
BRAKES



Here are some other symbols you may see:

FUSE



LIGHTER



HORN



SPEAKER



FUEL





Section 1 Seats and Restraint Systems

Here you'll find information about the seats in your vehicle and how to use your safety belts properly. You can also learn about some things you should *not* do with air bags and safety belts.

1-2	Seats and Seat Controls	1-26	Rear Seat Passengers
1-5	Safety Belts: They're for Everyone	1-29	Rear Safety Belt Comfort Guides for Children and Small Adults
1-9	Here Are Questions Many People Ask About Safety Belts -- and the Answers	1-32	Children
1-10	How to Wear Safety Belts Properly	1-35	Child Restraints
1-10	Driver Position	1-47	Larger Children
1-17	Safety Belt Use During Pregnancy	1-50	Safety Belt Extender
1-18	Right Front Passenger Position	1-50	Checking Your Restraint Systems
1-18	Supplemental Restraint System (SRS)	1-50	Replacing Restraint System Parts After a Crash
1-25	Center Passenger Position		

Seats and Seat Controls

This section tells you about the seats -- how to adjust them -- and also about reclining seatbacks and head restraints.

Manual Front Seat

CAUTION:

You can lose control of the vehicle if you try to adjust a manual driver's seat while the vehicle is moving. The sudden movement could startle and confuse you, or make you push a pedal when you don't want to. Adjust the driver's seat only when the vehicle is not moving.



Pull up on the control bar under the front of the seat to unlock it. Slide the seat to where you want it, then release the bar and try to move the seat with your body to make sure the seat is locked into place.

Power Seat (If Equipped)



The power seat controls are on the armrest.

Front TILT Control: Raise the front of the seat by pressing the outer side of the TILT switch. Press the inner side of the TILT switch to lower the front of the seat.

Center Control: Move the seat forward or backward by pushing FWD (forward) or BACK. Raise the seat by pushing the UP control. Lower the seat by pushing the DN (down) control.

Rear TILT Control: Raise the rear of the seat by pressing the outer side of the TILT switch. Lower the rear of the seat by pressing the inner side of the TILT switch.

Reclining Front Seatbacks

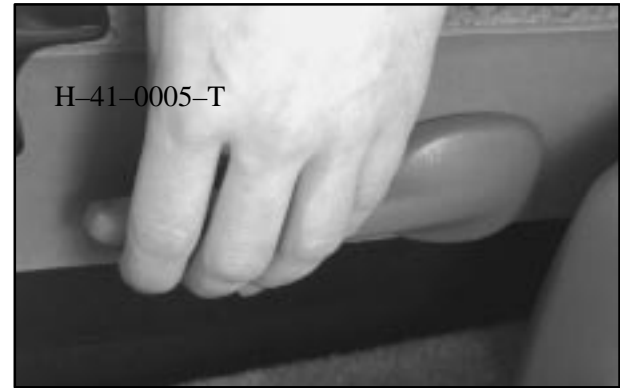

To adjust the seatback, lift the lever on the outer side of the seat and move the seatback to where you want it. Release the lever to lock the seatback. Pull up on the lever and the seat will go to an upright position.



But don't have a seatback reclined if your vehicle is moving.

⚠ CAUTION:

Sitting in a reclined position when your vehicle is in motion can be dangerous. Even if you buckle up, your safety belts can't do their job when you're reclined like this.

The shoulder belt can't do its job because it won't be against your body. Instead, it will be in front of you. In a crash you could go into it, receiving neck or other injuries.

The lap belt can't do its job either. In a crash the belt could go up over your abdomen. The belt forces would be there, not at your pelvic bones. This could cause serious internal injuries.

For proper protection when the vehicle is in motion, have the seatback upright. Then sit well back in the seat and wear your safety belt properly.

Head Restraints

Slide the head restraint up or down so that the top of the restraint is closest to the top of your ears. This position reduces the chance of a neck injury in a crash.

Safety Belts: They're for Everyone

This part of the manual tells you how to use safety belts properly. It also tells you some things you should not do with safety belts.

And it explains the Supplemental Restraint System (SRS), or air bag system.

CAUTION:

Don't let anyone ride where he or she can't wear a safety belt properly. If you are in a crash and you're not wearing a safety belt, your injuries can be much worse. You can hit things inside the vehicle or be ejected from it. You can be seriously injured or killed. In the same crash, you might not be if you are buckled up. Always fasten your safety belt, and check that your passengers' belts are fastened properly too.

CAUTION:

It is extremely dangerous to ride in a cargo area, inside or outside of a vehicle. In a collision, people riding in these areas are more likely to be seriously injured or killed. Do not allow people to ride in any area of your vehicle that is not equipped with seats and safety belts. Be sure everyone in your vehicle is in a seat and using a safety belt properly.



Your vehicle has a light that comes on as a reminder to buckle up. (See "Safety Belt Reminder Light" in the Index.)

In most states and Canadian provinces, the law says to wear safety belts. Here's why: *They work.*

You never know if you'll be in a crash. If you do have a crash, you don't know if it will be a bad one.

A few crashes are mild, and some crashes can be so serious that even buckled up a person wouldn't survive. But most crashes are in between. In many of them, people who buckle up can survive and sometimes walk away. Without belts they could have been badly hurt or killed.

After more than 30 years of safety belts in vehicles, the facts are clear. In most crashes buckling up does matter ... a lot!

Why Safety Belts Work

When you ride in or on anything, you go as fast as it goes.

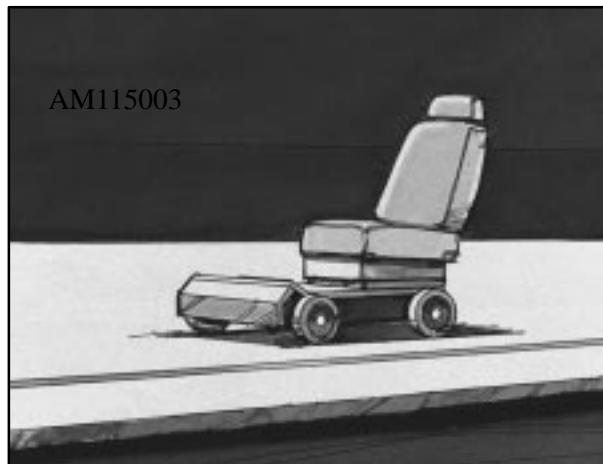

Take the simplest vehicle. Suppose it's just a seat on wheels.

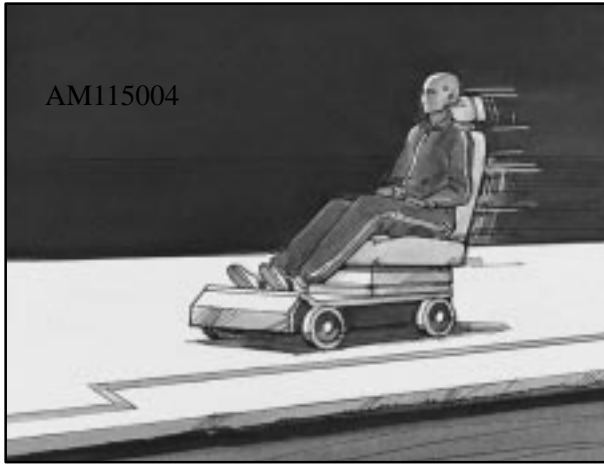

Put someone on it.

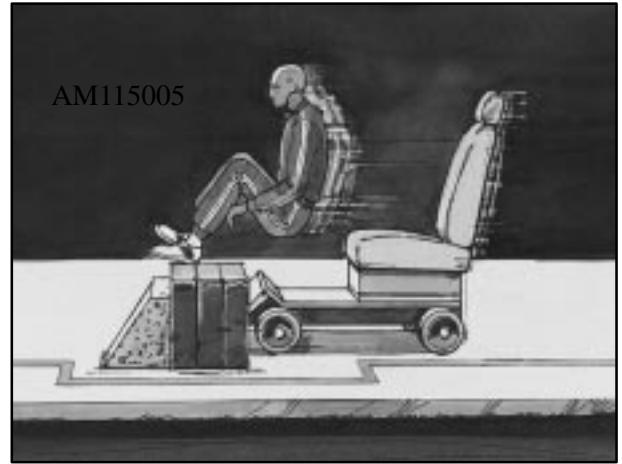

Get it up to speed. Then stop the vehicle. The rider doesn't stop.



The person keeps going until stopped by something.
In a real vehicle, it could be the windshield ...



or the instrument panel ...



or the safety belts!

With safety belts, you slow down as the vehicle does. You get more time to stop. You stop over more distance, and your strongest bones take the forces. That's why safety belts make such good sense.

Here Are Questions Many People Ask About Safety Belts -- and the Answers

- Q:** Won't I be trapped in the vehicle after an accident if I'm wearing a safety belt?
- A:** You *could* be -- whether you're wearing a safety belt or not. But you can unbuckle a safety belt, even if you're upside down. And your chance of being conscious during and after an accident, so you *can* unbuckle and get out, is *much* greater if you are belted.
- Q:** If my vehicle has air bags, why should I have to wear safety belts?
- A:** Air bags are in many vehicles today and will be in most of them in the future. But they are supplemental systems only; so they work *with* safety belts -- not instead of them. Every air bag system ever offered for sale has required the use of safety belts. Even if you're in a vehicle that has air bags, you still have to buckle up to get the most protection. That's true not only in frontal collisions, but especially in side and other collisions.

Q: If I'm a good driver, and I never drive far from home, why should I wear safety belts?

A: You may be an excellent driver, but if you're in an accident -- even one that isn't your fault -- you and your passengers can be hurt. Being a good driver doesn't protect you from things beyond your control, such as bad drivers.

Most accidents occur within 25 miles (40 km) of home. And the greatest number of serious injuries and deaths occur at speeds of less than 40 mph (65 km/h).

Safety belts are for everyone.

How to Wear Safety Belts Properly

Adults

This part is only for people of adult size.

Be aware that there are special things to know about safety belts and children. And there are different rules for smaller children and babies. If a child will be riding in your vehicle, see the part of this manual called "Children." Follow those rules for everyone's protection.

First, you'll want to know which restraint systems your vehicle has.

We'll start with the driver position.

Driver Position

This part describes the driver's restraint system.

Lap-Shoulder Belt

The driver has a lap-shoulder belt. Here's how to wear it properly.

1. Close and lock the door.
2. Adjust the seat (to see how, see "Seats" in the Index) so you can sit up straight.



3. Pick up the latch plate and pull the belt across you. Don't let it get twisted.
4. Push the latch plate into the buckle until it clicks.

Pull up on the latch plate to make sure it is secure. If the belt isn't long enough, see "Safety Belt Extender" at the end of this section.

Make sure the release button on the buckle is positioned so you would be able to unbuckle the safety belt quickly if you ever had to.

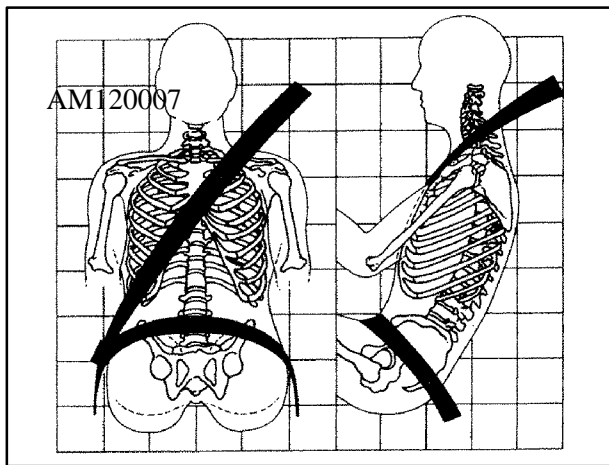

The lap part of the belt should be worn low and snug on the hips, just touching the thighs. In a crash, this applies force to the strong pelvic bones. And you'd be less likely to slide under the lap belt. If you slid under it, the belt would apply force at your abdomen. This could cause serious or even fatal injuries. The shoulder belt should go over the shoulder and across the chest. These parts of the body are best able to take belt restraining forces.

The safety belt locks if there's a sudden stop or crash.

Shoulder Belt Height Adjuster

Before you begin to drive, move the shoulder belt adjuster to the height that is right for you.

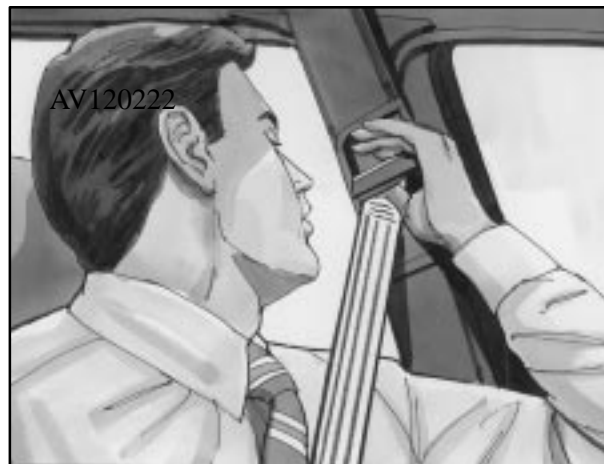

To move it down, squeeze the release handle and move the height adjuster to the desired position. You can move the adjuster up just by pushing up on the bottom of the release handle. After you move the adjuster to where you want it, try to move it down without squeezing the release handle to make sure it has locked into position.

Adjust the height so that the shoulder portion of the belt is centered on your shoulder. The belt should be away from your face and neck, but not falling off your shoulder.

Q: What's wrong with this?

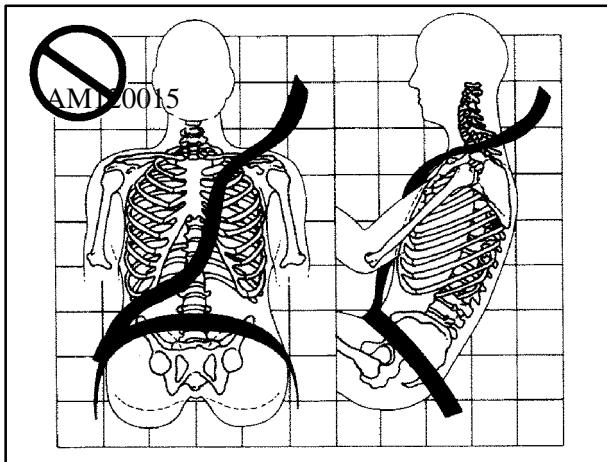

A: The shoulder belt is too loose. It won't give nearly as much protection this way.

⚠ CAUTION:

You can be seriously hurt if your shoulder belt is too loose. In a crash, you would move forward too much, which could increase injury. The shoulder belt should fit against your body.

Q: What's wrong with this?

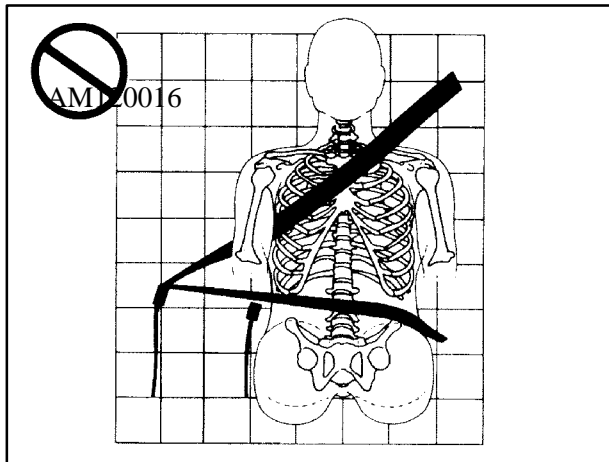

A: The belt is buckled in the wrong place.

⚠ CAUTION:

You can be seriously injured if your belt is buckled in the wrong place like this. In a crash, the belt would go up over your abdomen. The belt forces would be there, not at the pelvic bones. This could cause serious internal injuries. Always buckle your belt into the buckle nearest you.

Q: What's wrong with this?

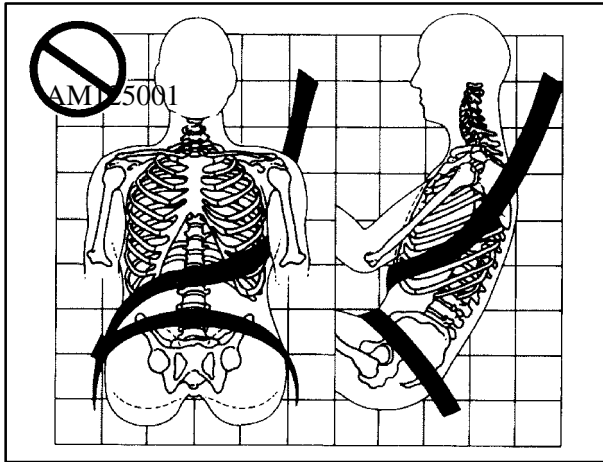

A: The shoulder belt is worn under the arm. It should be worn over the shoulder at all times.

⚠ CAUTION:

You can be seriously injured if you wear the shoulder belt under your arm. In a crash, your body would move too far forward, which would increase the chance of head and neck injury. Also, the belt would apply too much force to the ribs, which aren't as strong as shoulder bones. You could also severely injure internal organs like your liver or spleen.

Q: What's wrong with this?

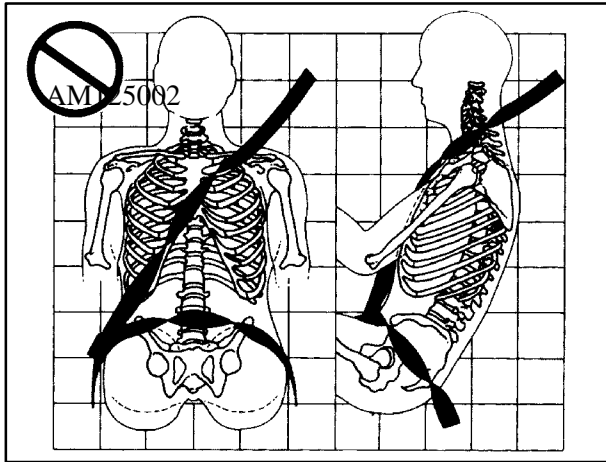

A: The belt is twisted across the body.

⚠ CAUTION:

You can be seriously injured by a twisted belt. In a crash, you wouldn't have the full width of the belt to spread impact forces. If a belt is twisted, make it straight so it can work properly, or ask your dealer to fix it.



To unlatch the belt, just push the button on the buckle. The belt should go back out of the way.

Before you close the door, be sure the belt is out of the way. If you slam the door on it, you can damage both the belt and your vehicle.

Safety Belt Use During Pregnancy

Safety belts work for everyone, including pregnant women. Like all occupants, they are more likely to be seriously injured if they don't wear safety belts.

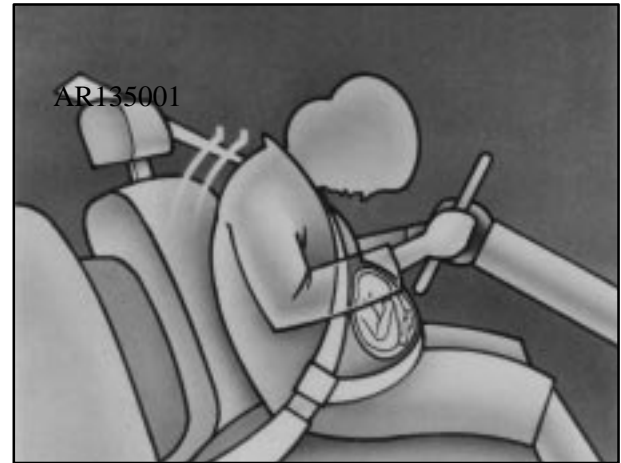

A pregnant woman should wear a lap-shoulder belt, and the lap portion should be worn as low as possible, below the rounding, throughout the pregnancy.

The best way to protect the fetus is to protect the mother. When a safety belt is worn properly, it's more likely that the fetus won't be hurt in a crash. For pregnant women, as for anyone, the key to making safety belts effective is wearing them properly.

Right Front Passenger Position

To learn how to wear the right front passenger's safety belt properly, see "Driver Position" earlier in this section.

The right front passenger's safety belt works the same way as the driver's safety belt -- except for one thing. If you ever pull the lap portion of the belt out all the way, you will engage the child restraint locking feature. If this happens, just let the belt go back all the way and start again.

If your vehicle has a center passenger position, be sure to use the correct buckle when buckling your lap-shoulder belt. If you find that the latch plate will not go fully into the buckle, see if you are using the buckle for the center passenger position.

Supplemental Restraint System (SRS)

This part explains the Supplemental Restraint System (SRS) or air bag system.

Your vehicle has "Next Generation" frontal air bags -- one air bag for the driver and another air bag for the right front passenger.

Next Generation frontal air bags are designed to help reduce the risk of injury from the force of an inflating air bag. But even these air bags must inflate very quickly if they are to do their job and comply with federal regulations.

Here are the most important things to know about the air bag system:

CAUTION:

You can be severely injured or killed in a crash if you aren't wearing your safety belt -- even if you have air bags. Wearing your safety belt during a crash helps reduce your chance of hitting things inside the vehicle or being ejected from it. Air bags are "supplemental restraints" to the safety belts. All air bags -- even Next Generation air bags -- are designed to work with safety belts, but don't replace them. Air bags are designed to work only in moderate to severe crashes where the front of your vehicle hits something. They

CAUTION: (Continued)

CAUTION: (Continued)

aren't designed to inflate at all in rollover, rear, side or low-speed frontal crashes. And, for unrestrained occupants, Next Generation air bags may provide less protection in frontal crashes than more forceful air bags have provided in the past. Everyone in your vehicle should wear a safety belt properly -- whether or not there's an air bag for that person.

 **CAUTION:**

Air bags inflate with great force, faster than the blink of an eye. If you're too close to an inflating air bag, as you would be if you were leaning forward, it could seriously injure you. This is true even with Next Generation frontal air bags. Safety belts help keep you in position before and during a crash. Always wear your safety belt, even with Next Generation air bags. The driver should sit as far back as possible while still maintaining control of the vehicle.

 **CAUTION:**

Children who are up against, or very close to, any air bag when it inflates can be seriously injured or killed. This is true even though your vehicle has Next Generation frontal air bags. Air bags plus lap-shoulder belts offer the best protection for adults, but not for young children and infants. Neither the vehicle's safety belt system nor its air bag system is designed for them. Young children and infants need the protection that a child restraint system can provide. Always secure children properly in your vehicle. To read how, see the part of this manual called "Children" and see the caution labels on the sunvisors and the right front passenger's safety belt.

X-01-0001-T

**AIR
BAG**

There is an air bag readiness light on the instrument panel, which shows AIR BAG.

The system checks the air bag electrical system for malfunctions. The light tells you if there is an electrical problem. See “Air Bag Readiness Light” in the Index for more information.

How the Air Bag System Works



Where are the air bags?

The driver's air bag is in the middle of the steering wheel.



The right front passenger's air bag is in the instrument panel on the passenger's side.

⚠ CAUTION:

If something is between an occupant and an air bag, the bag might not inflate properly or it might force the object into that person. The path of an inflating air bag must be kept clear. Don't put anything between an occupant and an air bag, and don't attach or put anything on the steering wheel hub or on or near any other air bag covering.

When should an air bag inflate?

An air bag is designed to inflate in a moderate to severe frontal or near-frontal crash. The air bag will inflate only if the impact speed is above the system's designed "threshold level." If your vehicle goes straight into a wall that doesn't move or deform, the threshold level is about 9 to 15 mph (14 to 24 km/h). The threshold level can vary, however, with specific vehicle design, so that it can be somewhat above or below this range. If your vehicle strikes something that will move or deform, such as a parked car, the threshold level will be higher. The air bag is not designed to inflate in rollovers, side impacts or rear impacts, because inflation would not help the occupant.

In any particular crash, no one can say whether an air bag should have inflated simply because of the damage to a vehicle or because of what the repair costs were. Inflation is determined by the angle of the impact and how quickly the vehicle slows down in frontal or near-frontal impacts.

What makes an air bag inflate?

In an impact of sufficient severity, the air bag sensing system detects that the vehicle is in a crash. The sensing system triggers a release of gas from the inflator, which inflates the air bag. The inflator, air bag and related hardware are all part of the air bag modules inside the steering wheel and in the instrument panel in front of the right front passenger.

How does an air bag restrain?

In moderate to severe frontal or near-frontal collisions, even belted occupants can contact the steering wheel or the instrument panel. Air bags supplement the protection provided by safety belts. Air bags distribute the force of the impact more evenly over the occupant's upper body, stopping the occupant more gradually. But air bags would not help you in many types of collisions, including rollovers, rear impacts and side impacts, primarily because an occupant's motion is not toward those air bags. Air bags should never be regarded as anything more than a supplement to safety belts, and then only in moderate to severe frontal or near-frontal collisions.

What will you see after an air bag inflates?

After an air bag inflates, it quickly deflates, so quickly that some people may not even realize the air bag inflated. Some components of the air bag module -- the steering wheel hub for the driver's air bag, or the instrument panel for the right front passenger's bag -- will be hot for a short time. The parts of the bag that come into contact with you may be warm, but not too hot to touch. There will be some smoke and dust coming from vents in the deflated air bags. Air bag inflation doesn't prevent the driver from seeing or from being able to steer the vehicle, nor does it stop people from leaving the vehicle.

 **CAUTION:**

When an air bag inflates, there is dust in the air. This dust could cause breathing problems for people with a history of asthma or other breathing trouble. To avoid this, everyone in the vehicle should get out as soon as it is safe to do so. If you have breathing problems but can't get out of the vehicle after an air bag inflates, then get fresh air by opening a window or door.

- Air bags are designed to inflate only once. After they inflate, you'll need some new parts for your air bag system. If you don't get them, the air bag system won't be there to help protect you in another crash. A new system will include air bag modules and possibly other parts. The service manual for your vehicle covers the need to replace other parts.
- Your vehicle is equipped with a crash sensing and diagnostic module, which records information about the air bag system. The module records information about the readiness of the system, when the sensors are activated and driver's safety belt usage at deployment.
- Let only qualified technicians work on your air bag system. Improper service can mean that your air bag system won't work properly. See your dealer for service.

NOTICE:

If you damage the covering for the driver's or the right front passenger's air bag, the bag may not work properly. You may have to replace the air bag module in the steering wheel or both the air bag module and the instrument panel for the right front passenger's air bag. Do not open or break the air bag coverings.

If your vehicle ever gets into a lot of water -- such as water up to the carpeting or higher -- or if water enters your vehicle and soaks the carpet, the air bag controller can be soaked and ruined. If this ever happens, and then you start your vehicle, the damage could make the air bags inflate, even if there's no crash. You would have to replace the air bags as well as the sensors and related parts. If your vehicle is ever in a flood, or if it's exposed to water that soaks the carpet, you can avoid needless repair costs by turning off the vehicle immediately and disconnecting the battery cables. Don't let anyone start the vehicle under any circumstances. See your dealer for service.

Servicing Your Air Bag-Equipped Vehicle

Air bags affect how your vehicle should be serviced. There are parts of the air bag system in several places around your vehicle. You don't want the system to inflate while someone is working on your vehicle. Your dealer and the LeSabre Service Manual have information about servicing your vehicle and the air bag system. To purchase a service manual, see "Service and Owner Publications" in the Index.

**CAUTION:**

For up to 10 minutes after the ignition key is turned off and the battery is disconnected, an air bag can still inflate during improper service. You can be injured if you are close to an air bag when it inflates. Avoid yellow connectors. They are probably part of the air bag system. Be sure to follow proper service procedures, and make sure the person performing work for you is qualified to do so.

The air bag system does not need regular maintenance.

Center Passenger Position

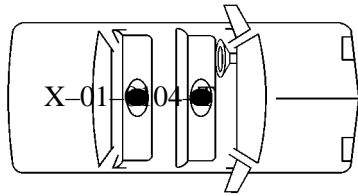

Lap Belt

If your vehicle has front and rear bench seats, someone can sit in the center positions.



When you sit in a center seating position, you have a lap safety belt, which has no retractor. To make the belt longer, tilt the latch plate and pull it along the belt.



To make the belt shorter, pull its free end as shown until the belt is snug.

Buckle, position and release it the same way as the lap part of a lap-shoulder belt. If the belt isn't long enough, see "Safety Belt Extender" at the end of this section.

Make sure the release button on the buckle is positioned so you would be able to unbuckle the safety belt quickly if you ever had to.

Rear Seat Passengers

It's very important for rear seat passengers to buckle up! Accident statistics show that unbelted people in the rear seat are hurt more often in crashes than those who are wearing safety belts.

Rear passengers who aren't safety belted can be thrown out of the vehicle in a crash. And they can strike others in the vehicle who are wearing safety belts.

Rear Seat Outside Passenger Positions

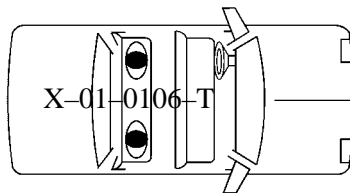

Lap-Shoulder Belt

The positions next to the windows have lap-shoulder belts. Here's how to wear one properly.



1. Pick up the latch plate and pull the belt across you. Don't let it get twisted.

The shoulder belt may lock if you pull the belt across you very quickly. If this happens, let the belt go back slightly to unlock it. Then pull the belt across you more slowly.

2. Push the latch plate into the buckle until it clicks.



If the belt stops before it reaches the buckle, tilt the latch plate and keep pulling until you can buckle it.

Pull up on the latch plate to make sure it is secure.

If the belt is not long enough, see “Safety Belt Extender” at the end of this section. Make sure the release button on the buckle is positioned so you would be able to unbuckle the safety belt quickly if you ever had to.

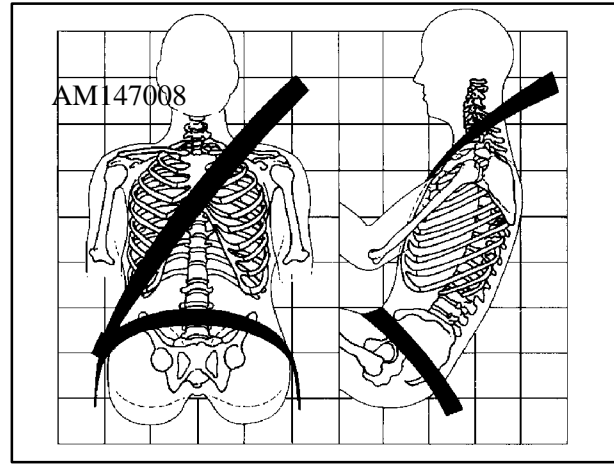

3. To make the lap part tight, pull down on the buckle end of the belt as you pull up on the shoulder part.

The lap part of the belt should be worn low and snug on the hips, just touching the thighs. In a crash, this applies force to the strong pelvic bones. And you'd be less likely to slide under the lap belt. If you slid under it, the belt would apply force at your abdomen. This could cause serious or even fatal injuries. The shoulder belt should go over the shoulder and across the chest. These parts of the body are best able to take belt restraining forces.

The safety belt locks if there's a sudden stop or a crash, or if you pull the belt very quickly out of the retractor.

⚠ CAUTION:

You can be seriously hurt if your shoulder belt is too loose. In a crash, you would move forward too much, which could increase injury. The shoulder belt should fit against your body.



To unlatch the belt, just push the button on the buckle.

Rear Safety Belt Comfort Guides for Children and Small Adults

Rear shoulder belt comfort guides will provide added safety belt comfort for children who have outgrown child restraints and for small adults. When installed on a shoulder belt, the comfort guide pulls the belt away from the neck and head.

There is one guide for each outside passenger position in the rear seat. To provide added safety belt comfort for children who have outgrown child restraints and for smaller adults, the comfort guides may be installed on the shoulder belts. Here's how to install a comfort guide and use the safety belt:



1. Pull the elastic cord out from between the edge of the seatback and the interior body to remove the guide from its storage clip.



2. Slide the guide under and past the belt. The elastic cord must be under the belt. Then, place the guide over the belt, and insert the two edges of the belt into the slots of the guide.



3. Be sure that the belt is not twisted and it lies flat. The elastic cord must be under the belt and the guide on top.

4. Buckle, position and release the safety belt as described in “Rear Seat Outside Passenger Positions” earlier in this section. Make sure that the shoulder belt crosses the shoulder.

To remove and store the comfort guides, squeeze the belt edges together so that you can take them out from the guides. Pull the guide upward to expose its storage clip, and then slide the guide onto the clip. Rotate the guide and clip inward and in between the seatback and the interior body, leaving only the loop of elastic cord exposed.

Children

Everyone in a vehicle needs protection! That includes infants and all children smaller than adult size. Neither the distance traveled nor the age and size of the traveler changes the need, for everyone, to use safety restraints. In fact, the law in every state in the United States and in every Canadian province says children up to some age must be restrained while in a vehicle.

Smaller Children and Babies



CAUTION:

Children who are up against, or very close to, any air bag when it inflates can be seriously injured or killed. This is true even though your vehicle has Next Generation frontal air bags. Air bags plus lap-shoulder belts offer the best protection for adults, but not for young children and infants. Neither the vehicle's safety belt system nor its air bag system is designed for them. Young children and infants need the protection that a child restraint system can provide. Always secure children properly in your vehicle.

 **CAUTION:**

Smaller children and babies should always be restrained in a child or infant restraint. The instructions for the restraint will say whether it is the right type and size for your child. A very young child's hip bones are so small that a regular belt might not stay low on the hips, as it should. Instead, the belt will likely be over the child's abdomen. In a crash, the belt would apply force right on the child's abdomen, which could cause serious or fatal injuries. So, be sure that any child small enough for one is always properly restrained in a child or infant restraint.

Infants need complete support, including support for the head and neck. This is necessary because an infant's neck is weak and its head weighs so much compared with the rest of its body. In a frontal crash, an infant in a rear-facing restraint settles into the restraint, so the crash forces can be distributed across the strongest part of the infant's body, the back and shoulders. A baby should be secured in an appropriate infant restraint. This is so important that many hospitals today won't release a newborn infant to its parents unless there is an infant restraint available for the baby's first trip in a motor vehicle.



CAUTION: (Continued)

at only 25 mph (40 km/h), a 12-lb. (5.5 kg) baby will suddenly become a 240-lb. (110 kg) force on your arms. The baby would be almost impossible to hold.

Secure the baby in an infant restraint.



⚠ CAUTION:

Never hold a baby in your arms while riding in a vehicle. A baby doesn't weigh much -- until a crash. During a crash a baby will become so heavy you can't hold it. For example, in a crash

CAUTION: (Continued)

Child Restraints

Every time infants and young children ride in vehicles, they should have protection provided by appropriate restraints.

Q: What are the different types of add-on child restraints?

A: Add-on child restraints are available in four basic types. When selecting a child restraint, take into consideration not only the child's weight and size, but also whether or not the restraint will be compatible with the motor vehicle in which it will be used.

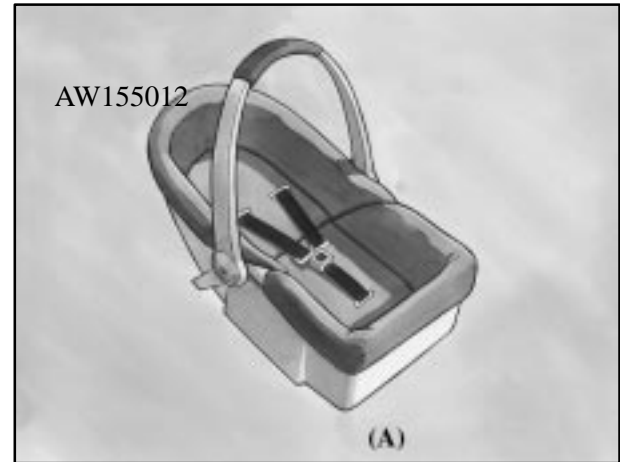

An infant car bed (A) is a special bed made for use in a motor vehicle. It's an infant restraint system designed to restrain or position a child on a continuous flat surface. With an infant car bed, make sure that the infant's head rests toward the center of the vehicle.

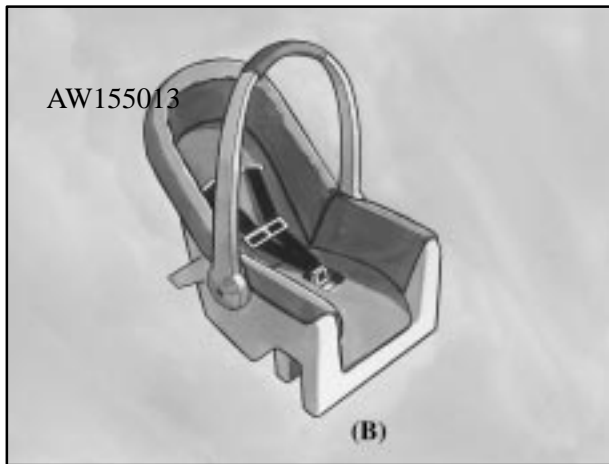

A rear-facing infant restraint (B) positions an infant to face the rear of the vehicle. Rear-facing infant restraints are designed for infants of up to about 20 lbs. (9 kg) and about one year of age. This type of restraint faces the rear so that the infant's head, neck and body can have the support they need in a frontal crash. Some infant seats come in two parts -- the base stays secured in the vehicle and the seat part is removable.

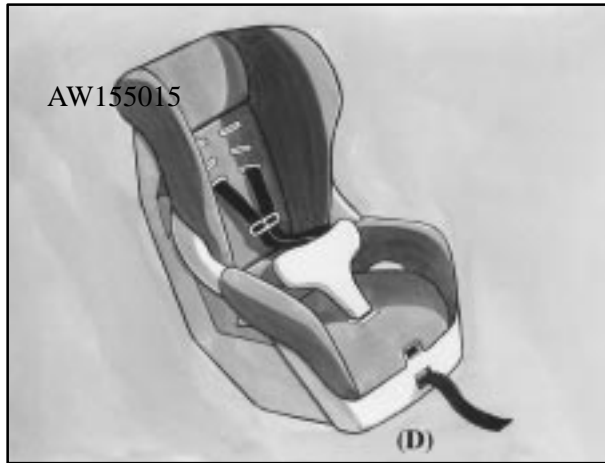

A forward-facing child restraint (C-E) positions a child upright to face forward in the vehicle. These forward-facing restraints are designed to help protect children who are from 20 to 40 lbs. (9 to 18 kg) and about 26 to 40 inches (66 to 102 cm) in height, or up to around four years of age. One type, a convertible restraint, is designed to be used either as a rear-facing infant seat or a forward-facing child seat.

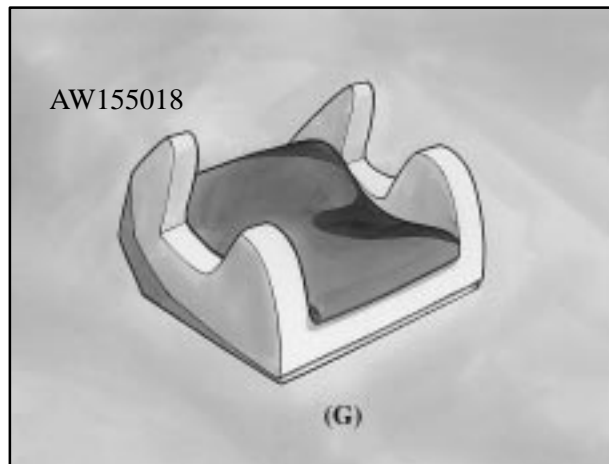
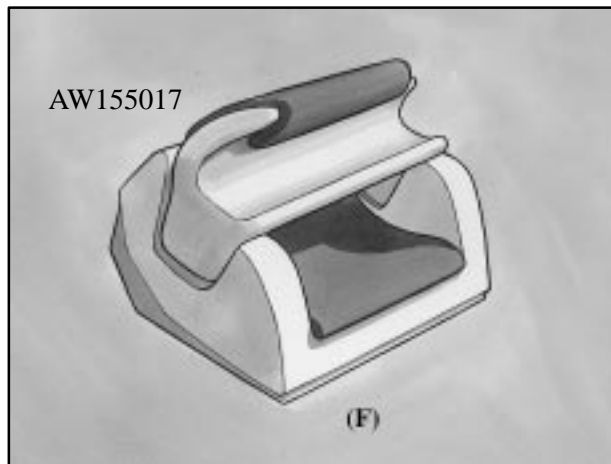

A booster seat (F, G) is designed for children who are about 40 to 60 lbs., or even up to 80 lbs. (18 to 27 kg, or even up to 36 kg), and about four to eight years of age. A booster seat is designed to improve the fit of the vehicle's safety belt system. Booster seats with shields use lap-only belts; however, booster seats without shields use lap-shoulder belts. Booster seats can also help a child to see out the window.

When choosing a child restraint, be sure the child restraint is designed to be used in a vehicle. If it is, it will have a label saying that it meets Federal Motor Vehicle Safety Standards.

Then follow the instructions for the restraint. You may find these instructions on the restraint itself or in a booklet, or both. These restraints use the belt system in your vehicle, but the child also has to be secured within the restraint to help reduce the chance of personal injury. The instructions that come with the infant or child restraint will show you how to do that. Both the owner's manual and the child restraint instructions are important, so if either one of these is not available, obtain a replacement copy from the manufacturer.

Where to Put the Restraint

Accident statistics show that children are safer if they are restrained in the rear rather than the front seat. We at General Motors therefore recommend that you put your child restraint in the rear seat. *Never* put a rear-facing child restraint in the front passenger seat. Here's why:

CAUTION:

A child in a rear-facing child restraint can be seriously injured or killed if the right front passenger's air bag inflates, even though your vehicle has Next Generation frontal air bags. This is because the back of the rear-facing child restraint would be very close to the inflating air bag. Always secure a rear-facing child restraint in a rear seat.

You may secure a forward-facing child restraint in the right front seat, but before you do, always move the front passenger seat as far back as it will go. It's better to secure the child restraint in a rear seat.

CAUTION:

A child in a child restraint in the center front seat can be badly injured or killed by the right front passenger air bag if it inflates, even though your vehicle has Next Generation frontal air bags. Never secure a child restraint in the center front seat. It's always better to secure a child restraint in the rear seat. You may secure a forward-facing child restraint in the right front passenger seat, but before you do, always move the front passenger seat as far back as it will go. It's better to secure the child restraint in a rear seat.

Wherever you install it, be sure to secure the child restraint properly.

Keep in mind that an unsecured child restraint can move around in a collision or sudden stop and injure people in the vehicle. Be sure to properly secure any child restraint in your vehicle -- even when no child is in it.

Top Strap

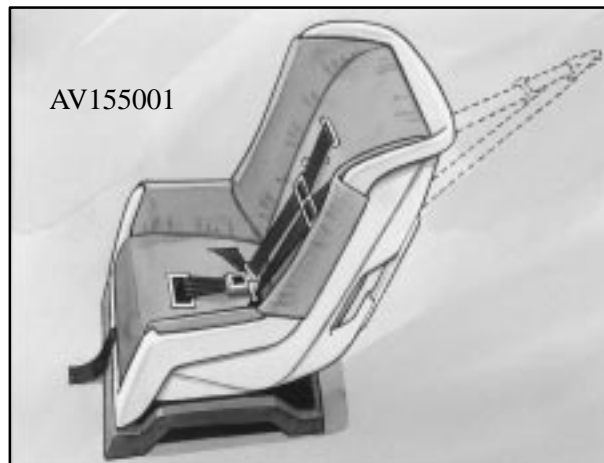

If your child restraint has a top strap, it should be anchored. If you need to have an anchor installed, you can ask your dealer to put it in for you. If you want to install an anchor yourself, your dealer can tell you how to do it.

Canadian law requires that child restraints have a top strap, and that the strap be anchored.

If your child restraint has a top strap, your dealer can obtain a kit with anchor hardware and installation instructions specifically designed for this vehicle. The dealer can then install the anchor for you. This work will be done for you free of charge. Or, you may install the anchor yourself using the instructions provided in the kit.

Securing a Child Restraint in a Rear Outside Seat Position

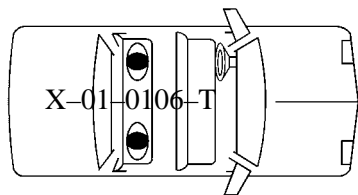

You'll be using the lap-shoulder belt. See the earlier part about the top strap if the child restraint has one. Be sure to follow the instructions that came with the child restraint. Secure the child in the child restraint when and as the instructions say.

1. Put the restraint on the seat.

2. Pick up the latch plate, and run the lap and shoulder portions of the vehicle's safety belt through or around the restraint. The child restraint instructions will show you how.



3. Tilt the latch plate to adjust the belt if needed.

If the shoulder belt goes in front of the child's face or neck, put it behind the child restraint.

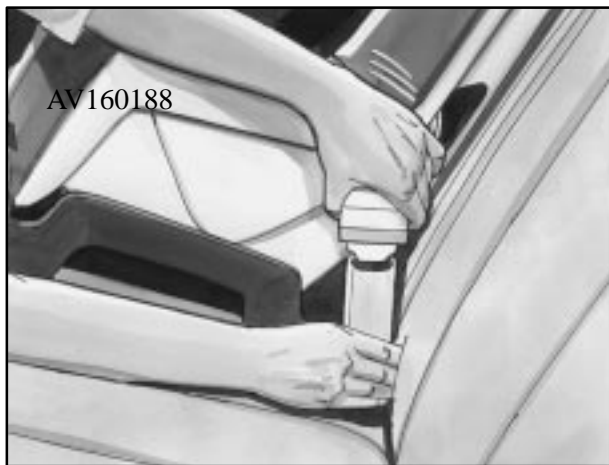

4. Buckle the belt. Make sure the release button is positioned so you would be able to unbuckle the safety belt quickly if you ever had to.



5. To tighten the belt, pull up on the shoulder belt while you push down on the child restraint. If you're using a forward-facing child restraint, you may find it helpful to use your knee to push down on the child restraint as you tighten the belt.
6. Push and pull the child restraint in different directions to be sure it is secure.

To remove the child restraint, just unbuckle the vehicle's safety belt and let it go back all the way. The safety belt will move freely again and be ready to work for an adult or larger child passenger.

Securing a Child Restraint in the Center Rear Seat Position

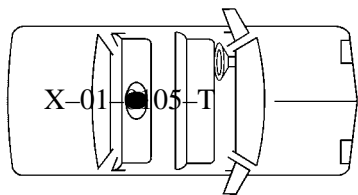

You'll be using the lap belt. Be sure to follow the instructions that came with the child restraint. Secure the child in the child restraint when and as the instructions say.

CAUTION:

A child in a child restraint in the center front seat can be badly injured or killed by the right front passenger air bag if it inflates even though your vehicle has Next Generation frontal air bags. Never secure a child restraint in the center front seat. It's always better to secure a child restraint in the rear seat. You may secure a forward-facing child restraint in the right front passenger seat, but before you do, always move the front passenger seat as far back as it will go. It's better to secure the child restraint in a rear seat.

See the earlier part about the top strap if the child restraint has one.



1. Make the belt as long as possible by tilting the latch plate and pulling it along the belt.
2. Put the restraint on the seat.
3. Run the vehicle's safety belt through or around the restraint. The child restraint instructions will show you how.



4. Buckle the belt. Make sure the release button is positioned so you would be able to unbuckle the safety belt quickly if you ever had to.
5. To tighten the belt, pull its free end while you push down on the child restraint. If you're using a forward-facing child restraint, you may find it helpful to use your knee to push down on the child restraint as you tighten the belt.
6. Push and pull the child restraint in different directions to be sure it is secure.

To remove the child restraint, just unbuckle the vehicle's safety belt. It will be ready to work for an adult or larger child passenger.

Securing a Child Restraint in the Right Front Seat Position

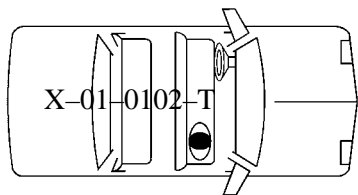

Your vehicle has a right front passenger air bag. *Never* put a rear-facing child restraint in this seat. Here's why:

⚠ CAUTION:

A child in a rear-facing child restraint can be seriously injured or killed if the right front passenger's air bag inflates, even though your vehicle has Next Generation frontal air bags. This is because the back of the rear-facing child restraint would be very close to the inflating air bag. Always secure a rear-facing child restraint in the rear seat.

Although a rear seat is a safer place, you can secure a forward-facing child restraint in the right front seat.

You'll be using the lap-shoulder belt. See the earlier part about the top strap if the child restraint has one. Be sure to follow the instructions that came with the child restraint. Secure the child in the child restraint when and as the instructions say.

1. Because your vehicle has a right front passenger air bag, always move the seat as far back as it will go before securing a forward-facing child restraint. (See "Seats" in the Index.)
2. Put the restraint on the seat.

3. Pick up the latch plate, and run the lap and shoulder portions of the vehicle's safety belt through or around the restraint. The child restraint instructions will show you how.

If the shoulder belt goes in front of the child's face or neck, put it behind the child restraint.



4. Buckle the belt. Make sure the release button is positioned so you would be able to unbuckle the safety belt quickly if you ever had to.



5. Pull the rest of the lap belt all the way out of the retractor to set the lock.



6. To tighten the belt, feed the lap belt back into the retractor while you push down on the child restraint. You may find it helpful to use your knee to push down on the child restraint as you tighten the belt.
7. Push and pull the child restraint in different directions to be sure it is secure.

To remove the child restraint, just unbuckle the vehicle's safety belt and let it go back all the way. The safety belt will move freely again and be ready to work for an adult or larger child passenger.

Larger Children

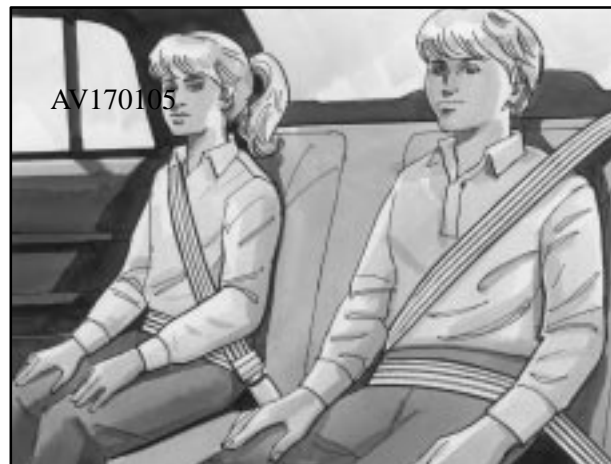

Children who have outgrown child restraints should wear the vehicle's safety belts.

If you have the choice, a child should sit next to a window so the child can wear a lap-shoulder belt and get the additional restraint a shoulder belt can provide.

Accident statistics show that children are safer if they are restrained in the rear seat. But they need to use the safety belts properly.

- Children who aren't buckled up can be thrown out in a crash.
- Children who aren't buckled up can strike other people who are.



⚠ CAUTION:

Never do this.

Here two children are wearing the same belt. The belt can't properly spread the impact forces. In a crash, the two children can be crushed together and seriously injured. A belt must be used by only one person at a time.

Q: What if a child is wearing a lap-shoulder belt, but the child is so small that the shoulder belt is very close to the child's face or neck?

A: Move the child toward the center of the vehicle, but be sure that the shoulder belt still is on the child's shoulder, so that in a crash the child's upper body would have the restraint that belts provide. If the child is sitting in a rear seat outside position, see "Rear Safety Belt Comfort Guides" in the Index. If the child is so small that the shoulder belt is still very close to the child's face or neck, you might want to place the child in the center seat position, the one that has only a lap belt.



⚠ CAUTION:

Never do this.

Here a child is sitting in a seat that has a lap-shoulder belt, but the shoulder part is behind the child. If the child wears the belt in this way, in a crash the child might slide under the belt. The belt's force would then be applied right on the child's abdomen. That could cause serious or fatal injuries.

Wherever the child sits, the lap portion of the belt should be worn low and snug on the hips, just touching the child's thighs. This applies belt force to the child's pelvic bones in a crash.

Safety Belt Extender

If the vehicle's safety belt will fasten around you, you should use it.

But if a safety belt isn't long enough to fasten, your dealer will order you an extender. It's free. When you go in to order it, take the heaviest coat you will wear, so the extender will be long enough for you. The extender will be just for you, and just for the seat in your vehicle that you choose. Don't let someone else use it, and use it only for the seat it is made to fit. To wear it, just attach it to the regular safety belt.

Checking Your Restraint Systems

Now and then, make sure the safety belt reminder light and all your belts, buckles, latch plates, retractors and anchorages are working properly. Look for any other loose or damaged safety belt system parts. If you see anything that might keep a safety belt system from doing its job, have it repaired.

Torn or frayed safety belts may not protect you in a crash. They can rip apart under impact forces. If a belt is torn or frayed, get a new one right away.

Also look for any opened or broken air bag covers, and have them repaired or replaced. (The air bag system does not need regular maintenance.)

Replacing Restraint System Parts After a Crash

If you've had a crash, do you need new belts?

After a very minor collision, nothing may be necessary. But if the belts were stretched, as they would be if worn during a more severe crash, then you need new belts.

If belts are cut or damaged, replace them. Collision damage also may mean you will need to have safety belt or seat parts repaired or replaced. New parts and repairs may be necessary even if the belt wasn't being used at the time of the collision.

If your seat adjuster won't work after a crash, the special part of the safety belt that goes through the seat to the adjuster may need to be replaced.

If an air bag inflates, you'll need to replace air bag system parts. See the part on the air bag system earlier in this section.



Section 2 Features and Controls

Here you can learn about the many standard and optional features on your vehicle, and information on starting, shifting and braking. Also explained are the instrument panel and the warning systems that tell you if everything is working properly -- and what to do if you have a problem.

2-2	Keys	2-31	Engine Exhaust
2-4	Door Locks	2-32	Running Your Engine While You're Parked
2-9	Remote Keyless Entry System (If Equipped)	2-33	Windows
2-14	Trunk	2-33	Horn
2-15	Theft	2-34	Tilt Wheel
2-16	Universal Theft-Deterrent (If Equipped)	2-34	Turn Signal/Multifunction Lever
2-18	PASS-Key [®] II	2-40	Exterior Lamps
2-19	New Vehicle "Break-In"	2-43	Interior Lamps
2-20	Ignition Positions	2-46	Mirrors
2-21	Starting Your Engine	2-51	Storage Compartments
2-23	Engine Coolant Heater (If Equipped)	2-53	Sun Visors
2-24	Automatic Transaxle Operation	2-53	OnStar [®] System
2-27	Parking Brake	2-54	The Instrument Panel - Your Information System
2-28	Shifting Into PARK (P)	2-59	Warning Lights, Gages and Indicators
2-30	Shifting Out of PARK (P)		
2-31	Parking Over Things That Burn		

Keys

CAUTION:

Leaving children in a vehicle with the ignition key is dangerous for many reasons. A child or others could be badly injured or even killed.

They could operate power windows or other controls or even make the vehicle move. Don't leave the keys in a vehicle with children.





The ignition key is for the ignition only.



The door keys are for the doors and all other locks.

When a new vehicle is delivered, the dealer removes the plugs from the keys and gives them to the first owner. However, the ignition key may not have a plug. If the ignition key doesn't have a plug, it will have a bar-coded key tag.

Each plug or tag has a code on it that tells your dealer or a qualified locksmith how to make extra keys. Keep the plugs or the tags in a safe place. If you lose your keys, you'll be able to have new ones made easily using these plugs or the tag. If your ignition keys don't have plugs or the tag, go to your dealer for the correct key code if you need a new ignition key.

NOTICE:

Your vehicle has a number of features that can help prevent theft. But you can have a lot of trouble getting into your vehicle if you ever lock your keys inside. You may even have to damage your vehicle to get in. So be sure you have extra keys.

Door Locks

CAUTION:

Unlocked doors can be dangerous.

Passengers -- especially children -- can easily open the doors and fall out. When a door is locked, the inside handle won't open it.

Outsiders can easily enter through an unlocked door when you slow down or stop your vehicle.

This may not be so obvious: You increase the chance of being thrown out of the vehicle in a crash if the doors aren't locked. Wear safety belts properly, lock your doors, and you will be far better off whenever you drive your vehicle.

There are several ways to lock and unlock your vehicle.

From the outside, use your door key or remote keyless entry transmitter (if equipped). With your door key, turning the key toward the rear of the vehicle will lock the door. Turning the key toward the front of the vehicle will unlock it.

If your vehicle has a theft-deterrent system and it is activated, unlock the doors only with the key or remote keyless entry system. This will avoid setting off the alarm.



To lock the door from the inside, slide the manual door lock control on the door down. To unlock the door, slide the manual door lock control up.

Power Door Locks



With power door locks, you can lock or unlock all the doors of your vehicle using the driver's or front passenger's door lock switch.

The switch on each rear door works only that door's lock. It won't lock (or unlock) all of the doors -- that's a safety feature.

Memory Door Locks

Close the doors and turn on the ignition. Every time you move the shift lever out of PARK (P), all of the doors will lock. And, every time you stop and move the shift lever into PARK (P), the doors will unlock. If someone needs to get out while you're not in PARK (P), have that person use the manual or power lock. When the door is

closed again, it will not lock automatically. Just use the manual or power lock to lock the door again. If you need to lock the doors before shifting out of PARK (P), just use the manual or power lock button.

Personal Choice Programming

If your vehicle is equipped with remote keyless entry, you can program the memory door locks feature to change to the following modes:

Mode	Operation
0	No automatic door lock or unlock.
1	All doors automatically lock when shifted out of PARK (P). No automatic door unlock.
2	All doors automatically lock when shifted out of PARK (P). Only the driver's door automatically unlocks when shifted into PARK (P).
3	All doors automatically lock when shifted out of PARK (P). All doors automatically unlock when shifted into PARK (P).

Vehicles are delivered programmed in Mode 3.

Use the following procedure to change modes:

1. Close all the doors and turn the ignition on. Keep all doors closed throughout this procedure.
2. Press and hold LOCK on the driver's power door lock switch through Step 4.
3. Press the LOCK button on the remote keyless entry transmitter. The automatic door locks will remain in the current mode.
4. Press the LOCK button on the transmitter again. Each time the transmitter's LOCK button is pressed, the mode will advance by one, going from 3 to 0 to 1, etc.

Note: The door locks will cycle according to the mode entered while customizing the memory door locks. (Mode "0" has no feedback.)

5. Release the power door lock switch. The automatic door locks will remain in the most recent mode selected.

Delayed Locking (If Equipped)

This feature lets the driver delay the actual locking of the vehicle. When the power door lock switch is pressed with the key removed from the ignition and the driver's door open, a chime will sound three times to signal that delayed locking is active. When all doors have been closed, the doors will lock automatically after five seconds. If any door is opened before this, the five-second timer will reset itself once all the doors have been closed again.

Pressing the door lock switch twice within two seconds will override this feature.

Personal Choice Programming

The delayed locking feature can be turned on or off for each remote keyless entry transmitter. Vehicles are delivered with each transmitter defaulted with delayed locking off.

To turn the feature on:

1. Press and hold LOCK on the driver's power door lock switch throughout this procedure. All the doors will lock.
2. Press the UNLOCK button on the transmitter. The lock delay is still off and all doors will remain locked.
3. Press the UNLOCK button on the transmitter again. Lock delay is now active and all doors will unlock.
4. Release the power door lock switch.

To turn this feature off, repeat the previous procedure.

This procedure only changes the mode for the transmitter used to change this setting. The procedure will need to be repeated for the second transmitter.

If your vehicle is not equipped with remote keyless entry, the delayed locking feature can be turned on or off by using the following procedure:

1. With the ignition on, press and hold LOCK on the driver's power door lock switch. All doors will lock.
2. Cycle the headlamp switch four times. On the third cycle, the doors will lock if the feature is now off, or will unlock if the feature has been turned on.
3. To change modes, cycle the headlamp switch once more. A locking action will confirm the new mode.
4. Release the power door lock switch.

To turn the feature off, repeat the previous procedure.

Rear Door Security Lock

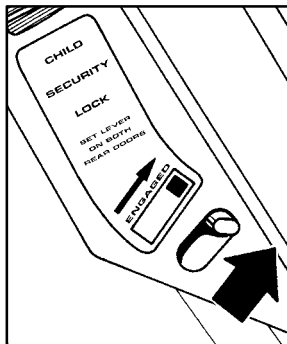

Your vehicle is equipped with rear door security locks that help prevent passengers from opening the rear doors of your vehicle from the inside.

To Use One of These Locks

1. Open the rear door you wish to lock.
2. Move the lever located on the door edge all the way up to the ENGAGED position.
3. Close the door.
4. Do the same thing to the other rear door lock.

The rear doors of your vehicle cannot be opened from the inside when this feature is in use.

To Open a Rear Door When the Security Lock is On

1. Unlock the door.
2. Then open the door from the outside.

If you don't cancel the security lock feature, adults or older children who ride in the rear seat won't be able to open the rear door from the inside. You should let adults and older children know how these security locks work, and how to cancel the locks.

To Cancel the Rear Door Lock

1. Unlock the door and open the door from the outside.
2. Move the lever all the way down.
3. Do the same for the other rear door.

The rear door locks will now work normally.

Lockout Protection

The power door locks will not work if the key is left in the ignition with the driver's door open. You can override this feature by holding the power door lock switch for more than three seconds, unless the engine is running.

Leaving Your Vehicle

If you are leaving the vehicle, take your keys, open your door and set the locks from the inside. Then get out and close the door. Or, you may also use the LOCK button on the remote keyless entry transmitter after shutting the doors.

If your vehicle has a theft-deterrent system, see “Universal Theft-Deterrent” in the Index.

Remote Keyless Entry System (If Equipped)



If your vehicle has this option, you can lock and unlock your doors or unlock your trunk from about 3 feet (1 m) up to 30 feet (9 m) away using the remote keyless entry transmitter supplied with your vehicle.

Your remote keyless entry system operates on a radio frequency subject to Federal Communications Commission (FCC) Rules and with Industry Canada.

This device complies with Part 15 of the FCC Rules. Operation is subject to the following two conditions: (1) this device may not cause harmful interference, and (2) this device must accept any interference received, including interference that may cause undesired operation.

This device complies with RSS-210 of Industry Canada. Operation is subject to the following two conditions: (1) this device may not cause interference, and (2) this device must accept any interference received, including interference that may cause undesired operation of the device.

Changes or modifications to this system by other than an authorized service facility could void authorization to use this equipment.

This system has a range of about 3 feet (1 m) up to 30 feet (9 m). At times you may notice a decrease in range. This is normal for any remote keyless entry system. If the transmitter does not work or if you have to stand closer to your vehicle for the transmitter to work, try this:

- Check to determine if battery replacement or resynchronization is necessary. See the instructions that follow.
- Check the distance. You may be too far from your vehicle. You may need to stand closer during rainy or snowy weather.
- Check the location. Other vehicles or objects may be blocking the signal. Take a few steps to the left or right, hold the transmitter higher, and try again.
- If you're still having trouble, see your dealer or a qualified technician for service.

Operation

The driver's door will unlock when UNLOCK is pressed.

If UNLOCK is pressed again within five seconds, all doors will unlock. Pressing the UNLOCK button will also illuminate the interior lamps. See "Illuminated Entry" in the Index.

All doors will lock when LOCK is pressed.

The trunk will unlock when the trunk symbol is pressed when the ignition is in OFF. The trunk symbol will also work when the ignition is on, but only while the transaxle is in PARK (P).

Instant Alarm

When the button with the horn symbol on the remote keyless entry transmitter is pressed, the horn will sound and the headlamps and taillamps will flash for up to one minute. This can be turned off by pressing the instant alarm button again or by turning the ignition on. If your vehicle is equipped with the Universal Theft-Deterrent feature, you may also turn off the instant alarm by unlocking the vehicle with a key.

Personal Choice Features

The following list of features that are available on your vehicle can be programmed to each driver's preference for each of the key transmitters.

- **Memory Door Locks:** This feature programs your door locks to automatically lock or unlock when shifting in and out of PARK (P).

- **Security Feedback:** This feature provides feedback to the driver when the vehicle receives a command from the remote keyless entry transmitter.
- **Delayed Locking:** This feature lets the driver delay the actual locking of the vehicle. When all doors have been closed, the doors will lock automatically after five seconds.
- **Perimeter Lighting:** When the UNLOCK button on the key transmitter is pressed, the headlamps, parking lamps, back-up lamps and cornering lamps will turn on.

For more detailed information and programming instructions, refer to the Index for each individual feature listed above.

Security Feedback

This feature provides feedback to the driver when the vehicle receives a command from the remote keyless entry transmitter. One of the following modes may be selected for each transmitter:

Mode Security Feedback

- | | |
|---|--|
| 0 | No feedback when locking or unlocking vehicle. |
|---|--|

Mode Security Feedback

- | | |
|---|---|
| 1 | No feedback when locking; headlamps, parking lamps and cornering lamps (if equipped) flash when unlocking vehicle. |
| 2 | Headlamps, parking lamps and cornering lamps (if equipped) flash when locking; no feedback when unlocking vehicle. |
| 3 | Headlamps, parking lamps and cornering lamps (if equipped) flash when locking and unlocking vehicle. |
| 4 | Headlamps, parking lamps and cornering lamps (if equipped) flash and horn chirps when locking; no feedback when unlocking vehicle. |
| 5 | Headlamps, parking lamps and cornering lamps (if equipped) flash and horn chirps when locking; headlamps, parking lamps and cornering lamps (if equipped) flash when unlocking vehicle. |

Feedback will be provided according to the mode that has been selected.

Vehicles are delivered programmed in Mode 5. To change to another mode:

1. Turn the ignition key to OFF.
2. Press and hold LOCK on the driver's power door lock switch.
3. Press the trunk button on the transmitter. The transmitter will remain in its current mode.
4. Press the trunk button again. Each time the trunk button is pressed, the transmitter will advance to the next mode.
5. Release the power door lock switch.

This procedure only changes the mode for the transmitter used to change this setting. The procedure will need to be repeated for the second transmitter.

Matching Transmitter(s) To Your Vehicle

Each remote keyless entry transmitter is coded to prevent another transmitter from unlocking your vehicle. If a transmitter is lost or stolen, a replacement can be purchased through your dealer. Remember to bring any remaining transmitters with you when you go to your dealer. When the dealer matches the replacement transmitter to your vehicle, any remaining transmitters must also be matched. Once your dealer has coded the new transmitter, the lost transmitter will not unlock your vehicle. Each vehicle can have only four transmitters matched to it.

See your dealer to match transmitters to another vehicle.

Battery Replacement

Under normal use, the battery in your remote keyless entry transmitter should last about two years.

You can tell the battery is weak if the transmitter won't work at the normal range in any location. If you have to get close to your vehicle before the transmitter works, it's probably time to change the battery.

NOTICE:

When replacing the battery, use care not to touch any of the circuitry. Static from your body transferred to these surfaces may damage the transmitter.



For battery replacement, use one Duracell® battery, type DL-2032, or a similar type.

To replace the battery:

1. Insert a coin into the notch near the key ring. Turn the coin counterclockwise to separate the two halves of the transmitter.
2. Once the transmitter is separated, use a pencil eraser to remove the old battery. Do not use a metal object.
3. Remove and replace the battery. Replace it as the instructions inside the cover indicate.
4. Snap the transmitter back together tightly to be sure no moisture can enter.
5. Test the operation of the transmitter with your vehicle. If the transmitter does not work, resynchronize the transmitter.

Resynchronization

After replacing the battery in your transmitter, or if only the instant alarm works, the transmitter needs to be resynchronized to the receiver. Do this by pressing and holding both the LOCK and UNLOCK buttons at the same time for about eight seconds. You must be within range of the vehicle.

Once the transmitter has been resynchronized, the horn will chirp and the exterior lamps will flash once. The system should now operate properly.

Trunk

CAUTION:

It can be dangerous to drive with the trunk lid open because carbon monoxide (CO) gas can come into your vehicle. You can't see or smell CO. It can cause unconsciousness and even death.

If you must drive with the trunk lid open or if electrical wiring or other cable connections must pass through the seal between the body and the trunk lid:

- Make sure all other windows are shut.
- Turn the fan on your heating or cooling system to its highest speed with the setting on VENT. That will force outside air into your vehicle. See "Comfort Controls" in the Index.
- If you have air outlets on or under the instrument panel, open them all the way.

See "Engine Exhaust" in the Index.

Trunk Lock Release

To unlock the trunk from the outside, insert the door key and turn it clockwise.

Remote Trunk Release



The TRUNK release button is on the instrument panel to the left of the steering column. The transaxle must be in PARK (P) or NEUTRAL (N).

If the remote trunk release button does not open the trunk, make sure the remote trunk release lockout switch in the glove box is in the on position.

Remote Trunk Release Lockout



The trunk release lockout switch in the glove box must be on for the TRUNK button to work. This feature allows you to secure items in the trunk when you must leave the ignition key with an attendant.

To secure the trunk, turn off the TRUNK RELEASE switch, lock the glove box, then take the door key with you. Now the trunk button to the left of the steering column will not open the trunk.

Trunk Security Override

The remote keyless entry transmitter (if equipped), will open the trunk even if the trunk release lockout switch is OFF.

Theft

Vehicle theft is big business, especially in some cities. Although your vehicle has a number of theft-deterrent features, we know that nothing we put on it can make it impossible to steal. However, there are ways you can help.

Key in the Ignition

If you leave your vehicle with the keys inside, it's an easy target for joy riders or professional thieves -- so don't do it.

With the ignition off and the driver's door open, you'll hear a chime reminding you to remove your key from the ignition and take it with you. Always do this. Your steering wheel will be locked, and so will your ignition and transaxle. And remember to lock the doors.

Parking at Night

Park in a lighted spot, close all windows and lock your vehicle. Remember to keep your valuables out of sight. Put them in a storage area, or take them with you.

Parking Lots

If you park in a lot where someone will be watching your vehicle, it's best to lock it up and take your keys. But what if you have to leave your ignition key?

- If possible, park in a busy, well lit area.
- Put your valuables in a storage area, like your trunk or glove box. Be sure to close and lock the storage area.
- Close all windows.
- Turn off the TRUNK RELEASE lockout in the glove box.
- Lock the glove box.
- Lock all the doors except the driver's.
- Then take the door key and remote keyless entry transmitter with you.

Universal Theft-Deterrent (If Equipped)



If your vehicle has this option, it has a theft-deterrent alarm system. With this system, the SECURITY light will flash as you open the door (if your ignition is off).

This light reminds you to activate the theft-deterrent system when leaving your vehicle.

Activating the system:

1. Open the door.
2. Lock the door with the power door lock switch while the door is open, or with the remote keyless entry transmitter. The SECURITY light should turn on and stay on.
3. Close all doors. The SECURITY light should go off after about 30 seconds. The alarm is not armed until the SECURITY light goes off.

If the SECURITY light comes on for one minute and then shuts off while the ignition is on, the security system has detected a problem with itself. See your dealer for service.

If a door or the trunk is opened without the key or remote keyless entry transmitter, the alarm will go off. It will also go off if the trunk lock is damaged. Your vehicle's lamps will flash and the horn will sound for one minute, and then will go off in order to save battery power.

Remember, the theft-deterrent system won't activate if you lock the doors with a key or manual door lock. It activates only if you use a power door lock switch with a door open, or the remote keyless entry transmitter. You should also remember that you can start your vehicle with the correct ignition key if the alarm has been set off. You must still shut off the alarm by inserting the key in the door lock, or by pressing the UNLOCK button on the remote keyless entry transmitter.

Here's how to avoid setting off the alarm by accident:

- If you don't want to activate the theft-deterrent system, lock the door by using the door key or the manual door lock switch.
- Always unlock a door with a key, or use the remote keyless entry system transmitter. Unlocking a door any other way will set off the alarm.

If you set off the alarm by accident, unlock any door with your key.

You can also turn off the alarm by pressing UNLOCK on the remote keyless entry transmitter, if you have it. The alarm won't stop if you try to unlock a door any other way.

Testing the Alarm

1. From inside the vehicle, roll down the window.
2. Activate the system by locking the doors with the power door lock switch while the door is open, or with the remote keyless entry transmitter.
3. Get out of the car, close the door and wait for the SECURITY light to go out.
4. Then reach in through the window, unlock the door with the manual door lock and open the door. This should set off the alarm.

If the alarm does not sound when it should, but the vehicle's lamps flash, check to see if the horn works. The horn fuse may be blown. To replace the fuse, see "Fuses and Circuit Breakers" in the Index.

If the alarm does not sound or the vehicle's lamps do not flash, the vehicle should be serviced by an authorized service center.

PASS-Key® II



Your vehicle is equipped with the PASS-Key II (Personalized Automotive Security System) theft-deterrent system. PASS-Key II is a passive theft-deterrent system. It works when you insert or remove the key from the ignition.

PASS-Key II uses a resistor pellet in the ignition key that matches a decoder in your vehicle.

When the PASS-Key II system senses that someone is using the wrong key, it shuts down the vehicle's starter and fuel systems. For about three minutes, the starter won't work and fuel won't go to the engine. If someone tries to start your vehicle again or uses another key during this time, the vehicle will not start. This discourages someone from randomly trying different keys with different resistor pellets in an attempt to make a match.

The ignition key must be clean and dry before it's inserted in the ignition or the engine may not start. If the engine does not start and the SECURITY light turns on, the key may be dirty or wet. Turn the ignition off.

Clean and dry the key. Wait about three minutes and try again. If the starter still won't work, and the key appears to be clean and dry, wait about three minutes and try another ignition key. At this time, you may also want to check the fuse (see "Fuses and Circuit Breakers" in the Index). If the starter won't work with the other key, your vehicle needs service. If your vehicle does start, the first ignition key may be faulty. See your dealer or a locksmith who can service the PASS-Key II.

If you accidentally use a key that has a damaged or missing resistor pellet, the starter won't work. The SECURITY light will flash. But you don't have to wait three minutes before trying another ignition key.

See your dealer or a locksmith who can service the PASS-Key II to have a new key made.

If you're ever driving and the SECURITY light comes on and stays on, you will be able to restart your engine if you turn it off. Your PASS-Key II system, however, is not working properly and must be serviced by your dealer. Your vehicle is not protected by the PASS-Key II system.

If you lose or damage a PASS-Key II ignition key, see your dealer or a locksmith who can service PASS-Key II to have a new key made. In an emergency, call the Buick Premium Roadside Assistance Center at 1-800-252-1112. In Canada, call 1-800-268-6800.

New Vehicle “Break-In”

NOTICE:

Your vehicle doesn't need an elaborate “break-in.” But it will perform better in the long run if you follow these guidelines:

- **Don't drive at any one speed -- fast or slow -- for the first 500 miles (805 km). Don't make full-throttle starts.**
- **Avoid making hard stops for the first 200 miles (322 km) or so. During this time your new brake linings aren't yet broken in. Hard stops with new linings can mean premature wear and earlier replacement. Follow this breaking-in guideline every time you get new brake linings.**
- **Don't tow a trailer during break-in. See “Towing a Trailer” in the Index for more information.**

Ignition Positions

CAUTION:

Leaving children in a vehicle with the ignition key is dangerous for many reasons. A child or others could be injured or even killed. They could operate power windows or other controls or even make the vehicle move. Don't leave the keys in the vehicle with children.

With the ignition key in the ignition switch, you can turn the switch to five different positions.

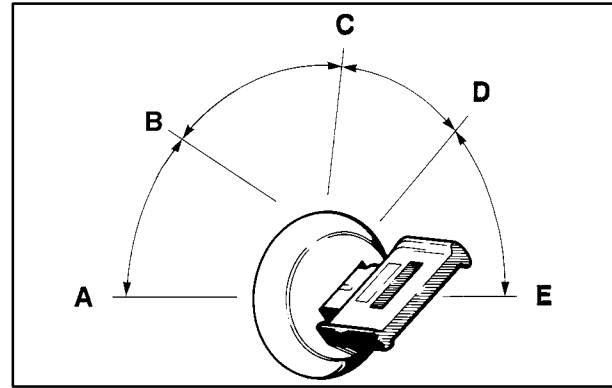

ACCESSORY (A): This position lets you use things like the radio and the windshield wipers when the engine is off. To use, push in the key and turn it toward you. Your steering wheel will remain locked, just as it was before you inserted the key.

LOCK (B): This is the only position in which you can remove the key. This position locks your ignition, steering wheel and transaxle. It's a theft-deterrent feature.

OFF (C): This position lets you turn off the engine but still turn the steering wheel. It doesn't lock the steering wheel like LOCK and it doesn't send any electrical power to the accessories. Use OFF if you must have your vehicle in motion while the engine is not running.

RUN (D): The switch returns to this position after you start your engine and release the key. This is the position for normal driving. Even when the engine is not running, you can use RUN to operate your electrical power accessories and to display some instrument panel warning lights.

START (E): This position starts your engine. When the engine starts, release the key and the switch will move to RUN.

NOTICE:

If your key seems stuck in LOCK and you can't turn it, be sure you are using the correct key; if so, is it all the way in? If it is, then turn the steering wheel left and right while you turn the key hard. But turn the key only with your hand. Using a tool to force it could break the key or the ignition switch. If none of this works, then your vehicle needs service.

Key Reminder Warning

If you leave your key in the ignition, in OFF, you will hear a warning chime when you open the driver's door.

Always leave your key in LOCK. If you leave it in any other position, you will drain your battery power.

Starting Your Engine

Move your shift lever to PARK (P) or NEUTRAL (N). Your engine won't start in any other position -- that's a safety feature. To restart when you're already moving, use NEUTRAL (N) only.

NOTICE:

Don't try to shift to PARK (P) if your vehicle is moving. If you do, you could damage the transaxle. Shift to PARK (P) only when your vehicle is stopped.

Starting Your 3800 Series II V6 Engine

1. Without pushing the accelerator pedal, turn your ignition key to *START*. When the engine starts, let go of the key. The idle speed will go down as your engine gets warm.

NOTICE:

Holding your key in *START* for longer than 15 seconds at a time will cause your battery to be drained much sooner. And the excessive heat can damage your starter motor. Wait about 15 seconds between each try to help avoid draining your battery or damaging your starter.

2. If it doesn't start right away, hold your key in *START* for about three to five seconds at a time until your engine starts. Wait about 15 seconds between each try to help avoid draining your battery or damaging your starter.

3. If your engine still won't start (or starts but then stops), it could be flooded with too much gasoline. Try pushing your accelerator pedal all the way to the floor and holding it there as you hold the key in *START* for about three seconds. If the vehicle starts briefly but then stops again, do the same thing, but this time keep the pedal down for five or six seconds. This clears the extra gasoline from the engine. After waiting about 15 seconds, repeat the normal starting procedure.

NOTICE:

Your engine is designed to work with the electronics in your vehicle. If you add electrical parts or accessories, you could change the way the engine operates. Before adding electrical equipment, check with your dealer. If you don't, your engine might not perform properly.

If you ever have to have your vehicle towed, see the part of this manual that tells how to do it without damaging your vehicle. See "Towing Your Vehicle" in the Index.

Engine Coolant Heater (If Equipped)

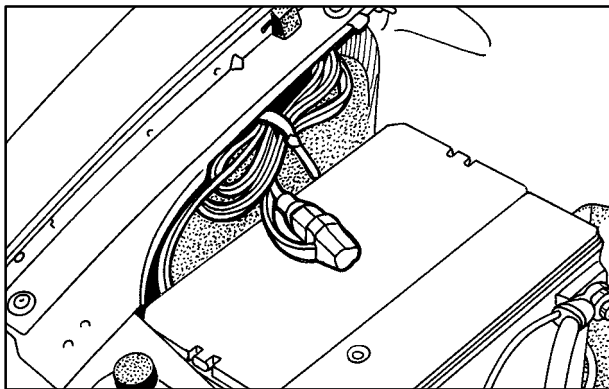

In very cold weather, 0°F (-18°C) or colder, the engine coolant heater can help. You'll get easier starting and better fuel economy during engine warm-up. Usually, the coolant heater should be plugged in a minimum of four hours prior to starting your vehicle.

To Use the Engine Coolant Heater

1. Turn off the engine.
2. Open the hood and unwrap the electrical cord.
3. Plug it into a normal, grounded 110-volt AC outlet.

CAUTION:

Plugging the cord into an ungrounded outlet could cause an electrical shock. Also, the wrong kind of extension cord could overheat and cause a fire. You could be seriously injured. Plug the cord into a properly grounded three-prong 110-volt AC outlet. If the cord won't reach, use a heavy-duty three-prong extension cord rated for at least 15 amps.

4. Before starting the engine, be sure to unplug and store the cord as it was before to keep it away from moving engine parts. If you don't, it could be damaged.

How long should you keep the coolant heater plugged in? The answer depends on the outside temperature, the kind of oil you have, and some other things. Instead of trying to list everything here, we ask that you contact your dealer in the area where you'll be parking your vehicle. The dealer can give you the best advice for that particular area.

Automatic Transaxle Operation

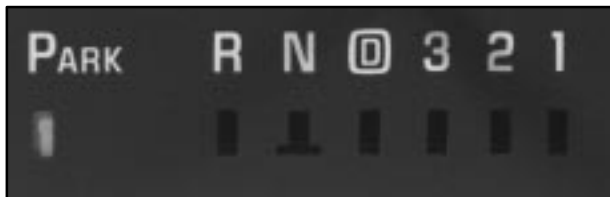

Your automatic transaxle has a shift lever located on the steering column.

PARK (P): This position locks your front wheels. It's the best position to use when you start your engine because your vehicle can't move easily.

CAUTION:

It is dangerous to get out of your vehicle if the shift lever is not fully in PARK (P) with the parking brake firmly set. Your vehicle can roll. Don't leave your vehicle when the engine is running unless you have to. If you have left the engine running, the vehicle can move suddenly. You or others could be injured. To be sure your vehicle won't move, even when you're on fairly level ground, always set your parking brake and move the shift lever to PARK (P).

See "Shifting Into PARK (P)" in the Index. If you're pulling a trailer, see "Towing a Trailer" in the Index.

Ensure the shift lever is fully in PARK (P) before starting the engine. Your vehicle has a Brake-Transaxle Shift Interlock (BTSI). You have to fully *apply* your regular brakes *before* you can shift from PARK (P) when the ignition key is in RUN. If you cannot shift out of PARK (P), ease pressure on the shift lever and push the shift lever all the way into PARK (P) as you maintain brake application. Then move the shift lever into the gear you wish. See “Shifting Out of PARK (P)” in the Index.

REVERSE (R): Use this gear to back up.

NOTICE:

Shifting to REVERSE (R) while your vehicle is moving forward could damage your transaxle. Shift to REVERSE (R) only after your vehicle is stopped.

To rock your vehicle back and forth to get out of snow, ice or sand without damaging your transaxle, see “Stuck: In Sand, Mud, Ice or Snow” in the Index.

NEUTRAL (N): In this position, your engine doesn’t connect with the wheels. To restart when you’re already moving, use NEUTRAL (N) only. Also, use NEUTRAL (N) when your vehicle is being towed.

CAUTION:

Shifting out of PARK (P) or NEUTRAL (N) while your engine is “racing” (running at high speed) is dangerous. Unless your foot is firmly on the brake pedal, your vehicle could move very rapidly. You could lose control and hit people or objects. Don’t shift out of PARK (P) or NEUTRAL (N) while your engine is racing.

NOTICE:

Damage to your transaxle caused by shifting out of PARK (P) or NEUTRAL (N) with the engine racing isn’t covered by your warranty.

AUTOMATIC OVERDRIVE (Ⓢ): This position is for normal driving. If you need more power for passing, and you're:

- Going less than about 35 mph (55 km/h), push your accelerator pedal about halfway down.
- Going about 35 mph (55 km/h) or more, push the accelerator all the way down.

You'll shift down to the next gear and have more power.

THIRD (3): This position is also used for normal driving, however, it offers more power and lower fuel economy than AUTOMATIC OVERDRIVE (Ⓢ).

Here are some times you might choose THIRD (3) instead of AUTOMATIC OVERDRIVE (Ⓢ):

- When driving on hilly, winding roads
- When towing a trailer, so there is less shifting between gears
- When going down a steep hill

SECOND (2): This position gives you more power but lower fuel economy than THIRD (3). You can use SECOND (2) on hills. It can help control your speed as you go down steep mountain roads, but then you would also want to use your brakes off and on.

NOTICE:

Don't drive in SECOND (2) for more than 5 miles (8 km), or at speeds over 55 mph (90 km/h), or you can damage your transaxle. Use AUTOMATIC OVERDRIVE (Ⓢ) or THIRD (3) as much as possible.

Don't shift into SECOND (2) unless you are going slower than 65 mph (105 km/h), or you can damage your engine.

FIRST (1): This position gives you even more power (but lower fuel economy) than SECOND (2). You can use it on very steep hills, or in deep snow or mud. If the selector lever is put in FIRST (1), the transaxle won't shift into first gear until the vehicle is going slowly enough.

NOTICE:

If your front wheels can't rotate, don't try to drive. This might happen if you were stuck in very deep sand or mud or were up against a solid object. You could damage your transaxle.

Also, if you stop when going uphill, don't hold your vehicle there with only the accelerator pedal. This could overheat and damage the transaxle. Use your brakes or shift into PARK (P) to hold your vehicle in position on a hill.

Parking Brake

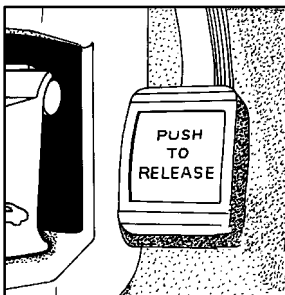

This vehicle has a PUSH TO RELEASE parking brake pedal. To set the parking brake, hold the regular brake pedal down with your right foot. Push down the parking brake pedal with your left foot.

If the ignition is on, the brake system warning light will turn on and a single chime will be heard. The parking brake uses the brakes on the rear wheels.

To release the parking brake, hold the regular brake pedal down and push the parking brake pedal with your left foot. This will release the parking brake pedal. When you lift your left foot, the park brake pedal will follow it to the released position.

If you try to drive approximately 40 feet (12.2 m) with the parking brake on, the brake light stays on and a chime sounds until you release the parking brake.

NOTICE:

Driving with the parking brake on can cause your rear brakes to overheat. You may have to replace them, and you could also damage other parts of your vehicle.

If you are towing a trailer and are parking on any hill, see "Towing a Trailer" in the Index. That section explains what to do first to keep the trailer from moving.

Shifting Into PARK (P)

CAUTION:

It can be dangerous to get out of your vehicle if the shift lever is not fully in PARK (P) with the parking brake firmly set. Your vehicle can roll. If you have left the engine running, the vehicle can move suddenly. You or others could be injured. To be sure your vehicle won't move, even when you're on fairly level ground, use the steps that follow. If you're pulling a trailer, see "Towing a Trailer" in the Index.

1. Hold the brake pedal down with your right foot and set the parking brake.

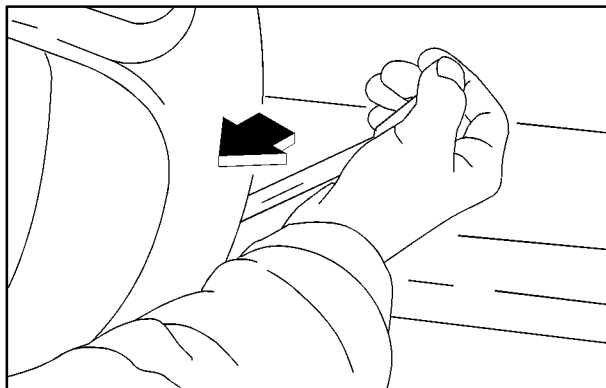

2. Move the shift lever into PARK (P) like this:
 - Pull the lever toward you.

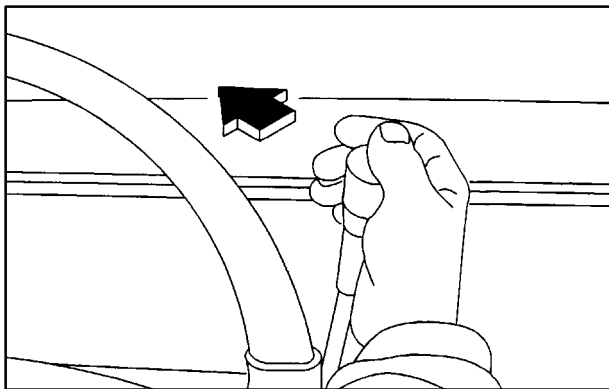

- Move the lever up as far as it will go.
3. Turn the ignition key to LOCK.
 4. Remove the key and take it with you. If you can leave your vehicle with the ignition key in your hand, your vehicle is in PARK (P).

Leaving Your Vehicle With the Engine Running

CAUTION:

It can be dangerous to leave your vehicle with the engine running. Your vehicle could move suddenly if the shift lever is not fully in PARK (P) with the parking brake firmly set. And, if you leave the vehicle with the engine running, it could overheat and even catch fire. You or others could be injured. Don't leave your vehicle with the engine running unless you have to.

If you have to leave your vehicle with the engine running, be sure your vehicle is in PARK (P) and your parking brake is firmly set before you leave it. After you've moved the shift lever into PARK (P), hold the regular brake pedal down. Then, see if you can move the shift lever away from PARK (P) without first pulling it toward you. If you can, it means that the shift lever wasn't fully locked into PARK (P).

Torque Lock

If you are parking on a hill and you don't shift your transaxle into PARK (P) properly, the weight of the vehicle may put too much force on the parking pawl in the transaxle. You may find it difficult to pull the shift lever out of PARK (P). This is called "torque lock." To prevent torque lock, set the parking brake and then shift into PARK (P) properly before you leave the driver's seat. To find out how, see "Shifting Into PARK (P)" in the Index.

When you are ready to drive, move the shift lever out of PARK (P) *before* you release the parking brake.

If torque lock does occur, you may need to have another vehicle push yours a little uphill to take some of the pressure from the parking pawl in the transaxle, so you can pull the shift lever out of PARK (P).

Shifting Out of PARK (P)

CAUTION:

Before shifting out of PARK (P) you must fully apply your regular brakes. Your vehicle can roll.

CAUTION: (Continued)

CAUTION: (Continued)

If you have left the engine running the vehicle can move suddenly. You or others could be injured. If you're pulling a trailer, see "Pulling a Trailer" in the Index.

Your vehicle has a Brake-Transaxle Shift Interlock (BTSI). You have to fully *apply* your regular brake *before* you can shift from PARK (P) when the ignition is in RUN. See "Automatic Transaxle" in the Index.

If you cannot shift out of PARK (P), ease pressure on the shift lever -- push the shift lever all the way into PARK (P) as you maintain brake application. Then move the shift lever into the gear you want. If you ever hold the brake pedal down but still can't shift out of PARK (P), try this:

1. Turn the key to the OFF ignition position.
2. Apply and hold the brake until the end of Step 4.
3. Shift to NEUTRAL (N).
4. Start the vehicle and then shift to the drive gear you want.
5. Take your vehicle to an authorized service center as soon as you can.

Parking Over Things That Burn

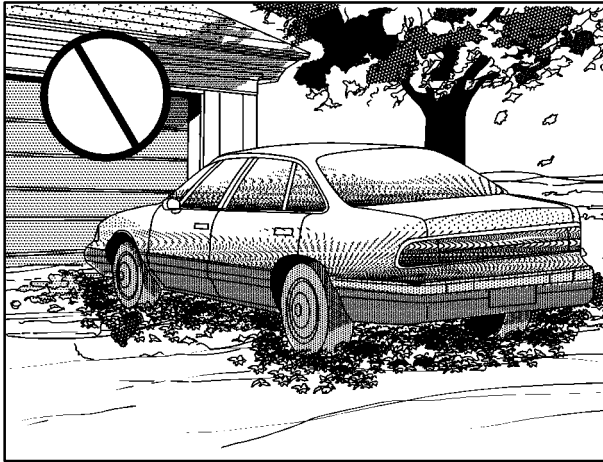

CAUTION:

Things that can burn could touch hot exhaust parts under your vehicle and ignite. Don't park over papers, leaves, dry grass or other things that can burn.

Engine Exhaust

CAUTION:

Engine exhaust can kill. It contains the gas carbon monoxide (CO), which you can't see or smell. It can cause unconsciousness and death.

You might have exhaust coming in if:

- Your exhaust system sounds strange or different.
- Your vehicle gets rusty underneath.
- Your vehicle was damaged in a collision.
- Your vehicle was damaged when driving over high points on the road or over road debris.
- Repairs weren't done correctly.
- Your vehicle or exhaust system had been modified improperly.

If you ever suspect exhaust is coming into your vehicle:

- Drive it only with all the windows down to blow out any CO; and
- Have your vehicle fixed immediately.

Running Your Engine While You're Parked

It's better not to park with the engine running. But if you ever have to, here are some things to know.

CAUTION:

Idling the engine with the climate control system off could allow dangerous exhaust into your vehicle (see the earlier Caution under "Engine Exhaust").

Also, idling in a closed-in place can let deadly carbon monoxide (CO) into your vehicle even if the fan switch is at the highest setting. One place this can happen is a garage. Exhaust -- with CO -- can come in easily. NEVER park in a garage with the engine running.

Another closed-in place can be a blizzard. (See "Blizzard" in the Index.)

CAUTION:

It can be dangerous to get out of your vehicle if the shift lever is not fully in PARK (P) with the parking brake firmly set. Your vehicle can roll. Don't leave your vehicle when the engine is running unless you have to. If you've left the engine running, the vehicle can move suddenly. You or others could be injured. To be sure your vehicle won't move, even when you're on fairly level ground, always set your parking brake and move the shift lever to PARK (P).

Follow the proper steps to be sure your vehicle won't move. See "Shifting Into PARK (P)" in the Index.

If you are parking on a hill and if you're pulling a trailer, also see "Towing a Trailer" in the Index.

Windows

Power Windows



Switches on the driver's armrest control each of the windows while the ignition is on. In addition, each passenger door has a switch for its own window.

Express-Down Window

The switch for the driver's window has an express-down feature. Pull the switch back all the way, release it and the window will lower automatically. To stop the window from lowering, pull the switch again. To partially open the window, pull the switch back and quickly release it. To raise the window, hold the switch forward.

Window Lock

Press the LOCK switch on the driver's armrest to disable all passenger window switches. The driver's window controls will still be operable. This is a useful feature when you have children as passengers.

Press the UNLOCK switch to allow passengers to use their window switches again.

Horn

Nearly the entire surface of the center pad of the steering wheel is an active horn switch. Press anywhere on the pad to sound the horn.

Tilt Wheel



A tilt steering wheel allows you to adjust the steering wheel before you drive.

You can also raise it to the highest level to give your legs more room when you exit and enter the vehicle.

To tilt the wheel, hold the steering wheel and pull the lever toward you. Move the steering wheel to a comfortable level, then release the lever to lock the wheel in place.

Turn Signal/Multifunction Lever



The lever on the left side of the steering column includes your:

- Turn Signal and Lane Change Indicator
- Headlamp High/Low Beam Changer and Passing Signal
- Windshield Wipers and Washer
- Cruise Control

Turn and Lane Change Indicator

The turn signal has two upward (for right) and two downward (for left) positions. These positions allow you to signal a turn or a lane change.

To signal a turn, move the lever all the way up or down. When the turn is finished, the lever will return automatically.

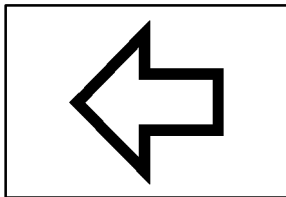

An arrow on the instrument panel will flash in the direction of the turn or lane change.

To signal a lane change, just raise or lower the lever until the arrow starts to flash. Hold it there until you complete your lane change. The lever will return by itself when you release it.

If the arrows just stay on and don't flash as you signal a turn or a lane change, a signal bulb may be burned out and other drivers won't see your turn signal.

If a bulb is burned out, replace it to help avoid an accident. If the arrows don't go on at all when you signal a turn, check the fuse (see "Fuses and Circuit Breakers" in the Index) and for burned-out bulbs.

Turn Signal On Chime

If your turn signal is left on for more than 3/4 of a mile (1.2 km), a chime will sound at each flash of the turn signal. To turn off the chime, move the turn signal lever to the off position.

Headlamp High/Low Beam Changer

To change the headlamps from low beam to high beam or high beam to low beam, pull the turn signal lever toward you and release it.

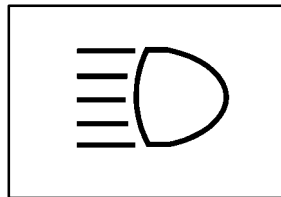

When the high beams are on, this light on the instrument panel will also be on.

Windshield Wipers



The windshield wipers are controlled by turning the band marked WIPER.

For a single wiping cycle, turn the band to MIST. Hold it there until the wipers start, then let go. The wipers will stop after one cycle. If you want more cycles, hold the band on MIST longer.

For steady wiping at low speed, turn the band away from you to the LO position. For high-speed wiping, turn the band further, to HI. To stop the wipers, turn the band to OFF.

The wiper speed may be set for a long or short delay between wipes. This can be very useful in light rain or snow. Turn the band to choose the delay time. The closer to LO, the shorter the delay.

Heavy snow or ice can overload your wiper motor. A circuit breaker will stop the motor until it cools. Clear away snow or ice to prevent an overload.

Keep in mind that damaged wiper blades may prevent you from seeing well enough to drive safely. To avoid damage, be sure to clear ice and snow from the wiper blades before using them. If your blades do become damaged, get new blades or blade inserts.

Windshield Washer

At the top of the turn signal/multifunction lever, there's a paddle with the word PUSH on it. To spray washer fluid on the windshield, push the paddle briefly. The wipers will clear the window and either stop or return to your preset speed. For more washer cycles, push and hold the paddle.

⚠ CAUTION:

In freezing weather, don't use your washer until the windshield is warmed. Otherwise the washer fluid can form ice on the windshield, blocking your vision.

Cruise Control



With cruise control, you can maintain a speed of about 25 mph (40 km/h) or more without keeping your foot on the accelerator. This is helpful on long trips.

Cruise control does not work at speeds below about 25 mph (40 km/h).

When you apply your brakes, the cruise control shuts off.

⚠ CAUTION:

- **Cruise control can be dangerous where you can't drive safely at a steady speed. So, don't use your cruise control on winding roads or in heavy traffic.**
- **Cruise control can be dangerous on slippery roads. On such roads, fast changes in tire traction can cause needless wheel spinning, and you could lose control. Don't use cruise control on slippery roads.**

If your vehicle is in cruise control when the optional traction control system begins to limit wheel spin, the cruise control will automatically disengage. (See "Traction Control System" in the Index.) When road conditions allow you to safely use it again, you may turn the cruise control back on.

Setting Cruise Control

CAUTION:

If you leave your cruise control switch on when you're not using cruise, you might hit a button and go into cruise when you don't want to. You could be startled and even lose control. Keep the cruise control switch off until you want to use it.

1. Move the cruise control switch to ON.
2. Get up to the speed you want.
3. Push in the SET button at the end of the lever and release it.
4. Take your foot off the accelerator pedal.

Resuming a Set Speed

Suppose you set your cruise control at a desired speed and then you apply the brake. This, of course, shuts off the cruise control. But you don't need to reset it.

Once you're going about 25 mph (40 km/h) or more, you can briefly move the cruise control switch from ON to R/A (resume/accelerate).

You'll go right back up to your chosen speed and stay there. If you hold the switch at R/A, the vehicle will keep going faster until you release the switch or apply the brake. So unless you want to go faster, don't hold the switch at R/A.

Increasing Speed While Using Cruise Control

There are two ways to go to a higher speed:

- Use the accelerator pedal to get to the higher speed. Push the SET button at the end of the lever, then release the button and the accelerator pedal. You'll now cruise at the higher speed.
- Move the cruise switch from ON to R/A. Hold it there until you get up to the speed you want, and then release the switch. To increase your speed in very small amounts, briefly move the switch to R/A and then release it. Each time you do this, your vehicle will go about 1 mph (1.6 km/h) faster.

The accelerate feature will only work after you have set the cruise control speed by pushing the SET button.

Reducing Speed While Using Cruise Control

There are two ways to reduce your speed while using cruise control:

- Push in the SET button at the end of the lever until you reach the lower speed you want, then release it.
- To slow down in very small amounts, push the SET button briefly. Each time you do this, you'll go 1 mph (1.6 km/h) slower.

Passing Another Vehicle While Using Cruise Control

Use the accelerator pedal to increase your speed. When you take your foot off the pedal, your vehicle will slow down to the cruise control speed you set earlier.

Using Cruise Control on Hills

How well your cruise control will work on hills depends upon your speed, load and the steepness of the hills. When going up steep hills, you may have to step on the accelerator pedal to maintain your speed. When going downhill, you may have to brake or shift to a lower gear to keep your speed down. Applying the brake or shifting into a lower gear will take you out of cruise control. If you need to apply the brake or shift to a lower gear due to the grade of the downhill slope, you may not want to attempt to use your cruise control feature.

Ending Cruise Control

There are two ways to turn off the cruise control:

- Step lightly on the brake pedal; or
- Move the cruise switch to OFF.

Erasing Speed Memory

When you turn off the cruise control or the ignition, your cruise control set speed memory is erased.

Exterior Lamps

Headlamps



These switches control these systems:

- Headlamps
- Taillamps
- Parking Lamps
- License Lamps
- Sidemarker Lamps
- Instrument Panel Lights

Press the LIGHTS switch to turn on the headlamps. Press it again to turn them off. When the headlamps are turned on, the instrument panel lights will also turn on. The brightness of the instrument panel lights can be adjusted with the PANEL LIGHTS switch to the left of the steering column. Some lights will not dim during daylight hours.

Press the PARK switch to turn on the parking lamps. Press it again to turn them off. (If the parking lamps were turned on with the PARK switch, they must be turned off with that switch).

Lamps On Reminder

If you leave the manual headlamp or parking lamp switch on, remove the key from the ignition and open the driver's door, you will hear a continuous warning chime. The chime will turn off when the lamps are turned off.

Daytime Running Lamps

Daytime Running Lamps (DRL) can make it easier for others to see the front of your vehicle during the day. DRL can be helpful in many different driving conditions, but they can be especially helpful in the short periods after dawn and before sunset.

A light sensor on top of the instrument panel monitors the exterior light level for the operation of DRL and twilight sentinel, so be sure it isn't covered.

The DRL system will make your high-beam headlamps turn on at reduced brightness in daylight when:

- The ignition is on,
- The headlamp switch is off and
- The transaxle is not in PARK (P).

When the DRL are on, only your high-beam headlamps will be on. The parking lamps, taillamps, sidemarker and other lamps won't be on. Your instrument panel lights won't be on either.

When it is dark enough outside, your low-beam headlamps will come on. The other lamps that turn on with your headlamps will also turn on. When it is bright enough outside, the regular lamps will go off, and your high-beam headlamps change to the reduced brightness of DRL.

To turn off all exterior lighting at night when you are parked, turn off the headlamps and move the twilight sentinel control all the way toward MIN. The exterior lamps will turn back on automatically when you move the transaxle out of PARK (P).

As with any vehicle, you should turn on the regular headlamp system when you need it.

Cornering Lamps (If Equipped)

The cornering lamps are designed to turn on when you signal a turn. This will provide more lighting when cornering at night.

Twilight Sentinel



Twilight sentinel turns your lamps on and off by sensing how dark it is outside.

To operate it, leave the lamp switch off.

If you move the control all the way to MAX, your headlamps will remain on for three minutes after you turn off your engine. As you move the control toward MIN, the headlamps will turn off more quickly when you turn off your engine. You can change this delay time from only a few seconds to three minutes.

The exterior lamps can be completely shut off while the vehicle is in PARK (P) by sliding the twilight sentinel control all the way toward MIN, and release. To turn the exterior lamps back on, slide the control all the way toward MIN again, and release; or, shift out of PARK (P).

Light Sensor



Your twilight sentinel and DRL work with the light sensor on top of the instrument panel. Don't cover it up. If you do, the sensor will read "dark" and the headlamps will turn on.

Interior Lamps

Instrument Panel Intensity/Brightness Control



The instrument panel intensity can be adjusted by moving this lever between LO and HI. The instrument panel lights will be on only when the headlamps are on. The interior courtesy lamps can be turned on by sliding the lever all the way to the right, to INT.

Courtesy Lamps

When any door is opened, several lamps go on. They make it easy for you to enter and leave the vehicle. You can also turn these lamps on by sliding the PANEL LIGHTS switch to INT (Interior).

Illuminated Entry (If Equipped)

Press the UNLOCK button on the remote keyless entry transmitter (if equipped) and the interior courtesy lamps will turn on and stay on for up to one minute. The lamps will turn off immediately by pressing the LOCK button on the remote keyless entry transmitter, starting the engine or activating the power door locks.

Delayed Entry Lighting

When you open the door, the interior lamps will turn on. When you close the door with the ignition off, the interior lamps will stay on for 25 seconds or until the ignition is turned to an on position. Note that locking the doors will override the delayed entry lighting feature and the lamps will turn off right away.

Theater Dimming

This feature allows for a three to five-second fade out of the courtesy lamps instead of immediate turn off.

Delayed Exit Lighting

With this feature, the interior lamps will turn on and stay on for up to 25 seconds after you remove the key from the ignition. This will give you time to find the door pull handle or lock switches.

Perimeter Lighting (If Equipped)

When the UNLOCK button on the remote keyless entry transmitter is pressed, the headlamps, parking lamps, back-up lamps and cornering lamps will turn on if it is dark enough outside according to the twilight sentinel.

If your vehicle is not equipped with twilight sentinel and perimeter lighting is active, the lights will turn on whenever the UNLOCK button on the transmitter is pressed.

Personal Choice Programming

This feature can be programmed in the on or off mode for each transmitter.

To turn the feature off:

1. Turn the ignition key to OFF.
2. Press and hold LOCK on the power door lock switch throughout this procedure. All the doors will lock.
3. Press the instant alarm on the remote keyless entry transmitter. Perimeter lighting remains on at this time and the horn will chirp two times.

4. Press the instant alarm on the remote keyless entry transmitter again. Perimeter lighting is disabled and the horn will chirp one time.
5. Release the door lock switch. The perimeter lighting feature is now off.

To turn the feature on:

1. Turn the ignition key to OFF.
2. Press and hold LOCK on the power door lock switch throughout this procedure. All the doors will lock.
3. Press the instant alarm on the transmitter again. Perimeter lighting is now enabled and the horn will chirp one time.
4. Press the instant alarm on the transmitter again. Perimeter lighting is now enabled and the horn will chirp two times.
5. Release the door lock switch. The perimeter lighting feature is now on.

This procedure only changes the mode for the transmitter used to change this setting. The procedure will need to be repeated for the second transmitter.

Front Reading Lamps (If Equipped)



Front seat reading lamps are turned on or off by pressing the LAMP switch.

Rear Reading Lamps (If Equipped)



The lamp, switch and a coat hanger are above each rear door. Slide the switch to turn the lamp on or off.

Battery Rundown Protection

This feature automatically turns off the interior lamps if any are left on for more than 10 minutes when the ignition is off or a door is left open. This will keep your battery from running down.

This feature also shuts off the exterior lamps if they are left on for more than 10 minutes when the ignition is OFF. You may override this feature for the exterior lamps by turning the lamps off and then back on after the ignition is turned to OFF. If you do this, the exterior lamps will stay on until you manually turn them off.

If the feature is enabled for the interior and exterior lamps, all lamps should turn off at approximately the same time.

Mirrors

Day/Night Manual Rearview Mirror With Integral Reading Lamps



When you are sitting in a comfortable driving position, adjust the mirror so you can see clearly behind your vehicle. The day-night adjustment allows you to adjust the mirror to avoid glare from the headlamps behind you.

The integral reading lamps are turned on or off by pressing the toggle switch at the bottom of the mirror. These lamps are also part of the courtesy lamps described earlier in this section.

Electrochromic Day/Night Rearview Mirror (If Equipped)

Your vehicle may have an automatic electrochromic day/night rearview mirror.

When this feature is turned on, the mirror automatically changes to reduce glare from headlamps behind you. A photocell on the mirror senses when it is becoming dark outside. Another photocell built into the mirror face senses when headlamps are behind you.

At night, when the glare is too high, the mirror will gradually darken to reduce glare (this change may take a few seconds). The mirror will return to its clear daytime state when the glare is reduced.



Mirror Operation

To turn on the automatic dimming feature, press AUTO. To turn off automatic dimming, press OFF. The green indicator light will be illuminated when this feature is active.

Time Delay

The automatic mirror has a time delay feature which prevents unnecessary switching from the night back to the day position. This delay prevents rapid changing of the mirror as you drive under lights and through traffic.

Cleaning the Photocells

Use a cotton swab and glass cleaner to clean the photocells when necessary.

Electrochromic Day/Night Rearview Mirror with Compass (If Equipped)

Your vehicle may have an electrochromic inside rearview mirror with a compass.



When set in the MIRROR position, this mirror automatically changes to reduce glare from headlamps behind you. A time delay feature prevents rapid changing from the day to night positions while driving under lights and through traffic.

The mirror also includes an eight-point compass display in the upper right corner of the mirror face. When on, the compass automatically calibrates as the vehicle is driven.

When cleaning the mirror, use a paper towel or similar material dampened with glass cleaner. Do not spray glass cleaner directly on the mirror as that may cause the liquid cleaner to enter the mirror housing. Use a cotton swab and glass cleaner to clean the photocells when necessary.

Mirror Operation



The right side of the switch located at the bottom of the mirror turns the electrochromic mirror on and off. To turn on the automatic dimming feature, press MIRROR. To turn off automatic dimming, press MIRROR again. The green indicator light will be illuminated when this feature is active.

Compass Operation

Press the COMPASS button once to turn the compass on or off.

When the ignition and the compass feature are on, the compass will show two character boxes for approximately two seconds. After two seconds, the mirror will display the compass heading.

If, after two seconds, the display does not show a compass heading (“N” for North, for example), there may be a strong magnetic field interfering with the compass. Such interference may be caused by a magnetic antenna mount, magnetic note pad holder or a similar magnetic item.

Compass Calibration

If the letter “C” should ever appear in the compass window, the mirror may need calibration.

The mirror can be calibrated in one of two ways:

- Drive the vehicle in circles at five mph (8 km/h) or less until the display reads a direction, or
- Drive the vehicle on your everyday routine.

Compass Variance

The mirror is set in zone eight upon leaving the factory. It will be necessary to adjust the compass to compensate for compass variance if you live outside zone eight. Under certain circumstances, as during a long distance cross-country trip, it will be necessary to adjust for compass variance. Compass variance is the difference between earth’s magnetic north and true geographic north. If not adjusted to account for compass variance, your compass could give false readings.

To adjust for compass variance:

1. Press and hold the COMPASS button located at the bottom of the mirror until a zone number appears in the display.
2. Find your current location and variance zone number on the following zone map.

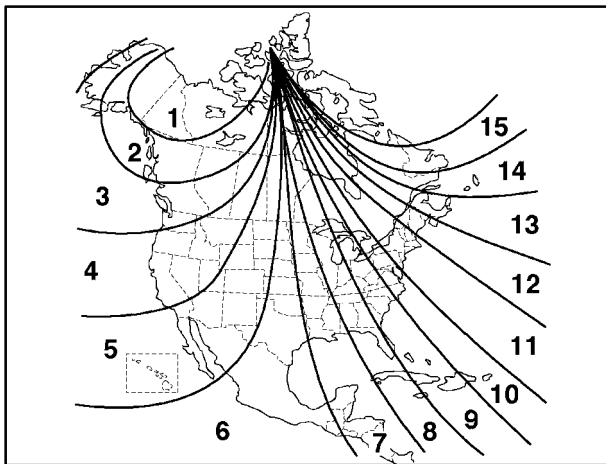

3. Press the COMPASS button on the bottom of the mirror until the new zone number appears in the display. After you stop pressing the button, the display will show a compass direction within a few seconds. (This is the automatic calibration mode. Drive in a circle to calibrate the mirror. See “Compass Calibration” explained previously.)

Manual Remote Control Mirror



To adjust the driver's side outside mirror, rotate the knob located on the driver's door. The right outside mirror must be adjusted manually.

The outside rearview mirror should be adjusted so you can just see the side of your vehicle when you are sitting in a comfortable driving position.

To adjust your passenger's side mirror, sit in the driver's seat and have a passenger adjust the mirror for you.

Power Remote Control Mirrors (If Equipped)



If your vehicle has the outside power remote mirrors, the control is located on the driver's door.

Move the switch in the middle of the control to choose the right or left mirror. Push the arrow controls in the direction you want to move the mirror.

Adjust each mirror so you can see the side of your vehicle and the area behind your vehicle.

Convex Outside Mirror

Your passenger's side mirror is convex. A convex mirror's surface is curved so you can see more from the driver's seat.

CAUTION:

A convex mirror can make things (like other vehicles) look farther away than they really are. If you cut too sharply into the right lane, you could hit a vehicle on your right. Check your inside mirror or glance over your shoulder before changing lanes.

Automatic Dimming/Heated Outside Rearview Mirror (If Equipped)

If you have this feature, the outside mirrors will adjust for the glare of headlamps behind you. This feature is controlled by the on and off settings on the automatic electrochromic day/night rearview mirror. See "Electrochromic Day/Night Rearview Mirror" earlier in this section.

When you operate the rear window defogger, a defogger also warms the heated driver's and passenger's outside rearview mirrors to help clear them of ice and snow.

Storage Compartments

Glove Box

Use the door key to lock and unlock the glove box. To open, lift the latch release on the left side of the glove box door.

Center Console Cupholder/Coinholder



The armrest between the front seats opens into a storage area. To open it, press the lever at the front edge of the armrest upward.

Inside, a cupholder flips forward and unfolds to hold two cups. The cupholder is designed to break away should it receive excessive pressure. If it breaks away, snap the edges back into place.

There is also a removable coinholder, cassette tape and compact disc storage area.

Convenience Net (If Equipped)

Your vehicle may have a convenience net. You'll see it just inside the back wall of the trunk.

Put small loads, like grocery bags, behind the net. It can help keep them from falling over during sharp turns or quick starts and stops. For heavier loads, store them in the trunk as far forward as you can.

You can unhook the net so that it will lie flat when you're not using it.

Ashtrays and Cigarette Lighter

The front center and rear ashtrays may be removed for cleaning. Hold the sides of the ashtray and then pull the ashtray up and out.

NOTICE:

Don't put papers or other flammable objects into your ashtrays. Hot cigarettes or other smoking materials could ignite them, causing a damaging fire.

To use a lighter, push the center all the way in and let it go. When it is ready, the center will pop back by itself. Pull out the entire unit to use it.

NOTICE:

Don't hold a cigarette lighter in with your hand while it is heating. If you do, it won't be able to back away from the heating element when it's ready. That can make it overheat, damaging the lighter and the heating element.

Sun Visors

Illuminated Visor Vanity Mirrors (If Equipped)

When you open the cover to either the passenger's or driver's visor vanity mirror, the lamps will turn on. The brightness of the lamp can be adjusted by sliding the switch up or down.

Dual Sun Visors

Each sun visor has two parts, so that both the windshield and door glass can be shaded at the same time. To use the dual sun visors, flip the first visor down and turn toward the window. Then, flip the second visor down toward the windshield.

OnStar[®] System (Option)

Your vehicle may be equipped with the OnStar Communications service. The following services are available 24 hours a day from an OnStar representative:

- Roadside Service with Location
- Emergency Services Button
- Remote Door Unlock
- Theft Detection/Notification and Stolen Vehicle Tracking
- Automatic Notification of Air Bag Deployment
- Concierge/Customer Conveniences Services

NOTE: Installation of aftermarket equipment is possible, however, the features described above will not be compatible with any portable phone other than the OnStar cellular phone available from your dealer.

For more information, contact your dealer.

The Instrument Panel - Your Information System

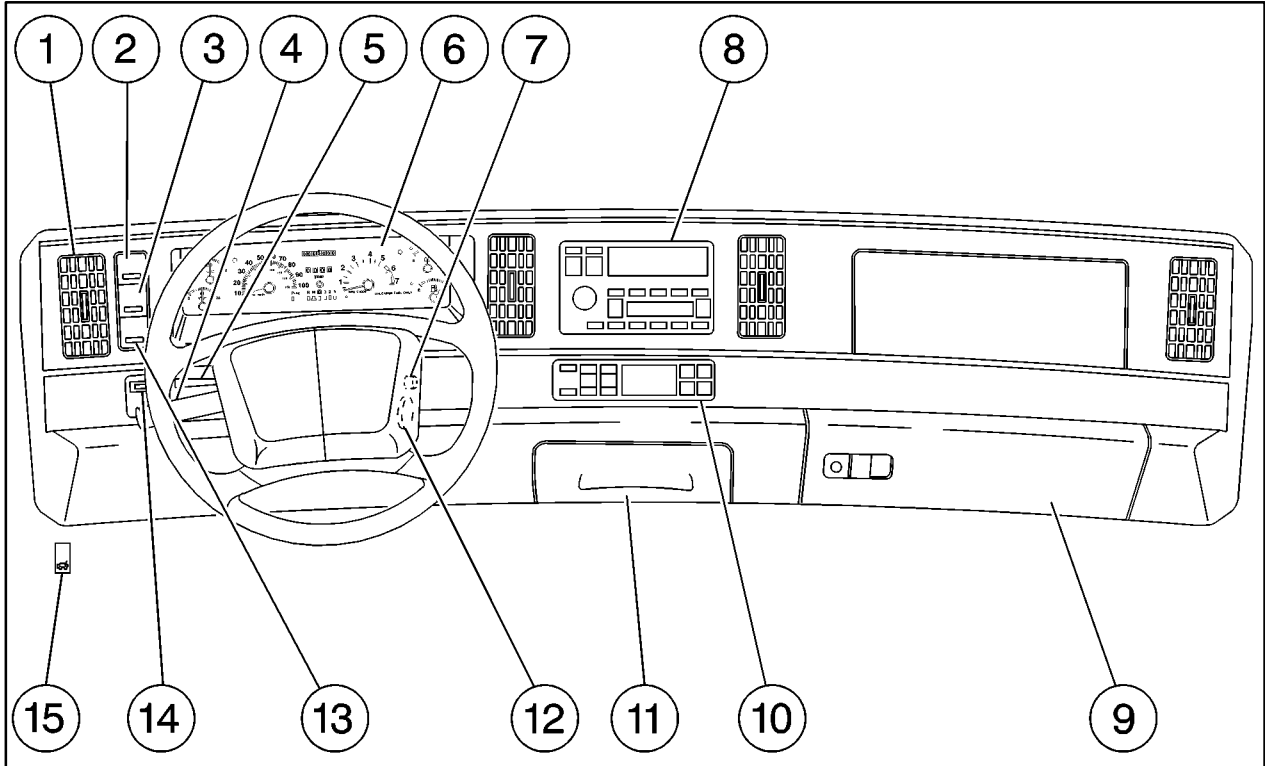

1. Air Outlet
2. Instrument Panel Intensity Control
3. Twilight Sentinel
4. Turn Signal/Multifunction Lever
5. Tilt Steering Wheel Lever
6. Instrument Cluster/Gages
7. Hazard Warning Flasher Switch
8. Audio System
9. Glove Box
10. Climate Control System
11. Ashtray and Cigarette Lighter
12. Ignition Switch
13. Traction Control Button
14. Trunk Release Button
15. Hood Release

Instrument Panel Clusters

Your instrument panel cluster is designed to let you know at a glance how your vehicle is running. You'll know how fast you're going, how much fuel you're using, and many other things you'll need to drive safely and economically.

Your vehicle is equipped with one of these instrument panel clusters, which includes indicator warning lights and gauges that are explained on the following pages.

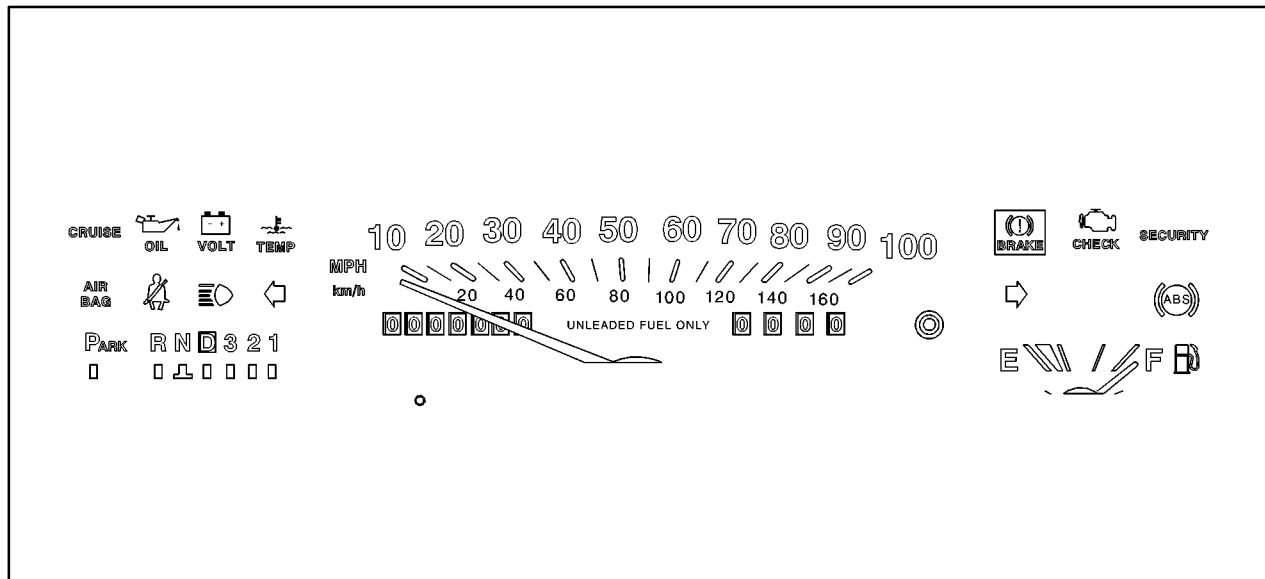

Standard Cluster

Speedometer and Odometer

Your speedometer lets you see your speed in both miles per hour (mph) and kilometers per hour (km/h). Your odometer shows how far your vehicle has been driven, in either miles (used in the United States) or kilometers (used in Canada).

Your vehicle has a tamper resistant odometer. If you see bright silver lines between the numbers, you'll know that someone has probably tried to turn it back. The numbers may not be true.

You may wonder what happens if your vehicle needs a new odometer installed. If the new one can be set to the mileage total of the old odometer, then it must be. But if it can't, then it's set at zero and a label must be put on the driver's door to show the old mileage reading when the new odometer was installed.

Trip Odometer

A trip odometer can tell you how far you have driven since you last set it to zero. To reset it, push the button.

Tachometer (If Equipped)

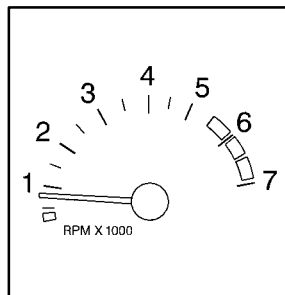

The tachometer tells you how fast the engine is going. It displays engine speed in thousands of revolutions per minute (rpm).

NOTICE:

Do not operate the engine with the tachometer in the red area or engine damage may occur.

Warning Lights, Gages and Indicators

This part describes the warning lights and gages that may be on your vehicle. The pictures will help you locate them.

Warning lights and gages can signal that something is wrong before it becomes serious enough to cause an expensive repair or replacement. Paying attention to your warning lights and gages could also save you or others from injury.

Warning lights come on when there may be or is a problem with one of your vehicle's functions. As you will see in the details on the next few pages, some warning lights come on briefly when you start the engine just to let you know they're working. If you are familiar with this section, you should not be alarmed when this happens.

Gages can indicate when there may be or is a problem with one of your vehicle's functions. Often gages and warning lights work together to let you know when there's a problem with your vehicle.

When one of the warning lights comes on and stays on when you are driving, or when one of the gages shows there may be a problem, check the section that tells you what to do about it. Please follow this manual's advice. Waiting to do repairs can be costly -- and even dangerous. So please get to know your warning lights and gages. They're a big help.

Safety Belt Reminder Light

When the key is turned to RUN or START, a chime will come on for about eight seconds to remind people to fasten their safety belts.



The safety belt light will also come on and stay on for about 70 seconds. If the driver's belt is already buckled, neither the chime nor the light will come on.

Air Bag Readiness Light

There is an air bag readiness light on the instrument panel, which shows AIR BAG. The system checks the air bag's electrical system for malfunctions. The light tells you if there is an electrical problem. The system check includes the air bag sensors, the air bag modules, the wiring and the crash sensing and diagnostic module. For more information on the air bag system, see "Air Bag" in the Index.



AIR
BAG

This light will come on when you start your engine, and it will flash for a few seconds. Then the light should go out. This means the system is ready.

If the air bag readiness light stays on after you start the engine or comes on when you are driving, your air bag system may not work properly. Have your vehicle serviced right away.

The air bag readiness light should flash for a few seconds when you turn the ignition key to RUN. If the light doesn't come on then, have it fixed so it will be ready to warn you if there is a problem.

Battery System Warning Light

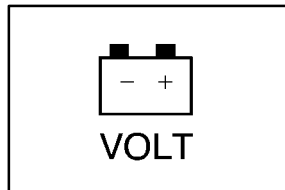

Standard Cluster

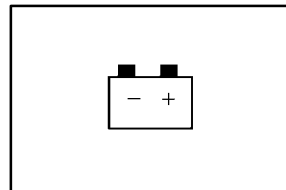

Gage Cluster

When you turn the key to RUN, one of these lights will turn on briefly to show that your generator and battery charging systems are working.

If the light stays on, you need service and you should take your vehicle to the dealer at once. To save your battery until you get there, turn off all accessories and set your climate control system to OFF.

Voltage Gage (If Equipped)

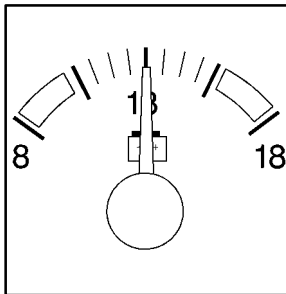

If your vehicle is equipped with the gage cluster, this gage shows voltage in the electrical system.

The normal range is 11 to 15 volts. If the gage reading stays in either red range, or the battery warning light turns on, have your dealer check the electrical system.

Brake System Warning Light

Your vehicle's hydraulic brake system is divided into two parts. If one part isn't working, the other part can still work and stop you. For good braking, though, you need both parts working well.

If the warning light comes on, there is a brake problem. Have your brake system inspected right away.

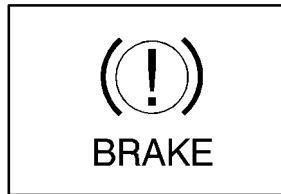

Standard Cluster

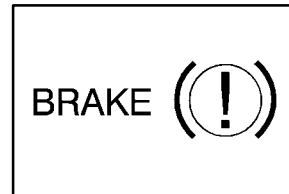

Gage Cluster

One of these lights should come on when you turn the key to START. If it doesn't come on then, have it fixed so it will be ready to warn you if there's a problem.

If the light and chime come on while you are driving, pull off the road and stop carefully. You may notice that the pedal is harder to push. Or, the pedal may go closer to the floor. It may take longer to stop. If the light is still on, have the vehicle towed for service. (See "Towing Your Vehicle" in the Index.)

⚠ CAUTION:

Your brake system may not be working properly if the brake system warning light is on. Driving with the brake system warning light on can lead to an accident. If the light is still on after you've pulled off the road and stopped carefully, have the vehicle towed for service.

When the ignition is on, the brake system warning light will also come on when you set your parking brake. The light will stay on if your parking brake doesn't release fully. If you try to drive off with the parking brake set, a chime will also come on until you release the parking brake. If the light and chime stay on after your parking brake is fully released, it means you have a brake problem.

Anti-Lock Brake System Warning Light

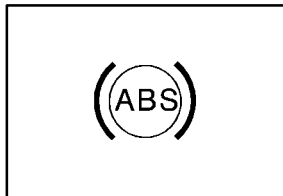

With the anti-lock brake system, the light(s) will come on when you start your engine and may stay on for several seconds. That's normal.

If the light stays on, turn the ignition to OFF. Or, if the light comes on when you're driving, stop as soon as possible and turn the ignition off. Then start the engine again to reset the system. If the light still stays on, or comes on again while you're driving, your vehicle needs service. If the regular brake system warning light isn't on, you still have brakes, but you don't have anti-lock brakes. If the regular brake system warning light is also on, you don't have anti-lock brakes and there's a problem with your regular brakes. See "Brake System Warning Light" earlier in this section.

The anti-lock brake system warning light should come on briefly when you turn the ignition key to RUN. If the light doesn't come on then, have it fixed so it will be ready to warn you if there is a problem.

Traction Control System Warning Light (Option)



**TRACTION
OFF**

This warning light should come on briefly as you start the engine. If the warning light doesn't come on then, have it fixed so it will be ready to warn you if there's a problem.

If it stays on, or comes on when you're driving, there may be a problem with your traction control system and your vehicle may need service. When this warning light is on, the system will not limit wheel spin. Adjust your driving accordingly.

The traction control system warning light may come on for the following reasons:

- If you turn the system off by pressing the button located to the left of the steering column, the warning light will come on and stay on. To turn the system back on, press the button again. The warning light should go off. (See "Traction Control System" in the Index for more information.)
- If there's a brake system problem that is specifically related to traction control, the traction control system will turn off and the warning light will come on. If your brakes begin to overheat, the traction control system will turn off and the warning light will come on until your brakes cool down.
- If the traction control system is affected by an engine-related problem, the system will turn off and the warning light will come on.

If the traction control system warning light comes on and stays on for an extended period of time when the system is turned on, your vehicle needs service.

Engine Coolant Temperature Warning Light

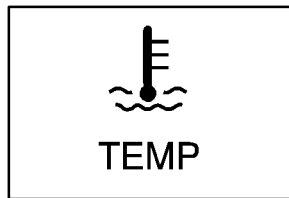

This light will tell you that your engine coolant has overheated or your radiator cooling fans are not working.

If you have been operating your vehicle under normal driving conditions, you should pull off the road, stop your vehicle and turn the engine off as soon as possible.

See “Engine Overheating” in the Index.

Engine Coolant Temperature Gage (If Equipped)

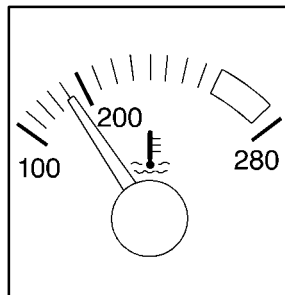

If your vehicle is equipped with the gage cluster, you have a gage that shows the engine coolant temperature. If the gage pointer moves into the red area, your engine is too hot!

That reading means the same thing as the warning light. It means that your engine coolant has overheated. If you have been operating your vehicle under normal driving conditions, you should pull off the road, stop your vehicle and turn off the engine as soon as possible.

The engine coolant temperature gage indicates the coolant temperature in degrees Fahrenheit. The Canadian instrument panels indicate the coolant temperature in degrees Celsius.

See “Engine Overheating” in the Index.

Malfunction Indicator Lamp (Check Engine Light)

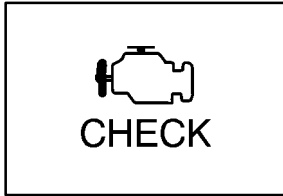

Your vehicle is equipped with a computer which monitors operation of the fuel, ignition and emission control systems.

This system is called OBD II (On-Board Diagnostics-Second Generation) and is intended to assure that emissions are at acceptable levels for the life of the vehicle, helping to produce a cleaner environment. The CHECK ENGINE light comes on to indicate that there is a problem and service is required. Malfunctions often will be indicated by the system before any problem is apparent. This may prevent more serious damage to your vehicle. This system is also designed to assist your service technician in correctly diagnosing any malfunction.

NOTICE:

If you keep driving your vehicle with this light on, after a while, your emission controls may not work as well, your fuel economy may not be as good and your engine may not run as smoothly. This could lead to costly repairs that may not be covered by your warranty.

NOTICE:

Modifications made to the engine, transaxle, exhaust or fuel system of your vehicle or the replacement of the original tires with other than those of the same Tire Performance Criteria (TPC) can affect your vehicle's emission controls and may cause the CHECK ENGINE light to come on. Modifications to these systems could lead to costly repairs not covered by your warranty. This may also result in a failure to pass a required Emission Inspection/Maintenance test.

This light should come on, as a check to show you it is working, when the ignition is on and the engine is not running. If the light doesn't come on, have it repaired. This light will also come on during a malfunction in one of two ways:

- **Light Flashing** -- A misfire condition has been detected. A misfire increases vehicle emissions and may damage the emission control system on your vehicle. Dealer or qualified service center diagnosis and service may be required.
- **Light On Steady** -- An emission control system malfunction has been detected on your vehicle. Dealer or qualified service center diagnosis and service may be required.

If the Light Is Flashing

The following may prevent more serious damage to your vehicle:

- Reducing vehicle speed.
- Avoiding hard accelerations.
- Avoiding steep uphill grades.
- If you are towing a trailer, reduce the amount of cargo being hauled as soon as it is possible.

If the light stops flashing and remains on steady, see “If the Light Is On Steady” following.

If the light continues to flash, when it is safe to do so, *stop the vehicle*. Find a safe place to park your vehicle. Turn the key off, wait at least 10 seconds and restart the engine. If the light remains on steady, see “If the Light Is On Steady” following. If the light is still flashing, follow the previous steps, and drive the vehicle to your dealer or qualified service center for service.

If the Light Is On Steady

You may be able to correct the emission system malfunction by considering the following:

Did you recently put fuel into your vehicle?

If so, reinstall the fuel cap, making sure to fully install the cap. See “Filling Your Tank” in the Index. The diagnostic system can determine if the fuel cap has been left off or improperly installed. A loose or missing fuel cap will allow fuel to evaporate into the atmosphere. A few driving trips with the cap properly installed should turn the light off.

Did you just drive through a deep puddle of water?

If so, your electrical system may be wet. The condition will usually be corrected when the electrical system dries out. A few driving trips should turn the light off.

Have you recently changed brands of fuel?

If so, be sure to fuel your vehicle with quality fuel (see “Fuel” in the Index). Poor fuel quality will cause your engine not to run as efficiently as designed. You may notice this as stalling after start-up, stalling when you put the vehicle into gear, misfiring, hesitation on acceleration or stumbling on acceleration. (These conditions may go away once the engine is warmed up.) This will be detected by the system and cause the light to turn on.

If you experience one or more of these conditions, change the fuel brand you use. It will require at least one full tank of the proper fuel to turn the light off.

If none of the above steps have made the light turn off, have your dealer or qualified service center check the vehicle. Your dealer has the proper test equipment and diagnostic tools to fix any mechanical or electrical problems that may have developed.

Oil Pressure Light/Gage

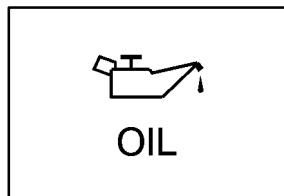

Standard Cluster

If your vehicle has the standard instrument panel cluster, this light will come on if there is a problem with your engine oil pressure.

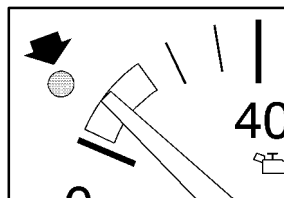

Gage Cluster

If your vehicle has the optional gage cluster, you can read your oil pressure directly from the gage on your instrument panel. A small light to the left of the gage will come on if there is a problem with the engine oil pressure.

The oil light could come on briefly when you turn your key to RUN. It goes off once you turn it to START. That's just a check to be sure the light works. If it doesn't, be sure to have it fixed so it will be there to warn you if something goes wrong.

But, when this light *comes* on and *stays* on, it means oil isn't going through your engine properly. You could be low on oil, or you might have some other oil problem. See your dealer for service.

CAUTION:

Don't keep driving if the oil pressure is low. If you do, your engine can become so hot that it catches fire. You or others could be burned. Check your oil as soon as possible and have your vehicle serviced.

NOTICE:

Damage to your engine from neglected oil problems can be costly and is not covered by your warranty.

Check Oil Level Light (If Equipped)

CHECK
OIL LEVEL

The CHECK OIL LEVEL light turns on for three seconds as a bulb check each time the ignition key is turned to RUN. If the light doesn't turn on, have your vehicle serviced.

If the engine oil is more than one quart (0.95 L) low and the engine has been shut off for at least eight minutes, the CHECK OIL LEVEL light will turn on for about one minute and will then remain off until the next time you start the vehicle.

If the CHECK OIL LEVEL light turns on, the engine oil should be checked at the dipstick then brought up to the proper level if necessary. See "Engine Oil" in the Index.

Change Oil Soon Light (If Equipped)

A rectangular box with a black border containing the text "CHANGE OIL SOON" in bold, black, uppercase letters.

**CHANGE
OIL SOON**

This light is activated by the Engine Oil Life Monitor System.

The CHANGE OIL SOON light turns on for three seconds as a bulb check each time the ignition key is turned to RUN. It will stay on for 60 seconds once 90 percent of the oil life has been used and each time the engine is started after that. If the CHANGE OIL SOON light is on continuously, there is a problem with the Engine Oil Life Monitor System and service is required.

The Engine Oil Life Monitor determines the condition of the engine oil and lets you know when the oil should be changed. See “Engine Oil” in the Index.

The Engine Oil Life Monitor receives information about engine speed, coolant temperature and vehicle speed to determine how much the oil has degraded.

When to change your oil depends on your driving habits and conditions. The CHANGE OIL SOON light may turn on as early as 2,000 miles (3 218 km) or less for harsh circumstances.

For additional information, see “Engine Oil, When to Change” in the Index. To reset the Oil Life Monitor, see “Engine Oil Life Monitor” in the Index.

Cruise Light

A rectangular box with a black border containing the text "CRUISE" in bold, black, uppercase letters.

CRUISE

The cruise light comes on whenever you set your cruise control. See “Cruise Control” in the Index.

Washer Fluid Low Light (If Equipped)

A rectangular box with a black border containing the text "WASHER FLUID LOW" in bold, black, uppercase letters.

**WASHER
FLUID LOW**

When the vehicle has a low fluid condition, this light will come on to remind you to get more washer fluid soon.

Trunk Ajar Light (If Equipped)



This light comes on if your vehicle's trunk is not completely closed.

Fuel Gage

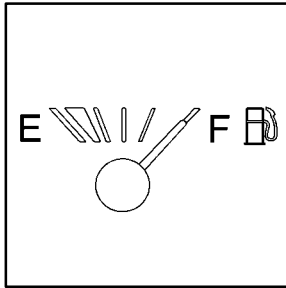

Standard Cluster

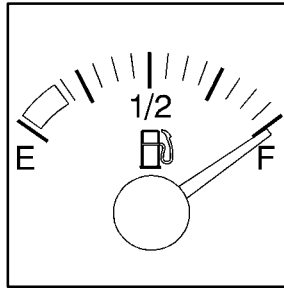

Gage Cluster

Your fuel gage shows about how much fuel is in your tank. It works only when the engine is on. When the indicator nears EMPTY (E), you still have a little fuel left. You need to get more fuel right away.

Here are some things that some owners ask about. None of these show a problem with your fuel gage:

- At the service station, the gas pump shuts off before the gage reads FULL (F).
- It takes a little more or less fuel to fill up than the gage indicated. For example, the gage may have indicated the tank was half full, but it actually took a little more or less than half the tank's capacity to fill the tank.
- The gage moves a little when you turn a corner, speed up, or make a hard stop.
- The gage doesn't go back to EMPTY (E) when you turn off the ignition.

Low Fuel Warning Light (If Equipped)

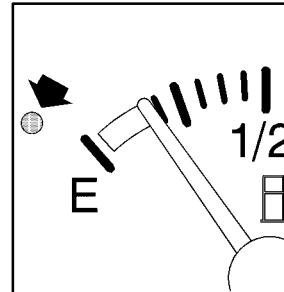

If your vehicle has the gage cluster, a light near the fuel gage will turn on when you are low on fuel. You should get more fuel as soon as you can.



Section 3 Comfort Controls and Audio Systems

In this section, you'll find out how to operate the comfort control and audio systems offered with your vehicle. Be sure to read about the particular systems supplied with your vehicle.

3-2	Comfort Controls	3-17	AM-FM Stereo with Cassette Tape Player and Automatic Tone Control (If Equipped)
3-6	Air Conditioning	3-21	AM-FM Stereo with Compact Disc Player and Automatic Tone Control (If Equipped)
3-7	Heating	3-25	AM-FM Stereo with Cassette Tape and Compact Disc Player with Automatic Tone Control (If Equipped)
3-8	Defogging and Defrosting	3-30	Theft-Deterrent Feature
3-8	Rear Window Defogger	3-32	Audio Steering Wheel Controls (If Equipped)
3-9	Passenger Control (If Equipped)	3-33	Understanding Radio Reception
3-10	Ventilation System	3-34	Care of Your Cassette Tape Player
3-11	Steering Wheel Controls for Climate Control (If Equipped)	3-35	Care of Your Compact Discs
3-12	Audio Systems	3-35	Care of Your Compact Disc Player
3-12	Setting the Clock	3-36	Heated Backlite Antenna
3-12	AM-FM Stereo		
3-14	AM-FM Stereo with Cassette Tape Player (If Equipped)		

Comfort Controls

This section describes how to operate your climate control system. Your climate control system uses ozone-friendly R-134a refrigerant.

With these systems, you can control the heating, cooling and ventilation in your vehicle. Your vehicle also has a flow-through ventilation system described later in this section.

Electronic Touch Climate Control

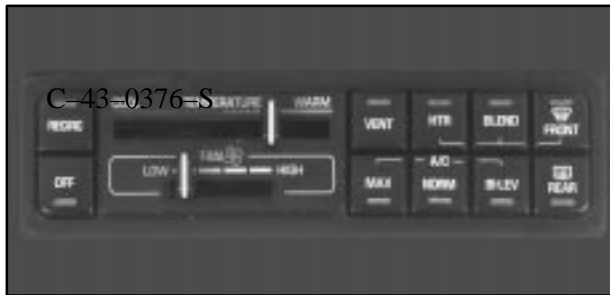

If your vehicle has this climate control system, the following information tells you how it works.

Fan Button

The FAN control is used to select the speed of the blower fan and the force of air you want. There are four speeds to choose from. Moving the lever between LOW and HIGH will decrease or increase the fan speed. The fan will be off when the system is off.

Temperature Lever

This lever adjusts the temperature of the air coming through the system. Move the TEMPERATURE lever to change the temperature of the air coming through your outlets. Move the lever between COOL and WARM to lower or raise the temperature.

Mode Controls

The buttons on your system allow you to choose settings to deliver air through the lower, middle or windshield outlets.

RECIRC: Press this button to limit the amount of outside air entering your vehicle. This is helpful when you are trying to cool the interior of the vehicle quickly, or limit the amount of outside air entering your vehicle. To turn off RECIRC, press the button again. If you select FRONT defrost or BLEND while RECIRC is selected, the system will automatically turn off RECIRC to prevent fogging.

VENT: This setting directs outside air through the middle instrument panel outlets. The air conditioning compressor is not working when VENT is selected.

HTR: This button directs air out of the heater outlets. Most of the air will come from the floor outlets while some air will flow through the windshield and side window outlets. The air conditioning compressor is not working when HTR is selected.

BLEND: When BLEND is selected, the airflow will be split between the windshield and the floor outlets. The air conditioning compressor will be operating.

FRONT: This setting directs most of the airflow toward the windshield.

OFF: The ventilation system always allows fresh air to flow through your vehicle when it is moving. The system will try to keep the air at a previously chosen temperature. When the system is off, the blower fan is also off.

MAX: This setting directs airflow through the middle instrument panel outlets. The amount of outside air entering your vehicle is limited with this setting. The air conditioning compressor is on in this mode.

NORM: This setting cools the outside air entering your vehicle and directs it through the middle instrument panel outlets. The air conditioner is on in this mode.

BI-LEV: This setting directs warm air to the floor and cooler air to the middle instrument panel outlets. The air conditioner is on in this mode.

Dual Automatic Comfortemp Climate Control (If Equipped)

If your vehicle has the Dual Automatic Comfortemp Climate Control option, the following information tells you how it works.

You will hear a beep each time a button is pushed and a light on the button will indicate which function is active. The lights are on all buttons except TEMP, FAN and AIR FLOW. The display will show fan speed, comfort level setting and airflow direction for a few seconds whenever AUTO is selected, and then it will display the outside temperature. The outside temperature reading is most accurate when the vehicle is moving. During stops, the display shows the previous temperature for best accuracy and system control.



If the display is flashing after the climate control system is started, there is a problem with the system and you should see your dealer for service.

Sun and temperature sensors automatically adjust the air temperature, the airflow direction and the fan speed to maintain your comfort setting. The system may supply cooler air to the side of the vehicle toward the sun. Be careful not to put anything over the sensors on top of the dash.

Temperature Button

To adjust the comfort level you want maintained inside the vehicle, push the TEMP button. If you want a warmer comfort level, push the red arrow. If you want a cooler comfort level, push the blue arrow. Your comfort setting is shown in the display.

Fan Button

The speed of the blower fan is controlled automatically if you have the system set for AUTO. Pressing the FAN button will display and hold the current blower fan setting.

If you want the blower fan to run at a lower speed, push the bottom of the FAN button. The fan speed will decrease with every push of the button until the lowest speed is reached. If you want to increase the fan speed, push the top of the FAN button. Notice the fan indicators in the display.

Mode Controls

Press the AIR FLOW button to deliver air through the floor, middle or windshield outlets. The system will stay in the selected mode until the AUTO button is pushed. Use the up and down arrows on the AIR FLOW button to cycle through the available modes.

Automatic Operation

Press the AUTO button when you want the system to automatically adjust to changes in the temperature inside the vehicle, the outside temperature and the sun load on the vehicle. When the system is set for automatic operation, air will come from the floor, middle or windshield outlets depending on the temperature inside the vehicle, the outside temperature and sun load. Fan speed will vary as the system gets to and maintains the comfort setting you have selected through the use of the TEMP button.

To find your comfort setting, start with the system in AUTO mode and the TEMP button adjusted to 75°F (24°C), give the vehicle about 20 minutes to stabilize, and adjust your comfort setting if necessary, by using the TEMP button. The display will show the comfort setting for a few seconds and then it will display the outside temperature. If you want to see your current automatic fan speed, airflow direction and comfort setting, press the AUTO button.

In cold weather, the system will delay turning on the fan, to avoid blowing cold air. The length of the delay depends on the engine coolant temperature and the outside temperature. Pushing the FAN, AIR FLOW or FRONT buttons will override this delay, turn off the AUTO setting and change the fan speed.

Manual Operation

You may also manually adjust the air delivery or fan speed.

AIR FLOW: This button is used to change the direction of the airflow. The airflow choices available are FLOOR, FLOOR-MID, MID and WINDSHIELD-FLOOR. If the system is set for AUTO, pressing the AIR FLOW button will display the current airflow direction and the comfort setting. Press the AIR FLOW up or down button again to change the direction of the airflow.

If the AIR FLOW up button is selected while in the FRONT defrost mode, the system will direct the air toward the windshield and the floor. If the AIR FLOW down button is selected while in the FRONT defrost mode, the system will direct the air toward the floor, and the FRONT defrost mode will cancel. Notice the arrows in the display.

OFF: If the passenger comfort control is turned on, it can be turned off by pressing the OFF button once. Pressing the OFF button a second time will turn off the main system. Turning off the main system causes the fan to turn off and the airflow to be directed toward the floor. The system will still try to keep the interior of the vehicle at the previous chosen comfort setting. The outside temperature will show on the display when the system is OFF.

The ventilation system always allows fresh air to flow through your vehicle when the vehicle is moving even with the system in the OFF mode.

VENT: The VENT button allows outside air to flow through your vehicle without the air conditioning compressor working. Selecting VENT and the AUTO button at the same time allows the system to control automatically without the use of the air conditioning compressor or the use of the RECIRC mode. To turn off the VENT selection, push the VENT button again.

RECIRC: When RECIRC is selected, the system will limit the amount of outside air entering your vehicle. This is helpful when you are trying to cool the interior of the vehicle quickly or limit the amount of outside air entering your vehicle. RECIRC and AUTO may be selected at the same time. The system will remain in RECIRC until the ignition is turned off, then the system will return back to the previously selected mode. Deselecting the RECIRC button will also turn off the RECIRC function. RECIRC can be selected in all manual airflow modes except FRONT defrost and VENT.

FRONT: This selection is used to defrost the windshield by directing the airflow toward the windshield.

If FRONT is selected while in the AUTO mode, the fan speed and the air temperature from the front defroster will vary. If a manual fan speed setting is selected, the fan speed will remain at that selection until another fan speed selection is made or the AUTO mode is selected. To turn off FRONT, press the AUTO or AIR FLOW button.

FRONT defrost will work better if any ice or snow is cleared from the hood and the air inlet area between the base of the windshield and the hood.

Air Conditioning

On hot days, open the windows long enough to let hot inside air escape. This reduces the time it takes for your vehicle to cool down. Then keep your windows closed for the air conditioner to work its best.

If you have the electronic touch system, for quick cool-down on very hot days, use MAX with the temperature and fan speed adjusted to COOL and HIGH. If this setting is used for long periods of time, the air in your vehicle may become too cold and dry.

For normal cooling on hot days, use NORM and adjust the temperature and fan speed for your comfort. If RECIRC is selected while in the NORM air conditioning mode, the system works like MAX and recirculates the air.

On sunny days, when the air is moderately warm or cool, use BI-LEV to deliver warm air to the floor and cooler air to the middle instrument panel outlets. On days like these, the sun may adequately warm your upper body, but your lower body may not be warm enough. To warm or cool the air delivered, adjust the TEMPERATURE lever.

The amount of fresh air entering the vehicle is limited when RECIRC is selected. This is helpful when you are trying to cool the air in your vehicle or limit the air entering the vehicle.

If your vehicle has the Dual Automatic Comfortemp system and it is set for AUTO, on very hot days, the system will automatically enter the RECIRC mode and the temperature door will be positioned at the full cold position for maximum cooling. If the system is not in the AUTO mode, RECIRC should be selected to provide maximum cooling. You can choose the extreme comfort setting of 60°F (16°C), but the system will not cool any faster by choosing the extreme comfort setting.

When the air conditioner is on, you may sometimes notice slight changes in your vehicle's engine speed and power. This is normal because the system is designed to cycle the compressor on and off to keep the desired temperature.

Heating

If your vehicle has the electronic touch system, on cold days, use HTR with the TEMPERATURE lever toward WARM.

If your vehicle has the Dual Automatic Comfortemp system, and on cold days, if the AUTO mode is selected, the system will automatically direct the air toward the floor and the temperature door will be positioned at the full hot position. You can choose the extreme comfort setting of 90°F (32°C) but the system will not warm up any faster by selecting the extreme comfort setting. If the outside temperature is cold, the fan will be delayed to avoid blowing cold air. Pushing the FAN, AIR FLOW or FRONT buttons will override this delay, turn off the AUTO mode and change the fan speed.

With each system, outside air will be brought in and sent through the floor outlets. The heater works best if you keep your windows closed while using it.

Defogging and Defrosting

If you have the electronic touch system, adjust the TEMPERATURE lever toward WARM and the FAN lever toward HIGH.

If you have the Dual Automatic Comfortemp system, use the FRONT button to defog or defrost the windshield. By choosing this button, the airflow will be directed at the windshield. Adjust your comfort level by pressing the TEMP up or down arrow. The fan speed will be controlled by the system. You can change the fan speed by pressing the top of the FAN button to increase speed, and the bottom of the button to decrease speed.

To reduce the chance of fogging your windows in cold weather, using the electronic touch system, select HTR to supply air through the floor outlets. Then move the FAN lever to HIGH for a few moments before driving away. This will blow moist air from the intake outlets toward the floor, not the windshield. If you have the Dual Automatic Comfortemp system, the AUTO setting will do this for you. Manual operation of the automatic comfortemp system in the FLOOR mode will also supply air through the floor outlets.

Rear Window Defogger

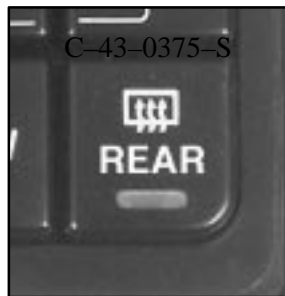

The lines you see on the rear window warm the glass. Press this button to start warming your window.

After 10 minutes it will turn off by itself, or pressing the button during the heating cycle will turn it off. If you need additional warming time, push the button again. The system will then operate for five minutes before going off by itself.

Do not attach a temporary vehicle license, tape or decals across the defogger grid on the rear window.

NOTICE:

Do not try to clear frost or other material from the inside of the rear window with a razor blade or anything else that is sharp. This may damage the rear defogger grid. The repairs wouldn't be covered by your warranty.

Passenger Control (If Equipped)



If you have the Dual Automatic Comfortemp system, the front seat passenger can control the air temperature in their seating area.

The temperature can be set up to 5°F or 3°C cooler or warmer than the primary setting. To activate the passenger control, simply press the COOL or WARM buttons located on the passenger's door.

The indicator lights above the control will show the difference from the main temperature setting.

If the passenger control has been turned on, it can be turned off by pressing the OFF button once. Pressing the OFF button a second time will turn off the main system.

Ventilation System

For mild outside temperatures when little heating or cooling is needed, use VENT (on the electronic touch system or manual operation on the Dual Automatic Comfortemp system) to direct outside air through your vehicle. Air will flow through the middle instrument panel outlets.

Your vehicle's flow-through ventilation system supplies outside air into the vehicle when it's moving. When the vehicle is not moving, you can get outside air to flow through by selecting any air choice (except the rear window defogger) and any fan speed.

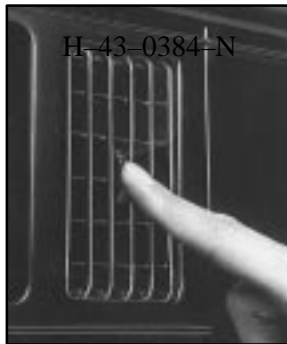

Adjust the direction of airflow by moving the louvered vents.

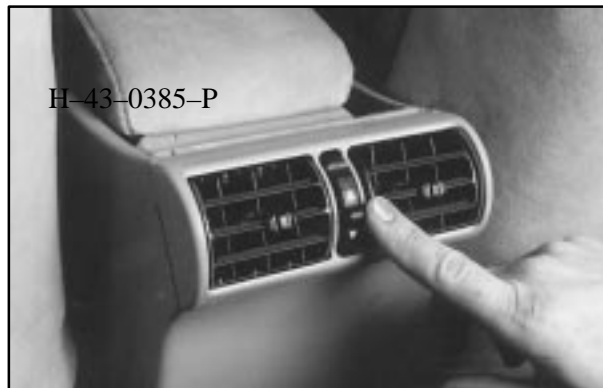

If you have the rear passenger comfortemp option, you can adjust the direction of the airflow to the rear seating area.

Ventilation Tips

- Keep the hood and front air inlet free of ice, snow or any other obstruction such as leaves. The heater and defroster will work better, reducing the chance of fogging your windows.
- Keep the air path under the front seats clear of objects. This helps air to circulate throughout your vehicle.
- When the engine idles for a long time, the exterior temperature sensor may cause the system to blow air that is too cool. Once the vehicle is moving again, the system will try to maintain the set temperature inside your vehicle.
- When you start your vehicle and the EXT display flashes (Dual Automatic Comfortemp system only) for some time, the system may need repair. See your dealer.

Steering Wheel Controls for Climate Control (If Equipped)



If your vehicle has this feature, you can control the temperature function by using the button on your steering wheel. Press the TEMP up arrow to increase the temperature and the TEMP down arrow to decrease the temperature.

Audio Systems

Your Delco Electronics audio system has been designed to operate easily and give years of listening pleasure. You will get the most enjoyment out of it if you acquaint yourself with it first. Find out what your Delco Electronics system can do and how to operate all its controls, to be sure you're getting the most out of the advanced engineering that went into it.

Setting the Clock

Press and hold HRS until the correct hour appears. Press and hold MIN until the correct minute appears.

You may set the clock with the ignition off if you press RECALL first and follow the same procedure described above.

AM-FM Stereo



Playing the Radio

VOLUME: This knob turns the system on and off and controls the volume. To increase volume and turn the radio on, turn the knob clockwise. Turn it counterclockwise to decrease volume.

RECALL: Press the upper knob briefly to recall the station being played or to display the clock. To change what is normally shown on the display (station or time), press the knob until you see the display you want, then hold the knob until the display flashes. If you press the knob when the ignition is off, the clock will show for a few seconds.

Finding a Station

AM-FM: Press the AM-FM button to switch between AM, FM1 and FM2. The display shows your selection.

TUNE: Turn the lower knob to choose radio stations.

SEEK: Press the right or left arrow to go to the next higher or lower station and stay there. The sound will mute while seeking.

SCAN: Press one of the SEEK arrows for two seconds, and SCAN will appear on the display. Use SCAN to listen to stations for a few seconds. The radio will go to a station, stop for a few seconds, then go on to the next station. Press one of the SEEK arrows again to stop scanning. The sound will mute while scanning.

PUSHBUTTONS: The six numbered pushbuttons let you return to your favorite stations. You can set up to 18 stations (six AM, six FM1 and six FM2). Just:

1. Turn the radio on.
2. Press the AM-FM button to select the band.
3. Tune in the desired station.
4. Press and hold one of the six numbered buttons. The sound will mute. When it returns, release the button. Whenever you press that numbered button, the station you set will return.
5. Repeat the steps for each pushbutton.

P SCAN: Press this button to listen to each of your preset stations for a few seconds. The radio will go to the first preset station, stop for a few seconds, then go on to the next preset station. Press P SCAN again to stop scanning. The radio will not stop at a preset station if the station is weak.

Setting the Tone

BASS: Press this knob lightly so it extends. Turn the knob to increase or decrease bass.

TREB: Press this knob lightly so it extends. Turn the knob to increase or decrease treble. If a station is weak or noisy, you may want to decrease the treble.

Push these knobs back into their stored positions when you're not using them.

Adjusting the Speakers

BAL: Turn the control behind the upper knob to move the sound to the left or right speakers. The middle position balances the sound between the speakers.

FADE: Turn the control behind the lower knob to move the sound to the front or rear speakers. The middle position balances the sound between the speakers.

AM-FM Stereo with Cassette Tape Player (If Equipped)



Playing the Radio

VOLUME: This knob turns the system on and off and controls the volume. To increase volume and turn the radio on, turn the knob clockwise. Turn it counterclockwise to decrease volume.

RECALL: Press the upper knob briefly to recall the station being played or to display the clock. To change what is normally shown on the display (station or time), press the knob until you see the display you want, then hold the knob until the display flashes. If you press the knob when the ignition is off, the clock will show for a few seconds.

Finding a Station

AM-FM: Press the lower knob to switch between AM, FM1 and FM2. The display shows your selection.

TUNE: Turn the lower knob to choose radio stations.

SEEK: Press the right or left arrow to go to the next higher or lower station and stay there. The sound will mute while seeking.

SCAN: Press one of the SEEK arrows for two seconds, and SCAN will appear on the display. Use SCAN to listen to stations for a few seconds. The radio will go to a station, stop for a few seconds, then go on to the next station. Press one of the SEEK arrows again to stop scanning. The sound will mute while scanning.

PUSHBUTTONS: The six numbered pushbuttons let you return to your favorite stations. You can set up to 18 stations (six AM, six FM1 and six FM2). Just:

1. Turn the radio on.
2. Press AM-FM to select the band.
3. Tune in the desired station.
4. Press and hold one of the six numbered buttons. The sound will mute. When it returns, release the button. Whenever you press that numbered button, the station you set will return.
5. Repeat the steps for each pushbutton.

P SCAN: Press this button to listen to each of your preset stations for a few seconds. The radio will go to the first preset station, stop for a few seconds, then go on to the next preset station. Press P SCAN again to stop scanning. The radio will not stop at a preset if the station is weak.

Setting the Tone

BASS: Press this knob lightly so it extends. Turn the knob to increase or decrease bass.

TREB: Press this knob lightly so it extends. Turn the knob to increase or decrease treble. If a station is weak or noisy, you may want to decrease the treble.

Push these knobs back into their stored positions when you're not using them.

Adjusting the Speakers

BAL: Turn the control behind the upper knob to move the sound to the left or right speakers. The middle position balances the sound between the speakers.

FADE: Turn the control behind the lower knob to move the sound to the front or rear speakers. The middle position balances the sound between the speakers.

Playing a Cassette Tape

The longer side with the tape visible should face to the right. If the ignition and the radio are on, the tape can be inserted and will begin playing. If you hear nothing or hear a garbled sound, the tape may not be in squarely. Press EJECT to remove the tape and start over.

While the tape is playing, use the VOLUME, FADE, BAL, BASS and TREB controls just as you do for the radio. Other controls may have different functions when a tape is inserted. The display will show an arrow to show which side of the tape is playing.

If you want to insert a tape when the ignition or radio is off, first press EJECT or RECALL. Note that the cassette tape adapter kits for portable compact disc players will work in your cassette tape player.

Your tape bias is set automatically.

If E and a number appear on the radio display, the tape won't play because of an error.

- **E10:** The tape is tight and the player can't turn the tape hubs. Remove the tape. Hold the tape with the open end down and try to turn the right hub counterclockwise with a pencil. Turn the tape over and repeat. If the hubs do not turn easily, your tape may be damaged and should not be used in the player. Try a new tape to make sure your player is working properly.
- **E11:** The tape is broken. Try a new tape.

If any error occurs repeatedly or if an error can't be corrected, please contact your dealer. If your radio displays an error number, write it down and provide it to your dealer when reporting the problem.

PREV (1): Press this button to search for the previous selection on the tape. Your tape must have at least three seconds of silence between each selection for PREV to work. The sound will mute while seeking.

NEXT (2): Press this button to search for the next selection on the tape. Your tape must have at least three seconds of silence between each selection for NEXT to work. The sound will mute while seeking.

The SEEK left and right arrows will also find the previous and next selections on the tape.

◀◀ (3): Press this button to reverse the tape rapidly. Press it again to return to playing speed. The radio will play while the tape reverses.

▶▶ (4): Press this button to advance quickly to another part of the tape. Press the button again to return to playing speed. The radio will play while the tape advances.

SIDE (5): Press this button to change the side of the tape that is playing.

DD (6): Press this button to reduce background noise. The display will show either OFF or ON for a few seconds when you press the button.

Dolby Noise Reduction is manufactured under a license from Dolby Laboratories Licensing Corporation. Dolby and the double-D symbol are trademarks of Dolby Laboratories Licensing Corporation.

EJECT: Press this button to remove the tape. The radio will play.

CLN: If this message appears on the display, the cassette tape player needs to be cleaned. It will still play tapes, but you should clean it as soon as possible to prevent damage to the tapes and player. See “Care of Your Cassette Tape Player” in the Index. After you clean the player, press and hold EJECT for five seconds to reset the CLN indicator. The radio will display --- to show the indicator was reset.

AM-FM Stereo with Cassette Tape Player and Automatic Tone Control (If Equipped)



Playing the Radio

VOLUME: Press this knob to turn the system on and off. To increase volume, turn the knob clockwise. Turn it counterclockwise to decrease the volume.

RECALL: Press this button briefly to recall the station being played or to display the clock. To change what is normally shown on the display (station or time), press this button until you see the display you want, then hold the button until the display flashes. If you press the button when the ignition is off, the clock will show for a few seconds.

Finding a Station

AM-FM: Press this button to switch between AM, FM1 and FM2. The display shows your selection.

TUNE: Press the up or down arrow to choose radio stations.

SEEK: Press the up or down arrow to go to the next higher or lower station and stay there. The sound will mute while seeking.

SCAN: Press one of the SEEK arrows for two seconds and SCAN will appear on the display. Use SCAN to listen to stations for a few seconds. The radio will go to a station, stop for a few seconds, then go on to the next station. Press one of the SEEK buttons again to stop scanning. The sound will mute while scanning.

PUSHBUTTONS: The six numbered pushbuttons let you return to your favorite stations. You can set up to 18 stations (six AM, six FM1 and six FM2). Just:

1. Turn the radio on.
2. Press AM-FM to select the band.
3. Tune in the desired station.
4. Press TONE to select the setting you prefer.
5. Press and hold one of the six numbered buttons. The sound will mute. When it returns, release the button. Whenever you press that numbered button, the station you set will return and the tone you selected will be automatically selected for that button.
6. Repeat the steps for each pushbutton.

P SCAN: Press this button to listen to each of your preset stations for a few seconds. The radio will go to the first preset station, stop for a few seconds, then go on to the next preset station. Press P SCAN again to stop scanning. If a preset station has weak reception, the radio will not stop at the preset station.

AUTO SET: Press this button and the system will seek and set the 12 strongest FM or the 6 strongest AM stations on your preset buttons (depending on which band (AM or FM) you are listening to). AUTO SET will flash while seeking and will remain on until this function is complete. To return to the stations you manually set, press AUTO SET again.

Setting the Tone

BASS: Press this knob lightly so it extends. Turn the knob to increase or decrease bass.

TREB: Press this knob lightly so it extends. Turn the knob to increase or decrease treble. If a station is weak or noisy, you may want to decrease the treble.

Push these knobs back into their stored positions when you're not using them.

TONE: This feature allows you to choose preset bass and treble equalization settings designed for classical, pop, rock, jazz, talk and country/western stations. CLASS will appear on the display when you first press TONE. Each time you press it, another setting will appear on the display. Press it again after C & W appears and MANUAL will appear. Tone control will return to the BASS and TREB knobs. Also, if you use the BASS and TREB knobs, control will return to them and MANUAL will appear.

Adjusting the Speakers

BAL: Press this knob lightly so it extends. Turn the knob to move the sound to the left or right speakers. The middle position balances the sound between the speakers.

FADE: Press this knob lightly so it extends. Turn the knob to move the sound to the front or rear speakers. The middle position balances the sound between the speakers.

Push these knobs back into their stored positions when you're not using them.

Playing a Cassette Tape

The longer side with the tape visible should face to the right. If the ignition and the radio are on, the tape can be inserted and will begin playing. If you hear nothing or hear a garbled sound, the tape may not be in squarely. Press EJECT to remove the tape and start over.

While the tape is playing, use the VOLUME, FADE, BAL, BASS and TREB controls just as you do for the radio. Other controls may have different functions when a tape is inserted. The display will show an arrow to show which side of the tape is playing.

If you want to insert a tape when the ignition or radio is off, first press EJECT or RECALL. Note that the cassette tape adapter kits for portable compact disc players will work in your cassette tape player.

Your tape bias is set automatically.

If E and a number appear on the radio display, the tape won't play because of an error.

- **E10:** The tape is tight and the player can't turn the tape hubs. Remove the tape. Hold the tape with the open end down and try to turn the right hub counterclockwise with a pencil. Turn the tape over and repeat. If the hubs do not turn easily, your tape may be damaged and should not be used in the player. Try a new tape to make sure your player is working properly.
- **E11:** The tape is broken. Try a new tape.

If any error occurs repeatedly or if an error can't be corrected, please contact your dealer. If your radio displays an error number, write it down and provide it to your dealer when reporting the problem.

PREV (1): Press this button to search for the previous selection on the tape. Your tape must have at least three seconds of silence between each selection for PREV to work. The sound will mute while seeking.

NEXT (2): Press this button to search for the next selection on the tape. Your tape must have at least three seconds of silence between each selection for NEXT to work. The sound will mute while seeking.

The SEEK up and down arrows will also find the previous and next selections on the tape.

◀◀ (3): Press this button to reverse the tape rapidly. Press it again to return to playing speed. The radio will play while the tape reverses.

▶▶ (4): Press this button to advance quickly to another part of the tape. Press the button again to return to playing speed. The radio will play while the tape advances.

SIDE (5): Press this button to change the side of the tape that is playing.

DD (6): Press this button to reduce background noise. The double-D symbol will appear on the display.

Dolby Noise Reduction is manufactured under a license from Dolby Laboratories Licensing Corporation. Dolby and the double-D symbol are trademarks of Dolby Laboratories Licensing Corporation.

AM-FM: Press this button to play the radio when a tape is in the player.

SOURCE: Press this button to change to the tape function when the radio is on. TAPE PLAY with an arrow will appear on the display when the tape is active.

EJECT: Press this button to remove the tape. The radio will play.

CLN: If this message appears on the display, the cassette tape player needs to be cleaned. It will still play tapes, but you should clean it as soon as possible to prevent damage to the tapes and player. See “Care of Your Cassette Tape Player” in the Index. After you clean the player, press and hold EJECT for five seconds to reset the CLN indicator. The radio will display --- to show the indicator was reset.

AM-FM Stereo with Compact Disc Player and Automatic Tone Control (If Equipped)



Playing the Radio

VOLUME: Press this knob to turn the system on and off. To increase volume, turn the knob clockwise. Turn it counterclockwise to decrease the volume.

RECALL: Press this button briefly to recall the station being played or to display the clock. To change what is normally shown on the display (station or time), press the button until you see the display you want, then hold the button until the display flashes. If you press the button when the ignition is off, the clock will show for a few seconds.

Finding a Station

AM-FM: Press this button to switch between AM, FM1 and FM2. The display shows your selection.

TUNE: Press the up or down arrow to choose radio stations.

SEEK: Press the up or down arrow to go to the next higher or lower station and stay there. The sound will mute while seeking.

SCAN: Press one of the SEEK arrows for two seconds and SCAN will appear on the display. Use SCAN to listen to stations for a few seconds. The radio will go to a station, stop for a few seconds, then go on to the next station. Press one of the SEEK arrows again to stop scanning. The sound will mute while scanning.

PUSHBUTTONS: The six numbered pushbuttons let you return to your favorite stations. You can set up to 18 stations (six AM, six FM1 and six FM2). Just:

1. Turn the radio on.
2. Press AM-FM to select the band.
3. Tune in the desired station.
4. Press TONE to select the setting you prefer.
5. Press and hold one of the six numbered buttons. The sound will mute. When it returns, release the button. Whenever you press that numbered button, the station you set will return and the tone you selected will be automatically selected for that button.
6. Repeat the steps for each pushbutton.

P SCAN: Press this button to listen to each of your preset stations for a few seconds. The radio will go to the first preset station, stop for a few seconds, then go on to the next preset station. Press P SCAN again to stop scanning. If a preset station has weak reception, the radio will not stop at the preset station.

AUTO SET: Press this button and the system will seek and set the 12 strongest FM or the 6 strongest AM stations on your preset buttons (depending on which band (AM or FM) you are listening to). AUTO SET will flash while seeking and will remain on until this function is complete. To return to the stations you manually set, press AUTO SET again.

Setting the Tone

BASS: Press this knob lightly so it extends. Turn the knob to increase or decrease bass.

TREB: Press this knob lightly so it extends. Turn the knob to increase or decrease treble. If a station is weak or noisy, you may want to decrease the treble.

Push these knobs back into their stored positions when you're not using them.

TONE: This feature allows you to choose preset bass and treble equalization settings designed for classical, pop, rock, jazz, talk and country/western stations. CLASS will appear on the display when you first press TONE. Each time you press it, another setting will appear on the display. Press it again after C & W appears and MANUAL will appear. Tone control will return to the BASS and TREB knobs. Also, if you use the BASS and TREB knobs, control will return to them and MANUAL will appear.

Adjusting the Speakers

BAL: Press this knob lightly so it extends. Turn this knob to move the sound to the left or right speakers. The middle position balances the sound between the speakers.

FADE: Press this knob lightly so it extends. Turn this knob to move the sound to the front or rear speakers. The middle position balances the sound between the speakers.

Push these knobs back into their stored positions when you're not using them.

Playing a Compact Disc

Insert a disc partway into the slot, label side up. The player will pull it in. The disc should begin playing.

If you want to insert a CD while the ignition or the radio is off, first press EJECT or RECALL.

If you're driving on a very rough road or if it's very hot, the disc may not play and an error code may appear on the display. When things get back to normal, the disc should play. If the disc comes out, it could be that:

- **E20:** The disc is upside down.
- **E20:** It is dirty, scratched or wet.
- **E20:** There's too much moisture in the air. (Wait about an hour and try again.)

If any error occurs repeatedly or if an error can't be corrected, please contact your dealer. If your radio displays an error number, write it down and provide it to your dealer when reporting the problem.

PREV (1): Press this button to go to the start of the current track if more than eight seconds have played. If you hold the button or press it more than once, the player will continue moving back through the disc. The sound will mute while seeking.

NEXT (2): Press this button to go to the next track. If you hold the button or press it more than once, the player will continue moving forward through the disc. The sound will mute while seeking.

The **SEEK** down and up arrows will also find the previous and next selections on the disc.

◀◀ (3): Press and hold this button to quickly reverse within a track. You will hear sound.

▶▶ (4): Press and hold this button to quickly advance within a track. You will hear sound.

RAND (6): Press this button to hear the tracks in random, rather than sequential, order. Press **RAND** again to turn off random play.

RECALL: Press this button to see which track is playing. Press it again within five seconds to see how long it has been playing. To change what is normally shown on the display (track or elapsed time), press the button until you see the display you want, then hold the button until the display flashes.

AM-FM: Press this button to play the radio when a disc is in the player.

SOURCE: Press this button to change to the disc function when the radio is on. When a disc is inserted, the disc will play until you press **AM-FM**. Then the disc will stop playing and the radio will play. Press **SOURCE** again to play a disc again. **CD PLAY** will show on the display.

EJECT: Press this button to remove the disc. The radio will play.

If you turn off the ignition or radio with a disc in the player, it will stay in the player. When you turn on the ignition or system, the disc will start playing where it stopped, if it was the last selected audio source.

AM-FM Stereo with Cassette Tape and Compact Disc Player with Automatic Tone Control (If Equipped)



Playing the Radio

VOLUME: Press this knob to turn the system on and off. To increase volume, turn the knob clockwise. Turn it counterclockwise to decrease volume.

RECALL: Press this button briefly to recall the station being played or to display the clock. To change what is normally shown on the display (station or time), press the RECALL button until you see the display you want, then hold the RECALL button until the display flashes. If you press the button when the ignition is off, the clock will show for a few seconds.

Finding a Station

AM-FM: Press this button to switch between AM, FM1 and FM2. The display shows your selection.

TUNE: Press the up or down arrow to choose radio stations.

SEEK: Press the up or down arrow to go to the next higher or lower station and stay there. The sound will mute while seeking.

SCAN: Press one of the SEEK arrows for two seconds and SCAN will appear on the display. Use SCAN to listen to stations for a few seconds. The radio will go to a station, stop for a few seconds, then go on to the next station. Press one of the SEEK arrows again to stop scanning. The sound will mute while scanning.

PUSHBUTTONS: The six numbered pushbuttons let you return to your favorite stations. You can set up to 18 stations (six AM, six FM1 and six FM2). Just:

1. Turn the radio on.
2. Press AM-FM to select the band.
3. Tune in the desired station.
4. Press TONE to select the setting you prefer.
5. Press and hold one of the six numbered buttons. The sound will mute. When it returns, release the button. Whenever you press that numbered button, the station you set will return and the tone you selected will be automatically selected for that button.
6. Repeat the steps for each pushbutton.

P SCAN: Press this button to listen to each of your preset stations for a few seconds. The radio will go to the first preset station, stop for a few seconds, then go on to the next preset station. Press P SCAN again to stop scanning. If a preset station has weak reception, the radio will not stop at the preset station.

AUTO SET: Press this button and the system will seek and set the 12 strongest FM or the 6 strongest AM stations on your preset buttons. AUTO SET will flash while seeking and will remain on until this function is complete. To return to the stations you manually set, press AUTO SET again.

Setting the Tone

BASS: Press this knob lightly so it extends. Turn the knob to increase or decrease bass.

TREB: Press this knob lightly so it extends. Turn the knob to increase or decrease treble. If a station is weak or noisy, you may want to decrease the treble.

Push these knobs back into their stored positions when you're not using them.

TONE: This feature allows you to choose preset bass and treble equalization settings designed for classical, pop, rock, jazz, talk and country/western stations. CLASS will appear on the display when you first press TONE. Each time you press it, another setting will appear on the display. Press it again after C & W appears and MANUAL will appear. Tone control will return to the BASS and TREB knobs. Also, if you use the BASS and TREB knobs, control will return to them and MANUAL will appear.

Adjusting the Speakers

BAL: Press this knob lightly so it extends. Turn the knob to move the sound to the left or right speakers. The middle position balances the sound between the speakers.

FADE: Press this knob lightly so it extends. Turn the knob to move the sound to the front or rear speakers. The middle position balances the sound between the speakers.

Push these knobs back into their stored positions when you're not using them.

Playing a Cassette Tape

The longer side with the tape visible should face to the right. If the ignition and the radio are on, the tape can be inserted and will begin playing. If you hear nothing or hear a garbled sound, the tape may not be in squarely. Press EJECT to remove the tape and start over.

While the tape is playing, use the VOLUME, FADE, BAL, BASS and TREB controls just as you do for the radio. Other controls may have different functions when a tape is inserted. The display will show an arrow to show which side of the tape is playing.

If you want to insert a tape when the ignition or radio is off, first press EJECT or RECALL.

Your tape bias is set automatically.

If E and a number appear on the radio display, the tape won't play because of an error.

- **E10:** The tape is tight and the player can't turn the tape hubs. Remove the tape. Hold the tape with the open end down and try to turn the right hub counterclockwise with a pencil. Turn the tape over and repeat. If the hubs do not turn easily, your tape may be damaged and should not be used in the player. Try a new tape to make sure your player is working properly.
- **E11:** The tape is broken. Try a new tape.

If any error occurs repeatedly or if an error can't be corrected, please contact your dealer. If your radio displays an error number, write it down and provide it to your dealer when reporting the problem.

PREV (1): Press this button to search for the previous selection on the tape. Your tape must have at least three seconds of silence between each selection for PREV to work. The sound will mute while seeking.

NEXT (2): Press this button to search for the next selection on the tape. Your tape must have at least three seconds of silence between each selection for NEXT to work. The sound will mute while seeking.

The SEEK down and up arrows will also find the previous and next selections on the tape.

◀◀ (3): Press this button to reverse the tape rapidly. Press it again to return to playing speed. The radio will play while the tape reverses.

▶▶ (4): Press this button to advance quickly to another part of the tape. Press the button again to return to playing speed. The radio will play while the tape advances.

SIDE (5): Press this button to change the side of the tape that is playing.

RAND (6): Press this button to reduce background noise. The double-D symbol will appear in the display.

Dolby Noise Reduction is manufactured under a license from Dolby Laboratories Licensing Corporation. Dolby and the double-D symbol are trademarks of Dolby Laboratories Licensing Corporation.

SOURCE: Press this button to change to the tape or disc function when the radio is on. If both a tape and a disc are installed, the system will first go to tape play; TAPE SIDE and an arrow will appear on the display. If SOURCE is pressed again, the system will go to disc play; CD PLAY will appear on the display.

EJECT: The system has two EJECT buttons. Press the button near the CD slot to remove a disc. Press the button near the tape slot to remove a tape and the radio will play.

CLN: If this message appears on the display, the cassette tape player needs to be cleaned. It will still play tapes, but you should clean it as soon as possible to prevent damage to the tapes and player. See “Care of Your Cassette Tape Player” in the Index. After you clean the player, press and hold EJECT for five seconds to reset the CLN indicator. The radio will display --- to show the indicator was reset.

Your cassette tape player automatically reduces background noise from tapes encoded with Dolby NR. You may turn Dolby NR off by pressing the number six preset.

Playing a Compact Disc

Insert a disc partway into the slot, label side up. The player will pull it in. The disc should begin playing.

If you want to insert a CD while the ignition or the radio is off, first press EJECT or RECALL.

If you're driving on a very rough road or if it's very hot, the disc may not play and an error code may appear on the display. When things get back to normal, the disc should play. If the disc comes out, it could be that:

- **E20:** The disc is upside down.
- **E20:** It is dirty, scratched or wet.
- **E20:** There's too much moisture in the air. (Wait about an hour and try again.)

If any error occurs repeatedly or if an error can't be corrected, please contact your dealer. If your radio displays an error number, write it down and provide it to your dealer when reporting the problem.

PREV (1): Press this button to go to the start of the current track, if more than eight seconds have played. If you hold the button or press it more than once, the player will continue moving back through the disc. The sound will mute while seeking.

NEXT (2): Press this button to go to the next track. If you hold the button or press it more than once, the player will continue moving forward through the disc. The sound will mute while seeking.

The SEEK down and up arrows will also find the previous and next selections on the disc.

◀◀ **(3):** Press and hold this button to quickly reverse within a track. You will hear sound.

▶▶ **(4):** Press and hold this button to quickly advance within a track. You will hear sound.

RAND (6): Press this button to hear the tracks in random, rather than sequential, order. Press RAND again to turn off random play.

RECALL: Press this button to see which track is playing. Press it again within five seconds to see how long it has been playing. To change what is normally shown on the display (track or elapsed time), press the RECALL button until you see the display you want, then hold the RECALL button until the display flashes.

AM-FM: Press this button to play the radio when a disc is in the player.

SOURCE: Press this button to change to the disc function when the radio is on. When a disc is inserted, the disc will play until you press AM-FM. Then the disc will stop playing and the radio will play. Press SOURCE again to play a disc again. CD PLAY will show on the display.

EJECT: Press this button to remove the disc. The radio will play.

If you turn off the ignition or radio with a disc in the player, it will stay in the player. When you turn on the ignition or system, the disc will start playing where it stopped, if it was the last selected audio source.

Also, as a protection feature, if a CD is ejected and left in the player, it will be pulled back in the player with the ignition on or off.

Theft-Deterrent Feature

THEFTLOCK[®] is designed to discourage theft of your radio. It works by using a secret code to disable all radio functions whenever battery power is removed.

If THEFTLOCK is active, the THEFTLOCK indicator will flash when the ignition is off.

The THEFTLOCK feature for the radio may be used or ignored. If ignored, the system plays normally and the radio is not protected by the feature. If THEFTLOCK is activated, your radio will not operate if stolen.

When THEFTLOCK is activated, the radio will display LOC to indicate a locked condition anytime battery power is removed. If your battery loses power for any reason, you must unlock the radio with the secret code before it will operate.

Activating the Theft-Deterrent Feature

The instructions which follow explain how to enter your secret code to activate the THEFTLOCK system. It is recommended that you read through all nine steps before starting the procedure.

NOTE: If you allow more than 15 seconds to elapse between any steps, the radio automatically reverts to time and you must start the procedure over at Step 4.

1. Write down any three or four-digit number from 000 to 1999 and keep it in a safe place separate from the vehicle.
2. Turn the ignition to ACCESSORY or RUN.
3. Turn the radio off.
4. Press the 1 and 4 buttons together. Hold them down until --- shows on the display. Next you will use the secret code number which you have written down.
5. Press MIN and 000 will appear on the display.
6. Press MIN again to make the last two digits agree with your code.
7. Press HRS to make the first one or two digits agree with your code.

8. Press AM-FM after you have confirmed that the code matches the secret code you have written down. The display will show REP to let you know that you need to repeat Steps 5 through 7 to confirm your secret code.
9. Press AM-FM and this time the display will show SEC to let you know that your radio is secure.
4. Press HRS to make the first one or two digits agree with your code.
5. Press AM-FM after you have confirmed that the code matches the secret code you have written down. The display will show SEC, indicating the radio is now operable and secure.

Unlocking the Theft-Deterrent Feature After a Power Loss

Enter your secret code as follows; pause no more than 15 seconds between steps:

1. Turn the ignition on. LOC will appear on the display.
2. Press MIN and 000 will appear on the display.
3. Press MIN again to make the last two digits agree with your code.

If you enter the wrong code eight times, INOP will appear on the display. You will have to wait an hour with the ignition on before you can try again. When you try again, you will only have three more chances (eight tries per chance) to enter the correct code before INOP appears.

If you lose or forget your code, contact your dealer.

Disabling the Theft-Deterrent Feature

Enter your secret code as follows; pause no more than 15 seconds between steps:

1. Turn the ignition to ACCESSORY or RUN.
2. Turn the radio off.
3. Press the 1 and 4 buttons together. Hold them down until SEC shows on the display.
4. Press MIN and 000 will appear on the display.
5. Press MIN again to make the last two digits agree with your code.
6. Press HRS to make the first one or two digits agree with your code.
7. Press AM-FM after you have confirmed that the code matches the secret code you have written down. The display will show ---, indicating that the radio is no longer secured.

If the code entered is incorrect, SEC will appear on the display. The radio will remain secured until the correct code is entered.

When battery power is removed and later applied to a secured radio, the radio won't turn on and LOC will appear on the display.

To unlock a secured radio see “Unlocking the Theft-Deterrent Feature After a Power Loss” earlier in this section.

Audio Steering Wheel Controls (If Equipped)

If your vehicle has this feature, you can control certain radio functions using the buttons on your steering wheel.

Some steering wheel controls may operate climate controls. See “Steering Wheel Controls for Climate Control” earlier in this section.



SEEK: Press this button to go to the next higher or lower radio station. Press and hold this button again for two seconds and SCAN will appear. Press it again to stop scanning.

SCAN: Press this button to scan the stations preset on your radio pushbuttons. This feature works like your radio's P SCAN button and allows you to listen to each of your preset stations for a few seconds. The radio will go to the first preset station, stop for a few seconds, then go on to the next preset station. Press SCAN again to stop scanning. If a preset station has weak reception, the radio will not stop at the preset station.

AM-FM: Press this button to choose AM, FM1 or FM2.



VOL: Press the up or down arrow to increase or decrease volume.

SRCE: If you have radio-only controls, you will have this control. Press SRCE to play a cassette tape or compact disc when the radio is playing. If both a tape and disc are installed, the system will first go to tape play. Press SRCE again to go to disc play.

MUTE: If you have radio-only controls, you will have this control. Press MUTE to silence the system. Press it again to turn on the sound.

Understanding Radio Reception

AM

The range for most AM stations is greater than for FM, especially at night. The longer range, however, can cause stations to interfere with each other. AM can pick up noise from things like storms and power lines. Try reducing the treble to reduce this noise if you ever get it.

FM Stereo

FM stereo will give you the best sound, but FM signals will reach only about 10 to 40 miles (16 to 65 km). Tall buildings or hills can interfere with FM signals, causing the sound to come and go.

Tips About Your Audio System

Hearing damage from loud noise is almost undetectable until it is too late. Your hearing can adapt to higher volumes of sound. Sound that seems normal can be loud and harmful to your hearing. Take precautions by adjusting the volume control on your radio to a safe sound level before your hearing adapts to it.

To help avoid hearing loss or damage:

- Adjust the volume control to the lowest setting.
- Increase volume slowly until you hear comfortably and clearly.

NOTICE:

Before you add any sound equipment to your vehicle -- like a tape player, CB radio, mobile telephone or two-way radio -- be sure you can add what you want. If you can, it's very important to do it properly. Added sound equipment may interfere with the operation of your vehicle's engine, Delco Electronics radio or other systems, and even damage them. Your vehicle's systems may interfere with the operation of sound equipment that has been added improperly.

So, before adding sound equipment, check with your dealer and be sure to check Federal rules covering mobile radio and telephone units.

Care of Your Cassette Tape Player

A tape player that is not cleaned regularly can cause reduced sound quality, ruined cassettes or a damaged mechanism. Cassette tapes should be stored in their cases away from contaminants, direct sunlight and extreme heat. If they aren't, they may not operate properly or may cause failure of the tape player.

Your tape player should be cleaned regularly after every 50 hours of use. Your radio may display CLN to indicate that you have used your tape player for 50 hours without resetting the tape clean timer. If this message appears on the display, your cassette tape player needs to be cleaned. It will still play tapes, but you should clean it as soon as possible to prevent damage to your tapes and player. If you notice a reduction in sound quality, try a known good cassette to see if it is the tape or the tape player at fault. If this other cassette has no improvement in sound quality, clean the tape player.

The recommended cleaning method for your cassette tape player is the use of a scrubbing action, non-abrasive cleaning cassette with pads which scrub the tape head as the hubs of the cleaner cassette turn. The recommended cleaning cassette is available through your dealership (GM Part No. 12344789).

When using a scrubbing action, non-abrasive cleaning cassette, it is normal for the cassette to eject because your unit is equipped with a cut tape detection feature and a cleaning cassette may appear as a broken tape. If the cleaning cassette ejects, insert the cassette at least three times to ensure thorough cleaning.

You may also choose a non-scrubbing action, wet-type cleaner which uses a cassette with a fabric belt to clean the tape head. This type of cleaning cassette will not eject on its own. A non-scrubbing action cleaner may not clean as thoroughly as the scrubbing type cleaner. The use of a non-scrubbing action, dry-type cleaning cassette is not recommended.

After you clean the player, press and hold EJECT for five seconds to reset the CLN indicator. The radio will display --- to show the indicator was reset.

Cassettes are subject to wear and the sound quality may degrade over time. Always make sure the cassette tape is in good condition before you have your tape player serviced.

Care of Your Compact Discs

Handle discs carefully. Store them in their original cases or other protective cases and away from direct sunlight and dust. If the surface of a disc is soiled, dampen a clean, soft cloth in a mild, neutral detergent solution and clean it, wiping from the center to the edge.

Be sure never to touch the signal surface when handling discs. Pick up discs by grasping the outer edges or the edge of the hole and the outer edge.

Care of Your Compact Disc Player

The use of CD lens cleaner discs is not advised, due to the risk of contaminating the lens of the CD optics with lubricants internal to the CD mechanism.

Heated Backlite Antenna

Your AM-FM antenna is integrated with your rear window defogger, located in the rear window. Be sure that the inside surface of the rear window is not scratched and that the lines on the glass are not damaged. If the inside surface is damaged, it could interfere with radio reception.

Do not apply aftermarket glass tinting. The metallic film in some tinting materials will interfere with or distort the incoming radio reception.

If, when you turn on your rear window defogger, you hear static on your radio station, it could mean that a defogger grid line has been damaged. If this is true, the grid line must be repaired.

If you choose to add a cellular telephone to your vehicle, and the antenna needs to be attached to the glass, be sure that you do not damage the grid lines for the AM-FM antenna. There's a specific location at the middle of the glass, near the top of the rear window, for you to attach a cellular telephone antenna. Be sure the antenna does not touch a grid line.

NOTICE:

Do not try to clear frost or other material from the inside of the rear window with a razor blade or anything else that is sharp. This may damage the rear defogger grid and affect your radio's ability to pick up stations clearly. The repairs wouldn't be covered by your warranty.



Section 4 Your Driving and the Road

Here you'll find information about driving on different kinds of roads and in varying weather conditions. We've also included many other useful tips on driving.

4-2	Defensive Driving	4-20	City Driving
4-3	Drunken Driving	4-21	Freeway Driving
4-6	Control of a Vehicle	4-22	Before Leaving on a Long Trip
4-6	Braking	4-23	Highway Hypnosis
4-10	Steering	4-23	Hill and Mountain Roads
4-12	Off-Road Recovery	4-25	Winter Driving
4-13	Passing	4-29	Recreational Vehicle Towing
4-14	Loss of Control	4-30	Loading Your Vehicle
4-15	Driving at Night	4-32	Towing a Trailer
4-17	Driving in Rain and on Wet Roads		



Defensive Driving

The best advice anyone can give about driving is:
Drive defensively.

Please start with a very important safety device in your vehicle: Buckle up. (See “Safety Belts” in the Index.)

Defensive driving really means “be ready for anything.” On city streets, rural roads or freeways, it means “always expect the unexpected.”

Assume that pedestrians or other drivers are going to be careless and make mistakes. Anticipate what they might do. Be ready for their mistakes.

Rear-end collisions are about the most preventable of accidents. Yet they are common. Allow enough following distance. It’s the best defensive driving maneuver, in both city and rural driving. You never know when the vehicle in front of you is going to brake or turn suddenly.

Defensive driving requires that a driver concentrate on the driving task. Anything that distracts from the driving task -- such as concentrating on a cellular telephone call, reading, or reaching for something on the floor -- makes proper defensive driving more difficult and can even cause a collision, with resulting injury. Ask a passenger to help do things like this, or pull off the road in a safe place to do them yourself. These simple defensive driving techniques could save your life.

Drunken Driving

Death and injury associated with drinking and driving is a national tragedy. It's the number one contributor to the highway death toll, claiming thousands of victims every year.

Alcohol affects four things that anyone needs to drive a vehicle:

- Judgment
- Muscular Coordination
- Vision
- Attentiveness.

Police records show that almost half of all motor vehicle-related deaths involve alcohol. In most cases, these deaths are the result of someone who was drinking and driving. In recent years, over 17,000 annual motor vehicle-related deaths have been associated with the use of alcohol, with more than 300,000 people injured.

Many adults -- by some estimates, nearly half the adult population -- choose never to drink alcohol, so they never drive after drinking. For persons under 21, it's against the law in every U.S. state to drink alcohol. There are good medical, psychological and developmental reasons for these laws.

The obvious way to solve the leading highway safety problem is for people never to drink alcohol and then drive. But what if people do? How much is "too much" if the driver plans to drive? It's a lot less than many might think. Although it depends on each person and situation, here is some general information on the problem.

The Blood Alcohol Concentration (BAC) of someone who is drinking depends upon four things:

- The amount of alcohol consumed
- The drinker's body weight
- The amount of food that is consumed before and during drinking
- The length of time it has taken the drinker to consume the alcohol.

According to the American Medical Association, a 180-lb. (82 kg) person who drinks three 12-ounce (355 ml) bottles of beer in an hour will end up with a BAC of about 0.06 percent. The person would reach the same BAC by drinking three 4-ounce (120 ml) glasses of wine or three mixed drinks if each had 1-1/2 ounces (45 ml) of a liquor like whiskey, gin or vodka.



It's the amount of alcohol that counts. For example, if the same person drank three double martinis (3 ounces or 90 ml of liquor each) within an hour, the person's BAC would be close to 0.12 percent. A person who consumes food just before or during drinking will have a somewhat lower BAC level.

There is a gender difference, too. Women generally have a lower relative percentage of body water than men.

Since alcohol is carried in body water, this means that a woman generally will reach a higher BAC level than a man of her same body weight when each has the same number of drinks.

The law in many U.S. states sets the legal limit at a BAC of 0.10 percent. In a growing number of U.S. states, and throughout Canada, the limit is 0.08 percent. In some other countries, it's even lower. The BAC limit for all commercial drivers in the United States is 0.04 percent.

The BAC will be over 0.10 percent after three to six drinks (in one hour). Of course, as we've seen, it depends on how much alcohol is in the drinks, and how quickly the person drinks them.

But the ability to drive is affected well below a BAC of 0.10 percent. Research shows that the driving skills of many people are impaired at a BAC approaching 0.05 percent, and that the effects are worse at night. All drivers are impaired at BAC levels above 0.05 percent. Statistics show that the chance of being in a collision increases sharply for drivers who have a BAC of 0.05 percent or above. A driver with a BAC level of 0.06 percent has doubled his or her chance of having a collision. At a BAC level of 0.10 percent, the chance of this driver having a collision is 12 times greater; at a level of 0.15 percent, the chance is 25 times greater!

The body takes about an hour to rid itself of the alcohol in one drink. No amount of coffee or number of cold showers will speed that up. "I'll be careful" isn't the right answer. What if there's an emergency, a need to take sudden action, as when a child darts into the street? A person with even a moderate BAC might not be able to react quickly enough to avoid the collision.

There's something else about drinking and driving that many people don't know. Medical research shows that alcohol in a person's system can make crash injuries worse, especially injuries to the brain, spinal cord or heart. This means that when anyone who has been drinking -- driver or passenger -- is in a crash, that person's chance of being killed or permanently disabled is higher than if the person had not been drinking.

 **CAUTION:**

Drinking and then driving is very dangerous. Your reflexes, perceptions, attentiveness and judgment can be affected by even a small amount of alcohol. You can have a serious -- or even fatal -- collision if you drive after drinking. Please don't drink and drive or ride with a driver who has been drinking. Ride home in a cab; or if you're with a group, designate a driver who will not drink.

Control of a Vehicle

You have three systems that make your vehicle go where you want it to go. They are the brakes, the steering and the accelerator. All three systems have to do their work at the places where the tires meet the road.

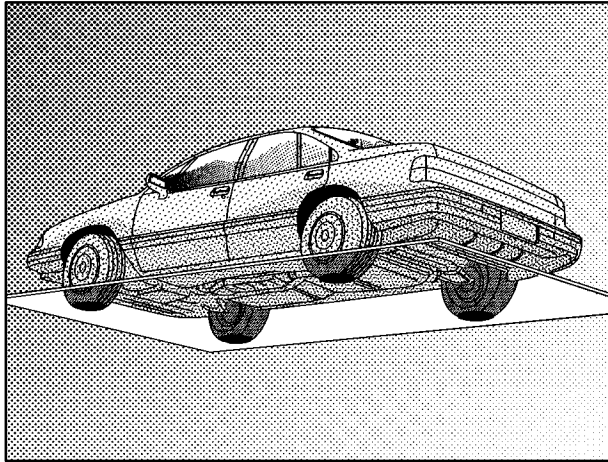

Sometimes, as when you're driving on snow or ice, it's easy to ask more of those control systems than the tires and road can provide. That means you can lose control of your vehicle.

Braking

Braking action involves *perception time* and *reaction time*.

First, you have to decide to push on the brake pedal. That's *perception time*. Then you have to bring up your foot and do it. That's *reaction time*.

Average *reaction time* is about $\frac{3}{4}$ of a second. But that's only an average. It might be less with one driver and as long as two or three seconds or more with another. Age, physical condition, alertness, coordination and eyesight all play a part. So do alcohol, drugs and frustration. But even in $\frac{3}{4}$ of a second, a vehicle moving at 60 mph (100 km/h) travels 66 feet (20 m). That could be a lot of distance in an emergency, so keeping enough space between your vehicle and others is important.

And, of course, actual stopping distances vary greatly with the surface of the road (whether it's pavement or gravel); the condition of the road (wet, dry, icy); tire tread; the condition of your brakes; the weight of the vehicle and the amount of brake force applied.

Avoid needless heavy braking. Some people drive in spurts -- heavy acceleration followed by heavy braking -- rather than keeping pace with traffic. This is a mistake. Your brakes may not have time to cool between hard stops. Your brakes will wear out much faster if you do a lot of heavy braking. If you keep pace with the traffic and allow realistic following distances, you will eliminate a lot of unnecessary braking. That means better braking and longer brake life.

If your engine ever stops while you're driving, brake normally but don't pump your brakes. If you do, the pedal may get harder to push down. If your engine stops, you will still have some power brake assist. But you will use it when you brake. Once the power assist is used up, it may take longer to stop and the brake pedal will be harder to push.

Anti-Lock Brakes (ABS)

Your vehicle has anti-lock brakes (ABS). ABS is an advanced electronic braking system that will help prevent a braking skid.

When you start your engine, or when you begin to drive away, your anti-lock brake system will check itself. You may hear a momentary motor or clicking noise while this test is going on, and you may even notice that your brake pedal moves or pulses a little. This is normal.

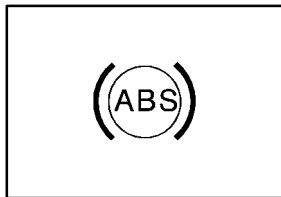

If there's a problem with the anti-lock brake system, this warning light will stay on. See "Anti-Lock Brake System Warning Light" in the Index.



Here's how anti-lock works. Let's say the road is wet. You're driving safely. Suddenly an animal jumps out in front of you.

You slam on the brakes. Here's what happens with ABS.

A computer senses that wheels are slowing down. If one of the wheels is about to stop rolling, the computer will separately work the brakes at each front wheel and at both rear wheels.

The anti-lock system can change the brake pressure faster than any driver could. The computer is programmed to make the most of available tire and road conditions.



You can steer around the obstacle while braking hard.

As you brake, your computer keeps receiving updates on wheel speed and controls braking pressure accordingly.

Remember: Anti-lock doesn't change the time you need to get your foot up to the brake pedal or always decrease stopping distance. If you get too close to the vehicle in front of you, you won't have time to apply your brakes if that vehicle suddenly slows or stops. Always leave enough room up ahead to stop, even though you have anti-lock brakes.

Using Anti-Lock

Don't pump the brakes. Just hold the brake pedal down firmly and let anti-lock work for you. You may feel a slight brake pedal pulsation or notice some noise, but this is normal.

Traction Control System (If Equipped)

Your vehicle may have a traction control system that limits wheel spin. This is especially useful in slippery road conditions. The system operates only if it senses that one or both of the front wheels are spinning or beginning to lose traction. When this happens, the system works the front brakes and reduces engine power to limit wheel spin.

You may feel or hear the system working, but this is normal.

If your vehicle is in cruise control when the traction control system begins to limit wheel spin, the cruise control will automatically disengage. When road conditions allow you to safely use it again, you may reengage the cruise control. (See "Cruise Control" in the Index.)

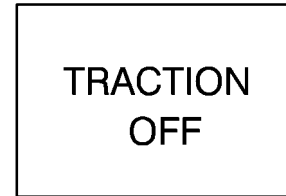

This light should come on briefly when you start the engine. If it stays on or comes on while you are driving, there's a problem with your traction control system.

See "Traction Control System Warning Light" in the Index. When this warning light is on, the system will not limit wheel spin. Adjust your driving accordingly.

The traction control system automatically comes on whenever you start your vehicle. To limit wheel spin, especially in slippery road conditions, you should always leave the system on. But you can turn the traction control system off if you ever need to. (You should turn the system off if your vehicle ever gets stuck in sand, mud, ice or snow. See "Rocking Your Vehicle" in the Index.)



To turn the system off, press the TRACTION CONTROL button on the instrument panel to the left of the steering wheel.

The traction control system warning light will come on and stay on. If the system is limiting wheel spin when you press the button, the warning light will come on -- but the system won't turn off right away. It will wait until there's no longer a current need to limit wheel spin.

You can turn the system back on at any time by pressing the button again. The traction control system warning light should go off.

Braking in Emergencies

With anti-lock, you can steer and brake at the same time. In many emergencies, steering can help you more than even the very best braking.

Steering

Power Steering

If you lose power steering assist because the engine stops or the system is not functioning, you can steer but it will take much more effort.

Magnasteer[®] (If Equipped)

Your vehicle may be equipped with GM Magnasteer, a steering system that continuously adjusts the effort you feel when steering at all vehicle speeds. It provides ease when parking, yet a firm, solid feel at highway speeds. Your steering can be adjusted for an easier or more firm setting. See your dealer for information.

Steering Tips

Driving on Curves

It's important to take curves at a reasonable speed.

A lot of the "driver lost control" accidents mentioned on the news happen on curves. Here's why:

Experienced driver or beginner, each of us is subject to the same laws of physics when driving on curves. The traction of the tires against the road surface makes it possible for the vehicle to change its path when you turn the front wheels. If there's no traction, inertia will keep the vehicle going in the same direction. If you've ever tried to steer a vehicle on wet ice, you'll understand this.

The traction you can get in a curve depends on the condition of your tires and the road surface, the angle at which the curve is banked, and your speed. While you're in a curve, speed is the one factor you can control.

Suppose you're steering through a sharp curve. Then you suddenly accelerate. Both control systems -- steering and acceleration -- have to do their work where the tires meet the road. Adding the sudden acceleration can demand too much of those places. You can lose control. Refer to "Traction Control" in the Index.

What should you do if this ever happens? Ease up on the accelerator pedal, steer the vehicle the way you want it to go, and slow down.

Speed limit signs near curves warn that you should adjust your speed. Of course, the posted speeds are based on good weather and road conditions. Under less favorable conditions you'll want to go slower.

If you need to reduce your speed as you approach a curve, do it before you enter the curve, while your front wheels are straight ahead.

Try to adjust your speed so you can "drive" through the curve. Maintain a reasonable, steady speed. Wait to accelerate until you are out of the curve, and then accelerate gently into the straightaway.

Steering in Emergencies

There are times when steering can be more effective than braking. For example, you come over a hill and find a truck stopped in your lane, or a car suddenly pulls out from nowhere, or a child darts out from between parked cars and stops right in front of you. You can avoid these problems by braking -- if you can stop in time. But sometimes you can't; there isn't room. That's the time for evasive action -- steering around the problem.

Your vehicle can perform very well in emergencies like these. First apply your brakes. (See "Braking in Emergencies" earlier in this section.) It is better to remove as much speed as you can from a possible collision. Then steer around the problem, to the left or right depending on the space available.

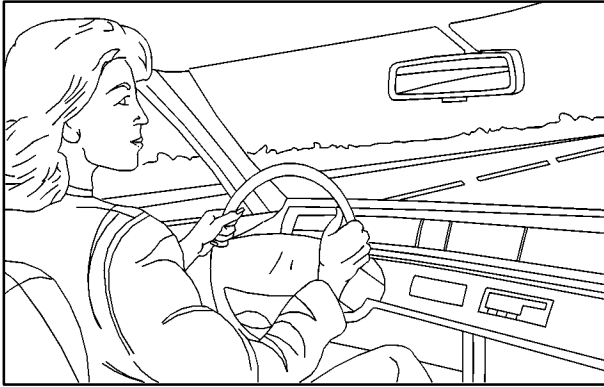

An emergency like this requires close attention and a quick decision. If you are holding the steering wheel at the recommended 9 and 3 o'clock positions, you can turn it a full 180 degrees very quickly without removing either hand. But you have to act fast, steer quickly, and just as quickly straighten the wheel once you have avoided the object.

The fact that such emergency situations are always possible is a good reason to practice defensive driving at all times and wear safety belts properly.

Off-Road Recovery

You may find that your right wheels have dropped off the edge of a road onto the shoulder while you're driving.

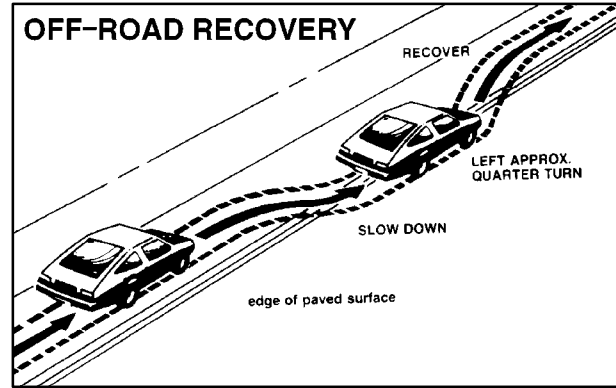

If the level of the shoulder is only slightly below the pavement, recovery should be fairly easy. Ease off the accelerator and then, if there is nothing in the way, steer so that your vehicle straddles the edge of the pavement. You can turn the steering wheel up to one-quarter turn until the right front tire contacts the pavement edge. Then turn your steering wheel to go straight down the roadway.

Passing

The driver of a vehicle about to pass another on a two-lane highway waits for just the right moment, accelerates, moves around the vehicle ahead, then goes back into the right lane again. A simple maneuver?

Not necessarily! Passing another vehicle on a two-lane highway is a potentially dangerous move, since the passing vehicle occupies the same lane as oncoming traffic for several seconds. A miscalculation, an error in judgment, or a brief surrender to frustration or anger can suddenly put the passing driver face to face with the worst of all traffic accidents -- the head-on collision.

So here are some tips for passing:

- “Drive ahead.” Look down the road, to the sides and to crossroads for situations that might affect your passing patterns. If you have any doubt whatsoever about making a successful pass, wait for a better time.
- Watch for traffic signs, pavement markings and lines. If you can see a sign up ahead that might indicate a turn or an intersection, delay your pass. A broken center line usually indicates it’s all right to pass (providing the road ahead is clear). Never cross a solid line on your side of the lane or a double solid line, even if the road seems empty of approaching traffic.
- Do not get too close to the vehicle you want to pass while you’re awaiting an opportunity. For one thing, following too closely reduces your area of vision, especially if you’re following a larger vehicle. Also, you won’t have adequate space if the vehicle ahead suddenly slows or stops. Keep back a reasonable distance.
- When it looks like a chance to pass is coming up, start to accelerate but stay in the right lane and don’t get too close. Time your move so you will be increasing speed as the time comes to move into the other lane. If the way is clear to pass, you will have a “running start” that more than makes up for the distance you would lose by dropping back. And if something happens to cause you to cancel your pass, you need only slow down and drop back again and wait for another opportunity.
- If other cars are lined up to pass a slow vehicle, wait your turn. But take care that someone isn’t trying to pass you as you pull out to pass the slow vehicle. Remember to glance over your shoulder and check the blind spot.

- Check your mirrors, glance over your shoulder, and start your left lane change signal before moving out of the right lane to pass. When you are far enough ahead of the passed vehicle to see its front in your inside mirror, activate your right lane change signal and move back into the right lane. (Remember that your right outside mirror is convex. The vehicle you just passed may seem to be farther away from you than it really is.)
- Try not to pass more than one vehicle at a time on two-lane roads. Reconsider before passing the next vehicle.
- Don't overtake a slowly moving vehicle too rapidly. Even though the brake lamps are not flashing, it may be slowing down or starting to turn.
- If you're being passed, make it easy for the following driver to get ahead of you. Perhaps you can ease a little to the right.

Loss of Control

Let's review what driving experts say about what happens when the three control systems (brakes, steering and acceleration) don't have enough friction where the tires meet the road to do what the driver has asked.

In any emergency, don't give up. Keep trying to steer and constantly seek an escape route or area of less danger.

Skidding

In a skid, a driver can lose control of the vehicle. Defensive drivers avoid most skids by taking reasonable care suited to existing conditions, and by not "overdriving" those conditions. But skids are always possible.

The three types of skids correspond to your vehicle's three control systems. In the braking skid, your wheels aren't rolling. In the steering or cornering skid, too much speed or steering in a curve causes tires to slip and lose cornering force. And in the acceleration skid, too much throttle causes the driving wheels to spin.

A cornering skid is best handled by easing your foot off the accelerator pedal.

If you have the traction control system, remember: It helps avoid only the acceleration skid.

If you do not have traction control, or if the system is off, then an acceleration skid is also best handled by easing your foot off the accelerator pedal.

If your vehicle starts to slide, ease your foot off the accelerator pedal and quickly steer the way you want the vehicle to go. If you start steering quickly enough, your vehicle may straighten out. Always be ready for a second skid if it occurs.

Of course, traction is reduced when water, snow, ice, gravel or other material is on the road. For safety, you'll want to slow down and adjust your driving to these conditions. It is important to slow down on slippery surfaces because stopping distance will be longer and vehicle control more limited.

While driving on a surface with reduced traction, try your best to avoid sudden steering, acceleration or braking (including engine braking by shifting to a lower gear). Any sudden changes could cause the tires to slide. You may not realize the surface is slippery until your vehicle is skidding. Learn to recognize warning clues -- such as enough water, ice or packed snow on the road to make a "mirrored surface" -- and slow down when you have any doubt.

Remember: Any anti-lock brake system (ABS) helps avoid only the braking skid.

Driving at Night

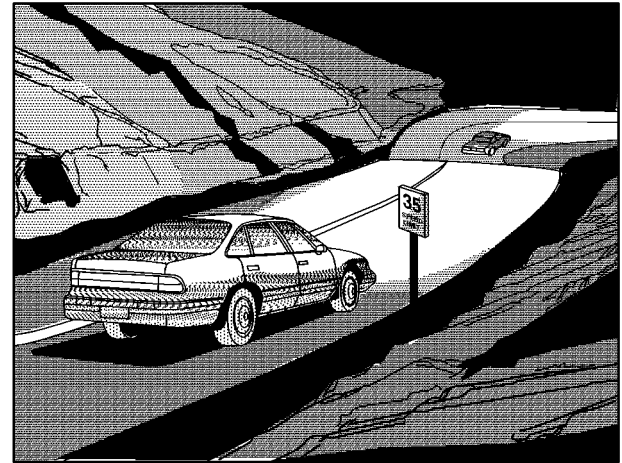

Night driving is more dangerous than day driving. One reason is that some drivers are likely to be impaired -- by alcohol or drugs, with night vision problems, or by fatigue.

Here are some tips on night driving.

- Drive defensively.
- Don't drink and drive.
- Adjust your inside rearview mirror to reduce the glare from headlamps behind you.
- Since you can't see as well, you may need to slow down and keep more space between you and other vehicles.
- Slow down, especially on higher speed roads. Your headlamps can light up only so much road ahead.
- In remote areas, watch for animals.
- If you're tired, pull off the road in a safe place and rest.

Night Vision

No one can see as well at night as in the daytime. But as we get older these differences increase. A 50-year-old driver may require at least twice as much light to see the same thing at night as a 20-year-old.

What you do in the daytime can also affect your night vision. For example, if you spend the day in bright sunshine you are wise to wear sunglasses. Your eyes will have less trouble adjusting to night. But if you're driving, don't wear sunglasses at night. They may cut

down on glare from headlamps, but they also make a lot of things invisible.

You can be temporarily blinded by approaching headlamps. It can take a second or two, or even several seconds, for your eyes to readjust to the dark. When you are faced with severe glare (as from a driver who doesn't lower the high beams, or a vehicle with misaimed headlamps), slow down a little. Avoid staring directly into the approaching headlamps.

Keep your windshield and all the glass on your vehicle clean -- inside and out. Glare at night is made much worse by dirt on the glass. Even the inside of the glass can build up a film caused by dust. Dirty glass makes lights dazzle and flash more than clean glass would, making the pupils of your eyes contract repeatedly.

Remember that your headlamps light up far less of a roadway when you are in a turn or curve. Keep your eyes moving; that way, it's easier to pick out dimly lighted objects. Just as your headlamps should be checked regularly for proper aim, so should your eyes be examined regularly. Some drivers suffer from night blindness -- the inability to see in dim light -- and aren't even aware of it.

Driving in Rain and on Wet Roads

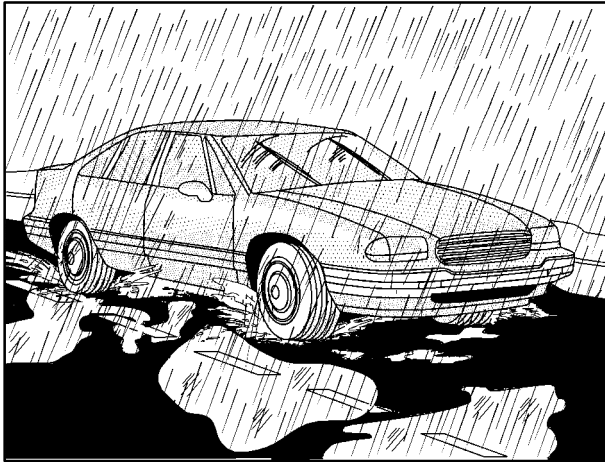

Rain and wet roads can mean driving trouble. On a wet road, you can't stop, accelerate or turn as well because your tire-to-road traction isn't as good as on dry roads. And, if your tires don't have much tread left, you'll get even less traction. It's always wise to go slower and be cautious if rain starts to fall while you are driving. The surface may get wet suddenly when your reflexes are tuned for driving on dry pavement.

The heavier the rain, the harder it is to see. Even if your windshield wiper blades are in good shape, a heavy rain can make it harder to see road signs and traffic signals, pavement markings, the edge of the road and even people walking.

It's wise to keep your windshield wiping equipment in good shape and keep your windshield washer tank filled with washer fluid. Replace your windshield wiper inserts when they show signs of streaking or missing areas on the windshield, or when strips of rubber start to separate from the inserts.



⚠ CAUTION:

Wet brakes can cause accidents. They won't work as well in a quick stop and may cause pulling to one side. You could lose control of the vehicle.

After driving through a large puddle of water or a car wash, apply your brake pedal lightly until your brakes work normally.

Driving too fast through large water puddles or even going through some car washes can cause problems, too. The water may affect your brakes. Try to avoid puddles. But if you can't, try to slow down before you hit them.

Hydroplaning

Hydroplaning is dangerous. So much water can build up under your tires that they can actually ride on the water. This can happen if the road is wet enough and you're going fast enough. When your vehicle is hydroplaning, it has little or no contact with the road.

Hydroplaning doesn't happen often. But it can if your tires do not have much tread or if the pressure in one or more is low. It can happen if a lot of water is standing on the road. If you can see reflections from trees, telephone poles or other vehicles, and raindrops "dimple" the water's surface, there could be hydroplaning.

Hydroplaning usually happens at higher speeds. There just isn't a hard and fast rule about hydroplaning. The best advice is to slow down when it is raining.

Driving Through Deep Standing Water

NOTICE:

If you drive too quickly through deep puddles or standing water, water can come in through your engine's air intake and badly damage your engine. Never drive through water that is slightly lower than the underbody of your vehicle. If you can't avoid deep puddles or standing water, drive through them very slowly.

Some Other Rainy Weather Tips

- Besides slowing down, allow some extra following distance. And be especially careful when you pass another vehicle. Allow yourself more clear room ahead, and be prepared to have your view restricted by road spray.
- Have good tires with proper tread depth. (See "Tires" in the Index.)

City Driving



One of the biggest problems with city streets is the amount of traffic on them. You'll want to watch out for what the other drivers are doing and pay attention to traffic signals.

Here are ways to increase your safety in city driving:

- Know the best way to get to where you are going. Get a city map and plan your trip into an unknown part of the city just as you would for a cross-country trip.
- Try to use the freeways that rim and crisscross most large cities. You'll save time and energy. (See the next part, "Freeway Driving.")
- Treat a green light as a warning signal. A traffic light is there because the corner is busy enough to need it. When a light turns green, and just before you start to move, check both ways for vehicles that have not cleared the intersection or may be running the red light.

Freeway Driving



Mile for mile, freeways (also called thruways, parkways, expressways, turnpikes or superhighways) are the safest of all roads. But they have their own special rules.

The most important advice on freeway driving is: Keep up with traffic and keep to the right. Drive at the same speed most of the other drivers are driving. Too-fast or too-slow driving breaks a smooth traffic flow. Treat the left lane on a freeway as a passing lane.

At the entrance, there is usually a ramp that leads to the freeway. If you have a clear view of the freeway as you drive along the entrance ramp, you should begin to check traffic. Try to determine where you expect to blend with the flow. Try to merge into the gap at close to the prevailing speed. Switch on your turn signal, check your mirrors and glance over your shoulder as often as necessary. Try to blend smoothly with the traffic flow.

Once you are on the freeway, adjust your speed to the posted limit or to the prevailing rate if it's slower. Stay in the right lane unless you want to pass.

Before changing lanes, check your mirrors. Then use your turn signal.

Just before you leave the lane, glance quickly over your shoulder to make sure there isn't another vehicle in your "blind" spot.

Once you are moving on the freeway, make certain you allow a reasonable following distance. Expect to move slightly slower at night.

When you want to leave the freeway, move to the proper lane well in advance. If you miss your exit, do not, under any circumstances, stop and back up. Drive on to the next exit.

The exit ramp can be curved, sometimes quite sharply.

The exit speed is usually posted.

Reduce your speed according to your speedometer, not to your sense of motion. After driving for any distance at higher speeds, you may tend to think you are going slower than you actually are.

Before Leaving on a Long Trip

Make sure you're ready. Try to be well rested. If you must start when you're not fresh -- such as after a day's work -- don't plan to make too many miles that first part of the journey. Wear comfortable clothing and shoes you can easily drive in.

Is your vehicle ready for a long trip? If you keep it serviced and maintained, it's ready to go. If it needs service, have it done before starting out. Of course, you'll find experienced and able service experts in Buick dealerships all across North America. They'll be ready and willing to help if you need it.

Here are some things you can check before a trip:

- *Windshield Washer Fluid*: Is the reservoir full? Are all windows clean inside and outside?
- *Wiper Blades*: Are they in good shape?
- *Fuel, Engine Oil, Other Fluids*: Have you checked all levels?
- *Lamps*: Are they all working? Are the lenses clean?
- *Tires*: They are vitally important to a safe, trouble-free trip. Is the tread good enough for long-distance driving? Are the tires all inflated to the recommended pressure?
- *Weather Forecasts*: What's the weather outlook along your route? Should you delay your trip a short time to avoid a major storm system?
- *Maps*: Do you have up-to-date maps?

Highway Hypnosis

Is there actually such a condition as “highway hypnosis”? Or is it just plain falling asleep at the wheel? Call it highway hypnosis, lack of awareness, or whatever.

There is something about an easy stretch of road with the same scenery, along with the hum of the tires on the road, the drone of the engine, and the rush of the wind against the vehicle that can make you sleepy. Don't let it happen to you! If it does, your vehicle can leave the road in *less than a second*, and you could crash and be injured.

What can you do about highway hypnosis? First, be aware that it can happen.

Then here are some tips:

- Make sure your vehicle is well ventilated, with a comfortably cool interior.
- Keep your eyes moving. Scan the road ahead and to the sides. Check your rearview mirrors and your instruments frequently.
- If you get sleepy, pull off the road into a rest, service or parking area and take a nap, get some exercise, or both. For safety, treat drowsiness on the highway as an emergency.

Hill and Mountain Roads



Driving on steep hills or mountains is different from driving in flat or rolling terrain.

If you drive regularly in steep country, or if you're planning to visit there, here are some tips that can make your trips safer and more enjoyable.

- Keep your vehicle in good shape. Check all fluid levels and also the brakes, tires, cooling system and transaxle. These parts can work hard on mountain roads.
- Know how to go down hills. The most important thing to know is this: let your engine do some of the slowing down. Shift to a lower gear when you go down a steep or long hill.

 **CAUTION:**

If you don't shift down, your brakes could get so hot that they wouldn't work well. You would then have poor braking or even none going down a hill. You could crash. Shift down to let your engine assist your brakes on a steep downhill slope.

 **CAUTION:**

Coasting downhill in NEUTRAL (N) or with the ignition off is dangerous. Your brakes will have to do all the work of slowing down. They could get so hot that they wouldn't work well. You would then have poor braking or even none going down a hill. You could crash. Always have your engine running and your vehicle in gear when you go downhill.

- Know how to go uphill. Drive in the highest gear possible.
- Stay in your own lane when driving on two-lane roads in hills or mountains. Don't swing wide or cut across the center of the road. Drive at speeds that let you stay in your own lane.
- As you go over the top of a hill, be alert. There could be something in your lane, like a stalled car or an accident.
- You may see highway signs on mountains that warn of special problems. Examples are long grades, passing or no-passing zones, a falling rocks area or winding roads. Be alert to these and take appropriate action.

Winter Driving



Here are some tips for winter driving:

- Have your vehicle in good shape for winter.
- You may want to put winter emergency supplies in your trunk.



Include an ice scraper, a small brush or broom, a supply of windshield washer fluid, a rag, some winter outer clothing, a small shovel, a flashlight, a red cloth and a couple of reflective warning triangles. And, if you will be driving under severe conditions, include a small bag of sand, a piece of old carpet or a couple of burlap bags to help provide traction. Be sure you properly secure these items in your vehicle.

Driving on Snow or Ice

Most of the time, those places where your tires meet the road probably have good traction.

However, if there is snow or ice between your tires and the road, you can have a very slippery situation. You'll have a lot less traction or "grip" and will need to be very careful.

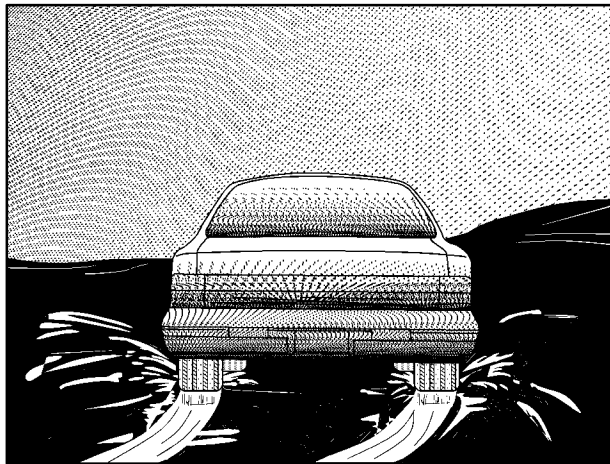

What's the worst time for this? "Wet ice." Very cold snow or ice can be slick and hard to drive on. But wet ice can be even more trouble because it may offer the least traction of all. You can get wet ice when it's about freezing (32°F; 0°C) and freezing rain begins to fall. Try to avoid driving on wet ice until salt and sand crews can get there.

Whatever the condition -- smooth ice, packed, blowing or loose snow -- drive with caution.

If you have traction control, keep the system on. It will improve your ability to accelerate when driving on a slippery road. Even though your vehicle has a traction control system, you'll want to slow down and adjust your driving to the road conditions. See "Traction Control System" in the Index.

If you don't have the traction control system, accelerate gently. Try not to break the fragile traction. If you accelerate too fast, the drive wheels will spin and polish the surface under the tires even more.

Your anti-lock brakes improve your vehicle's stability when you make a hard stop on a slippery road. Even though you have the anti-lock braking system, you'll want to begin stopping sooner than you would on dry pavement. See "Anti-Lock" in the Index.

- Allow greater following distance on any slippery road.
- Watch for slippery spots. The road might be fine until you hit a spot that's covered with ice. On an otherwise clear road, ice patches may appear in shaded areas where the sun can't reach: around clumps of trees, behind buildings or under bridges. Sometimes the surface of a curve or an overpass may remain icy when the surrounding roads are clear. If you see a patch of ice ahead of you, brake before you are on it. Try not to brake while you're actually on the ice, and avoid sudden steering maneuvers.

If You're Caught in a Blizzard

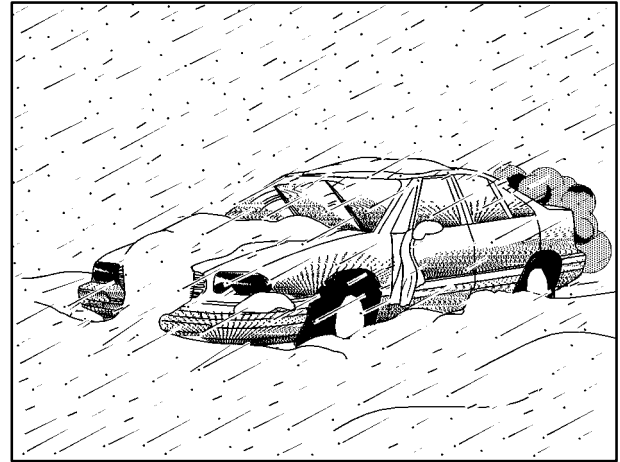

If you are stopped by heavy snow, you could be in a serious situation. You should probably stay with your vehicle unless you know for sure that you are near help and you can hike through the snow. Here are some things to do to summon help and keep yourself and your passengers safe:

- Turn on your hazard flashers.

- Tie a red cloth to your vehicle to alert police that you've been stopped by the snow.
- Put on extra clothing or wrap a blanket around you. If you have no blankets or extra clothing, make body insulators from newspapers, burlap bags, rags, floor mats -- anything you can wrap around yourself or tuck under your clothing to keep warm.

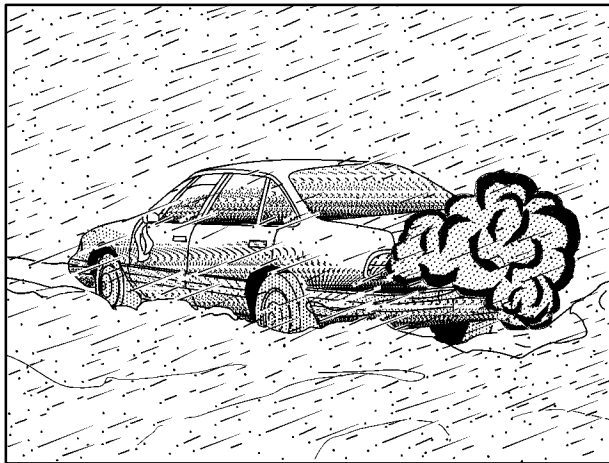

You can run the engine to keep warm, but be careful.

CAUTION:

Snow can trap exhaust gases under your vehicle. This can cause deadly CO (carbon monoxide) gas to get inside. CO could overcome you and kill you. You can't see it or smell it, so you might not know it is in your vehicle. Clear away snow from around the base of your vehicle, especially any that is blocking your exhaust pipe. And check around again from time to time to be sure snow doesn't collect there.

Open a window just a little on the side of the vehicle that's away from the wind. This will help keep CO out.

Run your engine only as long as you must. This saves fuel. When you run the engine, make it go a little faster than just idle. That is, push the accelerator slightly. This uses less fuel for the heat that you get and it keeps the battery charged. You will need a well-charged battery to restart the vehicle, and possibly for signaling later on with your headlamps. Let the heater run for a while.

Then, shut the engine off and close the window almost all the way to preserve the heat. Start the engine again and repeat this only when you feel really uncomfortable from the cold. But do it as little as possible. Preserve the fuel as long as you can. To help keep warm, you can get out of the vehicle and do some fairly vigorous exercises every half hour or so until help comes.

Recreational Vehicle Towing

You can tow your vehicle behind another vehicle for use at your destination. Be sure to use the proper towing equipment designed for recreational towing. Follow the instructions for the towing equipment.

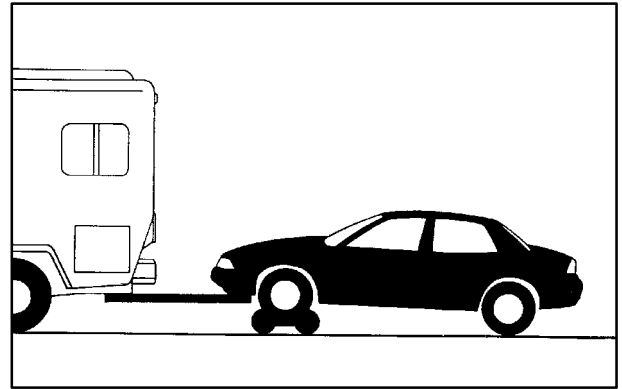

To tow your vehicle, follow these steps:

1. Put the front wheels on a dolly.
2. Put the vehicle in PARK (P).
3. Set the parking brake and then remove the key.
4. Clamp the steering wheel in a straight-ahead position with a clamping device designed for towing.
5. Release the parking brake.

Loading Your Vehicle

GM TIRE - LOADING INFORMATION

OCCUPANTS VEHICLE CAP. WT. (KG) (LBS)

FRT. CTR. RR. TOTAL

MAX. LOADING @ GVWR SAME AS VEHICLE CAPACITY WEIGHT

199

MODEL:

TIRE SIZE SPEED TC. COLD TIRE PRESSURE

FRT.

RR.

INCHES ARE NOT. ADD 28KPA(4LBS)

SEE OWNER'S MANUAL FOR MORE INFORMATION

Two labels on your vehicle show how much weight it may properly carry. The Tire-Loading Information label found on the rear edge of the driver's door tells you the proper size, speed rating and recommended inflation pressures for the tires on your vehicle. It also gives you important information about the number of people that can be in your vehicle and the total weight that you can carry. This weight is called the vehicle capacity weight and includes the weight of all occupants, cargo and all nonfactory-installed options.

GM MFD BY GENERAL MOTORS CORP

DATE GVWR GAWR FRT GVWR RR

THIS VEHICLE CONFORMS TO ALL APPLICABLE U.S. FEDERAL MOTOR VEHICLE SAFETY, BUMPER, AND TRAILER PREVENTION STANDARDS IN EFFECT ON THE DATE OF MANUFACTURE SHOWN ABOVE.

199

TYPE:

The other label is the Certification label, found on the rear edge of the driver's door. It tells you the gross weight capacity of your vehicle, called the Gross Vehicle Weight Rating (GVWR). The GVWR includes the weight of the vehicle, all occupants, fuel and cargo. Never exceed the GVWR for your vehicle, or the Gross Axle Weight Rating (GAWR) for either the front or rear axle.

And, if you do have a heavy load, you should spread it out. Don't carry more than 176 lbs. (80 kg) in your trunk.

⚠ CAUTION:

Do not load your vehicle any heavier than the GVWR, or either the maximum front or rear GAWR. If you do, parts on your vehicle can break, and it can change the way your vehicle handles. These could cause you to lose control and crash. Also, overloading can shorten the life of your vehicle.

NOTICE:

Your warranty does not cover parts or components that fail because of overloading.

If you put things inside your vehicle -- like suitcases, tools, packages, or anything else -- they will go as fast as the vehicle goes. If you have to stop or turn quickly, or if there is a crash, they'll keep going.

⚠ CAUTION:

Things you put inside your vehicle can strike and injure people in a sudden stop or turn, or in a crash.

- Put things in the trunk of your vehicle. In a trunk, put them as far forward as you can. Try to spread the weight evenly.
- Never stack heavier things, like suitcases, inside the vehicle so that some of them are above the tops of the seats.
- Don't leave an unsecured child restraint in your vehicle.
- When you carry something inside the vehicle, secure it whenever you can.

Electronic Level Control (If Equipped)

This feature keeps the rear of your vehicle level as the load changes. It is automatic -- you do not need to adjust anything.

Towing a Trailer

CAUTION:

If you don't use the correct equipment and drive properly, you can lose control when you pull a trailer. For example, if the trailer is too heavy, the brakes may not work well -- or even at all. You and your passengers could be seriously injured. You may also damage your vehicle; the resulting repairs would not be covered by your warranty. Pull a trailer only if you have followed all the steps in this section. Ask your dealer for advice and information about towing a trailer with your vehicle.

Your vehicle can tow a trailer if it is equipped with the proper trailer towing equipment. To identify what the vehicle trailering capacity is for your vehicle, you should read the information in “Weight of the Trailer” that appears later in this section. But trailering is different than just driving your vehicle by itself. Trailering means changes in handling, durability and fuel economy. Successful, safe trailering takes correct equipment, and it has to be used properly.

That's the reason for this part. In it are many time-tested, important trailering tips and safety rules. Many of these are important for your safety and that of your passengers. So please read this section carefully before you pull a trailer.

Load-pulling components such as the engine, transaxle, wheel assemblies and tires are forced to work harder against the drag of the added weight. The engine is required to operate at relatively higher speeds and under greater loads, generating extra heat. What's more, the trailer adds considerably to wind resistance, increasing the pulling requirements.

If You Do Decide To Pull A Trailer

If you do, here are some important points:

- There are many different laws, including speed limit restrictions, having to do with trailering. Make sure your rig will be legal, not only where you live but also where you'll be driving. A good source for this information can be state or provincial police.
- Consider using a sway control. You can ask a hitch dealer about sway controls.
- Don't tow a trailer at all during the first 1,000 miles (1 600 km) your new vehicle is driven. Your engine, axle or other parts could be damaged.
- Then, during the first 500 miles (800 km) that you tow a trailer, don't drive over 50 mph (80 km/h) and don't make starts at full throttle. This helps your engine and other parts of your vehicle wear in at the heavier loads.
- Obey speed limit restrictions when towing a trailer. Don't drive faster than the maximum posted speed for trailers (or no more than 55 mph (90 km/h)) to save wear on your vehicle's parts.

Three important considerations have to do with weight:

- the weight of the trailer,
- the weight of the trailer tongue
- and the total weight on your vehicle's tires.

Weight of the Trailer

How heavy can a trailer safely be?

It should never weigh more than 1,000 lbs. (450 kg). But even that can be too heavy.

It depends on how you plan to use your rig. For example, speed, altitude, road grades, outside temperature and how much your vehicle is used to pull a trailer are all important. And, it can also depend on any special equipment that you have on your vehicle.

You can ask your dealer for our trailering information or advice, or you can write us at:

Buick Motor Division,
Customer Relations Center
902 E. Hamilton Avenue
Flint, MI 48550

In Canada, write to:

General Motors of Canada Limited
Customer Communication Centre
1908 Colonel Sam Drive
Oshawa, Ontario L1H 8P7

Weight of the Trailer Tongue

The tongue load (A) of any trailer is an important weight to measure because it affects the total or gross weight of your vehicle. The Gross Vehicle Weight (GVW) includes the curb weight of the vehicle, any cargo you may carry in it, and the people who will be riding in the vehicle. And if you tow a trailer, you must add the tongue load to the GVW because your vehicle will be carrying that weight, too. See “Loading Your Vehicle” in the Index for more information about your vehicle’s maximum load capacity.

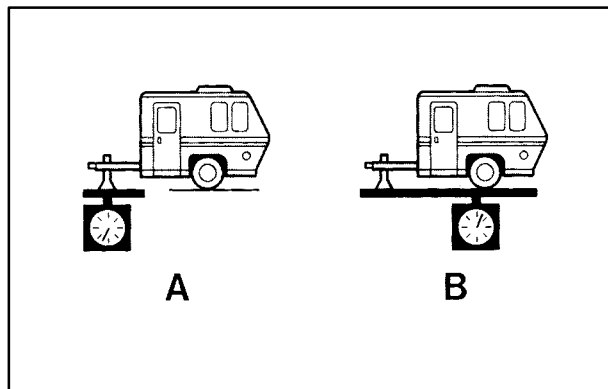

If you’re using a weight-carrying hitch, the trailer tongue (A) should weigh 10 percent of the total loaded trailer weight (B). If you have a weight-distributing hitch, the trailer tongue (A) should weigh 12 percent of the total loaded trailer weight (B).

After you’ve loaded your trailer, weigh the trailer and then the tongue, separately, to see if the weights are proper. If they aren’t, you may be able to get them right simply by moving some items around in the trailer.

Total Weight on Your Vehicle's Tires

Be sure your vehicle's tires are inflated to the upper limit for cold tires. You'll find these numbers on the Tire-Loading Information label located at the rear edge of the driver's door or see "Loading Your Vehicle" in the Index. Then be sure you don't go over the GVW limit for your vehicle, including the weight of the trailer tongue.

Hitches

It's important to have the correct hitch equipment. Crosswinds, large trucks going by and rough roads are a few reasons why you'll need the right hitch. Here are some rules to follow:

- The rear bumper on your vehicle is not intended for hitches. Do not attach rental hitches or other bumper-type hitches to it. Use only a frame-mounted hitch that does not attach to the bumper.
- Will you have to make any holes in the body of your vehicle when you install a trailer hitch? If you do, then be sure to seal the holes later when you remove the hitch. If you don't seal them, deadly carbon monoxide (CO) from your exhaust can get into your vehicle (see "Carbon Monoxide" in the Index). Dirt and water can, too.

Safety Chains

You should always attach chains between your vehicle and your trailer. Cross the safety chains under the tongue of the trailer so that the tongue will not drop to the road if it becomes separated from the hitch. Instructions about safety chains may be provided by the hitch manufacturer or by the trailer manufacturer. Follow the manufacturer's recommendation for attaching safety chains and do not attach them to the bumper. Always leave just enough slack so you can turn with your rig. And, never allow safety chains to drag on the ground.

Trailer Brakes

Does your trailer have its own brakes? Be sure to read and follow the instructions for the trailer brakes so you'll be able to install, adjust and maintain them properly.

Because you have anti-lock brakes, do not try to tap into your vehicle's brake system. If you do, both brake systems won't work well, or at all.

Driving with a Trailer

Towing a trailer requires a certain amount of experience. Before setting out for the open road, you'll want to get to know your rig. Acquaint yourself with the feel of handling and braking with the added weight of the trailer. And always keep in mind that the vehicle you are driving is now a good deal longer and not nearly as responsive as your vehicle is by itself.

Before you start, check the trailer hitch and platform (and attachments), safety chains, electrical connector, lamps, tires and mirror adjustment. If the trailer has electric brakes, start your vehicle and trailer moving and then apply the trailer brake controller by hand to be sure the brakes are working. This lets you check your electrical connection at the same time.

During your trip, check occasionally to be sure that the load is secure, and that the lamps and any trailer brakes are still working.

Following Distance

Stay at least twice as far behind the vehicle ahead as you would when driving your vehicle without a trailer. This can help you avoid situations that require heavy braking and sudden turns.

Passing

You'll need more passing distance up ahead when you're towing a trailer. And, because you're a good deal longer, you'll need to go much farther beyond the passed vehicle before you can return to your lane.

Backing Up

Hold the bottom of the steering wheel with one hand. Then, to move the trailer to the left, just move that hand to the left. To move the trailer to the right, move your hand to the right. Always back up slowly and, if possible, have someone guide you.

Making Turns

NOTICE:

Making very sharp turns while trailering could cause the trailer to come in contact with the vehicle. Your vehicle could be damaged. Avoid making very sharp turns while trailering.

When you're turning with a trailer, make wider turns than normal. Do this so your trailer won't strike soft shoulders, curbs, road signs, trees or other objects. Avoid jerky or sudden maneuvers. Signal well in advance.

Turn Signals When Towing a Trailer

When you tow a trailer, your vehicle may need a different turn signal flasher and/or extra wiring. Check with your dealer. The arrows on your instrument panel will flash whenever you signal a turn or lane change. Properly hooked up, the trailer lamps will also flash, telling other drivers you're about to turn, change lanes or stop.

When towing a trailer, the arrows on your instrument panel will flash for turns even if the bulbs on the trailer are burned out. Thus, you may think drivers behind you are seeing your signal when they are not. It's important to check occasionally to be sure the trailer bulbs are still working.

Your vehicle has bulb warning lights. When you plug a trailer lighting system into your vehicle's lighting system, its bulb warning lights may not let you know if one of your lamps goes out. So, when you have a trailer lighting system plugged in, be sure to check your vehicle and trailer lamps from time to time to be sure

they're all working. Once you disconnect the trailer lamps, the bulb warning lights again can tell you if one of your vehicle lamps is out.

Driving On Grades

Reduce speed and shift to a lower gear *before* you start down a long or steep downgrade. If you don't shift down, you might have to use your brakes so much that they would get hot and no longer work well.

Parking on Hills

CAUTION:

You really should not park your vehicle, with a trailer attached, on a hill. If something goes wrong, your rig could start to move. People can be injured, and both your vehicle and the trailer can be damaged.

But if you ever have to park your rig on a hill, here's how to do it:

1. Apply your regular brakes, but don't shift into PARK (P) yet.

2. Have someone place chocks under the trailer wheels.
3. When the wheel chocks are in place, release the regular brakes until the chocks absorb the load.
4. Reapply the regular brakes. Then apply your parking brake, and then shift to PARK (P).
5. Release the regular brakes.

When You Are Ready to Leave After Parking on a Hill

1. Apply your regular brakes and hold the pedal down while you:
 - Start your engine;
 - Shift into a gear; and
 - Release the parking brake.
2. Let up on the brake pedal.
3. Drive slowly until the trailer is clear of the chocks.
4. Stop and have someone pick up and store the chocks.

Maintenance When Trailer Towing

Your vehicle will need service more often when you're pulling a trailer. See the Maintenance Schedule for more on this. Things that are especially important in trailer operation are automatic transaxle fluid (don't overfill), engine oil, drive belts, cooling system and brake system. Each of these is covered in this manual, and the Index will help you find them quickly. If you're trailering, it's a good idea to review this information before you start your trip.

Check periodically to see that all hitch nuts and bolts are tight.

Engine Cooling When Trailer Towing

Your cooling system may temporarily overheat during severe operating conditions. See "Engine Overheating" in the Index.



Section 5 Problems on the Road

Here you'll find what to do about some problems that can occur on the road.

5-2 Hazard Warning Flashers
5-3 Other Warning Devices
5-3 Jump Starting
5-8 Towing Your Vehicle
5-9 Engine Overheating

5-12 Cooling System
5-19 If a Tire Goes Flat
5-20 Changing a Flat Tire
5-32 Compact Spare Tire
5-32 If You're Stuck: In Sand, Mud, Ice or Snow

Hazard Warning Flashers

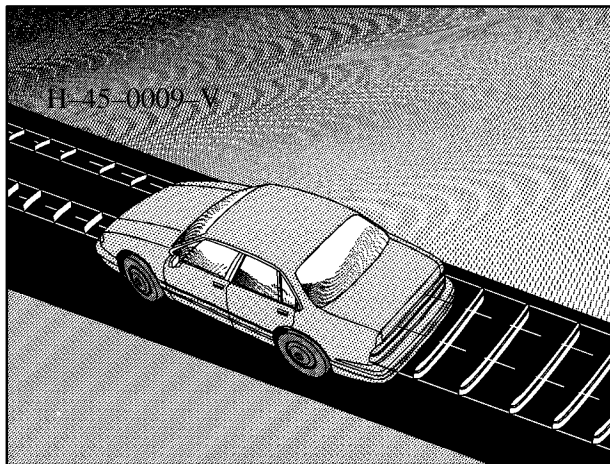

Your hazard warning flashers let you warn others. They also let police know you have a problem. Your front and rear turn signal lamps will flash on and off.

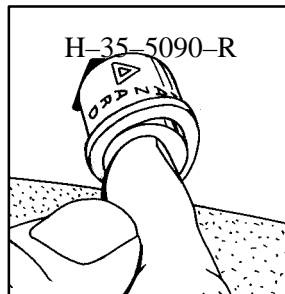

Press the button to make your front and rear turn signal lamps flash on and off.

Your hazard warning flashers work no matter what position your key is in, and even if the key isn't in.

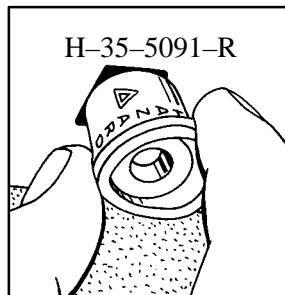

To turn off the flashers, pull out the collar.

When the hazard warning flashers are on, your turn signals won't work.

Other Warning Devices

If you carry reflective triangles, you can set one up at the side of the road about 300 feet (100 m) behind your vehicle.

Jump Starting

If your battery has run down, you may want to use another vehicle and some jumper cables to start your vehicle. But please use the following steps to do it safely.



CAUTION:

Batteries can hurt you. They can be dangerous because:

- They contain acid that can burn you.
- They contain gas that can explode or ignite.
- They contain enough electricity to burn you.

If you don't follow these steps exactly, some or all of these things can hurt you.

NOTICE:

Ignoring these steps could result in costly damage to your vehicle that wouldn't be covered by your warranty.

The ACDelco Freedom[®] battery in your vehicle has a built-in hydrometer. Do not charge, test or jump start the battery if the hydrometer looks clear or light yellow. Replace the battery when there is a clear or light yellow hydrometer and a cranking complaint.

Trying to start your vehicle by pushing or pulling it won't work, and it could damage your vehicle.

1. Check the other vehicle. It must have a 12-volt battery with a negative ground system.

NOTICE:

If the other system isn't a 12-volt system with a negative ground, both vehicles can be damaged.

2. Get the vehicles close enough so the jumper cables can reach, but be sure the vehicles aren't touching each other. If they are, it could cause a ground connection you don't want. You wouldn't be able to start your vehicle, and the bad grounding could damage the electrical systems.

To avoid the possibility of the vehicles rolling, set the parking brake firmly on both vehicles involved in the jump start procedure. Put your automatic transaxle in PARK (P) before setting the parking brake.

3. Turn off the ignition on both vehicles. Unplug unnecessary accessories plugged into the cigarette lighter. Turn off all lamps that aren't needed as well as radios. This will avoid sparks and help save both batteries. In addition, it could save your radio!

NOTICE:

If you leave your radio on, it could be badly damaged. The repairs wouldn't be covered by your warranty.

4. Open the hoods and locate the batteries.

 **CAUTION:**

An electric fan can start up even when the engine is not running and can injure you. Keep hands, clothing and tools away from any underhood electric fan.

 **CAUTION:**

Using a match near a battery can cause battery gas to explode. People have been hurt doing this, and some have been blinded. Use a flashlight if you need more light.

Be sure the battery has enough water. You don't need to add water to the ACDelco Freedom[®] battery installed in every new GM vehicle. But if a battery has filler caps, be sure the right amount of fluid is there. If it is low, add water to take care of that first. If you don't, explosive gas could be present.

Battery fluid contains acid that can burn you. Don't get it on you. If you accidentally get it in your eyes or on your skin, flush the place with water and get medical help immediately.

5. Find the positive (+) and negative (-) terminals on each battery.
6. Check that the jumper cables don't have loose or missing insulation. If they do, you could get a shock. The vehicles could be damaged, too.

Before you connect the cables, here are some basic things you should know. Positive (+) will go to positive (+) and negative (-) will go to a metal engine part. Don't connect positive (+) to negative (-) or you'll get a short that would damage the battery and maybe other parts, too.

 **CAUTION:**

Fans or other moving engine parts can injure you badly. Keep your hands away from moving parts once the engine is running.

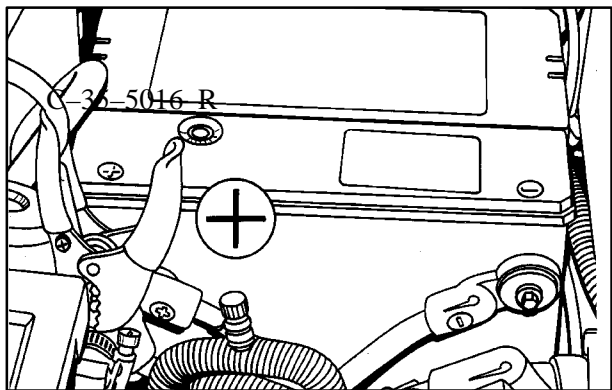

7. Connect the red positive (+) cable to the positive (+) terminal of the vehicle with the dead battery. Use a remote positive (+) terminal if the vehicle has one.



8. Don't let the other end of the cable touch metal. Connect it to the positive (+) terminal of the good battery. Use a remote positive (+) terminal if the vehicle has one.



9. Now connect the black negative (-) cable to the good battery's negative (-) terminal.

Don't let the other end touch anything until the next step. The other end of the negative (-) cable *doesn't* go to the dead battery. It goes to a heavy unpainted metal part on the engine of the vehicle with the dead battery.



10. Attach the cable at least 18 inches (45 cm) away from the dead battery, but not near engine parts that move. The electrical connection is just as good there, but the chance of sparks getting back to the battery is much less.
11. Now start the vehicle with the good battery and run the engine for a while.

12. Try to start the vehicle with the dead battery.
If it won't start after a few tries, it probably needs service.
13. Remove the cables in reverse order. Take care that they don't touch each other or any other metal.

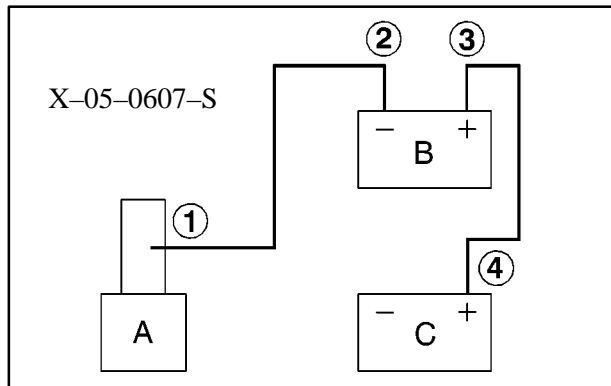

- A. Heavy Metal Engine Part
B. Good Battery
C. Dead Battery

Towing Your Vehicle

⚠ CAUTION:

To help avoid serious personal injury to you or others:

- Never let passengers ride in a vehicle that is being towed.
- Never tow faster than safe or posted speeds.
- Never tow with damaged parts not fully secured.
- Never get under your vehicle after it has been lifted by the tow truck.
- Always secure the vehicle on each side with separate safety chains when towing it.
- Use only the correct hooks.

NOTICE:

Use the proper towing equipment to avoid damage to the bumper, fascia or fog lamp areas of the vehicle.

With current trends in automotive styles and design, it is essential that the correct towing equipment is used to tow a vehicle. Your vehicle can be towed with wheel-lift or car-carrier equipment.

Consult your dealer or a professional towing service if you need to have your vehicle towed. See “Roadside Assistance” in the Index.

Engine Overheating

You will find a coolant light or a warning light about a hot engine on your vehicle's instrument panel. If you have the optional gage cluster, you may also have a coolant temperature warning gage. See “Engine Coolant Temperature Warning Light” or “Engine Coolant Temperature Gage” in the Index.

If Steam Is Coming From Your Engine



⚠ CAUTION:

Steam from an overheated engine can burn you badly, even if you just open the hood. Stay away from the engine if you see or hear steam coming from it. Just turn it off and get everyone away from the vehicle until it cools down. Wait until there is no sign of steam or coolant before you open the hood.

If you keep driving when your engine is overheated, the liquids in it can catch fire. You or others could be badly burned. Stop your engine if it overheats, and get out of the vehicle until the engine is cool.

NOTICE:

If your engine catches fire because you keep driving with no coolant, your vehicle can be badly damaged. The costly repairs would not be covered by your warranty.

If No Steam Is Coming From Your Engine

If you get an engine overheat warning but see or hear no steam, the problem may not be too serious. Sometimes the engine can get a little too hot when you:

- Climb a long hill on a hot day.
- Stop after high-speed driving.
- Idle for long periods in traffic.
- Tow a trailer.

If you get the overheat warning with no sign of steam, try this for a minute or so:

1. If your air conditioner is on, turn it off.
2. Turn on your heater to full hot at the highest fan speed and open the window as necessary.
3. If you're in a traffic jam, shift to NEUTRAL (N); otherwise, shift to the highest gear while driving -- AUTOMATIC OVERDRIVE (Ⓢ) or THIRD (3).

If you no longer have the overheat warning, you can drive. Just to be safe, drive slower for about 10 minutes. If the warning doesn't come back on, you can drive normally.

If the warning continues, pull over, stop, and park your vehicle right away.

If there's still no sign of steam, idle the engine for three minutes while you're parked. If you still have the warning, *turn off the engine and get everyone out of the vehicle* until it cools down.

You may decide not to lift the hood but to get service help right away.

Cooling System

When you decide it's safe to lift the hood, here's what you'll see:

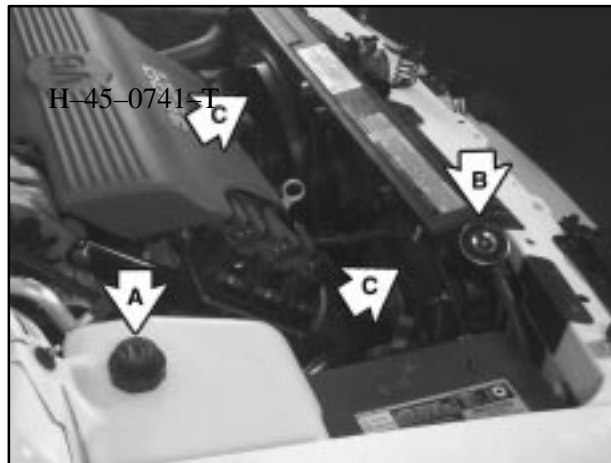

- A. Coolant Recovery Tank
- B. Radiator Pressure Cap
- C. Electric Engine Cooling Fans

CAUTION:

An electric engine cooling fan under the hood can start up even when the engine is not running and can injure you. Keep hands, clothing and tools away from any underhood electric fan.

If the coolant inside the coolant recovery tank is boiling, don't do anything else until it cools down.



The coolant level should be at or above the FULL COLD mark. If it isn't, you may have a leak in the radiator hoses, heater hoses, radiator, water pump or somewhere else in the cooling system.

 **CAUTION:**

Heater and radiator hoses, and other engine parts, can be very hot. Don't touch them. If you do, you can be burned.

Don't run the engine if there is a leak. If you run the engine, it could lose all coolant. That could cause an engine fire, and you could be burned. Get any leak fixed before you drive the vehicle.

NOTICE:

Engine damage from running your engine without coolant isn't covered by your warranty.

NOTICE:

When adding coolant, it is important that you use only DEX-COOL[®] (silicate-free) coolant.

If coolant other than DEX-COOL is added to the system, premature engine, heater core or radiator corrosion may result. In addition, the engine coolant will require change sooner -- at 30,000 miles (50 000 km) or 24 months, whichever occurs first. Damage caused by the use of coolant other than DEX-COOL[®] is not covered by your new vehicle warranty.

If there seems to be no leak, with the engine on, check to see if the electric engine cooling fans are running. If the engine is overheating, both fans should be running. If they aren't, your vehicle needs service.

How to Add Coolant to the Coolant Recovery Tank

If you haven't found a problem yet, but the coolant level isn't at the FULL COLD mark, add a 50/50 mixture of *clean, drinkable water* and DEX-COOL[®] engine coolant at the coolant recovery tank. (See "Engine Coolant" in the Index for more information.)

CAUTION:

Adding only plain water to your cooling system can be dangerous. Plain water, or some other liquid like alcohol, can boil before the proper coolant mixture will. Your vehicle's coolant warning system is set for the proper coolant mixture. With plain water or the wrong mixture, your engine could get too hot but you wouldn't get the overheat warning. Your engine could catch fire and you or others could be burned. Use a 50/50 mixture of clean, drinkable water and DEX-COOL[®] coolant.

NOTICE:

In cold weather, water can freeze and crack the engine, radiator, heater core and other parts. Use the recommended coolant and the proper coolant mixture.



 **CAUTION:**

You can be burned if you spill coolant on hot engine parts. Coolant contains ethylene glycol and it will burn if the engine parts are hot enough. Don't spill coolant on a hot engine.

When the coolant in the coolant recovery tank is at the FULL COLD mark, start your vehicle.

If the overheat warning continues, there's one more thing you can try. You can add the proper coolant mixture directly to the radiator, but be sure the cooling system is cool before you do it.

 **CAUTION:**

Steam and scalding liquids from a hot cooling system can blow out and burn you badly. They are under pressure, and if you turn the radiator pressure cap -- even a little -- they can come out at high speed. Never turn the cap when the cooling system, including the radiator pressure cap, is hot. Wait for the cooling system and radiator pressure cap to cool if you ever have to turn the pressure cap.



How to Add Coolant to the Radiator

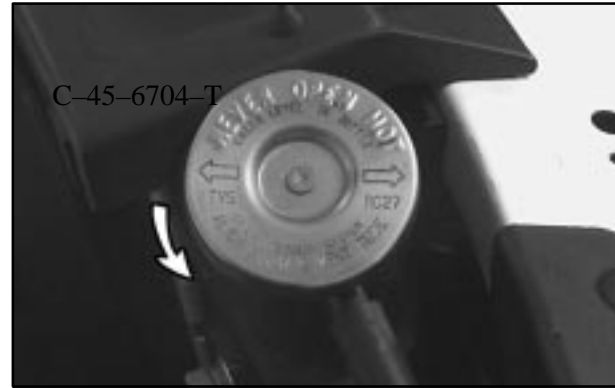

1. You can remove the radiator pressure cap when the cooling system, including the radiator pressure cap and upper radiator hose, is no longer hot. Turn the pressure cap slowly counterclockwise until it first stops. (Don't press down while turning the pressure cap.)

If you hear a hiss, wait for that to stop. A hiss means there is still some pressure left.

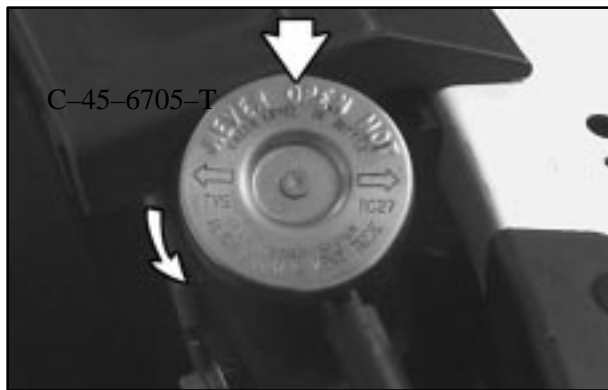

2. Then keep turning the pressure cap, but now push down as you turn it. Remove the pressure cap.



3. Fill the radiator with the proper DEX-COOL[®] coolant mixture, up to the base of the filler neck. (See "Engine Coolant" in the Index for more information about the proper coolant mixture.)



4. Then fill the coolant recovery tank to the FULL COLD mark.
5. Put the cap back on the coolant recovery tank, but leave the radiator pressure cap off.



6. Start the engine and let it run until you can feel the upper radiator hose getting hot. Watch out for the engine cooling fans.
7. By this time, the coolant level inside the radiator filler neck may be lower. If the level is lower, add more of the proper DEX-COOL[®] coolant mixture through the filler neck until the level reaches the base of the filler neck.



8. Then replace the pressure cap. At any time during this procedure if coolant begins to flow out of the filler neck, reinstall the pressure cap. Be sure the arrows on the pressure cap line up like this.

If a Tire Goes Flat

It's unusual for a tire to “blow out” while you're driving, especially if you maintain your tires properly. If air goes out of a tire, it's much more likely to leak out slowly. But if you should ever have a “blowout,” here are a few tips about what to expect and what to do:

If a front tire fails, the flat tire will create a drag that pulls the vehicle toward that side. Take your foot off the accelerator pedal and grip the steering wheel firmly. Steer to maintain lane position, and then gently brake to a stop well out of the traffic lane.

A rear blowout, particularly on a curve, acts much like a skid and may require the same correction you'd use in a skid. In any rear blowout, remove your foot from the accelerator pedal. Get the vehicle under control by steering the way you want the vehicle to go. It may be very bumpy and noisy, but you can still steer. Gently brake to a stop -- well off the road if possible.

If a tire goes flat, the next part shows how to use your jacking equipment to change a flat tire safely.

Changing a Flat Tire

If a tire goes flat, avoid further tire and wheel damage by driving slowly to a level place. Turn on your hazard warning flashers.

CAUTION:

Changing a tire can cause an injury. The vehicle can slip off the jack and roll over you or other people. You and they could be badly injured. Find a level place to change your tire. To help prevent the vehicle from moving:

1. Set the parking brake firmly.
2. Put the shift lever in PARK (P).
3. Turn off the engine.

To be even more certain the vehicle won't move, you can put blocks at the front and rear of the tire farthest away from the one being changed. That would be the tire on the other side of the vehicle, at the opposite end.

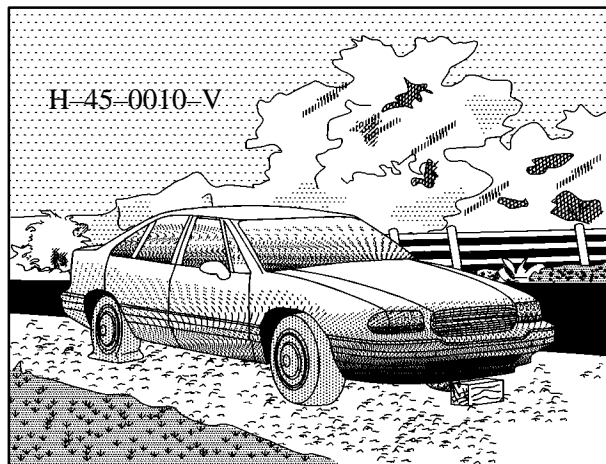

The following steps will tell you how to use the jack and change a tire.

Removing the Spare Tire and Tools



The equipment you'll need is in the trunk. Pull the carpeting from the floor of the trunk.

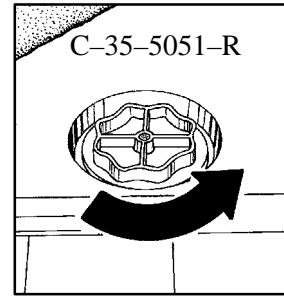

Turn the center retainer bolt on the spare tire cover counterclockwise to remove it.

Lift and remove the cover. See "Compact Spare Tire" in the Index for more information about the compact spare.

Remove the spare tire from the trunk.

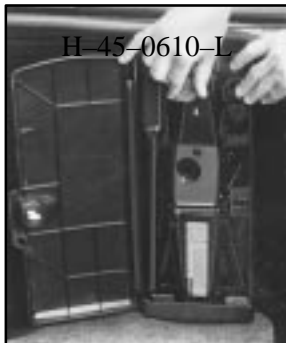

The box that stores the jack and wheel wrench is on the passenger side trunk wall.

Open the box and then remove the wing bolt by turning it counterclockwise.

Remove the jack and wheel wrench.



The tools you'll be using include the jack (A) and wheel wrench (B).

Removing Wheel Covers and Wheel Nut Caps

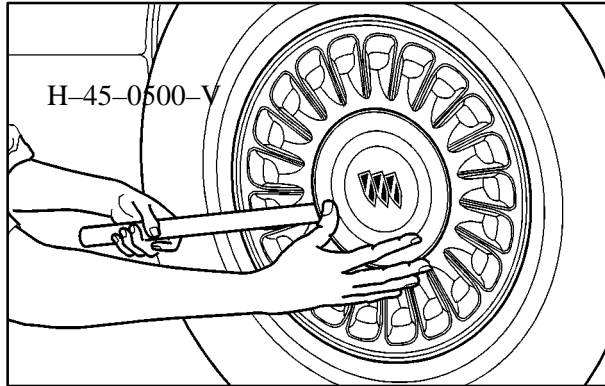

If your vehicle has an aluminum wheel with a center cover that hides the wheel nuts, remove the center cover by using the flat end of the wheel wrench to pry it off.



If your vehicle has a wheel cover, remove it by using the flat end of the wheel wrench.

Pry along the edge of the wheel cover until it comes off. Be careful, the rim edges may be sharp. Don't try to remove it with your bare hands.

Note: When replacing any wheel cover, carefully line up the tire valve stem and the notch in the wheel cover.



If your vehicle has this aluminum wheel, you may have plastic wheel nut caps. Use the wheel nut wrench to remove the wheel nut caps and to loosen the wheel nuts.



1. Use the wire wheel key wrench to remove the wheel cover.

When reinstalling the decorative nut caps, tighten the caps snugly with the wheel wrench, then continue one-quarter rotation to secure plastic caps.

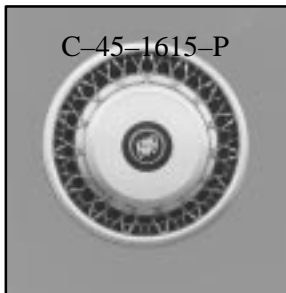

If your vehicle has wire wheel covers, remove them as follows:



2. Using the flat end of the key wrench handle, between the wire wheel cover and the center cap, pry off the center cap.



3. Remove the theft-deterrent nut by placing the key end of the wire wheel key wrench over the nut and turning it counterclockwise.

4. Pull off the wire wheel cover. Store it in the trunk until the flat tire is repaired or replaced.

NOTE: When replacing the wheel cover, carefully line up the tire valve stem and the notch in the wheel cover.

Removing the Flat Tire and Installing the Spare Tire

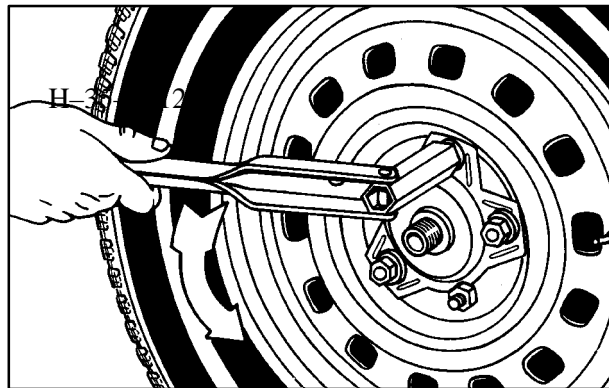

1. Use the wheel wrench to loosen the wheel nuts, but don't remove them.

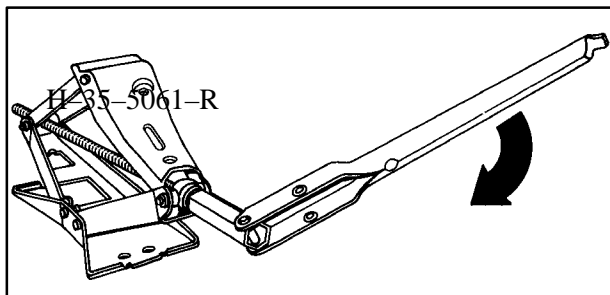

- Turn the wheel wrench clockwise by hand to raise the jack head until it fits under the vehicle.

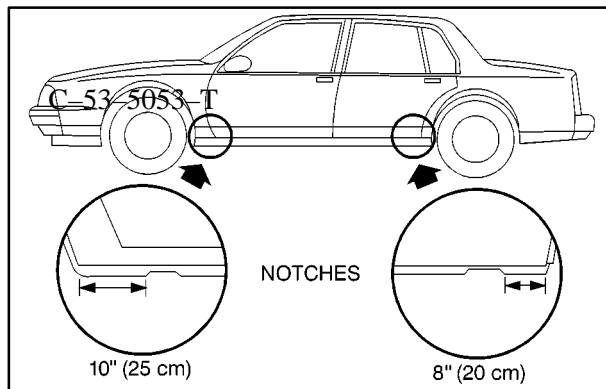

- Put the jack into a notch in the frame which is located near each wheel well. The front notch is 10 inches (25 cm) back from the front wheel well. The rear notch is 8 inches (20 cm) forward from the rear wheel well.
- Position the jack and raise the jack head until it fits firmly on the ridge in the vehicle's frame nearest the flat tire. Do not raise the vehicle yet. Put the compact spare tire near you.

⚠ CAUTION:

Getting under a vehicle when it is jacked up is dangerous. If the vehicle slips off the jack, you could be badly injured or killed. Never get under a vehicle when it is supported only by a jack.

⚠ CAUTION:

Raising your vehicle with the jack improperly positioned can damage the vehicle and even make the vehicle fall. To help avoid personal injury and vehicle damage, be sure to fit the jack lift head into the proper location before raising the vehicle.



5. Raise the vehicle by turning the wheel wrench clockwise in the jack. Raise the vehicle far enough so there's enough room for the spare tire to fit.
6. Remove all the wheel nuts and take off the flat tire.

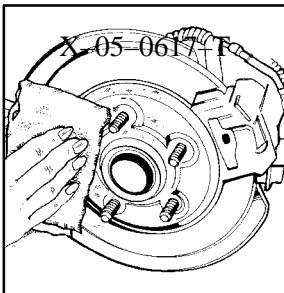

7. Remove any rust or dirt from the wheel bolts, mounting surfaces and spare wheel.

⚠ CAUTION:

Never use oil or grease on studs or nuts. If you do, the nuts might come loose. Your wheel could fall off, causing a serious accident.

8. Place the compact spare tire on the wheel-mounting surface.



9. Replace the wheel nuts with the rounded end of the nuts toward the wheel.

10. Make sure each wheel stud is centered in each wheel hole while tightening the nuts. Tighten each nut by hand until the wheel is held against the hub.

⚠ CAUTION:

Rust or dirt on the wheel, or on the parts to which it is fastened, can make the wheel nuts become loose after a time. The wheel could come off and cause an accident. When you change a wheel, remove any rust or dirt from the places where the wheel attaches to the vehicle. In an emergency, you can use a cloth or a paper towel to do this; but be sure to use a scraper or wire brush later, if you need to, to get all the rust or dirt off.



11. Lower the vehicle by turning the wheel wrench counterclockwise on the jack. Lower the jack completely.

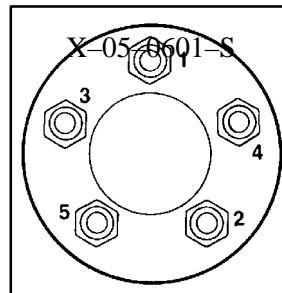

12. Tighten the wheel nuts firmly in a crisscross sequence.

⚠ CAUTION:

Incorrect wheel nuts or improperly tightened wheel nuts can cause the wheel to become loose and even come off. This could lead to an accident. Be sure to use the correct wheel nuts. If you have to replace them, be sure to get new GM original equipment wheel nuts.

Stop somewhere as soon as you can and have the nuts tightened with a torque wrench to 100 lb-ft (140 N·m).

NOTICE:

Improperly tightened wheel nuts can lead to brake pulsation and rotor damage. To avoid expensive brake repairs, evenly tighten the wheel nuts in the proper sequence and to the proper torque specification.

NOTICE:

Wheel covers won't fit on your compact spare. If you try to put a wheel cover on your compact spare, you could damage the cover or the spare.

Storing the Flat Tire and Tools

 **CAUTION:**

Storing a jack, a tire or other equipment in the passenger compartment of the vehicle could cause injury. In a sudden stop or collision, loose equipment could strike someone. Store all these in the proper place.

After you've put the compact spare tire on your vehicle, you'll need to store the flat tire in your trunk. Use the following procedure to secure the flat tire in the trunk.

Store the flat tire as far forward in the trunk as possible. Store the jack and wheel wrench in their box in the trunk on the passenger's side.



Storing the Spare Tire and Tools

CAUTION:

Storing a jack, a tire or other equipment in the passenger compartment of the vehicle could cause injury. In a sudden stop or collision, loose equipment could strike someone. Store all these in the proper place.

The compact spare is for temporary use only. Replace the compact spare tire with a full-size tire as soon as you can. See “Compact Spare Tire” later in this section. See the storing instructions label to replace your compact spare into your trunk properly.

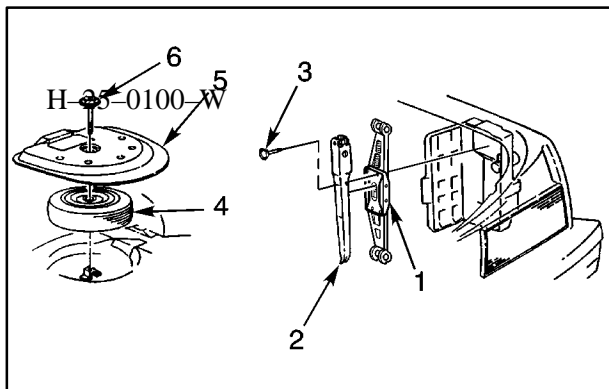

1. Jack
2. Wheel Wrench
3. Wing Bolt
4. Tire
5. Cover
6. Bolt

Compact Spare Tire

Although the compact spare tire was fully inflated when your vehicle was new, it can lose air after a time. Check the inflation pressure regularly. It should be 60 psi (420 kPa).

After installing the compact spare on your vehicle, you should stop as soon as possible and make sure your spare tire is correctly inflated. The compact spare is made to perform well at speeds up to 65 mph (105 km/h) for distances up to 3,000 miles (5 000 km), so you can finish your trip and have your full-size tire repaired or replaced where you want. Of course, it's best to replace your spare with a full-size tire as soon as you can. Your spare will last longer and be in good shape in case you need it again.

NOTICE:

When the compact spare is installed, don't take your vehicle through an automatic car wash with guide rails. The compact spare can get caught on the rails. That can damage the tire and wheel, and maybe other parts of your vehicle.

Don't use your compact spare on other vehicles.

And don't mix your compact spare tire or wheel with other wheels or tires. They won't fit. Keep your spare tire and its wheel together.

NOTICE:

Tire chains won't fit your compact spare. Using them can damage your vehicle and can damage the chains too. Don't use tire chains on your compact spare.

If You're Stuck: In Sand, Mud, Ice or Snow

In order to free your vehicle when it is stuck, you will need to spin the wheels, but you don't want to spin your wheels too fast. The method known as "rocking" can help you get out when you're stuck, but you must use caution.

CAUTION:

If you let your tires spin at high speed, they can explode, and you or others could be injured. And, the transaxle or other parts of the vehicle can overheat. That could cause an engine compartment fire or other damage. When you're stuck, spin the wheels as little as possible. Don't spin the wheels above 35 mph (55 km/h) as shown on the speedometer.

NOTICE:

Spinning your wheels can destroy parts of your vehicle as well as the tires. If you spin the wheels too fast while shifting your transaxle back and forth, you can destroy your transaxle.

For information about using tire chains on your vehicle, see “Tire Chains” in the Index.

Rocking Your Vehicle To Get It Out

First, turn your steering wheel left and right. That will clear the area around your front wheels. If your vehicle has traction control, you should turn the system off. (See “Traction Control System” in the Index.) Then shift back and forth between REVERSE (R) and a forward gear, spinning the wheels as little as possible. Release the accelerator pedal while you shift, and press lightly on the accelerator pedal when the transaxle is in gear. By slowly spinning your wheels in the forward and reverse directions, you will cause a rocking motion that may free your vehicle. If that doesn't get you out after a few tries, you may need to be towed out. If you do need to be towed out, see “Towing Your Vehicle” in the Index.



Section 6 Service and Appearance Care

Here you will find information about the care of your vehicle. This section begins with service and fuel information, and then it shows how to check important fluid and lubricant levels. There is also technical information about your vehicle, and a part devoted to its appearance care.

6-2	Service	6-48	Appearance Care
6-3	Fuel	6-49	Cleaning the Inside of Your Vehicle
6-5	Fuels in Foreign Countries	6-51	Care of Safety Belts
6-5	Filling Your Tank	6-51	Cleaning Glass Surfaces
6-7	Filling a Portable Fuel Container	6-51	Cleaning the Outside of Your Vehicle
6-8	Checking Things Under the Hood	6-54	Cleaning Aluminum Wheels (IF EQUIPPED)
6-11	Engine Oil	6-54	Cleaning Tires
6-16	Engine Air Cleaner/Filter	6-54	Sheet Metal Damage
6-18	Automatic Transaxle Fluid	6-55	Finish Damage
6-22	Radiator Pressure Cap	6-56	GM Vehicle Care/Appearance Materials
6-22	Engine Coolant	6-57	Vehicle Identification Number (VIN)
6-25	Power Steering Fluid	6-57	Service Parts Identification Label
6-26	Windshield Washer Fluid	6-58	Electrical System
6-27	Brakes	6-63	Replacement Bulbs
6-31	Battery	6-64	Capacities and Specifications
6-31	Bulb Replacement	6-64	Air Conditioning Refrigerants
6-40	Windshield Wiper Blade Replacement	6-65	Normal Maintenance Replacement Parts
6-40	Tires		

Service

Your dealer knows your vehicle best and wants you to be happy with it. We hope you'll go to your dealer for all your service needs. You'll get genuine GM parts and GM-trained and supported service people.

We hope you'll want to keep your GM vehicle all GM. Genuine GM parts have one of these marks:

ACDelco[®]

Genuine



Parts



Goodwrench

Doing Your Own Service Work

If you want to do some of your own service work, you'll want to use the proper service manual. It tells you much more about how to service your vehicle than this manual can. To order the proper service manual, see "Service and Owner Publications" in the Index.

Your vehicle has an air bag system. Before attempting to do your own service work, see "Servicing Your Air Bag-Equipped Vehicle" in the Index.

You should keep a record with all parts receipts and list the mileage and the date of any service work you perform. See "Maintenance Record" in the Index.



CAUTION:

You can be injured and your vehicle could be damaged if you try to do service work on a vehicle without knowing enough about it.

- **Be sure you have sufficient knowledge, experience, the proper replacement parts and tools before you attempt any vehicle maintenance task.**
- **Be sure to use the proper nuts, bolts and other fasteners. “English” and “metric” fasteners can be easily confused. If you use the wrong fasteners, parts can later break or fall off. You could be hurt.**

Adding Equipment to the Outside of Your Vehicle

Things you might add to the outside of your vehicle can affect the airflow around it. This may cause wind noise and affect windshield washer performance. Check with your dealer before adding equipment to the outside of your vehicle.

Fuel

Use regular unleaded gasoline rated at 87 octane or higher. It is recommended that the gasoline meet specifications which have been developed by the American Automobile Manufacturers Association (AAMA) and endorsed by the Canadian Motor Vehicle Manufacturers Association for better vehicle performance and engine protection. Gasolines meeting the AAMA specification could provide improved driveability and emission control system performance compared to other gasolines. For more information, write to: American Automobile Manufacturer's Association, 7430 Second Ave, Suite 300, Detroit MI 48202.

Be sure the posted octane is at least 87. If the octane is less than 87, you may get a heavy knocking noise when you drive. If it's bad enough, it can damage your engine.

If you're using fuel rated at 87 octane or higher and you hear heavy knocking, your engine needs service. But don't worry if you hear a little pinging noise when you're accelerating or driving up a hill. That's normal, and you don't have to buy a higher octane fuel to get rid of pinging. It's the heavy, constant knock that means you have a problem.

If your vehicle is certified to meet California Emission Standards (indicated on the underhood emission control label), it is designed to operate on fuels that meet California specifications. If such fuels are not available in states adopting California emissions standards, your vehicle will operate satisfactorily on fuels meeting federal specifications, but emission control system performance may be affected. The malfunction indicator lamp on your instrument panel may turn on and/or your vehicle may fail a smog-check test. (See “Malfunction Indicator Lamp” in the Index.) If this occurs, return to your authorized Buick dealer for diagnosis to determine the cause of failure. In the event it is determined that the cause of the condition is the type of fuels used, repairs may not be covered by your warranty.

Some gasolines that are not reformulated for low emissions may contain an octane-enhancing additive called methylcyclopentadienyl manganese tricarbonyl (MMT); ask your service station operator whether or not the fuel contains MMT. General Motors does not recommend the use of such gasolines. If fuels containing MMT are used, spark plug life may be reduced and your emission control system performance may be affected. The malfunction indicator lamp on your instrument panel may turn on. If this occurs, return to your authorized Buick dealer for service.

To provide cleaner air, all gasolines in the United States are now required to contain additives that will help prevent deposits from forming in your engine and fuel system, allowing your emission control system to function properly. Therefore, you should not have to add anything to the fuel. In addition, gasolines containing oxygenates, such as ethers and ethanol, and reformulated gasolines may be available in your area to contribute to clean air. General Motors recommends that you use these gasolines, particularly if they comply with the specifications described earlier.

NOTICE:

Your vehicle was not designed for fuel that contains methanol. Don't use it. It can corrode metal parts in your fuel system and also damage plastic and rubber parts. That damage wouldn't be covered under your warranty.

Fuels in Foreign Countries

If you plan on driving in another country outside the United States or Canada, the proper fuel may be hard to find. Never use leaded gasoline or any other fuel not recommended in the previous text on fuel. Costly repairs caused by use of improper fuel wouldn't be covered by your warranty.

To check on fuel availability, ask an auto club, or contact a major oil company that does business in the country where you'll be driving.

You can also write us at the following address for advice. Just tell us where you're going and give your Vehicle Identification Number (VIN).

General Motors Overseas Distribution Corporation
1908 Colonel Sam Drive
Oshawa, Ontario L1H 8P7

Filling Your Tank

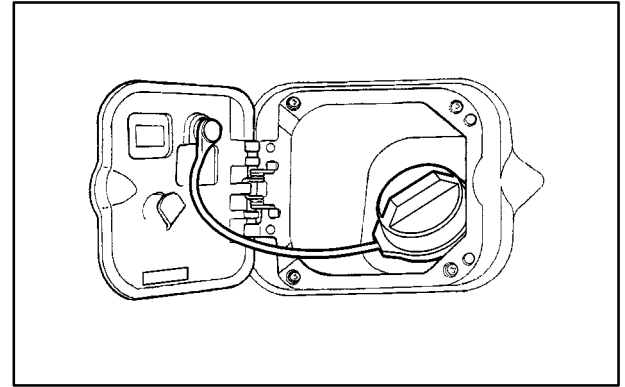

The cap is behind a hinged door on the driver's side of your vehicle.

⚠ CAUTION:

Gasoline vapor is highly flammable. It burns violently, and that can cause very bad injuries. Don't smoke if you're near gasoline or refueling your vehicle. Keep sparks, flames and smoking materials away from gasoline.

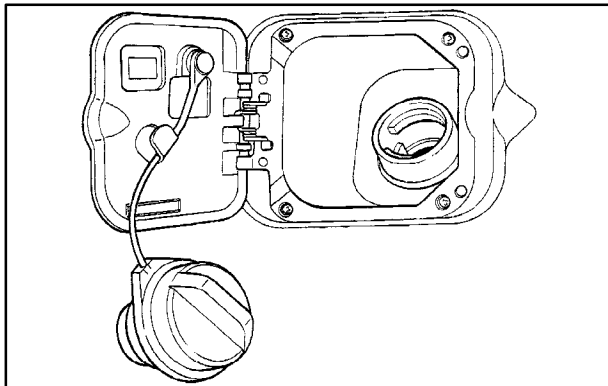

While refueling, hang the tethered cap from the hook on the fuel door.

To remove the cap, turn it slowly to the left (counterclockwise). The cap has a spring in it; if you let go of the cap too soon, it will spring back to the right.

⚠ CAUTION:

If you get gasoline on yourself and then something ignites it, you could be badly burned. Gasoline can spray out on you if you open the fuel filler cap too quickly. This spray can happen if your tank is nearly full, and is more likely in hot weather. Open the fuel filler cap slowly and wait for any “hiss” noise to stop. Then unscrew the cap all the way.

Be careful not to spill gasoline. Clean gasoline from painted surfaces as soon as possible. See “Cleaning the Outside of Your Vehicle” in the Index.

When you put the cap back on, turn it to the right (clockwise) until you hear a clicking sound. Make sure you fully install the cap. The diagnostic system can determine if the fuel cap has been left off or improperly installed. This would allow fuel to evaporate into the atmosphere. See “Malfunction Indicator Lamp” in the Index.

NOTICE:

If you need a new cap, be sure to get the right type. Your dealer can get one for you. If you get the wrong type, it may not fit properly. This may cause your malfunction indicator lamp to light and your fuel tank and emissions system may be damaged. See “Malfunction Indicator Lamp” in the Index.

Filling a Portable Fuel Container

CAUTION:

Never fill a portable fuel container while it is in your vehicle. Static electricity discharge from the container can ignite the gasoline vapor. You can be badly burned and your vehicle damaged if this occurs. To help avoid injury to you and others:

- **Dispense gasoline only into approved containers.**
- **Do not fill a container while it is inside a vehicle, in a vehicle’s trunk, pickup bed or on any surface other than the ground.**
- **Bring the fill nozzle in contact with the inside of the fill opening before operating the nozzle. Contact should be maintained until the filling is complete.**
- **Don’t smoke while pumping gasoline.**

Checking Things Under the Hood

CAUTION:

An electric fan under the hood can start up and injure you even when the engine is not running. Keep hands, clothing and tools away from any underhood electric fan.

CAUTION:

Things that burn can get on hot engine parts and start a fire. These include liquids like gasoline, oil, coolant, brake fluid, windshield washer and other fluids, and plastic or rubber. You or others could be burned. Be careful not to drop or spill things that will burn onto a hot engine.

Hood Release



To open the hood, first pull the hood release handle inside the vehicle. It is next to the parking brake pedal near the floor.



Then go to the front of the vehicle and pull up on the secondary hood release. The hood latch is under the hood, near the center, and at the front edge of the grille. Lift up on the lever as you lift up on the hood.

Before closing the hood, be sure all the filler caps are on properly. Then just pull the hood down and close it firmly.

3800 Series II Engine (L36 - Code K)

When you open the hood, you'll see:



A. Engine Coolant
Recovery Tank

B. Battery

C. Radiator Pressure Cap

D. Engine Oil Dipstick

E. Engine Oil Fill Cap

F. Automatic Transaxle
Fluid Dipstick

G. Brake Master Cylinder

H. Air Cleaner

I. Windshield Washer
Fluid Reservoir

Engine Oil

CHECK OIL LEVEL

If the CHECK OIL LEVEL light on the instrument panel comes on, it means you need to check your engine oil level right away.

For more information, see “Check Oil Level Light” in the Index. You should check your engine oil level regularly; this is an added reminder.

It’s a good idea to check your engine oil every time you get fuel. In order to get an accurate reading, the oil must be warm and the vehicle must be on level ground.



The engine oil dipstick is right behind the engine fans and in front of the engine oil fill cap. The top of the dipstick is a round, yellow loop.

Turn off the engine and give the oil several minutes to drain back into the oil pan. If you don’t, the oil dipstick might not show the actual level.

Checking Engine Oil

Pull out the dipstick and clean it with a paper towel or cloth, then push it back in all the way. Remove it again, keeping the tip down, and check the level.

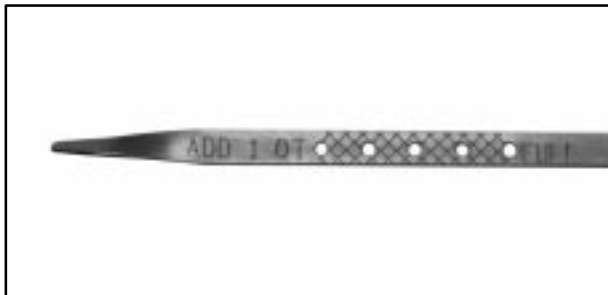

When to Add Engine Oil

If the oil is at or below the ADD mark, then you'll need to add at least one quart of oil. But you must use the right kind. This part explains what kind of oil to use. For crankcase capacity, see “Capacities and Specifications” in the Index.

NOTICE:

Don't add too much oil. If your engine has so much oil that the oil level gets above the cross-hatched area that shows the proper operating range, your engine could be damaged.

The engine oil fill cap is behind the engine oil dipstick and engine fans.

Be sure to fill it enough to put the level somewhere in the proper operating range. Push the dipstick all the way back in when you're through.

What Kind of Engine Oil to Use

Oils recommended for your vehicle can be identified by looking for the “Starburst” symbol. This symbol indicates that the oil has been certified by the American Petroleum Institute (API). Do not use any oil which does not carry this Starburst symbol.



If you change your own oil, be sure you use oil that has the Starburst symbol on the front of the oil container. If you have your oil changed for you, be sure the oil put into your engine is American Petroleum Institute certified for gasoline engines.

You should also use the proper viscosity oil for your vehicle, as shown in the following chart:

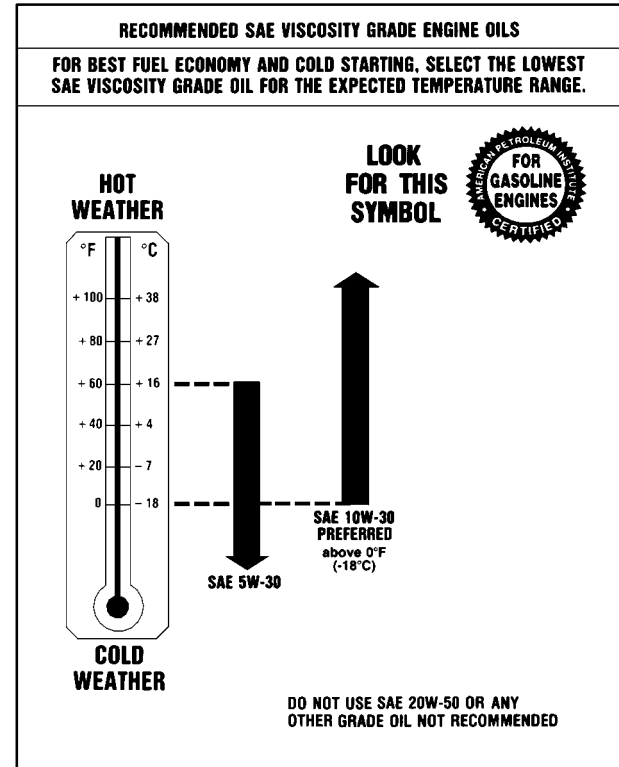

As shown in the chart, SAE 10W-30 is best for your vehicle. However, you can use SAE 5W-30 if it's going to be colder than 60°F (16°C) before your next oil change. When it's very cold, you should use SAE 5W-30. These numbers on an oil container show its viscosity, or thickness. Do not use other viscosity oils, such as SAE 20W-50.

NOTICE:

Use only engine oil with the American Petroleum Institute Certified For Gasoline Engines “Starburst” symbol. Failure to use the recommended oil can result in engine damage not covered by your warranty.

GM Goodwrench® oil meets all the requirements for your vehicle.

If you are in an area where the temperature falls below -20°F (-29°C), consider using either an SAE 5W-30 synthetic oil or an SAE 0W-30 oil. Both will provide easier cold starting and better protection for your engine at extremely low temperatures.

Engine Oil Additives

Don't add anything to your oil. Your dealer is ready to advise if you think something should be added.

When to Change Engine Oil

If any one of these is true for you, use the short trip/city maintenance schedule:

- Most trips are less than 5 to 10 miles (8 to 16 km). This is particularly important when outside temperatures are below freezing.
- Most trips include extensive idling (such as frequent driving in stop-and-go traffic).
- Most trips are through dusty areas.
- You frequently tow a trailer or use a carrier on top of your vehicle.
- The vehicle is used for delivery service, police, taxi or other commercial application.

Driving under these conditions causes engine oil to break down sooner. If any one of these is true for your vehicle, then you need to change your oil and filter every 3,000 miles (5 000 km) or 3 months -- whichever occurs first.

If none of them is true, use the long trip/highway maintenance schedule. Change the oil and filter every 7,500 miles (12 500 km) or 12 months -- whichever occurs first. Driving a vehicle with a fully warmed engine under highway conditions causes engine oil to break down slower.

How to Reset the Engine Oil Life Monitor (Option)

After changing the engine oil, the Engine Oil Life Monitor should be reset. It will not reset itself. This will cause the CHANGE OIL SOON light to be lit for a bulb check period of three seconds. Refer to “Engine Oil” in the Index to determine what type of oil to use.



To reset the Oil Life Monitor, the ignition key must be in RUN. Press and hold the OIL RESET button (located in the glove box) for at least five seconds but not more than 60 seconds. After five seconds, the CHANGE OIL SOON light will flash four times and then go off. This indicates that the Engine Oil Life Monitor System has been reset.

What to Do with Used Oil

Did you know that used engine oil contains certain elements that may be unhealthy for your skin and could even cause cancer? Don't let used oil stay on your skin for very long. Clean your skin and nails with soap and water, or a good hand cleaner. Wash or properly throw away clothing or rags containing used engine oil. (See the manufacturer's warnings about the use and disposal of oil products.)

Used oil can be a real threat to the environment. If you change your own oil, be sure to drain all free-flowing oil from the filter before disposal. Don't ever dispose of oil by putting it in the trash, pouring it on the ground, into sewers, or into streams or bodies of water. Instead, recycle it by taking it to a place that collects used oil. If you have a problem properly disposing of your used oil, ask your dealer, a service station or a local recycling center for help.

Engine Air Cleaner/Filter

The air cleaner and filter are on the driver's side of the engine compartment.



1. Remove the screws on the air cleaner housing cover.



2. Remove the air intake hose that is snapped over the throttle body by pulling the hose upward and away from the throttle body which is located near the top of the engine.



3. Disconnect the electrical connector from the air intake hose. This will allow you to lift the rear portion of the air cleaner.

4. After detaching the hose from the throttle body, pull back the entire rear portion of the air cleaner by pulling upward and rearward.



5. Replace the air filter.
6. Reinstall the rear section of the air cleaner.
7. Reconnect the electrical connector.
8. Reattach the air intake hose by snapping it back onto the throttle body.

Refer to the Maintenance Schedule to determine when to replace the air filter.

See “Scheduled Maintenance Services” in the Index.

 **CAUTION:**

Operating the engine with the air cleaner/filter off can cause you or others to be burned. The air cleaner not only cleans the air, it stops flame if the engine backfires. If it isn't there, and the engine backfires, you could be burned. Don't drive with it off, and be careful working on the engine with the air cleaner/filter off.

NOTICE:

If the air cleaner/filter is off, a backfire can cause a damaging engine fire. And, dirt can easily get into your engine, which will damage it. Always have the air cleaner/filter in place when you're driving.

Automatic Transaxle Fluid

When to Check and Change

A good time to check your automatic transaxle fluid level is when the engine oil is changed.

Change both the fluid and filter every 50,000 miles (83 000 km) if the vehicle is mainly driven under one or more of these conditions:

- In heavy city traffic where the outside temperature regularly reaches 90°F (32°C) or higher.
- In hilly or mountainous terrain.
- When doing frequent trailer towing.
- Uses such as found in taxi, police or delivery service.

If you do not use your vehicle under any of these conditions, change the fluid and filter at 100,000 miles (166 000 km).

See “Scheduled Maintenance Services” in the Index.

How to Check

Because this operation can be a little difficult, you may choose to have this done at the dealership service department.

If you do it yourself, be sure to follow all the instructions here, or you could get a false reading on the dipstick.

NOTICE:

Too much or too little fluid can damage your transaxle. Too much can mean that some of the fluid could come out and fall on hot engine parts or exhaust system parts, starting a fire. Be sure to get an accurate reading if you check your transaxle fluid.

Wait at least 30 minutes before checking the transaxle fluid level if you have been driving:

- When outside temperatures are above 90°F (32°C).
- At high speed for quite a while.
- In heavy traffic -- especially in hot weather.
- While pulling a trailer.

To get the right reading, the fluid should be at normal operating temperature, which is 180°F to 200°F (82°C to 93°C).

Get the vehicle warmed up by driving about 15 miles (24 km) when outside temperatures are above 50°F (10°C). If it's colder than 50°F (10°C), you may have to drive longer.

Checking the Fluid Level

- Park your vehicle on a level place. Keep the engine running.
- With the parking brake applied, place the shift lever in PARK (P).
- With your foot on the brake pedal, move the shift lever through each gear range, pausing for about three seconds in each range. Then, position the shift lever in PARK (P).
- Let the engine run at idle for three to five minutes.

Then, without shutting off the engine, follow these steps:



1. The transaxle fluid dipstick top is a round loop and is next to the brake master cylinder behind the engine block. Pull out the dipstick and wipe it with a clean rag or paper towel.
2. Push it back in all the way, wait three seconds and then pull it back out again.

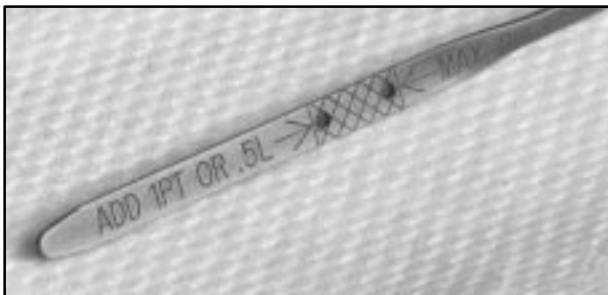

3. Check both sides of the dipstick, and read the lower level. The fluid level must be in the cross-hatched area.
4. If the fluid level is in the acceptable range, push the dipstick back in all the way.

How to Add Fluid

Refer to the Maintenance Schedule to determine what kind of transaxle fluid to use. See “Recommended Fluids and Lubricants” in the Index.

If the fluid level is low, add only enough of the proper fluid to bring the level into the cross-hatched area on the dipstick.

1. Pull out the dipstick.
2. Using a long-neck funnel, add enough fluid at the dipstick hole to bring it to the proper level.

It doesn't take much fluid, generally less than one pint (0.5 L). *Don't overfill.*

NOTICE:

We recommend you use only fluid labeled DEXRON®-III, because fluid with that label is made especially for your automatic transaxle. Damage caused by fluid other than DEXRON®-III is not covered by your new vehicle warranty.

3. After adding fluid, recheck the fluid level as described under “How to Check.”
4. When the correct fluid level is obtained, push the dipstick back in all the way.

Radiator Pressure Cap

NOTICE:

Your radiator cap is a 15 psi (105 kPa) pressure-type cap and must be tightly installed to prevent coolant loss and possible engine damage from overheating. Be sure the arrows on the cap line up with the overflow tube on the radiator filler neck.

When you replace your radiator pressure cap, a GM cap is recommended.

Thermostat

Engine coolant temperature is controlled by a thermostat in the engine coolant system. The thermostat stops the flow of coolant through the radiator until the coolant reaches a preset temperature.

Engine Coolant

The cooling system in your vehicle is filled with DEX-COOL[®] engine coolant. This coolant is designed to remain in your vehicle for 5 years or 150,000 miles (240 000 km), whichever occurs first, if you add only DEX-COOL[®] extended life coolant.

The following explains your cooling system and how to add coolant when it is low. If you have a problem with engine overheating, see “Engine Overheating” in the Index.

A 50/50 mixture of clean, drinkable water and DEX-COOL[®] coolant will:

- Give freezing protection down to -34°F (-37°C).
- Give boiling protection up to 265°F (129°C).
- Protect against rust and corrosion.
- Help keep the proper engine temperature.
- Let the warning lights and gages work as they should.

NOTICE:

When adding coolant, it is important that you use only DEX-COOL[®] (silicate-free) coolant.

If coolant other than DEX-COOL is added to the system, premature engine, heater core or radiator corrosion may result. In addition, the engine coolant will require change sooner -- at 30,000 miles (50 000 km) or 24 months, whichever occurs first. Damage caused by the use of coolant other than DEX-COOL[®] is not covered by your new vehicle warranty.

What to Use

Use a mixture of one-half *clean, drinkable water* and one-half DEX-COOL[®] coolant which won't damage aluminum parts. If you use this coolant mixture, you don't need to add anything else.

 **CAUTION:**

Adding only plain water to your cooling system can be dangerous. Plain water, or some other liquid like alcohol, can boil before the proper coolant mixture will. Your vehicle's coolant warning system is set for the proper coolant mixture. With plain water or the wrong mixture, your engine could get too hot but you wouldn't get the overheat warning. Your engine could catch fire and you or others could be burned. Use a 50/50 mixture of clean, drinkable water and DEX-COOL[®] coolant.

NOTICE:

If you use an improper coolant mixture, your engine could overheat and be badly damaged. The repair cost wouldn't be covered by your warranty. Too much water in the mixture can freeze and crack the engine, radiator, heater core and other parts.

If you have to add coolant more than four times a year, have your dealer check your cooling system.

NOTICE:

If you use the proper coolant, you don't have to add extra inhibitors or additives which claim to improve the system. These can be harmful.

Checking Coolant



The vehicle must be on a level surface. When your engine is cold, the coolant level should be at FULL COLD or a little higher. When your engine is warm, the level should be up to FULL HOT or a little higher.

Adding Coolant

If you need more coolant, add the proper DEX-COOL[®] coolant mixture *at the coolant recovery tank*, but be careful not to spill it.

CAUTION:

Turning the radiator pressure cap when the engine and radiator are hot can allow steam and scalding liquids to blow out and burn you badly. With the coolant recovery tank, you will almost never have to add coolant at the radiator. Never turn the radiator pressure cap -- even a little -- when the engine and radiator are hot.

CAUTION:

You can be burned if you spill coolant on hot engine parts. Coolant contains ethylene glycol, and it will burn if the engine parts are hot enough. Don't spill coolant on a hot engine.

Power Steering Fluid



When to Check Power Steering Fluid

It is not necessary to regularly check power steering fluid unless you suspect there is a leak in the system or you hear an unusual noise. A fluid loss in this system could indicate a problem. Have the system inspected and repaired.

How to Check Power Steering Fluid

When the engine compartment is cool, wipe the cap and the top of the reservoir clean, then unscrew the cap and wipe the dipstick with a clean rag. Replace the cap and completely tighten it. Then remove the cap again and look at the fluid level on the dipstick.

The level should be at the FULL COLD mark. If necessary, add only enough fluid to bring the level up to the mark.

What to Use

To determine what kind of fluid to use, see “Recommended Fluids and Lubricants” in the Index. Always use the proper fluid. Failure to use the proper fluid can cause leaks and damage hoses and seals.

Windshield Washer Fluid

What to Use

When you need windshield washer fluid, be sure to read the manufacturer’s instructions before use. If you will be operating your vehicle in an area where the temperature may fall below freezing, use a fluid that has sufficient protection against freezing.

Adding Washer Fluid



Open the cap labeled WASHER FLUID ONLY. Add washer fluid until the tank is full.

NOTICE:

- When using concentrated washer fluid, follow the manufacturer's instructions for adding water.
- Don't mix water with ready-to-use washer fluid. Water can cause the solution to freeze and damage your washer fluid tank and other parts of the washer system. Also, water doesn't clean as well as washer fluid.
- Fill your washer fluid tank only three-quarters full when it's very cold. This allows for expansion if freezing occurs, which could damage the tank if it is completely full.
- Don't use engine coolant (antifreeze) in your windshield washer. It can damage your washer system and paint.

Brakes**Brake Fluid**

Your brake master cylinder reservoir is on the driver's side of the engine compartment. It is filled with DOT-3 brake fluid.

There are only two reasons why the brake fluid level in the reservoir might go down. The first is that the brake fluid goes down to an acceptable level during normal brake lining wear. When new linings are put in, the fluid level goes back up. The other reason is that fluid is leaking out of the brake system. If it is, you should have your brake system fixed, since a leak means that sooner or later your brakes won't work well, or won't work at all.

So, it isn't a good idea to "top off" your brake fluid. Adding brake fluid won't correct a leak. If you add fluid when your linings are worn, then you'll have too much fluid when you get new brake linings. You should add (or remove) brake fluid, as necessary, only when work is done on the brake hydraulic system.

 **CAUTION:**

If you have too much brake fluid, it can spill on the engine. The fluid will burn if the engine is hot enough. You or others could be burned, and your vehicle could be damaged. Add brake fluid only when work is done on the brake hydraulic system.

When your brake fluid falls to a low level, your brake warning light will come on. A chime will sound if you try to drive with this warning light on. See "Brake System Warning Light" in the Index.

What to Add

When you do need brake fluid, use only DOT-3 brake fluid. Use new brake fluid from a sealed container only. Refer to "Recommended Fluids and Lubricants" in the Maintenance Schedule.

Always clean the brake fluid reservoir cap and the area around the cap before removing it. This will help keep dirt from entering the reservoir.

 **CAUTION:**

With the wrong kind of fluid in your brake system, your brakes may not work well, or they may not even work at all. This could cause a crash. Always use the proper brake fluid.

NOTICE:

- **Using the wrong fluid can badly damage brake system parts. For example, just a few drops of mineral-based oil, such as engine oil, in your brake system can damage brake system parts so badly that they'll have to be replaced. Don't let someone put in the wrong kind of fluid.**
- **If you spill brake fluid on your vehicle's painted surfaces, the paint finish can be damaged. Be careful not to spill brake fluid on your vehicle. If you do, wash it off immediately. See "Appearance Care" in the Index.**

Brake Wear

Your vehicle has front disc brakes and rear drum brakes.

Disc brake pads have built-in wear indicators that make a high-pitched warning sound when the brake pads are worn and new pads are needed. The sound may come and go or be heard all the time your vehicle is moving (except when you are pushing on the brake pedal firmly).

 **CAUTION:**

The brake wear warning sound means that soon your brakes won't work well. That could lead to an accident. When you hear the brake wear warning sound, have your vehicle serviced.

NOTICE:

Continuing to drive with worn-out brake pads could result in costly brake repair.

Some driving conditions or climates may cause a brake squeal when the brakes are first applied or lightly applied. This does not mean something is wrong with your brakes.

See “Caliper/Knuckle Maintenance Inspection” in Section 7 of this manual under Part C “Periodic Maintenance Inspections.”

Properly torqued wheel nuts are necessary to help prevent brake pulsation. When tires are rotated, inspect brake pads for wear and evenly torque wheel nuts in the proper sequence to GM specifications.

Your rear drum brakes don’t have wear indicators, but if you ever hear a rear brake rubbing noise, have the rear brake linings inspected immediately. Also, the rear brake drums should be removed and inspected each time the tires are removed for rotation or changing. When you have the front brake pads replaced, have the rear brakes inspected, too.

Brake linings should always be replaced as complete axle sets.

See “Brake System Inspection” in Section 7 of this manual under Part C “Periodic Maintenance Inspections.”

Brake Pedal Travel

See your dealer if the brake pedal does not return to normal height, or if there is a rapid increase in pedal travel. This could be a sign of brake trouble.

Brake Adjustment

Every time you apply the brakes, with or without the vehicle moving, your brakes adjust for wear.

Replacing Brake System Parts

The braking system on a vehicle is complex. Its many parts have to be of top quality and work well together if the vehicle is to have really good braking. Your vehicle was designed and tested with top-quality GM brake parts. When you replace parts of your braking system -- for example, when your brake linings wear down and you have to have new ones put in -- be sure you get new approved GM replacement parts. If you don’t, your brakes may no longer work properly. For example, if someone puts in brake linings that are wrong for your vehicle, the balance between your front and rear brakes can change -- for the worse. The braking performance you’ve come to expect can change in many other ways if someone puts in the wrong replacement brake parts.

Battery

Your new vehicle comes with an ACDelco Freedom[®] battery. When it's time for a new battery, we recommend an ACDelco Freedom battery. Get one that has the replacement number shown on the original battery's label.

Vehicle Storage

If you're not going to drive your vehicle for 25 days or more, remove the black, negative (-) cable from the battery. This will help keep your battery from running down.

CAUTION:

Batteries have acid that can burn you and gas that can explode. You can be badly hurt if you aren't careful. See "Jump Starting" in the Index for tips on working around a battery without getting hurt.

Contact your dealer to learn how to prepare your vehicle for longer storage periods.

Also, for your audio system, see "Theft-Deterrent Feature" in the Index.

Bulb Replacement

For any bulb changing procedure not listed in this section, contact your dealer's service department.

For the bulb types to be used in the following procedures, see "Replacement Bulbs" in the Index.

Halogen Bulbs

CAUTION:

Halogen bulbs have pressurized gas inside and can burst if you drop or scratch the bulb. You or others could be injured. Be sure to read and follow the instructions on the bulb package.

Headlamps

This procedure is for both the driver's and passenger's side headlamps.

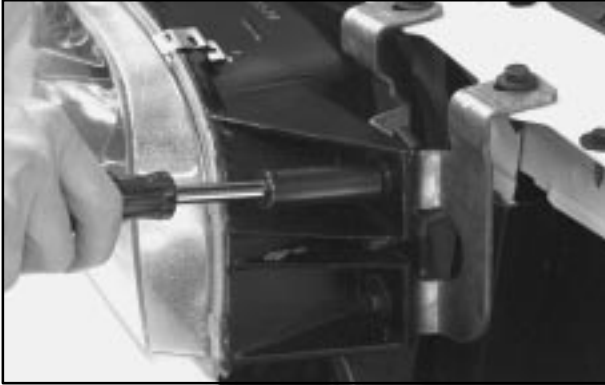

1. Use a 10 mm hex socket to remove two bolts retaining the headlamp assembly.



2. Slide the headlamp outboard until the pins are loose.
3. Remove the headlamp assembly to access the bulbs.



4. Rotate the bulb retainer counterclockwise to remove the bulb assembly.



5. Pull the tabs away from the bulb base to remove the bulb from the retainer.



6. Push the new bulb straight onto the retainer.
7. Reverse these steps to replace the bulb assembly.

Headlamp Aiming

Your vehicle has a headlamp system equipped with horizontal and vertical aim indicators. The aim has been pre-set at the factory and should need no further adjustment. This is true even though your vertical and horizontal aim indicators may not fall exactly on the “0” (zero) marks on their scales.

If your vehicle is damaged in an accident, the headlamp aim may be affected. Aim adjustment may be necessary if it is difficult to see lane markers (for horizontal aim), or if oncoming drivers flash their high beams at you (for vertical aim). If you believe your headlamps need to be re-aimed, we recommend that you take it to your dealer for service; however, it is possible for you to re-aim your headlamps as described in the following procedure.

NOTICE:

To make sure your headlamps are aimed properly, read all the instructions before beginning. Failure to follow these instructions could cause damage to headlamp parts.

The vehicle should be properly prepared as follows:

- The vehicle must have all four tires on a perfectly level surface.
- If necessary, pads may be used on an uneven surface.
- The vehicle should not have any snow, ice or mud attached to it.
- The vehicle should be fully assembled and all other work stopped while headlamp aiming is being done.
- There should not be any cargo or loading of the vehicle, except it should have a full tank of fuel and one person or 160 lbs. (75 kg) on the driver's seat.
- Close all doors.
- Tires should be properly inflated.
- Rock the vehicle to stabilize the suspension.

The headlamp aiming devices are under the hood near the headlamps.

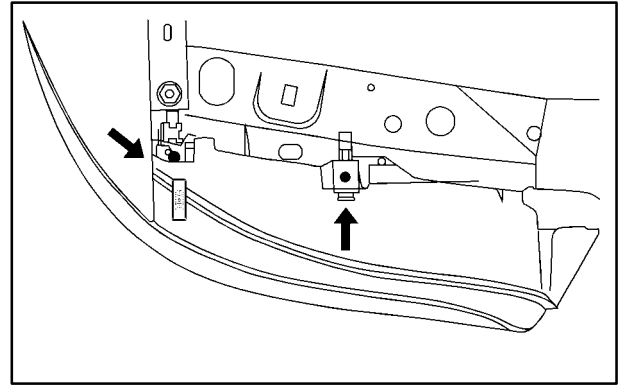

A. Horizontal Aiming Screw

B. Vertical Aiming Screw

Start with the horizontal aim. The adjustment screws can be turned with an E8 Torx[®] socket or T15 Torx screwdriver.

Once the horizontal aim is adjusted, then adjust the vertical aim.

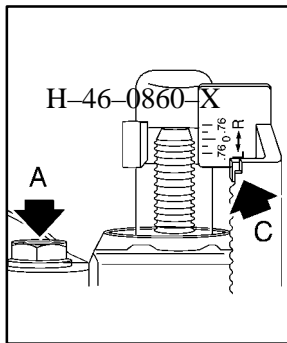

1. Turn the horizontal aiming screw (A) until the indicator (C) is lined up with zero.

A. Horizontal Aiming Screw

C. Indicator

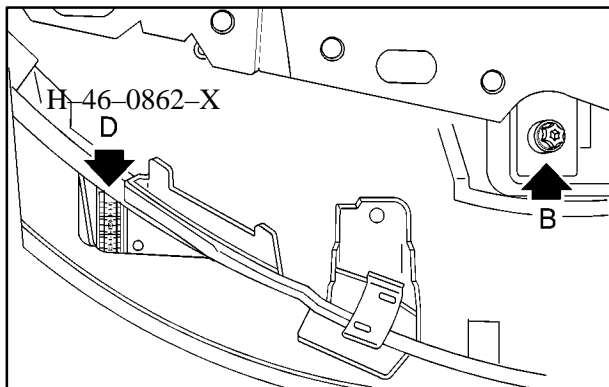

B. Vertical Aiming Screw

D. Level Bubble

2. Turn the vertical aiming screw (B) until the level bubble (D) is lined up with zero.

Front Turn Signal

The front turn signal bulbs can be accessed from under the front of the vehicle. Reach up from under the vehicle and, while pushing in the tab on the bulb assembly, turn the assembly counterclockwise and remove. Remove the old bulb by pulling it straight out of the retainer. Replace the bulb and turn the bulb assembly back into place.

Cornering Lamps

Follow the same procedure as used for replacing the headlamps. However, to remove the cornering lamp bulb, turn the bulb assembly counterclockwise and pull the bulb straight out.

Trunk-Mounted Back-Up and Taillamps



1. Loosen and remove the eight fasteners (four per side) that hold the assembly in place. The assembly for both sides is one piece. The entire piece must be removed to replace any bulbs.



2. Pull out the assembly.



3. Push in the tab and turn the bulb assembly counterclockwise to remove it.



4. Remove the old bulb by pulling it straight out.



5. Replace the bulb and reverse the steps to install the new bulb assembly.

Rear Turn Signals

1. Open the trunk. Turn the screw located just inside of the trunk counterclockwise and remove.
2. Pull the carpet away from the rear area to access the turn signal bulb assembly.
3. Turn the bulb socket one-quarter turn counterclockwise, while pressing it firmly.
4. Pull the bulb socket straight out of the assembly.
5. Remove the old bulb by pulling it straight out.
6. Replace with a new bulb by pushing the bulb straight into the socket until the bulb clicks into place.
7. Turn the bulb socket one-quarter turn into the assembly to lock it back into place.
8. Reverse Steps 1 through 3 to reinstall the bulb assembly.

Windshield Wiper Blade Replacement

Windshield wiper blades should be inspected at least twice a year for wear or cracking. See “Wiper Blade Check” in Section 7 of this manual under Part B “Owner Checks and Services” for more information.

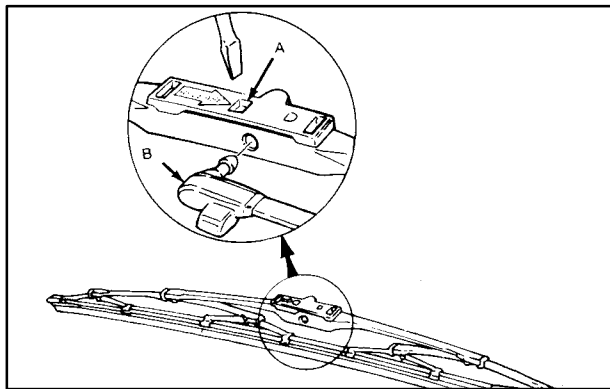

Replacement blades come in different types and are removed in different ways. Here's how to remove the type with a release hole:

1. Pull the windshield wiper arm away from the windshield.
2. Insert a small screwdriver into the hole (A) and pull the blade assembly off the wiper arm (B).
3. Push the new wiper blade securely on the wiper arm.

For the proper windshield wiper blade replacement length and type, see “Normal Maintenance Replacement Parts” in the Index.

Tires

Your new vehicle comes with high-quality tires made by a leading tire manufacturer. If you ever have questions about your tire warranty and where to obtain service, see your Buick Warranty booklet for details.

 **CAUTION:**

Poorly maintained and improperly used tires are dangerous.

- **Overloading your tires can cause overheating as a result of too much friction. You could have an air-out and a serious accident. See “Loading Your Vehicle” in the Index.**
- **Underinflated tires pose the same danger as overloaded tires. The resulting accident could cause serious injury. Check all tires frequently to maintain the recommended pressure. Tire pressure should be checked when your tires are cold.**
- **Overinflated tires are more likely to be cut, punctured or broken by a sudden impact -- such as when you hit a pothole. Keep tires at the recommended pressure.**
- **Worn, old tires can cause accidents. If your tread is badly worn, or if your tires have been damaged, replace them.**

Inflation -- Tire Pressure

The Tire-Loading Information label, which is on the rear edge of the driver’s door, shows the correct inflation pressures for your tires when they’re cold. “Cold” means your vehicle has been sitting for at least three hours or driven no more than 1 mile (1.6 km).

NOTICE:

Don’t let anyone tell you that underinflation or overinflation is all right. It’s not. If your tires don’t have enough air (underinflation), you can get the following:

- **Too much flexing**
- **Too much heat**
- **Tire overloading**
- **Bad wear**
- **Bad handling**
- **Bad fuel economy.**

NOTICE: (Continued)

NOTICE: (Continued)

If your tires have too much air (overinflation), you can get the following:

- **Unusual wear**
- **Bad handling**
- **Rough ride**
- **Needless damage from road hazards.**

When to Check

Check your tires once a month or more.

Don't forget your compact spare tire. It should be at 60 psi (420 kPa).

How to Check

Use a good quality pocket-type gage to check tire pressure. You can't tell if your tires are properly inflated simply by looking at them. Radial tires may look properly inflated even when they're underinflated.

Be sure to put the valve caps back on the valve stems. They help prevent leaks by keeping out dirt and moisture.

Tire Inspection and Rotation

Tires should be rotated every 6,000 to 8,000 miles (10 000 to 13 000 km). Any time you notice unusual wear, rotate your tires as soon as possible and check wheel alignment. Also check for damaged tires or wheels. See "When It's Time for New Tires" and "Wheel Replacement" later in this section for more information.

The purpose of regular rotation is to achieve more uniform wear for all tires on the vehicle. The first rotation is the most important. See "Scheduled Maintenance Services" in the Index for scheduled rotation intervals.

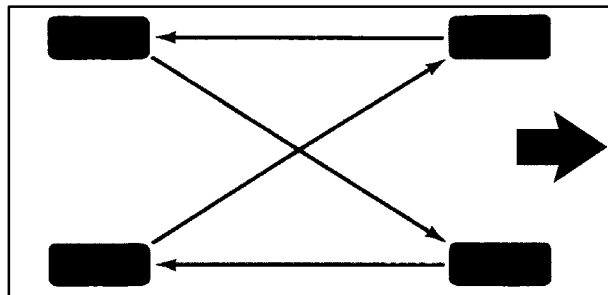

When rotating your tires, always use the correct rotation pattern shown here.

Don't include the compact spare tire in your tire rotation.

After the tires have been rotated, adjust the front and rear inflation pressures as shown on the Tire-Loading Information label. Make certain that all wheelnuts are properly tightened. See "Wheel Nut Torque" in the Index.

CAUTION:

Rust or dirt on a wheel, or on the parts to which it is fastened, can make wheel nuts become loose after a time. The wheel could come off and cause an accident. When you change a wheel, remove any rust or dirt from places where the wheel attaches to the vehicle. In an emergency, you can use a cloth or a paper towel to do this; but be sure to use a scraper or wire brush later, if you need to, to get all the rust or dirt off. (See "Changing a Flat Tire" in the Index.)

When It's Time for New Tires

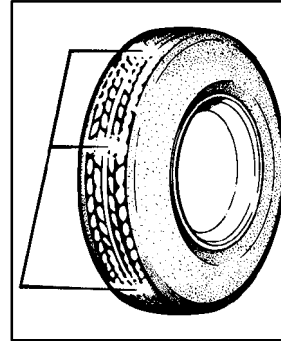

One way to tell when it's time for new tires is to check the treadwear indicators, which will appear when your tires have only 1/16 inch (1.6 mm) or less of tread remaining.

You need a new tire if any of the following statements are true:

- You can see the indicators at three or more places around the tire.
- You can see cord or fabric showing through the tire's rubber.
- The tread or sidewall is cracked, cut or snagged deep enough to show cord or fabric.
- The tire has a bump, bulge or split.
- The tire has a puncture, cut or other damage that can't be repaired well because of the size or location of the damage.

Buying New Tires

To find out what kind and size of tires you need, look at the Tire-Loading Information label.

The tires installed on your vehicle when it was new had a Tire Performance Criteria Specification (TPC Spec) number on each tire's sidewall. When you get new tires, get ones with that same TPC Spec number. That way your vehicle will continue to have tires that are designed to give proper endurance, handling, speed rating, traction, ride and other things during normal service on your vehicle. If your tires have an all-season tread design, the TPC number will be followed by an "MS" (for mud and snow).

If you ever replace your tires with those not having a TPC Spec number, make sure they are the same size, load range, speed rating and construction type (bias, bias-belted or radial) as your original tires.

CAUTION:

Mixing tires could cause you to lose control while driving. If you mix tires of different sizes or types (radial and bias-belted tires), the vehicle may not handle properly, and you could have a crash. Using tires of different sizes may also cause damage to your vehicle. Be sure to use the same size and type tires on all wheels.

It's all right to drive with your compact spare, though. It was developed for use on your vehicle.

CAUTION:

If you use bias-ply tires on your vehicle, the wheel rim flanges could develop cracks after many miles of driving. A tire and/or wheel could fail suddenly, causing a crash. Use only radial-ply tires with the wheels on your vehicle.

Uniform Tire Quality Grading

The following information relates to the system developed by the United States National Highway Traffic Safety Administration, which grades tires by treadwear, traction and temperature performance. (This applies only to vehicles sold in the United States.) The grades are molded on the sidewalls of most passenger car tires. The Uniform Tire Quality Grading system does not apply to deep tread, winter-type snow tires, space-saver or temporary use spare tires, tires with nominal rim diameters of 10 to 12 inches (25 to 30 cm), or to some limited-production tires.

While the tires available on General Motors passenger cars and light trucks may vary with respect to these grades, they must also conform to Federal safety requirements and additional General Motors Tire Performance Criteria (TPC) standards.

Treadwear

The treadwear grade is a comparative rating based on the wear rate of the tire when tested under controlled conditions on a specified government test course. For example, a tire graded 150 would wear one and a half (1 1/2) times as well on the government course as a tire graded 100. The relative performance of tires depends upon the actual conditions of their use, however, and may depart significantly from the norm due to variations in driving habits, service practices and differences in road characteristics and climate.

Traction -- AA, A, B, C

The traction grades, from highest to lowest, are AA, A, B, and C. Those grades represent the tire's ability to stop on wet pavement as measured under controlled conditions on specified government test surfaces of asphalt and concrete. A tire marked C may have poor traction performance. Warning: The traction grade assigned to this tire is based on straight-ahead braking traction tests, and does not include acceleration, cornering, hydroplaning, or peak traction characteristics.

Temperature -- A, B, C

The temperature grades are A (the highest), B, and C, representing the tire's resistance to the generation of heat and its ability to dissipate heat when tested under controlled conditions on a specified indoor laboratory test wheel. Sustained high temperature can cause the material of the tire to degenerate and reduce tire life, and excessive temperature can lead to sudden tire failure. The grade C corresponds to a level of performance which all passenger car tires must meet under the Federal Motor Vehicle Safety Standard No. 109. Grades B and A represent higher levels of performance on the laboratory test wheel than the minimum required by law.

Warning: The temperature grade for this tire is established for a tire that is properly inflated and not overloaded. Excessive speed, underinflation, or excessive loading, either separately or in combination, can cause heat buildup and possible tire failure.

Wheel Alignment and Tire Balance

The wheels on your vehicle were aligned and balanced carefully at the factory to give you the longest tire life and best overall performance.

Scheduled wheel alignment and wheel balancing are not needed. However, if you notice unusual tire wear or your vehicle pulling one way or the other, the alignment may need to be reset. If you notice your vehicle vibrating when driving on a smooth road, your wheels may need to be rebalanced.

Wheel Replacement

Replace any wheel that is bent, cracked, or badly rusted or corroded. If wheel nuts keep coming loose, the wheel, wheel bolts and wheel nuts should be replaced. If the wheel leaks air, replace it (except some aluminum wheels, which can sometimes be repaired). See your dealer if any of these conditions exist.

Your dealer will know the kind of wheel you need.

Each new wheel should have the same load-carrying capacity, diameter, width, offset and be mounted the same way as the one it replaces.

If you need to replace any of your wheels, wheel bolts or wheel nuts, replace them only with new GM original equipment parts. This way, you will be sure to have the right wheel, wheel bolts and wheel nuts for your vehicle.

CAUTION:

Using the wrong replacement wheels, wheel bolts or wheel nuts on your vehicle can be dangerous. It could affect the braking and handling of your vehicle, make your tires lose air and make you lose control. You could have a collision in which you or others could be injured. Always use the correct wheel, wheel bolts and wheel nuts for replacement.

NOTICE:

The wrong wheel can also cause problems with bearing life, brake cooling, speedometer or odometer calibration, headlamp aim, bumper height, vehicle ground clearance and tire or tire chain clearance to the body and chassis.

See “Changing a Flat Tire” in the Index for more information.

Used Replacement Wheels

CAUTION:

Putting a used wheel on your vehicle is dangerous. You can't know how it's been used or how far it's been driven. It could fail suddenly and cause an accident. If you have to replace a wheel, use a new GM original equipment wheel.

Tire Chains

NOTICE:

Use tire chains only where legal and only when you must. Use only SAE Class “S” type chains that are the proper size for your tires. Install them on the front tires and tighten them as tightly as possible with the ends securely fastened. Drive slowly and follow the chain manufacturer’s instructions. If you can hear the chains contacting your vehicle, stop and retighten them. If the contact continues, slow down until it stops. Driving too fast or spinning the wheels with chains on will damage your vehicle.

Appearance Care

Remember, cleaning products can be hazardous. Some are toxic. Others can burst into flame if you strike a match or get them on a hot part of the vehicle. Some are dangerous if you breathe their fumes in a closed space. When you use anything from a container to clean your vehicle, be sure to follow the manufacturer’s warnings and instructions. And always open your doors or windows when you’re cleaning the inside.

Never use these to clean your vehicle:

- Gasoline
- Benzene
- Naphtha
- Carbon Tetrachloride
- Acetone
- Paint Thinner
- Turpentine
- Lacquer Thinner
- Nail Polish Remover

They can all be hazardous -- some more than others -- and they can all damage your vehicle, too.

Don't use any of these unless this manual says you can. In many uses, these will damage your vehicle:

- Alcohol
- Laundry Soap
- Bleach
- Reducing Agents

Cleaning the Inside of Your Vehicle

Use a vacuum cleaner often to get rid of dust and loose dirt. Wipe vinyl, leather, plastic and painted surfaces with a clean, damp cloth.

Cleaning of Fabric/Carpet

Your dealer has two cleaners, Multi-Purpose Interior Cleaner and Capture Non-Solvent Dry Spot and Soil Remover for cleaning fabric and carpet. They will clean normal spots and stains very well. You can get GM-approved cleaning products from your dealer. (See "Appearance Care and Materials" in the Index.)

Here are some cleaning tips:

- Always read the instructions on the cleaner label.
- Clean up stains as soon as you can -- before they set.
- Carefully scrape off any excess stain.
- Use a clean cloth or sponge, and change to a clean area often. A soft brush may be used if stains are stubborn.
- If a ring forms on fabric after spot cleaning, clean the entire area immediately or it will set.

Using Multi-Purpose Interior Cleaner on Fabric

1. Vacuum and brush the area to remove any loose dirt.
2. Always clean a whole trim panel or section. Mask surrounding trim along stitch or welt lines.
3. Mix powdered cleaner following the directions on the container label to form thick suds.
4. Use suds only and apply with a clean sponge. Don't saturate the material and don't rub it roughly.
5. As soon as you've cleaned the section, use a sponge to remove the suds.
6. Wipe cleaned area with a clean, damp towel or cloth.
7. Wipe with a clean cloth and let dry.

Special Fabric Cleaning Problems

Stains caused by such things as catsup, coffee (black), egg, fruit, fruit juice, milk, soft drinks, vomit, urine and blood can be removed as follows:

1. Carefully scrape off excess stain, then sponge the soiled area with cool water.
2. If a stain remains, follow the multi-purpose interior cleaner instructions described earlier.
3. If an odor lingers after cleaning vomit or urine, treat the area with a water/baking soda solution:
1 teaspoon (5 ml) of baking soda to 1 cup (250 ml) of lukewarm water.
4. Let dry.

Stains caused by candy, ice cream, mayonnaise, chili sauce and unknown stains can be removed as follows:

1. Carefully scrape off excess stain.
2. First, clean with cool water and allow to dry completely.
3. If a stain remains, follow instructions for Multi-Purpose Interior Cleaner.

Cleaning Vinyl

Use warm water and a clean cloth.

- Rub with a clean, damp cloth to remove dirt. You may have to do it more than once.
- Things like tar, asphalt and shoe polish will stain if you don't get them off quickly. Use a clean cloth and a vinyl/leather cleaner. See your dealer for this product.

Cleaning Leather

Use a soft cloth with lukewarm water and a mild soap or saddle soap and wipe dry with a soft cloth. Then, let the leather dry naturally. Do not use heat to dry.

- For stubborn stains, use a leather cleaner. See your dealer for this product.
- *Never* use oils, varnishes, solvent-based or abrasive cleaners, furniture polish or shoe polish on leather.
- Soiled or stained leather should be cleaned immediately. If dirt is allowed to work into the finish, it can harm the leather.

Cleaning the Top of the Instrument Panel

Use only mild soap and water to clean the top surfaces of the instrument panel. Sprays containing silicones or waxes may cause annoying reflections in the windshield and even make it difficult to see through the windshield under certain conditions.

Cleaning Interior Plastic Components

Use only a mild soap and water solution on a soft cloth or sponge. Commercial cleaners may affect the surface finish.

Care of Safety Belts

Keep belts clean and dry.

CAUTION:

Do not bleach or dye safety belts. If you do, it may severely weaken them. In a crash, they might not be able to provide adequate protection. Clean safety belts only with mild soap and lukewarm water.

Cleaning Glass Surfaces

Glass should be cleaned often. GM Glass Cleaner or a liquid household glass cleaner will remove normal tobacco smoke and dust films on interior glass. (See “Appearance Care and Materials” in the Index.)

Don't use abrasive cleaners on glass, because they may cause scratches. Avoid placing decals on the inside rear window, since they may have to be scraped off later. If abrasive cleaners are used on the inside of the rear window, an electric defogger element may be damaged. Any temporary license should not be attached across the defogger grid.

Cleaning the Outside of the Windshield and Wiper Blades

If the windshield is not clear after using the windshield washer, or if the wiper blade chatters when running, wax, sap or other material may be on the blade or windshield.

Clean the outside of the windshield with GM Windshield Cleaner, Bon Ami[®] Powder (non-scratching glass cleaning powder), GM Part No. 1050011. The windshield is clean if beads do not form when you rinse it with water.

Grime from the windshield will stick to the wiper blades and affect their performance. Clean the blade by wiping vigorously with a cloth soaked in full-strength windshield washer solvent. Then rinse the blade with water.

Check the wiper blades and clean them as necessary; replace blades that look worn.

Weatherstrips

Silicone grease on weatherstrips will make them last longer, seal better, and not stick or squeak. Apply silicone grease with a clean cloth at least every six months. During very cold, damp weather more frequent application may be required. (See “Recommended Fluids and Lubricants” in the Index.)

Cleaning the Outside of Your Vehicle

The paint finish on your vehicle provides beauty, depth of color, gloss retention and durability.

Washing Your Vehicle

The best way to preserve your vehicle’s finish is to keep it clean by washing it often with lukewarm or cold water.

Don’t wash your vehicle in the direct rays of the sun. Use a car washing soap. Don’t use strong soaps or chemical detergents. Be sure to rinse the vehicle well, removing all soap residue completely. You can get GM-approved cleaning products from your dealer. (See “Appearance Care and Materials” in the Index.) Don’t use cleaning agents that are petroleum based, or that contain acid or abrasives. All cleaning agents should be flushed promptly and not allowed to dry on the surface, or they could stain. Dry the finish with a soft, clean chamois or an all-cotton towel to avoid surface scratches and water spotting.

High pressure car washes may cause water to enter your vehicle.

Cleaning Exterior Lamps/Lenses

Use lukewarm or cold water, a soft cloth and a car washing soap to clean exterior lamps and lenses. Follow instructions under “Washing Your Vehicle.”

Finish Care

Occasional waxing or mild polishing of your vehicle by hand may be necessary to remove residue from the paint finish. You can get GM-approved cleaning products from your dealer. (See “Appearance Care and Materials” in the Index.)

Your vehicle has a “basecoat/clearcoat” paint finish. The clearcoat gives more depth and gloss to the colored basecoat. Always use waxes and polishes that are non-abrasive and made for a basecoat/clearcoat paint finish.

NOTICE:

Machine compounding or aggressive polishing on a basecoat/clearcoat paint finish may dull the finish or leave swirl marks.

Foreign materials such as calcium chloride and other salts, ice melting agents, road oil and tar, tree sap, bird droppings, chemicals from industrial chimneys, etc., can damage your vehicle’s finish if they remain on painted surfaces. Wash the vehicle as soon as possible. If necessary, use non-abrasive cleaners that are marked safe for painted surfaces to remove foreign matter.

Exterior painted surfaces are subject to aging, weather and chemical fallout that can take their toll over a period of years. You can help to keep the paint finish looking new by keeping your vehicle garaged or covered whenever possible.

Cleaning Aluminum Wheels (If Equipped)

Keep your wheels clean using a soft clean cloth with mild soap and water. Rinse with clean water. After rinsing thoroughly, dry with a soft clean towel. A wax may then be applied.

The surface of these wheels is similar to the painted surface of your vehicle. Don't use strong soaps, chemicals, abrasive polishes, abrasive cleaners, cleaners with acid or abrasive cleaning brushes on them because you could damage the surface. Do not use chrome polish on any wheels other than chrome-plated wheels.

Don't take your vehicle through an automatic car wash that has silicon carbide tire cleaning brushes. These brushes can also damage the surface of these wheels.

Cleaning Tires

To clean your tires, use a stiff brush with a tire cleaner.

NOTICE:

When applying a tire dressing always take care to wipe off any overspray or splash from all painted surfaces on the body or wheels of the vehicle. Petroleum-based products may damage the paint finish and tires.

Sheet Metal Damage

If your vehicle is damaged and requires sheet metal repair or replacement, make sure the body repair shop applies anti-corrosion material to the parts repaired or replaced to restore corrosion protection.

Finish Damage

Any stone chips, fractures or deep scratches in the finish should be repaired right away. Bare metal will corrode quickly and may develop into a major repair expense.

Minor chips and scratches can be repaired with touch-up materials available from your dealer or other service outlets. Larger areas of finish damage can be corrected in your dealer's body and paint shop.

Underbody Maintenance

Chemicals used for ice and snow removal and dust control can collect on the underbody. If these are not removed, accelerated corrosion (rust) can occur on the underbody parts such as fuel lines, frame, floor pan and exhaust system even though they have corrosion protection.

At least every spring, flush these materials from the underbody with plain water. Clean any areas where mud and other debris can collect. Dirt packed in closed areas of the frame should be loosened before being flushed. Your dealer or an underbody car washing system can do this for you.

Chemical Paint Spotting

Some weather and atmospheric conditions can create a chemical fallout. Airborne pollutants can fall upon and attack painted surfaces on your vehicle. This damage can take two forms: blotchy, ringlet-shaped discolorations, and small irregular dark spots etched into the paint surface.

Although no defect in the paint job causes this, Buick will repair, at no charge to the owner, the surfaces of new vehicles damaged by this fallout condition within 12 months or 12,000 miles (20 000 km) of purchase, whichever occurs first.

GM Vehicle Care/Appearance Materials

PART NUMBER	SIZE	DESCRIPTION	USAGE
994954	23 in. x 25 in.	Polishing Cloth – Wax Treated	Exterior polishing cloth
1050172	16 oz. (0.473 L)	Tar and Road Oil Remover	Removes tar, road oil and asphalt
1050173	16 oz. (0.473 L)	Chrome Cleaner and Polish	Use on chrome, stainless steel, nickel, copper and brass
1050174	16 oz. (0.473 L)	White Sidewall Tire Cleaner	Removes soil and black marks from whitewalls
1050214	32 oz. (0.946 L)	Vinyl Cleaner	Cleans vinyl tops, upholstery and convertible tops
1050427	23 oz. (0.680 L)	Glass Cleaner	Removes dirt, grime, smoke and fingerprints
1052918**	8 oz. (0.237 L)	Armor All™ Protectant	Protects leather, wood, acrylics, Plexiglas™, plastic, rubber and vinyl
1052925	16 oz. (0.473 L)	Multi-Purpose Interior Cleaner	Cleans carpets, seats, interior trim, door panels and floor mats
1052929	16 oz. (0.473 L)	Wheel Cleaner	Spray on and rinse with water
1052930	8 oz. (0.237 L)	Capture Dry Spot Remover	Attracts, absorbs and removes soils on fabric
12345721	2.5 sq. ft.	Synthetic Chamois	Shines vehicle without scratching
12345725	12 oz. (0.354 L)	Silicone Tire Shine	Spray on tire shine
12377964*	16 oz. (0.473 L)	Finish Enhancer	Removes dust, fingerprints and surface contaminants
12377966*	16 oz. (0.473 L)	Cleaner Wax	Removes light scratches and oxidation and protects finish
12377984*	16 oz. (0.473 L)	Surface Cleaner	Removes contaminants, blemishes and swirl marks
See your General Motors Parts Department for these products. See “Recommended Fluids and Lubricants” in the Index.			* For exterior use only. **Not recommended for use on instrument panels.

Vehicle Identification Number (VIN)

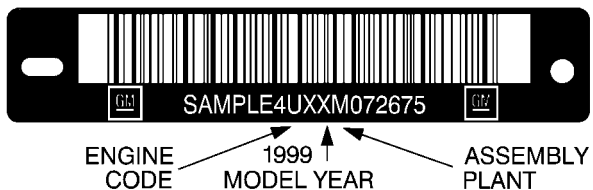

This is the legal identifier for your vehicle. It appears on a plate in the front corner of the instrument panel, on the driver's side. You can see it if you look through the windshield from outside your vehicle. The VIN also appears on the Vehicle Certification and Service Parts labels and the certificates of title and registration.

Engine Identification

The 8th character in your VIN is the engine code. This code will help you identify your engine, specifications and replacement parts.

Service Parts Identification Label

You'll find this label on your spare tire cover. It's very helpful if you ever need to order parts. On this label is:

- your VIN,
- the model designation,
- paint information and
- a list of all production options and special equipment.

Be sure that this label is not removed from the vehicle.

Electrical System

Add-On Electrical Equipment

NOTICE:

Don't add anything electrical to your vehicle unless you check with your dealer first. Some electrical equipment can damage your vehicle and the damage wouldn't be covered by your warranty. Some add-on electrical equipment can keep other components from working as they should.

Your vehicle has an air bag system. Before attempting to add anything electrical to your vehicle, see “Servicing Your Air Bag-Equipped Vehicle” in the Index.

Headlamp Wiring

The headlamp wiring is protected by an internal circuit breaker. An electrical overload will cause the lamps to go on and off, or in some cases to remain off. If this happens, have your headlamp system checked right away.

Windshield Wipers

The windshield wiper motor is protected by an internal circuit breaker and a fuse. If the motor overheats due to heavy snow, etc., the wiper will stop until the motor cools. If the overload is caused by some electrical problem, be sure to have it fixed.

Power Windows and Other Power Accessories

Circuit breakers in the fuse panel protect the power windows and other power accessories. When the current load is too heavy, the circuit breaker opens and closes, protecting the circuit until the problem is fixed or goes away.

Maxifuse[®]/Relay Center

To check the fuses in this underhood fuse center, turn the two knobs one-quarter turn counterclockwise and loosen the metal wing nut on the passenger side of the cover. Then remove the cover. The inside of the cover has a chart that explains the features and controls governed by each fuse and relay.

Fuses and Circuit Breakers

The wiring circuits in your vehicle are protected from short circuits by a combination of fuses, circuit breakers and fusible thermal links. This greatly reduces the chance of damage caused by electrical problems.

Look at the silver-colored band inside the fuse. If the band is broken or melted, replace the fuse. Be sure you replace a bad fuse with a new one of the identical size and rating.

If you ever have a problem on the road and don't have a spare fuse, you can "borrow" one that has the same amperage. Just pick some feature of your vehicle that you can get along without -- like the radio or cigarette lighter -- and use its fuse, if it is the correct amperage. Replace it as soon as you can.

There are two fuse blocks in your vehicle: the driver's side and passenger's side fuse blocks.

Driver's Side Fuse Block



The driver's side fuse block is to the left of the steering wheel, under the instrument panel.

Snap off the cover to reveal the fuses. You'll find a fuse puller clipped to the inside of the cover. Place the wide end of the fuse puller over the plastic end of the fuse. Squeeze the ends over the fuse and pull it out.

Spare fuses are located in the slots labeled "Spare" on the following chart.

When finished, replace the cover by snapping it back up into place.

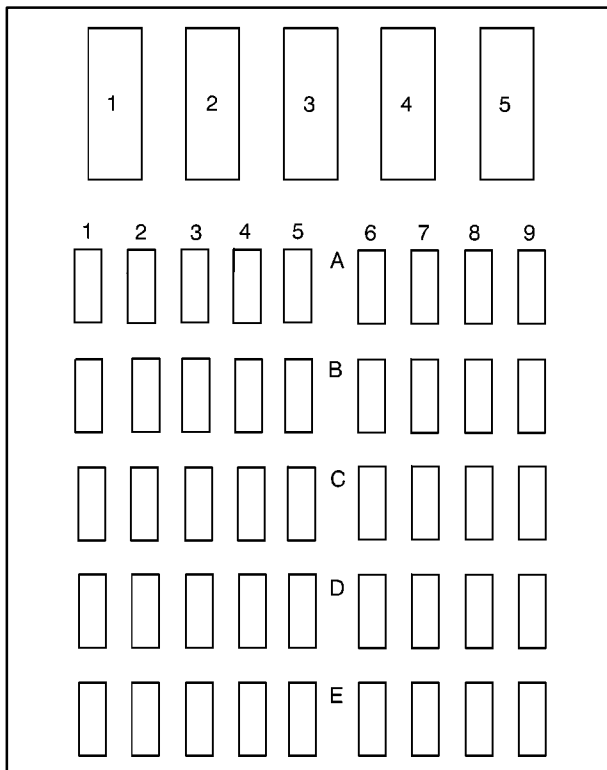

Fuse	Usage
1	Not Used
2	Not Used
3	Power Seats Circuit Breaker
4	Not Used
5	Not Used
1A	PASS Key
2A	Spare
3A	Not Used
4A	Not Used
5A	Auto HVAC, ALM, Cruise Control, Cluster
6A	Courtesy Lamps, Power Mirrors
7A	Not Used
8A	Perimeter Lighting
9A	Not Used
1B	Turn Signal, Back-Up Lamps, BTSI
2B	Spare
3B	Not Used

Fuse	Usage	Fuse	Usage
4B	Not Used	2D	Spare
5B	Anti-Lock Brake System, Computer Command Control	3D	Heated Mirrors
6B	Brake and Hazard Lamps	4D	Not Used
7B	Not Used	5D	Manual A/C
8B	Interior Lighting	6D	Not Used
9B	Cigarette Lighter	7D	TCC
1C	Air Bag System	8D	Radio
2C	Spare	9D	Not Used
3C	Not Used	1E	Not Used
4C	Not Used	2E	Air Bag System, PASS-Key
5C	Cooling Fans, Transaxle	3E	Not Used
6C	Parking Lamps, Interior Lamps	4E	Not Used
7C	Not Used	5E	Rear Defog
8C	Parking Lamps	6E	Not Used
9C	Radio, Cluster	7E	Miscellaneous Engine-Non OBD II
1D	Telltale, Chime, Cluster, RAC, LCM	8E	Wipers, Washer
		9E	Not Used

Passenger's Side Fuse Block

Additional fuses are located in the relay center, on the passenger's side, below the instrument panel. You must remove the sound insulator on the right side of the passenger footwell to replace these fuses.

Since the replacement of these fuses can be difficult, we recommend that you see your dealer for fuse replacement.

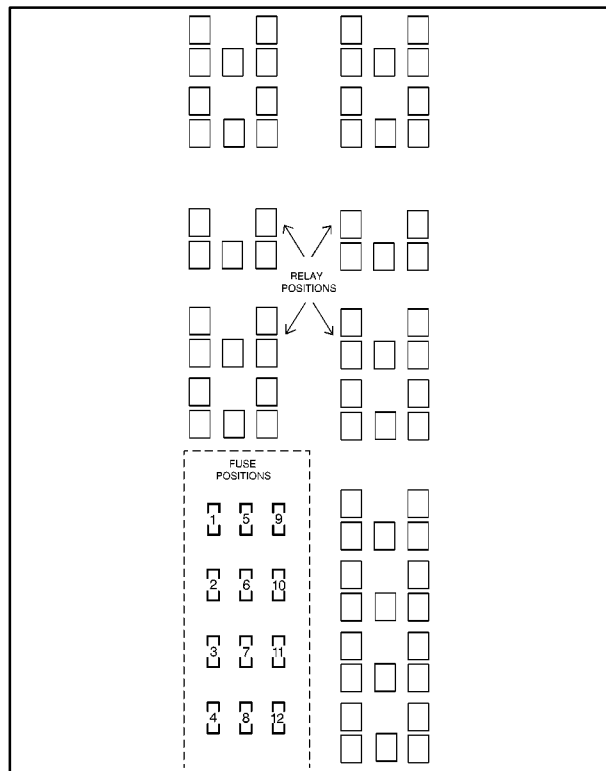

Fuse	Usage
1	Door Locks
2	Trunk Release, RAC
3	Horns
4	Not Used
5	Miscellaneous Engine Controls (OBD II)
6	Fuel Pump
7	Injectors
8	Powertrain Control Module
9	Not Used
10	Not Used
11	A/C Programmer
12	Not Used

Replacement Bulbs

	Bulb
Front Outside Lamps	
Cornering Lamps	3156
Halogen Headlamps	
Low Beam	9006
High Beam	9005
Parking/Turn Signal Lamps	3057
Rear Outside Lamps	
Back-Up Lamps	3156
Tail	194
Tail/Stop/Turn Signal lamps	3357

For service information on other bulbs, contact your dealer's service department.

Capacities and Specifications

The following approximate capacities are given in English and metric conversions. Please refer to “Recommended Fluids and Lubricants” in the Index for more information.

3800 Series II Engine (L36) Code K 3.8L V6

Automatic Transaxle (Overdrive)

Pan Removal and Replacement . . . 6.0 quarts (5.6 L)

After Complete Overhaul 10 quarts (9.5 L)

When draining or replacing torque convertor, more fluid may be needed.

Cooling System 13 quarts (12.3 L)

Engine Crankcase 4.5 quarts (4.3 L)

Oil change with filter change

Fuel Tank 18 gallons (68.1 L)

Tire Pressures *See Tire-Loading Information label on driver's door.*

Wheel Nut Torque 100 lb-ft (140 N·m)

R-134a Air Conditioning *See refrigerant charge label under the hood.*

All capacities are approximate. When adding, be sure to fill to the appropriate level, as recommended in this manual.

Engine Specifications

3800 Series II Engine (L36) Code K

VIN Engine Code K

Type V6

Displacement 3.8L

Horsepower 205-hp

Firing Order 1-6-5-4-3-2

Thermostat Temperature 195°F (91°C)

Air Conditioning Refrigerants

Not all air conditioning refrigerants are the same. If the air conditioning system in your vehicle needs refrigerant, be sure the proper refrigerant is used. If you're not sure, ask your dealer.

Normal Maintenance

Replacement Parts

Air Cleaner Filter	AC Type A-1096C
Engine Oil Filter	AC Type PF-47
Fuel Filter	AC Type GF-627
Transaxle Filter	GM Part No. 8651909
Spark Plugs	AC Type 41-921 Gap: 0.060 inch (1.52 mm)
Windshield Wiper Blades	
Type	Pin
Length	22 inches (56 cm)

Vehicle Dimensions

Length	200 inches (508.0 cm)
Width	73.6 inches (186.9 cm)
Height	55.7 inches (141.5 cm)
Wheelbase	110.8 inches (281.4 cm)
Tread Width	
Front	60.4 inches (153.4 cm)
Rear	60.2 inches (152.9 cm)

L36 Engine Accessory Belt

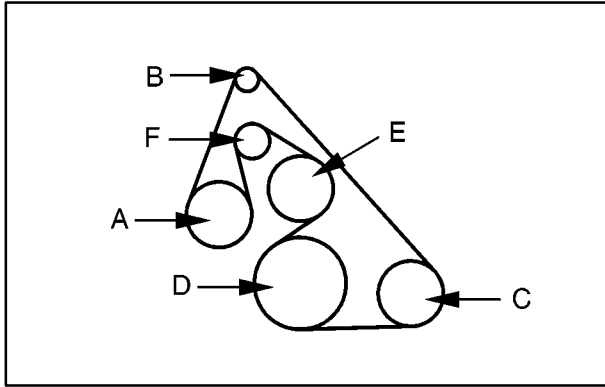

The L36 engine uses an engine accessory belt. This diagram shows the features connected and the routing. See “Maintenance Schedule” in the Index for when to check the belt.

- A. Power Steering
- B. Generator
- C. Air Conditioning
- D. Crank
- E. Coolant Pump
- F. Tensioner



Section 7 Maintenance Schedule

This section covers the maintenance required for your vehicle. Your vehicle needs these services to retain its safety, dependability and emission control performance.

7-2	Introduction	7-23	Long Trip/Highway Scheduled Maintenance
7-3	How This Section is Organized	7-33	Part B: Owner Checks and Services
7-4	Part A: Scheduled Maintenance Services	7-37	Part C: Periodic Maintenance Inspections
7-4	Using Your Maintenance Schedule	7-39	Part D: Recommended Fluids and Lubricants
7-4	Selecting the Right Schedule	7-41	Part E: Maintenance Record
7-7	Short Trip/City Scheduled Maintenance		

**IMPORTANT:
KEEP ENGINE OIL
AT THE PROPER
LEVEL AND CHANGE AS
RECOMMENDED**



Have you purchased the GM Protection Plan? The Plan supplements your new vehicle warranties. See your Warranty and Owner Assistance booklet, or your dealer for details.

Introduction

Your Vehicle and the Environment

Proper vehicle maintenance not only helps to keep your vehicle in good working condition, but also helps the environment. All recommended maintenance procedures are important. Improper vehicle maintenance can even affect the quality of the air we breathe. Improper fluid levels or the wrong tire inflation can increase the level of emissions from your vehicle. To help protect our environment, and to keep your vehicle in good condition, please maintain your vehicle properly.

How This Section is Organized

This maintenance schedule is divided into five parts:

“Part A: Scheduled Maintenance Services” shows what to have done and how often. Some of these services can be complex, so unless you are technically qualified and have the necessary equipment, you should let your dealer’s service department or another qualified service center do these jobs.

CAUTION:

Performing maintenance work on a vehicle can be dangerous. In trying to do some jobs, you can be seriously injured. Do your own maintenance work only if you have the required know-how and the proper tools and equipment for the job. If you have any doubt, have a qualified technician do the work.

If you are skilled enough to do some work on your vehicle, you will probably want to get the service information. See “Service and Owner Publications” in the Index.

“Part B: Owner Checks and Services” tells you what should be checked and when. It also explains what you can easily do to help keep your vehicle in good condition.

“Part C: Periodic Maintenance Inspections” explains important inspections that your dealer’s service department or another qualified service center should perform.

“Part D: Recommended Fluids and Lubricants” lists some recommended products to help keep your vehicle properly maintained. These products, or their equivalents, should be used whether you do the work yourself or have it done.

“Part E: Maintenance Record” provides a place for you to record the maintenance performed on your vehicle. Whenever any maintenance is performed, be sure to write it down in this part. This will help you determine when your next maintenance should be done. In addition, it is a good idea to keep your maintenance receipts. They may be needed to qualify your vehicle for warranty repairs.

Part A: Scheduled Maintenance Services

Using Your Maintenance Schedule

We at General Motors want to help you keep your vehicle in good working condition. But we don't know exactly how you'll drive it. You may drive very short distances only a few times a week. Or you may drive long distances all the time in very hot, dusty weather. You may use your vehicle in making deliveries. Or you may drive it to work, to do errands or in many other ways.

Because of all the different ways people use their vehicles, maintenance needs vary. You may need more frequent checks and replacements. So please read the following and note how you drive. If you have any questions on how to keep your vehicle in good condition, see your dealer.

This part tells you the maintenance services you should have done and when you should schedule them. If you go to your dealer for your service needs, you'll know that GM-trained and supported service people will perform the work using genuine GM parts.

The proper fluids and lubricants to use are listed in Part D. Make sure whoever services your vehicle uses these. All parts should be replaced and all necessary repairs done before you or anyone else drives the vehicle.

These schedules are for vehicles that:

- carry passengers and cargo within recommended limits. You will find these limits on your vehicle's Tire-Loading Information label. See "Loading Your Vehicle" in the Index.
- are driven on reasonable road surfaces within legal driving limits.
- use the recommended fuel. See "Fuel" in the Index.

Selecting the Right Schedule

First you'll need to decide which of the two schedules is right for your vehicle. Here's how to decide which schedule to follow:

Scheduled Maintenance

Short Trip/City Definition

Follow the Short Trip/City Scheduled Maintenance if any one of these conditions is true for your vehicle:

- Most trips are less than 5 to 10 miles (8 to 16 km). This is particularly important when outside temperatures are below freezing.
- Most trips include extensive idling (such as frequent driving in stop-and-go traffic).
- Most trips are through dusty areas.
- You frequently tow a trailer or use a carrier on top of your vehicle.
- If the vehicle is used for delivery service, police, taxi or other commercial application.

One of the reasons you should follow this schedule if you operate your vehicle under any of these conditions is that these conditions cause engine oil to break down sooner.

Short Trip/City Intervals

Every 3,000 Miles (5 000 km): Engine Oil and Filter Change (or 3 months, whichever occurs first).

Every 6,000 Miles (10 000 km): Chassis Lubrication (or 6 months, whichever occurs first). Tire Rotation.

Every 15,000 Miles (25 000 km): Air Cleaner Filter Inspection, if driving in dusty conditions.

Every 30,000 Miles (50 000 km): Air Cleaner Filter Replacement. Fuel Tank, Cap and Lines Inspection.

Every 50,000 Miles (83 000 km): Automatic Transaxle Service (severe conditions only).

Every 60,000 Miles (100 000 km): Engine Accessory Drive Belt Inspection.

Every 100,000 Miles (166 000 km): Spark Plug Wire Inspection. Spark Plug Replacement. Automatic Transaxle Service (normal conditions).

Every 150,000 Miles (240 000 km): Cooling System Service (or every 60 months, whichever occurs first).

These intervals only summarize maintenance services. Be sure to follow the complete scheduled maintenance on the following pages.

Scheduled Maintenance

Long Trip/Highway Definition

Follow this scheduled maintenance *only* if none of the conditions from the Short Trip/City Scheduled Maintenance is true. Do not use this schedule if the vehicle is used for trailer towing, driven in a dusty area or used off paved roads. Use the Short Trip/City schedule for these conditions.

Driving a vehicle with a fully warmed engine under highway conditions causes engine oil to break down slower.

Long Trip/Highway Intervals

Every 7,500 Miles (12 500 km): Engine Oil and Filter Change (or every 12 months, whichever occurs first). Chassis Lubrication (or every 12 months, whichever occurs first). Tire Rotation.

Every 30,000 Miles (50 000 km): Air Cleaner Filter Replacement. Fuel Tank, Cap and Lines Inspection.

Every 50,000 Miles (83 000 km): Automatic Transaxle Service (severe conditions only).

Every 60,000 Miles (100 000 km): Engine Accessory Drive Belt Inspection.

Every 100,000 Miles (166 000 km): Spark Plug Wire Inspection. Spark Plug Replacement. Automatic Transaxle Service (normal conditions).

Every 150,000 Miles (240 000 km): Cooling System Service (or every 60 months, whichever occurs first).

These intervals only summarize maintenance services. Be sure to follow the complete scheduled maintenance on the following pages.

Short Trip/City Scheduled Maintenance

The services shown in this schedule up to 100,000 miles (166 000 km) should be performed after 100,000 miles (166 000 km) at the same intervals. The services shown at 150,000 miles (240 000 km) should be performed at the same interval after 150,000 miles (240 000 km).

See “Owner Checks and Services” and “Periodic Maintenance Inspections” following.

Footnotes

† The U.S. Environmental Protection Agency or the California Air Resources Board has determined that the failure to perform this maintenance item will not nullify the emission warranty or limit recall liability prior to the completion of the vehicle’s useful life. We, however, urge that all recommended maintenance services be performed at the indicated intervals and the maintenance be recorded.

Lubricate the suspension and steering linkage, transaxle shift linkage, parking brake cable guides and underbody contact points.

* If your vehicle has an Engine Oil Life Monitor, the monitor will show you when to change the oil -- usually between 3,000 miles (5 000 km) and 7,500 miles (12 500 km) since your last oil change. Under severe conditions, the indicator may come on before 3,000 miles (5 000 km). Never drive your vehicle more than 7,500 miles (12 500 km) or 12 months, (whichever occurs first), without an oil change.

Short Trip/City Scheduled Maintenance

The system won't detect dust in the oil. So if you drive in a dusty area be sure to change your oil every 3,000 miles (5 000 km) or sooner if the CHANGE OIL SOON light comes on. Remember to reset the Oil Life Monitor when the oil has been changed. For more information, see "CHANGE OIL SOON Light" in the Index.

+ A good time to check your brakes is during tire rotation. See "Brake System Inspection" under "Periodic Maintenance Inspections" in Part C of this schedule.

++ If you drive in a highly corrosive environment, your brake calipers may require additional inspection and service, at every other tire rotation. See "Caliper/Knuckle Maintenance Inspection" under "Periodic Maintenance Inspections" in Part C of this schedule.

Short Trip/City Scheduled Maintenance

3,000 Miles (5 000 km)

- Change engine oil and filter (or every 3 months, whichever occurs first).
An Emission Control Service. (See footnote *.)

6,000 Miles (10 000 km)

- Change engine oil and filter (or every 3 months, whichever occurs first).
An Emission Control Service. (See footnote *.)
- Lubricate chassis components (or every 6 months, whichever occurs first).
(See footnote #.)
- Rotate tires. See “Tire Inspection and Rotation” in the Index for proper rotation pattern and additional information. (See footnote +.)

9,000 Miles (15 000 km)

- Change engine oil and filter (or every 3 months, whichever occurs first).
An Emission Control Service. (See footnote *.)

DATE	
ACTUAL MILEAGE	SERVICED BY:

DATE	
ACTUAL MILEAGE	SERVICED BY:

DATE	
ACTUAL MILEAGE	SERVICED BY:

Short Trip/City Scheduled Maintenance

12,000 Miles (20 000 km)

- Change engine oil and filter (or every 3 months, whichever occurs first).
An Emission Control Service. (See footnote *.)
- Lubricate chassis components (or every 6 months, whichever occurs first).
(See footnote #.)
- Rotate tires. See “Tire Inspection and Rotation” in the Index for proper rotation pattern and additional information. (See footnote +.)
(Also see footnote ++.)

DATE	
ACTUAL MILEAGE	SERVICED BY:

15,000 Miles (25 000 km)

- Change engine oil and filter (or every 3 months, whichever occurs first).
An Emission Control Service. (See footnote *.)
- Inspect air cleaner filter if you are driving in dusty conditions. Replace filter if necessary.
An Emission Control Service. (See footnote †.)

DATE	
ACTUAL MILEAGE	SERVICED BY:

18,000 Miles (30 000 km)

- Change engine oil and filter (or every 3 months, whichever occurs first).
An Emission Control Service. (See footnote *.)
- Lubricate chassis components (or every 6 months, whichever occurs first).
(See footnote #.)
- Rotate tires. See “Tire Inspection and Rotation” in the Index for proper rotation pattern and additional information. (See footnote +.)

DATE	
ACTUAL MILEAGE	SERVICED BY:

Short Trip/City Scheduled Maintenance

21,000 Miles (35 000 km)

- Change engine oil and filter (or every 3 months, whichever occurs first).
An Emission Control Service. (See footnote *.)

24,000 Miles (40 000 km)

- Change engine oil and filter (or every 3 months, whichever occurs first).
An Emission Control Service. (See footnote *.)
- Lubricate chassis components (or every 6 months, whichever occurs first).
(See footnote #.)
- Rotate tires. See “Tire Inspection and Rotation” in the Index for proper rotation pattern and additional information. (See footnote +.)
(Also see footnote ++.)

27,000 Miles (45 000 km)

- Change engine oil and filter (or every 3 months, whichever occurs first).
An Emission Control Service. (See footnote *.)

DATE	
ACTUAL MILEAGE	SERVICED BY:

DATE	
ACTUAL MILEAGE	SERVICED BY:

DATE	
ACTUAL MILEAGE	SERVICED BY:

Short Trip/City Scheduled Maintenance

30,000 Miles (50 000 km)

- Change engine oil and filter (or every 3 months, whichever occurs first).
An Emission Control Service. (See footnote *.)
- Lubricate chassis components (or every 6 months, whichever occurs first).
(See footnote #.)
- Replace air cleaner filter. *An Emission Control Service.*
- Inspect fuel tank, cap and lines for damage or leaks. Inspect fuel cap gasket for any damage. Replace parts as needed.
An Emission Control Service. (See footnote †.)
- Rotate tires. See “Tire Inspection and Rotation” in the Index for proper rotation pattern and additional information. (See footnote +.)

DATE	
ACTUAL MILEAGE	SERVICED BY:

33,000 Miles (55 000 km)

- Change engine oil and filter (or every 3 months, whichever occurs first).
An Emission Control Service. (See footnote *.)

DATE	
ACTUAL MILEAGE	SERVICED BY:

36,000 Miles (60 000 km)

- Change engine oil and filter (or every 3 months, whichever occurs first).
An Emission Control Service. (See footnote *.)

DATE	
ACTUAL MILEAGE	SERVICED BY:

Short Trip/City Scheduled Maintenance

- Lubricate chassis components (or every 6 months, whichever occurs first). (See footnote #.)
- Rotate tires. See “Tire Inspection and Rotation” in the Index for proper rotation pattern and additional information. (See footnote +.) (Also see footnote ++.)

39,000 Miles (65 000 km)

- Change engine oil and filter (or every 3 months, whichever occurs first). *An Emission Control Service.* (See footnote *.)

42,000 Miles (70 000 km)

- Change engine oil and filter (or every 3 months, whichever occurs first). *An Emission Control Service.* (See footnote *.)
- Lubricate chassis components (or every 6 months, whichever occurs first). (See footnote #.)
- Rotate tires. See “Tire Inspection and Rotation” in the Index for proper rotation pattern and additional information. (See footnote +.)

DATE	
ACTUAL MILEAGE	SERVICED BY:

DATE	
ACTUAL MILEAGE	SERVICED BY:

Short Trip/City Scheduled Maintenance

45,000 Miles (75 000 km)

- Change engine oil and filter (or every 3 months, whichever occurs first).
An Emission Control Service. (See footnote *.)
- Inspect air cleaner filter if you are driving in dusty conditions. Replace filter if necessary.
An Emission Control Service. (See footnote †.)

DATE	
ACTUAL MILEAGE	SERVICED BY:

48,000 Miles (80 000 km)

- Change engine oil and filter (or every 3 months, whichever occurs first).
An Emission Control Service. (See footnote *.)
- Lubricate chassis components (or every 6 months, whichever occurs first).
(See footnote #.)
- Rotate tires. See “Tire Inspection and Rotation” in the Index for proper rotation pattern and additional information. (See footnote +.)
(Also see footnote ++.)

DATE	
ACTUAL MILEAGE	SERVICED BY:

50,000 Miles (83 000 km)

- Change automatic transaxle fluid and filter if the vehicle is mainly driven under one or more of these conditions:
 - In heavy city traffic where the outside temperature regularly reaches 90°F (32°C) or higher.
 - In hilly or mountainous terrain.

DATE	
ACTUAL MILEAGE	SERVICED BY:

Short Trip/City Scheduled Maintenance

- When doing frequent trailer towing.
- Uses such as found in taxi, police or delivery service.

If you do not use your vehicle under any of these conditions, change the fluid and filter at 100,000 miles (166 000 km).

51,000 Miles (85 000 km)

- Change engine oil and filter (or every 3 months, whichever occurs first).
An Emission Control Service. (See footnote *.)

DATE	
ACTUAL MILEAGE	SERVICED BY:

54,000 Miles (90 000 km)

- Change engine oil and filter (or every 3 months, whichever occurs first).
An Emission Control Service. (See footnote *.)
- Lubricate chassis components (or every 6 months, whichever occurs first).
(See footnote #.)
- Rotate tires. See “Tire Inspection and Rotation” in the Index for proper rotation pattern and additional information. (See footnote +.)

DATE	
ACTUAL MILEAGE	SERVICED BY:

57,000 Miles (95 000 km)

- Change engine oil and filter (or every 3 months, whichever occurs first).
An Emission Control Service. (See footnote *.)

DATE	
ACTUAL MILEAGE	SERVICED BY:

Short Trip/City Scheduled Maintenance

60,000 Miles (100 000 km)

- Change engine oil and filter (or every 3 months, whichever occurs first).
An Emission Control Service. (See footnote *.)
- Lubricate chassis components (or every 6 months, whichever occurs first).
(See footnote #.)
- Inspect engine accessory drive belt.
An Emission Control Service.
- Replace air cleaner filter.
An Emission Control Service.
- Inspect fuel tank, cap and lines for damage or leaks. Inspect fuel cap gasket for any damage. Replace parts as needed.
An Emission Control Service. (See footnote †.)
- Rotate tires. See “Tire Inspection and Rotation” in the Index for proper rotation pattern and additional information. (See footnote +.)
(Also see footnote ++.)

DATE	
ACTUAL MILEAGE	SERVICED BY:

63,000 Miles (105 000 km)

- Change engine oil and filter (or every 3 months, whichever occurs first).
An Emission Control Service. (See footnote *.)

DATE	
ACTUAL MILEAGE	SERVICED BY:

Short Trip/City Scheduled Maintenance

66,000 Miles (110 000 km)

- Change engine oil and filter (or every 3 months, whichever occurs first).
An Emission Control Service. (See footnote *.)
- Lubricate chassis components (or every 6 months, whichever occurs first).
(See footnote #.)
- Rotate tires. See “Tire Inspection and Rotation” in the Index for proper rotation pattern and additional information. (See footnote +.)

69,000 Miles (115 000 km)

- Change engine oil and filter (or every 3 months, whichever occurs first).
An Emission Control Service. (See footnote *.)

72,000 Miles (120 000 km)

- Change engine oil and filter (or every 3 months, whichever occurs first).
An Emission Control Service. (See footnote *.)
- Lubricate chassis components (or every 6 months, whichever occurs first).
(See footnote #.)
- Rotate tires. See “Tire Inspection and Rotation” in the Index for proper rotation pattern and additional information. (See footnote +.)
(Also see footnote ++.)

DATE	
ACTUAL MILEAGE	SERVICED BY:

DATE	
ACTUAL MILEAGE	SERVICED BY:

DATE	
ACTUAL MILEAGE	SERVICED BY:

Short Trip/City Scheduled Maintenance

75,000 Miles (125 000 km)

- Change engine oil and filter (or every 3 months, whichever occurs first).
An Emission Control Service. (See footnote *.)
- Inspect air cleaner filter if you are driving in dusty conditions. Replace filter if necessary.
An Emission Control Service. (See footnote †.)

DATE	
ACTUAL MILEAGE	SERVICED BY:

78,000 Miles (130 000 km)

- Change engine oil and filter (or every 3 months, whichever occurs first).
An Emission Control Service. (See footnote *.)
- Lubricate chassis components (or every 6 months, whichever occurs first).
(See footnote #.)
- Rotate tires. See “Tire Inspection and Rotation” in the Index for proper rotation pattern and additional information. (See footnote +.)

DATE	
ACTUAL MILEAGE	SERVICED BY:

81,000 Miles (135 000 km)

- Change engine oil and filter (or every 3 months, whichever occurs first).
An Emission Control Service. (See footnote *.)

DATE	
ACTUAL MILEAGE	SERVICED BY:

Short Trip/City Scheduled Maintenance

84,000 Miles (140 000 km)

- Change engine oil and filter (or every 3 months, whichever occurs first).
An Emission Control Service. (See footnote *.)
- Lubricate chassis components (or every 6 months, whichever occurs first).
(See footnote #.)
- Rotate tires. See “Tire Inspection and Rotation” in the Index for proper rotation pattern and additional information. (See footnote +.)
(Also see footnote ++.)

DATE	
ACTUAL MILEAGE	SERVICED BY:

87,000 Miles (145 000 km)

- Change engine oil and filter (or every 3 months, whichever occurs first).
An Emission Control Service. (See footnote *.)

DATE	
ACTUAL MILEAGE	SERVICED BY:

90,000 Miles (150 000 km)

- Change engine oil and filter (or every 3 months, whichever occurs first).
An Emission Control Service. (See footnote *.)
- Lubricate chassis components (or every 6 months, whichever occurs first).
(See footnote #.)
- Replace air cleaner filter.
An Emission Control Service.

DATE	
ACTUAL MILEAGE	SERVICED BY:

(Continued)

Short Trip/City Scheduled Maintenance

90,000 Miles (150 000 km) (Continued)

- Inspect fuel tank, cap and lines for damage or leaks. Inspect fuel cap gasket for any damage. Replace parts as needed.
An Emission Control Service. (See footnote †.)
- Rotate tires. See “Tire Inspection and Rotation” in the Index for proper rotation pattern and additional information. (See footnote +.)

93,000 Miles (155 000 km)

- Change engine oil and filter (or every 3 months, whichever occurs first).
An Emission Control Service. (See footnote *.)

96,000 Miles (160 000 km)

- Change engine oil and filter (or every 3 months, whichever occurs first).
An Emission Control Service. (See footnote *.)
- Lubricate chassis components (or every 6 months, whichever occurs first).
(See footnote #.)
- Rotate tires. See “Tire Inspection and Rotation” in the Index for proper rotation pattern and additional information. (See footnote +.)
(Also see footnote ++.)

DATE	
ACTUAL MILEAGE	SERVICED BY:

DATE	
ACTUAL MILEAGE	SERVICED BY:

Short Trip/City Scheduled Maintenance

99,000 Miles (165 000 km)

- Change engine oil and filter (or every 3 months, whichever occurs first).
An Emission Control Service. (See footnote *.)

100,000 Miles (166 000 km)

- Inspect spark plug wires.
An Emission Control Service.
- Replace spark plugs.
An Emission Control Service.
- Change automatic transaxle fluid and filter if the vehicle is mainly driven under one or more of these conditions:
 - In heavy city traffic where the outside temperature regularly reaches 90°F (32°C) or higher.
 - In hilly or mountainous terrain.
 - When doing frequent trailer towing.
 - Uses such as found in taxi, police or delivery service.
- If you haven't used your vehicle under severe service conditions listed previously and, therefore, haven't changed your automatic transaxle fluid, change both the fluid and filter.

DATE	
ACTUAL MILEAGE	SERVICED BY:

DATE	
ACTUAL MILEAGE	SERVICED BY:

Short Trip/City Scheduled Maintenance

150,000 Miles (240 000 km)

- Drain, flush and refill cooling system (or every 60 months since last service, whichever occurs first). See “Engine Coolant” in the Index for what to use. Inspect hoses. Clean radiator, condenser, pressure cap and neck. Pressure test cooling system and pressure cap.

An Emission Control Service.

DATE	
ACTUAL MILEAGE	SERVICED BY:

Long Trip/Highway Scheduled Maintenance

The services shown in this schedule up to 100,000 miles (166 000 km) should be performed after 100,000 miles (166 000 km) at the same intervals. The services shown at 150,000 miles (240 000 km) should be performed at the same interval after 150,000 miles (240 000 km).

See “Owner Checks and Services” and “Periodic Maintenance Inspections” following.

Footnotes

† The U.S. Environmental Protection Agency or the California Air Resources Board has determined that the failure to perform this maintenance item will not nullify the emission warranty or limit recall liability prior to the completion of the vehicle’s useful life. We, however, urge that all recommended maintenance services be performed at the indicated intervals and the maintenance be recorded.

Lubricate the suspension and steering linkage, transaxle shift linkage, parking brake cable guides and underbody contact points.

* If your vehicle has an Engine Oil Life Monitor, the monitor will show you when to change the engine oil and filter -- usually between 3,000 miles (5 000 km) and 7,500 miles (12 500 km) since your last oil change. Under severe conditions, the indicator may come on before 3,000 miles (5 000 km). Never drive your vehicle more than 7,500 miles (12 500 km) or 12 months without an oil and filter change.

Long Trip/Highway Scheduled Maintenance

The system won't detect dust in the oil. So if you drive in a dusty area, be sure to change your oil and filter every 3,000 miles (5 000 km) or sooner if the CHANGE OIL SOON light comes on. Remember to reset the Oil Life Monitor whenever the oil is changed. For more information, see CHANGE OIL SOON Light in the Index.

+ A good time to check your brakes is during tire rotation. See “Brake System Inspection” under “Periodic Maintenance Inspections” in Part C of this schedule.

++ If you drive in a highly corrosive environment, your brake calipers may require additional inspection and service, at every other tire rotation. See “Caliper/Knuckle Maintenance Inspection” under “Periodic Maintenance Inspections” in Part C of this schedule.

Long Trip/Highway Scheduled Maintenance

7,500 Miles (12 500 km)

- Change engine oil and filter (or every 12 months, whichever occurs first).
An Emission Control Service. (See footnote *.)
- Lubricate chassis components (or every 12 months, whichever occurs first).
(See footnote #.)
- Rotate tires. See “Tire Inspection and Rotation” in the Index for proper rotation pattern and additional information. (See footnote +.)

DATE	
ACTUAL MILEAGE	SERVICED BY:

15,000 Miles (25 000 km)

- Change engine oil and filter (or every 12 months, whichever occurs first).
An Emission Control Service. (See footnote *.)
- Lubricate chassis components (or every 12 months, whichever occurs first).
(See footnote #.)
- Rotate tires. See “Tire Inspection and Rotation” in the Index for proper rotation pattern and additional information. (See footnote +.)
(Also see footnote ++.)

DATE	
ACTUAL MILEAGE	SERVICED BY:

22,500 Miles (37 500 km)

- Change engine oil and filter (or every 12 months, whichever occurs first).
An Emission Control Service. (See footnote *.)
- Lubricate chassis components (or every 12 months, whichever occurs first).
(See footnote #.)

DATE	
ACTUAL MILEAGE	SERVICED BY:

(Continued)

Long Trip/Highway Scheduled Maintenance

22,500 Miles (37 500 km) (Continued)

- Rotate tires. See “Tire Inspection and Rotation” in the Index for proper rotation pattern and additional information. (See footnote +.)

30,000 Miles (50 000 km)

- Change engine oil and filter (or every 12 months, whichever occurs first).
An Emission Control Service. (See footnote *.)
- Lubricate chassis components (or every 12 months, whichever occurs first).
(See footnote #.)
- Rotate tires. See “Tire Inspection and Rotation” in the Index for proper rotation pattern and additional information. (See footnote +.)
(Also see footnote ++.)
- Replace air cleaner filter.
An Emission Control Service.
- Inspect fuel tank, cap and lines for damage or leaks. Inspect fuel cap gasket for any damage. Replace parts as needed.
An Emission Control Service. (See footnote †.)

DATE	
ACTUAL MILEAGE	SERVICED BY:

37,500 Miles (62 500 km)

- Change engine oil and filter (or every 12 months, whichever occurs first).
An Emission Control Service. (See footnote *.)
- Lubricate chassis components (or every 12 months, whichever occurs first).
(See footnote #.)

DATE	
ACTUAL MILEAGE	SERVICED BY:

Long Trip/Highway Scheduled Maintenance

- Rotate tires. See “Tire Inspection and Rotation” in the Index for proper rotation pattern and additional information. (See footnote +.)

45,000 Miles (75 000 km)

- Change engine oil and filter (or every 12 months, whichever occurs first). *An Emission Control Service.* (See footnote *.)
- Lubricate chassis components (or every 12 months, whichever occurs first). (See footnote #.)
- Rotate tires. See “Tire Inspection and Rotation” in the Index for proper rotation pattern and additional information. (See footnote +.) (Also see footnote ++.)

DATE	
ACTUAL MILEAGE	SERVICED BY:

50,000 Miles (83 000 km)

- Change automatic transaxle fluid and filter if the vehicle is mainly driven under one or more of these conditions:
 - In heavy city traffic where the outside temperature regularly reaches 90°F (32°C) or higher.
 - In hilly or mountainous terrain.
 - When doing frequent trailer towing.
 - Uses such as found in taxi, police or delivery service.

If you do not use your vehicle under any of these conditions, change the fluid and filter at 100,000 miles (166 000 km).

DATE	
ACTUAL MILEAGE	SERVICED BY:

Long Trip/Highway Scheduled Maintenance

52,500 Miles (87 500 km)

- Change engine oil and filter (or every 12 months, whichever occurs first).
An Emission Control Service. (See footnote *.)
- Lubricate chassis components (or every 12 months, whichever occurs first).
(See footnote #.)
- Rotate tires. See “Tire Inspection and Rotation” in the Index for proper rotation pattern and additional information. (See footnote +.)

DATE	
ACTUAL MILEAGE	SERVICED BY:

60,000 Miles (100 000 km)

- Change engine oil and filter (or every 12 months, whichever occurs first).
An Emission Control Service. (See footnote *.)
- Lubricate chassis components (or every 12 months, whichever occurs first).
(See footnote #.)
- Rotate tires. See “Tire Inspection and Rotation” in the Index for proper rotation pattern and additional information. (See footnote +.)
(Also see footnote ++.)
- Inspect engine accessory drive belt. *An Emission Control Service.*
- Replace air cleaner filter.
An Emission Control Service.
- Inspect fuel tank, cap and lines for damage or leaks. Inspect fuel cap gasket for any damage. Replace parts as needed.
An Emission Control Service. (See footnote †.)

DATE	
ACTUAL MILEAGE	SERVICED BY:

Long Trip/Highway Scheduled Maintenance

67,500 Miles (112 500 km)

- Change engine oil and filter (or every 12 months, whichever occurs first).
An Emission Control Service. (See footnote *.)
- Lubricate chassis components (or every 12 months, whichever occurs first).
(See footnote #.)
- Rotate tires. See “Tire Inspection and Rotation” in the Index for proper rotation pattern and additional information. (See footnote +.)

DATE	
ACTUAL MILEAGE	SERVICED BY:

75,000 Miles (125 000 km)

- Change engine oil and filter (or every 12 months, whichever occurs first).
An Emission Control Service. (See footnote *.)
- Lubricate chassis components (or every 12 months, whichever occurs first).
(See footnote #.)
- Rotate tires. See “Tire Inspection and Rotation” in the Index for proper rotation pattern and additional information. (See footnote +.)
(Also see footnote ++.)

DATE	
ACTUAL MILEAGE	SERVICED BY:

82,500 Miles (137 500 km)

- Change engine oil and filter (or every 12 months, whichever occurs first).
An Emission Control Service. (See footnote *.)
- Lubricate chassis components (or every 12 months, whichever occurs first).
(See footnote #.)

DATE	
ACTUAL MILEAGE	SERVICED BY:

Long Trip/Highway Scheduled Maintenance

82,500 Miles (137 500 km) (Continued)

- Rotate tires. See “Tire Inspection and Rotation” in the Index for proper rotation pattern and additional information. (See footnote +.)

90,000 Miles (150 000 km)

- Change engine oil and filter (or every 12 months, whichever occurs first).
An Emission Control Service. (See footnote *.)
- Lubricate chassis components (or every 12 months, whichever occurs first).
(See footnote #.)
- Replace air cleaner filter.
An Emission Control Service.
- Inspect fuel tank, cap and lines for damage or leaks. Inspect fuel cap gasket for any damage. Replace parts as needed.
An Emission Control Service. (See footnote †.)
- Rotate tires. See “Tire Inspection and Rotation” in the Index for proper rotation pattern and additional information. (See footnote +.)
(Also see footnote ++.)

DATE	
ACTUAL MILEAGE	SERVICED BY:

97,500 Miles (162 500 km)

- Change engine oil and filter (or every 12 months, whichever occurs first).
An Emission Control Service. (See footnote *.)
- Lubricate chassis components (or every 12 months, whichever occurs first).
(See footnote #.)

DATE	
ACTUAL MILEAGE	SERVICED BY:

Long Trip/Highway Scheduled Maintenance

- Rotate tires. See “Tire Inspection and Rotation” in the Index for proper rotation pattern and additional information. (See footnote +.)

100,000 Miles (166 000 km)

- Inspect spark plug wires.
An Emission Control Service.
- Replace spark plugs.
An Emission Control Service.
- Change automatic transaxle fluid and filter if the vehicle is mainly driven under one or more of these conditions:
 - In heavy city traffic where the outside temperature regularly reaches 90°F (32°C) or higher.
 - In hilly or mountainous terrain.
 - When doing frequent trailer towing.
 - Uses such as found in taxi, police or delivery service.
- If you haven’t used your vehicle under severe service conditions listed previously and, therefore, haven’t changed your automatic transaxle fluid, change both the fluid and filter.

DATE	
ACTUAL MILEAGE	SERVICED BY:

Long Trip/Highway Scheduled Maintenance

150,000 Miles (240 000 km)

- Drain, flush and refill cooling system (or every 60 months since last service, whichever occurs first). See “Engine Coolant” in the Index for what to use. Inspect hoses. Clean radiator, condenser, pressure cap and neck. Pressure test the cooling system and pressure cap.

An Emission Control Service.

DATE	
ACTUAL MILEAGE	SERVICED BY:

Part B: Owner Checks and Services

Listed in this part are owner checks and services which should be performed at the intervals specified to help ensure the safety, dependability and emission control performance of your vehicle.

Be sure any necessary repairs are completed at once. Whenever any fluids or lubricants are added to your vehicle, make sure they are the proper ones, as shown in Part D.

At Each Fuel Fill

It is important for you or a service station attendant to perform these underhood checks at each fuel fill.

Engine Oil Level Check

Check the engine oil level and add the proper oil if necessary. See “Engine Oil” in the Index for further details.

Engine Coolant Level Check

Check the engine coolant level and add DEX-COOL[®] coolant mixture if necessary. See “Engine Coolant” in the Index for further details.

Windshield Washer Fluid Level Check

Check the windshield washer fluid level in the windshield washer tank and add the proper fluid if necessary. See “Windshield Washer Fluid” in the Index for further details.

At Least Once a Month

Tire Inflation Check

Make sure tires are inflated to the correct pressures. See “Tires” in the Index for further details.

Cassette Deck Service

Clean cassette deck. Cleaning should be done every 50 hours of tape play. See “Audio Systems” in the Index for further details.

At Least Twice a Year

Restraint System Check

Make sure the safety belt reminder light and all your belts, buckles, latch plates, retractors and anchorages are working properly. Look for any other loose or damaged safety belt system parts. If you see anything that might keep a safety belt system from doing its job, have it repaired. Have any torn or frayed safety belts replaced.

Also look for any opened or broken air bag coverings, and have them repaired or replaced. (The air bag system does not need regular maintenance.)

Wiper Blade Check

Inspect wiper blades for wear or cracking. Replace blade inserts that appear worn or damaged or that streak or miss areas of the windshield. Also see “Wiper Blades, Cleaning” in the Index.

Weatherstrip Lubrication

Silicone grease on weatherstrips will make them last longer, seal better, and not stick or squeak. Apply silicone grease with a clean cloth. During very cold, damp weather more frequent application may be required. (See “Recommended Fluids and Lubricants” in the Index.)

Automatic Transaxle Check

Check the transaxle fluid level; add if needed. See “Automatic Transaxle Fluid” in the Index. A fluid loss may indicate a problem. Check the system and repair if needed.

At Least Once a Year

Key Lock Cylinders Service

Lubricate the key lock cylinders with the lubricant specified in Part D.

Body Lubrication Service

Lubricate all body door hinges. Also lubricate all hinges and latches, including those for the hood, glove box door and console door. Part D tells you what to use. More frequent lubrication may be required when exposed to a corrosive environment.

Starter Switch Check

CAUTION:

When you are doing this check, the vehicle could move suddenly. If it does, you or others could be injured. Follow the steps below.

1. Before you start, be sure you have enough room around the vehicle.
2. Firmly apply both the parking brake (see “Parking Brake” in the Index if necessary) and the regular brake.

NOTE: Do not use the accelerator pedal, and be ready to turn off the engine immediately if it starts.
3. Try to start the engine in each gear. The starter should work only in PARK (P) or NEUTRAL (N). If the starter works in any other position, your vehicle needs service.

Brake-Transaxle Shift Interlock (BTISI) Check

CAUTION:

When you are doing this check, the vehicle could move suddenly. If it does, you or others could be injured. Follow the steps below.

1. Before you start, be sure you have enough room around the vehicle. It should be parked on a level surface.
2. Firmly apply the parking brake (see “Parking Brake” in the Index if necessary).

NOTE: Be ready to apply the regular brake immediately if the vehicle begins to move.
3. With the engine off, turn the key to the RUN position, but don’t start the engine. Without applying the regular brake, try to move the shift lever out of PARK (P) with normal effort. If the shift lever moves out of PARK (P), your vehicle’s BTISI needs service.

Ignition Transaxle Lock Check

While parked, and with the parking brake set, try to turn the ignition key to LOCK in each shift lever position.

- The key should turn to LOCK only when the shift lever is in PARK (P).
- The key should come out only in LOCK.

Parking Brake and Automatic Transaxle PARK (P) Mechanism Check

CAUTION:

When you are doing this check, your vehicle could begin to move. You or others could be injured and property could be damaged. Make sure there is room in front of your vehicle in case it begins to roll. Be ready to apply the regular brake at once should the vehicle begin to move.

Park on a fairly steep hill, with the vehicle facing downhill. Keeping your foot on the regular brake, set the parking brake.

- To check the parking brake's holding ability: With the engine running and transaxle in NEUTRAL (N), slowly remove foot pressure from the regular brake pedal. Do this until the vehicle is held by the parking brake only.
- To check the PARK (P) mechanism's holding ability: With the engine running, shift to PARK (P). Then release all brakes.

Underbody Flushing Service

At least every spring, use plain water to flush any corrosive materials from the underbody. Take care to clean thoroughly any areas where mud and other debris can collect.

Part C: Periodic Maintenance Inspections

Listed in this part are inspections and services which should be performed at least twice a year (for instance, each spring and fall). *You should let your dealer's service department or other qualified service center do these jobs. Make sure any necessary repairs are completed at once.*

Proper procedures to perform these services may be found in a service manual. See "Service and Owner Publications" in the Index.

Steering, Suspension and Front Drive Axle Boot and Seal Inspection

Inspect the front and rear suspension and steering system for damaged, loose or missing parts, signs of wear or lack of lubrication. Inspect the power steering lines and hoses for proper hook-up, binding, leaks, cracks, chafing, etc. Clean and then inspect the drive axle boot seals for damage, tears or leakage. Replace seals if necessary.

Exhaust System Inspection

Inspect the complete exhaust system. Inspect the body near the exhaust system. Look for broken, damaged, missing or out-of-position parts as well as open seams, holes, loose connections or other conditions which could cause a heat build-up in the floor pan or could let exhaust fumes into the vehicle. See "Engine Exhaust" in the Index.

Engine Cooling System Inspection

Inspect the hoses and have them replaced if they are cracked, swollen or deteriorated. Inspect all pipes, fittings and clamps; replace as needed. Clean the outside of the radiator and air conditioning condenser. To help ensure proper operation, a pressure test of the cooling system and pressure cap is recommended at least once a year.

Throttle System Inspection

Inspect the throttle system for interference or binding, and for damaged or missing parts. Replace parts as needed. Replace any components that have high effort or excessive wear. Do not lubricate accelerator and cruise control cables.

Brake System Inspection

Inspect the complete system. Inspect brake lines and hoses for proper hook-up, binding, leaks, cracks, chafing, etc. Inspect disc brake pads for wear and rotors for surface condition. Also inspect drum brake linings for wear and cracks. Inspect other brake parts, including drums, wheel cylinders, calipers, parking brake, etc. Check parking brake adjustment. You may need to have your brakes inspected more often if your driving habits or conditions result in frequent braking.

Caliper/Knuckle Maintenance Inspection

If you operate your vehicle in a highly corrosive environment, as indicated by the shaded areas on the map following this text, your vehicle may require additional brake service. Refer to the appropriate GM Service Bulletin for the proper caliper inspection procedure. As necessary, caliper pins and knuckle brake pad abutments should be lubricated at every other tire rotation. Also, see your GM dealer's service department or qualified service center for additional information.

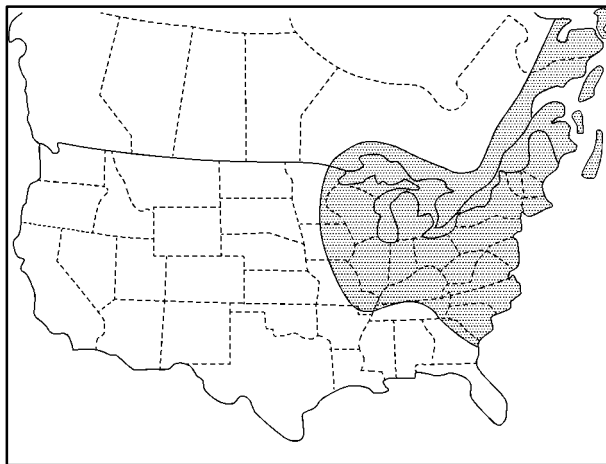

Part D: Recommended Fluids and Lubricants

NOTE: Fluids and lubricants identified below by name, part number or specification may be obtained from your dealer.

USAGE	FLUID/LUBRICANT
Engine Oil	Engine Oil with the American Petroleum Institute Certified For Gasoline Engines “Starburst” symbol of the proper viscosity. To determine the preferred viscosity for your vehicle’s engine, see “Engine Oil” in the Index.
Engine Coolant	50/50 mixture of clean, drinkable water and use only GM Goodwrench [®] DEX-COOL [®] or Havoline [®] DEX-COOL [®] Coolant. See “Engine Coolant” in the Index.

USAGE	FLUID/LUBRICANT
Hydraulic Brake System	Delco Supreme 11 [®] Brake Fluid (GM Part No. 12377967 or equivalent DOT-3 Brake Fluid).
Windshield Washer Solvent	GM Optikleen [®] Washer Solvent (GM Part No. 1051515 or equivalent).
Parking Brake Cable Guides	Chassis Lubricant (GM Part No. 12377985 or equivalent) or lubricant meeting requirements of NLGI # 2, Category LB or GC-LB.
Power Steering System	GM Power Steering Fluid (GM Part No. 1052884 - 1 pint, 1050017 - 1 quart, or equivalent).
Automatic Transaxle	DEXRON [®] -III Automatic Transmission Fluid.
Key Lock Cylinders	Multi-Purpose Lubricant, Superlube [®] (GM Part No. 12346241 or equivalent).

USAGE	FLUID/LUBRICANT
Chassis Lubrication	Chassis Lubricant (GM Part No. 12377985 or equivalent) or lubricant meeting requirements of NLGI # 2, Category LB or GC-LB.
Hood Latch Assembly, Secondary Latch, Pivots, Spring Anchor and Release Pawl	Lubriplate [®] Lubricant Aerosol (GM Part No. 12346293 or equivalent) or lubricant meeting requirements of NLGI # 2, Category LB or GC-LB.

USAGE	FLUID/LUBRICANT
Hood and Door Hinges	Multi-Purpose Lubricant, Superlube [®] (GM Part No. 12346241 or equivalent).
Fuel Door, Glove Box and Console Door Hinge and Rear Compartment Lid Hinges	Multi-Purpose Lubricant, Superlube [®] (GM Part No. 12346241 or equivalent).
Weatherstrip Conditioning	Dielectric Silicone Grease (GM Part No. 12345579 or equivalent).

Maintenance Record

DATE	ODOMETER READING	SERVICED BY	MAINTENANCE PERFORMED



Section 8 Customer Assistance Information

Here you will find out how to contact Buick if you need assistance. This section also tells you how to obtain service publications and how to report any safety defects.

8-2 Customer Satisfaction Procedure
8-4 Customer Assistance for Text Telephone (TTY) Users
8-4 Customer Assistance Offices
8-5 GM Mobility Program for Persons with Disabilities
8-6 Roadside Assistance
8-6 Canadian Roadside Assistance
8-7 Courtesy Transportation

8-8 Warranty Information
8-9 Reporting Safety Defects to the United States Government
8-9 Reporting Safety Defects to the Canadian Government
8-10 Reporting Safety Defects to General Motors
8-10 Ordering Service and Owner Publications in Canada

Customer Satisfaction Procedure



Your satisfaction and goodwill are important to your dealer and to Buick. Normally, any concerns with the sales transaction or the operation of your vehicle will be resolved by your dealer's sales or service departments. Sometimes, however, despite the best intentions of all concerned, misunderstandings can occur. If your concern has not been resolved to your satisfaction, the following steps should be taken:

STEP ONE -- Discuss your concern with a member of dealership management. Normally, concerns can be quickly resolved at that level. If the matter has already been reviewed with the sales, service or parts manager, contact the owner of the dealership or the general manager.

STEP TWO -- If after contacting a member of dealership management, it appears your concern cannot be resolved by the dealership without further help, contact the Buick Customer Relations Center by calling 1-800-521-7300. In Canada, contact GM of Canada Customer Communication Centre in Oshawa by calling 1-800-263-3777 (English) or 1-800-263-7854 (French).

We encourage you to call the toll-free number in order to give your inquiry prompt attention. Please have the following information available to give the Customer Assistance Representative:

- Vehicle Identification Number (This is available from the vehicle registration or title, or the plate at the top left of the instrument panel and visible through the windshield.)
- Dealership name and location
- Vehicle delivery date and present mileage

When contacting Buick, please remember that your concern will likely be resolved at a dealer's facility. That is why we suggest you follow Step One first if you have a concern.

STEP THREE -- Both General Motors and your dealer are committed to making sure you are completely satisfied with your new vehicle. However, if you continue to remain unsatisfied after following the procedure outlined in Steps One and Two, you must file with the GM/BBB Auto Line Program to enforce any additional rights you may have. Canadian owners refer to your Warranty and Owner Assistance Information booklet for information on the Canadian Motor Vehicle Arbitration Plan (CAMVAP).

The BBB Auto Line Program is an out of court program administered by the Council of Better Business Bureaus to settle automotive disputes regarding vehicle repairs or the interpretation of the New Vehicle Limited Warranty. Although you are required to resort to this informal dispute resolution program prior to filing any court action, use of the program is free of charge and your case will generally be heard within 40 days. If you do not agree with the decision given in your case, you may reject it and proceed with any other venue for relief available to you.

You may contact the BBB using the toll-free telephone number or write them at the following address:

BBB Auto Line
Council of Better Business Bureaus, Inc.
4200 Wilson Boulevard
Suite 800
Arlington, VA 22203-1804
Telephone: 1-800-955-5100

This program is available in all 50 states and the District of Columbia. Eligibility is limited by vehicle age, mileage and other factors. General Motors reserves the right to change eligibility limitations and/or discontinue its participation in this program.

Customer Assistance for Text Telephone (TTY) Users

To assist customers who are deaf, hard of hearing, or speech-impaired and who use Text Telephones (TTYs), Buick has TTY equipment available at its Customer Assistance Center. Any TTY user can communicate with Buick by dialing: 1-800-83-BUICK. (TTY users in Canada can dial 1-800-263-3830.)

Customer Assistance Offices

Buick encourages customers to call the toll-free number for assistance. If a U.S. customer wishes to write to Buick, the letter should be addressed to Buick's Customer Relations Center.

United States

Buick Customer Relations Center
P.O. Box 5039
Troy, MI 48098

1-800-521-7300
1-800-832-8425 (For Text Telephone devices (TTYs))
Roadside Assistance: 1-800-252-1112

Canada

General Motors of Canada Limited
Customer Communication Centre, 163-005
1908 Colonel Sam Drive
Oshawa, Ontario L1H 8P7

1-800-263-3777 (English)
1-800-263-7854 (French)
1-800-263-3830 (For Text Telephone devices (TTYs))
Roadside Assistance: 1-800-268-6800

All Overseas Locations

GMODC - Customer Communication Centre
169-007
1908 Colonel Sam Drive
Oshawa, Ontario L1H 8P7

Telephone: 905-644-4112
Fax: 905-644-4866

Caribbean Numbers

1-800-496-9992 (English) Puerto Rico
1-800-496-9993 (Spanish) Puerto Rico
1-800-751-4135 (English) Dominican Republic
1-800-751-4136 (Spanish) Dominican Republic
1-800-496-9994 U.S. Virgin Islands
1-800-389-0009 Bahamas
1-800-534-0122 Bermuda, Barbados, Antigua & B.V.I.

If toll free service is not available in the Caribbean, call Puerto Rico 1-787-763-1315.

GM Mobility Program for Persons with Disabilities

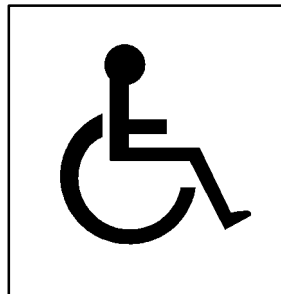

This program, available to qualified applicants, can reimburse you up to \$1,000 toward aftermarket driver or passenger adaptive equipment you may require for your vehicle (hand controls, wheelchair/scooter lifts, etc.).

This program can also provide you with free resource information, such as area driver assessment centers and mobility equipment installers. The program is available for a limited period of time from the date of vehicle purchase/lease. See your dealer for more details or call the GM Mobility Assistance Center at 1-800-323-9935. Text telephone (TTY) users, call 1-800-833-9935.

GM of Canada also has a Mobility Program. Call 1-800-GM-DRIVE (463-7483) for details. TTY users call 1-800-263-3830. When calling from the United States, please dial 1-905-644-3063.

Roadside Assistance

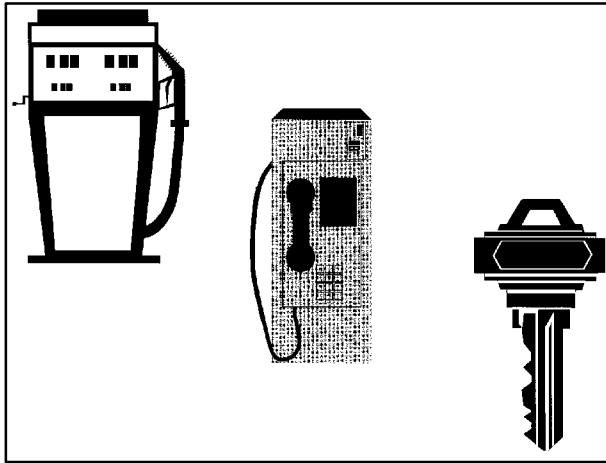

Buick Motor Division is proud to offer Buick Premium Roadside Assistance to customers for vehicles covered under the 3 year/36,000 mile (60 000 km) new car warranty (whichever occurs first).

Our commitment to Buick owners has always included superior service through our network of over 2,800 Buick dealers. Buick Premium Roadside Assistance provides an extra measure of convenience and security.

BUICK PREMIUM ROADSIDE ASSISTANCE:

- Provides owners with access to minor repairs or towing for disabled vehicles. Although Roadside Assistance is not a repair facility, it is a means of assisting customers in an emergency situation.
- Takes the anxiety out of uncertain situations by providing easy access to service professionals trained to work with Buick owners, 24 hours a day, 365 days a year, including weekends and holidays.

For details on Buick Premium Roadside Assistance, please consult your Buick Premium Roadside Assistance owner booklet included with your owner's manual. For needed assistance, call the Buick Premium Roadside Assistance toll-free hotline: 1-800-252-1112.

Canadian Roadside Assistance

Vehicles purchased in Canada have an extensive Roadside Assistance program accessible from anywhere in Canada or the United States. Please refer to the separate brochure provided by the dealer or call 1-800-268-6800 for emergency services.

Courtesy Transportation

Buick has always exemplified quality and value in its offering of motor vehicles. To enhance your ownership experience, we and our participating dealerships are proud to offer Courtesy Transportation, a customer support program for new vehicles.

The Courtesy Transportation program is offered to retail purchase/lease customers in conjunction with the Bumper to Bumper coverage provided by the New Vehicle Limited Warranty. Several transportation options are available when warranty repairs are required. This will reduce your inconvenience during warranty repairs.

Plan Ahead When Possible

When your vehicle requires warranty service, you should contact your dealer and request an appointment. By scheduling a service appointment and advising your service consultant of your transportation needs, your dealer can help minimize your inconvenience. If it is determined that your vehicle cannot be scheduled into the service department immediately and is still operative, you are encouraged to drive the vehicle until scheduling can be accomplished.

If the dealer requests that you simply drop the vehicle off for service, you are urged to do so as early in the work day as possible to allow for same day repair.

Transportation Options

Warranty service can generally be completed while you wait. However, if you are unable to wait Buick helps minimize your inconvenience by providing several transportation options. Depending on the circumstances, your dealer can offer you one of the following:

Shuttle Service

Participating dealerships can provide you with shuttle service to get you to your destination with minimal interruption of your daily schedule. This includes a one way shuttle ride to a destination up to 10 miles from the dealership.

Public Transportation or Fuel Reimbursement

If your vehicle requires overnight warranty repairs, reimbursement up to \$30 per day (five days maximum) may be available for the use of public transportation such as taxi or bus. In addition, should you arrange transportation through a friend or relative, reimbursement for reasonable fuel expenses up to \$10 per day (five day maximum) may be available. Claim amounts should reflect actual costs and be supported by original receipts.

Courtesy Rental Vehicle

When your vehicle is unavailable due to overnight warranty repairs, your dealer may arrange to provide you with a courtesy rental vehicle or reimburse you for a rental vehicle you obtained, at actual cost, up to a maximum of \$30.00 per day supported by receipts. This requires that you sign and complete a rental agreement and meet state, local and rental vehicle provider requirements.

Requirements vary and may include minimum age requirements, insurance coverage, credit card, etc. You are responsible for fuel usage charges and may also be responsible for taxes, levies, usage fees, excessive mileage or rental usage beyond the completion of the repair.

Generally it is not possible to provide a like-vehicle as a courtesy rental.

Additional Program Information

Courtesy Transportation is available during the Bumper-to-Bumper warranty coverage period, but it *is not* part of the New Vehicle Limited Warranty. A separate booklet entitled “Warranty and Owner Assistance Information” furnished with each new vehicle provides detailed warranty coverage information.

Courtesy Transportation is available only at participating dealerships and all program options, such as shuttle service, may not be available at every dealer.

Please contact your dealer for specific information about availability. All Courtesy Transportation arrangements will be administered by appropriate dealer personnel.

Canadian Vehicles: For warranty repairs during the Complete Vehicle Coverage period of the General Motors of Canada New Vehicle Limited Warranty, alternative transportation may be available under the Courtesy Transportation Program. Please consult your dealer for details.

General Motors reserves the right to unilaterally modify, change or discontinue Courtesy Transportation at any time and to resolve all questions of claim eligibility pursuant to the terms and conditions described herein at its sole discretion.

General Motors and participating dealerships reserve the right to deny a rental vehicle to anyone not possessing a valid motor vehicle operators license in their name, anyone who is under the influence of alcohol or drugs, or anyone whose mental or physical abilities are impaired so as to be unable to operate a motor vehicle safely.

Warranty Information

Your vehicle comes with a separate warranty booklet that contains detailed warranty information.

REPORTING SAFETY DEFECTS TO THE UNITED STATES GOVERNMENT

If you believe that your vehicle has a defect which could cause a crash or could cause injury or death, you should immediately inform the National Highway Traffic Safety Administration (NHTSA), in addition to notifying General Motors.

If NHTSA receives similar complaints, it may open an investigation, and if it finds that a safety defect exists in a group of vehicles, it may order a recall and remedy campaign. However, NHTSA cannot become involved in individual problems between you, your dealer or General Motors.

To contact NHTSA, you may either call the Auto Safety Hotline toll-free at 1-800-424-9393 (or 366-0123 in the Washington, D.C. area) or write to:

NHTSA, U.S. Department of Transportation
Washington, D.C. 20590

You can also obtain other information about motor vehicle safety from the hotline.

REPORTING SAFETY DEFECTS TO THE CANADIAN GOVERNMENT

If you live in Canada, and you believe that your vehicle has a safety defect, you should immediately notify Transport Canada, in addition to notifying General Motors of Canada Limited. You may write to:

Transport Canada
330 Sparks Street
Tower C
Ottawa, Ontario K1A 0N5

REPORTING SAFETY DEFECTS TO GENERAL MOTORS

In addition to notifying NHTSA (or Transport Canada) in a situation like this, we certainly hope you'll notify us. Please call us at 1-800-521-7300, or write:

Buick Customer Relations Center
P.O. Box 5039
Troy, MI 48098

In Canada, please call us at 1-800-263-3777 (English) or 1-800-263-7854 (French). Or, write:

General Motors of Canada Limited
Customer Communication Centre, 163-005
1908 Colonel Sam Drive
Oshawa, Ontario L1H 8P7

Ordering Service and Owner Publications in Canada

Service manuals, owner's manuals and other service literature are available for purchase for all current and past model General Motors vehicles.

The toll-free telephone number for ordering information in Canada is 1-800-668-5539.

1999 BUICK SERVICE PUBLICATIONS ORDERING INFORMATION

The following publications covering the operation and servicing of your vehicle can be purchased by filling out the Service Publication Order Form in this book and mailing it in with your check, money order, or credit card information to Helm, Incorporated (address below.)

CURRENT PUBLICATIONS FOR 1999 BUICK

SERVICE MANUALS

Service Manuals have the diagnosis and repair information on engines, transmission, axle, suspension, brakes, electrical, steering, body, etc.

RETAIL SELL PRICE: \$90.00

TRANSMISSION, TRANSAXLE, TRANSFER CASE UNIT REPAIR MANUAL

This manual provides information on unit repair service procedures, adjustments and specifications for the 1999 GM transmissions, transaxles and transfer cases.

RETAIL SELL PRICE: \$50.00

SERVICE BULLETINS

Service Bulletins give technical service information needed to knowledgeably service General Motors cars and trucks. Each bulletin contains instructions to assist in the diagnosis and service of your vehicle.

OWNER'S INFORMATION

Owner publications are written directly for Owners and intended to provide basic operational information about the vehicle. The owner's manual will include the Maintenance Schedule for all models.

In-Portfolio: Includes a Portfolio, Owner's Manual and Warranty Booklet.

RETAIL SELL PRICE: \$15.00

Without Portfolio: Owner's Manual only.

RETAIL SELL PRICE: \$10.00

CURRENT & PAST MODEL ORDER FORMS

Service Publications are available for current and past model GM vehicles. To request an order form, please specify year and model name of the vehicle.

PLEASE COMPLETE THE ORDER FORM SHOWN ON THE FOLLOWING PAGE AND MAIL TO:

Helm, Incorporated • P.O. Box 07130 • Detroit, MI 48207

OR ORDER TOLL FREE: 1-800-551-4123

Monday-Friday 8:00 AM – 6:00 PM Eastern Time

For Credit Card Orders Only (VISA–MasterCard–Discover)

<p align="center">ORDER TOLL FREE (NOTE: For Credit Card Holders Only) 1-800-551-4123 (Monday-Friday 8:00 AM – 6:00 PM EST) FAX Orders Only 1-313-865-5927</p>	<p>Orders will be mailed within 10 days of receipt. Please allow adequate time for postal service. If further information is needed, write to the address shown below or call 1-800-551-4123. Material cannot be returned for credit without packing slip with return information within 30 days of delivery. On returns, a re-stocking fee may be applied against the original order.</p>
--	--

1 9 9 9 G M	PUBLICATION FORM NUMBER	ITEM DESCRIPTION	VEHICLE MODEL		QTY.	PRICE EACH*	TOTAL PRICE
			NAME	YEAR			
		Service Manual		1999		\$90.00	
		Car & Light Truck Transmission Unit Repair		1999		\$50.00	
		Owner's Manual In Portfolio		1999		\$15.00	
		Owner's Manual Without Portfolio		1999		\$10.00	

S H I P T O	<p>NOTE: Dealers and Companies please provide dealer or company name, and also the name of the person to whose attention the shipment should be sent. Mail completed order form to: HELM, INCORPORATED • P.O. Box 07130 • Detroit, MI 48207 For purchases outside U.S.A. please write to the above address for quotation.</p>	P A Y M E N T	<input type="checkbox"/> Check or Money Order payable to Helm, Inc. (USA funds only — do not send cash.)	<table border="1" style="width:100%; border-collapse: collapse;"> <tr> <td colspan="2" style="text-align:center;">TOTAL MATERIAL</td> </tr> <tr> <td colspan="2">Michigan Purchasers add 6% sales tax</td> </tr> <tr> <td>U.S. Order Processing</td> <td align="right">\$5.00</td> </tr> <tr> <td colspan="2">Canadian Postage (See Note Below)</td> </tr> <tr> <td colspan="2" style="text-align:center;">GRAND TOTAL</td> </tr> </table>	TOTAL MATERIAL		Michigan Purchasers add 6% sales tax		U.S. Order Processing	\$5.00	Canadian Postage (See Note Below)		GRAND TOTAL	
	TOTAL MATERIAL													
	Michigan Purchasers add 6% sales tax													
	U.S. Order Processing		\$5.00											
	Canadian Postage (See Note Below)													
GRAND TOTAL														
_____ (CUSTOMER'S NAME) (ATTENTION)	<input type="checkbox"/> MasterCard													
_____ (STREET ADDRESS—NO P.O. BOX NUMBERS)	<input type="checkbox"/> VISA													
(CITY) (STATE) (ZIP CODE)	<input type="checkbox"/> Discover													
DAYTIME TELEPHONE NO. () AREA CODE	Account Number: <input type="text"/> <input type="text"/> <input type="text"/> <input type="text"/> <input type="text"/> <input type="text"/> <input type="text"/> <input type="text"/> <input type="text"/> <input type="text"/> <input type="text"/> <input type="text"/> <input type="text"/> <input type="text"/> <input type="text"/> <input type="text"/> <input type="text"/> <input type="text"/> <input type="text"/> <input type="text"/> <input type="text"/>													
	Expiration Date mo/yr: <input type="text"/> <input type="text"/> <input type="text"/> <input type="text"/> Check here if your billing address is different from your shipping address shown. <input type="checkbox"/>													
	_____ CUSTOMER SIGNATURE													

GM-BUI-ORD99 *(Prices are subject to change without notice and without incurring obligation. Allow ample time for delivery.) Note to Canadian Customers: All listed prices are quoted in U.S. funds. Canadian residents are to make checks payable in U.S. funds. To cover Canadian postage, add \$11.50 plus the U.S. order processing.



Section 9 Index

A ir Bag	1-18	Armrest, Storage	2-51
How Does it Restrain	1-22	Ashtrays	2-52
How it Works	1-20	Audio Equipment, Adding	3-34
Location	1-20	Audio, Steering Wheel Touch Controls	3-32
Readiness Light	1-20, 2-60	Audio Systems	3-12
Servicing	1-24	Automatic Dimming/Heated Outside Mirror	2-51
What Makes it Inflate	1-22	Automatic Transaxle	2-24
What Will You See After it Inflates	1-23	Check	7-34
When Should it Inflate	1-22	Fluid	6-18
Air Cleaner	6-16	Operation	2-24
Air Conditioning	3-6	Shifting	2-24
Air Conditioning Refrigerants	6-64	Overdrive	2-26
Air Control, Climate Control System	3-2, 3-4	Park Mechanism Check	7-36
Alarm, Instant, Keyless Entry	2-10		
Alarm, Universal Theft-Deterrent	2-16	B attery	6-31
Alignment and Balance, Tire	6-46	Jump Starting	5-3
Aluminum Wheels, Cleaning	6-54	Replacement, Remote Keyless Entry	2-12
Antenna, Heated Backlite	3-36	Rundown Protection	2-45
Antifreeze	6-22	Warning Light	2-60
Anti-Lock		Warnings	5-3
Brake System Warning Light	2-62, 4-7	BBB Auto Line	8-3
Brakes	4-7	Belt, Engine Accessory	6-66
Anti-Theft, Radio	3-30	Better Business Bureau Mediation	8-3
Appearance Care	6-48	Blizzard	4-27
Appearance Care Materials Chart	6-56		
Arbitration Program	8-3		

Brake	
Adjustment	6-30
Anti-lock System Warning Light	2-62, 4-7
Fluid	6-27
Master Cylinder	6-27
Parking	2-27
Pedal Travel	6-30
Replacing System Parts	6-30
System Warning Light	2-61
Trailer	4-35
Transaxle Shift Interlock Check	2-24, 7-35
Wear	6-29
Brakes, Anti-Lock	4-7
Braking	4-6
Braking in Emergencies	4-10
Break-In, New Vehicle	2-19
Brightness Control	2-43
BTSI Check	2-24, 7-35
Bulb Replacement	6-31
C anadian Roadside Assistance	8-6
Capacities and Specifications	6-64
Carbon Monoxide	2-15, 2-33, 2-34, 4-28, 4-35
Cassette Deck Service	7-33
Cassette Tape Player	3-17, 3-21, 3-25
Care	3-34
Errors	3-16, 3-20, 3-27
Center Passenger Position	1-25
Certification Label	4-30
Chains, Safety	4-35
Chains, Tire	6-48
Change Oil Soon Light	2-69
Changing a Flat Tire	5-20
Check Engine Light	2-65
Check Oil Level Light	2-68
Checking Your Restraint Systems	1-50
Chemical Paint Spotting	6-55
Child Restraints	1-35
Securing in a Rear Outside Seat Position	1-41
Securing in the Center Rear Seat Position	1-43
Securing in the Right Front Seat Position	1-45
Top Strap	1-40
Where to Put	1-39
Cigarette Lighter	2-52
Circuit Breakers and Fuses	6-59
Cleaner, Air	6-16
Cleaning	
Aluminum Wheels	6-54
Exterior Lamps/Lenses	6-53
Fabric	6-49
Glass Surfaces	6-51
Inside of Your Vehicle	6-49
Instrument Panel	6-51
Interior Plastic Components	6-51
Leather	6-51
Outside of Your Vehicle	6-52
Special Problems	6-50
Stains	6-49
Tires	6-54
Vinyl	6-50
Windshield and Wiper Blades	6-51

Climate Control, Steering Wheel Touch Control	3-11	Defects, Reporting Safety	8-9
Climate Control System	3-2	Defensive Driving	4-2
Clock, Setting the	3-12	Defogger, Rear Window	3-8
Coinholder	2-51	Defogging	3-8
Comfort Controls	3-2	Defrosting	3-8
Compact Disc Care	3-35	Delayed Entry Lighting	2-43
Compact Disc Player	3-21, 3-25	Delayed Exit Lighting	2-43
Care	3-35	Delayed Locking	2-6
Errors	3-23, 3-29	Personal Choice Programming	2-7
Compact Spare Tire	5-32	Dimensions, Vehicle	6-65
Console Storage	2-51	Dolby B Noise Reduction	3-17, 3-20, 3-28
Control of a Vehicle	4-6	Door Locks	2-4
Convenience Net	2-52	Driver Position	1-10
Convex Outside Mirror	2-50	Driving	
Coolant	6-22	City	4-20
Heater, Engine	2-23	Defensive	4-2
Recovery Tank	5-14	Drunken	4-3
Cooling System	5-12	Freeway	4-21
Cornering Lamps	2-41	In a Blizzard	4-27
Courtesy Lamps	2-43	In Foreign Countries	6-5
Courtesy Transportation	8-7	In the Rain	4-17
Cruise	2-69	Night	4-15
Cruise Control	2-37	On Curves	4-10
Cupholders	2-51	On Grades While Towing a Trailer	4-37
Customer Assistance for Text Telephone Users	8-4	On Hill and Mountain Roads	4-23
Customer Assistance Information	8-1	On Snow and Ice	4-26
Customer Satisfaction Procedure	8-2	Through Water	4-19
		Wet Roads	4-17
		Winter	4-25
D amage, Finish	6-55	With a Trailer	4-36
Damage, Sheet Metal	6-54	Drunken Driving	4-3
Daytime Running Lamps	2-41	Dual Automatic ComforTemp Climate Control	3-3
Dead Battery	5-3		

E lectrical Equipment, Adding	3-34, 6-58	Entry Lighting, Delayed	2-43
Electrical System	6-58	Ethanol	6-4
Electrochromic Day/Night Rearview Mirror	2-46	Exhaust, Engine	2-15, 2-31, 2-33, 2-34, 4-35
With Compass	2-47	Exit Lighting, Delayed	2-43
Electronic Level Control	4-31	Express-Down Window	2-33
Electronic Touch Climate Control	3-2	Exterior Lamps	2-40
Engine	6-10		
Accessory Belt	6-66	F abric Cleaning	6-49
Coolant	6-22	Fan Control, Climate Control System	3-2, 3-4
Coolant Heater	2-23	Filling a Portable Fuel Container	6-7
Coolant Level Check	7-33	Filling Your Tank	6-5
Coolant Temperature Gage	2-64	Filter, Air	6-16
Coolant Temperature Warning Light	2-64	Filter, Engine Oil	6-14
Exhaust	2-15, 2-31, 2-33, 2-34, 4-35	Finish Care	6-53
Fuse Block (Driver's Side)	6-59	Finish Damage	6-55
Fuse Block (Passenger's Side)	6-62	First Gear, Automatic Transaxle	2-27
Identification	6-57	Flashers, Hazard Warning	5-2
Oil Level Check	7-33	Flat Tire, Changing	5-20
Overheating	5-9	Fluids and Lubricants	7-39
Running While Parked	2-32	Foreign Countries, Fuel	6-5
Specifications	6-64	French Language Manual	ii
Starting Your	2-21	Front Turn Signal Bulb Replacement	6-36
Engine Cooling When Trailer Towing	4-38	Fuel	6-3
Engine Oil	6-11	Canada	6-3
Adding	6-12	Filling a Portable Container	6-7
Additives	6-14	Filling Your Tank	6-5
Checking	6-12	Gage	2-70
Life Monitor	2-69	In Foreign Countries	6-5
Pressure Gage	2-67	Fuses and Circuit Breakers	6-59
Pressure Light	2-67		
Used	6-15		
What Kind to Use	6-13		
When to Change	6-14		

G ages	
Engine Coolant Temperature	2-64
Engine Oil Pressure	2-67
Fuel	2-70
GAWR	4-30
Gear Positions, Automatic Transaxle	2-24
Glove Box	2-51
Gross Axle Weight Rating	4-30
Gross Vehicle Weight Rating	4-30
Guide en Français	ii
GVWR	4-30
H alogen Bulbs	6-31
Hazard Warning Flashers	5-2
Head Restraints	1-4
Headlamps	2-40
Aiming	6-34
Bulb Replacement	6-32
High/Low Beam Changer	2-35
On Reminder	2-41
Wiring	6-58
Hearing Impaired, Customer Assistance	8-4
Heating	3-7
High-Beam Headlamps	2-35
Highway Hypnosis	4-23
Hill and Mountain Roads	4-23
Hitches, Trailer	4-35
Hood	
Checking Things Under	6-8
Release	6-8
Horn	2-33
Hydroplaning	4-19
I gnition Positions	2-20
Ignition Transaxle Lock Check	7-36
Illuminated Entry	2-43
Inflation, Tire	6-41
Inside Day/Night Rearview Mirror	2-46
Inspections	7-37
Brake System	7-38
Caliper/Knuckle	7-38
Engine Cooling System	7-37
Exhaust System	7-37
Front Drive Axle Boot	7-37
Front Drive Axle Seal	7-37
Steering	7-37
Suspension	7-37
Throttle System	7-37
Instrument Panel	2-54
Brightness Control	2-43
Cleaning	6-51
Cluster	2-56, 2-57
Interior Lamps	2-43
J ack, Tire	5-22
Jump Starting	5-3
K ey Lock Cylinders Service	7-34
Key Reminder Warning	2-21
Keyless Entry System	2-9
Personal Choice Features	2-10
Remote	2-9
Keys	2-2

L abels	
Certification	4-30
Certification/Tire	4-30
Service Parts Identification	6-57
Tire-Loading Information	4-30
Vehicle Identification Number	6-57
Lamps	2-40
Courtesy	2-43
Entry Lighting, Delayed	2-43
Exit Lighting, Delayed	2-43
Exterior	2-40
Illuminated Entry	2-43
Interior	2-43
On Reminder	2-41
Perimeter Lighting	2-44
Theater Dimming	2-43
Leaving Your Vehicle	2-9
Leaving Your Vehicle with the Engine Running	2-29
Light Sensor, Twilight Sentinel	2-42
Lighter	2-52
Lights	
Air Bag Readiness	1-20, 2-60
Anti-Lock Brake System Warning	2-62, 4-7
Battery Warning	2-60
Brake System Warning	2-61
Change Oil Soon	2-69
Check Engine	2-65
Check Oil Level	2-68
Engine Coolant Temperature Warning	2-64
Engine Oil Pressure Light	2-67
Low Fuel	2-70
Oil Pressure	2-67
Safety Belt Reminder	2-59
Traction Control System Warning	2-63, 4-9
Traction Off Warning	4-9
Loading Your Vehicle	4-30
Lockout Protection	2-8
Locks	2-4
Cylinders	7-34
Delayed Locking	2-6
Door	2-4
Ignition Transaxle Lock Check	7-36
Key Lock Cylinder Service	7-34
Lockout Protection	2-8
Memory Door	2-5
Power Door	2-5
Rear Door Security	2-8
Trunk	2-14
Window	2-33
Low Fuel Light	2-70
Lubricants and Fluids	7-39
Lubrication Service, Body	7-34
M agnasteer®	4-10
Maintenance, Normal Replacement Parts	6-65
Maintenance Record	7-41
Maintenance Schedule	7-1
Long Trip/Highway Definition	7-6
Long Trip/Highway Intervals	7-6
Owner Checks and Services	7-33
Periodic Maintenance Inspections	7-37
Recommended Fluids and Lubricants	7-39
Scheduled Maintenance Services	7-4
Short Trip/City Definition	7-5
Short Trip/City Intervals	7-5

Maintenance, Underbody	6-55	Oil, Engine	6-11
Maintenance When Trailer Towing	4-38	Oil Level Warning Light	2-67
Malfunction Indicator Lamp	2-65	Oil Pressure Light	2-67
Manual Front Seat	1-2	OnStar [®] System	2-53
Manual Remote Control Mirror	2-50	Overdrive, Automatic Transaxle	2-26
Maxifuse [®] /Relay Center	6-58	Overheating Engine	5-9
Memory Door Locks	2-5	Owner Checks and Services	7-33
Personal Choice Programming	2-5	Owner Publications, Ordering	8-10, 8-11, 8-12
Remote	2-9		
Methanol	6-4	P aint Spotting, Chemical	6-55
Mirrors	2-46	P ark	
Automatic Dimming/Heated Outside	2-51	Automatic Transaxle	2-24
Convex Outside	2-50	Shifting Into	2-28
Day/Night Rearview with Reading Lamps	2-46	Shifting Out of	2-30
Electrochromic Day/Night Rearview	2-46	P arking	
Electrochromic Day/Night Rearview		At Night	2-15
With Compass	2-47	Brake	2-27
Manual Remote Control	2-50	Brake Mechanism Check	7-36
Power Remote Control	2-50	Lots	2-16
Visor Vanity	2-53	Over Things That Burn	2-31
MMT	6-4	Passenger Temperature Control	3-9
Multifunction Lever	2-34	Passing	4-13
		PASS-Key [®] II	2-18
N et, Convenience	2-52	Perimeter Lighting	2-44
Neutral, Automatic Transaxle	2-25	Periodic Maintenance Inspections	7-37
New Vehicle Break-In	2-19	Personal Choice Programming	2-44
Night Vision	4-16	Delayed Locking	2-6
Normal Maintenance Replacement Parts	6-65	Memory Door Locks	2-5
		Perimeter Lighting	2-43
O dometer	2-58	Security Feedback	2-11
Odometer, Trip	2-58		
Off-Road Recovery	4-12		

Power		Reclining Front Seatbacks	1-3
Door Locks	2-5	Recommended Fluids and Lubricants	7-39
Option Fuses	6-58	Recovery Tank, Coolant	5-14
Remote Control Mirror	2-50	Recreational Vehicle Towing	4-29
Seat	1-3	Refrigerants, Air Conditioning	6-64
Steering	4-10	Remote	
Steering Fluid	6-25	Trunk Release	2-14
Windows	2-33	Trunk Release Lockout	2-15
Pregnancy, Use of Safety Belts	1-17	Remote Keyless Entry	2-9
Problems on the Road	5-1	Instant Alarm	2-10
Publications, Service and Owner	8-10, 8-11, 8-12	Personal Choice	2-10
		Resynchronization	2-13
		Security Feedback	2-11
R adiator	5-16	Replacement	
Radiator Pressure Cap	6-22	Bulbs	6-63
Radio Reception	3-33	Parts	6-65
Radios	3-12, 3-14, 3-17, 3-21, 3-25	Wheel	6-46
Rain, Driving In	4-17	Replacing Safety Belts	1-50
Reading Lamps	2-45	Reporting Safety Defects	8-9
Rear		Restraints	
Door Security Locks	2-8	Checking	1-50
Outside Seat Position	1-26	Child	1-35
Safety Belt Comfort Guides	1-29	Head	1-4
Seat Passengers	1-26	Replacing Parts After a Crash	1-50
Turn Signal Bulb Replacement	6-39	System Check	7-34
Window Defogger	3-8	Reverse, Automatic Transaxle	2-25
Rearview Mirror	2-46	Right Front Passenger Position	1-18
Electrochromic Day/Night	2-46	Roadside Assistance	8-6
Inside Day/Night	2-46	Roadside Assistance, Canadian	8-6
Inside Day/Night with Reading Lamps	2-46	Rocking Your Vehicle	5-34
With Compass	2-47	Rotation, Tires	6-42

Safety Belt Extender	1-50	Restraint Systems	1-1
Safety Belts	1-5	Seat Controls	1-2
Adults	1-10	Securing a Child Restraint	1-41, 1-43, 1-45
Care	6-51	Second Gear, Automatic Transaxle	2-26
Center Passenger Position	1-25	Security Feedback	2-11
Children	1-32	Security System	2-17
Driver Position	1-10	Service	6-2
Extender	1-50	Bulletins, Ordering	8-10, 8-11, 8-12
How to Wear Properly	1-10	Manuals, Ordering	8-10, 8-11, 8-12
Incorrect Usage	1-13, 1-48, 1-49	Parts Identification Label	6-57
Lap Belt	1-25	Publications, Ordering	8-10, 8-11, 8-12
Lap-Shoulder	1-11, 1-26	Work, Doing Your Own	6-2
Larger Children	1-47	Service and Appearance Care	6-1
Questions and Answers	1-9	Service and Owner Publications	8-10, 8-11, 8-12
Rear Comfort Guides	1-29	Service Publications	8-10, 8-11, 8-12
Rear Seat Outside Passenger Positions	1-26	Servicing Your Air Bag-Equipped Vehicle	1-24
Rear Seat Passengers	1-26	Sheet Metal Damage	6-54
Reminder Light	2-59	Shifting	
Replacing After a Crash	1-50	Automatic Transaxle	2-24
Right Front Passenger Position	1-18	Into PARK (P)	2-28
Shoulder Belt Height Adjuster	1-12	Out of PARK (P)	2-31
Smaller Children and Babies	1-32	Shoulder Belt Height Adjuster	1-12
Use During Pregnancy	1-17	Signaling Turns	2-35
Why They Work	1-6	Skidding	4-14
Safety Chains	4-35	Sound Equipment, Adding	3-34
Safety Defects, Reporting	8-8	Spare Tire, Compact	5-32
Safety Warnings and Symbols	iii	Specifications and Capacities	6-64
Scheduled Maintenance Services	7-4	Specifications, Engine	6-64
Seats		Speech Impaired, Customer Assistance	8-4
Manual Front	1-2	Speedometer	2-58
Power	1-3	SRS	1-18
Reclining Front	1-3	Stains, Cleaning	6-49

Starter Switch Check	7-35
Starting Your Engine	2-21
Steam	5-10
Steering	4-10
In Emergencies	4-11
Magnasteer®	4-10
Power	4-10
Tips	4-10
Wheel, Tilt	2-34
Wheel Touch Controls	3-11, 3-32
Storage Compartments	2-51
Storage, Vehicle	6-31
Stuck: In Sand, Mud, Ice or Snow	5-33
Sun Visors	2-53
Supplemental Restraint System (SRS)	1-18
Symbols, Vehicle	v
T achometer	2-58
Taillamp Bulb Replacement	6-37
Tape Player Care	3-34
Temperature Control, Climate Control System	3-2, 3-4
Temperature Control, Passenger	3-9
Theater Dimming	2-43
Theft	2-15
Theft-Deterrent Alarm System	2-16
Theft-Deterrent Feature	3-30
THEFTLOCK™	3-30
Thermostat	6-22
Third Gear, Automatic Transaxle	2-26
Tilt Steering Wheel	2-34
Time, Setting the	3-12
Tire-Loading Information Label	4-30

Tires	6-40
Alignment and Balance	6-46
Buying New	6-44
Chains	6-48
Changing a Flat	5-20
Cleaning	6-54
Compact Spare	5-32
Inflation	6-41
Inflation Check	7-33
Inspection and Rotation	6-42
Loading	4-30
Pressure	6-41
Temperature	6-46
Traction	6-45
Treadwear	6-45
Uniform Quality Grading	6-45
Wear Indicators	6-43
Wheel Replacement	6-46
When It's Time for New	6-43
Top Strap	1-40
Torque Lock	2-30
Torque, Wheel Nut	5-29, 6-64
Towing	
Recreational Vehicle	4-29
Trailer	4-32
Your Vehicle	5-8
Traction	
Control System	4-9
Control System Warning Light	2-63, 4-9
Off Warning Light	4-9

Trailer		Turn Signal and Lane Change Indicator	2-35
Brakes	4-35	Turn Signal, Front Bulb Replacement	6-36
Driving on Grades	4-37	Turn Signal On Chime	2-35
Driving with	4-36	Turn Signal, Rear Bulb Replacement	6-39
Engine Cooling When Towing	4-38	Turn Signal/Multifunction Lever	2-34
Hitches	4-35	Turn Signals When Towing a Trailer	4-37
Maintenance When Towing	4-38	Twilight Sentinel [®]	2-42
Parking on Hills	4-37		
Safety Chains	4-35	U nderbody Flushing Service	7-36
Tongue Weight	4-34	Underbody Maintenance	6-55
Total Weight on Tires	4-35	Universal Theft-Deterrent	2-16
Towing	4-32		
Turn Signals	4-37	V ehicle	
Weight	4-33	Control	4-6
Transaxle Fluid, Automatic	6-18	Damage Warnings	iv
Transmitters, Matching to Your Vehicle	2-12	Dimensions	6-65
Transmitters, Remote Keyless Entry	2-9	Identification Number	6-57
Transportation, Courtesy	8-7	Loading	4-30
Trip Odometer	2-58	Storage	6-31
Trunk		Ventilation System	3-10
Lock	2-14	Visor Vanity Mirrors	2-53
Release Lockout, Remote	2-15	Visors, Sun	2-53
Release, Remote	2-14	Voltage Gage	2-61
Security Override	2-15		
TTY Users	8-4		

W arning Devices	5-3	Windows	2-33
Warning Lights, Gages and Indicators	2-59	Express-Down	2-33
Warranty Information	8-8	Power	2-33
Washer Fluid, Windshield	6-26	Windshield Washer	2-37
Washing Your Vehicle	6-52	Fluid	6-26
Weatherstrips	6-52	Fluid Level Check	7-33
Wheel		Windshield Wiper	2-36
Alignment	6-46	Blade Cleaning	6-51
Nut Torque	5-29, 6-64	Blade Replacement	6-40
Replacement	6-46	Fuses	6-58
Wheel Cover Removal	5-23	Winter Driving	4-25
Wheel Nut Cap Removal	5-23	Wiper Blade Check	7-34
Wire Wheel Cover Removal	5-24	Wiper Blades, Cleaning	6-51
Wrench	5-22	Wiring, Headlamp	6-58
Window Lock	2-33	Wrecker Towing	5-8
		Wrench, Wheel	5-22