

# CROWN® COMMERCIAL AUDIO SERIES MIXER-AMPLIFIER QUICK-START GUIDE

## ONE ROOM WITH A PAGING MICROPHONE using 180MA or 1160MA

Paging mic mutes CD player.

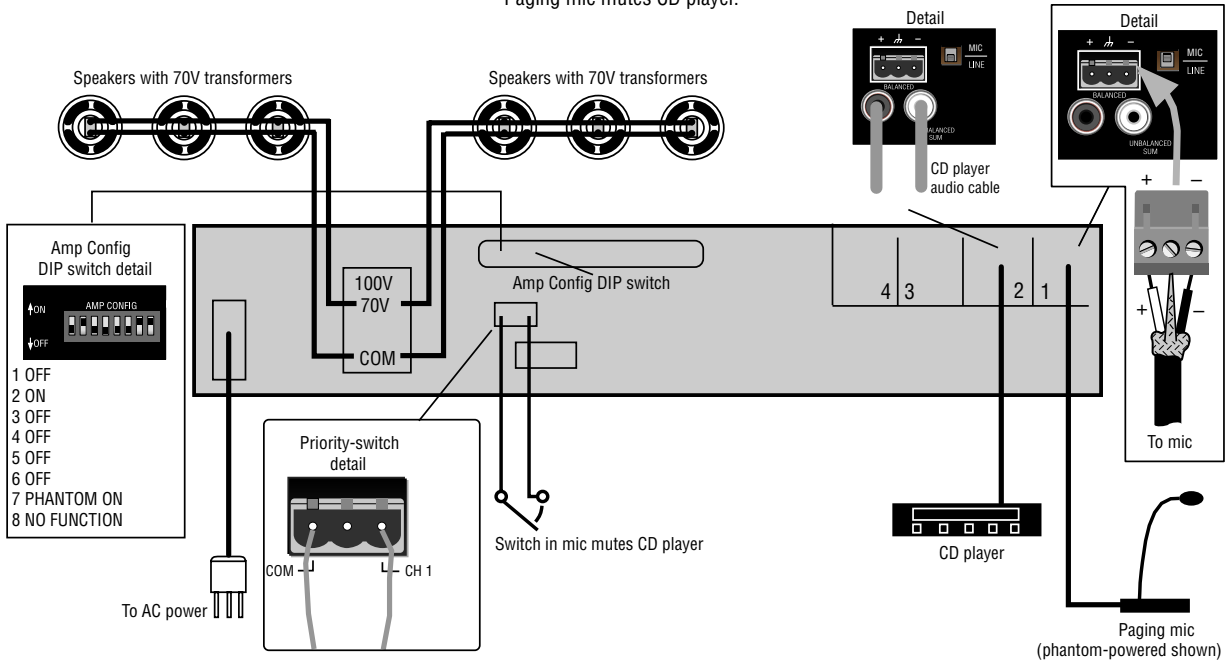

## TWO ROOMS WITH INDEPENDENT PAGING using 280MA

Mic 1 mutes room-1 TV tuner. Mic 2 mutes room-2 CD player.

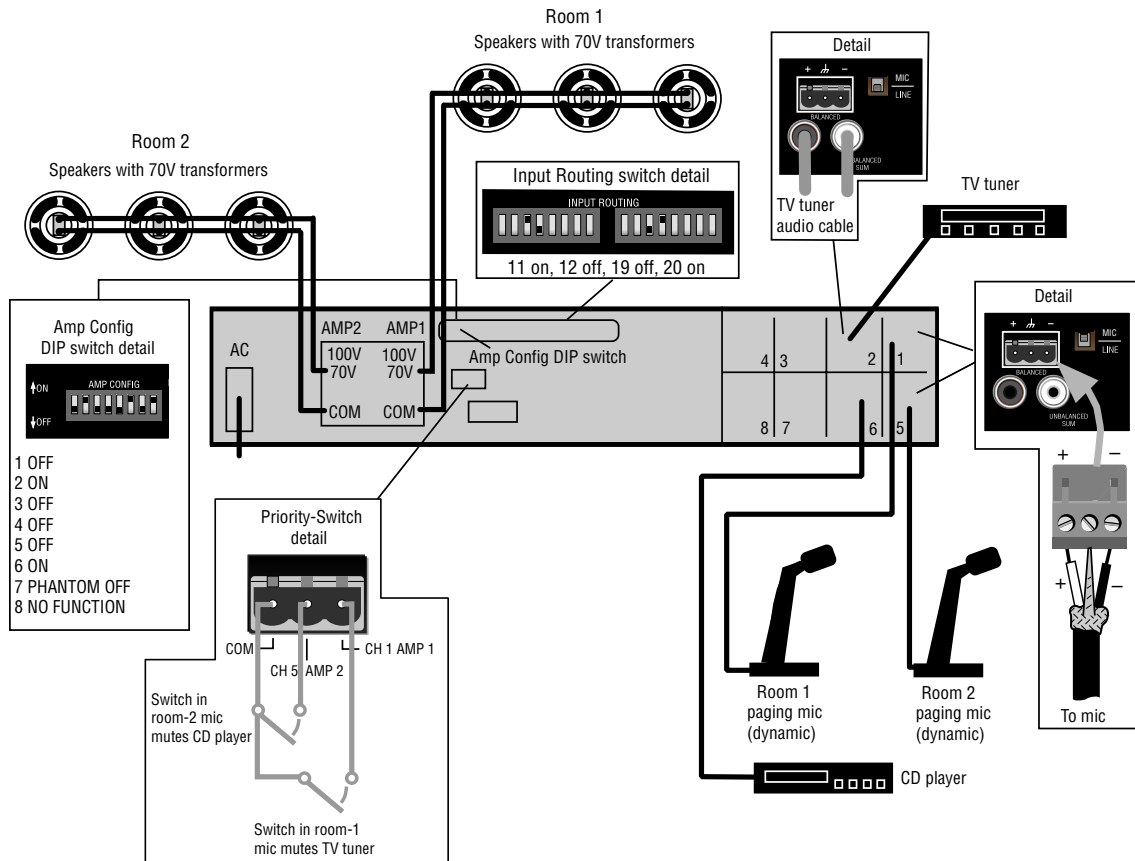

(OVER)

# CROWN COMMERCIAL AUDIO SERIES MIXER-AMPLIFIER QUICK-START GUIDE

## TWO ROOMS WITH INDEPENDENT PAGING using 280MA ROOM-1 MIC MUTES BOTH ROOMS

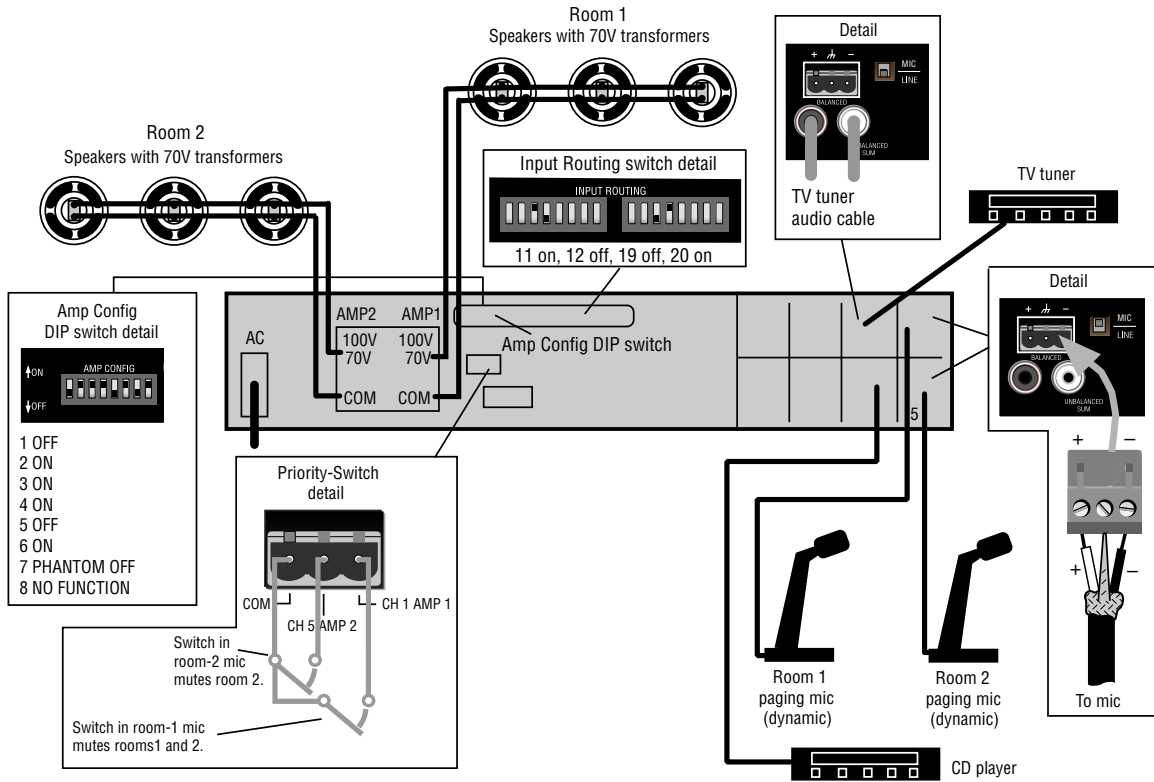

## SAMPLE APPLICATION HOUSE OF WORSHIP — SANCTUARY AND NURSERY using 280MA

Crown 1-VCAP volume control affects volume of Nursery speaker.  
All sources are heard in both rooms.  
No muting.  
Record out.

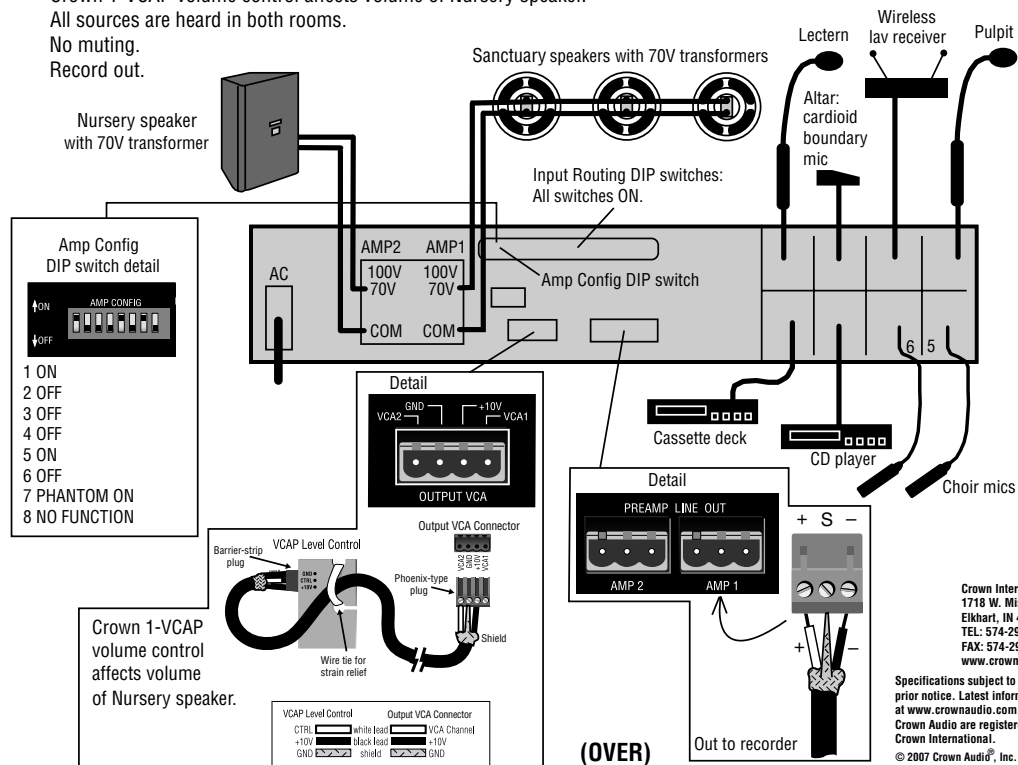

Crown International  
1718 W. Mishawaka Rd.  
Elkhart, IN 46517-9439  
TEL: 574-294-8200  
FAX: 574-294-8FAX  
www.crownaudio.com

Specifications subject to change without prior notice. Latest information available at [www.crownaudio.com](http://www.crownaudio.com). Crown and Crown Audio are registered trademarks of Crown International.

© 2007 Crown Audio®, Inc. 12/07 137784-3