

GENUINE REMOTE ENGINE START

USER'S INSTRUCTIONS



Parts number: C930 V7 620

Thank you for purchasing a genuine Mazda accessory.
Before use, be sure to thoroughly read these instructions.
Please read the contents of this booklet in order to properly use the Remote Engine Start.
Your safety depends on it.
After using this instruction manual, store it in a place where it can be easily located.
Note, consult your authorized Mazda dealer, or a dealer appointed store, for proper vehicle installation of the Remote Engine Start.
If the vehicle equipped with this product, or the product itself, is sold, transferred or loaned to another party, be sure to give this instruction manual to the new owner, so he or she can use this product safely and correctly.

<Safe and correct use of the product>

Various warnings and cautions are displayed in this manual to assist you in the safe and correct use of the product and as precautions against you or others being injured, or the product being damaged.

Depending on the degree of possible injury or damage that may be incurred, precautionary items have been divided into 'Warnings' and 'Cautions' and illustrated with symbols to depict the nature of the precautionary content.

 WARNING	A WARNING indicates a situation in which serious injury or death could result if the warning is ignored.
 CAUTION	A CAUTION indicates a situation in which bodily injury or damage to objects, or both, could result if the caution is ignored.
ADVICE	Always follow the ADVICE noted to ensure vehicle safety and performance. Vehicle damage could result, or proper performance may be compromised if the advice is ignored.
NOTE	A NOTE indicates information or a point related to vehicle usage. Vehicle damage could result, or proper performance may be compromised if the note is ignored.

GB



CONTENTS

1. Remote Engine Start features	3
2. Safety precautions	3
3. General information.....	6
4. Operating precautions.....	7
5. Part names.....	9
6. Display	10
7. Basic functions for Remote Engine Start.....	11
8. Low battery warning & replacement directions.....	13
9. Basic operations.....	14
9-1. Engine start operation	15
9-2. Engine stop operation	18
9-3. Warm up time check	20
9-4. Vehicle status check.....	21
9-5. Warm up time settings.....	22
9-6. Engine start operation with rear defrost start Up.....	23
9-7. Car find function.....	25
10. Troubleshooting.....	26
11. Servicing.....	31
12. Specifications	32

1. Remote Engine Start features

- The Remote Engine Start allows the user to start the engine of a vehicle from a remote location using a remote control.
- The user can turn on the air conditioner / heater beforehand so the cabin of the vehicle can be cooled or heated ahead of time.
- The user can check the status of the vehicle from a remote location.

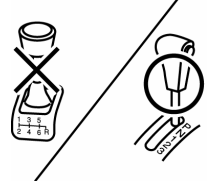
2. Safety precautions

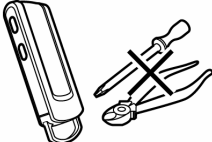
<p> WARNING</p> <p>Do not install this device on a vehicle equipped with a manual transmission.</p> <ul style="list-style-type: none">● Only install this device on designated vehicles which the harness fits.● This device can only be installed on vehicles equipped with AT / CVT. Do not install this product on a vehicle equipped with a manual transmission because it is hazardous.	
<p>Do not start the engine while inside an enclosed space or garage.</p> <ul style="list-style-type: none">● Never start up the engine while inside an enclosed space where the exhaust fumes can build up, such as a poorly ventilated garage, an underground parking garage or a parking tower. The exhaust fumes are hazardous and can cause poisoning or intoxication.	
<p>Ensure that the periphery of the vehicle is safe.</p> <ul style="list-style-type: none">● Use this device only where you can thoroughly check that the periphery of the vehicle is safe. In particular, using the device while a child or pet is close by can result in an unexpected accident.	
<p>Do not disassemble or modify this device.</p> <ul style="list-style-type: none">● Never disassemble or modify this device, or install it in a location not specified in this manual. Otherwise, it may not operate correctly and/or may result in an accident or breakdown. In addition, this situation is not covered under warranty.	

 **WARNING**

Do not start up the engine using the Remote Engine Start when parked on an incline.

- If the vehicle were to move unintentionally due to the engine vibration, jolt, etc., it could result in a serious accident.

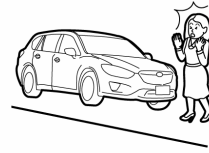

Performing safe maintenance and inspection.

- When performing vehicle inspection and maintenance, remove the (-) terminal on the vehicle battery. Never start up the engine with the remote control during inspection or maintenance at a gas or service station, etc. Otherwise, an accident may occur, such as getting a hand or clothes caught in the rotating parts. Do not perform inspection or maintenance in the engine compartment while the hood switch is pressed.

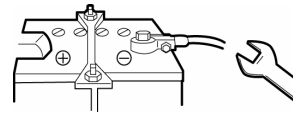

Keep the remote control in a safe and secure place.

- Keep the remote control out of the reach of children. Otherwise, they may swallow the lithium battery accidentally and choke.



Do not operate this device while other people are inside the vehicle.

- In order to prevent an unexpected jump start, etc., never start the engine while a pet or someone (especially children) is inside the vehicle. Stopping the engine automatically using the Remote Engine Start settings is hazardous (while someone is inside) because the temperature inside the vehicle may become too hot. In addition, there is also a risk of children accidentally pressing the climate control switch and setting the temperature too high or too low.



 **WARNING**

Fire prevention.

- Do not start the engine when the vehicle is near something flammable (oil or dry grass). Otherwise, the high temperature from the exhaust fumes or exhaust pipe could cause a fire.
- Do not start the engine while the vehicle is wrapped with a body cover. Otherwise, the high temperature from the exhaust fumes or exhaust pipe could cause a fire.



Do not pour water on the remote control.

- The remote control is water resistant for exposure during daily life, but it may break down if submerged in water or if water gets inside the device.



Do not perform standard inspection and maintenance right after warming up the engine.

- Performing inspection or maintenance before operation and immediately after warming up your vehicle could result in a burn injury. First, wait 5 minutes once the engine has stopped. Then, after checking all the parts for heat hazards, proceed with the inspection and maintenance.

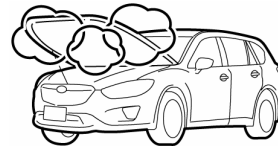

Check points when the vehicle is parked.

- Perform the following safety checks thoroughly when the vehicle is parked to prevent potential accidents when starting the engine.
 - Engage the parking brake.
 - Put the shift lever in the "P" position.
 - Be sure there is no advanced or smart key inside the vehicle.
 - Close all doors and windows.
 - Lock the doors.
 - Check that the hood is closed.
 - Turn off the windshield wipers.
 - If the vehicle is equipped with automatic lights, turn off the automatic light settings.
 - Be sure that the steering lock is engaged.

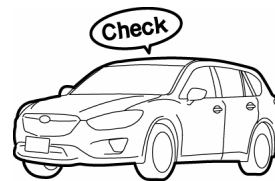

3. General information

-Laws in some communities may restrict the use of remote starters. For example, some laws may require a person using the remote start to have the vehicle in view when doing so. Check local regulations for any requirements on remote starting of vehicles.

-This device complies with part 15 of the FCC Rules.

Operation is subject to the following two conditions:

- (1) this device may not cause harmful interference, and
- (2) this device must accept any interference received, including interference that may cause undesired operation.

-This device complies with industry Canada licence-exempt RSS standard(s).

Operation is subject to the following two conditions:

- (1) this device may not cause interference, and
- (2) this device must accept any interference, including interference that may cause undesired operation of this device.

-Consult your authorized Mazda dealer for installation of the remote control engine starter system.

 **CAUTION**

-FCC WARNING

Changes or modifications not expressly approved by the party responsible for compliance could void the user's authority to operate the equipment.

4. Operating precautions

Usage Environment

- The remote control signal (or the response signal from the controller) may not reach the controller (or the remote control) if there are strong radio waves transmitting nearby, or if there are obstacles blocking the signal.
- The engine may be slow to start during severe cold weather conditions.

Vehicles with Remote Control Door Lock Function

- Door Lock and Door Unlock Function by the remote control keyless entry or advanced keyless entry system equipped the vehicle can be performed while the engine is running by the Remote Engine Start.

However, if Door Lock and Door Unlock Function do not work due to interference caused by engine noise, etc., perform these Door Lock and Door Unlock operations on the vehicle remote control, etc. after stop the engine.

Vehicles with Automatic Lights

- When vehicles equipped with automatic lights are set to the “AUTO” position for the light switch, the lights turn on if the engine is started at night with the remote control. However, if the engine automatically stops after warming up, the lights will also turn off at the same time to prevent the battery from draining. However, to avoid light interference, set the automatic light switch to the “OFF” position when using the remote control to turn on the engine at night.

Do Not Perform Unnecessary Idling

- To help protect the environment, conserve energy and avoid inconveniencing others, do not perform idling when it is unnecessary or longer than necessary.

Remote Control Handling Instructions

The remote control is a sensitive electronic device similar to a cellular telephone. Please follow the handling instructions below to avoid damage to or breakdown of the remote control.

- Avoid storing or using the remote control in places that expose it to direct sunlight, places that have high humidity, places with extremely high temperatures (on top of the dashboard, etc.) or places with extremely low temperatures (leaving inside the vehicle while parked at ski resorts, etc.).
- Do not store or use the remote control in places where it comes into direct contact with water.
- Avoid exposure to strong impacts such as dropping it on the floor or hitting it against something hard.
- If the remote control gets very dirty, use a cloth soaked in a watered-down, mild or neutral detergent, ring out the liquid solution and wipe down the remote control. (Never use benzene, thinner or chemically treated cloth/wipes.)
- Avoid attaching a lot of keys to the key ring on the remote control, or sitting down while the remote control is in your pocket, as it can cause the remote control to deform and may result in damage.
- While carrying the remote control, if the keys, etc., come into contact with a vehicle, it can lead to remote control breakdown or malfunction due an electrostatic discharge. Therefore, be careful of this risk during time periods when electrostatic discharges occur frequently.
- Be sure that the battery cover and clasp are securely locked. Otherwise, if water accidentally gets inside the internal part of the transmitter, it can cause breakdown.
- Do not use in restricted areas such as on board airplanes or inside hospitals.
- The remote control can negatively impact electronic and medical devices.
- Be sure to follow the instructions and rules posted inside medical clinics or facilities regarding the use of electronic devices.
- If the remote control is used on board airplanes, where usage is restricted, you may be subject to punishment due to airline rules and regulations.

ADVICE

- Depending on the surroundings and how the remote control is held, the minimum distance required for the signal transmission varies. Generally, if the remote control is directed toward the vehicle when transmitting the signal, it should successfully transmit from far away.

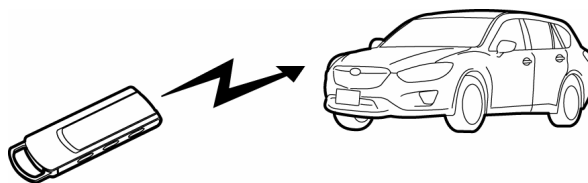

5. Part names

Remote Control

⚠ CAUTION

- Keep the remote control out of the reach of children. Otherwise, they may swallow the lithium battery accidentally and choke.
- Do not drop the remote control or hit it against something hard. Otherwise, it can result in breakdown or malfunction.
- Do not pour water on the remote control or submerge it. It can result in breakdown or malfunction.

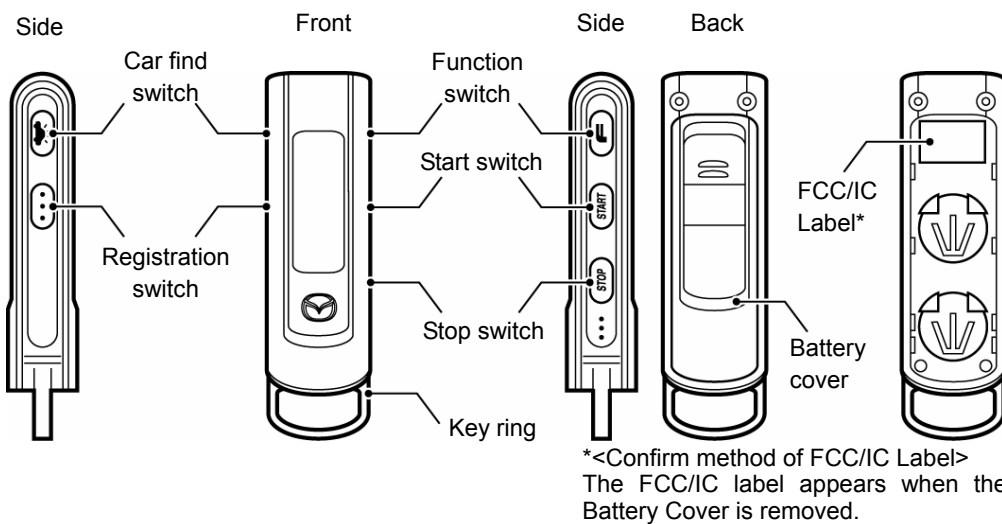

Controller

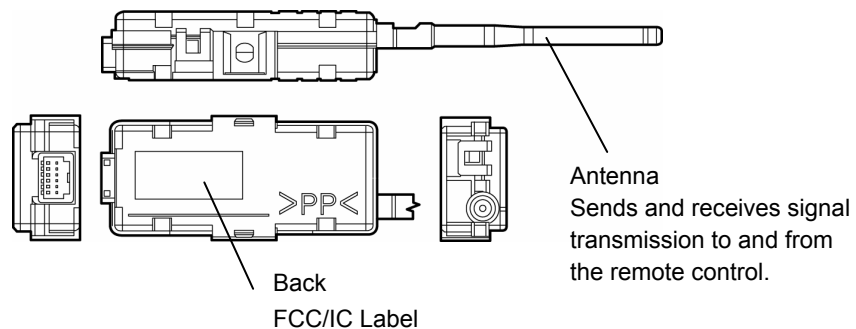

Note

- The location for the controller installation varies depending on the vehicle model.

6. Display



Display	Name	Description
	Antenna mark	Turns on when sending or receiving a signal.
	Send mark	Flashes when sending a transmission signal.
	Receive mark	Flashes when receiving a signal.
	Send error mark	Turns on when a signal for the same frequency band is being used.
	Battery mark	Turns on when the battery life is low.
	Time display	Displays the engine warm up time.
	Car find display	Turns on when conducting the car find operation.
	Error display	An error description will display when an error occurs. ⇒p.16
	Engine mark	Turns on when the engine starts up and is running.
	RUN mark	Turns on when the engine starts up and is running.
	STOP mark	Turns on when the engine stops.
	Rear defrost mark	Turns on when the rear defrost is running.
	Vehicle mark	Turns on when performing a sending operation.
	Hood mark	Turns on when performing a sending operation. When the hood is open, it does not turn on.
	Door close mark	Turns on when performing a sending operation. When all doors are closed, it turns on.
	Door open mark	If any door is open, it turns on.

*For further details on the display description, refer to the appropriate section in the manual.

7. Basic functions for Remote Engine Start

Engine Start & Stop Function

The remote control is equipped with engine start, engine stop and automatic stop (set with timer) functions. In addition, the engine start operation will perform when conditions outlined on page 14 are satisfied. The air conditioner / heater can be turned on beforehand so the cabin of the vehicle can be cooled or heated ahead of time.

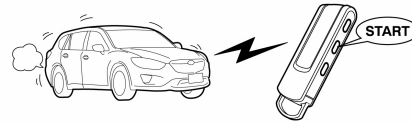

Engine start → p.15

Engine stop → p.18

Rear Defrost Function

The rear defrost turns on in the following situations.

- When the cabin temperature is 5°C (41°F) or less, 7 seconds after the engine start operation performed on the Remote Engine Start.
- When the rear defrost operation is performed on the remote control.

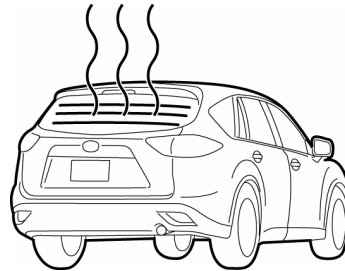

Directions for rear defrost operation on remote control → p.23

ADVICE

- The internal temperature of the vehicle cabin varies slightly depending on the installed location of the controller.
- The rear defrost will automatically stop when the engine stops.
- The rear defrost will automatically stop after 15 minutes of operation on some vehicle models.
- When the cabin temperature falls to 5°C (41°F) or less after 7 seconds from the engine start, the rear defrost will not turn on automatically.
- The rear defrost cannot be turned off using the remote control.
- On some vehicle models, dash light does not turn on when the rear defrost is turned on with the Remote Engine Start.

Car Find Function

If the car find operation is performed on the remote control, the hazard lights will flash twice and the horn will sound twice so you can confirm the vehicle's location. This function is convenient when looking for your vehicle in a large parking lot, etc.

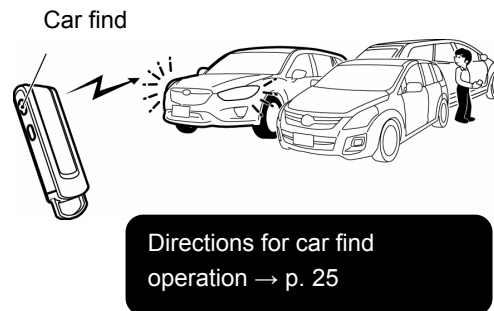

Answer Back Function

This device conducts bidirectional communication between the remote control and the controller (vehicle side). The user can check the status of the operations: engine start, engine stop, warm up time, and rear defrost, using the LCD monitor on the remote control.

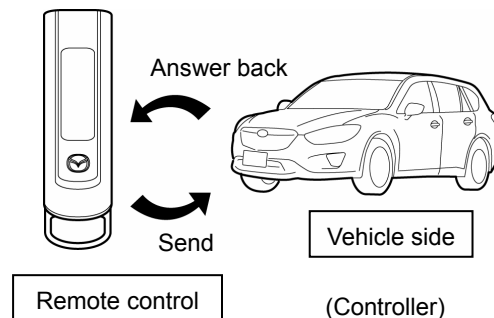

Note

1. The reference operating range of the remote control is approx. 300 ft(91m). However, this range can be reduced by interference caused by any of conditions as follows.
 - There is any obstruction nearby (Buildings, walls, other vehicles, etc.).
 - There is any radio wave transmission nearby (television, radio, cellular, another remote controller, etc.)
 - The battery becomes weak.
2. When there is a signal being transmitted that is close to the frequency band used by this device in the surrounding area, transmission between the remote control and controller shall be restricted. In this situation, the remote control will display a send error and/or a receive error.
3. When conducting consecutive operations with the remote control switches, wait "2 seconds or longer" after the "Send mark" on the LCD monitor has turned off, and then perform the next operation. The operation signal will not be received if the second operation is performed within 2 seconds of the first.
4. If a send error is displayed, the radio transmission in the area is restricted. Wait until the display mark turns off before operating the remote control.
5. A receive error may display on the remote control even if the engine has started, depending on the radio transmission conditions in the area.

8. Low battery warning & replacement directions

When the battery is running out and the user tries to conduct an operation, the “Low battery warning” on the LCD monitor will display. In this situation, be sure to replace both batteries at the same time with new ones. The performance will go down particularly under cold conditions.



Battery type: Lithium battery CR2032 / Qty. 2

- Release the clasps and slide off the battery cover to remove.

ADVICE

If the cover is stuck and does not slide off, wrap a flathead screwdriver in a cloth, etc., and use it in the depression to release the cover and slide it off.

- Replace with the new batteries so the plus (+) side is facing up.
- Re-attach the battery cover.

ADVICE

When replacing the batteries, be sure to replace both batteries at the same time.



WARNING

Keep the batteries out of the reach of children. In the event that a battery is accidentally swallowed, consult with a physician right away.

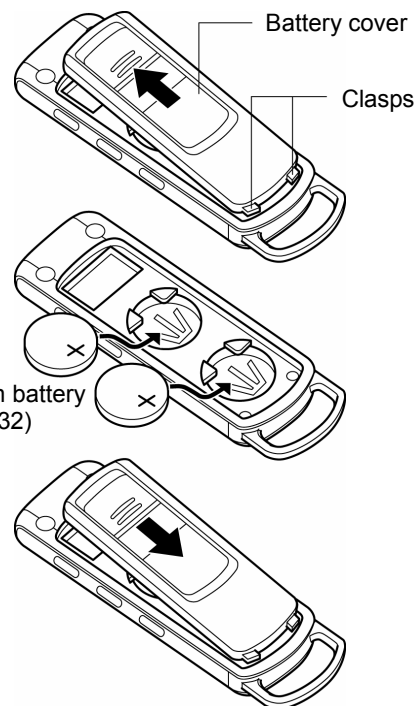

9. Basic operations

CAUTION

Check points when the vehicle is parked.

When using the engine start function with this device, follow the instructions below when parking, in order to avoid vehicle theft or an accident from occurring.

- Be sure to always engage the parking brake.
- Put the shift lever in the “P” position.
- Be sure there is no advanced or smart key inside the vehicle.
- Close all doors and windows.
- Lock the doors.
- Close the hood.
- Turn off the windshield wipers.

Engine Start Conditions

When using the Remote Engine Start, be sure to always check the start conditions listed below beforehand. Even if just one of the conditions has not been satisfied, the device will interpret this as a hazard and will not operate. Even if the user tries to operate the remote control, the engine will not start.

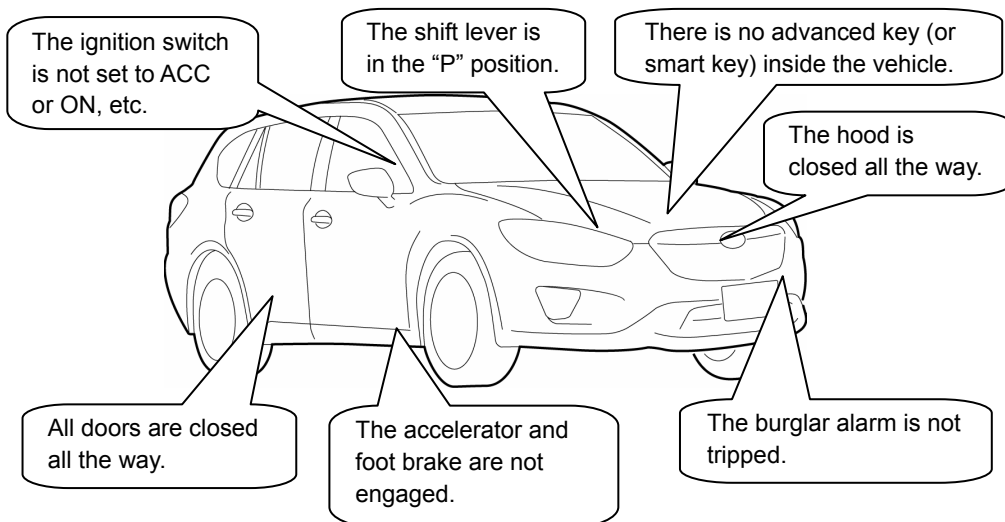

9-1. Engine start operation

- Press the function switch once.
The LCD display will appear as shown on the right.

ADVICE

The LCD display will appear when the switch is released.

- Press the start switch while the above LCD display is shown until it beeps.

After the send mark flashes, the send operation is completed. After the send operation is completed, the controller will send an answer back signal.

*Press the start switch within 2 seconds after the LCD display appears. If the start switch is not pressed in time and the LCD display disappears, start the procedure over again from step 1.

When the remote control receives a response from the vehicle, it indicates the engine start operation with a display (on the right) and a melody.

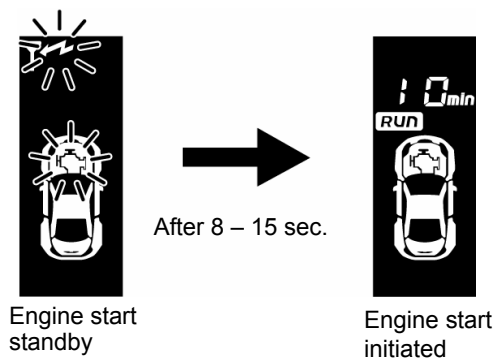
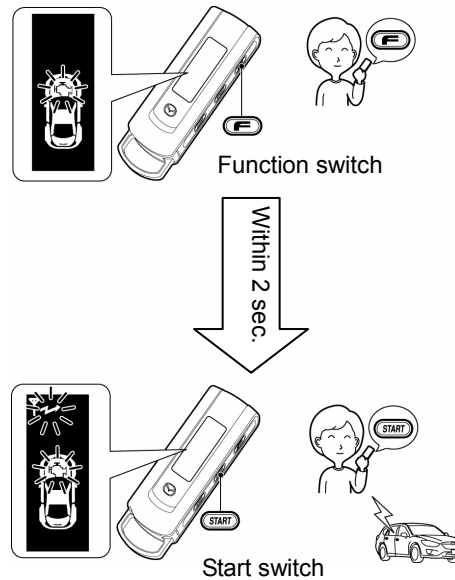

ADVICE

- After the engine start operation is initiated, the controller will automatically send an answer back signal 2 – 3 times.
- If there is a transmission error, there will not be an answer back signal after the second time.
- If the engine start conditions are not satisfied, the engine start operation cannot be performed. ⇒p.14
- For vehicles equipped with an automatic wiper function, when the engine start operation is activated with the remote control, the wipers will not turn on even when the wiper switch is set to the “AUTO” position and it begins to rain.

LCD Display During Engine Start Operation

The LCD display will change as shown below depending on the status of the vehicle, the signal transmission and the switch operation.

Condition Error Display

(Safety detection display description)

If the safety detection function is turns on, initiated by the vehicle status, the following display will appear on the LCD monitor. Be sure to check the vehicle status once more.



Error Display

Display	Description	Troubleshoot
A1	Vehicle transmission error	If this display description appears even after performing the engine start operation again, consult with an authorized Mazda dealer where you purchased the device.
A2	Remote Engine Start registration error	
A3	Remote Engine Start authentication error	
A4	Vehicle side error	
IG	ACC or IG is already ON.	Turn off ACC or IG.
E	Engine rotation error	Be sure that the accelerator is not engaged.
EC	Engine does not start	The battery or gas level may be low. Check the battery voltage or the fuel gauge.
H	Hood is open.	Close the hood all the way.
S	Push start switch is pressed.	Check whether the push start switch is pressed.
SK	There is an advanced key (or smart key) inside the vehicle.	Be sure there is no advanced or smart key inside the vehicle.
D	A door is open.	Close all doors (including the rear gate) all the way.
DC	Burglar alarm has been tripped.	Check whether the burglar alarm has been tripped.
P	Shift lever is not in the "P" position.	Put the shift lever in the "P" position.
PC	Foot brake is engaged.	Be sure that the foot brake is not engaged.

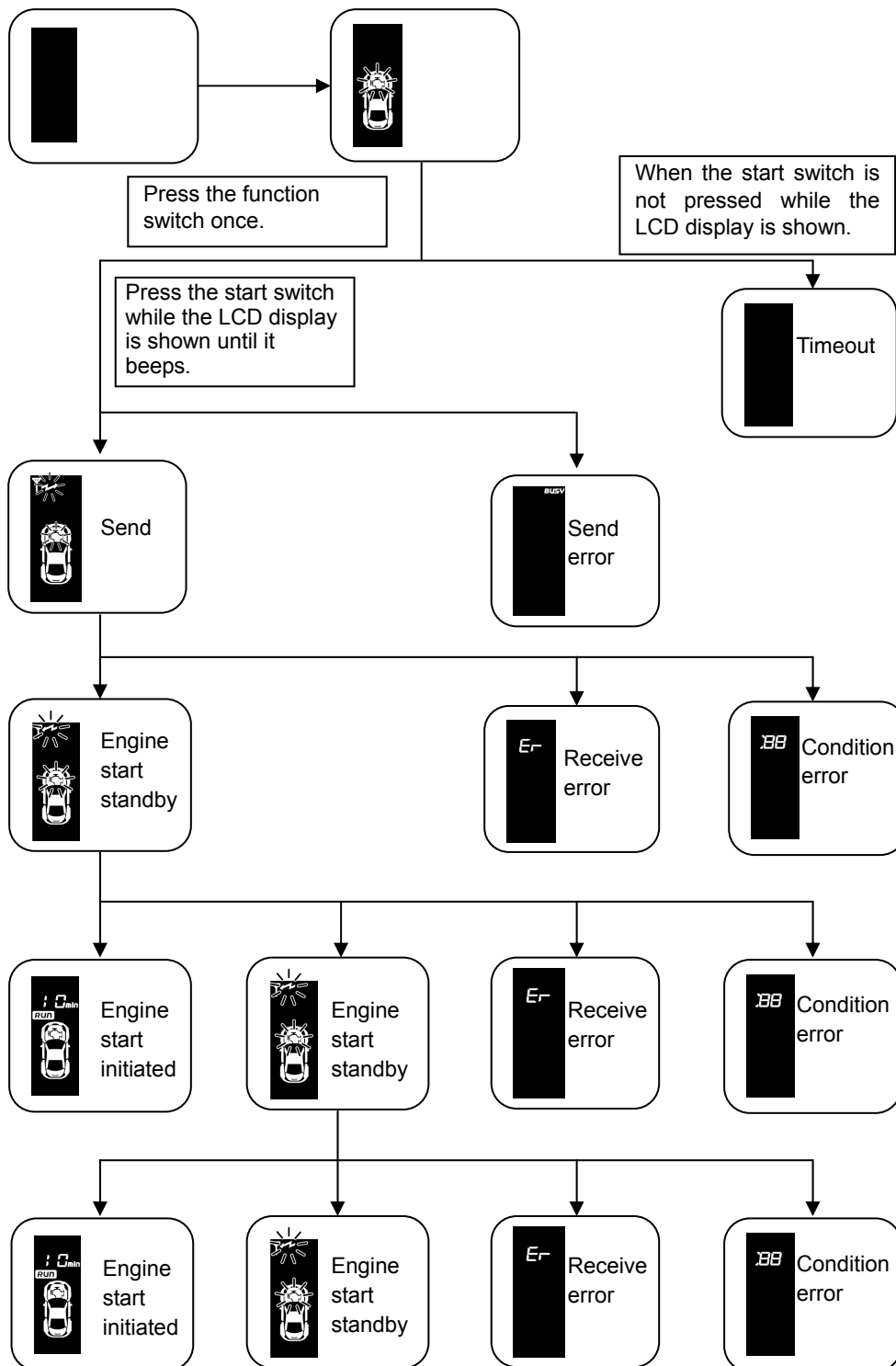

9-2. Engine stop operation

This operation only applies when the engine has been started with the remote control.

- Press the stop switch until it beeps.

The LCD display will appear as shown on the right. After the send mark flashes, the send operation is completed. After the send operation is completed, the controller will send an answer back signal.

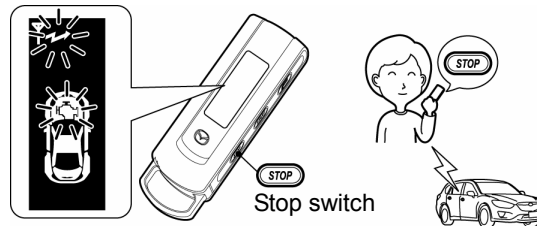

When the remote control receives a response from the vehicle, it indicates the engine stop operation with a display (on the right) and a melody.



Engine stop



Send error



Receive error

Note

- On some vehicle models, the engine also stops when the shift lever is pressed.
- The controller buzzer will sound if the engine is stopped for reasons other than a normal engine stop or the pre-set engine warm-up time has elapsed.

- Other Engine Stop Conditions

The engine will stop if one of the following conditions is true.

- 1) The hood is opened.
- 2) The shift lever is put in a position other than the "P" position.
- 3) A door is opened.
- 4) The push start switch is pressed.
- 5) The pre-set warm up time has elapsed.
- 6) The brake pedal is engaged.
- 7) The accelerator pedal is engaged (the engine stops by the rpm restriction).
- 8) There is an advanced key or smart key inside the vehicle.

To run the vehicle...

- If the vehicle engine is started with the remote control, stop the engine with the remote control or opening the vehicle's door.
- Restart the engine with the push start switch.

Note

If the engine is started with the push start switch, it cannot be stopped with the remote control.

9-3. Warm up time check

This operation only applies when the engine has been started with the remote control.

- Press the function switch once.

The LCD display will appear as shown on the right.

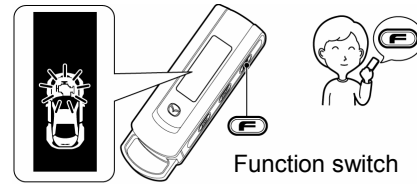

ADVICE

The LCD display will appear when the switch is released.

- Press the start switch while the above LCD display is shown until it beeps.

After the send mark flashes, the send operation is completed. After the send operation is completed, the controller will send an answer back signal.

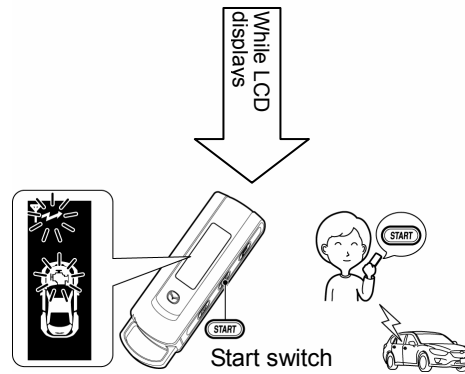

*Press the start switch within 2 seconds after the LCD display appears. If the start switch is not pressed in time and the LCD display disappears, start the procedure over again from step 1.

When the remote control receives a response from the vehicle, it indicates the engine start operation with the display below and a melody.

- Warm up time remaining?
(It only displays even numbers.)
- Is the engine running?
- Is the rear defrost turned on?

【Display Example】



- 8 min. warm up time remaining
- Engine running
- Rear defrost stopped

9-4. Vehicle status check

This operation can be performed before or after the engine start operation.

1) Press the function switch until it beeps.

The LCD display will appear as shown on the right.

After the send mark flashes, the send operation is completed. After the send operation is completed, the controller will send an answer back signal.

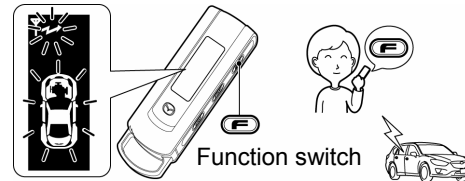

When the remote control receives a response from the vehicle, it indicates the engine start operation with a display (on the right) and a melody.

The following 2 items can be checked.

- Is the engine running?
- Is the rear defrost turned on?

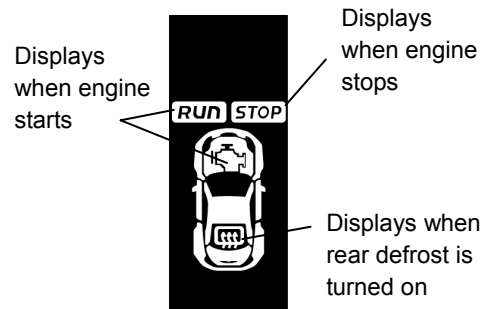

Note

Some vehicle models stop the rear defrost after 15 minutes. Condition error display (p.16) does not appear.

【Display Example】



Engine running



Engine stopped

Rear defrost is turned on.

9-5. Warm up time settings

The default setting is 10 minutes.

- Press the function switch and the start switch at the same time until it beeps.

The current setting time is displayed.

- Press the start switch to set the warm up time.

The setting time “min” will display.

- Press the function switch until it beeps.

Note

Some vehicle models stop the rear defrost after 15 minutes, even if the warm up time is set to 30 minutes.

<ex.>

When the setting of warm-up time is changed to “30 min” from “10 min”.

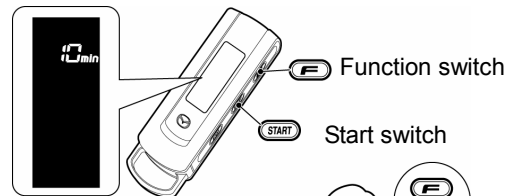

While LCD displays

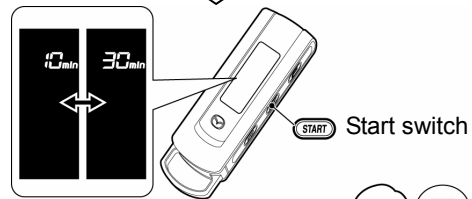

While LCD displays

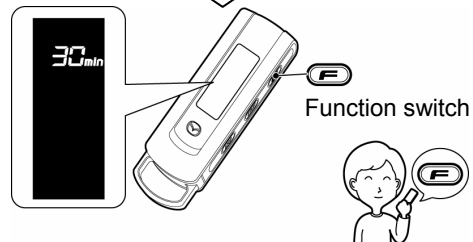

CAUTION

To help protect the environment, conserve energy and avoid inconveniencing others, do not perform idling when it is unnecessary, or longer than necessary.

9-6. Engine start operation with rear defrost start Up

- Press the function switch once.
The LCD display will appear as shown on the right.

ADVICE

The LCD display will appear when the switch is released.

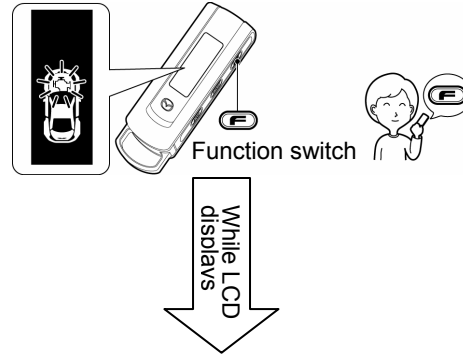

- Press the function switch once more while the above LCD display is shown.
The rear defrost mark will flash.

ADVICE

The LCD display will appear when the switch is released.

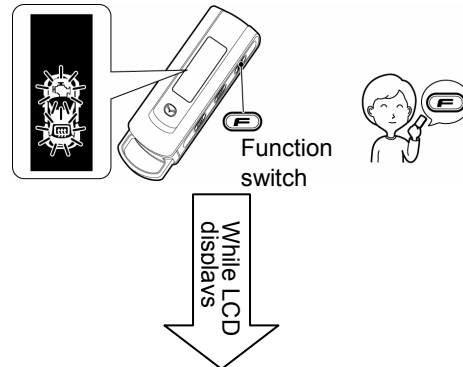

- Press the start switch while the above LCD display is shown until it beeps.
After the send mark flashes, the send operation is completed. After the send operation is completed, the controller will send an answer back signal.

*Press the start switch within 2 seconds after the LCD display appears. If the start switch is not pressed in time and the LCD display disappears, start the procedure over again from step 1.

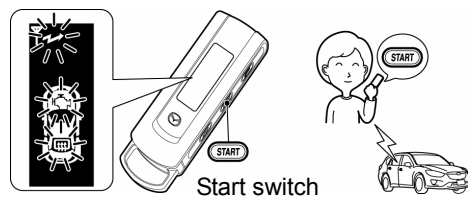

When the remote control receives a response from the vehicle, it indicates the engine start operation with a display (on the right) and a melody.

ADVICE

The rear defrost operation cannot be performed without starting the engine.

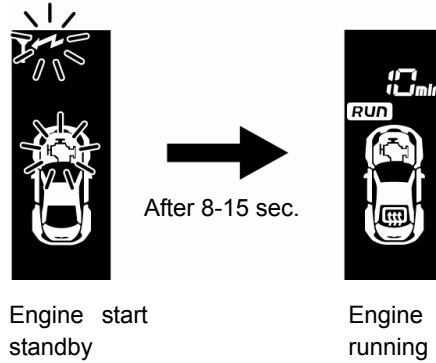

ADVICE

- After the engine start operation is initiated, the controller will automatically send an answer back.
- On some vehicle models, dash light does not turn on when the rear defrost is turned on with the Remote Engine Start.
- The rear defrost will automatically stop when the engine stops.
- The rear defrost will automatically stop after 15 minutes of operation on some vehicle models.

Note

- The rear defrost will turn on about 7 seconds after the engine starts, when performing this rear defrost operation.

9-7. Car find function

- Press the car find switch until it beeps.

The LCD display will appear as shown on the right.

After the send mark flashes, the send operation is completed. After the send operation is completed, the controller will send an answer back signal.

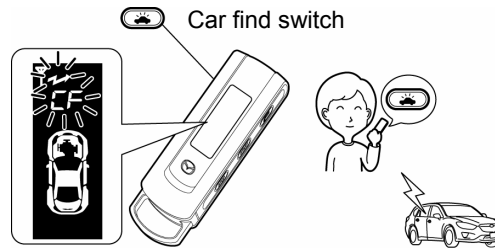

When the remote control receives a response from the vehicle, it indicates the car find operation with a display (on the right) and a melody.

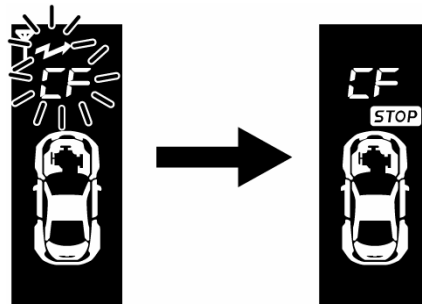

10. Troubleshooting

- Even if you think the device has broken down or malfunctioned, check once more to be sure.
- If an error occurs, read through this instruction manual thoroughly, and check the following items in the table below. If the error or problem persists, do not try to repair the device by yourself. Consult with the authorized Mazda dealer where you purchased the vehicle or device.

Problem	Check Item	Troubleshoot
Remote control does not work	Are the batteries inserted correctly?	Check the status of the batteries. (Refer to p.13.)
	Have the batteries run out?	Replace the batteries with new ones. (Refer to p.13.)
	Did you press more than one switch at the same time? (except the warm-up time setting operation)	Refer to the basic operation items to perform the remote control operation correctly. (Refer to p.14.)
	Did you try to conduct an operation too quickly right after another operation was sent?	The next transmission cannot be sent while the LCD display appears. Wait until the display turns off before conducting an operation. (Refer to p.12.)
Engine does not start using remote control	Did you make a mistake with the "Engine start" operation on the remote control?	Refer to the "Engine start operation" section on p.15.
	When the function or start switch was pressed, was another switch pressed at the same time or ahead of those switches?	Do not press another switch at the same time or ahead of those switches.
	Have the engine start conditions been satisfied?	Check the engine start conditions. (Refer to p.14, p.16.)
	Does the Error display appear on the LCD monitor of the remote control?	Refer to the "Condition Error Display" section on p.16.
Engine stops after starting it with the remote control	Are the engine stop conditions shown in p.19 true?	The engine will stop if one of the conditions shown in p.19 is true.

Problem	Check Item	Troubleshoot
The headlight or taillight turns on when the engine has been started with the remote control	Is the light switch set to the "AUTO" position?	The headlight or taillight will turn on if the engine is started at night with the remote control, when the light switch is set to the "AUTO" position.
Engine does not stop using remote control	Did you make a mistake with the "Engine stop" operation on the remote control?	Refer to the "Engine stop operation" section on p.18.
	When the stop switch was pressed, was another switch pressed at the same time or ahead of the stop switch?	Do not press another switch at the same time or ahead of the stop switch.
	Was the engine started using another method other than the Remote Engine Start?	If the engine is started using another method other than the Remote Engine Start, it cannot be stopped with the remote control.
Warm up time check does not work	Did you make a mistake with the "Warm up time check" operation on the remote control?	Refer to the "Warm up time check" section on p.20.
	When the function or start switch was pressed, was another switch pressed at the same time or ahead of those switches?	Do not press another switch at the same time or ahead of those switches.
	Was the engine started using another method other than the Remote Engine Start?	If the engine is started using another method other than the Remote Engine Start, it cannot check warm up time.
Warm up time remaining appeared on the LCD monitor of the remote control is different from its actual time.	—	Warm up time remaining appeared on the LCD monitor is expressed as the value of a unit for 2 minutes.

Problem	Check Item	Troubleshoot
Vehicle status check does not work	Did you make a mistake with the "Vehicle status check" operation on the remote control?	Refer to the "Vehicle status check" section on p. 21.
	When the function switch was pressed, was another switch pressed at the same time or ahead of the function switch?	Do not press another switch at the same time or ahead of the function switch.
The letter of "t" appears on the LCD monitor of the remote control	—	Consult with the authorized Mazda dealer where you purchased the vehicle or device.
RUN mark does not turn on when the engine has been started with the push start switch	Was the engine started using another method other than the Remote Engine Start?	If the engine is started using another method other than the Remote Engine Start, RUN mark does not turn on.
Warm up time settings does not work	Did you make a mistake with the "Warm up time settings" operation on the remote control?	Refer to the "Warm up time settings" section on p.22.
	When the function and start switch was pressed at the same time, was another switch pressed at the same time or ahead of those switches?	Do not press another switch at the same time or ahead of those switches.

Problem	Check Item	Troubleshoot
The rear defrost does not turn on	Did you make a mistake with the "Engine start with rear defrost start Up" operation on the remote control?	Refer to the "Engine start operation with rear defrost start Up" section on p.23.
	When the function or start switch was pressed, was another switch pressed at the same time or ahead of those switches?	Do not press another switch at the same time or ahead of those switches.
	Did you operate the "Engine start with rear defrost start Up" with the remote control after the engine started?	The "Engine start with rear defrost start Up" operation cannot be performed after the engine started.
	After the engine started, have approx. 15 minutes passed?	The rear defrost will automatically stop after 15 minutes from the engine started.
The rear defrost turns on in spite of the "Engine start operation" shown in p.15.	Is the cabin temperature 5°C(41° F) or less?	The rear defrost will automatically turn on when the cabin temperature is 5°C(41° F) or less and the engine is started with the Remote Engine Start.
The dash light does not turn on when the rear defrost is turned on with the Remote Engine Start	—	The dash light will not turn on when the rear defrost is turned on with the Remote Engine Start.
Car find does not work	Did you make a mistake with the "Car find" operation on the remote control?	Refer to the "Car find function" section on p. 25.
	When the car find switch was pressed, was another switch pressed at the same time or ahead of the car find switch?	Do not press another switch at the same time or ahead of the car find switch.
	Is the ignition switch set to ON?	The car find will not work when the ignition switch is set to ON.
	Are the turn signal lamps flashing with the turn signal switch operation?	The hazard flashing by the car find function will not work while the turn signal lamps are flashing.

Problem	Check Item	Troubleshoot
Remote control operating distance is short	Have the batteries run out?	Replace the batteries with new ones. (Refer to p.13)
	Are you too far from the vehicle?	Approach the vehicle and try operating the remote control.
	Is there something blocking the signal between the remote control and the vehicle, such as a building?	Move and try operating the remote control from a better location, or move closer to the vehicle when operating the remote control.
Displays a receive error "Er"	Have the batteries run out?	Replace the batteries with new ones. (Refer to p.13)
	Are you too far from the vehicle?	Approach the vehicle and try operating the remote control.
	Is there something blocking the signal between the remote control and the vehicle, such as a building?	Move and try operating the remote control from a better location, or move closer to the vehicle when operating the remote control.
	Was the engine started (or the hazard lights flashed) with the engine start operation (or the car find operation) even if the remote control displayed a receive error?	The send operation from the controller may be restricted due to the transmission conditions in the area. (Refer to p.12.)
Displays a send error "BUSY"	—	The send operation is restricted due to the transmission conditions in the area. Wait until the display mark turns off before operating the remote control. (Refer to p.12.)

11. Servicing

Servicing

If you are having a problem with the device, first re-read this instruction manual again to troubleshoot the problem or issue. If the problem or issue does not improve, consult with the authorized Mazda dealer where you purchased the vehicle or device. If you lose the remote control, contact the authorized Mazda dealer where you purchased the vehicle or device.

12. Specifications

Remote Control

Applicable standard	FCC and IC conforming
Transmission frequency	429.2125MHz
Transmission method	Single message transmission
Operating temperature range	-10 to +60 °C
Battery type	Coin type, lithium battery CR2032 / Qty. 2
Battery life	Approximately 1 year (When starting the engine 5 times / day. However, the battery life for the batteries included in the accessories is not guaranteed.)
Dimensions	30 × 97 × 19 (mm)
Weight	Approximately 50 g (including the batteries)
Transmission time	Approximately 3 seconds
Transmission rest time	2 seconds or more
Transmission antenna	Built-in antenna

Controller

Applicable standard	FCC and IC conforming
Transmission frequency	429.2125MHz
Transmission method	Single message transmission
Operating temperature range	-40 to +85°C
Rated voltage	DC 13.5 V
Power consumption during standby	3mA or less
Dimensions	201 × 46 × 26 (mm) (Max. dimensions include antenna)
Receiving antenna	Coaxial cable whip antenna

The specification and external appearance may change without prior notice given.

Request for Dealer Performing
Installation Service

Be sure to explain the device operation to the customer.

- Note that some contents of this instruction manual may not match the actual device due to changes in the vehicle or product specification.