

## **Table of Contents**

---

<b>Your Vehicle at a Glance</b>	<b>1</b>
<b>Essential Safety Equipment</b>	<b>2</b>
<b>Knowing Your Mazda</b>	<b>3</b>
<b>Protecting Your Mazda</b> Including Information on Trailer Towing (page 4-18)	<b>4</b>
<b>Driving Your Mazda</b>	<b>5</b>
<b>In Case of Emergency</b>	<b>6</b>
<b>Appearance Care</b>	<b>7</b>
<b>Maintenance</b>	<b>8</b>
<b>Customer Information</b> Including Information on How to Report Safety Defects (page 9-11)	<b>9</b>
<b>Specifications</b>	<b>10</b>
<b>Index</b>	<b>11</b>



## A Word to Mazda Owners

---

Thank you for choosing a Mazda. We at Mazda provide and build vehicles with complete customer satisfaction in mind.

To help ensure enjoyable and trouble-free operation of your Mazda, read this manual carefully and follow its recommendations.

An Authorized Mazda Dealer knows your vehicle best. So when maintenance or service is necessary, that's the place to go.

Our nationwide network of Mazda professionals is dedicated to providing you with the best possible service.

We assure you that all of us at Mazda have an ongoing interest in your motoring pleasure and in your full satisfaction with your Mazda product.

**Mazda Motor Corporation**  
HIROSHIMA, JAPAN

## **A Word to Mazda Owners**

---

### **Important Notes About This Manual**

Keep this manual in the glove box as a handy reference for the safe and enjoyable use of your Mazda. Should you resell the vehicle, leave this manual with it for the next owner.

Please be aware that this manual applies to all models, equipment and options. As a result, you may find some explanations for equipment not installed on your vehicle.

All specifications and descriptions are accurate at the time of printing. Because improvement is a constant goal at Mazda, we reserve the right to make changes in specifications at any time without notice and without obligation.

### **Air Conditioning and the Environment**

Your Mazda's genuine air conditioner is filled with R134a, a refrigerant that has been found not to damage the earth's ozone layer. If the air conditioner does not operate properly, consult an Authorized Mazda Dealer.

## How to Use This Manual

---

We want to help you get the most driving pleasure from your vehicle. Your owner's manual, when read from cover to cover, can do that in many ways.

Illustrations complement the words of the manual to best explain how to enjoy your Mazda. By reading your manual, you can find out about the features, about important safety information, and about driving under various road conditions.

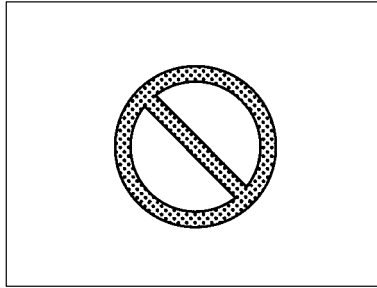

The above symbol in this manual means “Do not let this happen”.

**Index:** A good place to start is the Index, an alphabetical listing of all information in your manual.

**Sections:** This manual has eleven sections. Sections 1 through 10 begin with a brief list of contents so you can usually tell at a glance if that section has the information you want.

## How to Use This Manual

---

You'll find several WARNINGS, CAUTIONS, and NOTES in the manual.

### **WARNING**

*A WARNING indicates a situation in which serious injury or death could result if the warning is ignored.*

### **CAUTION**

A CAUTION indicates a situation in which injury or damage to your vehicle, or both, could result if the caution is ignored.















### **NOTE**

A NOTE provides information and sometimes suggests how to make better use of your vehicle.

## How to Use This Manual















### Graphic symbols:

Some of the following symbols are used to identify controls and displays on your vehicle.

				
LIGHTS	HEADLIGHT HIGH BEAM	HEADLIGHT LOW BEAM	PARKING LIGHTS	ILLUMINATION CONTROL
				
TURN SIGNALS	HAZARD WARNING FLASHER	HOOD RELEASE	TRUNK RELEASE	FUEL
				
ENGINE COOLANT TEMPERATURE	ENGINE OIL	BATTERY CHARGING SYSTEM	SEAT BELTS	BRAKE BRAKE SYSTEM

# How to Use This Manual

---

				
VENTILATION FAN	AIR RECIRCULATION	FRESH AIR	VENT	VENT-FLOOR
				
FLOOR	FLOOR DEFROSTING	DEFROSTING	REAR WINDOW DEFROSTING	WINDSHIELD WIPER & WASHER
				
LIGHTER	HORN	WASHER FLUID	MALFUNCTION INDICATOR LIGHT	



# 1

## Your Vehicle at a Glance

*Your Mazda is a complex vehicle, but the design throughout considers your safety and comfort paramount. This requires many controls, locks, graphic symbols, mechanisms, and amenities that need to be understood for proper operation.*

*Section 1 illustrates this information to familiarize you with what needs to be known to help make your motoring safer and easier, and lots more fun.*

Interior Overview	1-2
Dashboard Overview	1-3
Doors	1-4
Rear Compartment	1-5
Cargo Area	1-6

## Your Vehicle at a Glance

### Interior Overview

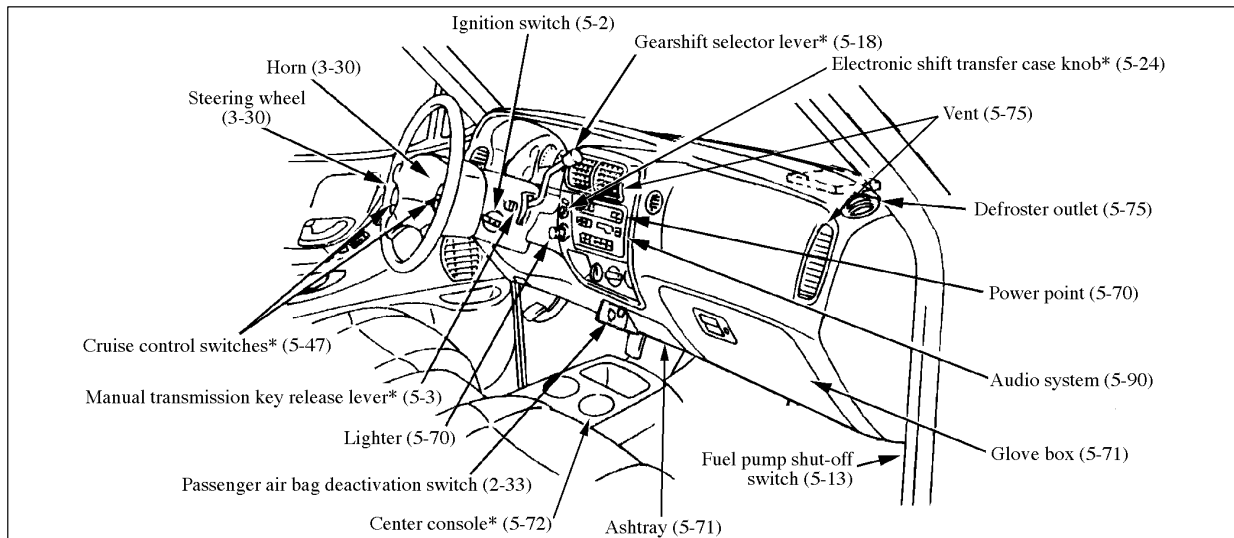

\*Some models.

## Dashboard Overview

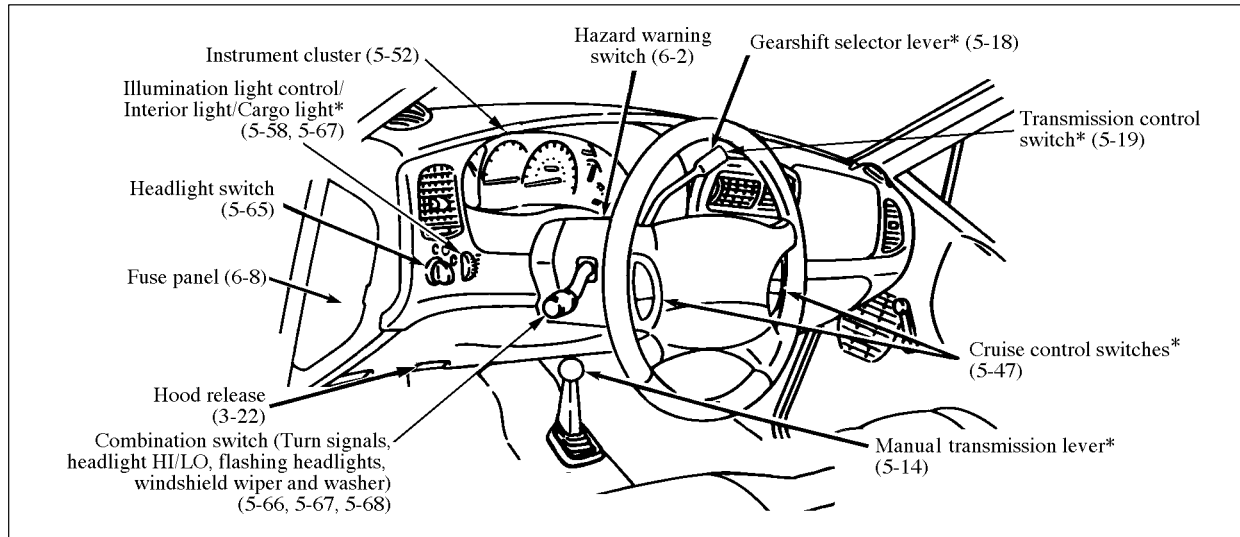

\*Some models.

## Your Vehicle at a Glance

### Doors

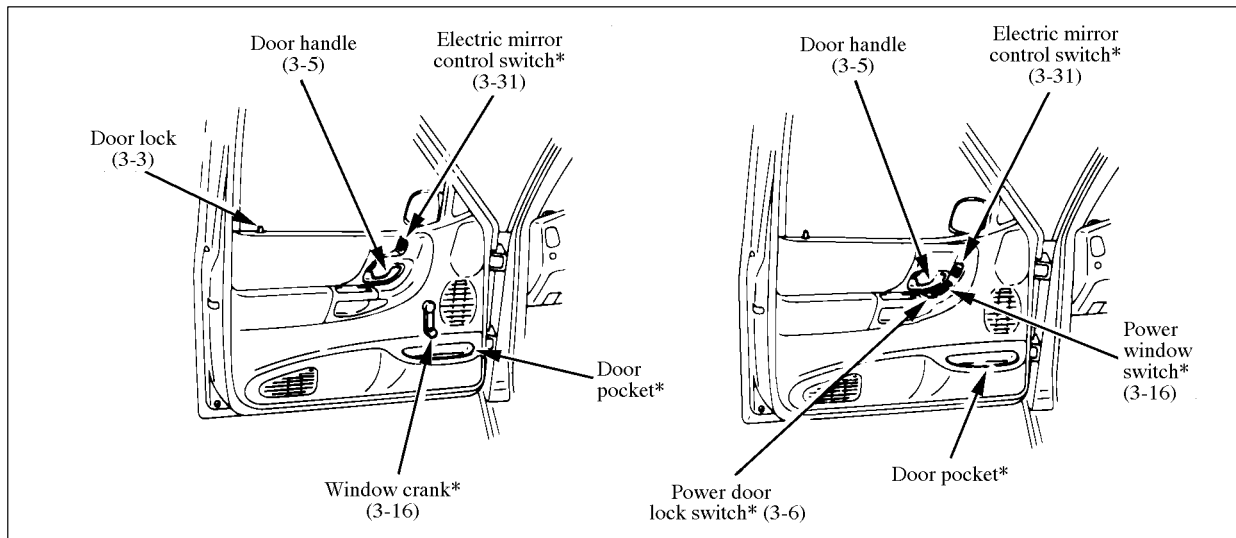

\*Some models.

## Rear Compartment

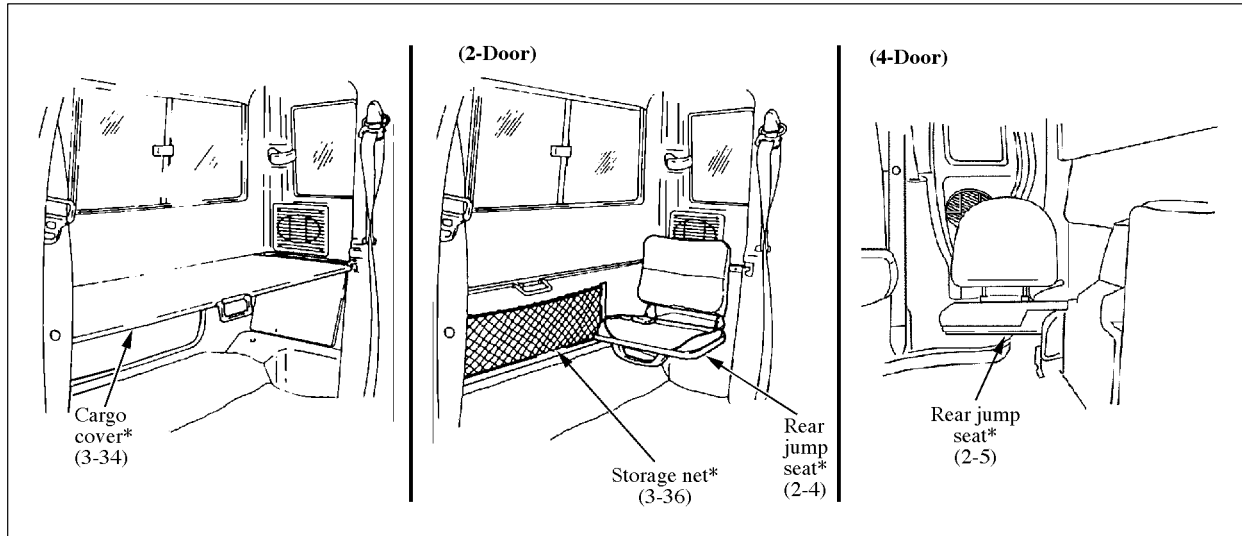

\*Some models.

## Your Vehicle at a Glance

---

### Cargo Area

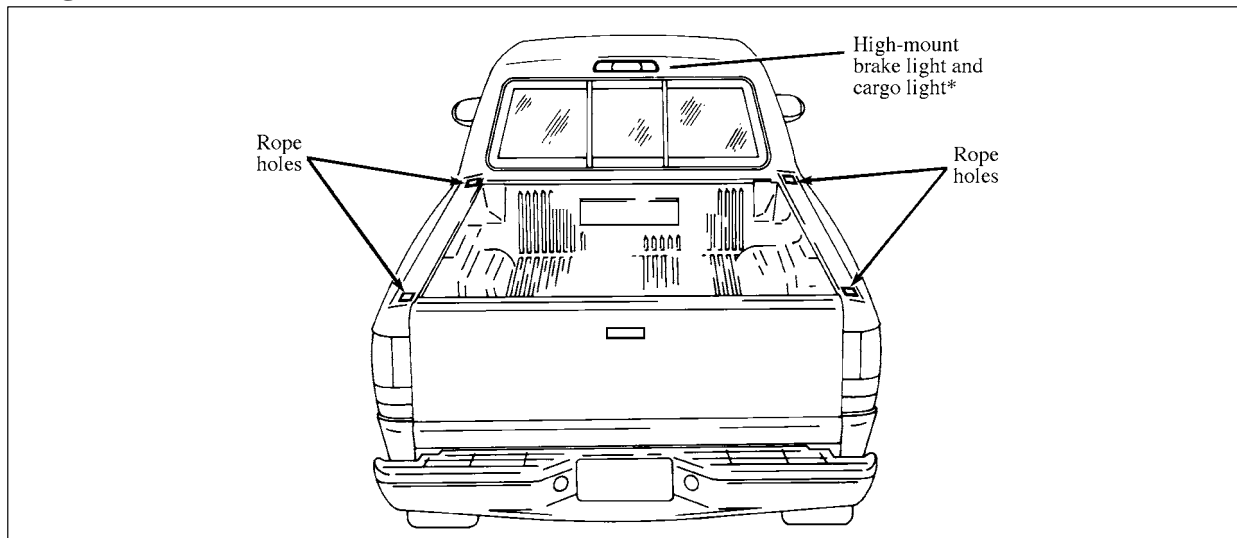

\*Some models.

# 2

## Essential Safety Equipment

*Personal safety and comfort are what make driving your Mazda a pleasurable experience. Section 2 describes essential information for optimal safe driving including seats, seat belt systems, and the supplemental restraint system.*

Front Seats	2- 2
Rear Seats	2- 4
Seat Belt System	2- 5
Child Restraint	2-21
Supplemental Air Bag Restraint System	2-29

## Essential Safety Equipment

---

### Front Seats

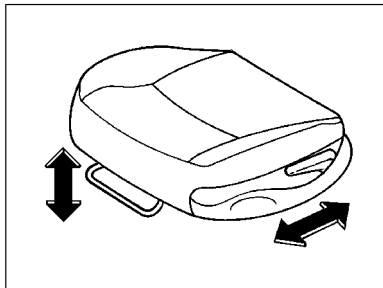

#### ■ Seat Adjustment

To move a front seat forward or backward, lift the handle up and slide the seat. Release the handle to latch the seat in its new position.

Make sure the seat locks securely in place.

\*Some models.

#### **WARNING**

##### *Driver's Seat Adjustment:*

*Adjusting the driver's seat while the vehicle is moving could cause the driver to lose control of the vehicle. Adjust this seat only when the vehicle is stopped.*

#### **WARNING**

##### *Luggage Behind Seatback:*

*Luggage or other cargo should not be piled higher than the seatbacks. This will help keep items from being thrown about and injuring people in a collision or sudden stop.*

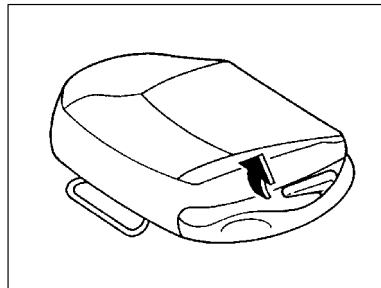

#### ■ Seat Recline\*

To change the seatback angle, lean forward slightly and raise the seat recline lever. Then, lean back to the position you want and release the lever.



Make sure the lever returns to its original position.

Lifting this lever (when a seat is unoccupied) allows the seatback to fold forward for access to the rear seat.

 **WARNING**

**Reclining:**

*Sitting in a reclined position in a moving vehicle can be dangerous because you don't get the full protection from seat belts. In a collision or sudden stop, you can slide under the lap belt and suffer serious internal injuries. For maximum protection, sit well back and upright.*

 **WARNING**

**Upright Seatbacks:**

*Rear seat passengers should not lean on the front seatback while the vehicle is in motion. A seatback which is folded forward even a small degree may not lock properly in the event of a sudden stop or collision. Do not allow packages or other objects to interfere with the normal positions of the seatback or the seat recline lever. This may prevent the seatback from locking in the event of a sudden stop or collision and could cause personal injury.*

## Essential Safety Equipment

---

### ■ Lumbar Support Adjustment\*

Turn the lumbar support control knob counterclockwise to increase firmness.

Turn the lumbar support control knob clockwise to increase softness.

The control knob is located on the outboard side of the driver's seat.

### **WARNING**

#### Seatback Lock:

*If the driver's seatback is unlocked while the vehicle is moving, it could cause the driver to lose control. To prevent this, and to prevent injury to a passenger, unlock a seatback only when the vehicle is stopped.*

## Rear Seats

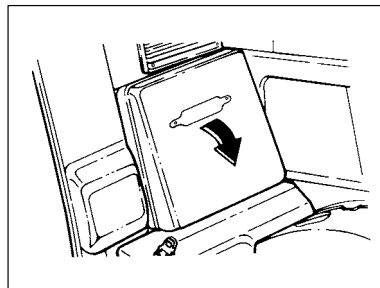

### ■ Jump Seats\*

#### 2-Door Cab Plus

To open, pull inboard and down on the seat handle.

To stow the seat, pull seat bottom back to the fully upright position.

\*Some models.

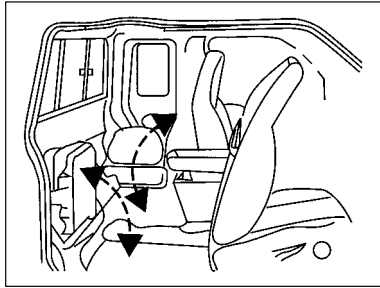

### 4-Door Cab Plus

To open, pull seat assembly down, then raise seatback.

To stow the seat, fold seat back down and raise seat assembly to the fully upright position.

### **WARNING**

#### **Installing a Child Seat in the Jump Seat:**

***Do not install a child seat in a center facing jump seat. They are not intended for this purpose.***

### Seat Belt System

Seat belts help decrease the possibility or severity of injury during accidents and sudden stops. Mazda recommends that the driver and passengers wear seat belts at all times.

#### ■ Energy Management Feature

This vehicle has a seat belt system with an energy management feature at the front outboard seating positions to help further reduce the risk of injury in the event of a head-on collision.

This seat belt system has a retractor assembly that is designed to pay out webbing in a controlled manner. This feature is designed to help reduce the belt force acting on the occupant's chest.

### NOTE

After any vehicle collision, the seat belt system at all outboard seating positions (except driver, which has no “automatic locking retractor” feature) must be checked by a qualified technician to verify the no “automatic locking retractor” feature for child seats is still functioning properly in addition to other checks for proper seat belt system function.

### **WARNING**

*Belt and retractor assembly must be replaced if the seat belt system “automatic locking retractor” feature or any other seat belt function is not operating properly when checked according to procedures in the workshop manual. Failure to replace the belt and retractor assembly could increase the risk of injury in collisions.*

### ■ **Emergency Locking Mode**

The emergency locking mode is the normal retractor mode, allowing free shoulder belt length adjustment to your movements and locking in response to vehicle movement. For example, if the driver brakes suddenly or turns a corner sharply, or the vehicle receives an impact of 5 mph (8 km/h) or more the combination seat belts will lock to help reduce forward movement of the driver and passengers.

### ■ Automatic Locking Mode

In this mode, the shoulder belt is automatically pre-locked. The belt will still retract to remove any slack in the shoulder belt.

The automatic locking mode is not available on the driver seat belt.

#### ▼ When to use the automatic locking mode

- When a tight lap/shoulder fit is desired.
- **Any time** a child safety seat is installed in a passenger front seating position. Children 12 years old and under should be properly restrained in the rear seat (if equipped) **whenever possible**. Refer to “Child Restraint” in this section.

#### ▼ How to use the automatic locking mode

1. Buckle the combination lap and shoulder belt.
2. Grasp the shoulder portion and pull downward until the entire belt is extracted.
3. Allow the belt to retract. As the belt retracts, you will hear a clicking sound. This indicates the safety belt is now in the automatic locking mode.

#### ▼ How to disengage the automatic locking mode

Disconnect the combination lap/shoulder belt and allow it to retract completely to disengage the automatic locking mode and activate the emergency locking mode.

- This vehicle has a seat belt system with an energy management feature at the front seating positions to help further reduce the risk of injury in the event of head-on collision.
- This seat belt system has a retractor assembly that is designed to pay out webbing in a controlled manner. This feature is designed to help reduce the belt force acting on an occupant’s chest.

### **WARNING**

#### Seat Belts:

*Make sure that you and your passengers, including pregnant women, wear seat belts. Be sure that the lap belt portion of your seat belt fits snugly and as low as possible around the hips. If seat belts are not used properly, the risk of you or your passengers being injured in a collision greatly increases. In a rollover crash, an unbelted person is significantly more likely to die than a person wearing a seat belt.*

*(Continued)*

### **WARNING**

*Always drive and ride with your seatback upright and the lap belt portion of your seat belt snug and low across the hips. This will reduce the risk of serious injury to the abdomen or neck that could be caused by sliding under the seat belts in a collision.*

### **WARNING**

#### Damaged Seat Belts:

*An accident can damage a seat belt in use. The belt webbing can be weakened and retractors and anchors can be bent or broken. Therefore, a damaged seat belt may not provide adequate protection in a collision. Have a professional inspect all seat belt systems in use during an accident before they are used again.*

**NOTE**

When the lap/shoulder belt is unbuckled and allowed to retract completely, the retractor will switch to the emergency locking mode.

** WARNING**

**No Passengers in Cargo Area:**

*Do not allow any people to ride in the cargo area of your vehicle. People who are not riding in seats with their seat belts fastened are much more likely to be injured in a collision.*

** WARNING**

**Twisted Seat Belts:**

*Twisted seat belts can cause injury. In a collision, the full width of the belt isn't available to absorb the impact. This puts more force on the bones beneath the belt, which could break them or cause other serious injury. If you cannot untwist or unjam the seat belt, see your nearest qualified technician immediately. Never drive or ride with twisted seat belts.*

**NOTE**

Refer to page 2-15 for more information on how to untwist a seat belt.

** WARNING**

**One Belt, One Passenger:**

*Using one seat belt for more than one person at a time is dangerous. A seat belt used in this way can't spread the impact force properly and the two passengers could be crushed together and seriously injured. Never use one belt for more than one person at a time.*

## Essential Safety Equipment

---

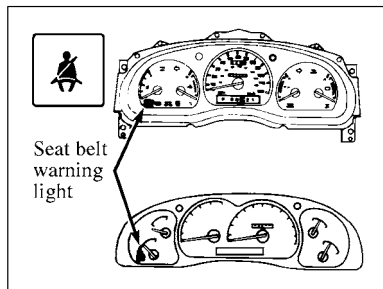

If the seat belt is not buckled before the ignition is turned to ON, the light comes on for one to two minutes and the chime sounds for 4 to 8 seconds.

If the seat belt is buckled while the light is on and the chime is sounding, both the light and chime turn off.

If the seat belt is buckled before the ignition is turned to ON, both the light and chime will not turn on.

### ■ Seat Belt Warning Light/Chime

The seat belt warning light/chime reminds you to fasten your seat belt. One of the following will take place:

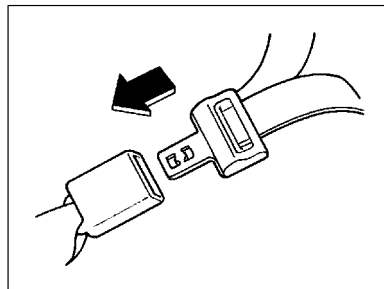

### ■ Front Seat Belts

To fasten:

1. Grasp the buckle and tongue plate.
2. Slowly pull out the lap/shoulder belt.



3. Insert the tongue into the buckle closest to the direction the tongue is coming from until you hear a click.
4. Pull slightly to ensure a proper connection.

**⚠ WARNING**

**Positioning the Shoulder Portion of the Seat Belt:**

*Improper positioning of the shoulder portion of the seat belt is dangerous. An improperly positioned belt will provide little or no protection in a collision. Always make sure the shoulder portion of the seat belt is positioned across your shoulder and near your neck, but never under your arm, on your neck, or on your upper arm.*

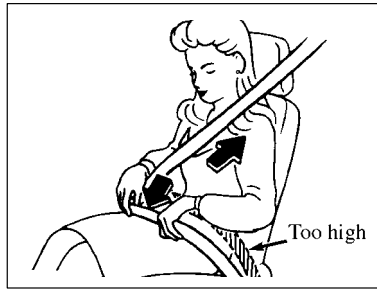

**⚠ WARNING**

**Positioning the Lap Portion of the Seat Belt:**

*The lap portion of the seat belt worn too high can be dangerous. In a collision, this would concentrate the impact force directly on the abdominal area, causing serious injury. Wear the lap belt snugly and as low as possible.*

## Essential Safety Equipment

---

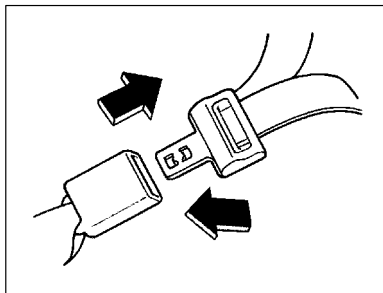

### To unfasten:

Push the red release button and remove the tongue from the buckle.

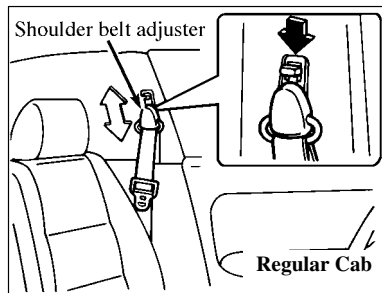

### ■ Shoulder Belt Adjuster

Your vehicle has seat belt height adjustments for the driver and front passenger. Adjust the height of the shoulder belt so the belt rests across the middle of your shoulder.

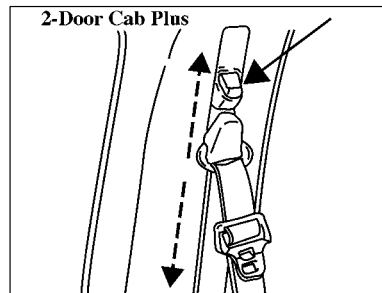

To lower the shoulder belt height, push the button and slide the height adjuster down. To raise the height of the shoulder belt, slide the height adjuster up. Pull down on the height adjuster assembly to make sure it is locked in place.

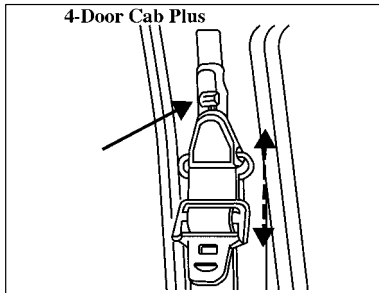

Be sure the belt is properly positioned on your shoulder each time you use the belt.

**⚠ WARNING**

**Positioning the Shoulder Portion of the Seat Belt:**

*Improper positioning of the shoulder portion of the seat belt is dangerous. An improperly positioned belt will provide little or no protection in a collision. Always make sure the shoulder portion of the seat belt is positioned across your shoulder and near your neck, but never under your arm, on your neck, or on your upper arm.*

**⚠ WARNING**

*If the shoulder belt is off your shoulder, under your arm or against your neck, there is a greater risk of severe injury in a collision.*

## Essential Safety Equipment

---

### ■ Front Center Seat Belt (No Retractor)

The lap belt does not adjust automatically.

#### To fasten:

1. Grasp the tongue plate and pull it to the desired length. To lengthen the belt, hold the tongue at a right angle to the webbing and pull; to shorten, pull the loose end of the webbing.
2. Insert the tongue into the correct buckle (the buckle closest to the direction the tongue is coming from).
3. Pull slightly to ensure a proper connection.

4. Adjust belt so that it fits snugly and as low as possible around the hips.

#### To unfasten:

Depress the button on the buckle. Shorten and fasten the belt when not in use.

### ■ Rear Lap Belts With Retractors

The lap belt will adjust automatically.

#### To fasten:

Grasp the tongue, and with a continuous motion, pull out enough webbing to buckle the tongue into the correct buckle. If you did not pull out enough webbing to reach the buckle, allow the

tongue to retract fully before trying to pull it out again. The lap belts should fit snugly and as low as possible around the hips, not around the waist.

If you need to lengthen the belt, unfasten it and repeat the procedure above.

#### To unfasten:

Push in the release button prior to opening the rear door.

<b>NOTE</b>
On 4-door cab plus vehicles, do not open the rear door when the rear seat belt is still buckled.

**⚠ WARNING**

**Wearing the Lap Belt:**

*A lap belt worn too high can be dangerous. In a collision, this would concentrate the impact force directly on the abdominal area, causing serious injury. Wear the lap belt snugly and as low as possible.*

**■ How to Untwist or Unjam a Seat Belt Retractor**

If you should jam the lap belt retractor by allowing the belt to retract when it is twisted, you can free the webbing with this procedure:

1. Pull on the belt with both hands to tighten it on the retractor spool.
2. Feed the belt back into the retractor until it is completely retracted. Repeat previous step if necessary.
3. Pull the belt out of its holder as far as it will go and untwist the belt or remove the object that is jamming the belt. Let the belt retract.
4. Then, pull the belt out and let it retract several times to make sure that the belt works properly.

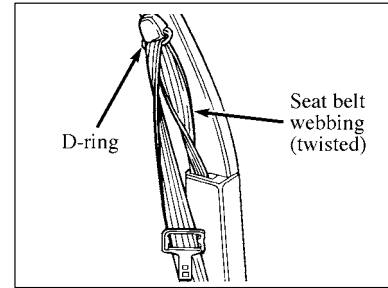

**■ Procedure to Correct a Twisted Seat Belt at the D-Ring**

1. Grasp the belt webbing at the D-ring. (Wire type shown—vehicles with other types of D-rings also affected.)

## Essential Safety Equipment

---

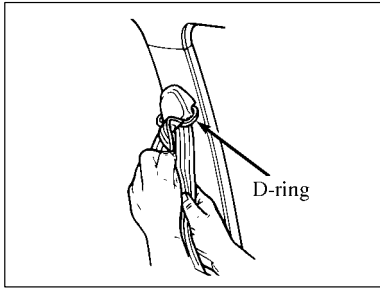

2. Rotate and fold the belt webbing over itself as required to remove the twist.
3. Feed the folded portion of the belt through the D-ring.

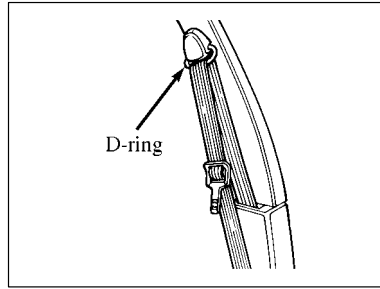

4. When completed, the seat belt should look like the above figure.

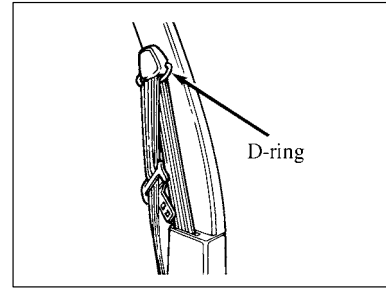

### ■ Procedure to Correct a Rotated Tongue on the Seat Belt

1. Grasp the belt tongue and pull down on the belt webbing closest to you to form a loop through the **upper** (narrow and longer) slot in the tongue.

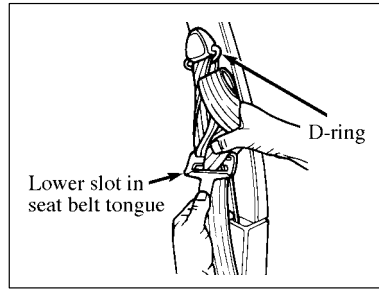
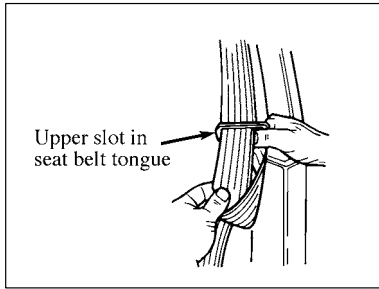

2. Working within the **upper** slot, rotate and fold the belt webbing over itself as required to remove the twist.
3. Pull the excess belt webbing back through the **upper** slot in the tongue.
4. Repeat the above steps to complete the removal of the twist at the **lower** (wider and larger) slot in the tongue.
5. When completed, the seat belt should look like the second figure on page 2-16.

### ■ Seat Belt Extender

If your seat belt is not long enough, even when fully extended, your Authorized Mazda Dealer can provide you with a seat belt extender. It is free. The extender will be only for you and for the particular vehicle and seat that you choose. When ordering an extender, only order one that provides the necessary additional length to fasten the seat belt properly. Please contact your Authorized Mazda Dealer for more information.

### **WARNING**

#### Using an Improper Extender:

*Using a seat belt extender that is for another person or a different vehicle or seat is dangerous. The seat belt will not provide adequate protection and the user could be seriously injured in an accident. Only use the extender provided for you and for the particular vehicle and seat. NEVER use the extender in a different vehicle or seat.*

### **WARNING**

#### Unnecessary Use of an Extender:

*Using a seat belt extender when not necessary is dangerous. The seat belt will be too long and not fit properly. In an accident, the seat belt will not provide adequate protection and you could be seriously injured. Only use the extender when it is required to fasten the seat belt properly.*

### **WARNING**

#### Using an Extender That is Too Long:

*Using an extender that is too long is dangerous. The seat belt will not fit properly. In an accident, the seat belt will not provide adequate protection and you could be seriously injured. Don't use the extender or choose one shorter in length if the distance between the extender's buckle and the center of the user's body is less than 6 inches.*



### ■ Pregnant Women

Pregnant women should wear seat belt assemblies as recommended by their doctors. The lap belt should be worn **SNUGLY AND AS LOW AS POSSIBLE**.

### ■ Seat Belt Maintenance

Inspect the seat belt systems periodically to make sure they work properly and are not damaged. Inspect the seat belts to make sure there are no nicks, wears or cuts, replacing if necessary. All seat belt assemblies, including retractors, buckles, front seat belt buckle assemblies (slide bar) (if equipped), shoulder belt height adjusters (if equipped), child safety seat tether bracket assemblies (if equipped), and attaching hardware, should be inspected after a collision. Mazda recommends that all seat belt assemblies used in vehicles involved in

a collision be replaced. However, if the collision was minor and a qualified technician finds that the belts do not show damage and continue to operate properly, they do not need to be replaced. Seat belt assemblies not in use during a collision should also be inspected and replaced if either damage or improper operation is noted.

## Essential Safety Equipment

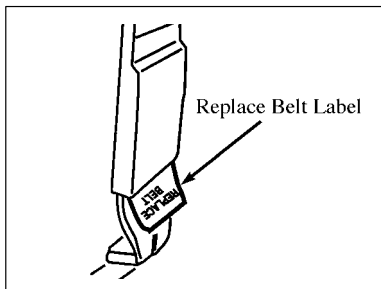

The short plastic boot on the front seat belt at the outboard anchor location (Regular Cab, driver; Cab Plus, driver and passenger) covers an energy absorbing sew pattern on the seat belt. In the event of an accident, the sew pattern may release and a colored label (REPLACE BELT) may become visible. If this occurs, the seat belt must be replaced.

### **⚠ WARNING**

#### **Inspecting Seat Belts After a Collision:**

*All seat belt assemblies, including retractors, buckles, front seat buckle support assemblies (slide bar, if so equipped), shoulder belt height adjusters (if equipped), child safety seat tether bracket assemblies (if equipped) and attaching hardware should be inspected after any collision. Mazda recommends that all seat belt assemblies used in vehicles involved in a collision be replaced. However, if the collision was minor and a qualified technician finds*

*(Continued)*

*that the belts do not show damage and continue to operate properly, they do not need to be replaced. Seat belt assemblies not in use during a collision should also be inspected and replaced if either damage or improper operation is noted.*

### **⚠ WARNING**

#### **Replace Belt Label:**

*If any part of the colored label is exposed, the belt must be replaced. Failure to do so could result in severe personal injuries in a collision.*

## Child Restraint

You are required by law to use safety restraints for children in the U.S. and Canada. If small children ride in your vehicle (generally children who are four years old or younger and who weigh 40 lbs [18 kg] or less), you must put them in safety seats made especially for children. Check your local and state or provincial laws for specific requirements regarding the safety of children in your vehicle.

Always follow the instructions and warnings that come with any infant or child restraint you might use.

When possible, always place children under age 12 in the rear seat of your vehicle. Accident statistics suggest that children are safer when properly

restrained in the rear seating positions than in the front seating positions.

### **WARNING**

#### **Child Restraint Instructions:**

*When using any infant or child restraint system, it is important that you follow the instructions and warnings provided by the manufacturer concerning its installation and use. Failure to follow each of the restraint manufacturer's instructions could increase the risk or severity of an injury in the event of a collision or sudden stop.*

### **WARNING**

#### **Installing Child Restraint Seats:**

*When installing a child safety seat, be sure to use the correct seat belt buckle for that seating position, and make sure the tongue is securely fastened in the buckle. All child restraint systems are designed to be secured in vehicle seats by the lap portion of a lap-shoulder belt. If you do not properly secure the safety seat to the vehicle, the risk is greater that a child, occupying the seat during a collision or sudden stop, will be injured. An un-secured safety seat could also injure other passengers in the vehicle.*

## Essential Safety Equipment

---

### **WARNING**

#### Unsecured Restraint System:

*A child-restraint system that is not securely fastened down can be dangerous. In a sudden stop or collision, it can become a projectile and hit someone, causing serious injury. When not in use, remove it from the vehicle or fasten it with a seat belt.*

### **WARNING**

#### Holding a Child:

*A child should never be held on the lap or in the arms of a passenger in a moving vehicle. No matter how strong a person may be, he or she cannot hold a child during an accident. The child may thus be injured by hitting parts of the vehicle, by being crushed by an unrestrained passenger or even being ejected from the vehicle.*

### **WARNING**

#### Unattended Children:

*Leaving children unattended in a vehicle can be dangerous. In hot weather, temperatures inside a parked vehicle can become high enough to cause brain damage or even death. Never leave children or animals unattended in the vehicle.*

## ■ Installing a Child-Restraint System

The front passenger seat lap/shoulder belt retractor operates in two modes, emergency locking mode and automatic locking mode. Automatic locking mode must be used when installing a child safety seat on the passenger side seat. (Refer to “Passenger Air Bag” Warning on page 2-24.)

### **WARNING**

#### **Improperly Secured System:**

*Carefully follow all of the manufacturer’s instructions that come with the safety seat that you put in your vehicle. Make sure that the shoulder belt (if provided at the seating position where the safety seat is being used) does not cross or rest in front of the child’s face or neck. If you do not install and use the safety seat properly, the child may be injured in a sudden stop or collision.*

### **WARNING**

#### **Keep Seatbacks Upright:**

*Children should always ride with the seatback in the fully upright position. When the seatback is not fully upright, there is a greater risk that the child will slide under the seat belt and be seriously injured in a collision. Seatbacks should be upright for use with child safety seats.*

### **WARNING**

#### **Center Facing Jump Seats:**

*Safety seats for children are not intended for use in center facing seats.*

### **⚠ WARNING**

#### **Passenger Air Bag:**

**REAR-FACING INFANT SEATS SHOULD NEVER BE USED IN THE FRONT SEAT UNLESS THE PASSENGER AIR BAG SWITCH IS TURNED TO OFF. When using forward-facing child seats in the front seat, always move the passenger seat as far back from the instrument panel as possible. Failure to follow these warnings could result in injury to the child.**

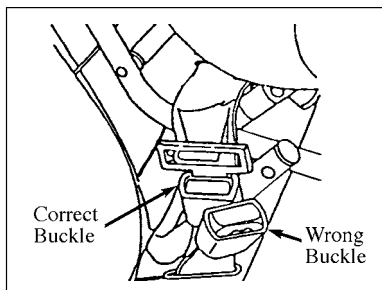

When installing a child safety seat, be sure to use the correct belt buckle for that seating position. Insert the belt tongue into the proper buckle until you hear a snap and feel it latch. Make sure the tongue is securely fastened in the buckle.

### **⚠ WARNING**

#### **Buckle Release Button:**

**Always keep the buckle release button pointing upward and away from the child seat, with the tongue between the child seat and the release button. Failure to follow these instructions could result in accidental unbuckling of the seat belt if the child safety seat hits the release button. Release of the seat belt could result in serious injuries.**

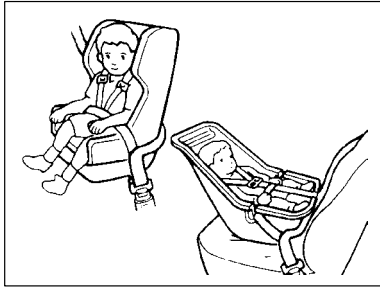

### ▼ Front seat passenger position

1. Slide the seat as far back as possible.
2. Secure the system with the lap portion of the lap/shoulder belt.
3. Pull down on the shoulder belt and then grasp the shoulder belt and lap belt together.
4. While holding the shoulder and lap belt portions together, route the tongue through the child seat according to the child seat manufacturer's instructions. Be sure the belt webbing is not twisted.
5. Insert the belt tongue into the proper buckle (the buckle closest to the direction the tongue is coming from) for that seating position until you hear and feel the latch engage. Make sure the tongue is latched securely by pulling on it.
6. To put the retractor in the automatic locking mode, grasp the shoulder portion of the belt and pull downward until all of the belt is retracted and a click is heard.
7. Allow the belt to retract. The belt will click as it retracts to indicate it is in the automatic locking mode.
8. Pull the lap belt portion across the child seat toward the buckle and pull up on the shoulder belt while pushing down on the seat.
9. Allow the seat belt to retract to remove any slack in the belt.
10. Before placing the child in the seat, forcibly tilt the seat forward and back to make sure the seat is securely held in place.
11. Try to pull the belt out of the retractor to make sure the retractor is in the automatic locking mode. (You should not be able to pull more belt out.) If the retractor is not locked, unbuckle the belt and repeat steps 3 through 10.

## Essential Safety Equipment

---

### ■ Attaching Safety Seats With Tether Straps

#### ▼ General instructions

Some manufacturers make safety seats that include a tether strap that goes over the back of the vehicle seat and attaches to an anchoring point. Contact the child seat manufacturer for information about ordering a tether strap.

You can attach a tether strap anchor bracket to the cab inner back panel by using a tether anchor kit available at no charge from any Authorized Mazda Dealer.

A tethered seat can be installed in the front seat. Put the tether strap over the seatback and attach it to an anchor bracket.

An anchor bracket can be installed on the rear edge of the front seat cushion. The attaching hole is provided in the rear edge of the front passenger seat cushion frame.

Read and carefully follow the instructions provided with the kit for installation of the child tether strap anchor.

Follow the child seat manufacturer's instructions to attach the tether strap to the tether bracket.

### **WARNING**

#### **Tether Attachment:**

***Use only the tether attachment hole locations. The tether anchorage may not perform properly if the wrong mounting location is used.***

### **WARNING**

#### **Follow Precautions:**

***Failure to follow these precautions could increase the chance and/or severity of injury in an accident.***



 **WARNING**

Center Facing Jump Seats:

*In Cab Plus vehicles equipped with center facing jump seats, the tether strap anchor bracket should be installed only at the center of the cab's back panel with the child seat in the front center seating position. Installing an anchor bracket at the right rear of the cab may increase risk of injury to an occupant of the right rear center facing jump seat in the event of a collision or sudden stop. If a tethered child seat is installed in the right front seating position, secure the tether strap to*

*(Continued)*

*the webbing of the buckled right rear lap belt. Do not install a child seat in a center facing jump seat. Safety seats for children are not intended for use in center facing seats.*

 **WARNING**

Test Child Restraints:

*Once you have attached the safety seat, test the seat before you place the child in it. Tilt the seat from side to side. Also try to tug the seat forward. Check to see if the belt holds the seat firmly in place.*

*If the safety seat is not anchored properly, the risk of a child being injured in a collision or sudden stop greatly increases. Reclining seat-backs should be in the most upright position for use with child safety seats.*

## Essential Safety Equipment

---

To improve the fit of lap and shoulder belts on children who have outgrown child safety seats, Mazda recommends use of a belt-positioning booster seat that is labeled as conforming to all Federal motor vehicle safety standards. Belt-positioning booster seats raise the child and provide a shorter, firmer seating cushion that encourages safer seating posture and better fit of lap and shoulder belts on the child. A belt-positioning booster should be used if the shoulder belt rests in front of the child's face or neck, or if the lap belt does not fit snugly on both thighs, or if the thighs are too short to let the child sit all the way back on the seat cushion when the lower legs hang over the edge of the seat cushion. You may wish to discuss the specific needs of your child with your pediatrician.

### ■ Older Children

A child who has outgrown child restraint systems should use seat belts, both lap and shoulder. If the shoulder belt crosses the neck or face, use the adjustable shoulder belt and/or move the child closer to the center of the vehicle.

#### **WARNING**

##### Proper Belt Adjustment:

*If seat belts are not properly worn and adjusted as described, the risk of serious injury to the child in a collision will be much greater. Make sure the seat belt is worn properly as described in this section.*

#### **WARNING**

##### Shoulder Belt Positioning:

*The child should wear the lap and shoulder belt only if the shoulder belt portion can be positioned so that it does not cross or rest in front of the child's face or neck. Moving the child closer to the center of the vehicle may help provide proper shoulder belt fit.*

*If the shoulder belt cannot be properly positioned, the child should be protected by a child restraint system. If you do not have a child restraint system, obtain one immediately. In the meantime, move the child to a lap belt-only seat position if the vehicle is so equipped.*

 **WARNING**

**Lap Belt Position:**

*Lap belts and the lap belt portion of lap and shoulder belts should always be worn snugly and below the hips, touching the child's thighs.*

 **CAUTION**

A seat belt or child restraint can become very hot in a closed vehicle during warm weather. To avoid burning yourself or a child, inspect the seat belt or child restraint before using.

## Supplemental Air Bag Restraint System

In a front-end accident, the supplemental restraint system is designed to provide protection in addition to the three-point seat belt system. Without seat belt usage, the air bags cannot provide adequate protection during an accident. Seat belt usage is necessary to:

- Keep the passenger away from an inflating air bag.
- Reduce the possibility of injuries during an accident that is not designed for air bag inflation, such as rollover, side or rear collisions.

- Reduce the possibility of injuries in a frontal collision that is not severe enough to activate the air bag.
- Reduce the possibility of being thrown from your vehicle.
- Reduce the possibility of injuries to lower body and legs during an accident because the air bag provides no protection to these parts.
- Hold the driver in a position which allows better control of the vehicle.

## Essential Safety Equipment

---

The National Highway Traffic Safety Administration (NHTSA) recommends a minimum of at least 10 inches (25 cm) between an occupant's chest and the air bag module.

To properly position yourself away from the air bag:

- Move your seat to the rear as far as you can while still reaching the pedals comfortably.
- Recline the seat one or two notches from the upright position.

### **WARNING**

***Air Bags without Seat Belts:***  
***Depending only on the air bags for protection during an accident is dangerous. Alone, air bags may not prevent serious injuries. The appropriate air bags can be expected to inflate only during a frontal or near-frontal collision of at least moderate force. Vehicle occupants should always wear seat belts.***

Small children, those under 40 lbs (18 kg), should be protected by a child-restraint system (page 2-21).

### **WARNING**

***The driver and passenger air bags are not designed to restrain occupants in the center front seating position on bench seats. Please wear your seat belts.***

### **WARNING**

#### **Rear-Facing Child Restraint:**

*When a rear-facing child restraint is installed on the passenger seat and the passenger side air bag deactivation switch is not in the OFF position, it is extremely dangerous. In an accident, the air bag could inflate and cause serious injuries or even death to the child in the rear-facing child restraint. When first installing a rear-facing child restraint until it is removed, always set and leave the passenger side air bag deactivation switch in the OFF position.*

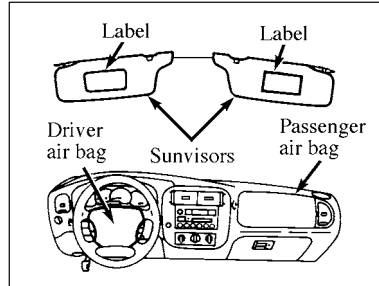

#### ■ System Description

The air bag system consists of:

- Driver and passenger air bag modules (which include the inflators and air bags)

- One or more impact and safing sensors, passenger air bag deactivation (PAD) switch and diagnostic monitor
- Readiness light and tone
- Electrical wiring which connects the components

## Essential Safety Equipment

---



The driver air bag is mounted in the center of the steering wheel and remains out of sight until activated.

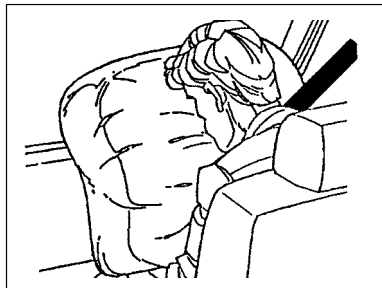

The passenger air bag is mounted in the upper right hand section of the instrument panel and remains out of sight until activated. It is not intended to provide protection to the center occupant's position.

### ■ Passenger Air Bag

It is important for front seat passengers' safety that they remain properly seated whenever the vehicle is moving. This means that small children should be secured in appropriate child safety seats. All other occupants should sit upright, with their backs against the seatback, and restrained by lap and shoulder belts. No passenger should sit toward the front edge of the seat, or stand or lean near the air bag cover (which is near the glove box).

■ **Passenger Air Bag  
Deactivation Switch**

Your vehicle is equipped with a front passenger side air bag deactivation switch. The switch is located at the lower center of the instrument panel next to the ash-tray.

The passenger side air bag should always be ON (the air bag OFF light should NOT be illuminated) unless the passenger is a person who meets the requirements stated either in Category 1, 2 or 3 of the NHTSA deactivation criteria which follows.

 **WARNING**

*Air Bags and Seat Belts*

*The seat belts for the driver and right front passenger seating positions have been specifically designed to function together with the air bags in certain types of crashes. When you turn OFF your air bag, you not only lose the protection of the air bag, you also may reduce the effectiveness of your seat belt system which was designed to work with your air bag. If you are not a person who meets the requirements stated in the NHTSA deactivation criteria turning OFF the air bag can increase the risk of serious injury or death in a collision.*

 **WARNING**

*Rear-Facing Child Restraint:*

*When a rear-facing child restraint is installed on the passenger seat and the passenger side air bag deactivation switch is not in the OFF position, it is extremely dangerous. In an accident, the air bag could inflate and cause serious injuries or even death to the child in the rear-facing child restraint. When first installing a rear-facing child restraint until it is removed, always set and leave the passenger side air bag deactivation switch in the OFF position.*

## Essential Safety Equipment

---

The vast majority of drivers and passengers are much safer with an air bag than without. To do their job and reduce the risk of life threatening injuries, air bags must open with great force, and this force can pose a potentially deadly risk in some situations, particularly when a front seat occupant is not properly buckled up. The most effective way to reduce the risk of unnecessary air bag injuries without reducing the overall safety of the vehicle is to make sure all occupants are properly restrained in the vehicle, especially in the front seat. This provides the protection of seat belts and permits the air bags to provide the additional protection they were designed to provide. If you choose to deactivate your air bag, you are losing the very significant risk reducing benefits of the air bag and you are also reducing the effectiveness of the seat belts, because seat belts

in modern vehicles are designed to work as a safety system with the air bags.

Read all air bag warning labels in the vehicle as well as the other important air bag instructions and warnings in this owner's manual.

### NHTSA deactivation criteria

1. **Infant** – An infant (less than 1 year old) must ride in the front seat because:
  - the vehicle has no rear seat;
  - the vehicle has a rear seat too small to accommodate a rear-facing infant seat; or
  - the infant has a medical condition which, according to the infant's physician, makes it necessary for the infant to ride in the front so that the driver can constantly monitor the child's condition.



2. **Child age 1 to 12** – A child age 1 to 12 must ride in the front seat because:
  - the vehicle has no rear seat;
  - although children ages 1 to 12 ride in the rear seat(s) whenever possible, children ages 1 to 12 sometimes must ride in the front because no space is available in the rear seat(s) of the vehicle; or
  - the child has a medical condition which, according to the child's physician, makes it necessary for the child to ride in the front seat so that the driver can constantly monitor the child's condition.
3. **Medical condition** – A passenger has a medical condition which, according to his or her physician:
  - causes the passenger air bag to pose a special risk for the passenger; and
  - makes the potential harm from the passenger air bag in a crash greater than the potential harm from turning OFF the air bag and allowing the passenger, even if belted, to hit the dashboard or windshield in a crash.

### **WARNING**

#### *Energy Management Seat Belts*

*This vehicle has special energy management seat belts for the driver and/or right front passenger. These particular belts are specifically designed to work with air bags to help reduce the risk of injury in a collision. The energy management seat belt is designed to give or release additional belt webbing in some accidents to reduce concentration of force on an occupant and reduce the risk of injuries to underlying organs.*

*(Continued)*

## Essential Safety Equipment

---

*In a crash, if the air bag is turned OFF, this energy management seat belt might permit the person wearing the belt to move forward enough to incur a serious or fatal injury. The more severe the crash, and the heavier the occupant, the greater the risk is. Be sure the air bag is turned ON for any person who does not qualify under the NHTSA deactivation criteria.*

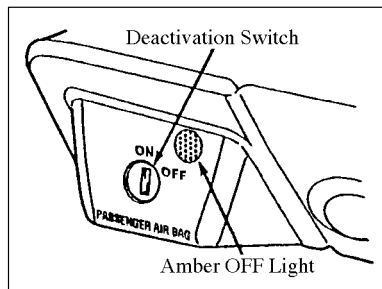

### NOTE

If the yellow peel-off label is still on the switch, pull the tab to remove it, and discard it.

### ▼ To deactivate the passenger air bag

1. Insert the ignition key, turn the switch to OFF position and hold in OFF position while removing the key.
2. When the ignition is turned on, the OFF light illuminates briefly, momentarily shuts off and then turns back on. This indicates that the passenger air bag is deactivated.

### **WARNING**

#### Light Malfunction:

*If the light fails to illuminate when the passenger air bag deactivation switch is in the OFF position and the ignition switch is in ON, have the passenger air bag switch serviced at your Mazda dealer immediately.*

### **WARNING**

*In order to avoid inadvertent activation of the deactivation switch and the passenger air bag, always remove the ignition key from the passenger air bag deactivation switch.*

The passenger air bag remains OFF until you turn it back ON.

#### ▼ **To activate the passenger air bag**

1. Insert the ignition key and turn the switch to ON.
2. The OFF light will briefly illuminate when the ignition is turned to ON. This indicates the passenger air bag is operational.

## Essential Safety Equipment

---

### **WARNING**

#### **Light Malfunction:**

*If the light is illuminated when the passenger air bag deactivation switch is in the ON position and the ignition switch is in ON, have the passenger air bag deactivation switch serviced at your Mazda dealer immediately.*

The amber OFF light warns the driver and any passengers that the passenger air bag is turned off. The passenger air bag should be turned off ONLY when a rear-facing infant seat is installed at the right front passenger seat.

### **WARNING**

#### **Keep Switch On:**

*Keep the passenger air bag turned ON unless there is an infant seat installed in the front seat. When the passenger air bag switch is turned OFF, the passenger air bag will not inflate in a collision.*

### **WARNING**

#### **Passenger Seated and Restrained:**

*If a passenger is not properly seated and restrained, an inflating air bag could cause a serious injury or death.*

### **WARNING**

#### **Rear-Facing Child Restraint:**

*When a rear-facing child restraint is installed on the passenger seat and the passenger side air bag deactivation switch is not in the OFF position, it is extremely dangerous. In an accident, the air bag could inflate and cause serious injuries or even death to the child in the rear-facing child restraint. When first installing a rear-facing child restraint until it is removed, always set and leave the passenger side air bag deactivation switch in the OFF position.*

### ■ **How the Air Bag Works**

When air bag crash sensors detect a greater than moderate frontal impact (more severe than hitting a parked vehicle of similar size and weight head-on at about 28 mph [45 km/h]), an electrical current is sent to the inflator and nitrogen gas is produced to inflate the air bag. After the inflation, the bag quickly deflates.

### **WARNING**

#### **Seating Position:**

*Sitting too close to an air bag storage compartment or placing hands on it is extremely dangerous. Air bags inflate with great force and speed. Serious injuries could occur if someone is sitting too close. The driver should always hold onto only the rim of the steering wheel. The front seat passenger should keep both feet on the floor. Front seat occupants should adjust their seats as far back as possible, always sit upright against the seat backs and wear their seat belts properly.*

### **NOTE**

When an air bag deploys, a loud inflation noise can be heard and some smoke will be released. Neither is likely to cause injury.

### **WARNING**

#### **Hot Air Bag Inflators:**

*Hot air bag inflators are dangerous. Immediately after inflation, the inflators in the steering wheel or the dashboard are very hot. You could get burned. Don't touch the internal components of the air bag storage areas after the bags have inflated.*

 **WARNING**

Modification of the Supplemental Restraint System:

*Modifying the components or wiring of the supplemental restraint system is dangerous. You could accidentally activate it or make it inoperable. Don't make any modifications to the supplemental restraint system. This includes installing trim, badges or anything else over the air bag storage areas. It also includes installing extra electric equipment on or near system components or wiring.*

 **WARNING**

Front Air Bag Storage Areas:

*Attaching an object to a front air bag storage area or placing something in front of it is dangerous. In an accident, the object could interfere with front air bag inflation and injure the occupants. Always keep the front air bag storage areas free of objects.*

 **WARNING**

Air Bag Inspection After a Collision:

*If your Mazda was in a collision not strong enough to inflate the air bag, parts on which the sensors are mounted may be distorted, and without repairs the system may not operate when necessary.*

*Have an Authorized Mazda Dealer make a very careful inspection of the system.*

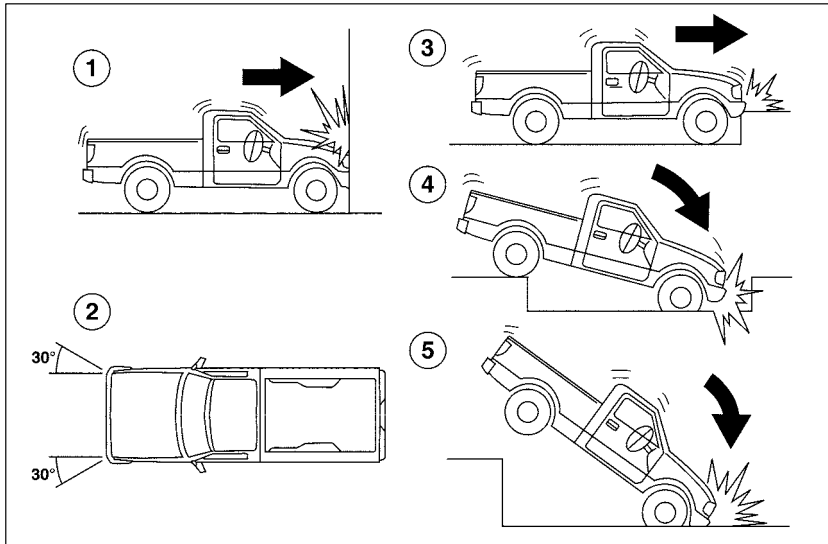

### ■ Front Air Bag Activation

A greater than moderate impact will cause the front air bags to inflate in the following cases:

1. Hitting a solid wall straight on at greater than about 14 mph (22 km/h).
2. Frontal impact within about a 30 degree range from head on to the vehicle.
3. Hitting a curb, pavement edge or hard material.
4. Driving into a big hole or hitting the far side of a hole.
5. Landing hard or vehicle falling.



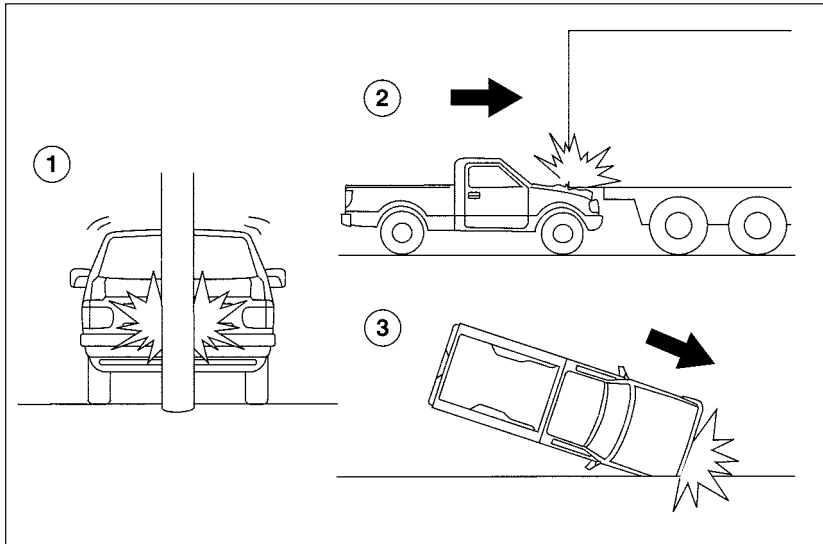

### ■ Limitations to Front Air Bag Activation

Depending on the severity of impact, the front air bags may not inflate in the following cases:

1. Impacts involving trees or poles cause severe cosmetic damage but may not have enough impact to activate the air bag.
2. Rear-ending or running under a truck's tail gate may not provide the stopping force necessary for air bag deployment.
3. Frontal offset impact to the vehicle may not provide the stopping force necessary for air bag deployment.

## Essential Safety Equipment

---

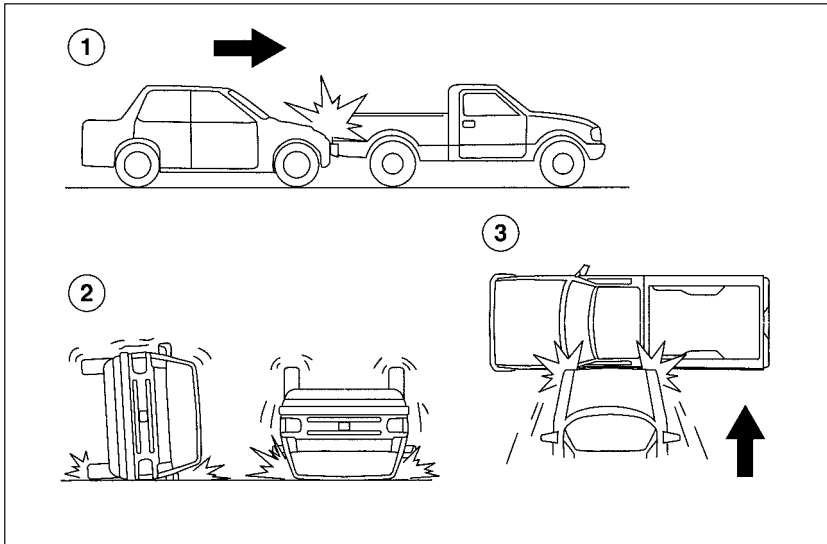

### ■ Non-Activation of Front Air Bags

Front air bags will not normally inflate in the following cases:

1. Collision from the rear.
2. Vehicle rollover.
3. Impact to the side.

## ■ Constant Monitoring

These components are monitored by the air bag system warning light or beeper:

- SRS units
- Air bag modules
- Related wiring
- Warning lights

A diagnostic monitor continuously monitors the system's readiness. This begins when the ignition is turned on and continues while the vehicle is being driven.

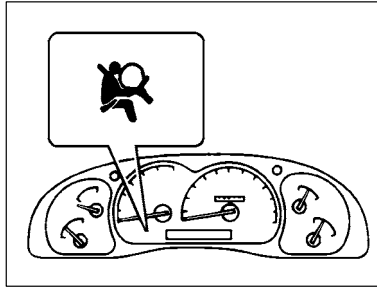

### ▼ Warning light

If the air bag system is OK, the warning light comes on when the ignition is turned on or after the engine is cranked. After about 6 seconds it goes out.

## **⚠ WARNING**

### System Problems:

*A problem with the system is indicated by one or more of the following: the readiness light will either flash or stay lit, or it will not light, or a group of five beeps will be heard.*

*If any of these things happen, the system may not work in an accident and you will lose the enhanced benefits of your air bag. Have the air bag system serviced at your Authorized Mazda dealer immediately.*

*Because hidden damage may disable an air bag system, always have your air bag system checked after an accident.*

## Essential Safety Equipment

---

### ▼ Warning beeper

A warning light is the basic method of reporting the system's condition.

But if the light is out **and** a malfunction occurs, a series of five sets of five beeps will be heard.

This also signals need for servicing. Consult an Authorized Mazda Dealer at your first opportunity.

These beeps will continue periodically until the reason for the light being out is taken care of.

Again: If this happens, the system may not work in an accident.

### **WARNING**

#### *Self-Servicing the Supplemental Restraint Systems:*

*Self-servicing or tampering with the supplemental restraint systems is dangerous. An air bag could accidentally activate or become disabled. This could cause serious injuries. Never tamper with the supplemental restraint systems and always have an Authorized Mazda Dealer perform all servicing and repairs.*

### **WARNING**

#### *Removing Interior Parts:*

*Removing the front dashboard, or the steering wheel or parts containing air bag sensors is dangerous. These parts contain air bags. The air bag could accidentally activate and cause injuries. Always have an Authorized Mazda Dealer remove these parts.*

 **WARNING**

**Air Bag Disposal:**

*Improper disposal of an air bag or a vehicle with live air bags in it can be extremely dangerous. Unless all safety procedures are followed, injury can result. Ask an Authorized Mazda Dealer how to safely dispose of an air bag or how to scrap an air bag equipped vehicle.*

■ **Maintenance**

This air bag system is maintenance-free. But if any of the following occurs, take your vehicle to an Authorized Mazda Dealer as soon as possible.

- Warning light flashes
- Warning light stays on
- Warning light stays off when the ignition is turned on and warning beeps sound
- Air bag inflates

**NOTE**

Should you sell your Mazda, we urge you to tell the new owner it has an air bag system and that he or she should become familiar with all instructions about it in the Owner's Manual.

**Memo**

---

**2-48**

# 3

## Knowing Your Mazda

*Security takes many forms and is highly necessary to owner and occupants. Section 3 describes the safe way to use your Mazda: key, locks, windows, and interior lighting.*

Key	3- 2	Fuel-Filler Lid	3-23
Door Locks	3- 3	Fuel-Filler Cap	3-24
Power Door Locks	3- 6	Service and Information Labels	3-26
Keyless Entry System	3- 6	Tilt Steering	3-30
Illuminated Entry System	3-11	Horn	3-30
Battery Saver	3-11	Mirrors	3-31
SecuriLock <sup>™</sup> Passive		Interior Light	3-33
Anti-Theft System	3-12	Cargo Shade	3-34
Windows	3-16	Rope Holes	3-35
Power Windows	3-16	Tie-Down Hooks	3-35
Rear Quarter Windows	3-18	Rear Storage Compartment	
Tailgate	3-19	With Net	3-36
Hood Release	3-22		

## Knowing Your Mazda

---

### Key

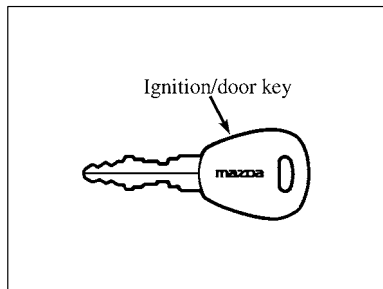

Your vehicle has one key that starts your vehicle, unlocks the doors, and opens the glove box.

A code number is stamped on the plate attached to the key set; detach this plate and store it in a safe place—not in the vehicle—for use if you need to make a replacement key.

Also write down the code number and keep it in another safe and handy place, but not in the vehicle.

If your key is lost, consult your Authorized Mazda Dealer.

#### NOTE

Your Authorized Mazda Dealer can use the code to make new keys if the originals are lost or stolen.

#### **WARNING**

##### ***Keys and Children:***

***Leaving small children in a vehicle with the ignition key is dangerous. This could result in someone being badly injured or even killed. They could play with power windows or other controls, or even make the vehicle move. Don't leave the keys in your vehicle with small children.***



## Door Locks

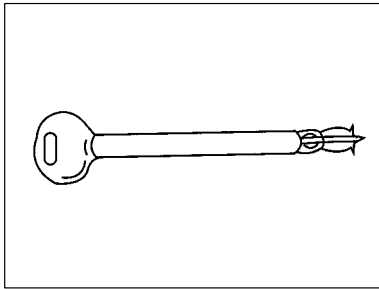

If you have an optional spare tire lock, use this key to remove the lock from the access hole in the rear bumper.

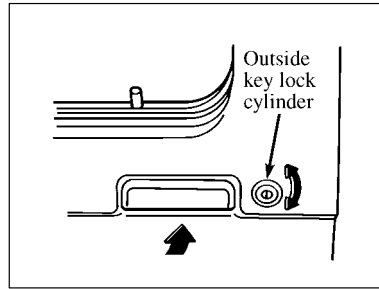

### ■ Outside Door Lock

#### ▼ Locking, unlocking, with key

- Either door can be locked or unlocked with the key.
- For the driver's door, turn the key counterclockwise to unlock, clockwise to lock.

- For the passenger's door, turn the key clockwise to unlock, counterclockwise to lock.
- For optional rear doors, open the front driver's or passenger's door and then pull the rear door handle toward you.
- Lift the handle to open an unlocked door.

## Knowing Your Mazda

---

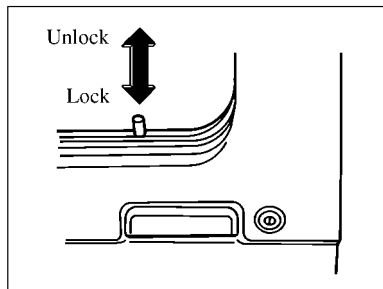

### NOTE

Always remove the ignition key, close all windows, and lock all doors when leaving your vehicle unattended. This discourages intruders and thieves.

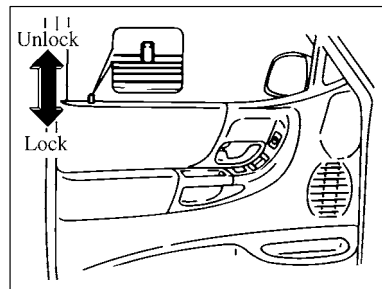

### ▼ Locking without key

To lock a door without the key, push the inside lock button down and close the door.

### ■ Inside Door Lock

- To lock any door, push down the lock button.
- To unlock, pull on the inside door handle.

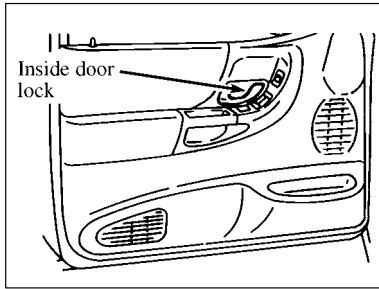

- To open, pull on the inside door handle.

**⚠ WARNING**

**Unlocked Doors:**

*Unlocked doors in a moving vehicle can be dangerous. Passengers can fall out if a door is accidentally opened and can more easily be thrown out in an accident. So keep all doors locked when driving.*

**⚠ WARNING**

**Unattended Children and Pets:**

*Leaving a child or an animal unattended in a parked vehicle can be dangerous. In hot weather, temperatures inside a vehicle can become high enough to cause brain damage or even death. Always take all children and animals with you or leave a responsible person with them.*

## Knowing Your Mazda

### Power Door Locks\*

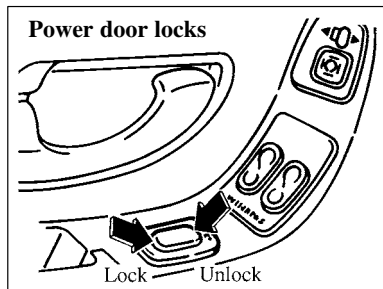

- The power door lock switches are located on both doors.

#### NOTE

Always remove the ignition key, close all windows, and lock all doors when leaving your vehicle unattended. This discourages intruders and thieves.

### Keyless Entry System\*

- To lock all doors, push the side of the switch button marked "LOCK".
- To unlock all doors, push the side of the switch button marked "UNLOCK".

This system locks and unlocks the vehicle doors without using a key. This system also has a personal alarm feature. The buttons for the system are located on the hand-held transmitter that came with your vehicle. The system can also help you signal for attention.

\*Some models.

**NOTE**

- The keyless entry system is designed to operate up to 33 feet (10 meters) from the receiver, but this may vary because of local conditions.
- This system operates only when the ignition switch is in the OFF position.
- If there is any potential keyless entry problem with your vehicle, ensure **ALL key fobs** (keyless entry transmitters) are brought to the dealership, to aid in troubleshooting.

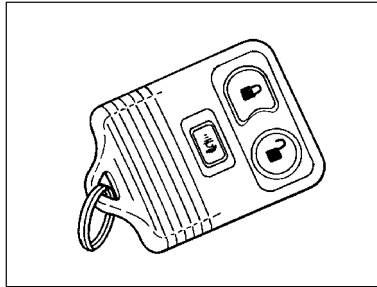

**⚠ CAUTION**

Pressing the transmitter buttons excessively beyond the range of the system will cause the keyless entry system to malfunction.

**■ Unlocking the Doors with the Keyless Entry System**

To unlock the driver's door, press . The interior lamps will illuminate.

To unlock the other door, press  a second time within five seconds.

### ■ Locking the Doors with the Keyless Entry System



To lock all the doors, press . This will also arm the factory-installed Anti-Theft system.

To confirm that all doors have been locked, press  again within 5 seconds. If all doors are completely closed the doors will lock again, the horn will chirp and the parking lights will flash. If a door is open or ajar, the horn will give two short chirps warning you that a door is open.

### ■ Keyless Entry Personal Alarm

Press  to activate the personal alarm. This will honk the horn and flash the lights for approximately 2 minutes and 45 seconds.

To deactivate the alarm press  again or turn the ignition to ACC or ON.

When you press  or , the illuminated entry system turns on the vehicle's interior lights for 25 seconds. You can turn these lights off by pressing  or by turning the ignition to the ON or ACC position.

#### NOTE

This device complies with Part 15 of the FCC Rules and with RS-210 of Industry Canada. Operation is subject to the following two conditions: (1) This device may not cause harmful interference, and (2) This device must accept any interference received, including interference that may cause undesired operation.

#### NOTE

Changes or modifications not expressly approved by the party responsible for compliance could void the user's authority to operate the equipment.

### ■ Arming and Disarming the Alarm System with Keyless Entry

Your keyless entry system will automatically arm the factory installed anti-theft system when the doors are locked, and automatically disarm it when the doors are unlocked. The remote will also reset the anti-theft alarm (when the driver's door is unlocked, or when  is pressed) if it was triggered.

The keyless entry system may not arm and disarm non-factory installed anti-theft systems.

### ■ Replacing the Batteries

The keyless entry transmitter is powered by one coin type three-volt lithium battery CR2032 or equivalent. Typical operating range will allow you to be up to 33 feet (10 meters) away from your vehicle. A decrease in operating range can be caused by:

- weather conditions
- nearby radio towers
- structures around the vehicle
- other vehicles parked next to the vehicle.

If you notice a significant decrease in operating range, the battery should be replaced. Replacement batteries can be purchased at most pharmacies, watch stores or at your authorized Mazda dealer.

1. Twist a thin coin between the two halves of the transmitter near the key ring. **DO NOT TAKE THE FRONT PART OF THE TRANSMITTER APART.**
2. Remove the battery.

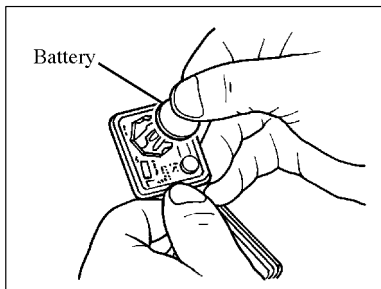

3. Install the new battery with the positive (+) side up as marked.
4. Snap the two halves back together.

### ■ Replacing Lost Transmitters

If a remote transmitter has been lost and you would like to remove it from the vehicle's memory, or you would like to purchase additional remote transmitters and have them programmed to your vehicle:

- take all your vehicle's transmitters to your dealer for programming, or
- perform the programming procedure yourself.

### ■ Programming Transmitters

To reprogram the transmitters yourself, place the key in the ignition and turn from OFF to ON eight times in rapid succession (within 10 seconds) ending in ON. After doors lock/unlock, press any control on all transmitters (up to four possible) within 20 seconds. The doors will lock/unlock one last time to confirm completion of program mode. When completed, switch the ignition to OFF. Again the doors will lock/unlock one last time to confirm completion of programming.

All transmitters **must** be programmed at the same time.



## Illuminated Entry System

This system will provide illumination of the vehicle's interior courtesy lights when the keyless entry system is used to unlock the door or sound the personal alarm. The system automatically turns off after approximately 25 seconds or when the ignition is turned to the START or ACC positions. On some models, the light will turn immediately off when the passenger door is closed. The dome lamp control (if equipped) must not be set to the OFF position for the illuminated entry system to operate.

### NOTE

The inside lights will not turn off if:

- they have been turned on with the dimmer control or
- any door is open.

The battery saver will shut off the interior lamps 40 minutes after the ignition has been turned to the OFF position.

## Battery Saver

When the ignition is turned off, the vehicle will turn off battery voltage to all courtesy and interior (including cargo) lights after 40 minutes.

This will prevent draining of the battery if these lights have been left on inadvertently or if a door is not completely closed. Battery voltage to these lights will be restored when the keyless entry transmitter is used, any door is opened, or the ignition key is turned on again.

### SecuriLock™ Passive Anti-Theft System\*

The SecuriLock™ passive anti-theft system provides an advanced level of vehicle theft protection. Your vehicle's engine can only be started with the two special SecuriLock™ electronically coded keys provided with your vehicle. Each time you start your vehicle, the SecuriLock™ key is read by the SecuriLock™ passive anti-theft system. If the SecuriLock™ key identification code matches the code stored in the SecuriLock™ passive anti-theft system, the vehicle's engine is allowed to start. If the SecuriLock™ key identification code does not match the code stored in the system or if a SecuriLock™ key is not

detected (vehicle theft situation), the vehicle's engine will not operate.

If there is any potential SecuriLock™ anti-theft problem with your vehicle, ensure **ALL SecuriLock™ keys** for that vehicle are brought to the dealership, to aid in troubleshooting.

The SecuriLock™ passive anti-theft system is not compatible with aftermarket remote start systems. Use of these systems may result in vehicle starting problems and a loss of security protection. Large metallic objects or devices such as the Mobil Speedpass™ on the same key ring as your SecuriLock™ key may cause vehicle starting problems. These objects and devices cannot damage the SecuriLock™ key, but can cause a

momentary problem if they are too close to the key when starting the engine. If a problem occurs, turn ignition off and restart the engine with all other objects on the key ring held away from the SecuriLock™ ignition key.

Spare SecuriLock™ keys can be purchased from your dealership and programmed to your SecuriLock™ passive anti-theft system. Refer to "Programming spare SecuriLock™ keys" for more information.

If one or both of your SecuriLock™ keys are lost or stolen and you want to ensure the lost or stolen key will not operate your vehicle, bring your vehicle and all available SecuriLock™ keys to your dealership for reinitialization.

\*Some models.

### ■ THEFT indicator

The THEFT indicator on the instrument cluster will operate as follows:

- When the ignition is OFF, the theft indicator will flash briefly every 2 seconds to indicate the SecuriLock™ system is protecting your vehicle.
- When the ignition is turned to ON or START, the THEFT indicator will light for 3 seconds and then go out. If the THEFT indicator stays on for an extended period of time or flashes rapidly, have the system serviced by your dealership or a qualified technician.

The THEFT indicator is controlled by the SecuriLock™ system. During the 30 second prearm state, it is normal to see the THEFT indicator pulse brighter behind the constant glow.

### ■ Programming spare SecuriLock™ keys

Spare SecuriLock™ keys can be purchased from your dealership and programmed to your SecuriLock™ passive anti-theft system (up to a total of 8 keys). Your dealership can program your new SecuriLock™ key(s) to your vehicle or you can do it yourself using the following simple procedure. To program a new SecuriLock™ key yourself, you will need two previously programmed SecuriLock™ keys (keys that already operate your vehicle's engine). If two

previously programmed SecuriLock™ keys are not available (one or both of your original keys were lost or stolen), you must bring your vehicle to your dealership to have the spare SecuriLock™ key(s) programmed.

### ■ Procedure to program spare SecuriLock™ keys to your vehicle

New SecuriLock™ keys must have the correct mechanical key cut for your vehicle.

Conventional (non-SecuriLock™) keys **cannot** be programmed to your vehicle.

You will need to have two previously programmed SecuriLock™ keys and the

new unprogrammed SecuriLock™ key readily accessible for the procedure. Please read and understand the entire procedure before you begin.

1. Insert the first previously programmed SecuriLock™ key into the ignition and turn the ignition from OFF to ON (maintain ignition in ON for at least one second).
2. Turn ignition to OFF and remove the first SecuriLock™ key from the ignition.
3. Within five seconds of turning the ignition to OFF, insert the second previously programmed SecuriLock™ key into the ignition and turn the ignition from OFF to ON (maintain ignition in ON for at least one second but no more than 5 seconds).

4. Turn the ignition to OFF and remove the second SecuriLock™ key from the ignition.
  5. Within 10 seconds of turning the ignition to OFF, insert the unprogrammed SecuriLock™ key (new key/valet key) into the ignition and turn the ignition from OFF to ON (maintain ignition in ON for at least one second). This step will program your new SecuriLock™ key.
  6. To program additional SecuriLock™ key(s), repeat this procedure from step 1.
- If the programming procedure was successful, the new SecuriLock™ key(s) will start the vehicle's engine. The THEFT indicator (located on the instrument cluster) will light for three seconds and then go out.

If the programming procedure was not successful, the new SecuriLock™ key(s) will not operate the vehicle's engine. The THEFT indicator will flash on and off. Wait at least one minute and then repeat the procedure from step 1. If failure repeats, bring your vehicle to your dealership to have the spare SecuriLock™ key(s) programmed.

## Knowing Your Mazda

---

### Windows

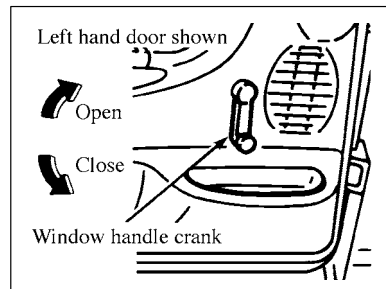

The door windows can be opened and closed by turning the handle crank.

\*Some models.

3-16

### Power Windows\*

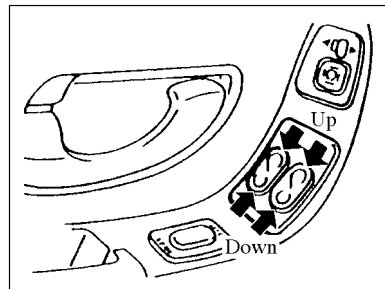

Each door has a power control that opens and closes the window on that door. The control switch on the driver's door operates both front door windows. The ignition switch must be in ON or ACC to use the power windows.

- To open a window, press down on the lower portion of the switch.
- To close a window, press down on the upper portion of the switch.

■ **One-Touch Power Window\***

When the lower part of the switch is pressed completely down and released quickly, the window will move to its fully open position (driver's side only). To stop the window before the fully open position, press the lower part of the switch again.

■ **Accessory Delay\***

With accessory delay, the window switches may be used for up to 10 minutes after the ignition switch is turned to OFF or until either door is opened.

 **WARNING**

**Unintentional Window Operation:**

*Unintentional window operation can be dangerous. A person's hands, head, or neck could be caught by the window and result in serious injury. Unless a passenger needs to operate a window, keep the power window main switch in the locked position.*

 **WARNING**

**Children Playing with Power Windows:**

*Playing with power windows is dangerous. Someone's hands, head, or neck could get caught in a closing window. They would be seriously injured or even killed. Don't let children play with power windows.*

\*Some models.

## Knowing Your Mazda

### Rear Quarter Windows\*

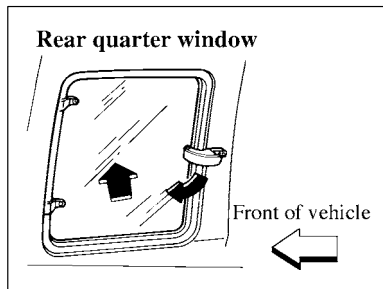

- To open a window, pull the latch inward and then push the window outward.
- To close it, pull the latch inward and then push it backward until it snaps shut. Make sure the window is securely closed.

Open or close the swing-out rear quarter windows by releasing the latch and moving the window.

\*Some models.

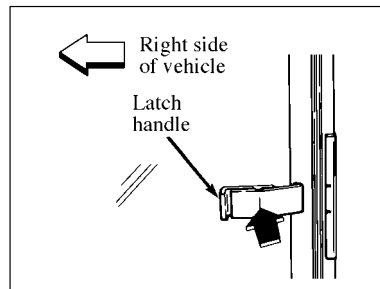

The sliding rear window has only one sliding portion.



### Tailgate

To open the window, push the center portion of the latch handle toward the glass and slide the window to the right.

To close the window, slide the window to the left and push the latch handle back to the left. Check for proper latching by gently tugging the latch handle to the right without pressing the release portion of the latch.

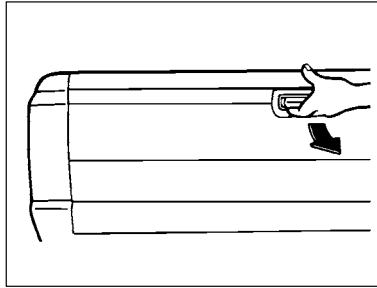

To open the tailgate, pull the handle toward you. The connecting cables will hold the gate in a straight-open position. When closing the gate, make sure the lock is secure.

When the tailgate is open, the tailgate load should not exceed 500 lbs (227 kgs). If you want to load heavy items on your vehicle, you should load them one at a time, directly on the bed floor, to avoid damage to the tailgate or its supports.

### **⚠ WARNING**

#### **Riding in the Truck Bed:**

*Riding in the truck bed, on the bumper, or on the tailgate, whether it's open or closed, is dangerous. Someone doing this could be injured or killed during a sudden stop or accident. Camper type covers of any kind offer no real protection from these dangers and may trap poisonous exhaust fumes. They should only be occupied when the vehicle is parked without the engine running. Never allow anyone to ride outside the passenger compartment.*

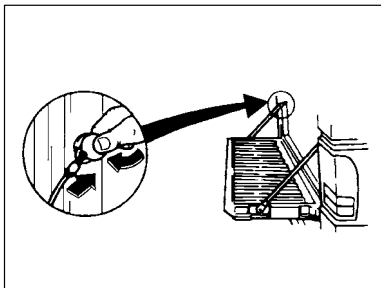

If there is no rear step-bumper and you want to let the tailgate hang freely, here's what to do:

1. Lower the tailgate partially.
2. Support it to allow slack in both cables.
3. Use a coin or similar object to pry the spring clip (on each upper cable connector) past the head of the support screw. This will allow you to disconnect the loop of the connector cable from the support screw.
4. Do the same on the other side.
5. Lower the tailgate carefully.

### NOTE

Step-bumpers or hitches may damage the tailgate if it is lowered completely.

Reattach the cables in the reverse order of removal.

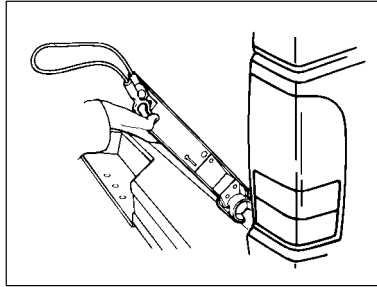

### ■ Tailgate Removal

First, release the tailgate as described previously. Be sure to support the left side to prevent it from falling. Then, raise the tailgate to a 45 degree angle (see

illustration) and lift the right side of the tailgate off its hinge. You can now pull the left side of the tailgate away from the left hinge.

### ■ Tailgate Installation

1. First, insert the left side of the tailgate into the left hinge and raise it to a 45 degree angle; next, insert the right side into the right hinge.
2. Support the tailgate to allow slack in the cables and reattach the cables one at a time.

**⚠ WARNING**

**Tailgate Open While Driving:**  
*Do not drive your truck with the tailgate open unless there is a load holding it in place. Without a load, a bump in the road or rough terrain could make the tailgate bounce and disconnect from your truck. The loose tailgate could be damaged and could endanger other motorists.*

### Hood Release

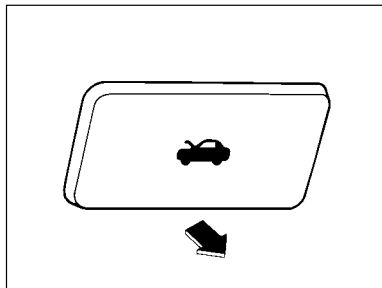

1. Pull down the release handle located below the steering column.

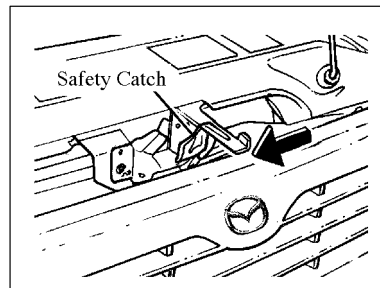

2. Slide the safety catch to the left and lift the hood.

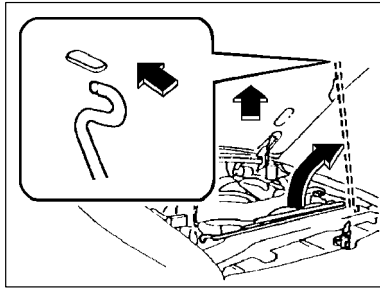

3. Use the support rod to hold the hood open.

Before closing the hood, secure the rod in its clip.

**To close the hood:**

- Check out the underhood area to make certain all filler caps are in place and that all loose items have been removed.
- Close the hood so that it locks securely.
- Attempt to lift the hood after closing it to be sure it is securely latched.

**Fuel-Filler Lid**

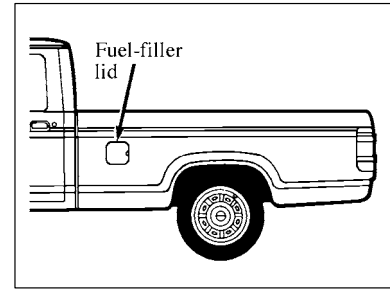

To open the fuel-filler lid, pull it open with your finger.

### Fuel-Filler Cap

#### **⚠ WARNING**

##### Fuel Tank Pressure:

*Pressure sometimes builds up in the fuel tank. If this happens and the fuel cap is removed quickly, fuel can spray out. Fuel can burn skin and eyes and cause illness when ingested. The fuel system may be under pressure. If the fuel filler cap is venting vapor or if you hear a hissing sound, wait until it stops before completely removing the fuel filler cap.*

#### **⚠ WARNING**

##### Fuel Vapor:

*Fuel vapor can be hazardous. Before refueling, stop the engine. Always keep sparks and flames away from the filler neck.*

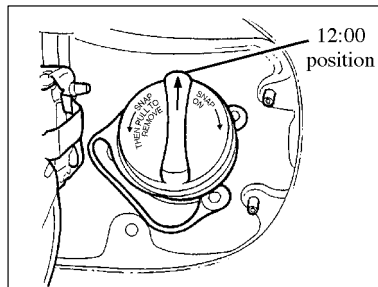

Your fuel filler cap has an indexed design with a one-eighth turn on/off feature.

When fueling your vehicle:

1. Turn the engine off.
2. Carefully turn the filler cap counter-clockwise 1/8 of a turn until it stops.

3. Pull to remove the cap from the fuel filler pipe.
4. To install the cap, align the tabs on the cap with the notches on the filler pipe.
5. Turn the filler cap clockwise 1/8 of a turn until it stops.

If the CHECK ENGINE indicator comes on and stays on when you start the engine, the fuel filler cap may not be properly installed. Turn off the engine, remove the fuel filler cap and reinstall it being careful to align the cap properly.

 **CAUTION**

Use only a designated Mazda fuel cap or an approved equivalent, available at Authorized Mazda Dealers. The wrong cap can result in a serious malfunction of the fuel system and the emission control system and may void the customer warranty for any damage to the fuel tank and/or fuel system.

### Service and Information Labels

Service and information labels are attached to the sunvisors, passenger seat belt and the radiator support in the engine compartment.

This label appears on the driver sunvisor in the stowed position.

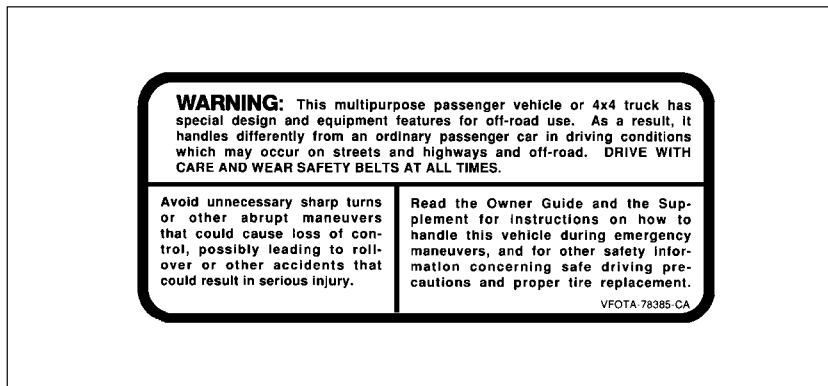





This label appears on the driver sunvisor in the stowed position. For the passenger air bag, this label appears on the passenger side sunvisor in the stowed position.

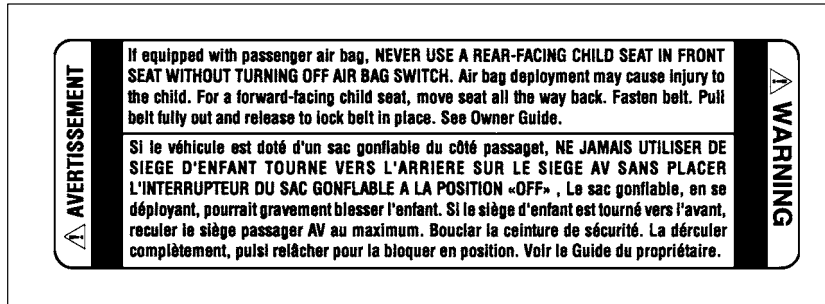

This label appears on the passenger side seat belt ends.



This label will be on the driver's and passenger's sunvisor.

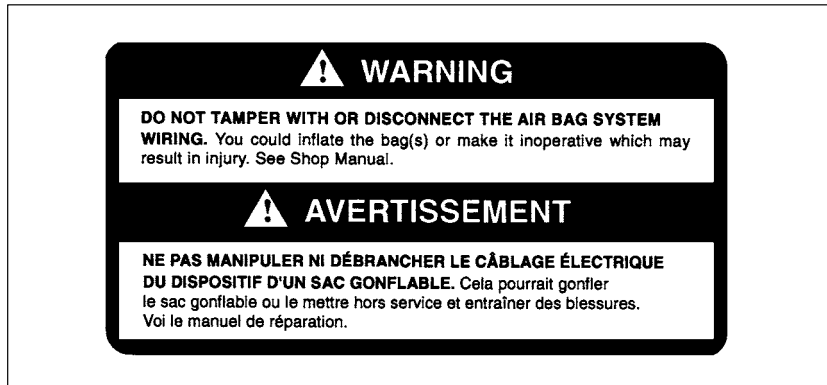

This label is located on the radiator support shield in the engine compartment.

## Knowing Your Mazda

### Tilt Steering\*

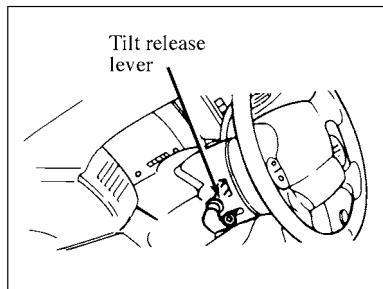

The tilt steering feature allows you to adjust the steering wheel up or down.

To change the position of your vehicle's steering wheel:

1. Stop the vehicle.
2. Pull the release lever toward you.

\*Some models.

**3-30**

3. Tilt the wheel up or down.
4. Release the lever to lock the wheel in place.

Be sure the steering wheel locks in a notch. It is not infinitely adjustable.

Do not adjust the steering wheel while the vehicle is in motion.

### Horn

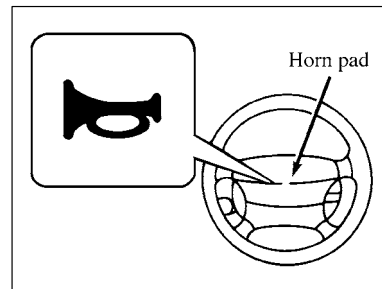

To sound the horn, firmly press the center of the horn pad in the center of the steering wheel.

Inspect the horn's operation regularly.

## Mirrors

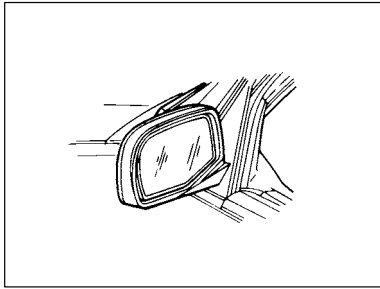

### ■ Outside Mirrors

Check the mirrors' angles before driving.

### ▼ Manual outside mirrors

Adjust the mirrors by hand.

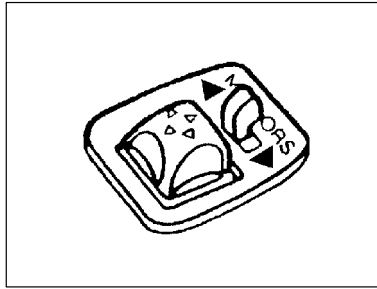

### ▼ Power outside mirrors\*

This switch controls the adjustments for both right and left outside mirrors.

To adjust your mirrors:

1. Select ◀ to adjust the left mirror or ▶ to adjust the right mirror.
2. Move the control in the direction you wish to tilt the mirror.
3. Return to the center position to lock mirrors in place.

If you have a folding outside mirror, it will fold flat against the vehicle when pushed toward it. Mirrors should be folded rearward into the body position before entering automatic car wash systems.

\*Some models.

### CAUTION

Do not clean the plastic housing of any electric mirror with gasoline or other petroleum-based cleaning products.

### CAUTION

The mirrors stop moving when they reach the maximum adjusting angle. But the motor continues rotating while the switch is on. Do not leave the switch on. Do not leave the switch on unnecessarily.

### WARNING

#### Convex Mirror:

*What you see in the convex mirror (passenger's side) will be closer than it appears. If you don't remember this when changing lanes, you could hit a vehicle. Be sure to look over your shoulder or to check your inside mirror before changing lanes.*

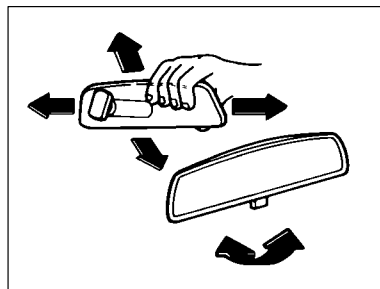

#### ■ Day/Night Mirror

Adjust the inside mirror to center on the scene through the rear window. Do this with the day/night lever in the day position.

Push the lever away from you for day driving. Pull it back to reduce glare from headlights at night.

**⚠ WARNING**

**Blocked View:**

*Cargo stacked higher than the seatbacks can be dangerous. It can block your view in the rearview mirror, which might cause you to hit another car when changing lanes. Don't stack things higher than the seatbacks.*

## Interior Light

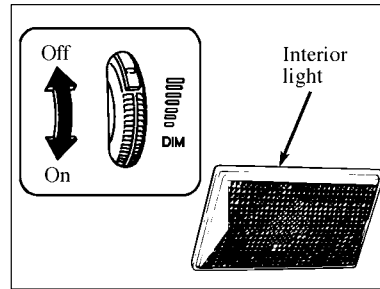

### ■ Without Map Light\*

- To turn on the interior light, turn the thumbwheel to the right of the headlight switch up until you hear a click.

- To turn off the interior light, turn the thumbwheel down until you hear a click.
- When the driver's or passenger's door is open, the interior light also comes on.

The interior lights will shut off after 25 seconds with all the doors closed, or immediately when the ignition switch is turned to the START position, or if the vehicle speed is above five mph (8 km/h). The interior lights will turn off after 40 minutes if any of the doors are left open. Refer to the Battery Saver earlier in this section for more details.

\*Some models.

## Knowing Your Mazda

---

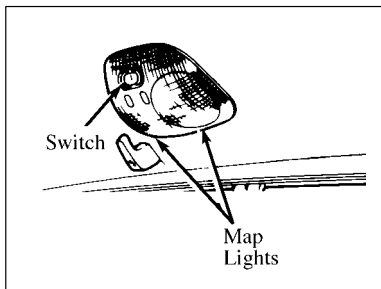

- To turn on the interior light, turn the thumbwheel to the right of the headlamp switch up until you hear a click.
- To turn off the interior light, turn the thumbwheel down until you hear a click.
- When the driver's or passenger's door is open, the interior light also comes on.

### ■ With Map Light\*

- To turn on the right-hand side map light, slide the switch to the right.
- To turn on the left-hand side map light, slide the switch to the left.

\*Some models.

## Cargo Shade\*

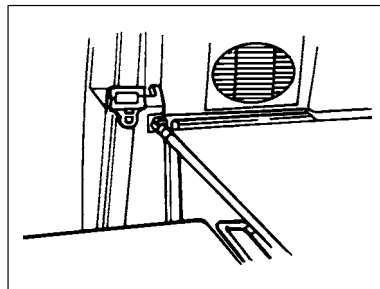

The shade is for added security—hiding objects when the vehicle is parked. It will keep some things from flying around the cab when in an accident, but it is best to secure heavy items in the cargo bed rather than leaving them in the cab itself.



To extend the shade:

1. Grasp the end of the shade and pull it toward you.
2. Hook the sides of the outstretched shade to latch in the side trim panel notches behind the front seat.

**⚠ WARNING**

**Cargo Shade:**

*The cargo shade will keep some light items from flying forward and striking the occupants in some collisions, so it is better to attach it. The cargo net is an even better way to secure smaller items. Heavy items should be secured in the cargo box rather than in the cab at all while driving.*

**Rope Holes**

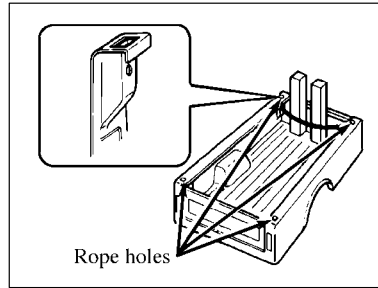

There are four holes inside the bed.  
Use them to help secure a load with ropes.

**Tie-Down Hooks\***

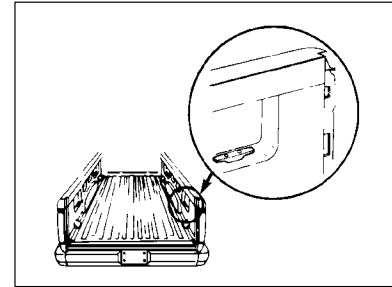

Your vehicle may have tie-down hooks inside the bed. To prevent damage to your vehicle, secure a load with ropes and the tie-down hooks.

\*Some models.

## **Rear Storage Compartment With Net\***

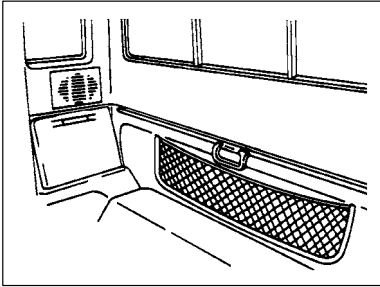

Your vehicle may have a small storage compartment which is located on the back panel. This compartment has a net which will secure small objects.

\*Some models.

# 4

## Protecting Your Mazda

*Most people like to save money. With a vehicle, that can be done in several ways from its first day of operation. Probably tops on the list of cost-efficiency is using the right kind of fuel and using that fuel conservatively.*

*Section 4 explains how to do this. Further, it discusses proper loading and how to respond to unusual driving conditions. It also illustrates where important vehicle information labels may be found.*

Fuel Requirements	4- 2
Emission Control System	4- 7
Engine Exhaust	4- 8
Before Driving	4- 9
Break-In Period	4-10
Money-Saving Suggestions	4-11
Special Driving Conditions	4-12
Trailer Towing Loading	4-24
Trailer Towing Load Tables	4-28
Vehicle Information Labels	4-36

## Protecting Your Mazda

---

### Fuel Requirements

Vehicles with catalytic converters must use **ONLY UNLEADED FUEL**, which will reduce exhaust emissions and keep spark plug fouling to a minimum.

If your vehicle is a flexible fuel vehicle (FFV), use only **UNLEADED FUEL** and **ETHANOL (E-85)**. The use of leaded fuel and methanol is prohibited by law and could damage your vehicle.

Do not use fuel containing methanol. It can damage critical fuel systems components.

Your vehicle was not designed to use fuel or fuel additives with metallic compounds, including manganese-based compounds containing **MMT**.

Repairs to correct the effects of using a fuel for which your vehicle was not designed may not be covered by your warranty.

Your Mazda will perform best with regular unleaded fuel having an octane

rating (anti-knock index) of at least 87 [(R+M)/2 method].

Fuel with a lower rating could cause the emission control system to lose effectiveness. It could also cause engine knocking and serious engine damage.

U.S. federal law requires that octane ratings be posted on gasoline station pumps.

**⚠ WARNING**

**Misusing Automotive Fuels:**

*Automotive fuels can cause serious injury or death if misused or mishandled. To minimize the risk that you will be injured please read the following information carefully and observe the recommended precautions.*

**⚠ WARNING**

**Overfilling Tank:**

*Do not overfill the fuel tank. If you do, the pressure may cause leakage which can lead to spray and fire.*

**⚠ CAUTION**

**NEVER USE LEADED FUEL.**

It is harmful to the catalytic converter. The lead will accumulate on the oxygen sensor and the catalyst inside the converter.

This will result in a malfunction of the emission control system, causing poor performance.

Gasoline blended with oxygenates such as alcohol or an ether compound are generally referred to as oxygenated fuels. The common gasoline blend that can be used with your vehicle is ethanol or grain

alcohol blended at no more than 10% ethanol.

Gasoline containing alcohol, such as ethanol or methanol, may be marketed under the name "Gasohol".

**⚠ CAUTION**

Your vehicle can only use oxygenated fuels containing no more than 10% ethanol by volume. Damage to your vehicle may occur when ethanol exceeds this recommendation, or if the gasoline contains any methanol.

Stop using any kind of gasohol at a sign of driving problems.

### CAUTION

Add only fuel system cleaning agents that Mazda has specified, or the equivalent. Others may damage the system. Consult an Authorized Mazda Dealer.

Vehicle damage and driveability problems resulting from using the following may not be covered by the manufacturer's warranty:

- Gasohol containing more than 10% ethanol
- Gasoline or gasohol containing methanol
- Leaded fuel or leaded gasohol

\*Some models.

### ■ Cleaner Air

Mazda approves the use of reformulated "cleaner-burning" gasolines to improve air quality. These gasolines may contain oxygenates up to 10% ethanol or 15% MTBE.

### ■ FFV engine\*

Your vehicle is designed to use Fuel Ethanol (E85), "Regular" unleaded gasoline or any percentage of the two fuels combined.

### CAUTION

U.S. government regulations require fuel ethanol dispensing pumps to have a small, square, orange and black label with the common abbreviation E85 or the appropriate percentage for that region. Use of other fuels such as Fuel Methanol may cause powertrain damage, a loss of vehicle performance, and your warranty may be invalidated.

FFV fuel tanks may contain zero to 85 percent or more of ethanol. Any fuel blends containing gasoline and ethanol should be treated the same as fuel ethanol (E85).

Your FFV will operate well on ordinary “Regular” unleaded gasoline, but only the highest quality fuel ethanol will provide the same level of protection and performance.

If you are experiencing a rough or rolling idle after start-up with the outside temperature above 27°C (80°F), the idle should improve within 10 to 30 seconds. If the problems persist below this temperature, see your dealer or a qualified service technician.

### **WARNING**

*Fuel ethanol may contain benzene, which is a cancer-causing agent.*

### **CAUTION**

Flexible fuel components and standard unleaded gasoline fuel components are not interchangeable. If your vehicle is not serviced in accordance with flexible fuel vehicles procedures, damage may occur and your warranty may be invalidated.

### ■ **Running Out of Fuel**

Avoid running out of fuel because this situation may have an adverse affect on modern powertrain components.

If you have run out of fuel:

- You may need to crank the engine several times after refueling before the system starts to pump the fuel from the tank to the engine.
- Your Check Engine light may come on. For more information on the Check Engine light, refer to “Malfunction Indicator Light (page 5-62).”

### **WARNING**

#### Replacement Fuel Caps:

*If you lose the fuel cap, replace it with one that is an authorized Mazda service part or an equivalent part. If you do not use the proper fuel filler cap, excessive pressure or vacuum in the fuel tank may damage the fuel system or cause the fuel system to work improperly in a collision, which may result in possible personal injury.*

### **CAUTION**

When refueling always shut the engine off and never allow sparks or open flames near the filler neck. Never smoke while refueling. Fuel vapor is extremely hazardous under certain conditions. Care should be taken to avoid inhaling excess fumes.

### **CAUTION**

The flow of fuel through a fuel pump nozzle can produce static electricity, which can cause a fire if fuel is pumped into an ungrounded fuel container.



Use the following guidelines to avoid static build-up when filling an ungrounded fuel container:

- Place approved fuel container on the ground.
- DO NOT fill a fuel container while it is in the vehicle.
- Keep the fuel pump nozzle in contact with the fuel container while filling.
- DO NOT use a device that would hold the fuel pump handle in the fill position.

## Emission Control System

Your vehicle is equipped with an emission control system (the catalytic converter is part of this system) that enables your vehicle to comply with the U.S. exhaust emissions requirements.

Under U.S. federal law, any modification to the original-equipment emission control system before the first sale and registration of a vehicle is subject to penalties. In some states, such modification made on a used vehicle is also subject to penalties.

### **WARNING**

***Parking Over Things That Burn:***  
*Parking over or near anything inflammable, such as dry grass, is dangerous. Even with the engine turned off, the exhaust system could ignite it because the exhaust system gets very hot in normal use. A resulting fire could cause serious injury or death. Don't park over or near anything inflammable.*

### CAUTION

Ignoring the following precautions could cause lead to accumulate on the catalyst inside the converter or cause the converter to get very hot. Either condition will damage the converter and cause poor performance.

- USE ONLY UNLEADED FUEL.
- Don't drive your Mazda with any sign of engine malfunction.
- Don't coast with the ignition switch turned off.
- Don't descend steep grades in gear with the ignition switch turned off.

*(Continued)*

- Don't operate the engine at high idle for more than 5 minutes.
- Don't tamper with the emission control system. All inspection and adjustments must be made by a qualified technician.
- Don't try to push-start or pull-start your vehicle.

Lumination of the charging system warning light or CHECK ENGINE light, fluid leaks, strange odors, smoke or loss of oil pressure could indicate that the emission control system is not working properly.

## Engine Exhaust

### WARNING

*Engine exhaust, some of its constituents, and certain vehicle components contain or emit chemicals known to the State of California to cause cancer, and birth defects or other reproductive harm.*

 **WARNING**

Engine Exhaust:

*Engine exhaust contains carbon monoxide, which is dangerous to inhale. It can even kill.*

- *Carbon monoxide is colorless and odorless. If you smell exhaust fumes of any kind inside your Mazda, immediately consult an Authorized Mazda Dealer.*

*If you must drive even though you smell fumes, keep all windows fully open, no matter how cold the weather is.*

*(Continued)*

- *If the engine is run in a closed area, such as a garage, exhaust gas can easily enter the passenger compartment. Don't run the engine in closed areas.*
- *When the vehicle is stopped for long in an open area with the engine running, adjust the heating or cooling system to draw air inside.*
- *Snow under a vehicle that is stopped with the engine running can trap exhaust gas. This gas has fumes containing CO (carbon monoxide) that can enter the passenger compartment and kill anyone in it. Be sure to clear away snow from beneath and around your vehicle.*

## Before Driving

### ■ Before Getting In

- Be sure the windows, outside mirror(s) and outside lights are clean.
- Inspect inflation pressures and condition of tires.
- Look under the vehicle for any sign of a leak.
- If you plan to back up, make sure nothing will be in your way.

### NOTE

Engine oil, engine coolant, brake fluid, clutch fluid, washer fluid, and other fluid levels should be inspected daily, weekly, or at refueling, depending on the fluid. See Maintenance, Section 8.

### ■ After Getting In

- Are all doors closed and locked?
- Are the inside and outside mirrors adjusted?
- Is everyone's seat belt fastened?
- Do all the lights work?
- Check all gauges.
- Check all warning lights when the ignition switch is in the ON position.
- Release the parking brake and make sure the brake warning light goes off.

Always be thoroughly familiar with your Mazda.

### Break-In Period

No special break-in is necessary, but a few precautions in the first 1,000 miles (1,600 km) may add to the performance, economy, and life of your Mazda.

- Don't race the engine.
- Avoid unnecessary hard stops.

The break-in period for new brake linings lasts for 100 miles (160 km) of city driving or 1,000 miles (1,600 km) of highway driving.

- Avoid full-throttle starts.
- Don't tow a trailer during the vehicle's first 500 miles (800 km) (page 4-19).
- Wheel lug nuts must be retightened to proper torque specifications at 500 miles (800 km) of new vehicle operation.
- Use only the type of engine oil recommended in this guide.
  - Do not use special "break-in" oils.

### Money-Saving Suggestions

How you operate your Mazda determines how far it will travel on a tank of fuel. Use these suggestions to help save money on fuel and repairs.

- Avoid long warm-ups. Once the engine runs smoothly, begin driving.
- Avoid fast starts.
- Keep the engine tuned. Follow the maintenance schedule (page 8-4) and have an Authorized Mazda Dealer perform inspections and servicing.
- Use the air conditioning only when necessary.
- Slow down on rough roads.
- Keeps the tires properly inflated.
- Don't carry unnecessary weight.
- Don't rest your foot on the brake pedal while driving.
- Keep the wheels in correct alignment.
- Keep windows closed at high speeds.
- Slow down when driving in crosswinds and headwinds.
- **(4x4)**  
Four-wheel drive operation is not recommended on dry pavement. Driving in 4WD HIGH or 4WD LOW will cause:
  - Unnecessary noise;
  - Unnecessary tire and component wear;
  - Higher fuel consumption.

### **WARNING**

#### Coasting:

*Turning off the engine to coast down a hill can be dangerous. This causes the loss of power steering and power brake control. Any loss of steering or braking control could cause an accident. Never turn off the engine and coast down a hill.*

## Special Driving Conditions

### ■ Hazardous Driving

When driving on ice or in water, snow, mud, sand, or similar hazards:

- Be cautious and allow extra distance for braking.
- Avoid sudden braking and quick steering.
- Brake with the pedal by using a light up-down motion. Don't constantly hold the pedal down.
- To stop on ice, shift to N (Neutral) when the vehicle is moving below 10 mph (16 km/h) and gently pump the brakes.

- Consider using one of the lower gears.
- If you get stuck, use 1 (First) or 2 (Second) gear and accelerate slowly. Don't spin the rear wheels.
- For more traction when starting, use sand, rock salt, chains, carpeting, or other non-slip material under the rear wheels.

#### **(4x4)**

Besides these instructions, starting in 4-wheel drive may be best.

 **WARNING**

**Downshifting on Slippery Surfaces:**

*Downshifting into 1 (First) gear with a manual transmission or into L (Low) with an automatic transmission while driving on slippery surfaces could be dangerous. The sudden change in tire speed could cause the tires to skid. This could lead to loss of vehicle control and an accident. If it is necessary to downshift on slippery surfaces, be very careful.*

 **WARNING**

**Rear Antilock Brake System:**

*The rear antilock brake system may not prevent brake lock-up on extremely slippery surfaces. Rear brake lock-up may also occur while driving in 4-wheel drive because the transfer case couples the front and rear axles together.*

▼ **Limited slip differential rear axle\***

This axle provides added drive away traction on slippery surfaces, particularly when one or more wheels is on a surface with poor traction.

 **WARNING**

**Limited Slip Differential Rear Axle:**

*To avoid injury from vehicles equipped with a limited slip differential rear axle, never run the engine with one wheel off the ground, such as when changing a tire. The wheel still on the ground could cause the vehicle to move.*

\*Some models.

## Protecting Your Mazda

---

### ■ Rocking the Vehicle

If you must rock the vehicle to free it from snow, sand, or mud, depress the accelerator slightly and . . .

**With an automatic transmission,** pull the shift lever toward you and gently move the selector back and forth from **D** (Drive) to **R** (Reverse) being careful not to put it into **P** (Park).

**With a manual transmission,** shift back and forth from **1** (First) to **R** (Reverse) using the clutch.

#### (4x4)

Besides these instructions, starting in 4x4 may be best.

### **WARNING**

#### *Spinning the Wheels:*

*When the vehicle is stuck, spinning the wheels at high speed could be dangerous. The spinning tire could overheat and explode. This could cause serious injuries. Don't spin the wheels at more than 35 mph (56 km/h), and don't allow anyone to stand behind a wheel when pushing the vehicle.*

### **CAUTION**

Too much rocking may cause engine overheating, transmission failure, and tire damage.

### ■ Wheel Spin

- Extreme acceleration can cause the rear wheels to spin, possibly resulting in reduced steering control.
- If the wheels spin, use **2** (Second) to gain traction. Move forward slowly and evenly. If this does not work, try rocking the vehicle.
- For 4x4 vehicles, try engaging 4-wheel drive to drive away.



### ■ High Speed Driving

#### **WARNING**

##### High Speed Driving:

*Mazda recommends obeying posted speed limits. Driving too fast for conditions is dangerous and creates the possibility of loss of vehicle control and resulting personal injury. Driving at very high speeds for extended periods of time, under some circumstances, may result in damage to vehicle components.*

Your vehicle is equipped with an engine speed (RPM) limiting device. If you are experiencing an “Engine Cut-Out” condition at high speed, this may be a

result of this limiting device. This is a normal condition that can be avoided by reducing vehicle/engine speed.

### ■ Winter Driving

- Carry emergency gear, including tire chains, a window scraper, flares, a small shovel, jumper cables, and a small bag of sand or salt.
- Have the proper ratio of antifreeze in the radiator. (page 8-23)
- Inspect the battery and its cables. Cold reduces battery capacity. (page 8-40)
- Use only cold-weather engine oil. (page 8-16)
- Inspect the ignition system for damage and loose connections.

- Use washer fluid made with anti-freeze—but don’t use engine coolant antifreeze for washer fluid. (page 8-36)
- Don’t use the parking brake if it might freeze. Instead, shift to P (Park) with an automatic transmission and to 1 (First) or R (Reverse) with a manual transmission. Block the rear wheels.

### ▼ Snow tires

Don’t go faster than 75 mph (120 km/h) or the posted speed limit. Inflate snow tires 4 psi (27.5 kPa) more than recommended on the tire pressure label (driver’s door frame), but never more than the maximum cold-tire pressure shown on the tires.

### **WARNING**

#### *Snow Tires:*

*Snow tires used with regular tires should be the same size and type as the regular tires. If radial tires are mixed with non-radials, or if tires of different sizes are installed, the safety and handling of your vehicle may be adversely affected. Make sure snow tires and regular tires are all the same size and type.*

#### **NOTE**

Check out local regulations before using studded tires.

#### **▼ Tire chains**

Check local regulations before using chains.

Use only SAE Class “S” chains, and make sure they fit.

#### **Installing the chains**

Follow the chain manufacturer’s instructions.

Secure the chains on the rear tires as tightly as possible; retighten them after driving 1/4-1/2 mile (1/2-1 kilometer).

Don’t use chains on the front tires.

### **CAUTION**

- Chains may scratch or chip aluminum wheels. Install tire chains on steel wheels only.
- Chains may affect handling.
- Don’t go faster than 30 mph (50 km/h) or the chain manufacturer’s recommended limit, whichever is lower.
- Drive carefully and avoid bumps, holes, and sharp turns.
- Avoid locked-wheel braking.
- Don’t use chains on the temporary tire; it may result in damage to the vehicle and to the tire.

*(Continued)*

- Avoid fully loading your light truck if possible.
- Remove the chains at the first opportunity after using them on snow and ice. Don't use the chains on dry roads.

### ■ Snowplowing

Do not use this vehicle for snowplowing.

### ■ Driving on Sand

When driving over sand, try to keep all four wheels of the vehicle on the most solid area of the trail.

Do not reduce the tire pressures but shift to a lower gear and drive steadily through the terrain.

Apply the accelerator slowly and avoid spinning the wheels.

### ■ Driving Through Water

#### CAUTION

Make sure water does not enter the vehicle interior or the engine area. The vehicle interior could become wet or the engine could be damaged.

Do not drive quickly through standing water, especially if the depth is unknown. Traction or brake capability may be limited and if the ignition system gets wet, your engine may stall. Water may also enter your engine's air intake and severely damage your engine.

If driving through deep or standing water is unavoidable, proceed very slowly. Never drive through water that is higher than the bottom of the hubs.

Once through the water, always try the brakes. Wet brakes do not stop the vehicle as effectively as dry brakes. Drying can be improved by moving your vehicle slowly while applying light pressure on the brake pedal.

Driving through deep water where the transmission is submerged may allow water into the transmission and cause internal damage.

Replace rear axle lubricant any time the axle has been submerged in water. The rear axle does not normally require a lubricant change for the life of the vehicle. Rear axle lubricant quantities are not to be checked or changed unless a leak is suspected or repair is required.

## Protecting Your Mazda

---

### ■ Driving on Hills

When driving on a hill, avoid driving crosswise or turning on steep slopes. You could lose traction and slip sideways. Drive straight up, straight down or avoid the hill completely.

Know the conditions on the other side of a hill before driving over the crest.

When climbing a steep hill, start in a lower gear, rather than downshifting to a lower gear after the ascent has started. This reduces strain on the engine and the possibility of stalling.

When descending a steep hill avoid sudden braking. Rapid pumping of the brake pedal will help slow the vehicle and still maintain steering control.

If cruise control cancels after climbing the hill, reset speed by pressing and holding the SET ACCEL button to resume speeds over 50 km/h (30 mph).

Automatic transmissions may shift frequently while driving up steep grades. Eliminate frequent shifting by shifting out of **D** (Overdrive) into D (Drive).

### ■ Trailer Towing

Your Mazda was designed and built primarily to carry passengers and cargo.

If you must tow a trailer, read the following instructions and any trailer manufacturer instructions because driver and passenger safety depends on proper equipment and safe driving habits. Towing a trailer will affect handling, braking, durability, performance, and economy.

Never overload vehicle or trailer. Consult an Authorized Mazda Dealer if you need further details.

▼ **No Trailer Towing During Vehicle Break-in**

 **CAUTION**

Don't tow a trailer during the first 500 miles (800 km) of driving your new Mazda. If you do, you may damage the engine, transmission, differential, wheel bearings, and other powertrain components.

▼ **Tires**

When towing a trailer, make sure all tires are inflated to the recommended cold-tire pressure, as indicated on the tire pressure chart on the driver's door frame.

Trailer tire size, load rating, and inflation pressures should conform to tire manufacturer specifications.

 **WARNING**

*Using a Temporary Spare When Towing:*

*Using a temporary spare tire on your vehicle when towing a trailer could result in tire failure, loss of control, and injury to vehicle occupants. Never use a temporary spare when towing.*

## Protecting Your Mazda

---

### ▼ Safety chains

Safety chains must be used as a precautionary measure in case the trailer becomes unintentionally unhitched. They should cross under the trailer tongue and attach to the vehicle frame or hook retainers. Leave enough slack to allow full turns. Consult literature published by your trailer or hitch manufacturer for more details.



Never attach chains to the bumper.

### ▼ Fuel consumption

Trailer towing causes higher fuel consumption.

### ▼ Suspension Modifications

The suspension and steering systems on your vehicle have been designed and tested to provide predictable performance (whether loaded or empty) as well as durable load carrying capability.

Any modifications to the suspension or steering systems can reduce your vehicle's performance capability and adversely affect driver and passenger safety.

Mazda recommends that you DO NOT make modifications such as adding or removing parts (like lowering or lifting kits, stabilizer bars or snowplowing equipment) or by using replacement parts non-equivalent to the original factory equipment.

▼ Exhaust System Modifications

**⚠ WARNING**

**Exhaust System Modifications:**

*Modifying your vehicle exhaust system is dangerous. Exhaust gas entering the vehicle could kill you.*

*When mounting the trailer hitch, make no modifications to the vehicle exhaust system. Regularly check the exhaust system for any leaks. Leaks under or near the cab or under a camper-covered bed are dangerous. Pay close attention to possible leaks around the mounting bolts.*

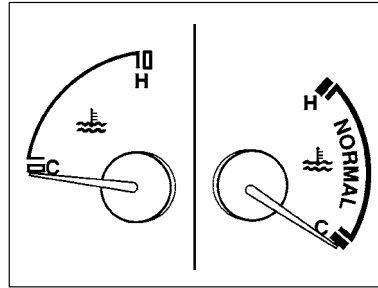

**Temperature Gauge**

**Constantly monitor the coolant temperature gauge.** The extra weight of the trailer may strain the engine on hot days and on long or steep upgrades.

**Overheated Engine**

Your vehicle's engine coolant protects the engine from overheating in the summer and from freezing in the winter. Check the level of the engine coolant at least once a month. Look at the engine coolant recovery reservoir located in the engine compartment. If the coolant level is low, add a 50/50 mixture to the engine coolant recovery reservoir. Only add a mixture specified by Mazda.

For further information, refer to "Overheating" on page 6-3.

## Protecting Your Mazda

---

### ▼ Maintenance

If you tow a trailer frequently, have your vehicle serviced as shown in Scheduled Maintenance (Schedule II/Special Operating Conditions, page 8-8).

### ▼ Trailer hitch

Use only a hitch ball recommended by the trailer manufacturer that conforms to the gross trailer weight requirement. Make sure the hitch is securely attached to prevent the danger of trailer sway from crosswinds, rough roads, or other causes.

Use a weight carrying hitch and ball for towing trailers up to 2,000 lbs. (907 kg). Use a frame-mounted weight distributing hitch for trailers over 2,000 lbs. (907 kg).

When not towing a trailer, remove the trailer hitch (if detachable).

The optional step bumper has a built-in hitch and only requires a ball with a 3/4 inch shank diameter. The step bumper has a Class I capability (2,000 lb/907 kg trailer weight and 200 lb/91 kg tongue weight).

### CAUTION

- Examine all trailer hitch mounting bolts regularly and tighten any that are loose. If the hitch is removed, seal any open mounting holes to prevent exhaust, dust, water, dirt, and other foreign elements from filtering in and possibly endangering personal safety and damaging your vehicle.
- Don't install a trailer hitch that will nullify the function of the bumper. If it is necessary to relocate the trailer hitch ball, a frame-mounted trailer hitch must be installed.



▼ **Trailer brakes**

The braking system of the tow vehicle is rated for operation at the gross vehicle weight rating (GVWR), not the gross combined weight rating (GCWR). For further information, refer to “Trailer Towing Loading” on page 4-24.

If the total trailer weight exceeds 1,500 lbs. (680 kg), trailer brakes are required.

If your trailer has brakes, check that they work and make sure they meet all federal, state, and local regulations.

 **WARNING**

**Hydraulic Trailer-Brake System:**

***Connecting a hydraulic trailer-brake system directly to the vehicle brake system will result in inadequate braking and possible injury. Don't connect a hydraulic trailer-brake system to your vehicle's brake system.***

▼ **Trailer lights**

Trailer lights must meet all federal, state, and local regulations.

 **CAUTION**

Don't connect a trailer lighting system directly into the lighting system of your Mazda. This may damage your vehicle's electrical system and lighting systems. Have a recreational vehicle dealer or trailer rental agency connect the system, and inspect the brake lights and turn signals before driving each time this is done.

### Trailer Towing Loading

#### **⚠ WARNING**

*Loaded vehicles, with a higher center of gravity, may handle differently than unloaded vehicles. Extra precautions, such as slower speeds and increased stopping distance, should be taken when driving a heavily loaded vehicle.*

Your vehicle has the capability to haul more cargo and people than most passenger cars. Depending upon the type and placement of the load, hauling people and cargo may raise the center of gravity of the vehicle.

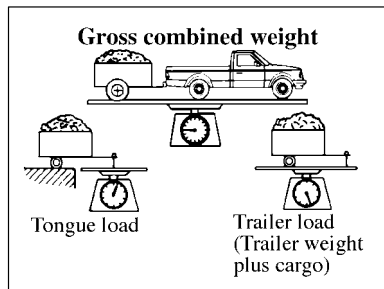

#### **TTW and GCWR**

The total trailer weight (TTW), gross combined weight rating (GCWR), gross axle weight rating (GAWR), trailer load, and trailer tongue load must be within the prescribed limits.

- The total trailer weight is the sum of the weights of the trailer load (trailer weight plus cargo), trailer

hitch, truck passengers, and vehicle load. Never allow the total trailer weight to exceed specifications in the Trailer Towing Load Table.

- The maximum GCWR is the combined weight of the trailer and load plus the towing vehicle (including trailer hitch, truck passengers, and load). It must not exceed specifications in the load table.

#### **GAWR and GVWR**

Don't exceed front and rear GAWR (gross axle weight rating) and GVWR (gross vehicle weight rating). If you do, vehicle handling, braking, and performance will be affected.

These values are listed on your Mazda's Federal Motor Vehicle Safety Standard certification label posted on the driver's door pillar.

### Maximum permissible trailer load

The maximum permissible trailer load is determined by subtracting the towing vehicle weight (including trailer hitch, vehicle passengers, and load) from the maximum GCWR in the load table.

### High-altitude operation

In a high-altitude operating environment, a gasoline engine loses power at a rate of 3% to 4% per 1,000 ft; (304 m) of elevation. In these conditions, a reduction in gross vehicle weight and gross combined weight is recommended.

#### NOTE

For high-altitude operation, reduce GCW by 2% per 1,000 ft (304 m) of elevation.

### ▼ Tongue load

Trailer tongue load is part of the passenger and cargo load.

### ▼ Weight limits

#### NOTE

The total trailer weight and tongue load can be determined by weighing the trailer on platform scales at a highway weigh station or a trucking company. Avoiding overloading will help to prevent the danger of trailer sway from crosswinds, rough roads, or other causes.

## **WARNING**

### Trailer Loading:

*Loading the trailer with more weight in the rear than in the front is dangerous. Doing so could cause you to lose control. The trailer tongue load must be 10%-15% of the trailer load (sum of the weights of the trailer and cargo). Try to load the trailer with the weight about 60% toward the front and 40% toward the rear.*

### **WARNING**

#### *Tow Loads:*

*Attempting to tow loads greater than those specified may cause serious handling and performance problems that could result in personal injury or vehicle damage, or both. Always keep tow loads within specified limits.*

### ■ **Overloading**

If you don't overload your vehicle, you'll get better service from it. It's been designed for loads not to exceed the Gross Vehicle Weight Rating (GVWR) or the maximum Front and Rear Axle Weight Ratings (GAWRs) specified on the Federal Motor Vehicle Safety Standard label on the left door frame.

Always distribute cargo evenly over the floor of the cargo area. If you have a heavy load that's concentrated, center it in the cargo area.

Once you reach the weight capacity, don't load more, even if you have the room for it.

The Certification Label, found on the inside pillar of the driver's door, lists several important vehicle weight rating limitations. Before adding any additional equipment, refer to these limitations. If you are adding weight to the front of your vehicle, (potentially including weight added to the cab), the weight added should not exceed the Front Axle Reserve Capacity (FARC). Additional frontal weight may be added to the front axle reserve capacity provided you limit your payload in other ways (i.e. restrict the number of passengers or amount of cargo carried).

You may add equipment throughout your vehicle if the total weight added is equal to or less than the Total Axle Reserve Capacity (TARC) weight. You should NEVER exceed the Total Axle Reserve Capacity.

Always ensure that the weight of passengers, cargo and equipment being carried is within the weight limitations that have been established for your vehicle including both Gross Vehicle Weight and Front

and Rear Gross Axle Weight Rating limits. Under no circumstance should these limitations be exceeded. Exceeding any vehicle weight rating limitation could result in serious damage to the vehicle and/or personal injury.

### **WARNING**

#### **Vehicle Load Weight:**

*The gross axle weight rating (GAWR) and the gross vehicle weight rating (GVWR) of your vehicle are on the Federal Motor Vehicle Safety Standard Label on the driver's door frame. Exceeding these ratings can cause an accident or vehicle damage. You can estimate the weight of your load by weighing the items (or people) before putting them in the vehicle. Be careful not to overload your vehicle.*

## Protecting Your Mazda

---

### Trailer Towing Load Tables

#### 4x2 Manual Transmission Regular Cab

Model	Rear Axle Ratio	Maximum GCWR	Maximum Trailer Weight (0-Max.)
2.5L	3.73	4,800 lbs. (2,177 kg)	0-1,580 lbs. (0-717 kg)
2.5L	4.10	4,800 lbs. (2,177 kg)	0-1,580 lbs. (0-717 kg)
3.0L	3.73	6,000 lbs. (2,721 kg)	0-2,660 lbs. (0-1,207 kg)
4.0L	3.55	7,000 lbs. (3,175 kg)	0-3,620 lbs. (0-1,642 kg)

#### 4x2 Manual Transmission Cab Plus

Model	Rear Axle Ratio	Maximum GCWR	Maximum Trailer Weight (0-Max.)
2.5L	3.73	4,800 lbs. (2,177 kg)	0-1,380 lbs. (0-626 kg)
2.5L	4.10	4,800 lbs. (2,177 kg)	0-1,380 lbs. (0-626 kg)
3.0L	3.73	6,000 lbs. (2,721 kg)	0-2,460 lbs. (0-1,116 kg)
3.0L (Troy Lee)	4.10	6,000 lbs. (2,721 kg)	0-2,400 lbs. (0-1,089 kg)
4.0L	3.55	7,000 lbs. (3,175 kg)	0-3,420 lbs. (0-1,551 kg)

**4x4 Manual Transmission  
Regular Cab**

Model	Rear Axle Ratio	Maximum GCWR	Maximum Trailer Weight (0-Max.)
3.0L	3.73	6,000 lbs. (2,721 kg)	0-2,400 lbs. (0-1,089 kg)
3.0L	4.10	6,000 lbs. (2,721 kg)	0-2,400 lbs. (0-1,089 kg)
4.0L	3.73	7,000 lbs. (3,175 kg)	0-3,320 lbs. (0-1,506 kg)
4.0L	4.10	7,000 lbs. (3,175 kg)	0-3,320 lbs. (0-1,506 kg)

**4x4 Manual Transmission  
Cab Plus**

Model	Rear Axle Ratio	Maximum GCWR	Maximum Trailer Weight (0-Max.)
3.0L	3.73	6,000 lbs. (2,721 kg)	0-2,200 lbs. (0-998 kg)
3.0L	4.10	6,000 lbs. (2,721 kg)	0-2,200 lbs. (0-998 kg)
4.0L	3.73	7,000 lbs. (3,175 kg)	0-3,120 lbs. (0-1,415 kg)
4.0L	4.10	7,000 lbs. (3,175 kg)	0-3,120 lbs. (0-1,415 kg)

## Protecting Your Mazda

---

### 4x2 Automatic Transmission Regular Cab

Model	Rear Axle Ratio	Maximum GCWR	Maximum Trailer Weight (0-Max.)
2.5L	4.10	5,500 lbs. (2,494 kg)	0-2,180 lbs. (0-989 kg)
3.0L	3.73	7,500 lbs. (3,401 kg)	0-4,120 lbs. (0-1,869 kg)
4.0L	3.55	9,500 lbs. (4,309 kg)	0-6,080 lbs. (0-2,758 kg)

### 4x2 Automatic Transmission Cab Plus

Model	Rear Axle Ratio	Maximum GCWR	Maximum Trailer Weight (0-Max.)
2.5L	4.10	5,500 lbs. (2,494 kg)	—
3.0L	3.73	7,500 lbs. (3,401 kg)	0-3,920 lbs. (0-1,778 kg)
3.0L (Troy Lee)	4.10	7,500 lbs. (3,401 kg)	0-3,860 lbs. (0-1,751 kg)
4.0L	3.55	9,500 lbs. (4,309 kg)	0-5,880 lbs. (0-2,667 kg)



**4x4 Automatic Transmission  
Regular Cab**

Model	Rear Axle Ratio	Maximum GCWR	Maximum Trailer Weight (0-Max.)
3.0L	3.73	7,500 lbs. (3,401 kg)	0-3,860 lbs. (0-1,751 kg)
3.0L	4.10	8,000 lbs. (3,628 kg)	0-4,360 lbs. (0-1,978 kg)
4.0L	3.73	9,500 lbs. (4,309 kg)	0-5,780 lbs. (0-2,622 kg)
4.0L	4.10	9,500 lbs. (4,309 kg)	0-5,780 lbs. (0-2,622 kg)

**4x4 Automatic Transmission  
Cab Plus**

Model	Rear Axle Ratio	Maximum GCWR	Maximum Trailer Weight (0-Max.)
3.0L	3.73	7,500 lbs. (3,401 kg)	0-3,680 lbs. (0-1,669 kg)
3.0L	4.10	8,000 lbs. (3,628 kg)	0-4,180 lbs. (0-1,896 kg)
4.0L	3.73	9,500 lbs. (4,309 kg)	0-5,580 lbs. (0-2,531 kg)
4.0L	4.10	9,500 lbs. (4,309 kg)	0-5,580 lbs. (0-2,531 kg)

## Protecting Your Mazda

---

### ▼ Trailer-towing tips

The three main causes of vehicle-trailer accidents are driver error, excessive speed, and improper trailer loading.

#### Before driving

- Verify that your Mazda maintain a near-normal attitude when a loaded or unloaded trailer is connected. Don't drive if it has an abnormal front-up or front-down position. Inspect for incorrect tongue load, worn suspension parts, and trailer overloading. Have the vehicle inspected by an Authorized Mazda Dealer.
- Make sure the trailer cargo is secure to prevent it from shifting.
- Make sure the mirrors meet all government regulations. Inspect them regularly.
- Before starting out, inspect the operation of all vehicle and trailer lights and all vehicle-to-trailer lights and all vehicle-to-trailer connections. Stop and reinspect all lights and connections after driving a short distance (about 50 miles [80 km]).

### Servicing

If you tow a trailer for a long distance, your vehicle will need to be serviced more frequently.

### Driving

- Your Mazda will handle differently with a trailer in tow, so practice turning, backing, and stopping in a traffic-free area.
- Take time to get accustomed to the extra weight and length.
- Never drive faster than 45 mph (72 km/h) when you tow in hilly country on hot days.
- Allow more room between your vehicle and the one in front because braking distance increases with a trailer. For each 10 mph (16 km/h) of speed, allow at least one vehicle and trailer length behind the vehicle ahead.

- Avoid sudden braking. It may cause loss of control and result in jackknifing, especially on wet or slippery roads.
- Avoid abrupt starts and fast acceleration. Start in 1 (First) gear and gradually release the clutch pedal (manual transmission) at low engine speed to prevent clutch slippage.
- With an automatic transmission, use the following positions when towing a trailer in hilly terrain or when heavily loaded.

### 4x2 models:

- Selector in “D” (Drive)

### 4x4 models:

- Selector in “D” position
- 4x4 indicator light off

These positions will allow operating the vehicle without frequent down-and-up-shifting.

- With a 5-speed overdrive manual transmission don't use overdrive gear for trailer towing. Shift as though you were driving a vehicle with a 4-speed transmission.

## Protecting Your Mazda

---

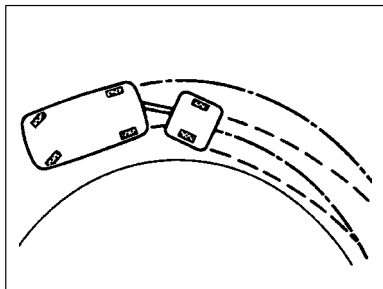

### Lane changes and turning

- Avoid quick lane changes, sudden turns, and tight turns. Avoid sudden braking.
- A turning trailer will make a tighter arc than the tow vehicle. Compensate with turns that are larger than normal.

### Passing

- Plan well ahead to pass other vehicles, and provide plenty of room when changing lanes.
- Crosswinds from passing vehicles, especially larger ones, and the effects of rough roads will affect handling.

If swaying occurs, firmly grip the steering wheel and reduce speed immediately, but gradually.

Steer straight ahead. If no extreme correction of steering or braking is made, the combination of less speed and firm steering will result in stability.

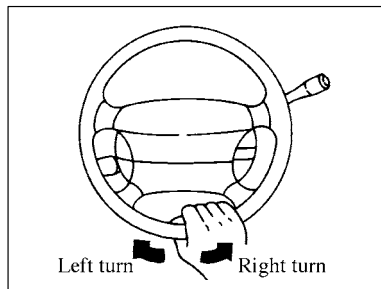

### Backing up

- Backing a vehicle with a trailer requires practice and patience. Back slowly, and have a helper outside at the rear of the trailer.

- To turn the trailer, place your hand at the bottom of the steering wheel and turn it in the direction you want the trailer to go. Make only slight movements to prevent sharp turns of the trailer.

### Ascending a hill

- Shift into a lower gear to reduce the possibility of overloading or overheating the engine, or both.

### Descending a hill

- Shift into a lower gear and use engine compression as a braking effect. Pay constant attention to speed and use the brakes only as needed. Holding the brake pedal down for a prolonged period may cause the brakes to overheat and lose power.

### Parking

- Always make sure the tires of the trailer and the tow vehicle are blocked while parked.
- Apply the parking brake and put the transmission in 1 (First) or R (Reverse) (manual) or in P (Park) (automatic).

### Parking on an incline

- **Avoid parking on an incline**, but if you must, follow these instructions.
- Apply the brake pedal and hold it.
- Have another person place wheel chocks under the trailer wheels.

- With the chocks in place, release the brake pedal, making sure the chocks are holding.
- For automatic transmissions—apply the parking brake by pressing the brake pedal down firmly with your right foot while applying the parking brake pedal with your left foot.
- For manual transmission—apply the service brake and shift into N (Neutral) while still maintaining pressure on the brake pedal. Set the parking brake fully.
- Shift an automatic transmission into P (Park). Put the gearshift of a manual transmission in R (Reverse).

## Protecting Your Mazda

---

### To restart after parking on an incline:

1. Apply the brake pedal and hold it.
2. With the transmission in P (Park) (automatic) or with the clutch depressed (manual), start the engine. (With an automatic transmission, be sure to depress and hold the brake pedal.)
3. Shift into gear.
4. Release the parking brake (also the foot brake on vehicles with automatic transmissions) and move the vehicle uphill to free the wheel chocks. Stop and apply the foot brake.
5. Have a helper retrieve the chocks.

## Vehicle Information Labels

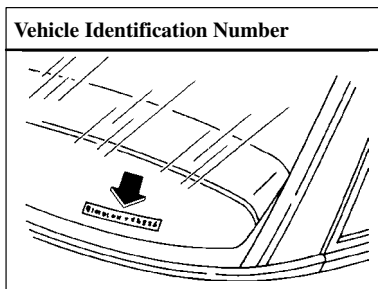

The vehicle identification number legally identifies your vehicle. It's on a plate attached to the left top side of the dashboard. This plate can easily be seen through the windshield.

**Federal Motor Vehicle  
Safety Standard**

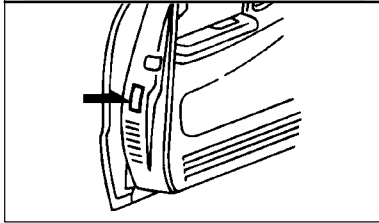

**Vehicle Emission Control  
Information Label\***

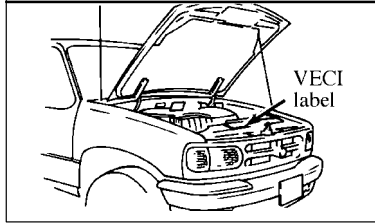

**NOTE**

Tire inflation pressure information is included on the Federal Motor Vehicle Safety Standard Label.

\*Includes Vacuum Hose Routing Diagram for California.

**Memo**

---

**4-38**



# 5

## Driving Your Mazda

*Operating your vehicle requires a good understanding of the many controls you must know and use. Section 5 describes all this in step-by-step information from use of the ignition switch to cruise control and braking.*

*Also highlighted are the gearshift and shifting modes, use of 4-wheel drive, power steering, instruments and gauges, warnings and indicators, windshield wipers, and interior features. You'll find complete details about the advanced audio system too.*

Ignition Switch Positions	5- 2	Windshield Wipers and Washer	5-68
Preparing to Drive Your Vehicle	5- 6	Lighter	5-70
Starting the Engine	5- 7	Power Point	5-70
Using the Engine Block Heater	5-12	Ashtray	5-71
The Fuel Pump Shut-Off Switch	5-13	Glove Box	5-71
Manual Transmission Operation	5-14	Center Console	5-72
Automatic Transmission	5-18	Cupholders	5-72
4-Wheel Drive System –		Sunvisors	5-74
Electronic Shift Control	5-24	Vanity Mirror	5-74
Brake System	5-36	Climate Control Systems	5-75
Power Steering	5-46	Radio Reception	5-86
Cruise Control	5-47	AM/FM Radio	5-90
Instrument Clusters	5-52	AM/FM Radio with Cassette Player	5-91
Gauges	5-54	AM/FM Radio with Compact	
Dashboard Illumination	5-58	Disc Player	5-92
Warning Lights/Beeps	5-59	AM/FM Radio with Cassette and	
Lighting Control	5-65	Compact Disc Player	5-93

### Ignition Switch Positions

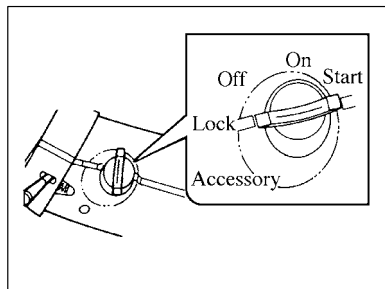

#### ■ ON

The warning lights (except the brake warning light) can be inspected before the engine is started.

The key returns to the ON position once the engine is started and remains in this position while the engine runs.

#### ■ START

The engine is started in this position. It will crank until you release the key; then it returns to ON. The brake warning light can be checked in the START position.

#### ■ ACC (Accessory)

The steering wheel unlocks and some electrical accessories will operate.

#### ■ LOCK

The steering wheel locks to protect against theft. Only in this position can the key be removed. If your key is stuck in the LOCK position, move your steering wheel left or right.

#### ■ OFF

In the OFF position you can shut off the engine and all accessories without locking the steering wheel, or the automatic transmission selector lever.

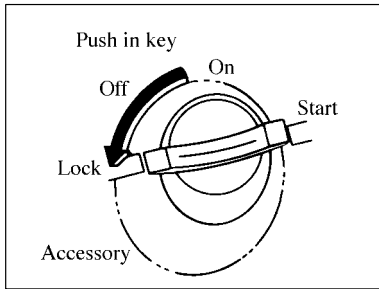

▼ **Manual transmission**

When turning the ignition switch to the LOCK position, push the key in at ACC. In order to turn the key from ON or OFF to the ACCESSORY position, you must push the key release button since your vehicle's manual transmission selector lever is mounted on the floor.

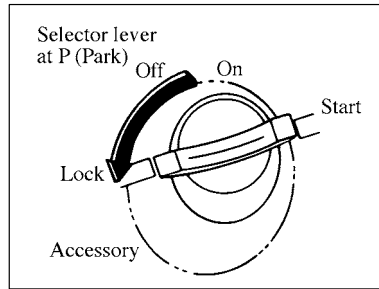

▼ **Automatic transmission**

When turning the ignition switch to the LOCK position, keep the selector lever at P (Park).

**NOTE**

If turning the key is difficult, jiggle the steering wheel from side to side.

**⚠ WARNING**

**Removing the Key:**

*It's dangerous to remove the key from the ignition switch while the vehicle is moving. Removing the key allows the steering wheel to lock. You will lose steering control and a serious accident could occur. Remove the key only when the vehicle is parked.*

### **WARNING**

#### Parking Brake:

*The anti-theft steering column lock is not a substitute for the parking brake. Before leaving the driver's seat, always make sure the gearshift selector lever is at P (Park) with an automatic transmission or in 1 (First) with a manual transmission; set the parking brake fully AND stop the engine. Unexpected and possibly sudden vehicle movement may occur if these precautions aren't taken.*

### **WARNING**

#### Locking the Gearshift Selector Lever:

*LOCK does not lock the gearshift selector lever on the steering column or floor-mounted gearshifts. If the parking brake is not set and the gearshift is moved out of P (Park) (automatic transmission) or out of gear (manual transmission), your vehicle may move unexpectedly and injure someone.*

#### **NOTE**

If a door is open and the key is in the ignition switch when the engine is off, a warning sounds.

### ■ **Key Removal**

Procedures for removing your key from the ignition will vary, depending on the type of ignition your vehicle has. Gearshift selector levers may be mounted on the steering column or on the floor console.

If the vehicle's gearshift selector lever is mounted on the column:

1. Put the gearshift selector lever in P (Park).
2. Set the parking brake fully before removing your foot from the service brake. (This will avoid "binding" or "loading" the park gear if you park on a grade.)
3. Turn the ignition key to LOCK.
4. Remove the key.

If the vehicle's gearshift selector lever is mounted on the floor:

1. Put the gearshift selector lever in 1 (First).
2. Set the parking brake fully by pressing down with your left foot before removing your right foot from the service brake.
3. Turn the ignition key to OFF.
4. Push in the key release button until it catches and stays in.
5. Turn the key to LOCK.
6. Remove the key.

 **WARNING**

Safety Procedures:

- ***Removing the key from the ignition switch locks the steering. If removed while driving, loss of steering control will occur which could result in an accident. Remove the key only when parked.***
- ***The anti-theft steering column lock is not a substitute for the parking brake. Before leaving the driver's seat, always make sure the gearshift selector lever is in P (Park) with an automatic transmission or 1 (First) with a manual transmission; set the parking***

*(Continued)*

***brake fully AND shut off the engine. Unexpected and possibly sudden vehicle movement may occur if these precautions are not taken.***

- ***Never reach for the ignition switch through the steering wheel; it could suddenly turn, causing serious injury.***

■ **Testing the Warning Lights**

Before you start your vehicle, you should test the warning lights on the dashboard to make sure that they work. Turn the key to the ON position. All the warning lights except the brake warning light should light up. If any of them do not, have the bulb and circuit checked.

If your brake warning light does light up with the key in the ON position, you may not have fully released the parking brake or the brake fluid may be low.

The key must be in the START position, which cranks the engine, to test the brake warning light. If the brake warning light does not light up, have the bulb and circuit checked.

After starting the engine, check all the warning lights to make sure that they are off. When you release the parking brake, the brake warning light should go off.

### Preparing to Drive Your Vehicle

#### **WARNING**

- *Utility vehicles have a significantly higher rollover rate than other types of vehicles.*
- *In a rollover crash, an unbelted person is significantly more likely to die than a person wearing a seat belt.*
- *Vehicles with a higher center of gravity such as utility and four-wheel drive vehicles handle differently than vehicles with a lower center of gravity. Utility and four-wheel drive vehicles are not designed for cornering*

*(Continued)*

*at speeds as high as passenger cars any more than low-slung sports cars are designed to perform satisfactorily under off-road conditions. Avoid sharp turns, excessive speed and abrupt maneuvers in these vehicles. Failure to drive cautiously could result in an increased risk of vehicle rollover, personal injury and death.*

- *Loaded vehicles, with a higher center of gravity, may handle differently than unloaded vehicles. Extra precautions, such as slower speeds and increased stopping distance, should be taken when driving a heavily loaded vehicle.*

Your vehicle has special design and equipment features to make it capable of performing in a wide variety of circumstances. These special design features, such as larger tires and increased ground clearance, give the vehicle a higher center of gravity than a passenger car.

Your vehicle has the capability to haul more cargo and people than most passenger cars. Depending upon the type and placement of the load, hauling people and cargo may raise the center of gravity of the vehicle.

Use extra caution while becoming familiar with your vehicle. Know the capabilities and limitations of both you as a driver and your vehicle.

### Starting the Engine

When starting a fuel-injected engine, avoid pressing the accelerator before or during starting. Only use the accelerator when you have difficulty starting the engine.

A computer system controls the engine's idle revolutions per minute (RPM). When the engine starts, the idle RPM runs faster to warm the engine. If the engine idle speed does not slow down automatically, have the vehicle checked. Do not allow the vehicle to idle for more than ten minutes at high engine RPM.

### **WARNING**

#### Exhaust Fumes:

*Do not start your vehicle in a closed garage or any other enclosed area. Exhaust fumes can be toxic. Always open the garage door before you start the engine.*

### ■ **Preparing Your Vehicle**

1. Occupants should fasten their seat belts.
2. Make sure your headlights and other accessories are turned off when starting.
3. Make sure the parking brake is on.
4. **Manual Transmission**—Push the clutch pedal to the floor.  
Keep the pedal to the floor while starting the engine.  
**Automatic Transmission**—Place the gearshift selector lever in P (Park).
5. Turn the key to ON without turning the key to START.

If there is difficulty in turning the key, firmly rotate the steering wheel left and right until the key turns freely. This condition may occur when:

- front wheels are turned
- front wheel is against the curb
- steering wheel is turned when getting in or out of the vehicle.



■ **Starting Your Vehicle**

1. Turn the ignition switch to START without pressing the accelerator pedal.

**NOTE**

The starter will not operate . . .

- If the gearshift selector lever is **not** in P (Park) or N (Neutral) (automatic), or
- If the clutch pedal is **not** pushed down all the way (manual).

2. Release the key as soon as the engine starts. Excessive cranking could damage the starter or flood the engine.  
After starting the engine, let it idle for a few seconds.

Keep your foot on the pedal and put the gearshift lever in gear. Release the parking brake. Slowly release the brake pedal and drive away in the normal manner.

**NOTE**

Whether cold or warm, the engine should be started without use of the accelerator except when noted in this section.

### ▼ If the engine doesn't start

- If the temperature is above 10°F (–12°C) and the engine does not start within five seconds on the first try, turn the key to OFF, wait ten seconds and try again.
  - If the temperature is below 10°F (–12°C) and the engine does not start in fifteen seconds on the first try, turn the key OFF and wait ten seconds and try again. If the engine does not start in two attempts, press the accelerator pedal 1/3 to 1/2 of the way to the floor and hold. Turn the key to START.
3. When the engine starts, release the key, then release the accelerator pedal gradually as the engine speeds up.
  4. After idling for a few seconds, apply the brake and release the parking brake.
  5. If the engine still does not start, the fuel pump shut-off switch may have been triggered and needs to be reset.

### **WARNING**

#### **Engine Idling Speed:**

***If the engine idling speed does not slow down automatically, do not allow your vehicle to idle for more than ten minutes. Have the vehicle checked. Extended idling at high engine speeds can produce very high temperatures in the engine and exhaust system, creating the risk of fire or other damage to the vehicle and possibly resulting in personal injury.***

### NOTE

Engine noise (from valve tappets) may occur if the engine has not been operated for an extended period.

The noise should stop after the engine has reached normal operating temperature. If the noise does not stop, have the vehicle inspected by an Authorized Mazda Dealer.

### Cold weather starting (Flexible Fuel Vehicles Only)\*

As the outside temperature approaches freezing, ethanol fuel distributors should supply winter grade (E<sub>85</sub>) ethanol (same as with unleaded gasoline). If summer grade (E<sub>85</sub>) ethanol is used in cold weather conditions, you may expe-

rience increased cranking times, rough idle or hesitation until the engine has warmed up. Consult your fuel distributor for the availability of winter grade (E<sub>85</sub>) ethanol.

High-quality blends of winter grade (E<sub>85</sub>) ethanol will produce satisfactory cold weather starting and driving results. However, fuel composition varies, and sub-optimal winter grade blends could produce increased cranking times, rough idle or hesitation at temperatures below 0°F (-18°C). If you experience this condition you may find that a different brand of winter grade (E<sub>85</sub>) (if available in your area) improves the performance of your vehicle.

Cold starting performance can also be improved with the use of an engine block heater. The engine block heater is available as a Mazda option and can also be obtained from your Mazda dealer. Consult the engine block heater section for proper use of the engine block heater.

If you should experience cold weather starting problems on (E<sub>85</sub>) ethanol, and neither an alternative brand of (E<sub>85</sub>) ethanol nor an engine block heater is available, the addition of unleaded gasoline to your tank will improve cold starting performance. Your vehicle is designed to operate on (E<sub>85</sub>) ethanol alone, unleaded gasoline alone, or any mixture of the two.

\*Some models.

### If the engine fails to start using the preceding instructions:

1. Press the accelerator pedal 1/3 to 1/2 of the way to floor and hold.
2. Turn the key to START position.
3. When the engine starts, release the key, then release the accelerator pedal gradually as the engine speeds up.
4. If the engine still fails to start, repeat steps one through three.
5. After the engine starts, hold your foot on the brake pedal, put the gearshift lever in gear and release the parking brake. Slowly release the brake pedal and drive away in a normal manner.

\*Some models.

### Using the Engine Block Heater\*

Engine block heaters are strongly recommended if you live in a region where temperatures reach  $-10^{\circ}\text{F}$  ( $-23^{\circ}\text{C}$ ) or below consistently during the winter months. An engine block heater warms the engine coolant, which improves starting, warms up the engine faster, and allows the heater-defrost system to respond quickly.

If you have this option, use it whenever the temperature is  $-10^{\circ}\text{F}$  ( $-23^{\circ}\text{C}$ ) or below.

### **WARNING**

#### **Ungrounded Connections:**

***Do not use your heater with ungrounded electrical systems or two-pronged (cheater) adapters. You can be injured by an electrical shock if you use an ungrounded connection.***

For best results, plug the heater in at least three hours before you start your vehicle.

Using the heater for longer than three hours will not damage the engine, so you can plug it in at night to start your vehicle the following morning.

**NOTE**

Be sure to disconnect the engine block heater before driving your vehicle.

## The Fuel Pump Shut-Off Switch

If the engine cranks but does not start or does not start after a collision, the fuel pump shut-off switch may have been triggered. The Fuel Reset indicator light will illuminate in the instrument cluster. The shut-off switch is a device intended to automatically stop the fuel pump when your vehicle has been involved in a substantial jolt.

Once the shut-off switch is triggered, you must reset the switch by hand before you can start your vehicle.

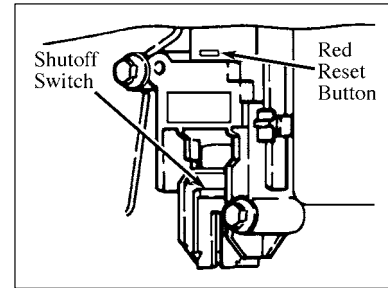

The shut-off switch is located behind the lower right trim panel under the instrument panel.

### **WARNING**

#### **Fuel Pump Shut-Off Switch:**

*If you see or smell fuel, do not reset the switch or try to start your vehicle. You could injure yourself or others. Have all the passengers get out of the vehicle and call the local fire department or a towing service.*

If your engine cranks but does not start after a collision:

1. Turn the key in the ignition to OFF.
2. Check the fuel system for leaks.
3. If no fuel leak is apparent, reset the switch by pushing in the red button on the switch. If the button is already set, you may have a different mechanical problem.
4. Turn the ignition key ON for a few seconds, then turn it OFF.
5. Make a further check for leaks in the system. **If you see or smell fuel, do not start your vehicle again.** If you do not see or smell fuel, you can try to start your vehicle again.
6. Check all vehicle warning lights before driving your vehicle.

## Manual Transmission Operation

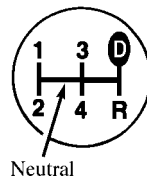

### ■ Manual Transmission Shift Pattern

The gearshift for a manual transmission is mounted on the floor. The gearshift pattern consists of seven positions: Neutral, five forward gears and reverse.

Press the clutch pedal all the way down while shifting; then release it slowly.

**NOTE**

Make sure the vehicle is stopped before shifting to R (Reverse). Wait at least 3 seconds before shifting into R (Reverse) to prevent a “grinding” noise. Do not release the clutch.

 **CAUTION**

Keep your foot off the clutch pedal except when shifting gears. Also, don't use the clutch to hold the vehicle on an upgrade. This will avoid needless clutch wear and damage.

With the 5-speed transmission you can engage R (Reverse) only by moving the gearshift from the left of 3 (Third) and 4 (Fourth) gears before you shift into R (Reverse). This is a special lockout feature that protects you from accidentally shifting into R (Reverse) when you downshift from Overdrive (  ) gear.

 **WARNING**

**Do Not Abuse the Clutch:**

*Do not abuse the clutch. Continued use of a damaged or worn clutch, prolonged clutch slippage or downshifting at excessive speeds can result in an explosion of the engine, transmission or clutch components, resulting in potential serious personal injury.*

## Driving Your Mazda

---

### ■ Recommendations for Shifting

#### ▼ Upshifting

For normal acceleration, we recommend these shift points.

NOTE
Shifting during extremely low rpms can result in a momentary audible rattle which disappears as vehicle rpms are increased. Shifting at higher speeds will eliminate this sound.

#### Upshifts: Normal Accelerating (Recommended for Best Fuel Economy)

Upshift from:	Transfer Case Position	
	2H or 4H*	4L
First to Second	10 mph (16 km/h)	4 mph (6 km/h)
Second to Third	22 mph (35 km/h)	9 mph (14 km/h)
Third to Fourth	33 mph (53 km/h)	13 mph (21 km/h)
Fourth to Overdrive	41 mph (66 km/h)	17 mph (27 km/h)

\*Use the following for 4x2 applications.

#### Upshifts: Cruising Conditions (Recommended for Best Fuel Economy)

Upshift from:	Transfer Case Position	
	2H or 4H*	4L
First to Second	10 mph (16 km/h)	4 mph (6 km/h)
Second to Third	19 mph (30 km/h)	8 mph (13 km/h)
Third to Fourth	28 mph (43 km/h)	12 mph (19 km/h)
Fourth to Overdrive	40 mph (64 km/h)	16 mph (26 km/h)

\*Use the following for 4x2 applications.



▼ **Downshifting**

When you must slow down in heavy traffic or on a steep **upgrade**, downshift before the engine starts to overwork. This reduces the chance of stalling and gives better acceleration when you need more speed.

On a steep **downgrade**, downshifting helps maintain safe speed and prolongs brake life. When you come to a stop, do not downshift through each gear. Disengage the clutch and use as necessary. Downshifting through the gears decreases fuel economy.

**Maximum Downshift Speeds  
(For Overdrive\*)**

Shift from:	Transfer Case Position	
	2H or 4H**	4L
Overdrive to Fourth	55 mph (88 km/h)	22 mph (35 km/h)
Fourth to Third	45 mph (72 km/h)	18 mph (29 km/h)
Third to Second	35 mph (56 km/h)	14 mph (22 km/h)
Second to First	20 mph (32 km/h)	8 mph (13 km/h)

\*Downshift at lower speeds when driving on slippery surfaces.

\*\*Use the following for 4x2 applications.

▼ **Parking**

To park your vehicle, apply the service brake, shift into N (Neutral) while still maintaining pressure on the service brake pedal. Set the parking brake fully. Shift into 1 (First) and turn off the ignition.

 **WARNING**

**Parking in Neutral:**

*Do not park your vehicle in N (Neutral). Use 1 (First) gear and set the parking brake fully. If you do not take these precautions, your vehicle may move unexpectedly and injure someone.*

### Automatic Transmission

Your vehicle is equipped with either a four-speed overdrive transmission (4R44E) or a five-speed overdrive transmission (5R55E). All 2.5L and 3.0L engines use the 4R44E transmission, while all 4.0L engines use the 5R55E transmission. Both transmission types have a lock-up torque converter. Transmission operation is controlled by the Powertrain Control Module (PCM).

The PCM will automatically adjust transmission operation to make up for varying conditions. Several sensors located on the engine and transmission such as throttle position, engine speed, vehicle speed and transmission temperature are used by the PCM to shift the transmission into a higher to lower gear when required for the best performance and fuel economy.

For example, you may notice that the transmission will upshift to a higher gear more quickly when the vehicle has not reached normal operating temperature.

The PCM also controls the transmission's torque converter clutch to further raise vehicle performance and fuel economy. The torque converter clutch will engage when the transmission operating temperature and other conditions determined by the PCM have been met. Engagement of the clutch may be noted as a decrease in engine speed.

To help in troubleshooting, the PCM continually performs self-tests on the electronic control system and if any faults are detected, will store them in memory. The Transmission Control Indicator Light (TCIL), which is located on the instrument cluster, may flash steadily if a mal-function has been detected. If the TCIL is flashing, contact your Authorized Mazda Dealer as soon as possible. If this condition persists, damage to your transmission could occur.

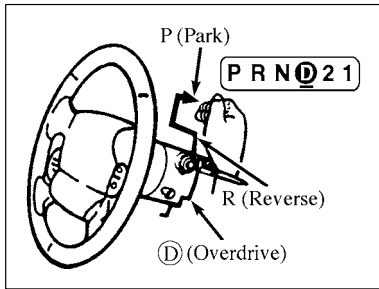

### ■ Transmission Ranges

The gearshift selector lever must be at P (Park) or N (Neutral) to operate the starter.

### ■ Putting Your Vehicle in Gear

Your vehicle's gearshift selector lever is on the steering column. The Transmission Control Switch is located on the end of the gearshift selector lever. You can put the gearshift selector lever in any of the several positions.

Once you place the gearshift selector lever securely into position, gradually release the brake pedal and use the accelerator as necessary.

#### ▼ P (Park)

P (Park) locks the transmission and prevents the rear wheels from rotating.

Always come to a complete stop before you shift into P (Park). This position locks the transmission and prevents the rear wheels from turning. To securely latch the gearshift in the P (Park) position, pull it toward you, push it completely counterclockwise against the stop, and then push it toward the instrument panel.

The gearshift is securely latched in P (Park) if you cannot rotate it in a clockwise direction without lifting it toward you.

### **WARNING**

#### Moving Selector Lever:

*Hold the brake pedal down while you move the selector lever from position to position. If you do not hold the brake pedal down, your vehicle may move unexpectedly and injure someone.*

### **WARNING**

#### The Parking Brake vs. P (Park):

*Using P (Park) instead of the parking brake to hold the vehicle is unsafe. If P (Park) fails to hold, the vehicle will move freely and possibly cause an accident. Don't use P (Park) in place of the parking brake. Always use both P (Park) and the parking brake.*

### **CAUTION**

Shifting into P (Park) or R (Reverse) while the vehicle is moving can damage your transmission.

Your vehicle is equipped with a brake-shift interlock feature. This feature prevents you from shifting from P (Park) with the key in the ON position unless you have the brake pedal depressed. If you cannot shift from P (Park) with the brake pedal depressed:

- 1 Apply the parking brake.
2. Remove the key.
3. Insert the key and rotate one position clockwise to OFF.
4. Apply the brake pedal and shift to N (Neutral). If the vehicle is shifted to P (Park) you must repeat the previous steps.
5. Start the vehicle.

 **WARNING**

**Shifting From P (Park) with  
Shift-Lock Override:**

*If you need to shift out of P (Park) by using the alternate procedure described here, it is possible that a fuse has blown or the vehicle's brake lamps may not be operating properly. Refer to the In Case of Emergency section for information on checking and replacing fuses. Do not drive your vehicle until you verify that the brake lights are working.*

▼ **R (Reverse)**

In the R (Reverse) position, the vehicle will move backward. You should always come to a complete stop before shifting into or out of R (Reverse), except as explained under Rocking the Vehicle (page 4-14).

▼ **N (Neutral)**

In N (Neutral), the wheels and transmission are not locked. The vehicle will roll freely even on the slightest incline unless the parking brake or brakes are engaged.

 **WARNING**

**Shifting From N (Neutral) or  
P (Park):**

*It's dangerous to shift from N (Neutral) or P (Park) into a driving gear when the engine is running faster than idle. If this is done, the vehicle could move suddenly, causing an accident or serious injury. If the engine is running faster than idle, don't shift from N (Neutral) or P (Park) into a driving gear.*

### ▼ **D (Overdrive)**

**D** (Overdrive) is the normal drive position for the best fuel economy. As the vehicle picks up speed, the 4R44E transmission will automatically upshift to second, third and fourth gears when

**D** (Overdrive) is chosen on the selector and the transmission control switch has not been pressed.

The 5R55E transmission will automatically upshift to second, third, fourth and fifth gears, when **D** (Overdrive) is chosen on the selector and the transmission control switch has not been pressed.

The transmission will shift into correct gear when the right speed is achieved for the accelerator pedal position you have chosen.

### ▼ **Drive**

You will note that there is not a drive position on your gearshift indicator. However, you will find a transmission control switch labeled “O/D ON/OFF” located on the end of the gearshift lever. Press this switch and “O/D OFF” will illuminate on the instrument cluster.

With overdrive cancelled and the “O/D OFF” illuminated, the 4R44E transmission will operate in gears one through three and the 5R55E transmission will operate in gears one through four. Operating in “OFF” gives more engine braking than Overdrive and is useful for ascending or descending hills or when towing. Shift back to **D** (Overdrive) whenever practical for optimum powertrain cooling.

To return the transmission to the normal **D** (Overdrive) operation, press the transmission control switch again. When starting your vehicle, the overdrive system will automatically be in the normal overdrive mode.

### ▼ **2 (Second)**

The 2 (Second) position is helpful when driving in heavy, slow-moving traffic and climbing hills; for braking assist when going down hills; or for starting on slick surfaces and other situations where gentle acceleration may be necessary.

### ▼ **1 (Low)**

Use the 1 (Low) position in hard-pulling situations, or for climbing and descending very steep grades.

**Shift patterns with overdrive:**

Ⓓ = 1st, 2nd, 3rd, 4th (4R44E)

Ⓓ = 1st, 2nd, 3rd, 4th, 5th (5R55E)

2 = 2nd

1 = 1st

**Shift patterns without overdrive:**

D = 1st, 2nd, 3rd (4R44E)

D = 1st, 2nd, 3rd, 4th (5R55E)

2 = 2nd

1 = 1st

**■ Driving Tips**

**▼ Passing**

For extra power when passing another vehicle or climbing steep grades, depress the accelerator fully. The 4R44E transmission will automatically downshift to the appropriate gear; third, second, or first. The 5R55E transmission will automatically downshift to the appropriate gear; fourth, third, second or first.

**▼ Climbing steep grades from a stop**

To climb a steep grade from a stopped position:

1. Depress the brake pedal.

2. Shift to Ⓓ or 1 (First) depending on load weight and grade steepness.
3. Release all brakes while gradually accelerating.

**▼ Power braking**

Increasing the engine speed above idle without vehicle movement (such as holding the brake) in a forward gear causes transmission stall.

**NOTE**

Continued operation in the stall condition can result in transmission overheating, malfunction or fluid expulsion.

### ▼ Descending steep grades

When descending a steep grade, shift to 2 (Second) or 1 (First), depending on load weight and grade steepness. Descend slowly, using the brakes only occasionally to prevent them from overheating.

### ■ Overdrive

#### ▼ Overdrive operation

In **D**, the transmission automatically shifts to Overdrive, which improves fuel economy and reduces noise.

But to increase engine braking, don't use Overdrive when going down a steep grade.

And for a smoother ride with less shifting, don't use it when:

- Going up a steep grade;
- Driving in stop-and-go traffic;
- Pulling heavy loads.

## 4-Wheel Drive System – Electronic Shift Control

The electronic shift control 4x4 system functions in three modes. In 2-wheel drive mode, power is delivered only to the rear axle at normal road speed.

The 4x4 HIGH position provides 4-wheel drive with power delivered to the front and rear axles for increased traction. The 4x4 LOW position provides 4-wheel drive with power delivered to the front and rear axles when above average power is required at reduced speeds.



4-wheel drive operation (4x4 or 4x4 LOW) on dry pavement is not recommended. Operating the vehicle in 4-wheel drive on dry pavement will increase tire wear, decrease fuel economy, and make 4-wheel drive disengagement difficult for the transfer case.

### ■ Electronic Shift Control System Indicator Lights

A 4x4 indicator light and a 4x4 LOW indicator light are located on the instrument cluster. If either light flashes, take your vehicle in for service.

- 2-wheel drive mode—Neither the 4x4 nor the 4x4 LOW lights are lit.
- 4x4 mode—Only the 4x4 light is lit.
- 4x4 LOW mode—Both the 4x4 and 4x4 LOW lights are lit.

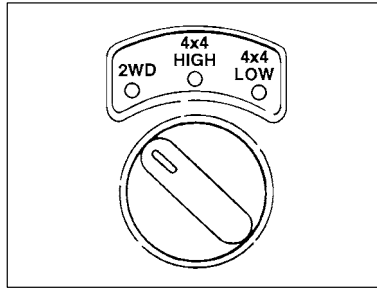

### ■ Shifting From 2-Wheel Drive to 4x4 HIGH

To shift into 4x4, turn the knob located on the instrument panel to 4x4 HIGH.

At temperatures below 32°F (0°C), shifts from 2-wheel drive to 4x4 HIGH should not be performed above 45 mph (72 km/h).

Do not shift into 4x4 HIGH with the rear wheels slipping.

### ■ Shifting From 4x4 HIGH to 2-Wheel Drive

Turn the knob from 4x4 HIGH to 2WD; the 4x4 light on the instrument cluster will go out indicating the vehicle is in 2-wheel drive. This can be done at any speed.

### ■ Shifting From 2-Wheel Drive to 4x4 LOW

1. Bring the vehicle to a stop.
2. Depress the brake.
3. Place the automatic transmission in N (Neutral) or depress the brake pedal and clutch pedal fully on vehicles with a manual transmission.
4. Move the four-wheel drive knob to 4x4 LOW.

### ■ Shifting From 4x4 LOW to 2-Wheel Drive

1. Bring the vehicle to a stop.
2. Depress the brake.
3. Place the automatic transmission in N (Neutral) or depress the brake pedal and clutch pedal fully on vehicles with a manual transmission.
4. Move the four-wheel drive knob to 2WD.

■ **Shifting Between 4x4 HIGH and 4x4 LOW**

Stop the vehicle, depress the brake, and place the automatic transmission in N (Neutral) or depress the brake pedal and clutch pedal fully on vehicles with a manual transmission. Move the four-wheel drive knob to the 4x4 HIGH or 4x4 LOW position.

 **CAUTION**

- If the four-wheel drive knob is moved to 4x4 LOW while the vehicle is moving, the system will not engage and no damage will occur to the system.
- Driving on dry, hard surfaces in 4H or 4L may cause unnecessary noise and tire wear. Drive in 2-wheel drive under these conditions.

It is not recommended to operate the vehicle in the 4WD modes with a temporary spare unless absolutely necessary. If you must use both 4WD and a temporary spare, don't operate at speeds above 10 mph (16 km/h) or for distances over 50 miles (80 km).

■ **Off-Road Driving**

 **WARNING**

**4-Wheel Driving Precautions:**

*All utility-type and 4-wheel drive vehicles have a special design and equipment features to make them capable of performing in a wide variety of off-road applications. Specific design characteristics give them higher centers of gravity than ordinary passenger cars. These vehicles are not designed for cornering at speeds as high as passenger cars any more than low-slung sports cars are designed to perform satisfactorily under off-road conditions. If at all*

*(Continued)*

## Driving Your Mazda

---

***possible, avoid sharp turns or abrupt maneuvers in these vehicles. As with other vehicles of this type, failure to operate your vehicle correctly may result in loss of control or vehicle rollover resulting in serious injury.***

Most vehicles with 4-wheel drive are especially equipped for driving on sand, snow, mud, or rough terrain and have operating characteristics that are somewhat different from conventional vehicles, both off and on the road. The driving tips below will help you learn to use 4-wheel drive.

- Do not use 4-wheel drive on dry, hard-surfaced roads, especially with a temporary spare tire in use. This may damage the driveline and axles.
- Drive slower in strong crosswinds which can affect the normal steering characteristics of your vehicle.
- Be extremely careful when driving on pavement made slippery by loose sand, water, gravel, snow or ice.

When using 4-wheel drive, maintain steering wheel control at all times, especially in rough terrain. Since sudden changes in terrain can result in abrupt steering wheel motion, make sure you grip the steering wheel rim from the outside. Do not grip the spokes.

Drive cautiously to avoid vehicle damage from concealed objects such as rocks and stumps. Know the terrain or examine maps of the area in question before driving. Map out your route beforehand. To maintain steering and braking control of your vehicle, you must have all four tires on the ground, and they must be rolling, not sliding or spinning.

If the vehicle is stuck it may be rocked out by shifting from forward and reverse gears, stopping between shifts, in a steady pattern. Press lightly on the accelerator in each gear.

### **NOTE**

Do not rock the vehicle for more than a few minutes. The transmission and tires may be damaged or the engine can overheat.

Transmission upshift in 4x4 with transfer case in 4L may be quite firm due to large total gear reduction. This condition is normal.

### ▼ Sand

When driving over sand, try to keep all four wheels of the vehicle on the most solid area of the trail. Avoid reducing the tire pressure. Instead, shift to a lower gear and drive steadily through the terrain. Apply accelerator slowly and avoid spinning the wheels.

If you must reduce the tire pressure for whatever reason in sand, make sure you re-inflate the tires as soon as possible.

Avoid excessive speed because vehicle momentum can work against you and cause the vehicle to become stuck to the point that assistance may be required from another vehicle. Remember, you may be able to back out the way you came if you proceed with caution.

### ▼ Water

Before driving through water, determine the depth. Avoid water higher than the bottom of the hubs. Proceed slowly to avoid splashing, if the ignition system gets wet, the vehicle may stall.

Once through water, always try the brakes. Wet brakes do not stop the vehicle as effectively as dry brakes. You can dry the brakes faster by driving the vehicle slowly while applying light pressure on the brake pedal.

## Driving Your Mazda

---

### ▼ Mud

Be cautious of sudden changes in vehicle speed or direction when you are driving in mud. Even 4x4 vehicles can lose traction in slick mud. As when you are driving over sand, apply the accelerator slowly and avoid spinning your wheels. If the vehicle does slide, steer in the direction of the slide until you regain control of the vehicle.

After driving through mud, clean off residue stuck to rotating driveshafts and tires. Excess mud stuck on tires and rotating driveshafts causes an imbalance which could damage drive components.

<b>NOTE</b>
If the transmission, transfer case or front axle are submerged in water, their fluids should be checked and changed, if necessary.

Replace rear axle lubricant any time the axle has been submerged in water. The rear axle does not normally require a lubricant change for the life of the vehicle. Rear axle lubricant quantities are not to be checked or changed unless a leak is suspected or repair is required.

### ▼ Driving on hill or steep terrain

Although natural obstacles may make it necessary to travel diagonally up or down a hill or steep incline, you should always try to drive straight up or straight down. Avoid driving crosswise or turning on steep slopes or hills. A danger lies in losing traction, slipping sideways and possibly rolling over. Whenever driving on a hill, determine beforehand the route you will use. Do not drive over the crest of a hill without seeing what conditions are on the other side. Do not drive in reverse over a hill without the aid of an observer.

When climbing a steep slope or hill, start in a lower gear rather than downshifting to a lower gear once the ascent has started. This reduces strain on the engine and the possibility of stalling.

If you do stall out, do not try to turn around because you might roll over. It is better to back down to a safe location.

Apply just enough power to the wheels to climb the hill. Too much power will cause the tires to slip, spin or lose traction, resulting in loss of vehicle control.

Descend a hill in the same gear you would use to climb up the hill to avoid excessive brake application and brake overheating. Do not descend in neutral, disengage overdrive or manually shift to a lower gear.

When descending a steep hill, avoid sudden hard braking as you could lose control. When you brake hard, the front wheels can't turn and if they aren't turning, you won't be able to steer. The front wheels have to be turning in order to steer the vehicle. Rapid pumping of the brake will help you slow the vehicle and still maintain steering control.

If your vehicle has antilock brakes, apply the brakes steadily. Do not "pump" the brakes.

When cruise control is on and you are driving uphill, your vehicle speed may drop considerably, especially if you are carrying a heavy load.

If vehicle speed drops more than 16 km/h (10 mph), the cruise control will cancel automatically. Resume speed with the accelerator pedal.

If cruise control cancels after climbing the hill, reset speed by pressing and holding the SET ACCEL button to resume speeds over 30 mph (50 km/h).

The automatic transmission may shift frequently while driving up steep grades. Eliminate frequent shifting by shifting out of  (Overdrive) into D (Drive).

### ▼ Driving on snow or ice

A 4-wheel drive vehicle has advantages over 2-wheel drive vehicles in snow and ice but can skid like any other vehicle. If so equipped, keep the vehicle in 4-wheel drive if icy or slippery conditions exist.

4x4 vehicles are unique in that they can be driven in deep snow that would stop a conventional two-wheel drive vehicle. Shift to a low gear and maintain steady pressure on the accelerator. This will help prevent spinning the wheels while maintaining sufficient momentum to keep from bogging down. Using tire chains will also help.

Never drive with chains on the front tires of 4x4 vehicles without also putting them on the rear tires. This could cause the rear to slide and swing around during braking.

### ■ Tire Replacement Requirements

Your 4x4 vehicle is equipped with tires designed to provide for safe ride and handling capability.

Do not use a size and type of tire and wheel other than that originally provided by Mazda because it can affect the safety and performance of your vehicle, which could lead to loss of vehicle control or rollover and serious injury. Make sure all tires and wheels on the vehicle are of the same size, type, tread design, brand and load-carrying capacity. If you have questions regarding tire replacement, see an authorized Mazda dealer.



If you nevertheless decide to equip your 4x4 for off-road use with tires larger than what Mazda recommends, you should not use these tires for highway driving. If you use any tire/wheel combination not recommended by Mazda, it may adversely affect vehicle handling and could cause steering, suspension, axle or transfer case failure.

Do not use “aftermarket lift kits” or other suspension modifications, whether or not they are used with larger tires and wheels.

These “aftermarket lift kits” could adversely affect the vehicle’s handling characteristics, which could lead to loss of vehicle control or rollover and serious injury.

Tires can be damaged during off-road use. For your safety, tires that are damaged should not be used for highway driving because they are more likely to blow out or fail.

You should carefully observe the recommended tire inflation pressure found on the safety compliance certification label attached to the left front door lock facing or door latch post pillar. Failure to follow tire pressure recommendations can adversely affect the way your vehicle handles. Do not exceed the Mazda recommended pressure even if it is less than the maximum pressure allowed for the tire.

Each day before you drive, check your tires. If one looks lower than the others, use a tire gauge to check pressure of all tires, and adjust if required. Check tire pressure with a tire gauge every few weeks (including spare). Safe operation requires tires that are neither underinflated nor overloaded.

Periodically inspect the tire treads and remove stones, nails, glass or other objects that may be wedged in the tread grooves. Check for holes or cuts that may permit air leakage from the tire and make necessary repairs.

Inspect the tire sidewalls for cuts, bruises and other damage. If internal damage to the tire is suspected, have the tire demounted and inspected in case it needs to be repaired or replaced.

### ■ **If Your Vehicle Goes Off the Edge of the Pavement**

If your vehicle goes off the edge of the pavement, slow down, but avoid severe brake application. Ease the vehicle back onto the pavement only after reducing your speed. Do not turn the steering wheel too sharply while returning to the road surface.

It may be safer to stay on the apron or shoulder of the road and slow down gradually before returning to the pavement. You may lose control if you do not slow down or if you turn the steering wheel too sharply or abruptly.

If often may be less risky to strike small inanimate objects, such as highway reflectors, with minor damage to your vehicle rather than attempt a sudden return to the pavement which could cause the vehicle to slide sideways out of control or rollover. Remember, your safety and the safety of others should be your primary concern.

### ■ Emergency Maneuvers

In an unavoidable emergency situation where a sudden sharp turn must be made, remember to avoid “over-driving” your vehicle, i.e. turn the steering wheel only as rapidly and as far as required to avoid the emergency. Excessive steering will result in less vehicle control, not more. Additionally, smooth variations of the accelerator and/or brake pedal pressure should be utilized if changes in vehicle speed are called for. Avoid abrupt steering, acceleration or braking. Use all available road surface to return the vehicle to a safe direction of travel.

In the event of an emergency stop, avoid skidding the tires and do not attempt any sharp steering wheel movements.

If the vehicle goes from one type of surface to another (i.e., from concrete to gravel) there will be a change in the way the vehicle responds to a maneuver (steering, acceleration or braking). Again, avoid these abrupt inputs.

### Brake System

#### ■ Foot Brake

Your Mazda has power-assisted brakes that adjust automatically through normal use.

Should power assist fail, you can stop by applying greater force than normal to the brake pedal. But the distance required to stop will be greater than usual.

When the engine is off, the reserve brake power is less each time the brake pedal is applied. Don't pump the pedal when the power assist has been interrupted, except when necessary to maintain steering control when sliding on ice or other slippery surfaces.

If the brakes should fail to operate while the vehicle is in motion, you can make an emergency stop with the parking brake. The stopping distance, however, will be much greater than normal.

#### **WARNING**

***Driving with the Engine Off:***  
***Continuing to drive when the engine is stalled or turned off is dangerous. Braking will require more effort, and the brake's power assist could be depleted if you pump the brake. This will cause longer stopping distances or even an accident. Don't continue driving when the engine is stalled or turned off, find a safe place to stop.***

 **WARNING**

**Riding the Brakes:**

*Driving with your foot continuously on the brake pedal or steadily applying the brakes for long distances is dangerous. This causes overheated brakes, resulting in longer stopping distances or even total brake failure. This could cause loss of vehicle control and a serious accident. Avoid continuous application of the brakes. Shift to a lower gear when going down steep hills.*

 **WARNING**

**Driving with Wet Brakes:**

*Driving with wet brakes is dangerous. Increased stopping distance or the vehicle pulling to one side when braking could result in a serious accident. Light braking will indicate whether the brakes have been affected. Dry the brakes by driving very slowly and applying the brakes lightly until brake performance is normal.*

■ **Front Disc Brakes**

The front disc brakes are self-adjusting. They do not require service other than periodic inspection for pad wear.

■ **Rear Drum Brakes**

The rear drum brakes are self-adjusting. Automatic adjustment occurs when the brakes are applied while “backing up.”

If normal operation does not include much backing up, adjust the rear brakes when they seem “low” and do not grip well by using the following procedure.

### ■ If Brakes Do Not Grip Well or Pedal is “Low”

If brakes do not grip well, it may indicate the rear drum brakes need adjustment.

Drive the vehicle in reverse at 5 mph (8 km/h) on level, dry pavement. Stop the vehicle by firmly applying the brakes. Repeat this procedure four or five times.

If the brakes seem low or do not grip well during normal operation, it may indicate the need for a brake system inspection and/or service. You should have your vehicle checked as soon as possible.

It is not an indication of brake problems to have an occasional brake squeal during light to moderate brake applications. However, if the squeal becomes louder or more frequent, have your brakes

inspected by your dealer or a qualified service technician.

### ■ If Brakes Pull

- Check tire pressure.
- Perform the self-adjustment procedure described under If Brakes Do Not Grip Well or Pedal is “Low.”

If pull occurs during the first 500 miles (800 km), make 10 moderately fast stops from 40 mph (64 km/h) and perform the self-adjustment procedure above. It may be necessary to repeat this operation to properly seat new brake linings and pads.

### ■ Stopping Distances

Stopping distances vary with different loads and driving conditions. Use caution when encountering new conditions and acquaint yourself with vehicle performance. Take full advantage of engine braking power when slowing down.

## ■ Applying the Brakes

Apply the brake pedal evenly. Use the “squeeze” technique. Push on the brake pedal with a steadily increasing force. This allows the wheels to continue to roll while you are slowing down, which lets you steer properly. If you lock the wheels, release the brake pedal and repeat the “squeeze” technique.

### **WARNING**

#### *Suspension Modification:*

*Modifications to the suspension spring rates and/or vehicle ride height may adversely affect vehicle stopping ability.*

## ■ Hydraulic Power Brakes

The hydraulic brake system is made up of two independent hydraulic circuits. One hydraulic circuit supplies fluid to the front disc brakes and the other hydraulic circuit supplies fluid to the rear drum brakes. These two circuits are supplied by a common hydraulic brake fluid reservoir, with a fluid level sensor.

The brake light in the instrument panel will light for low brake fluid in the common brake fluid reservoir.

### **WARNING**

#### *Reduced Braking Capability:*

*A loss of pressure in one of the circuits, indicated by an increase in pedal travel, will result in reduced braking capability. The brake system should be checked immediately.*

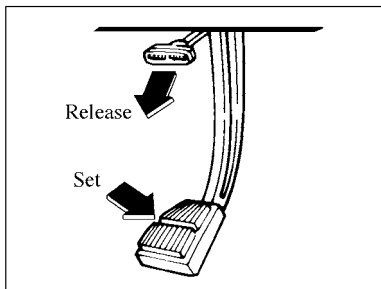

### ■ Parking Brake

The parking brake should be used whenever you park your vehicle.

The parking brake pedal is suspended just below the instrument panel to the left of the service brake and/or clutch pedals.

- To set the parking brake, press the brake pedal with your right foot and hold it while you depress the parking brake pedal fully with your left foot.

### CAUTION

Driving with the parking brake on will cause excessive wear of the brake linings or pads.

### WARNING

#### Set Parking Brake Fully:

*When parking, do not use the gearshift in place of the parking brake. Turn off the ignition whenever you leave your vehicle. Always set the parking brake fully and make sure that the gearshift is securely latched in P (Park) (automatic transmission) or in 1 (First) (manual transmission). Never leave your vehicle unattended while it is running. If you do not take these precautions, your vehicle may move unexpectedly and injure someone.*



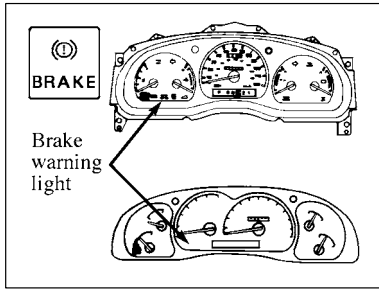

If the brake warning light stays on after the parking brake is fully released, the brake system has a malfunction. Refer to Warning Lights/Beeps (page 5-59).

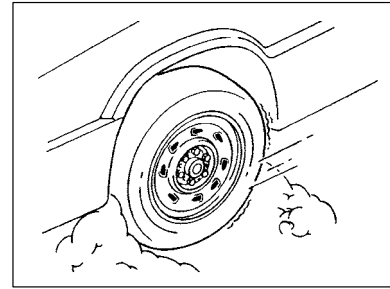

### ■ Brake System Warning Light

Note the brake warning light each time you start the engine. It should be on when the engine is running and the parking brake is set.

### ■ 4-Wheel Antilock Brake System (4-Wheel ABS)\*

This system helps the driver to maintain vehicle control by preventing wheel lock-up during hard braking.

\*Some models.

The 4WABS operates with a computer that is able to optimize vehicle control during braking on varying tire and road conditions by modulating the brake pressure at each of the front wheels and the rear axle. This “pumping action” is similar to the driver “pumping” the brakes but happens at a much faster rate.

### **WARNING**

#### Antilock System:

*The antilock system will NOT allow the vehicle to stop as quickly on wet or icy surfaces as it would on a dry surface. Heavy braking on roads with loose surfaces such as snow or gravel, or severe pavement irregularities could cause you to lose control of your vehicle.*

### ▼ Using antilock brakes

The operation of a vehicle with 4WABS is very similar to the operation of normal brakes. However, some differences exist and are listed below:

- Apply the brake steadily. In the event of a panic stop, do NOT “pump” the brakes. “Pumping” the brakes during an antilock stop will diminish braking effectiveness.
- During an antilock stop, the driver will notice a brake pedal pulsation and hear some noise from the engine compartment. This is an indication that the 4WABS system is working correctly and is normal. If the vehicle has continuous vibration or shudder in the steering wheel while braking,

the vehicle should be inspected by a qualified service technician.

### **WARNING**

#### Antilock System:

*The antilock system does not decrease the time necessary to apply the brakes or always reduce stopping distance. Always leave enough room between your vehicle and the vehicle in front of you to stop.*

▼ **4WABS warning light**

The 4WABS computer continuously monitors the system while driving for any electrical or system malfunctions.

In addition, the 4WABS computer performs an initial system check called bulb proveout when the vehicle ignition is switched on. During bulb proveout, the amber “ABS” light on the instrument cluster will momentarily illuminate and then go out.

**NOTE**

After starting the vehicle and upon initial drive-off, the driver may notice a single pulse of the brake pedal and a noise from the engine compartment. This is part of the initial system check and is normal.

The ABS warning light in the instrument cluster momentarily illuminates when the ignition is turned on and the engine is off. If the light does not illuminate momentarily at start up, remains on or continues to flash, the ABS needs to be serviced. With the ABS light on, the anti-lock brake system is disabled and normal braking is still effective unless the brake warning light also remains illuminated with parking brake released. (If your

brake warning light illuminates, have your vehicle serviced immediately.)

**NOTE**

Mobile phones or radio transmitters not installed by Mazda Motor Corporation may interfere with the antilock brake system. Should the antilock system activate unexpectedly or the ABS light illuminate after installation of such a unit, have the installation of the unit checked.

### **WARNING**

#### **Antilock Brake System Warning**

##### **Light:**

*If there is a malfunction in the system, the antilock brake system warning light will light as the system becomes disabled. The system should receive immediate service.*

### **WARNING**

#### **Suspension Modification:**

*Modifications to the suspension spring rates and/or vehicle ride height may adversely affect vehicle stopping ability.*

### ■ **Rear-Wheel Antilock Brake System (Rear-Wheel ABS)\***

This system reduces the possibility of sustained rear-wheel brake lockup by immediately sensing any lockup and modulating the rear brake pressure.

Even so, you must always be careful in all hazardous driving situations, especially on unusual surfaces, such as ice and water.

Even with ABS, you may lose control of the vehicle through heavy braking on loose surfaces such as snow and gravel, on broken pavement, and on alternate patches of slippery and dry surfaces.

You'll notice some pulsation in the brake pedal when the ABS system is operating normally. If the vehicle has continuous vibration or shudder in the steering wheel while braking, the vehicle should be inspected by a qualified service technician.

### **NOTE**

If the antilock warning light stays on while you're driving, the ABS control unit has detected a system malfunction. If this occurs, your brakes will function normally as if they had no ABS. Should this happen, consult an Authorized Mazda Dealer as soon as possible.

\*Some models.

**NOTE**

Braking distances may be longer on loose surfaces (snow or gravel, for example), which usually have a hard foundation. A vehicle with a normal braking system may require less distance to stop under these conditions because the tires will build up a wedge of surface layer when the wheels skid.

 **WARNING**

**ABS:**

*The ABS cannot compensate for unsafe and reckless driving, excessive speed, tailgating (following another vehicle too closely), and hydroplaning (reduced tire friction and road contact because of water on the road surface). You can still have an accident. So don't rely on ABS as a substitute for safe driving.*

 **WARNING**

**Antilock Brake System Light:**

*If the amber antilock brake system warning light remains on or comes on while driving, a fault has been detected in the antilock brake system, and the antilock system has been disabled. Have the braking system checked by a qualified service technician as soon as possible.*

### NOTE

If a fault occurs in the antilock system, and the brake warning light is not lit, the antilock system is disabled but normal brake function remains operational. If the light does not illuminate momentarily at start up, remains on or continues to flash, the ABS needs to be serviced.

### **WARNING**

***Suspension Modification:***  
***Modifications to the suspension spring rates and/or vehicle ride height may adversely affect vehicle stopping ability.***

## Power Steering

Your vehicle is equipped with power steering.

Power steering uses energy from the engine to help steer the vehicle.

To prevent damage to the power steering pump:

- Never hold the steering wheel to the extreme right or the extreme left for more than a few seconds when the engine is running.
- Do not operate the vehicle with a low power steering pump fluid level.

If the power steering system breaks down (or if the engine is turned off), you can steer the vehicle manually, but it takes more effort.

If the steering wanders or pulls, the condition could be caused by any of the following:

- underinflated tire(s) on any wheel(s)
- high crown in center of road
- high crosswinds
- wheels out of alignment
- loose or worn components in steering linkage

**NOTE**

After any severe impact such as striking potholes, sliding into curbs on icy roads, or a collision involving the front end, observe the steering wheel alignment. If the spokes of the steering wheel seem to be in a different position while going straight down the road, have the front suspension and steering checked for possible damage.

**Cruise Control\***

With cruise control, you can set and automatically maintain any speed of more than about 30 mph (48 km/h).

**⚠ WARNING**

***Cruise Control Use:***

*Using cruise control in the following conditions could cause you to lose control of the vehicle:*

- *Heavy or unsteady traffic*
- *Slippery or winding roads*
- *Similar restrictions that require inconsistent speed*

*Don't use cruise control in these situations.*

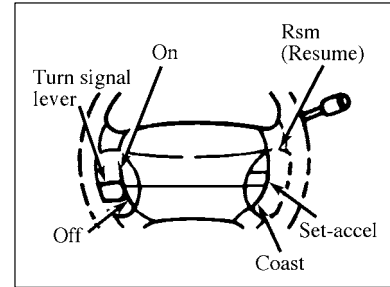

**To activate** the system, press the ON switch.

**To deactivate** the system:

- Press the OFF switch.
- Turn off the vehicle ignition.

\*Some models.

## Driving Your Mazda

---

Once cruise control is switched OFF, the previously programmed set speed will be released.

- Touch the brakes.

### **WARNING**

#### *Cruise ON Switch:*

*If the ON switch is left on, cruise control may be switched on accidentally. This could result in loss of vehicle control. Keep the cruise control OFF when cruise control is not in use.*

### ■ **To Set Speed:**

1. Press and release the ON switch.
2. Accelerate to the desired speed, which must be more than 30 mph (48 km/h).
3. Press SET ACCEL and release it immediately. This will set your speed and the cruise control indicator light will illuminate (refer to page 4-57). If you keep this button pressed, your speed will continue to increase and will not be set until the switch is released.

### **NOTE**

- On a steep grade, the vehicle may momentarily slow down going up or speed up while going down.
- You may have to temporarily cancel cruise control while driving on steep grades.



**NOTE**

Cruise control cannot reduce the vehicle speed if it increases above the set speed on a downhill grade. If your vehicle speed is faster than the set speed while driving downhill, you may want to shift to the next lower gear to reduce vehicle speed.

In mountainous areas, at higher elevations, or when pulling a trailer, the cruise control may not be able to maintain the preset speed with the transmission in overdrive.

If your vehicle comes with a 5-speed manual transmission, you may prefer to drive in 4 (Fourth) gear, in mountainous areas or at high altitudes, to improve cruise control performance.

To maintain a preset speed with an automatic transmission, under these conditions, push the Overdrive Off button on the end of the gearshift lever. The O/D OFF light will illuminate on the instrument cluster. You can select this position at any speed. For the best fuel economy during normal driving conditions, leave the shift selector in Overdrive.

In order to downshift (with a manual transmission) with the cruise control operating, you must press either the brake or clutch pedal long enough to disengage the cruise control. Wait a second before depressing the clutch again and making the shift so that the cruise control can fully return to the idle position.

## Driving Your Mazda

---

### ▼ To Cancel:

To turn off the system, use **one** of these methods:

- Press the OFF switch. The cruise control is cancelled.
- Press the brake or clutch pedal (if equipped) slightly. The cruise control is turned off, but can be reset by pressing SET ACCEL or RSM.

### **WARNING**

#### **Avoiding High Engine RPM:**

*Do not shift the transmission into N (Neutral) with the cruise control on, as high engine RPM run up will occur until the cruise control is turned off.*

The system is off when the ignition is off.

### **NOTE**

Cruise control will cancel at about 8 to 14 mph (13-23 km/h) below the preset speed.

### ■ To Increase Cruising Speed:

Follow either of these procedures.

- Press and hold SET ACCEL. Release the control when the desired speed is reached.
- Accelerate with your accelerator pedal. When the desired vehicle speed is reached, press and release SET ACCEL.

Your vehicle has a “tap-up” feature that allows you to increase your current speed in increments of 1 mph (1.6 km/h) by a momentary tap of the SET ACCEL button. Multiple taps of the SET ACCEL button will increase your vehicle speed 1 mph (1.6 km/h) for each tap. For example, if you are currently set at 60 mph (96 km/h) and tap the SET ACCEL button 5 times, your vehicle speed will increase and set at 65 mph (104 km/h).

### ■ Accelerating With Cruise Control On

Accelerate if you want to speed up temporarily when the cruise control is on. Greater speed will not interfere with it or change the set speed.

Take your foot off the accelerator to return to the set speed.

### ■ To Decrease Cruising Speed:

1. Press and hold the COAST button.
2. The vehicle will gradually slow. Release the button at the speed you want.

Your vehicle has a “tap-down” feature that allows you to decrease your current speed in increments of 1 mph (1.6 km/h) by a momentary tap of the COAST button. Multiple taps of the COAST button will decrease your vehicle speed 1 mph (1.6 km/h) for each tap. For example, if you are currently set at 65 mph (104 km/h) and tap the COAST button 5 times, your vehicle speed will decrease and set at 60 mph (96 km/h).

### ■ To Resume Cruising Speed at More Than 30 mph (48 km/h):

If something besides the OFF button was used to cancel cruising speed and the system is still activated, the most recent set speed will automatically resume when the RSM button is pressed. It will not resume though, if vehicle speed has dropped below 30 mph (48 km/h).

## Instrument Clusters

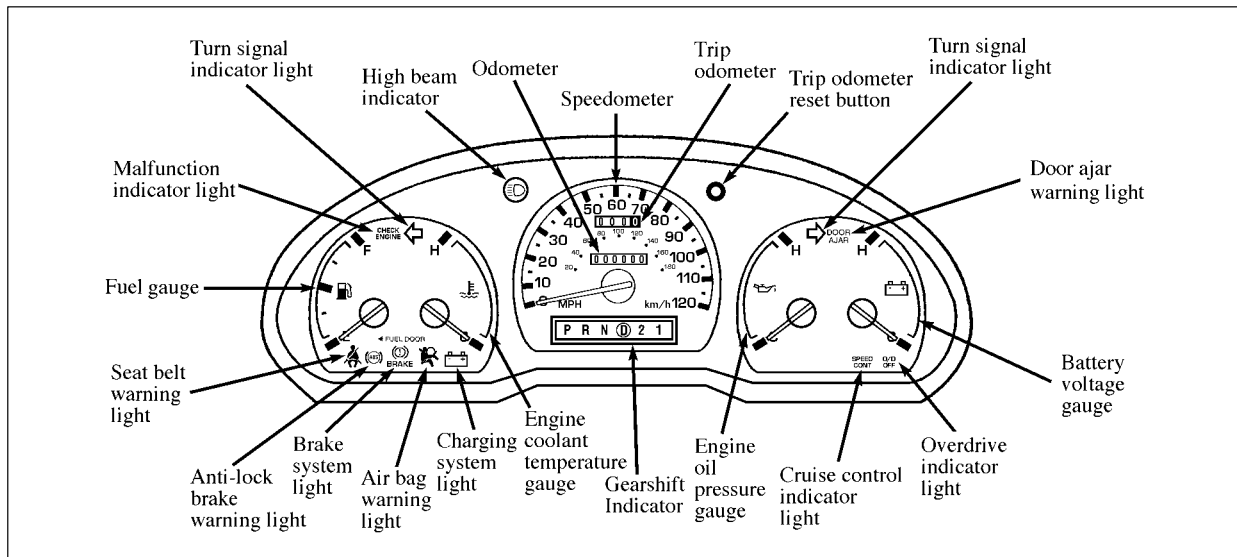

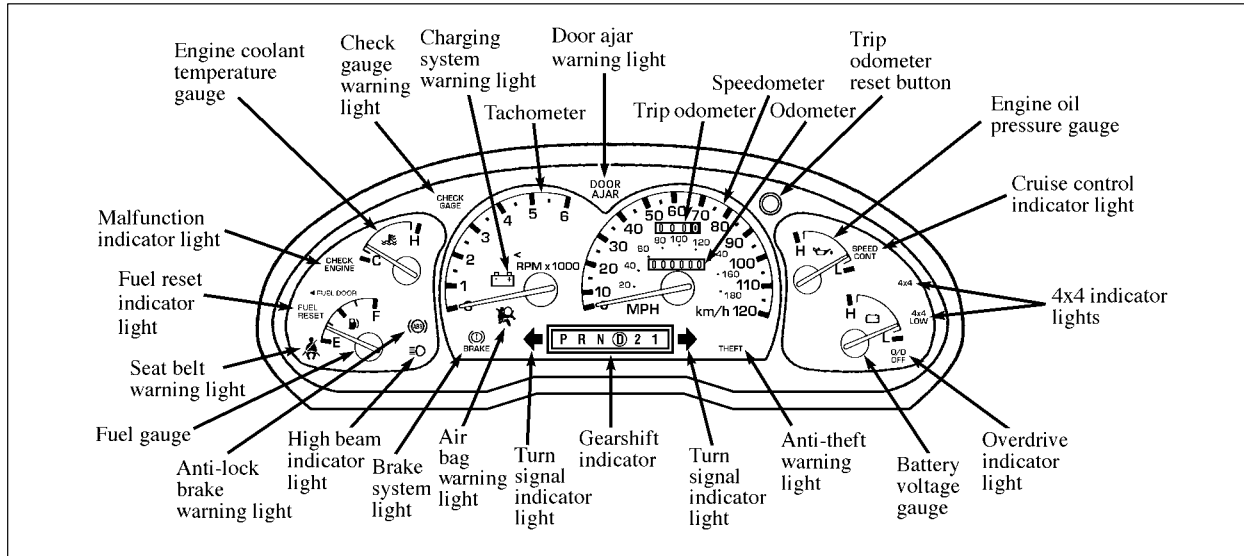

## Driving Your Mazda

---

### Gauges

#### ■ Speedometer

The speedometer shows forward speed in miles and kilometers per hour.

#### ■ Odometer

The odometer records in miles (kilometers) the total distance the vehicle has been driven.

#### ■ Trip Odometer

Push in the reset button to reset the trip odometer at zero. It will then reduce in miles (kilometers) the total distance the vehicle is driven until the meter is again reset. Use the trip odometer to measure trip distances and in computing fuel consumption.

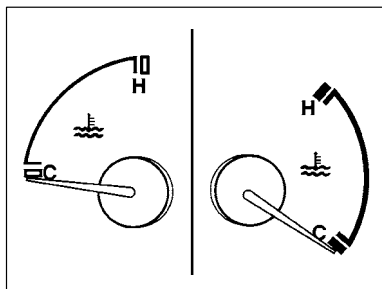

#### ■ Engine Coolant Temperature Gauge

This gauge shows the temperature of the engine coolant.

At normal operating temperature, the needle remains within the normal area (the area between the H and C). If it enters the red section, the engine is overheating. Stop the vehicle as soon as possible, switch off the engine immediately and let the engine cool.

### CAUTION

Driving with an overheated engine can cause serious engine damage (see page 6-3).

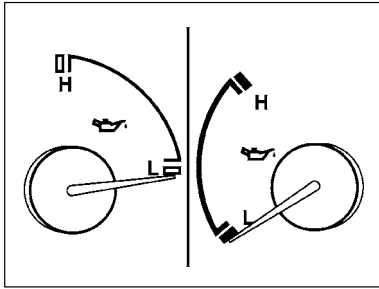

■ **Engine Oil Pressure Gauge**

This gauge indicates whether or not there is adequate oil pressure. If the engine is running, the pointer will be in the center band of the gauge, indicating

adequate oil pressure. If the pointer remains or drops below the center band while the engine is running, you have inadequate oil pressure. If this happens, stop the vehicle as soon as safely possible, switch off the engine immediately and refer to page 8-18 for instructions on checking oil level.

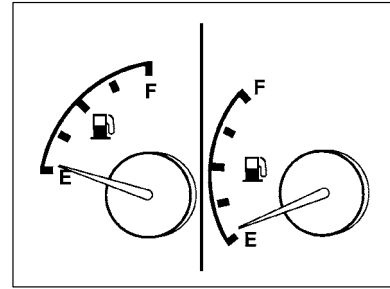

■ **Fuel Gauge**

The fuel gauge shows how much fuel is in the tank when the ignition is in the ON or START position.

## Driving Your Mazda

---

For a proper fuel gauge reading, the ignition switch must be in the OFF position before you add fuel to the fuel tank.

The fuel gauge indicator may vary slightly while the vehicle is in motion. This is the result of fuel movement within the tank. An accurate reading may be obtained with the vehicle on smooth, level ground.

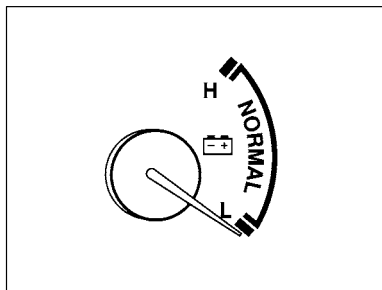

### ■ Battery Voltage Gauge

This gauge shows you the battery voltage when the ignition key is in the ON position. Normally the pointer will stay in the center band.

If the pointer stays outside the center band when you are running electrical accessories with the engine off or idling, have the system checked as soon as possible.



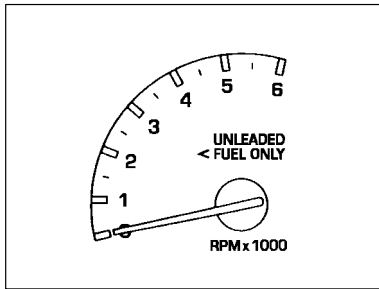

### ■ Tachometer\*

The tachometer shows engine speed in thousands of revolutions per minute (RPM). Use it while selecting shift points and to prevent lugging and over-revving.

Some vehicles are equipped with an engine speed (RPM) limiting device contained within the Powertrain Control Module (PCM). The purpose of this device is to maintain peak engine speed (RPM) below a specified limit. This feature is only evident on automatic transmission vehicles when shifting manually (1, 2, D) and on all manual transmission units. (Engine speed limits may vary based on engine displacement).

If you are experiencing an “engine cut-out” condition at high speeds, it may be the result of this limiting device. It is a normal condition and can be avoided by reducing engine/vehicle speed.

#### NOTE

The needle may move slightly when the ignition switch is at ACC or ON with the engine off. This is normal and will not affect accuracy once the engine is running.

#### NOTE

If the 4.0L engine exceeds 5200 RPM, the powertrain control module will restrict fuel flow to maintain engine speed at or below 5200 RPM. This function protects the engine and should be considered normal operation.

\*Some models.

### CAUTION

Don't run the engine with the tachometer in the RED ZONE.

Driving with your tachometer pointer continuously in the RED ZONE may damage the engine.

## Dashboard Illumination

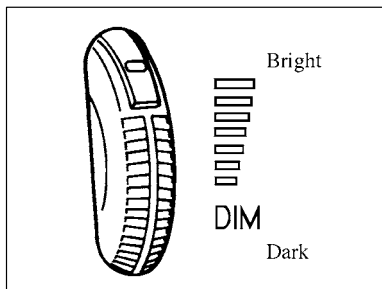

Use to adjust the brightness of the dashboard lights during headlight and parking light operation.

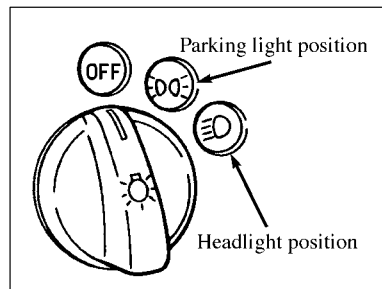

- Rotate up to brighten.
- Rotate down to dim.
- Rotate to full up position (past detent) to turn on interior lights.

## Warning Lights/Beeps

### ■ Warning Lights Inspection

Inspect the warning lights by turning on the ignition switch with the engine off and the parking brake on. Consult an Authorized Mazda Dealer about any light that doesn't come on.

If the brake system warning light is off when the ignition switch is at START, have the system inspected by an Authorized Mazda Dealer.

After starting the engine, make sure all warning lights are off. If one stays on, it's signaling for attention.

The brake system warning light should go off when the parking brake is released.

### ■ Brake System Warning Light



This warning has two functions.

#### ▼ Parking brake warning

The light comes on when the parking brake is applied with the ignition in the START or ON position. It goes off when the brake is fully released.

#### ▼ Low brake fluid level warning

If the light stays on after the parking brake is fully released, you may have a brake problem.

#### If it stays on:

1. Be sure the parking brake is fully released.

2. If this light is still on, drive to the side of the road and park off the right-of-way.

You may notice that the pedal is harder to push or that it may go closer to the floor. In either case, it will take longer to stop the vehicle.

3. With the engine stopped, check the brake fluid level immediately and add fluid as required (page 8-28).
4. After adding fluid, if the light remains on, or if the brakes do not operate properly, do not drive the vehicle. Have it towed to an Authorized Mazda Dealer.

Even if the light goes off, have your brake system inspected as soon as possible.

### **WARNING**

#### **Brake Warning Light:**

*Driving with the brake system warning light on is dangerous. It indicates that your brakes may not work at all or that they could completely fail at any time. If this light remains on, have the brakes inspected immediately. Don't drive with this light on.*

### ■ **Antilock Brake System (ABS) Warning Light\***



The ABS warning light illuminates momentarily when the ignition switch is turned to the ON position. If the ABS control unit determines that all components are OK, it turns off the light (page 5-43).

If the ABS brake warning light remains on, continues to flash or fails to illuminate, have the system serviced immediately. With the ABS light on, the antilock brake system is disabled and normal braking is still effective unless the brake warning light also remains illuminated with the parking brake released.

### **CAUTION**

If the amber antilock brake system warning light remains on or comes on while driving, a fault has been detected in the antilock brake system and the antilock system has been disabled. Have the braking system checked by a qualified service technician as soon as possible. (Note: If a fault occurs in the antilock system, the normal brake function remains operational.)

\*Some models.

■ **Seat Belt Warning Light/Chime**



For further information refer to Section 2.

■ **Fuel Reset Light\***



The fuel reset light will come on when the ignition is turned to ON and the fuel pump shut off switch has been triggered. Refer to The Fuel Pump Shut-Off Switch in this section.

■ **Charging System Warning Light**



This light comes on when you turn the ignition switch to the ON or START position. The light should go off when the engine starts and the generator begins to charge.

This warning shows a malfunction of the generator or of the electrical wiring system.

**If the light comes on while the vehicle is moving:**

1. Drive to the side of the road and park off the right-of-way.

2. Turn off the engine. Inspect the alternator drive belt for looseness and breakage.
3. If it's OK, the charging system has a problem. Consult an Authorized Mazda Dealer as soon as possible.

 **CAUTION**

Don't drive with a loose or broken generator or fan belt. The engine could overheat because the water pump or the fan would not work.

\*Some models.

### ■ Check Gauge Light



This light comes on when the key is in the ON position and:

1. The engine coolant temperature is high.
2. The engine oil pressure is low.
3. The fuel level is near empty.

This light will also illuminate for several seconds after the ignition is turned to the ON position and serves as a notice that the system needs your attention and to check the engine coolant temperature gauge, the engine oil pressure gauge, and the fuel level gauge. Please see the Engine Temperature Gauge, Engine Oil Pressure Gauge, or Fuel Gauge in this section for more information.

### ■ Malfunction Indicator Light



Your vehicle is equipped with a computer that monitors the engine's emission control system. This system is commonly known as the On Board Diagnostics System (OBD II). This OBD II system protects the environment by ensuring that your vehicle continues to meet government emission standards. The OBD II system also assists the service technician in properly servicing your vehicle.

The malfunction indicator light illuminates when the ignition is first turned to the ON position to check the bulb. If it

comes on after the engine is started, one of the engine's emission control systems may be malfunctioning. The light may illuminate without a driveability concern being noted. The vehicle will usually be drivable and will not require towing.

#### **If the check engine light turns on solid:**

Temporary malfunctions may cause your malfunction indicator light to illuminate. Examples are:

1. The vehicle has run out of fuel. (The engine may misfire or run poorly.)
2. Poor fuel quality or water in the fuel.
3. The fuel cap may not have been securely tightened.

These temporary malfunctions can be corrected by filling the fuel tank with good quality fuel and/or properly tightening the gas cap. After three driving cycles without these or any other temporary malfunctions present, the malfunction indicator light should turn off. (A driving cycle consists of a cold engine startup followed by mixed city/highway driving.) No additional vehicle service is required.

If the malfunction indicator light remains on, have your vehicle serviced at the first available opportunity.

### If the check engine light is blinking:

Engine misfire is occurring which could damage your catalytic converter. You should drive in a moderate fashion (avoid heavy acceleration and deceleration) and have your vehicle serviced at the first available opportunity.

### ■ Headlight High-Beam Indicator Light



This light indicates one of two things:

- The high-beam headlights are on;
- The turn-signal lever is in the flash-to-pass position.

### ■ 4x4 Indicator Light\*

4 X 4

The 4x4 indicator light comes on when 4x4 HIGH is activated.

If this light flashes, it indicates that there is a malfunction in the 4x4 system and you should take your vehicle in for service.

### ■ 4x4 LOW Indicator Light\*

4 X 4  
LOW

The 4x4 LOW indicator light comes on when 4x4 LOW is activated.

If this light flashes, it indicates that there is a malfunction in the 4x4 system and you should take your vehicle in for service.

\*Some models.

### ■ Anti-Theft Alarm Light\*

THEFT

For further information, refer to Section 3.

### ■ Overdrive On/Off\*

O/D  
OFF

Illuminates when the transmission control switch has been pushed turning the transmission overdrive function OFF. When the light is on, the transmission does not operate in the overdrive.

The light may also flash steadily if a transmission malfunction is detected. If the light does not come on when the transmission control switch is depressed or if the light flashes steadily, have your vehicle serviced as soon as possible, damage to the transmission could occur.

### ■ Door Ajar Warning Light\*

DOOR  
AJAR

If the ignition switch is in the ON position and any door is not completely closed, the DOOR AJAR light illuminates. If the light illuminates, close the doors securely.

### ■ Air Bag Warning Light



For further information, refer to Section 2.

### ■ Cruise Control Light\*

SPEED  
CONTROL

The cruise control light will illuminate in the instrument cluster when the cruise control system is engaged. The light will turn off when the brake pedal is pressed, the ignition is in the OFF position, or the cruise control OFF button is pressed.

This display does not indicate any problems with the cruise control, but is simply a convenient way of knowing when cruise control is activated.

\*Some models.



## Lighting Control

### ■ Warning Beeps

#### ▼ Headlights on beep

This warning sounds if you open the door while the parking lights or headlights are on and the ignition key is removed from the ignition.

The warning sounds again after 20 seconds if the headlights are on and the doors are closed.

#### ▼ Key-in-ignition beep

This warning sounds if you open the driver's door while the key is in the ignition.

#### ▼ Seat belt beep

This warning sounds if you turn on the ignition before you fasten the seat belt.

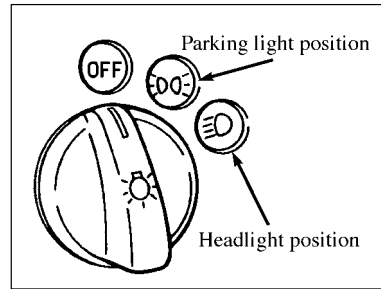

### ■ Headlights

#### First stop ☰☱☲☳

Taillights and dashboard, parking, and license lights are on.

#### Second stop ☰☱☲☳

Head- and taillights, dashboard, parking, and license lights are on.

#### NOTE

- To prevent discharging the battery, don't leave the lights on while the engine is off.
- If you stop the engine and leave the lights on, a chime will sound when the driver's door is opened.

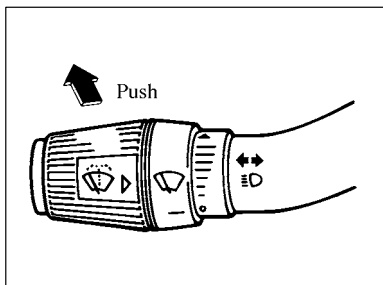

### ▼ Headlight high-low beam

Push the lever forward to activate high beams. Pull the lever toward you to deactivate high beams.

The high-beam indicator light on the dashboard is blue. It will remain illuminated until the headlights are returned to low beam.

\*Some models.

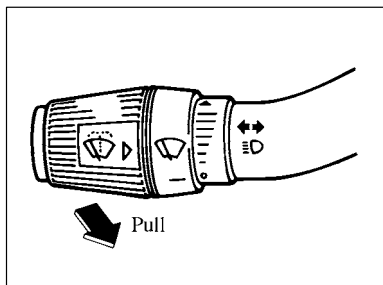

### ▼ Flashing the headlights

To flash the headlights, pull the lever toward you and release it. The headlight switch need not be on, and the lever will return to the normal position when released.

The high-beam indicator light on the dashboard is blue. It will illuminate briefly when the headlights are flashed.

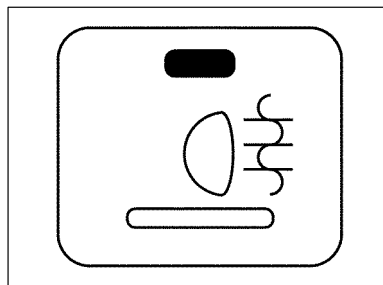

### ■ Fog Lamps\*

Press the fog lamp control button to activate the fog lamps. The fog lamp control button will illuminate when the fog lamps are on. Press the fog lamps a second time to deactivate the fog lamps.

The fog lamp switch is located to the right of the audio system on the instrument panel.

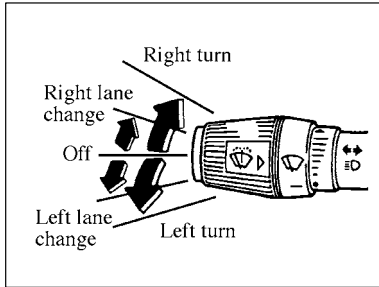

## ■ Turn and Lane-Change Signals

### ▼ Turn signals

Move the signal lever down (for a left turn) or up (for a right turn) to the stop position. The signal will self-cancel after the turn is completed.

Green indicators on the dashboard show which signal is working.

If the indicator light continues to flash after a turn, manually return the lever to its original position.

### ▼ Lane-change signals

Move the lever slightly toward the direction of the change—until the indicator flashes—and hold it there. It will return to the off position when released.

#### NOTE

If an indicator light stays on without flashing or if it flashes abnormally, the turn signal bulb may be burned out.

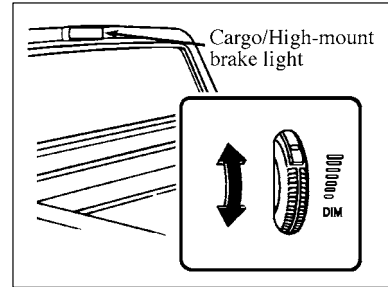

## ■ Combination Cargo and High-Mount Brake Light\*

Use the thumbwheel to the right of the headlight knob to turn the cargo light on and off.

\*Some models.

**⚠ WARNING**

***Driving With Interior Lights On:***  
*Do not drive your vehicle with the cargo or interior light on. Showing a white light to the rear while driving on public roads is illegal in some places.*

## Windshield Wipers and Washer

Rotate for interval wiper operations, ▲ (Low), and ▲▲ (High)

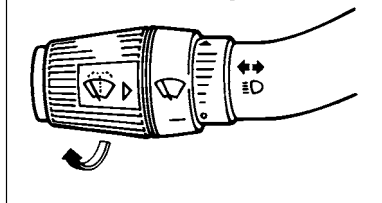

### ■ Windshield Wipers

The ignition switch must be in ON or ACC.

### ▼ Variable interval wipers

To set the interval wipers, rotate the knob at the end of the turn signal lever toward the front of the vehicle to the wiping speed you prefer. The shorter lines indicate a slow interval wiper speed and the longer lines indicate a fast interval wiper speed.

### ▼ Low or high speed wipers

Turn the wipers on by turning the knob on the end of the turn signal lever toward the front of the vehicle. Turn it to either the ▲ (Low) or ▲▲ (High) speed position.

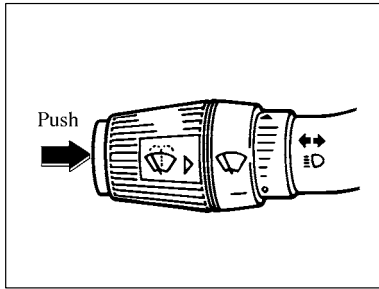

### ■ Windshield Washer

The ignition must be in ON or ACC.

Push the end of the lever and hold it to spray washer fluid. In the OFF position, they will automatically make a few wipes after you release the lever.

If the washer doesn't work, inspect the fluid level (page 8-36). If it's OK, consult an Authorized Mazda Dealer.

Do not try to clean the windshield when the washer fluid container is empty or activate the washers at any time for more than 15 seconds continuously. This could damage the washer pump system.

#### NOTE

The addition of shields to the front of the vehicle, as used to deflect bugs, may also adversely affect the washer system from delivering fluid to the windshield. Devices such as bug shields are not recommended for your Mazda vehicle.

### **WARNING**

#### Freezing Washer Fluid:

*In freezing temperatures, windshield washer fluid could freeze on the windshield and block your vision, which could easily cause an accident. Don't use the washer without first warming the windshield.*

### Lighter

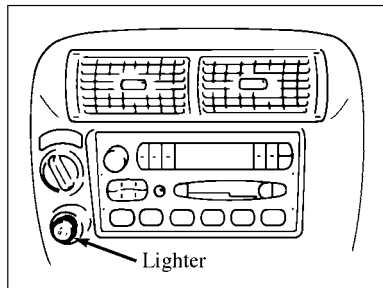

The lighter is located to the left of the audio system on the instrument panel.

To operate the lighter, press it in and release it. When ready for use, it automatically pops out.

### CAUTION

- Don't hold the lighter in because it will overheat.
- Don't use the lighter socket for plug-in accessories such as shavers and coffee pots. They may damage it or cause electrical failure. Use only a genuine Mazda lighter or the equivalent.
- If the lighter doesn't pop out within 30 seconds, remove it to prevent overheating.

### Power Point

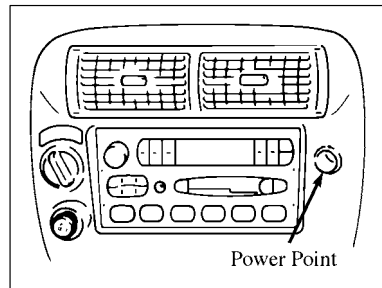

The power point outlet should be used in place of the cigarette lighter for optional electrical accessories.

The power point outlet is located to the right of the audio system on the instrument panel.

**⚠ WARNING**

**Optional Electrical Accessories:**

*Do not use more than 12 volt accessories in the 12 volt power point.*

*Do not plug optional electrical accessories into the cigarette lighter. Electrical system damage could occur.*

*Use the power point outlet.*

**Ashtray**

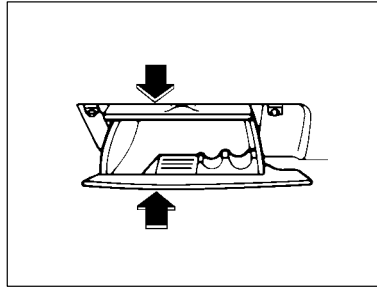

To remove an ashtray, lift it up and out. Push the ashtray into the tray holder until it locks.

**⚠ WARNING**

**Ashtrays:**

*Don't use ashtrays for trash. You might start a fire.*

**Glove Box**

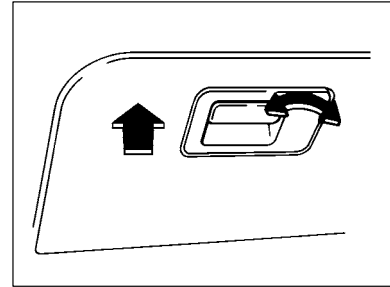

To open the glove box, lift up the handle and pull the door downward.

## Driving Your Mazda

---

### Center Console\*

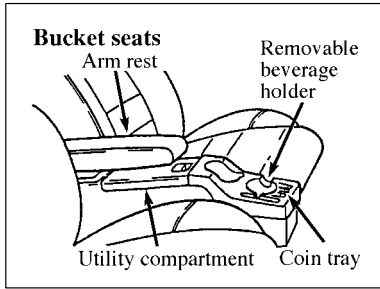

Lift the lid to open the center console.

The full console has all of the features shown in the illustration above as well as a removable utility bag.

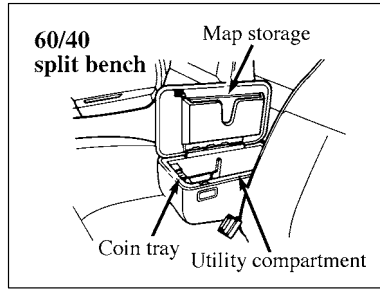

The storage armrest that is equipped with the 60/40 split bench seat also has a coin tray, utility compartment with cassette/compact disc storage and a map storage pocket.

### Cupholders\*

If your Mazda has a bench seat or split-bench seat, you may have cupholders in the floor-mounted consoleette.

The inside of the cupholders can be adjusted to various heights to accommodate different size cups. They can also be removed to allow access and cleaning of the cupholder.

\*Some models.



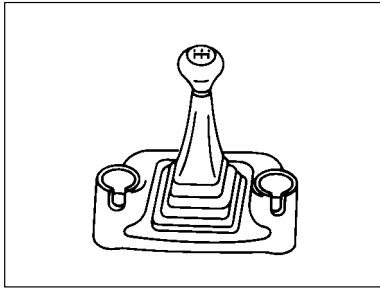

On a manual transmission, the cupholders are located on the floor on either side of the gearshift lever.

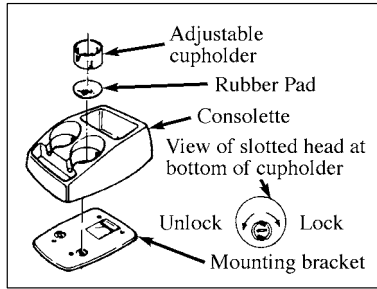

On an automatic transmission, a removable console may be removed when the center seat position is occupied.

**To remove the automatic console:**

1. Pull the adjustable portion of each cupholder from the console.
2. Remove the rubber pad at the bottom of each cupholder.
3. Using a quarter, turn the slotted head at the bottom of each cupholder 90° (one quarter turn).
4. Lift the console from the floor and secure it in a safe place.

## Driving Your Mazda

---

### Sunvisors

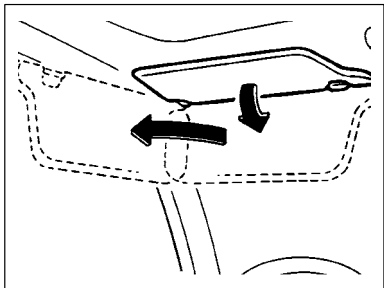

When you need a sunvisor, lower it for use in front or swing it to the side.

### Vanity Mirror\*

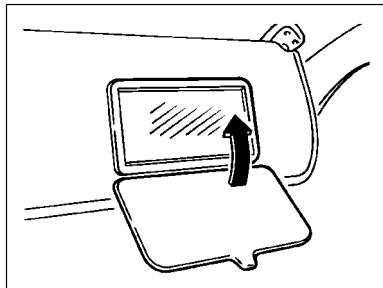

To use the vanity mirror, lower the sunvisor on the passenger's side.

\*Some models.

## Climate Control Systems

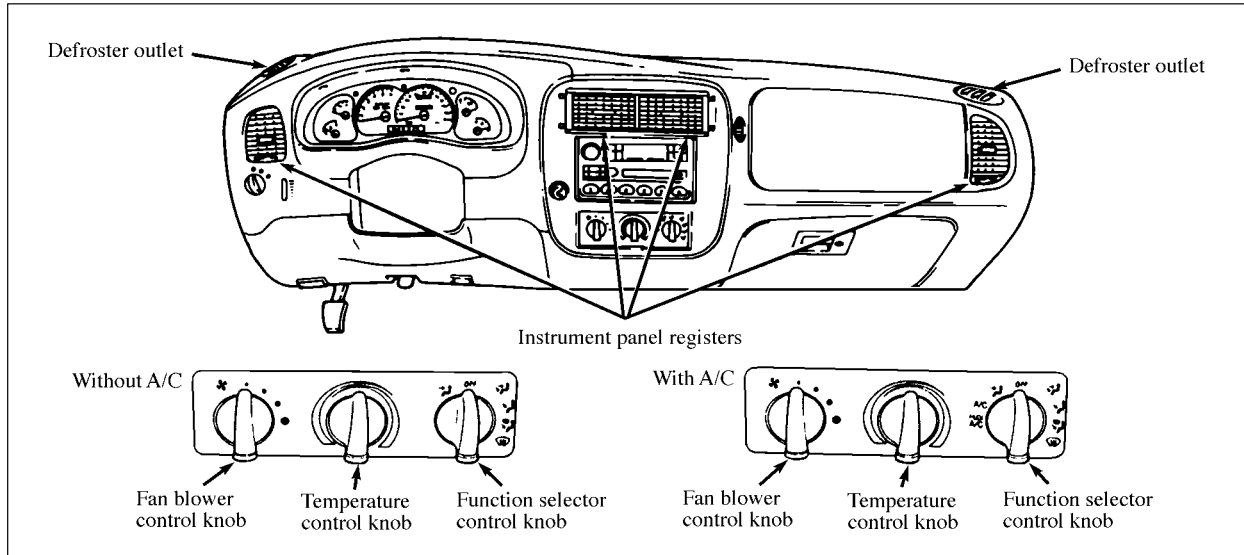

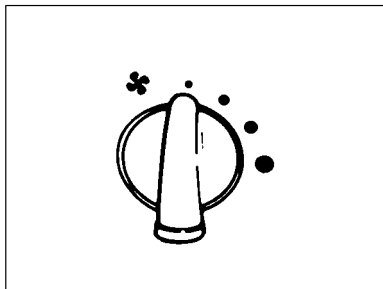

### ■ Fan Blower Control Knob

This knob allows variable fan speeds.

There are four fan settings, plus an OFF position. The larger the dot, the higher the fan setting.

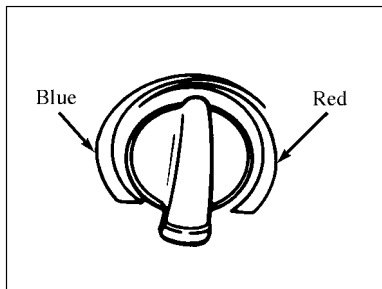

### ■ Temperature Control Knob

This controls air temperature. Adjust the knob to Cool air in the blue range or to Warm air in the red range.

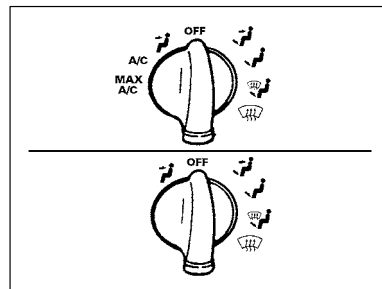

### ■ Function Selector Control Knob

Use this knob to direct airflow from the vents.

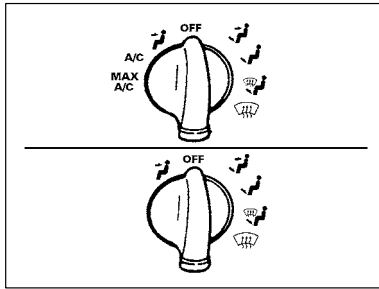

▼ Off position

The flow of outside air is shut off; however, a small amount of air is directed toward the face.

▼ A/C position\*

Select A/C to get refrigerated outside air through the instrument panel registers.



This position is used for cooling except when it is extremely hot or fast cooling of the vehicle is needed. In this case, select MAX A/C for fast cooling and return to A/C when you are comfortable.

▼ MAX A/C position\*

The MAX A/C position produces cool air more rapidly to provide faster cooling of your vehicle. Select MAX A/C to get recirculated refrigerated air through the instrument panel registers.

**⚠ WARNING**

***Fog Build-Up on Interior Glass:***

*Operating with the function selector in Off or MAX A/C for extended periods of time in cold weather can result in fog build-up on interior glass surfaces. This fogging can make it difficult to see the road for safe driving. To help prevent fogging, simply draw in outside air by placing the function selector control knob in , , or  position and adjust the temperature as necessary.*

\*Some models.

## Driving Your Mazda

---

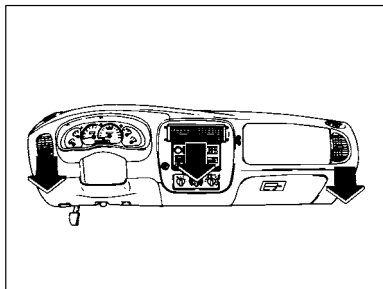

### ▼ (VENT) position

Use  to bring outside air through the instrument panel registers.

You can heat the air in this position by rotating the temperature control knob into the red (WARM) area. The air cannot be cooled below the outside temperature regardless of the temperature control knob setting. Select A/C or MAX A/C to get cool air through the instrument panel registers.

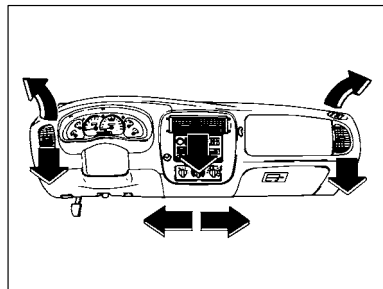

### ▼ (PANEL and FLOOR) position

Select  for airflow to the floor and through the instrument panel registers at the same time.

The air conditioner will operate to cool the air if the outside temperature is about 50°F (10°C) or warmer.

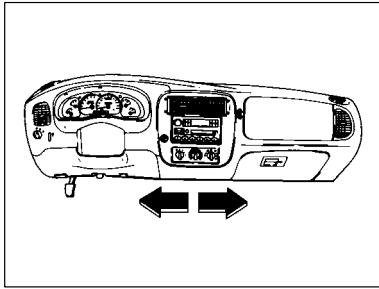

▼  (FLOOR) position

Air is delivered to the floor vents.

The air cannot be cooled in this position but can be heated by rotating the temperature control knob into the red (WARM) area.

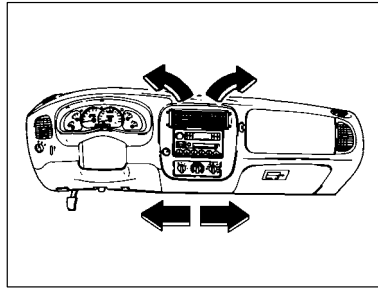

▼  (FLOOR and DEFROST) position

The air is delivered to the floor and the windshield. The A/C will operate to cool the air if the outside temperature is about 50°F (10°C) or warmer. The air will also be dehumidified to remove moisture.

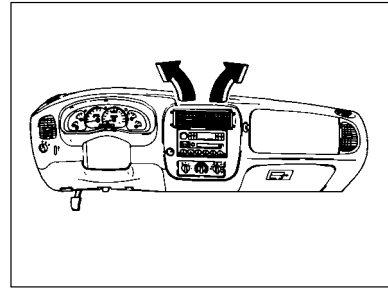

▼  (DEFROST) position

The air is delivered to the windshield. The compressor is engaged to dehumidify the air if the ambient temperature is above approximately 50°F (10°C).

## Driving Your Mazda

---

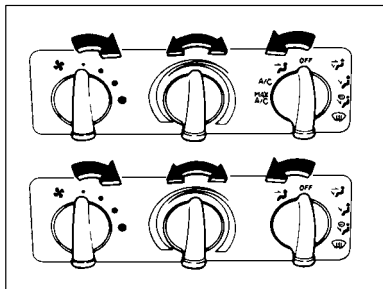

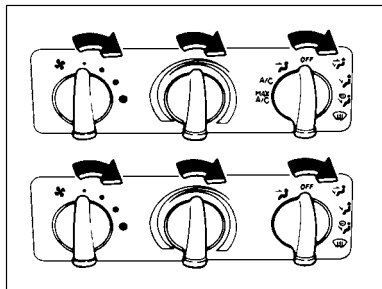

### ▼ Ventilation

- Set the function selector knob at the  position.
- Set the temperature control knob at a desirable position.
- Set the fan blower control knob at a desirable position.
- Airflow may be controlled by adjusting the side vents.



### ▼ Heating

- Set the function selector control knob at the  position.
- Set the temperature control knob to the desired position near the red (WARM) area.
- Set the fan blower control knob.

- For dehumidified heating, turn the function selector control knob to the  position and turn on the air conditioner. (If the outside temperature is about 50°F {10°C} or warmer, the air will automatically be dehumidified.)



**NOTE**

For maximum heating, turn the function selector control knob to , the temperature control knob to the red (WARM) area and turn the fan blower control knob to the highest setting.

**NOTE**

If the windshield fogs up easily, set the selector at  (DEFROST).

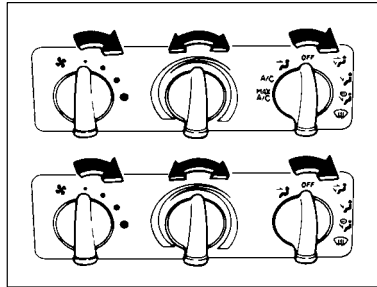

■ **Windshield Defrosting and Defogging**

- Set the function selector control knob at  (DEFROST).
- Set the temperature control knob to the desired position.
- Set the fan blower control knob.



**NOTE**

For maximum defrosting, turn the function selector control knob to the  (DEFROST) position, the temperature control knob to the red (WARM) range and the fan blower control knob to the highest setting.

**NOTE**

For maximum defogging, set the function selector control knob at MAX A/C, the temperature control knob to the red (WARM) range and the fan blower control knob to the highest setting.

### NOTE

- If warm air is desired on the floor, set the function selector control knob at  or .
- If dehumidified heating is desired, turn the function selector control knob to A/C or MAX A/C.
- Clear all snow and ice from the hood and the air inlets in the cowl-ing grille to improve heater and defroster efficiency and to reduce the chance of fogging on the inside of the windshield.

### ■ Dehumidifying (With Air Conditioning)

Operate the air conditioner in cool or cold weather to help defog the windshield and side windows.

- Set the temperature control knob at a comfortable position.
- Start the engine. Turn the function selector control knob to A/C or MAX A/C.
- Select the desired airflow and fan speed position.

### NOTE

Since the air conditioner removes considerable moisture from the air during operation, it is normal if water drips on the pavement under the air conditioner drain after you have stopped the vehicle.



## ■ Heater Controls (Heater-only Vehicles)

The fan speed, temperature, and function controls are essentially the same as the A/C controls with the exception that the heater-only control assembly has no function control settings for A/C or MAX A/C.

## ■ Operating Tips

### ▼ Air-conditioning controls

- If the vehicle has been parked in direct sunlight during hot weather, run the air conditioner at its coolest setting with the windows open. This will let warm air escape.
- Use the air conditioner to clean foggy windows on rainy days.

- If the engine overheats, turn the function control knob to  or  to turn the air conditioning OFF and stop the compressor for a short time.

### NOTE

The optional air conditioner is filled with R-134a, a refrigerant that will not damage the ozone.

If the air conditioner is low on refrigerant or has some other problem, consult an Authorized Mazda Dealer.

### NOTE

Whenever service to the air conditioning system is required, make sure the service facility uses a refrigerant recycling system. These systems will capture the refrigerant for reuse. Releasing the refrigerant into the atmosphere can damage our environment.

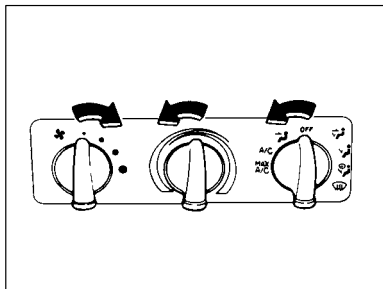

### ▼ Cooling\* (Air Conditioning)

1. Start the engine.
2. Turn the function selector control knob to A/C or MAX A/C.

3. Set the temperature control knob in the blue (COOL) range.
4. Set the fan blower control knob.  
For maximum comfort, adjust the fan blower control knob and temperature control knob.

#### NOTE

For maximum cooling, set the temperature control knob at the extreme left and set the function selector knob at the MAX A/C position. Then turn the fan blower control knob to the far right for the highest speed.

#### CAUTION

When using the air conditioner on long hills or in heavy traffic, watch the temperature gauge closely. If it indicates overheating, turn the air conditioner off (page 4-47).

#### CAUTION

When stopped in traffic for long periods of time in hot weather, place the automatic transmission gearshift selector in P (Park), or in N (Neutral) for manual transmissions, to increase the engine idle speed.

\*Some models.

**NOTE**

Slight increases and decreases in engine rpm may be noticed. This should be considered normal because of A/C compressor cycling. The reduction in compressor operation helps improve fuel economy.

 **WARNING**

**Foggy Windshield:**

*Don't use the  position during cool operation in very humid outside weather. The difference between outside air and windshield temperatures could fog up the inside of the windshield. Choose one of the other positions.*

**NOTE**

When your vehicle's engine is operated at full throttle, the air conditioner compressor will automatically be turned off to allow maximum engine power. This may occur during passing or when climbing steep grades. The compressor will return to normal operation within a few seconds after full throttle is no longer needed.

### Radio Reception

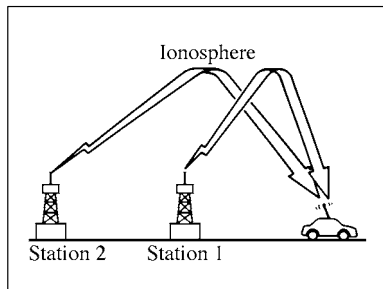

#### ■ AM Characteristics

##### ▼ Station Mixing

AM signals bend around such things as buildings and mountains and bounce off the ionosphere. Therefore, they can reach longer distances than FM signals. But because of this, two stations may sometimes be picked up at once on the same frequency.

5-86

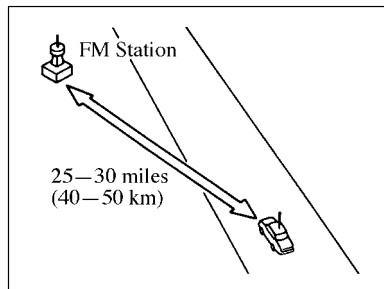

#### ■ FM Characteristics

An FM broadcast range usually extends up to about 25 to 30 miles (40 to 50 km) from the source. Because of extra coding needed to break the sound into two channels, stereo FM has even less range than monaural (nonstereo) FM.

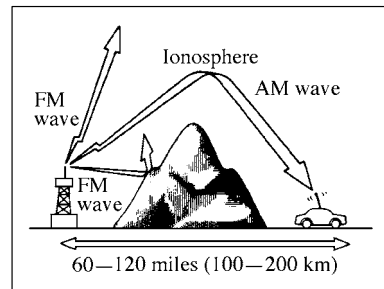

FM transmitter signals are similar to beams of light because they don't bend around corners, but they do reflect.

Unlike AM signals, they cannot travel beyond the horizon. That's why FM stations can't reach the great distances AM stations can.

Atmospheric conditions can also affect FM reception. High humidity will cause poor reception, but cloudy days may provide better reception than clear days.

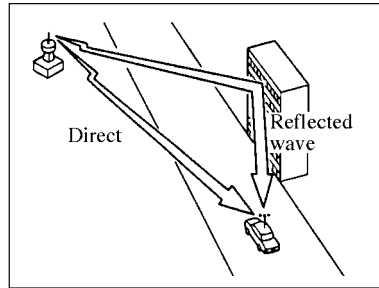

### ▼ Multipath noise

Because FM signals can be reflected by obstructions, the direct signal and the reflected signal may be received at once. This slightly delays reception and may be heard as a broken sound or a distortion. This problem may also arise when reception is close to the station transmitter.

To minimize these conditions, a stereo/mono blend circuit has been incorporated into this system. This feature automatically switches a weak stereo signal to a clear monaural signal, which improves the quality of reception.

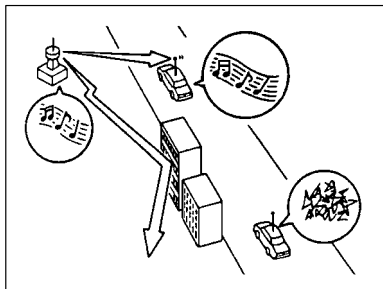

### ▼ Flutter/skip noise

FM signals move in straight lines and weaken in valleys between tall buildings, mountains, and other obstacles. Reception in these areas may fade out and result in annoying noise.

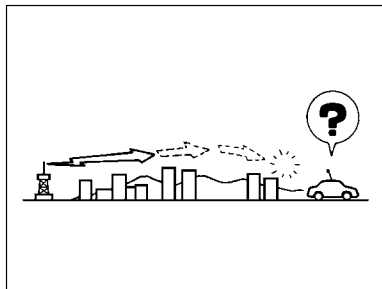

### ▼ Weak signal noise

In some areas, broadcast signals become weak, because of distance from the transmitter. Reception in such fringe areas is characterized by sound breakup

### ▼ Strong signal noise

This occurs very close to a transmission tower. The broadcast signals are extremely strong, so the result is noise and sound breakup at the radio receiver.



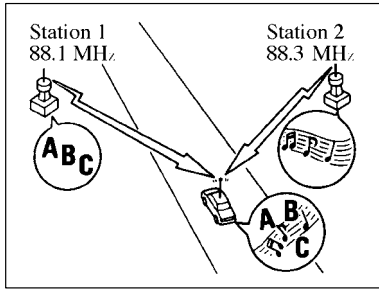

▼ **Station drift noise**

When a vehicle reaches the area of two strong stations broadcasting at similar frequencies, the original station may be temporarily lost and the second station picked up. At this time there will be some noise from the disturbance.

## Driving Your Mazda

### AM/FM Radio

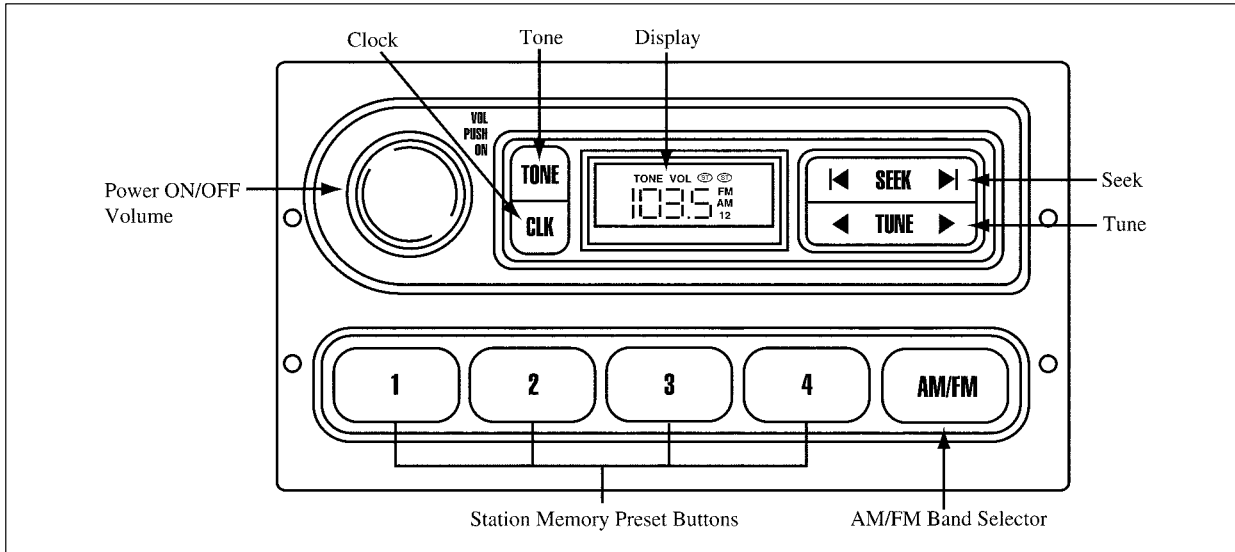

### AM/FM Radio with Cassette Player\*

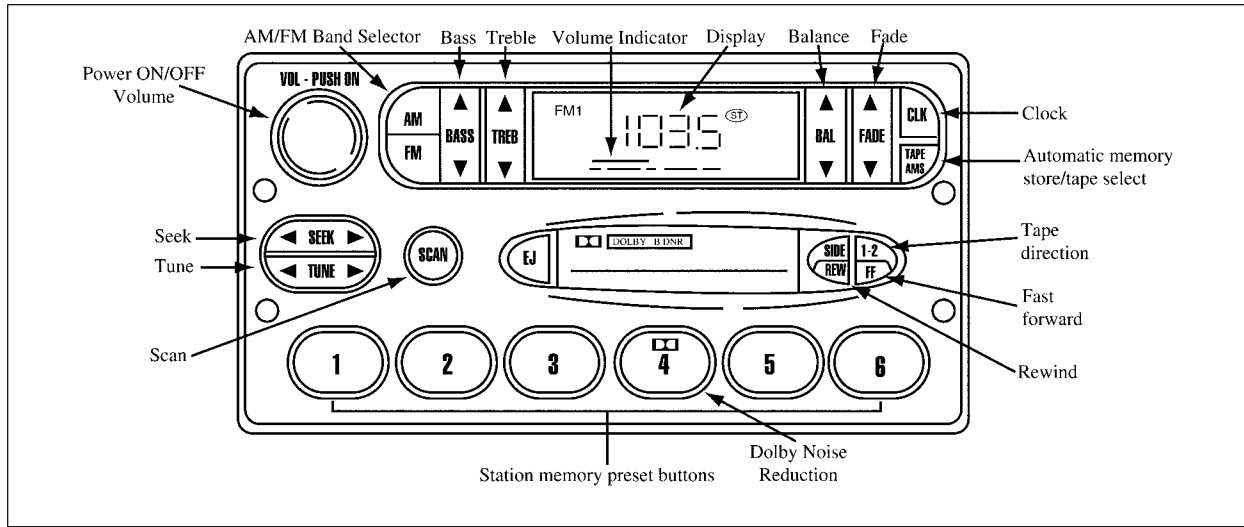

\*Some models.

## Driving Your Mazda

### AM/FM Radio with Compact Disc Player\*

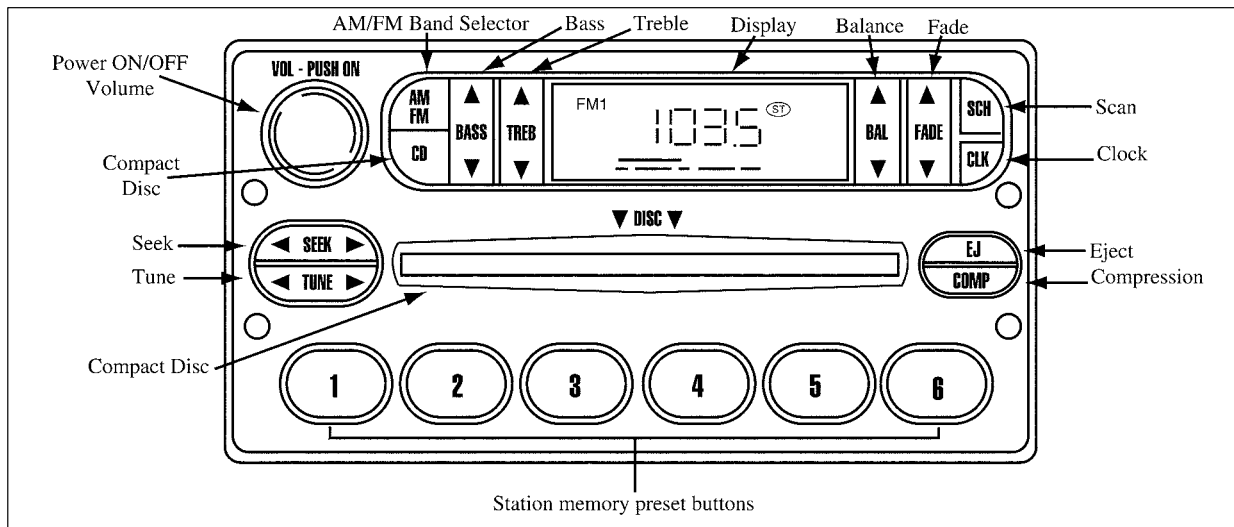

\*Some models.

### AM/FM Radio with Cassette and Compact Disc Player\*

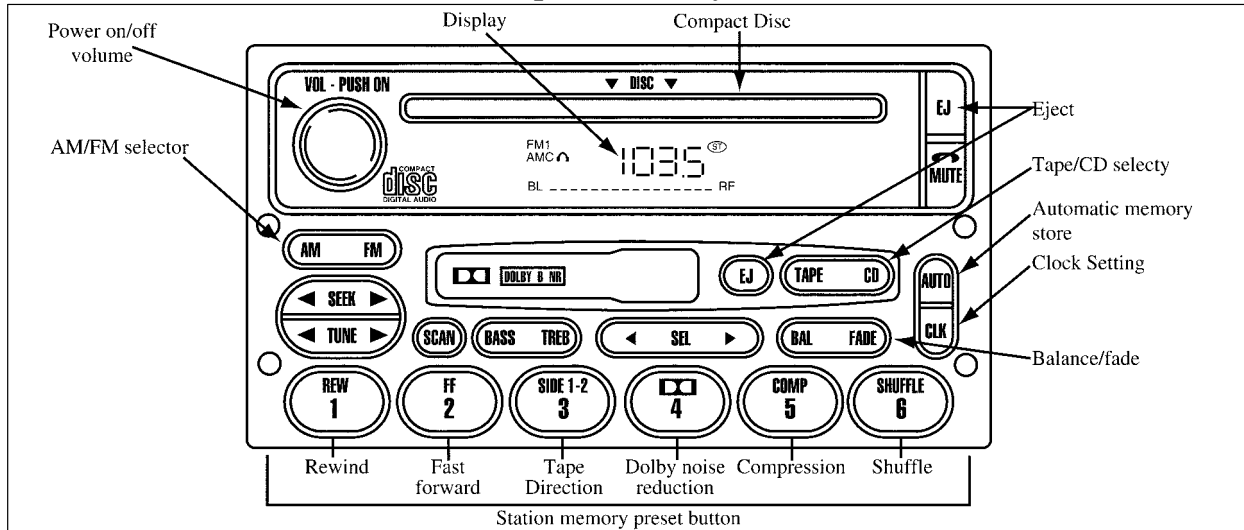

\*Some models.

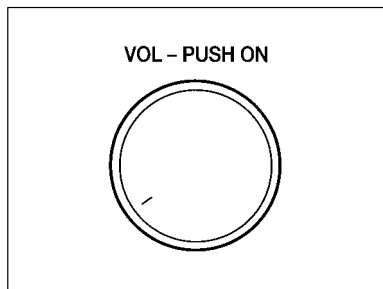

### ■ How to Turn the Radio On and Off

Press the VOL/PUSH ON knob to turn the audio system on or off.

If you have an AM/FM radio with cassette and CD player, audio power can also be turned on by pressing the AM/FM select control or the Tape/CD select control. Audio power is turned off by using the VOL/PUSH ON knob.

### ■ How to Adjust the Volume

Turn the VOL/PUSH ON knob to the right to increase the volume and to the left to decrease the volume.

#### NOTE

If the volume level is set above a certain level and the ignition switch is turned off, the volume will come back on at a “nominal” listening level when the ignition switch is turned back on.

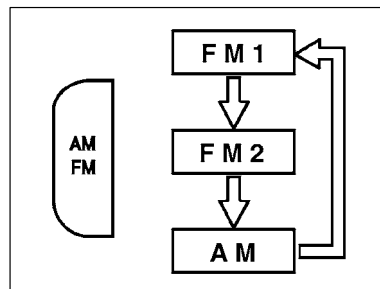

### ■ AM/FM Select

The AM/FM select control works in radio, tape and CD modes (if equipped).

### ▼ AM/FM select in radio mode

This control allows you to select AM or FM frequency bands. Press the control to switch between AM, FM1 or FM2 memory preset stations.

### ▼ AM/FM select in tape mode\*

Press AM/FM to stop tape play and begin radio play.

### ▼ AM/FM select in CD mode\*

Press AM/FM to stop CD play and begin radio play.

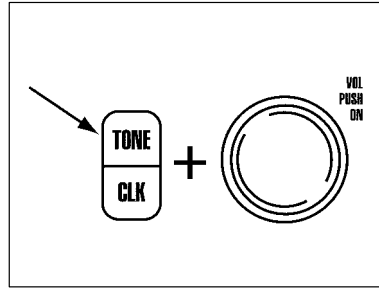

If you have an AM/FM radio, press the TONE control once, then use the volume knob to adjust the level.

## ■ Tone Balance and Speaker Output

### ▼ Bass adjust

The bass adjust control allows you to increase or decrease the audio system's bass output.

\*Some models.

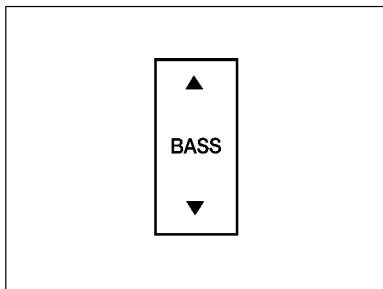

If you have an AM/FM radio with cassette or CD player, press ▲ to increase or ▼ to decrease the bass output.

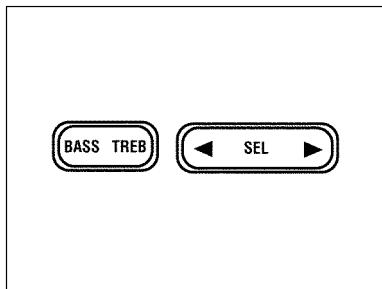

If you have an AM/FM radio with cassette and CD player, press the BASS control then press:

- ◀ to decrease bass output
- ▶ to increase bass output

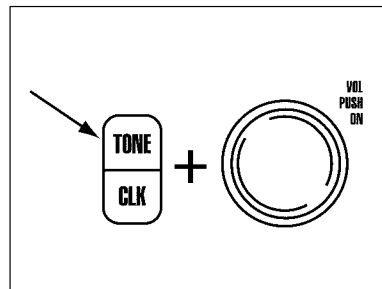

### ▼ Treble adjust

The treble adjust control allows you to increase or decrease the audio system's treble output.

If you have an AM/FM radio, press the TONE control twice, then use the volume knob to adjust the level.



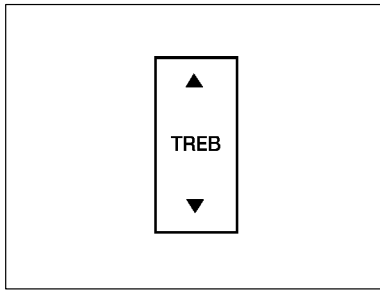

If you have an AM/FM radio with cassette or CD player, press ▲ to increase or ▼ to decrease the treble output.

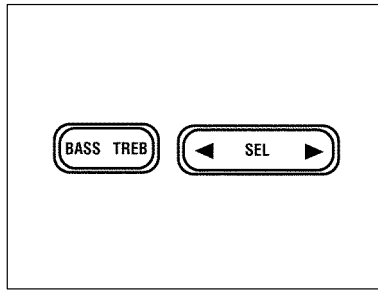

If you have an AM/FM radio with cassette and CD player, press the TREB control then press:

- ◀ to decrease treble output
- ▶ to increase treble output

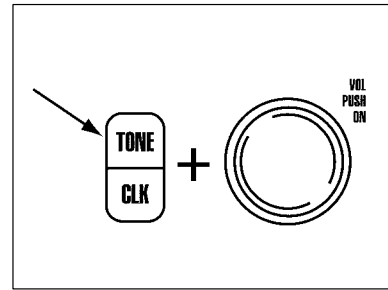

▼ **Speaker balance adjust**

Speaker sound distribution can be adjusted between the right and left speakers.

If you have an AM/FM radio, press the TONE control three times, then use the volume knob to adjust the level.

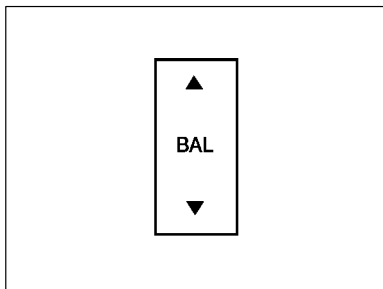

If you have an AM/FM radio with cassette or CD player, speaker sound distribution can be adjusted between the right (▲) and left (▼) speakers.

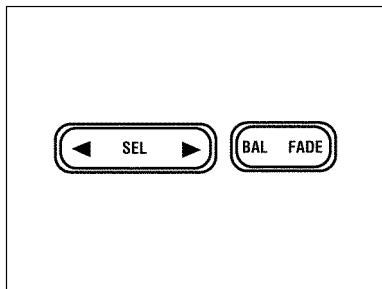

If you have an AM/FM radio with cassette and CD player, press the BAL control then press:

- ◀ to shift sound to the left
- ▶ to shift sound to the right

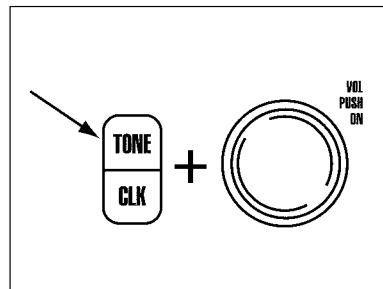

### ▼ Speaker fade adjust

Speaker sound can be adjusted between the front and rear speakers.

If you have an AM/FM radio, press the TONE control four times, then use the volume knob to adjust the level.

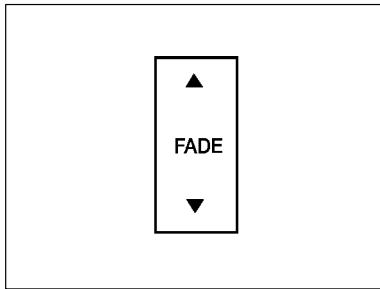

If you have an AM/FM radio with cassette or CD player, speaker sound can be adjusted between the front (▲) and rear (▼) speakers.

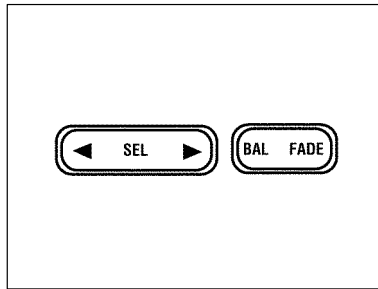

If you have an AM/FM radio with cassette and CD player, press the FADE control then press:

- ◀ to shift sound to the front
- ▶ to shift sound to the rear

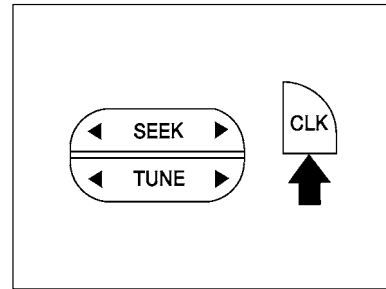

### ■ Clock Operation

Press the CLK control button to display the time. The time will continue to be displayed until a radio, tape or CD function is chosen.

## Driving Your Mazda

---

After 10 seconds, the time will again appear in the display. To display radio or tape information only, press the CLK control button a second time.

### NOTE

The clock can be displayed whether the ignition is on or off.

### ▼ Setting the clock

Press CLK to toggle between listening frequencies and clock mode while in radio mode.

To set the hour, press and hold the CLK control button and press:

SEEK ◀ to decrease hours

SEEK ▶ to increase hours

To set the minute, press and hold the CLK control button and press:

TUNE ◀ to decrease minutes

TUNE ▶ to increase minutes

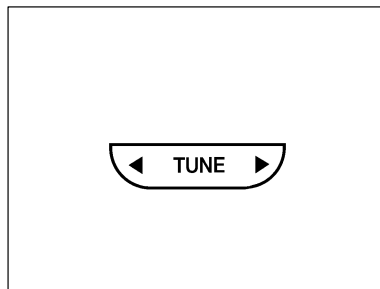

### ■ TUNE Adjust

The TUNE control works in the radio mode.

### ▼ TUNE adjust in radio mode

Press ◀ to move to the next frequency down the band (whether or not a listenable station is located there). Hold the control to move through the frequencies quickly.

Press ▶ to move to the next frequency up the band (whether or not a listenable station is located there). Hold for quick movement.

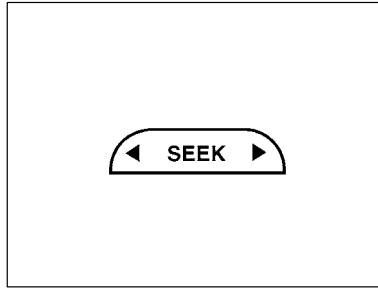

### ■ SEEK Function

The SEEK control function works in the radio mode.

If you have an AM/FM radio with cassette and CD player, the SEEK control function works in the radio, tape and CD mode.

### ▼ SEEK function in radio mode

Press ◀ to find the next listenable station down the frequency band.

Press ▶ to find the next listenable station up the frequency band.

### ▼ SEEK function in tape mode\*

Press ◀ to listen to the previous selection on the tape.

Press ▶ to listen to the next selection on the tape.

\*Some models.

### ▼ SEEK function in CD mode\*

Press ◀ to seek to the previous track on the disc.

Press ▶ to seek to the next track on the disc. After the last track has been completed, the first track of the disc will automatically replay.

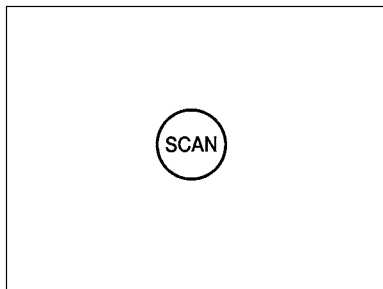

### ▼ SCAN function in radio mode\*

The SCAN control function is available on all audio systems except the AM/FM radio.

Press the SCAN control to hear a brief sampling of all listenable stations on the frequency band. Press the control again to stop the scan mode.

### ▼ SCAN function in tape mode\*

If you have an AM/FM radio with cassette and CD player, press the SCAN control to hear a short sampling of all selections on the tape. (The tape scans in a forward direction. At the end of the tape's first side, direction automatically reverses to the opposite side of the tape.) To stop on a particular selection, press the control again.

### ▼ SCAN function in CD mode\*

Press the SCAN control to hear a short sampling of all selections on the CD. (The CD scans in a forward direction, wrapping back to the first track at the end of the CD.) To stop on a particular selection, press the control again.

\*Some models.

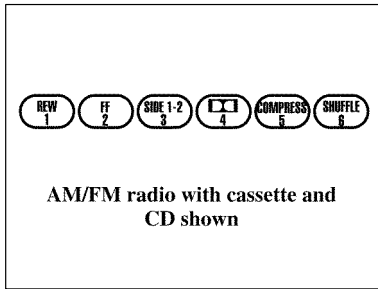

### ▼ Radio station memory preset

The radio is equipped with four or six station memory preset buttons. These buttons can be used to select up to four or six preset AM stations and eight or twelve FM stations (four or six in FM1 and four or six in FM2).

### ▼ Setting memory preset stations

1. Select a frequency band with the AM/FM select control.
2. Select a station.
3. Press and hold a memory preset button until the sound returns, indicating the station is held in memory on the control you selected.

### ■ Autoset Memory Preset\*

Autoset allows you to set strong radio stations without losing your original manually set preset stations. This feature is helpful on trips when you travel between cities with different radio stations.

### ▼ Starting autoset memory preset

1. Select a frequency using the AM/FM select controls.
2. Press the AUTO control.
3. When the first six strong stations are filled, the station stored in memory preset control 1 will start playing.

If there are less than six strong stations available on the frequency band, the remaining memory preset controls will all store the last strong station available.

To deactivate autoset and return to your audio system's manually set memory stations, press the AUTO control again.

\*Some models

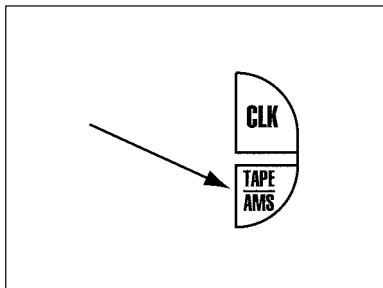

### ■ Automatic Music Search\*

The Automatic Music Search feature allows you to quickly locate the beginning of the tape selection being played or to skip to the next selection.

To activate the feature, momentarily depress the TAPE AMS button. Then, press either REW (for the beginning of the current selection) or FF (to advance to the next selection). The tape deck stops and returns to play mode when the AMS circuit senses a blank section on the tape.

In order to ensure proper operation of the AMS feature, the tape **MUST** have a blank section of at least 4 seconds duration between programs.

\*Some models.

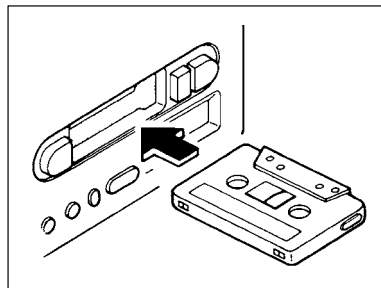

### ■ How to Insert a Tape\*

Your cassette tape player is equipped with power loading. Once you insert a tape and push slightly (with the open edge to the right), the loading mechanism draws the tape the rest of the way in and play will begin after a momentary (one second) tape tightening process. Display indicates "TAPE" while tape is playing.



### ■ How to Insert a Compact Disc and Begin Playing\*

Insert a disc, label side up, into the disc opening. When inserted, the disc automatically loads into the unit and play starts at the beginning of the first track (selection).

#### NOTE

Once a disc is inserted, the disc opening is secured to prevent the accidental insertion of another disc.

#### NOTE

The CD player has heat protection circuitry to protect the laser diode. If the temperature of the player reaches 167°F (76°C), the heat detection circuit will shut off the player and (CD HOT) will scroll in the display for approximately five seconds (radio will resume playing). When the temperature returns to normal operating range, the CD player will again be operational.

\*Some models.

## Driving Your Mazda

---

### ■ Tape/CD Select\*

To begin tape play (with a tape loaded in the audio system) while in the radio or CD mode, press the TAPE control.

Press the button during rewind or fast forward to stop the rewind or fast forward function.

To begin CD play (if CDs are loaded), press the CD control. The first track of the disc will begin playing. After that, CD play will begin where it stopped last.

### ▼ Rewind\*

The rewind control works in tape and CD modes.

In tape mode, radio play will continue until rewind is stopped (with the TAPE control) or the beginning of the tape is reached.

If you have an AM/FM radio with cassette and CD player, pressing the REW control rewinds the CD within the current track.

### ▼ Fast forward\*

The fast forward control works in tape and CD modes.

In tape mode, tape direction will automatically reverse when the end of the tape is reached.

If you have an AM/FM radio with cassette and CD player, pressing the FF control in the CD mode fast forwards the CD within the current track.

\*Some models.

### ■ Tape Direction Select\*

Press SIDE 1-2 to play the alternate side of a tape.

### ■ Eject Function\*

Press the control to stop and eject a tape and/or CD.

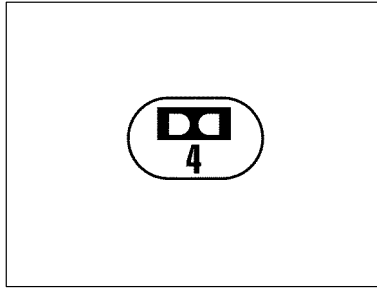

### ■ Dolby® Noise Reduction\*

Dolby® noise reduction operates only in tape mode.

Dolby® reduces the amount of hiss and static during tape playback. Press the  control to activate (and deactivate) the noise reduction.

Dolby noise reduction is manufactured under license from Dolby Laboratories Licensing Corporation. “Dolby” and the double-D symbol  are trademarks of Dolby Laboratories Licensing Corporation.

\*Some models.

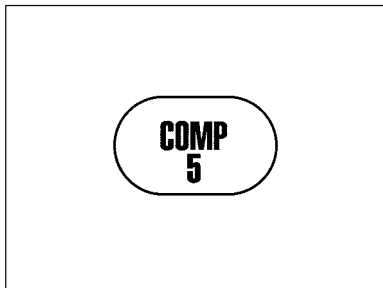

### ■ Compression Adjust\*

Compression adjust brings soft and loud CD passages together for a more consistent listening level.

Press the COMP control to activate and deactivate compression adjust.

\*Some models.

**5-108**

### ■ Shuffle Feature\*

The shuffle feature operates in CD mode and plays all tracks on the current disc in random order.

Press the SHUFFLE control to start this feature. Random order play will continue until the SHUFFLE control is pressed again.

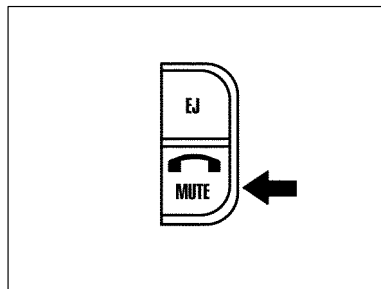

### ■ Mute\*

Press this button to mute the sound without turning off the radio. "Audio Mute" will appear on the display. Press again to return to normal operation.

### ■ Tips on Caring for the Cassette Player and Tapes\*

In order to keep your cassette tape player performing the way it was meant to, read and follow these simple precautions:

- Using a Mazda Cassette Cleaning Cartridge to clean the tape player head after 10-12 hours of play will help maintain the best playback sound and proper tape operation.
- Only cassettes that are 90 minutes long or less should be used. Tapes longer than 90 minutes are thinner and subject to breakage or may jam the tape player's mechanism.
- Protect cassettes from exposure to direct sunlight, high humidity and extreme hot or cold. If they are exposed to extreme conditions, allow them to reach a moderate temperature before playing.
- If a tape is loose inside the cassette, tighten it before playing by putting your finger or a pencil into one of the holes and turning the hub until the tape is tight.
- Loose labels on cassette tapes can become lodged in the mechanism. Remove any loose label material before inserting the cassette.
- Do not leave a tape in the cassette tape player. High heat in the vehicle can cause the cassette to warp.

\* Some models.

### ■ How to Take Care of and Clean Your System and Discs\*

Your system is designed to give years of listening enjoyment. To ensure this continued performance, carefully read the following precaution:

- Always handle the disc by its edge. Never touch the playing surface.
- Before playing, inspect the disc for any contamination. If needed, clean the disc with an approved disc cleaner, such as the Discwasher Compact Disc Cleaner or the Allsop 3 Compact Disc Cleaner, by wiping from the center out to the edges. **Do not use a circular motion to clean.**

- Do not clean discs with solvents such as benzine, thinner, commercially available cleaners or antistatic spray intended for analog records.
- Do not expose the disc to direct sunlight or heat sources such as defroster and floor heating ducts. Do not leave any discs in a parked car in direct sunlight where there may be a considerable rise in temperature or damage may result.
- After playing, store the disc in its case.
- If a disc has already been inserted, do not try to insert another disc. Doing so may damage the disc player.
- Do not insert anything other than a disc into the disc player.

\*Some models.

### **WARNING**

#### *Disassembling the Compact Disc Changer System:*

*The use of optical instruments with this product will increase eye hazard as the laser beam used in this compact disc changer system is harmful to the eyes. Do not attempt to disassemble the case. Refer servicing to qualified personnel only.*

### ■ Common Operating Conditions\*

The following information is designed to help recognize typical situations that could be mistakenly interpreted as mechanical malfunctions of the compact disc player:

- A disc is already loaded.
- The disc is inserted with the label surface downward.
- The disc is dusty or defective.
- The player temperature is above 167°F (76°C). Allow the player to cool off before operating.

- Different manufacturers of compact discs may produce discs with different dimensions or tolerances, some of which may not be within industry standards or in accordance with the CD format. Because of this, a new disc that is free of dust and scratches could be defective and may not play on your disc player.

If play does not begin once the disc has been inserted:

- The unit may be in the stop mode.

- Moisture may have condensed on the lenses within the unit. If this occurs, remove the disc and wait approximately an hour until the moisture evaporates.

If the sound skips:

- Badly scratched discs or extremely rough roads will cause the sound to skip. Skipping will not damage the disc player or scratch the disc.

\*Some models.

**Memo**

---

**5-112**



# 6

## In Case of Emergency

*Because an emergency can occur any time, we strongly urge you to become familiar with this section of your manual. It provides helpful information on what to do if the engine overheats, if you have a flat tire, and if the battery is discharged.*

*You will also find out what to do if you confront a problem in the electrical system, and there's some guidance on the correct way to tow your Mazda.*

Hazard Warning Flasher	6- 2
Overheating	6- 3
Emergency Starting	6- 4
Fuses and Circuit Breakers	6- 8
Towing	6-18
Flat Tire	6-26

## In Case of Emergency

---

### Hazard Warning Flasher

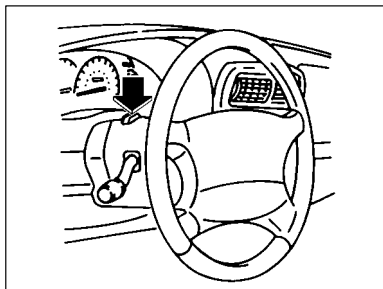

The hazard warning lights warn other drivers that your vehicle is a traffic hazard and that they must take extreme caution when near it.

The hazard warning lights should always be used when you stop on or near a roadway.

Depress the hazard warning button and all four turn signals will flash at once. To stop the hazard flashers, press the button again.

The flashers will flash and the high mount brake light will stay on steadily (not flash) with the brake pedal depressed.

The flashers work whether your vehicle is running or not. The flashers work for up to two hours when the battery is fully

charged and in good condition. They will not drain the battery excessively. If the flashers run for longer than two hours or if your battery is not fully charged, your battery can be drained.

#### NOTE

- The turn signals don't work when the hazard lights are on.
- Check local regulations about the use of hazard warning lights while the vehicle is being towed. They may forbid it.

## Overheating

If the temperature gauge indicates overheating, if you experience power loss, or if you hear a loud knocking or pinging noise, the engine is probably too hot.

If this happens:

1. Drive safely to the side of the road and park off the right-of-way. Set an automatic transmission in P (Park), a manual transmission in N (Neutral). Apply the parking brake. Turn the engine off and let it cool.
2. The air conditioner must be off.



### WARNING

***Overheated Engine:***

***Overheated engines are dangerous. The escaping steam could seriously burn you.***

***If steam is coming from the engine compartment, don't go near the front of the vehicle. Stop the engine.***

***Open the hood ONLY after steam is no longer escaping from the engine.***

3. If **neither coolant nor steam is escaping**, open the hood.
4. Visually inspect the alternator/water pump drive belt for looseness and breakage and all cooling hose connections for leaks. If the belt is broken or coolant is leaking, call an Authorized Mazda Dealer for assistance.
5. If the drive belt is OK, if the engine is cool, and if no coolant leaks are obvious, inspect the coolant level. Carefully add coolant as required (page 8-22).

### **WARNING**

#### Radiator Cap:

*When the engine and radiator are hot, scalding coolant and steam may shoot out under pressure and cause serious injury. Don't remove the radiator cap when the engine and radiator are hot.*

### **CAUTION**

If the engine continues to overheat or frequently overheats, have the cooling system inspected. The engine could be seriously damaged unless repairs are made.

## Emergency Starting

### ■ Jump-Starting

Jump-starting is dangerous if done incorrectly. So follow procedures carefully. If you feel unsure about jump-starting, we strongly recommend that you have a competent service technician do the work.

### **CAUTION**

Use only a 12-volt booster system. You can damage a 12-volt starter motor, ignition system, and other electrical parts beyond repair with a 24-volt power supply (two 12-volt batteries in series or a 24-volt motor generator set).

### **CAUTION**

Do not disconnect the battery of the vehicle that needs a jump-start. You could damage the vehicle's electrical system.

### **WARNING**

#### Battery-Related Explosion:

*Hydrogen gas is produced during normal battery operation. A battery-related explosion can cause serious injury. Keep all flames (including cigarettes), heat, and sparks away from the top and surrounding area of open battery cells.*

**⚠ WARNING**

***Jump-Starting:***

*Jump-starting a frozen battery or one with a low fluid level is dangerous. It may rupture or explode, causing serious injury. Don't jump-start a frozen battery or one with a low fluid level.*

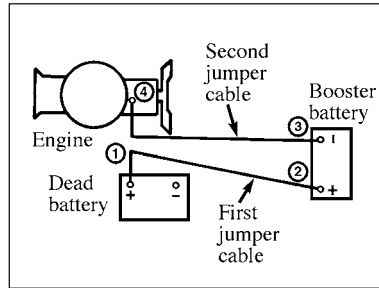

1. Make sure the booster battery is 12-volts and that its negative terminal is grounded.

**⚠ CAUTION**

If the booster is in another vehicle, don't allow the vehicles to touch. A short could be created.

2. Turn off the engine of the vehicle and all unnecessary electrical loads.

## In Case of Emergency

---

3. Connect the jumper cables in the exact sequence as shown in the illustration.
    - (1) Connect one end of a cable to the positive terminal on the discharged battery ①.
    - (2) Attach the other end to the positive terminal on the booster ②.
    - (3) Connect one end of the other cable to the negative terminal of the booster ③.
    - (4) Connect the other end to a solid, stationary, metallic point (for example, the engine lifting bracket or the strut mounting bolt) away from the battery ④.
  4. Start the engine of the booster vehicle and run it a few minutes. Then start the engine of the other vehicle.
  5. When finished, carefully disconnect the cables in the reverse order described in Step 3.
- After your vehicle is started, let it idle for a while to let the engine “relearn” its idle conditions and drive it around for a little while with all electrical accessories turned off to let the battery recharge. You may need to use a battery charger to fully recharge the battery.

### **WARNING**

#### **Handling the Battery:**

***Applying too much pressure on the ends when lifting a battery could cause acid to spill. Lift the battery with a carrier or with your hands on the opposite corners. Batteries contain sulfuric acid which burns skin, eyes and clothing. If acid touches someone's skin, eyes or clothing, immediately flush the area with water for at least 15 minutes. If someone swallows the acid, have him or her drink lots of milk or water first, then Milk of Magnesia, a beaten egg or vegetable oil. Call a doctor immediately.***

 **WARNING**

Connecting to Negative Terminal:  
Connecting the end of the second cable to the negative (–) terminal of the discharged battery is dangerous. A spark could cause the gas around the battery to explode and injure someone. Connect the cable to a point away from the battery.

 **WARNING**

Connecting Jumper Cable to a Moving Part:  
Connecting a jumper cable near or to a moving part is dangerous. The cable could get caught when the engine starts and cause serious injury. Never connect a jumper cable to or near any part that moves.

■ **Push-Starting**

You can't start a vehicle with an automatic transmission by pushing it.

 **CAUTION**

You shouldn't push-start a vehicle that has a manual transmission. It can damage the emission control system.

### **WARNING**

**Towing a Vehicle to Start It:**  
*Towing a vehicle to start it could be dangerous. The sudden surge forward when the engine starts could cause the two vehicles to collide. Therefore, never tow a vehicle to start it.*

## Fuses and Circuit Breakers

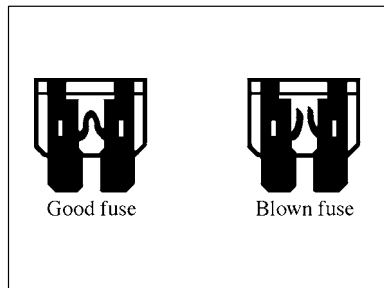

Your vehicle's electrical system is protected by fuses and circuit breakers.

If any lights, accessories, or controls don't work, inspect the appropriate circuit protector. If a fuse has blown, the inside element will be melted.

If the same fuse blows again, avoid using that system and consult an Authorized Mazda Dealer as soon as possible.



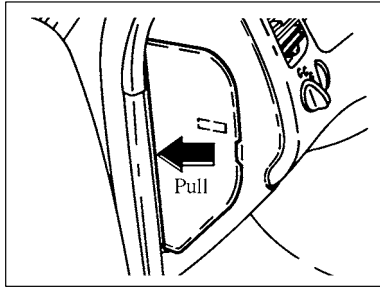

### ■ Fuse Replacement

If the electrical system doesn't work, first inspect fuses on the driver's side of the instrument panel.

1. Turn off the ignition and other switches.

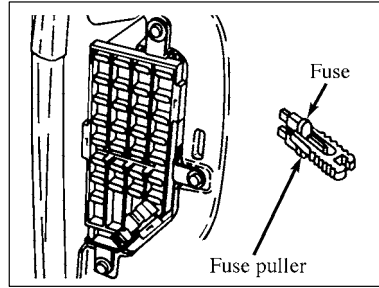

2. Pull the fuse straight out with the fuse puller provided on the fuse block cover.
3. Inspect it and replace it if it's blown.
4. Push in a new fuse of the same rating, and make sure it fits tightly. If it doesn't, have an Authorized Mazda Dealer install it.

Some spare fuses have been supplied for your use: one 10 amp (red), one 15 amp (blue), one 20 amp (yellow), and one 30 amp (light green). If you use these spare fuses, replace them with other fuses of the same rating so you will have them when you need them.

## In Case of Emergency

---

### CAUTION

Always replace a fuse with one of the same rating. Otherwise you may damage the electrical system.

### WARNING

#### Replacing Fuses:

*Always disconnect the battery before removing the cover to the fuse block to replace an open (blown) high current fuse.*

*Always replace the cover to the fuse block before reconnecting the battery.*

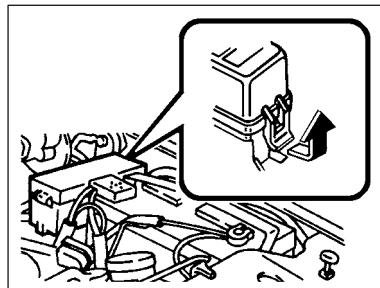

If the headlights or other electrical components don't work and the fuses in the cabin are OK, inspect the fuse block (power distribution box) under the hood. If a fuse is blown, it must be replaced. Follows these steps:

1. Turn off the ignition and all other switches.

2. Open the fuse block cover by squeezing the tabs on one end and pulling the cover upward.
3. If a fuse is blown, replace it with a new one **of the same rating**.

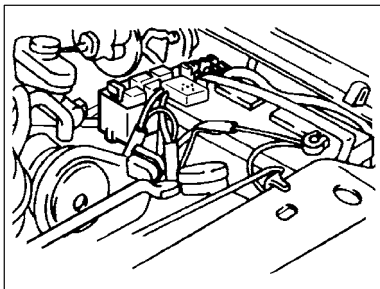

### ■ Circuit Breakers

Circuit breakers will reset themselves and allow the electrical parts to work again once the overload on the circuit is removed. If the circuit breakers continue to cut off electricity, have the electrical system checked by an Authorized Mazda Dealer.

Always replace a circuit breaker with one of the same rating.

To remove a circuit breaker located in the engine compartment fuse block, grip it with your finger and thumb and pull it straight out of the socket.

## In Case of Emergency

### ■ Fuse Panel Description

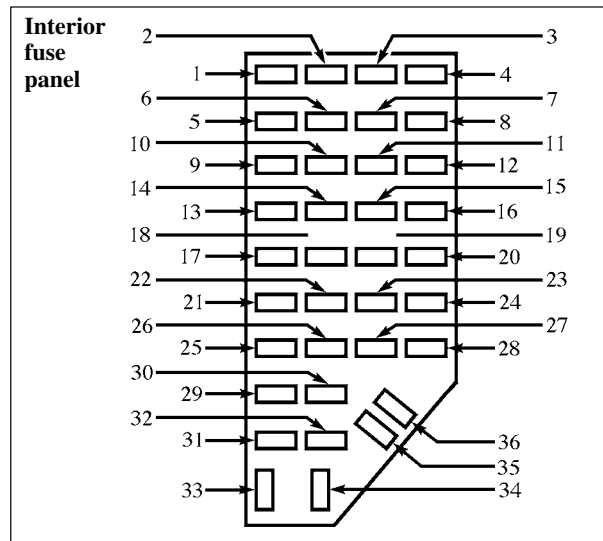

### ▼ Interior fuse panel

NUMBER	FUSE RATING	PROTECTED COMPONENT
1	5A	Power Mirror
2	10A	Blower Motor Relay, Air Bag Diagnostic Monitor, Passive Deactivation (PAD) Module
3	7.5A	Trailer Tow Connector (LH Stop/Turn)
4	—	Not Used
5	10A	4x4 Control Module
6	—	Not Used
7	7.5A	Trailer Tow Connector (LH Stop/Turn)
8	—	Not Used
9	7.5A	Stoplamp Switch
10	7.5A	Cruise Control Servo/Amplifier Assy., GEM/CTM, Shift Lock Actuator, Blend Door Actuator, A/C Heater Control Assy., Turn Signals

## In Case of Emergency

NUMBER	FUSE RATING	PROTECTED COMPONENT
11	7.5A	Instrument Cluster, Main Light Switch, RABS Resistor
12	—	—
13	20A	Brake Pedal Position Switch
14	20A	RABS Module
14	10A	4WABS Mod., 4WABS Main Relay
15	—	Not Used
16	30A	W/W Motor, Wiper Hi-Lo Relay, Wiper Run/Park Relay, Washer Pump Relay
17	25A	Cigar Lighter, Data Link Connector (DLC)
18	—	Not Used
19	25A	PCM Power Diode, Ignition, PATS
20	7.5A	GEM/CTM, Radio

NUMBER	FUSE RATING	PROTECTED COMPONENT
21	20A	Flasher
22	20A	Auxiliary Power Point
23	—	—
24	7.5A	Clutch Pedal Position (CPP) Switch, Starter Interrupt Relay
25	—	Not Used
26	10A	Battery Saver Relay, 4x4 Electronic Shift Relay, Interior Lamp Relay, 4x4 Elec. Shift Control Module, Dome/Map Lamp, Instrument Illumination Dimming Module, Restraint Control Module, GEM/CTM, Instrument Cluster
27	—	Not Used
28	7.5A	GEM/CTM System, Radio
29	15A	Radio
30	—	Not Used

## In Case of Emergency

---

<b>NUMBER</b>	<b>FUSE RATING</b>	<b>PROTECTED COMPONENT</b>
31	—	Not Used
32	—	Not Used
33	15A	Headlights, DRL Module, Instrument Cluster
34	—	Not Used
35	15A or Not Used	ISA Horn Relay if not Equipped with Truck Security Module
36	—	Not Used

**Engine compartment  
fuse block**

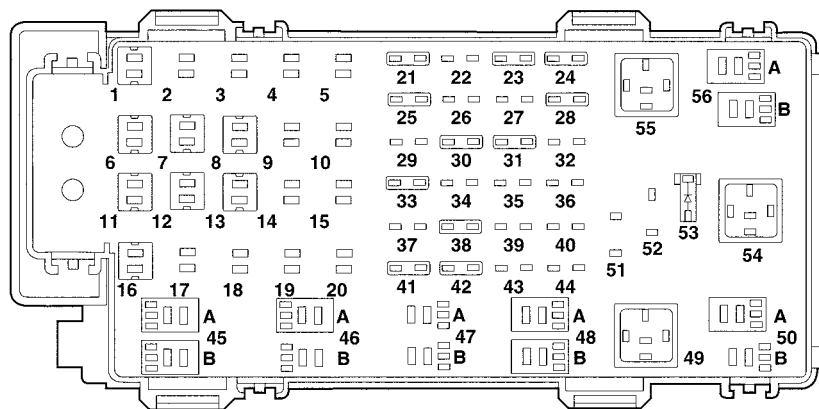

## In Case of Emergency

---

NUMBER	AMP RATING	DESCRIPTION
1	50A	I/P Fuse Panel
2	—	Not Used
3	—	Not Used
4	—	Not Used
5	—	Not Used
6	50A	ABS Pump Motor
7	30A	Powertrain Control Module
8	20A	Power Door Locks and Remote Entry
9	—	—
10	—	—
11	50A	Starter Relay Ignition Switch
12	10A	PCM Memory
13	20A	4x4 Motor
14	—	—
15	—	—
16	40A	Blower Motor

NUMBER	AMP RATING	DESCRIPTION
17	—	—
18	—	—
19	—	—
20	—	—
21	10A	PCM Memory
22	—	—
23	20A	Fuel Pump Motor
24	30A	Headlights
25	10A	A/C Clutch
26	—	—
27	—	—
28	30A	4WABS Module
29	—	—
30	15A	Trailer Tow
31	20A	Fog Lamps, Day Time Running Lamps (DRL)
32	—	—



## In Case of Emergency

NUMBER	AMP RATING	DESCRIPTION
33	15A	Park Lamp
34	—	—
35	—	—
36	—	—
37	—	—
38	10A	Left Headlamp Low Beam
39	—	—
40	—	—
41	—	Heated Oxygen Sensors
42	10A	Right Headlamp Low Beam
43	—	—
44	—	—
45A	—	Wiper High/Low
45B	—	Wiper Park/Run
46A	—	Not Used

NUMBER	AMP RATING	DESCRIPTION
46B	—	Front Washer Pump
47A	—	Not Used
47B	—	Not Used
48A	—	Fog Lamp
48B	—	Fog Lamp Relay
49	—	Full Starter
50A	—	Not Used
50B	—	Fuel Pump
51	—	Not Used
52	—	Not Used
53	—	Powertrain Control Module (PCM) Diode
54	—	Powertrain Control Module (PCM) Diode
55	—	Blower
56A	—	A/C Clutch Solenoid
56B	—	Trailer Tow

## In Case of Emergency

---

### Towing

We recommend that towing be done only by an Authorized Mazda Dealer or a commercial tow-truck service.

Proper lifting and towing are necessary to prevent damage to the vehicle. State and local laws must be followed.

When a vehicle is towed on its front wheels, lock the steering wheel in a straight ahead position with a steering wheel clamp.

On 4x2 vehicles, it is acceptable to tow the vehicle with the front wheels on the ground and the rear wheels off the ground.

On 4x4 vehicles, it is recommended that your vehicle be towed with a wheel lift or flatbed equipment.

Do not tow with slingbelt equipment.

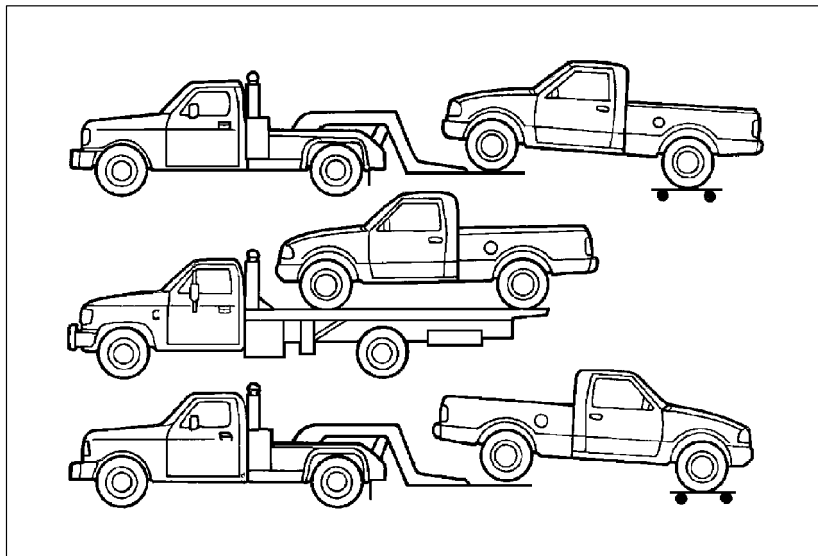

 **WARNING**

***Disconnecting Propeller Shaft:***  
***When disconnecting/connecting the propeller shaft, the parking brake must be set and the wheels must be blocked to ensure the vehicle does not roll during this procedure.***

■ **Towing with Front Wheels on Ground**

Before your vehicle is towed on its front wheels, release the parking brake and put the gearshift (both manual and automatic) in N (Neutral). If the transmission is malfunctioning, place the front wheels on dollies or disconnect the front propeller shaft. If the transfer case is malfunctioning, disconnect the front propeller shaft from the axle and secure or place the front wheels on dollies.

■ **Towing with Rear Wheels on Ground**

Before your vehicle is towed on its rear wheels, release the parking brake and put the gearshift (both manual and automatic) in N (Neutral). If the transmission is malfunctioning, place the rear wheels on dollies or disconnect the rear propeller shaft. If the transfer case is malfunctioning, disconnect the rear propeller shaft from the axle and secure or place the rear wheels on dollies.

## In Case of Emergency

---

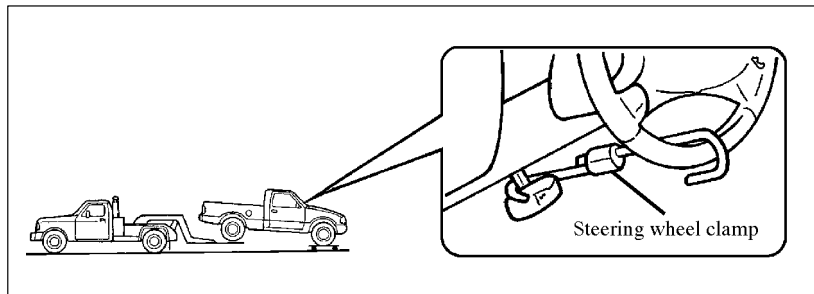

### ■ Towing 2-Wheel Drive Vehicles

#### ▼ Towing with rear wheels off the ground

For manual or automatic transmissions:

1. Place the transmission in N (Neutral).

2. Lock the steering wheel straight ahead.
3. Do not exceed 55 mph (88 km/h).

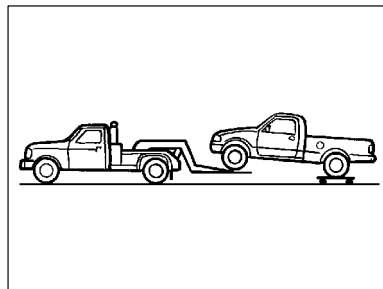

#### ▼ Towing a vehicle with a manual transmission with front wheels off the ground or with all four wheels on the ground:

1. Place the transmission in N (Neutral).
2. There is no limitation on the distance you can tow with a manual transmission.

3. Do not exceed the maximum speed limited by the towing equipment manufacturer's recommendations.

▼ **Towing a vehicle with an automatic transmission with all four wheels on the ground or with the front wheels off the ground:**

1. Place the transmission in N (Neutral).
2. Do not drive faster than 35 mph (56 km/h).
3. Do not tow farther than 50 miles (80 km).

**NOTE**

If you must tow farther than 50 miles (80 km) or faster than 35 mph (56 km/h), you must disconnect the propeller shaft. Even with the propeller shaft disconnected, you should not exceed 55 mph (88 km/h).

■ **Towing 4-Wheel Drive Vehicles**

On 4x4 vehicles, it is recommended that your vehicle be towed with a wheel lift or flatbed equipment.

▼ **Towing a vehicle with a manual transmission with all four wheels on the ground:**

1. Place the transmission in N (Neutral).
2. There is no limitation on distance.
3. Maximum speed is limited by the towing equipment manufacturer's recommendations.

▼ **Towing with an electronic shift control system transfer case**

For manual or automatic transmissions:

1. Place the gear selector lever in N (Neutral).
2. Place the transfer case in 2WD.

## In Case of Emergency

---

### NOTE

With the ignition in the ON position, both the 4x4 and 4x4 LOW lights in the instrument cluster will be off when the transfer case is in 2WD.

### NOTE

Confirm by observation that the front propeller shaft is not rotating prior to towing with the rear wheels off the ground.

3. Lock the steering wheel straight ahead if the vehicle is to be towed with rear wheels off the ground.
- **If you tow your vehicle with the rear wheels off the ground**, the front axle automatic locking hubs must first be disengaged by shifting the transfer case to 2WD. Do not tow faster than 55 mph (88 km/h).

- **For automatic transmissions:**  
When towing your vehicle with the rear wheels on the ground or all four wheels on the ground and the propeller shafts connected, do not exceed 35 mph (56 km/h) or transmission damage could result. If a distance of 50 miles (80 km) is exceeded, disengage the automatic locking hubs and disconnect the rear propeller shaft from the axle and secure. (Maximum speed is 55 mph {88 km/h} with propeller shafts disconnected.)

- **For manual transmissions:**  
When towing your vehicle with the rear wheels on the ground and the driveshafts connected, do not exceed 55 mph (80 km/h). If a distance of 50 miles (80 km) is exceeded, disengage the automatic locking hubs.

### **WARNING**

#### *Towing Your Vehicle:*

*Never use a tow bar that attaches to the bumper when you tow your vehicle. You could damage the bumper and cause an accident.*

If the ignition key is not available to unlock the steering column, place a dolly under the rear wheels and tow the vehicle with the front wheels raised.

When a vehicle is towed on its front wheels, lock the steering wheel in a straight ahead position with a steering wheel clamp. Do not use the vehicle's steering column lock to secure the wheels in a straight ahead position when pulled from the rear.

### ■ Recreational Towing

Towing your vehicle can be successfully performed by following the appropriate guidelines for the type of powertrain on the vehicle to be towed. The following guidelines, by powertrain combination, are designed to ensure that the transmission is not damaged due to insufficient lubrication.

#### ▼ Towing 2-wheel drive vehicles

##### **Automatic transmission with all four wheels on the ground:**

1. Release the parking brake.
2. Place the transmission gear selector lever in N (Neutral).
3. Maximum speed is 35 mph (56 km/h).

4. Maximum distance is 50 miles (80 km).

NOTE
Mazda recommends the propeller shaft be removed/installed only by a qualified technician. See your Authorized Mazda Dealer for propeller shaft removal/installation.

If a distance of 50 miles (80 km) or speed of 35 mph (56 km/h) will be exceeded, you must:

## In Case of Emergency

---

- Disconnect the propeller shaft at the rear differential and properly support it under the vehicle.
- Mark the propeller shaft and axle flanges to ensure proper position when reconnecting the propeller shaft.  
Refer to the workshop manual for proper propeller shaft fastener torque specifications.
- Maximum speed is 55 mph (88 km/h), unlimited distance.

### **WARNING**

#### ***Disconnecting the Propeller Shaft:***

***When disconnecting/installing the propeller shaft, the parking brake must be set and the wheels must be blocked to ensure the vehicle does not roll during this procedure.***

#### **Manual transmission with all four wheels on the ground:**

1. Release the parking brake.
2. Place the transmission gearshift in N (Neutral).
3. Maximum speed is limited by towing equipment manufacturer's recommendation.

#### **▼ Towing 4-wheel drive vehicles**

##### **Electronic shift transfer case with all four wheels on the ground:**

Regarding recreational towing, 4x4 vehicles with electronic shift on the fly cannot be towed with any wheels on the ground (with the exception of moving it as a disabled vehicle off the road out of traffic).



 **WARNING**

***Removing the Propeller Shaft:***

***When removing/installing the propeller shaft, the parking brake must be set and the wheels must be blocked to ensure the vehicle does not roll during this procedure.***

**Manual transmission with all four wheels on the ground:**

- Maximum speed is 55 mph (88 km/h), unlimited distance.

Limited vehicle operation, such as driving the vehicle while at a campsite, can be accomplished with the rear propeller shaft removed by using the front drive to propel the vehicle. To operate

the vehicle in this condition, you must follow the following guidelines:

- Place the transfer case in 4H by rotating the electronic shift transfer case (2WD/4x4) knob to 4WD HIGH.
- Drive the vehicle only on good surface roads to avoid excessive loads on the front-wheel drive system.
- Maximum speed is 35 mph (56 km/hr).
- Maximum distance is 50 miles (80 km).
- Avoid quick acceleration and steep grades.

To return the vehicle to a towable condition, you must:

- Place the transfer case in 2WD by rotating the electronic shift transfer case (2WD/4x4) knob to 2WD.

**NOTE**

Both the 4x4 and 4x4 LOW indicator lights in the instrument cluster will be off when the transfer case is in 2WD.

- Confirm the front hubs are unlocked by inspecting the front propeller shaft to verify it does not turn when the vehicle is towed.

In addition to the above guidelines, it is recommended that you follow the instructions provided by the manufacturer of the towing apparatus.

## In Case of Emergency

### Flat Tire

#### ■ Tire, Jack, and Tool Storage

**Regular Cab** – Behind passenger seat.

**Cab Plus – 2 Door** – Behind passenger-side jump seat.

**Cab Plus – 4 Door** – Between rear jump seats.

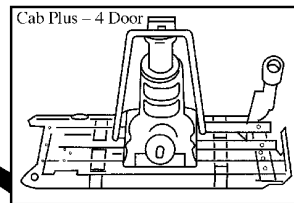
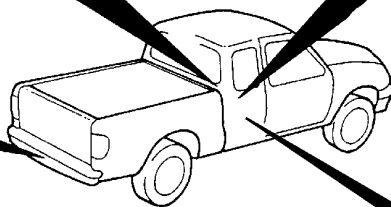
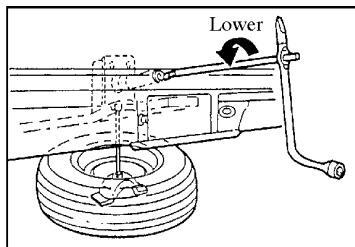
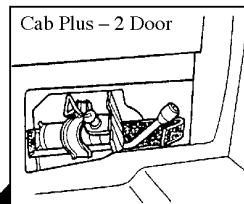
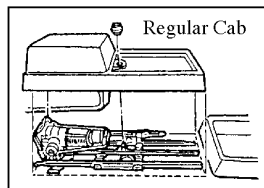

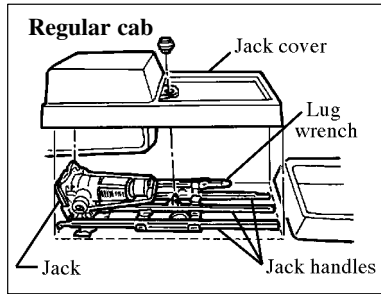

### ▼ To remove the jack, jack handles and lug wrench:

On regular cab vehicles, the jack, jack handles and lug wrench are located directly behind the passenger seat.

To remove the jack cover, remove the hold down screw and lift up. Loosen the thumbwheel and remove the jack, jack handles and lug wrench.

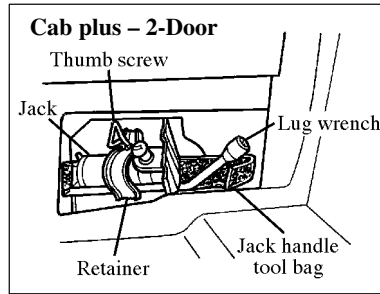

On 2-door Cab Plus vehicles, the jack, jack handles and lug wrench are located behind the passenger-side jump seat. The jack handles are located in a tool bag.

Turn the thumbscrew counterclockwise to remove the jack, jack handles, tool bag and lug wrench.

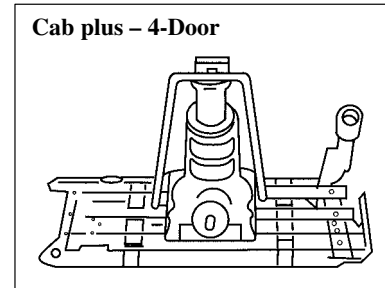

On 4-door Cab Plus vehicles, the jack, jack handles and lug wrench are located between the jump seats.

To remove the jack cover, turn the cover screw to the left and lift up. Turn the yellow knob to the left to remove the jack, jack handles and lug wrench.

## In Case of Emergency

---

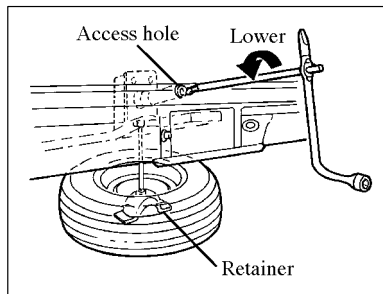

### ▼ To remove the spare tire:

1. Assemble the jack handle to the lug wrench.
2. If equipped, unlock and remove the spare tire carrier lock from the rear access hole located just above the rear bumper and below the tailgate.

3. Insert the straight end of the jack handle into the rear access hole.  
Forward motion will stop and resistance to turning will be felt when properly engaged.
4. Turn the handle counterclockwise until tire is lowered to the ground and the cable is slightly slack.
5. Remove the retainer from the spare tire.

### ▼ Stowing the spare tire:

1. Lay the tire on the ground with the outboard side facing up.
2. Install the retainer through the wheel center and slide the wheel under the vehicle.

3. Turn the spare handle clockwise until the tire is raised to its original position underneath the vehicle. The spare handle ratchets when the tire is raised to the stowed position. It will not allow you to overtighten.
4. If your vehicle is equipped with P265/75 R15 AT tires, do not stow a flat or inflated full size spare tire in the spare tire carrier. The flat full size tire should be stowed and tied down in the pickup box bed until it can be repaired.
5. If removed, install the spare tire carrier lock on the access hole in the bumper.

 **WARNING**

Temporary Spare:

*Do not engage 4-wheel drive with the use of a temporary spare. It can easily cause loss of control.*

■ **Changing a Flat Tire**

If you have a flat tire, drive slowly to a level spot that is well off the road and out of the way of traffic to change the tire. Stopping in traffic or on the shoulder of a busy road is dangerous.

 **WARNING**

Jacking a Vehicle:

*Changing a tire can be dangerous. The vehicle can slip off the jack and seriously injure someone.*

*Be sure to follow the directions for changing a tire, and never get under a vehicle that is supported only by a jack.*

*To avoid injury, never run the engine with one wheel off the ground, such as when changing a tire. The wheel still on the ground could cause the vehicle to move.*

 **WARNING**

Temporary Spare Tire:

*If you use the temporary spare tire continuously or do not follow the proper precautions, the tire could fail, causing you to lose control of the vehicle and possibly injure yourself or others.*

## In Case of Emergency

---

### **WARNING**

#### Changing a Tire:

*When one of the back wheels is off the ground, the transmission alone will not prevent the vehicle from moving or slipping off the jack, even if the vehicle is in P (Park) or 1 (First). To prevent the vehicle from moving when you change a tire, be sure the parking brake is set, then block (both directions) the wheel that is diagonally opposite the tire being changed. If the vehicle slips off the jack, someone could be seriously injured.*

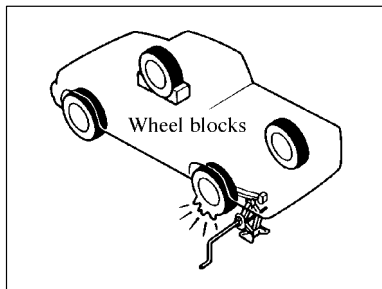

1. Park on a level surface off the right-of-way and firmly set the parking brake. Turn off the engine.
2. Shift an automatic transmission to P (Park); shift a manual transmission to R (Reverse).
3. Turn on the hazard warning flasher.
4. Remove the jack, jack handle, lug wrench, and spare tire.
5. Block both the front and rear of the wheel diagonally opposite the tire being changed.
6. Use the tapered end of the lug nut wrench to unscrew wheel ornaments attached by retaining screws. Remove any wheel trim. Insert the tapered end of the lug nut wrench behind wheel covers or hub caps and twist off.

 **CAUTION**

Only the lug nut wrench provided should be used to remove wheel ornaments. Use of anything other than the lug nut wrench provided may damage the finish or your wheels.

 **CAUTION**

Not using the tapered end of the lug nut wrench at the pry-off notches may result in damage to the finish of the wheel and ornament.

7. Loosen the lug nuts by pulling up on the handle of the lug nut wrench about one-half turn (counterclockwise), but don't remove any until the tire has been raised a maximum of one inch off the ground.
8. Insert the jack handle into the jack and use the handle to slide the jack under the vehicle.

 **WARNING**

**Incorrect Jacking Position:**

*Attempting to jack the vehicle in positions other than those recommended in this manual is dangerous. The vehicle could slip off the jack and seriously injure or even kill someone. Use only the correct front and rear jacking positions.*

## In Case of Emergency

### Jack points

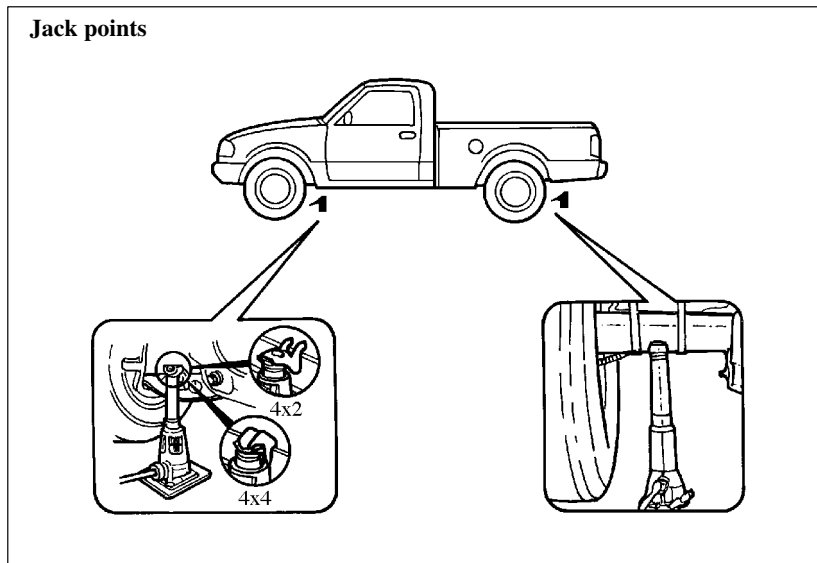

9. To raise a front wheel, place the jack directly under the lower suspension arm.

To raise a rear tire, place the jack under the rear axle between the spring shackle bolts.

### **⚠ WARNING**

#### ***Improper Jack:***

*Using a jack that isn't designed for your Mazda could be dangerous. The vehicle could slip off the jack and seriously injure someone. Use only the jack provided with your Mazda.*



**⚠ WARNING**

*To lessen the risk of personal injury, do not put any part of the body under the vehicle while changing a tire. Do not start the engine when your vehicle is on the jack. The jack is only meant for changing the tire.*

**⚠ CAUTION**

Never use the differential housing as a lift point.

**⚠ WARNING**

*Placing Objects Under the Jack:*  
*Jacking the vehicle with an object under the jack is dangerous. The jack could slip and someone could be seriously injured by the jack or the falling vehicle. Never place objects under the jack.*

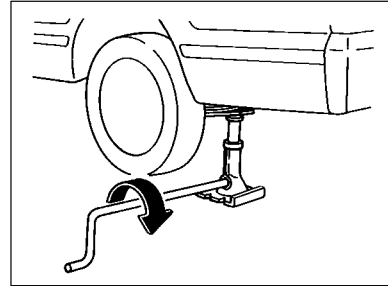

10. Turn the jack handle clockwise until the tire just clears the ground, less than 1 inch (30 mm). Before removing the lug nuts, make sure your Mazda is firmly in position and that it cannot slip or move.

## In Case of Emergency

---

11. Remove the lug nuts by turning them counterclockwise; then remove the wheel.
12. Mount the spare tire making sure the valve stem is facing outward.
13. Install the lug nuts with the beveled edge inward. Use the lug nut wrench to screw the lug nut snug against the wheel, but do not tighten.

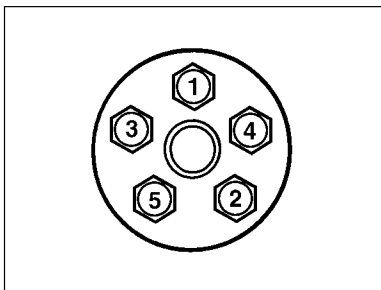

14. Turn the jack handle counterclockwise, lower the vehicle and remove the jack. Use the lug wrench to tighten the nuts in the order shown.

If you're unsure of how tight the nuts should be, have them inspected at a service station. The specified torque is 135 N·m (13.8 kgf·m, 100 ft-lb).

Also, retighten to the specified torque at 500 miles (800 km), after any wheel change, or when the lug nuts are loosened.

### **WARNING**

#### Loose Lug Nuts:

*Improperly or loosely tightened lug nuts are dangerous. The wheel could wobble or come off. This could result in loss of vehicle control and cause a serious accident. Always securely and correctly tighten the lug nuts.*

 **WARNING**

**Metric Studs and Lug Nuts:**

*Because the wheel studs and lug nuts on your Mazda have metric threads, using a nonmetric nut would be dangerous. On a metric stud, it would not secure the wheel and would damage the stud, which could cause the wheel to slip off and cause an accident. Be sure to reinstall the same nuts you removed or replace them with metric nuts of the same configuration.*

 **WARNING**

**Incorrect Tire Air Pressure:**

*Driving on tires with incorrect air pressure is dangerous. Tires with incorrect pressure could affect handling and result in an accident. Don't drive with any tires that have incorrect air pressure. When you check the regular tire's air pressure, check the spare tire too.*

15. Store the tools in their proper places. If your vehicle is equipped with a P265 75R15 AT tire, do not stow the flat tire (or a fully inflated tire) in the spare tire carrier. It may damage the tire or the vehicle. Stow only the temporary spare in the spare tire carrier. Stow the flat full size tire with ropes in the pickup box bed. Repair the tire as soon as possible.

 **WARNING**

**Stow Equipment Properly:**

*To prevent personal injury, make sure the spare tire and jacking equipment are stowed and secured in the proper storage location.*

## In Case of Emergency

---

### ■ Temporary Spare Tire

Your Mazda may have a temporary spare tire. It's lighter and smaller than a conventional tire, is designed only for emergency use, and should be used only for VERY short periods. Temporary spares should NEVER be used for long drives or extended periods.

#### **WARNING**

##### *In Ice and Snow:*

*Using a temporary spare on the rear (driving) wheels when driving on ice or snow is dangerous. It can easily cause loss of control. Put the temporary spare on the front axle and move a conventional tire to the rear.*

#### **CAUTION**

To avoid damage to the temporary spare or to the vehicle, observe the following:

- Don't exceed 50 mph (80 km/h).
- Avoid driving over obstacles. Also don't drive through an automatic car wash. This tire's diameter is smaller than a conventional tire's; so the ground clearance is reduced about one inch (25 mm).
- Don't use a tire chain on this tire because it won't fit properly.
- Don't use your temporary spare on any other vehicle; it has been designed only for your Mazda.

*(Continued)*

- Do not tow a trailer while using this tire.
- Don't load the vehicle beyond maximum vehicle load rating listed on the Safety Compliance Label.

# 7

## Appearance Care

*This section features care, inside and out, of your Mazda . . . how to best keep it clean and looking good.*

*Be aware that appearance is not the only reason for cleanliness. Road grime tends to eat away at the metal, so keeping your vehicle clean in the way Section 7 prescribes will help prevent its early deterioration and rusting.*

How to Minimize Environmental Paint Damage	7- 2
Exterior Care	7- 5
Interior Care	7-10

### How to Minimize Environmental Paint Damage

The paintwork on your Mazda represents the latest technical developments in composition and methods of application.

Environmental hazards, however, can harm the paint's protective, properties, if proper care is not taken.

Here are some examples of possible damage, with tips on how to prevent them.

#### ■ Etching Caused by Acid Rain or Industrial Fallout

##### ▼ Occurrence

Industrial pollutants and vehicle emissions drift into the air and mix with rain or dew to form acids. These acids can settle on a vehicle's finish. As the water evaporates, the acid becomes concentrated and can damage the finish. And the longer the acid remains on the surface, the greater the chance is for damage.

##### ▼ Prevention

It is necessary to wash and wax your vehicle to preserve its finish according to the instructions in this section. These steps should be taken immediately after you suspect that acid rain has settled on your vehicle's finish.

#### ■ Damage Caused by Bird Droppings, Insects, or Tree Sap

##### ▼ Occurrence

Bird droppings contain acids. If these aren't removed they can eat away the clear and color base coat of the vehicle's paintwork.

When insects stick to the paint surface and decompose, corrosive compounds form. These can erode the clear and color base coat of the vehicle's paintwork if they are not removed.

Tree sap will harden and adhere permanently to the paint finish. If you scratch the sap off while it is hard, some vehicle paint could come off with it.

### ▼ Prevention

It is necessary to have your Mazda washed and waxed to preserve its finish according to the instructions in this section. This should be done as soon as possible.

Bird droppings can be removed with a soft sponge and water. If you are traveling and these are not available, a moistened tissue may also take care of the problem. The cleaned area should be waxed according to the instructions in this section.

Insects and tree sap are best removed with a soft sponge and water or a commercially available chemical cleaner.

Another method is to cover the affected area with dampened newspaper for one to two hours. After removing the newspaper, rinse off the loosened debris with water.

## Appearance Care

---

### ■ Water Marks

#### ▼ Occurrence

Rain, fog, dew, and even tap water can contain harmful minerals such as salt and lime. If moisture containing these minerals settles on the vehicle and evaporates, the minerals will concentrate and harden to form white rings. The rings can damage your vehicle's finish.

#### ▼ Prevention

It is necessary to wash and wax your vehicle to preserve its finish according to the instructions in this section. These steps should be taken immediately after you find water marks on your vehicle's finish.

### ■ Paint Chipping

#### ▼ Occurrence

Paint chipping occurs when gravel thrown in the air by another vehicle's tires hits your vehicle.

#### ▼ How to avoid paint chipping

Keeping a safe distance between you and the vehicle ahead reduces the chances of having your paint chipped by flying gravel.

#### NOTE

- The paint chipping zone varies with the speed of the vehicle. For example, when traveling at 56 mph (90 km/h), the paint chipping zone is 164 feet (50 m).
- In low temperatures a vehicle's finish hardens. This increases the chance of paint chipping.
- Chipped paint can lead to rust forming on your Mazda. Before this happens, repair the damage by using Mazda touch-up paint according to the instructions in this section. Failure to repair the affected area could lead to serious rusting and expensive repairs.



## Exterior Care

Follow **all** label and container directions when using a chemical cleaner or polish. Read all warnings and cautions.

### ■ Maintaining the Finish

#### ▼ Washing

To help protect the finish from rust and deterioration, wash your Mazda thoroughly and frequently (at least once a month) with lukewarm or cold water.

Pay special attention to removing salt, dirt, mud, and other foreign materials from the underside of the fenders, and make sure the drain holes in the lower edges of the doors and rocker panels are kept clear and clean.

Insects, tar, tree sap, bird droppings, industrial fallout, and similar deposits

can damage the finish if not removed immediately. When prompt washing with plain water is ineffective, use a mild soap made for use on vehicles.

Thoroughly rinse off all soap with lukewarm or cold water. Don't allow soap to dry on the finish.

Wash chrome and aluminum parts with the same mild soap you used to wash the vehicle's body.

Take similar precautions if your vehicle is exposed to chemical industrial fallout.

Remove any exterior accessories, such as antennas, before entering a car wash. If you have wax applied to the vehicle at a commercial car wash, it is recommended

that you clean the wiper blades and windshield (refer to page 8-37).

### **WARNING**

#### ***Driving with Wet Brakes:***

***Driving with wet brakes is dangerous. Increased stopping distance or the vehicle pulling to one side when braking could result in a serious accident. Light braking will indicate whether the brakes have been affected. Dry the brakes by driving very slowly and applying the brakes lightly until brake performance is normal.***

## Appearance Care

---

### CAUTION

- Do not wash your vehicle with hot water. Also, do not wash your vehicle while it sits in direct sunlight or while the body is hot.
- Wiping off dust or dirt with a dry cloth will scratch the finish.
- Don't use steel wool, abrasive cleaners, or strong detergents containing highly alkaline or caustic agents on chrome-plated or anodized aluminum parts. This may damage the protective coating; also, the cleaners and detergents may discolor or deteriorate the paint.

*(Continued)*

### CAUTION

- To prevent damaging the antenna, remove it before entering a car wash or passing beneath a low overhead clearance.

#### ▼ Waxing

Wax your Mazda when water no longer beads on the paint.

Always wash and dry it before waxing.

Use a good-quality liquid or paste wax, and follow the manufacturer's instructions.

Wax all the metal trim to maintain its luster.

Avoid getting wax on the windshield. If you have wax applied at a commercial car wash, it is recommended that you clean the wiper blades and windshield (refer to page 8-37).

### NOTE

A spot remover to remove oil, tar, and similar materials will usually also take off the wax. Rewax these areas even if the rest of the vehicle doesn't need it.

### ■ Cleaning Plastic Parts

Some vehicle trim parts are plastic. These may include the outside door handles, the side view mirror, exterior nameplates and the bumper. Use a mild detergent to remove dirt, wax buildup and other deposits from these parts. Do not clean plastic parts with fuel or other petroleum-based cleaners.

Because your vehicle's side moldings are painted in lacquer, do not use thinners or solvents to clean them.

### ■ Cleaning Rustproofing

If you rustproof your vehicle after you buy it, inspect its plastic and rubber parts for overspray, drips, and runs. If the rustproofing is not removed from these parts, the parts may become distorted or

deteriorated. To remove rustproofing, clean with a hi-flash, naphtha-wetted cloth. Then wipe the area completely dry.

### ■ Repairing Damage to the Finish

Deep scratches or chips on the finish should be repaired promptly. Exposed metal quickly rusts and can lead to major repairs.

 **CAUTION**

If your Mazda is damaged and needs metal parts repaired or replaced, make sure the body shop applies anti-corrosion materials to all parts, both repaired and new. This will prevent them from rusting.

### ■ Bright-Metal Maintenance

- Use tar remover to remove road tar and insects. Never do this with a knife or similar tool.
- To prevent corrosion on bright-metal surfaces, apply wax or chrome preservative and rub it to a high luster.
- During cold weather or in coastal areas, cover bright-metal parts with a coating of wax or preservative heavier than usual. It would also help to coat them with noncorrosive petroleum jelly or some other protective compound.

### ■ **Cleaning the Headlights and Taillights**

Dirty lights reduce your ability to see and be seen. Because your headlights and taillights are plastic, clean them with a cloth and mild detergent that is diluted in water. Then rinse them with clear water.

Do not clean the lights with abrasive cleaners. Such cleaners scratch the lights. Also, do not wipe the lights when they are dry. This can scratch them as well. Do not use fuel, commercial tar remover, chemical solvents, or strong detergents. These products can crack the lights.

### ■ **Cleaning the Mirrors**

Do not clean the mirrors with a dry cloth or abrasive cleaners. Use a soft cloth and mild detergent diluted in water or glass cleaner. Be careful when you remove ice from the outside mirror. You can easily damage the reflective surface.

### ■ **Cleaning the Windows**

When the windows become dirty, clean them with glass cleaner. Follow the directions on the container of cleaner.

### ■ **Engine Compartment**

A clean engine is not only nicer to look at, but it is also easier to work on. A clean engine is also more efficient because the engine is able to cool properly. A buildup of grease and dirt acts as an insulator, keeping the engine warmer than normal.

- Extreme care must be used if a power washer is used to clean the engine. The high pressure fluid could penetrate sealed parts and assemblies causing damage or malfunctions.
- In order to avoid possible cracking of the engine block or fuel injection pump, do not spray a hot engine or injection pump with cold water.
- The battery, ignition coil, air intake and engine compartment fuse box must be covered. Covering these components will help prevent water damage.
- Never wash or rinse the engine while it is running. Water getting into the engine may cause internal damage.

## ■ Underbody Maintenance

Road chemicals and salt used for ice and snow removal and solvents used for dust control may collect on the underbody. If not removed, they will speed up rusting and deterioration of such underbody parts as fuel lines, frame, floor pan, and exhaust system, even though these parts may be coated with anticorrosive material.

Thoroughly flush the underbody and wheel housings with lukewarm or cold water at the end of each winter. Try also to do this every month.

Pay special attention to these areas because they easily hide mud and dirt. **It will do more harm than good to wet down the road grime without removing it.**

The lower edges of doors, rocker panels, and frame members have drain holes that should not be clogged. Water trapped there will cause rusting.

### **WARNING**

#### *Driving with Wet Brakes:*

*Driving with wet brakes is dangerous. Increased stopping distance or the vehicle pulling to one side when braking could result in a serious accident. Light braking will indicate whether the brakes have been affected. Dry the brakes by driving very slowly and applying the brakes lightly until brake performance is normal.*

## Appearance Care

---

### ■ Cleaning the Wheels

Your aluminum wheels are coated with a clear protective finish.

#### NOTE

- Use only a mild soap or neutral detergent and always use a sponge or soft cloth to clean the wheels. Rinse thoroughly with lukewarm or cold water. Also, be sure to clean the wheels after driving on salted roads. This helps prevent corrosion.

*(Continued)*

- Do not use acid-based or alcohol-based wheel cleaners, steel wool, fuel or strong detergents. Never use abrasives that will damage the finish of special wheel surfaces. Use a tar remover to remove grease and tar.
- The brushes used in some automatic car washes may damage the finish on your wheels. Before going to a car wash, find out if the brushes are abrasive.
- If your aluminum wheels lose luster, wax the wheels.

## Interior Care

### ■ Dashboard Precautions

Prevent caustic solutions such as perfume and cosmetic oils from contacting the dashboard. They'll damage and discolor it. If these solutions get on the dashboard, wipe them off immediately.

### ■ Cleaning the Upholstery and Interior Trim

#### ▼ Vinyl

Remove dust and loose dirt from vinyl with a whisk broom or vacuum cleaner. Clean vinyl with a leather-and-vinyl cleaner.

Be careful when you apply any cleaner to the vinyl surfaces. Some cleaners will change the gloss (shine) and should be avoided.

1. For routine cleaning, wipe the surface with a soft, damp cloth.
2. For a more thorough cleaning, wipe the surface with a soft cloth and mild detergent and a vinyl cleaner. Do not use solvent-type cleaners such as spot remover or powder-type spot lifter on these materials.
3. Wipe the surface clean with a damp, soft cloth.
4. Then, dry and buff the surface with a dry, soft cloth.

### ▼ Leather

Real leather isn't uniform and may have scars, scratches, and wrinkles. Clean it with a leather cleaner or mild soap.

Wipe it with a **damp** soft cloth; then dry and buff it with a **dry** soft cloth.

### ▼ Fabric

Remove dust and loose dirt from fabric with a whisk broom or vacuum cleaner. Remove fresh spots immediately.

To keep the fabric looking clean and fresh, take care of it. Otherwise its color will be affected, it can be stained easily, and its fire-resistance may be reduced.

To clean a cloth interior, complete the following steps:

1. Remove any excess staining materials from the fabric by scraping or wiping with a clean cloth.
2. Identify the cause of the stain if you can.
3. Depending on what type of stain you have, use one of the two procedures that follow.

Before using any cleaner, test it on a small, hidden area of fabric. If the fabric's color or texture is adversely affected by a particular cleaner, do not use the cleaner.

For water soluble stains, try using a damp cloth first, followed by a soft cloth with a mild detergent and water.

## Appearance Care

---

For grease, oil, tar, water spots, crayon, and lipstick stains:

1. Apply soil and spot lifter to the soiled area.
2. Brush powder into fabric using more gentle strokes with more delicate fabrics. Use dry terry cloth for very delicate fabrics.
3. Allow cleaner to work at least 20 minutes, then vacuum up powder.
4. Repeat, if necessary, or go to step 5.

If the stain is still visible:

5. Blot the stain with a clean, white cotton cloth that is saturated with a stain remover.

6. Rub in a circular motion, keeping a clean portion of the cloth in contact with the fabric.

7. Gradually widen the area as you rub.

If the stain requires that you use a large amount of cleaner, clean the entire seat so that a ring does not appear where the stain was.

8. Repeat steps 5 through 7, as necessary.

9. Wipe clean with a damp cloth to remove any remaining cleaner.

10. Allow the material to dry completely.

For dirt, dry soil, food, soda, and coffee stains:

1. Apply upholstery cleaner to the soiled area. Follow the directions that come with the cleaner.

2. Scrub area with a damp cloth or sponge.

3. Gradually widen the areas as you rub.

If the stain requires that you use a large amount of cleaner, clean the entire seat so that a ring does not appear where the stain was.



4. Wipe immediately with a dry cloth.
5. Allow upholstery to dry completely before using.

### CAUTION

Use only recommended cleaners and procedures. Others may affect appearance and fire-resistance.

### ■ **Cleaning the Seat Belt Webbing**

Clean the webbing with a mild soap solution recommended for upholstery or carpets. Follow instructions. Don't bleach or dye the webbing; this may weaken it.

### WARNING

#### ***Damaged Seat Belt:***

***Using damaged seat belts is dangerous. In a collision, damaged seat belts cannot provide adequate protection. Have your authorized Mazda dealer replace damaged belts immediately.***

### ■ **Cleaning the Window Interiors**

If the windows become covered with an oily, greasy, or waxy film, clean them with glass cleaner. Follow the directions on the container.

### ■ **Cleaning the Instrument Panel**

Any cleaner or polish that increases the gloss (shine) of the upper part of the instrument panel should be avoided. The dull finish in this area is to help protect the driver from undesirable windshield reflection.

## Appearance Care

---

### ■ **Cleaning the Instrument Panel Lens**

Clean the instrument panel lens with a soft cloth and glass cleaner. Do not use a paper towel or an abrasive cleaner to clean the lens as these may cause scratches.

### ■ **Cleaning the Interior Plastic Lights**

The interior dome lights and map lights are plastic and should be cleaned with a mild detergent diluted in water. Rinse them with clear water. Do not clean the interior lights with abrasive cleaners that could scratch the lights. Do not wipe them when they are dry as this can also scratch them. Do not use fuel, commercial tar remover or strong detergents as these products could crack the lights.

# 8

## Maintenance

*Because your Mazda is a large piece of intricate machinery, it needs regular care in the form of maintenance and servicing. Many owners prefer to do much of this work themselves.*

*Section 8 has been prepared as a guide for the operator who wants to self-service such minor jobs as changing the engine oil, replacing bulbs and wiper blades, charging the battery, and rotating the tires. All maintenance schedules are included, along with instructions on how to make regular inspections of such things as fluid levels.*

Introduction	8- 2
Scheduled Maintenance	8- 3
Owner Maintenance	8- 9
Bulb Replacement (Front)	8-52
Bulb Replacement (Rear)	8-54

## Maintenance

---

### Introduction

Be extremely careful to prevent injury to yourself and others and damage to your vehicle when using this manual for inspection and maintenance.

If you're unsure about any procedure it describes, we strongly urge you to have a reliable and qualified service shop perform the work, preferably an Authorized Mazda Dealer.

Factory-trained Mazda technicians and genuine Mazda parts are best for your vehicle. Without this expertise and the

parts that have been designed and made especially for your Mazda, inadequate, incomplete, and insufficient servicing may result in problems. This could lead to vehicle damage or an accident and injuries.

For expert advice and quality service, consult an Authorized Mazda Dealer.

The owner should retain evidence that proper maintenance has been performed as prescribed.

A claim against a warranty will not qualify if it results from lack of maintenance and not from defective material or authorized Mazda workmanship.

Any auto repair shop using parts equivalent to your Mazda's original equipment may perform maintenance. **But we recommend that it always be done by an Authorized Mazda Dealer using genuine Mazda parts.**

## Scheduled Maintenance

Follow Schedule I if the vehicle is operated mainly where none of the following conditions apply. If any do apply, follow Schedule II.

- Repeated short-distance driving.
- Driving in dusty conditions.
- Towing a trailer.
- Operating in hot weather in stop-and-go “rush hour” traffic.
- Extended periods of idling or low-speed operation.
- High-speed operation with a fully loaded vehicle.
- Off-road operation.

<b>NOTE</b>
After 120 months or 120,000 miles (193,000 km), continue to follow the prescribed maintenance and intervals periodically.

## Maintenance

### Schedule I — Normal Driving Conditions/Emission Control Systems

R: Replace. I: Inspect, and, if necessary, repair, clean or replace.

Normal driving service intervals — perform at the months or distances shown, whichever occurs first.

MAINTENANCE OPERATION	Miles (Thousands)		5	10	15	20	25	30	35	40	45	50	55	60	65	70	75	80	85	90	95	100	105	110	115	120	
	Kilometers (Thousands)		8	16	24	32	40	48	56	64	72	80	88	96	104	112	120	128	136	144	152	160	168	176	184	192	
<b>Emission Control Systems</b>																											
Change engine oil and replace filter—every 6 months OR	R	R	R	R	R	R	R	R	R	R	R	R	R	R	R	R	R	R	R	R	R	R	R	R	R	R	R
Replace spark plugs*																						R					
Replace green engine coolant initially at 45,000 miles, then replace every 30,000 miles											R						R							R			
Check engine coolant condition and protection, hoses and clamps annually—prior to cold weather every 12 months				I			I			I			I			I			I				I			I	
Replace air cleaner filter								R						R						R							R
Replace PCV valve (2.5L) *2														R*2													R
Replace PCV valve (3.0L/4.0L)																							R				
Inspect steering linkage, ball joints, suspension and driveshaft				I			I			I			I			I			I				I			I	
Inspect camshaft drive belt tension (2.5L)																											I
Inspect accessory drive belts																							I				

Refer to footnotes on following page.

**Schedule I — Normal Driving Conditions (Continued)/Other Systems**

MAINTENANCE OPERATION	Miles (Thousands)		5	10	15	20	25	30	35	40	45	50	55	60	65	70	75	80	85	90	95	100	105	110	115	120			
	Kilometers (Thousands)		8	16	24	32	40	48	56	64	72	80	88	96	104	112	120	128	136	144	152	160	168	176	184	192			
<b>Other Systems</b>																													
Inspect tires for wear and rotate (X = recommended interval for optimal tire life)			I	X	I	X	X	I	X	X	I	X	X	I	X	X	I	X	X	I	X	X	I	X	X	I	X	X	I
Inspect front wheel bearings for end play (4x2 only)								I						I						I								I	
Lubricate front wheel bearings (4x2 only)														I														I	
Inspect disc brake system					I			I			I			I			I			I				I				I	
Inspect drum brake systems, lines and hoses					I			I			I			I			I			I				I				I	
Inspect exhaust system for leaks, damage or loose parts								I						I						I								I	

\* Refer to Vehicle Emission Control Information for Spark Plug and Gap Specifications.

\*2 At 60,000 miles (96 000 km), your dealer will replace the PCV valve at no cost, **except California vehicles**.

\*3 If vehicle is registered in California, the California Air Resources Board has determined that the failure to perform this maintenance item will not nullify the emission warranty or limit recall liability prior to the completion of the vehicle's useful life. We, however, urge that all recommended maintenance services be performed at the indicated intervals and the maintenance be recorded.

Rear axles are lubricated for life. These lubricants are not to be checked or changed unless a leak is suspected, service is required, or the axle assembly has been submerged in water. The axle lubricant should be changed anytime the axle has been submerged in water. For police and taxi applications, replace rear axle lubricant every 100,000 miles (160,000 km). Rear axle lubricant change may be waived if the axle was filled with 75W140 synthetic gear lubricant. Add four ounces of additive friction modifier or equivalent for complete refill of Traction-Lok rear axles.

## Maintenance

### Schedule I — Normal Driving Conditions (Continued)/Other Systems

MAINTENANCE OPERATION	Miles (Thousands)		5	10	15	20	25	30	35	40	45	50	55	60	65	70	75	80	85	90	95	100	105	110	115	120	
	Kilometers (Thousands)		8	16	24	32	40	48	56	64	72	80	88	96	104	112	120	128	136	144	152	160	168	176	184	192	
Replace manual transmission fluid														R													R
Inspect automatic transmission fluid				I			I			I			I			I			I				I				I
Inspect and lubricate 4x2 ball joints				I			I			I			I			I			I				I				I
Inspect and remove any foreign material trapped by exhaust system shielding								I					I							I							I
Inspect parking brake system for damage and operation				I			I			I			I			I			I					I			I
Replace transfer case fluid (4x4)														R													R
Change fuel filter *3									R					R							R						R

\* Refer to Vehicle Emission Control Information for Spark Plug and Gap Specifications.

\*2 At 60,000 miles (96 000 km), your dealer will replace the PCV valve at no cost, **except California vehicles**.

\*3 If vehicle is registered in California, the California Air Resources Board has determined that the failure to perform this maintenance item will not nullify the emission warranty or limit recall liability prior to the completion of the vehicle's useful life. We, however, urge that all recommended maintenance services be performed at the indicated intervals and the maintenance be recorded.

Rear axles are lubricated for life. These lubricants are not to be checked or changed unless a leak is suspected, service is required, or the axle assembly has been submerged in water. The axle lubricant should be changed anytime the axle has been submerged in water. For police and taxi applications, replace rear axle lubricant every 100,000 miles (160,000 km). Rear axle lubricant change may be waived if the axle was filled with 75W140 synthetic gear lubricant. Add four ounces of additive friction modifier or equivalent for complete refill of Traction-Lok rear axles.



## Schedule II — Special Operating Conditions

If your driving habits **FREQUENTLY** include one or more of the following conditions:

- Short trips of **less** than 10 miles (16 km) when outside temperatures remain below freezing.
- Towing a trailer, or carrying maximum loads.
- Operating in severe dust conditions.
- Operating during **hot weather** in stop-and-go “rush-hour” traffic.
- Extensive idling, such as police, taxi or door-to-door delivery service.

- High speed operation with a fully loaded vehicle (max. GVW).
- Off-road operation.

Change ENGINE OIL AND OIL FILTER every 3 months or 3,000 miles (4,800 km) whichever occurs first.

### NOTE

Idling the engine for extended periods will accumulate more hours of use on your vehicle than is actually indicated by the mileage odometer. Consequently, the odometer reading  
*(Continued)*

can be often misleading when determining the right time to change your engine oil and filter. If you are using your vehicle in a manner which allows it to remain stationary while the engine is running for long periods (door-to-door delivery, taxi, police, power/utility company trucks, or similar duty), then Mazda recommends you increase the frequency of oil and filter changes to an interval equivalent to 200 ENGINE HOURS of use. Since most vehicles are not equipped with hour-meters, it may be necessary for you to approximate your idle time and plan oil/filter changes accordingly.

## Maintenance

### Schedule II — Special Operating Conditions

Special Operating Conditions	Replace Engine Oil and Filter	Inspect Brake System	Replace Fuel Filter	Change Automatic Transmission Fluid	Replace Spark Plugs	Replace Engine Air Filter	Change Manual Transmission Fluid	Inspect and Lubricate U-Joints	Change Brake Fluid
<b>Suggested Maintenance Interval</b>	3,000 miles or 3 months	5,000 miles	15,000 miles	30,000 miles	60,000 miles	As required	As required	As required	Every two years
Towing a trailer or using a camper or car top carrier	X			X			X	X	
Extensive idling or low-speed driving for long distances as in heavy commercial use such as delivery, taxi or patrol car	X	X	X	X	X				
Operating in dusty conditions such as unpaved or dusty roads	X		X	X		X			
Off road operation				X				X	

For specific recommendations see your authorized Mazda dealer or qualified service professional.

### Owner Maintenance

#### ■ Owner Maintenance Schedule

The owner or a qualified service technician should make these vehicle inspections at the indicated intervals to ensure safe and dependable operation.

Bring any problem to the attention of an Authorized Mazda Dealer or qualified service technician as soon as possible.

#### ▼ While operating your vehicle

- Note any changes in the sound of the exhaust or any smell of exhaust fumes in the vehicle.
- Check for vibrations in the steering wheel. Notice any increased steering effort or looseness in the steering wheel, or change in its straight ahead position.
- Notice if your vehicle constantly turns slightly or “pulls” to one side when traveling on a smooth, level road.
- When stopping, listen and check for strange sounds, pulling to one side, increased brake pedal travel or “hard to push” brake pedal.
- If any slipping or changes in the operation of your transmission occur, check the transmission fluid level.
- Check automatic transmission Park function.
- Check parking brake.

## Maintenance

---

### ▼ At least monthly

- Check function of all interior and exterior lights.
- Check tires for wear and proper air pressure (page 8-40).
- Check engine oil level (page 8-18).
- Check coolant level in the coolant reservoir (page 8-23).
- Check washer fluid level (page 8-36).

### ▼ At least twice a year (for example, every spring and fall)

- Check power steering fluid level (page 8-31).
- Check clutch fluid level (if equipped) (page 8-30).
- Check and clean body and door drain holes.
- Check and lubricate all hinges, latches, and outside locks.
- Check and lubricate door rubber weather strips.
- Check parking brake for proper operation (page 5-40).

- Check lap/shoulder belts and seat latches for wear and function (page 2-19).
- Check air pressure in spare tire.
- Check windshield washer spray and wiper operation. Clean wiper blades with clean cloth dampened with washer fluid.
- Check safety warning lamps (brake, ABS, air bag, safety belt) for operation.
- Check cooling system fluid level and coolant strength.
- Check battery water level (non-maintenance free).
- Check battery connections and clean if necessary.

### ■ Owner Maintenance Precautions

Improper or incomplete service may result in problems. This section gives instructions only for items easy to perform.

**WARNING**

**Maintenance Procedures:**

***Performing maintenance work on a vehicle can be dangerous. You can be seriously injured while performing some maintenance procedures. If you lack sufficient knowledge and experience or the proper tools and equipment to do the work, have it done by a qualified technician.***

Several procedures may be more easily done by a qualified service technician with special tools.

Improper owner maintenance during the warranty period may affect warranty coverage. For details, read the separate Mazda Warranty statement provided with the vehicle. If you're unsure about any servicing or maintenance procedure, have it done by an Authorized Mazda Dealer.

### **WARNING**

#### **Running the Engine:**

- *Working under the hood with the engine running is dangerous. It becomes even more dangerous when you wear jewelry or loose clothing. Either can become entangled in moving parts and result in injury. Therefore, if you must run the engine while working under the hood, make certain that you remove all jewelry (especially rings, bracelets, watches, and necklaces) and all neckties, scarves, and similar loose clothing before getting near the engine or cooling fan.*

*(Continued)*

- *Set the parking brake fully, and make sure that the gearshift is securely latched in P (Park) (automatic transmission) or N and block the wheels. This will prevent your vehicle from moving unexpectedly.*
- *Do not start your engine with the air cleaner removed and do not remove it while the engine is running.*

## ■ Engine Compartment Overview

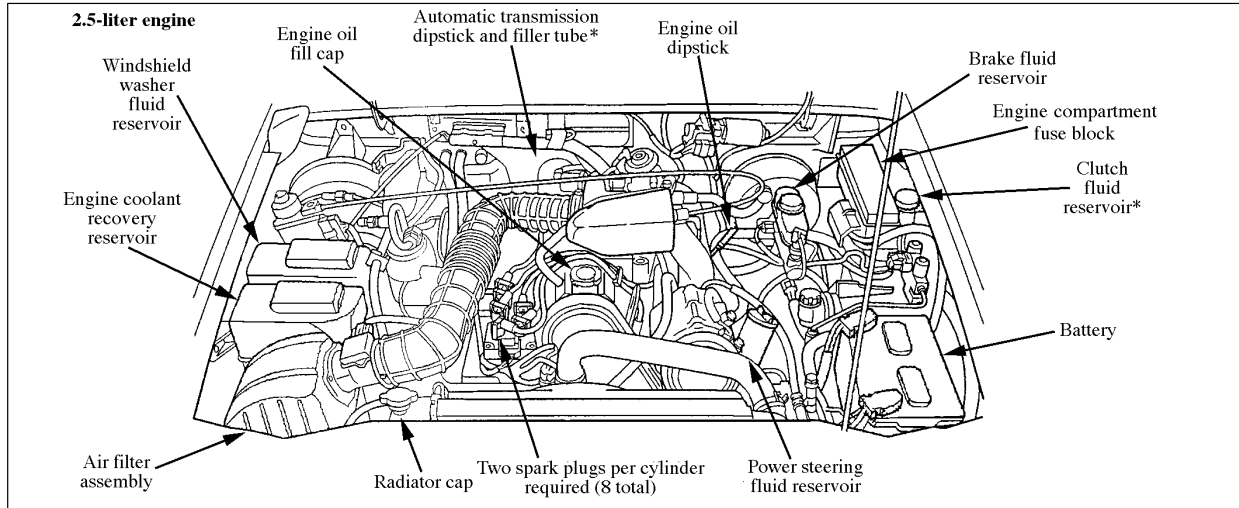

\*Some models.

## Maintenance

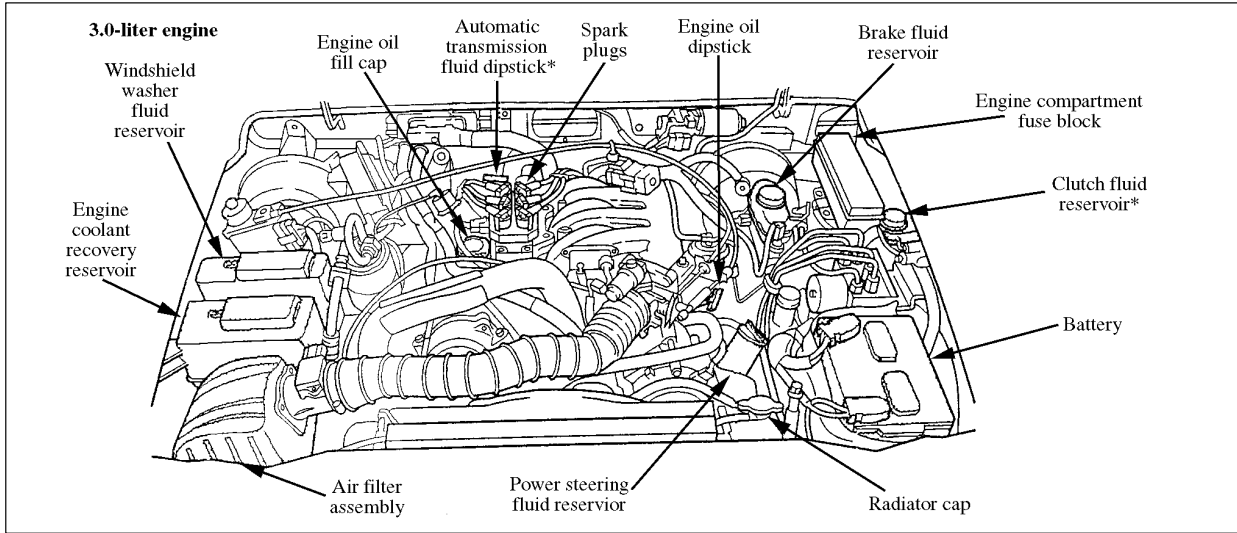

\*Some models.



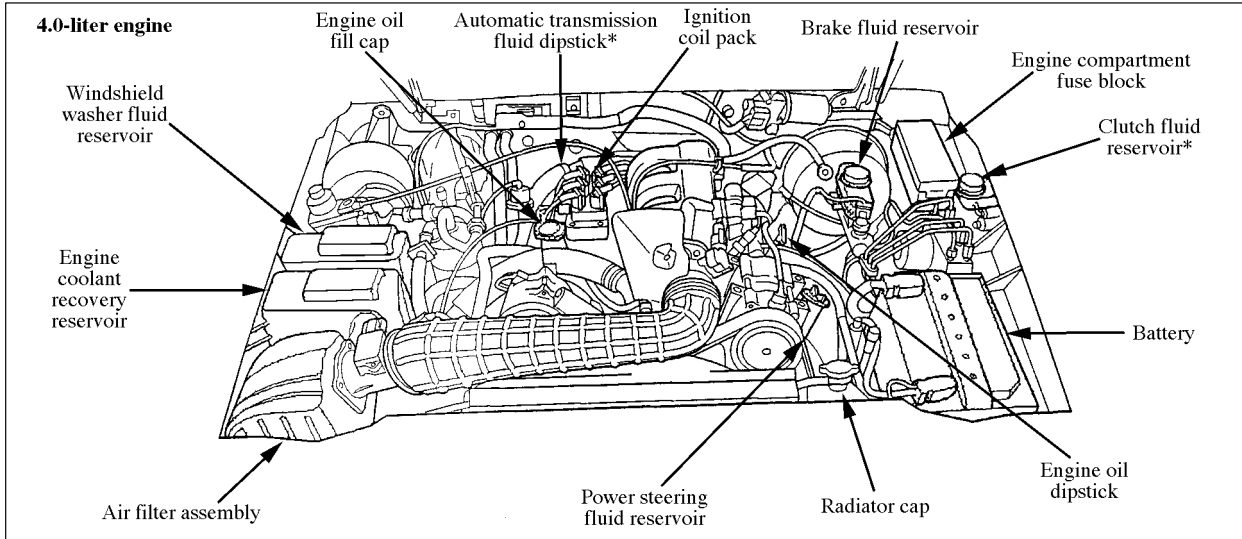

\*Some models.



### ■ Engine Oil

#### ▼ Recommended oil

Oil container labels provide important information.

Look for the American Petroleum Institute certification mark on the front of the oil container. Motor oil displaying the API certification trademark will meet all requirements for your vehicle's engine.

Engine oil viscosity, or thickness, has an effect on fuel economy and cold-weather operation (starting and oil flow). Low-viscosity engine oils can provide improved fuel economy and cold-weather performance.

High-temperature weather conditions require higher-viscosity engine oils for satisfactory lubrication.

Use SAE 5W-30 motor oil certified for gasoline engines by the American Petroleum Institute.

Do not use supplemental engine oil additives, oil treatments or engine treatments. They are unnecessary and could, under certain conditions, lead to engine damage which is not covered by your warranty.

### CAUTION

Using oils of viscosity besides those recommended for specific temperature ranges could result in engine damage.

Energy conserving oils are recommended. A chief contribution they make to fuel economy is reducing the amount of fuel necessary to overcome engine friction.

### ■ Engine Oil Pressure Gauge

This gauge indicates whether or not there is adequate oil pressure. If the engine is running the pointer should be in the center band, indicating adequate oil pressure. If the pointer drops below or remains below the center band while the engine is running, you have inadequate oil pressure.

If this happens, follow this procedure:

1. Drive safely to the side of the road and park off the right-of-way. Set an automatic transmission in P (Park), a manual transmission in N (Neutral). Apply the parking brake. Turn the engine off. Allow it to reach normal operating temperature.
2. Check the engine's oil level, following the instructions on inspecting engine oil level later in this section. If you do not follow these instructions, you or others could be injured. To assure an accurate reading, your vehicle should be on level ground.
3. Add only as much oil as necessary before you start the engine again. Refer to "Adding Engine Oil" in this section.

## Maintenance

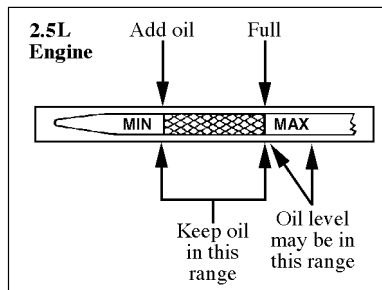
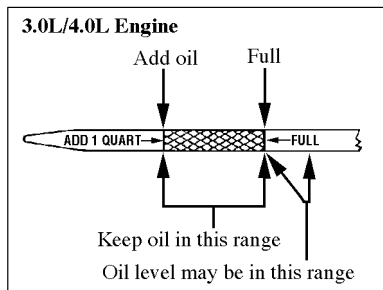

### ▼ Inspecting engine oil level

1. Be sure the vehicle is on a level surface.
2. Warm up the engine to normal operating temperature.
3. Turn it off and wait a few minutes for the oil to return to the oil pan.

4. Set the parking brake fully and make sure that the gearshift is securely latched in P (Park) (automatic transmission) or 1 (First) (manual transmission).
5. Open the hood. Protect yourself from engine heat.

6. Pull out the dipstick, wipe it clean, and reinsert it fully. Refer to Engine Compartment Overview for dipstick location.
7. Pull it out again and examine the level. It's OK if it's within the crosshatched area.

But if it's near or at the bottom of the crosshatched area, add enough oil to bring the level to MAX (2.5L) or FULL (3.0L/4.0L).

It may be necessary to add some oil between oil changes. Make sure you use a certified engine oil of the preferred viscosity. Your vehicle's warranty coverage may not apply if engine damage is caused by the use of improper engine oil.

### ▼ Adding Engine Oil

1. Check the engine oil.
2. If fluid level is not within the normal range, add only certified engine oil of the preferred viscosity. Add engine oil through the oil filler cap. Remove the filler cap and use a funnel to pour oil in the opening.
3. Recheck the oil level. Make sure the oil level is not above the MAX (2.5L) mark or the letter F in FULL (3.0L/4.0L) on the dipstick.
4. Install the indicator and ensure it is fully seated.
5. Fully install the engine oil filler cap by turning the filler cap clockwise until three clicks can be heard.

**CAUTION**

To avoid possible oil loss, DO NOT operate the vehicle with the engine oil level indicator and/or the engine oil filler cap removed.

**CAUTION**

Overfilling with engine oil will damage your engine.

### ▼ Changing engine oil and filter

Change engine oil and filter according to Scheduled Maintenance, pages 8-4 through 8-8.

Please act responsibly—protect the environment and take used oil to a recycling facility. Ask your dealer or a service station for information.

**WARNING**

**Used Engine Oil:**

***Continuous contact with USED engine oil has caused skin cancer in laboratory mice. Protect your skin by washing with soap and water immediately after this work.***

## Maintenance

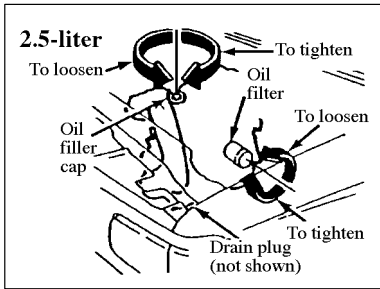

1. Warm up the engine for a few minutes and turn it off after it has reached normal operating temperature. Set the parking brake fully and latch the gear selector in P (Park) (automatic transmission), or 1 (First) (manual transmission). Block the wheels. Remove the oil filler cap.

2. Protect yourself from engine heat and the engine oil being drained.
3. Then remove the drain plug and drain the oil into a suitable container.

### **WARNING**

***Checking or Changing Engine Oil:***  
***Hot engine oil could be dangerous. If the engine has been running, the engine oil becomes very hot. You could be seriously burned. Don't check or change the engine oil when the engine is hot.***

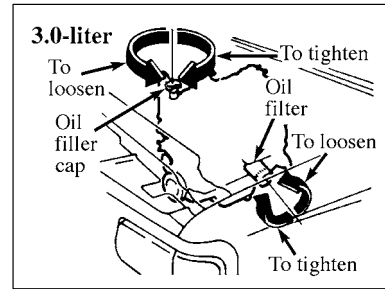

4. Remove the engine oil filter with an oil-filter wrench.
5. Use a clean rag to clean the surface where the filter mounts on the engine.
6. Apply a small amount of engine oil to the rubber seal of a new oil filter.

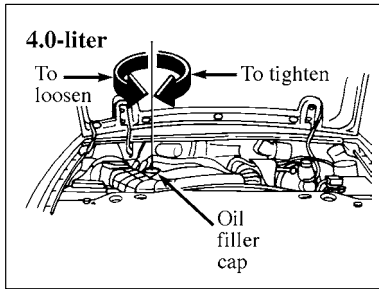

7. Install the new filter and tighten it. (Refer to the caution label on the oil filter for tightening instructions.)
  8. Replace the plug(s) tightly after the oil has thoroughly drained.
  9. Fill the engine with new oil to the MAX (2.5L) or FULL (3.0L/4.0L) mark on the dipstick.
  10. Securely replace the oil filler cap.
  11. Start the engine and inspect around the oil filter seal for leaks.
  12. Turn engine off and wait 5 minutes for the oil to return to the oil pan.
- Check the oil level and fill to the Full mark if necessary.

**Oil capacity**

**2.5L**

	US qt	Imp qt	Liter
with oil filter	4.5	3.8	4.3
without oil filter	4.0	3.4	3.8

**3.0L**

	US qt	Imp qt	Liter
with oil filter	4.5	3.8	4.3
without oil filter	4.0	3.4	3.8

**4.0L**

	US qt	Imp qt	Liter
with oil filter	5.0	4.2	4.7
without oil filter	4.0	3.4	3.8

### NOTE

Use only specified engine oil (page 8-16).

### ⚠ CAUTION

- Follow these instructions carefully. An incorrectly installed filter can cause leakage and engine damage.
- Although oil filters may look the same, they may be very different inside. They are not interchangeable. To avoid engine damage, use only specified filters.

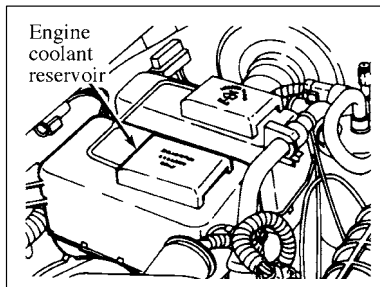

### ■ Engine Coolant

### ⚠ WARNING

#### Hot Engine:

*A hot engine is dangerous. If the engine has been running, parts of the engine compartment can become very hot. You could be burned. Don't inspect the coolant system or add coolant when the engine is hot.*



### ▼ Inspecting coolant level

Inspect the antifreeze protection and coolant level at least once a month, at the beginning of the winter season and before traveling where temperatures may drop below freezing.

Inspect the condition and connections of all cooling system and heater hoses. Replace any that are swollen or deteriorated.

The coolant should be at full in the radiator and to the appropriate level marks on the coolant reservoir when the engine is cool.

If coolant level is low, add enough coolant to provide freezing and corrosion

protection and to bring the level to the appropriate level marks on the coolant reservoir when the engine is cool.

When the engine is cool, add a 50/50 mixture of engine coolant and water to the engine coolant reservoir—**DO NOT ADD DIRECTLY TO THE RADIATOR**. Add straight water only in an emergency, but you should replace it with a 50/50 mixture of coolant and distilled water as soon as possible.

Check the coolant level in the coolant reservoir the next few times you drive the vehicle. If necessary, add enough of a 50/50 mixture of coolant and water to bring the liquid level to the fill line on the reservoir.

### ▼ Severe climate

If you drive in extremely cold climates (less than  $-34^{\circ}\text{F}$  [ $-36^{\circ}\text{C}$ ]), it may be necessary to increase the coolant concentration above 50%. Refer to the chart on the coolant container to ensure the coolant concentration in your vehicle is such that the coolant will not freeze at the temperature level in which you drive during winter months. Never increase the engine coolant concentration above 60%. If you drive in extremely hot climates, it is necessary to maintain the coolant concentration above 40%. Refer to the chart on the coolant container to ensure the coolant concentration in your vehicle will

## Maintenance

---

provide adequate protection at the temperatures in which you drive. Never decrease the coolant concentration below 40% to prevent possible engine damage. Leave a 50/50 mixture of engine coolant and water in your vehicle year-round in non-extreme climates.

### **Do not overfill.**

If new coolant is required frequently, consult an Authorized Mazda Dealer. Have your dealer check the engine cooling system for leaks if you have to add more than 1.0 quart (1.0 liter) of engine coolant per month.

### **WARNING**

*The engine coolant must be maintained at the correct fluid level and concentration to work properly. If the engine coolant fluid level and concentration are not maintained correctly, damage to the engine and cooling system may result.*

### **CAUTION**

Radiator coolant will damage paint. Rinse it off quickly.

### ▼ **Changing coolant at the proper intervals**

Change coolant according to Scheduled Maintenance, page 8-4.

 **CAUTION**

- The use of an improper coolant may void your warranty of your vehicle's engine cooling system.
- Do not use an extended life engine coolant (orange in color).
- Do not use a DEX-COOL engine coolant or an equivalent engine coolant.
- DO NOT USE alcohol or methanol antifreeze. DO NOT MIX alcohol or methanol with the coolant. This could damage the cooling system.

*(Continued)*

- Do not use supplemental coolant additives in your vehicle. These additives may harm your engine cooling system.
- Don't use a solution that contains more than 60 percent or less than 40 percent antifreeze. This would reduce effectiveness.
- Do not add windshield washer fluid to the engine coolant reservoir. This could damage your cooling system.

 **WARNING**

**Removing the Radiator Cap:**

***Removing the radiator cap or drain plug while the engine is running is dangerous. This might lead to cooling system and engine damage and could result in serious injury from escaping hot coolant or steam.***

***Be careful when adding engine coolant. Do not put engine coolant or antifreeze in the container for the windshield washer fluid. If sprayed to clean the glass, engine coolant or antifreeze could make it difficult to see through the windshield.***

*(Continued)*

*Never remove the radiator cap while the engine is running or hot.*

*If you must remove the radiator cap, follow these steps to avoid personal injury that can be caused by escaping steam or engine coolant.*

*Turn off the engine and wait until it's cool. Even then, be very careful when removing the cap. Wrap a thick cloth around it and slowly turn it counterclockwise to the first stop. Step back while the pressure escapes.*

*When you're sure all the pressure is gone, press down on the cap—still using a cloth—turn it, and remove it.*

*Stand away from the radiator opening. Hot steam may blow out or hot engine coolant may even splash out.*

### To Change Coolant

#### NOTE

Do not mix conventional green coolant, orange coolant or recycled coolants together in your vehicle. Use only the type of coolant that your vehicle was originally equipped with. If you are unsure which type of coolant your vehicle requires, contact your authorized Mazda dealer.

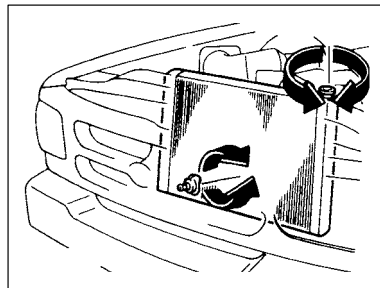

1. Shut off the engine and allow engine to cool. Fully depressurize the engine cooling system by covering the radiator cap with a thick cloth and turning it slowly to the first stop. Step back while the pressure releases.
2. Remove the radiator cap.

3. Only when the engine is cool, attach a small hose to the drain tube at the bottom of the radiator. Loosen the radiator drain plug. Drain the coolant into a suitable container.
4. With the drain plug loose but not fully removed, flush out the system with running water.

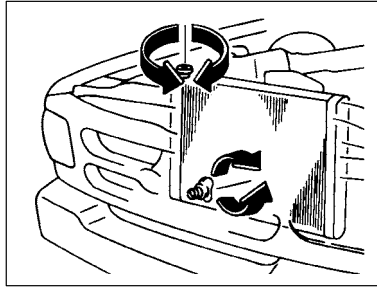

5. Drain the system completely and retighten the plug. Add a 50/50 mixture of coolant and water as necessary to provide freezing and corrosion protection. When cold, fill the radiator to a level 1 to 1 1/2 inches (25 to 38 mm) below the filler neck seat.

In extremely cold climates, add the amount recommended in the coolant manufacturer's instructions.

6. Replace the radiator cap to its fully installed position, then back it off to the first stop. This will prevent high pressure from building up in the cooling system during this part of the procedure.

## Maintenance

---

7. Start and idle the engine until the thermostat opens and the radiator upper hose becomes warm.
8. Shut off the engine immediately. Cover the radiator cap with a thick cloth and cautiously remove it. Step back while the pressure releases.
9. Finally, check the radiator and add more engine coolant if needed, following the procedures noted above. Reinstall the radiator cap securely when finished.
10. If more engine coolant is needed, fill the overflow reservoir to the appropriate level marked on the bottle.

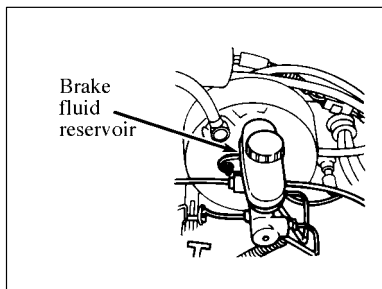

### ■ Inspecting the Brake Fluid Level

Brake fluid should be checked and refilled as needed at least once each year:

1. Clean the reservoir cap before removal to prevent dirt or water from entering the reservoir.
2. Visually inspect the fluid level.
3. If necessary, add brake fluid until the level reaches MAX. Do not fill above this line.
4. Use only a DOT 3 brake fluid certified to meet Mazda specifications. Refer to Section 10.

### CAUTION

Brake fluid will damage painted surfaces. If brake fluid does get on a painted surface, wipe it off immediately.

**⚠ CAUTION**

Using nonspecified brake fluids (see chart, page 10-2) will damage the system. Mixing different fluids will also damage it.

If the brake system frequently requires new fluid, consult an Authorized Mazda Dealer.

**⚠ WARNING**

**Spilled Brake Fluid:**

*Spilled brake fluid is dangerous. If it gets in your eyes, they could be seriously injured. If this happens, immediately flush your eyes with water and get medical attention. Brake fluid spilled on a hot engine could cause a fire. Be careful not to spill brake fluid on yourself or on the engine.*

**⚠ WARNING**

**Low Brake Fluid Levels:**

- *Low brake fluid levels could be dangerous. Low levels could signal brake lining wear or a leak. Your brakes could fail and cause an accident. If you find a low fluid level, have the brakes inspected.*
- *Do not let the brake fluid reservoir run dry. This may cause the brakes to fail.*

## Maintenance

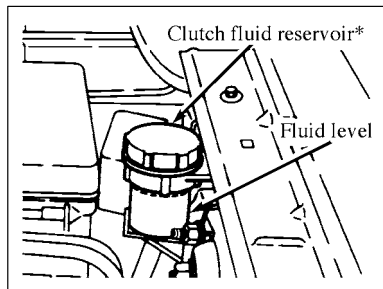

### ■ Inspecting Clutch Fluid Level\*

During normal operation, the fluid level in the clutch reservoir should remain constant. If for any reason the fluid level drops, maintain the fluid level at the step in the reservoir body.

\*Some models.

Use only a DOT 3 brake fluid designed to meet Mazda specifications.

1. Clean the reservoir cap before removal to prevent dirt and water from entering the reservoir.
2. Remove cap and rubber diaphragm from reservoir.
3. Add fluid until the level reaches the step in the reservoir.
4. Reinstall rubber diaphragm and cap onto reservoir.

### CAUTION

Clutch fluid will damage painted surfaces. If clutch fluid does get on a painted surface, wipe it off immediately.

### CAUTION

Using nonspecified clutch fluids (see chart, page 10-2) will damage the system. Mixing different fluids will also damage it.

If the clutch system frequently requires new fluid, it should be inspected. Consult an Authorized Mazda Dealer immediately.



## **WARNING**

### Spilled Clutch Fluid:

*Spilled clutch fluid is dangerous. If it gets in your eyes, they could be seriously injured. If this happens, immediately flush your eyes with water and get medical attention. Clutch fluid spilled on a hot engine could cause a fire. Be careful not to spill clutch fluid on yourself or on the engine.*

### **NOTE**

Low clutch fluid level may signal a fluid leak. If you find a low fluid level, have the clutch inspected.

## ■ **Inspecting Power Steering Fluid Level**

Inspect the fluid level in the reservoir at least twice a year (i.e., every spring and fall). Although you may check the fluid when it is hot or cold, you should check it when hot, if possible, for a more accurate reading.

If you check the power steering fluid when it is cold, make sure the fluid reaches the FULL COLD range on the dipstick. The reading will only be accurate if the fluid temperature is approximately 50 to 85°F (10 to 30°C).

Visually examine the lines and hoses for leaks and damage.

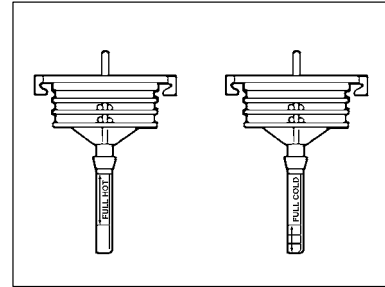

The level must be kept between the FULL HOT and FULL COLD marks.

Do not add fluid if the level is within the FULL HOT range.

## Maintenance

---

1. Park on a level surface, well off the right-of-way, and set the parking brake firmly. Start the engine and let it run until the power steering fluid reaches normal operating temperature. The power steering fluid will be at the right temperature when the engine coolant temperature gauge indicator will be near the center of the normal area between H and C.
2. While the engine idles, turn the steering wheel back and forth several times. Make sure the cap assembly is installed at this time.
3. Turn off the engine.

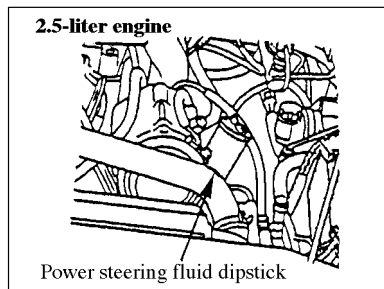

4. Check the fluid level on the dipstick. The fluid level should be at the FULL HOT range.
5. Wipe it clean and put it back.
6. Remove the dipstick again and inspect the level.

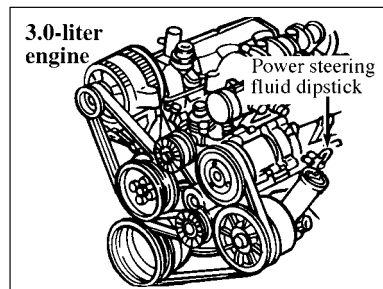

7. The fluid level must be at FULL HOT. Add fluid if necessary. Do not add fluid if the level is within the FULL HOT range.

**Don't overfill.**

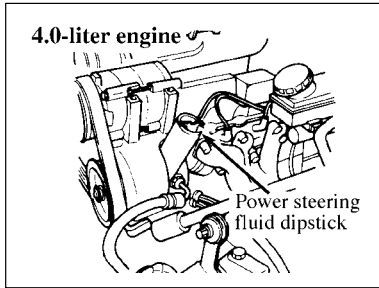

If new fluid is required frequently, consult an Authorized Mazda Dealer.

**⚠ CAUTION**

To avoid damage to the power steering oil pump, don't operate the vehicle for long periods when the power steering fluid level is low.

**NOTE**

Use only specified power steering fluid (see chart, page 10-2).

**NOTE**

Do not turn the steering wheel of your vehicle with the engine off. It could force power steering fluid out from the reservoir cap or in extreme cases, it could unseat the cap.

**■ Inspecting Automatic Transmission Fluid Level\***

The automatic transmission fluid level needs to be inspected under normal circumstances. Measure it as described below.

The transmission fluid should be checked at normal operating temperatures 150°F to 170°F (66°C to 77°C).

Automatic transmission fluid expands when warmed. For that reason, it is best to examine the level after approximately 20 miles (32 km) of driving. If necessary, however, it can also be inspected without driving, if outside temperatures are above 50°F (10°C).

\*Some models.

## Maintenance

---

### NOTE

If the vehicle has been operated for an extended period at high speeds, in city traffic during hot weather, or has been pulling a trailer, the vehicle should be turned off for about 30 minutes. This will allow the vehicle to cool before checking.

### CAUTION

- Low fluid level causes transmission slippage. Overfilling can cause foaming, loss of fluid, and malfunction.
- Use only specified fluid (page 10-2). A nonspecified fluid could result in transmission malfunction and failure.
- Do not drive your vehicle if the fluid level is below the bottom hole on the dipstick and the outside bottom temperature is above 50°F (10°C).

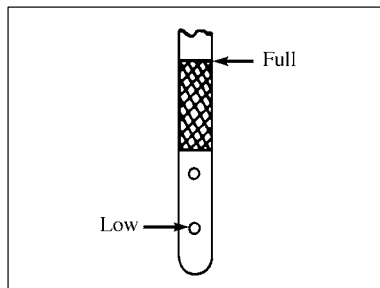

1. Park on a level surface and set the parking brake firmly.
2. Idle the engine about two minutes. Push down on the brake pedal; move the selector lever through all ranges and set it at P (Park).

**⚠ WARNING**

**Sudden Vehicle Movement:**

***Shifting the selector lever without first depressing the brake pedal is dangerous. The vehicle could move suddenly and cause an accident. Make sure the brake pedal is applied before shifting the selector.***

3. With the engine still idling, wipe off the dipstick handle, pull out the dipstick, wipe it clean, and put it back, making sure it is fully seated in the filler tube.

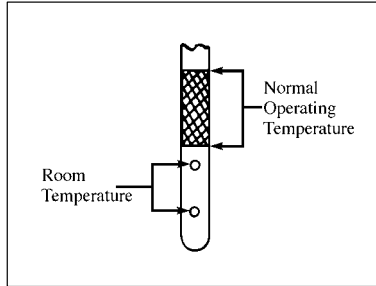

4. Pull it out again. At normal operating temperature, the level should be within the crosshatched area on the dipstick. If the vehicle has not been driven and the fluid is not at normal operating temperature, the fluid level should be between the two holes on the dipstick.

5. If necessary, add fluid in .25L (1/2 pint) increments through the filler tube until the level is correct.
6. If an overfill occurs, excess fluid should be removed by a qualified technician.

**⚠ CAUTION**

An overfill condition of transmission fluid may cause shift and/or engagement concerns and/or possible damage. Don't overfill.

### NOTE

Always dispose of used automotive fluids in a responsible manner. Follow your community's standards for disposing of these types of fluids. Call your local recycling center for recycling automotive fluids.

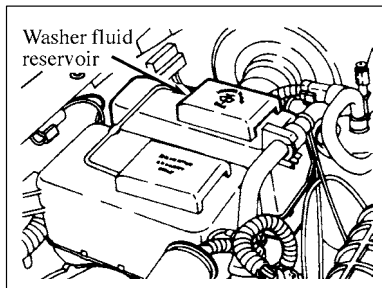

### ■ Inspecting Washer Fluid Level

Check the level of the windshield washer fluid every time you stop for fuel. The reservoir for washer fluid is located in the engine compartment.

Before adding fluid, make sure the engine is turned off. Use special windshield washer fluid, rather than plain water, because these special fluids contain additives that dissolve road grime. Also, washer fluid will not freeze in cold weather.

If you choose to use a windshield washing solution that must be mixed, follow the manufacturer's mixing instructions. Improperly mixed solutions may freeze unexpectedly.

 **WARNING**

Washer Fluid:

*Do not add the windshield washer fluid to the engine coolant reservoir. This could damage your cooling system. Do not add engine coolant to the washer fluid reservoir. This could damage your wiper/washer system and could severely affect visibility when sprayed on the windshield and may cause damage to paint and body trim.*

 **WARNING**

Freezing Washer Fluid:

*Before using the washer fluid in very cold weather, warm up the windshield first by using the defroster. If you do not warm up the windshield first, the fluid may freeze and reduce visibility when sprayed on the windshield.*

■ **Body Lubrication**

All moving points of the body, such as door and hood hinges and locks, should be lubricated each time the engine oil is changed. Use a nonfreezing lubricant on locks during cold weather.

Make sure the engine hood's secondary latch keeps the hood from opening when the primary latch is released.

■ **Maintaining Wiper Blades**

 **CAUTION**

Hot waxes applied by automatic car washes have been known to affect the cleanability of windows.

## Maintenance

---

Check the windshield wiper blades at least twice a year. Also check them whenever they seem less effective than usual.

Contamination of either the windshield or the blades with foreign matter can reduce wiper effectiveness. Common sources are insects, tree sap, and hot wax treatments used by some commercial car washes.

If the blades are not wiping properly, clean the window and blades with a good cleaner or mild detergent; then rinse thoroughly with clean water. Repeat if necessary.

To make reaching the wiper blades easy, simply turn the ignition switch to ACC and turn your wipers on. Wait for them to reach a vertical position and turn the ignition OFF. Do not move the wipers manually. Moving the wipers manually may damage them.



### CAUTION

To prevent damage to the wiper blades, don't use gasoline, kerosene, paint thinner, or other solvents on or near them.

## ■ Replacing Windshield Wiper Blade Assemblies

When the wipers no longer clean well, the blades are probably worn or cracked. Replace the wiper blade assemblies.



### CAUTION

To prevent damage to the wiper arms, and other components, don't move the wipers by hand.



1. Pull the wiper arm away from the windshield and lock into the service position.
2. Turn the blade at an angle from the wiper arm. Push the lock pin with a screwdriver to release the blade and pull the wiper blade down toward the windshield to remove it from the arm.
3. Attach the new wiper to the wiper arm and press it into place until a click is heard.

 **CAUTION**

To prevent damage to the windshield, don't let the wiper arm fall on it.

**NOTE**

Install the blade so that the tabs are toward the bottom of the wiper arm.

■ **Battery**

 **WARNING**

***Battery:***

***Batteries are dangerous. To avoid injury, pay careful attention to the advice below.***

***Keep all flames, sparks, and lit smoking materials away from the battery. Battery cells contain hydrogen, a highly combustible gas.***

***Keep batteries, which contain SULFURIC ACID, out of the reach of children. Prevent battery contact with skin, eyes, clothing, and the vehicle.***

*(Continued)*

## Maintenance

---

*If electrolyte (battery fluid) gets into your eyes, flush them with clean water for at least 15 minutes and get immediate medical attention. If possible, continue to apply water with a sponge or cloth while on the way to a doctor.*

*If electrolyte gets on your skin, thoroughly wash the contacted area. If you feel pain or a burning sensation, get medical attention immediately.*

*When lifting a plastic-coated battery, excessive pressure on the end walls could cause acid to spew through the vent caps, resulting in personal injury. Lift the battery with a carrier or with your hands on opposite corners.*

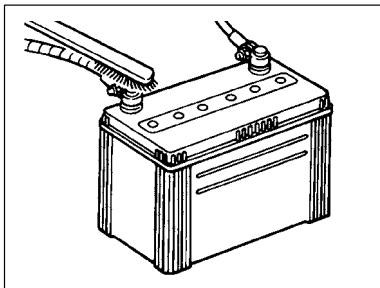

To get the best service from a battery:

- Keep it securely mounted.
- Keep the top clean and dry.
- Keep terminals and connections clean, tight, and coated with petroleum jelly or terminal grease.

- Rinse off spilled electrolyte immediately with a solution of water and baking soda.
- If the vehicle will not be used for an extended time, disconnect the battery cables.

### ■ Tires

For reasons of proper performance, safety, and better fuel economy, always maintain recommended tire inflation pressures and stay within the recommended load limits and weight distribution.

**⚠ WARNING**

**Using Different Tire Types:**

*Driving your vehicle with different types of tires is dangerous. It could cause poor handling and poor braking, leading to loss of control. Except when using the temporary spare tire, use only the same type tires (radial, bias-belted, bias-type tires) on all four wheels.*

**⚠ WARNING**

**Using Wrong-Sized Tires:**

*Using any other tire size or type than what is specified for your Mazda (page 10-9) may seriously affect ride, handling, ground clearance, tire clearance, and speedometer calibration. This could cause you to have an accident. Do not replace your tires with “high performance” tires or larger-sized tires. Use only tires that are the correct size specified for your Mazda.*

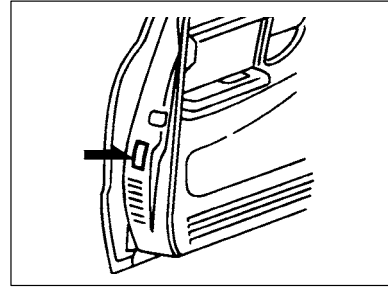

**▼ Tire inflation pressure**

Inspect all tire pressures monthly (including the spare) when the tires are cold. Maintain recommended pressures for the best ride, top handling, and minimum tire wear.

Refer to the specification chart (page 10-9).

### NOTE

- Warm tires normally exceed recommended pressures. Don't release air from warm tires to adjust the pressure.
- Underinflation can cause reduced fuel economy and poor sealing of the tire bead, which will deform the wheel and cause separation of the tire from the rim.
- Overinflation can produce a harsh ride and a greater possibility of damage from road hazards.
- So keep your tire pressure at the correct levels. If one frequently needs inflating, have it inspected.

### **WARNING**

***Incorrect Tire Inflation:***  
***Overinflation or underinflation of tires is dangerous. Adverse handling or unexpected tire failure could result in a serious accident. Always inflate the tires to the correct pressure (page 10-9)***

### ▼ **Tire inspection and maintenance**

Inspect the tire treads, and remove stones, nails, glass or other objects that may be wedged in the tread grooves. Check for holes or cuts that may permit air to leak from the tire, and make the necessary repairs.

Inspect the tire side walls for cuts, bruises and other damage. If you suspect internal damage to the tire, have it demounted and checked. You may need to repair or replace it.

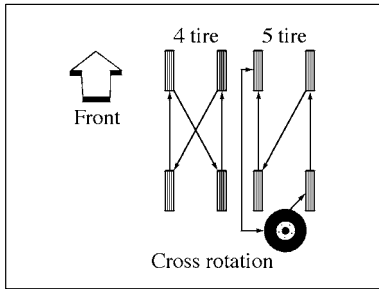

### ▼ Tire rotation

To equalize tread wear, rotate the tires at 5,000 miles (8,000 km) and after that every 10,000 miles (16,000 km) (or sooner

if irregular wear develops). During rotation, inspect them for correct balance and proper lug nut tightness.

Also, inspect them for uneven wear and damage. Abnormal wear is usually caused by one or a combination of the following:

- Incorrect tire pressure
- Improper wheel alignment
- Out-of-balance wheel
- Severe braking

After rotation, bring all tire pressures to specification (page 10-9).

## CAUTION

- Rotate radial tires that have an asymmetrical tread pattern or studs only from front to rear, not from left to right.
- Rotate directional tires only from front to rear, not from left to right.
- In situations where the tires differ from front to rear (snow traction), simply rotate using a side to side pattern.

## Maintenance

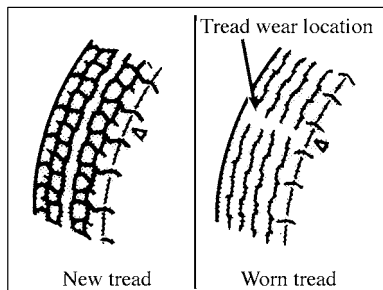

Replace the tire when this happens. You may need to replace it before the band is across the entire tread.

For additional information on replacing tires on 4x4 vehicles, refer to Section 5.

### **WARNING**

#### Worn Tires:

*Driving with worn-out tires dangerous. Reduced braking, steering and traction could result in an accident. Always use tires that are in good condition.*

### **WARNING**

#### Re-installing Wheels:

*Whenever a wheel is removed and then re-installed, always remove any corrosion that may be present on the mounting surface of the wheel and/or the surface of the hub, drum or rotor that contacts the wheel. Installing wheels without good metal-to-metal contact at the wheel mounting surface can cause the wheel lug nuts to loosen and could allow the wheel to come off while the vehicle is in motion, causing loss of control.*

### ▼ Replacing a tire

If a tire wears evenly, a wear indicator will appear as a solid band across the tread. When your tire shows a wear band, it has only 1/16 inch (1.59 mm) of tread left.

 **WARNING**

**Tire Specifications:**

*Never mix radial, bias-belted or bias-type tires. Never mix brands. Use only the tire size that is listed on the Safety Compliance Certification Label, located near the left front door latch.*

*Make sure that all replacement tires are of the same size, type, load-carrying capacity, and tread design (e.g., “All Terrain,” etc.), as originally specified by Mazda.*

*(Continued)*

*Do not replace your Mazda 4x4 or Mazda 4x2 tires with “high performance” tires, or larger size tires than approved for your vehicle by Mazda.*

*Do not use P235/75R15 “All Season” tires. For Mazda 4x4 Regular Cab vehicles, P235/75R15 “All Terrain” tires are acceptable only on 15x7 inch wheels.*

*Do not use P265/75R15SL tires on the Mazda 4x4 112 inch wheelbase. The P265/75R15SL “All Terrain” tires are acceptable only on the 126 inch wheelbase Mazda 4x4 models, and only with 15x7 inch wheels.*

 **WARNING**

**Replacement Tires and Snow Tires:**

*If you have questions concerning replacement tires, contact an Authorized Mazda Dealer. Failure to follow these precautions may adversely affect the handling of the vehicle and make it easier to lose control and roll over, which could result in serious or fatal injury.*

*If you use snow tires, make sure that they are the same size and grade as the tires you now have on your vehicle. If they are not, your vehicle may not handle safely.*

## Maintenance

---

### ▼ Tire identification

Note that the size in the following chart is typical. To determine what specific size tire and rim is recommended by Mazda for use on your vehicle, refer to the Safety Compliance Certification Label on your vehicle.

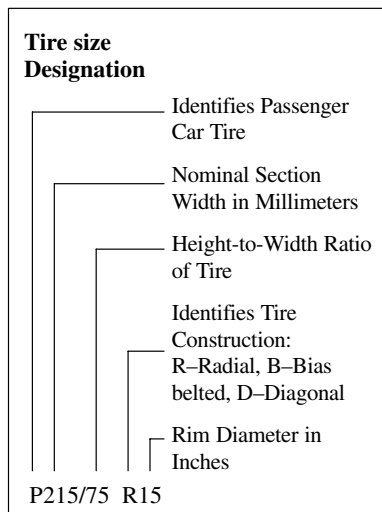

### ▼ Temporary spare tire

Inspect the temporary spare tire at least monthly to make sure it's properly inflated and stored. Refer to the Federal Motor Vehicle Safety Standard Label for appropriate cold pressure. This label is located on the driver's door pillar.

The temporary spare tire is easier to handle because of its construction. It is lighter and smaller than a conventional tire and should be used only for an emergency and only for a short distance.

Use the temporary only until the conventional tire is repaired, which should be as soon as possible.

Don't use a temporary tire in your tire rotation pattern.



 **CAUTION**

- Don't use your temporary spare tire rim with a snow tire or a conventional tire. Neither will properly fit and could damage both tire and rim.
- The temporary spare tire has a tread life of up to 3,000 miles (4,800 km), depending on road conditions and driving habits.
- When the tread wear solid-band indicator appears, replace the tire with the same type of temporary spare.

▼ **Replacing a wheel**

When replacing a wheel, make sure the new one is the same as the original factory wheel in diameter, rim width, and offset.

Proper tire balancing provides the best riding comfort and helps reduce tread wear. Out-of-balance tires can cause vibration and uneven wear, such as cupping and flat spots.

 **WARNING**

*Using a Wrong-Sized Wheel:*

*Using a wrong-sized wheel is dangerous. Braking and handling could be affected, leading to loss of control and an accident. Always use wheels of the correct size on your Mazda.*

### **⚠ WARNING**

***Aftermarket Wheel Assemblies:***  
*Use of aftermarket wheel assemblies that are different in size or offset may damage your vehicle or cause accidents resulting in serious injury.*

### **⚠ CAUTION**

A wrong-sized wheel may adversely affect:

- Tire fit
- Wheel and bearing life
- Ground clearance
- Snow-chain clearance
- Speedometer calibration
- Headlight aim
- Bumper height

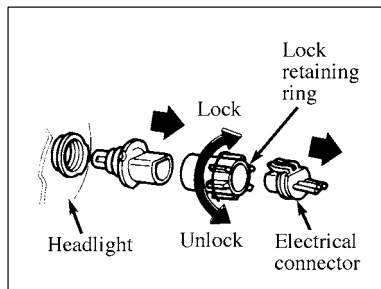

### ■ Headlight Replacement

The headlamps on your vehicle are properly aimed at the assembly plant.

If your vehicle has been in an accident, a qualified service technician should check the alignment of your headlamps.

▼ **To remove a bulb:**

The headlights on your vehicle use replaceable bulbs. When the light burns out, simply replace the bulb, rather than the whole light.

 **WARNING**

**Handling Halogen Bulbs:**

*When a halogen bulb breaks, it is dangerous. These bulbs contain pressurized gas. If one is broken, it will explode and serious injuries could be caused by the flying glass. If the glass portion is touched with bare hands, body oil could cause the bulb to overheat and explode when lit. Never touch the glass portion of the bulb with your bare hands and always wear eye protection when handling or working around halogen bulbs.*

 **WARNING**

**Children and Halogen Bulbs:**

*Playing with a halogen bulb is dangerous. Serious injuries could be caused by dropping a halogen bulb or breaking it some other way. Always keep halogen bulbs out of the reach of children.*

## Maintenance

---

### NOTE

If the bulb is accidentally touched, it should be cleaned with rubbing alcohol before being used.

Do not remove the burned-out bulb unless you can immediately replace it with a new one. If a bulb is removed for an extended period of time, contaminants may enter the headlight housing and affect its performance.

1. Make sure the headlight control switch is in the OFF position.
2. Open the hood. If you are replacing the driver side headlight, unclip the electronic module on the right side of the battery and move it out of the way.
3. Locate the headlight bulb through the hole in the upper radiator support assembly.
4. Disconnect the electrical connector from the bulb by pulling rearward.
5. Remove the bulb retaining ring by rotating it counterclockwise (when viewed from the rear) to free it from the bulb socket, and slide the ring off the plastic base. **Keep the ring in the rearward position.** You must use it again to hold the new bulb in place.
6. Carefully remove the bulb assembly from its connector by gently pulling it rearward without turning.

### ▼ To install a bulb:

1. With the flat side of the bulb's plastic base facing upward, insert the glass end of the bulb into the light assembly. You may need to turn the bulb left or right to line up the grooves in the plastic base with the tabs in the light assembly. When the grooves are aligned, push the bulb into the socket until the plastic base contacts the rear of the light assembly.
2. Install the bulb retaining ring over the plastic base until it contacts the rear of the socket. Lock the ring into the socket by rotating it clockwise until you feel a "stop."
3. Install the electrical connector into the rear of the plastic base until it snaps, locking it into position.
4. Turn the headlights on and make sure that they work properly. If the headlight was correctly aligned before you changed the bulb, you should not need to align it again.

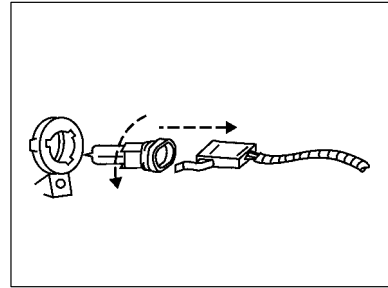

### ■ Foglight Bulb Replacement

1. Remove the bulb socket from the foglight by turning counterclockwise.
2. Disconnect the electrical connector from the foglamp bulb.
3. Connect the electrical connector to the new foglamp bulb.
4. Install the bulb socket in the foglamp turning clockwise.

## Maintenance

### Bulb Replacement (Front)

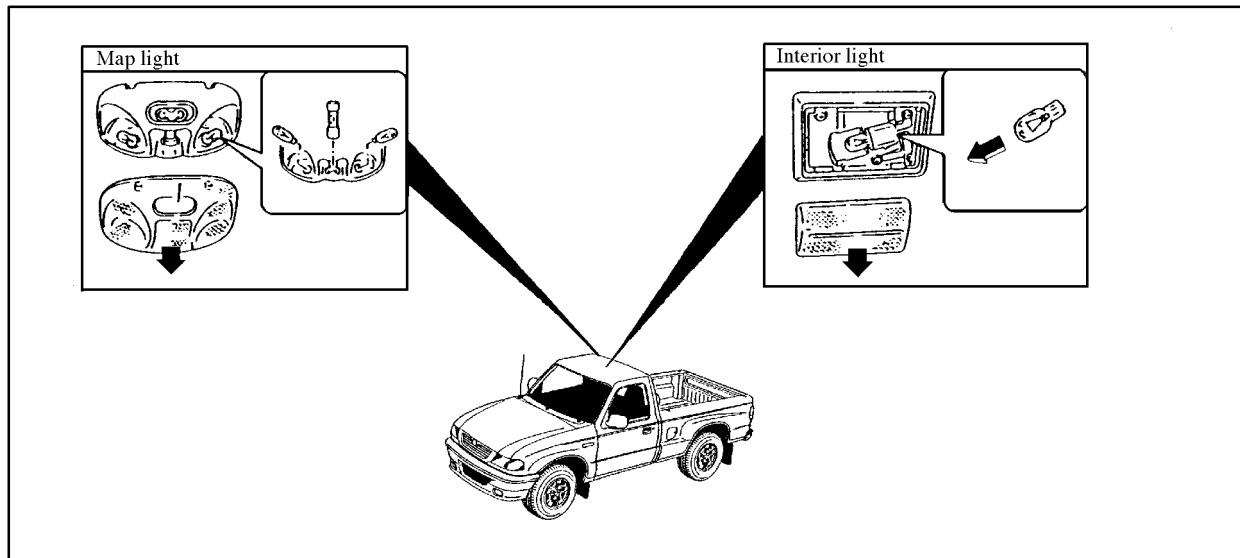

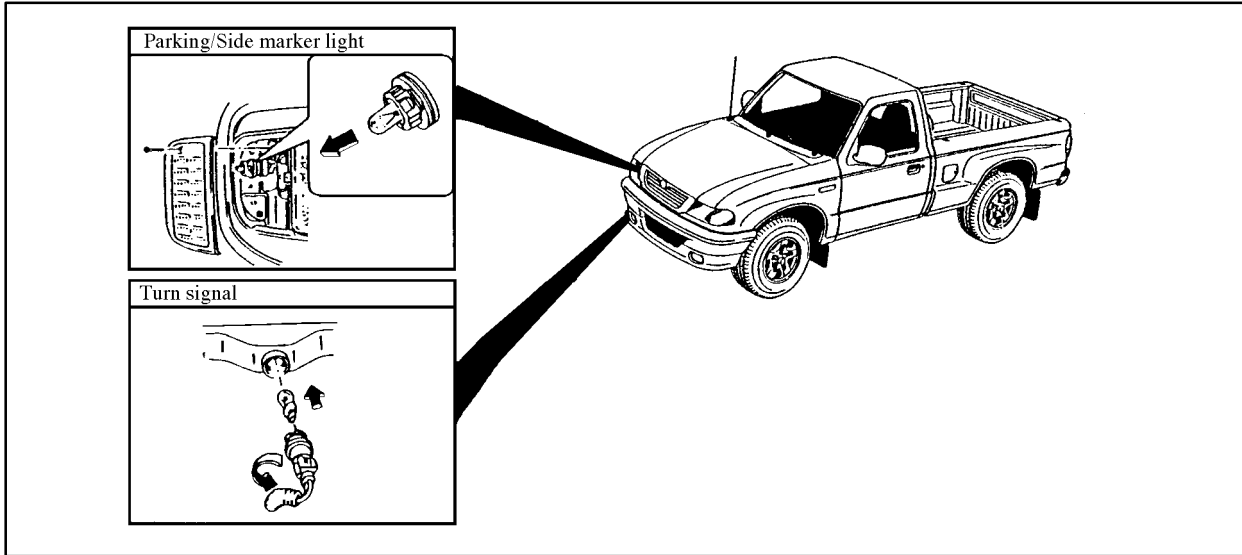

## Maintenance

### Bulb Replacement (Rear)

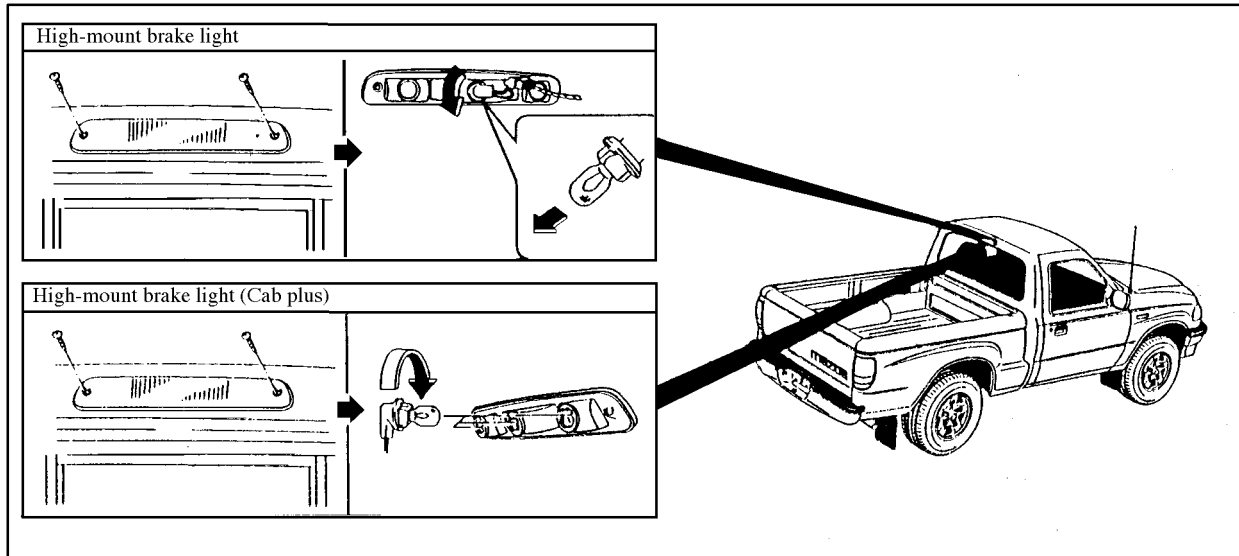



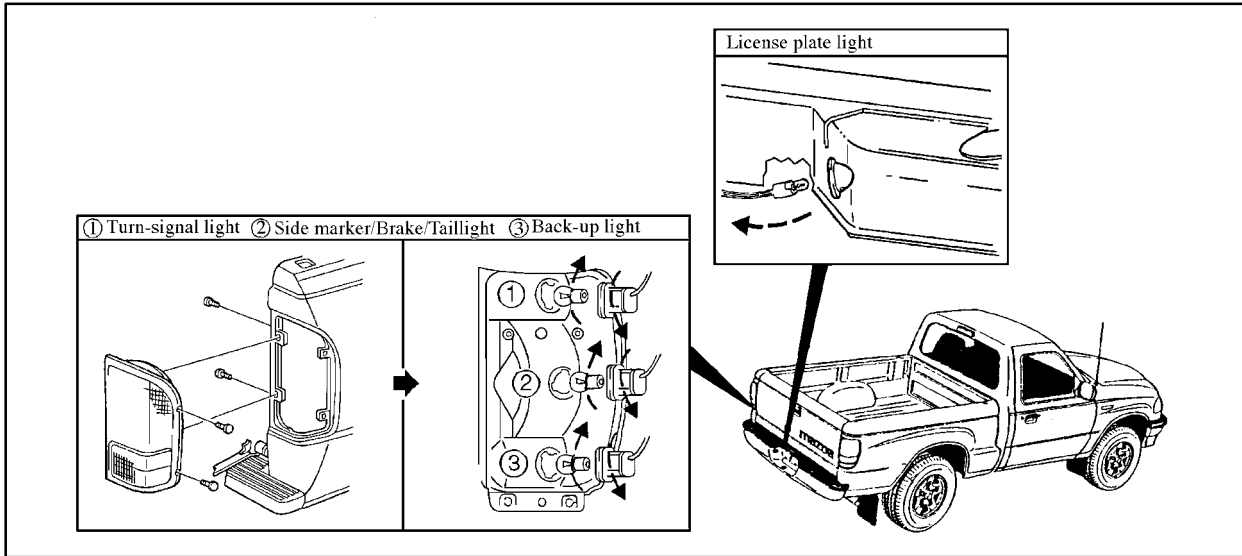

**Memo**

---

**8-56**

# 9

## Customer Information

*Who to consult about a problem; what to do if your vehicle has a safety defect; what warranties protect your vehicle; driving outside the United States and Canada; adding equipment; tire quality grades: This is the kind of consumer information you'll find in Section 9.*

Customer Assistance	9- 2
Mazda Importer/Distributors	9- 5
Warranties for Your Mazda	9- 6
Outside the United States and Canada	9- 6
Slide-In Camper	9- 7
Add-On Non-Genuine Parts and Accessories	9- 7
Uniform Tire Quality Grading System (UTQGS)	9- 8
Reporting Safety Defects	9-11
Service Publications	9-12

## Customer Information

---

### Customer Assistance

Your complete and permanent satisfaction is our business. We're here to serve you. All Authorized Mazda Dealers have the knowledge and the tools to keep your Mazda vehicle in top condition.

If you have any questions or recommendations for improvement regarding the service of your Mazda vehicle or servicing by Mazda Dealer personnel, we recommend that you take the following steps:

#### **STEP 1: Contact the Mazda Dealer**

Discuss the matter with an Authorized Mazda Dealer. This is the quickest and best way to address the issue. If your concern has not been resolved by the CUSTOMER RELATIONS, SALES, SERVICE, or PARTS MANAGER, then please contact the GENERAL MANAGER of the dealership or the OWNER.

**STEP 2: Call the Mazda National Customer Assistance Center**

If for any reason you feel the need for further assistance after contacting your dealership management, call Mazda North American Operations' Customer Assistance Center toll-free at:

**1-800-222-5500**

In order to serve you efficiently and effectively, please help us by providing the following information:

1. Your name, address, and telephone number
2. Year and model of vehicle
3. Vehicle Identification Number (17 digits, noted on your registration or title or located on the upper driver's side corner of the dash)
4. Purchase date and current mileage
5. Your dealer's name and location
6. Your question(s)

## Customer Information

---

If you would like to write a letter, please address it to the following. Attn: Customer Assistance, which corresponds with your state:

<b>COVERING STATES</b>	<b>OFFICE</b>
All states excluding Illinois, Indiana, Michigan, Ohio, Wisconsin	<b>Mazda North American Operations</b> <b>7755 Irvine Center Drive</b> <b>Irvine, CA 92618-2922</b> <b>P.O. Box 19734</b> <b>Irvine, CA 9623-9734</b>
Illinois Indiana Michigan Ohio Wisconsin	<b>Mazda Distributors Great Lakes</b> <b>618 Kenmoor Avenue, SE</b> <b>Grand Rapids, MI 49546</b> <b>P.O. Box 2008</b> <b>Grand Rapids, MI 49501-2008</b>

This way, we can be sure to respond to you as efficiently as possible. That is our goal.

If you live outside of the U.S.A., please contact your nearest Mazda Distributor. (Please see page 9-5.)

## Mazda Importer/Distributors

### U.S.A. (Importer/Distributor)

#### Mazda North American Operations

7755 Irvine Center Drive  
Irvine, CA 92618-2922  
P.O. Box 19734  
Irvine, CA 92623-9734

TEL: 1-800-222-5500 (in the U.S.A.)  
(949) 727-1990 (outside U.S.A.)

#### (Distributor in each area)

### CANADA

#### Mazda Canada, Inc.

305 Milner Avenue, Suite 400  
Scarborough, Ontario M1B 3V4  
Canada

TEL: 1 (800) 263-4680 (In Canada)  
TEL: (416) 609-9909  
(Outside Canada)

### PUERTO RICO

#### Plaza Motors Corp. (Mazda de Puerto Rico)

P.O. Box 362722  
San Juan, Puerto Rico 00936-2722  
TEL: (787) 788-9300

### GUAM

#### Keico Motors Ltd.

P.O. Box CP, Agana, Guam 96910  
TEL: (671) 477-7807

### SAIPAN

#### Pacific International Marianas, Inc. (d.b.a. Midway Motors)

P.O. Box 887  
Saipan, MP 96950  
TEL: (670) 234-7524

### AMERICAN SAMOA

#### Polynesia Motors, Inc.

P.O. Box 1120  
Pago Pago, American Samoa 96799  
TEL: (684) 699-9347

## Customer Information

---

### Warranties for Your Mazda

- New Vehicle Limited Warranty
- Safety Restraint System Limited Warranty
- Anti-Perforation Limited Warranty
- Federal Emission Control Warranty
  - Emission Defect Warranty
  - Emission Performance Warranty
- California Emission Control Warranty (if applicable)
- Replacement Parts and Accessories Limited Warranty
- Tire Warranty

<b>NOTE</b>
Detailed warranty information is provided with your Mazda.

### Outside the United States and Canada

Government regulations in the United States require that automobiles meet specific emission regulations and safety standards. Therefore, vehicles built for use in the United States, its territories, and Canada may differ from those sold in other countries.

The differences may make it difficult or even impossible for your vehicle to receive satisfactory servicing in other countries. We strongly recommend that you NOT take your Mazda outside these areas.

You may have these problems if you do:

- Recommended fuel may be unavailable. Any kind of leaded fuel or low-octane fuel will affect vehicle performance and damage the emission controls and engine.
- Proper repair facilities, tools, testing equipment, and replacement parts may not be available.

The manufacturer's warranty applies only to Mazda vehicles registered and normally operated in the United States, its territories, and Canada.



## Slide-In Camper

Your Mazda vehicle is not designed to be used with a slide-in camper.

### **WARNING**

#### **Riding in the Truck Bed:**

*Riding in the truck bed, on the bumper, or on the tailgate, whether it's open or closed, is dangerous. Someone doing this could be injured or killed during a sudden stop or accident. Camper type covers of any kind offer no real protection from these dangers and may trap poisonous exhaust fumes. They should only be occupied when the vehicle is parked without the engine running. Never allow anyone to ride outside the passenger compartment.*

## Add-On Non-Genuine Parts and Accessories

Non-genuine parts and accessories for Mazda vehicles can be found in stores. These may fit your vehicle, but they are not approved by the manufacturer for use with Mazda vehicles. When you install non-genuine parts or accessories, they could affect your vehicle's performance or safety system; the manufacturer's warranty doesn't cover this. Before you install any non-genuine parts or accessories, consult an Authorized Mazda Dealer.

### **WARNING**

#### **Installation of Non-Genuine Parts or Accessories:**

*Installation of non-genuine parts or accessories could be dangerous. Improperly designed parts or accessories could seriously affect your vehicle's performance or safety system. This could cause you to have an accident or increase your chances of injuries in an accident. Always consult an Authorized Mazda Dealer before you install non-genuine parts or accessories.*

### **WARNING**

#### **Add-On Electrical and Electronic Equipment:**

*Incorrectly choosing or installing improper add-on equipment or choosing an improper installer could be dangerous. Essential systems could be damaged, causing engine stalling, air bag (SRS) activation, ABS inactivation, or a fire in the vehicle. Be very careful in choosing and installing add-on electrical equipments, such as mobile telephones, two-way radios, stereo systems, and car alarm systems.*

Mazda assumes no responsibility for death, injury, or expenses that may result from the installation of add-on non-genuine parts or accessories.

## **Uniform Tire Quality Grading System (UTQGS)**

This information relates to the tire grading system developed by the U.S. National Highway Traffic Safety Administration for grading tires by tread wear, traction, and temperature performance.

### **■ Tread Wear**

The tread wear grade is a comparative rating based on the wear rate of the tire when tested under controlled conditions on a specified government test course. For example, a tire graded 150 would wear one-and-a-half times as well on the government course as a tire graded 100.

The relative performance of tires depends upon the actual conditions of their use, however, and may depart significantly from the norm because of variations in driving habits, service practices and differences in road characteristics and climate.

### ■ Traction—AA, A, B, C

The traction grades from highest to lowest, are AA, A, B and C. Those grades represent the tire's ability to stop on wet pavement as measured under controlled conditions on specified government test surfaces of asphalt and concrete. A tire marked C may have poor traction performances.

 <b>WARNING</b>
<p><b><i>Tire Traction Grade:</i></b> <i>The traction grade assigned to this tire is based on braking (straight ahead) traction tests and does not include acceleration, cornering (turning), hydroplaning or peak traction characteristics.</i></p>

### ■ Temperature—A, B, C

The temperature grades, A (the highest), B, and C, represent the tire's resistance to the generation of heat and its ability to dissipate heat when tested under controlled conditions on a specified indoor laboratory test wheel.

Sustained high temperatures can cause the material of the tire to degenerate and reduce tire life, and excessive temperatures can lead to sudden tire failure.

Grade C corresponds to a level of performance which all passenger vehicle tires must meet under the Federal Motor Vehicle Safety Standard No. 109. Grades B and A represent higher levels of performance on the laboratory test wheel than the minimum required by law.

## Customer Information

---

### **WARNING**

#### ***Tire Temperature Grade:***

***The temperature grade for this tire is established for a tire that is properly inflated and not overloaded. Excessive speed, underinflation, or excessive loading, either separately or in combination, can cause heat buildup and possible tire failure.***

These grades will be added to the sidewalls of passenger vehicle tires over the next several years according to a schedule established by the NHTSA and the tire manufacturers.

The grade of tires available as standard or optional equipment on Mazda vehicles may vary with respect to grade.

**ALL PASSENGER VEHICLE TIRES MUST CONFORM TO THESE GRADES AND TO ALL OTHER FEDERAL TIRE SAFETY REQUIREMENTS.**

#### **UTQGS Mark (example)**

**Treadwear 160 Traction B  
Temperature B**

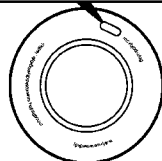

Refer to the tire sidewall for the specific tire grades of tires which are equipped on the vehicle.

## **Reporting Safety Defects**

If you believe that your vehicle has a defect which could cause a crash or could cause injury or death, you should immediately inform the National Highway Traffic Safety Administration (NHTSA) in addition to notifying Mazda Motor Corporation (Your Mazda Importer/Distributor).

If NHTSA receives similar complaints, it may open an investigation, and if it finds that a safety defect exists in a group of vehicles, it may order a recall and remedy campaign. However, NHTSA cannot become involved in individual problems

between you, your dealer, or Mazda Motor Corporation (Your Mazda Importer/Distributor).

To contact NHTSA, you may either call the Auto Safety Hotline toll-free at 1-800-424-9393 (or 366-0123 in Washington, D.C. area) or write to: NHTSA, U.S. Department of Transportation, Washington, D.C. 20590. You can also obtain other information about motor vehicle safety from the Hotline.

### **NOTE**

If you live in the U.S.A., all correspondence to Mazda Motor Corporation should be forwarded to:

Mazda North American  
Operations

Attn: Customer Assistance  
7755 Irvine Center Drive  
Irvine, California 92618-2922  
P.O. Box 19734  
Irvine, CA 92623-9734  
or call toll-free at  
1-800-222-5500.

If you live outside of the U.S.A., please contact the nearest Mazda Distributor shown on page 9-5 in this booklet.

## Customer Information

---

### Service Publications

Factory-authorized Mazda service publications are available for owners who wish to do some of their own maintenance and repair.

When requesting any of our publications through an Authorized Mazda Dealer, refer to the chart.

If they don't have what you need in stock, they can order it for you.

#### **WORKSHOP MANUAL:**

Covers recommended maintenance and repair procedures of the powertrain, body and chassis.

#### **WIRING DIAGRAM:**

Provides electrical schematics as well as component location for the entire electrical system.

#### **OWNER'S MANUAL:**

Contains information regarding the proper care and operation of your vehicle. This is not a technician's manual.

<b>PUBLICATION ORDER NUMBER</b>	<b>PUBLICATION</b>
9999 95 022B 00	2000 WORKSHOP MANUAL
9999 95 020G 00	2000 WIRING DIAGRAM
9999 95 23CS 00	2000 OWNER'S MANUAL

# 10

## Specifications

---

Lubricant Quality	10-2
Dimensions	10-3
Payload Capacity and Standard	
Equipment Specifications	10-4
Engine	10-6
Electrical System	10-6
Capacities	10-7
Air Conditioner	10-8
Tires	10-9
Light Bulbs	10-9

## Specifications

---

### Lubricant Quality

Item		Classification or Equivalent
Engine oil		API Certified SAE 5W-30
Automatic transmission fluid		Mazda ATF Type 5
Manual transmission oil		Mercon® ATF or M-III
Transfer case oil* <sup>1</sup>		Mercon® ATF or M-III
Front* <sup>1</sup> and Rear differential oil		API GI-5 SAE 80W90
Propeller shaft grease* <sup>1</sup>	Sliding Joint	Molybdenum disulphide grease
	Universal Joint	NLGI No. 2 (Lithium base)
Manual steering gear grease		C3AZ19578A or equivalent ESWMIC87-A
Power steering fluid		Mercon® ATF or M-III
Wheel bearing grease		NLGI No. 2 (Lithium base)
Multi-purpose grease		NLGI No. 2 (Lithium base)
Molybdenum disulphide grease		NLGI No. 2
Brake and clutch fluid		FMVSS116 DOT-3

\*<sup>1</sup> 4x4 models

#### NOTE

Use molybdenum disulphide grease for suspension upper arm shafts.



## Dimensions

		Regular Cab	Cab Plus
<b>Overall length</b>	in (mm)	187.5* (4,763)	202.9* (5,153)
<b>Overall width</b>	in (mm)	70.3 (1,785)	70.3 (1,785)
<b>Overall height</b>			
<b>4x2</b>	in (mm)	62 (1,575)	62.4 (1,585)
<b>4x4</b>	in (mm)	65.2 (1,655)	66.3 (1,684)
Wheelbase	in (mm)	111.4 (2,831)	125.7 (3,192)
<b>Cargo bed</b>			
Inside length	in (mm)	72.2 (1,834)	72.3 (1,836)
Inside length	in (mm)	51.2 (1,301)	51.2 (1,301)
Inside height	in (mm)	16.5 (419)	16.5 (419)

\*With rear step-bumper

## Specifications

---

### Payload Capacity and Standard Equipment Specifications

	4x2 Payload Package		4x4 Payload Package	
	#1-Std	#2-Opt	#1-Std	#2-Opt
Maximum Payload Rating: <sup>(1)</sup> <sup>(2)</sup> (lbs.)				
— 112" Wheelbase	1260	1660	1260	1500
— 126" Wheelbase	1260	1620	1260	1500
GVWR: (lbs.)				
— 112" Wheelbase	4320	4740	4760	4980
— 126" Wheelbase	4540	4900	4940	5120
GAWR: <sup>(3)</sup> (lbs.) — w/112" Wheelbase				
— Front Min.	2288	2288	2490	2490
— Front Max.	2400	2400	2710	2710
— Rear Min.	2317	2735	2511	2731
— Rear Max.	2600	2750	2600	2750

See footnotes on page 10-5.

## Specifications

	4x2 Payload Package		4x4 Payload Package	
	#1-Std	#2-Opt	#1-Std	#2-Opt
GAWR: <sup>(3)</sup> (lbs.) — w/126" Wheelbase				
— Front Min.	2558	2558	2773	2773
— Front Max.	2600	2600	2850	2850
— Rear Min.	2421	2747	2569	2749
— Rear Max.	2600	2750	2600	2750

- (1) Load rating represents maximum allowable weight of people, cargo and body equipment and is reduced by optional equipment weight.
- (2) PICKUP BOX REMOVAL PROGRAM — Allows aftermarket alteration of models by pickup box removal and installation of a second unit body. Contact the Body Builders Advisory Service for information.
- (3) Gross Axle Weight Rating is determined by the rated capacity of the minimum component of the Axle System (Axle, computer-selected springs, wheels, tires) of a specific vehicle. Front and rear GAWR's will, in all cases, sum to a number equal to or greater than the GVWR for the particular vehicle. Maximum loaded vehicle (including passengers, equipment and payload) cannot exceed the GVW rating or GAWR (front or rear).

## Specifications

---

### Engine

Item	2.5L	3.0L FFV*	4.0L
Type	4 cylinder in line, 4 cycle gasoline	6 cylinder V-6, 4 cycle gasoline	6 cylinder V-6, 4 cycle gasoline
Bore and stroke	3.78 x 3.402 in (96.0 x 86.4 mm)	3.5 x 3.14 in (89 x 80 mm)	3.94 x 3.31 in (100 x 84 mm)
Displacement	153 cu in (2,298 cc)	182 cu in (2,968 cc)	245 cu in (3,965 cc)
Compression ratio	9.4:1	9.14:1	9.0:1
Spark plug gap	1.07 – 1.17 mm (0.042 – 0.046 in.)	1.07 – 1.17 mm (0.042 – 0.046 in.)	1.3 – 1.4 mm (0.052 – 0.056 in.)

\*Flexible Fuel Vehicle

### Electrical System

Item	Model	2.5L	3.0L	4.0L
Battery Maintenance- free	All	58AH-12V	58AH-12V	58AH-12V

Capacities

Item		2.5L	3.0L FFV*	4.0L
Engine oil with filter		4.5 US qt (3.8 Imp qt, 4.3 liters)	4.5 US qt (3.8 Imp qt, 4.3 liters)	5.0 US qt (4.2 Imp qt, 4.7 liters)
Engine oil without filter		4.0 US qt (3.4 Imp qt, 3.8 liters)	4.0 US qt (3.4 Imp qt, 3.8 liters)	4.0 US qt (3.4 Imp qt, 3.8 liters)
Coolant	without A/C	6.5 US qt (5.4 Imp qt, 6.2 liters)	9.5 US qt (7.9 Imp qt, 9.0 liters)	7.8 US qt (6.5 Imp qt, 7.4 liters)
	with A/C	7.2 US qt (6.0 Imp qt, 6.8 liters)	10.2 US qt (8.5 Imp qt, 9.6 liters)	8.6 US qt (7.2 Imp qt, 8.1 liters)
Windshield washer reservoir		2.8 US qt (2.4 Imp qt, 6.8 liters)		
Manual transmission		5.6 US pints (4.7 Imp pints, 2.65 liters)		

Item	2.5L	3.0L FFV*	4.0L
Automatic transmission 4x2	9.8 US qt (7.9 Imp qt, 9.0 liters)	10.0 US qt (8.5 Imp qt, 9.5 liters)	10.0 US qt (8.5 Imp qt, 9.5 liters)
Automatic transmission 4x4	–	10.3 US qt (8.8 Imp qt, 9.8 liters)	10.3 US qt (8.8 Imp qt, 9.8 liters)
Transfer case	2.5 US pints (2.1 Imp pints, 1.2 liters)		
Front axle Dana 35 front axle (4x4 only) Dana 28 front axle (2.5L and 3.0L automatic transmission only)	3.6 US pints (3.0 Imp pints, 1.7 liters)  3.0 US pints (2.5 Imp pints, 1.4 liters)		

\*Flexible Fuel Vehicle

## Specifications

---

Item	2.5L	3.0L	4.0L
Rear axle Conventional 7.5"	5.0 – 5.3 US pints (4.2 – 4.6 Imp pints, 2.4 – 2.5 liters)		
Limited Slip Differential 8.8"	4.75 – 5.0 US pints (4.0 – 4.2 Imp pints, 2.2 – 2.4 liters)		
Fuel tank Regular Cab Cab Plus	16.5 US gal (13.7 Imp gal, 62.4 liters) 19.5 US gal (16.2 Imp gal, 73.8 liters)		

## Air Conditioner\*

Gas complies with SAE J639:	R-134a
Maximum operating charge:	Refer to label in engine compartment

\*Some models.

## Tires

Item	Tire	Front	Rear	Temporary Spare
Size	4x2	P225/70R 15 P245/75R 16		P225/70R 15 P235/75R 15
	4x4	P215/75R 15 P235/75R 15 P265/75R 15 P245/75R 16		P225/70R 15 P235/75R 15 P235/75R 15 P235/75R 15
Inflation pressure psi (kg/cm <sup>2</sup> , kPa)	4x2	P225/70R 15 35 (2.4, 241) P245/75R 16 26 (1.8, 179)	35 (2.4, 241)	35 (2.4, 241)
	4x4	P215/75R 15 35 (2.4, 241) P235/75R 15 30 (2.1, 207) P265/75R 15 30 (2.1, 207) P245/75R 16 30 (2.1, 207)	35 (2.4, 241)	35 (2.4, 241)

psi: pounds per square inch

## Light Bulbs

Light Bulb	Number of Bulbs Required	Bulb Number
Headlights	2	9007
Foglights	2	9006 HB4
Front parking/turn signal lights	4	3157
	2	194
Rear turn signal lights	2	3156
Rear brake/Tailights	2	3157
Back-up lights	2	3156
License plate light (with bumper)	2	194
License plate light (without bumper)	1	194
Interior light	1	912

\*1 Replaceable at authorized Mazda radio service centers.

\*2 Refer to your Mazda Dealer for bulb replacement.

\*3 Replace cruise control switch.

## Specifications

---

Light Bulb	Number of Bulbs Required	Bulb Number
High-mount brake light	2	906
Cargo light	1	922
Map/Interior light (Cab Plus)	2	904
Map/Interior light (Regular Cab)	1	904
Instrument panel gauge illumination	5	194
Radio illumination	–	*1
Brake warning light/ABS	1	194
Charging system light	1	194
Seat belt warning light	1	194
High beam indicator	1	194
Transfer case switch indicator light	1	*2
Turn signal indicator light	2	194

Light Bulb	Number of Bulbs Required	Bulb Number
Malfunction indicator light	1	194
4x4 indicator lights – I/P	2	194
A/C control illumination	1	161
Headlight switch illumination	1	1815
Heater control illumination	1	161
Cruise control switch illumination	2	*3

\*1 Replaceable at authorized Mazda radio service centers.

\*2 Refer to your Mazda Dealer for bulb replacement.

\*3 Replace cruise control switch.

**Fuses** ..... Refer to page 6-8



---

# **11** Index

## Index

---

	Page		Page
<b>A</b>			
Acid Rain or Industrial Fallout, Etching Caused by	7-2	Automatic Transmission	5-18
Add-On Non-Genuine Parts and Accessories	9-7	Putting your vehicle in gear	5-19
Air-Conditioner	5-77	Driving tips	5-23
Aluminum Wheel Maintenance	7-10	Overdrive	5-24
AM/FM Radio	5-90	Ranges	5-19
AM/FM Radio with Cassette and Compact Disc Player	5-93	Automatic Transmission Fluid	8-33
AM/FM Radio with Cassette Player	5-91		
AM/FM Radio with Compact Disc Player	5-92	<b>B</b>	
Antilock Brakes	5-41, 5-44	Battery	8-39
Anti-Theft System, SecuriLock™ Passive	3-12	Battery Saver	3-11
Procedure to program spare keys	3-14	Battery Voltage Gauge	5-56
Programming spare keys	3-13	Before Driving	4-9
THEFT indicator	3-13	After getting in	4-10
Appearance Care	7-1	Before getting in	4-9
Ashtray	5-71	Belts, Front Seat	2-10
		Belt, Front Center Seat	2-14
		Belts, Rear Lap	2-14
		Bird Droppings, Insects or Tree Sap, Damage Caused by	7-2
		Body Lubrication	8-37
		Brake System	5-36
		Applying brakes	5-39
		Brake lights	8-54
		Brakes pull	5-38
		Fluid level	8-28
		Foot brake	5-36
		Four-wheel antilock brake system (ABS)	5-41
		Front disc brakes	5-37
		Hydraulic power brakes	5-39
		Low grip or low pedal	5-38
		Parking brake	5-40
		Rear drum brakes	5-37
		Stopping distances	5-38
		Rear-wheel antilock brake system (ABS)	5-44
		Warning light	5-41
		Break-In Period	4-10
		Bulb Replacement, Front	8-52
		Bulb Replacement, Rear	8-54

	Page		Page
<b>C</b>			
Camper, Slide-In . . . . .	9-7	Cleaning the Window Interiors . . . . .	7-13
Carbon Monoxide (Engine Exhaust Gas) . . . . .	4-8	Climate Control Systems . . . . .	5-75
Cargo Area . . . . .	1-6	Air conditioning . . . . .	5-77
Cargo Shade . . . . .	3-34	Dehumidifying . . . . .	5-82
Cassette Tape Player Care . . . . .	5-109	Fan blower control knob . . . . .	5-76
Center Console . . . . .	5-72	Function selector control knob . . . . .	5-76
Center Seat Belt, Front . . . . .	2-14	Heater controls . . . . .	5-83
Changing a Flat Tire . . . . .	6-29	Operating tips . . . . .	5-83
Changing the Oil . . . . .	8-19	Temperature control knob . . . . .	5-76
Charging System Warning Light . . . . .	5-61	Windshield defrosting and defogging . . . . .	5-81
Checking Power Steering Fluid Level . . . . .	8-31	Clock Operation . . . . .	5-99
Child-Restraint System . . . . .	2-21	Clutch Fluid Level . . . . .	8-30
Attaching seats with tether straps . . . . .	2-26	Coolant, Engine . . . . .	8-22
Installing . . . . .	2-23	Changing . . . . .	8-26
Older children . . . . .	2-28	Inspecting . . . . .	8-23
Circuit Breakers . . . . .	6-11	Overheating . . . . .	6-3
Cleaning the Seat Belt Webbing . . . . .	7-13	Temperature gauge . . . . .	5-54
Cleaning the Upholstery and Interior Trim . . . . .	7-10	Cooling (Air-Conditioning) . . . . .	5-77
		Cruise Control . . . . .	5-47
		Accelerating with cruise control on . . . . .	5-51
		Light . . . . .	5-64
		To cancel . . . . .	5-50
		To decrease cruising speed . . . . .	5-51
		To increase cruising speed . . . . .	5-50
		To resume cruising speed . . . . .	5-51
		To set speed . . . . .	5-48
		Cupholders . . . . .	5-72
		Customer Assistance . . . . .	9-2
		Customer Information . . . . .	9-1
		<b>D</b>	
		Dashboard Illumination . . . . .	5-58
		Dashboard Overview . . . . .	1-3
		Day/Night Mirror . . . . .	3-32
		Dehumidifying . . . . .	5-82
		Door Locks . . . . .	3-3
		Inside . . . . .	3-4

## Index

---

	Page		Page		Page
Outside	3-3	Jump-starting	6-4	Environmental Paint Damage,	
Power	3-6	Push-starting	6-7	How to Minimize	7-2
Doors	1-4	Engine Block Heater	5-12	Exterior Care	7-5
Driving		Emission Control System	4-7	Cleaning the wheels	7-10
After getting in	4-10	Engine Compartment Overviews	8-13	Bright-metal maintenance	7-7
Before getting in	4-9	Engine Coolant	8-22	Cleaning headlights	
Hazardous	4-12	Changing coolant	8-26	and taillights	7-8
High speed	4-15	Inspecting coolant level	8-23	Cleaning mirrors	7-8
On hills	4-18	Overheating	6-3	Cleaning plastic parts	7-7
On sand	4-17	Engine Exhaust Gas		Cleaning rustproofing	7-7
Rocking the vehicle	4-14	(Carbon Monoxide)	4-8	Engine compartment	7-8
Through water	4-17	Engine Oil	8-16	Maintaining the finish	7-5
Wheel spin	4-14	Adding engine oil	8-19	Repairing finish damage	7-7
Winter	4-15	Changing engine oil and filter	8-19	Underbody maintenance	7-9
With a trailer	4-33	Inspecting engine oil level	8-18		
Driving Your Mazda	5-1	Pressure gauge	5-55, 8-17		
		Recommended oil	8-16		
		Engine Coolant Temperature		<b>F</b>	
		Gauge	5-54	Fan Blower Control Knob	5-76
<b>E</b>		Engine, FFV	4-4	Flasher, Hazard Warning	6-2
Emergencies	6-1			Flashing the Headlights	5-66
Emergency Starting	6-4				

## Index

	Page		Page		Page
Flat Tire	6-26	Emergency maneuvers	5-36	FFV engine	4-4
Changing a flat tire	6-29	Off pavement edge	5-34	Fuel, Running Out of	4-5
Temporary spare tire	6-36	Off-road driving	5-27	Function Selector Control Knob	5-76
Tire, jack and tool storage	6-26	Shifting between 4x4 HIGH and 4x4 LOW	5-27	Defrosting position	5-79
Fluids		Shifting from 2-wheel drive to 4x4 HIGH	5-25	Floor-defrosting position	5-79
Automatic transmission	8-33	Shifting from 4x4 LOW to 2-wheel drive	5-26	Floor position	5-79
Brake	8-28	Shifting from 4x4 HIGH to 2-wheel drive	5-26	Heating	5-80
Capacities	10-7	2-wheel drive	5-26	Panel-floor position	5-78
Clutch	8-30	Tire replacement requirements	5-32	Ventilation	5-80
Power steering	8-31	Front Seat Passenger Position (Child Restraints)	2-25	Vent position	5-78
Windshield washer	8-36	Front Seat Belts	2-10	Fuses and Circuit Breakers	6-8
FM Characteristics	5-86	Front Center Seat Belt	2-14	Circuit breakers	6-11
Foglight Bulb Replacement	8-51	Fuel Gauge	5-55	Fuse panel description	6-12
Foot Brake	5-36	Fuel Reset Light	5-61	Fuse replacement	6-9
4x4 Indicator Light	5-63	Fuel-Filler Cap	3-24		
4x4 LOW Indicator Light	5-63	Fuel-Filler Lid	3-23	<b>G</b>	
4-Wheel Antilock Brake System		Fuel Pump Shut-Off Switch	5-13	GAWR and GVWR	4-24
(4-Wheel ABS)	5-41	Fuel Requirements	4-2	Gauges	5-54
Warning Light	5-60	Cleaner air	4-4	Battery voltage	5-56
4-Wheel Drive System	5-24			Engine oil pressure	5-55
Electronic shift control	5-24			Engine coolant temperature	5-54
Electronic shift control system indicator lights	5-25				



	Page		Page		Page
<b>J</b>		<b>L</b>		Lumbar Support Adjustment . . . . .	2-4
Jack Storage . . . . .	6-35	Label Information . . . . .	4-37	<b>M</b>	
Removal . . . . .	6-27	Labels, Service and Information . . . . .	3-26	Maintenance . . . . .	8-1
Jump Seats . . . . .	2-4	Lane Change Signals . . . . .	5-67	Malfunction Indicator Light . . . . .	5-62
Jump-Starting . . . . .	6-4	Lighter . . . . .	5-70	Manual Transmission Operation . . . . .	5-14
<b>K</b>		Lighting Control . . . . .	5-65	Recommendations for shifting . . . . .	5-16
Key . . . . .	3-2	Combination cargo and		Shift pattern . . . . .	5-14
Keyless Entry System . . . . .	3-6	high-mount stoplight . . . . .	5-67	Map Light . . . . .	3-34
Arming and disarming . . . . .	3-9	Fog Lamps . . . . .	5-66	Mazda Importer/Distributors . . . . .	9-5
Keyless entry personal alarm . . . . .	3-8	Headlights . . . . .	5-65	Mirrors . . . . .	3-31
Locking the doors		Turn and lane change signal . . . . .	5-67	Day/night mirror . . . . .	3-32
(with keyless entry) . . . . .	3-8	<b>Lights</b>		Outside mirrors . . . . .	3-31
Replacing lost transmitters . . . . .	3-10	Head . . . . .	5-65	Vanity . . . . .	5-74
Replacing the batteries . . . . .	3-9	Interior . . . . .	3-33	Money-Saving Suggestions . . . . .	4-11
Unlocking the doors		Map . . . . .	3-34	<b>O</b>	
(with keyless entry) . . . . .	3-7	Parking . . . . .	8-53	Odometer . . . . .	5-54
Knowing Your Mazda . . . . .	3-1	Side marker . . . . .	8-53	Off-Road Driving . . . . .	5-27
		Warning . . . . .	5-59		
		Low Brake Fluid Level Warning . . . . .	5-59		
		Lubrication, Body . . . . .	8-37		

## Index

---

	Page		Page		Page
Oil, Engine	8-16	Power Point	5-70	Clock operation	5-99
Outside Door Lock	3-3	Power Steering	5-46	Common operating conditions	5-111
Outside Mirrors	3-31	Power Steering Fluid Level	8-31	Compression adjust	5-108
Outside the United States		Power Windows	3-16	Dolby noise reduction	5-107
and Canada	9-6	Protecting Your Mazda	4-1	Eject function	5-107
Overdrive	5-24	Push-Starting	6-7	How to adjust the volume	5-94
Overheating	6-3			How to insert a compact disc	
Overloading	4-26			and begin playing	5-105
Owner Maintenance	8-9	<b>R</b>		How to insert a tape	5-104
Owner Maintenance Precautions	8-11	Radio Reception	5-86	How to take care of and clean	
Owner Maintenance Schedule	8-9	AM characteristics	5-86	your system and discs	5-110
At least monthly	8-10	FM characteristics	5-86	How to turn the radio on and off	5-94
At least twice a year	8-10	Radios		Mute	5-108
While operating your vehicle	8-9	AM/FM radio	5-90	SEEK function	5-101
<b>P</b>		AM/FM radio with cassette and		Shuffle feature	5-108
Paint Chipping	7-4	compact disc player	5-93	Tape/CD select	5-106
Paint Damage, How to Minimize		AM/FM radio with cassette		Tape direction select	5-107
Environmental	7-2	player	5-91	Tips on caring for the cassette	
Parking Brake	5-40	AM/FM radio with compact		player and tapes	5-109
Parking Brake Warning Light	5-59	disc player	5-92	Tone balance and	
Power Door Locks	3-6	AM/FM select	5-94	speaker output	5-95
		Automatic Music Search	5-104	TUNE adjust	5-100
		Autoset memory preset	5-103	Rear Compartment	1-5



	Page		Page		Page
Rear Quarter Windows	3-18	Emergency locking mode	2-6	Snowplowing	4-17
Rear Lap Belts	2-14	Energy management feature	2-5	Snow Tires	4-15
Rear Storage Compartment		Extender	2-17	Spare Tire Removal	5-27
(with net)	3-36	Front	2-10	Spare Tire, Temporary	6-36, 8-46
Recommendations for Shifting	5-16	Front Center	2-14	Special Driving Conditions	4-12
Downshifting	5-17	Maintenance	2-19	Hazardous	4-12
Upshifting	5-16	Pregnant women, seat belt usage	2-19	High speed	4-15
Repairing Damage to the Finish	7-7	Rear lap	2-14	Hills	4-18
Replacing Windshield Wiper		Rotated tongue, correction	2-16	Overloading	4-26
Blades	8-38	Shoulder belt adjuster	2-12	Rocking the vehicle	4-14
Reporting Safety Defects	9-11	Twisted D-ring, correction	2-15	Sand	4-17
Rocking the Vehicle	4-14	Untwist/unjam	2-15	Snowplowing	4-17
Rope Holes	3-35	Warning light/chime	2-10	Through water	4-17
		Seat Belt Warning		Trailer towing	4-18
		Light/Chime	2-10, 5-61	Wheel spin	4-14
<b>S</b>		Seat Recline	2-2	Winter	4-15
Safety Defects, Reporting	9-11	Seats	2-2	Specifications	10-1
Safety Seat Tether Straps	2-26	Jump	2-4	Air conditioner	10-8
Scheduled Maintenance	8-3	Lumbar support adjustment	2-4	Capacities	10-7
Seat Adjustment	2-2	Recline	2-2	Dimensions	10-3
Seat Belt System	2-5	Service Publications	9-12	Electrical system	10-6
Automatic locking mode	2-7	Slide-In Camper	9-7	Engine	10-6



	Page		Page		Page
<b>V</b>		4x4 LOW indicator	5-63	Power	3-16
Vanity Mirror	5-74	Fuel reset	5-61	Rear quarter	3-18
Vehicle Information Labels	4-36	Gauge	5-62	Windshield Defrosting and Defogging	5-81
<b>W</b>		Headlight high-beam	5-63	Windshield Washer Fluid Level	8-36
Warning Lights Inspection	5-59	Malfunction indicator	5-62	Windshield Wipers and Washer	5-68
Warning Lights/Beeps	5-59	Overdrive	5-64	Washer	5-69
ABS	5-60	Seat belt	5-61	Wiper blade replacement	8-38
Air Bag	5-64	Warning beeps	5-65	Wiper blades, maintaining	8-37
Anti-theft alarm	5-64	Warning inspection	5-59	Wipers	5-68
Brake system	5-59	Warranties for Your Mazda	9-6	Winter Driving	4-15
Charging system	5-61	Washing	7-5		
Cruise control	5-64	Water Marks	7-4	<b>Y</b>	
Door ajar	5-64	Waxing	7-6	Your Vehicle at a Glance	1-1
4x4 indicator	5-63	Wheel Replacement	8-47		
		Windows	3-16		
		Accessory Delay	3-17		
		One-touch power	3-17		

Part No.

9999-95-023C-01

© Mazda North American Operations

Printed in U.S.A.