

Revised January 9, 2001

MAINTENANCE SCHEDULE

NORMAL SERVICE INTERVALS

5,000 miles*	A
7,500 miles	A
15,000 miles	A
22,500 miles	A
30,000 miles	A B
37,500 miles	A
45,000 miles	A C
52,500 miles	A
60,000 miles	A B D
67,500 miles	A
75,000 miles	A C
82,500 miles	A
90,000 miles	A B

 **Tip:** For additional service intervals and complete details, see Owner's Manual

Maintenance notes:

Rotate tires every 3,750 miles

A. Change: Engine oil/replace filter
Lubricate: Locks and hinges

B. Inspect: Drive belts, fuel lines and hoses, idle speed, brake lines and hoses, disc and drum brakes, steering operation and linkages, front suspension ball joints, driveshaft dust boots, chassis and body bolts, exhaust system and heat shields

Replace: Air filter, spark plugs

C. Change: Engine coolant

D. Inspect: Engine valve clearance, hoses and tubes for emission system

Replace: Engine timing belt, manual transmission oil, rear differential oil

* Special operating conditions

This Quick Tips® guide is provided by MazdaTown to make your Mazda ownership experience more convenient. It is not intended to replace your Owner's Manual.

If you have any questions about your vehicle, you are invited to contact your local dealer.

Or if you need additional help, feel free to call our

Customer Assistance Center at 1-800-222-5500

Monday through Friday,
8 am-5 pm



©2001 Calcar. Quick Tips® is a trademark of Calcar, made in USA 9/00 46M GL Mazda North American Operations reserves the right to change product specifications at any time without incurring obligations.

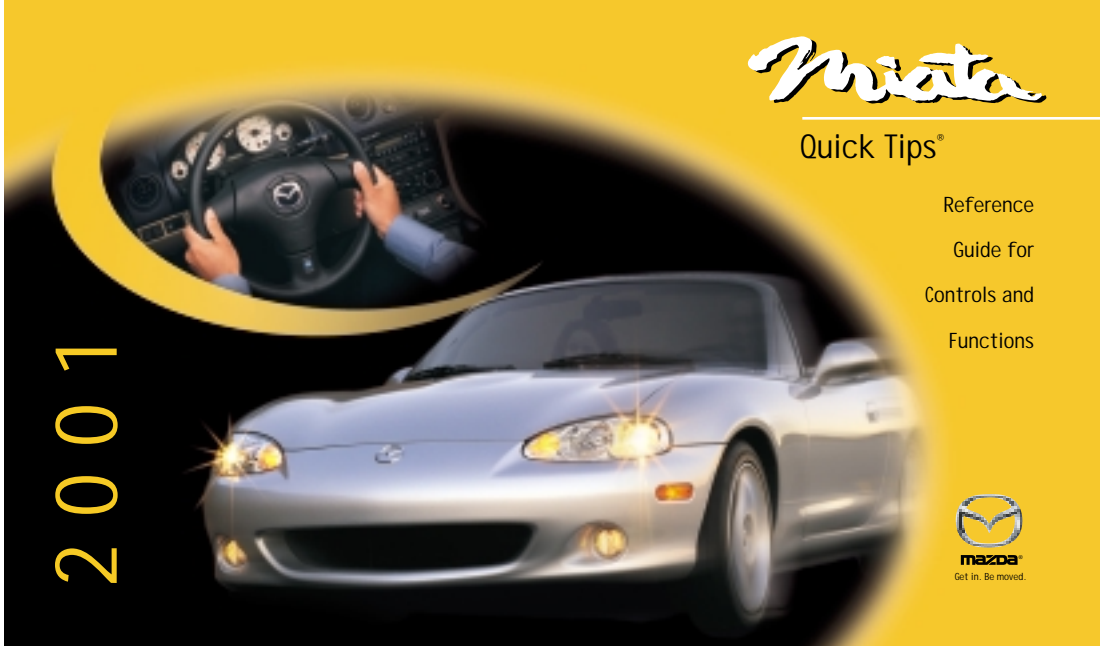

2001

Miata

Quick Tips®

Reference
Guide for
Controls and
Functions



mazda
Get In. Be Moved.

Revised January 9, 2001

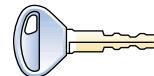
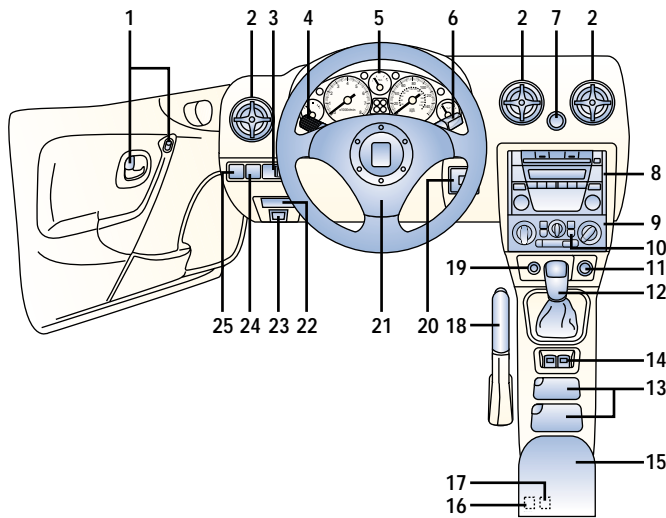
DRIVER'S VIEW**Key**

Operates ignition and all locks

 **Tip:** Use key number plate to purchase a new key; store in a safe place separate from vehicle

Immobilizer system

Prevents engine from running unless coded key used, see Owner's Manual

**Remote entry system***, see

Owner's Manual

- | | | |
|---|--|---|
| <p>1. Door locks,
see Switches</p> <p>2. Air vents
Twist vents to direct airflow</p> <p>3. Instrument panel lighting selector,
see Interior Lights</p> <p>4. Turn signal/lighting control lever,
see Driver Controls</p> <p>5. Instrument cluster,
see Instrument Cluster</p> <p>6. Wiper/washer/Cruise control* lever,
see Driver Controls</p> <p>7. Hazard warning switch
Press on/off</p> <p>8. Audio system,
see Audio System</p> | <p>9. Climate control system,
see Climate Controls</p> <p>10. Rear window defogger switch
Press on/off</p> <p>11. Cigarette lighter</p> <p>12. Gearshift lever,
see Transmission</p> <p>13. Ashtray/cup holder</p> <p>14. Power-window switches,
see Switches</p> <p>15. Center console,
see Console/Trunk</p> <p>16. Fuel door release lever
Pull to open fuel door</p> <p>17. Remote trunk-lid release
Pull to open trunk</p> | <p>18. Parking-brake lever,
see Console/Trunk</p> <p>19. Passenger-side air bag deactivation switch,
see Child Seats</p> <p>20. Power outside mirror switch, see Switches</p> <p>21. Horn/air bag
Press for horn</p> <p>22. Fuse panel</p> <p>23. Hood release handle
Pull to open partially</p> <p>24. Cruise control main switch*,
see Driver Controls</p> <p>25. Fog light switch,
see Driver Controls</p> |
|---|--|---|

*Denotes optional equipment

Always check the Owner's Manual for more operating information and safety featuresDriver's
View

Revised January 9, 2001

Instrument
Cluster

INSTRUMENT CLUSTER

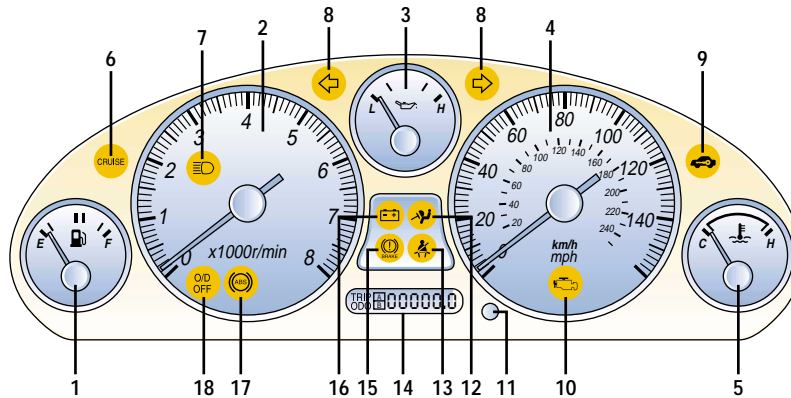

GAUGES

1. **Fuel gauge**
12.7-gallon/48-liter tank
2. **Tachometer**
Avoid red zone
3. **Engine oil pressure gauge**
If outside normal range, stop vehicle safely and turn off engine, check oil level
4. **Speedometer**
5. **Coolant temperature gauge**
If above normal range, stop vehicle safely and turn off engine; check coolant level when safe

WARNING LIGHTS

6. **CRUISE** **Cruise control on***
Lights when cruise control is set
7. **H** **High beams on,**
see Driver Controls

8. **↔** **Turn signal/hazard warning on**
9. **Ⓜ** **Immobilizer system on,** see Driver's View
10. **⚠** **Check engine**
Dealer inspection required
11. **Ⓜ** **Odometer/trip odometer selector**
Press to select odometer or trip odometer A/B; press and hold to reset selected trip odometer
12. **Ⓜ** **Air bag readiness**
If light flashes or stays on, the air bags may not operate in an accident; dealer inspection required
13. **Ⓜ** **Always fasten safety belts**

14. **Odometer/trip odometer display**
15. **Ⓜ** **Brake system**
Parking brake on/low brake fluid
16. **⚠** **Charging system warning light**
Possible alternator or charging system malfunction, dealer inspection required
17. **Ⓜ** **Anti-lock Brake System (ABS)***
Indicates ABS malfunction, dealer inspection required
18. **Ⓜ** **Overdrive off indicator (Automatic transmission)***
Lights when the overdrive button is in the off position

*Denotes optional equipment

Always check the Owner's Manual for more operating information and safety features

Instrument
Cluster

Revised January 9, 2001

Driver Controls

DRIVER CONTROLS

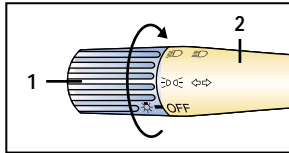
**Turn signal/lighting control lever**

OFF = Lights off

☰ = Tail, parking and dashboard lights on: Rotate knob to (1) first notch

☷ = Tail, parking, dashboard and headlights on: Rotate knob (1) to second notch

High beams on/off: Push lever (2) forward to detent/pull back

To flash high beams: Pull lever (2) toward you and release

Fog lights

Press (3) on/off; functions only with headlight low beams on

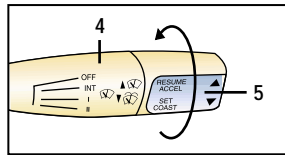
**Windshield wiper/washer/Cruise control* lever**

For slow/normal/fast wiper speeds: Push lever (4) down through detents

Single wipe: Set the wipers to OFF; push lever (4) forward Wash and wipe: Pull lever (4) toward you and hold; washer and wipers will be activated until lever is released

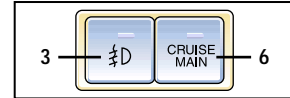
**Cruise control***

Operates above 25 mph Press CRUISE MAIN switch (6) to enable/disable

To set speed: Twist control knob (5) down toward SET/COAST ▼ and release

To increase set speed: Twist control knob (5) up toward RESUME/ACCEL ▲ and release at desired speed

To decrease set speed: Twist control knob (5) down toward SET/COAST ▼ and release at desired speed

To cancel: Tap brake or clutch pedal (manual transmission) or press CRUISE MAIN switch (6)

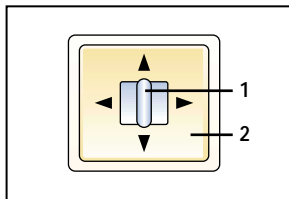
**Dual power mirrors**

Operates only with ignition on

To adjust left/right mirror: Push selector switch (1) left/right, press switch (2) in direction of desired movement

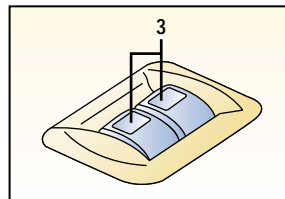
**Power windows**

Operates only with ignition on

To open/close: Push down/pull up front of switch (3)

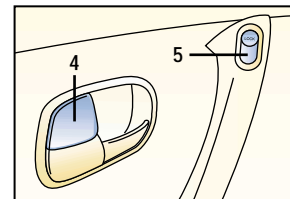
**Manual door locks**

To lock/unlock: Push tab (4) into handle/pull toward you

Power door locks*

Both doors lock/unlock by using key in driver's door or by using driver's tab (5)

*Denotes optional equipment

Always check the Owner's Manual for more operating information and safety features

Switches

Revised January 9, 2001

Interior
Lights

INTERIOR LIGHTS

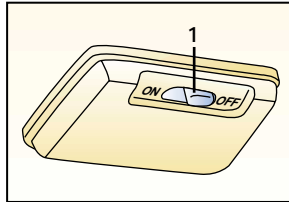
**1. Dome light**

On = Light always on
 Off = Light always off
 Center position = Light on when a door is open

2. Instrument panel lighting

To brighten/dim instrument panel lighting: Turn thumb-wheel right/left

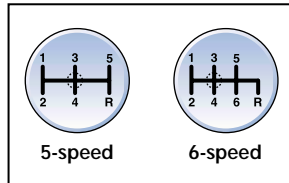
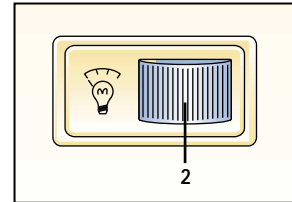

5-speed

6-speed

Manual transmission

Depress clutch pedal to start engine and change gears

Tip: Do not shift into 1st above 20 mph or clutch failure could occur

Tip: Resting your foot on the clutch pedal while driving and using the clutch to hold your vehicle at a standstill while waiting on a hill may reduce clutch life

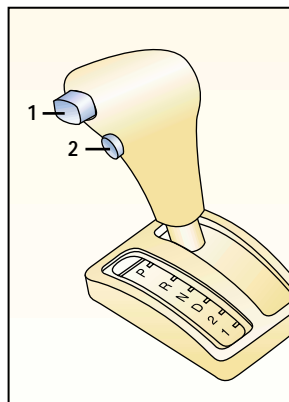
**Automatic transmission*****P = Park**

To move gearshift from Park: Press firmly on brake pedal, then press release button (1) on gearshift

R = Reverse

Do not engage Reverse when vehicle is moving forward

N = Neutral

No gear engaged; vehicle can roll freely, even on a slight incline, unless the brakes are applied

Overdrive Switch

Press (2) to lockout/enable overdrive

D (Overdrive)

For normal driving: Shifts through four forward gears automatically

D (Overdrive Off)

Shifts through three forward gears automatically

Provides extra power and increased engine braking, stops 3rd-4th gear cycling in stop/go driving

2 = Second gear

Provides extra power and increased engine braking

Use to reduce wheel spin when starting on slippery surfaces

1 = First gear

Use for engine braking when second gear is not sufficient

*Denotes optional equipment

Always check the Owner's Manual for more operating information and safety features

Transmission

Revised January 9, 2001

Seats

SEATS

Manual controls**1. Fore-aft adjustment**

Lift lever and hold, slide seat, release lever

2. Safety belt buckle**3. Seatback angle**

To adjust: Lift and hold lever, lean forward or backward, release lever

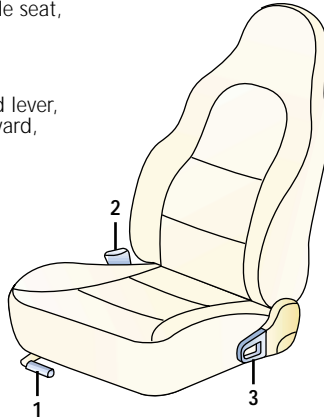
**Safety belt emergency locking mode/automatic locking mode**

(front passenger only)

Emergency locking mode: Belt locks only on hard braking/cornering or impacts of about 5 mph or more

Automatic locking mode: Must be used when installing child-restraint seat (see below)

To activate: Pull webbing fully out of retractor until click is heard; belt will only tighten

To disengage: Unbuckle belt and allow webbing to retract fully

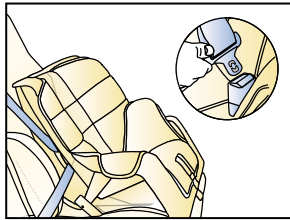
**Child-restraint seat***

To install in passenger seat: Move seat as far back as possible; use dual locking mode retractor safety belt; see Owner's Manual for proper installation instructions

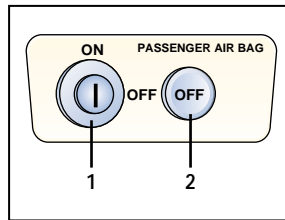
**Passenger's front air bag deactivation switch,**

see Driver's View for switch location

Deactivate passenger air bag when using a rear-facing child-restraint seat in front seat†

To deactivate/activate: Insert ignition key in switch (1), rotate to OFF/ON, remove key

Light (2) illuminates when deactivated and ignition is ON

⚠ WARNINGS:

Do not adjust seats while driving
Safety belts must always be worn when vehicle is in motion

Air bags are supplemental and do not replace safety belt usage

Read all information and warnings in Owner's Manual and attached to seat before using child-restraint seat

Children less than 4 years old and under 40 pounds should always use a child-restraint seat

When using a rear-facing child-restraint seat, always set the passenger air bag deactivation switch to OFF position

*Denotes optional equipment

†For other rare circumstances when passenger air bag can be shut off, refer to NHTSA guidelines

Always check the Owner's Manual for more operating information and safety features

Child Seats

Revised January 9, 2001

Climate Controls

CLIMATE CONTROLS

1. Temperature control

Rotate knob to blue for cool/red for warm

2. Air Conditioning

Press to turn on/off



 **Tip: Use A/C to dehumidify air**



3. Fan control

Rotate knob to increase/decrease speed, turn to **0** to shut system off

4. Air intake control

Slide lever to select

 = recirculate inside air; use for maximum heating/cooling or to keep odors out
 = fresh air

 **WARNING: Do not use  position in cold weather, windows could fog and hamper vision**

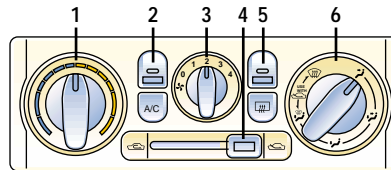
**5.  Rear window defogger**

Press to activate/deactivate

6. Airflow selections

 = air to dash

 = air to dash and floor

 = air to floor

 = air to floor and windshield

 = defrost, air to windshield

Control positions for maximum defrost

Fan to maximum, temperature to maximum hot, airflow selector knob to 

 **Tips: When  selected, air is dried when temperature is above 39°F**

To help prevent windshield fogging in humid weather, select  before starting engine
To prevent moisture buildup, never drive with system off

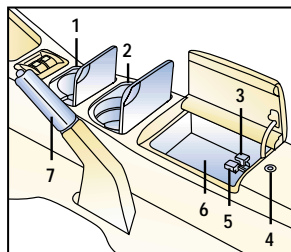
**Center console****1. Ashtray/Cup holder**

Pull up ashtray to remove; space can be used as a cup holder

2. Cup holder**3. Remote trunk-lid release**

To open trunk: Lift up on front of lever

4. Center console lock

To lock/unlock: Insert key and turn clockwise/counterclockwise

5. Remote fuel door release

To open fuel door: Lift up on front of lever

6. Center console storage**7. Parking-brake**

To engage: Pull up
 To release: Pull up slightly while depressing button at the front of lever, lower parking-brake lever

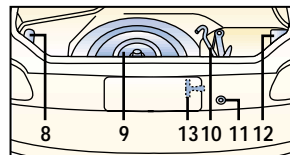
**Trunk****8. Lug wrench****9. Temporary spare tire**

To change flat tire: Follow instructions in Owner's Manual

 **WARNING: Do not exceed 50 mph with temporary spare**

 **Tip: Do not use temporary spare tire for long periods of time**

10. Jack/jack handle**11. Lock**

To lock/unlock: Insert key and turn counterclockwise/clockwise

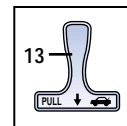
12. Battery**Trunk release handle**

Allows you to escape should you become locked in trunk

To open: Pull "T" handle; "T" handle will glow if it has been exposed to light

Always check the Owner's Manual for more operating information and safety features

Console/
Trunk

Revised January 9, 2001

Convertible

CONVERTIBLE

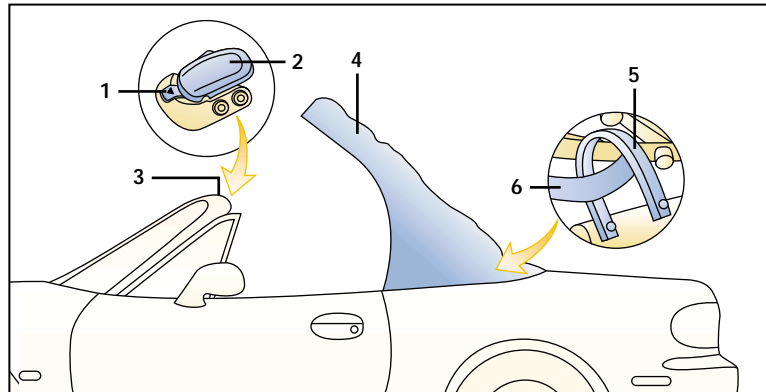

Convertible top operation

Tip: Using an automatic car wash can damage top

Storing articles inside near the rear window can cause damage to top upon lowering

To lower: Park on a level surface away from traffic lanes; set parking brake; lower side windows and pull down sun visors

Press unlock button (1); pull top latches (2) until they completely disengage from windshield header (3); lift up on front section of top (4); lower top into storage area; snap top latches (2) into closed position

Tip: Do not store a wet or damp convertible top for long periods of time

Tip: To install convertible top cover: Thread tether straps (5) through anchor (6) and snap into position; attach top covering using fasteners; insert rear edges into body molding groove

To raise: Park on a level surface away from traffic lanes; set parking brake; lower side windows and pull down sun visors. Open top latches (2) fully; lift top (4) until it rests on windshield header (3); fasten latches to windshield header by pushing up until click is heard

Tip: To ensure that top is securely fastened: Push up on top (4); if rattling is heard, repeat top latching process or have vehicle inspected by dealer

Detachable hardtop*

Tip: Perform hardtop installation or removal with two people

Park on a level surface away from traffic lanes; set parking brake and lower side windows; pull down sun visors

To remove: Disconnect rear window defogger coupler; lower antenna; press unlock on top and side latches to release top, slide top rearward while pressing down on the rear deck latches, lift hard top straight off the body

To install: Lower antenna, fully lower convertible top, align rear latches with rear deck studs, slide hard top forward while pressing down on the rear deck, push up top and side latches to lock, reconnect rear window defogger

*Denotes optional equipment

Always check the Owner's Manual for more operating information and safety features

Convertible

Revised January 9, 2001

Audio System

AM/FM STEREO/CASSETTE/CD

1. Power/Volume

Press to turn on/off; rotate to increase/decrease volume

2. Memory preset buttons

To set: Tune to station, press and hold until beep is heard

3. SEEK/TRACK/APC

Radio: Press \wedge / \vee to automatically seek higher/lower frequency

CD: Press \wedge / \vee to select next/previous track

Tape: Press \wedge / \vee to automatically advance tape to beginning of next selection/replay selection; to stop this operation, press button again

4. FM1/2

Press to select between FM1/FM2 station preset buttons (2)

5. AM

Press to select AM frequency band

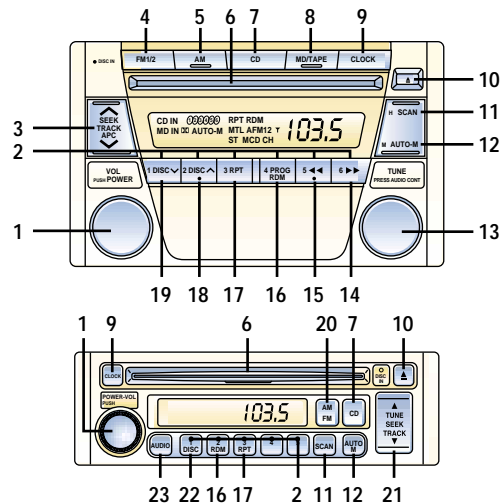
**6. CD Slot****7. CD**

Press to play CD

8. MD*/Tape*

Press to play Mini-disc Player/cassette tape

9. Clock

To set: Press (9) and hold until beep is heard; press Minutes (12) or (21)/Hours (11) or (21) to advance; press (9) again to set

10. CD eject**11. Scan**

Press to briefly sample next listenable selections; functions in all modes

12. Auto-Memory

Radio: Press and hold until a beep is heard; system automatically scans and temporarily stores 6 strong stations in each band; press again to cancel

13. Tuning/Audio Control

Tune: Rotate counterclockwise/clockwise for lower frequency/higher frequency
Audio control: Press to select BASS/MID/TREBLE/FADE/BALANCE; rotate right/left to adjust selected feature

14. Fast forward \gg

Press to fast forward through a track

15. Reverse \ll

Press to reverse through a track

16. Program Random[†]

Press to enable/cancel random play

17. Repeat

Press to replay current CD/tape selection

18. Disc up \wedge [†]

Press to skip forward to beginning of next CD

19. Disc down \vee [†]

Press to skip back to beginning of previous CD

20. AM/FM

Press to select AM/FM1/FM2 frequency band

21. Tune/Seek/Track

Tune: Press \wedge / \vee to change frequency up/down
Seek: Press \wedge / \vee until beep is heard; tunes to next listenable station up/down

22. Disc select

Enable CD changer*

23. Audio

Press repeatedly until BASS, TREB, FADE, BAL or VOL appears in display, turn (1) clockwise/counterclockwise to increase/decrease selected function

*Denotes optional equipment

[†]For use with cassette tape player, MD player, or CD changer*

Always check the Owner's Manual for more operating information and safety features

Audio System

Revised January 9, 2001

Under
Hood

UNDER HOOD

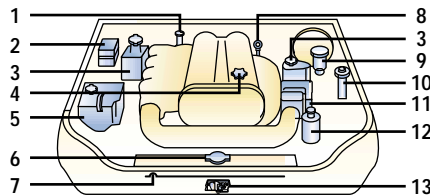

1.8-liter 4-cylinder

Tip: Check all fluids with vehicle parked on a level surface

1. Automatic transmission fluid dipstick*

If checked at operating temperature, fluid should be between FULL and LOW marks on dipstick; if checked with engine cold, fluid should be just below the bottom notch on dipstick

2. Fuse block

3. Windshield washer fluid reservoir

(In one of two locations)
Refill with windshield washer fluid

Break-in period

First 600 miles: Avoid heavy braking and acceleration; drive at varying road and engine speeds

Tip: Follow same procedures with overhauled engine or when brakes are replaced

Anti-lock Brake System (ABS)*

When brake pedal is pressed, ABS automatically reduces hydraulic pressure to any wheel on the verge of locking up. You may feel a slight pulsing of the brake pedal and hear a clicking noise; this tells you the ABS is functioning properly; increase pressure on pedal for maximum braking

4. Engine oil filler cap, see Owner's Manual for recommended engine oil viscosity

5. Engine coolant reservoir
Check when engine is cold; fluid level should be between the FULL and LOW marks on reservoir

WARNING: Never remove coolant system or reservoir cap while engine is running or hot; remove only when safe

6. Cooling system cap
Do not remove if engine is running or hot

7. Hood support rod

Tips: Maintain constant pressure on the brake pedal. Do not pump the brakes

Tire economy and tips

Check pressure at least monthly when tires are cold. Maintain correct front-end alignment and tire balance; rotate tires at 3,750-mile intervals; see Owner's Manual for rotation chart

Tire pressure

Decal on the edge of the driver's door provides tire pressure information

Tire chains*

Tire chains can damage aluminum wheels; use on steel wheels only

8. Engine oil dipstick

Check with engine off and at operating temperature. Engine oil should be between F and L marks on dipstick

9. Brake fluid reservoir

Level should be kept at the MAX mark on reservoir; fill with DOT 3 fluid from a sealed container

10. Clutch fluid reservoir (Manual transmission)

Level should be kept at the MAX mark on reservoir; fill with DOT 3 fluid from a sealed container

11. Air filter

12. Power steering fluid filler cap/dipstick

Check with engine off and at operating temperature. Level should be between H and L marks on the crosshatched area of dipstick

13. Hood latch

Pull up to release hood

Tip: Battery is located in the trunk

Tip: Use only SAE class "S" chains; install only on rear tires; install as tightly as possible and retighten periodically

*Denotes optional equipment

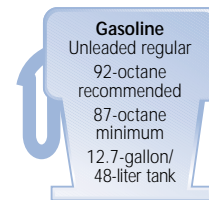

Gasoline
Unleaded regular
92-octane recommended
87-octane minimum
12.7-gallon/
48-liter tank

Always check the Owner's Manual for more operating information and safety features