

# Table of Contents

## **Introduction 4**

## **Instrument Cluster 12**

Warning and control lights	12
Gauges	18

## **Entertainment Systems 21**

AM/FM stereo	21
AM/FM stereo with single CD	25
AM/FM stereo with CD	32
AM/FM stereo cassette with single CD	45

## **Climate Controls 68**

Heater only	68
Manual heating and air conditioning	69

## **Lights 73**

Headlamps	73
Turn signal control	75
Bulb replacement	75

## **Driver Controls 82**

Windshield wiper/washer control	82
Steering wheel adjustment	83
Power windows	85
Speed control	89

## **Locks and Security 97**

Keys	97
Locks	97
Anti-theft system	97

## Table of Contents

### **Seating and Safety Restraints 105**

Seating	105
Safety restraints	107
Air bags	119
Child restraints	131

### **Driving 148**

Starting	148
Brakes	153
Transmission operation	158
Vehicle loading	170
Trailer towing	172

### **Roadside Emergencies 181**

Getting roadside assistance	181
Hazard flasher switch	182
Fuel pump shut-off switch	182
Fuses and relays	183
Changing tires	194
Jump starting	201
Wrecker towing	206

### **Customer Assistance 207**

Reporting safety defects (U.S. only)	217
--------------------------------------	-----

### **Cleaning 218**

Underbody preservation	223
------------------------	-----

## Table of Contents

### **Maintenance and Specifications** **224**

Engine compartment	234
Engine oil	238
Battery	243
Fuel information	250
Refill capacities	272
Lubricant specifications	275
Engine data	276

### **Accessories** **279**

### **Index** **280**

All rights reserved. Reproduction by any means, electronic or mechanical including photocopying, recording or by any information storage and retrieval system or translation in whole or part is not permitted without written authorization from Mazda Motor Corporation. Mazda may change the contents without notice and without incurring obligation.

Copyright © 2002 Mazda Motor Corporation

## Introduction

The following warning may be required by California law:

### **CALIFORNIA Proposition 65 Warning**

**WARNING: Engine exhaust, some of its constituents, and certain vehicle components contain or emit chemicals known to the State of California to cause cancer and birth defects or other reproductive harm. In addition, certain fluids contained in vehicles and certain products of component wear contain or emit chemicals known to the State of California to cause cancer and birth defects or other reproductive harm.**

## CONGRATULATIONS

Congratulations on acquiring your new Mazda Motor Corporation product. Please take the time to get well acquainted with your vehicle by reading this handbook. The more you know and understand about your vehicle the greater the safety and pleasure you will derive from driving it.

For more information on Mazda Motor Corporation and its products visit the following website:

- In the United States: [www.mazdausa.com](http://www.mazdausa.com)
- In Canada: [www.mazda.ca](http://www.mazda.ca)

Additional owner information is given in separate publications.

This Owner's Guide describes every option and model variant available and therefore some of the items covered may not apply to your particular vehicle. Furthermore, due to printing cycles it may describe options before they are generally available.

Remember to pass on the Owner's Guide when reselling the vehicle. It is an integral part of the vehicle.

**WARNING: In the event of an accident the Fuel pump shut-off switch will automatically cut off the fuel supply to the engine. The switch can also be activated through sudden vibration (e.g. collision when parking). To reset the switch, refer to the *Fuel pump shut-off switch* in the *Roadside emergencies* chapter.**

## **SAFETY AND ENVIRONMENT PROTECTION**

### **Warning symbols in this guide**

How can you reduce the risk of personal injury and prevent possible damage to others, your vehicle and its equipment? In this guide, answers to such questions are contained in comments highlighted by the warning triangle symbol. These comments should be read and observed.

### **Warning symbols on your vehicle**

When you see this symbol, it is imperative that you consult the relevant section of this guide before touching or attempting adjustment of any kind.



### **Protecting the environment**

We must all play our part in protecting the environment. Correct vehicle usage and the authorized disposal of waste cleaning and lubrication materials are significant steps towards this aim. Information in this respect is highlighted in this guide with the tree symbol.



## **BREAKING-IN YOUR VEHICLE**

There are no particular breaking-in rules for your vehicle. During the first 1,600 km (1,000 miles) of driving, vary speeds frequently. This is necessary to give the moving parts a chance to break in.

# Introduction

## SPECIAL NOTICES

### Emission warranty

The New Vehicle Limited Warranty includes Bumper to Bumper Coverage, Safety Restraint Coverage and Corrosion Coverage. In addition, your vehicle is eligible for Emissions Defect and Emissions Performance Warranties. For a detailed description of what is covered and what is not covered, refer to the *Warranty Guide* that is provided to you along with your Owner's Guide.

### Special instructions

For your added safety, your vehicle is fitted with sophisticated electronic controls.

**WARNING: Please read the section *Air bag* in the *Seating and safety restraints* chapter. Failure to follow the specific warnings and instructions could result in personal injury.**

**WARNING: Front seat mounted rear facing child or infant seats should NEVER be used in front of a passenger side air bag unless the air bag can be and is turned OFF.**

## Notice to owners of pickup trucks and utility type vehicles

**WARNING: Utility vehicles have a significantly higher rollover rate than other types of vehicles.**

Before you drive your vehicle, please read this Owner's Guide carefully. Your vehicle is not a passenger car. As with other vehicles of this type, failure to operate this vehicle correctly may result in loss of control, vehicle rollover, personal injury or death.

Be sure to read *Driving off road* in the *Driving* chapter.

## Using your vehicle with a snowplow

**WARNING: Do not use this vehicle for snowplowing.**

## Using your vehicle as an ambulance

**WARNING: Do not use this vehicle as an ambulance.**

Your vehicle is not equipped with the Mazda Ambulance Preparation Package.

# Introduction





These are some of the symbols you may see on your vehicle.

## Vehicle Symbol Glossary

Safety Alert		See Owner's Guide	
Protecting the Environment		Fasten Safety Belt	
Air Bag-Front		Air Bag-Side	
Child Seat		Child Seat Installation Warning	
Child Seat Tether Anchorage		Brake System	
Anti-Lock Brake System		Brake Fluid - Non-Petroleum Based	
Traction Control		Master Lighting Switch	
Hazard Warning Flasher		Fog Lamps-Front	
Fuse Compartment		Fuel Pump Reset	
Windshield Wash/Wipe		Windshield Defrost/Demist	
Rear Window Defrost/Demist		Power Windows Front/Rear	



## Vehicle Symbol Glossary

Power Window Lockout		Panic Alarm System Feature	
Engine Oil		Engine Coolant	
Engine Coolant Temperature		Do Not Open When Hot	
Battery		Avoid Smoking, Flames, or Sparks	
Battery Acid		Explosive Gas	
Fan Warning		Power Steering Fluid	
Maintain Correct Fluid Level		Emission System	
Engine Air Filter		Passenger Compartment Air Filter	
Jack		Check fuel cap	

### INFORMATION ABOUT THIS GUIDE

The information found in this guide was accurate at the time of printing. Mazda may change the contents without notice.

# Instrument Cluster

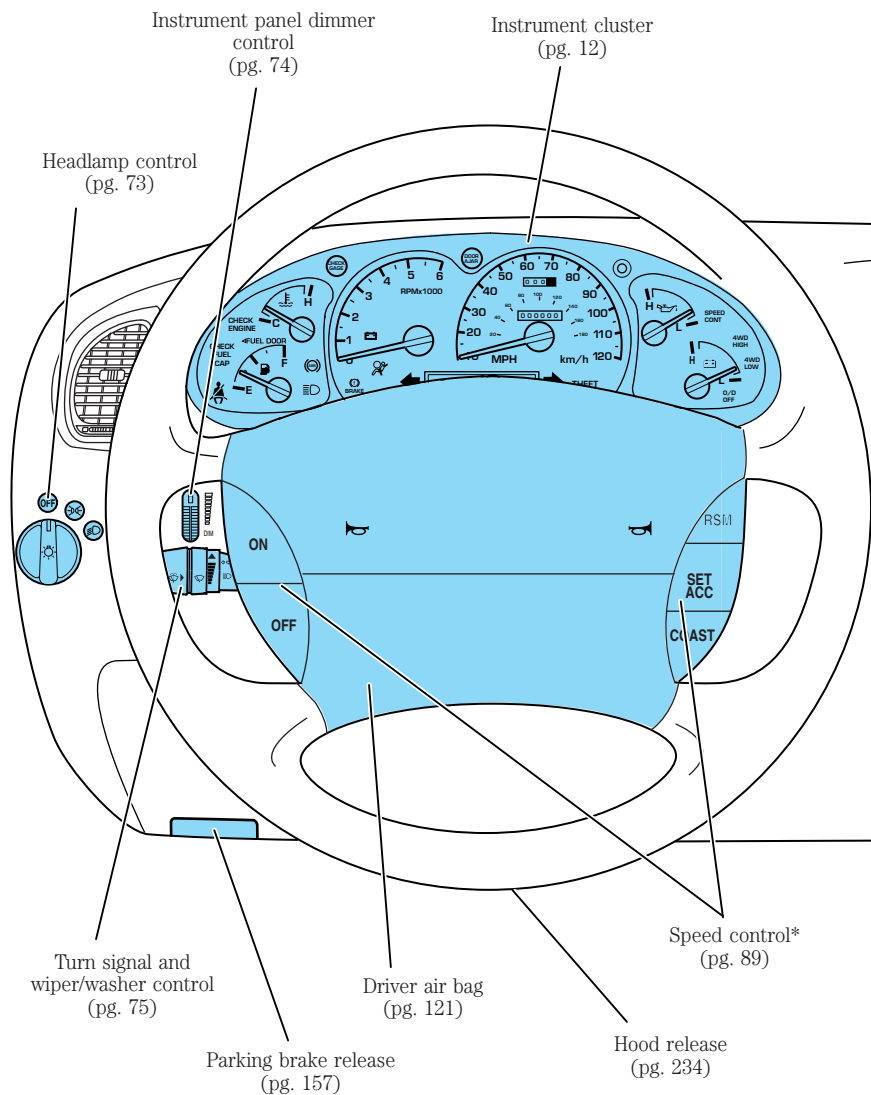

# Instrument Cluster

4wd control\*  
(pg. 167)

Audio system  
(pg. 21)

Auxiliary power point  
(pg. 84)

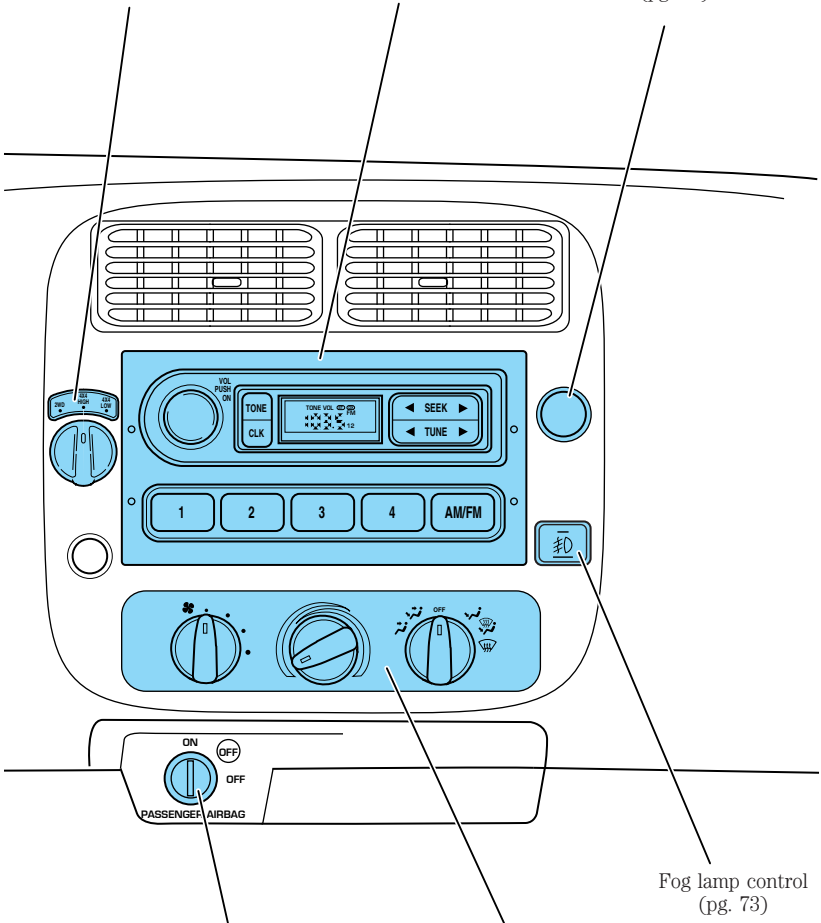

Passenger air bag deactivate switch  
(pg. 128)

Climate control system  
(pg. 69)

Fog lamp control  
(pg. 73)

\* if equipped

# Instrument Cluster

## WARNING LIGHTS AND CHIMES

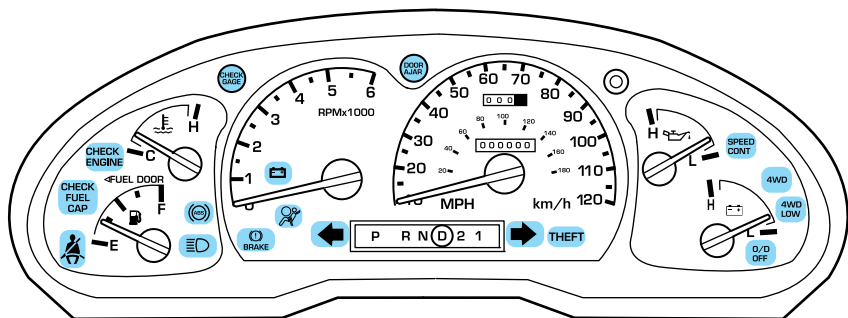

Warning lights and gauges can alert you to a vehicle condition that may become serious enough to cause expensive repairs. A warning light may illuminate when a problem exists with one of your vehicle's functions. Many lights will illuminate when you start your vehicle to make sure the bulb works. **If any light remains on after starting the vehicle, have the respective system inspected immediately.**

### Check engine

Illuminates briefly to ensure the system is functional. If it comes on after the engine is started, one of the engine's emission control systems may be malfunctioning. The light may illuminate without a driveability concern being noted and will not require towing.

## CHECK ENGINE

### Light turns on (without blinking):

Temporary malfunctions may cause your light to illuminate. Examples are:

1. The vehicle has run out of fuel.
2. Poor fuel quality or water in the fuel.
3. The fuel cap may not have been properly installed and securely tightened.

These temporary malfunctions can be corrected by filling the fuel tank with high quality fuel of the recommended octane and/or properly installing and securely tightening the fuel cap. After three driving cycles without these or any other temporary malfunctions present, the light

## Instrument Cluster

should turn off. (A driving cycle consists of a cold engine startup followed by mixed city/highway driving.) No additional vehicle service is required.

If the light remains on, have your vehicle serviced at the first available opportunity.

**NOTE:** The **CHECK ENGINE** light will illuminate if vehicle refueling is conducted with the engine running.

**WARNING: Never refuel vehicle with the engine running.**

### Light is blinking:

Engine misfire is occurring which could damage your catalytic converter. You should drive in a moderate fashion (avoid heavy acceleration and deceleration) and have your vehicle serviced at the first available opportunity.

**WARNING: Under engine misfire conditions, excessive exhaust temperatures could damage the catalytic converter, the fuel system, interior floor coverings or other vehicle components, possibly causing a fire.**

### Check gage

Illuminates when the engine coolant temperature is high, the engine oil pressure is low or the fuel gauge is at or near empty. Refer to *Engine coolant temperature gauge*, *Engine oil pressure gauge* or *Fuel gauge* in this chapter for more information.

**CHECK  
GAGE**

### Brake system warning

To confirm the brake system warning light is functional, it will momentarily illuminate when the ignition is turned to the ON position (alternatively for some vehicles when the ignition is moved from the ON position to START position, the light will momentarily illuminate prior to reaching the START position). It also illuminates if the parking brake is engaged. If the brake system warning light does not illuminate as described, seek service immediately. Illumination after the parking brake is released indicates low brake fluid

**(!)**  
**BRAKE**

## Instrument Cluster

level or a brake system malfunction and the brake system should be serviced immediately by a qualified technician. Refer to *Brakes* in the *Driving* chapter for more information.

**WARNING: Illumination after releasing the parking brake indicates low brake fluid level and the brake system should be inspected immediately.**

### Anti-lock brake system (ABS)

Illuminates to ensure the circuit is functional.



**WARNING: If the light remains on, continues to flash or fails to illuminate, have the system serviced immediately. With the ABS light on, the anti-lock brake system is disabled and normal braking is still effective unless the brake warning light also remains illuminated with the parking brake released.**

### Safety belt

Illuminates to remind you to fasten your safety belts. For more information, refer to the *Seating and safety restraints* chapter.



### Air bag readiness

Illuminates to confirm that the air bags (front or side) are operational. If the light fails to illuminate, continues to flash or remains on, have the system serviced immediately.



### **Passenger Air bag Deactivation switch warning light**

Illuminates to warn that the passenger air bag is deactivated, refer to *Passenger Air Bag ON/OFF Switch* in the *Seating and Safety* chapter.

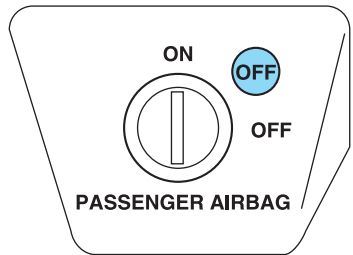

### **Charging system**

Illuminates when the battery is not charging properly.



### **Check fuel cap**

Illuminates when the fuel cap is not installed correctly. Check the fuel cap for proper installation. When the fuel filler cap is properly re-installed, the light(s) will turn off after a period of normal driving. Continuing to operate the vehicle with the check fuel cap light on, or a mis-installed fuel cap can activate the *Check Engine* warning light.

**CHECK  
FUEL  
CAP**

**It may take a long period of time for the system to detect an improperly installed fuel filler cap.**

For more information, refer to *Fuel filler cap* in the *Maintenance and specifications* chapter.

### **Speed control**

Illuminates when the speed control is activated.

**SPEED  
CONT**

## Instrument Cluster

### O/D off

Illuminates when the overdrive function has been turned OFF using the transmission control switch (TCS).

O/D  
OFF

**If the light does not come on or the light flashes steadily, have your vehicle serviced as soon as possible, damage to the transmission could occur.**

### Turn signals

Illuminates when the turn signals or the hazard lights are turned on. If the lights stay on continuously or flash faster, check for a burned-out bulb.



### High beams

Illuminates when the high beam headlamps are turned on.



### Door ajar

Illuminates when any door is open (or not fully closed).

DOOR  
AJAR

### Anti-theft system (if equipped)

Refer to *SecuriLock™ passive anti-theft system* in the *Locks and Security* chapter.

THEFT

### Four wheel drive high (if equipped)

Illuminates when four-wheel drive is put in high range.

4WD

**NOTE:** If the light continues to flash have the system serviced.



### Four wheel drive low (if equipped)

Illuminates when four-wheel drive low is engaged. If the light continues to flash have the system serviced.

**4WD  
LOW**

### Safety belt warning chime

Sounds to remind you to fasten your safety belts.

### BeltMinder™ chime

Sounds intermittently to remind you to fasten your safety belts.

### Supplemental restraint system (SRS) warning chime

Sounds when a malfunction in the supplemental restraint system (front or side airbags) has been detected. Have the supplemental restraint system inspected immediately.

### Supplemental restraint system (SRS) warning chime

Sounds when a malfunction in the supplemental restraint system (front or side airbags) has been detected. Have the supplemental restraint system inspected immediately.

### Headlamps ON warning chime

Sounds when the headlamps or parking lamps are on, the key is removed from the ignition and the driver's door is opened.

### Key-in-ignition warning chime

Sounds when the key is left in the ignition and the driver's door is opened.

# Instrument Cluster

## GAUGES

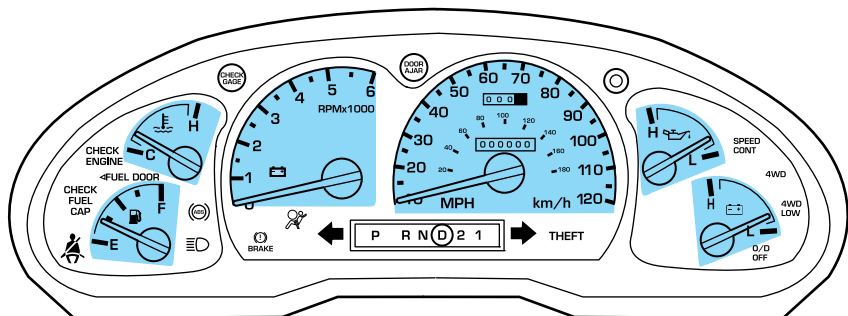

### Engine coolant temperature gauge

Indicates the temperature of the engine coolant. At normal operating temperature, the needle remains within the normal area (the area between the “H” and “C”).

**If it enters the red section, the engine is overheating. Stop the vehicle as soon as safely possible, switch off the engine immediately and let the engine cool.**

Refer to *Engine coolant* in the *Maintenance and specifications* chapter.

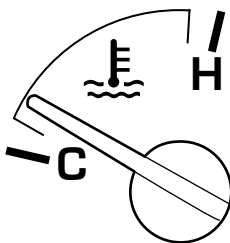

**WARNING:** Never remove the coolant reservoir cap and/or the radiator cap while the engine is running or hot, this may result in serious burns.

**NOTE:** This gauge indicates the temperature of the engine coolant, not the coolant level. If the coolant is not at its proper level the gauge indication will not be accurate.

## Engine oil pressure gauge

Indicates engine oil pressure. At normal operating temperature, the needle will be in the normal range (the area between the “L” and “H”); **if the needle goes below the normal range, stop the vehicle as soon as safely possible and switch off the engine immediately.** Check the oil level.

Add oil if needed (refer to *Engine oil* in the *Maintenance and Specifications* chapter).

If the oil level is correct, have your vehicle checked by your authorized Mazda dealership.

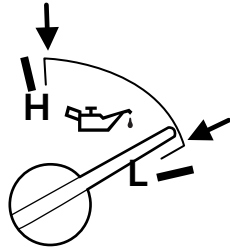

## Battery voltage gauge

Indicates battery voltage.

**NOTE:** If the pointer moves and stays outside the normal operating range (as indicated by arrows), have the vehicle's electrical system checked as soon as possible.

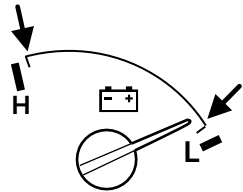

## Fuel gauge

Displays approximately how much fuel is in the fuel tank. The fuel gauge may vary slightly when the vehicle is in motion or on a grade.

When refueling the vehicle from empty indication, the amount of fuel that can be added will be less than the advertised capacity due to the reserve fuel.

**NOTE:** The FUEL DOOR icon and arrow indicates which side of the vehicle the fuel filler door is located.



# Instrument Cluster

## Speedometer

Indicates the current vehicle speed.

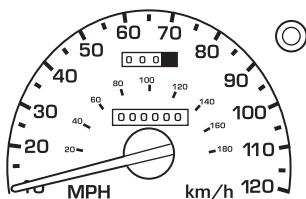

## Odometer

Registers the total kilometers (miles) of the vehicle.

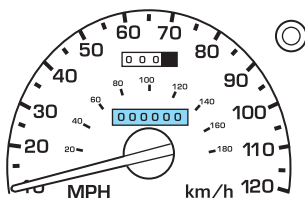

## Trip odometer

Registers the kilometers (miles) of individual journeys. To reset, depress the control.

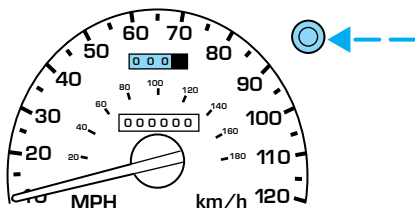

## Tachometer

Indicates the engine speed in revolutions per minute.

**Driving with your tachometer pointer continuously at the top of the scale may damage the engine.**

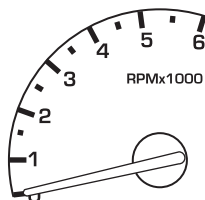

## AM/FM STEREO

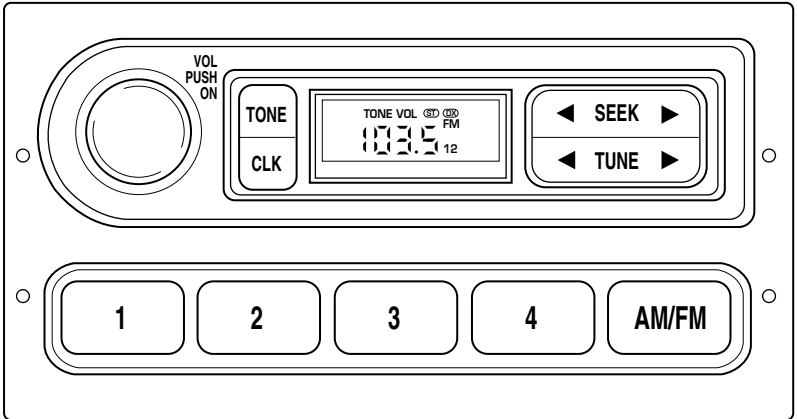

### Volume/power control

Press the control to turn the audio system on or off.

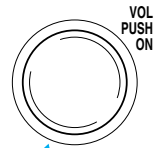

Turn the control to raise or lower volume.

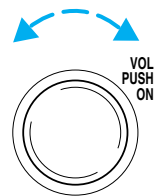

If the volume is set above a certain level and the ignition is turned off, the volume will come back on at a “nominal” listening level when the ignition switch is turned back on.

# Entertainment Systems

## AM/FM select

The AM/FM select control works in radio mode.



## AM/FM select in radio mode

This control allows you to select AM or FM frequency bands. Press the control to switch between AM, FM1 or FM2 memory preset stations.

## Tune adjust

The tune control works in radio mode.

## Tune adjust in radio mode

- Press ◀ to move to the next frequency down the band (whether or not a listenable station is located there). Hold the control to move through the frequencies quickly.
- Press ▶ to move to the next frequency up the band (whether or not a listenable station is located there). Hold for quick movement.



## Seek function

The seek function control works in radio mode.

## Seek function in radio mode

- Press ◀ to find the next listenable station down the frequency band.
- Press ▶ to find the next listenable station up the frequency band.

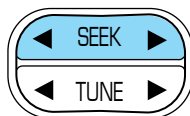

## Radio station memory preset



The radio is equipped with four station memory preset controls. These controls can be used to select up to four preset AM stations and eight FM stations (four in FM1 and four in FM2).

### Setting memory preset stations

1. Select the frequency band with the AM/FM select control.
2. Select a station. Refer to *Tune adjust* or *Seek function* for more information on selecting a station.
3. Press and hold a memory preset control until the sound returns, indicating the station is held in memory on the control you selected.



### Bass adjust

The bass adjust control allows you to increase or decrease the audio system's bass output.

Press the TONE control once, then use the volume knob to adjust the desired level.

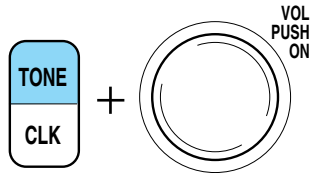

### Treble adjust

The treble adjust control allows you to increase or decrease the audio system's treble output.

Press the TONE control twice, then use the volume knob to adjust the desired level.

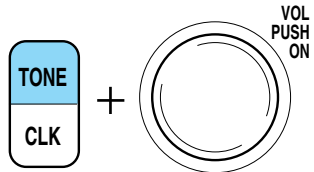

# Entertainment Systems

## Speaker balance adjust

Speaker sound distribution can be adjusted between the right and left speakers.

Press the TONE control three times, then use the volume knob to adjust the desired level.

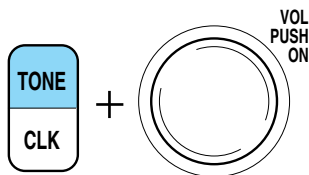

## Setting the clock

Press CLK to toggle between listening frequencies and clock mode.

To set the hour, press and hold the CLK control until CLOCK SET appears in the display and press the SEEK control:

- ◀ to decrease hours and
- ▶ to increase hours.

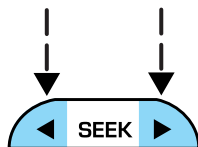
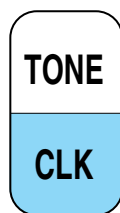

To set the minute, press and hold the CLK control until CLOCK SET appears in the display and press the TUNE control:

- ◀ to decrease minutes and
- ▶ to increase minutes.

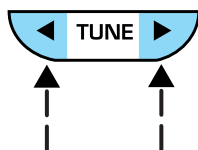

The CLK control will allow you to switch between media display mode (radio station, stereo information, etc.) and clock display mode (time).

When in clock mode, the media information will display for ten seconds,



## Entertainment Systems

when the radio is turned on, and then revert to clock information. Any time that the media is changed, (new radio station, etc.), the media information will again display for ten seconds before reverting back to the clock. In media mode, the media information will always be displayed.

### AM/FM STEREO / SINGLE CD RADIO

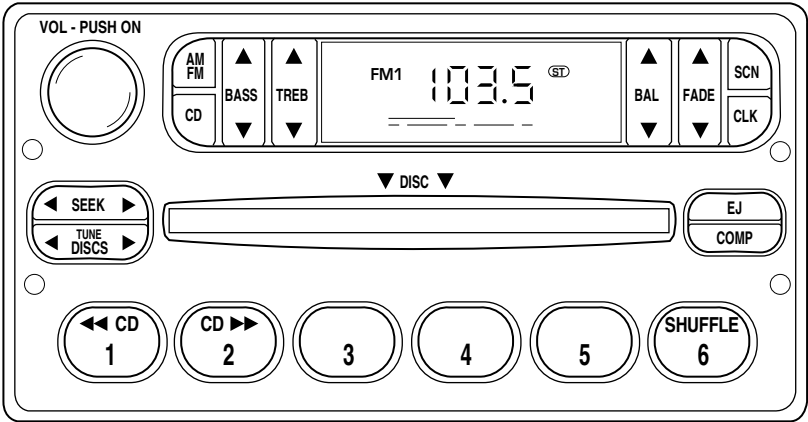

### Volume/power control

Press the control to turn the audio system on or off.

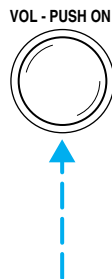

## Entertainment Systems

Turn the control to raise or lower volume.



If the volume is set above a certain level and the ignition is turned off, the volume will come back on at a “nominal” listening level when the ignition switch is turned back on.

### AM/FM select

The AM/FM select control works in radio and CD modes.



### AM/FM select in radio mode

This control allows you to select AM or FM frequency bands. Press the control to switch between AM, FM1 or FM2 memory preset stations.

### AM/FM select in CD mode

Press this control to stop CD play and begin radio play.

### Tune adjust

The tune control works in radio mode.

### Tune adjust in radio mode

- Press ◀ to move to the next frequency down the band (whether or not a listenable station is located there). Hold the control to move through the frequencies quickly.
- Press ▶ to move to the next frequency up the band (whether or not a listenable station is located there). Hold for quick movement.



## Seek function

The seek function control works in radio or CD mode.

### Seek function in radio mode

- Press ◀ to find the next listenable station down the frequency band.
- Press ▶ to find the next listenable station up the frequency band.

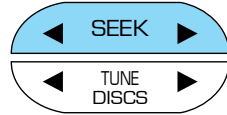

### Seek function for CD mode

- Press ◀ to seek to the previous track of the current disc. If a selection has been playing for three seconds or more and you press ◀, the CD changer will replay that selection from the beginning.
- Press ▶ to seek forward to the next track of the current disc. After the last track has been completed, the first track of the current disc will automatically replay.

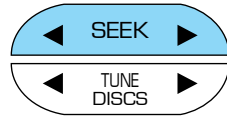

## Scan function

The scan function works in radio or CD mode.



### Scan function in radio mode

Press SCN to hear a brief sampling of all listenable stations on the frequency band. Press SCN again to stop the scan mode.

### Scan function in CD mode

Press SCN to hear a short sampling of all selections on the CD. (The CD scans in a forward direction, wrapping back to the first track at the end of the CD.) To stop on a particular selection, press the control again.

## Radio station memory preset

The radio is equipped with four or six station memory preset controls. These controls can be used to select up to four or six preset AM stations and eight or twelve FM stations (four to six in FM1 and four to six in FM2).

# Entertainment Systems

## Setting memory preset stations

1. Select the frequency band with the AM/FM select control.
2. Select a station. Refer to *Tune adjust* or *Seek function* for more information on selecting a station.
3. Press and hold a memory preset control until the sound returns, indicating the station is held in memory on the control you selected.

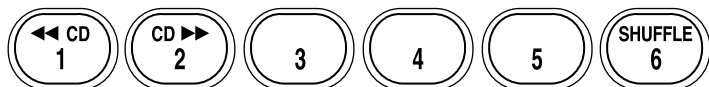

## Bass adjust

The bass adjust control allows you to increase or decrease the audio system's bass output.

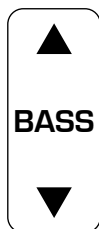

## Treble adjust

The treble adjust control allows you to increase or decrease the audio system's treble output.



## Speaker balance adjust

Speaker sound distribution can be adjusted between the right and left speakers.

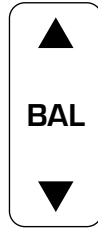

## Speaker fade adjust

Speaker sound can be adjusted between the front and rear speakers.

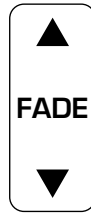

## CD select

- To begin CD play (if CD[s] are loaded), press the CD control. The first track of the disc will begin playing. After that, CD play will begin where it stopped last.

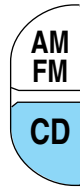

**This player is designed to use standard 4 5/8 compact discs. Do not insert any promotional (odd shaped or sized) discs, or discs with removable labels into the CD player as jamming may occur.**

## Rewind

The rewind control works in CD mode.

To rewind in CD mode press the CD control (preset 1).

Pressing the control for less than three seconds results in slow

rewind. Pressing the control for more than three seconds results in fast

rewind.

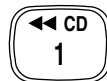

# Entertainment Systems

## Fast forward

The fast forward control works in CD mode.

To fast forward in CD mode, press the CD control (preset 2).



Pressing the control for less than three seconds results in slow

forward action. Pressing the control for more than three seconds results in fast forward action.

## Eject function

Press the control to stop and eject a CD.



## Compression feature

Compression adjust brings soft and loud CD passages together for a more consistent listening level.



Press the COMP control to activate and deactivate compression adjust.

## Shuffle feature (if equipped)

The shuffle feature operates in CD mode only and plays all tracks on the current disc in random order.



Press the SHUFFLE control to start this feature. Random order play will continue until the SHUFFLE control is pressed again.

## Setting the clock

Press CLK to toggle between listening frequencies and clock mode while in radio mode.

To set the hour, press and hold the CLK control.

Press the SEEK control:

- ◀ to decrease hours and
- ▶ to increase hours.

To set the minute, press and hold the CLK control.

Press the TUNE control:

- ◀ to decrease minutes and
- ▶ to increase minutes.

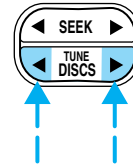
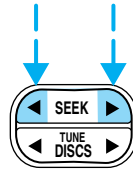

# Entertainment Systems

## MACH® MP3 MUSIC SYSTEM

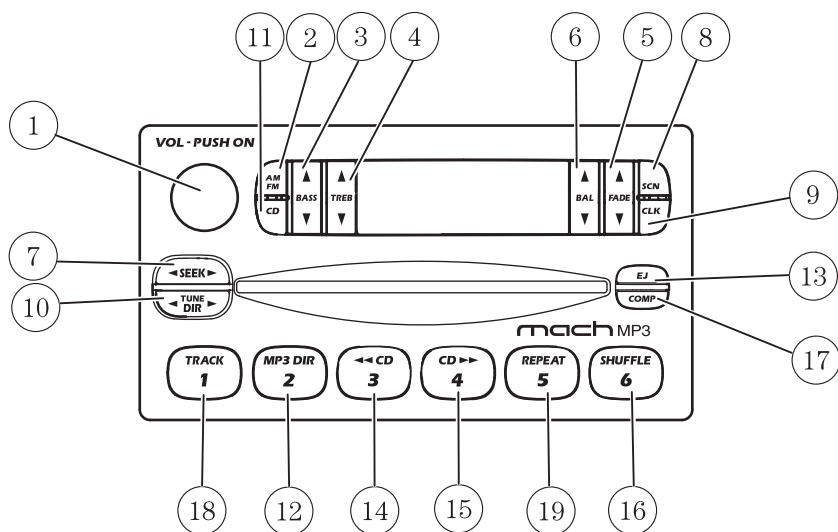

- |                              |                             |
|------------------------------|-----------------------------|
| 1. ON/OFF and volume control | 11. CD control              |
| 2. AM/FM control             | 12. MP3 directory control   |
| 3. Bass control              | 13. Eject control           |
| 4. Treble control            | 14. CD rewind control       |
| 5. Fade control              | 15. CD fast forward control |
| 6. Balance control           | 16. Shuffle control         |
| 7. Seek control              | 17. Compression control     |
| 8. Scan control              | 18. Track control           |
| 9. Clock control             | 19. Repeat control          |
| 10. Tune/Directory control   |                             |



## Volume/power control

Press the control to turn the audio system on or off.

**VOL - PUSH ON**

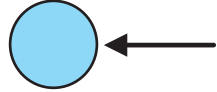

Turn the control to raise or lower the volume.

**VOL - PUSH ON**

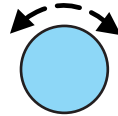

If the volume is set above a certain level and the ignition is turned off, the volume will come back on at a “nominal” listening level when the ignition switch is turned back on.

## AM/FM select

The AM/FM select control works in radio mode.

### *AM/FM select in radio mode*

This control allows you to select AM or FM frequency bands. Press the control to switch between AM, FM1 or FM2 memory preset stations.

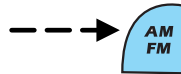

## Tune adjust

The tune adjust control works in radio mode.

### *Tune adjust in radio mode*

- Press ◀ to move to the next frequency down the band. Hold for quick movement through the frequencies.



## Entertainment Systems

- Press  to move to the next frequency up the band. Hold for quick movement through the frequencies. When the top of the band is reached, the tuner will continue to select from the lowest frequency upward.

When a radio frequency is in tune, the ST icon will appear in the display for stereo broadcasts.

### MP3 functions

Your audio system is equipped with MP3 capability which allows you to listen to songs in MP3 flat file mode and MP3 directory mode.

To engage MP3 flat file mode, insert an MP3 disc. If an MP3 disc is already present in the player, press the CD control. The MP3 icon will display while the player is in MP3 mode.

While in MP3 flat file mode, press the MP3 DIR control to enter into MP3 directory mode. The MP3 icon and the DIR icon will display while the player is in directory mode.



Your MACH® MP3 player is also equipped with an anti-shock buffer for MP3 discs.

### MP3 file directory structure

The MACH® MP3 music system recognizes MP3 disc file and directory (folder) structure as follows:

- There are two different modes for MP3 disc playback: MP3 flat file mode (default) and MP3 directory mode.
- MP3 flat file mode ignores any directory structure present on the MP3 disc. The player sequentially numbers each MP3 track on the disc (denoted by the .mp3 file extension) from T001 to T255.
- MP3 directory mode represents a directory structure consisting of one level of directories (folders). The CD player sequentially numbers all MP3 tracks on the disc (denoted by .mp3 extension) and all directories containing MP3 files, from 01–01 to 99–99. The first two digits denote the directory number and the last two digits denote the track number within that directory.
- Creating discs with only one level of subdirectories will help with navigation through the disc files.

### Seek function

The seek function control works in radio, CD, MP3 flat file mode and MP3 directory modes.

## **Seek function in radio mode**

- Press ◀ to find the next listenable station down the frequency band.
- Press ▶ to find the next listenable station up the frequency band.



## **Seek function in CD, MP3 flat file and MP3 directory modes**

- Press ◀ to select and play the previous track on the disc. If the current track is the first track on the disc, pressing ◀ will select the last track on the disc.
- Press ▶ to select and play the next track on the disc. If the current track is the last track on the disc, pressing ▶ will select the first track on the disc.



Press and hold the SEEK control to quickly seek through all tracks in MP3 flat file mode or all tracks in the current MP3 directory.

**Note:** If a track has been playing for three seconds or more and you press ◀ on the SEEK control, the player will replay that track from the beginning.

## **Scan function**

The scan function works in radio, CD, MP3 flat file and MP3 directory modes.

### **Scan function in radio mode**

Press SCN to engage scan mode and to hear a brief sampling of all listenable stations on the frequency band. When the top of the band is reached, the tuner will continue to scan from the lowest frequency upward.



Press SCN again to disengage scan mode.

## Entertainment Systems

### **Scan function in CD mode**

Press SCN to engage scan mode and to hear a brief sampling of all tracks on the disc. The track number in the display will blink while the scan function is enabled. When the end of the disc is reached, the player will continue to scan from the first track forward.

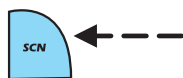

Press SCN again to disengage scan mode.

### **Scan function in MP3 flat file mode**

The scan function in MP3 flat file mode allows you to briefly audition all tracks on the MP3 disc.

Press SCN to engage scan mode and to hear a brief sampling of all tracks on the MP3 disc. The track number in the display will blink while the scan function is enabled. When the end of the disc is reached, the player will continue to scan from the first track forward.



Press SCN again to disengage scan mode.

### **Scan function in MP3 directory mode**

The scan function in MP3 directory mode allows you to briefly audition all tracks within the current directory on the MP3 disc.

Press SCN to engage scan mode and to hear a brief sampling of all tracks in the current directory. The track number in the display will blink while the scan function is enabled. When the last track is reached, the player will continue to scan from the first track in the current directory forward.



Press SCN again to disengage scan mode.

To scan tracks in another directory, press ◀ or ▶ on the TUNE DIR control to select the desired directory. The scan function will be disabled when you change directories.

Press the SCN control again to enable the scan function for the selected directory.

## Radio station memory preset



The radio is equipped with six station memory preset controls. These controls can be used to select up to six preset AM stations and twelve FM stations (six in FM1 and six in FM2).

### Setting memory preset stations

1. Select the frequency band with the AM/FM select control.



2. Select a station. Refer to *Tune adjust* or *Seek function* for more information on selecting a station.



3. Press and hold a memory preset control until the sound returns, indicating the station is held in memory on the control you selected.

### Accessing memory preset stations

1. Select the desired frequency band with the AM/FM select control.

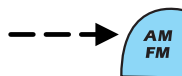

2. Press the preset control which contains the desired station frequency. The desired station will begin to play.

# Entertainment Systems

## Bass adjust

The bass adjust control allows you to increase or decrease the audio system's bass output.

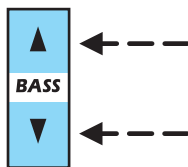

## Treble adjust

The treble adjust control allows you to increase or decrease the audio system's treble output.

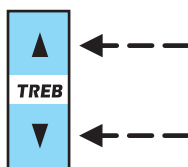

## Speaker balance adjust

Speaker sound distribution can be adjusted between the right and left speakers.

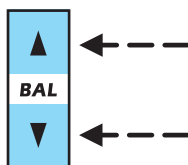

## Speaker fade adjust

Speaker sound can be adjusted between the front and rear speakers.

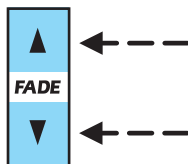

## CD select

The CD select function allows you to play CDs.

## Playing a CD

- If a CD is already loaded, press the CD control. CD play will begin where it stopped last.
- If a CD is not already loaded, insert the CD into the system. CD will briefly appear in the display and then the first track on the disc will begin playing.



## Playing an MP3 disc in MP3 flat file mode and MP3 directory mode

- Insert an MP3 disc into the player. CD and LOAD will appear in the display. Initialization may take up to two minutes for discs containing complex file directories.
- The display will briefly show the total number of tracks on the disc as TXXX (XXX= number of tracks).

- If an MP3 disc is already present in the player, press the CD control to begin play.

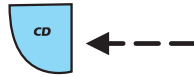

- Press the MP3 DIR control to engage MP3 directory mode, if desired. The track number format on the display will change from TXXX (XXX=current track number) to XX-XX (directory —track number).



**Note:** If the car's ignition is turned off and on again, play will begin at the beginning of the last song played. If the radio was powered off by the VOL control, play will start where it last left off.



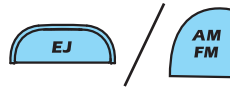

- To stop MP3 disc play, eject the disc or press the AM/FM control. The player will return to radio mode.



## Selecting a directory in MP3 directory mode

The TUNE DIR control allows you to select a different directory to play on the MP3 disc.

## Entertainment Systems

- Press  on the TUNE DIR control to advance to the next directory on the MP3 disc. If the current directory is the last directory on the disc, pressing  will select the first directory on the disc. Press and hold for fast selection.
- Press  on TUNE DIR to revert to the previous directory on the MP3 disc. If the current directory is the first directory on the disc, pressing  will select the last directory on the disc. Press and hold for fast selection.



### Eject function

Press the control to stop and eject a disc.



If a disc is ejected and not removed from the player, the player will automatically reload the disc and return to radio mode. This feature will operate when the ignition is on or off.

### Rewind

The rewind control works in CD mode. It is not enabled in MP3 flat file mode or MP3 directory mode.

Press and hold the rewind control until the desired selection point is reached. The display will show the elapsed time for each track as you reverse through it. When the beginning of the disc is reached, the first track on the disc will begin to play.



Release the rewind control again to disengage rewind mode.

### Fast forward

The fast forward control works in CD mode. It is not enabled in MP3 flat file mode or MP3 directory mode.

Press and hold the control until the desired selection point is reached. The display will show the elapsed time for each track as you



fast-forward through it. When the end of the disc is reached, the player will continue fast-forwarding from the first track forward.

Release the control to disengage fast-forwarding.



## Compression feature

The compression feature works in CD, MP3 flat file mode and MP3 directory mode.

Compression adjust brings soft and loud CD passages together for a more consistent listening level.



Press the COMP control to activate compression adjust. The compression icon (c) will illuminate in the display while the compression function is enabled.

Press the COMP control again to disengage the feature.

## Shuffle feature

The shuffle feature works in CD mode, MP3 flat file mode and MP3 directory mode.

### Shuffle feature in CD mode

The shuffle feature plays all tracks on the current disc in random order.

- Press the SHUFFLE control to engage random play. SHF and then ON will briefly appear in the display. The player will then begin random play.
- To select another random track on the disc, press ◀ or ▶ on the SEEK control.

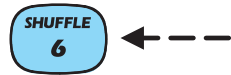

- Press the SCN control to scan through random tracks. The track number will flash in the display. The shuffle feature will remain enabled.

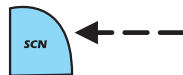

Press the SHUFFLE control again to disable the shuffle function. SHF and then OFF will briefly appear in the display.

### Shuffle feature in MP3 flat file mode

The shuffle feature in MP3 flat file mode allows you to play all the tracks on the MP3 disc in random order.

## Entertainment Systems

- Press the SHUFFLE control to engage random play. SHF and then ON will briefly appear in the display. The player will then begin random play.
- To select another random track on the disc, press ◀ or ▶ on the SEEK control.
- Press SCN to scan through random tracks. The track number will flash in the display. The shuffle function will remain enabled.
- Press SHUFFLE again to disengage the shuffle feature. SHF and then OFF will briefly display and the current track will continue to play.



### **Shuffle feature in MP3 directory mode**

The shuffle feature in MP3 directory mode allows you to play all the tracks in the current directory in random order.

- Press the SHUFFLE control to engage random play in the current directory. SHF and then ON will briefly appear in the display. The player will then begin random play.
- To select another random track in the current directory, press ◀ or ▶ on the SEEK control.



# Entertainment Systems

- Press the SCN control to scan through random tracks in the current directory. The track number will flash in the display. The shuffle feature will remain enabled.

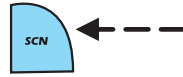

To shuffle tracks in another directory, press ◀ or ▶ on the TUNE DIR control to select the desired directory. The shuffle function still remains enabled.



Press the SHUFFLE control again to disengage the SHUFFLE feature. SHUF and OFF will briefly display and the current track will continue to play.

## MACH® Track function

The MACH® track function allows you to quickly search through a large number of tracks or directories on the MP3 disc. The function works in MP3 flat file mode and MP3 directory mode.

### Track function in MP3 flat file mode and MP3 directory mode

- Press the TRACK control. TRAC will appear in the display.
- Rotate the volume control to advance or reverse through the tracks.

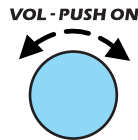
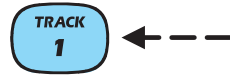

The MP3 icon will blink in the display while the MACH® track function is enabled.

When the desired track is reached, the selected track will begin play after a two second delay.

To disengage the MACH® track function, press the TRACK control again.

## Repeat track function

This function works in MP3 flat file mode or MP3 directory mode and allows you repeat the current track on the MP3 disc.

## Entertainment Systems

### **Repeat track function in MP3 flat file mode and MP3 directory mode.**

Press the REPEAT control to repeat the current track. The repeat icon will display and the current track will continue to repeat until the repeat function is disengaged.



Press the REPEAT control again to disengage the feature.

### **Error messages**

You may experience an error message for the following situations:

- NO DISC when the CD control is pressed and there is not a CD present.
- DISC ERR when there is a damaged or unreadable disc. Such as, data discs containing no .mp3 files, or for data discs containing more than 255 files or directories.
- CD ERR for any other disc malfunction.

### **Setting the clock**

To set the hour, press and hold the CLK control while performing the following functions:



- Press ◀ on the SEEK control to decrease the hours.
- Press ▶ on the SEEK control to increase the hours.



To set the minutes, press and hold the CLK control while performing the following functions:

- Press ◀ on the TUNE DIR control to decrease the minutes.
- Press ▶ on the TUNE DIR control to increase the minutes.



Release the CLK control to save the clock settings. Press the CLK control again to return the display to radio mode.

## Saving and naming MP3 files

- Your MACH® MP3 music system supports discs containing up to 255 files in 255 directories. Discs containing more than 255 files will not play.
- Always save MP3 files with the .mp3 extension. The player recognizes an MP3 file by the .mp3 extension, so MP3 files saved with different extensions will not be played. **Never save a non-MP3 file with the .mp3 extension as the file will not play properly and damage may occur to the player or your sound system.**
- The player supports multi session discs. However, be sure to import the previous session of the disc before you add new files. If you do not import the previous session, only the last session will be played.
- When burning a disc, ensure that you close/finalize the disc before playback, or the disc may not play properly or an error message may appear.
- The player supports DAM (Digital Automatic Music) discs.

## PREMIUM AM/FM STEREO/CASSETTE/SINGLE CD

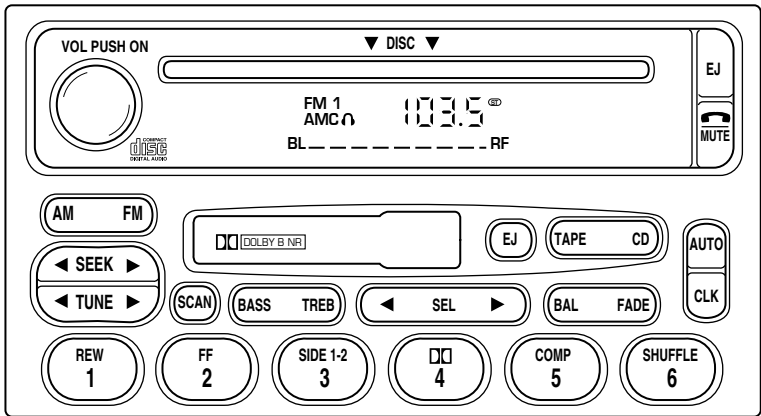

# Entertainment Systems

## Volume/power control

Press the control to turn the audio system on or off.

Audio power can also be turned on by pressing the AM/FM select control or the TAPE/CD select control.

VOL - PUSH ON

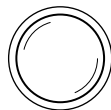

Turn control to raise or lower volume.



If the volume is set above a certain level and the ignition is turned off, the volume will come back on at a “nominal” listening level when the ignition switch is turned back on.

## AM/FM select

The AM/FM select control works in radio, tape and CD modes.



### *AM/FM select in radio mode*

This control allows you to select AM or FM frequency bands. Press the control to switch between AM, FM1 or FM2 memory preset stations.

### *AM/FM select in tape mode*

Press this control to stop tape play and begin radio play.

## Tune adjust

The tune control works in radio mode.

### *Tune adjust in radio mode*

- Press ◀ to move to the next frequency down the band (whether or not a listenable station is located there). Hold the control to move through the frequencies quickly.



## Entertainment Systems

- Press ► to move to the next frequency up the band (whether or not a listenable station is located there). Hold for quick movement.

### Seek function

The seek function control works in radio, tape or CD mode.

#### **Seek function in radio mode**

- Press ◀ to find the next listenable station down the frequency band.
- Press ► to find the next listenable station up the frequency band.



#### **Seek function in tape mode**

- Press ◀ to listen to the previous selection on the tape.
- Press ► to listen to the next selection on the tape.

#### **Seek function in CD mode**

- Press ◀ to seek to the previous track of the current disc.
- Press ► to seek forward to the next track of the current disc. After the last track has been completed, the first track of the current disc will automatically replay.



### Scan function

The scan function works in radio, tape or CD mode.



#### **Scan function in radio mode**

Press the SCAN control to hear a brief sampling of all listenable stations on the frequency band. Press the control again to stop the scan mode.

#### **Scan function in tape mode**

Press the SCAN control to hear a short sampling of all selections on the tape. (The tape scans in a forward direction. At the end of the tape's first side, direction automatically reverses to the opposite side of the tape.) To stop on a particular selection, press the control again.

#### **Scan function in CD mode**

Press the SCAN control to hear a short sampling of all selections on the CD. (The CD scans in a forward direction, wrapping back to the first track at the end of the CD.) To stop on a particular selection, press the control again.

# Entertainment Systems

## Radio station memory preset

The radio is equipped with six station memory preset controls. These controls can be used to select up to six preset AM stations and twelve FM stations (six in FM1 and six in FM2).

### Setting memory preset stations

1. Select the frequency band with the AM/FM select control. 
2. Select a station. Refer to *Tune adjust* or *Seek function* for more information on selecting a station.
3. Press and hold a memory preset control until the sound returns, indicating the station is held in memory of the control you selected.



## Autoset memory preset

Autoset allows you to set strong radio stations without losing your original manually set preset stations. This feature is helpful on trips when you travel between cities with different radio stations.

### Starting autoset memory preset

1. Select a frequency using the AM/FM select controls.
2. Press the control.
3. When the first six strong stations are filled, the station stored in memory preset control 1 will start playing.

If there are less than six strong stations available on the frequency band, the remaining memory preset controls will all store the last strong station available.

These stations are temporarily stored in the memory preset controls (until deactivated) and are accessed in the same manner as your original presets.

To deactivate autoset and return to your audio system's manually set memory stations, press the AUTO control again.

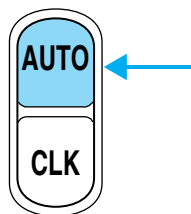



## Bass adjust

The bass adjust control allows you to increase or decrease the audio system's bass output.

Press the BASS control then press:

- ◀ to decrease the bass output and
- ▶ to increase the bass output.

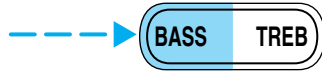

## Treble adjust

The treble adjust control allows you to increase or decrease the audio system's treble output.

Press the TREB control then press:

- ◀ to decrease the treble output and
- ▶ to increase the treble output.



## Speaker balance adjust

Speaker sound distribution can be adjusted between the right and left speakers.

Press the BAL control then press:

- ◀ to shift sound to the left and
- ▶ to shift sound to the right.



## Speaker fade adjust

Speaker sound can be adjusted between the front and rear speakers.

Press the FADE control then press:

- ▶ to shift the sound to the front and
- ◀ to shift the sound to the rear.



# Entertainment Systems

## Tape/CD select

- To begin tape play (with a tape loaded into the audio system) while in the radio or CD mode, press the TAPE control. Press the button during rewind or fast forward to stop the rewind or fast forward function.
- To begin CD play (if CD is loaded), press the CD control. The first track of the disc will begin playing. If returning from radio or tape mode, CD play will begin where it stopped last.



## Rewind

The rewind control works in tape and CD modes.

- In tape mode, radio play will continue until rewind is stopped (with the TAPE control) or the beginning of the tape is reached.
- In CD mode, pressing the REW control rewinds the CD within the current track.

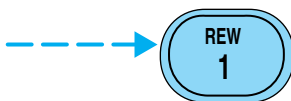

## Fast forward

The fast forward control works in tape and CD modes.

- In the tape mode, tape direction will automatically reverse when the end of the tape is reached.
- In CD mode, pressing the FF control fast forwards the CD within the current track.

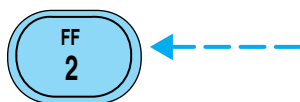

## Tape direction select

Press to play the alternate side of the tape.

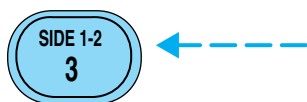



## Eject function

Press the EJ control to stop and eject a tape or CD.

## Dolby® noise reduction

Dolby® noise reduction operates in tape mode. Dolby® noise reduction reduces the amount of hiss and static during tape playback.

Press the  control to activate (and deactivate) the Dolby® noise reduction.

Dolby® noise reduction is manufactured under license from Dolby® Laboratories Licensing Corporation. “Dolby®” and the double-D symbol  are registered trademarks of Dolby® Laboratories Licensing Corporation.

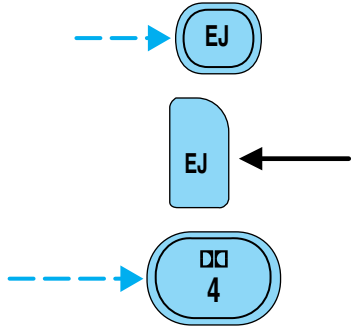

## Compression adjust

Compression adjust brings soft and loud CD passages together for a more consistent listening level.

Press the COMP control to activate and deactivate compression adjust.

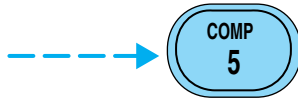

## Shuffle feature (if equipped)

The shuffle feature operates in CD mode and plays all tracks on the current disc in random order.

Press the SHUFFLE control to start this feature. Random order play will continue until the SHUFFLE control is pressed again.

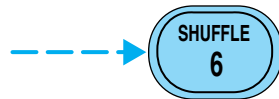

# Entertainment Systems

## Setting the clock

To set the hour, press and hold the CLK control and press SEEK:

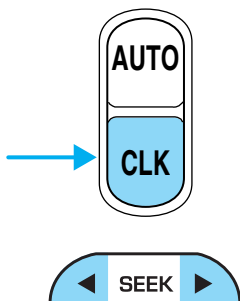

- ◀ to decrease hours and
- ▶ to increase hours.

To set the minute, press and hold the CLK control and press TUNE:

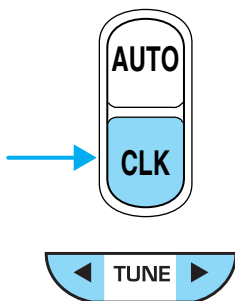

- ◀ to decrease minutes and
- ▶ to increase minutes.

If your vehicle has a separate clock, (other than the digital radio display), the CLK control will not function in the above manner.

The CLK control will allow you to switch between media display mode (radio station, stereo information, etc.) and clock display mode (time).

When in clock mode, the media information will display for 10 seconds, when the radio is turned on, and then revert to clock information. Any time that the media is changed, (new radio station, etc.), the media information will

again display for 10 seconds before reverting back to the clock. In media mode, the media information will always be displayed.

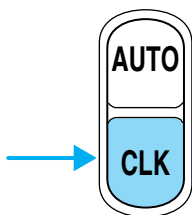

## Mute mode

Press the MUTE control to mute the playing media. Press the MUTE control again to return to the playing media.

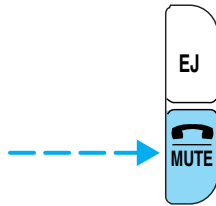

## PREMIUM AM/FM STEREO IN DASH SIX CD RADIO

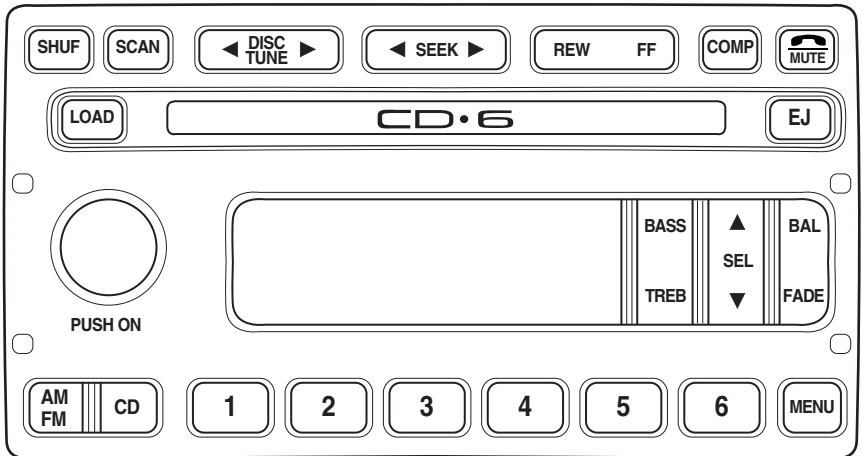

## Volume/power control

Press the control to turn the audio system on or off. Turn the control to raise or lower volume.

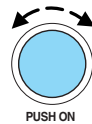

If the volume is set above a certain level and the ignition is turned off, the volume will come back on at a “nominal” listening level when the ignition switch is turned back on.

# Entertainment Systems

## AM/FM select

The AM/FM select control works in radio and CD modes.



### AM/FM select in radio mode

This control allows you to select AM or FM frequency bands. Press the control to switch between AM, FM1 or FM2 memory preset stations.

### AM/FM select in CD mode

Press this control to stop CD play and begin radio play.

## Tune/disc adjust

The tune control works in radio or CD mode.

### Tune adjust in radio mode

- Press ◀ to move to the next frequency down the band (whether or not a listenable station is located there). Hold the control to move through the frequencies quickly.
- Press ▶ to move to the next frequency up the band (whether or not a listenable station is located there). Hold for quick movement.



### Disc adjust for CD mode

- Press ◀ to select the previous disc. (Play will begin on the first track of the disc unless shuffle mode is engaged.) Refer to *Shuffle feature* for more information. Hold the control to continue reversing through the discs.
- Press ▶ to select the next disc. Hold the control to fast-forward through the remaining discs.



## Seek function

The seek function works in radio or CD mode.

## **Seek function in radio mode**

- Press ◀ to find the next listenable station down the frequency band. SEEK DOWN will display.
- Press ▶ to find the next listenable station up the frequency band. SEEK UP will display.



## **Seek function in CD mode**

- Press ◀ to seek to the previous track of the current disc. If the beginning of the disc is reached, the CD player seeks to the beginning of the last track on the current disc and begins playing.
- Press ▶ to seek forward to the next track of the current disc. After the last track has been completed, the first track of the current disc will automatically replay.



## **Scan function**

The scan function works in radio or CD mode.

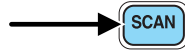

## **Scan function in radio mode**

Press the SCAN control to hear a brief sampling of all listenable stations on the frequency band. Press the SCAN control again to stop the scan mode.

## **Scan function in CD mode**

Press the SCAN control to hear a short sampling of all selections on the CD. (The CD scans in a forward direction, wrapping back to the first track at the end of the CD.) To stop on a particular selection, press the control again.

## **Autostore**

Autostore allows you to set the strongest local radio stations without losing your original manually set preset stations. This feature is helpful on trips when you travel between cities with different radio stations.

# Entertainment Systems

## Starting autostore

1. Press and momentarily hold the AM/FM control.
2. AUTOSET will flash in the display as the frequency band is scrolled through.
3. When the six strongest stations are filled, the station stored in memory preset control 1 will start playing.



If there are fewer than six strong stations available on the frequency band, the remaining memory preset controls will all store the last strong station available.

To deactivate autostore and return to your audio system's manually set memory stations, press the AM/FM control again.

## Radio station memory preset

The radio is equipped with six station memory preset controls. These controls can be used to select up to six preset AM stations and twelve FM stations (six in FM1 and six in FM2).

## Setting memory preset stations

1. Select the frequency band with the AM/FM select control. Press the AM/FM control to toggle between AM, FM1, or FM2.
2. Press the SEEK control to access the next listenable station up or down the frequency band. Press the TUNE control to go up or down the listening band in individual increments.
3. Select a station. Refer to *Seek function* for more information on selecting a station.
4. Press and hold a memory preset control. The playing media will mute momentarily. When the sound returns, the station is held in memory on the control you selected. The display will read **SAVED**.

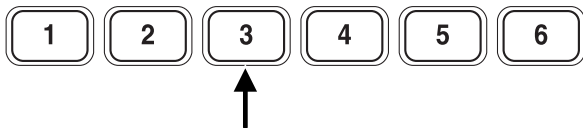



## CD select

CD mode may be entered by pressing the CD control and the LOAD control. Load the CD into the audio system. The first track of the disc will begin playing. After that, CD play will begin where it stopped last.



If an alternative CD is desired, press the corresponding preset control (1–6) of a loaded CD, or press the TUNE control to access the other loaded CDs.

NO CD will display if the CD control is activated when there is not a CD present in the audio system.

If the CD control is pressed followed by with a preset number and that particular slot is empty, NO CD will display and the system will begin to play the next available disc.

**CD units are designed to play commercially pressed 12 cm (4.75 in) audio compact discs only. Due to technical incompatibility, certain recordable and re-recordable compact discs may not function correctly when used in Mazda CD players. Irregular shaped CDs, CDs with a scratch protection film attached, and CDs with homemade paper (adhesive) labels should not be inserted into the CD player. The label may peel and cause the CD to become jammed. It is recommended that homemade CDs be identified with permanent felt tip marker rather than adhesive labels. Ball point pens may damage CDs. Please contact your dealer for further information.**

### *Display description*

Six circles are always lit in the digital display. These signify the six CD slots in the audio system. When a disc is loaded into a particular slot (1–6), the number inside that specific circle lights. If the circle is empty, there is no CD in that particular slot.

## Load

The load feature allows you to load single CDs into the player internal to the radio.



**This six disc CD player is equipped with a CD door. Compact discs should only be inserted into the player after the CD door has been opened by the player. Do not attempt to force the door open. Compact discs should only be loaded by pressing the LOAD control.**

## Entertainment Systems

Press the LOAD control. (You can choose which slot will be loaded by pressing the desired preset number. If you do not choose a slot, the system will choose the next available one.) Wait until the CD door opens. Load the CD into the player. LOADING CD# is displayed. When the CD has been loaded, the door will close and the CD will begin to play. For example, to load a CD into slot 2, press the LOAD control and then press preset 2.

### **Auto load**

This feature allows you to autoloading up to 6 discs into the multi disc CD player internal to the radio.



Press and hold the LOAD control until AUTOLOAD # is displayed. The CD door will open. Load the desired discs, one at a time. The CD is loaded into position and the audio system will display CD#. Each time the CD door opens, INSERT CD# is displayed. The door will close and the player will move to the next slot after each disc has been loaded. The process is repeated until all 6 slots are full. The audio system plays the last CD loaded and the display is updated. If some slots are already full and autoloading is activated, the system will fill all empty slots.

### **Eject**

Press the EJ control to stop and eject a CD. You can choose which CD will be ejected by pressing the



EJ control and the desired preset number (1–6). For example, to eject CD 2, press the EJ control and then press the preset 2 control. If you do not choose a specific CD, the player will eject the current CD.

If a CD is ejected and not removed from the door of the CD player, the player will automatically reload the CD. This feature may be used when the ignition is ON or OFF.

### **Auto eject**

Press and momentarily hold the EJ control to engage auto eject. All CDs which are present in the player will



be ejected one at a time. If a CD is ejected and not removed from the door of the CD player, the player will automatically reload the CD. This feature may be used when the ignition is ON or OFF.

## Rewind

The rewind control works in CD modes.



Press and hold the REW control until the desired selection is reached. If the beginning of the disc is reached, the CD will begin play at the first track. Release the control to disengage rewind mode.

When in rewind mode, your audio system will automatically lower the volume level of the playing media.

## Fast forward

The fast forward control works in CD modes.



Press and hold the FF control until the desired selection is reached. If the end of the disc is reached, the CD will return to the first track. Release the control to disengage fast forward mode.

When in fast forward mode, your audio system will automatically lower the volume level of the playing media.

## Shuffle feature

Press the SHUF control until the desired shuffle mode is displayed. The audio system will then engage the desired shuffle mode.

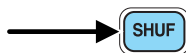

When engaged, the shuffle feature has two different modes: SHUFFLE DISC and SHUFFLE TRK.

SHUFFLE DISC randomly plays tracks from all the discs presently in the audio system.

SHUFFLE TRK plays all the tracks on the current disc in random order.

## Compression feature

The compression feature operates in CD mode and brings soft and loud CD passages together for a more consistent listening level.

Press the COMP control until COMP ON is displayed.



# Entertainment Systems

## Bass adjust

The bass adjust control allows you to increase or decrease the audio system's bass output.

Press the BASS control. Use the SEL control to increase or decrease the amount of bass.



## Treble adjust

The treble adjust control allows you to increase or decrease the audio system's treble output.

Press the TREB control. Use the SEL control to increase or decrease the amount of treble.



## Speaker balance adjust

Speaker sound distribution can be adjusted between the right and left speakers.

Press the BAL control. Use the SEL control to adjust the sound between the left and right speakers.

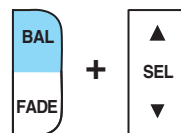

## Speaker fade adjust

Speaker sound can be adjusted between the front and rear speakers.

Press the FADE control. Use the SEL control to adjust the sound between the front and rear speakers.

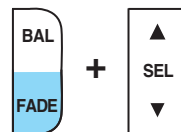

## Menu mode

The MENU control allows you to access many different features within your audio system. There are three sets of menus available depending upon which mode or feature is activated.



## Entertainment Systems

While in FM mode, two menus are available. **If RDS is turned OFF**, you can access the following:

- SELECT HOURS — Refer to *Setting the clock*.
- SELECT MINUTES — Refer to *Setting the clock*.
- RDS OFF — Refer to *Radio data system feature*.

**If RDS is turned ON**, you can access the following:

- TRAFFIC ON/OFF—Refer to *Traffic announcements*.
- FIND type—Refer to *Program type*.
- SHOW (NAME, TYPE, NONE)— Refer to *Radio data system feature*.
- RDS ON— Refer to *Radio data system feature*.
- SELECT HOURS — Refer to *Setting the clock*.
- SELECT MINUTES —Refer to *Setting the clock*.

When in CD mode, you can access: SELECT HOURS, SELECT MINUTES or COMP ON/OFF.

SELECT HOURS, SELECT MINUTES— Allows you to adjust the hours and minutes. Refer to *Setting the clock*.

TRAFFIC ON/OFF— Traffic announcements can be programmed as local or distant. Refer to *Traffic announcements*.

RDS ON/OFF— This feature allows your audio system to receive text information from RDS-equipped FM radio stations. Refer to *Radio Data System feature*.

FIND type — Allows you to select your desired FM program type and search for that selection.

SHOW — Allows you to select from NAME (displays the name of the radio station), TYPE (displays the RDS program type: rock, jazz, etc.), or NONE (deactivates the RDS display).

### Traffic announcements

This feature allows you to hear traffic announcements. When in this mode, traffic announcements will interrupt radio and CD play.

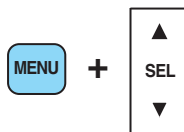

When in FM mode and RDS is activated, press the MENU until TRAFFIC OFF displays. Press the SEL control to engage the feature. The display will read TRAFFIC ON.

## Entertainment Systems

This feature also allows you to control the volume of traffic announcements. With the display reading TRAFFIC ON, adjust the volume using the volume control to the desired level. The volume level will show at the bottom of the display. Interrupting traffic announcements will be at the selected volume level.

To disengage the feature, press the MENU control until TRAFFIC ON displays. Press the SEL control. The display will read TRAFFIC OFF.

### **RDS traffic seek feature**

When in traffic mode, you can use the SEEK feature to seek up or down the listenable traffic capable frequencies.

With the RDS activated, press MENU until TRAFFIC ON is displayed. Press and hold the SEEK control until the desired selection is reached. The feature disengages when the control is released.

### **RDS traffic scan feature**

When in traffic mode, you can use the SCAN feature to scan up the frequency band for listenable traffic capable frequencies.

With the RDS activated, press the MENU control until TRAFFIC ON is displayed. Press the SCAN control. SCAN TRAFFIC will display. The audio system will scan to all traffic capable frequencies. If no valid stations are found after one pass, the scan function is cancelled and NOT FOUND displays.

**Traffic announcements are not available in most U.S. markets.**

### **Radio data system (RDS) feature**

This feature allows your audio system to receive text information from RDS-equipped FM radio stations.

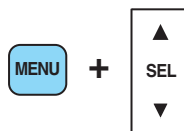

#### **To activate RDS:**

- When in FM mode, press the MENU control until RDS OFF displays.
- Press the SEL control to engage this feature (RDS ON).

#### **RDS features:**

Once the RDS feature is on, press the MENU control to scroll through the following selections:

#### **Traffic announcements**

This feature allows you to hear traffic announcements while in CD mode. These announcements are broadcast by traffic capable RDS stations.

When in this mode, traffic announcements will interrupt radio and CD play.

## Entertainment Systems

- Press the MENU control until TRAFFIC is displayed.
- Press the SEL control to engage the feature. The display will read TRAFFIC ON.

This feature also allows you to control the volume of traffic announcements. With the display reading TRAFFIC ON, adjust the volume using the volume control to the desired level. The volume level will show at the bottom of the display. Interrupting traffic announcements will be at the selected volume level.

To disengage the feature, press the MENU control until TRAFFIC ON displays. Press the SEL control. The display will read TRAFFIC OFF.

**Traffic announcements are not available in most U.S. markets.**

### ***Program type***

This feature allows you to search for RDS stations selectively by their program type.

Press the MENU control until FIND program type is displayed.

Use the SEL control to select the program type. With the feature on, use the SEEK or SCAN control to find the desired program type from the following selections:

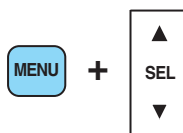

- Classic
- Country
- Info
- Jazz
- Oldies
- R & B
- Religious
- Rock
- Soft
- Top 40

# Entertainment Systems

## Show

This feature allows you to select the type of RDS broadcast information the radio will regularly show in the display.

With RDS activated, press the MENU control until SHOW is displayed.

Use the SEL control to select TYPE (displays the RDS program type: rock, jazz, etc), NAME (displays the name of the radio station) or NONE (deactivates the RDS display).

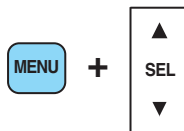
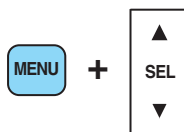

## Mute mode

Press the control to mute the playing media. Press the control again to return to the playing media.



## Setting the clock

Press the MENU control until SELECT HOUR or SELECT MINUTE is displayed. (The menu mode must be engaged to enable clock mode).

Use the SEL control to manually set the time.

- Press ▲ to increase hours/minutes.
- Press ▼ to decrease hours/minutes.



Press the MENU control again to disengage the clock mode.

## CLEANING COMPACT DISCS

Inspect all discs for contamination before playing. If necessary, clean discs only with an approved CD cleaner and wipe from the center out to the edge. Do not use circular motion.



## MP3 DISC QUALITY FACTORS

The MACH® MP3 music system is designed for use with CD-DA (regular audio discs), CD-R and CD-RW discs. Discs must comply with ISO 9660 and Joliet standards.

Several factors can effect disc playback quality:

- Disc capacity — Each disc contains about 650 MB of storage capacity. We do not recommend using high capacity discs containing 700MB of storage.
- Disc type — Some CD-RW discs may operate inconsistently and may cause an error message to appear. We recommend burning MP3 files onto CD-R discs.
- Disc finalization — The disc may be left open for the purpose of adding sessions to it at a later time, but be sure to close each session or the disc will not play.
- Bit rate — The player supports bit rates from 56–320 kbps, as well as variable bit rate MP3 files, but lower bit rates will have a noticeable effect on sound quality and are recommended only for speech or low fidelity music material. We recommend that you encode MP3 files using a high quality encoder.
- PC configuration — Encoding MP3 files requires intensive use of your computer's resources. Follow the PC configuration recommendations of the encoder software vendor. We recommend that you avoid running other software applications on your PC during MP3 encoding to avoid undesirable noise and distortion.

## CD, MP3 AND CD PLAYER CARE

- Handle discs by their edges only. Never touch the playing surface.
- Do not expose discs to direct sunlight or heat sources for extended periods of time.
- Do not insert more than one disc into the slot of the CD player (if equipped).
- Always store discs out of direct sunlight. Excessive heat may damage or warp discs.
- Use care when handling and playing CD-R and CD-RW discs, which are more susceptible to damage from heat, light and stress than are regular CDs.
- Always insert and remove a disc by holding the disc flat, with the playing surface facing down, in order to prevent damage to the disc or the player.

## Entertainment Systems

- Never insert any object other than a compact disc into the player, as doing so may damage the player and may cause injury to you.
- Do not disassemble the player. The laser used in disc playback is extremely harmful to the eyes.

**CD units are designed to play commercially pressed 12 cm (4.75 in) audio compact discs only. Due to technical incompatibility, certain recordable and re-recordable compact discs may not function correctly when used in Mazda CD players. Irregular shaped CDs, CDs with a scratch protection film attached, and CDs with homemade paper (adhesive) labels should not be inserted into the CD player. The label may peel and cause the CD to become jammed. It is recommended that homemade CDs be identified with permanent felt tip marker rather than adhesive labels. Ball point pens may damage CDs. Please contact your dealer for further information.**

### **CLEANING CASSETTE PLAYER (IF EQUIPPED)**

Clean the tape player head with a cassette cleaning cartridge after 10 to 12 hours of play in order to maintain the best sound and operation.

### **CASSETTE AND CASSETTE PLAYER CARE**

- Use only cassettes that are 90 minutes long or less.
- Do not expose tapes to direct sunlight, high humidity, extreme heat or extreme cold. Allow tapes that may have been exposed to extreme temperatures to reach a moderate temperature before playing.
- Tighten very loose tapes by inserting a finger or pencil into the hole and turning the hub.
- Remove loose labels before inserting tapes.
- Do not leave tapes in the cassette player for a long time when not being played.

### **RADIO FREQUENCY INFORMATION**

The Federal Communications Commission (FCC) and the Canadian Radio and Telecommunications Commission (CRTC) establish the frequencies AM and FM stations may use for their broadcasts. Allowable frequencies are:

AM 530, 540–1600, 1610 kHz

FM 87.7, 87.9–107.7, 107.9 MHz

Not all frequencies are used in a given area.

### RADIO RECEPTION FACTORS

Three factors can affect radio reception:

- **Distance/strength.** The further an FM signal travels, the weaker it is. The listenable range of the average FM station is approximately 40 km (24 miles). This range can be affected by “signal modulation.” Signal modulation is a process radio stations use to increase their strength/volume relative to other stations.
- **Terrain.** Hills, mountains and tall buildings between your vehicle’s antenna and the radio station signal can cause FM reception problems. Static can be caused on AM stations by power lines, electric fences, traffic lights and thunderstorms. Moving away from an interfering structure (out of its “shadow”) returns your reception to normal.
- **Station overload.** Weak signals are sometimes captured by stronger signals when you pass a broadcast tower. A stronger signal may temporarily overtake a weaker signal and play while the weak station frequency is displayed.

The audio system automatically switches to single channel reception if it will improve the reception of a station normally received in stereo.

### AUDIO SYSTEM WARRANTIES AND SERVICE

Refer to the *Warranty Guide* for audio system warranty information.

If service is necessary, see your authorized Mazda dealership.

# Climate Controls

## HEATER ONLY SYSTEM

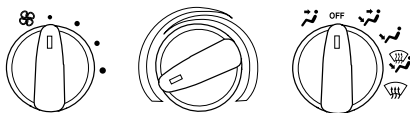

### Fan speed control

Controls the volume of air circulated in the vehicle.





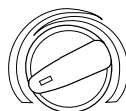

### Temperature control knob

Controls the temperature of the airflow inside the vehicle. On heater-only systems, the air cannot be cooled below the outside temperature.



### Mode selector control

Controls the direction of the airflow to the inside of the vehicle.

-  (Panel) – Distributes outside air through the instrument panel registers.
- OFF – Outside air is shut out and the fan will not operate. For short periods of time only, use this mode to prevent undesirable odors from entering the vehicle.
-  (Panel and floor) – Distributes outside air through the instrument panel registers and the floor ducts.
-  (Floor) – Distributes outside air through the floor ducts.
-  (Floor and defrost) – Distributes outside air through the floor ducts and the windshield defroster ducts.
-  (Defrost) – Distributes outside air through the windshield defroster ducts. It can be used to clear ice or fog from the windshield.

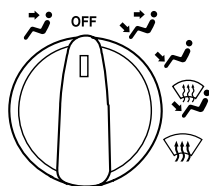

# Climate Controls

## Operating tips

- In humid weather, place the climate control system in DEF before driving. This will reduce fogging on your windshield. Once the windshield has been cleared, select any desired position.
- To reduce humidity buildup inside the vehicle, do not drive with the climate control system in the OFF position.
- Under normal weather conditions, your vehicle's climate control system should be left in any position other than OFF position when the vehicle is parked. This allows the vehicle to "breathe" through the outside air inlet duct.
- Under snowy or dirty weather conditions, your vehicle's climate control system should be left in the OFF position when the vehicle is parked. This allows the climate control system to be free from contamination of outside pollutants.
- Do not place objects under the front seat which may interfere with the airflow to the rear seats.
- Remove any snow, ice, or leaves from the air intake area (at the base of the windshield and underneath the hood).
- Do not place objects over the defroster outlets. These objects may block airflow and reduce your visibility through the windshield. Avoid placing small objects on top of the instrument panel. These objects can fall into the defroster outlets and block airflow, in addition to, damaging your climate control system.

**WARNING: Do not place objects on top of the instrument panel, as these objects may become projectiles in a collision or sudden stop.**

## MANUAL HEATING AND AIR CONDITIONING SYSTEM

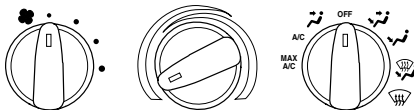

# Climate Controls

## Fan speed control

Controls the volume of air circulated in the vehicle.



## Temperature control knob

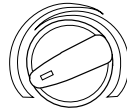

Controls the temperature of the airflow inside the vehicle.

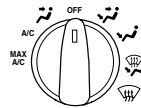

## Mode Selector Control

Controls the direction of the airflow to the inside of the vehicle.







The air conditioning compressor can operate in all modes except  and . However, the air conditioning will only function if the outside temperature is about 6°C (43°F) or higher.

Since the air conditioner removes considerable moisture from the air during operation, it is normal if clear water drips on the ground under the air conditioner drain while the system is working and even after you have stopped the vehicle.

- **MAX A/C** – Uses recirculated air to cool the vehicle. MAX A/C is noisier than A/C but more economical and will cool the inside of the vehicle faster. Airflow will be from the instrument panel registers. This mode can also be used to prevent undesirable odors from entering the vehicle.
- **A/C** – Uses outside air to cool the vehicle. It is quieter than MAX A/C but not as economical. Airflow will be from the instrument panel registers.
-  (Panel) – Distributes outside air through the instrument panel registers. However, the air will not be cooled below the outside temperature because the air conditioning does not operate in this mode.

## Climate Controls

- OFF – Outside air is shut out and the fan will not operate. For short periods of time only, use this mode to prevent undesirable odors from entering the vehicle.
-  (Panel and floor) – Distributes outside air through the instrument panel registers and the floor ducts. Heating and air conditioning capabilities are provided in this mode. For added customer comfort, when the temperature control knob is anywhere in between the full hot and full cold positions, the air distributed through the floor ducts will be slightly warmer than the air sent to the instrument panel registers.
-  (Floor) – Distributes outside air through the floor ducts. However, the air will not be cooled below the outside temperature because the air conditioning does not operate in this mode.
-  (Floor and defrost) – Distributes outside air through the windshield defroster ducts and the floor ducts. Heating and air conditioning capabilities are provided in this mode. For added customer comfort, the air distributed through the floor ducts will be slightly warmer than the air sent to the windshield defroster ducts. If the temperature is about 6°C (43°F) or higher, the air conditioner will automatically dehumidify the air to reduce fogging.
-  (Defrost) – Distributes outside air through the windshield defroster ducts. It can be used to clear ice or fog from the windshield. If the temperature is about 6°C (43°F) or higher, the air conditioner will automatically dehumidify the air to reduce fogging.

### Operating tips

- In humid weather conditions, place the climate control system in Defrost mode before driving. This will reduce fogging on your windshield. Once the windshield has been cleared, operate the climate control system as desired.
- To reduce humidity buildup inside the vehicle in cold weather conditions, don't drive with the climate control system in the OFF or MAX A/C position.
- To reduce humidity buildup inside the vehicle in warm weather conditions, don't drive with the climate control system in the OFF position.
- Under normal weather conditions, your vehicle's climate control system should be left in any position other than the MAX A/C or OFF when the vehicle is parked. This allows the vehicle to "breathe" through the outside air inlet duct.

## Climate Controls

- Under snowy or dirty weather conditions, your vehicle's climate control system should be left in the OFF position when the vehicle is parked. This allows the climate control system to be free from contamination of outside pollutants.
- If your vehicle has been parked with the windows closed during warm weather conditions, the air conditioner will perform more efficiently in cooling the vehicle if driven for two or three minutes with the windows open. This will force most of the hot, stale air out of the vehicle. Once the vehicle has been "aired out", operate the climate control system as desired.
- Do not put objects under the front seat which may interfere with the airflow to the rear seats (if equipped).
- Remove any snow, ice or leaves from the air intake area (at the bottom of the windshield and underneath the hood).
- Do not place objects over the defroster outlets. These objects can block airflow and reduce visibility through your windshield. Avoid placing small objects on top of the instrument panel. These objects may fall down into the defroster outlets and block airflow, in addition to, damaging the climate control system.

To aid in side window defogging/demisting in cold weather conditions:

1. Select the position that distributes air through the Panel and Floor.
2. Set the temperature control to full heat.
3. Set the fan speed to full fan.
4. Direct the outer panel vents towards the side windows.
5. To increase airflow to the outer panel vents, close the central panel vents.

**WARNING: Do not place objects on top of the instrument panel as these objects may become projectiles in a collision or sudden stop.**



## HEADLAMP CONTROL ☀

Rotate the headlamp control to the first position to turn on the parking lamps.

Rotate to the second position to turn on the headlamps.

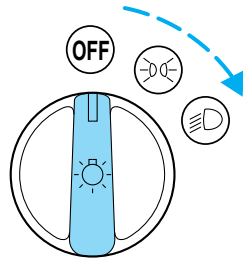

## FOG LAMP CONTROL (IF EQUIPPED) ⌘

The fog lamps can only be turned on when the headlamp control is in the low beams position.

Press the foglamp control to activate the fog lamps. The fog lamp indicator light will illuminate. When the highbeams are activated, the fog lamps will not operate.

Press the fog lamp control again to deactivate the fog lamps.

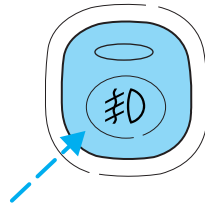

## Daytime running lamps (DRL) (if equipped)

Turns the headlamps on with a reduced output.

To activate:

- the ignition must be in the ON position and
- the headlamp control is in the OFF or Parking lamps position.

**WARNING:** Always remember to turn on your headlamps at dusk or during inclement weather. The Daytime Running Lamp (DRL) system does not activate with your tail lamps and generally may not provide adequate lighting during these conditions. Failure to activate your headlamps under these conditions may result in a collision.

# Lights

## High beams

Push the lever toward the instrument panel to activate. Pull the lever towards you to deactivate.

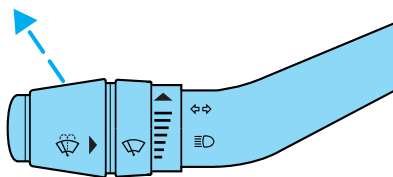

## Flash to pass

Pull toward you slightly to activate and release to deactivate.

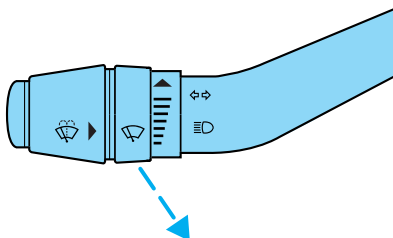

## PANEL DIMMER CONTROL

Use to adjust the brightness of the instrument panel and all applicable switches in the vehicle during headlamp and parklamp operation.

Move the control to the full upright position, past detent, to turn on the interior lamps.

Move the control to the full down position, past detent, to prevent the interior lights from illuminating when the doors are opened.

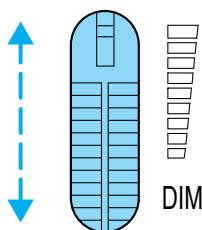

## AIMING THE HEADLAMPS

The headlamps on your vehicle are properly aimed at the assembly plant.

If your vehicle has been in an accident the alignment of your headlamps should be checked by your authorized Mazda dealer.

## TURN SIGNAL CONTROL ⇐⇒

- Push down to activate the left turn signal.
- Push up to activate the right turn signal.
- In vehicles equipped with daytime running lights, use of the turn signals will shut off the highbeams in daytime driving.

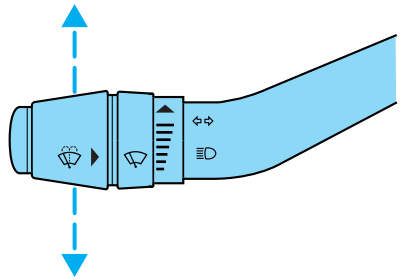

## COURTESY/READING LAMPS (IF EQUIPPED)

The courtesy lamp lights when:

- any door is opened.
- the instrument panel dimmer switch is held up until the courtesy lamps come on.
- the remote entry controls are pressed and the ignition is OFF.

The reading lamps can be turned on by moving the switch on the dome lamp to either the left or the right.

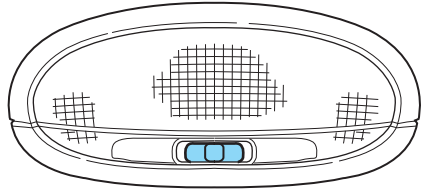

## BULBS

### Replacing exterior bulbs

Check the operation of the following lamps frequently:

- Headlamps
- Fog lamps (if equipped)
- High-mount brake lamp
- Brake lamps
- Turn signal lamps
- License plate lamp
- Tail lamps
- Back-up lamps

Do not remove lamp bulbs unless they can be replaced immediately with new ones. If a bulb is removed for an extended period of time, contaminants may enter the lamp housings and affect lamp performance.

# Lights

## Using the right bulbs

Replacement bulbs are specified in the chart below. Headlamp bulbs must be marked with an authorized "D.O.T." for North America to assure lamp performance, light brightness and pattern and safe visibility.

**NOTE:** The correct bulbs will not damage the lamp assembly or void the lamp assembly warranty and will provide quality bulb burn time.

Function	Number of bulbs	Trade number
Park/turn lamps (front)	2	3157 AK (amber)
Headlamps	2	9003
Rear stop/tail lamps	2	3157K
Rear turn lamps	2	3156K
Rear license plate lamps	2	3156K/168
Backup lamp	2	3156K
Rear/turn/sidemarkers	2	916NA (amber)
Fog lamp (if equipped)	2	899
Cargo lamp	1	211-2
Interior overhead lamp	1	912 (906)
Front door courtesy lamp	1	168
Map lamps	2	168 (T10)
Ashtray lamp	1	161
All replacement bulbs are clear in color except where noted.		
To replace all instrument panel lights - see your dealer.		

## Replacing the interior bulbs

Check the operation of the following interior bulbs frequently:

- interior overhead lamp
- map lamp

For bulb replacement, see an authorized Mazda dealer.

## Replacing headlamp bulbs

**WARNING: Handling Halogen Bulbs:** When a halogen bulb breaks, it is dangerous. These bulbs contain pressurized gas. If one is broken, it will explode and serious injuries could be caused by the flying glass. If the glass portion of the bulb is touched with bare hands, body oil could cause the bulb to overheat and explode when lit. Never touch the glass portion of the bulb with your bare hands and always wear eye protection when handling or working around halogen bulbs.

**Children and Halogen Bulbs:** Playing with a halogen bulb is dangerous. Serious injuries could be caused by dropping a halogen bulb or breaking in some other way. Always keep halogen bulbs out of the reach of children.

To remove the headlamp bulb:

1. Make sure headlamp switch is in OFF position, then open the hood.
2. At the back of the headlamp, pry up the two retainer pins to release the headlamp assembly from the vehicle and pull headlamp forward.
3. Remove the bulb retaining ring by rotating it counterclockwise (when viewed from the rear) to free it from the bulb socket, and slide the ring off the plastic base. Keep the ring to retain the new bulb.
4. Without turning, remove the old bulb by gently pulling it straight back out of the lamp assembly.

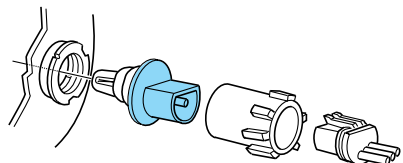
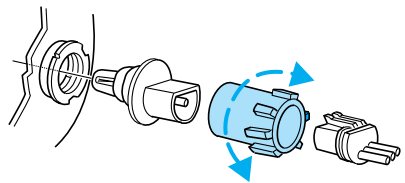
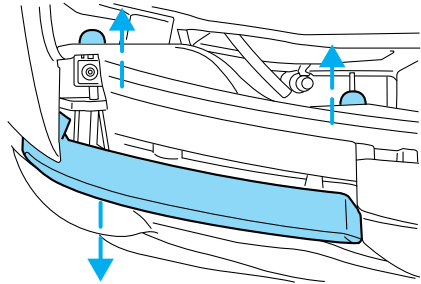

## Lights

To install the new bulb:

**Handle a halogen headlamp bulb carefully and keep out of children's reach. Grasp the bulb only by its plastic base and do not touch the glass. The oil from your hands could cause the bulb to break the next time the headlamps are operated.**

**NOTE:** If the bulb is accidentally touched, it should be cleaned with rubbing alcohol before being used.

1. With the flat side of the bulb's plastic base facing upward, insert the glass end of the bulb into the lamp assembly. You may need to turn the bulb left or right to align the grooves in the plastic base with the tabs in the lamp assembly. When the grooves are aligned, push the bulb into the lamp assembly until the plastic base contacts the rear of the lamp assembly.
2. Install the bulb retaining ring over the plastic base until it contacts the rear of the socket by rotating clockwise until you feel a "stop."
3. Install the electrical connector into the plastic base until it snaps, locking it into position.
4. Install the headlamp on vehicle, push rearward and secure with two retainer pins.
5. Turn the headlamps on and make sure they work properly. If the headlamp was correctly aligned before you changed the bulb, you should not need to align it again.

### **Replacing front side marker bulbs**

1. Open the hood.
2. At the back of the headlamp, pry up the two retainer pins to release the headlamp assembly from the vehicle and pull headlamp forward.

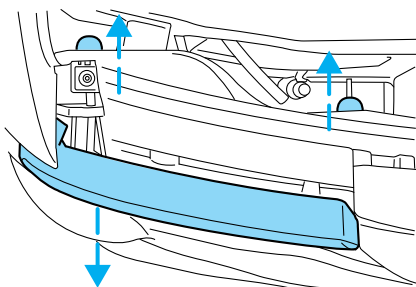

3. Remove screw(s) from lamp assembly.
4. Disengage lamp assembly (it has a snap fit).

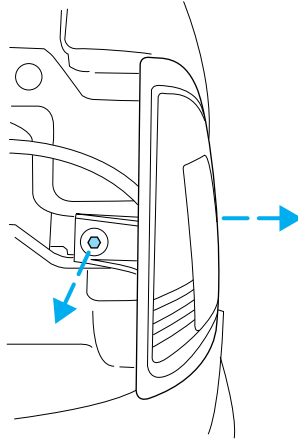

5. Rotate bulb socket counterclockwise and remove from lamp assembly.
6. Carefully pull bulb straight out of socket and push in the new bulb.
7. Install the bulb socket in lamp assembly by turning clockwise.

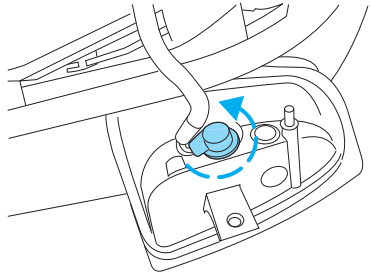

8. Align the lamp on the vehicle and push to snap in place.
9. Install screw(s) on lamp assembly.
10. Install the headlamp on vehicle, push rearward and secure with two retainer pins.

# Lights

## Replacing tail lamp/backup lamp bulbs

The tail lamp/backup lamp bulbs are located in the same portion of the tail lamp assembly, one just below the other. Follow the same steps to replace either bulb:

1. Open the tailgate to expose the lamp assemblies.
2. Remove the four screws and the lamp assembly from vehicle.

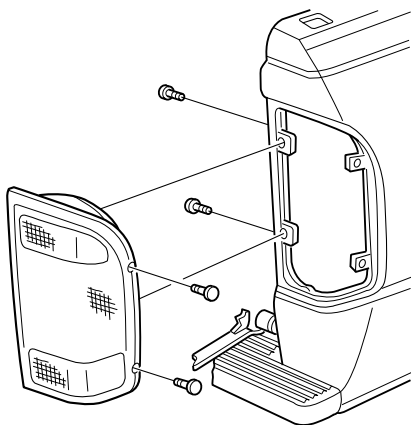

3. Rotate bulb socket counterclockwise turn and remove from lamp assembly.
4. Carefully pull the bulb straight out of the socket and push in the new bulb.
5. Install the bulb socket in lamp assembly by turning clockwise.
6. Install the lamp assembly and secure with four screws.

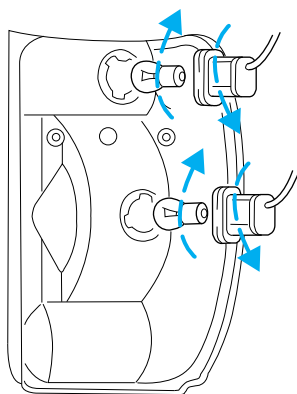

## Replacing fog lamp bulbs

1. Remove the bulb socket from the fog lamp by turning counterclockwise.
2. Disconnect the electrical connector from the fog lamp bulb.

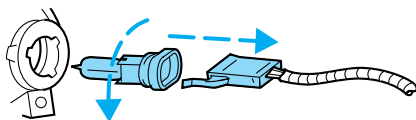



3. Connect the electrical connector to the new fog lamp bulb.
4. Install the bulb socket in the fog lamp turning clockwise.

## **Replacing high-mount brake lamp and cargo lamp bulbs**

The replacement of the high-mount brake lamp bulb and cargo lamp bulb is basically the same. This procedure covers the high-mount brake lamp bulb.

To remove the brake lamp assembly:

1. Remove the two screws and lamp assembly from vehicle.
2. Remove the bulb socket from lamp assembly by rotating it counterclockwise.
3. Carefully pull bulb straight out of socket and push in the new bulb.

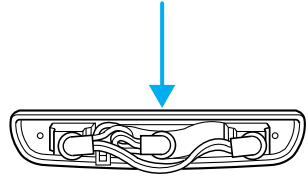

To install the brake lamp assembly:

1. Install the bulb socket into the lamp assembly by rotating clockwise.
2. Install the lamp assembly on the vehicle and secure with two screws.

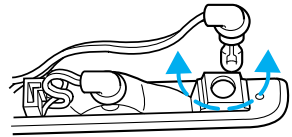

## **Replacing license plate lamp bulbs**

The license plate bulbs are located behind the rear bumper. To change the license plate lamp bulbs:

1. Reach behind the rear bumper to locate the bulb socket.
2. Twist the socket counterclockwise and remove.
3. Pull out the old bulb from socket and push in the new bulb.
4. Install the bulb socket in lamp assembly by turning it clockwise.

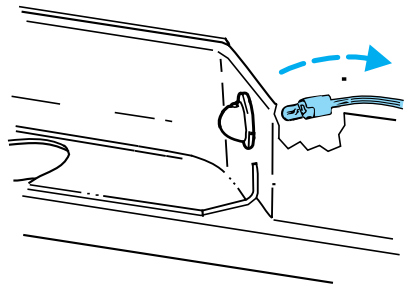

## Driver Controls

### WINDSHIELD WIPER/WASHER CONTROLS

Rotate the windshield wiper control to the desired interval, low or high speed position.

The bars of varying length are for intermittent wipers. When in this position rotate the control upward for fast intervals and downward for slow intervals.

Push (tap) the end of the stalk briefly for a single swipe (no wash). Push and hold for three swipes with wash. Push and hold for a longer wash (up to ten seconds).

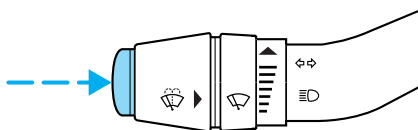
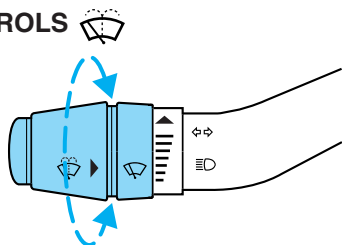

### Checking the wiper blades

If the wiper blades do not wipe properly, clean both the windshield and wiper blades using undiluted windshield wiper solution or a mild detergent. Rinse thoroughly with clean water. To avoid damaging the blades, do not use fuel, kerosene, paint thinner or other solvents.

### Windshield wiper blades

Check the wiper blades for wear at least twice a year or when they seem less effective. Substances such as tree sap and some hot wax treatments used by commercial car washes reduce the effectiveness of wiper blades.

### ***Changing the wiper blades***

To replace the wiper blades:

1. Pull the wiper arm away from the windshield and lock into the service position.
2. Turn the blade at an angle from the wiper arm. Push the lock pin manually to release the blade and pull the wiper blade down toward the windshield to remove it from the arm.
3. Attach the new wiper to the wiper arm and press it into place until a click is heard.

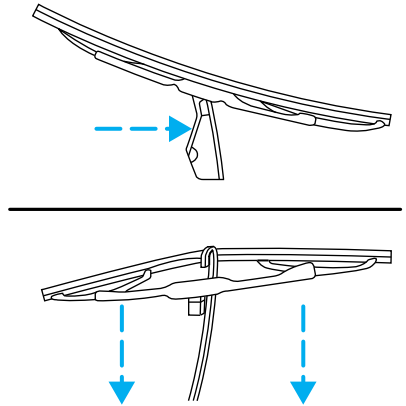

### **TILT STEERING WHEEL (IF EQUIPPED)**

Pull the tilt steering control toward you to move the steering wheel up or down. Hold the control while adjusting the wheel to the desired position, then release the control to lock the steering wheel in position.

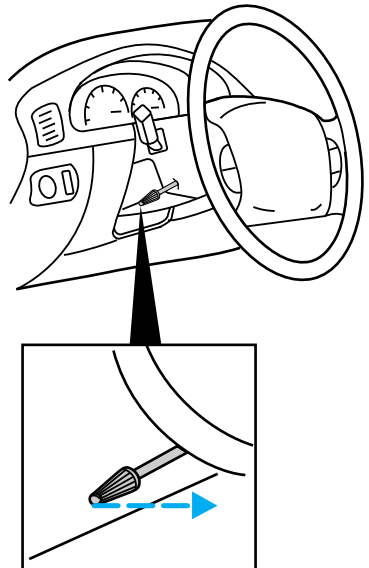

## Driver Controls

**WARNING:** Never adjust the steering wheel when the vehicle is moving. You could lose control of the vehicle.

### AUXILIARY POWER POINT 12V

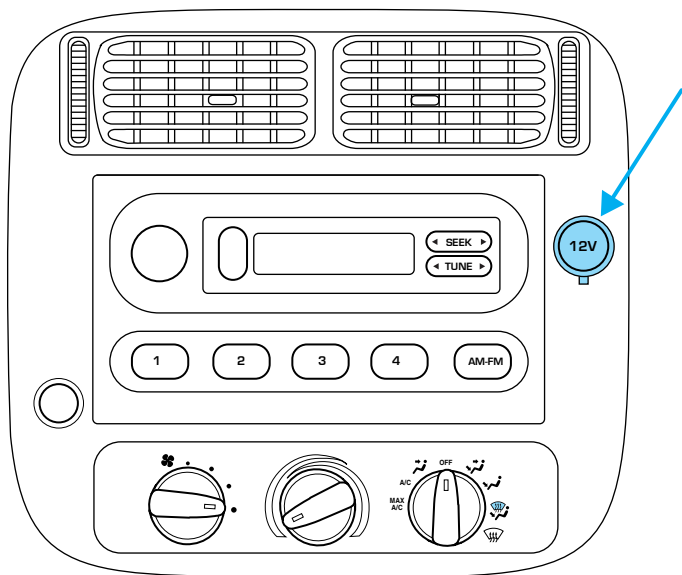

**Power outlets are designed for accessory plugs only. Do not hang any type of accessory or accessory bracket from the plug. Improper use of the power outlet can cause damage not covered by your warranty.**

The auxiliary power point is located on the instrument panel. This outlet should be used in place of the cigarette lighter for optional electrical accessories.

### POWER WINDOWS (IF EQUIPPED)

Press and hold the rocker switches to open and close windows.

- Press the top portion of the rocker switch to close.

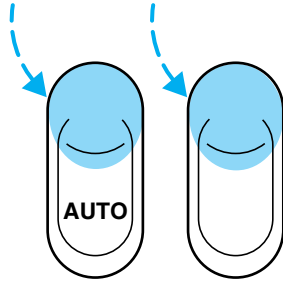

- Press the bottom portion of the rocker switch to open.

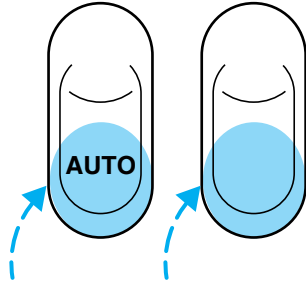

### One touch down

- Press AUTO completely down and release quickly. The driver's window will open fully. Depress again to stop window operation.

One touch down can be deactivated during operation by pushing down on the top part of the driver power window control.

**NOTE:** This feature will only operate the driver's side window.

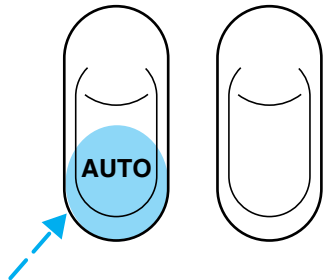

## Driver Controls

### **AUTOMATIC DIMMING REAR VIEW MIRRORS (IF EQUIPPED)**

Your vehicle is equipped with an inside rear view mirror with an auto-dimming function. The electronic day/night mirror will change from the normal state to the non-glare state when bright lights (glare) reach the inside rear view mirror. When the inside rear view mirror detects bright light from behind the vehicle, the inside rear view mirror will automatically adjust (darken) to minimize glare.

Do not block the sensor on the backside of the inside rear view mirror since this may impair proper system performance.

Press the left button on the mirror to turn the auto dimming ON or OFF. The green indicator light left of the display will illuminate when this feature is ON.

The mirror will automatically return to the normal state whenever the vehicle is placed in R (Reverse) (when the mirror is on) to ensure a bright clear view when backing up.

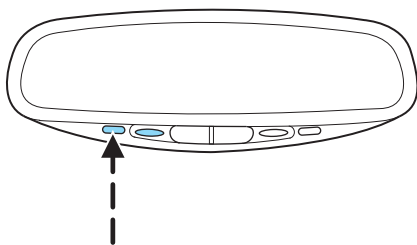

### **COMPASS/TEMPERATURE EC MIRROR (IF EQUIPPED)**

The compass reading may be affected when you drive near large buildings, bridges, power lines and powerful broadcast antennas. Magnetic or metallic objects placed in, on or near the vehicle may also affect compass accuracy.

Usually, when something affects the compass readings, the compass will correct itself after a few days of operating your vehicle in normal conditions. If the compass still appears to be inaccurate, a manual calibration may be necessary. Refer to *Compass calibration adjustment*.

Most geographic areas (zones) have a magnetic north compass point that varies slightly from the northerly direction on maps. This variation is four degrees between adjacent zones and will become noticeable as the vehicle crosses multiple zones. A correct zone setting will eliminate this error. Refer to *Compass zone adjustment*.

### OUTSIDE AIR TEMPERATURE

Display operation of the mirror with the compass feature:

- Press the right button to toggle the display between the compass direction and no display.

Display operation of mirror with temperature and compass feature:

- Press the right button once to display temperature °F and compass.
- Press the right button twice to display temperature °C and compass.
- Press the right button three times to turn the display OFF.

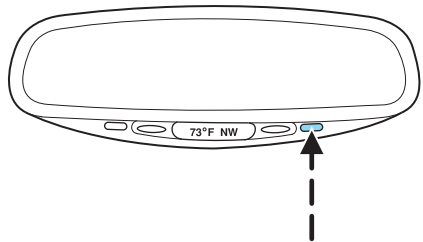

**WARNING: The outside temperature indicator is not designed to serve as an ICE warning device and is therefore unsuitable for that purpose. Indicated temperatures just above the freezing point do not guarantee that the road surface is free of ice.**

### COMPASS ZONE ADJUSTMENT

1. Determine which compass zone you are in by referring to the zone map.
2. Turn ignition to the ON position.

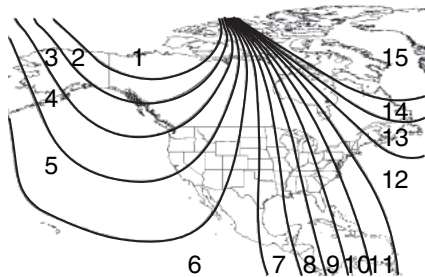

## Driver Controls

3. To change the zone setting, push and hold the right button until ZONE appears in the display.
4. Press the right button repeatedly until desired compass zone number is displayed. The display will change back to the compass direction after 3 seconds when the button is not activated.

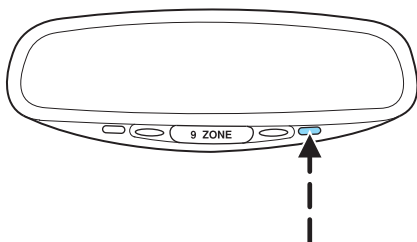

### COMPASS CALIBRATION ADJUSTMENT

The compass calibrates itself under normal driving conditions. There is not a need for manual compass calibration. If calibration is still desired, follow these instructions:

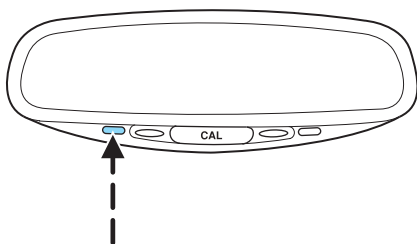

1. Start the vehicle.
2. For optimum calibration, turn off all electrical accessories and make sure that all vehicle doors are shut.
3. Perform this adjustment in an open area free from steel structures and high voltage lines.
4. Press and hold the left button for approximately 3 seconds until CAL appears in the display. Release the left button to enter the calibration mode.
5. Drive the vehicle slowly (less than 5 km/h [3 mph] in a circle until CAL indicator disappears in the display (about two or three circles).
6. The compass is now calibrated.





### POWER MIRROR CONTROL (IF EQUIPPED)

To adjust your mirrors:

1. Select  to adjust the left mirror or  to adjust the right mirror.
2. Move the control in the direction you wish to tilt the mirror.
3. Return to the center position to lock mirrors in place.

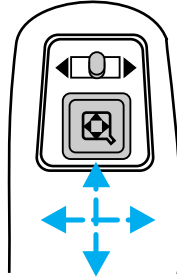

### SPEED CONTROL (IF EQUIPPED)

To turn speed control on

- Press ON.

**NOTE:** Vehicle speed cannot be controlled until the vehicle is traveling at or above 48 km/h (30 mph).

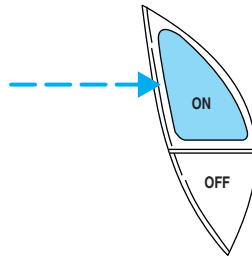

**WARNING: Do not use the speed control in heavy traffic or on roads that are winding, slippery, or unpaved. You may lose control of the vehicle.**

**WARNING: Do not shift the gearshift lever into N (Neutral) with the speed control on. You may lose control of the vehicle or cause engine system damage.**

## Driver Controls

### To turn speed control off

- Press OFF.

**NOTE:** Once speed control is turned off or the ignition is switched off, the previously programmed set speed will be erased.

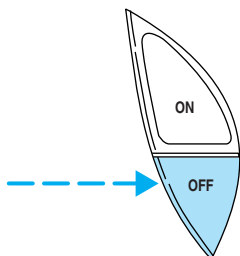

### To set a speed

- Press SET ACC.

**NOTE:** For speed control to operate, the speed control must be ON and the vehicle speed must be greater than 48 km/h (30 mph).

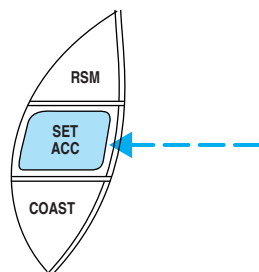

If you drive up or down a steep hill, your vehicle speed may vary momentarily slower or faster than the set speed. This is normal.

Speed control cannot reduce the vehicle speed if it increases above the set speed on a downhill. If your vehicle speed is faster than the set speed while driving on a downhill, you may want to shift to the next lower gear or apply the brakes to reduce your vehicle speed.

If your vehicle slows down more than 16 km/h (10 mph) below your set speed on an uphill, your speed control will disengage. This is normal. Pressing RSM will re-engage it.

**WARNING: Do not use the speed control in heavy traffic or on roads that are winding, slippery, mountainous, hilly, or unpaved. This may cause an accident.**

## To set a higher set speed

- Press and hold SET ACC. Release the control when the desired vehicle speed is reached or
- Press and release SET ACC to operate the Tap-Up function. Each press will increase the set speed by 1.6 km/h (1 mph) or
- Accelerate with your accelerator pedal. When the desired vehicle speed is reached, press and release SET ACC.

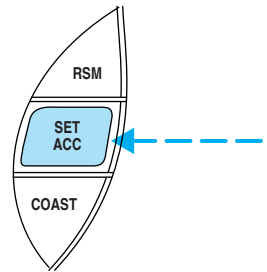

**NOTE:** You can accelerate with the accelerator pedal at any time during speed control usage. Releasing the accelerator pedal will return your vehicle to the previously programmed set speed.

## To set a lower set speed

- Press and hold COAST. Release the control when the desired speed is reached or
- Press and release COAST to operate the Tap-Down function. Each press will decrease the set speed by 1.6 km/h (1 mph) or
- Depress the brake pedal. When the desired vehicle speed is reached, press SET ACC.

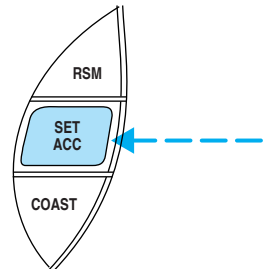
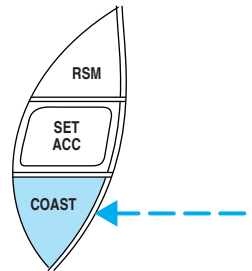

## Driver Controls

### To disengage speed control

- Depress the brake pedal or

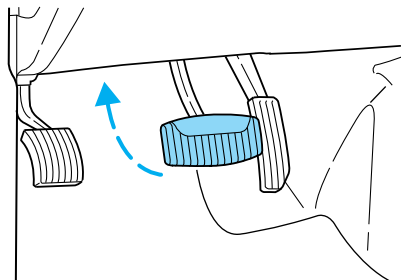

- Depress the clutch pedal (if equipped).

**NOTE:** Disengaging the speed control will not erase the previously programmed set speed.

**NOTE:** Fully depressing the clutch pedal may cause a flare in engine RPM as the throttle is returned to idle. This is normal.

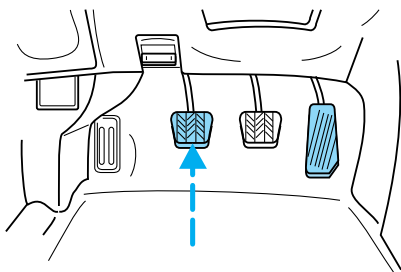

**NOTE:** Pressing OFF will erase the previously programmed set speed.

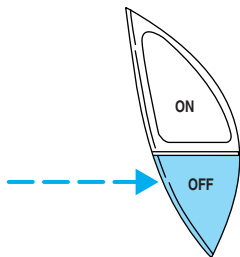

### To return to a previously set speed

- Press RSM. For RSM to operate, the vehicle speed must be faster than 48 km/h (30 mph).

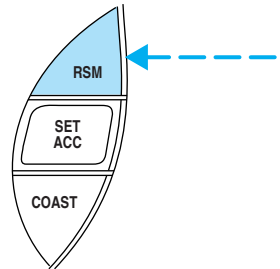

### Indicator light

This light comes on when either the SET ACCEL or RES controls are pressed. It turns off when the speed control OFF control is pressed, the brake or clutch is applied or the ignition is turned to the OFF position.

**SPEED  
CONT**

### OVERDRIVE CONTROL (IF EQUIPPED)

#### Activating overdrive

**D** (Overdrive) is the normal drive position for the best fuel economy. The overdrive function allows automatic upshifts and downshifts through all available gears.

#### Deactivating overdrive

Press the Transmission Control Switch (TCS) located on the end of the gearshift lever. The O/D Off indicator light will illuminate on the instrument cluster. The transmission will operate in all gears except overdrive.

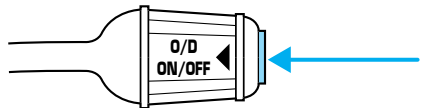

## Driver Controls

To return to normal overdrive mode, press the Transmission Control Switch again. The O/D Off indicator light will no longer be illuminated.

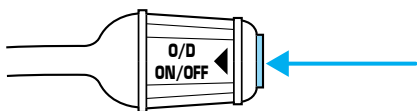

When you shut off and re-start your vehicle, the transmission will automatically return to normal **D** (Overdrive) mode.

For additional information about the gearshift lever and the transmission control switch operation refer to the *Automatic Transmission Operation* section of the *Driving* chapter.

### CENTER CONSOLE (IF EQUIPPED)

Your vehicle may be equipped with a variety of console features. These include:

- Utility compartment with cassette/compact disc storage
- Cupholders
- Coin holder slots
- Flip up armrest

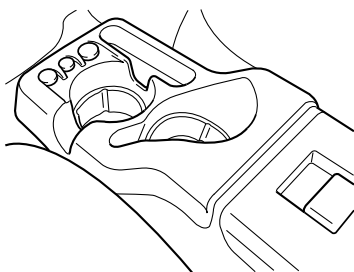

**WARNING: Use only soft cups in the cupholder. Hard objects can injure you in a collision.**

### CARGO AREA FEATURES

#### Cargo area shade (if equipped)

Your vehicle may be equipped with notches in the side trim panels that are used for a cargo area shade. See your dealer for more information.

#### BED EXTENDER (IF EQUIPPED)

Your vehicle may be equipped with a bed extender designed to extend the pickup box for longer loads.

To extend the bed extender:

1. Lower tailgate.
2. Pull the round knobs on each side of the extender to release it from the pickup box.
3. Pivot extender on to the tailgate.

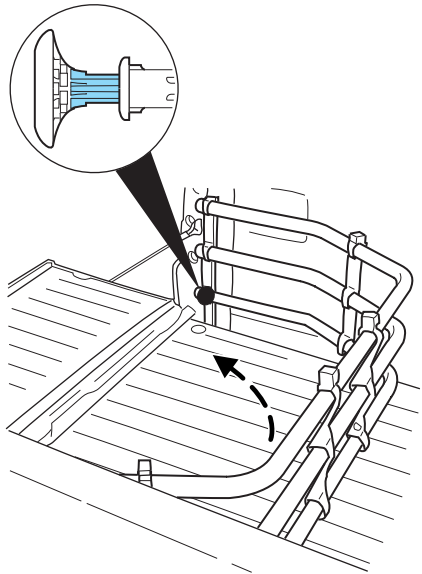

## Driver Controls

4. Evenly push down on the extender and push the round knobs in on each side locking it in place.

Green markings on the shaft indicate the locked position. The locking clip screws below the middle bar can be tightened counterclockwise for extra security.

To stow the bed extender, follow steps one through four in reverse order.

The bed extender may be used to secure a load of up to 46 kg (100 lbs.) on the tailgate.

**The bed extender should always be kept in the stowed position with the tailgate closed when not in use.**

To remove the bed extender:

1. Extend the bed extender.
2. Pull the round knobs on each side of the extender to unlock it.

Make sure the locking clip screws are loose before removing the extender.

1. Press the locking clips below the middle bar on each side and lift the extender out of the bed.

To install the bed extender, follow the removal procedure in reverse order.

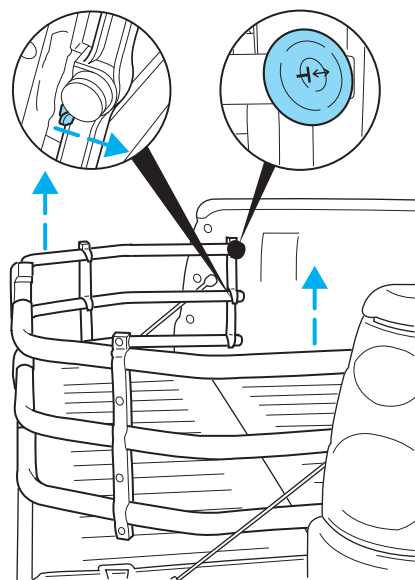
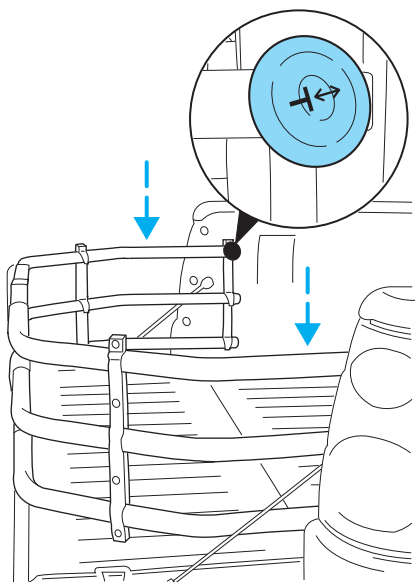



### KEYS

The key operates all locks on your vehicle. In case of loss, replacement keys are available from your dealer.

You should always carry a second key with you in a safe place in case you require it in an emergency.

Refer to *SecuriLock™ Passive Anti-Theft System* for more information.

### POWER DOOR LOCKS (IF EQUIPPED)

Press the top of the control to unlock all doors and the bottom to lock all doors.

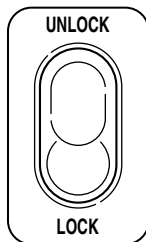

### REMOTE ENTRY SYSTEM (IF EQUIPPED)

The remote entry system allows you to lock or unlock all vehicle doors without a key.

The remote entry features only operate with the ignition in the LOCK position.

If there is any potential remote keyless entry problem with your vehicle, ensure **ALL remote entry transmitters** are brought to the dealership, to aid in troubleshooting.

**GENERAL INFORMATION:** This device complies with part 15 of the FCC rules and with RS-210 of Industry Canada. Operation is subject to the following two conditions: (1) This device may not cause harmful interference, and (2) This device must accept any interference received, including interference that may cause undesired operation. Changes or modifications not expressly approved by the party responsible for compliance could void the user's authority to operate the equipment.

## Locks and Security

### Unlocking the doors

Press this control to unlock the driver's door. The interior lamps will illuminate.

Press the control a second time within five seconds to unlock all doors.

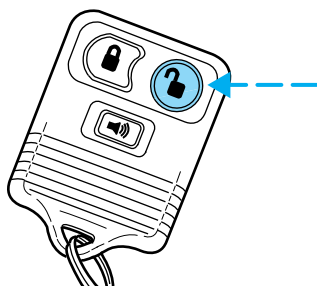

### Locking the doors

Press this control to lock all doors.

To confirm all doors are closed and locked, press the control a second time within five seconds. The doors will lock again, the horn will chirp and the lamps will flash.

If any of the doors are ajar, the horn will make two quick chirps, reminding you to properly close all doors.

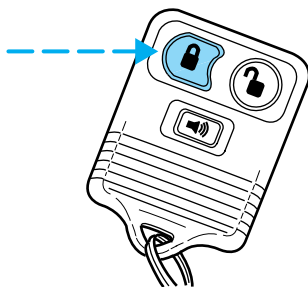

### Illuminated entry

The interior lamps illuminate when the remote entry system is used to unlock the door(s) or sound the personal alarm.

The system automatically turns off after 25 seconds or when the ignition is turned to the ON or ACC position.

**NOTE:** The dome lamp control (if equipped) must **not** be set to the OFF position for the illuminated entry system to operate.

The inside lights will not turn off if:

- they have been turned on with the dimmer control, or
- any door is open.

**NOTE:** The battery saver will shut off the interior lamps 45 minutes after the ignition has been turned to the OFF position.

### Power door lock disable feature

This feature will help protect your vehicle from unauthorized entry.

The UNLOCK function on the power door control will not operate with the ignition OFF and twenty seconds after the doors are closed and electronically locked by the remote entry transmitter, key pad, or power door control (if pressed while the door was open).

The UNLOCK function will operate again after you unlock the vehicle using the remote entry transmitter or key pad, turn the ignition to ON, or open the door from inside of the vehicle.

### Deactivating/activating power door lock disable feature

1. Turn the ignition key to ON, then press the UNLOCK button 3 times.
2. Turn the ignition key to OFF, then press the UNLOCK button 3 times.
3. Turn the ignition key to ON, within five seconds press the UNLOCK button 2 times then LOCK once.

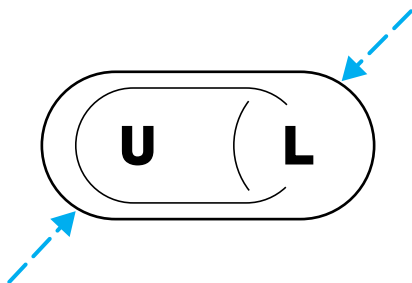

The user should receive 2 horn chirps to indicate the system has been disabled or 2 chirps followed by a honk to indicate the system has been enabled.

Pressing the power door LOCK button two times again will turn the feature ON if it was previously OFF, or OFF if it was previously ON. Every two consecutive presses of the LOCK button after successfully entering the configuration mode will change the enable/disable condition of the feature.

Turn ignition to OFF to exit programming.

## Locks and Security

### Sounding a panic alarm

Press this control to activate the alarm.

To deactivate the alarm, press the control again or turn the ignition to ACC or ON.

Panic alarm will only operate with the ignition in the OFF position.

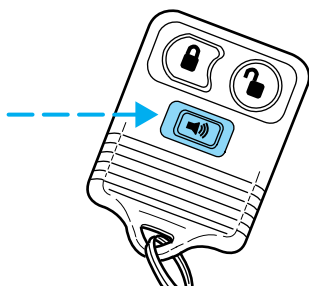

### Replacing the battery

The transmitter is powered by one coin type three-volt lithium battery CR2032 or equivalent. Typical operating range will allow you to be up to 10 meters (33 feet) away from your vehicle. A decrease in operating range can be caused by:

- Weather conditions
- Nearby radio towers
- Structures around the vehicle
- Other vehicles parked next to the vehicle

To replace the battery:

1. Twist a thin coin between the two halves of the transmitter near the key ring.

**DO NOT TAKE THE FRONT PART OF THE TRANSMITTER APART. Damage to the transmitter may result in operation failure.**

2. Place the positive (+) side of new battery in the same orientation. Refer to the diagram inside the transmitter unit.
3. Snap the two halves back together.

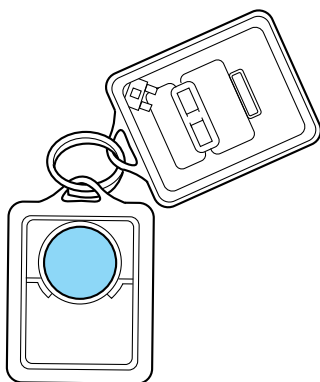

### Replacing lost transmitters

If a remote transmitter has been lost and you would like to remove it from the vehicle's memory, or you would like to purchase additional remote transmitters and have them programmed to your vehicle:

- Take **all** your vehicle's transmitters to your dealer for programming, or
- Perform the programming procedure yourself.

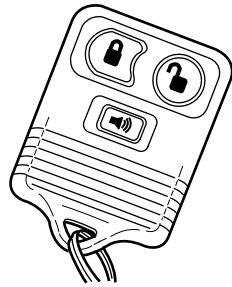

### Programming remote transmitters

It is necessary to have **all** (maximum of four — original and/or new) of your remote transmitters available prior to beginning this procedure.

**NOTE:** This procedure must be completed within the specified times. If not completed within the specified time period, reprogramming procedures must be restarted from the beginning.

To program the transmitters yourself:

- Place the key in the ignition and turn from 2 (LOCK) to 3 (OFF) and cycle between 3 (OFF) and 4(ON) eight times in rapid succession (within 10 seconds) with the eighth turn ending in the 4 (ON) position. The doors will lock/unlock to confirm that programming mode has been entered.
- Within 20 seconds, program a remote transmitter by pressing any button on a transmitter. The doors will lock/unlock to confirm that the remote transmitter has been programmed. (If more than 20 seconds pass before pressing a remote transmitter button, the programming mode will exit and the procedure will have to be repeated.)
- Repeat the previous step to program additional remote transmitters. The doors will lock/unlock to confirm that each remote transmitter has been programmed.

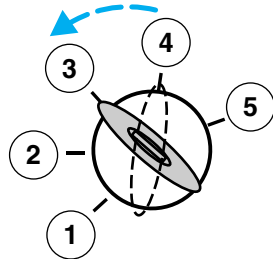

## Locks and Security

- When you have completed programming the remote transmitters, turn the ignition to 3 (OFF). Again the doors will lock/unlock to confirm programming has been completed.

### SECURILOCK™ PASSIVE ANTI-THEFT SYSTEM

SecuriLock™ passive anti-theft system is an engine immobilization system. This system is designed to prevent the engine from being started unless a **coded key** is used.

**NOTE:** The SecuriLock™ passive anti-theft system is not compatible with non-Mazda aftermarket remote start systems. Use of these systems may result in vehicle starting problems and a loss of security protection.

### THEFT INDICATOR

The theft indicator is the flashing red indicator located on top of the instrument panel.

- When the ignition is in the OFF position, the indicator will flash once every 2 seconds to indicate the SecuriLock™ system is functioning as a theft deterrent.
- When the ignition is in the ON position, the indicator will glow for 3 seconds to indicate normal system functionality.

If a problem occurs with the SecuriLock™ system, the indicator will flash rapidly or glow steadily when the ignition is in the ON position. If this occurs, the vehicle should be taken to an authorized dealer for service.

### Automatic arming

The vehicle is armed immediately after switching the ignition to the 3 (OFF) position. The **THEFT** indicator in the instrument cluster will flash every two seconds when the vehicle is armed.

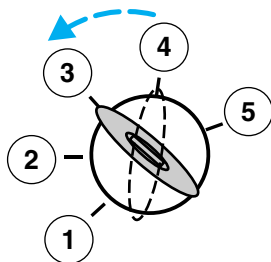

### Automatic disarming

Switching the ignition to the 4 (ON) position with a **coded key** disarms the vehicle. The **THEFT** indicator will illuminate for three seconds and then go out. If the **THEFT** indicator stays on for an extended period of time or flashes rapidly, have the system serviced by your authorized Mazda dealership.

### Key information

Your vehicle is supplied with **two coded keys**. Only a **coded key** will start your vehicle. Spare coded keys can be purchased from your authorized Mazda dealership. Your dealership can program your key or you can “do it yourself.” Refer to *Programming spare keys*.

**The SecuriLock™ passive anti-theft system is not compatible with aftermarket remote start systems. Use of these systems may result in vehicle starting problems and a loss of security protection.**

**NOTE:** Large metallic objects, electronic devices on the key chain that can be used to purchase gasoline or similar items, or a second key on the same key ring as the **coded key** may cause vehicle starting issues.

**NOTE:** If present, you need to keep these objects from touching the **coded key** while starting the engine.

**NOTE:** These objects and devices cannot damage the **coded key**, but can cause a momentary issue if they are too close to the key during engine start.

**NOTE:** If a problem occurs, turn ignition OFF and restart the engine with all other objects on the key ring held away from the ignition key. Check to make sure the encoded ignition key is an approved Mazda encoded ignition key.

If your keys are lost or stolen you will need to do the following:

- Use your spare key to start the vehicle. or
- Have your vehicle towed to an authorized Mazda dealership. . The key codes will need to be erased from your vehicle and new key codes will need to be re-coded.

Replacing **coded key** can be very costly and you may want to store an extra programmed key away from the vehicle in a safe place to prevent an unforeseen inconvenience.

**WARNING: If an unprogrammed key is used in the ignition it will cause a “no start” condition.**

### Programming spare keys

A maximum of eight keys can be coded to your vehicle. Only SecuriLock™ keys can be used. To program a **coded key** yourself, you will need two previously programmed **coded keys** (keys that already operate your vehicle’s engine) and the new unprogrammed key(s) readily accessible for timely implementation of each step in the procedure.

## Locks and Security

If two previously programmed coded keys are not available, you must bring your vehicle to your dealership to have the spare coded key(s) programmed.

**NOTE:** Please read and understand the entire procedure before you begin.

**NOTE:** This procedure must be completed within the specified times. If not completed within the specified time period, the reprogramming procedure must be restarted from the beginning.

1. Insert the first previously programmed **coded key** into the ignition and turn the ignition from 3 (OFF) to 4 (ON) (maintain ignition in 4 (ON) for at least one second).
2. Turn ignition to 3 (OFF) then 2 (LOCK) and remove the first **coded key** from the ignition.
3. Within ten seconds of removing the first **coded key**, insert the second previously programmed **coded key** into the ignition and turn the ignition from 3 (OFF) to 4 (ON) (maintain ignition in 4 (ON) for at least one second but no more than ten seconds).
4. Turn the ignition to 3 (OFF) then 2 (LOCK) and remove the second **coded key** from the ignition.
5. Within 20 seconds of removing the second **coded key**, insert the new unprogrammed key (new key/valet key) into the ignition and turn the ignition from 3 (OFF) to 4 (ON) (maintain ignition in 4 (ON) for at least one second). This step will program your new key to a coded key.
6. To program additional new unprogrammed key(s), repeat this procedure from step 1.

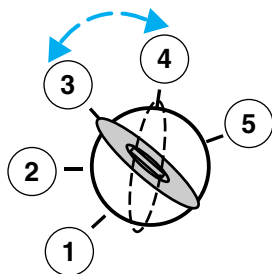

If successful, the new coded key(s) will start the vehicle's engine and the theft indicator will illuminate for three seconds and then go out.

If not successful, the new coded key(s) will not start the vehicle's engine and the theft indicator will flash on and off and you may repeat steps 1 through 6. If failure repeats, bring your vehicle to your authorized Mazda dealership to have the new spare key(s) programmed.



## Seating and Safety Restraints

### SEATING

#### Adjusting the front manual seat

**WARNING:** Never adjust the driver's seat or seatback when the vehicle is moving. Sudden braking or a collision could cause serious injury. Adjust the seat only when the vehicle is stopped.

**WARNING:** Do not pile cargo higher than the seatbacks to reduce the risk of injuring people in a collision or sudden stop.

**WARNING:** Always drive and ride with your seatback upright and the lap belt snug and low across the hips.

**WARNING:** Sitting in a reclined position while the vehicle is moving is dangerous because you don't get the full protection from seat belts. During sudden braking or a collision, you can slide under the lap belt and suffer serious internal injuries. For maximum protection, sit well back and upright.

Lift handle to move seat forward or backward.

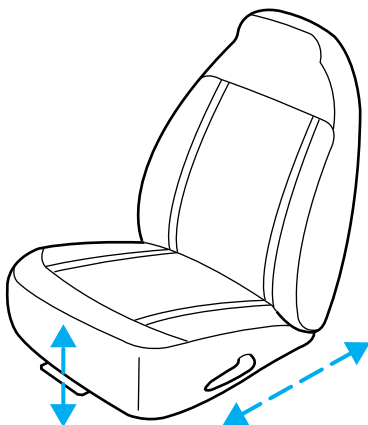

## Seating and Safety Restraints

Pull lever up to adjust seatback.

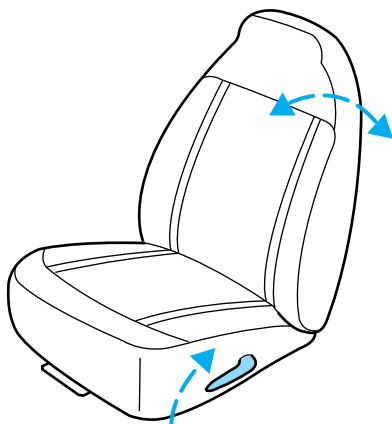

### Using the manual lumbar support (if equipped)

Turn the lumbar support control clockwise to increase firmness.

Turn the lumbar support control counterclockwise to increase softness.

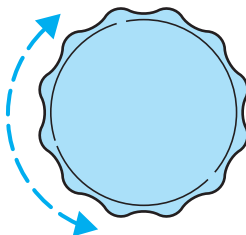

## REAR SEATS

### Center facing jump seat (2 door SuperCab) (if equipped)

To open, pull inboard and down on the seat handle.

To stow the seat, pull seat bottom back to the fully upright position.

**WARNING: Do not install a child seat in a center facing jump seat.**

## Seating and Safety Restraints

### Center facing jump seat (4 door CabPlus) (if equipped)

To open, pull seat assembly down, then raise seatback.

To stow the seat, fold seat back down and raise seat assembly to the fully upright position.

**WARNING: Do not install a child seat in a center facing jump seat.**

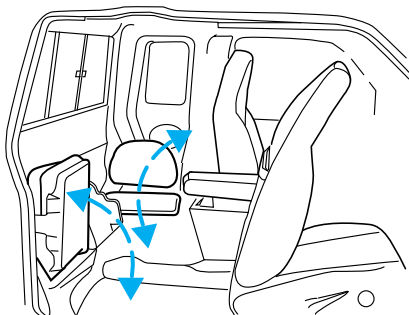

## SAFETY RESTRAINTS

### Safety restraints precautions

**WARNING: Always drive and ride with your seatback upright and the lap belt snug and low across the hips.**

**WARNING: To reduce the risk of injury, make sure children sit where they can be properly restrained.**

**WARNING: Never let a passenger hold a child on his or her lap while the vehicle is moving. The passenger cannot protect the child from injury in a collision.**

**WARNING: All occupants of the vehicle, including the driver, should always properly wear their safety belts, even when an air bag (SRS) is provided.**

**WARNING: It is extremely dangerous to ride in a cargo area, inside or outside of a vehicle. In a collision, people riding in these areas are more likely to be seriously injured or killed. Do not allow people to ride in any area of your vehicle that is not equipped with seats and safety belts. Be sure everyone in your vehicle is in a seat and using a safety belt properly.**

## Seating and Safety Restraints

**WARNING:** In a rollover crash, an unbelted person is significantly more likely to die or be seriously injured than a person wearing a seat belt.

**WARNING:** In a rollover crash, an unbelted person is significantly more likely to die than a person wearing a safety belt.

**WARNING:** Each seating position in your vehicle has a specific safety belt assembly which is made up of one buckle and one tongue that are designed to be used as a pair. 1) Use the shoulder belt on the outside shoulder only. Never wear the shoulder belt under the arm. 2) Never swing the safety belt around your neck over the inside shoulder. 3) Never use a single belt for more than one person.

**WARNING:** On four-door SuperCab vehicles, do not open the rear door when the rear seat belt is still buckled.

### Combination lap and shoulder belts

1. Insert the belt tongue into the proper buckle (the buckle closest to the direction the tongue is coming from) until you hear a snap and feel it latch. Make sure the tongue is securely fastened in the buckle.

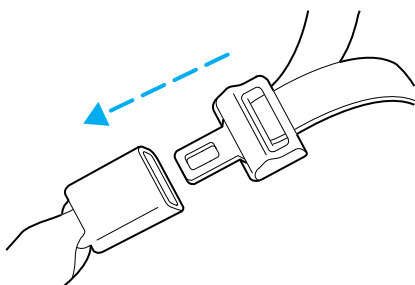

## Seating and Safety Restraints

2. To unfasten, push the release button and remove the tongue from the buckle.

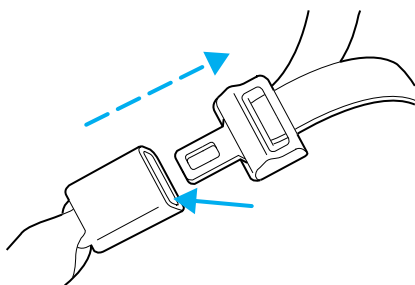

The front outboard safety restraints in the vehicle are combination lap and shoulder belts. The front passenger outboard safety belt has two types of locking modes described below:

### Energy Management Feature

- This vehicle has a seat belt system with an energy management feature at the front outboard seating positions to help further reduce the risk of injury in the event of a head-on collision.
- This seat belt system has a retractor assembly that is designed to pay out webbing in a controlled manner. This feature is designed to help reduce the belt force acting on the occupant's chest.

### Vehicle sensitive mode

The vehicle sensitive mode is the normal retractor mode, allowing free shoulder belt length adjustment to your movements and locking in response to vehicle movement. For example, if the driver brakes suddenly or turns a corner sharply, or the vehicle receives an impact of approximately 8 km/h (5 mph) or more, the combination safety belts will lock to help reduce forward movement of the driver and passengers.

### Automatic locking mode

In this mode, the shoulder belt is automatically pre-locked. The belt will still retract to remove any slack in the shoulder belt.

The automatic locking mode is not available on the driver safety belt.

### When to use the automatic locking mode

- **Any time** a child safety seat is installed in a passenger front seat. Refer to *Safety Restraints for Children, Safety Seats for Children,* or *Passenger air bag On/Off switch* later in this chapter.

## Seating and Safety Restraints

### ***How to use the automatic locking mode***

- Buckle the combination lap and shoulder belt.

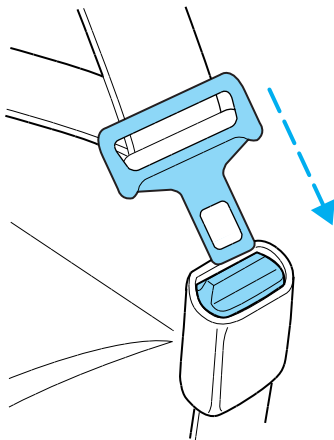

- Grasp the shoulder portion and pull downward until the entire belt is extracted.



- Allow the belt to retract. As the belt retracts, you will hear a clicking sound. This indicates the safety belt is now in the automatic locking mode.

### ***How to disengage the automatic locking mode***

Disconnect the combination lap/shoulder belt and allow it to retract completely to disengage the automatic locking mode and activate the vehicle sensitive (emergency) locking mode.

## Seating and Safety Restraints

**WARNING:** After any vehicle collision, the entire seat belt system should be checked for proper operation by a qualified technician. Verify that the "automatic locking retractors" in all outboard seating positions are functioning properly. Additionally check that the "automatic locking mode" feature for child safety seat in the passenger outboard seating position is functioning properly.

**WARNING: BELT AND RETRACTOR ASSEMBLY MUST BE REPLACED** if the seat belt assembly "automatic locking retractor" feature or any other seat belt function is not operating properly when checked according to the procedures in Workshop Manual.

**WARNING:** Failure to replace the Belt and Retractor assembly could increase the risk of injury in collisions.

### Safety belt pretensioner

Your vehicle is equipped with safety belt pretensioners at the driver and front outboard passenger seating positions.

The safety belt pretensioners are designed to activate during certain frontal or near-frontal collisions with sufficient longitudinal deceleration. A safety belt pretensioner is a device which tightens the webbing of the lap and shoulder belts in such a way that they fit more snugly against the body.

The driver and front outboard passenger safety belt system (including retractors, buckle assembly, pretensioner assembly with seat and height adjusters) must be replaced if the vehicle is involved in a collision that results in the activation of the safety belt pretensioners. Refer to the *Safety belt maintenance* section in this chapter.

**WARNING:** Failure to replace the safety belt assembly under the above conditions could result in severe personal injuries in the event of a collision.

### Front safety belt height adjustment

Your vehicle has safety belt height adjustments for the driver and front passenger. Adjust the height of the shoulder belt so the belt rests across the middle of your shoulder.

## Seating and Safety Restraints

- Regular Cab and 4-door Cab Plus

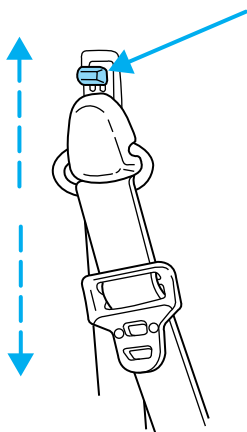

- 2-door Cab Plus

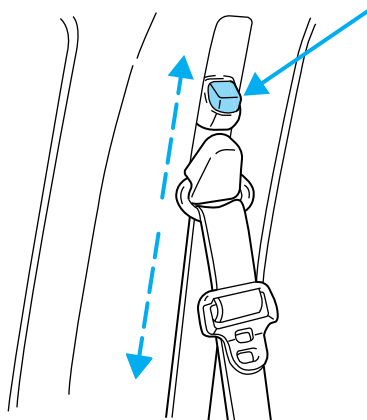

To lower the shoulder belt height, push the button and slide the height adjuster down. To raise the height of the shoulder belt, slide the height adjuster up. Pull down on the height adjuster to make sure it is locked in place.

**WARNING: Position the safety belt height adjusters so that the belt rests across the middle of your shoulder. Failure to adjust the safety belt properly could reduce the effectiveness of the seat belt and increase the risk of injury in a collision.**



## Seating and Safety Restraints

### Lap belts

#### *Adjusting the center lap belt*

The lap belt does not adjust automatically.

**WARNING: The lap belts should fit snugly and as low as possible around the hips, not around the waist. Failure to position the lap belt correctly may cause serious injury in an accident.**

Insert the tongue into the correct buckle (the buckle closest to the direction the tongue is coming from). To lengthen the belt, turn the tongue at a right angle to the belt and pull across your lap until it reaches the buckle. To tighten the belt, pull the loose end of the belt through the tongue until it fits snugly across the hips.

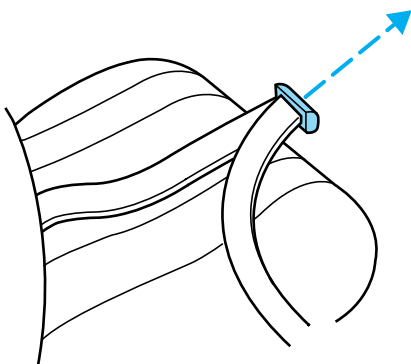

**Shorten and fasten the belt when not in use to keep the belt away from door openings and available after unfolding the seats.**

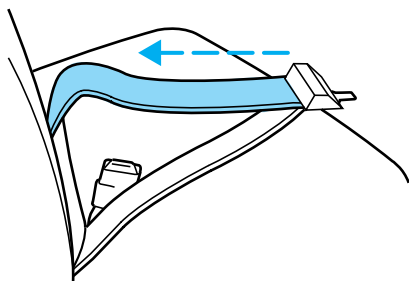

#### *Adjusting the rear center facing jump seat lap belt (if equipped)*

The lap belt will adjust automatically. To fasten, grasp the tongue, and with a continuous motion, pull out enough webbing to buckle the tongue into the correct buckle. If you did not pull out enough webbing to reach the buckle, allow the tongue to retract fully before trying to pull it out again.

## Seating and Safety Restraints

**WARNING:** The lap belts should fit snugly and as low as possible around the hips, not around the waist. Failure to position the lap belt correctly may cause serious injury in an accident.

If you need to lengthen the belt, unfasten it and repeat the procedure above.

To unfasten the belt, push in the release button prior to opening the rear door.

### Safety belt extension assembly

If the safety belt assembly is too short for you, even when fully extended, 20 cm (8 inches) can be added to the safety belt assembly by adding a safety belt extension assembly. Safety belt extension assemblies can be obtained from your authorized Mazda dealership.

Use only extensions manufactured by the same supplier as the safety belt. Manufacturer identification is located at the end of the webbing on the label. Also, use the safety belt extension only if the safety belt is too short for you when fully extended.

**NOTE:** Do not use extensions to change the fit of the shoulder belt across the torso.

### Safety belt warning light and indicator chime

The seat belt warning light illuminates in the instrument cluster and a chime sounds to remind the occupants to fasten their safety belts.

#### Conditions of operation

If...	Then...
The driver's safety belt is not buckled before the ignition switch is turned to the ON position...	The safety belt warning light illuminates 1-2 minutes and the warning chime sounds 4-8 seconds.
The driver's safety belt is buckled while the indicator light is illuminated and the warning chime is sounding...	The safety belt warning light and warning chime turn off.
The driver's safety belt is buckled before the ignition switch is turned to the ON position...	The safety belt warning light and indicator chime remain off.

## Seating and Safety Restraints

### BeltMinder

The BeltMinder feature is a supplemental warning to the safety belt warning function. This feature provides additional reminders to the driver that the driver's safety belt is unbuckled by intermittently sounding a chime and illuminating the safety belt warning lamp in the instrument cluster.

If...	Then...
The driver's safety belt is not buckled before the vehicle has reached at least 5 km/h (3 mph) and 1-2 minutes have elapsed since the ignition switch has been turned to ON...	The BeltMinder feature is activated - the safety belt warning light illuminates and the warning chime sounds for 6 seconds every 30 seconds, repeating for approximately 5 minutes or until driver's safety belt is buckled.
The driver's safety belt is buckled while the safety belt indicator light is illuminated and the safety belt warning chime is sounding...	The BeltMinder feature will not activate.
The driver's safety belt is buckled before the ignition switch is turned to the ON position...	The BeltMinder feature will not activate.

The purpose of the Safety Belt Warning Chime/Light is to remind occupants of the vehicle to wear safety belts all of the time.

## Seating and Safety Restraints

The following are reasons most often given for not wearing safety belts:  
(All statistics based on U.S. data)

Reasons given...	Consider...
"Crashes are rare events"	<b>36,700 crashes occur every day.</b> The more we drive, the more we are exposed to "rare" events, even for good drivers. <i>1 in 4 of us will be seriously injured in a crash during our lifetime.</i>
"I'm not going far"	<b>3 of 4</b> fatal crashes occur within <b>25</b> miles of home.
"Belts are uncomfortable"	Safety belts are designed to enhance comfort. If you are uncomfortable - try different positions for the safety belt upper anchorage and seatback which should be as upright as possible; this can improve comfort.
"I was in a hurry"	<b>Prime time for an accident.</b> Belt Minder reminds us to take a few seconds to buckle up.
"Seat belts don't work"	<b>Safety belts</b> , when used properly, <b>reduce risk of death</b> to front seat occupants by <b>45% in cars</b> , and by <b>60% in light trucks</b> .
"Traffic is light"	<b>Nearly 1 of 2 deaths occur in single-vehicle crashes</b> , many when no other vehicles are around.
"Belts wrinkle my clothes"	Possibly, but a serious crash can do much more than wrinkle your clothes, particularly if you are unbelted.
"The people I'm with don't wear belts"	Set the example, teen deaths occur 4 times more often in vehicles with <b>TWO or MORE</b> people. Children and younger brothers/sisters imitate behavior they see.

## Seating and Safety Restraints

Reasons given...	Consider...
"I have an air bag"	Air bags offer greater protection when used with safety belts. Frontal airbags are not designed to inflate in rear and side crashes or rollovers.
"I'd rather be thrown clear"	Not a good idea. <b>People</b> who are <b>ejected are 40 times more likely to DIE</b> . Safety belts help prevent ejection, WE CAN'T "PICK OUR CRASH".

**WARNING: Do not sit on top of a buckled safety belt to avoid the Safety Belt Warning Light. Sitting on the safety belt will increase the risk of injury in an accident.**

### ***One time disable***

Any time the safety belt is buckled and then unbuckled during an ignition ON cycle, BeltMinder will be disabled for that ignition cycle only.

### ***Deactivating/activating the BeltMinder feature***

*Read steps 1 - 9 thoroughly before proceeding with the deactivation/activation programming procedure.*

The BeltMinder feature can be deactivated/activated by performing the following procedure:

Before following the procedure, make sure that:

- The parking brake is set.
- The gearshift is in P (Park) (automatic transmission) or the neutral position (manual transmission).
- The ignition switch is in the OFF position.
- All vehicle doors are closed.
- The driver's safety belt is unbuckled.
- The parklamps/headlamps are in OFF position (If vehicle is equipped with Autolamps, this will not affect the procedure).

**WARNING: To reduce the risk of injury, do not deactivate/activate the Belt Minder feature while driving the vehicle.**

# Seating and Safety Restraints

## **BeltMinder activation and deactivation procedure**

1. Turn the ignition switch to the RUN (or ON) position. (DO NOT START THE ENGINE.)
  2. Wait until the safety belt warning light turns off. (Approximately 1–2 minutes.)
- Steps 3–5 must be completed within 60 seconds or the procedure will have to be repeated.
3. Buckle then unbuckle the safety belt three times, ending with the safety belt unbuckled. This can be done before or during BeltMinder warning activation.
  4. Turn on the parklamps/headlamps, turn off the parklamps/headlamps.
  5. Buckle then unbuckle the safety belt three times, ending with the safety belt unbuckled.
- After step 5 the safety belt warning light will be turned on for three seconds.
  - 6. Within seven seconds of the safety belt warning light turning off, buckle then unbuckle the safety belt.
  - This will disable BeltMinder if it is currently enabled, or enable BeltMinder if it is currently disabled.
  - 7. Confirmation of disabling BeltMinder is provided by the safety belt warning light flashing four times per second for three seconds.
  - 8. Confirmation of enabling BeltMinder is provided by:
    - The safety belt warning light flashing four times per second for three seconds.
    - Followed by three seconds with the safety belt warning light off.
    - Once again, the safety belt warning light will flash four times per second for three seconds.
  - 9. After receiving confirmation, the deactivation/activation procedure is complete.

## **Safety belt maintenance**

Inspect the safety belt systems periodically to make sure they work properly and are not damaged.

**NOTE:** If unsure about the proper procedures, bring your vehicle to an authorized Mazda dealership for inspection. Inspect the safety belts to

## Seating and Safety Restraints

make sure there are no nicks, tears or cuts, replacing if necessary. All safety belt assemblies, including retractors, buckles, front seat belt buckle assemblies, buckle support assemblies (slide bar-if equipped), shoulder belt height adjusters (if equipped), shoulder belt guide on seatback (if equipped), child safety seat tether bracket assemblies (if equipped), LATCH child seat tether anchors and lower anchors (if equipped), and attaching hardware, should be inspected after a collision. Mazda recommends that all safety belt assemblies used in vehicles involved in a collision be replaced. However, if the collision was minor and an authorized Mazda technician finds that the belts do not show damage and continue to operate properly, they do not need to be replaced. Safety belt assemblies not in use during a collision should also be inspected and replaced if either damage or improper operation is noted.

The energy absorbing functions may have been activated in a collision so the restraints should be examined; if the front air bags have deployed, the pretensioners have also deployed and must be replaced — regardless of whether there was an occupant in the passenger seat or not. The optional side air bags are not connected to the pretensioners.

**WARNING: Failure to inspect and if necessary replace the safety belt assembly under the above conditions could result in severe personal injuries in the event of a collision.**

Refer to *Cleaning and maintaining the safety belts* in the *Cleaning* chapter.

### AIR BAG SUPPLEMENTAL RESTRAINT SYSTEM (SRS)

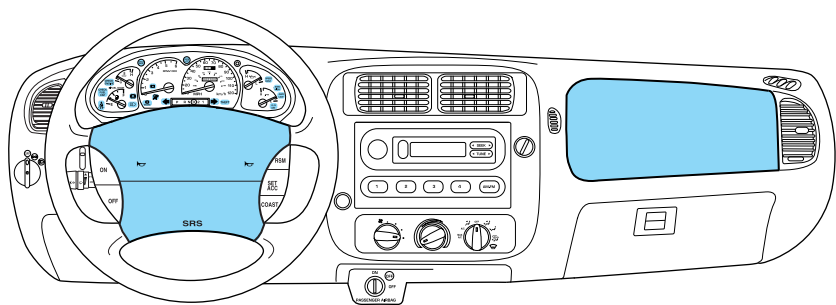

## Seating and Safety Restraints

### Important supplemental restraint system (SRS) precautions

The supplemental restraint system is designed to work with the safety belt to help protect the driver and right front passenger from certain upper body injuries.

**WARNING: Air bags DO NOT inflate slowly or gently and the risk of injury from a deploying air bag is greatest close to the trim covering the air bag module. Always wear your safety belt.**



**WARNING: Airbags have been known to kill or injure a child in front facing child restraints. When placing a child safety seat in a front seating position including the center (if equipped), you should turn off the passenger air bag switch after being certain the child is properly restrained. If the child safety seat is in the outboard seating position, slide the seat all the way back.**

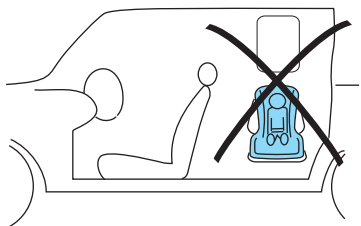

**WARNING: Do not install a child seat in a center facing jump seat.**



## Seating and Safety Restraints

**WARNING:** Rear facing child seats should NEVER be placed in the front seats unless the passenger airbag switch is turned off. See *Passenger airbag ON/OFF switch* in this chapter.

**WARNING:** All occupants of the vehicle, including the driver, should always properly wear their safety belts, even when an air bag (SRS) is provided.

**WARNING:** National Highway Traffic Safety Administration (NHTSA) recommends a minimum distance of at least 25 cm (10 inches) between an occupant's chest and the driver air bag module.

**WARNING:** Never place your arm or feet over the air bag module as a deploying air bag can result in serious arm fractures or other injuries.

**WARNING:** Never place a rear facing infant seat in the front seat unless the passenger air bag is turned off.

Steps you can take to properly position yourself away from the airbag:

- Move your seat to the rear as far as you can while still reaching the pedals comfortably.
- Recline the seat slightly (one or two degrees) from the upright position.

**WARNING:** Do not put anything on or over the air bag module including hands or feet. Placing objects on or over the air bag inflation area may cause those objects to be propelled by the air bag into your face and torso causing serious injury.

**WARNING:** Do not attempt to service, repair, or modify the Air Bag Supplemental Restraint System or its fuses. See your authorized Mazda dealership.

## Seating and Safety Restraints

**WARNING:** Modifications to the front end of the vehicle, including frame, bumper, front end body structure, tow hooks and snow plows may effect the performance of the air bag sensors increasing the risk of injury. Do not modify the front end of the vehicle.

**WARNING:** Additional equipment may effect the performance of the air bag sensors increasing the risk of injury. Consult your authorized Mazda dealership before installation of additional equipment.

**WARNING:** The front passenger air bag is not designed to offer protection to an occupant in the center front seating position.

### Children and air bags

For additional important safety information, read all information on safety restraints in this guide.

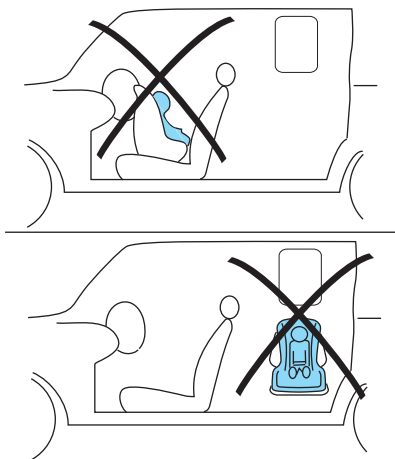

## Seating and Safety Restraints

**WARNING:** Never place a rearward facing child safety restraint in front of an airbag. Airbags have been known to kill or injure children in front facing child safety restraints. Whenever placing a child safety seat in a front seating position (including center if equipped), turn off the passenger side air bag switch after being certain the child is properly restrained. If using a forward facing child safety restraint in the front outboard seat, slide the seat all the way back, and turn off the passenger air bag. If using a rear facing child safety seat in the front outboard seating position, make sure the passenger airbag is turned off and slide the passenger seat all the way forward until the safety seat rests on the dashboard. See *Passenger air bag on/off switch* in this chapter.

**WARNING:** Do not install a child seat in a center facing jump seat.

**WARNING:** An air bag can kill or injure a child in a child seat. Child seats should never be placed in the front seats, unless passenger air bag switch is turned off. See *Passenger air bag on/off switch* in this chapter.

**WARNING:** Rear facing child seats should NEVER be placed in the front seats unless the passenger airbag switch is turned off.

**WARNING:** Booster seats must be installed only in seating positions equipped with a combination lap/shoulder belt.

## Seating and Safety Restraints

### How does the air bag supplemental restraint system work?

The air bag SRS is designed to activate when the vehicle sustains sufficient longitudinal deceleration.

The fact that the air bags did not inflate in a collision does not mean that something is wrong with the system. Rather, it means the forces were not of the type sufficient to cause activation. Air bags are designed to inflate in frontal and near-frontal collisions, not rollover, side-impact, or rear-impacts.

The air bags inflate and deflate rapidly upon activation. After air bag deployment, it is normal to notice a smoke-like, powdery residue or smell the burnt propellant. This may consist of cornstarch, talcum powder (to lubricate the bag) or sodium compounds (e.g., baking soda) that result from the combustion process that inflates the air bag. Small amounts of sodium hydroxide may be present which may irritate the skin and eyes, but none of the residue is toxic.

While the system is designed to help reduce serious injuries, it may also cause minor abrasions, swelling or temporary hearing loss. Because air bags must inflate rapidly and with considerable force, there is the risk of death or serious injuries such as fractures, facial and eye injuries or internal injuries, particularly to occupants who are not properly restrained or are otherwise out of position at the time of air bag deployment. Thus, it is extremely important that occupants be properly restrained as far away from the air bag module as possible while maintaining vehicle control.

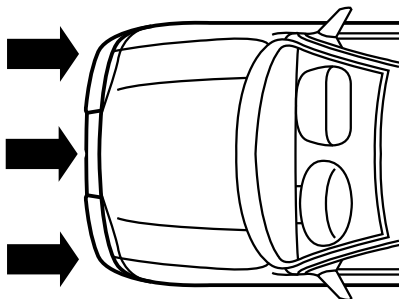

## Seating and Safety Restraints

**WARNING:** Several air bag system components get hot after inflation. Do not touch them after inflation or you may be burned.

**WARNING:** If the air bag has deployed, the air bag will not function again and must be replaced immediately. If the air bag is not replaced, the unrepaired area will increase the risk of injury in a collision.

The SRS consists of:

- driver and passenger air bag modules (which include the inflators and air bags),
- passenger air bag deactivation switch and restraint control module (RCM)
- a readiness light and tone,
- and the electrical wiring which connects the components.

The RCM (restraints control module) monitors its own internal circuits and the supplemental air bag electrical system warning (including the passenger air bag deactivation switch, the system wiring, the air bag system readiness light, the air bag back up power and the air bag ignitors).

### Determining if the system is operational

The SRS uses readiness lights in the instrument cluster and the passenger air bag deactivate switch or a tone to indicate the condition of the system. Refer to the *Air bag readiness* section in the *Instrumentation* chapter or *Passenger air bag deactivate switch* section in this chapter. Routine maintenance of the air bag is not required.

A difficulty with the system is indicated by one or more of the following:

- The readiness lights will either flash or stay lit.
- The readiness lights will not illuminate immediately after ignition is turned on.
- A series of five beeps will be heard. The tone pattern will repeat periodically until the problem and/or light are repaired.



## Seating and Safety Restraints

If any of these things happen, even intermittently, have the SRS serviced at your authorized Mazda dealership immediately.

**WARNING: Unless serviced, the system may not function properly in the event of a collision.**

### Disposal of air bags and air bag equipped vehicles (including safety belt pretensioners)

For disposal of air bags or air bag equipped vehicles, see your authorized Mazda dealership or qualified technician. Air bags **MUST BE** disposed of by qualified personnel.

### Passenger air bag ON/OFF switch

**WARNING: An air bag ON/OFF switch has been installed in this vehicle. Before driving, *always* look at the face of the switch to be sure the switch is in the proper position in accordance with these instructions and warnings. Failure to put the switch in a proper position can increase the risk of serious injury or death in a collision.**

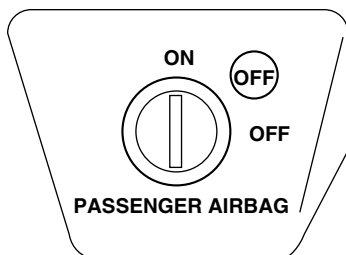

### Turning the passenger air bag off

1. Insert the ignition key, turn the switch to OFF position and hold in OFF position while removing the key.
2. When the ignition switch is turned to the ON position the OFF light illuminates briefly, momentarily shuts off and then turns back on. This indicates that the passenger air bag is deactivated.

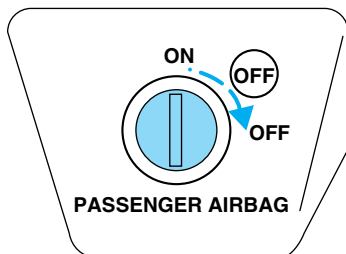

## Seating and Safety Restraints

**WARNING:** If the OFF light fails to illuminate when the passenger air bag switch is in the OFF position and the ignition switch is in ON, have the passenger air bag switch serviced at your authorized Mazda dealership.

**WARNING:** In order to avoid inadvertent activation of the switch, always remove the ignition key from the passenger air bag ON/OFF switch.

### **Turning the passenger air bag back on**

The passenger air bag remains OFF until you turn it back ON.

1. Insert the ignition key and turn the switch to ON.
2. The OFF light will briefly illuminate when the ignition is turned to ON. This indicates that the passenger air bag is operational.

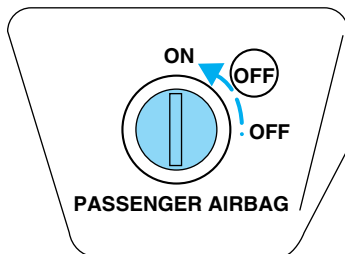

**WARNING:** If the light is illuminated when the passenger air bag ON/OFF switch is in the ON position and the ignition switch is ON, have the passenger air bag ON/OFF switch serviced at your authorized Mazda dealership immediately.

The passenger side air bag should always be ON (the air bag OFF light should *not* be illuminated) unless the passenger is a person who meets the requirements stated either in Category 1, 2 or 3 of the NHTSA/Transport Canada deactivation criteria which follows.

## Seating and Safety Restraints

**WARNING:** The safety belts for the driver and right front passenger seating positions have been specifically designed to function together with the air bags in certain types of crashes. When you turn OFF your air bag, you not only lose the protection of the air bag, you also may reduce the effectiveness of your safety belt system, which was designed to work with the air bag. If you are not a person who meets the requirements stated in the NHTSA/Transport Canada deactivation criteria turning OFF the air bag can increase the risk of serious injury or death in a collision.

**WARNING:** Always use safety belts and child restraints properly. If a child in a rear facing infant seat must be transported in front, the passenger air bag *must* be turned OFF. This is because the back of the infant seat is too close to the inflating air bag and the risk of a fatal injury to the infant when the air bag inflates is substantial.

The vast majority of drivers and passengers are much safer with an air bag than without. To do their job and reduce the risk of life threatening injuries, air bags must open with great force, and this force can pose a potentially deadly risk in some situations, particularly when a front seat occupant is not properly buckled up. The most effective way to reduce the risk of unnecessary air bag injuries without reducing the overall safety of the vehicle is to make sure all occupants are properly restrained in the vehicle, especially in the front seat. This provides the protection of safety belts and permits the air bags to provide the additional protection they were designed to provide. If you choose to deactivate your air bag, you are losing the very significant risk reducing benefits of the air bag and you are also reducing the effectiveness of the safety belts, because safety belts in modern vehicles are designed to work as a safety system with the air bags.

Read all air bag Warning labels in the vehicle as well as the other important air bag instructions and Warnings in this Owner's Guide.

### ***NHTSA deactivation criteria (excluding Canada)***

1. **Infant.** An infant (less than 1 year old) must ride in the front seat because:
  - the vehicle has no rear seat;
  - the vehicle has a rear seat too small to accommodate a rear-facing infant seat; or



## Seating and Safety Restraints

- the infant has a medical condition which, according to the infant's physician, makes it necessary for the infant to ride in the front so that the driver can constantly monitor the child's condition.
2. **Child age 1 to 12.** A child age 1 to 12 must ride in the front seat because:
- the vehicle has no rear seat;
  - although children ages 1 to 12 ride in the rear seat(s) whenever possible, children ages 1 to 12 sometimes must ride in the front because no space is available in the rear seat(s) of the vehicle; or
  - the child has a medical condition which, according to the child's physician, makes it necessary for the child to ride in the front seat so that the driver can constantly monitor the child's condition.
3. **Medical condition.** A passenger has a medical condition which, according to his or her physician:
- causes the passenger air bag to pose a special risk for the passenger; and
  - makes the potential harm from the passenger air bag in a crash greater than the potential harm from turning OFF the air bag and allowing the passenger, even if belted, to hit the dashboard or windshield in a crash.

**WARNING: This vehicle has special energy management safety belts for the driver and/or right front passenger. These particular belts are specifically designed to work with air bags to help reduce the risk of injury in a collision. The energy management safety belt is designed to give or release additional belt webbing in some accidents to reduce concentration of force on an occupant's chest and reduce the risk of certain bone fractures and injuries to underlying organs. In a crash, if the air bag is turned OFF, this energy management safety belt might permit the person wearing the belt to move forward enough to incur a serious or fatal injury. The more severe the crash, and the heavier the occupant, the greater the risk is. Be sure the air bag is turned ON for any person who does not qualify under the NHTSA deactivation criteria.**

## Seating and Safety Restraints

### **Transport Canada air bag deactivation criteria (Canada Only)**

1. **Infant:** An infant (less than 1 year old) must ride in the front seat because:
  - my vehicle has no rear seat;
  - the rear seat in my vehicle cannot accommodate a rear-facing infant seat; or
  - the infant has a medical condition which, according to the infant's physician, makes it necessary for the infant to ride in the front seat so that the driver can monitor the infant's condition.
2. **Child age 12 or under:** A child age 12 or under must ride in the front seat because:
  - my vehicle has no rear seat;
  - although children age 12 and under ride in the rear seat whenever possible, children age 12 and under have no option but to sometimes ride in the front seat because rear seat space is insufficient; or
  - the child has a medical condition that, according to the child's physician, makes it necessary for the child to ride in the front seat so that the driver can monitor the child's condition.
3. **Medical condition:** A passenger has a medical condition that, according to his or her physician:
  - poses a special risk for the passenger if the air bag deploys; and
  - makes the potential harm from the passenger air bag deployment greater than the potential harm from turning OFF the air bag and experiencing a crash without the protection offered by the air bag

### **Transport Canada air bag deactivation criteria (continued)**

## Seating and Safety Restraints

**WARNING:** This vehicle has special energy management safety belts for the driver and/or right front passenger. These particular belts are specifically designed to work with air bags to help reduce the risk of injury in a collision. The energy management safety belt is designed to give or release additional belt webbing in some accidents to reduce concentration of force on an occupant's chest and reduce the risk of certain bone fractures and injuries to underlying organs. In a crash, if the air bag is turned OFF, this energy management safety belt might permit the person wearing the belt to move forward enough to incur a serious or fatal injury. The more severe the crash, and the heavier the occupant, the greater the risk is. Be sure the air bag is turned ON for any person who does not qualify under the Transport Canada deactivation criteria.

### SAFETY RESTRAINTS FOR CHILDREN

See the following sections for directions on how to properly use safety restraints for children. Also see *Air bag supplemental restraint system (SRS)* in this chapter for special instructions about using air bags.

#### Important child restraint precautions

**NOTE:** You are required by law to use a child-restraint system in the U.S. and Canada. Check your local and state or provincial laws for specific requirements regarding the safety of children in your vehicle.

**WARNING:** Never let a passenger hold a child on his or her lap while the vehicle is moving. The passenger cannot protect the child from injury in a collision.

**NOTE:** Always follow the instructions and warnings that come with any infant or child restraint you might use.

**WARNING:** Air bags can kill or injure a child in a child seat. Never place a rear facing child seat in front of an active air bag. If you must use a forward facing child seat in the front seat, position the vehicle seat fully rearward and turn the passenger air bag off.

## Seating and Safety Restraints

**WARNING:** An air bag can kill or injure a child in a child seat. Child seats should never be placed in the front seats, unless passenger air bag switch is turned off, See *Passenger air bag on/off switch*.

**WARNING:** Rear facing child seats should NEVER be placed in the front seats unless the passenger airbag switch is turned off.

**WARNING:** Do not install a child seat in a center facing jump seat.

### Children and safety belts

If the child is the proper size, restrain the child in a safety seat.

Children who are too large for child safety seats (as specified by your child safety seat manufacturer) should always wear safety belts.

Follow all the important safety restraint and air bag precautions that apply to adult passengers in your vehicle.

If the shoulder belt portion of a combination lap and shoulder belt can be positioned so it does not cross or rest in front of the child's face or neck, the child should wear the lap and shoulder belt. Moving the child closer to the center of the vehicle may help provide a good shoulder belt fit.

**WARNING:** Do not leave children, unreliable adults, or pets unattended in your vehicle.

### Child booster seats

Children outgrow a typical convertible or toddler seat when they weigh 40 pounds and are around 4 years of age. Although the lap/shoulder belt will provide some protection, these children are still too small for lap/shoulder belts to fit properly, which could increase the risk of serious injury.

To improve the fit of both the lap and shoulder belt on children who have outgrown child safety seats, Mazda recommends use of a belt-positioning booster.

Booster seats position a child so that safety belts fit better. They lift the child up so that the lap belt rests low across the hips and the knees

## Seating and Safety Restraints

bend comfortably. Booster seats also make the shoulder belt fit better and more comfortably for growing children.

### When children should use booster seats

Children need to use booster seats from the time they outgrow the toddler seat until they are big enough for the vehicle seat and lap/shoulder belt to fit properly. Generally this is when they weigh about 80 lbs (about 8 to 12 years old).

Booster seats should be used until you can answer YES to ALL of these questions:

- Can the child sit all the way back against the vehicle seat back with knees bent comfortably at the edge of the seat without slouching?

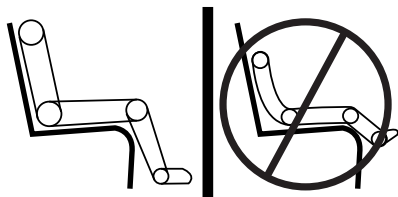

- Does the lap belt rest low across the hips?
- Is the shoulder belt centered on the shoulder and chest?
- Can the child stay seated like this for the whole trip?

**WARNING: Booster seats must be installed only in seating positions equipped with a combination lap/shoulder belt.**

### Types of booster seats

There are two types of belt-positioning booster seats:

- Those that are backless.

If your backless booster seat has a removable shield, remove the shield and use the lap/shoulder belt. If a seating position has a low seat back and no head restraint, a backless booster seat may place your child's head (top of ear level) above the top of the seat. In this case, use a high-backed booster seat.



## Seating and Safety Restraints

- Those with a high back.

If, with a backless booster seat, you cannot find a seating position that adequately supports your child's head, a high back booster seat would be a better choice.



Both can be used in any vehicle in a seating position equipped with lap/shoulder belts if your child is over 40 lbs.

The shoulder belt should cross the chest, resting snugly on the center of the shoulder. The lap belt should rest low and snug across the hips, never up high across the stomach.

If the booster seat slides on the vehicle seat, placing a rubberized mesh sold as shelf or carpet liner under the booster seat may improve this condition.

### **The importance of shoulder belts**

Using a booster without a shoulder belt increases the risk of a child's head hitting a hard surface in a collision. For this reason, you should never use a booster seat with a lap belt only. It is best to use a booster seat with lap/shoulder belts in the back seat- the safest place for children to ride.

**WARNING: Follow all instructions provided by the manufacturer of the booster seat.**

**WARNING: Never put the shoulder belt under a child's arm or behind the back because it eliminates the protection for the upper part of the body and may increase the risk of injury or death in a collision.**

**WARNING: Never use pillows, books, or towels to boost a child. They can slide around and increase the likelihood of injury or death in a collision.**

# Seating and Safety Restraints

## SAFETY SEATS FOR CHILDREN



### Child and infant or child safety seats

Use a safety seat that is recommended for the size and weight of the child. Carefully follow all of the manufacturer's instructions with the safety seat you put in your vehicle. If you do not install and use the safety seat properly, the child may be injured in a sudden stop or collision.

When installing a child safety seat:

- Review and follow the information presented in the *Air Bag Supplemental Restraint System* section in this chapter.
- Use the correct safety belt buckle for that seating position (the buckle closest to the direction the tongue is coming from).
- Insert the belt tongue into the proper buckle until you hear a snap and feel it latch. Make sure the tongue is securely fastened in the buckle.

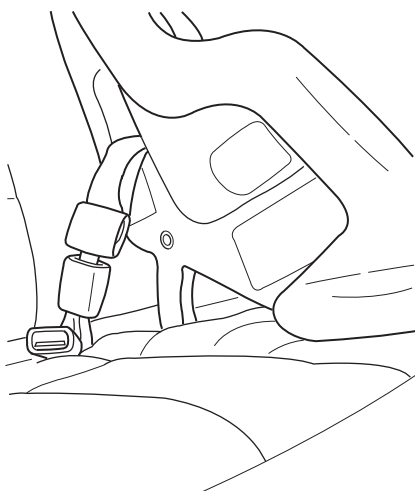

**WARNING: Do not install a child seat in a center facing jump seat.**

- Keep the buckle release button pointing up and away from the safety seat, with the tongue between the child seat and the release button, to prevent accidental unbuckling.

## Seating and Safety Restraints

- Place seat back in upright position.
- Put the safety belt in the automatic locking mode. Refer to *Automatic locking mode* (passenger side front seat).

Mazda recommends the use of a child safety seat having a top tether strap. Install the child safety seat in a seating position which is capable of providing a tether anchorage. For more information on top tether straps, refer to *Attaching child safety seats with tether straps*.

**WARNING: Carefully follow all of the manufacturer's instructions included with the safety seat you put in your vehicle. If you do not install and use the safety seat properly, the child may be injured in a sudden stop or collision.**

### Installing child safety seats in combination lap and shoulder belt seating positions

1. Position the child safety seat in a seat with a combination lap and shoulder belt.

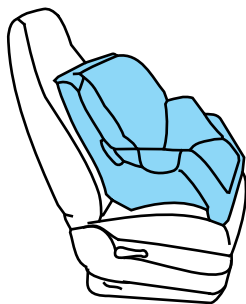

**WARNING: If there is a tether on the child safety seat, attach it to the tether anchor point. Refer to *Attaching child safety seats with tether straps* in this chapter.**

**WARNING: Air bags can kill or injure a child in a child seat. Never place a rear facing child seat in the right front seat unless the air bag on/off switch is turned OFF. If you place a forward-facing child seat in the right front seat, turn the air bag on/off switch to OFF. See *Passenger air bag on/off switch* in this chapter.**



## Seating and Safety Restraints

**WARNING: Rear facing child seats should NEVER be placed in the front seats unless the passenger air bag switch is turned off.**

2. Pull down on the shoulder belt and then grasp the shoulder belt and lap belt together.

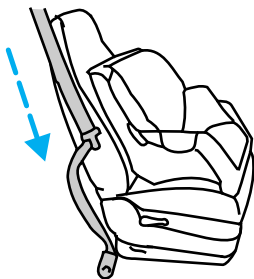

3. While holding the shoulder and lap belt portions together, route the tongue through the child seat according to the child seat manufacturer's instructions. Be sure the belt webbing is not twisted.

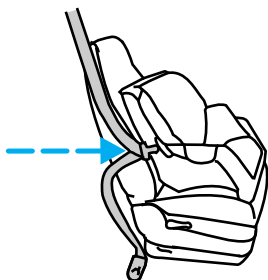

4. Insert the belt tongue into the proper buckle (the buckle closest to the direction the tongue is coming from) for that seating position until you hear and feel the latch engage. Make sure the tongue is latched securely by pulling on it.



## Seating and Safety Restraints

5. To put the retractor in the automatic locking mode, grasp the shoulder portion of the belt and pull downward until all of the belt is extracted and a click is heard.

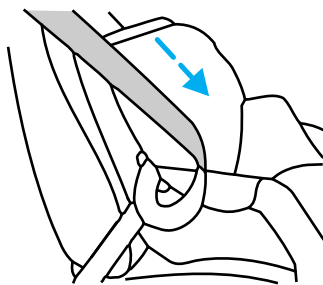

6. Allow the belt to retract. The belt will click as it retracts to indicate it is in the automatic locking mode.
7. Pull the lap belt portion across the child seat toward the buckle and pull up on the shoulder belt while pushing down with knee on the child seat.

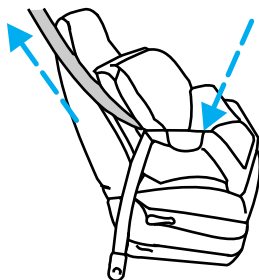

8. Allow the safety belt to retract to remove any slack in the belt.
9. Before placing the child in the seat, forcibly tilt the seat forward and back to make sure the seat is securely held in place. To check this, grab the seat at the belt path and attempt to move it side to side and forward. There should be no more than one inch of movement for proper installation.

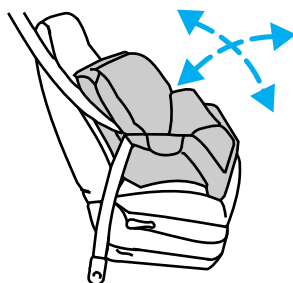

10. Try to pull the belt out of the retractor to make sure the retractor is in the automatic locking mode (you should not be able to pull more belt out). If the retractor is not locked, unbuckle the belt and repeat steps two through nine.

Check to make sure the child seat is properly secured before each use.

## Seating and Safety Restraints

### *Installing child safety seats in the center front seating position*

**WARNING:** Use the appropriate tether anchor when mounting a child safety seat in the center seating position. See *Child safety seats with tether straps* in this chapter.

1. Lengthen the lap belt. To lengthen the belt, hold the tongue so that its bottom is perpendicular to the direction of webbing while sliding the tongue up the webbing.
2. Place the child safety seat in the center seating position.
3. Attach the tether strap on the child seat to the appropriate tether anchor. See *Attaching child safety seats with tether straps* in this chapter.
4. Route the tongue and webbing through the child seat according to the child seat manufacturer's instructions.
5. Insert the belt tongue into the proper buckle for the center seating position until you hear a snap and feel it latch. Make sure the tongue is securely fastened to the buckle by pulling on tongue.
6. Push down on the child seat with your knee while pulling on the loose end of the lap belt webbing to tighten the belt. Tighten the tether strap.
7. Before placing the child into the child seat, forcibly move the child seat from side to side and forward to make sure that the seat is held securely. If the child seat moves excessively, repeat steps 5 through 6, or properly install the child seat in the outboard seating position.

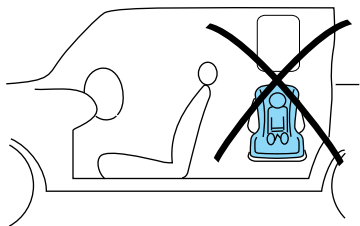

**WARNING:** Do not install a child seat in a center facing jump seat.

## Seating and Safety Restraints

### Attaching child safety seats with tether straps

Most new forward-facing child safety seats include a tether strap which goes over the back of the seat and hooks to an anchoring point. Tether straps are available as an accessory for many older safety seats. Contact the manufacturer of your child seat for information about ordering a tether strap.

The tether anchors in your vehicle are located on the back of the front seat cushion.

The tether strap anchors in your vehicle are in the following positions (shown from top view):

- **Bucket seats**

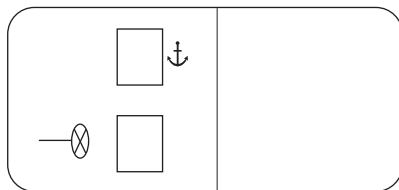

- **60/40 seats**

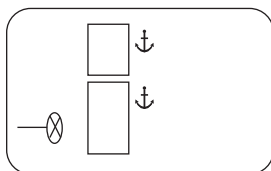

**WARNING: Attach the tether strap only to the appropriate tether anchor as shown. The tether strap may not work properly if attached somewhere other than the correct tether anchor.**

## Seating and Safety Restraints

**WARNING:** This anchor information applies to child safety seats equipped with tether straps. For child safety seats equipped with LATCH anchors, refer to *Attaching safety seats with LATCH (Lower Anchors and Tethers for Children) attachments for child seat anchors* in this chapter.

1. Position the child safety seat on the front seat cushion.
2. Route the child safety seat tether strap over the back of the seat.

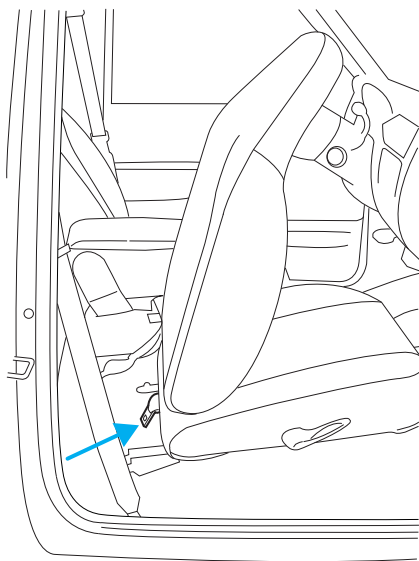

3. Locate the correct anchor for the selected seating position.

## Seating and Safety Restraints

The tether anchor is located on the rear lower portion of the passenger seat.

4. Clip the tether strap to the anchor.

**WARNING:** If the tether strap is clipped incorrectly, the child safety seat may not be retained properly in the event of a collision.

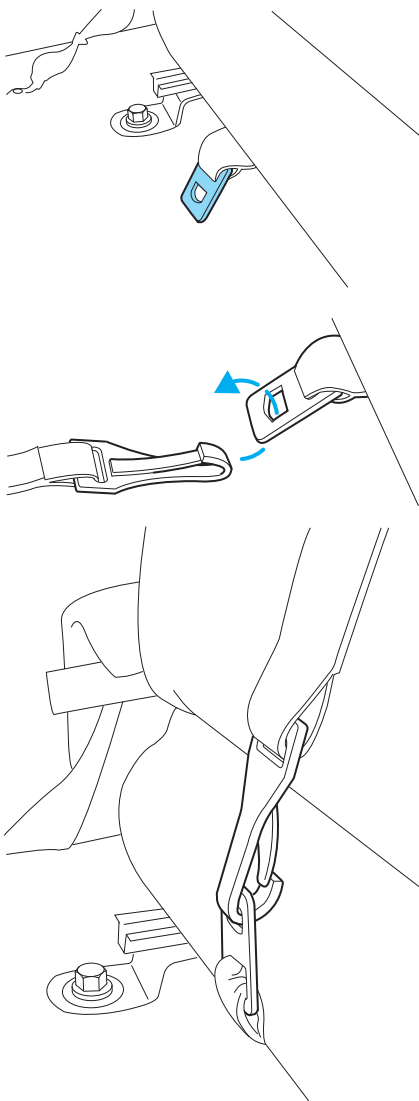

## Seating and Safety Restraints

### *Center seating location 60/40 seats with folding armrest*

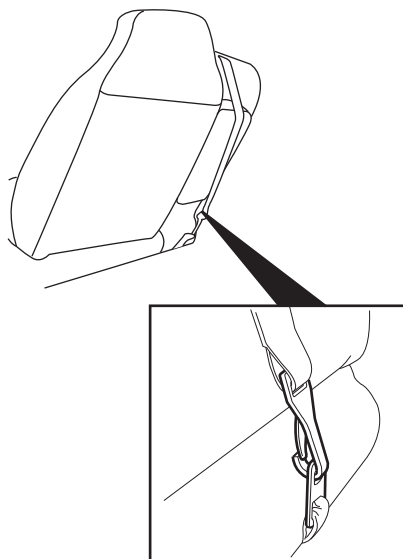

When installing a child safety seat in the center position, route the tether strap over the center arm rest and clip it to the center anchor.

See next page for center seating location of vinyl 60/40 seat.

**WARNING: If the tether strap is clipped incorrectly, the child safety seat may not be retained properly in the event of a collision.**

## Seating and Safety Restraints

### Center seating location 60/40 vinyl seats

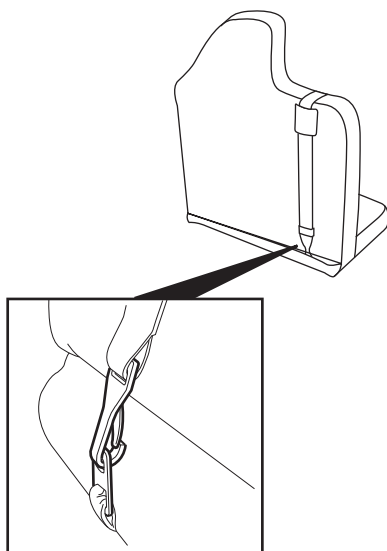

When installing a child safety seat in the center position on a 60/40 vinyl seat, route the tether strap through the guiding sleeve and clip it to the center anchor.

**WARNING: If the tether strap is clipped incorrectly, the child safety seat may not be retained properly in the event of a collision.**

5. Refer to the *Installing child safety seats in combination lap and shoulder belt seating positions* section of this chapter for further instructions to secure the child safety seat.
6. Tighten the child safety seat tether strap according to the manufacturer's instructions.

**WARNING: If the safety seat is not anchored properly, the risk of a child being injured in a collision greatly increases.**



## Seating and Safety Restraints

### Attaching safety seats with LATCH (Lower Anchors and Tethers for Children) attachments for child seat anchors

Some child safety seats have two rigid or webbing mounted attachments that connect to two anchors at certain seating positions in your vehicle. This type of child seat eliminates the need to use seat belts to attach the child seat. For forward-facing child seats, the tether strap must also be attached to the proper tether anchor. See *Attaching safety seats with tether straps* in this chapter.

Your vehicle may be equipped with LATCH anchors for child seat installation at the seating positions with gray locator buttons.

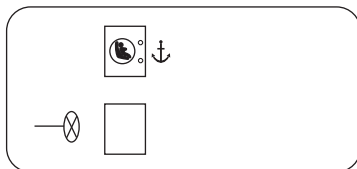

- Bucket seats

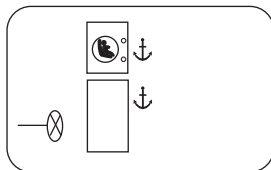

- 60/40 seats

 represents LATCH anchors.

 represents tether strap anchors.

To improve child seat protection, use the tether anchor when using the LATCH to install a child safety seat. See *Attaching child safety seats with tether straps* in this section.

**WARNING: Never attach two LATCH child safety seats to the same anchor. In a crash, one anchor may not be strong enough to hold two child safety seat attachments and may break, causing serious injury or death.**

## Seating and Safety Restraints

**WARNING:** Do not put the LATCH type seat in the center seat position — it only has one possible anchor point and the seat will not be properly attached.

**WARNING:** If there are two LATCH seats to install — you can only mount one LATCH seat in this vehicle with the LATCH anchor bars. You need to mount the second seat with the center seat belt using the normal lap belt method.

**WARNING:** Do not attach two seats to one LATCH anchor bar.

Connectors on the LATCH child seat and the child seat instructions may use the symbol shown here. Your vehicle seat will have plain gray buttons, instead of this symbol, to indicate the location of the LATCH lower anchors.



The lower anchors for child seat installation are located at the rear section of the front passenger seat between the cushion and seat back. The LATCH anchors are below the gray locator buttons on the seat back. Two plastic LATCH guides may be purchased from your local Mazda dealer (part number 1F60-57-751). They snap onto the latch lower anchor in the vehicle to help attach a child seat with rigid latch attachments. It will hold the seat foam away and expose the anchor making attachment of the child seat easier.

Make sure you attach the proper child safety seat tether after securing the LATCH.

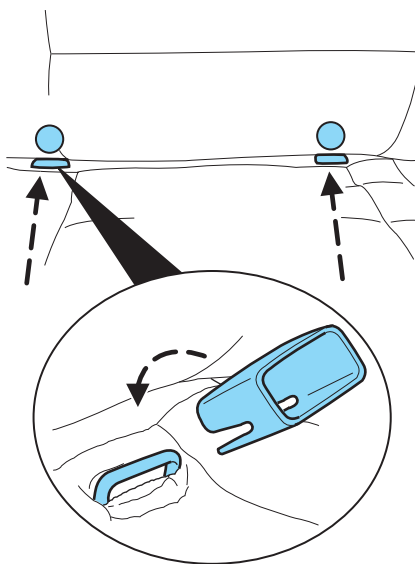

## Seating and Safety Restraints

**WARNING: If the tether strap is clipped incorrectly, the child safety seat may not be retained properly in the event of a collision.**

Follow the child seat manufacturer's instructions to properly install a child seat with LATCH attachments.

**WARNING: Attach LATCH lower attachments of the child seat only to the anchors shown.**

If you install a child seat with rigid LATCH attachments, do not tighten the tether strap enough to lift the child seat off the vehicle seat cushion when the child is seated in it. Keep the tether strap just snug without lifting the front of the child seat. Keeping the child seat just touching the vehicle seat gives the best protection in a severe crash.

Each time you use the safety seat, check that the seat is properly attached to the lower anchors and tether anchor. Try to tilt the child seat from side to side. Also try to tug the seat forward. Check to see if the anchors hold the seat in place.

**WARNING: If the safety seat is not anchored properly, the risk of a child being injured in a crash greatly increases.**

**WARNING: If the tether strap is clipped incorrectly, the child safety seat may not be retained properly in the event of a collision.**

# Driving

## STARTING

### Positions of the ignition

1. ACCESSORY, allows the electrical accessories such as the radio to operate while the engine is not running.
2. LOCK, locks the steering wheel, automatic transmission gearshift lever and allows key removal.
3. OFF, shuts off the engine and all accessories without locking the steering wheel. This position also allows the automatic transmission shift lever to be moved from the P (Park) position without the brake pedal being depressed.

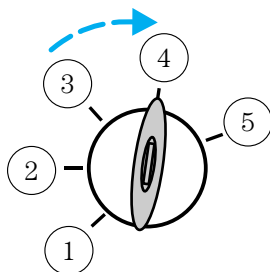

**WARNING:** In the ignition OFF position, the automatic transmission shift lever can be moved from the P (Park) position without the brake pedal depressed. To avoid unwanted vehicle movement, always set the parking brake.

4. ON, all electrical circuits operational. Warning lights illuminated. Key position when driving.
5. START, cranks the engine. Release the key as soon as the engine starts.

### Preparing to start your vehicle

Engine starting is controlled by the powertrain control system.

**Note:** This system meets all Canadian Interference-Causing Equipment standard requirements regulating the impulse electrical field strength of radio noise.

When starting a fuel-injected engine, avoid pressing the accelerator before or during starting. Only use the accelerator when you have difficulty starting the engine. For more information on starting the vehicle, refer to *Starting the engine* in this chapter.

**WARNING:** Extended idling at high engine speeds can produce very high temperatures in the engine and exhaust system, creating the risk of fire or other damage.

**WARNING:** Do not park, idle, or drive your vehicle in dry grass or other dry ground cover. The emission system heats up the engine compartment and exhaust system, which can start a fire.

**WARNING:** Do not start your vehicle in a closed garage or in other enclosed areas. Exhaust fumes can be toxic. Always open the garage door before you start the engine. See *Guarding against exhaust fumes* in this chapter for more instructions.

**WARNING:** If you smell exhaust fumes inside your vehicle, have your authorized Mazda dealer inspect your vehicle immediately. Do not drive if you smell exhaust fumes.

### Important safety precautions

A computer system controls the engine's idle revolutions per minute (RPM). When the engine starts, the idle RPM runs higher than normal in order to warm the engine. If the engine idle speed does not slow down automatically, have the vehicle checked authorized at an Mazda dealership. Do not allow the vehicle to idle for more than 10 minutes at high engine RPM.

Before starting the vehicle:

1. Make sure all vehicle occupants have buckled their safety belts. For more information on safety belts and their proper usage, refer to the *Seating and safety restraints* chapter.
2. Make sure the headlamps and vehicle accessories are off.

If starting a vehicle with an automatic transmission:

- Make sure the parking brake is set.
- Make sure the gearshift is in P (Park).

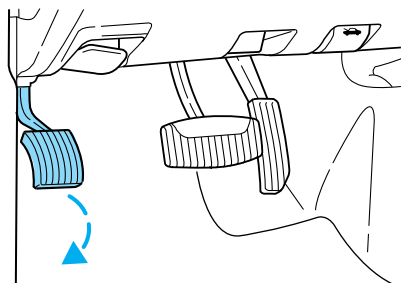

## Driving

If starting a vehicle with a manual transmission:

- Make sure the parking brake is set.
- Push the clutch pedal to the floor.

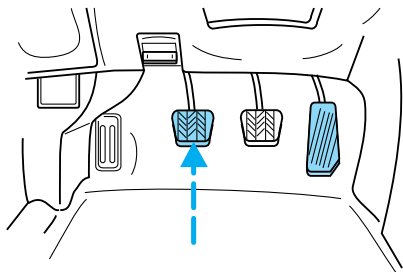

3. Turn the key to 4 (ON) without turning the key to 5 (START).

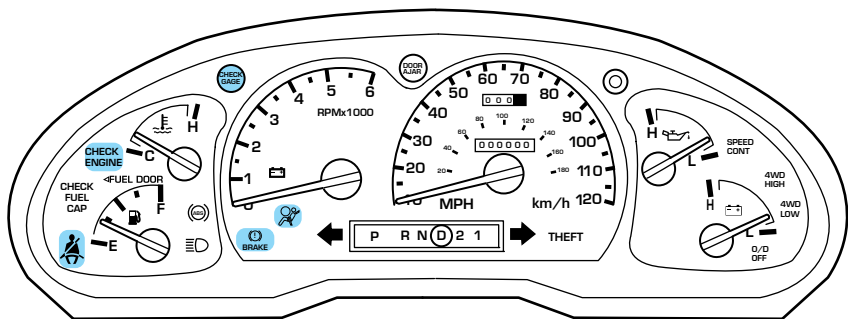
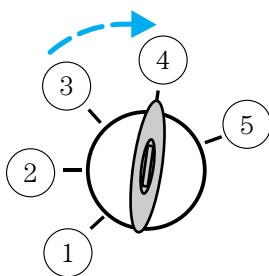

Make sure the corresponding lights illuminate or illuminate briefly. If a light fails to illuminate, have the vehicle serviced.

- **Note:** If the driver's safety belt is fastened, the  light may not illuminate.

### Starting the engine

**Note:** Whenever you start your vehicle, release the key as soon as the engine starts. Excessive cranking could damage the starter.

1. Turn the key to 5 (START) without pressing the accelerator pedal and release as soon as the engine starts. The key will return to 4 (ON).
2. If the temperature is above  $-12^{\circ}\text{C}$  ( $10^{\circ}\text{F}$ ) and the engine does not start within five seconds on the first try, turn the key to OFF, wait 10 seconds and try again. If the engine does not start in two attempts, press the accelerator all the way to the floor and hold. Turn the key to the START position.
3. If the temperature is below  $-12^{\circ}\text{C}$  ( $10^{\circ}\text{F}$ ) and the engine does not start in 15 seconds on the first try, turn the key OFF and wait 10 seconds and try again. If the engine does not start in two attempts, press the accelerator pedal all the way to floor and hold. Turn the key to START position.
4. When the engine starts, release the key, then release the accelerator pedal gradually as the engine speeds up.
5. After idling for a few seconds, apply the brake, shift into gear and drive.

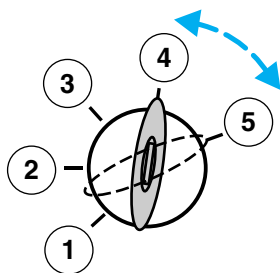

## Cold weather starting (flexible fuel vehicles only)

As the outside temperature approaches freezing, ethanol fuel distributors should supply winter grade (E<sub>d</sub>85) ethanol (same as with unleaded gasoline). If summer grade (E<sub>d</sub>85) ethanol is used in cold weather conditions, you may experience increased cranking times, rough idle or hesitation until the engine has warmed up. Consult your fuel distributor for the availability of winter grade (E<sub>d</sub>85) ethanol.

High-quality blends of winter grade (E<sub>d</sub>85) ethanol will produce satisfactory cold weather starting and driving results. However, fuel composition varies, and sub-optimal winter grade blends could produce increased cranking times, rough idle or hesitation at temperatures below  $-18^{\circ}\text{C}$  ( $0^{\circ}\text{F}$ ). If you experience this condition you may find that a different brand of winter grade (E<sub>d</sub>85) (if available in your area) improves the performance of your vehicle.

Cold starting performance can also be improved with the use of an engine block heater. The engine block heater is available as a Mazda option and can also be obtained from your Mazda dealer. Consult the engine block heater section for proper use of the engine block heater.

## Driving

If you should experience cold weather starting problems on (E<sub>d</sub>85) ethanol, and neither an alternative brand of (E<sub>d</sub>85) ethanol nor an engine block heater is available, the addition of unleaded gasoline to your tank will improve cold starting performance. Your vehicle is designed to operate on (E<sub>d</sub>85) ethanol alone, unleaded gasoline alone, or any mixture of the two.

### If the engine fails to start using the preceding instructions

1. Press the accelerator pedal 1/3 to 1/2 way to floor and hold.
2. Turn the key to START position.
3. When the engine starts, release the key, then release the accelerator pedal gradually as the engine speeds up.
4. If the engine still fails to start, repeat steps one through three.
5. After the engine starts, hold your foot on the brake pedal, put the gearshift lever in gear and release the parking brake. Slowly release the brake pedal and drive away in a normal manner.

### Using the engine block heater (if equipped)

An engine block heater warms the engine coolant, which improves starting, warms up the engine faster and allows the heater-defroster system to respond quickly. Use of an engine block heater is strongly recommended if you live in a region where temperatures reach -23° C (-10° F) or below.

For best results, plug the heater in at least three hours before starting the vehicle. Using the heater for longer than three hours will not harm the engine, so the heater can be plugged in the night before starting the vehicle.

**WARNING: To prevent electrical shock, do not use your heater with ungrounded electrical systems or two-pronged (cheater) adapters.**

### Guarding against exhaust fumes

Although odorless and colorless, carbon monoxide is present in exhaust fumes. Take precautions to avoid its dangerous effects.



**WARNING: If you ever smell exhaust fumes of any kind inside your vehicle, have your authorized Mazda dealer inspect and fix your vehicle immediately. Do not drive if you smell exhaust fumes. These fumes are harmful and result in accident or death.**

Have the exhaust and body ventilation systems checked whenever:

- the vehicle is raised for service.
- the sound of the exhaust system changes.
- the vehicle has been damaged in a collision.

**WARNING: Engine exhaust, some of its constituents, and certain vehicle components contain or emit chemicals known to the State of California to cause cancer and birth defects or other reproductive harm. In addition, certain fluids contained in vehicles and certain products of component wear contain or emit chemicals known to the State of California to cause cancer and birth defects or other reproductive harm.**

### Important ventilating information

If the engine is idling while the vehicle is stopped in an open area for long periods of time, open the windows at least 2.5 cm (one inch).

Adjust the heating or air conditioning (if equipped) to bring in fresh air.

**Note:** Improve vehicle ventilation by keeping all air inlet vents clear of snow, leaves and other debris.

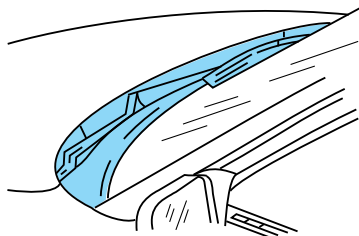

### BRAKES

Your service brakes are self-adjusting. Refer to the service maintenance section for scheduled maintenance.

Occasional brake noise is normal and often does not indicate a performance concern with the vehicle's brake system. In normal operation, automotive brake systems may emit occasional or intermittent

## Driving

squeal or groan noises when the brakes are applied. Such noises are usually heard during the first few brake applications in the morning; however, they may be heard at any time while braking and can be aggravated by environmental conditions such as cold, heat, moisture, road dust, salt or mud. If a “metal-to-metal,” “continuous grinding” or “continuous squeal” sound is present while braking, the brake linings may be worn-out and should be inspected by an authorized Mazda dealership.

### Four-wheel anti-lock brake system (ABS)

This vehicle is equipped with an anti-lock braking system (ABS), a noise from the hydraulic pump motor and pulsation in the pedal may be observed during ABS braking events. Pedal pulsation coupled with noise while braking under panic conditions or on loose gravel, bumps, wet or snowy roads is normal and indicates proper functioning of the vehicle’s anti-lock brake system.

**NOTE:** The ABS performs a self-check after you start the engine and begin to drive away.

A brief mechanical noise may be heard during this test. This is normal. If a malfunction is found, the ABS warning light will come on. If the vehicle has continuous vibration or shudder in the steering wheel while braking, the vehicle should be inspected by an authorized Mazda dealership.

The ABS operates by detecting the onset of wheel lockup during brake applications and compensates for this tendency. The wheels are prevented from locking even when the brakes are firmly applied. The accompanying illustration depicts the advantage of an ABS equipped vehicle (on bottom) to a non-ABS equipped vehicle (on top) during hard braking with loss of front braking traction.

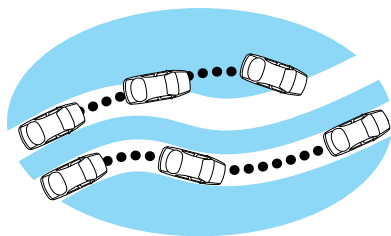

traction.

**WARNING: The Anti-Lock system does not decrease the time necessary to apply the brakes or always reduce stopping distance. Always leave enough room between your vehicle and the vehicle in front of you to stop.**

## Using four wheel ABS

- In an emergency or when maximum efficiency from the ABS is required, apply continuous force on the brake. The ABS will be activated immediately, thus allowing you to retain full steering control of your vehicle and, providing there is sufficient space, will enable you to avoid obstacles and bring the vehicle to a controlled stop.

**WARNING: The Anti-Lock system does not reduce stopping distance. Always leave enough room between your vehicle and the vehicle in front of you to stop.**

**NOTE:** We recommend that you familiarize yourself with this braking technique. However, avoid taking any unnecessary risks.

## ABS warning lamp (ABS)

The (ABS) warning lamp in the instrument cluster momentarily illuminates when the ignition is turned to the ON position. If the light does not illuminate momentarily at start up, remains on or continues to flash, the ABS needs to be serviced.

With the ABS light on, the anti-lock brake system is disabled and normal braking is still effective unless the brake warning light also remains illuminated with parking brake released. (If your brake warning lamp illuminates, have your vehicle serviced immediately by an authorized Mazda dealership.)

(!)  
**BRAKE**

## Parking brake (P)

Apply the parking brake whenever the vehicle is parked. To set the parking brake, press the parking brake pedal down until the pedal stops.

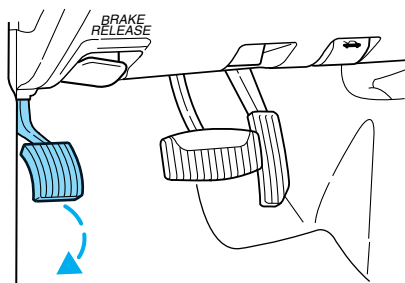

## Driving

The BRAKE warning lamp in the instrument cluster illuminates and remains illuminated (when the ignition is turned ON) until the parking brake is released.



**WARNING:** Always set the parking brake fully and make sure that the gearshift is securely latched in P (Park) (automatic transmission) or in 1 (First) (manual transmission).

**NOTE:** The parking brake is not recommended to stop a moving vehicle. However, if the normal brakes fail, the parking brake can be used to stop your vehicle in an emergency. Since the parking brake applies only the rear brakes, the vehicle's stopping distance will increase greatly and the handling of your vehicle will be adversely affected.

Pull the release lever to release the brake.

**Driving with the parking brake on will cause the brakes to wear out quickly and reduce fuel economy.**

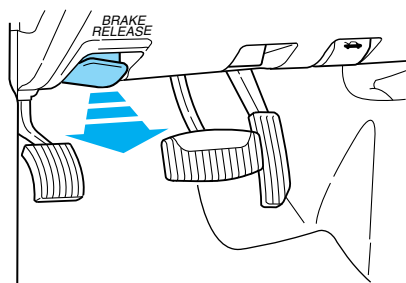

## STEERING

Your vehicle is equipped with power steering. Power steering uses energy from the engine to decrease the driver's effort in steering the vehicle.

To prevent damage to the power steering pump:

- Never hold the steering wheel to the extreme right or the extreme left for more than a few seconds when the engine is running.
- Do not operate the vehicle with the power steering pump fluid level below the MIN mark on the reservoir.

If the power steering system breaks down (or if the engine is turned off), you can steer the vehicle manually, but it takes more effort.

If the steering wanders or pulls, the condition could be caused by any of the following:

- Underinflated tire(s) on any wheel(s)
- Uneven vehicle loading
- High crown in center of road
- High crosswinds
- Wheels out of alignment
- Loose or worn suspension components

### **TRACTION-LOK AXLE (IF EQUIPPED)**

This axle provides added traction on slippery surfaces, particularly when one wheel is on a poor traction surface. Under normal conditions, the Traction-Lok axle functions like a standard rear axle.

Extended use of other than the manufacturer's specified size tires on a Traction-Lok rear axle could result in a permanent reduction in effectiveness. This loss of effectiveness does not affect normal driving and should not be noticeable to the driver.

**WARNING: To reduce the risk of injury, never run the engine with one wheel off the ground, such as when changing a tire.**

### **PREPARING TO DRIVE YOUR VEHICLE**

**WARNING: Utility vehicles have a significantly higher rollover rate than other types of vehicles.**

**WARNING: In a rollover crash, an unbelted person is significantly more likely to die than a person wearing a seat belt.**

Your vehicle has special design and equipment features to make it capable of performing in a wide variety of circumstances. These special design features, such as larger tires and increased ground clearance, give the vehicle a higher center of gravity than a passenger car.

## Driving

**WARNING:** Vehicles with a higher center of gravity such as utility and four-wheel drive vehicles handle differently than vehicles with a lower center of gravity. Utility and four-wheel drive vehicles are not designed for cornering at speeds as high as passenger cars any more than low-slung sports cars are designed to perform satisfactorily under off-road conditions. Avoid sharp turns, excessive speed and abrupt maneuvers in these vehicles. Failure to drive cautiously could result in an increased risk of vehicle rollover, personal injury and death.

**WARNING:** Loaded vehicles, with a higher center of gravity, may handle differently than unloaded vehicles. Extra precautions, such as slower speeds and increased stopping distance, should be taken when driving a heavily loaded vehicle.

Your vehicle has the capability to haul more cargo and people than most passenger cars. Depending upon the type and placement of the load, hauling people and cargo may raise the center of gravity of the vehicle.

Use extra caution while becoming familiar with your vehicle. Know the capabilities and limitations of both you as a driver and your vehicle.

### **AUTOMATIC TRANSMISSION OPERATION (IF EQUIPPED)**

#### **Brake-shift interlock**

This vehicle is equipped with a brake-shift interlock feature that prevents the gearshift lever from being moved from P (Park) when the ignition is in the ON position unless the brake pedal is depressed.

If you cannot move the gearshift lever out of P (Park) with ignition in the ON position and the brake pedal depressed:

1. Apply the parking brake, turn ignition key to LOCK, then remove the key.
2. Insert the key and turn it to OFF. **Apply the brake pedal and shift to N (Neutral).**

**WARNING:** In the ignition OFF position, the automatic transmission shift lever can be moved from the P (Park) position without the brake pedal depressed. To avoid unwanted vehicle movement, always set the parking brake.

### 3. Start the vehicle.

If it is necessary to use the above procedure to move the gearshift lever, it is possible that a fuse has blown or the vehicle's brakelamps are not operating properly. Refer to *Fuses and relays* in the *Roadside emergencies* chapter.

**WARNING: Do not drive your vehicle until you verify that the brakelamps are working.**

If your vehicle gets stuck in mud or snow it may be rocked out by shifting from forward and reverse gears, stopping between shifts, in a steady pattern. Press lightly on the accelerator in each gear.

**Do not rock the vehicle if the engine is not at normal operating temperature or damage to the transmission may occur.**

**Do not rock the vehicle for more than a few minutes or damage to the transmission and tires may occur or the engine may overheat.**

**WARNING: Always set the parking brake fully and make sure the gearshift is latched in P (Park). Turn the ignition to the LOCK position and remove the key whenever you leave your vehicle.**

**WARNING: If the parking brake is fully released, but the brake warning lamp remains illuminated, the brakes may not be working properly. See your authorized Mazda dealership.**

### **Driving with a 5-speed automatic transmission (if equipped)**

Your automatic transmission electronically controls the shift feel by using an adaptive learning strategy. This feature is designed to increase durability, and provide consistent shift feel over the life of the vehicle. It is normal for a new transmission to shift firmly. This operation is considered normal and will not affect function or durability of the transmission. Once the vehicle is at operating temperature it may take several shifts at the same operating condition for the transmission to properly adapt. Over time the adaptive learning process will fully update transmission operation. The more varied the driving habits, speed and torque, the longer it may take to adapt, but the more complete the process will be.

## Driving

When the battery is disconnected or a new battery installed, the transmission must learn its adaptive strategy. As a result of this, the transmission may shift firmly. This operation is considered normal and will fully update transmission operation to its optimum shift feel.

### *Understanding gearshift positions*

**WARNING:** Hold the brake pedal down while you move the gearshift lever from P (Park) to another position. If you do not hold the brake pedal down, your vehicle may move unexpectedly and injure someone.

#### *P (Park)*

To put your vehicle in gear, start the engine, depress the brake pedal, then move gearshift lever out of P (Park).

Always come to a complete stop before shifting into P (Park). Make sure the gearshift lever is securely latched in P (Park). This position locks the transmission and prevents the rear wheels from turning.



**WARNING:** Always set the parking brake fully and make sure the gearshift is latched in P (Park). Turn the ignition to the LOCK position and remove the key whenever you leave your vehicle.

#### *R (Reverse)*

With the gearshift lever in R (Reverse), the vehicle will move backward. Always come to a complete stop before shifting into and out of R (Reverse).



#### *N (Neutral)*

With the gearshift lever in N (Neutral), the vehicle can be started and is free to roll. Hold the brake pedal down while in this position.





**D (Overdrive)**

The normal driving position for the best fuel economy. Transmission operates in gears one through five.



**D** (Overdrive) can be deactivated by pressing the transmission control switch on the end of the gearshift lever.

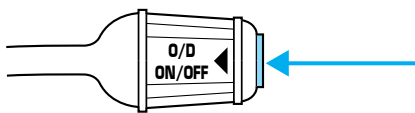

The transmission control indicator light (TCIL) will illuminate on the instrument cluster.

O/D  
OFF

**Drive** – Not shown on the display. Activate by pressing the transmission control switch on the end of the gearshift lever with the gearshift in the **D** (Overdrive) position. The TCIL will illuminate on the instrument cluster. Transmission operates in gears one through four. Drive (O/D OFF) provides more engine braking than **D** (Overdrive) and is useful whenever driving conditions (i.e., city traffic, hilly terrain, etc.) cause the transmission to excessively shift between **D** (Overdrive) and other gears. Deactivate **D** (Overdrive) when:

- driving with a heavy load.
- towing a trailer up or down steep hills.
- additional engine braking is desired. If towing a trailer, refer to *Driving while you tow* in the *Trailer Towing* section.

To return to **D** (Overdrive) mode, press the transmission control switch. The TCIL will no longer be illuminated.

Each time the vehicle is started, the transmission will automatically return to normal **D** (Overdrive) mode.

**2 (Second)**

Use 2 (Second) to start-up on slippery roads or to provide additional engine braking on downgrades.



# Driving

## 1 (First)

Use 1 (First) to provide maximum engine braking on steep downgrades. Upshifts can be made by shifting to 2 (Second) or to **D**



(Overdrive). Selecting 1 (Low) at higher speeds causes the transmission to shift to a lower gear and will shift to 1 (First) after the vehicle decelerates to the proper vehicle speed.

## Forced Downshifts

To gain acceleration in **D** (Overdrive) or Drive (O/D OFF) when passing another vehicle, push the accelerator to the floor. The transmission will downshift to the appropriate gear: fourth, third, second or first gear.

## MANUAL TRANSMISSION OPERATION (IF EQUIPPED)

### USING THE CLUTCH

Vehicles equipped with a manual transmission have a starter interlock that prevents starting the engine unless the clutch pedal is fully depressed.

When starting a vehicle with a manual transmission:

1. Hold down the brake pedal.
  2. Depress the clutch pedal.
  3. Put the gearshift lever in N (Neutral).
  4. Start the engine and let it idle for a few seconds.
- Put the gearshift lever in 1 (First) or R (Reverse).
  - 5. Release the clutch slowly while pressing gradually down on the accelerator pedal.
  - Do not drive with your foot resting on the clutch pedal. Do not use the clutch to hold your vehicle at a standstill while waiting on a hill. These actions may reduce clutch life.

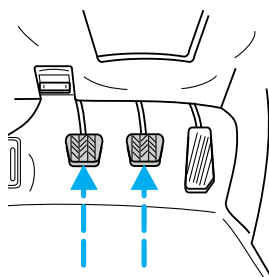

## PARKING

1. Apply the brake, depress the clutch and shift into N (Neutral).

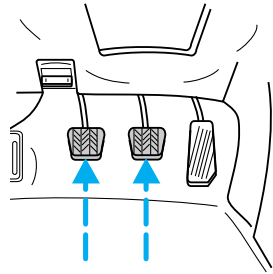

2. Engage the parking brake.

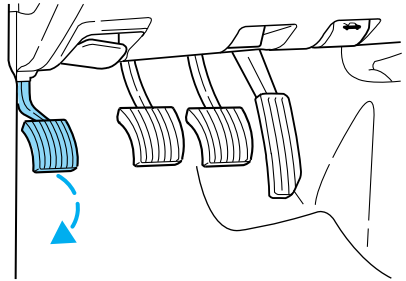

3. Shift into 1 (First).
4. Turn the ignition to Off.

**WARNING: Do not park your vehicle in Neutral, it may move unexpectedly and injure someone. Use 1 (First) gear and set the parking brake fully.**

# Driving

## RECOMMENDED SHIFT SPEEDS

<b>Upshifts when accelerating (for best fuel economy)</b>		
Shift from:	Transfer case position (if equipped)	
	4H	4L
1 - 2	14 km/h (10 mph)	5 km/h (4 mph)
2 - 3	32 km/h (22 mph)	11 km/h (9 mph)
3 - 4	50 km/h (33 mph)	19 km/h (13 mph)
4 - 5 (Overdrive)	71 km/h (41 mph)	27 km/h (17 mph)
<b>Upshifts when cruising (recommended for best fuel economy)</b>		
Shift from:	Transfer case position (if equipped)	
	4H	4L
1 - 2	16 km/h (10 mph)	6 km/h (4 mph)
2 - 3	26 km/h (19 mph)	10 km/h (8 mph)
3 - 4	43 km/h (28 mph)	16 km/h (12 mph)
4 - 5 (Overdrive)	68 km/h (40 mph)	26 km/h (16 mph)
<b>Maximum downshift speeds</b>		
Shift from:	Transfer case position (if equipped)	
	4H	4L
5 (Overdrive) - 4	88 km/h (55 mph)	34 km/h (22 mph)
4 - 3	72 km/h (45 mph)	27 km/h (18 mph)
3 - 2	56 km/h (35 mph)	21 km/h (14 mph)
2 - 1	32 km/h (20 mph)	11 km/h (8 mph)

## REVERSE

Ensure that the vehicle is at a complete stop before shifting into R (Reverse). Failure to do so may damage the transmission.

Put the gearshift lever into N and wait at least several seconds before shifting into R.

You can shift into R (Reverse) only by moving the gearshift lever from left of 3 (Third) and 4 (Fourth) gears before you shift into R (Reverse). This is a special lockout feature that protects you from accidentally shifting into R (Reverse) when you downshift from 5 (Overdrive).

## FOUR-WHEEL DRIVE (4WD) OPERATION (IF EQUIPPED)

**WARNING:** For important information regarding safe operation of this type of vehicle, see *Preparing to drive your vehicle* in this chapter.

When four-wheel drive (4WD) is engaged, power is supplied to all four wheels through a transfer case. 4WD can be selected when additional driving power is desired.

**If equipped with the Electronic Shift 4WD System, and 4WD Low is selected while the vehicle is moving, the 4WD system will not engage. This is normal and should be no reason for concern. Before 4WD Low can be engaged, the vehicle must be brought to a complete stop, the brake pedal depressed and the transmission placed in neutral (or the clutch pedal depressed on manual transmissions).**

4WD operation is not recommended on dry pavement. Doing so could result in difficult disengagement of the transfer case, increased tire wear and decreased fuel economy.

### 4WD system indicator lights

The 4WD system indicator lights illuminate only under the following conditions. If these lights illuminate when driving in 2WD, contact your Mazda dealer as soon as possible.

- **4WD** -momentarily illuminates when the vehicle is started. **4WD**  
Illuminates when 4H (4WD High) is engaged.
- **4WD LOW** –momentarily illuminates when the vehicle is started. Illuminates when 4L (4WD Low) is engaged. **4WD  
LOW**

### Using the electronic shift 4WD system (if equipped)

#### *Positions of the electronic shift system*

**2WD (2WD High)** – Power to rear axle only.

**4X4 HIGH (4WD High)** – Power delivered to front and rear axles for increased traction.

**4X4 LOW (4WD Low)** – Power to front and rear axles at low speeds.

## Driving

### **Shifting from 2WD (2WD high) to 4X4 HIGH (4WD high)**

Move the 4WD control to the 4X4 HIGH position.

**Do not shift into 4X4 HIGH with the rear wheels slipping.**

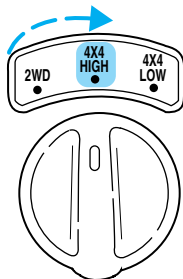

### **Shifting from 4X4 HIGH (4WD high) to 2WD (2WD high)**

Move the 4WD control to 2WD position at any forward speed.

- You **do not** need to operate the vehicle in R (Reverse) to disengage your front hubs.

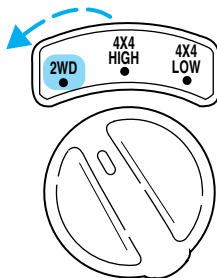

### **Shifting from 2WD (2WD high) to 4X4 LOW (4WD low)**

1. Bring the vehicle to a stop.
2. Depress the brake.
3. Place the gearshift in N (Neutral) (automatic transmission) or depress the clutch (manual transmission).
4. Move the 4WD control to the 4X4 LOW position.

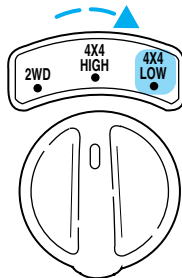

## **Shifting from 4X4 LOW (4WD low) to 2WD (2WD high)**

1. Bring the vehicle to a stop.
2. Depress the brake.
3. Place the gearshift in N (Neutral) (automatic transmission) or depress the clutch (manual transmission).
4. Move the 4WD control to the 2WD position.

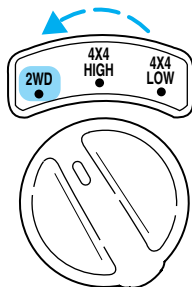

## **Shifting between 4X4 HIGH (4WD high) and 4X4 LOW (4WD low)**

1. Bring the vehicle to a stop.
2. Depress the brake.
3. Place the gearshift in N (Neutral) (automatic transmission) or depress the clutch (manual transmission).
4. Move the 4WD control to the 4X4 HIGH or 4X4 LOW position.

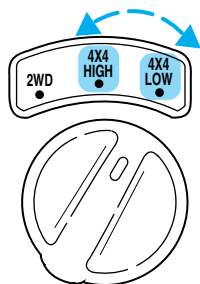

## **Driving off-road with 4WD**

Your vehicle is specially equipped for driving on sand, snow, mud and rough terrain and has operating characteristics that are somewhat different from conventional vehicles, both on and off the road.

Maintain steering wheel control at all times, especially in rough terrain. Since sudden changes in terrain can result in abrupt steering wheel motion, make sure you grip the steering wheel from the outside. Do not grip the spokes.

## Driving

Drive cautiously to avoid vehicle damage from concealed objects such as rocks and stumps.

You should either know the terrain or examine maps of the area before driving. Map out your route before driving in the area. For more information on driving off-road, read the “Four Wheeling” supplement in your owner’s portfolio.

### ***If your vehicle gets stuck***

If the vehicle is stuck it may be rocked out by shifting from forward and reverse gears, stopping between shifts, in a steady pattern. Press lightly on the accelerator in each gear.

**Do not rock the vehicle if the engine is not at normal operating temperature or damage to the transmission may occur.**

**Do not rock the vehicle for more than a few minutes or damage to the transmission and tires may occur or the engine may overheat.**

**WARNING: Do not spin the wheels at over 56 km/h (35 mph). The tires may fail and injure a passenger or bystander.**

### ***Sand***

When driving over sand, try to keep all four wheels on the most solid area of the trail. Do not reduce the tire pressures but shift to a lower gear and drive steadily through the terrain. Apply the accelerator slowly and avoid spinning the wheels.

### ***Mud and water***

If you must drive through high water, drive slowly. Traction or brake capability may be limited.

When driving through water, determine the depth; avoid water higher than the bottom of the hubs (if possible) and proceed slowly. If the ignition system gets wet, the vehicle may stall.

Once through water, always try the brakes. Wet brakes do not stop the vehicle as effectively as dry brakes. Drying can be improved by moving your vehicle slowly while applying light pressure on the brake pedal.

After driving through mud, clean off residue stuck to the driveshafts and tires. Excess mud stuck on tires and rotating driveshafts causes an imbalance that could damage drive components.

If the transmission, transfer case or front axle are submerged in water, their fluids should be checked and changed, if necessary.



### **Driving through deep water may damage the transmission.**

Replace rear axle lubricant any time the axle has been submerged in water. The rear axle does not normally require a lubricant change for the life of the vehicle. Rear axle lubricant quantities are not to be checked or changed unless a leak is suspected or repair is required.

### **Driving on hilly or sloping terrain**

When driving on a hill, avoid driving crosswise or turning on steep slopes. You could lose traction and slip sideways. Drive straight up, straight down or avoid the hill completely. Know the conditions on the other side of a hill before driving over the crest.

When climbing a steep hill, start in a lower gear rather than downshifting to a lower gear from a higher gear once the ascent has started. This reduces strain on the engine and the possibility of stalling.

When descending a steep hill, avoid sudden braking. Shift to a lower gear when added engine braking is desired.

When speed control is on and you are driving uphill, your vehicle speed may drop considerably, especially if you are carrying a heavy load.

If vehicle speed drops more than 16 km/h (10 mph), the speed control will cancel automatically. Resume speed with accelerator pedal.

If speed control cancels after climbing the hill, reset speed by pressing and holding the SET ACCEL button (to resume speeds over 50 km/h [30 mph]).

Automatic transmissions may shift frequently while driving up steep grades. Eliminate frequent shifting by shifting out of **D** (Overdrive) into a lower gear.

### **Driving on snow and ice**

A 4WD vehicle has advantages over 2WD vehicles in snow and ice but can skid like any other vehicle.

Avoid sudden applications of power and quick changes of direction on snow and ice. Apply the accelerator slowly and steadily when starting from a full stop.

When braking, apply the brakes as you normally would. In order to allow the anti-lock brake system (ABS) to operate properly, keep steady pressure on the brake pedal.

Allow more stopping distance and drive slower than usual. Consider using one of the lower gears.

# Driving

## DRIVING THROUGH WATER

Do not drive quickly through standing water, especially if the depth is unknown. Traction or brake capability may be limited and if the ignition system gets wet, your engine may stall. Water may also enter your engine's air intake and severely damage your engine.

If driving through deep or standing water is unavoidable, proceed very slowly. Never drive through water that is higher than the bottom of the hubs (for trucks) or the bottom of the wheel rims (for cars).

Once through the water, always try the brakes. Wet brakes do not stop the vehicle as effectively as dry brakes. Drying can be improved by moving your vehicle slowly while applying light pressure on the brake pedal.

**Driving through deep water where the transmission vent tube is submerged may allow water into the transmission and cause internal transmission damage. Have the fluid checked and, if water is found, replace the fluid.**

## VEHICLE LOADING

Before loading a vehicle, familiarize yourself with the following terms:

- **Base Curb Weight:** Weight of the vehicle including any standard equipment, fluids, lubricants, etc. It does not include occupants or aftermarket equipment.
- **Payload:** Combined maximum allowable weight of cargo, occupants and optional equipment. The payload equals the gross vehicle weight rating minus base curb weight.
- **GVW (Gross Vehicle Weight):** Base curb weight plus payload weight. The GVW is not a limit or a specification.
- **GVWR (Gross Vehicle Weight Rating):** Maximum permissible total weight of the base vehicle, occupants, optional equipment and cargo. The GVWR is specific to each vehicle and is listed on the Safety Certification Label on the driver's door pillar.
- **GAWR (Gross Axle Weight Rating):** Carrying capacity for each axle system. The GAWR is specific to each vehicle and is listed on the Safety Certification Label on the driver's door pillar.
- **GCW (Gross Combined Weight):** The combined weight of the towing vehicle (including occupants and cargo) and the loaded trailer.
- **GCWR (Gross Combined Weight Rating):** Maximum permissible combined weight of towing vehicle (including occupants and cargo) and the loaded trailer

- **Maximum Trailer Weight Rating:** Maximum weight of a trailer the vehicle is permitted to tow. The maximum trailer weight rating is determined by subtracting the vehicle curb weight for each engine/transmission combination, any required option weight for trailer towing and the weight of the driver from the GCWR for the towing vehicle.
- **Maximum Trailer Weight:** Maximum weight of a trailer the loaded vehicle (including occupants and cargo) is permitted to tow. It is determined by subtracting the weight of the loaded trailer towing vehicle from the GCWR for the towing vehicle.
- **Trailer Weight Range:** Specified weight range that the trailer must fall within that ranges from zero to the maximum trailer weight rating.

Remember to figure in the tongue load of your loaded trailer when figuring the total weight.

**WARNING: Do not exceed the GVWR or the GAWR specified on the certification label.**

Do not use replacement tires with lower load carrying capacities than the originals because they may lower the vehicle's GVWR and GAWR limitations. Replacement tires with a higher limit than the originals do not increase the GVWR and GAWR limitations.

The Safety Certification Label, found on the driver's door pillar, lists several important vehicle weight rating limitations. Before adding any additional equipment, refer to these limitations. If you are adding weight to the front of your vehicle, (potentially including weight added to the cab), the weight added should not exceed the front axle reserve capacity (FARC). Additional frontal weight may be added to the front axle reserve capacity provided you limit your payload in other ways (i.e. restrict the number of occupants or amount of cargo carried).

Always ensure that the weight of occupants, cargo and equipment being carried is within the weight limitations that have been established for your vehicle including both gross vehicle weight and front and rear gross axle weight rating limits. Under no circumstance should these limitations be exceeded.

**WARNING: Exceeding any vehicle weight rating limitation could result in serious damage to the vehicle and/or personal injury.**

## Driving

### Special loading instructions for owners of pickup trucks and utility-type vehicles

**WARNING:** For important information regarding safe operation of this type of vehicle, see the *Preparing to drive your vehicle* section in this chapter.

**WARNING:** Loaded vehicles, with a higher center of gravity, may handle differently than unloaded vehicles. Extra precautions, such as slower speeds and increased stopping distance, should be taken when driving a heavily loaded vehicle.

Your vehicle has the capability to haul more cargo and people than most passenger cars. Depending upon the type and placement of the load, hauling cargo and people may raise the center of gravity of the vehicle.

### Calculating the load your vehicle can carry/tow

1. Use the appropriate maximum gross combined weight rating (GCWR) chart (in the *Trailer Towing* section) to find the maximum GCWR for your type engine and rear axle ratio.
2. Weigh your vehicle as you customarily operate the vehicle without cargo. To obtain correct weights, try taking your vehicle to a shipping company or an inspection station for trucks.
3. Subtract your loaded vehicle weight from the maximum GCWR on the following charts. This is the maximum trailer weight your vehicle can tow and must fall below the maximum shown under maximum trailer weight on the chart.

### TRAILER TOWING

Your vehicle may tow a class I, II or III trailer provided the maximum trailer weight is less than or equal to the maximum trailer weight listed for your engine and rear axle ratio on the following charts.

Your vehicle's load capacity is designated by weight, not by volume, so you cannot necessarily use all available space when loading a vehicle.

Towing a trailer places an additional load on your vehicle's engine, transmission, axle, brakes, tires and suspension. Inspect these components carefully after any towing operation.

4x2 w/manual transmission				
Engine	Rear axle ratio	Maximum GCWR - kg (lbs.)	Maximum trailer weight - kg (lbs.)	Maximum frontal area of trailer - m <sup>2</sup> (ft <sup>2</sup> )

Regular Cab				
2.3L	All	2,177 (4,800)	744 (1,640)	Equal to frontal area of vehicle
3.0L Dual Sport	All	2,722 (6,000)	1,161 (2,560)	4.64 (50)

Cab Plus				
3.0L Dual Sport	All	2,722 (6,000)	1,070 (2,360)	4.64 (50)
4.0L Dual Sport	All	3,175 (7,000)	1,488 (3,380)	4.64 (50)

For high altitude operation, reduce GCW by 2% per 300 meters (1,000 ft.) elevation.

For definition of terms used in this table see *Vehicle Loading* earlier in this chapter.

To determine maximum trailer weight designed for your particular vehicle, see *Calculating the load* earlier in this chapter.

Maximum trailer weight is shown. The combined weight of the completed towing vehicle (including hitch, passengers and cargo) and the loaded trailer must not exceed the Gross Combined Weight Rating (GCWR).

4x4 w/manual transmission				
Engine	Rear axle ratio	Maximum GCWR - kg (lbs.)	Maximum trailer weight - kg (lbs)	Maximum frontal area of trailer - m <sup>2</sup> (ft <sup>2</sup> )

Regular Cab				
3.0L	All	2,722 (6,000)	1,070 (2,360)	4.64 (50)

Cab Plus				
3.0L	All	2,722 (6,000)	980 (2,160)	4.64 (50)
4.0L	All	3,175 (7,000)	1,388 (3,060)	4.64 (50)

For high altitude operation, reduce GCW by 2% per 300 meters (1,000 ft.) of elevation.

## Driving

### 4x4 w/manual transmission

For definition of terms used in this table, see *Vehicle loading* earlier in this chapter.

To determine maximum trailer weight designed for your vehicle, see *Calculating the load* earlier in this chapter.

Maximum trailer weight is shown. The combined weight of the completed towing vehicle (including hitch, passengers and cargo) and the loaded trailer must not exceed the Gross Combined Weight Rating (GCWR).

### 4x2 w/automatic transmission

Engine	Rear axle ratio	Maximum GCWR - kg (lbs.)	Maximum trailer weight - kg (lbs.)	Maximum frontal area of trailer - m <sup>2</sup> (ft <sup>2</sup> )
<b>Regular Cab</b>				
2.3L	All	2,495 (5,500)	1,025 (2,260)	Equal to frontal area of vehicle
3.0L Dual Sport	All	3,402 (7,500)	1,823 (4,020)	4.64 (50)
<b>Cab Plus</b>				
3.0L Dual Sport	All	3,402 (7,500)	1,733 (3,820)	4.64 (50)
4.0L Dual Sport	All	4,309 (9,500)	2,604 (5,740)	4.64 (50)

For high altitude operation, reduce GCW by 2% per 300 meters (1,000 ft.) elevation.

For definition of terms used in this table see *Vehicle Loading* earlier in this chapter.

To determine maximum trailer weight designed for your particular vehicle, see *Calculating the load* earlier in this chapter.

Maximum trailer weight is shown. The combined weight of the completed towing vehicle (including hitch, passengers and cargo) and the loaded trailer must not exceed the Gross Combined Weight Rating (GCWR).

## 4x4 w/automatic transmission

Engine	Rear axle ratio	Maximum GCWR - kg (lbs.)	Maximum trailer weight - kg (lbs.)	Maximum frontal area of trailer - m <sup>2</sup> (ft <sup>2</sup> )
<b>Regular Cab</b>				
3.0L	All	3,402 (7,500)	1,742 (3,840)	4.64 (50)
<b>Cab Plus</b>				
3.0L	All	3,402 (7,500)	1,651 (3,640)	4.64 (50)
4.0L	All	4,309 (9,500)	2,504 (5,520)	4.64 (50)
For high altitude operation, reduce GCW by 2% per 300 meters (1,000 ft.) of elevation.				
For definition of terms used in this table, see <i>Vehicle loading</i> earlier in this chapter.				
To determine maximum trailer weight designed for your vehicle, see <i>Calculating the load</i> earlier in this chapter.				
Maximum trailer weight is shown. The combined weight of the completed towing vehicle (including hitch, passengers and cargo) and the loaded trailer must not exceed the Gross Combined Weight Rating (GCWR).				

**WARNING: Do not exceed the GVWR or the GAWR specified on the certification label.**

**WARNING: Towing trailers beyond the maximum recommended gross trailer weight could result in engine damage, transmission/axle damage, structural damage, loss of control and personal injury.**

## Preparing to tow

Use the proper equipment for towing a trailer, and make sure it is properly attached to your vehicle. See your dealer or a reliable trailer dealer if you require assistance.

### Hitches

For towing trailers up to 907 kg (2,000 lb), use a weight carrying hitch and ball which uniformly distributes the trailer tongue loads through the underbody structure. Use a frame-mounted weight distributing hitch for trailers over 907 kg (2,000 lb).

## Driving

Do not install a single or multi-clamp type bumper hitch, or a hitch which attaches to the axle. Underbody mounted hitches are acceptable if they are installed properly. Follow the towing instructions of a reputable rental agency.

Whenever a trailer hitch and hardware are removed, make sure all mounting holes in the underbody are properly sealed to prevent noxious gases or water from entering.

### ***Safety chains***

Always connect the trailer's safety chains to the frame or hook retainers of the vehicle hitch. To connect the trailer's safety chains, cross the chains under the trailer tongue and allow slack for turning corners.

If you use a rental trailer, follow the instructions that the rental agency gives to you.

**Do not attach safety chains to the bumper.**

### ***Trailer brakes***

Electric brakes and manual, automatic or surge-type trailer brakes are safe if installed properly and adjusted to the manufacturer's specifications. The trailer brakes must meet local and Federal regulations.

**WARNING: Do not connect a trailer's hydraulic brake system directly to your vehicle's brake system. Your vehicle may not have enough braking power and your chances of having a collision greatly increase.**

The braking system of the tow vehicle is rated for operation at the GVWR not GCWR.

### ***Trailer lamps***

Trailer lamps are required on most towed vehicles. Make sure your trailer lamps conform to local and Federal regulations. See your dealer or trailer rental agency for proper instructions and equipment for hooking up trailer lamps.

### ***Using a step bumper***

The optional step bumper is equipped with an integral hitch and requires only a ball with a 19 mm (3/4 inch) shank diameter. The bumper has a 907 kg (2,000 lb.) trailer weight and 91 kg (200 lb.) tongue weight capability.



The rated capacities (as shown in this guide) for trailer towing with the factory bumper are only valid when the trailer hitch ball is installed directly into the ball hole in the bumper. Addition of bracketry to either lower the ball hitch position or extend the ball hitch rearward will significantly increase the loads on the bumper and its attachments. This can result in the failure of the bumper or the bumper attachments. Use of any type of hitch extensions should be considered abuse.

## **Trailer tow connector**

The trailer tow connector is located under the rear bumper, on the driver's side of the vehicle.

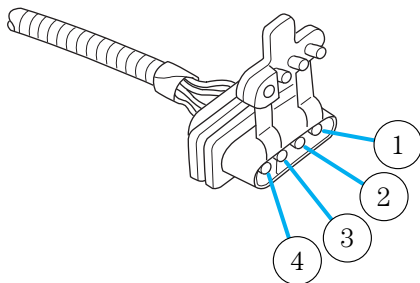

Refer to the following chart for information regarding the factory-equipped trailer tow connector:

<b>Trailer tow connector</b>		
<b>Color</b>	<b>Function</b>	<b>Comment</b>
1. Dark Green	Trailer right-hand turn signal	Circuit activated when brake pedal is depressed or when ignition is on and right-hand turn signal is applied.
2. Yellow	Trailer left-hand turn signal	Circuit activated when brake pedal is depressed or when ignition is on and left-hand turn signal is applied.
3. Tan/White	Tail lamp	Relay controlled circuit activated when the park lamps/headlamps are on.
4. White	Ground	Matching vehicle circuit returns to battery's negative ground.

# Driving

## Driving while you tow

When towing a trailer:

- Turn off the speed control. The speed control may shut off automatically when you are towing on long, steep grades.
- Consult your local motor vehicle speed regulations for towing a trailer.
- To eliminate excessive shifting, use a lower gear. This will also assist in transmission cooling. (For additional information, refer to the *Driving with a 4-speed automatic transmission* section in this chapter.
- Anticipate stops and brake gradually.
- Do not exceed the GCWR rating or transmission damage may occur.

## Servicing after towing

If you tow a trailer for long distances, your vehicle will require more frequent service intervals. Refer to your service maintenance section for more information.

## Trailer towing tips

- Practice turning, stopping and backing up before starting on a trip to get the feel of the vehicle trailer combination. When turning, make wider turns so the trailer wheels will clear curbs and other obstacles.
- Allow more distance for stopping with a trailer attached.
- The trailer tongue weight should be 10–15% of the loaded trailer weight.
- After you have traveled 80 km (50 miles), thoroughly check your hitch, electrical connections and trailer wheel lug nuts.
- To aid in engine/transmission cooling and A/C efficiency during hot weather while stopped in traffic, place the gearshift lever in P (Park) (automatic transmission) or N (Neutral) (manual transmissions).
- Vehicles with trailers should not be parked on a grade. If you must park on a grade, place wheel chocks under the trailer's wheels.

## Launching or retrieving a boat

**Disconnect the wiring to the trailer before backing the trailer into the water. Reconnect the wiring to the trailer after the trailer is removed from the water.**

When backing down a ramp during boat launching or retrieval:

- do not allow the static water level to rise above the bottom edge of the rear bumper.
- do not allow waves to break higher than 15 cm (6 inches) above the bottom edge of the rear bumper.

Exceeding these limits may allow water to enter vehicle components:

- causing internal damage to the components.
- affecting driveability, emissions and reliability.

Replace the rear axle lubricant any time the axle has been submerged in water. Rear axle lubricant quantities are not to be checked or changed unless a leak is suspected or repair required.

## RECREATIONAL TOWING

Follow these guidelines if you have a need for recreational towing. An example of recreational towing would be towing your vehicle behind a motorhome. These guidelines are designed to ensure that your transmission is not damaged.

### **4x2 and 4x4 vehicles equipped with manual transmissions:**

Before you have your vehicle towed:

- Release the parking brake.
- Move the gearshift to the neutral position.
- Turn the key in the ignition to the OFF/UNLOCKED position.
- The maximum recommended speed is 88 km/h (55 mph).
- The maximum recommended distance is unlimited.

**In addition, it is recommended that you follow the instructions provided by the after market manufacturer of the towing apparatus if one has been installed.**

## Driving

### **4x2 and 4x4 vehicles equipped with automatic transmissions:**

4x2 vehicles with automatic transmissions or 4x4 vehicles with manual transfer cases and automatic transmissions, follow these guidelines for recreational towing:

- Release the parking brake.
- Turn the key in the ignition to the OFF/UNLOCKED position.
- Place the transmission in N (Neutral).
- Do not exceed a distance of 80 km (50 miles).
- Do not exceed 56 km/h (35 mph) vehicle speed.

If a distance of 80 km (50 miles) or a speed of 56 km/h (35 mph) must be exceeded, you must disconnect the driveshaft. Mazda recommends the driveshaft be removed/installed only by a qualified technician. See your local dealer for driveshaft removal/installation.

**Improper removal/installation of the driveshaft can cause transmission fluid loss, damage to the driveshaft and internal transmission components.**

### **CAMPER BODIES**

Your pickup is not recommended for slide-in camper bodies.

# Roadside Emergencies

## GETTING ROADSIDE ASSISTANCE

To fully assist you should you have a vehicle concern, Mazda Motor Corporation offers a complimentary roadside assistance program. This program is separate from the New Vehicle Limited Warranty. The service is available:

- 24-hours, seven days a week
- for the New Vehicle Limited Warranty period of three years or 60,000 km (36,000 miles), whichever occurs first on Mazda vehicles, and four years or 80,000 km (50,000 miles) on Mazda vehicles.

Roadside assistance will cover:

- changing a flat tire
- jump-starts
- lock-out assistance
- limited fuel delivery
- towing of your disabled vehicle to the nearest Mazda Motor Corporation dealership, or your selling dealer if within 56.3 km (35 miles) of the nearest Mazda Motor Corporation dealership (one tow per disablement). Even non-warranty related tows, like accidents or getting stuck in the mud or snow, are covered (some exclusions apply, such as impound towing or repossession).

## Canadian customers refer to your Owner Information Guide for information on:

- Coverage period
- Exact fuel amounts
- Towing of your disabled vehicle
- Emergency travel expense reimbursement
- Travel planning benefits

## USING ROADSIDE ASSISTANCE

Complete the roadside assistance identification card and place it in your wallet for quick reference. In the United States, this card is found in the Owner Guide portfolio in the glove compartment. In Canada, the card is found in the Roadside Assistance book in the glove compartment.

U.S. Mazda vehicle customers who require roadside assistance, call 1-800-241-3673.

Canadian customers who require roadside assistance, call 1-800-665-2006.

## Roadside Emergencies

If you need to arrange roadside assistance for yourself, Mazda Corporation will reimburse a reasonable amount. To obtain reimbursement information, U.S. Mazda vehicle customers call 1-800-241-3673.

Canadian customers who need to obtain reimbursement information, call 1-800-665-2006.

### ROADSIDE COVERAGE BEYOND BASIC WARRANTY

In the United States, you may purchase additional roadside assistance coverage beyond this period through the Mazda Auto Club by contacting your Mazda dealer.

Similarly in Canada, for uninterrupted Roadside Assistance coverage, you may purchase extended coverage prior to your Basic Warranty's Roadside Assistance expiring. For more information and enrollment, contact 1-877-294-2582 or visit our website at [www.mazda.ca](http://www.mazda.ca).

### HAZARD FLASHER

Use only in an emergency to warn traffic of vehicle breakdown, approaching danger, etc. The hazard flashers can be operated when the ignition is off.

- The hazard lights control is located on top of the steering column.
- Depress hazard lights control to activate all hazard flashers simultaneously.
- Depress control again to turn the flashers off.

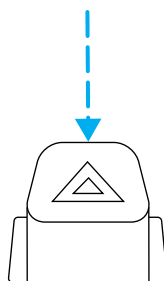

### FUEL PUMP SHUT-OFF SWITCH FUEL RESET

The fuel pump shut-off switch is a device intended to stop the electric fuel pump when your vehicle has been involved in a substantial jolt.

After a collision, if the engine cranks but does not start, the fuel pump shut-off switch may have been activated. The “Fuel Reset” indicator light will illuminate in the instrument cluster.

## Roadside Emergencies

The fuel pump shut-off switch is located in the passenger's foot well, by the kick panel.

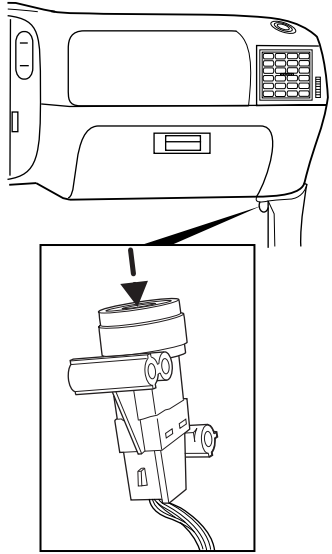

Use the following procedure to reset the fuel pump shut-off switch.

1. Turn the ignition to the OFF position.
2. Check the fuel system for leaks.
3. If no fuel leak is apparent, reset the fuel pump shut-off switch by pushing in on the reset button.
4. Turn the ignition to the ON position. Pause for a few seconds and return the key to the OFF position.
5. Make a further check for leaks in the fuel system.

## FUSES AND RELAYS

### Fuses

If electrical components in the vehicle are not working, a fuse may have blown. Blown fuses are identified by a broken wire within the fuse. Check the appropriate fuses before replacing any electrical components.

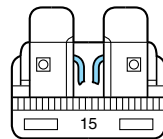

## Roadside Emergencies

**Note:** Always replace a fuse with one that has the specified amperage rating. Using a fuse with a higher amperage rating can cause severe wire damage and could start a fire.

### *Standard fuse amperage rating and color*

COLOR					
Fuse rating	Mini fuses	Standard fuses	Maxi fuses	Cartridge maxi fuses	Fuse link cartridge
2A	Grey	Grey	—	—	—
3A	Violet	Violet	—	—	—
4A	Pink	Pink	—	—	—
5A	Tan	Tan	—	—	—
7.5A	Brown	Brown	—	—	—
10A	Red	Red	—	—	—
15A	Blue	Blue	—	—	—
20A	Yellow	Yellow	Yellow	Blue	Blue
25A	Natural	Natural	—	—	—
30A	Green	Green	Green	Pink	Pink
40A	—	—	Orange	Green	Green
50A	—	—	Red	Red	Red
60A	—	—	Blue	—	Yellow
70A	—	—	Tan	—	Brown
80A	—	—	Natural	—	Black



# Roadside Emergencies

## Passenger compartment fuse panel

The fuse panel is located on the left-hand side of the instrument panel facing the driver's side door. Pull the panel cover outward to access the fuses.

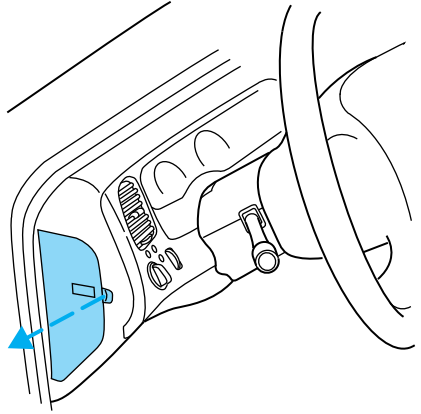

To remove a fuse use the fuse puller tool provided on the fuse panel cover.

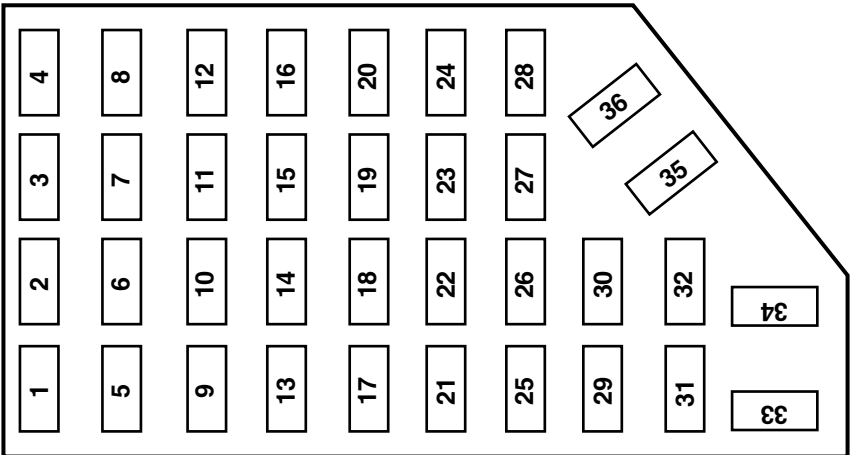

## Roadside Emergencies

The fuses are coded as follows:

Fuse/Relay Location	Fuse Amp Rating	Passenger Compartment Fuse Panel Description
1	5A	Power mirror switch
2	10A	Daytime Running Lights (DRL), Back-up lamps, Transmission, Passenger air bag deactivation switch, Blower motor relay
3	7.5A	Right stop/turn trailer tow connector
4	—	Not used
5	15A	4x4 control module
6	2A	Brake pressure switch
7	7.5A	Left stop/turn trailer tow connector
8	—	Not used
9	7.5A	Brake pedal position switch
10	7.5A	Speed control servo/amplifier assembly, Generic Electronic Module (GEM), Shift lock actuator, Turn signals
11	7.5A	Instrument cluster, 4x4, Main light switch, Central Security Module (CSM)
12	—	Not used
13	20A	Brake pedal position switch
14	10A or Not Used	10A: Anti-lock Brake System (ABS) Control Module (if equipped)
15	—	Not used
16	30A	Windshield wiper motor, Wiper HI/LO relay, Wiper run/park relay
17	20A	Cigar lighter, Data Link Connector (DLC)

## Roadside Emergencies

Fuse/Relay Location	Fuse Amp Rating	Passenger Compartment Fuse Panel Description
18	—	Not used
19	25A	Powertrain Control Module (PCM) power diode, Ignition, PATS
20	7.5A	GEM, Radio
21	15A	Hazard flasher
22	20A	Auxiliary power socket
23	—	Not used
24	7.5A	Clutch Pedal Position (CPP) switch, Starter interrupt relay
25	—	Not used
26	10A	Battery saver relay, Auxiliary relay box, Restraint Central Module (RCM), GEM, Instrument cluster
27	—	Not used
28	7.5A	GEM, Radio
29	20A	Radio
30	—	Not used
31	—	Not used
32	—	Not used
33	15A	Headlamps, Daytime Running Lamps (DRL) module, Instrument cluster
34	—	Not used
35	15A	Horn relay (if not equipped with a CSM)
36	—	Not used

## Roadside Emergencies

### Power distribution box

The power distribution box is located in the engine compartment. The power distribution box contains high-current fuses that protect your vehicle's main electrical systems from overloads.

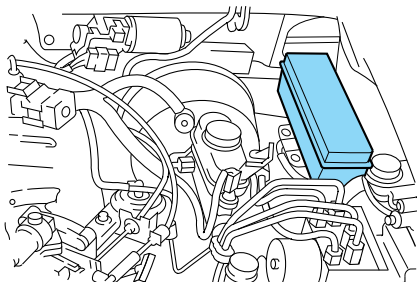

**WARNING:** Always disconnect the battery before servicing high current fuses.

**WARNING:** To reduce risk of electrical shock, always replace the cover to the Power Distribution Box before reconnecting the battery or refilling fluid reservoirs.

If the battery has been disconnected and reconnected, refer to the *Battery* section of the *Maintenance and specifications* chapter.

# Roadside Emergencies

## 2.3L engine (if equipped)

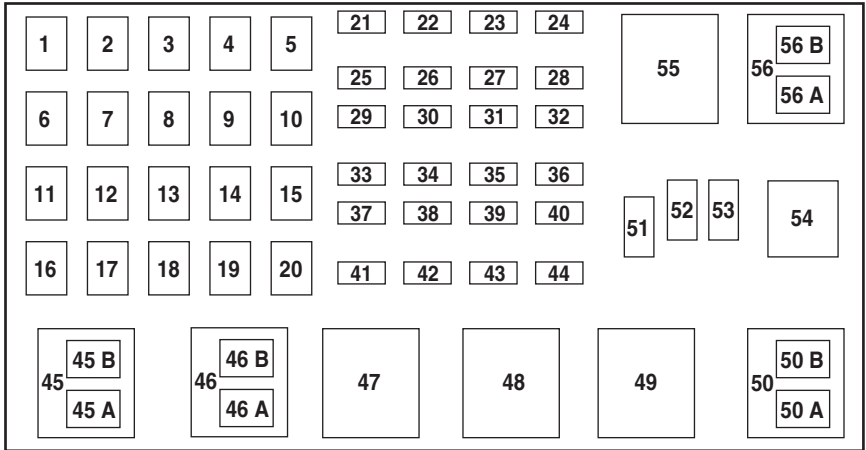

The high-current fuses are coded as follows:

Fuse/Relay Location	Fuse Amp Rating	Power Distribution Box Description
1	50A**	I/P fuse panel
2	—	Not used
3	—	Not used
4	—	Not used
5	—	Not used
6	50A**	Anti-lock Brake System (ABS) pump motor
7	30A*	Powertrain Control Module (PCM)
8	20A*	Central security module, Power door locks, Remote entry
9	—	Not used
10	—	Not used
11	50A**	Starter relay, Ignition switch
12	20A*	Power windows

## Roadside Emergencies

Fuse/Relay Location	Fuse Amp Rating	Power Distribution Box Description
13	—	Not used
14	—	Not used
15	—	Not used
16	40A**	Blower motor
17	20A**	Auxiliary cooling fan
18	—	Not used
19	—	Not used
20	—	Not used
21	10A*	PCM memory
22	—	Not used
23	20A*	Fuel pump motor
24	30A*	Headlamps
25	10A*	A/C clutch relay
26	—	Not used
27	—	Not used
28	30A*	ABS module
29	—	Not used
30	15A*	Trailer Tow
31	20A*	Foglamp, Daytime Running Lamps (DRL)
32	—	Not used
33	15A*	Park lamp, Central security module
34	—	Not used
35	—	Not used
36	—	Not used
37	—	Not used
38	10A*	Left headlamp low beam
39	—	Not used
40	—	Not used
41	20A*	Heated oxygen sensors

## Roadside Emergencies

Fuse/Relay Location	Fuse Amp Rating	Power Distribution Box Description
42	10A*	Right headlamp low beam
43	—	(Resistor)
44	—	Not used
45A	—	Wiper HI/LO relay
45B	—	Wiper park/run relay
46A	—	Fuel pump relay
46B	—	Trailer tow relay
47	—	Starter relay
48	—	Auxiliary cooling fan
49	—	Not used
50	—	Not used
51	—	Not used
52	—	Not used
53	—	PCM Diode
54	—	PCM Relay
55	—	Blower motor relay
56A	—	A/C clutch relay
56B	—	Front washer pump relay
* Mini Fuses ** Maxi Fuses		

# Roadside Emergencies

## 3.0L and 4.0L engines (if equipped)

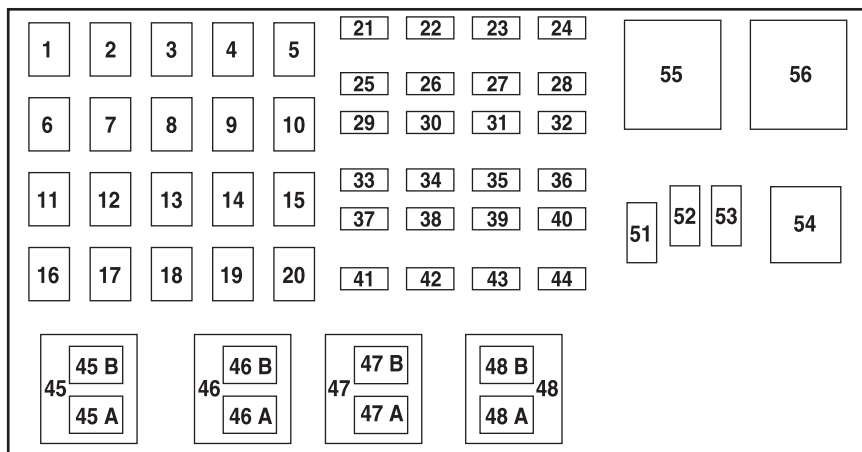

The high-current fuses are coded as follows:

Fuse/Relay Location	Fuse Amp Rating	Power Distribution Box Description
1	50A**	I/P fuse panel
2	—	Not used
3	—	Not used
4	—	Not used
5	—	Not used
6	50A**	Anti-lock Brake System (ABS) Pump Motor
7	30A*	Powertrain Control Module (PCM)
8	20A*	Power door locks, Remote entry
9	—	Not used
10	—	Not used
11	50A**	Starter relay, Ignition switch
12	20A*	Power windows
13	20A*	4x4 motor



## Roadside Emergencies

Fuse/Relay Location	Fuse Amp Rating	Power Distribution Box Description
14	—	Not used
15	—	Not used
16	40A**	Blower motor
17	—	Not used
18	—	Not used
19	—	Not used
20	—	Not used
21	10A*	PCM memory
22	—	Not used
23	20A*	Fuel pump motor
24	30A*	Headlamps
25	10A*	A/C clutch solenoid
26	—	Not used
27	—	Not used
28	30A*	ABS module
29	—	Not used
30	15A*	Trailer tow
31	20A*	Foglamps, Daytime Running Lamps (DRL)
32	—	Not used
33	15A*	Park lamp
34	—	Not used
35	—	Not used
36	—	Not used
37	—	Not used
38	10A*	Left headlamp low beam
39	—	Not used
40	—	Not used
41	20A*	Heated oxygen sensors
42	10A*	Right headlamp low beam
43	—	Not used

## Roadside Emergencies

Fuse/Relay Location	Fuse Amp Rating	Power Distribution Box Description
44	—	Not used
45A	—	Wiper HI/LO
45B	—	Wiper park/run
46A	—	Fuel pump
46B	—	Trailer tow
47A	—	A/C clutch solenoid
47B	—	Front washer pump
48A	—	Fog lamps
48B	—	Fog lamp relay
51	—	Not used
52	—	Not used
53	—	PCM Diode
54	—	PCM
55	—	Blower
56	—	Starter
* Mini Fuses ** Maxi Fuses		

### CHANGING THE TIRES

If you get a flat tire while driving, do not apply the brake heavily. Instead, gradually decrease your speed. Hold the steering wheel firmly and slowly move to a safe place on the side of the road.

The use of tire sealants is not recommended and may compromise the integrity of your tires. The use of tire sealants may also affect your tire pressure monitoring system (if equipped).

## Roadside Emergencies

### Temporary spare tire information

Your vehicle may have a temporary or conventional spare tire. The temporary spare tire for your vehicle is labeled as such. It is smaller than a regular tire and is designed for emergency use only. Replace this tire with a full-size tire as soon as possible.

It is not recommended that the vehicle be operated in 4WD modes with a temporary spare. If 4WD operation is necessary, do not operate above speeds of 16 km/h (10 mph) or for distances above 80 km (50 miles).

**WARNING: If you use the temporary spare tire continuously or do not follow these precautions, the tire could fail, causing you to lose control of the vehicle, possibly injuring yourself or others.**

When driving with the temporary spare tire **do not:**

- exceed 80 km/h (50 mph) under any circumstances
- load the vehicle beyond maximum vehicle load rating listed on the Safety Compliance Label
- tow a trailer
- use tire chains
- drive through an automatic car wash, because of the vehicle's reduced ground clearance
- try to repair the temporary spare tire or remove it from its wheel rim
- use the wheel for any other type of vehicle

### Conventional spare tire information

If you have the conventional spare tire, you can use it as a spare or a regular tire. The spare is identical to the other tires on your vehicle, although the wheel may not match.

# Roadside Emergencies

## Location of the spare tire and tools

The spare tire and tools for your vehicle are stowed in the following locations:

Tool	Location
Spare tire	Under the vehicle, just forward of the rear bumper
Jack, jack handle, wheel nut wrench	Regular Cab: behind seats and underneath the jack and tools cover
	SuperCab: stowed in the passenger side rear cab compartment or behind the jump seat in a separate tool bag
	Four-door models: stowed behind the front seats, between jump seats and underneath jack and tools cover.
Key, spare tire lock (if equipped)	In the glove box

## Removing the spare tire

1. Assemble the jack handle to the lug wrench as shown in the illustrations.

When connecting the jack handle, assemble the following:

- one handle extension and one typical extension. To assemble, slide parts together. To disconnect, depress button and pull apart.
- one wheel nut wrench. Depress button and slide together.

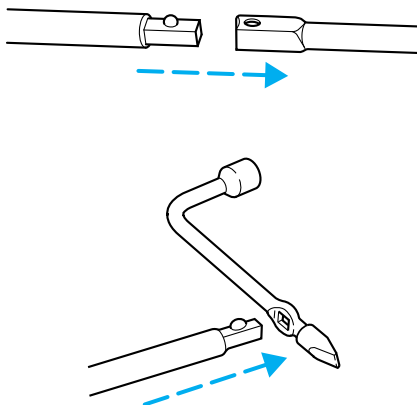

## Roadside Emergencies

2. If equipped, unlock and remove the spare tire carrier lock from the rear access hole located just above the rear bumper and below the tailgate.

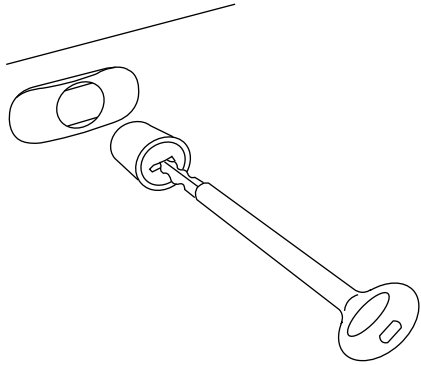

3. Insert the straight end of the jack handle into the rear access hole located just above the rear bumper and below the tailgate.

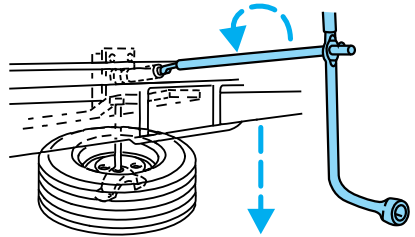

Forward motion will stop and resistance to turning will be felt when properly engaged.

4. Turn the handle counterclockwise until tire is lowered to the ground and the cable is slightly slack.
5. Remove the retainer from the spare tire.

### **Stowing the spare tire**

1. Lay the tire on the ground with the valve stem facing up.
2. Install the retainer through the wheel center and slide the wheel under the vehicle.
3. Turn the spare handle clockwise until the tire is raised to its original position underneath the vehicle. The spare handle ratchets when the tire is raised to the stowed position. It will not allow you to overtighten.

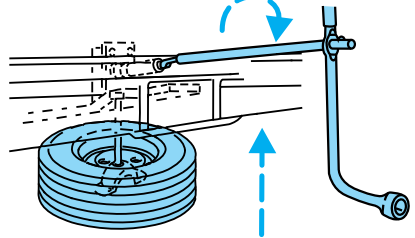

## Roadside Emergencies

4. If your vehicle is equipped with P265/75 R15 AT tires, do not stow a flat or inflated full size spare tire in the spare tire carrier. The flat full size tire should be stowed and tied down in the pickup box bed until it can be repaired.
5. If removed, install the spare tire carrier lock on the access hole above the bumper.

### Tire change procedure

**WARNING:** When one of the front wheels is off the ground, the transmission alone will not prevent the vehicle from moving or slipping off the jack, even if the vehicle is in P (Park) (automatic transmission) or R (Reverse) (manual transmission).

**WARNING:** To prevent the vehicle from moving when you change a tire, be sure the parking brake is set, then block (in both directions) the wheel that is diagonally opposite (other side and end of the vehicle) to the tire being changed.

**WARNING:** If the vehicle slips off the jack, you or someone else could be seriously injured.

1. Park on a level surface, activate hazard flashers and place gearshift lever in P (Park) (automatic transmission) or 1 (First) (manual transmission).
2. Set the parking brake and turn engine OFF.

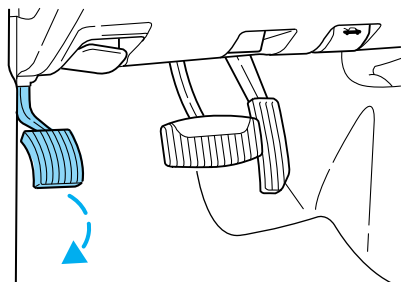

## Roadside Emergencies

- Block the diagonally opposite wheel.

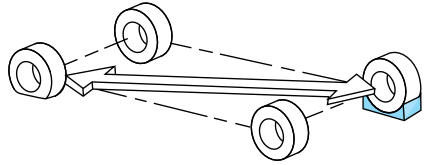

- Insert tapered end of the lug wrench behind hub caps and twist them off.
- Loosen each wheel lug nut one-half turn counterclockwise but do not remove them until the wheel is raised off the ground.

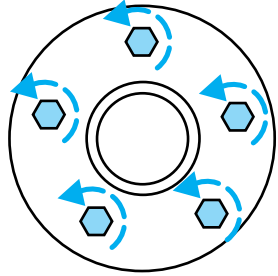

- Position the jack according to the following guides and turn the jack handle clockwise until the tire is a maximum of 25 mm (1 inch) off the ground.

- Front

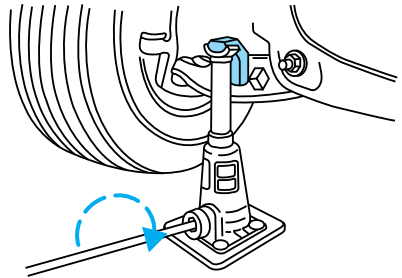

## Roadside Emergencies

- Rear

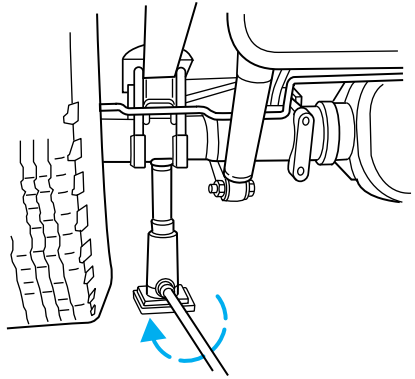

**WARNING:** To lessen the risk of personal injury, do not put any part of your body under the vehicle while changing a tire. Do not start the engine when your vehicle is on the jack. The jack is only meant for changing the tire.

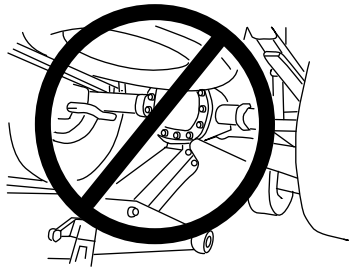

**Never use the differential as a jacking point. It is too easy for the vehicle to tilt or fall and you can be injured.**

7. Remove the wheel lug nuts with the lug wrench.
8. Replace the flat tire with the spare tire, making sure the valve stem is facing outward. Reinstall the lug nuts until the wheel is snug against the hub. Do not fully tighten the lug nuts until the wheel has been lowered.
9. Lower the wheel by turning the jack handle counterclockwise.



## Roadside Emergencies

10. Remove the jack and fully tighten the lug nuts in the order shown.
11. Stow the flat tire. Refer to *Stowing the spare tire*.
12. Stow the jack and lug wrench. Make sure the jack is fastened so it does not rattle when you drive.
13. Unblock the wheels.

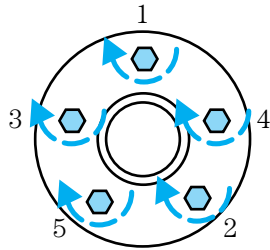

## JUMP STARTING YOUR VEHICLE

**WARNING:** The gases around the battery can explode if exposed to flames, sparks, or lit cigarettes. An explosion could result in injury or vehicle damage.

**WARNING:** Batteries contain sulfuric acid which can burn skin, eyes and clothing, if contacted.

**Do not attempt to push-start your vehicle. Automatic transmissions do not have push-start capability; also, the catalytic converter may become damaged.**

### Preparing your vehicle

When the battery is disconnected or a new battery is installed, the transmission must relearn its shift strategy. As a result, the transmission may have firm and/or soft shifts. This operation is considered normal and will not affect function or durability of the transmission. Over time, the adaptive learning process will fully update transmission operation.

1. **Use only a 12-volt supply to start your vehicle.**
2. Do not disconnect the battery of the disabled vehicle as this could damage the vehicle's electrical system.
3. Park the booster vehicle close to the hood of the disabled vehicle making sure the two vehicles **do not** touch. Set the parking brake on both vehicles and stay clear of the engine cooling fan and other moving parts.

## Roadside Emergencies

4. Check all battery terminals and remove any excessive corrosion before you attach the battery cables. Ensure that vent caps are tight and level.
5. Turn the heater fan on in both vehicles to protect any electrical surges. Turn all other accessories off.

### Connecting the jumper cables

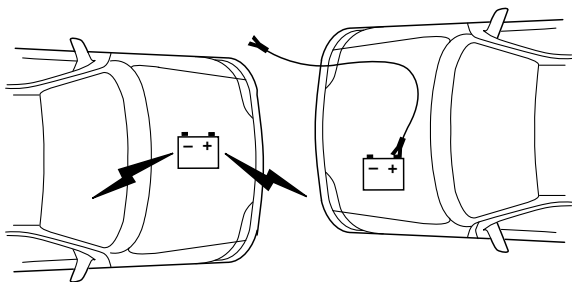

1. Connect the positive (+) booster cable to the positive (+) terminal of the discharged battery.

**Note:** In the illustrations, *lightning bolts* are used to designate the assisting (boosting) battery.

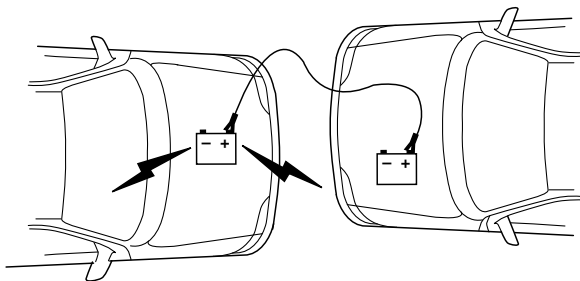

2. Connect the other end of the positive (+) cable to the positive (+) terminal of the assisting battery.

## Roadside Emergencies

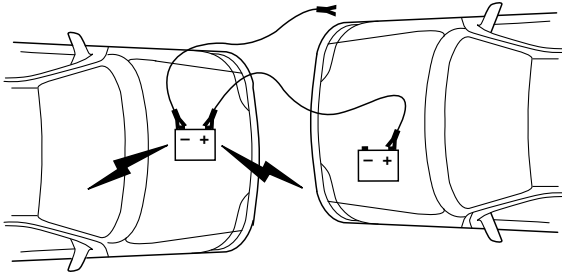

3. Connect the negative (-) cable to the negative (-) terminal of the assisting battery.

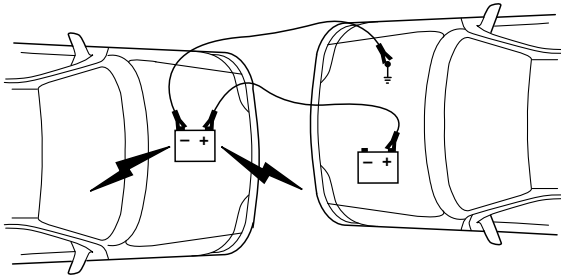

4. Make the final connection of the negative (-) cable to an exposed metal part of the stalled vehicle's engine, away from the battery and the carburetor/fuel injection system. **Do not** use fuel lines, engine rocker covers or the intake manifold as *grounding* points.

**WARNING:** Do not connect the end of the second cable to the negative (-) terminal of the battery to be jumped. A spark may cause an explosion of the gases that surround the battery.

5. Ensure that the cables are clear of fan blades, belts, moving parts of both engines, or any fuel delivery system parts.

# Roadside Emergencies

## Jump starting

1. Start the engine of the booster vehicle and run the engine at moderately increased speed.
2. Start the engine of the disabled vehicle.
3. Once the disabled vehicle has been started, run both engines for an additional three minutes before disconnecting the jumper cables.

## Removing the jumper cables

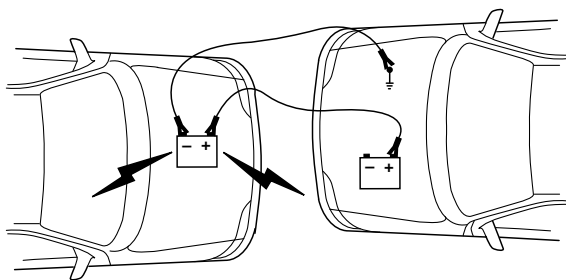

### **Remove the jumper cables in the reverse order that they were connected.**

1. Remove the jumper cable from the *ground* metal surface.

**Note:** In the illustrations, *lightning bolts* are used to designate the assisting (boosting) battery.

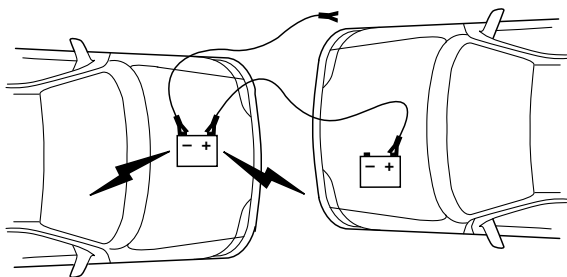

2. Remove the jumper cable on the negative (-) connection of the booster vehicle's battery.

## Roadside Emergencies

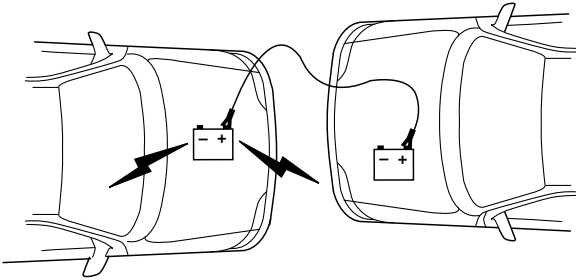

3. Remove the jumper cable from the positive (+) terminal of the booster vehicle's battery.

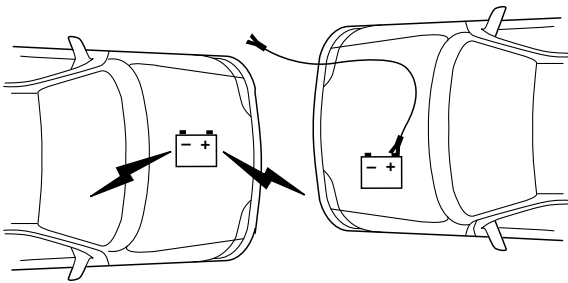

4. Remove the jumper cable from the positive (+) terminal of the disabled vehicle's battery.

After the disabled vehicle has been started and the jumper cables removed, allow it to idle for several minutes so the engine computer can *relearn* its idle conditions.

## Roadside Emergencies

### WRECKER TOWING

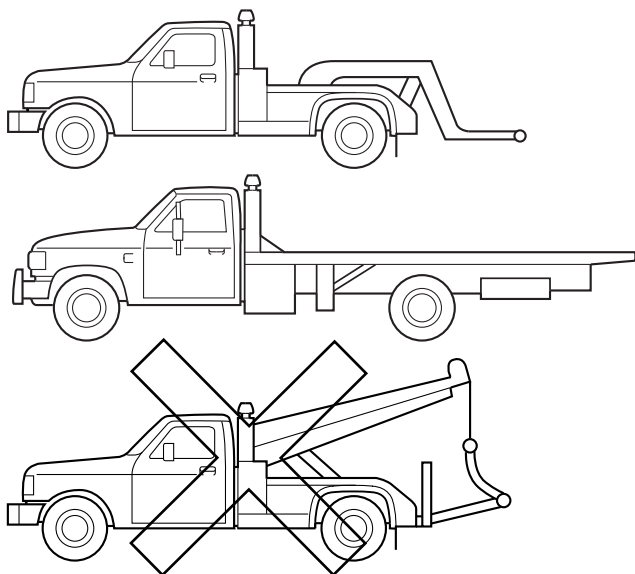

If you need to have your vehicle towed, contact a professional towing service or, if you are a member, your roadside assistance center.

It is recommended that your vehicle be towed with a wheel lift or flatbed equipment. Do not tow with a slingbelt. Mazda Motor Corporation has not approved a slingbelt towing procedure.

On 4x2 vehicles, it is acceptable to tow the vehicle with the front wheels on the ground and the rear wheels off the ground.

On 4x4 vehicles, it is recommended that your vehicle be towed with a wheel lift and dollies or flatbed equipment with all the wheels off the ground.

**If the vehicle is towed by other means or incorrectly, vehicle damage may occur.**

Mazda Motor Corporation produces a towing manual for all authorized tow truck operators. Have your tow truck operator refer to this manual for proper hook-up and towing procedures for your vehicle.

### **CUSTOMER ASSISTANCE (U.S.A.)**

Your complete and permanent satisfaction is our business. We are here to serve you. All Authorized Mazda Dealers have the knowledge and the tools to keep your Mazda vehicle in top condition.

If you have any questions or recommendations for improvement regarding the service of your Mazda vehicle or servicing by Mazda Dealer personnel, we recommend that you take the following steps:

#### **STEP 1: Contact Your Mazda Dealer**

Discuss the matter with an Authorized Mazda Dealer. This is the quickest and best way to address the issue. If your concern has not been resolved by the CUSTOMER RELATIONS, SALES, SERVICE, or PARTS MANAGER, then please contact the GENERAL MANAGER of the dealership or the OWNER.

#### **STEP 2: Call the Mazda National Customer Assistance Center**

If for any reason you feel the need for further assistance after contacting your dealership management, call Mazda North American Operations' Customer Assistance Center toll-free at: **1 (800) 222-5500**

In order to serve you efficiently and effectively, please help us by providing the following information:

1. Your name, address, and telephone number
2. Year and model of vehicle
3. Vehicle Identification Number (17 digits, noted on your registration or title or located on the upper driver's side corner of the dash)
4. Purchase date and current mileage
5. Your dealer's name and location
6. Your question(s)

If you would like to write a letter, please address it to the following, Attn: Customer Assistance.

Mazda North American Operations  
7755 Irvine Center Drive  
Irvine, CA 92618-2922  
P.O. Box 19734  
Irvine, CA 92623-9734

This way, we can be sure to respond to you as efficiently as possible. That is our goal.

If you live outside the U.S.A., please contact your nearest Mazda Distributor.

# Customer Assistance

## **CUSTOMER ASSISTANCE (CANADA)**

Your complete and permanent satisfaction is our business. We are here to serve you. All Authorized Mazda Dealers have the knowledge and the tools to keep your Mazda vehicle in top condition.

In our experience, any questions, problems or complaints regarding the operation of your Mazda or any other general service transactions are most effectively resolved by your dealer. If the cause of your dissatisfaction cannot adequately be addressed by normal dealership procedures, we recommend that you take the following steps:

### **STEP 1: Contact Your Mazda Dealer**

Discuss the matter with a member of dealership management. If the Service Manager has already reviewed your concerns, contact the owner of the dealership or its General Manager

### **STEP 2: Call the Mazda Regional Office**

If you feel that you still require assistance, ask the dealer Service Manager to arrange for you to meet the local Mazda Service Representative. If more expedient, contact Mazda Canada Inc. Regional Office nearest you for such arrangements.

### **STEP 2: Contact the Mazda Customer Relations Department**

If still not substantially satisfied, contact the Customer Relations Department, Mazda Canada Inc., 305 Milner Avenue, Suite 400 Scarborough, Ontario M1B 3V4 Canada TEL: 1 (800) 263-4680.

Provide the Department with the following information:

1. Your name, address, and telephone number
2. Year and model of vehicle
3. Vehicle Identification Number (VIN). Refer to the "Vehicle Identification Labels" page of section 10 of this manual for the location of the VIN.
4. Purchase date.
5. Present odometer reading.
6. Your dealer's name and location
7. The nature of your problem and/or cause of dissatisfaction.

The Department, in cooperation with the local Mazda Service Representative, will review the case to determine if everything possible has been done to ensure your satisfaction.



Please recognize that the resolution of service problems in most cases requires the use of your Mazda dealer's service facilities, personnel and equipment. We urge you to follow the above three steps in sequence therefore for most effective results.

### **MEDIATION/ARBITRATION PROGRAM**

Occasionally a customer concern cannot be resolved through Mazda's Customer Satisfaction Program. If after exhausting procedures in this manual, your concern is still not resolved, you have another option.

Mazda Canada Inc. participates in an arbitration program administered by the Canadian Motor Vehicle Arbitration Plan (CAMVAP). CAMVAP will advise you about how your concern may be reviewed and resolved by an independent third party through binding arbitration.

Your complete satisfaction is the goal of Mazda Canada Inc. and our dealers. Mazda's participation in CAMVAP makes a valuable contribution to our achieving that goal. There is no charge for using CAMVAP. CAMVAP results are fast, fair and final as the award is binding on both you and Mazda Canada Inc.

### **CANADIAN MOTOR VEHICLE ARBITRATION PLAN (CAMVAP)**

If a specific item of concern arises, where a solution cannot be reached between an owner, Mazda, and/or one of its dealers (that all parties cannot agree upon), the owner may wish to use the services offered by the Canadian Motor Vehicle Arbitration Plan (CAMVAP).

CAMVAP uses the services of Provincial Administrators to assist consumers in scheduling and preparing for their arbitration hearings. However, before you can proceed with CAMVAP you must follow your Mazda dispute resolution process as outlined previously.

CAMVAP is fully implemented in all provinces and territories. Consumers wishing to obtain further information about the Program can obtain an information booklet from their dealer, the Provincial Administrator of the Canadian Motor Vehicle Arbitration Plan Office at the following address or telephone number.

Canadian Motor Vehicle Arbitration Office  
235 Yorkland Boulevard, Suite 300  
North York, Ontario  
M2J 4Y8  
1 (800) 207-0685

## Customer Assistance

Provincial Administrators may be reached locally as listed below:

Province/Territory	CAMVAP Number
British Columbia & Yukon Territories	(604) 681-0312
Alberta & Northwest Territories	(403) 426-0650
Saskatchewan	(306) 352-9259
Manitoba	(204) 942-7166
Ontario	(416) 596-8824
Atlantic Canada	(902) 422-5413
Quebec	(418) 649-1330

### REGIONAL OFFICES

Regional Offices	Areas Covered
Mazda Canada Inc. Western Region 8171 Ackroyd Road Suite 2000 Richmond, B.C. V6X 3K1 (604) 303-5670	Alberta, British Columbia, Manitoba, Saskatchewan, Yukon
Mazda Canada Inc. Central/Atlantic Region 305 Milner Avenue Suite 400 Scarborough, Ontario. M1B 3V4 1 (800) 263-4680	Ontario, New Brunswick, Nova Scotia, Prince Edward Island, Newfoundland
Mazda Canada Inc. Quebec Region 6111 Route Trans Canadienne Pointe Claire, Quebec H9R 5A5 (514) 694-6390	Quebec

### **CUSTOMER ASSISTANCE (PUERTO RICO)**

Your complete and permanent satisfaction is our business. That is why all Authorized Mazda Dealers have the knowledge and the tools to keep your Mazda vehicle in top condition.

If you have any questions or recommendations for improvement regarding the service of your Mazda vehicle or servicing by Mazda Dealer personnel, we recommend that you take the following steps:

#### **STEP 1**

Discuss the matter with an Authorized Mazda Dealer. This is the quickest and best way to address the issue. If your concern has not been resolved by the CUSTOMER RELATIONS, SALES, SERVICE, or PARTS MANAGER, then please contact the GENERAL MANAGER of the dealership or the OWNER.

#### **STEP 2**

If, after following STEP 1, you feel the need for further assistance, please contact your area's Mazda representative (Indicated on the next page).

Please help us by providing the following information:

1. Your name, address, and telephone number
2. Year and model of vehicle
3. Vehicle Identification Number (17 digits, noted on your registration or title or located on the upper driver's side corner of the dash)
4. Purchase date and current mileage
5. Your dealer's name and location
6. Your question(s)

If you would like to write a letter, please address it to the following,  
Attn: Customer Assistance

Plaza Motors Corp.

Mazda de Puerto Rico

P.O. Box 362722

San Juan, Puerto Rico

00936-2722

Tel: (787) 788-9300

This way, we can be sure to respond to you as efficiently as possible. That is our goal.

If you live outside the U.S.A., please contact your nearest Mazda Distributor.

# Customer Assistance

## **MAZDA IMPORTERS/DISTRIBUTORS**

### **U.S.A (Importer/Distributor)**

#### **Mazda North American Operations**

7755 Irvine Center Drive

Irvine, CA 92618-2922

P.O. Box 19734

Irvine, CA 92623-9734

TEL: 1 (800) 222-5500 (in U.S.A.)

(949) 727-1990 (outside U.S.A.)

### **(Distributor in each area)**

## **CANADA**

### **Mazda Canada Inc.**

305 Milner Avenue, Suite 400

Scarborough, Ontario M1B 3V4 Canada

TEL: 1 (800) 263-4680 (in Canada)

(416) 609-9909 (outside Canada)

## **PUERTO RICO**

### **Plaza Motors Corp. (Mazda de Puerto Rico)**

P.O. Box 362722, San Juan, Puerto Rico 00936-2722

TEL: (787) 788-9300

## **GUAM**

### **Triple J. Motors**

P.O. Box 6066 Tamuning, Guam

TEL: (671) 649-6555

## **SAIPAN**

### **Triple J Saipan, Inc.**

#### **(d.b.a. Triple J Motors)**

P.O. Box 500487 Saipan, MP 96950-0487

TEL: (670) 234-7133 / 3051

## **AMERICAN SAMOA**

### **Polynesia Motors, Inc.**

P.O. Box 1120, Pago Pago, American Samoa 96799

TEL: (684) 699-9347

### ADD-ON NON-GENUINE PARTS AND ACCESSORIES

Non-genuine parts and accessories for Mazda vehicles can be found in stores. These may fit your vehicle, but they are not approved by the manufacturer for use with Mazda vehicles. When you install non-genuine parts or accessories, they could affect your vehicle's performance or safety system; the manufacturer's warranty doesn't cover this. Before you install any non-genuine parts or accessories, consult an Authorized Mazda Dealer.

**WARNING: Installation of Non-Genuine Parts or Accessories: Installation of non-genuine parts or accessories could be dangerous. Improperly designed parts or accessories could seriously affect your vehicle's performance or safety system. This could cause you to have an accident or increase your chances of injuries in an accident. Always consult an Authorized Mazda Dealer before you install non-genuine parts or accessories.**

**WARNING: Add-On Electrical and Electronic Equipment: Incorrectly choosing or installing improper add-on equipment or choosing an improper installer could be dangerous. Essential systems could be damaged, causing engine stalling, air-bag (SRS) activation, ABS inactivation, or a fire in the vehicle. Be very careful in choosing and installing add-on electrical equipments, such as mobile telephones, two-way radios, stereo systems, and car alarm systems.**

Mazda assumes no responsibility for death, injury, or expenses that may result from the installation of add-on non-genuine parts or accessories.

### WARRANTIES FOR YOUR MAZDA

- New Vehicle Limited Warranty
- Safety Restraint System Limited Warranty
- Anti-perforation Limited Warranty
- Federal Emission Control Warranty
  - Emission Defect Warranty
  - Emission Performance Warranty
- California Emission Control Warranty (if applicable)
- Replacement Parts and Accessories Limited Warranty
- Tire Warranty

**NOTE:**Detailed warranty information is provided with your Mazda.

## Customer Assistance

### OUTSIDE THE UNITED STATES AND CANADA

Government regulations in the United States require that automobiles meet specific emission regulations and safety standards. Therefore, vehicles built for use in the United States, its territories, and Canada may differ from those sold in other countries.

The differences may make it difficult or even impossible for your vehicle to receive satisfactory servicing in other countries. We strongly recommend that you NOT take your Mazda outside these areas.

You may have these problems if you do:

- Recommended fuel may be unavailable. Any kind of leaded fuel or low-octane fuel will affect vehicle performance and damage the emission controls and engine.
- Proper repair facilities, tools, testing equipment, and replacement parts may not be available.

The manufacturer's warranty applies only to Mazda vehicles registered and normally operated in the United States, its territories, and Canada.

### REPORTING SAFETY DEFECTS

If you believe that your vehicle has a defect which could cause a crash or could cause injury or death, you should immediately inform the National Highway Traffic Safety Administration (NHTSA) in addition to notifying Mazda Motor Corporation (Your Mazda Importer/Distributor).

If NHTSA receives similar complaints, it may open an investigation, and if it finds that a safety defect exists in a group of vehicles, it may order a recall and remedy campaign. However NHTSA cannot become involved in individual problems between you, your dealer, or Mazda Motor Corporation (Your Mazda Importer/Distributor).

To contact NHTSA, you may either call the Auto Safety Hotline toll-free at 1 (800) 424-9393 (or 366-0123 in Washington, D.C. area) or write to: NHTSA, U.S. Department of Transportation, Washington, D.C. 20590. You can also obtain other information about motor vehicle safety from the Hotline.

## Customer Assistance

(Note)

If you live in the U.S.A., all correspondence to Mazda Motor Corporation should be forwarded to:

Mazda North American Operations  
7755, Irvine Center Drive  
Irvine, California 92618-2922  
P.O. Box 19734  
Irvine, CA 92623-9734  
Customer Assistance Center  
or toll free at 1 (800) 222-5500

If you live outside of the U.S.A., please contact the nearest Mazda Distributor. ( See the *Mazda Importers/Distributors* section of this manual).

### SERVICE PUBLICATIONS

Factory-authorized Mazda service publication are available for owners who wish to do some of their own maintenance and repair.

When requesting any of our publications through an Authorized Mazda Dealer, refer to the chart below.

If they don't have what you need in stock, they can order it for you.

PUBLICATION ORDER NUMBER	PUBLICATION DESCRIPTION
9999 95 062B 02	2002 WORKSHOP MANUAL
9999 95 038G 02	2002 WIRING DIAGRAM
9999 95 014C 02	2002 OWNER'S MANUAL

### WORKSHOP MANUAL:

Covers recommended maintenance and repair procedures of the drive train, body and chassis.

### WIRING DIAGRAM:

Provides electrical schematics as well as component location for the entire electrical system.

### OWNER'S MANUAL:

This booklet contains information regarding the proper care and operation of your vehicle. This is not a technician's manual.

**Please note that your Authorized Mazda Dealership has trained personnel and special service tools to correctly and safely maintain Mazda vehicles.**

## Customer Assistance

### IN CALIFORNIA (U.S. ONLY)

California Civil Code Section 1793.2(d) requires that, if a manufacturer or its representative is unable to repair a motor vehicle to conform to the vehicle's applicable express warranty after a reasonable number of attempts, the manufacturer shall be required to either replace the vehicle with one substantially identical or repurchase the vehicle and reimburse the buyer in an amount equal to the actual price paid or payable by the consumer (less a reasonable allowance for consumer use). The consumer has the right to choose whether to receive a refund or replacement vehicle.

California Civil Code Section 1793.22(b) presumes that the manufacturer has had a reasonable number of attempts to conform the vehicle to its applicable express warranties if, within the first 18 months of ownership of a new vehicle or the first 29 000 km (18 000 miles), whichever occurs first:

1. Two or more repair attempts are made on the same nonconformity likely to cause death or serious bodily injury OR
2. Four or more repair attempts are made on the same nonconformity (a defect or condition that substantially impairs the use, value or safety of the vehicle) OR
3. The vehicle is out of service for repair of nonconformities for a total of more than 30 calendar days (not necessarily all at one time)

In the case of 1 or 2 above, the consumer must also notify the manufacturer of the need for the repair of the nonconformity at the following address:

Mazda North American Operations  
7755, Irvine Center Drive  
Irvine, CA 92618-2922



### **REPORTING SAFETY DEFECTS (U.S. ONLY)**

If you believe that your vehicle has a defect that could cause a crash, or could cause injury or death, you should immediately inform the National Highway Traffic Safety Administration (NHTSA) in addition to notifying Mazda Corporation.

If NHTSA receives similar complaints, it may open an investigation, and if it finds that a safety defect exists in a group of vehicles, it may order a recall and remedy campaign. However, NHTSA cannot become involved in individual problems between you, your dealer or Mazda Corporation.

To contact NHTSA, you may either call the Auto Safety Hotline toll-free at 1-800-424-9393 (202-366-0123 in the Washington D.C. area) or write to:

NHTSA  
U.S. Department of Transportation  
400 Seventh Street  
Washington D.C. 20590

You can also obtain other information about motor vehicle safety from the Hotline.

# Cleaning

## WASHING THE EXTERIOR

Wash your vehicle regularly with cool or lukewarm water and a neutral Ph shampoo, such as Detail Wash (ZC-3-A), which is available from your dealer.

- Never use strong household detergents or soap, such as dish washing or laundry liquid. These products can discolor and spot painted surfaces.
- Never wash a vehicle that is “hot to the touch” or during exposure to strong, direct sunlight.
- Always use a clean sponge or carwash mitt with plenty of water for best results.
- Dry the vehicle with a chamois or soft terry cloth towel in order to eliminate water spotting.
- It is especially important to wash the vehicle regularly during the winter months, as dirt and road salt are difficult to remove and cause damage to the vehicle.
- Immediately remove items such as gasoline, diesel fuel, bird droppings and insect deposits because they can cause damage to the vehicle’s paintwork and trim over time.
- Remove any exterior accessories, such as antennas, before entering a car wash.
- **Suntan lotions and insect repellents can damage any painted surface; if these substances come in contact with your vehicle, wash off as soon as possible.**

## WAXING

Applying a polymer paint sealant to your vehicle every six months will assist in reducing minor scratches and paint damage.

- Wash the vehicle first.
- Do not use waxes that contain abrasives.
- Do not allow paint sealant to come in contact with any non-body (low-gloss black) colored trim, such as grained door handles, roof racks, bumpers, side moldings, mirror housings or the windshield cowl area. The paint sealant will “gray” or stain the parts over time.

## PAINT CHIPS

Your dealer has touch-up paint to match your vehicle's color. Touch-up paint can be used to repair minor scratches to painted surfaces.

- Remove particles such as bird droppings, tree sap, insect deposits, tar spots, road salt and industrial fallout before repairing paint chips.
- Always read the instructions before using the products.

## ALUMINUM WHEELS AND COVERS

Aluminum wheel rims or covers are coated with a clearcoat paint finish. In order to maintain their shine:

- Clean with One Step Wash and Wax Concentrate, which is available from your local Mazda dealer.
- Never apply any cleaning chemical to hot or warm wheel rims or covers.
- Some automatic car washes may cause damage to the finish on your wheel rims or covers. Chemical-strength cleaners, or cleaning chemicals, in combination with brush agitation to remove brake dust and dirt, could wear away the clearcoat finish over time.
- Do not use hydrofluoric acid-based or high caustic-based wheel cleaners, steel wool, fuels or strong household detergent.
- To remove tar and grease, use Extra Strength Tar and Road Oil Removal, available from your local Mazda dealer.

## ENGINE

Engines are more efficient when they are clean because grease and dirt buildup keep the engine warmer than normal. When washing:

- Take care when using a power washer to clean the engine. The high-pressure fluid could penetrate the sealed parts and cause damage.
- Never spray the engine or other engine components with water. Water will damage the engine or other engine components.
- Spray Engine Shampoo and Degreaser, available at your local Mazda dealer, on all parts that require cleaning and pressure rinse clean.
- Cover the highlighted areas to prevent water damage when cleaning the engine.

## Cleaning

- **2.3L Engine**

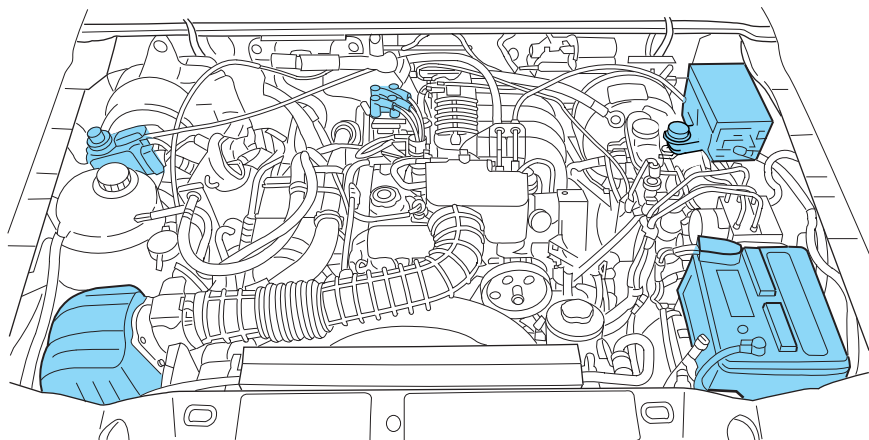

- **3.0L Engine**

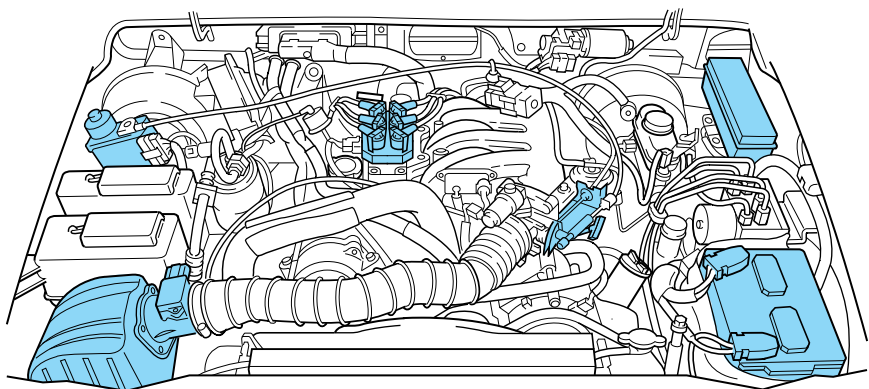

- **4.0L Engine**

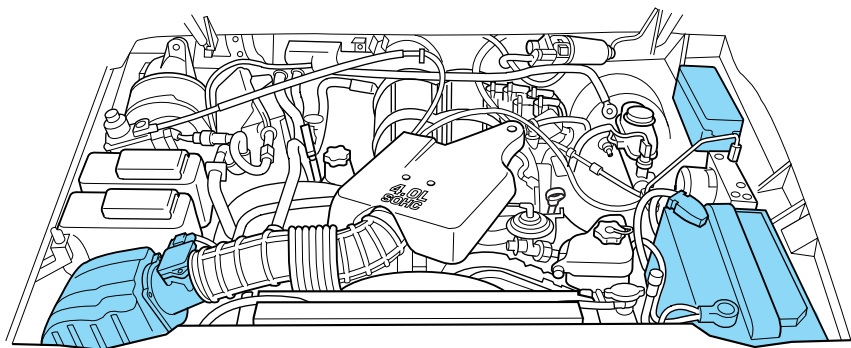

- Never wash or rinse the engine while it is running; water in the running engine may cause internal damage.

### **PLASTIC (NON-PAINTED) EXTERIOR PARTS**

Use only approved products to clean plastic parts. These products are available from your dealer.

- For routine cleaning, use One Step Wash and Wax Concentrate, available at your local Mazda dealer.
- If tar or grease spots are present, use Extra Strength Tar and Road Oil Removal, available at your local Mazda dealer.

### **CLEANING MIRRORS**

Do not clean your mirrors with a dry cloth or abrasive materials. Use a soft cloth and mild detergent and water. Be careful when removing ice from outside mirrors because you may damage the reflective surface.

### **WINDOWS AND WIPER BLADES**

The windshield, rear window and wiper blades should be cleaned regularly. If the wiper does not wipe properly, substances on the windshield, rear window or the wiper blades may be the cause. These may include hot wax treatments used by commercial car washes, tree sap, or other organic contamination. To clean these items, please follow these tips:

- The windshield or rear window may be cleaned with a non-abrasive cleaner such as Ultra Clear Spray Glass Cleaner, available from your local Mazda dealer.
- Do not use abrasives, as they may cause scratches.

## Cleaning

- Do not use fuel, kerosene, or paint thinner to clean any parts.
- Wiper blades can be cleaned with isopropyl (rubbing) alcohol or windshield washer solution. Be sure to replace wiper blades when they appear worn or do not function properly.

### CLEANING THE INSTRUMENT PANEL

Clean the instrument panel with a damp cloth, then dry with a dry cloth.

Avoid cleaners or polish that increase the gloss of the upper portion of the instrument panel. The dull finish in this area helps protect the driver from undesirable windshield reflection.

**Your vehicle is designed with painted controls and features which are particularly sensitive to certain products such as insect repellent and suntan lotion. When operating the various features on your vehicle, be certain to wash or wipe your hands clean if you have been in contact with any of these types of products in order to avoid possible damage to the painted surfaces.**

**WARNING: Do not use chemical solvents or strong detergents when cleaning the steering wheel or instrument panel to avoid contamination of the air bag system.**

### CLEANING THE INSTRUMENT CLUSTER LENS

Clean with a damp cloth, then dry with a dry cloth.

Do not use household or glass cleaners as these may damage the lens.

### INTERIOR

For fabric, carpets, cloth seats, safety belts and seats equipped with side air bags:

- Remove dust and loose dirt with a vacuum cleaner.
- Remove light stains and soil with Extra Strength Upholstery Cleaner, available at your local Mazda dealer.
- If grease or tar is present on the material, spot-clean the area first with Spot and Stain Remover, available at your local Mazda dealer.
- Never saturate the seat covers with cleaning solution.
- Do not use household cleaning products or glass cleaners, which can stain and discolor the fabric and affect the flame retardant abilities of the seat materials.

**WARNING: Do not use chemical solvents or strong detergents when cleaning the seat where the side air bag is mounted. Such products may contaminate the side air bag system and affect performance of the side air bag in a collision. The air bag may not function correctly and not provide any injury reduction benefits.**

### LEATHER SEATS (IF EQUIPPED)

Your leather seating surfaces have a clear, protective coating over the leather.

- To clean, use a soft cloth with Deluxe Leather and Vinyl Cleaner. Dry the area with a soft cloth.
- To help maintain its resiliency and color, use the Deluxe Leather Care Kit, available at your local Mazda dealer.
- Do not use household cleaning products, alcohol solutions, solvents or cleaners intended for rubber, vinyl and plastics, or oil/petroleum-based leather conditioners. These products may cause premature wearing of the clear, protective coating.

### UNDERBODY

Flush the complete underside of vehicle frequently. Keep body drain holes unplugged. Inspect for road damage.

### MAZDA CAR CARE PRODUCTS

Your Mazda dealer has many quality products available to clean your vehicle and protect its finishes. These quality products have been specifically engineered to fulfill your automotive needs; they are custom designed to complement the style and appearance of your vehicle. Each product is made from high quality materials that meet or exceed rigid specifications. For best results, use these products or products of equivalent quality. These products are available at your local Mazda dealer.

# Maintenance and Specifications

## INTRODUCTION

Be extremely careful to prevent injury to yourself and others and damage to your vehicle when using this manual for inspection and maintenance.

If you're unsure about any procedure it describes, we strongly urge you to have a reliable and qualified service shop perform the work, preferably an Authorized Mazda Dealer.

Factory-trained Mazda technicians and genuine Mazda parts are best for your vehicle. Without this expertise and the parts that have been designed and made especially for your Mazda, inadequate, incomplete, and insufficient servicing may result in problems. This could lead to vehicle damage or an accident and injuries.

For expert advice and quality service, consult an Authorized Mazda Dealer.

The owner should retain evidence that proper maintenance has been performed as prescribed.

A claim against a warranty will not qualify if it results from lack of maintenance and not from defective material or authorized Mazda workmanship.

Any auto repair shop using parts equivalent to your Mazda's original equipment may perform maintenance. **But we recommend that it always be done by an Authorized Mazda Dealer using genuine Mazda parts.**

## SCHEDULED MAINTENANCE

### Schedule I – Normal Driving Conditions/Emission Control Systems

Follow Schedule I if the vehicle is operated mainly where none of the following conditions apply. If any do apply follow Schedule II.

- Repeated short-distance driving.
- Driving in dusty conditions.
- Towing a trailer.
- Operating in hot weather in stop-and-go “rush hour” traffic.
- Extended periods of idling or low-speed operation.
- High-speed operation with a fully loaded vehicle.
- Off-road operation.

**NOTE:** After the described period, continue to follow the described maintenance at the recommended intervals.



# Maintenance and Specifications

## Chart symbols

**I:** Inspect, and if necessary correct, clean or replace

**A:** Adjust

**R:** Replace

**L:** Lubricate

Normal driving service intervals – perform at the months or distances shown, whichever occurs first.

Maintenance Item	Maintenance Interval (Number of months or km (miles), whichever comes first)												
	Months	4	8	12	16	20	24	28	32	36	40	44	48
	x 1000 Miles	5	10	15	20	25	30	35	40	45	50	55	60
	(x 1000 km)	(8)	(16)	(24)	(32)	(40)	(48)	(56)	(64)	(72)	(80)	(88)	(96)
<b>ENGINE</b>													
Engine oil—every 6 months	R	R	R	R	R	R	R	R	R	R	R	R	R
Oil filter—every 6 months	R	R	R	R	R	R	R	R	R	R	R	R	R
PCV valve													
<b>AIR CLEANER</b>													
Air cleaner filter							R						R
<b>IGNITION SYSTEM</b>													
Spark plugs	*4												
<b>COOLING SYSTEM</b>													
Engine Coolant (green)	Replace at first 45,000 miles (72,000 km) or 36 months, after that, every 30,000 miles (48,000 km) or 24 months												
Coolant condition and protection, hoses and clamps — annually —prior to cold weather every 12 months			I				I			I			I
<b>CHASSIS AND BODY</b>													
Wheel lug nut torque	*1	I	I	I	I	I	I	I	I	I	I	I	I
Inspect tires for wear and rotate (X = recommended interval for optimal tire life)		I	X	I	X	X	I	X	X	I	X	X	I
Clutch reservoir fluid level		I		I		I		I		I		I	
Front wheel bearings (4x2)													L
Disc brake system				I			I			I			I
Caliper slide rails				L			L			L			L

# Maintenance and Specifications

Maintenance Item	Maintenance Interval (Number of months or km (miles), whichever comes first)												
	Months	4	8	12	16	20	24	28	32	36	40	44	48
	x 1000 Miles	5	10	15	20	25	30	35	40	45	50	55	60
	(x 1000 km)	(8)	(16)	(24)	(32)	(40)	(48)	(56)	(64)	(72)	(80)	(88)	(96)
Drum brake system, lines and hoses			I				I			I			I
Exhaust system for leaks, damage, looseness							I						I
Manual transmission fluid													R
Automatic transmission fluid *2							I						I
Exhaust system shielding (for trapped material)							I						I
Propeller shaft U-joints (if equipped with grease fittings)	L		L			L		L		L		L	
Parking brake system (for damage and operation)			I				I			I			I
Ball joints (4x2)			I/L				I/L			I/L			I/L
Transfer case fluid (4x4)	Replace every 150,000 miles (240,000 km)												
Rear axle lubricant	Does not require replacement unless rear axle submerged in water												
Accessory drive belts													
Fuel filter *5							R						R
Steering linkage, ball joints, suspension and driveshaft			I				I			I			I

**Remarks:** For \* marked items in this maintenance chart, please pay attention to the following points:

1. The wheel lug nuts must be retightened to the proper specifications at 800 km (500 miles) of new vehicle operation, at any wheel change, or at any other time the wheel lug nuts have been loosened.
2. Replace every 150,000 miles (240,000 km) unless submerged in water.
3. At 60,000 miles (96,000 km), the dealer will replace the PCV valve at no cost, except Canada and California vehicles.
4. Refer to vehicle emission control information label for spark plug and gap specifications.

## Maintenance and Specifications

5. The California Air Resources Board has determined that the failure to perform this maintenance item will not nullify the emission warranty nor limit recall liability prior to completion of the vehicle's useful life.

Maintenance Item	Maintenance Interval (Number of months or Miles (km), whichever comes first)												
	Months	52	56	60	64	68	72	76	80	84	88	92	96
	x 1000 Miles	65	70	75	80	85	90	95	100	105	110	115	120
	(x 1000 km)	(104)	(112)	(121)	(128)	(136)	(144)	(152)	(160)	(168)	(176)	(184)	(192)
<b>ENGINE</b>													
Engine oil—every 6 months	R	R	R	R	R	R	R	R	R	R	R	R	R
Oil filter—every 6 months	R	R	R	R	R	R	R	R	R	R	R	R	R
PCV valve									R				
<b>AIR CLEANER</b>													
Air cleaner filter							R						R
<b>IGNITION SYSTEM</b>													
Spark plugs *4									R				
<b>COOLING SYSTEM</b>													
Engine Coolant (green)	Replace at first 45,000 miles (72,000 km) or 36 months, after that, every 30,000 miles (48,000 km) or 24 months												
Coolant condition and protection, hoses and clamps—annually—prior to cold weather every 12 months			I			I			I				I
<b>CHASSIS AND BODY</b>													
Wheel lug nut torque *1	I	I	I	I	I	I	I	I	I	I	I	I	I
Inspect tires for wear and rotate (X = recommended interval for optimal tire life)	X	X	I	X	X	I	X	X	I	X	X	X	I
Clutch reservoir fluid level	I		I		I		I		I		I		I
Front wheel bearings (4x2)													L
Disc brake system			I			I			I				I
Caliper slide rails			L			L			L				L
Drum brake system, lines and hoses			I			I			I				I

## Maintenance and Specifications

Maintenance Item	Maintenance Interval (Number of months or Miles (km), whichever comes first)												
	Months	52	56	60	64	68	72	76	80	84	88	92	96
	x 1000 Miles	65	70	75	80	85	90	95	100	105	110	115	120
	(x 1000 km)	(104)	(112)	(121)	(128)	(136)	(144)	(152)	(160)	(168)	(176)	(184)	(192)
Exhaust system for leaks, damage, looseness							I						I
Manual transmission fluid													R
Automatic transmission fluid *2							I						I
Exhaust system shielding (for trapped material)							I						I
Propeller shaft U-joints (if equipped with grease fittings)	L		L		L		L		L		L		L
Parking brake system (for damage and operation)			I				I			I			I
Ball joints (4x2)			I/L				I/L			I/L			I/L
Transfer case fluid (4x4)	Replace every 150,000 miles (240,000 km)												
Rear axle lubricant	Does not require replacement unless rear axle submerged in water												
Accessory drive belts									I				
Fuel filter *5							R						R
Steering linkage, ball joints, suspension and driveshaft			I				I			I			I

**Remarks:** For \* marked items in this maintenance chart, please pay attention to the following points:

1. The wheel lug nuts must be retightened to the proper specifications at 800 km (500 miles) of new vehicle operation, at any wheel change, or at any other time the wheel lug nuts have been loosened.
2. Replace every 150,000 miles (240,000 km) unless submerged in water.
3. At 60,000 miles (96,000 km), the dealer will replace the PCV valve at no cost, except Canada and California vehicles.
4. Refer to vehicle emission control information label for spark plug and gap specifications.

## Maintenance and Specifications

5. The California Air Resources Board has determined that the failure to perform this maintenance item will not nullify the emission warranty nor limit recall liability prior to completion of the vehicle's useful life.

### SCHEDULE II – SPECIAL OPERATING CONDITIONS

If your driving habits **FREQUENTLY** include one or more of the following conditions:

- Short trips of **less** than 16 km (10 miles) when outside temperatures remain below freezing.
- Towing a trailer, or carrying maximum loads.
- Operating in severe dust conditions.
- Operating during **hot weather** in stop-and-go “rush-hour” traffic.
- Extensive idling, such as police, taxi or door-to-door delivery service.
- High speed operation with a fully loaded vehicle (max. GVW).
- Off-road operation.

Change ENGINE OIL AND OIL FILTER every 3 months or 4,800 km (3,000 miles) whichever occurs first.

**NOTE:** Idling the engine for extended periods will accumulate more hours of use on your vehicle than is actually indicated by the mileage odometer. Consequently, the odometer reading can be often misleading when determining the right time to change your engine oil and filter. If you are using your vehicle in a manner which allows it to remain stationary while the engine is running for long periods (door-to-door delivery, taxi, police, power/utility company trucks, or similar duty), then Mazda recommends you increase the frequency of oil and filter changes to an interval equivalent to 200 ENGINE HOURS of use. Since most vehicles are not equipped with hour-meters, it may be necessary for you to approximate your idle time and plan oil/filter changes accordingly.

# Maintenance and Specifications

Special Operating Conditions	Replace Engine Oil and Filter	Inspect Brake System	Replace Fuel Filter	Change Automatic Transmission Fluid	Replace Spark Plugs	Replace Engine Air Filter	Change Manual Transmission Fluid	Inspect and Lubricate U-Joints	Lubricate Front Wheel Bearing (4x2)	Change Transfer Case Fluid (4x4)
Suggested Maintenance Interval	3,000 miles or 3 months	5,000 miles	15,000 miles	30,000 miles	60,000 miles	As required	As required	As required	30,000 miles	60,000 miles
Towing a trailer or using a camper or car top carrier	X			X			X	X		
Extensive idling or low-speed driving for long distances as in heavy commercial use such as delivery, taxi or patrol car	X	X	X	X	X				X	X
Operating in dusty conditions such as unpaved or dusty roads	X		X	X		X				
Off road operation				X				X		X

For specific recommendations see your authorized Mazda dealer or qualified service professional.

## OWNER MAINTENANCE

### Owner Maintenance Schedule

The owner or a qualified service technician should make these vehicle inspections at the indicated intervals to ensure safe and dependable operation.

Bring any problem to the attention of an Authorized Mazda Dealer or qualified service technician as soon as possible.

### While operating your vehicle

## Maintenance and Specifications

- Note any changes in the sound of the exhaust or any smell or exhaust fumes in the vehicle.
- Check for vibrations in the steering wheel. Notice any increased steering effort or looseness in the steering wheel, or change in this straight ahead position.
- Notice if your vehicle constantly turns slightly or “pulls” to one side when traveling on a smooth, level road.
- When stopping, listen and check for strange sounds, pulling to one side, increased brake pedal travel or “hard to push” brake pedal.
- If any slipping or changes in the operation of your transmission occur, check the transmission fluid level.
- Check automatic transmission Park function.
- Check parking brake.

### **At least monthly**

- Check function of all interior and exterior lights.
- Check tires for wear and proper air pressure.
- Check engine oil level.
- Check coolant level in the coolant reservoir.
- Check washer fluid level.

### **At least twice a year (for example, every spring and fall)**

- Check power steering fluid level.
- Check clutch fluid level (if equipped).
- Check and clean body and door drain holes.
- Check and lubricate all hinges, latches, and outside locks.
- Check and lubricate door rubber weather strips.
- Check parking brake for proper operation.
- Check lap/shoulder belts and seat latches for wear and function.
- Check air pressure in spare tire.
- Check windshield washer spray and wiper operation. Clean wiper blades with clean cloth dampened with washer fluid.
- Check safety warning lamps (brake, ABS, air bag, safety belt) for operation.
- Check cooling system fluid level and coolant strength.

## Maintenance and Specifications

- Check battery water level (non-maintenance free).
- Check battery connections and clean if necessary.

### SERVICE RECOMMENDATIONS

To help you service your vehicle:

- We highlight do-it-yourself items in the engine compartment for easy location.
- We provide a Scheduled Maintenance section which makes tracking routine service easy.

If your vehicle requires professional service, your dealership can provide necessary parts and service. Check your “Warranty Information” to find out which parts and services are covered.

Use only recommended fuels, lubricants, fluids and service parts conforming to specifications. Genuine Mazda parts are designed and built to provide the best performance in your vehicle.

### PRECAUTIONS WHEN SERVICING YOUR VEHICLE

Be especially careful when inspecting or servicing your vehicle.

- Do not work on a hot engine.
- When the engine is running, make sure that loose clothing, jewelry or long hair does not get caught up in moving parts.
- Do not work on a vehicle with the engine running in an enclosed space, unless you are sure you have enough ventilation.
- Keep all lit cigarettes, open flames and other lit material away from the battery and all fuel related parts.

If you disconnect the battery, the engine must “relearn” its idle conditions before your vehicle will drive properly, as explained in the *Battery* section of this chapter.

### Working with the engine off

- Automatic transmission:
  1. Set the parking brake and ensure the gearshift is securely latched in P (Park).
  2. Turn off the engine and remove the key.
  3. Block the wheels to prevent the vehicle from moving unexpectedly.



## Maintenance and Specifications

- Manual transmission:

1. Set the parking brake.
2. Depress the clutch and place the gearshift in 1 (First).
3. Turn off the engine and remove the key.
4. Block the wheels to prevent the vehicle from moving unexpectedly.

### Working with the engine on

- Automatic transmission:

1. Set the parking brake and ensure the gearshift is securely latched in P (Park).
2. Block the wheels to prevent the vehicle from moving unexpectedly.

**Note:** Do not start your engine with the air cleaner removed and do not remove it while the engine is running.

- Manual transmission:

1. Set the parking brake, depress the clutch and place the gearshift in neutral.
2. Block the wheels to prevent the vehicle from moving unexpectedly.

**Note:** Do not start your engine with the air cleaner removed and do not remove it while the engine is running.

**WARNING:** The cooling fan is automatic and may come on at any time. Always disconnect the negative terminal of the battery before working near the fan.

### OPENING THE HOOD

1. Inside the vehicle, pull the hood release handle located under the bottom of the instrument panel near the steering column.
2. Go to the front of the vehicle and release the auxiliary latch that is located under the front center of the hood.
3. Lift the hood and support it with the prop rod.

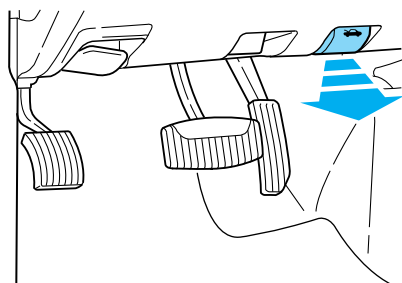

# Maintenance and Specifications

## IDENTIFYING COMPONENTS IN THE ENGINE COMPARTMENT

### 2.3L I4 engine

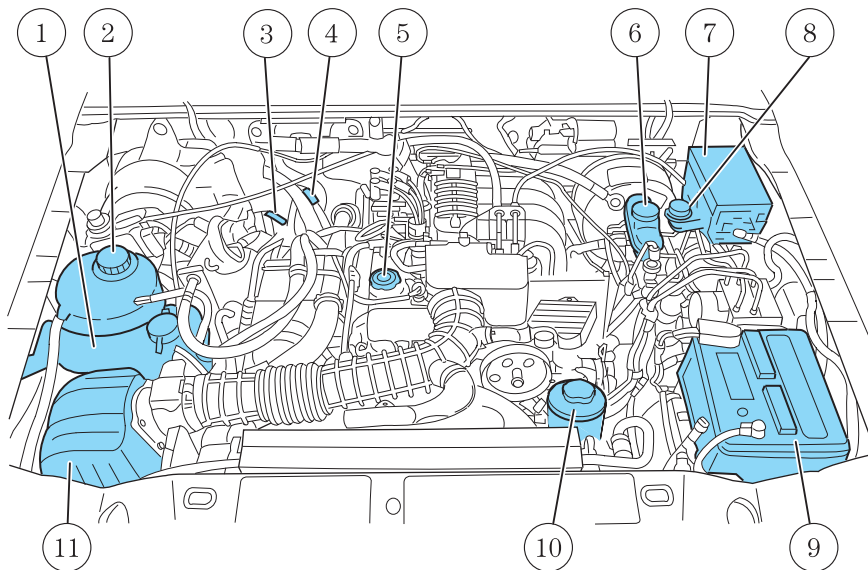

1. Windshield washer fluid reservoir
2. Engine coolant reservoir
3. Engine oil dipstick
4. Transmission fluid dipstick (automatic transmission)
5. Engine oil filler cap
6. Brake fluid reservoir
7. Power distribution box
8. Clutch fluid reservoir (manual transmission)
9. Battery
10. Power steering fluid reservoir
11. Air filter assembly

## Maintenance and Specifications

### 3.0L V6 engine

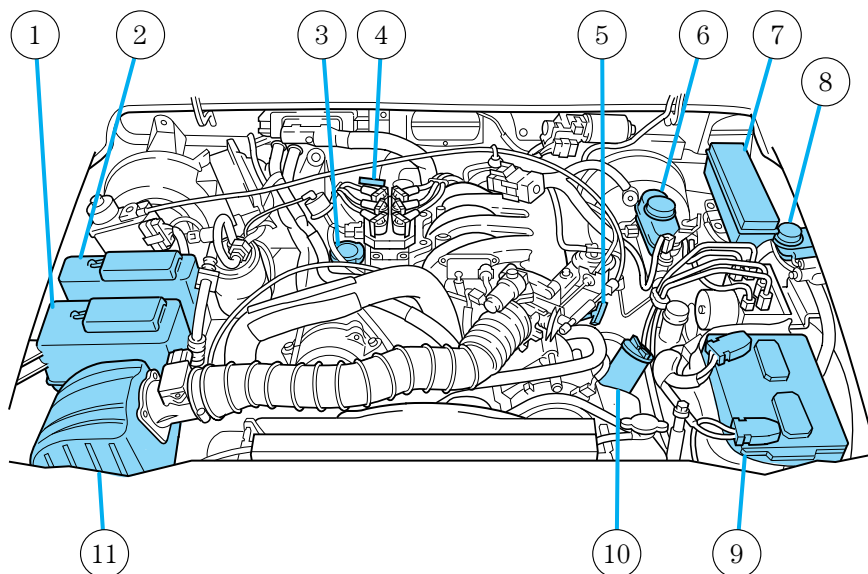

1. Engine coolant reservoir
2. Windshield washer fluid reservoir
3. Engine oil filler cap
4. Transmission fluid dipstick (automatic transmission)
5. Engine oil dipstick
6. Brake fluid reservoir
7. Power distribution box
8. Clutch fluid reservoir (manual transmission)
9. Battery
10. Power steering fluid reservoir
11. Air filter assembly

## Maintenance and Specifications

### 4.0L SOHC V6 engine

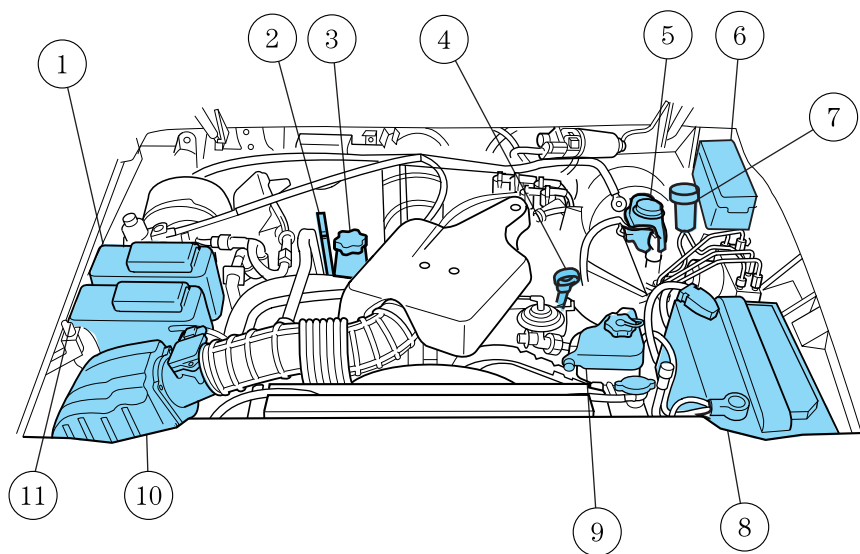

1. Windshield washer fluid reservoir
2. Transmission fluid dipstick (automatic transmission)
3. Engine oil filler cap
4. Engine oil dipstick
5. Brake fluid reservoir
6. Power distribution box
7. Clutch fluid reservoir (manual transmission)
8. Battery
9. Power steering fluid reservoir
10. Air filter assembly
11. Engine coolant reservoir

## Maintenance and Specifications

### WINDSHIELD WASHER FLUID

#### Windshield washer fluid

Check the washer fluid whenever you stop for fuel. The reservoir is highlighted with a  symbol.

Add fluid to fill the reservoir if the level is low. In very cold weather, do not fill the reservoir completely.

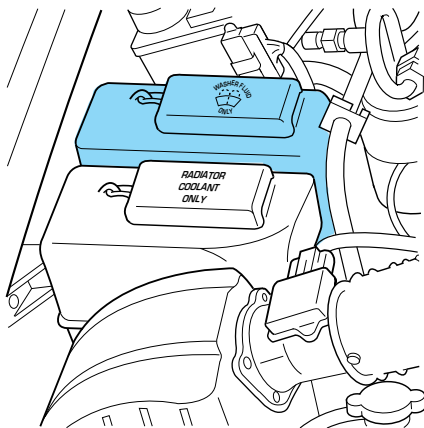

Only use a washer fluid that meets Mazda specification . Refer to *Lubricant specifications* in this chapter.

State or local regulations on volatile organic compounds may restrict the use of methanol, a common windshield washer antifreeze additive. Washer fluids containing non-methanol antifreeze agents should be used only if they provide cold weather protection without damaging the vehicle's paint finish, wiper blades or washer system.

**Note:** Do not put washer fluid in the engine coolant reservoir. Washer fluid placed in the cooling system may harm engine and cooling system components.

# Maintenance and Specifications

## ENGINE OIL

### Checking the engine oil

Refer to the service maintenance section for the appropriate intervals for checking the engine oil.

1. Make sure the vehicle is on level ground.
  2. Turn the engine off and wait a few minutes for the oil to drain into the oil pan.
  3. Set the parking brake and ensure the gearshift is securely latched in P (Park) (automatic transmission) or 1 (First) (manual transmission).
  4. Open the hood. Protect yourself from engine heat.
  5. Locate and carefully remove the engine oil level indicator (dipstick).
- 2.3L I4 engine

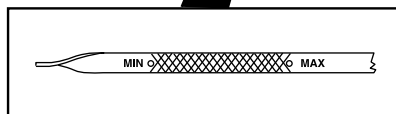
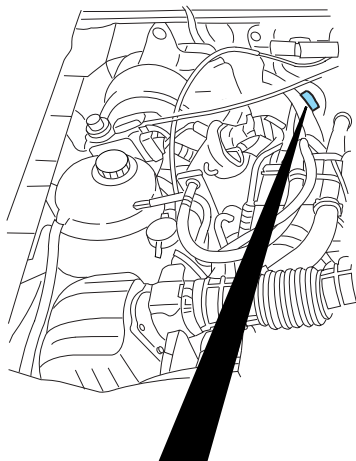

## Maintenance and Specifications

- 3.0L V6 engine

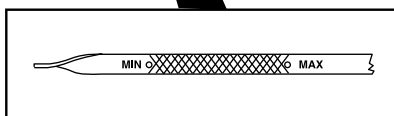
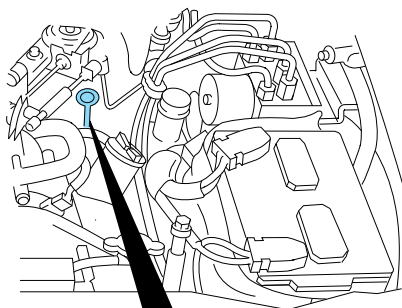

- 4.0L SOHC V6 engine

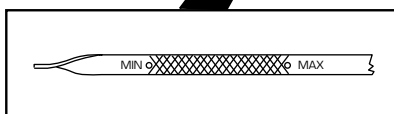
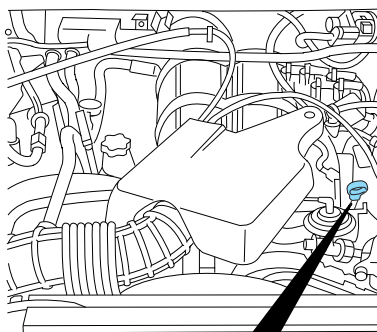

## Maintenance and Specifications

6. Wipe the indicator clean. Insert the indicator fully, then remove it again.
- If the oil level is **between the MIN and MAX marks**, the oil level is acceptable, **DO NOT ADD OIL**.
  - If the oil level is below the MIN mark, add enough oil to raise the level within the MIN-MAX range.
  - 2.3L I4 engine

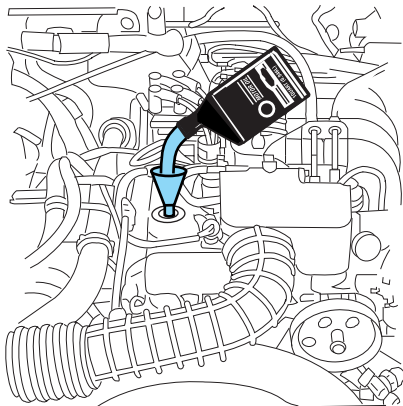

- 3.0L V6 engine

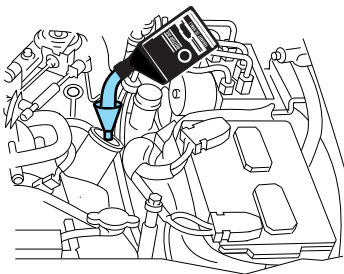



## Maintenance and Specifications

- 4.0L SOHC V6 engine

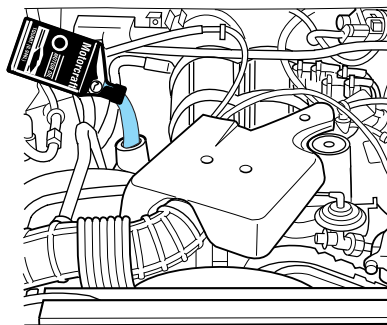

- Oil levels above the MAX mark may cause engine damage. Some oil must be removed from the engine by a service technician.
7. Put the indicator back in and ensure it is fully seated.

### Adding engine oil

1. Check the engine oil. For instructions, refer to *Checking the engine oil* in this chapter.
2. If the engine oil level is not within the normal range, add only certified engine oil of the recommended viscosity. Remove the engine oil filler cap and use a funnel to pour the engine oil into the opening.
3. Recheck the engine oil level. Make sure the oil level is not above the MAX mark or the letter F in FULL on the engine oil level indicator (dipstick).
4. Install the indicator and ensure it is fully seated.
5. Fully install the engine oil filler cap by turning the filler cap clockwise until three clicks can be heard.

**To avoid possible oil loss, DO NOT operate the vehicle with the engine oil level indicator and/or the engine oil filler cap removed.**

## Maintenance and Specifications

### Engine Oil Recommendations

#### 2.3L & 3.0L Engines

Look for this certification trademark.



#### ***SAE 5W-20 engine oil is recommended.***

Only use oils “Certified For Gasoline Engines” by the American Petroleum Institute (API). Use an equivalent oil Mazda specification.

**SAE 5W-20 oil provides optimum fuel economy and durability performance meeting all requirements for your vehicle’s engine.**

Change your engine oil and filter according to the appropriate schedule listed in the service maintenance section.

Do not use supplemental engine oil additives, oil treatments or engine treatments. They are unnecessary and could, under certain conditions, lead to engine damage which is not covered by your warranty.

#### 4.0L Engine

Look for this certification trademark.



## Maintenance and Specifications

### **SAE 5W-30 engine oil is recommended.**

Only use oils “Certified For Gasoline Engines” by the American Petroleum Institute (API). Use an equivalent Mazda Specification.

Do not use supplemental engine oil additives, oil treatments or engine treatments. They are unnecessary and could, under certain conditions, lead to engine damage which is not covered by your warranty.

Change your engine oil according to the appropriate schedule listed in the service maintenance section.

### **Engine Oil Filter Recommendation**

Change your engine oil filter according to the appropriate schedule listed in the service maintenance section. Mazda production and aftermarket (Mazda) oil filters are designed for added engine protection and long life. If a replacement oil filter is used that does not meet Mazda Material and design specifications, start-up engine noises or knock may be experienced.

It is recommended you use the appropriate Mazda oil filter (or another brand meeting Mazda specifications) for your engine.

### **BATTERY**

Your vehicle is equipped with a Mazda maintenance-free battery which normally does not require additional water during its life of service.

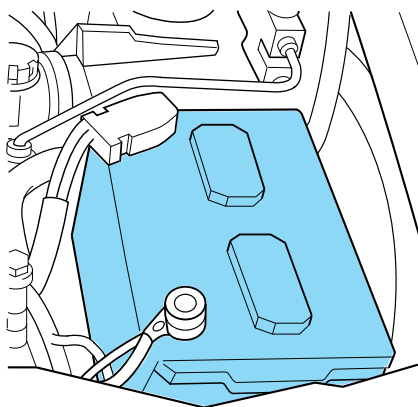

However, for severe usage or in high temperature climates, check the battery electrolyte level. Refer to the service maintenance section for the service interval schedules.

**Keep the electrolyte level in each cell up to the “level indicator”. Do not overfill the battery cells.**

## Maintenance and Specifications

If possible, try to only fill the battery cells with distilled water. If the battery needs water often, have the charging system checked.

**If your battery has a cover/shield, make sure it is reinstalled after the battery has been cleaned or replaced.**

For longer, trouble-free operation, keep the top of the battery clean and dry. Also, make certain the battery cables are always tightly fastened to the battery terminals.

If you see any corrosion on the battery or terminals, remove the cables from the terminals and clean with a wire brush. You can neutralize the acid with a solution of baking soda and water.

**WARNING: Batteries normally produce explosive gases which can cause personal injury. Therefore, do not allow flames, sparks or lighted substances to come near the battery. When working near the battery, always shield your face and protect your eyes. Always provide proper ventilation.**

**WARNING: When lifting a plastic-cased battery, excessive pressure on the end walls could cause acid to flow through the vent caps, resulting in personal injury and/or damage to the vehicle or battery. Lift the battery with a battery carrier or with your hands on opposite corners.**

**WARNING: Keep batteries out of reach of children. Batteries contain sulfuric acid. Avoid contact with skin, eyes or clothing. Shield your eyes when working near the battery to protect against possible splashing of acid solution. In case of acid contact with skin or eyes, flush immediately with water for a minimum of 15 minutes and get prompt medical attention. If acid is swallowed, call a physician immediately.**

**WARNING: Battery posts, terminals and related accessories contain lead and lead compounds. Wash hands after handling.**

Because your vehicle's engine is electronically controlled by a computer, some control conditions are maintained by power from the battery. When the battery is disconnected or a new battery is installed, the engine must relearn its idle and fuel trim strategy for optimum driveability and performance. To begin this process:

## Maintenance and Specifications

1. With the vehicle at a complete stop, set the parking brake.
  2. Put the gearshift lever in P (Park), turn off all accessories and start the engine.
  3. Run the engine until it reaches normal operating temperature.
  4. Allow the engine to idle for at least one minute.
  5. Turn the A/C on and allow the engine to idle for at least one minute.
  6. Drive the vehicle to complete the relearning process.
- The vehicle may need to be driven to relearn the idle and fuel trim strategy.
  - **If you do not allow the engine to relearn its idle trim, the idle quality of your vehicle may be adversely affected until the idle trim is eventually relearned.**

When the battery is disconnected or a new battery installed, the transmission must relearn its adaptive strategy. As a result of this, the transmission may shift firmly. This operation is considered normal and will not affect function or durability of the transmission. Over time the adaptive learning process will fully update transmission operation to its optimum shift feel.

If the battery has been disconnected or a new battery has been installed, the clock and the preset radio stations must be reset once the battery is reconnected.

- Always dispose of automotive batteries in a responsible manner. Follow your local authorized standards for disposal. Call your local authorized recycling center to find out more about recycling automotive batteries.

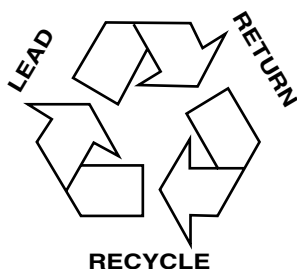

### ENGINE COOLANT

#### Checking engine coolant

Your engine's cooling system has been factory-filled with a 50/50 mixture of distilled water and Mazda Genuine Engine Coolant, or an equivalent premium engine coolant that meets Mazda specification.

## Maintenance and Specifications

A **50/50 mixture** of distilled water and Mazda Genuine Engine Coolant provides:

- **maximum cooling system efficiency.**
- **freeze protection down to  $-36^{\circ}\text{C}$  ( $-34^{\circ}\text{F}$ ).**
- **boiling protection up to  $129^{\circ}\text{C}$  ( $265^{\circ}\text{F}$ ).**
- **protection against rust and other forms of corrosion.**
- **an accurate temperature readout from the engine coolant gauge.**

**The engine coolant must be maintained at the correct fluid level and concentration to work properly. If the engine coolant fluid level and concentration is not maintained correctly, damage to the engine and cooling system may result.**

- 2.3L engine

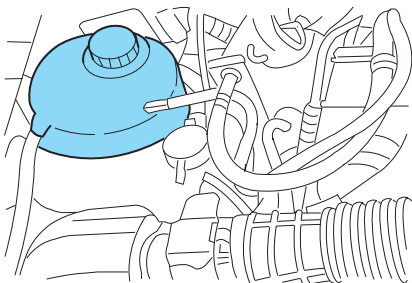

- 3.0L & 4.0L engines

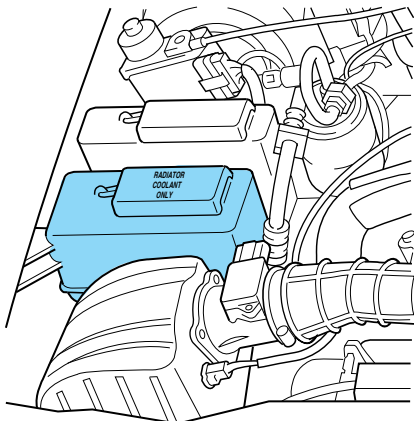

When the engine is cold, check the level of the engine coolant in the reservoir.

## Maintenance and Specifications

- The engine coolant should be at the “cold fill level” or within the “cold fill range” as listed on the engine coolant reservoir (depending upon application).
- Refer to the service maintenance section for service interval schedules.
- Be sure to read and understand *Precautions when servicing your vehicle* in this chapter.

If the engine coolant has not been checked at the recommended interval, the engine coolant reservoir may become low or empty. If the reservoir is low or empty, add engine coolant to the reservoir. Refer to *Adding engine coolant* in this chapter.

**WARNING: Automotive fluids are not interchangeable; do not use engine coolant, antifreeze or windshield washer fluid outside of its specified function and vehicle location.**

### Adding engine coolant

Use only Mazda Genuine Engine Coolant or a premium engine coolant that meets a Mazda specification.

- **DO NOT USE Extended Life Engine Coolant (orange in color).**
- **DO NOT USE a DEX-COOL® engine coolant or an equivalent engine coolant.**
- **DO NOT USE alcohol or methanol antifreeze or any engine coolants mixed with alcohol or methanol antifreeze.**
- **DO NOT USE supplemental coolant additives in your vehicle. These additives may harm your engine’s cooling system.**
- **DO NOT MIX recycled coolant and conventional coolant together in your vehicle. Mixing of engine coolants may harm your engine’s cooling system.**
- **The use of an improper coolant may harm engine and cooling system components and may void the warranty of your vehicle’s engine cooling system. If you are unsure which type of coolant your vehicle requires, contact your local dealer.**

**WARNING: Do not put engine coolant in the windshield washer fluid reservoir. If engine coolant is sprayed onto the windshield, it could make it difficult to see through the windshield.**

## Maintenance and Specifications

When the engine is cool, add a **50/50 mixture** of engine coolant and distilled water to the engine coolant reservoir, until the coolant is at the “cold fill level” or within the “cold fill range” as listed in the engine coolant reservoir (depending upon application).

- **NEVER increase the coolant concentration above 60%.**
- **NEVER decrease the coolant concentration below 40%.**
- **Engine coolant concentrations above 60% or below 40% will decrease the freeze protection characteristics of the engine coolant and may cause engine damage.**

Plain water may be added in an emergency, but you **must** replace it with a 50/50 mixture of engine coolant and distilled water as soon as possible.

Check the coolant level in the reservoir before you drive your vehicle the next few times (with the engine cool). If necessary, add a **50/50 mixture** of engine coolant and distilled water to the engine coolant reservoir until the coolant level is at the “cold fill level” or within the “cold fill range” as listed on the reservoir (depending upon application).

Have your dealer check the engine cooling system for leaks if you have to add more than 1.0 liter (1.0 quart) of engine coolant per month.

**WARNING: To avoid scalding hot steam or coolant from being released from the engine cooling system, never remove the reservoir cap while the engine is running or hot. Failure to follow this warning may result in damage to the engine’s cooling system and possible severe personal injury.**

If you must remove the coolant cap, follow these steps to avoid personal injury:

1. Before you remove the cap, turn the engine off and let it cool.
2. When the engine is cool, wrap a thick cloth around the cap. Slowly turn cap counterclockwise until pressure begins to release.
3. Step back while the pressure releases.
4. When you are sure that all the pressure has been released, use the cloth to turn it counterclockwise and remove the cap.

### Recycled engine coolant

Not all coolant recycling processes produce coolant which meets Mazda specification. Use of a recycled engine coolant which does not meet Mazda specifications may harm engine and cooling system components.



## Maintenance and Specifications



Always dispose of used automotive fluids in a responsible manner. Follow your community's regulations and standards for recycling and disposing of automotive fluids.

### Coolant refill capacity

To find out how much fluid your vehicle's cooling system can hold, refer to *Refill capacities* in this chapter.

Fill your engine coolant reservoir as outlined in *Adding engine coolant* in this chapter.

### Severe climates

If you drive in extremely cold climates (less than  $-36^{\circ}\text{C}$  [ $-34^{\circ}\text{F}$ ):

- **It may be necessary to increase the coolant concentration above 50%.**
- **NEVER increase the coolant concentration above 60%.**
- **Increased engine coolant concentrations above 60% will decrease the overheat protection characteristics of the engine coolant and may cause engine damage.**
- **Refer to the chart on the coolant container to ensure the coolant concentration in your vehicle will provide adequate freeze protection at the temperatures in which you drive in the winter months.**

If you drive in extremely hot climates:

- **It is still necessary to maintain the coolant concentration above 40%.**
- **NEVER decrease the coolant concentration below 40%.**
- **Decreased engine coolant concentrations below 40% will decrease the corrosion protection characteristics of the engine coolant and may cause engine damage.**
- **Decreased engine coolant concentrations below 40% will decrease the freeze protection characteristics of the engine coolant and may cause engine damage.**
- **Refer to the chart on the coolant container to ensure the coolant concentration in your vehicle will provide adequate protection at the temperatures in which you drive.**

Vehicles driven year-round in non-extreme climates should use a 50/50 mixture of engine coolant and distilled water for optimum cooling system and engine protection.

## Maintenance and Specifications

### WHAT YOU SHOULD KNOW ABOUT AUTOMOTIVE FUELS

#### Important safety precautions

**WARNING:** Do not overfill the fuel tank. The pressure in an overfilled tank may cause leakage and lead to fuel spray and fire.

**WARNING:** The fuel system may be under pressure. If the fuel filler cap is venting vapor or if you hear a hissing sound, wait until it stops before completely removing the fuel filler cap. Otherwise, fuel may spray out and injure you or others.

**WARNING:** If you do not use the proper fuel filler cap, excessive pressure or vacuum in the fuel tank may damage the fuel system or cause the fuel cap to disengage in a collision, which may result in possible personal injury.

**WARNING:** Automotive fuels can cause serious injury or death if misused or mishandled.

**WARNING:** Fuel ethanol and gasoline may contain benzene, which is a cancer-causing agent.

Observe the following guidelines when handling automotive fuel:

- Extinguish all smoking materials and any open flames before fueling your vehicle.
- Always turn off the vehicle before fueling.
- Automotive fuels can be harmful or fatal if swallowed. Fuels such as gasoline and ethanol are highly toxic and if swallowed can cause death or permanent injury. If fuel is swallowed, call a physician immediately, even if no symptoms are immediately apparent. The toxic effects of fuel may not be visible for hours.
- Avoid inhaling fuel vapors. Inhaling too much fuel vapor of any kind can lead to eye and respiratory tract irritation. In severe cases, excessive or prolonged breathing of fuel vapor can cause serious illness and permanent injury.



## Maintenance and Specifications

- Avoid getting fuel liquid in your eyes. If fuel is splashed in the eyes, remove contact lenses (if worn), flush with water for 15 minutes and seek medical attention. Failure to seek proper medical attention could lead to permanent injury.
- Fuels can also be harmful if absorbed through the skin. If fuel is splashed on the skin and/or clothing, promptly remove contaminated clothing and wash skin thoroughly with soap and water. Repeated or prolonged skin contact with fuel liquid or vapor causes skin irritation.
- Be particularly careful if you are taking “Antabuse” or other forms of disulfiram for the treatment of alcoholism. Breathing gasoline and/or ethanol vapors, or skin contact could cause an adverse reaction. In sensitive individuals, serious personal injury or sickness may result. If fuel is splashed on the skin, promptly wash skin thoroughly with soap and water. Consult a physician immediately if you experience an adverse reaction.
- FFV fuel tanks may contain zero to 85 percent ethanol. Any fuel blends containing gasoline and ethanol should be treated the same as “Fuel Ethanol”. To identify if your vehicle is an FFV, check your VIN or the label on the inside of your fuel filler door. When checking the VIN look for the engine type identifier (8th character). If your vehicle is an FFV, then the character will be labeled as a “K.”

Pure ethanol is the alcohol which is the intoxicating agent in liquor, beer and wine. It is distilled from the fermentation of plants such as field corn and sugar cane. When ethanol is used in the making of motor fuels, a small amount of a bad tasting chemical is added to discourage beverage use. The resulting fuel is called E<sub>d</sub>100 meaning 100% pure ethanol diluted by 2% to 5% gasoline as the “denaturant.”

Fuel ethanol (summer blend<sub>d</sub>) is then made by adding 15% more unleaded gasoline. The resulting fuel also has a higher octane rating than unleaded regular gasoline and other properties which allow engine designs with greater efficiency and power.

Winter blends may contain up to 30% (E70) unleaded gasoline (25% plus the denaturant) to enhance cold engine starts. Severely cold weather may require additional measures for reliable starting. Refer to *Cold Weather Starting* in the *Driving* chapter.

Ethanol is more chemically active than gasoline. It corrodes some metals and causes some plastic and rubber components to swell, break down or become brittle and crack, especially when mixed with gasoline. Special materials and procedures have been developed for flexible fuel vehicles and the dispensers used by ethanol fuel providers.

## Maintenance and Specifications

**WARNING:** Flexible fuel components and standard unleaded gasoline fuel components are not interchangeable. If your vehicle is not serviced in accordance with flexible fuel vehicles procedures, damage may occur and your warranty may be invalidated.

**WARNING:** When refueling always shut the engine off and never allow sparks or open flames near the filler neck. Never smoke while refueling. Fuel vapor is extremely hazardous under certain conditions. Care should be taken to avoid inhaling excess fumes.

**WARNING:** The flow of fuel through a fuel pump nozzle can produce static electricity, which can cause a fire if fuel is pumped into an ungrounded fuel container.

Use the following guidelines to avoid static build-up when filling an ungrounded fuel container:

- Place approved fuel container on the ground.
- DO NOT fill a fuel container while it is in the vehicle (including the cargo area).
- Keep the fuel pump nozzle in contact with the fuel container while filling.
- DO NOT use a device that would hold the fuel pump handle in the fill position.

### Fuel Filler Cap

Your fuel tank filler cap has an indexed design with a 1/8 turn on/off feature.

When fueling your vehicle:

1. Turn the engine off.
2. Carefully turn the filler cap counterclockwise 1/8 of a turn until it stops.
3. Pull to remove the cap from the fuel filler pipe.
4. To install the cap, align the tabs on the cap with the notches on the filler pipe.

## Maintenance and Specifications

5. Turn the filler cap clockwise 1/8 of a turn until it stops.

“Check Fuel Cap” illuminates when the ignition is turned to the ON position to ensure your bulb is working. When this light turns on, check the fuel filler cap. Continuing to operate the vehicle with the Check Fuel Cap light on, can activate the Service Engine Soon warning. When the fuel filler cap is properly re-installed, the light(s) will turn off after a period of normal driving. **It may take a long period of time for the system to detect an improperly installed fuel filler cap.**

**If you must replace the fuel filler cap, replace it with a fuel filler cap that is designed for your vehicle. The warranty may be void for any damage to the fuel tank or fuel system if the correct genuine Mazda fuel filler cap is not used.**

**WARNING: The fuel system may be under pressure. If the fuel filler cap is venting vapor or if you hear a hissing sound, wait until it stops before completely removing the fuel filler cap. Otherwise, fuel may spray out and injure you or others.**

**WARNING: If you do not use the proper fuel filler cap, excessive pressure or vacuum in the fuel tank may damage the fuel system or cause the fuel cap to disengage in a collision, which may result in possible personal injury.**

### Choosing the right fuel

Use only UNLEADED FUEL. The use of leaded fuel is prohibited by law and could damage your vehicle.

If your vehicle is a flexible fuel vehicle (FFV), use only UNLEADED FUEL and (E85) ETHANOL. The use of leaded fuel is prohibited by law and could damage your vehicle.

Do not use fuel containing methanol. It can damage critical fuel system components.

Your vehicle was not designed to use fuel or fuel additives with metallic compounds, including manganese-based compounds containing MMT.

Repairs to correct the effects of using a fuel for which your vehicle was not designed may not be covered by your warranty.

## Maintenance and Specifications

### Octane recommendations

Do not be concerned if your engine sometimes knocks lightly. However, if it knocks heavily under most driving conditions while you are using fuel with the recommended octane rating, see your authorized Mazda dealership to prevent any engine damage.

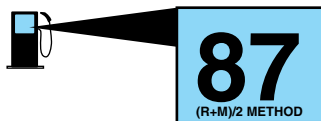

### Unleaded Gasoline engines

Your vehicle is designed to use “Regular” unleaded gasoline with an (R+M)/2 octane rating of 87. We do not recommend the use of gasolines labeled as “Regular” that are sold with octane ratings of 86 or lower in high altitude areas.

### FFV engine (if equipped)

Your vehicle is designed to use (E85) Fuel Ethanol, “Regular” unleaded gasoline or any percentage of the two fuels combined.

**U.S. government regulations require fuel ethanol dispensing pumps to have a small, square, orange and black label with the common abbreviation or the appropriate percentage for that region. Use of other fuels such as Fuel Methanol may cause powertrain damage, a loss of vehicle performance, and your warranty may be invalidated.**

### Fuel quality

Many of the world’s automakers issued the World-wide Fuel Charter that recommends gasoline specifications to provide improved performance and emission control system protection for your vehicle. Gasolines that meet the World-wide Fuel Charter should be used when available. Ask your fuel supplier about gasolines that meet the World-wide Fuel Charter. In Canada, look for fuels that display the **Auto Makers’ Choice**<sup>™</sup> logo.



It should not be necessary to add any aftermarket products to your fuel tank if you continue to use high quality fuel of the recommended octane rating. Aftermarket products could cause damage to the fuel system. Repairs to correct the effects of using an aftermarket product in your fuel may not be covered by your warranty.

# Maintenance and Specifications

## Unleaded Gasoline engines

If you are experiencing starting, rough idle or hesitation driveability problems during a cold start, try a different brand of “Regular” unleaded gasoline. “Premium” unleaded gasoline is not recommended (particularly in the United States) because it may cause these problems to become more pronounced. If the problems persist, see your authorized Mazda dealership.

## FFV engine (if equipped)

Your FFV will operate well on ordinary “Regular” unleaded gasoline, but only the highest quality fuel ethanol will provide the same level of protection and performance. To identify if your vehicle is an FFV, check your VIN or the label on the inside of your fuel filler door. When checking the VIN, look for the engine type identifier (8th character). If your vehicle is an FFV, then the character will be labeled as a “K.”

If you operate your vehicle 50% or more of the time on ethanol, you should follow a different maintenance schedule. See the *Service Maintenance Section* for more information.

If you are experiencing a rough or rolling idle after start-up with the outside temperature above 27° C (80° F), the idle should improve within 10 to 30 seconds. If the problems persist below this temperature, see your authorized Mazda dealership.

## Cleaner air

Mazda endorses the use of reformulated “cleaner-burning” gasolines to improve air quality.

## Running out of fuel

Avoid running out of fuel because this situation may have an adverse affect on powertrain components.

If you have run out of fuel:

- You may need to cycle the ignition from OFF to ON several times after refueling, to allow the fuel system to pump the fuel from the tank to the engine.
- Your “Check Engine” indicator may come on. For more information on the “Check Engine” indicator, refer to the *Instrument Cluster* chapter.

## Fuel Filter

For fuel filter replacement, see your authorized Mazda dealership. Refer to the service maintenance section for the appropriate intervals for changing the fuel filter.

## Maintenance and Specifications

**Replace the fuel filter with an authorized Mazda part. The customer warranty may be void for any damage to the fuel system if an authorized Mazda fuel filter is not used.**

### ESSENTIALS OF GOOD FUEL ECONOMY

#### Measuring techniques

Your best source of information about actual fuel economy is you, the driver. You must gather information as accurately and consistently as possible. Fuel expense, frequency of fillups or fuel gauge readings are NOT accurate as a measure of fuel economy. We do not recommend taking fuel economy measurements during the first 1,600 km (1,000 miles) of driving (engine break-in period). You will get a more accurate measurement after 3,000 km–5,000 km (2,000 miles–3,000 miles).

#### Filling the tank

The advertised fuel capacity of the fuel tank on your vehicle is equal to the rated refill capacity of the fuel tank as listed in the *Refill capacities* section of this chapter.

The advertised capacity is the amount of the indicated capacity and the empty reserve combined. Indicated capacity is the difference in the amount of fuel in a full tank and a tank when the fuel gauge indicates empty. Empty reserve is the small amount of fuel remaining in the fuel tank after the fuel gauge indicates empty.

**The amount of usable fuel in the empty reserve varies and should not be relied upon to increase driving range. When refueling your vehicle after the fuel gauge indicates empty, you might not be able to refuel the full amount of the advertised capacity of the fuel tank due to the empty reserve still present in the tank.**

For consistent results when filling the fuel tank:

- Turn the engine/ignition switch to the off position prior to refueling, an error in the reading will result if the engine is left running.
- Use the same filling rate setting (low — medium — high) each time the tank is filled.
- Allow no more than 2 automatic click-offs when filling.
- Always use fuel with the recommended octane rating.
- Use a known quality gasoline, preferably a national brand.
- Use the same side of the same pump and have the vehicle facing the same direction each time you fill up.



## Maintenance and Specifications

- Have the vehicle loading and distribution the same every time.

Your results will be most accurate if your filling method is consistent.

### Calculating fuel economy

1. Fill the fuel tank completely and record the initial odometer reading (in kilometers or miles).
2. Each time you fill the tank, record the amount of fuel added (in liters or gallons).
3. After at least three to five tank fill-ups, fill the fuel tank and record the current odometer reading.
4. Subtract your initial odometer reading from the current odometer reading.
5. Follow one of the simple calculations in order to determine fuel economy:

**Multiply liters used by 100, then divide by total kilometers traveled.**

**Divide total miles traveled by total gallons used.**

Keep a record for at least one month and record the type of driving (city or highway). This will provide an accurate estimate of the vehicle's fuel economy under current driving conditions. Additionally, keeping records during summer and winter will show how temperature impacts fuel economy. In general, lower temperatures give lower fuel economy.

Ethanol has less energy per gallon than gasoline. Fuel economy will decrease as the percentage of ethanol used is increased.

### Driving style — good driving and fuel economy habits

Give consideration to the lists that follow and you may be able to change a number of variables and improve your fuel economy.

#### **Habits**

- Smooth, moderate operation can yield up to 10% savings in fuel.
- Steady speeds without stopping will usually give the best fuel economy.
- Idling for long periods of time (greater than one minute) may waste fuel.
- Anticipate stopping; slowing down may eliminate the need to stop.
- Sudden or hard accelerations may reduce fuel economy.

## Maintenance and Specifications

- Slow down gradually.
- Driving at reasonable speeds (traveling at 88 km/h [55 mph] uses 15% less fuel than traveling at 105 km/h [65 mph]).
- Revving the engine before turning it off may reduce fuel economy.
- Using the air conditioner or defroster may reduce fuel economy.
- You may want to turn off the speed control in hilly terrain if unnecessary shifting between third and fourth gear occurs. Unnecessary shifting of this type could result in reduced fuel economy.
- Warming up a vehicle on cold mornings is not required and may reduce fuel economy.
- Resting your foot on the brake pedal while driving may reduce fuel economy.
- Combine errands and minimize stop-and-go driving.

### **Maintenance**

- Keep tires properly inflated and use only recommended size.
- Operating a vehicle with the wheels out of alignment will reduce fuel economy.
- Use recommended engine oil. Refer to *Lubricant specifications* in this chapter.
- Perform all regularly scheduled maintenance items. Follow the recommended maintenance schedule and owner maintenance checks found in your vehicle service maintenance section.

### **Conditions**

- Heavily loading a vehicle or towing a trailer may reduce fuel economy at any speed.
- Carrying unnecessary weight may reduce fuel economy (approximately 0.4 km/L [1 mpg] is lost for every 180 kg [400 lb] of weight carried).
- Adding certain accessories to your vehicle (for example bug deflectors, rollbars/light bars, running boards, ski/luggage racks) may reduce fuel economy.
- Using fuel blended with alcohol may lower fuel economy.
- Fuel economy may decrease with lower temperatures during the first 12–16 km (8–10 miles) of driving.
- Driving on flat terrain offers improved fuel economy as compared to driving on hilly terrain.

## Maintenance and Specifications

- Transmissions give their best fuel economy when operated in the top cruise gear and with steady pressure on the gas pedal.
- Four-wheel-drive operation (if equipped) is less fuel efficient than two-wheel-drive operation.
- Close windows for high speed driving.

### EPA window sticker

Every new vehicle should have the EPA window sticker. Contact your dealer if the window sticker is not supplied with your vehicle. The EPA window sticker should be your guide for the fuel economy comparisons with other vehicles.

It is important to note the box in the lower left corner of the window sticker. These numbers represent the Range of L/100 km (MPG) expected on the vehicle under optimum conditions. Your fuel economy may vary depending upon the method of operation and conditions.

### EMISSION CONTROL SYSTEM

Your vehicle is equipped with various emission control components and a catalytic converter which will enable your vehicle to comply with applicable exhaust emission standards. To make sure that the catalytic converter and other emission control components continue to work properly:

- Use only the specified fuel listed.
- Avoid running out of fuel.
- Do not turn off the ignition while your vehicle is moving, especially at high speeds.
- Have the items listed in your service maintenance section performed according to the specified schedule.

The scheduled maintenance items listed in the service maintenance section are essential to the life and performance of your vehicle and to its emissions system.

If other than Mazda or Mazda-authorized parts are used for maintenance replacements or for service of components affecting emission control, such non-Mazda parts should be equivalent to genuine Mazda Motor Corporation parts in performance and durability.

**WARNING: Do not park, idle, or drive your vehicle in dry grass or other dry ground cover. The emission system heats up the engine compartment and exhaust system, which can start a fire.**

## Maintenance and Specifications

Illumination of the “Service Engine Soon” light, charging system warning light or the temperature warning light, fluid leaks, strange odors, smoke or loss of engine power, could indicate that the emission control system is not working properly.

**WARNING: Exhaust leaks may result in entry of harmful and potentially lethal fumes into the passenger compartment.**

Do not make any unauthorized changes to your vehicle or engine. By law, vehicle owners and anyone who manufactures, repairs, services, sells, leases, trades vehicles, or supervises a fleet of vehicles are not permitted to intentionally remove an emission control device or prevent it from working. Information about your vehicle’s emission system is on the Vehicle Emission Control Information Decal located on or near the engine. This decal identifies engine displacement and gives some tune up specifications.

Please consult your *Warranty Guide* for complete emission warranty information.

### Readiness for Inspection/Maintenance (I/M) testing

In some localities, it may be a legal requirement to pass an I/M test of the on-board diagnostics system. If your “Check Engine/Service Engine Soon” light is on, refer to the description in the *Warning lights and chimes* section of the *Instrument cluster* chapter. Your vehicle may not pass the I/M test with the “Check Engine/Service Engine Soon” light on.

If the vehicle’s powertrain system or its battery has just been serviced, the on-board diagnostics system is reset to a “not ready for I/M test” condition. To ready the on-board diagnostics system for I/M testing, a minimum of 30 minutes of city and highway driving is necessary as described below:

- First, at least 10 minutes of driving on an expressway or highway.
- Next, at least 20 minutes driving in stop-and-go, city-type traffic with at least four idle periods.

Allow the vehicle to sit for at least eight hours without starting the engine. Then, start the engine and complete the above driving cycle. The engine must warm up to its normal operating temperature. Once started, do not turn off the engine until the above driving cycle is complete.

# Maintenance and Specifications

## CHECKING AND ADDING POWER STEERING FLUID

Check the power steering fluid. Refer to the service maintenance section for the service interval schedules. If adding fluid is necessary, use only MERCON® ATF.

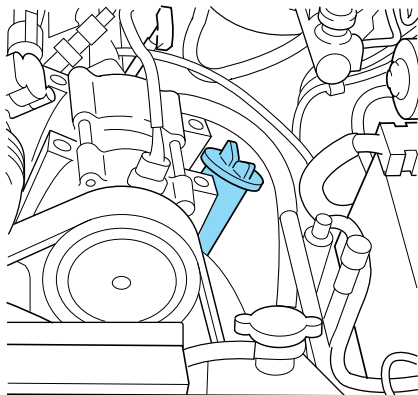

1. Start the engine and let it run until it reaches normal operating temperature (the engine coolant temperature gauge indicator will be near the center of the normal area between H and C).
2. While the engine idles, turn the steering wheel left and right several times.
3. Turn the engine off.
4. **If your vehicle is equipped with a 3.0L V6 engine**, check the fluid level on the dipstick. It should be within the FULL HOT range. Do not add fluid if the level is within this range.
5. **If your vehicle is equipped with a 4.0L SOHC V6 or 2.3L I4 engine**, check the fluid level in the reservoir. It should be between the MIN and MAX lines. Do not add fluid if the level is within this range.
6. If the fluid is low, add fluid in small amounts, continuously checking the level until it reaches the FULL HOT range. Be sure to put the dipstick back in the reservoir.

## Maintenance and Specifications

### BRAKE FLUID

#### Checking and adding brake fluid

Brake fluid should be checked and refilled as needed. Refer to the service maintenance section for the service interval schedules.

1. Clean the reservoir cap before removal to prevent dirt or water from entering the reservoir.
2. Visually inspect the fluid level.
3. If necessary, add brake fluid from a clean un-opened container until the level reaches MAX. Do not fill above this line.
4. Use only a DOT 3 brake fluid certified to meet Mazda specification . Refer to *Lubricant specifications* in this chapter.

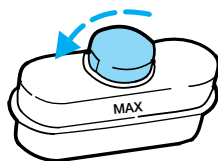
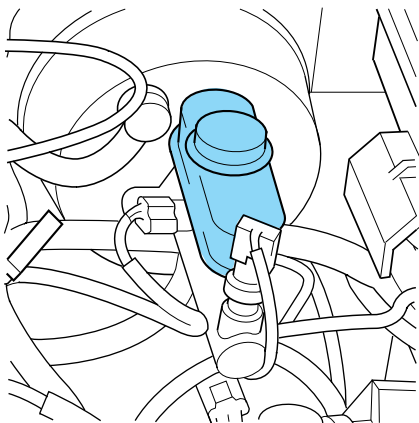

**WARNING: Brake fluid is toxic. If brake fluid contacts the eyes, flush eyes with running water for 15 minutes. Seek medical attention if irritation persists. If taken internally, drink water and induce vomiting. Seek medical attention immediately.**

**WARNING: If you use a brake fluid that is not DOT 3, you will cause permanent damage to your brakes.**

**WARNING: Do not let the reservoir for the master cylinder run dry. This may cause the brakes to fail.**

## Maintenance and Specifications

### CLUTCH FLUID (IF EQUIPPED)

Check the fluid level. Refer to the service maintenance section for the service interval schedules.

During normal operation, the fluid level in the clutch reservoir should remain constant. If the fluid level drops, refill the fluid level to the step in the reservoir.

Use only a DOT 3 brake fluid designed to meet Mazda specification. Refer to *Lubricant Specifications* in this chapter.

**WARNING: Brake fluid is toxic. If brake fluid contacts the eyes, flush eyes with running water for 15 minutes. Seek medical attention if irritation persists. If taken internally, drink water and induce vomiting. Seek medical attention immediately.**

1. Clean the reservoir cap before removal to prevent dirt and water from entering the reservoir.
2. Remove cap and rubber diaphragm from reservoir.
3. Add fluid until the level reaches the step in the reservoir.
4. Reinstall rubber diaphragm and cap onto reservoir.

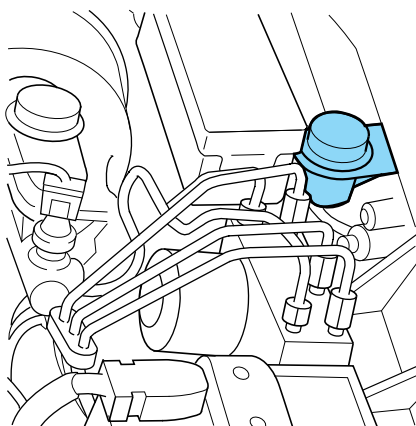

### TRANSMISSION FLUID

#### Checking automatic transmission fluid (if equipped)

Refer to your service maintenance section for scheduled intervals for fluid checks and changes. Your transmission does not consume fluid. However, the fluid level should be checked if the transmission is not working properly, i.e., if the transmission slips or shifts slowly or if you notice some sign of fluid leakage.

Automatic transmission fluid expands when warmed. To obtain an accurate fluid check, drive the vehicle until it is at normal operating

## Maintenance and Specifications

temperature (approximately 30 km [20 miles]). If your vehicle has been operated for an extended period at high speeds, in city traffic during hot weather or pulling a trailer, the vehicle should be turned off for about 30 minutes to allow fluid to cool before checking.

1. Drive the vehicle 30 km (20 miles) or until it reaches normal operating temperature.
2. Park the vehicle on a level surface and engage the parking brake.
3. With the parking brake engaged and your foot on the brake pedal, start the engine and move the gearshift lever through all of the gear ranges. Allow sufficient time for each gear to engage.
4. Latch the gearshift lever in P (Park) and leave the engine running.
5. Remove the dipstick, wiping it clean with a clean, dry lint free rag. If necessary, refer to *Identifying components in the engine compartment* in this chapter for the location of the dipstick.
6. Install the dipstick making sure it is fully seated in the filler tube.
7. Remove the dipstick and inspect the fluid level. The fluid should be in the designated area for normal operating temperature or ambient temperature.

### Low fluid level

Do not drive the vehicle if the fluid level is at the bottom of the dipstick and the ambient temperature is above 10°C (50°F).

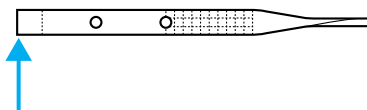

### Correct fluid level

The transmission fluid should be checked at normal operating temperature 66°C-77°C (150°F-170°F) on a level surface. The normal operating temperature can be reached after approximately 30 km (20 miles) of driving.

You can check the fluid without driving if the ambient temperature is above 10°C (50°F). However, if fluid is added at this time, an overfill condition could result when the vehicle reaches normal operating temperature.

The transmission fluid should be in this range if at normal operating temperature (66°C-77°C [150°F-170°F]).

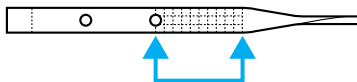



## Maintenance and Specifications

The transmission fluid should be in this range if at ambient temperature (10°C-35°C [50°F-95°F]).

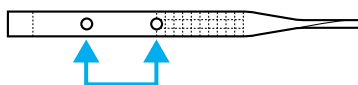

### **High fluid level**

Fluid levels above the safe range may result in transmission failure. An overfill condition of transmission fluid may cause shift and/or engagement concerns and/or possible damage.

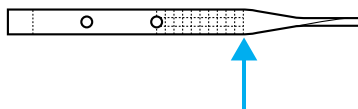

High fluid levels can be caused by an overheating condition.

### **Adjusting automatic transmission fluid levels**

Before adding any fluid, make sure the correct type is used. The type of fluid used is normally indicated on the dipstick and also in the *Lubricant specifications* section in this chapter.

**Use of a non-approved automatic transmission fluid may cause internal transmission component damage.**

If necessary, add fluid in 250 ml (1/2 pint) increments through the filler tube until the level is correct.

If an overfill occurs, excess fluid should be removed by a qualified technician.

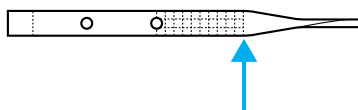

**An overfill condition of transmission fluid may cause shift and/or engagement concerns and/or possible damage.**

Do not use supplemental transmission fluid additives, treatments or cleaning agents. The use of these materials may affect transmission operation and result in damage to internal transmission components.

## Maintenance and Specifications

### Checking and adding manual transmission fluid (if equipped)

1. Clean the filler plug.
2. Remove the filler plug and inspect the fluid level.

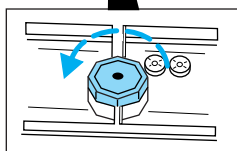
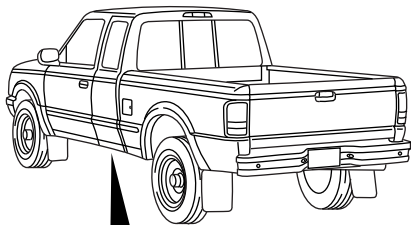

3. Fluid level should be at bottom of the opening.
4. Add enough fluid through the filler opening so that the fluid level is at the bottom of the opening.
5. Install and tighten the fill plug securely.

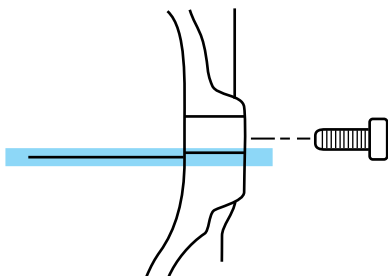

Use only fluid that meets Mazda specifications. Refer to *Lubricant Specifications* in this chapter.

## Maintenance and Specifications

### Checking and adding transfer case fluid (if equipped)

Vehicle must be on level surface.

1. Clean the filler plug.
2. Remove the filler plug and inspect the fluid level.

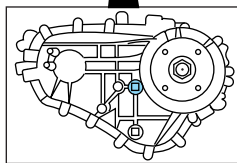
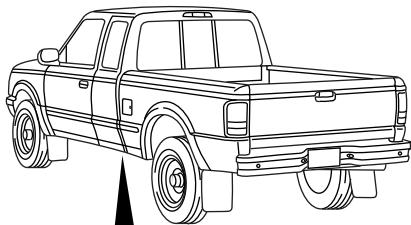

3. Add only enough fluid through the filler opening so that the fluid level is at the bottom of the opening.

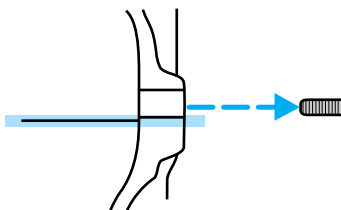

Use only fluid that meets Mazda specifications. Refer to *Lubricant Specifications* in this chapter.

### DRIVELINE UNIVERSAL JOINT AND SLIP YOKE

Your vehicle may be equipped with universal joints that require lubrication. If the original universal joints are replaced with universal joints equipped with grease fittings, lubrication will also be necessary.

## Maintenance and Specifications

### INFORMATION ABOUT UNIFORM TIRE QUALITY GRADING

New vehicles are fitted with tires that have a rating on them called Tire Quality Grades. The Quality grades can be found where applicable on the tire sidewall between tread shoulder and maximum section width. For example:

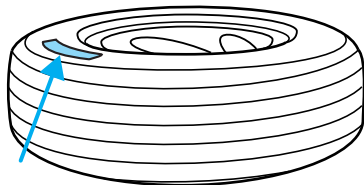

- **Treadwear 200 Traction AA Temperature A**

These Tire Quality Grades are determined by standards that the United States Department of Transportation has set.

Tire Quality Grades apply to new pneumatic tires for use on passenger cars. They do not apply to deep tread, winter-type snow tires, space-saver or temporary use spare tires, tires with nominal rim diameters of 10 to 12 inches or limited production tires as defined in Title 49 Code of Federal Regulations Part 575.104(c)(2).

**U.S. Department of Transportation-Tire quality grades:** The U.S. Department of Transportation requires Mazda to give you the following information about tire grades exactly as the government has written it.

#### Treadwear

The treadwear grade is a comparative rating based on the wear rate of the tire when tested under controlled conditions on a specified government test course. For example, a tire graded 150 would wear one and one-half (1 1/2) times as well on the government course as a tire graded 100. The relative performance of tires depends upon the actual conditions of their use, however, and may depart significantly from the norm due to variations in driving habits, service practices, and differences in road characteristics and climates.

#### Traction AA A B C

The traction grades, from highest to lowest are AA, A, B, and C. The grades represent the tire's ability to stop on wet pavement as measured under controlled conditions on specified government test surfaces of asphalt and concrete. A tire marked C may have poor traction performance.

**NOTE:** The traction grade assigned to this tire is based on straight-ahead braking traction tests, and does not include acceleration, cornering, hydroplaning or peak traction characteristics.

## Maintenance and Specifications

### Temperature A B C

The temperature grades are A (the highest), B, and C, representing the tire's resistance to the generation of heat and its ability to dissipate heat when tested under controlled conditions on a specified indoor laboratory test wheel. Sustained high temperature can cause the material of the tire to degenerate and reduce tire life, and excessive temperature can lead to sudden tire failure. The grade C corresponds to a level of performance which all passenger car tires must meet under the Federal Motor Vehicle Safety Standard No. 109. Grades B and A represent higher levels of performance on the laboratory test wheel than the minimum required by law.

**WARNING: The temperature grade for this tire is established for a tire that is properly inflated and not overloaded. Excessive speed, underinflation, or excessive loading, either separately or in combination, can cause heat buildup and possible tire failure.**

### SERVICING YOUR TIRES

#### Checking the tire pressure

- Use an accurate tire pressure gauge.
- Check the tire pressure when tires are cold, after the vehicle has been parked for at least one hour or has been driven less than 5 km (3 miles).
- Adjust tire pressure to recommended specifications found on the Certification Label or the Tire Label.

**WARNING: Improperly inflated tires can affect vehicle handling and can fail suddenly, possibly resulting in loss of vehicle control.**

#### Tire rotation

Because your vehicle's tires perform different jobs, they often wear differently. To make sure your tires wear evenly and last longer, rotate them as indicated in the service maintenance section. If you notice that the tires wear unevenly, have them checked.

The following procedure applies to vehicles equipped with single rear wheels, if your vehicle is equipped with dual rear wheels it is recommended that only the front wheels be rotated (side to side).

## Maintenance and Specifications

- Four tire rotation

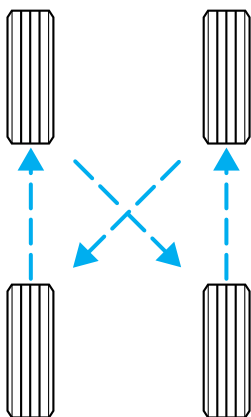

- Five tire rotation

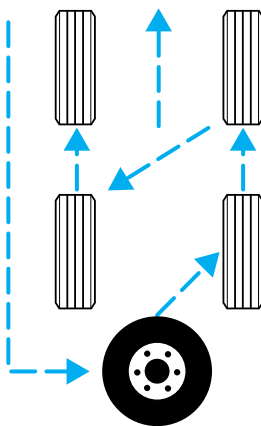

### Replacing the tires

Replace the tires when the wear band is visible through the tire treads.

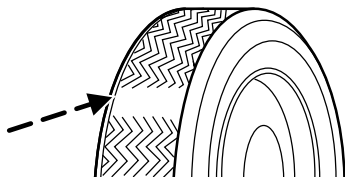

## Maintenance and Specifications

**WARNING:** When replacing full size tires, never mix radial bias-belted, or bias-type tires. Use only the tire sizes that are listed on the Certification Label. Make sure that all tires are the same size, speed rating, and load-carrying capacity. Use only the tire combinations recommended on the label. If you do not follow these precautions, your vehicle may not drive properly and safely and an accident can occur.

**WARNING:** Make sure that all replacement tires are of the same size, type, load-carrying capacity and tread (e.g., “All Terrain”, etc.), as originally offered by Mazda. Failure to do so can result in tire failure and a serious accident.

**WARNING:** Do not replace your tires with “high performance” tires or larger size tires.

**WARNING:** Failure to follow these precautions may adversely affect the handling of the vehicle, damage parts of the tire and make it easier for the driver to lose control and roll over.

Tires that are larger or smaller than your vehicle’s original tires may also affect the accuracy of your speedometer.

### **SNOW TIRES AND CHAINS**

**WARNING:** Driving too fast for conditions creates the possibility of loss of vehicle control. Driving at very high speeds for extended periods of time may result in damage to vehicle components.

**NOTE:** Snow tires must be the same size and grade as the tires you currently have on your vehicle.

The tires on your vehicle have all weather treads to provide traction in rain and snow. However, in some climates, you may need to use snow tires and chains. If you need to use snow tires and chains, it is recommended that steel wheels are used of the same size and specifications as those originally installed.

Follow these guidelines when using snow tires and chains:

- Do not use tire chains on aluminum wheels. Chains may chip the wheels.

## Maintenance and Specifications

- Use only SAE Class S chains.
- Install chains securely, verifying that the chains do not touch any wiring, brake lines or fuel lines.

**Drive cautiously. If you hear the cables rub or bang against the vehicle, stop and retighten them. If this does not work, remove the cables to prevent vehicle damage.**

- If possible, avoid fully loading your vehicle.
- Remove the tire chains when they are no longer needed. Do not use tire chains on dry roads.
- The suspension insulation and bumpers will help prevent vehicle damage. Do not remove these components from your vehicle when using snow tires and chains.

### REFILL CAPACITIES

Fluid	Mazda Part Name	Application	Capacity
Engine oil (includes filter change)	Mazda SAE 5W-20 Super Premium Motor Oil	2.3L engine	3.8L (4.0 quarts.)
		3.0L V6 engines	4.3L (4.5 quarts)
	Mazda SAE 5W-30 Super Premium Motor Oil	4.0L V6 engine	4.7L (5.0 quarts)
Brake fluid	High Performance DOT 3 Motor Vehicle Brake Fluid	All	Fill to line on reservoir
Power steering fluid	Mazda MERCON® ATF	All	Fill to range on dipstick



## Maintenance and Specifications

<b>Fluid</b>	<b>Mazda Part Name</b>	<b>Application</b>	<b>Capacity</b>
Transmission fluid <sup>1</sup>	Mazda MERCON® ATF	5-speed manual	2.65L (2.8 quarts) <sup>2</sup>
	Mazda MERCON®V ATF	4x2 vehicles with automatic and 2.3L I4 engine	9.4L (9.9 quarts) <sup>3</sup>
		4x2 vehicles with automatic and 3.0L or 4.0L engines	9.5L (10.0 quarts) <sup>3</sup>
		4x4 vehicles with automatic and 3.0L or 4.0L	9.8L (10.3 quarts) <sup>3</sup>
Engine coolant <sup>4</sup>	Premium Engine Coolant	2.3 L I4 engine with manual transmission	10.0L (10.5 quarts)
		2.3L I4 engine with automatic transmission	9.7L (10.2 quarts)
		3.0L V6 engine with manual transmission	14.3L (15.1 quarts)
		3.0L V6 engine with automatic transmission	14.0L (14.8 quarts)
		4.0L V6 engine with manual transmission	13.0L (13.7 quarts)
		4.0L V6 engine with automatic transmission	12.5L (13.2 quarts)

## Maintenance and Specifications

Fluid	Mazda Part Name	Application	Capacity
Fuel tank	N/A	Regular cab (Short wheel base)	62.4L (16.5 gallons)
		Regular cab (Long wheel base)	75.7L (20.0 gallons)
		SuperCab	73.8L (19.5 gallons)
Transfer Case Fluid	Mazda MERCON® ATF	4x4 Vehicles	1.2L (1.25 quarts)
Front axle lubricant	Mazda SAE 80W-90 Premium Rear Axle Lubricant	4x4 Vehicles	1.7L (3.6 pints)
Rear axle lubricant <sup>5</sup>	Mazda SAE 80W-90 Premium Rear Axle Lubricant	All	2.4-2.5L (5.0-5.3 pints)
Windshield washer fluid	Ultra-Clear Windshield Washer Concentrate	All	2.6L (2.75 quarts)

<sup>1</sup>Ensure the correct automatic transmission fluid is used. Transmission fluid requirements are indicated on the dipstick or on the dipstick handle. MERCON® and MERCON® V are not interchangeable. DO NOT mix MERCON® and MERCON®V. Refer to the service maintenance section to determine the correct service interval.

<sup>2</sup>Service refill capacity is determined by filling the transmission to the bottom of the filler hole with the vehicle on a level surface.

<sup>3</sup>Indicates only approximate dry-fill capacity. Some applications may vary based on cooler size and if equipped with an in-tank cooler. The amount of transmission fluid and fluid level should be set by the indication on the dipstick's normal operating range.

<sup>4</sup>Use Mazda Premium Engine Coolant (green in color). DO NOT USE Mazda Extended Life Engine Coolant (orange in color). Refer to *Adding engine coolant, in the Maintenance and Care chapter*.

## Maintenance and Specifications

<sup>5</sup>Traction-Lok axles use 2.2–2.4L (4.75–5.0 pints) of rear axle lubricant.

Add 118 ml (4 oz.) of Additive Friction Modifier meeting Mazda specifications for complete refill of Traction-Lok axles.

Service refill capacities are determined by filling the rear axle 6 mm to 14 mm (1/4 inch to 9/16 inch) below the bottom of the filler hole.

### LUBRICANT SPECIFICATIONS

Item	Mazda part name or equivalent
Front axle (4X4)	SAE 80W-90 Premium Rear Axle Lubricant
Rear axle	SAE 80W-90 Premium Rear Axle Lubricant <sup>1</sup>
Brake fluid and clutch fluid (if equipped)	High Performance DOT 3 Motor Vehicle Brake Fluid
Door weather strips	Silicone Lubricant
Engine coolant	Mazda Premium Engine Coolant
Engine oil 2.3L I4 and 3.0L V6 engines	SAE 5W-20 Premium Synthetic Blend Motor Oil
Engine oil 4.0L V6 engines	SAE 5W-30 Super Premium Motor Oil
Hinges, door checks, latches, striker plates, fuel filler door hinge and seat tracks	Multi-Purpose Grease
Transmission /steering/parking brake linkages and pivots, brake and clutch pedal shaft, clutch pilot bearing and input shaft spline (manual transmission).	Premium Long-Life Grease
Power steering fluid, transfer case fluid (4X4) and transmission fluid (manual)	MERCON® ATF
Automatic transmission (5R44E and 5R55E)	MERCON®V ATF <sup>2</sup>
Windshield washer fluid	Ultra-clear Windshield Washer Concentrate

## Maintenance and Specifications

<sup>1</sup>Add 118 ml (4 oz.) of Additive Friction Modifier meeting Mazda specifications for complete refill of Traction-Lok axles. If submerged in water, the rear axle lubricant should be changed.

<sup>2</sup>Ensure the correct automatic transmission fluid is used. Transmission fluid requirements are indicated on the dipstick or on the dipstick handle. MERCON® and MERCON® V are not interchangeable. DO NOT mix MERCON® and MERCON® V. Refer to your service maintenance section to determine the correct service interval.

### ENGINE SPECIFICATIONS

Engine	2.3L I4 engine	3.0L V6 engine	4.0L V6 engine
Cubic inches	138	182	245
Required fuel	87 octane	87 octane	87 octane
Firing order	1-3-4-2	1-4-2-5-3-6	1-4-2-5-3-6
Spark plug gap	1.04-1.19mm (0.041-0.047 inch)	1.07-1.17mm (0.042-0.046 inch)	1.3-1.4 mm (0.052-0.056 inch)
Ignition system	EDIS	EDIS	EDIS
Compression ratio	9.7:1	9.14:1	9.0:1

### VEHICLE DIMENSIONS

Vehicle dimensions	Regular Cab mm (in)	SuperCab mm (in)
(1) Overall length	4 763 (187.5)	5 153 (202.9)
(2) Overall width	1 785 (70.3)	1 785 (70.3)
(3) Overall height 4x2/4x4	1 575 (62.0) / 1 655 (65.2)	1 585 (62.4) / 1 684 (66.3)
(4) Wheelbase	2 831 (111.4)	3 192 (125.7)
(5) Track - Front	1 486 (58.5)	1 485 (58.5)
(5) Track - Rear	1 455 (57.3)	1 455 (57.3)

## Maintenance and Specifications

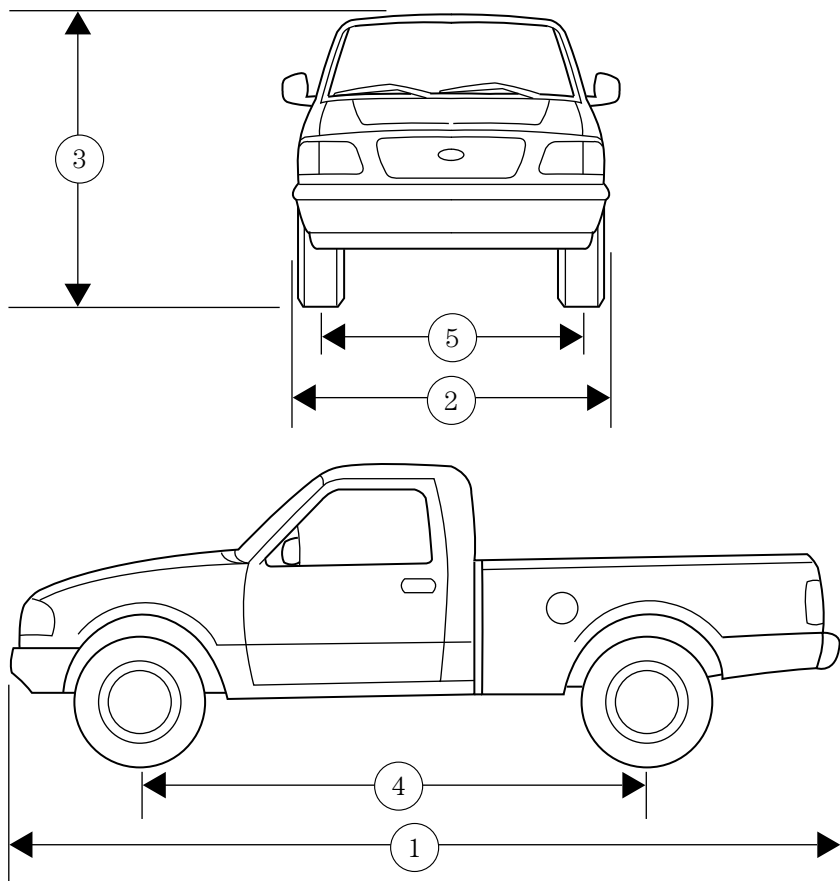

## Maintenance and Specifications

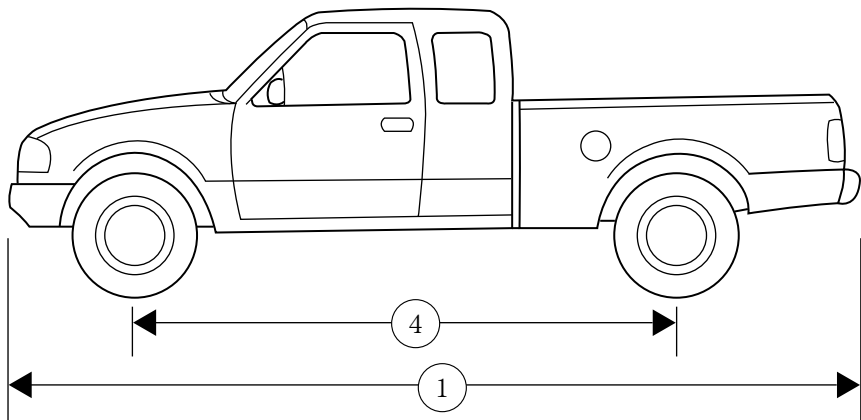

### IDENTIFYING YOUR VEHICLE

#### Certification label

The National Highway Traffic Safety Administration Regulations require that a Certification Label be affixed to a vehicle and prescribe where the Certification Label may be located. The Certification Label is located on the front door latch pillar on the driver's side.

#### Vehicle identification number (VIN)

The vehicle identification number is attached to a metal tag and is located on the driver side instrument panel. (Please note that in the graphic XXXX is representative of your vehicle identification number.)

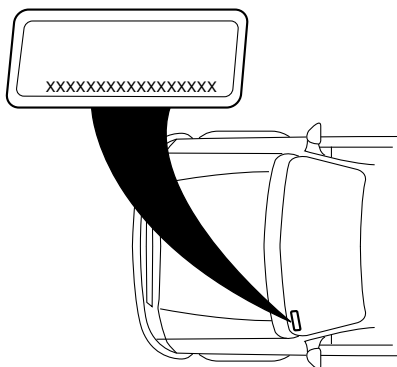

#### Engine number

The engine number (the last eight numbers of the vehicle identification number) is stamped on the engine block, transmission, frame and transfer case (if equipped).

### CELL PHONES

Use of cell phones and other devices by driver:

**WARNING:** Although not Mazda products, use of any electrical devices such as cell phones, computers, portable radios, vehicle navigation or other devices by the driver while the vehicle is moving is dangerous. Dialing a number on a cell phone while driving also ties-up the driver's hands. Use of these devices will cause the driver to be distracted and could lead to a serious accident. If a passenger is unable to use the device, pull off the right-of-way to a safe area before use. If use of a cell phone is necessary despite this warning, use a hands-free system to at least allow the hands free to drive the vehicle. Never use a cell phone or other electrical device while the vehicle is moving and, instead, concentrate on the full-time job of driving.

# Index

## A

- ABS (see Brakes) .....154
- Air bag supplemental restraint system .....119–120
  - and child safety seats .....122
  - description .....120
  - disposal .....126
  - driver air bag .....124
  - indicator light .....14–15, 125
  - operation .....124
  - passenger air bag .....124
  - passenger deactivation switch .....126
- Air conditioning
  - manual heating and air conditioning system .....69
- Ambulance packages .....7
- Antifreeze (see Engine coolant) .....245
- Anti-lock brake system (see Brakes) .....154–155
- Anti-theft system
  - warning light .....16
- Audio system (see Radio) .....21, 45, 53
- Automatic transmission .....158
  - driving an automatic overdrive .....159
  - fluid, adding .....263
  - fluid, checking .....263
  - fluid, refill capacities .....272
  - fluid, specification .....276
- Auxiliary power point .....84
- Axle
  - lubricant specifications ..275–276
  - refill capacities .....272
  - traction lok .....157

## B

- Battery .....243

- acid, treating emergencies .....243
- charging system warning light .....15
- jumping a disabled battery ....201
- maintenance-free .....243
- servicing .....243
- voltage gauge .....19
- Bed extender .....95
- BeltMinder .....115
- Brakes .....153
  - anti-lock .....154–155
  - anti-lock brake system (ABS) warning light .....14, 155
  - brake warning light .....13
  - fluid, checking and adding ....262
  - fluid, refill capacities .....272
  - fluid, specifications .....275–276
  - lubricant specifications ..275–276
  - parking .....155
  - shift interlock .....158
- Break-in period .....5
- Bulbs .....75

## C

- Capacities for refilling fluids ....272
- Cargo area shade .....95
- Cargo net .....95
- CD-6 disc .....53
- CD-single .....25
- CD-single premium .....45
- Cell phone warning .....279
- Certification Label .....278
- Changing a tire .....194
- Child safety restraints .....132
  - child safety belts .....132
- Child safety seats .....135



- attaching with tether straps ..140
- in front seat .....136
- in rear seat .....136, 139
- LATCH .....145
- tether anchorage hardware ...140
- Cleaning your vehicle
  - engine compartment .....219
  - exterior .....223
  - instrument cluster lens .....222
  - instrument panel .....222
  - interior .....222
  - mirrors .....221
  - plastic parts .....221
  - washing .....218
  - waxing .....218
  - wheels .....219
  - wiper blades .....221
- Climate control (see Air conditioning or Heating) .....68–69
- Clock .....24, 31, 44, 52, 64
- Clutch
  - fluid .....263
  - operation while driving .....162
  - recommended shift speeds ...164
- Compass, electronic .....86–87
  - calibration .....88
  - set zone adjustment .....87
- Console .....94
- Coolant
  - checking and adding .....245
  - refill capacities .....249, 272
  - specifications .....275–276
- Cruise control (see Speed control) .....89
- Customer Assistance .....181, 207–208, 211
  - Ford accessories for your vehicle .....223
  - Getting roadside assistance ...181
- D**
  - Daytime running lamps (see Lamps) .....73
  - Dipstick
    - automatic transmission fluid .....263
    - engine oil .....238
  - Doors
    - door ajar warning .....16
    - lubricant specifications .....275
  - Driveline universal joint and slip yoke .....267
  - Driving under special conditions .....168–169
    - mud .....168
    - sand .....168
    - snow and ice .....169
    - through water .....168, 170
- E**
  - Emergencies, roadside
    - jump-starting .....201
  - Emission control system .....259
  - Engine .....276
    - check engine/service engine soon light .....12
    - cleaning .....219
    - coolant .....245
    - idle speed control .....243
    - lubrication
      - specifications .....275–276
      - refill capacities .....272
    - service points .....234–236
    - starting after a collision .....182
  - Engine block heater .....152
  - Engine oil .....238
    - checking and adding .....238
    - dipstick .....238

# Index

- filter, specifications .....242
- recommendations .....242
- refill capacities .....272
- specifications .....275–276
- Exhaust fumes .....152
- F**
- Flexible Fuel Vehicle (FFV) ....250
- Fluid capacities .....272
- Foglamps .....73
- Four-Wheel Drive vehicles .....16–17, 165
  - description .....165
  - driving off road .....167
  - electronic shift .....165
  - indicator light .....165
  - preparing to drive your vehicle .....157
- Fuel .....250
  - calculating fuel economy .....256
  - cap .....15, 252
  - capacity .....272
  - choosing the right fuel .....253
  - comparisons with EPA fuel economy estimates .....259
  - detergent in fuel .....255
  - filling your vehicle with fuel .....250, 252, 256
  - filter, specifications .....255
  - fuel pump shut-off switch ....182
  - gauge .....19
  - improving fuel economy .....256
  - octane rating .....254, 276
  - quality .....254
  - running out of fuel .....255
  - safety information relating to automotive fuels .....250
- Fuel - flex fuel vehicle (FFV) .....250, 253–254
- Fuses .....183, 185
- G**
- Gas cap (see Fuel cap) .....15, 252
- Gas mileage (see Fuel economy) .....256
- Gauges .....18
  - battery voltage gauge .....19
  - engine coolant temperature gauge .....18
  - engine oil pressure gauge .....19
  - fuel gauge .....19
  - odometer .....20
  - speedometer .....20
  - tachometer .....20
  - trip odometer .....20
- GAWR (Gross Axle Weight Rating) .....170
  - calculating .....172
  - definition .....170
  - driving with a heavy load .....170
  - location .....170
- GVWR (Gross Vehicle Weight Rating) .....170
  - calculating .....170, 172
  - definition .....170
  - driving with a heavy load .....170
  - location .....170
- H**
- Hazard flashers .....182
- Headlamps .....73
  - aiming .....74
  - bulb specifications .....76
  - daytime running lights .....73
  - flash to pass .....74
  - high beam .....16, 74
  - replacing bulbs .....77
  - turning on and off .....73

- warning chime .....17
- Heating
  - heater only system .....68
  - heating and air conditioning system .....69
- Hood .....233
- I**
- Ignition .....148, 276
- Infant seats (see Safety seats) ..135
- Inspection/maintenance (I/M) testing .....260
- Instrument panel
  - cleaning .....222
  - cluster .....12, 222
  - lighting up panel and interior ...74
  - location of components .....12
- J**
- Jack .....194
  - positioning .....194
  - storage .....194–197
- Jump-starting your vehicle .....201
- K**
- Keys .....102–103
  - key in ignition chime .....17
  - positions of the ignition .....148
- L**
- Lamps
  - bulb replacement specifications chart .....76
  - cargo lamps .....74
  - daytime running light .....73
  - fog lamps .....73
  - headlamps .....73
  - headlamps, flash to pass .....74
  - instrument panel, dimming ....74
  - interior lamps .....75–76
  - replacing bulbs ..75, 77–78, 80–81
- Lane change indicator (see Turn signal) .....75
- LATCH anchors .....145
- Lights, warning and indicator ....12
  - air bag .....14–15
  - anti-lock brakes (ABS) ....14, 155
  - anti-theft .....16
  - brake .....13
  - charging system .....15
  - check coolant .....13
  - check engine .....12
  - cruise indicator .....15
  - door ajar .....16
  - fuel cap light .....15
  - high beam .....16
  - overdrive off .....16
  - safety belt .....14
  - speed control .....93
  - turn signal indicator .....16
- Limited slip axle (see Traction Loc) .....157
- Load limits .....170
  - GAWR .....170
  - GVWR .....170
  - trailer towing .....170
- Loading instructions .....172
- Lubricant specifications ...275–276
- Lumbar support, seats .....106
- M**
- Manual transmission .....162
  - fluid capacities .....272
  - lubricant specifications .....276
  - reverse .....164

# Index

- Mirrors  
  automatic dimming rearview  
  mirror .....86  
  cleaning .....221  
  side view mirrors (power) .....89
- Motorcraft parts .....255
- O**
- Octane rating .....254
- Odometer .....20
- Oil (see Engine oil) .....238
- Overdrive .....93
- P**
- Panic alarm feature, remote  
entry system .....100
- Parking brake .....155
- Power distribution box  
(see Fuses) .....188
- Power door locks .....97
- Power point .....84
- Power steering .....156  
  fluid, checking and adding ....261  
  fluid, refill capacity .....272  
  fluid, specifications .....275–276
- Power Windows .....85
- Preparing to drive your  
vehicle .....157
- R**
- Radio .....21, 45, 53
- Radio reception .....66–67
- Relays .....183
- Remote entry system .....97, 100
- illuminated entry .....98
- locking/unlocking doors .....97–99
- panic alarm .....100
- replacement/additional  
  transmitters .....101
- replacing the batteries .....100
- Roadside assistance .....181
- S**
- Safety belts (see Safety  
restraints) .....17, 107–111
- Safety defects, reporting .....217
- Safety restraints .....107–111  
  belt minder .....115  
  cleaning the safety belts .....118  
  extension assembly .....114  
  for adults .....108–110  
  for children .....131–132  
  lap belt .....113  
  warning light and  
  chime .....14, 17, 114
- Safety restraints - LATCH  
anchors .....145
- Safety restraints - tether  
anchors .....140
- Safety seats for children .....135
- Seat belts (see Safety  
restraints) .....107
- Seats .....105  
  child safety seats .....135
- SecuriLock passive anti-theft  
system .....102–103
- Servicing your vehicle .....232
- Snowplowing .....7
- Spare tire (see Changing the  
Tire) .....195
- Spark plugs, specifications .....276

- Special notice  
  ambulance conversions .....7  
  utility-type vehicles .....7
- Specification chart,  
lubricants .....275–276
- Speed control .....89
- Speedometer .....20
- Starting your vehicle .....148–150  
  jump starting .....201
- Steering wheel  
  controls .....83, 89  
  tilting .....83
- T**
- Tachometer .....20
- Temperature control  
(see Climate control) .....68
- Tether anchors .....140
- Tires .....194, 268–269  
  changing .....194–195, 198  
  checking the pressure .....269  
  replacing .....270  
  rotating .....269  
  snow tires and chains .....271  
  tire grades .....269  
  treadwear .....268
- Towing .....172  
  recreational towing .....179  
  trailer towing .....172  
  wrecker .....206
- Traction-lok rear axle .....157
- Transfer case  
  fluid checking .....267
- Transmission  
  automatic operation .....158  
  fluid, checking and adding  
  (automatic) .....263  
  fluid, checking and adding  
  (manual) .....266  
  fluid, refill capacities .....272  
  lubricant specifications ..275–276  
  manual operation .....162
- Trip odometer .....20
- Turn signal .....16, 75
- V**
- Vehicle dimensions .....276
- Vehicle Identification Number  
(VIN) .....278
- Vehicle loading .....170  
  camper bodies .....180
- Ventilating your vehicle .....153
- W**
- Warning chimes .....17
- Warning lights (see Lights) .....12
- Washer fluid .....237
- Water, Driving through .....170
- Windows  
  power .....85
- Windshield washer fluid and  
wipers  
  checking and adding fluid ....237  
  checking and cleaning .....82  
  operation .....82  
  replacing wiper blades .....83
- Wrecker towing .....206





