

Revised January 14, 2002

MAINTENANCE SCHEDULE

	NORMAL	SPECIAL
5,000 miles		F
15,000 miles	A	G
30,000 miles	A B	H I
45,000 miles	A C	
60,000 miles	A B D	J K
75,000 miles	A C	
90,000 miles	A B	
100,000 miles	E	

Change engine oil/replace filter every 3,000*/5,000 miles
Rotate/inspect tires every 5,000 miles

Normal operating conditions

- A.** Inspect: Engine cooling system, hoses and clamps, automatic transmission fluid level, steering linkage, suspension, brake system
Inspect/lubricate: 4x2 ball joints
- B.** Replace: Air filter/fuel filter
- C.** Change: Engine coolant
- D.** Lubricate: 4x2 wheel bearings
Replace: Manual transmission fluid

- E.** Inspect: Accessory drive belt(s)
Replace: Spark plugs
Replace: PCV valve (2.3L/3.0L/4.0L)

Special operating conditions

Towing, extensive idling, low speed driving, dusty conditions and off-road operation, see Owner's Manual

- F.** Inspect: Brake system
- G.** Replace: Fuel filter
- H.** Change: Automatic transmission fluid
- I.** Lubricate: Front wheel bearings (4x2)
- J.** Change: Transfer case fluid (4x4)
- K.** Replace: Spark plugs
- Perform maintenance as required**
Inspect/lubricate: U-joints
Replace: Engine air filter
Change: Manual transmission fluid

* Special operating conditions

This Quick Tips® guide is provided by Mazda North American Operations to make your Mazda ownership experience more convenient. It is not intended to replace your Owner's Manual.

If you have any questions about your vehicle, you are invited to contact your local dealer.

Or if you need additional help, feel free to call our

Customer Assistance Center at 1-800-222-5500

Monday through Friday,
9 a.m.-4:45 p.m., Pacific
9 a.m.-5:45 p.m., Eastern/Central



©2002 Calcar, Quick Tips® is a trademark of Calcar, made in USA 12/01 33.058M GL Mazda North American Operations reserves the right to change product specifications at any time without incurring obligations.

MAZDA TRUCK

Quick Tips®

Reference
Guide for
Controls and
Functions

2002



Revised January 14, 2002

DRIVER'S VIEW

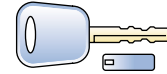
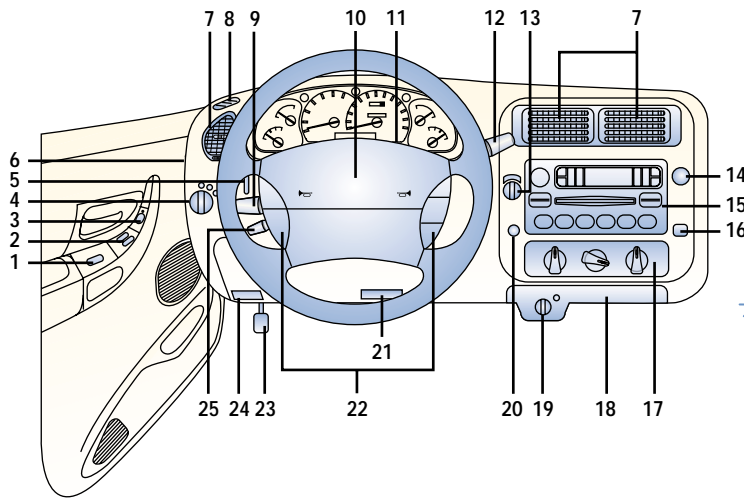
**Key/number plate**

Operates ignition and all locks



SecuriLock™ passive anti-theft key

Electronically coded key activates ignition; without correct key, engine will not start

 **Tip: Use key number plate to purchase new key; store in safe place**

Keyless remote entry system*, see Switches

*Denotes optional equipment

1. **Power door locks***, see Switches
2. **Power window switches***, see Switches
3. **Dual power mirrors***, see Switches
4. **Lighting switch**
 Tail, parking and dashboard lights on:
 Rotate knob to first notch
 Tail, parking, dashboard and headlights on: Rotate knob to second notch
5. **Instrument panel lighting**
 To brighten/dim: Rotate thumb-wheel up/down
6. **Fuse panel**
7. **Air vents**
 To open/close: Move thumb-wheel left/right
 To direct air flow: Move tab in center of vent
8. **Side window defroster**
9. **Turn signals/headlight high beams/wiper/washer lever**, see Driver Controls
10. **Horn/Air bag**
 To beep: Press
11. **Hazard warning switch**
 Press on/off
12. **Gearshift lever (A/T)***, see Transmission
13. **4x4 control***, see Transmission
14. **Power point electrical outlet**
 Use for optional electrical accessories, do not use cigarette lighter for accessories
15. **Audio system**, see Audio Systems
16. **Fog light switch***
 Press on/off; on with low-beams/parking lights only
17. **Climate control panel**, see Climate Control
18. **Ashtray**
 To open/close: Pull out/push in
19. **Passenger's front air bag deactivation switch/light**, see Seats/Console
20. **Cigarette lighter**
21. **Hood release handle**
 Pull to open partially
22. **Cruise control***, see Switches
23. **Parking brake pedal**
24. **Parking brake release lever**
25. **Tilt steering-wheel lever***
 To change position: Pull lever, tilt wheel up or down, release to lock

Always check the Owner's Manual for more operating information and safety features

Driver's
View

Revised January 14, 2002

Instrument Cluster

INSTRUMENT CLUSTER

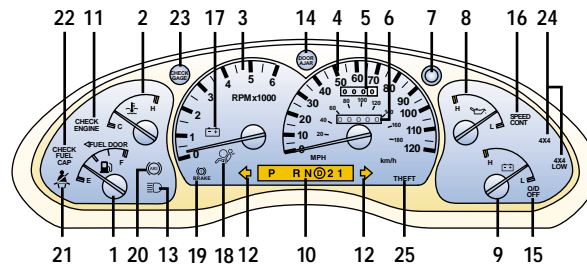

GAUGES

- | | | |
|---|---|--|
| <p>1. Fuel gauge
Fuel tank capacity varies by model; see Owner's Manual</p> <p>2. Engine coolant temperature gauge
If above normal range, stop truck and turn off engine; check coolant level when safe</p> | <p>3. Tachometer</p> <p>4. Speedometer</p> <p>5. Trip odometer</p> <p>6. Odometer</p> <p>7. Trip odometer reset button Push to reset</p> | <p>8. Oil-pressure gauge
If outside normal range, stop truck and turn off engine, check oil level</p> <p>9. Battery voltage gauge
If outside normal range, dealer inspection required</p> <p>10. Gearshift indicator* (A/T)</p> |
|---|---|--|

WARNING LIGHTS

- | | | |
|---|---|--|
| <p>11. Check engine
Dealer inspection required</p> <p>12. Turn signals/hazard warning on</p> <p>13. High beams on</p> <p>14. Door ajar*
Door not completely shut</p> <p>15. Overdrive off indicator* (A/T)
When lit, transmission does not shift into overdrive</p> <p>16. Cruise control on*</p> | <p>17. Charging system warning light
Dealer inspection required</p> <p>18. Air bag readiness
Air bag malfunction; dealer inspection required</p> <p>19. Brake system Parking brake on/low brake fluid</p> <p>20. Anti-lock Brake System (ABS)
ABS malfunction, normal brakes only, dealer inspection required</p> | <p>21. Always fasten safety belts
Light and chimes</p> <p>22. Check fuel cap
Fuel cap not securely tightened</p> <p>23. Check gauge
Check temperature/oil/fuel gauges</p> <p>24. 4wd high/4wd low*, see Transmission</p> <p>25. Anti-theft on*</p> |
|---|---|--|

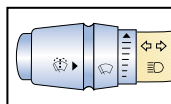

High beams on/off: Push

Turn signals/headlight high beams/wiper/washer lever

forward to detent/pull back To flash high beams: Pull rearward and release
To turn on wipers: Rotate knob forward; first 7 detents are progressively faster intervals,

8th detent is low speed, 9th is high
To activate washers: Push in end of knob; will also operate wipers

*Denotes optional equipment

Always check the Owner's Manual for more operating information and safety features

Driver Controls

Revised January 14, 2002

Switches

SWITCHES

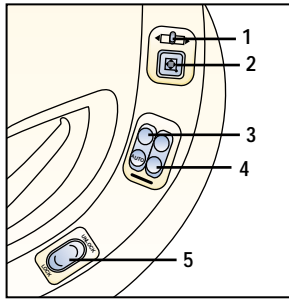

Dual power mirrors*

To adjust left/right mirror: Press control switch (1) left/right, tilt knob (2) in direction of desired mirror movement

Tip: To lock mirrors in place, move control switch (1) to center position

Power window switches*

Operate only with ignition in ACC or ON position

Both windows may be controlled from driver's door; passenger door has separate switch

Driver's window (3): One touch-down; press and release, window goes all the way down; tap front of switch to stop

Press and hold top of switch to close

Passenger window switch (4): Press bottom/top of switch to open/close

Power door locks*

Front door lock switches

To lock/unlock both doors: Press bottom/top on either door switch (5)

To lock doors without key, exit the vehicle, press lock on either door, close the door

To unlock: Use key to unlock either front door, open door and press top of switch to unlock other door

Manual door locks will override power locks

Power door lock disable feature, see Owner's Manual

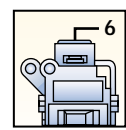

Fuel pump shutoff

Located in right front trim panel under instrument panel
Disables fuel pump after a substantial jolt or collision
To reset: Press down top of exposed red reset button (6)

WARNING: Do not reset shutoff switch if you see or smell fuel

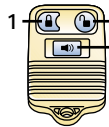

Keyless remote entry system*

Functions only with ignition in OFF position

To lock doors:

Press lock button (1); pressing again within 5 seconds causes doors to relock, horn to beep once if all doors are closed, twice if any door is ajar

To unlock doors: Press unlock button (2) to open driver's door; press again within 5 seconds to open other door

Panic alarm: Press panic button (3); horn sounds, parking lights flash and interior lights illuminate; press (3) again to stop or insert key and turn ignition to ON or ACC position



Cruise control*

Operates above 30 mph

Press and release ON (4)

To set speed: Press and release SET ACC (6) at desired speed; hold (6) to accelerate

To decelerate: Press and hold COAST (7), release at desired speed; or tap brake pedal, press and release (6) at desired speed

Incremental deceleration: Press and release (7), each tap = minus 1 mph

Incremental acceleration: Press and release (6), each tap = plus 1 mph

To cancel: Tap brake/clutch pedal or push OFF button (8)

Return to preset speed (after braking): Press and release RSM (resume) button (5)

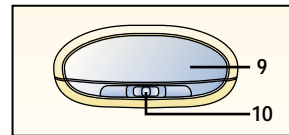

Interior lights

9. Interior light

10. Interior light switch

ON = light always on

DOOR = light on when door open

OFF = light always off

Tip: Battery saver shuts off interior lamps after 45 minutes with ignition off

*Denotes optional equipment

Always check the Owner's Manual for more operating information and safety features

Switches

Revised January 14, 2002

Seats

SEATS

Seats

1. Fore/aft adjustment

Raise lever and hold, slide seat, release lever

2. Seatback angle*

To adjust: Lift and hold lever, lean forward or backward to tilt seat, release lever

3. Manual lumbar control*

Rotate clockwise/counter clockwise to increase/decrease firmness

⚠️ WARNINGS: All air bags are supplemental and do not replace safety belt usage. Do not adjust seats while driving

Shoulder belt height adjustment

To raise belt: Slide adjuster up
To lower belt: Push release button (4) and slide down

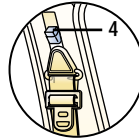

⚠️ WARNING: Make sure adjuster locks in one of its positions



Dual locking mode lap/shoulder belt retractor (passenger only)

Emergency locking mode: Belt locks only on hard braking/cornering or impacts of about 5 mph or higher

Automatic locking mode: Must be used when installing child-safety seat

To activate: Pull webbing fully out of retractor; belt will only tighten

To disengage: Unbuckle belt and allow webbing to retract fully, for complete details see Owner's Manual

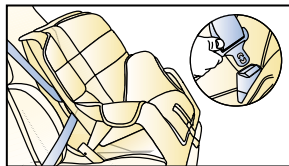

Child-safety seat

To install, use dual-locking mode retractor safety belts; see Owner's Manual for proper installation and seat tether instructions

⚠️ WARNINGS: Read all information and warnings in Owner's Manual and attached seat before using child-safety seat. You are required by law to use safety restraints for children in U.S. and Canada, check your local and state or provincial laws for specific requirements regarding the safety of children in your vehicle

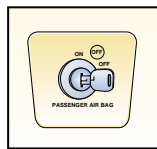

Passenger's front air bag deactivation switch

Deactivate passenger's front air bag

when using a child-safety seat
To deactivate/activate: Insert ignition key in switch, rotate to OFF/ON, remove key
Amber OFF light illuminates when deactivated and ignition is on

💡 Tip: Turn ignition off when disabling passenger front air bag

⚠️ WARNINGS: When using a child-safety seat always set the passenger front air bag deactivation switch to OFF position, serious injury or death may result if front passenger air bag is deployed

with child-safety seat installed
If you choose to install a child-safety seat in the front seat, move seat as far back as possible, for complete details see Owner's Manual

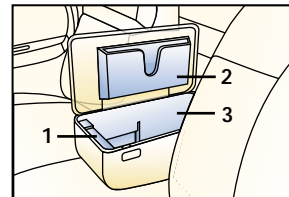

Console (Split bench)

- 1. Coin tray**
- 2. Map storage**
- 3. Storage compartment**

*Denotes optional equipment

Always check the Owner's Manual for more operating information and safety features

Seats/
Console

Revised January 14, 2002

Audio
Systems

AM/FM STEREO/COMPACT DISC

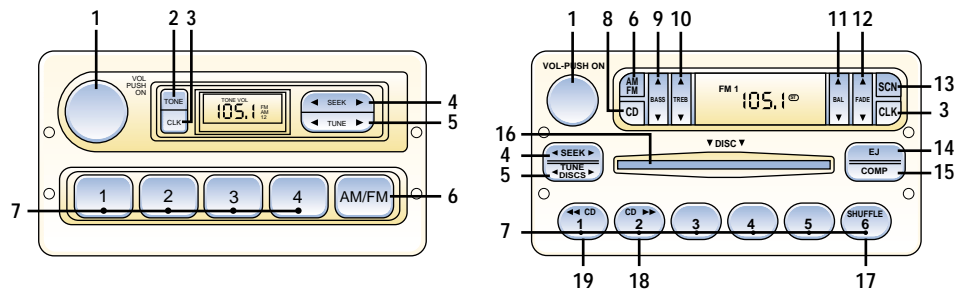

AM/FM Stereo

AM/FM/Single Compact Disc Stereo*

(MACH® MP3 Music System* available, see Owner's Manual)

1. Power/Volume

Press to turn on/off; turn clockwise/counterclockwise to increase/decrease volume

2. Tone

Press to select Bass, Treble, or Balance; then rotate (1) to adjust

3. Clock

To display: Press

To set: Press and hold, then press SEEK ◀/▶ (4) or TUNE ◀/▶ (5) to decrease/increase hours or minutes

4. Seek

Radio: Press and release ◀/▶ for next strong station down/up; press and hold to skip stations

CD: Press and release ◀/▶ to select previous/next selection

5. Tune

Press ◀/▶ to change frequency down/up
Press and hold to move down/up quickly

6. AM/FM

Press to select AM/FM1/FM2 frequency bands

7. Memory preset buttons

To set: Tune to station, press and hold until sound returns

8. CD

Press to select CD

9. Bass

Press ▲/▼ to increase/decrease

10. Treble

Press ▲/▼ to increase/decrease

11. Balance

Press ▲/▼ to shift sound between right/left speakers

12. Fade

Press ▲/▼ to shift sound between front/rear speakers

13. Scan

Press to briefly sample next listenable selections, press again to cancel; functions in all modes

14. Eject

Press to eject CD; radio resumes playing

15. Compression adjust

Press to bring soft and loud CD passages closer together for more consistent listening levels

16. CD slot**17. Shuffle**

Press to play CD changer* single disc tracks in random order

18. CD ▶▶

Press for next track

19. CD ◀◀

Press for previous track

*Denotes optional equipment

Always check the Owner's Manual for more operating information and safety features

Audio
Systems

Revised January 14, 2002

Audio
Systems

AM/FM STEREO/COMPACT DISC

1. Volume Push On

Press to turn on/off; turn clockwise/counterclockwise to increase/decrease volume

2. CD door

To open: Press LOAD (3)

 **Tip: Insert CD only when open**

3. Load

Press to open CD door; load up to six discs into player one at a time

Select a specific slot by pressing desired number (19)

4. Shuffle

Press to select SHUFFLE DISC which plays random tracks from all available discs; press again to select SHUFFLE TRK which plays tracks on current disc in random order

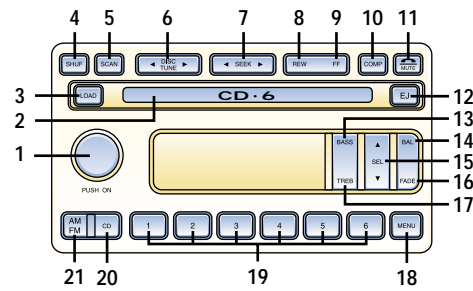

Premium AM/FM Stereo/In-Dash 6-Compact Disc Changer*

10. Compression

Press to bring soft and loud CD passages together

11. Mute

Press to mute playing media; press again for normal volume

17. Treble

Press, then press SEL (15) ▲ / ▼ to increase/decrease

18. MENU

Works with SEL (15) to activate RDS or DSP, see Owner's Manual

5. Scan

Radio: Press to briefly sample listenable stations
CD: Press to briefly sample tracks
Press again to stop

6. Disc Tune

Radio: Press ◀ / ▶ to change frequency down/up
CD: Press ◀ / ▶ to select previous/next disc
Hold for rapid movement

7. Seek

Radio: Press ◀ / ▶ for next listenable station down/up
CD: Press ◀ / ▶ to select previous/next track

8. Rewind

Press and hold to play previous disc tracks

9. Fast Forward

Press and hold to play next disc tracks

12. Eject

Press once to eject current CD
Press and hold to eject all stored discs one at a time
Press once, then press desired number 1-6 (19) to eject a specific CD

13. Bass

Press, then press SEL (15) ▲ / ▼ to increase/decrease

14. Balance

Press, then press SEL (15) ▲ / ▼ to shift sound right/left

15. SEL

Press ▲ / ▼ to increase/decrease selected function; works with (13, 14, 16, 17, 18), see Owner's Manual

16. Fade

Press, then press SEL (15) ▲ / ▼ to shift sound to front/rear

To set CLOCK: Press MENU (18) until SELECT HOUR/SELECT MINUTE displayed; press SEL (15) ▲ / ▼ to increase/decrease

19. Memory preset buttons 1-6

To set: Tune to station, press and hold until sound returns

20. CD

Press to select CD mode

21. AM/FM

Press to select radio and alternate among AM/ FM1/ FM2 bands; works with (19)

 **Tip: Press and hold AM/FM (21) to enable/disable the AUTO STORE function which stores the six strongest stations in memory preset buttons (19)**

*Denotes optional equipment

Always check the Owner's Manual for more operating information and safety features

Audio
Systems

Revised January 14, 2002

Transmission

TRANSMISSION

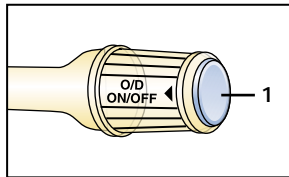
**Automatic transmission***

Gearshift must be in Park or Neutral to start engine; it must be in Park to remove ignition key

P = Park

To move gearshift from Park: You **MUST** press firmly on the brake pedal and the ignition must be in the ON position. Never put moving vehicle in Park.

Always apply parking brake when exiting the vehicle.

R = Reverse

Do not engage Reverse when vehicle is moving forward.

N = Neutral

No gear is engaged; vehicle can roll freely, even on a slight incline, unless the brakes are applied.

D (Overdrive)

For normal driving: Shifts through all forward gears automatically for more relaxed highway driving and optimum fuel economy.

Tip: Torque converter lock-up improves fuel economy and can feel like an additional gear.

D (Overdrive Off)

Press (1) to disengage overdrive; an indicator light on the instrument cluster will illuminate.

Driving without overdrive provides a lower gear for climbing hills and engine braking when descending hills; you can depress (1) at any speed.

To re-engage overdrive, press (1) again and the instrument cluster light will go out.

Tip: A flashing Overdrive Off light indicates a system malfunction; dealer inspection required.

2 = Second

Place the gearshift lever in second when accelerating on slippery roads or to provide additional engine braking on downgrades.

1 = Low

Low provides maximum engine braking on steep downgrades.

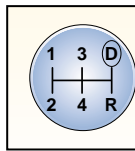
**Manual transmission***

Depress clutch pedal completely to start engine and change gears; stop

truck completely before shifting into reverse.

Tip: Extended use of other than manufacturer's specified tires on a limited-slip rear axle may result in damage, this may not affect normal driving and may not be noticeable by the driver.

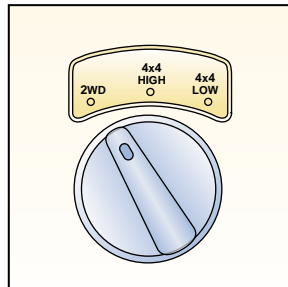
**4-wheel drive system***

2WD = Two-wheel drive
Power to rear axle only, 4X4 indicator lights off.

4x4 HIGH = Four-wheel drive
Power to front and rear axles at normal speed, 4X4 light on.

4x4 LOW = Four-wheel drive (low range)

Power to front and rear axles at reduced speed, 4X4 LOW light on.

To shift from 2WD to 4X4 HIGH: Rotate switch from 2WD to 4x4 HIGH.

To shift from 4X4 HIGH to 2WD: Rotate switch from 4x4 HIGH to 2WD.

Tip: You do not need to shift into reverse to disengage front hubs.

To shift into/out of 4X4 LOW: Stop vehicle, depress brake, place automatic transmission in neutral (with manual transmission, depress clutch pedal); rotate switch to desired setting.

Tip: Pulsation may occur during cornering in 4X4 mode.

*Denotes optional equipment

Always check the Owner's Manual for more operating information and safety features

Transmission

Revised January 14, 2002

Climate
Control

CLIMATE CONTROL





1. Fan control

To increase speed and flow:
Rotate knob clockwise

2. Temperature selection

Cooler/warmer = rotate
knob counterclockwise/
clockwise

3. Air flow selections

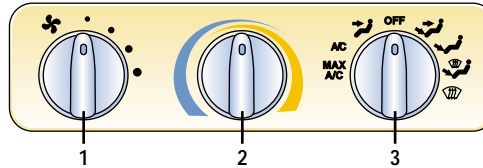

-  = air to dash
- OFF = system off, no air flow
-  = air to dash and floor
-  = air to floor
-  = air to floor and windshield
-  = defrost, air to windshield

**Air conditioning system***

MAX A/C = cooling with inside air, air to dash only
A/C = cooling with outside air, air to dash only

Control positions for maximum defrost

Fan to maximum, temperature to maximum hot, air flow selector knob to 

 **Tips:** To prevent moisture buildup, never drive with system off
When  , or  selected, air is dried when temperature is above 50° F

Break-in period

First 1,000 miles: Avoid heavy repeated brake use; avoid full throttle, rapid acceleration or kick-down of transmission; drive at varying road and engine speeds
Do not tow a trailer for first 500 miles

Do not use special "break-in" oils

 **Tip:** Follow the same break-in period procedures with newly overhauled engine or when brakes are replaced

4-wheel Anti-lock Braking System (ABS)

ABS automatically reduces hydraulic pressure to all four wheels (4-wheel ABS) on the verge of locking up

You may feel a slight pulsing of the brake pedal and hear a clicking noise, this tells you the

ABS is functioning properly, increase pressure on pedal for maximum braking

 **Tips:** Maintain constant pressure on the brake pedal
Do not pump the brakes

ABS self test

A self-diagnostic test is performed when the engine is started; you may feel some pulsation and hear some noise; this is normal

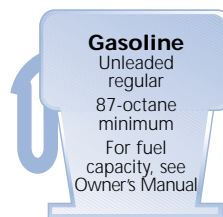
**Tire economy and tips**

Check pressure monthly when tires are cold
Check for unusual wear and overall condition, do not exceed weight limit on tires and axles
Maintain correct front-end alignment and tire balance; see Owner's Manual for rotation chart

Tire pressure

Decal on the edge of the driver's door provides tire size and pressure information

Tire chains

Tire chains can damage aluminum wheels; use on steel wheels only

 **Tips:** Use only SAE class "S" chains, install only on rear tires; install as tightly as possible and retighten periodically
Never exceed 30 mph with tire chains

*Denotes optional equipment

Always check the Owner's Manual for more operating information and safety features

Driving
Tips

Revised January 14, 2002

Under Hood

UNDER HOOD

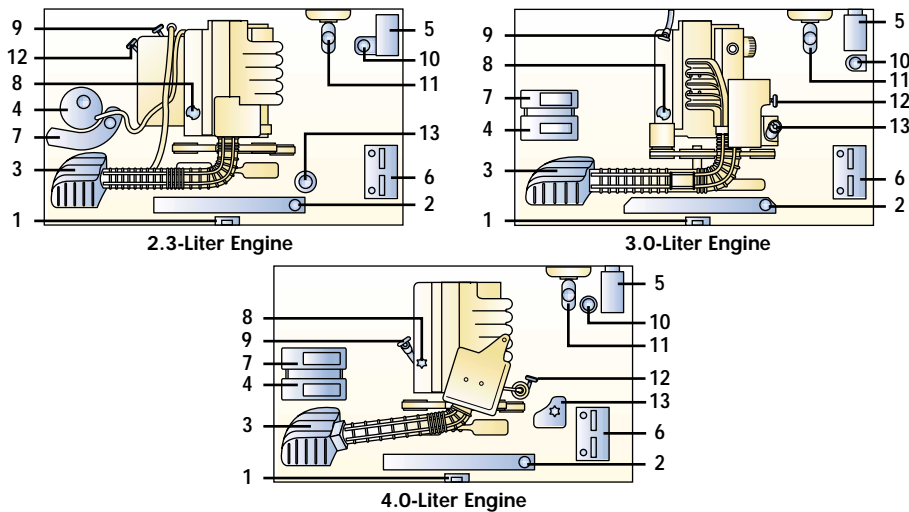
**1. Hood latch**

Pull inside hood release handle, hood pops up slightly; while applying upward pressure on hood, lift auxiliary latch handle and raise hood

2. Radiator cap

Remove cap only when safe and engine is cool

3. Air filter**4. Engine coolant reservoir**

Level should be at fill line indicator mark; remove cap only when safe and engine is cool

5. Fuse block**6. Battery****7. Windshield washer reservoir**

Fill with windshield washer fluid, not water; use fluids containing non-methanol antifreeze agents only if they will not damage paint, wiper blades and washer system

8. Engine oil filler cap

Use SAE 5W-20 (2.3L, 3.0L) 5W-30 (4.0L) oil for all temperatures; use only oils displaying American Petroleum Institute Certified for Gasoline Engines

9. Automatic transmission fluid dipstick*

Check with engine on at normal operating temperature; fluid should be within crosshatched area on dipstick

10. Clutch fluid reservoir

With cap on, check that fluid level is at ridge in reservoir body, use DOT 3 brake fluid

11. Brake fluid reservoir

Clean filler cap before removing; use only DOT 3 fluid from a sealed container

12. Engine oil dipstick

Check with engine off and at normal temperature; fluid should be within cross-hatched area on dipstick; do not fill above MAX/FULL line

13. Power steering fluid reservoir

Check with engine off and at normal temperature; fluid level on dipstick should be between arrows in FULL HOT range

*Denotes optional equipment

Always check the Owner's Manual for more operating information and safety features