

Table of Contents

Introduction 4

Instrument Cluster 10

Warning and control lights	12
Gauges	16

Entertainment Systems 19

AM/FM stereo	19
AM/FM stereo with CD	21
AM/FM stereo with in-dash six CD	24
AM/FM stereo with CD/MP3	27

Climate Controls 35

Manual heating and air conditioning	35
-------------------------------------	----

Lights 38

Headlamps	38
Turn signal control	40
Bulb replacement	40

Driver Controls 47

Windshield wiper/washer control	47
Steering wheel adjustment	48
Power windows	49
Speed control	53

Locks and Security 59

Keys	59
Locks	59
Anti-theft system	59

Table of Contents

Seating and Safety Restraints 67

Seating	67
Safety restraints	69
Air bags	81
Child restraints	93

Driving 110

Starting	110
Brakes	115
Transmission operation	119
Vehicle loading	129
Trailer towing	131
Recreational towing	137

Roadside Emergencies 139

Hazard flasher switch	139
Fuel pump shut-off switch	139
Fuses and relays	140
Overheating	150
Changing tires	151
Jump starting	159
Wrecker towing	164

Customer Assistance 165

Reporting safety defects (U.S. only)	174
--------------------------------------	-----

Cleaning 176

Repairing paint chips	177
Underbody preservation	181

Table of Contents

Maintenance and Specifications 182

Engine compartment	192
Engine oil	195
Battery	202
Fuel information	208
Refill capacities	231
Lubricant specifications	235
Engine data	236

Accessories 239

Index 240

All rights reserved. Reproduction by any means, electronic or mechanical including photocopying, recording or by any information storage and retrieval system or translation in whole or part is not permitted without written authorization from MNAO. MNAO may change the contents without notice and without incurring obligation.

Copyright © 2003 MNAO

Introduction

CALIFORNIA Proposition 65 Warning

WARNING: Engine exhaust, some of its constituents, and certain vehicle components contain or emit chemicals known to the State of California to cause cancer and birth defects or other reproductive harm. In addition, certain fluids contained in vehicles and certain products of component wear contain or emit chemicals known to the State of California to cause cancer and birth defects or other reproductive harm.

CONGRATULATIONS

Congratulations on acquiring your new Mazda product. Please take the time to get well acquainted with your vehicle by reading this handbook. The more you know and understand about your vehicle the greater the safety and pleasure you will derive from driving it.

For more information on Mazda and its products visit the following website:

- In the United States: www.mazdausa.com
- In Canada: www.mazda.ca

Additional owner information is given in separate publications.

This Owner's Guide describes every option and model variant available and therefore some of the items covered may not apply to your particular vehicle. Furthermore, due to printing cycles it may describe options before they are generally available.

Remember to pass on the Owner's Guide when reselling the vehicle. It is an integral part of the vehicle.

WARNING: In the event of an accident the Fuel pump shut-off switch will automatically cut off the fuel supply to the engine. The switch can also be activated through sudden vibration (e.g. collision when parking). To reset the switch, refer to the *Fuel pump shut-off switch* in the *Roadside emergencies* chapter.

SAFETY AND ENVIRONMENT PROTECTION

Warning symbols in this guide

How can you reduce the risk of personal injury and prevent possible damage to others, your vehicle and its equipment? In this guide, answers to such questions are contained in comments highlighted by a bold **WARNING** statement. These comments should be read and observed.



Warning symbols on your vehicle

When you see this symbol, it is imperative that you consult the relevant section of this guide before touching or attempting adjustment of any kind.



Protecting the environment

We must all play our part in protecting the environment. Correct vehicle usage and the authorized disposal of waste cleaning and lubrication materials are significant steps towards this aim. Information in this respect is highlighted in this guide with the tree symbol.



Always dispose of used automotive fluids in a responsible manner. Follow your community's regulations and standards for recycling and disposing of automotive fluids.

BREAKING-IN YOUR VEHICLE

There are no particular breaking-in rules for your vehicle. During the first 1,600 km (1,000 miles) of driving, vary speeds frequently. This is necessary to give the moving parts a chance to break in.

Introduction

SPECIAL NOTICES

Emission warranty

The New Vehicle Limited Warranty includes Bumper to Bumper Coverage, Safety Restraint Coverage and Corrosion Coverage. In addition, your vehicle is eligible for Emissions Defect and Emissions Performance Warranties. For a detailed description of what is covered and what is not covered, refer to the *Warranty Guide* that is provided to you along with your Owner's Guide.

Event Data Recorder

The computer in your vehicle is capable of recording detailed data potentially including but not limited to information such as:

- the use of restraint systems including seat belts by the driver and passengers,
- information about the performance of various systems and modules in the vehicle, and
- information related to engine, throttle, steering, brake or other system status potentially including information related to how the driver operates the vehicle including but not limited to vehicle speed.

This information may be stored during regular operation or in a crash or near crash event. This stored information may be read out and used by:

- service and repair facilities.
- law enforcement or government agencies.
- the Manufacturer and Distributor.

Special instructions

For your added safety, your vehicle is fitted with sophisticated electronic controls.

WARNING: Please read the section *Supplemental Restraint System (SRS)* in the *Seating and safety restraints* chapter. Failure to follow the specific warnings and instructions could result in personal injury.

WARNING: Front seat mounted rear facing child or infant seats should NEVER be used in front of a passenger side air bag unless the air bag can be and is turned OFF.

Notice to owners of pickup trucks and utility type vehicles

WARNING: Utility vehicles have a significantly higher rollover rate than other types of vehicles.

Before you drive your vehicle, please read this Owner's Guide carefully. Your vehicle is not a passenger car. As with other vehicles of this type, failure to operate this vehicle correctly may result in loss of vehicle control, vehicle rollover, personal injury or death.

Be sure to read *Driving off road* in the *Driving* chapter.

Using your vehicle with a snowplow

WARNING: Do not use this vehicle for snowplowing.

Using your vehicle as an ambulance

WARNING: Do not use this vehicle as an ambulance.

Do not use your vehicle as an ambulance, as it is not equipped with an ambulance preparation package.



















Introduction

These are some of the symbols you may see on your vehicle.

Vehicle Symbol Glossary

Safety Alert		See Owner's Guide	
Protecting the Environment		Fasten Safety Belt	
Air Bag-Front		Air Bag-Side	
Child Seat		Child Seat Installation Warning	
Child Seat Lower Anchor		Child Seat Tether Anchor	
Brake System		Anti-Lock Brake System	
Brake Fluid - Non-Petroleum Based		Hazard Warning Flasher	
Master Lighting Switch		Fuse Compartment	
Fog Lamps-Front		Windshield Wash/Wipe	
Fuel Pump Reset		Rear Window Defrost/Demist	
Windshield Defrost/Demist			

Vehicle Symbol Glossary

Power Windows		Power Window Lockout	
Personal Alarm System Feature		Engine Oil	
Engine Coolant		Engine Coolant Temperature	
Do Not Open When Hot		Battery	
Avoid Smoking, Flames, or Sparks		Battery Acid	
Explosive Gas		Fan Warning	
Power Steering Fluid		Maintain Correct Fluid Level	
Emission System		Engine Air Filter	
Passenger Compartment Air Filter		Jack	
Check fuel cap			

INFORMATION ABOUT THIS GUIDE

The information found in this guide was accurate at the time of printing. Mazda may change the contents without notice.

Instrument Cluster

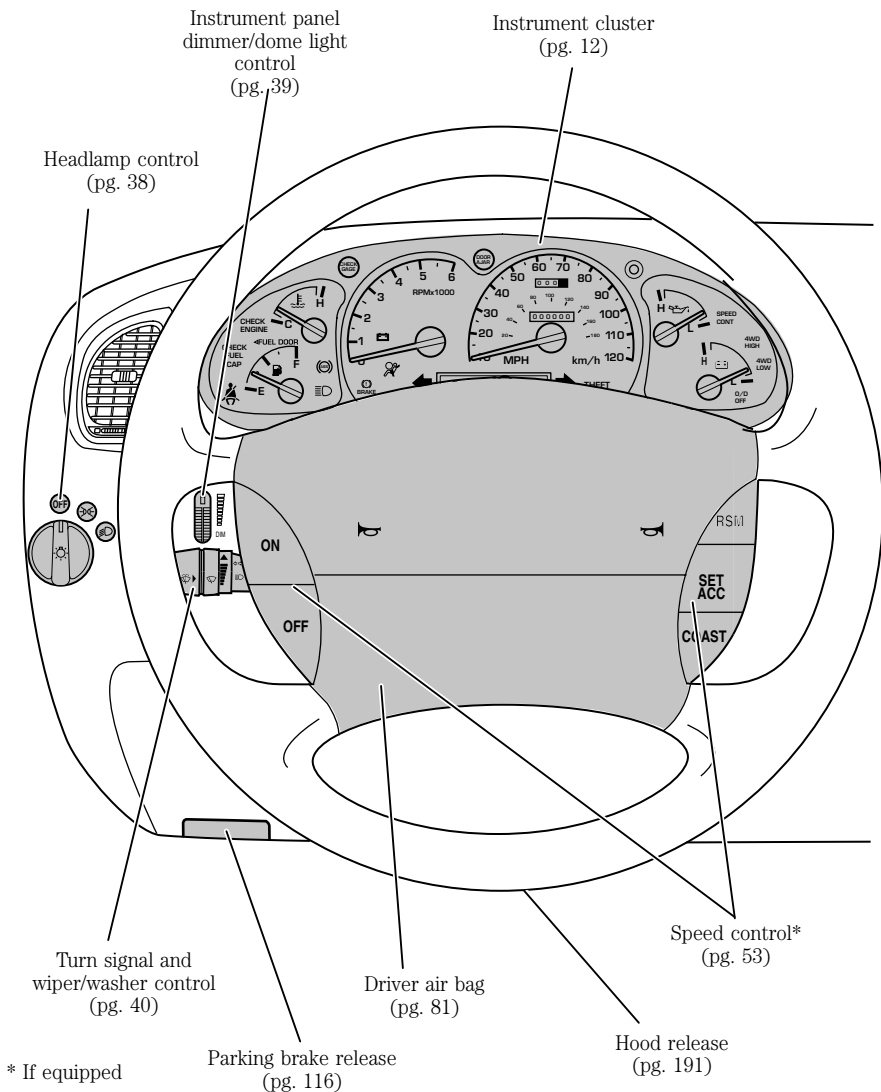

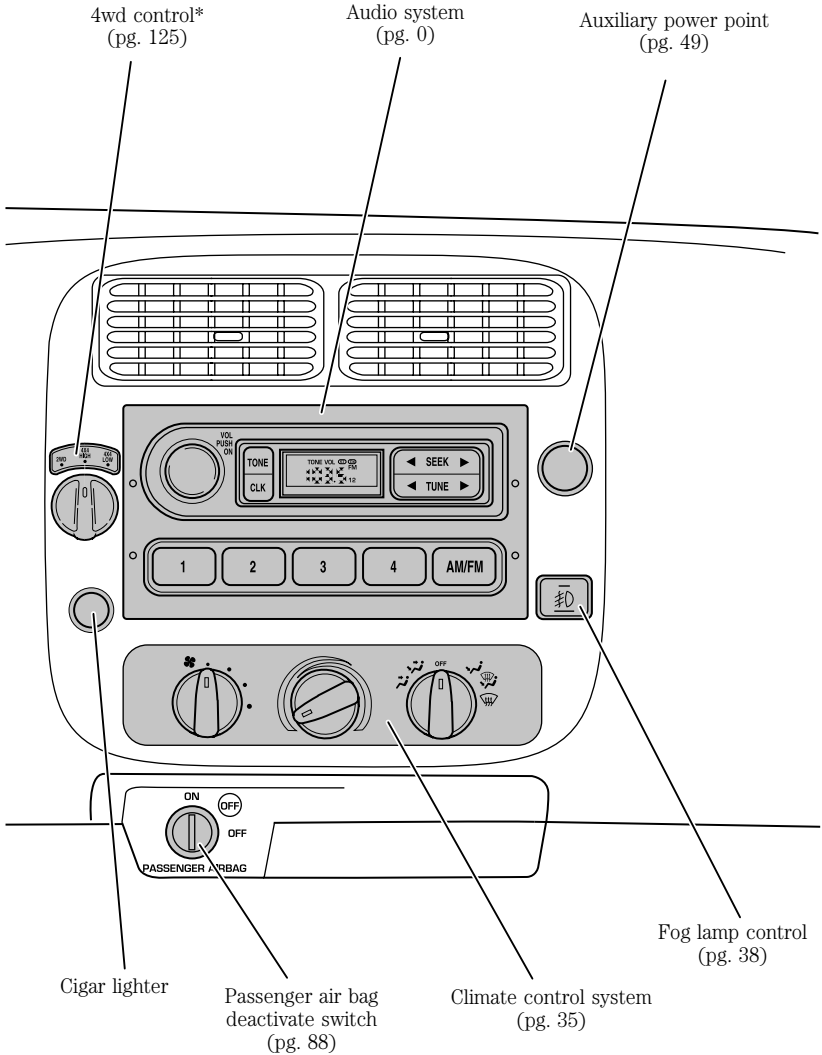

* if equipped

Instrument Cluster

WARNING LIGHTS AND CHIMES

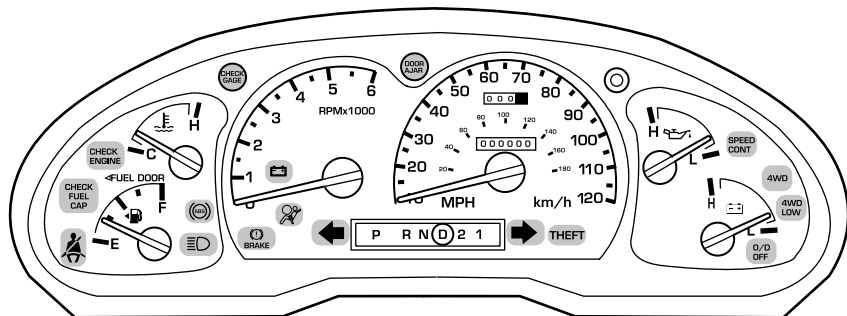

Warning lights and gauges can alert you to a vehicle condition that may become serious enough to cause expensive repairs. A warning light may illuminate when a problem exists with one of your vehicle's functions. Many lights will illuminate when you start your vehicle to make sure the bulb works. If any light remains on after starting the vehicle, have the respective system inspected immediately.

Check engine: Illuminates briefly to ensure the system is functional. If it comes on after the engine is started, one of the engine's emission control systems may be malfunctioning. The light may illuminate without a driveability concern being noted and will not require towing.

CHECK ENGINE

Light turns on (without blinking):

Temporary malfunctions may cause your light to illuminate. Examples are:

1. The vehicle has run out of fuel.
2. Poor fuel quality or water in the fuel.
3. The fuel cap may not have been properly installed and securely tightened.

These temporary malfunctions can be corrected by filling the fuel tank with high quality fuel of the recommended octane and/or properly installing and securely tightening the fuel cap. After three driving cycles without these or any other temporary malfunctions present, the light should turn off. (A driving cycle consists of a cold engine startup followed by mixed city/highway driving.) No additional vehicle service is required.

If the light remains on, have your vehicle serviced at the first available opportunity.

NOTE: The **CHECK ENGINE** light will illuminate if vehicle refueling is conducted with the engine running.

WARNING: Never refuel vehicle with the engine running.

Light is blinking:

Engine misfire is occurring which could damage your catalytic converter. You should drive in a moderate fashion (avoid heavy acceleration and deceleration) and have your vehicle serviced at the first available opportunity.

WARNING: Under engine misfire conditions, excessive exhaust temperatures could damage the catalytic converter, the fuel system, interior floor coverings or other vehicle components, possibly causing a fire.

Check Fuel Cap: Illuminates when the fuel cap is not installed correctly. Check the fuel cap for proper installation. When the fuel filler cap is properly re-installed, the light(s) will turn off after a period of normal driving. Continuing to operate the vehicle with the check fuel cap light on, or a mis-installed fuel cap can activate the *Check Engine* warning light.

**CHECK
FUEL
CAP**

It may take a long period of time for the system to detect an improperly installed fuel filler cap.

For more information, refer to *Fuel filler cap* in the *Maintenance and specifications* chapter.

Brake system warning light: To confirm the brake system warning light is functional, it will momentarily illuminate when the ignition is turned to the ON position when the engine is not running, or in a position between ON and START, or by applying the parking brake when the ignition is turned to the ON

(!)
BRAKE

Instrument Cluster

position. If the brake system warning light does not illuminate at this time, seek service immediately from your dealership. Illumination after releasing the parking brake indicates low brake fluid level and the brake system should be inspected immediately by your servicing dealership.

WARNING: Driving a vehicle with the brake system warning light on is dangerous. A significant decrease in braking performance may occur. It will take you longer to stop the vehicle. Have the vehicle checked by your dealer immediately.

Anti-lock brake system: If the ABS light stays illuminated or continues to flash, a malfunction has been detected, have the system serviced immediately. Normal braking is still functional unless the brake warning light also is illuminated.



Air bag readiness: If this light fails to illuminate when ignition is turned to ON, continues to flash or remains on, have the system serviced immediately. A chime will also sound when a malfunction in the supplemental restraint system has been detected.



Safety belt: Reminds you to fasten your safety belt. A chime will also sound to remind you to fasten your safety belt. Refer to the *Seating and safety restraints* chapter.



Charging system: Illuminates when the battery is not charging properly.



Check gage: Illuminates when any of the following conditions has occurred:

- The engine coolant temperature is high.
- The engine oil pressure is low.
- The fuel gage is at or near empty.

**CHECK
GAGE**

Door ajar: Illuminates when the ignition is in the ON position and any door is open.

**DOOR
AJAR**

Overdrive off (if equipped): Illuminates when the overdrive function has been turned OFF using the transmission control switch (TCS).

**O/D
OFF**

If the light does not come on or the light flashes steadily, have your vehicle serviced as soon as possible, damage to the transmission could occur.

Four wheel drive low (if equipped): Illuminates when four-wheel drive low is engaged.

**4WD
LOW**

NOTE: If the light continues to flash have the system serviced.

Four wheel drive high (if equipped): Illuminates when four-wheel drive high is engaged.

4WD

NOTE: If the light continues to flash have the system serviced.

Anti-theft system: Flashes when the Securilock[™] Passive Anti-theft System has been activated.

THEFT

Speed control: Illuminates when the speed control is engaged. Turns off when the speed control system is disengaged.

**SPEED
CONT**

Turn signal: Illuminates when the left or right turn signal or the hazard lights are turned on. If the indicators stay on or flash faster, check for a burned out bulb.

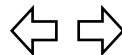

High beams: Illuminates when the high beam headlamps are turned on.



Instrument Cluster

Key-in-ignition warning chime: Sounds when the key is left in the ignition in the OFF/LOCK or ACC position and the driver's door is opened.

Headlamps on warning chime: Sounds when the headlamps or parking lamps are on, the ignition is off (and the key is not in the ignition) and the driver's door is opened.

GAUGES

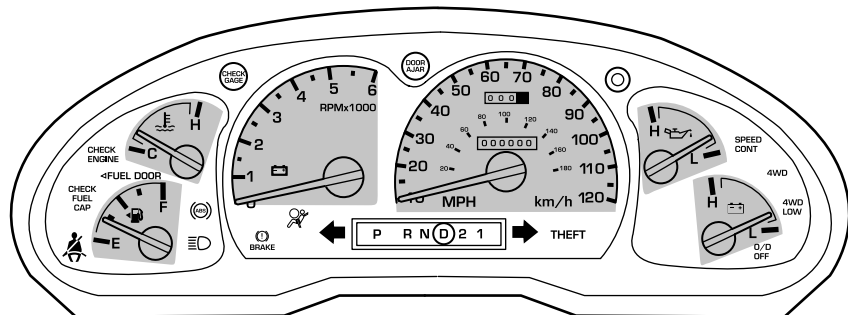

Speedometer: Indicates the current vehicle speed.

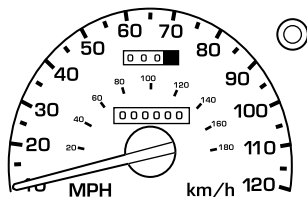

Engine coolant temperature gauge: Indicates engine coolant temperature. At normal operating temperature, the needle will be in the normal range (between “H” and “C”). **If it enters the red section, the engine is overheating. Stop the vehicle as soon as safely possible, switch off the engine and let the engine cool.**

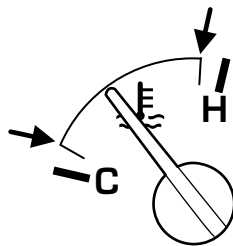

Refer to *Engine coolant* in the *Maintenance and specifications* chapter.

WARNING: Never remove the coolant reservoir cap and/or the radiator cap while the engine is running or hot, this may result in serious burns.

Odometer: Registers the total kilometers (miles) of the vehicle.

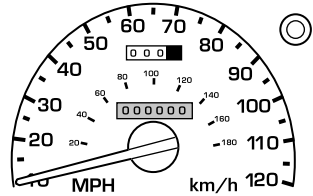

Trip odometer: Registers the kilometers (miles) of individual journeys. To reset, depress the control button.

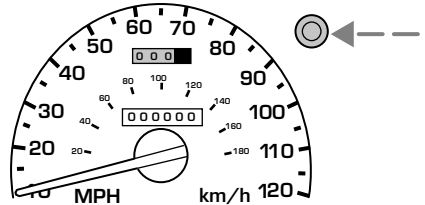

Tachometer: Indicates the engine speed in revolutions per minute. Driving with your tachometer pointer continuously at the top of the scale may damage the engine.

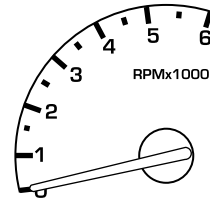

Battery voltage gauge: Indicates the battery voltage when the ignition is in the ON position. If the pointer moves and stays outside the normal operating range (as indicated by arrows), have the vehicle's electrical system checked as soon as possible.

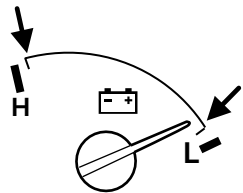

Instrument Cluster

Engine oil pressure gauge:

Indicates engine oil pressure. At normal operating temperature, the needle will be in the normal range (the area between the “L” and “H”);

if the needle goes below the normal range, stop the vehicle as soon as safely possible and switch off the engine immediately. Check the oil level.

Add oil if needed (refer to *Engine oil* in the *Maintenance and Specifications* chapter). If the oil level is correct, have your vehicle checked by your authorized Mazda dealership.

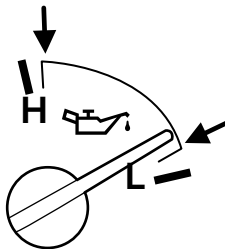

Fuel gauge: Displays approximately how much fuel is in the fuel tank. The fuel gauge may vary slightly when the vehicle is in motion or on a grade.

When refueling the vehicle from empty indication, the amount of fuel that can be added will be less than the advertised capacity due to the reserve fuel.

NOTE: The FUEL DOOR icon and arrow indicates which side of the vehicle the fuel filler door is located.



AM/FM STEREO

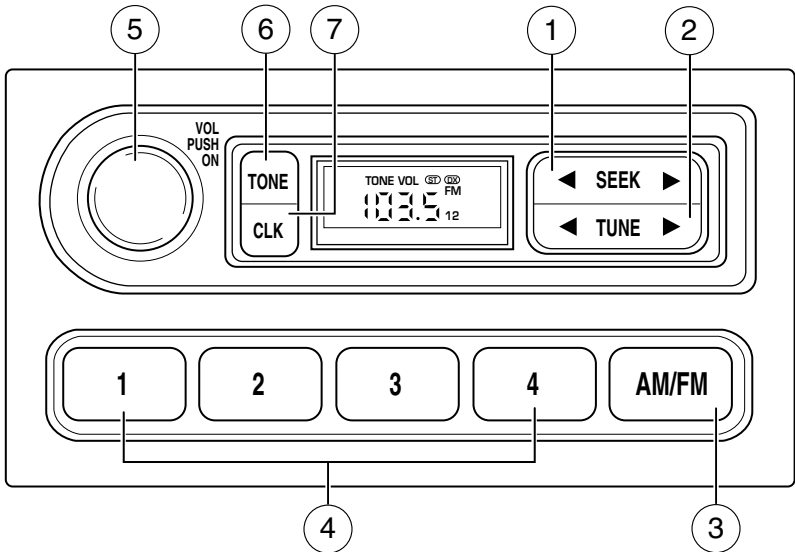

1. **Seek:** Press ◀ / ▶ to find the next strong station down/up the frequency band.



2. **Tune:** Press ◀ / ▶ to manually change radio frequency down/up.



3. **AM/FM:** Press to choose a frequency band in radio mode.



4. **Memory preset buttons:** To set a station: Select frequency band AM/FM; tune to a station, press and hold a preset button until sound returns.



Entertainment Systems

5. **Power/volume:** Press to turn ON/OFF; turn to increase or decrease volume levels.

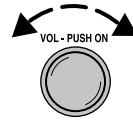

6. **Tone:** Press TONE until the desired level — Bass, Treble, Fade appears on the display. Turn the volume control to raise/lower the levels, or to move the audio sound from the right to left or the front to back (if equipped).

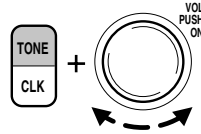

7. **CLK (Clock):** To set the hour, press and hold CLK until CLOCK SET appears in the display. Press SEEK to decrease ◀ or increase ▶ the hours.



To set the minute, press and hold CLK until CLOCK set appears in the display. Press TUNE to decrease ◀ or increase ▶ the minutes.

AM/FM STEREO / SINGLE CD RADIO

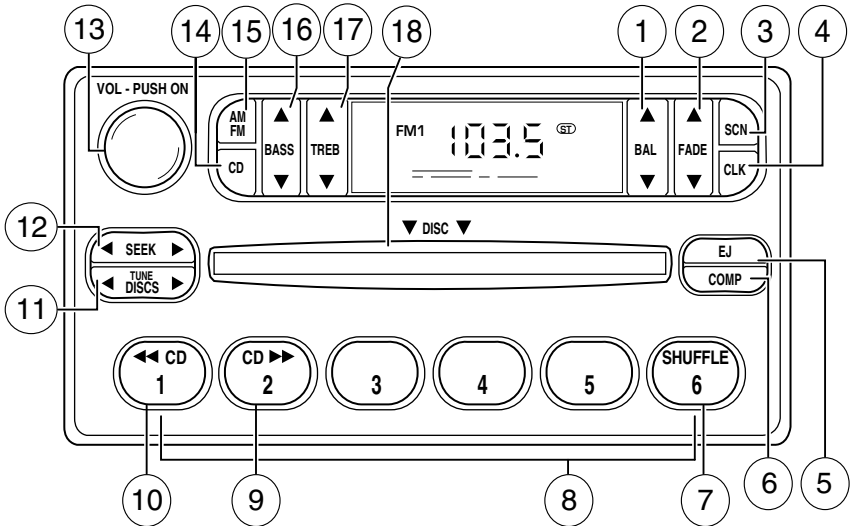

1. **Balance:** Press ▲ / ▼ to shift sound to the left/right speakers.



2. **Fade:** Press ▲ / ▼ to shift sound to the front/rear speakers.



3. **SCN (Scan):** Press to hear a brief sampling of all listenable stations or CD tracks. Press again to stop.



4. **CLK:** To set the hour, press and hold CLK and press SEEK to decrease ◀ or increase ▶ the hours.



To set the minute, press and hold CLK and press TUNE to decrease ◀ or increase ▶ the minutes.

Entertainment Systems

5. **EJ (eject):** Press to eject a CD.



6. **COMP (Compression):** In CD mode, press to bring louder and softer levels into more comfortable listening level. The compression icon (c) will appear in the display.



7. **Shuffle:** Press to listen to the tracks on the CD in random order. Press again to turn off.



8. **Memory presets:** To set a station: Select frequency band AM/FM; tune to a station. Press and hold a preset button until sound returns. This radio is equipped with six station memory preset controls which allow you to set up to six AM stations and 12 FM stations (six in FM1 and six in FM2).



9. **CD:** Press and hold until desired selection is reached.



10. **CD:** Press and hold until desired selection is reached.



11. **Tune / Discs:** In radio mode, press to move up or down the frequency band in individual increments.



12. **Seek:** Press and release SEEK ◀ / ▶ for previous/next strong station, selection or track.



13. **Power/volume:** Press to turn ON/OFF; turn to increase or decrease volume levels.

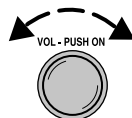

14. **CD:** Press to enter CD mode or to play a CD already loaded into the system.



15. **AM/FM:** Press to choose a frequency band in radio mode.



16. **Bass:** Press ▲ / ▼ to increase/decrease the bass output.



17. **Treble:** Press ▲ / ▼ to increase/decrease the treble output.



18. **CD door:** Insert a CD printed side up.

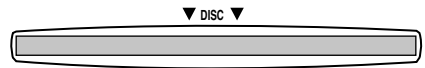



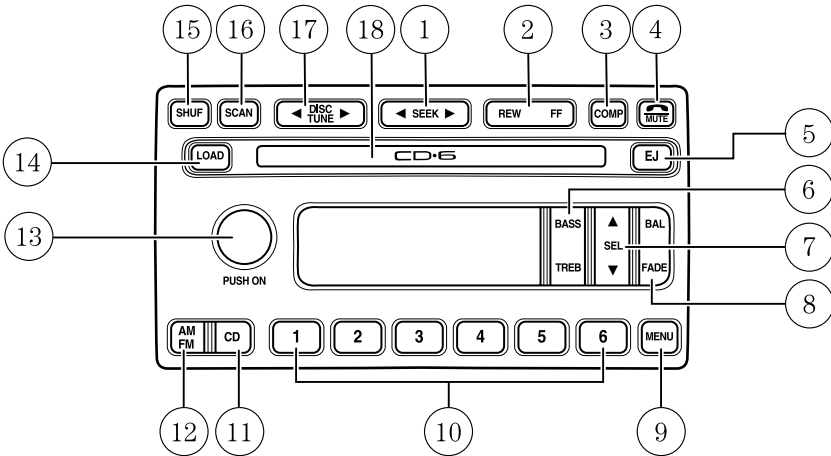

CD unit are designed to play commercially pressed 12 cm (4.75 in) audio compact discs only. Due to technical incompatibility, certain recordable and re-recordable compact discs may not function correctly when used in Mazda CD players. Irregular shaped CDs, CDs with a scratch protection film attached, and CDs with homemade paper (adhesive) labels should not be inserted into the CD player. The label may peel and cause the CD to become jammed. It is recommended that homemade CDs be identified with permanent felt tip marker rather than adhesive labels. Ball point pens may damage CDs. Please contact your dealer for further information.

Entertainment Systems

PREMIUM IN-DASH SIX CD SOUND SYSTEM



- 1. Seek:** Press and release SEEK ◀ / ▶ for previous/next strong station, or track of current disc.

- 2. Rewind:** Press for a slow rewind, press and hold for a fast rewind.

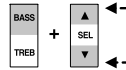
- Fast forward:** Press for a slow advance, press and hold for a fast advance.

- 3. Comp (Compression):** In CD mode, press to adjust the soft and loud passages together for a more consistent listening level. Press the COMP control until COMP ON is displayed.
- 4. Mute:** Press to MUTE playing media; press again return to playing media. In CD mode, MUTE acts as a pause feature.

- 5. Eject:** Press to eject a CD. Press and hold to auto eject all loaded discs.

6. **Bass:** Press BASS; then press SEL ◀ / ▶ to decrease/increase the bass output.



- Treble:** Press TREB; then press SEL ◀ / ▶ to decrease/increase the treble output.



7. **Select:** Use with Bass, Treble, Balance and Fade controls to adjust levels. Use with MENU to set the clock and engage RDS.

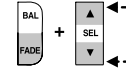

8. **Balance:** Press BAL; then press SEL ◀ / ▶ to shift sound to the left/right speakers.

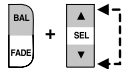

- Fade:** Press FADE; then press SEL ◀ / ▶ to shift sound to the rear/front speakers.

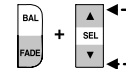

9. **Menu:** Press MENU and SEL to access clock mode, RDS on/off, Traffic, Program type, Show type and Compression modes.



Traffic: Allows you to hear traffic broadcasts. With the feature ON, press SEEK or SCAN to find a station broadcasting a traffic report (if it is broadcasting RDS data). *Traffic information is not available in most U.S. markets.*

FIND Program type: Allows you to search RDS-equipped stations for a certain category of music format: Classic, Country, Info, Jazz, Oldies, R&B, Religious, Rock, Soft, Top 40.

Show TYPE: Displays the station's call letters and format.

Compression: Brings soft and loud CD passages together for a more consistent listening level.

Setting the clock: Press MENU until SELECT HOUR or SELECT MINUTE is displayed. Use SEL to manually increase (▲) or decrease (▼) the hours/minutes. Press MENU again to disengage clock mode.

Entertainment Systems

10. **Memory presets:** To set a station: Select frequency band



AM/FM; tune to a station, press and hold a preset button until

sound returns. In CD mode, press to move between CDs.

This radio is equipped with six station memory preset controls which allow you to set up to six AM stations and 12 FM stations (six in FM1 and six in FM2).

11. **CD:** Press to select CD mode.



Seamless play: In CD mode, the transition between the end of one

CD and the beginning of another will not contain delay time unless SEEK or a preset control is pressed.

12. **AM/FM:** Press to select a frequency band in radio mode.



Autostore: Allows you to set the strongest local radio stations without losing your original manually set preset stations for AM/FM1/FM2 . Press and momentarily hold AM/FM. AUTOSTORE will flash on the display. When the six strongest stations are filled, the station stored in preset 1 will begin playing. If there are less than six strong stations, the system will store the last one in the remaining presets. Press again to disengage.

13. **Power/volume:** Press to turn ON/OFF; turn to increase or decrease volume levels.



14. **Load:** Press to load a CD. Press and hold to load up to six discs.



15. **Shuffle:** Press to play tracks in random order. Press SHUF to cycle through SHUF DISC, SHUF TRAC or SHUF OFF.



16. **Scan:** Press to hear a brief sampling of all listenable stations or CD tracks. Press again to stop.



17. **Disc/Tune:** Radio: Press ◀ or ▶ to manually tune down or up the frequency band.
 CD: Press ◀ or ▶ to select the previous or next track on the CD.
18. **CD door:** Insert a CD label side up.



MACH® MP3 AUDIO SYSTEM

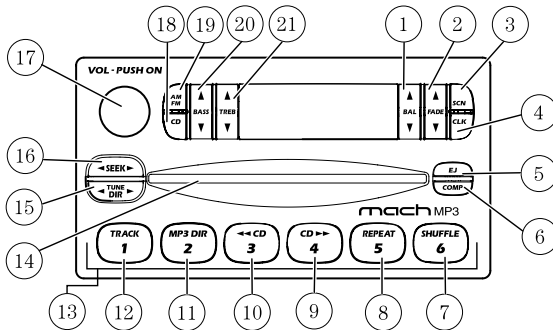

1. **Balance:** Press ▲ / ▼ to shift sound to the left/right speakers.



2. **Fade:** Press ▲ / ▼ to shift sound to the rear/front speakers.



3. **Scan:** Press to hear a brief sampling of all listenable radio stations, CD or MP3 tracks. Press again to stop.



Entertainment Systems

4. **CLK:** To set the clock press and hold the CLK control for the following functions:



- To set the hour, press SEEK ◀ / ▶ control to decrease or increase to the hours.
- To set the minutes, press TUNE DIR ◀ / ▶ to decrease or increase the minutes.

Release CLK to save the clock settings. Press CLK again to return the display to radio mode.

5. **EJ (Eject):** Press to stop and eject a disc. If a disc is ejected and not removed, the player will automatically reload the disc and return to radio mode.



6. **COMP (Compression):** In CD and MP3 mode, press to adjust the soft and loud sounds together for a more consistent listening level. The compression icon (c) will illuminate in the display.



7. **Shuffle:** Press to engage random play on the CD or MP3 disc. SHF then ON will briefly appear in the display. Press SEEK to select another random track on the disc. Press shuffle again to disable.



8. **Repeat:** Press to repeat the current track.



9. **CD ▶▶▶ (Fast forward):** Press and hold until the desired selection point is reached. This function is not enabled in MP3 mode.



10. **◀◀ CD (Rewind):** Press and hold until the desired selection point is reached. This function is not enabled in MP3 mode.



11. **MP3 directory:** Allows you to listen to songs in MP3 flat file mode and MP3 directory mode.



- Insert a MP3 disc to engage in the flat file mode. The MP3 icon will be displayed.
- While in the MP3 flat file mode, press the MP3 DIR control to enter into the directory mode. Press the TUNE DIR control to change directories. The MP3 icon and the DIR icon will be displayed.

12. **Track:** Press to locate a specific MP3 track or directory. TRAC will appear in the display.



Rotate volume control to advance or reverse through the tracks or directories. The MP3 icon will flash in the display while the MACH[®] track function is enabled.

13. **Memory presets:** To set a station: Select frequency band AM/FM; tune to a station, press and hold a preset button until sound returns.
14. **CD door:** Insert a CD with the label side up.



15. **Tune/Directory:** Press TUNE DIR ◀ / ▶ to change the radio frequency down/up or change the MP3 directories.



16. **Seek:** Press and release SEEK ◀ / ▶ for previous/next strong station selection or CD and MP3 tracks.



17. **Power/volume:** Press to turn ON/OFF; turn to increase or decrease volume levels.

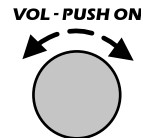

18. **CD:** Press CD to play a CD or MP3 disc. When the MP3 disc is loaded, CD and LOAD will appear on the display. The display will briefly show the total number of tracks on the disc as TXXX (XXX=number of tracks).



Entertainment Systems

19. **AM/FM:** Press to select a frequency band in radio mode.



20. **Bass:** Press ▲ / ▼ to decrease/increase the bass output.



21. **Treble:** Press ▲ / ▼ to decrease/increase the treble output.



MP3 FUNCTIONS

Your audio system is equipped with MP3 capability which allows you to listen to songs in MP3 flat file mode and MP3 directory mode.

To engage MP3 flat file mode, insert an MP3 disc. If an MP3 disc is already present in the player, press the CD control. The MP3 icon will display while the player is in MP3 mode.

While in MP3 flat file mode, press the MP3 DIR control to enter into MP3 directory mode. The MP3 icon and the DIR icon will display while the player is in directory mode.



Your MACH® MP3 player is also equipped with an anti-shock buffer for MP3 discs.

MP3 FILE DIRECTORY STRUCTURE

The MACH® MP3 music system recognizes MP3 disc file and directory (folder) structure as follows:

- There are two different modes for MP3 disc playback: MP3 flat file mode (default) and MP3 directory mode.
- MP3 flat file mode ignores any directory structure present on the MP3 disc. The player sequentially numbers each MP3 track on the disc (denoted by the .mp3 file extension) from T001 to T255.
- MP3 directory mode represents a directory structure consisting of one level of directories (folders). The CD player sequentially numbers all

MP3 tracks on the disc (denoted by .mp3 extension) and all directories containing MP3 files, from 01–01 to 99–99. The first two digits denote the directory number and the last two digits denote the track number within that directory.

- Creating discs with only one level of subdirectories will help with navigation through the disc files.

ERROR MESSAGES

You may experience an error message for the following situations:

- NO DISC when the CD control is pressed and there is not a CD present.
- DISC ERR when there is a damaged or unreadable disc. Such as, data discs containing no .mp3 files, or for data discs containing more than 255 files or directories.
- CD ERR for any other disc malfunction.

SAMPLE HIERARCHIES

If you are burning your own MP3 discs, it is important to understand how the MACH® MP3 music system will read the hierarchies you create. This is an example of creating a directory structure that is one level deep with various types of music. While various files are present, (files with extensions other than mp3), only files with the .mp3 extension will be played. Other files will be ignored by the system. This enables you to use the same MP3 disc for a variety of tasks on your work computer, home computer and your MACH® MP3 music system.

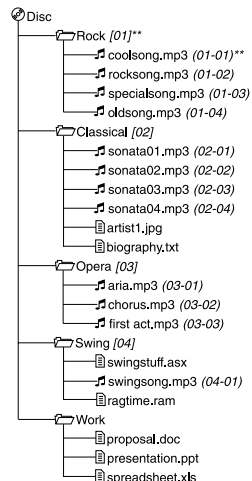

Entertainment Systems

This hierarchy is an example of a more complex directory structure. While you are capable of setting up many directory levels when burning a CD, the MACH® MP3 music system will display the structure as if it were only one level deep. Therefore, the system will condense the complex hierarchy into a structure similar to the one-level-deep example above. This will not harm the MP3 disc and will not change the hierarchy that is actually written on the disc. Only mp3 files will be played, files with other extensions will be skipped.

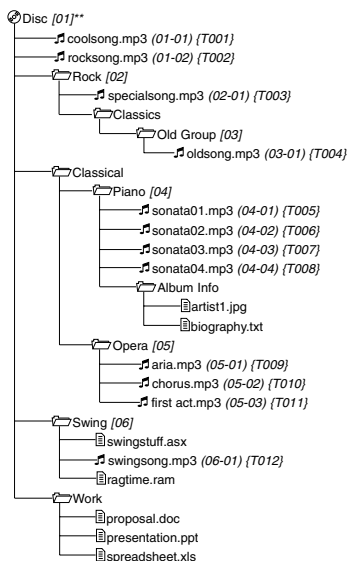

In this example, (xx) = directory, (xx-xx) = directory -track, and (Txxx) = flat file track.

SAVING AND NAMING MP3 FILES

- Your MACH® MP3 music system supports discs containing up to 255 files in 255 directories. Discs containing more than 255 files will not play.
- Always save MP3 files with the .mp3 extension. The player recognizes an MP3 file by the .mp3 extension, so MP3 files saved with different extensions will not be played. **Never save a non-MP3 file with the .mp3 extension as the file will not play properly and damage may occur to the player or your sound system.**
- The player supports multi session discs. However, be sure to import the previous session of the disc before you add new files. If you do not import the previous session, only the last session will be played.
- When burning a disc, ensure that you close/finalize the disc before playback, or the disc may not play properly or an error message may appear.
- The player supports DAM (Digital Automatic Music) discs.

RADIO FREQUENCIES

AM and FM frequencies are established by the Federal Communications Commission (FCC) and the Canadian Radio and Telecommunications Commission (CRTC). Those frequencies are:

AM - 530, 540–1600, 1610 kHz

FM- 87.7, 87.9–107.7, 107.9 MHz

RADIO RECEPTION FACTORS

There are three factors that can effect radio reception:

- Distance/strength: The further you travel from an FM station, the weaker the signal and the weaker the reception.
- Terrain: Hills, mountains, tall buildings, power lines, electric fences, traffic lights and thunderstorms can interfere with your reception.
- Station overload: When you pass a broadcast tower, a stronger signal may overtake a weaker one and play while the weak station frequency is displayed.

CASSETTE/PLAYER CARE

Do:

- Use only cassettes which are 90 minutes long or less.
- Tighten very loose tapes by inserting a finger or pencil into the hole and turning the hub.
- Remove loose labels before inserting tapes.
- Allow tapes which have been subjected to extreme heat, humidity or cold to reach a moderate temperature before playing.
- Clean the cassette player head with a cassette cleaning cartridge after 10–12 hours of play to maintain good sound/operation.

Don't:

- Expose tapes to direct sunlight, extreme humidity, heat or cold.
- Leave tapes in the cassette player for a long time when not being played.

CD/CD PLAYER CARE

Do:

- Handle discs by their edges only. Never touch the playing surface.
- Inspect discs before playing. Clean only with an approved CD cleaner and wipe from the center out.

Entertainment Systems

Don't:

- Expose discs to direct sunlight or heat sources for extended periods of time.
- Insert more than one disc into each slot of the CD changer magazine.
- Clean using a circular motion.

CD units are designed to play commercially pressed 12 cm (4.75 in) audio compact discs only. Due to technical incompatibility, certain recordable and re-recordable compact discs may not function correctly when used in CD players. Irregular shaped CDs, CDs with a scratch protection film attached, and CDs with homemade paper (adhesive) labels should not be inserted into the CD player. The label may peel and cause the CD to become jammed. It is recommended that homemade CDs be identified with permanent felt tip marker rather than adhesive labels. Ball point pens may damage CDs. Please contact your dealer for further information.

AUDIO SYSTEM WARRANTY AND SERVICE

Refer to the *Warranty Guide* for audio system warranty information. If service is necessary, see your authorized Mazda dealership.

HEATER ONLY SYSTEM (IF EQUIPPED)

1. **Fan speed adjustment:**

Controls the volume of air circulated in the vehicle.

2. **Temperature selection:**

Controls the temperature of the airflow in the vehicle.

3. **Air flow selections:** Controls the direction of the airflow in the vehicle. See the following for a brief description on each control.

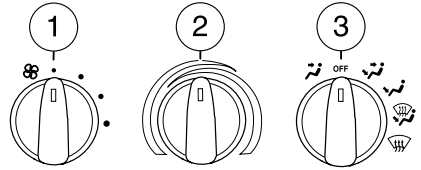



 : Distributes outside air through the instrument panel vents.

OFF: Outside air is shut out and the fan will not operate.

 : Distributes outside air through the instrument panel vents and the floor vents.

 : Distributes outside air through the floor vents.

 : Distributes outside air through the windshield defroster vents and floor vents.

 : Distributes outside air through the windshield defroster vents.

OPERATING TIPS

- To reduce fog build up on the windshield during humid weather, place the air flow selector in the  position.
- To reduce humidity build up inside the vehicle during cold or warm weather, do not drive with the air flow selector in the OFF position.
- Under normal weather conditions, do not leave the air flow selector in OFF when the vehicle is parked. This allows the vehicle to “breathe” using the outside air inlet vents.
- Do not put objects under the front seats that will interfere with the air flow to the back seats.
- Remove any snow, ice or leaves from the air intake area at the base of the windshield.

To aid in side window defogging/demisting in cold weather:

1. Select 
2. Set the temperature control to full heat
3. Set the fan speed to HI

Climate Controls

4. Direct the outer instrument panel vents towards the side windows
To increase airflow to the outer instrument panel vents, close the vents located in the middle of the instrument panel.

WARNING: Do not place objects on top of the instrument panel as these objects may become projectiles in a collision or sudden stop.

MANUAL HEATING AND AIR CONDITIONING SYSTEM

- Fan speed adjustment:**
Controls the volume of air circulated in the vehicle.
- Temperature selection:**
Controls the temperature of the airflow in the vehicle.
- Air flow selections:** Controls the direction of the airflow in the vehicle. See the following for a brief description on each control.

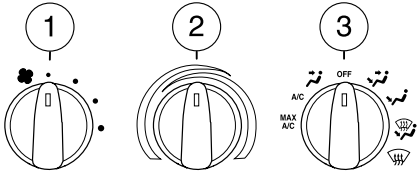



MAX A/C: Uses recirculated air to cool the vehicle. Air flows from the instrument panel vents only.

A/C: Uses outside air to cool the vehicle. Air flows from the instrument panel vents only.

 : Distributes outside air through the instrument panel vents.

OFF: Outside air is shut out and the fan will not operate.

 : Distributes outside air through the instrument panel vents and the floor vents.

 : Distributes outside air through the floor vents.

 : Distributes outside air through the windshield defroster vents and floor vents.

 : Distributes outside air through the windshield defroster vents.

OPERATING TIPS

- To reduce fog build up on the windshield during humid weather, place the air flow selector in the  position.
- To reduce humidity build up inside the vehicle: do not drive with the air flow selector in the OFF or MAX A/C position.

Climate Controls

- Under normal weather conditions, do not leave the air flow selector in MAX A/C or OFF when the vehicle is parked. This allows the vehicle to “breathe” using the outside air inlet vents.
- Do not put objects under the front seats that will interfere with the airflow to the back seats.
- Remove any snow, ice or leaves from the air intake area at the base of the windshield.

To aid in side window defogging/demisting in cold weather:

1. Select 
2. Select A/C
3. Modulate the temperature control to maintain comfort.
4. Set the fan speed to HI
5. Direct the outer instrument panel vents towards the side windows

To increase airflow to the outer instrument panel vents, close the vents located in the middle of the instrument panel.

WARNING: Do not place objects on top of the instrument panel as these objects may become projectiles in a collision or sudden stop.

Lights

HEADLAMP CONTROL ☀

OFF Turns the lamps off.

☀ Turns on the parking lamps, instrument panel lamps, license plate lamps and tail lamps.

☀ Turns the headlamps on.

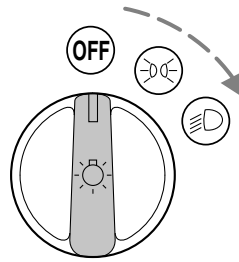

FOG LAMP CONTROL (IF EQUIPPED) ⌘

The fog lamps can only be turned on when the headlamp control is in the low beams position.

Press the foglamp control to activate the fog lamps. The fog lamp indicator light will illuminate. When the highbeams are activated, the fog lamps will not operate.

Press the fog lamp control again to deactivate the fog lamps.

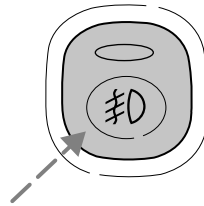

Daytime running lamps (DRL) (if equipped)

Turns the headlamps on with a reduced output.

To activate:

- the ignition must be in the ON position and
- the headlamp control is in the OFF, parking lamp or headlamp position.

WARNING: Always remember to turn on your headlamps at dusk or during inclement weather. The Daytime Running Lamp (DRL) system does not activate with your parking lights or side marker lights and generally may not provide adequate lighting during these conditions. Failure to activate your headlamps under these conditions may result in a collision.

High beams

After turning the headlamps on, push the lever toward the instrument panel to activate. Pull the lever towards you to deactivate.

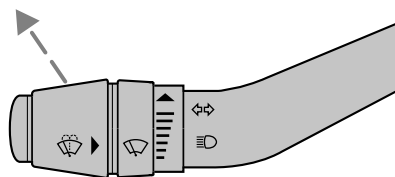

Flash to pass

Pull toward you slightly to activate and release to deactivate.

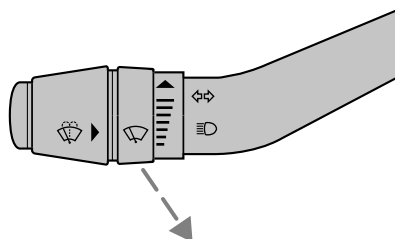

PANEL DIMMER CONTROL

Use to adjust the brightness of the instrument panel and all applicable switches in the vehicle during headlamp and parklamp operation.

Move the control up or down to adjust the intensity of the panel lighting.

Move the control to the full upright position, past detent, to turn on the interior lamps.

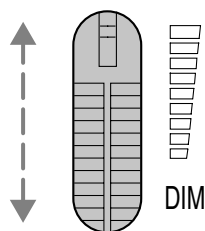

AIMING THE HEADLAMPS

The headlamps on your vehicle are properly aimed at the assembly plant.

If your vehicle has been in an accident the alignment of your headlamps should be checked by your authorized Mazda dealer.

Lights

TURN SIGNAL CONTROL ↵↶

- Push down to activate the left turn signal.
- Push up to activate the right turn signal.

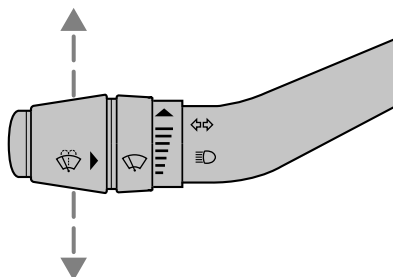

COURTESY/READING LAMPS (IF EQUIPPED)

The courtesy lamp lights when:

- any door is opened.
- the instrument panel dimmer switch is held up until the courtesy lamps come on.
- the remote entry controls are pressed and the ignition is OFF.

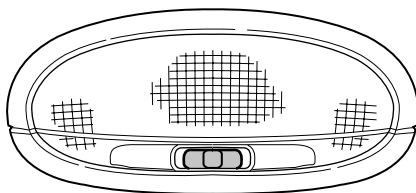

The reading lamps can be turned on by moving the switch on the dome lamp to either the left or the right.

BULBS

Replacing exterior bulbs

Check the operation of all the bulbs frequently.

Using the right bulbs

Replacement bulbs are specified in the chart below. Headlamp bulbs must be marked with an authorized "D.O.T." for North America to assure lamp performance, light brightness and pattern and safe visibility.

NOTE: The correct bulbs will not damage the lamp assembly or void the lamp assembly warranty and will provide quality bulb burn time.

Function	Number of bulbs	Trade number
Park/turn lamps (front)	2	3157 AK (amber)
Headlamps	2	9003
Rear stop/tail lamps	2	3157K
Rear turn lamps	2	3156K
Rear license plate lamps	2	3156K/168
Backup lamp	2	3156K
Rear/turn/sidemarker	2	916NA (amber)
Fog lamp (if equipped)	2	899
Cargo lamp	1	211-2
Interior overhead lamp	1	912 (906)
Front door courtesy lamp	1	168
Map lamps	2	168 (T10)
Ashtray lamp	1	161
All replacement bulbs are clear in color except where noted.		
To replace all instrument panel lights - see your dealer.		

Replacing the interior bulbs

Check the operation of the following interior bulbs frequently:

- interior overhead lamp
- map lamp

For bulb replacement, see an authorized Mazda dealer.

Replacing headlamp bulbs

NOTE: The procedure can be difficult. Your Mazda dealer has the proper tools, training and parts to perform this task. If you have difficulty with this, visit your local Mazda dealer.

Lights

WARNING: Handling Halogen Bulbs: When a halogen bulb breaks, it is dangerous. These bulbs contain pressurized gas. If one is broken, it will explode and serious injuries could be caused by the flying glass. If the glass portion of the bulb is touched with bare hands, body oil could cause the bulb to overheat and explode when lit. Never touch the glass portion of the bulb with your bare hands and always wear eye protection when handling or working around halogen bulbs.

Children and Halogen Bulbs: Playing with a halogen bulb is dangerous. Serious injuries could be caused by dropping a halogen bulb or breaking in some other way. Always keep halogen bulbs out of the reach of children.

To remove the headlamp bulb:

1. Make sure headlamp switch is in OFF position, then open the hood.
2. At the back of the headlamp, pry up the two retainer pins to release the headlamp assembly from the vehicle and pull headlamp forward.
3. Remove the bulb retaining ring by rotating it counterclockwise (when viewed from the rear) to free it from the bulb socket, and slide the ring off the plastic base. Keep the ring to retain the new bulb.
4. Without turning, remove the old bulb by gently pulling it straight back out of the lamp assembly.

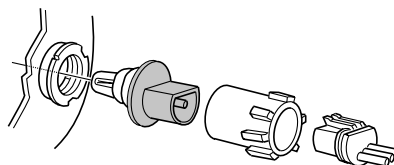
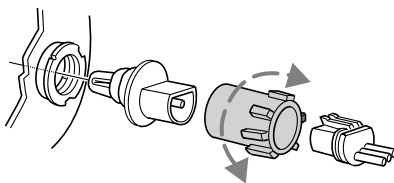
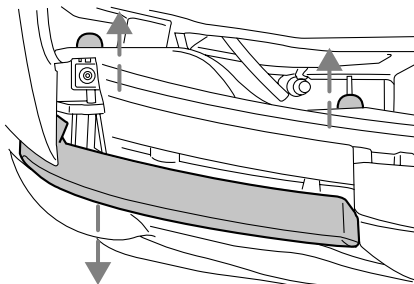

To install the new bulb:

Handle a halogen headlamp bulb carefully and keep out of children's reach. Grasp the bulb only by its plastic base and do not touch the glass. The oil from your hands could cause the bulb to break the next time the headlamps are operated. Always wear safety glasses while handling bulbs.

NOTE: If the bulb is accidentally touched, it should be cleaned with rubbing alcohol before being used.

1. With the flat side of the bulb's plastic base facing upward, insert the glass end of the bulb into the lamp assembly. You may need to turn the bulb left or right to align the grooves in the plastic base with the tabs in the lamp assembly. When the grooves are aligned, push the bulb into the lamp assembly until the plastic base contacts the rear of the lamp assembly.
2. Install the bulb retaining ring over the plastic base until it contacts the rear of the socket by rotating clockwise until you feel a "stop."
3. Install the electrical connector into the plastic base until it snaps, locking it into position.
4. Install the headlamp on vehicle, push rearward and secure with two retainer pins.
5. Turn the headlamps on and make sure they work properly. If the headlamp was correctly aligned before you changed the bulb, you should not need to align it again.

Replacing front side marker bulbs

1. Open the hood.
2. At the back of the headlamp, pry up the two retainer pins to release the headlamp assembly from the vehicle and pull headlamp forward.

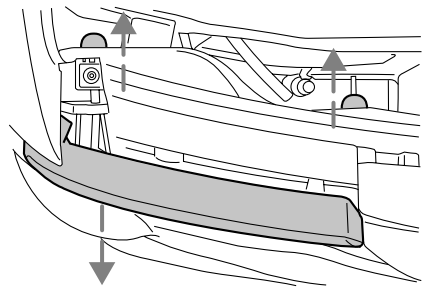

Lights

3. Remove screw(s) from lamp assembly.
4. Disengage lamp assembly (it has a snap fit).

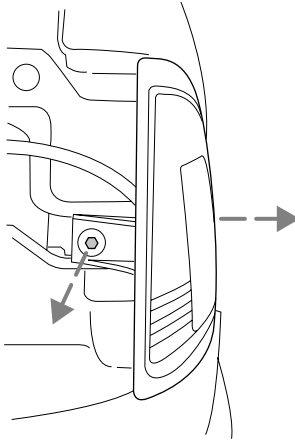

5. Rotate bulb socket counterclockwise and remove from lamp assembly.
6. Carefully pull bulb straight out of socket and push in the new bulb.
7. Install the bulb socket in lamp assembly by turning clockwise.
8. Align the lamp on the vehicle and push to snap in place.
9. Install screw(s) on lamp assembly.
10. Install the headlamp on vehicle, push rearward and secure with two retainer pins.

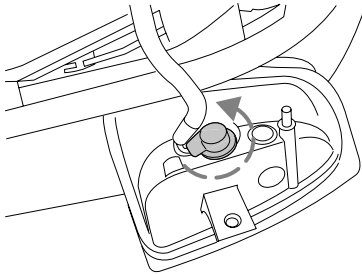

Replacing tail lamp/backup lamp bulbs

The tail lamp/backup lamp bulbs are located in the same portion of the tail lamp assembly, one just below the other. Follow the same steps to replace either bulb:

1. Open the tailgate to expose the lamp assemblies.
2. Remove the four screws and the lamp assembly from vehicle.

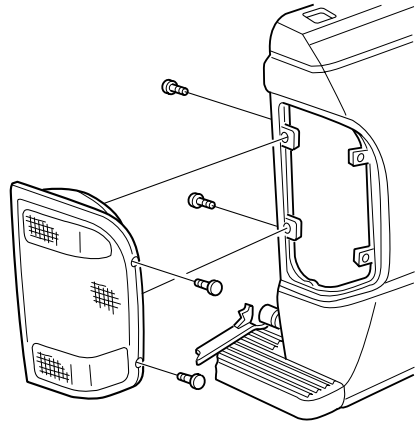

3. Rotate bulb socket counterclockwise turn and remove from lamp assembly.
4. Carefully pull the bulb straight out of the socket and push in the new bulb.
5. Install the bulb socket in lamp assembly by turning clockwise.
6. Install the lamp assembly and secure with four screws.

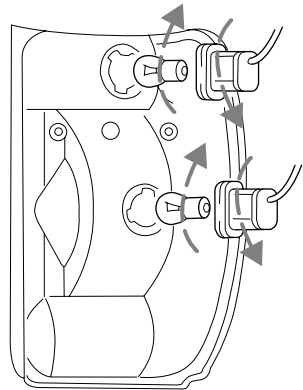

Replacing fog lamp bulbs

1. Remove the bulb socket from the fog lamp by turning counterclockwise.
2. Disconnect the electrical connector from the fog lamp bulb.
3. Connect the electrical connector to the new fog lamp bulb.
4. Install the bulb socket in the fog lamp turning clockwise.

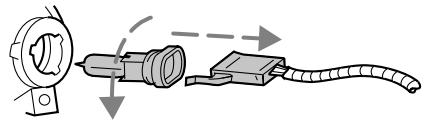

Lights

Replacing high-mount brake lamp and cargo lamp bulbs

The replacement of the high-mount brake lamp bulb and cargo lamp bulb is basically the same. This procedure covers the high-mount brake lamp bulb.

To remove the brake lamp assembly:

1. Remove the two screws and lamp assembly from vehicle.
2. Remove the bulb socket from lamp assembly by rotating it counterclockwise.
3. Carefully pull bulb straight out of socket and push in the new bulb.

To install the brake lamp assembly:

1. Install the bulb socket into the lamp assembly by rotating clockwise.
2. Install the lamp assembly on the vehicle and secure with two screws.

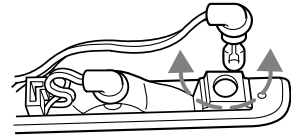
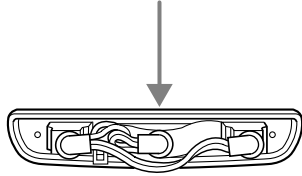

Replacing license plate lamp bulbs

The license plate bulbs are located behind the rear bumper. To change the license plate lamp bulbs:

1. Reach behind the rear bumper to locate the bulb socket.
2. Twist the socket counterclockwise and remove.
3. Pull out the old bulb from socket and push in the new bulb.
4. Install the bulb socket in lamp assembly by turning it clockwise.

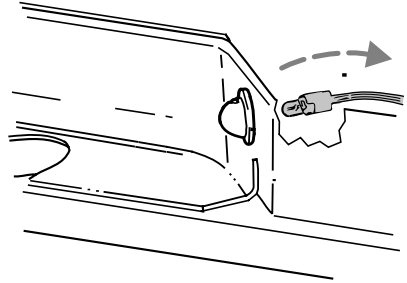

MULTI-FUNCTION LEVER

Windshield wiper: Rotate the end of the control away from you to increase the speed of the wipers; rotate towards you to decrease the speed of the wipers.

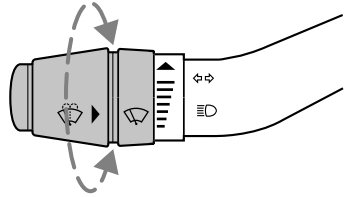

Windshield washer: Push the end of the stalk:

- briefly: causes a single swipe of the wipers without washer fluid.
- a quick push and hold: the wipers will swipe three times with washer fluid.
- a long push and hold: the wipers and washer fluid will be activated for up to ten seconds.

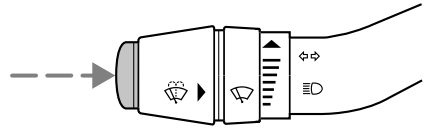

Windshield wiper blades

If the wiper blades do not wipe properly, clean both the windshield and wiper blades using undiluted windshield wiper solution or a mild detergent. Rinse thoroughly with clean water. To avoid damaging the blades, do not use fuel, kerosene, paint thinner or other solvents.

Check the wiper blades for wear at least twice a year or when they seem less effective. Substances such as tree sap and some hot wax treatments used by commercial car washes reduce the effectiveness of wiper blades.

Note: There are different wiper blades for cold and warm weather use.

Driver Controls

Changing the wiper blades

1. Pull the wiper arm away from the vehicle. Turn the blade at an angle from the wiper arm. Push the lock pin manually to release the blade and pull the wiper blade down toward the windshield to remove it from the arm.
2. Attach the new wiper to the wiper arm and press it into place until a click is heard.
3. Replace wiper blades every 6 months for optimum performance.

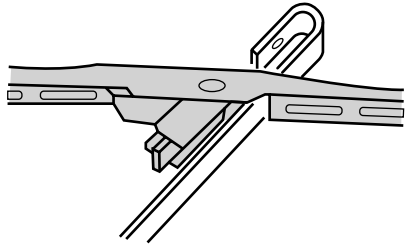

TILT STEERING WHEEL (IF EQUIPPED)

To adjust the steering wheel:

1. Pull and hold the steering wheel release control toward you.
2. Move the steering wheel up or down until you find the desired location.
3. Release the steering wheel release control. This will lock the steering wheel in position.

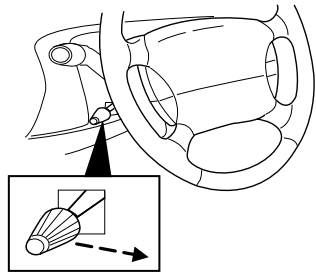

WARNING: Never adjust the steering wheel when the vehicle is moving.

AUXILIARY POWER POINT 12V

Power outlets are designed for accessory plugs only. Do not hang any type of accessory or accessory bracket from the plug. Improper use of the power outlet can cause damage not covered by your warranty.

The auxiliary power point is located on the instrument panel. Do not plug optional electrical accessories into the cigarette lighter. Use the power point.

Do not use the power point for operating the cigarette lighter element.

The Maximum power each power point can supply depends on the fuse rating. For example: a 20A fuse should supply a maximum of 240 Watts, a 15A fuse should supply a maximum of 180 Watts and a 10A fuse should supply a maximum of 120 Watts. Exceeding these limits will result in a blown fuse. Refer to *Passenger Compartment Fuse Panel* in the *Roadside Emergencies* chapter for fuse ratings in your vehicle.

Always keep the power point caps closed when not being used.

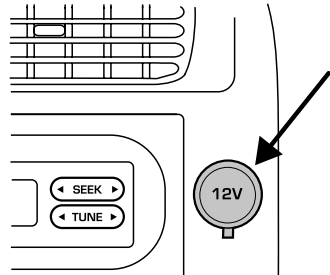

POWER WINDOWS (IF EQUIPPED)

WARNING: When closing the power windows, you should verify they are free of obstructions and ensure that children and/or pets are not in the proximity of the window openings.

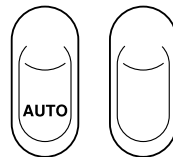

Press and hold the bottom part of the rocker switch to open the window. Press and hold the top part of the rocker switch to close the window.

Driver Controls

One touch down

Allows the driver's window to open fully without holding the control down. Press completely down on AUTO and release quickly. Press again to stop.

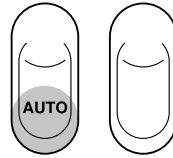

AUTOMATIC DIMMING REAR VIEW MIRRORS (IF EQUIPPED)

The electronic day/night mirror will change from the normal state to the non-glare state when bright lights (glare) reach the inside rear view mirror. When the inside rear view mirror detects bright light from behind the vehicle, the inside rear view mirror will automatically adjust (darken) to minimize glare.

Do not block the sensor on the backside of the inside rear view mirror since this may impair proper system performance.

Press the left button on the mirror to turn the auto dimming ON or OFF. The green indicator light left of the display will illuminate when this feature is ON.

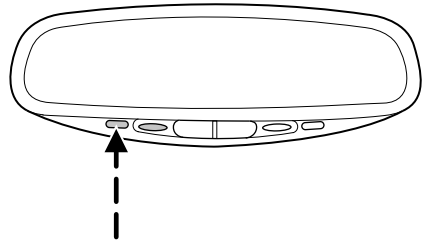

COMPASS/TEMPERATURE EC MIRROR (IF EQUIPPED)

The compass reading may be affected when you drive near large buildings, bridges, power lines and powerful broadcast antennas. Magnetic or metallic objects placed in, on or near the vehicle may also affect compass accuracy.

Usually, when something affects the compass readings, the compass will correct itself after a few days of operating your vehicle in normal conditions. If the compass still appears to be inaccurate, a manual calibration may be necessary. Refer to *Compass calibration adjustment*.

Most geographic areas (zones) have a magnetic north compass point that varies slightly from the northerly direction on maps. This variation is four

degrees between adjacent zones and will become noticeable as the vehicle crosses multiple zones. A correct zone setting will eliminate this error. Refer to *Compass zone adjustment*.

Outside air temperature

Display operation of the mirror with the compass feature:

- Press the right button to toggle the display between the compass direction and no display.

Display operation of mirror with temperature and compass feature:

- Press the right button once to display temperature °F and compass.
- Press the right button twice to display temperature °C and compass.
- Press the right button three times to turn the display OFF.

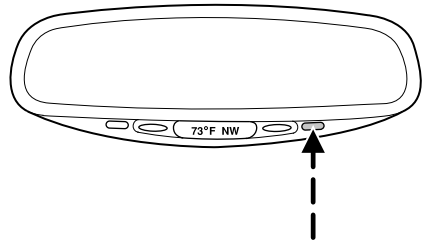

WARNING: The outside temperature indicator is not designed to serve as an ICE warning device and is therefore unsuitable for that purpose. Indicated temperatures just above the freezing point do not guarantee that the road surface is free of ice.

Compass zone adjustment

1. Determine which compass zone you are in by referring to the zone map.
2. Turn ignition to the ON position.

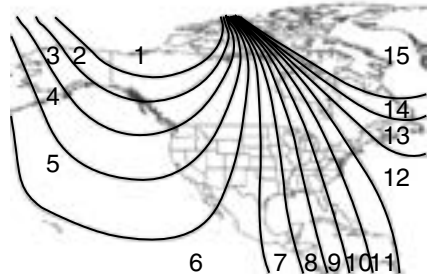

Driver Controls

3. To change the zone setting, push and hold the right button until ZONE appears in the display.
4. Press the right button repeatedly until desired compass zone number is displayed. The display will change back to the compass direction after 3 seconds when the button is not activated.

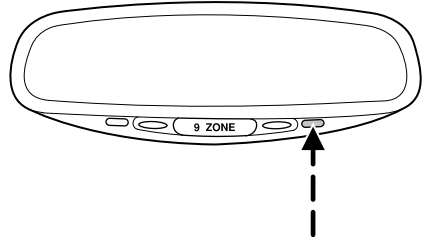

Compass calibration adjustment

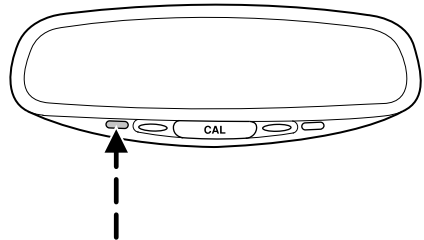

The compass calibrates itself under normal driving conditions. There is not a need for manual compass calibration. If calibration is still desired, follow these instructions:

1. Start the vehicle.
2. For optimum calibration, turn off all electrical accessories and make sure that all vehicle doors are shut.
3. Perform this adjustment in an open area free from steel structures and high voltage lines.
4. Press and hold the left button for approximately 3 seconds until CAL appears in the display. Release the left button to enter the calibration mode.
5. Drive the vehicle slowly (less than 5 km/h [3 mph] in a circle until CAL indicator disappears in the display (about two or three circles).
6. The compass is now calibrated.



POWER MIRROR CONTROL (IF EQUIPPED)

To adjust your mirrors:

1. Select  to adjust the left mirror or  to adjust the right mirror.
2. Move the control in the direction you wish to tilt the mirror.
3. Return to the center position to lock mirrors in place.

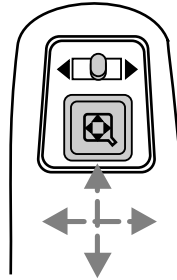

SPEED CONTROL (IF EQUIPPED)

With speed control set, you can maintain a speed of 48 km/h (30 mph) or more without keeping your foot on the accelerator pedal. Speed control does not work at speeds below 48 km/h (30 mph).

WARNING: Do not use the speed control in heavy traffic or on roads that are winding, slippery, or unpaved. You may lose control of the vehicle.

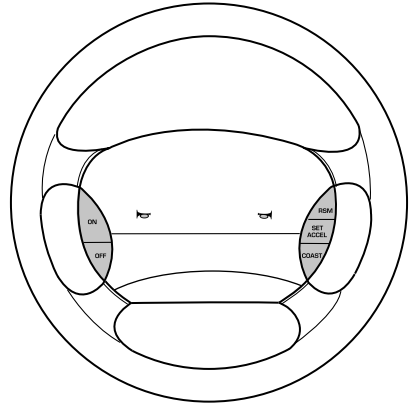

WARNING: Do not shift the gearshift lever into N (Neutral) with the speed control on. You may lose control of the vehicle or cause engine system damage.

Driver Controls

Setting speed control

The controls for using your speed control are located on the steering wheel for your convenience.

1. Press the ON control and release it.
2. Accelerate to the desired speed.
3. Press the SET ACC control and release it.
4. Take your foot off the accelerator pedal.
5. The indicator light **SPEED CONT** on the instrument cluster will turn on.

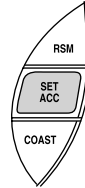
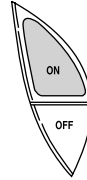

Note:

- Vehicle speed may vary momentarily when driving up and down a steep hill.
- If the vehicle speed increases above the set speed on a downhill, you may want to apply the brakes to reduce the speed.
- If the vehicle speed decreases more than 16 km/h (10 mph) below your set speed on an uphill, your speed control will disengage.

Resuming a set speed

Press the RSM (resume) control and release it. This will automatically return the vehicle to the previously set speed. The RSM control will not work if the vehicle speed is not faster than 48 km/h (30 mph).

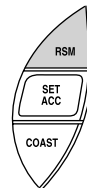

Increasing speed while using speed control

There are two ways to set a higher speed:

- Press and hold the SET ACC control until you get to the desired speed, then release the control. You can also use the SET ACC control to operate the Tap-Up function. Press and release this control to increase the vehicle set speed in small amounts by 1.6 km/h (1 mph).
- Use the accelerator pedal to get to the desired speed. When the vehicle reaches that speed, press and release the SET ACC control.

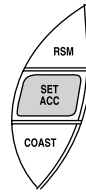

Reducing speed while using speed control

There are two ways to reduce a set speed:

- Press and hold the COAST control until you get to the desired speed, then release the control. You can also use the COAST control to operate the Tap-Down function. Press and release this control to decrease the vehicle set speed in small amounts by 1.6 km/h (1 mph).
- Depress the brake pedal until the desired vehicle speed is reached, press the SET ACC control.

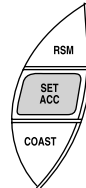
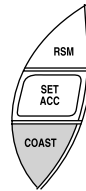

Turning off speed control

There are two ways to turn off the speed control:

- Depress the brake pedal or the clutch pedal (if equipped). This will not erase your vehicles previously set speed.

Driver Controls

- Press the speed control OFF control.

Note: When you turn off the speed control or the ignition, your speed control set speed memory is erased.



OVERDRIVE CONTROL (IF EQUIPPED)

Activating overdrive

D (Overdrive) is the normal drive position for the best fuel economy.

The overdrive function allows automatic upshifts and downshifts through all available gears.

Deactivating overdrive

Press the Transmission Control Switch (TCS) located on the end of the gearshift lever. The O/D Off indicator light will illuminate on the instrument cluster. The transmission will operate in all gears except overdrive.

To return to normal overdrive mode, press the Transmission Control Switch again. The O/D Off indicator light will no longer be illuminated.

When you shut off and re-start your vehicle, the transmission will automatically return to normal **D** (Overdrive) mode.

For additional information about the gearshift lever and the transmission control switch operation refer to the *Automatic Transmission Operation* section of the *Driving* chapter.

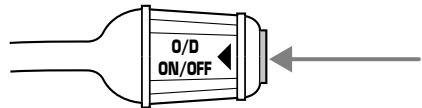
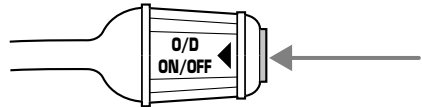

CENTER CONSOLE (IF EQUIPPED)

Your vehicle may be equipped with a variety of console features. These include:

- Utility compartment with cassette/compact disc storage
- Cupholders
- Coin holder slots
- Flip up armrest

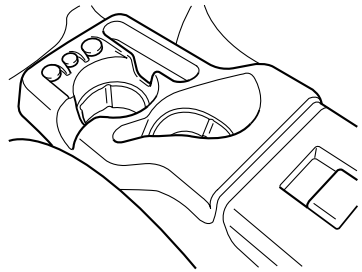

WARNING: Use only soft cups in the cupholder. Hard objects can injure you in a collision.

BED EXTENDER (IF EQUIPPED)

Your vehicle may be equipped with a bed extender designed to extend the pickup box for longer loads.

To extend the bed extender:

1. Lower tailgate.
2. Pull the round knobs on each side of the extender to release it from the pickup box.
3. Pivot extender on to the tailgate.
4. Evenly push down on the extender and push the round knobs in on each side locking it in place.

Green markings on the shaft indicate the locked position. The locking clip screws below the middle bar can be tightened counterclockwise for extra security.

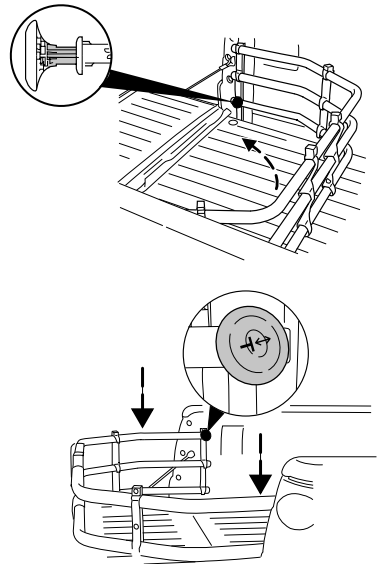

Driver Controls

Note: If the red marking on the shaft is visible, the bed extender is not locked or properly secured.

To stow the bed extender, follow steps one through four in reverse order.

The bed extender may be used to secure a load of up to 46 kg (100 lbs.) on the tailgate.

The bed extender should always be kept in the stowed position with the tailgate closed when not in use.

When driving the vehicle off road, the bed extender should be removed and the tailgate closed.

To remove the bed extender:

1. Extend the bed extender.
2. Pull the round knobs on each side of the extender to unlock it.

Make sure the locking clip screws are loose before removing the extender.

3. Press the locking clips below the middle bar on each side and lift the extender out of the bed.

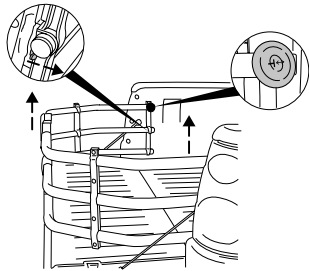

To install the bed extender, follow the removal procedure in reverse order.

KEYS

The key operates all locks on your vehicle. In case of loss, replacement keys are available from your dealer.

You should always carry a second key with you in a safe place in case you require it in an emergency.

Refer to *SecuriLock™ Passive Anti-Theft System* for more information.

POWER DOOR LOCKS (IF EQUIPPED)

Press the top of the control to unlock all doors and the bottom to lock all doors.

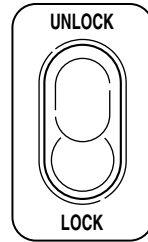

REMOTE ENTRY SYSTEM (IF EQUIPPED)

The remote entry system allows you to lock or unlock all vehicle doors without a key.

The remote entry features only operate with the ignition in the LOCK position.

If there is any potential remote keyless entry problem with your vehicle, ensure **ALL remote entry transmitters** are brought to the dealership, to aid in troubleshooting.

GENERAL INFORMATION: This device complies with part 15 of the FCC rules and with RS-210 of Industry Canada. Operation is subject to the following two conditions: (1) This device may not cause harmful interference, and (2) This device must accept any interference received, including interference that may cause undesired operation. Changes or modifications not expressly approved by the party responsible for compliance could void the user's authority to operate the equipment.

This device complies with part 15 of the FCC rules and with RS-210 of Industry Canada. Operation is subject to the following two conditions: (1) This device may not cause harmful interference, and (2) This device must accept any interference received, including interference that may cause undesired operation.

Locks and Security

Changes or modifications not expressly approved by the party responsible for compliance could void the user's authority to operate the equipment.

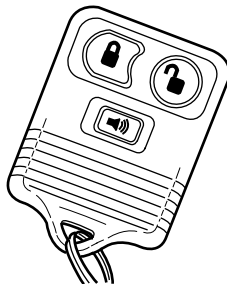

Your vehicle is equipped with a remote entry system which allows you to:

- unlock the vehicle doors without a key.
- lock all the vehicle doors without a key.
- activate the personal alarm.





If there is any potential remote keyless entry problem with your vehicle, ensure **ALL remote entry transmitters** are taken to the dealership, to aid in troubleshooting.

Unlocking the doors

1. Press  and release to unlock the driver's door. **Note:** The interior lamps will illuminate.
2. Press  and release again within three seconds to unlock all the doors.

Locking the doors

1. Press  and release to lock all the doors.
2. Press  and release again within three seconds to confirm that all the doors are closed and locked. **Note:** the doors will lock again, the horn will chirp once, and the lamps will flash.

If any of the doors are not properly closed the horn will make two quick chirps and the lamps will not flash.

Power door unlock disabled

The UNLOCK feature on your power door locks will not work from inside the vehicle when:

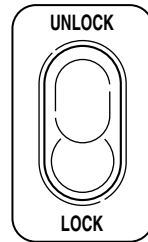

- the ignition has been turned to the OFF position, and
- 20 seconds elapse after all vehicle doors are closed and locked using the remote entry transmitter, or the power door unlock control (while the accompanying door is open).

The UNLOCK feature will work again after:

- a door has become ajar,
- the ignition is turned to the ON position, or
- using the UNLOCK  control on your remote entry transmitter, or
- using the keyless entry keypad to unlock the vehicle.

Sounding a personal alarm

Press  to activate the alarm. The horn will sound for a maximum of 30 seconds and the parklamps will flash for a maximum of 3 minutes. Press again or turn the ignition to ON to deactivate, or wait for the alarm to timeout in 3 minutes.

Note: The personal alarm will only operate when the ignition is in the OFF or ACC position.

Replacing the battery

The remote entry transmitter uses one coin type three-volt lithium battery CR2032 or equivalent. The typical operating range for your remote entry transmitter is approximately 10 meters (33 feet). A decrease in the operating range could be caused by:

- weather conditions,
- nearby radio towers,
- structures around the vehicle and
- other vehicles parked next to the vehicle.

Locks and Security

To replace the battery:

1. Twist a thin coin between the two halves of the remote entry transmitter near the key ring.
DO NOT TAKE THE FRONT PART OF THE REMOTE ENTRY TRANSMITTER APART. Damage to the transmitter may result in operation failure.

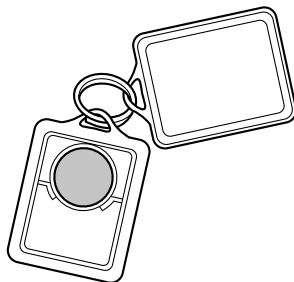

2. Remove the old battery.
3. Insert the new battery. Refer to the diagram inside the remote entry transmitter for the correct orientation of the battery.
4. Snap the two halves back together.

Note: Replacement of the battery will **not** cause the remote transmitter to become deprogrammed from your vehicle. The remote transmitter should operate normally after battery replacement.

Replacing lost remote entry transmitters

If you would like to have your remote entry transmitter reprogrammed because you lost one, or would like to buy additional remote entry transmitters, you can either reprogram them yourself, or take **all remote entry transmitters** to your authorized dealer for reprogramming.

How to reprogram your remote entry transmitters

You must have **all remote entry transmitters** (maximum of four) available before beginning this procedure.

To reprogram the remote entry transmitters:

1. Ensure the vehicle is electronically unlocked.
2. Put the key in the ignition.

- Turn the key from the 2 (LOCK) position to 3 (OFF).

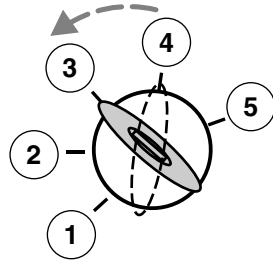

- Cycle, eight times, rapidly (within 10 seconds) between the 3 (OFF) position and 4 (ON). **Note:** The eighth turn must end in the 4 (ON) position. The instrument lights in the cluster will come on for a bulb check in the 4 (ON) position.
- The doors will lock, then unlock, to confirm that the programming mode has been activated.
- Within 20 seconds press any button on the remote entry transmitter. **Note:** If more than 20 seconds have passed you will need to start the procedure over again.
- The doors will lock, then unlock, to confirm that this remote entry transmitter has been programmed.
- Repeat Step 6 to program each additional remote entry transmitter.
- Turn the ignition to the 3 (OFF) position after you have finished programming all of the remote entry transmitters.
- The doors will lock, then unlock, to confirm that the programming mode has been exited.

Illuminated entry

The interior lamps illuminate when the remote entry system is used to unlock the door(s) or sound the personal alarm.

The illuminated entry system will turn off the interior lights if:

- the ignition switch is turned to the ON position, or
- the remote transmitter lock control is pressed, or
- after 25 seconds of illumination.

The dome lamp control (if equipped) must **not** be set to the OFF position for the illuminated entry system to operate.

Locks and Security

The inside lights will not turn off if:

- they have been turned on with the dimmer control, or
- any door is open.

The battery saver will shut off the interior lamps 45 minutes after the last door is closed, even if the dimmer control is on.

SECURILOCK™ PASSIVE ANTI-THEFT SYSTEM

SecuriLock™ passive anti-theft system is an engine immobilization system. This system is designed to prevent the engine from being started unless a **coded key programmed to your vehicle** is used.

The SecuriLock™ passive anti-theft system is not compatible with non-Mazda aftermarket remote start systems. Use of these systems may result in vehicle starting problems and a loss of security protection.

Your vehicle comes with two coded keys; additional coded keys may be purchased from your dealer. The dealer can program your spare keys to your vehicle or you can program the keys yourself. Refer to *Programming spare keys* for instructions on how to program the coded key.

Note: A maximum of eight keys can be coded to your vehicle.

Note: Large metallic objects, electronic devices that are used to purchase gasoline or similar items, or a second coded key on the same key chain may cause vehicle starting issues. You need to prevent these objects from touching the coded key while starting the engine. These objects will not cause damage to the coded key, but may cause a momentary issue if they are too close to the key when starting the engine. If a problem occurs, turn the ignition off, remove all objects on the key chain away from the coded key and restart the engine.

Theft indicator

The theft indicator is located in the instrument cluster.

- When the ignition is in the OFF position, the indicator will flash once every 2 seconds to indicate the SecuriLock™ system is functioning as a theft deterrent.
- When the ignition is in the ON position, the indicator will glow for 3 seconds, then turn off, to indicate normal system functionality.

If a problem occurs with the SecuriLock™ system, the indicator will flash rapidly or glow steadily when the ignition is in the ON position. If this occurs, the vehicle should be taken to an authorized dealer for service.

Automatic arming

The vehicle is armed immediately after switching the ignition to the 3 (OFF) position.

The **THEFT** indicator will flash every two seconds when the vehicle is armed.

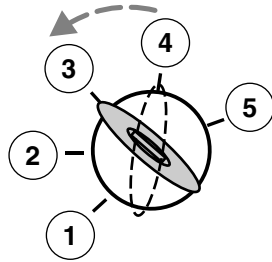

Automatic disarming

Switching the ignition to the 4 (ON) position with a **coded key** disarms the vehicle.

- The **THEFT** indicator will illuminate for three seconds and then go out.
- If the **THEFT** indicator stays on for an extended period of time or flashes rapidly, have the system serviced by your dealer.

Replacement keys

If your keys are lost or stolen and you don't have an extra coded key, you will need to have your vehicle towed to a dealership. The key codes need to be erased from your vehicle and new coded keys will need to be programmed.

Replacing coded keys can be very costly. Store an extra programmed key away from the vehicle in a safe place to help prevent any inconveniences. Please visit an authorized dealer to purchase additional spare or replacement keys.

Programming spare keys

You can program your own coded keys to your vehicle. Please read and understand the entire procedure before you begin.

Tips:

- A maximum of eight keys can be coded to your vehicle.
- Only use Securilock[™] keys.
- You must have two previously programmed coded keys (keys that already operate your vehicle's engine) and the new unprogrammed key(s) readily accessible.

Locks and Security

- If you do not have at least 2 previously programmed keys, you must take your vehicle to your dealer to have the spare key(s) programmed.

1. Insert a previously programmed coded key into the ignition.

2. Turn the ignition from the 3 (OFF) position to the 4 (ON) position. Keep the ignition in the 4 (ON) position for at least one second, but no more than 10 seconds.

3. Turn the ignition to the 3 (OFF) position, and remove the coded key from the ignition.

4. Within ten seconds of removing the previously programmed coded key, insert the other previously programmed coded key into the ignition.

5. Turn the ignition from the 3 (OFF) position to the 4 (ON) position. Keep the ignition in the 4 (ON) position for at least one second but not more than 10 seconds.

6. Turn the ignition to the 3 (OFF) position, and remove the second key from the ignition.

7. Within twenty seconds of removing the previously programmed coded key, insert the unprogrammed key (new/valet key) into the ignition.

8. Turn the ignition from the 3 (OFF) position to the 4 (ON) position. Keep the ignition in the 4 (ON) position for at least one second.

9. Your new unprogrammed key is now programmed.

If the key has been successfully programmed it will start the vehicle's engine and the theft indicator light will illuminate for three seconds and then go out. If the key was not successfully programmed, it will not start your vehicle's engine and the theft indicator light will flash on and off. If failure repeats, bring your vehicle to your dealer to have the new key(s) programmed.

To program additional new unprogrammed key(s), repeat this procedure from step 1 for each additional key.

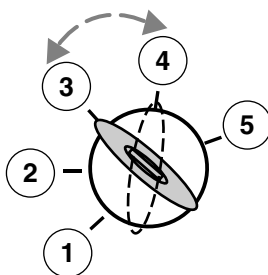

Seating and Safety Restraints

SEATING

Adjusting the front manual seat

WARNING: Never adjust the driver's seat or seatback when the vehicle is moving. Sudden braking or a collision could cause serious injury. Adjust the seat only when the vehicle is stopped.

WARNING: Do not pile cargo higher than the seatbacks to reduce the risk of injuring people in a collision or sudden stop.

WARNING: Always drive and ride with your seatback upright and the lap belt snug and low across the hips.

WARNING: Sitting in a reclined position while the vehicle is moving is dangerous because you don't get the full protection from seat belts. During sudden braking or a collision, you can slide under the lap belt and suffer serious internal injury, or in a rear end collision you could fly up and out of the vehicle. For maximum protection, sit well back and upright.

Lift handle to move seat forward or backward.

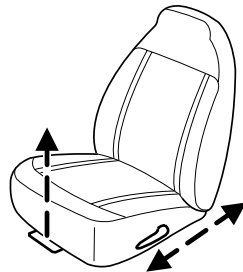

Seating and Safety Restraints

Pull lever up to adjust seatback.

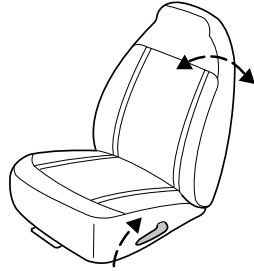

Using the manual lumbar support (if equipped)

Turn the lumbar support control clockwise to increase firmness.

Turn the lumbar support control counterclockwise to increase softness.

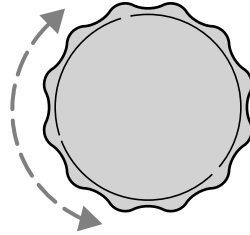

Passenger side rear access (if equipped)

Pull up on the recliner handle. The seat will lean forward and unlock the track. Slide the seat forward to access the rear area of the cab.

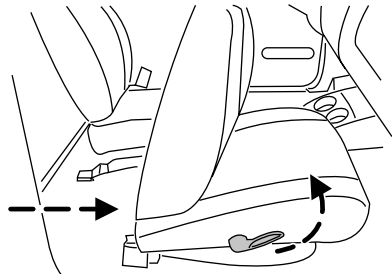

To return seat to original position, slide the seat bottom back, then push the seatback up to lock it in place. If the seatback is pushed first, the seat will lock, and you will have to use the seat adjust handle to move the seat back to the original position.

Seating and Safety Restraints

REAR SEATS

Center facing jump seat (2-door Cab Plus) (if equipped)

To open, pull inboard and down on the seat handle.

To stow the seat, pull seat bottom back to the fully upright position.

WARNING: Do not install a child seat in a center facing jump seat.

Center facing jump seat (4 door CabPlus 4) (if equipped)

To open, pull seat assembly down, then raise seatback.

To stow the seat, fold seat back down and raise seat assembly to the fully upright position.

WARNING: Do not install a child seat in a center facing jump seat.

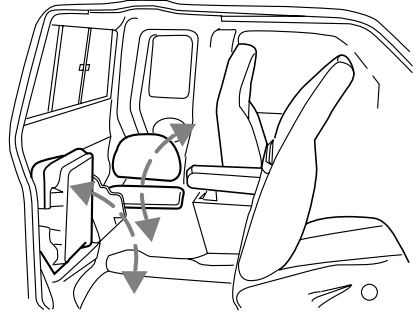

SAFETY RESTRAINTS

Safety restraints precautions

WARNING: Always drive and ride with your seatback upright and the lap belt snug and low across the hips.

WARNING: To reduce the risk of injury, make sure children sit where they can be properly restrained.

WARNING: Never let a passenger hold a child on his or her lap while the vehicle is moving. The passenger cannot protect the child from injury in a collision.

WARNING: All occupants of the vehicle, including the driver, should always properly wear their safety belts, even when an air bag (SRS) is provided.

Seating and Safety Restraints

WARNING: It is extremely dangerous to ride in a cargo area, inside or outside of a vehicle. In a collision, people riding in these areas are more likely to be seriously injured or killed. Do not allow people to ride in any area of your vehicle that is not equipped with seats and safety belts. Be sure everyone in your vehicle is in a seat and using a safety belt properly.

WARNING: In a rollover crash, an unbelted person is significantly more likely to die than a person wearing a safety belt.

WARNING: Each seating position in your vehicle has a specific safety belt assembly which is made up of one buckle and one tongue that are designed to be used as a pair. 1) Use the shoulder belt on the outside shoulder only. Never wear the shoulder belt under the arm. 2) Never swing the safety belt around your neck over the inside shoulder. 3) Never use a single belt for more than one person.

WARNING: On four-door Cab Plus 4 vehicles, do not open the rear door when the rear seat belt is still buckled.

Combination lap and shoulder belts

1. Insert the belt tongue into the proper buckle (the buckle closest to the direction the tongue is coming from) until you hear a snap and feel it latch. Make sure the tongue is securely fastened in the buckle.

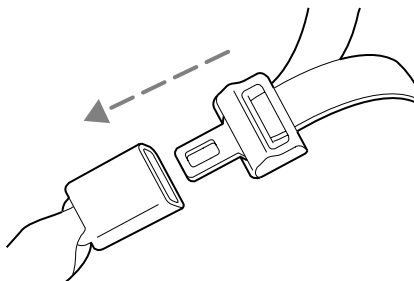

Seating and Safety Restraints

2. To unfasten, push the release button and remove the tongue from the buckle.

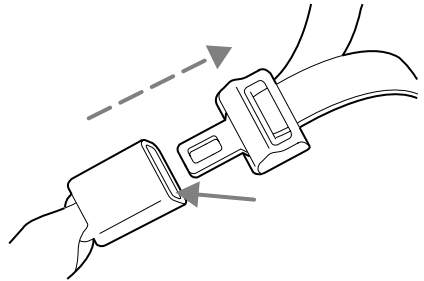

The front outboard safety restraints in the vehicle are combination lap and shoulder belts. The front passenger outboard safety belt has two types of locking modes described below:

Energy Management Feature

- This vehicle has a safety belt system with an energy management feature at the front outboard seating positions to help further reduce the risk of injury in the event of a head-on collision.
- This safety belt system has a retractor assembly that is designed to pay out webbing in a controlled manner. This feature is designed to help reduce the belt force acting on the occupant's chest.

Vehicle sensitive mode

This is the normal retractor mode, which allows free shoulder belt length adjustment to your movements and locking in response to vehicle movement. For example, if the driver brakes suddenly or turns a corner sharply, or the vehicle receives an impact of approximately 8 km/h (5 mph) or more, the combination safety belts will lock to help reduce forward movement of the driver and passengers.

Automatic locking mode (outboard front passenger seating position only) for use with child safety seats

In this mode, the shoulder belt is automatically pre-locked. The belt will still retract to remove any slack in the shoulder belt.

The automatic locking mode is not available on the driver safety belt.

When to use the automatic locking mode

- **Any time** a child safety seat is installed in a passenger front seat. Refer to *Safety Restraints for Children, Safety Seats for Children, or Passenger air bag On/Off switch* later in this chapter.

Seating and Safety Restraints

How to use the automatic locking mode (Outboard front passenger seating position only) for use with child safety seats

- Buckle the combination lap and shoulder belt.

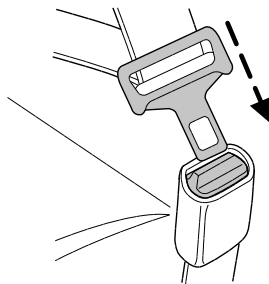

- Grasp the shoulder portion and pull downward until the entire belt is pulled out.



- Allow the belt to retract. As the belt retracts, you will hear a clicking sound. This indicates the safety belt is now in the automatic locking mode.

How to disengage the automatic locking mode

Disconnect the combination lap/shoulder belt and allow it to retract completely to disengage the automatic locking mode and activate the vehicle sensitive (emergency) locking mode.

WARNING: After any vehicle collision, the entire seat belt system should be checked for proper operation by a qualified technician. Verify that the "automatic locking retractors" in all outboard seating positions are functioning properly. Additionally check that the "automatic locking mode" feature for child safety seat in the passenger outboard seating position is functioning properly.

Seating and Safety Restraints

WARNING: BELT AND RETRACTOR ASSEMBLY MUST BE REPLACED if the seat belt assembly “automatic locking retractor” feature or any other seat belt function is not operating properly when checked according to the procedures in Workshop Manual.

WARNING: Failure to replace the Belt and Retractor assembly could increase the risk of injury in collisions.

Safety belt pretensioner

Your vehicle is equipped with safety belt pretensioners at the driver and front outboard passenger seating positions. Both pretensioners will fire if the front airbags fire, whether or not there is a belted occupant in either front outboard seat.

The safety belt pretensioners are designed to activate during certain frontal or near-frontal collisions with sufficient longitudinal deceleration. A safety belt pretensioner is a device which tightens the webbing of the lap and shoulder belts in such a way that they fit more snugly against the body.

The driver and front outboard passenger safety belt system (including retractors, buckle assembly, pretensioner assembly with seat and height adjusters) must be replaced if the vehicle is involved in a collision that results in the activation of the safety belt pretensioners. Refer to the *Safety belt maintenance* section in this chapter.

WARNING: Failure to replace the safety belt assembly under the above conditions could result in severe personal injuries in the event of a collision.

Front safety belt height adjustment

Your vehicle has safety belt height adjustments for the driver and front passenger. Adjust the height of the shoulder belt so the belt rests across the middle of your shoulder.

Seating and Safety Restraints

- Regular Cab and 4-door Cab Plus

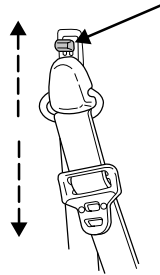

- 2-door Cab Plus

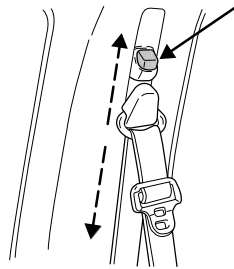

To lower the shoulder belt height, push the button and slide the height adjuster down. To raise the height of the shoulder belt, slide the height adjuster up. Pull down on the height adjuster to make sure it is locked in place.

WARNING: Position the safety belt height adjusters so that the belt rests across the middle of your shoulder. Failure to adjust the safety belt properly could reduce the effectiveness of the seat belt and increase the risk of injury in a collision.

Lap belts

Adjusting the center lap belt

The lap belt does not adjust automatically.

WARNING: The lap belts should fit snugly and as low as possible around the hips, not around the waist. Failure to position the lap belt correctly may cause serious injury in an accident.

Seating and Safety Restraints

Insert the tongue into the correct buckle (the buckle closest to the direction the tongue is coming from). To lengthen the belt, turn the tongue at a right angle to the belt and pull across your lap until it reaches the buckle.

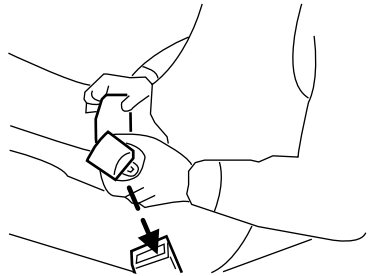

To tighten the belt, pull the loose end of the belt through the tongue until it fits snugly across the hips.

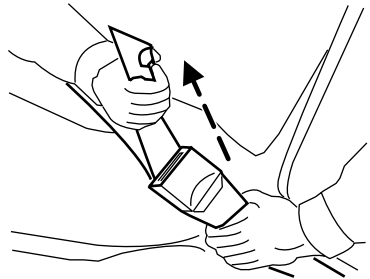

Shorten and fasten the belt when not in use to keep the belt away from door openings and available after unfolding the seats.

Adjusting the rear center facing jump seat lap belt (if equipped)

The center facing rear jump seat lap belt will adjust automatically. To fasten, grasp the tongue, and with a continuous motion, pull out enough webbing to buckle the tongue into the correct buckle. If you did not pull out enough webbing to reach the buckle, allow the tongue to retract fully before trying to pull it out again.

WARNING: The lap belts should fit snugly and as low as possible around the hips, not around the waist. Failure to position the lap belt correctly may cause serious injury in an accident.

If you need to lengthen the belt, unfasten it and repeat the procedure above.

To unfasten the belt, push in the release button prior to opening the rear door.

Seating and Safety Restraints

Safety belt extension assembly

If the safety belt assembly is too short for you, even when fully extended, 20 cm (8 inches) can be added to the safety belt assembly by adding a safety belt extension assembly. Safety belt extension assemblies can be obtained from your authorized Mazda dealership.

Use only extensions manufactured by the same supplier as the safety belt. Manufacturer identification is located at the end of the webbing on the label. Also, use the safety belt extension only if the safety belt is too short for you when fully extended.

NOTE: Do not use extensions to change the fit of the shoulder belt across the torso.

Safety belt warning light and indicator chime

The safety belt warning light illuminates in the instrument cluster and a chime sounds to remind the occupants to fasten their safety belts.

Conditions of operation

If...	Then...
The driver's safety belt is not buckled before the ignition switch is turned to the ON position...	The safety belt warning light illuminates 1-2 minutes and the warning chime sounds 4-8 seconds.
The driver's safety belt is buckled while the indicator light is illuminated and the warning chime is sounding...	The safety belt warning light and warning chime turn off.
The driver's safety belt is buckled before the ignition switch is turned to the ON position...	The safety belt warning light and indicator chime remain off.

BeltMinder

The BeltMinder feature is a supplemental warning to the safety belt warning function. This feature provides additional reminders to the driver that the driver's safety belt is unbuckled by intermittently sounding a chime and illuminating the safety belt warning lamp in the instrument cluster.

Seating and Safety Restraints

If...	Then...
The driver's safety belt is not buckled before the vehicle has reached at least 5 km/h (3 mph) and 1-2 minutes have elapsed since the ignition switch has been turned to ON...	The BeltMinder feature is activated - the safety belt warning light illuminates and the warning chime sounds for 6 seconds every 30 seconds, repeating for approximately 5 minutes or until driver's safety belt is buckled.
The driver's safety belt is buckled while the safety belt indicator light is illuminated and the safety belt warning chime is sounding...	The BeltMinder feature will not activate.
The driver's safety belt is buckled before the ignition switch is turned to the ON position...	The BeltMinder feature will not activate.

The following are reasons most often given for not wearing safety belts:
(All statistics based on U.S. data)

Reasons given...	Consider...
"Crashes are rare events"	36,700 crashes occur every day. The more we drive, the more we are exposed to "rare" events, even for good drivers. <i>1 in 4 of us will be seriously injured in a crash during our lifetime.</i>
"I'm not going far"	3 of 4 fatal crashes occur within 25 miles of home.
"Belts are uncomfortable"	Safety belts are designed to enhance comfort. If you are uncomfortable - try different positions for the safety belt upper anchorage and seatback which should be as upright as possible; this can improve comfort.

Seating and Safety Restraints

Reasons given...	Consider...
"I was in a hurry"	Prime time for an accident. Safety Belt Warning Chime reminds us to take a few seconds to buckle up.
"Seat belts don't work"	Safety belts , when used properly, reduce risk of death to front seat occupants by 45% in cars , and by 60% in light trucks .
"Traffic is light"	Nearly 1 of 2 deaths occur in single-vehicle crashes , many when no other vehicles are around.
"Belts wrinkle my clothes"	Possibly, but a serious crash can do much more than wrinkle your clothes, particularly if you are unbelted.
"The people I'm with don't wear belts"	Set the example, teen deaths occur 4 times more often in vehicles with TWO or MORE people. Children and younger brothers/sisters imitate behavior they see.
"I have an air bag"	Air bags offer greater protection when used with safety belts. Frontal airbags are not designed to inflate in rear and side crashes or rollovers.
"I'd rather be thrown clear"	Not a good idea. People who are ejected are 40 times more likely to DIE . Safety belts help prevent ejection, WE CAN'T "PICK OUR CRASH".

WARNING: Always wear the safety belt. Do not be tempted to sit on top of the belt to fool police or to defeat the warning system. The safety belt and safety belt warning system are there to protect your life.

Seating and Safety Restraints

One time disable

Any time the safety belt is buckled and then unbuckled during an ignition ON cycle, the BeltMinder will be disabled for that ignition cycle only.

Deactivating/activating the BeltMinder feature

Read steps 1 - 9 thoroughly before proceeding with the deactivation/activation programming procedure.

The BeltMinder feature can be deactivated/activated by performing the following procedure:

Before following the procedure, ensure that the following conditions are met:

- The parking brake is set.
- The gearshift is in P (Park) (automatic transmission) or the neutral position (manual transmission).
- The ignition switch is in the OFF position.
- All vehicle doors are closed.
- The driver's safety belt is unbuckled.
- The parklamps/headlamps are in OFF position (If vehicle is equipped with Autolamps, this will not affect the procedure).

WARNING: To reduce the risk of injury, do not deactivate/activate the Belt Minder feature while driving the vehicle.

BeltMinder activation and deactivation procedure

1. Turn the ignition switch to the RUN (or ON) position. (DO NOT START THE ENGINE.)
2. Wait until the safety belt warning light turns off. (Approximately 1–2 minutes.)
- Steps 3–5 must be completed within 60 seconds or the procedure will have to be repeated.
3. Buckle then unbuckle the safety belt three times, ending with the safety belt unbuckled. This can be done before or during BeltMinder warning activation.
4. Turn on the parklamps/headlamps, turn off the parklamps/headlamps.

Seating and Safety Restraints

5. Buckle then unbuckle the safety belt three times, ending with the safety belt unbuckled.
- After step 5 the safety belt warning light will be turned on for three seconds.
6. Within seven seconds of the safety belt warning light turning off, buckle then unbuckle the safety belt.
- This will disable BeltMinder if it is currently enabled, or enable BeltMinder if it is currently disabled.
7. Confirmation of disabling BeltMinder is provided by the safety belt warning light flashing four times per second for three seconds.
8. Confirmation of enabling BeltMinder is provided by:
 - The safety belt warning light flashing four times per second for three seconds.
 - Followed by three seconds with the safety belt warning light off.
 - Once again, the safety belt warning light will flash four times per second for three seconds.
9. After receiving confirmation, the deactivation/activation procedure is complete.

Safety belt maintenance

Inspect the safety belt systems periodically to make sure they work properly and are not damaged.

NOTE: If unsure about the proper procedures, bring your vehicle to an authorized Mazda dealership for inspection. Inspect the safety belts to make sure there are no nicks, tears or cuts, replacing if necessary. Check all automatic locking retractors on all outboard seating positions as well as the automatic locking mode for child safety seats on the passenger front belt. All safety belt assemblies, including retractors, buckles, front seat belt buckle assemblies, buckle support assemblies (slide bar-if equipped), shoulder belt height adjusters (if equipped), shoulder belt guide on seatback (if equipped), child safety seat tether bracket assemblies (if equipped), LATCH child seat tether anchors and lower anchors (if equipped), and attaching hardware, should be inspected after a collision. Mazda recommends that all safety belt assemblies used in vehicles involved in a collision be replaced. However, if the collision was minor and an authorized Mazda technician finds that the belts do not show damage and continue to operate properly, they do not need to be replaced. Safety belt assemblies not in use during a collision should also be inspected and replaced if either damage or improper operation is noted.

Seating and Safety Restraints

The energy absorbing functions may have been activated in a collision so the restraints should be examined; if the front air bags have deployed, the pretensioners have also deployed and must be replaced — regardless of whether there was an occupant in the passenger seat or not.

WARNING: Failure to inspect and if necessary replace the safety belt assembly under the above conditions could result in severe personal injuries in the event of a collision.

Refer to *Interior* in the *Cleaning* chapter.

AIR BAG SUPPLEMENTAL RESTRAINT SYSTEM (SRS)

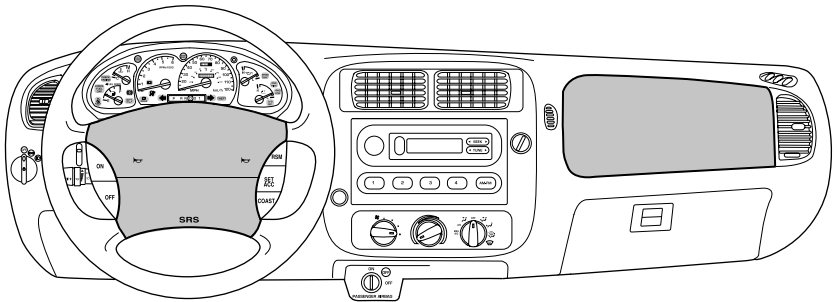

Important supplemental restraint system (SRS) precautions

The supplemental restraint system is designed to work with the safety belt to help protect the driver and right front passenger from certain upper body injuries.

WARNING: Air bags DO NOT inflate slowly or gently and the risk of injury from a deploying air bag is greatest close to the trim covering the air bag module. Always wear your safety belt.

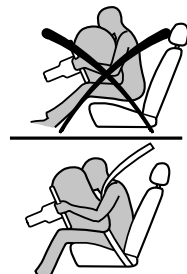

Seating and Safety Restraints

WARNING: Airbags have been known to kill or injure a child in front facing child restraints. When placing a child safety seat in a front seating position including the center (if equipped), you should turn off the passenger airbag switch after being certain the child is properly restrained. If the child safety seat is in the outboard seating position, slide the seat all the way back.

WARNING: Do not install a child seat in a center facing jump seat.

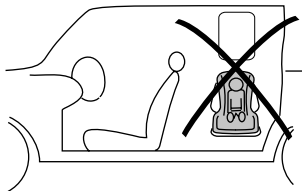

WARNING: Rear facing child seats should NEVER be placed in the front seats unless the passenger airbag switch is turned off. See *Passenger airbag ON/OFF switch* in this chapter.



WARNING: All occupants of the vehicle, including the driver, should always properly wear their safety belts, even when an air bag (SRS) is provided.

WARNING: National Highway Traffic Safety Administration (NHTSA) recommends a minimum distance of at least 25 cm (10 inches) between an occupant's chest and the driver air bag module.

WARNING: Never place your arm or feet over the air bag module as a deploying air bag can result in serious arm fractures or other injuries.

Seating and Safety Restraints

WARNING: Never place a rear facing infant seat in the front seat unless the passenger air bag is turned off.

Steps you can take to properly position yourself away from the airbag:

- Move your seat to the rear as far as you can while still reaching the pedals comfortably.
- Recline the seat slightly (one or two degrees) from the upright position.

WARNING: Do not put anything on or over the air bag module including hands or feet. Placing objects on or over the air bag inflation area may cause those objects to be propelled by the air bag into your face and torso causing serious injury.

WARNING: Do not attempt to service, repair, or modify the Air Bag Supplemental Restraint System or its fuses. See your authorized Mazda dealership.

WARNING: Modifications to the front end of the vehicle, including frame, bumper, front end body structure, tow hooks and snow plows may effect the performance of the air bag sensors increasing the risk of injury. Do not modify the front end of the vehicle.

WARNING: Additional equipment may effect the performance of the air bag sensors increasing the risk of injury. Consult your authorized Mazda dealership before installation of additional equipment.

WARNING: The front passenger air bag is not designed to offer protection to an occupant in the center front seating position.

Seating and Safety Restraints

Children and air bags

For additional important safety information, read all information on safety restraints in this guide.

WARNING: Never place a rearward facing child safety restraint in front of an airbag. Airbags have been known to kill or injure children in front facing child safety restraints. Whenever placing a child safety seat in a front seating position (including center if equipped), turn off the passenger side air bag switch after being certain the child is properly restrained. If using a forward facing child safety restraint in the front outboard seat, slide the seat all the way back, and turn off the passenger air bag. If using a rear facing child safety seat in the front outboard seating position, make sure the passenger air bag is turned off and slide the passenger seat all the way forward until the safety seat rests on the dashboard. See *Passenger air bag on/off switch* in this chapter.



WARNING: Do not install a child seat in a center facing jump seat.

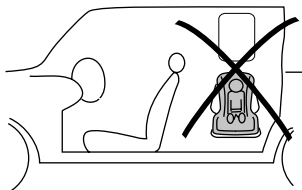

Seating and Safety Restraints

WARNING: An air bag can kill or injure a child in a child seat. Child seats should never be placed in the front seats, unless passenger air bag switch is turned off. See *Passenger air bag on/off switch* in this chapter.

WARNING: Rear facing child seats should NEVER be placed in the front seats unless the passenger airbag switch is turned off.

WARNING: Booster seats must be installed only in seating positions equipped with a combination lap/shoulder belt.

WARNING: To reduce the risk of injury, make sure children sit where they can be properly restrained.

How does the air bag supplemental restraint system work?

The air bag SRS is designed to activate when the vehicle sustains sufficient longitudinal deceleration.

The fact that the air bags did not inflate in a collision does not mean that something is wrong with the system. Rather, it means the forces were not of the type sufficient to cause activation. Air bags are designed to inflate in frontal and near-frontal collisions, not rollover, side-impact, or rear-impacts.

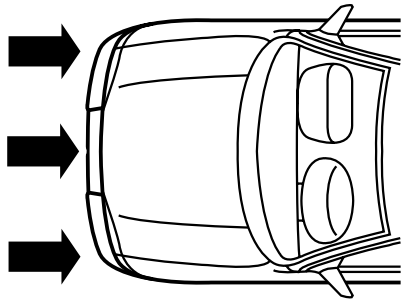

Seating and Safety Restraints

The air bags inflate and deflate rapidly upon activation. After air bag deployment, it is normal to notice a smoke-like, powdery residue or smell the burnt propellant. This may consist of cornstarch, talcum powder (to lubricate the bag) or sodium compounds (e.g., baking soda) that result from the combustion process that inflates the air bag. Small amounts of sodium hydroxide may be present which may irritate the skin and eyes, but none of the residue is toxic.



While the system is designed to help reduce serious injuries, it may also cause minor abrasions, swelling or temporary hearing loss. Because air bags must inflate rapidly and with considerable force, there is the risk of death or serious injuries such as fractures, facial and eye injuries or internal injuries, particularly to occupants who are not properly restrained or are otherwise out of position at the time of air bag deployment. Thus, it is extremely important that occupants be properly restrained as far away from the air bag module as possible while maintaining vehicle control.

WARNING: Several air bag system components get hot after inflation. Do not touch them after inflation or you may be burned.

WARNING: If the air bag has deployed, the air bag will not function again and must be replaced immediately. If the air bag is not replaced, the unrepaired area will increase the risk of injury in a collision.

The SRS consists of:

- driver and passenger air bag modules (which include the inflators and air bags),
- passenger air bag deactivation switch and restraint control module (RCM)
- a readiness light and tone,

Seating and Safety Restraints

- and the electrical wiring which connects the components.

The RCM (restraints control module) monitors its own internal circuits and the supplemental air bag electrical system warning (including the passenger air bag deactivation switch, the system wiring, the air bag system readiness light, the air bag back up power and the air bag ignitors).

Determining if the system is operational

The SRS uses readiness lights in the instrument cluster and the passenger air bag deactivate switch or a tone to indicate the condition of the system. Refer to the *Air bag readiness* section in the *Instrumentation* chapter or *Passenger air bag deactivate switch* section in this chapter. Routine maintenance of the air bag is not required.

A difficulty with the system is indicated by one or more of the following:

- The readiness lights will either flash or stay lit.
- The readiness lights will not illuminate immediately after ignition is turned on.
- A series of five beeps will be heard. The tone pattern will repeat periodically until the problem and/or light are repaired.



If any of these things happen, even intermittently, have the SRS serviced at your authorized Mazda dealership immediately.

WARNING: Unless serviced, the system may not function properly in the event of a collision.

Disposal of air bags and air bag equipped vehicles (including safety belt pretensioners)

For disposal of safety belt pretensioners, air bags, or air bag equipped vehicles, see your authorized Mazda dealership or qualified technician. Air bags **MUST BE** disposed of by qualified personnel.

Seating and Safety Restraints

Passenger air bag ON/OFF switch

WARNING: An air bag ON/OFF switch has been installed in this vehicle. Before driving, *always* look at the face of the switch to be sure the switch is in the proper position in accordance with these instructions and warnings. Failure to put the switch in a proper position can increase the risk of serious injury or death in a collision.

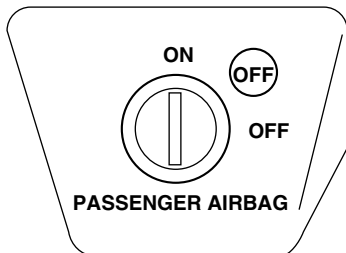

Turning the passenger air bag off

1. Ignition OFF.
2. Insert the ignition key, turn the switch to OFF position and hold in OFF position while removing the key.
3. When the ignition switch is turned to the ON position the OFF light illuminates briefly, momentarily shuts off and then turns back on. This indicates that the passenger air bag is deactivated. Do not use a second key to turn off the passenger airbag, as the lock position might be changed without your knowing.

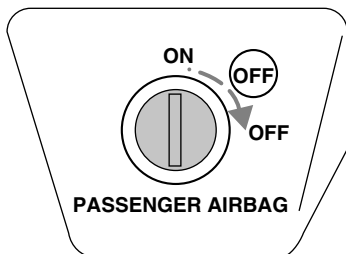

Seating and Safety Restraints

WARNING: You must turn the passenger air bag Off if you have a rear facing child seat in the front seat of the pickup (the center lapbelt on front split seats or the center facing rear seats do not accommodate child seats). Statistics show that children under 12 are more likely to suffer minor injuries in the front passenger seats than adults. If you must have a child in the front passenger seat, place the largest child in the front seat, make sure that the child is belted, the vehicle seat is all the way back, and the passenger airbag is turned OFF. The front seat center lap belt and the center facing rear seats do not accommodate child seats; therefore, you may not be able to put a larger child in the front passenger seat if a child seat is involved.

WARNING: If the OFF light fails to illuminate when the passenger air bag switch is in the OFF position and the ignition switch is in ON, have the passenger air bag switch serviced at you authorized Mazda dealership.

WARNING: In order to avoid inadvertent activation of the switch, always remove the ignition key from the passenger air bag ON/OFF switch.

Turning the passenger air bag back on

The passenger air bag remains OFF until you turn it back ON.

1. Insert the ignition key and turn the switch to ON.
2. The OFF light will briefly illuminate when the ignition is turned to ON. This indicates that the passenger air bag is operational.

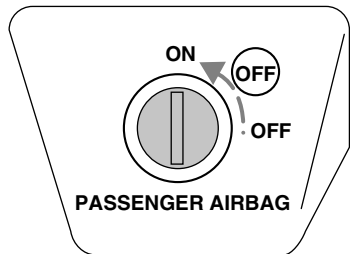

Seating and Safety Restraints

WARNING: If the light is illuminated when the passenger air bag ON/OFF switch is in the ON position and the ignition switch is ON, have the passenger air bag ON/OFF switch serviced at your authorized Mazda dealership immediately.

The passenger side air bag should always be ON (the air bag OFF light should *not* be illuminated) except for certain vulnerable persons. See guidance on following pages.

WARNING: The safety belts for the driver and right front passenger seating positions have been specifically designed to function together with the air bags in certain types of crashes. When you turn OFF your air bag, you not only lose the protection of the air bag, you also may reduce the effectiveness of your safety belt system, which was designed to work with the air bag. Most vehicles with full back seats do not have cut-off switches, but NHTSA and Transport Canada will allow a cut-off switch to be installed on request for a certain category of persons who must ride up front and there is a concern about riding there. Please see the guidance below.

WARNING: Always use safety belts and child restraints properly. If a child in a rear facing infant seat must be transported in front, the passenger air bag *must* be turned OFF. This is because the back of the infant seat is too close to the inflating air bag and the risk of a fatal injury to the infant when the air bag inflates is substantial.

The vast majority of drivers and passengers over the age of 12 years are much safer with an air bag than without. To do their job and reduce the risk of life threatening injuries, air bags must open with great force, and this force can pose a potentially deadly risk in some situations, particularly when a front seat occupant is not properly buckled up. The most effective way to reduce the risk of unnecessary air bag injuries without reducing the overall safety of the vehicle is to make sure all occupants are properly restrained in the vehicle, especially in the front seat. This provides the protection of safety belts and permits the air bags to provide the additional protection they were designed to provide. If you choose to deactivate your air bag, you are losing the very significant risk reducing benefits of the air bag and you are also reducing the

Seating and Safety Restraints

effectiveness of the safety belts, because safety belts in modern vehicles are designed to work as a safety system with the air bags.

Read all air bag Warning labels in the vehicle as well as the other important air bag instructions and Warnings in this Owner's Guide.

NHTSA gives permission to install airbag cut-off switches in the following terms:

1. **Infant.** An infant (less than 1 year old) must ride in the front seat because:
 - the vehicle has no rear seat;
 - the vehicle has a rear seat too small to accommodate a rear-facing infant seat; or
 - the infant has a medical condition which, according to the infant's physician, makes it necessary for the infant to ride in the front so that the driver can constantly monitor the child's condition.
2. **Child age 1 to 12.** A child age 1 to 12 must ride in the front seat because:
 - the vehicle has no rear seat;
 - although children ages 1 to 12 ride in the rear seat(s) whenever possible, children ages 1 to 12 sometimes must ride in the front because no space is available in the rear seat(s) of the vehicle; or
 - the child has a medical condition which, according to the child's physician, makes it necessary for the child to ride in the front seat so that the driver can constantly monitor the child's condition.
3. **Medical condition.** A passenger has a medical condition which, according to his or her physician:
 - causes the passenger air bag to pose a special risk for the passenger; and
 - makes the potential harm from the passenger air bag in a crash greater than the potential harm from turning OFF the air bag and allowing the passenger, even if belted, to hit the dashboard or windshield in a crash.

Seating and Safety Restraints

WARNING: This vehicle has special energy management safety belts for the driver and right front passenger. These particular belts are specifically designed to work with air bags to help reduce the risk of injury in a collision. The energy management safety belt is designed to give or release additional belt webbing in some accidents to reduce concentration of force on an occupant's chest and reduce the risk of certain bone fractures and injuries to underlying organs. In a crash, if the air bag is turned OFF, this energy management safety belt might permit the person wearing the belt to move forward enough to incur a serious or fatal injury. The more severe the crash, and the heavier the occupant, the greater the risk is. Be sure the air bag is turned ON for any person who does not qualify under the NHTSA deactivation criteria.

Transport Canada gives permission to install aribag cut-off switches in the following terms:

1. **Infant:** An infant (less than 1 year old) must ride in the front seat because:
 - my vehicle has no rear seat;
 - the rear seat in my vehicle cannot accommodate a rear-facing infant seat; or
 - the infant has a medical condition which, according to the infant's physician, makes it necessary for the infant to ride in the front seat so that the driver can monitor the infant's condition.
2. **Child age 12 or under:** A child age 12 or under must ride in the front seat because:
 - my vehicle has no rear seat;
 - although children age 12 and under ride in the rear seat whenever possible, children age 12 and under have no option but to sometimes ride in the front seat because rear seat space is insufficient; or
 - the child has a medical condition that, according to the child's physician, makes it necessary for the child to ride in the front seat so that the driver can monitor the child's condition.
3. **Medical condition:** A passenger has a medical condition that, according to his or her physician:
 - poses a special risk for the passenger if the air bag deploys; and
 - makes the potential harm from the passenger air bag deployment greater than the potential harm from turning OFF the air bag and experiencing a crash without the protection offered by the air bag

Seating and Safety Restraints

WARNING: This vehicle has special energy management safety belts for the driver and/or right front passenger. These particular belts are specifically designed to work with air bags to help reduce the risk of injury in a collision. The energy management safety belt is designed to give or release additional belt webbing in some accidents to reduce concentration of force on an occupant's chest and reduce the risk of certain bone fractures and injuries to underlying organs. In a crash, if the air bag is turned OFF, this energy management safety belt might permit the person wearing the belt to move forward enough to incur a serious or fatal injury. The more severe the crash, and the heavier the occupant, the greater the risk is. Be sure the air bag is turned ON for any person who does not qualify under the Transport Canada deactivation criteria.

SAFETY RESTRAINTS FOR CHILDREN

See the following sections for directions on how to properly use safety restraints for children. Also see *Air bag supplemental restraint system (SRS)* in this chapter for special instructions about using air bags.

Important child restraint precautions

NOTE: You are required by law to use a child-restraint system in the U.S. and Canada. Check your local and state or provincial laws for specific requirements regarding the safety of children in your vehicle.

WARNING: Never let a passenger hold a child on his or her lap while the vehicle is moving. The passenger cannot protect the child from injury in a collision.

NOTE: Always follow the instructions and warnings that come with any infant or child restraint you might use.

WARNING: Air bags can kill or injure a child in a child seat. Never place a rear facing child seat in front of an active air bag. If you must use a forward facing child seat in the front seat, position the vehicle seat fully rearward and turn the passenger air bag off.

Seating and Safety Restraints

WARNING: An air bag can kill or injure a child in a child seat. Child seats should never be placed in the front seats, unless passenger air bag switch is turned off, See *Passenger air bag on/off switch*.

WARNING: Rear facing child seats should NEVER be placed in the front seats unless the passenger airbag switch is turned off. Also, slide the front seat forward until the rear facing child seat contacts the dash board for maximum support. (All other children and forward facing child seats and booster seats should be on front seats that are slid back as far away as possible from the dashboard.

WARNING: Do not install a child seat in a center facing jump seat.

Children and safety belts

If the child is the proper size, restrain the child in a safety seat.

Children who are too large for child safety seats (as specified by your child safety seat manufacturer) should always wear safety belts.

Follow all the important safety restraint and air bag precautions that apply to adult passengers in your vehicle.

If the shoulder belt portion of a combination lap and shoulder belt can be positioned so it does not cross or rest in front of the child's face or neck, the child should wear the lap and shoulder belt. Moving the child closer to the center of the vehicle may help provide a good shoulder belt fit.

WARNING: Do not leave children, unreliable adults, or pets unattended in your vehicle.

Seating and Safety Restraints

WARNING: Placing a child, 12 years or younger, in the front seat is dangerous. The child could be hit by a deploying air bag and be seriously injured or even killed. Never place a child safety seat in a center facing rear jump seat. If you must place a child safety seat in a front seating position, make sure the passenger airbag is turned off. See *Turning the airbag Off* in this section. Never use a rear-facing child restraint system in the front seat with an air bag that could deploy.

Child booster seats

Children outgrow a typical convertible or toddler seat when they weigh 40 pounds and are around 4 years of age. Although the lap/shoulder belt will provide some protection, these children are still too small for lap/shoulder belts to fit properly, which could increase the risk of serious injury.

To improve the fit of both the lap and shoulder belt on children who have outgrown child safety seats, Mazda recommends use of a belt-positioning booster.

Booster seats position a child so that safety belts fit better. They lift the child up so that the lap belt rests low across the hips and the knees bend comfortably. Booster seats also make the shoulder belt fit better and more comfortably for growing children.

When children should use booster seats

Children need to use booster seats from the time they outgrow the toddler seat until they are big enough for the vehicle seat and lap/shoulder belt to fit properly. Generally this is when they weigh about 80 lbs (about 8 to 12 years old).

Booster seats should be used until you can answer YES to ALL of these questions:

- Can the child sit all the way back against the vehicle seat back with knees bent comfortably at the edge of the seat without slouching?

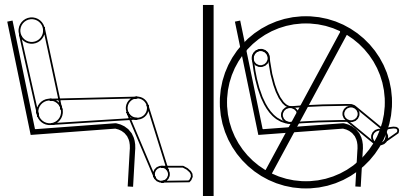

- Does the lap belt rest low across the hips?
- Is the shoulder belt centered on the shoulder and chest?

Seating and Safety Restraints

- Can the child stay seated like this for the whole trip?

WARNING: Booster seats must be installed only in seating positions equipped with a combination lap/shoulder belt.

Types of booster seats

There are two types of belt-positioning booster seats:

- Those that are backless.

If your backless booster seat has a removable shield, remove the shield and use the lap/shoulder belt. If a seating position has a low seat back and no head restraint, a backless booster seat may place your child's head (top of ear level) above the top of the seat. In this case, use a high-backed booster seat.



- Those with a high back.

If, with a backless booster seat, you cannot find a seating position that adequately supports your child's head, a high back booster seat would be a better choice.



Both can be used in any vehicle in a seating position equipped with lap/shoulder belts if your child is over 40 lbs.

The shoulder belt should cross the chest, resting snugly on the center of the shoulder. The lap belt should rest low and snug across the hips, never up high across the stomach.

If the booster seat slides on the vehicle seat, placing a rubberized mesh sold as shelf or carpet liner under the booster seat may improve this condition.

Seating and Safety Restraints

The importance of shoulder belts

Using a booster without a shoulder belt increases the risk of a child's head hitting a hard surface in a collision. For this reason, you should never use a booster seat with a lap belt only. It is best to use a booster seat with combination lap/shoulder belts.

WARNING: Follow all instructions provided by the manufacturer of the booster seat.

WARNING: Never put the shoulder belt under a child's arm or behind the back because it eliminates the protection for the upper part of the body and may increase the risk of injury or death in a collision.

WARNING: Never use pillows, books, or towels to boost a child. They can slide around and increase the likelihood of injury or death in a collision.

SAFETY SEATS FOR CHILDREN



Child and infant or child safety seats

Use a safety seat that is recommended for the size and weight of the child. Carefully follow all of the manufacturer's instructions with the safety seat you put in your vehicle. If you do not install and use the safety seat properly, the child may be injured in a sudden stop or collision.

Seating and Safety Restraints

When installing a child safety seat:

- Review and follow the information presented in the *Air Bag Supplemental Restraint System* section in this chapter.
- Use the correct safety belt buckle for that seating position (the buckle closest to the direction the tongue is coming from).
- Insert the belt tongue into the proper buckle until you hear a snap and feel it latch. Make sure the tongue is securely fastened in the buckle.

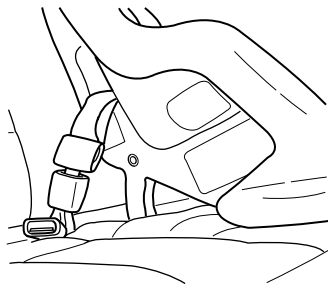

WARNING: Do not install a child seat in a center facing jump seat.

- Keep the buckle release button pointing up and away from the safety seat, with the tongue between the child seat and the release button, to prevent accidental unbuckling.
- Place seat back in upright position.
- Put the safety belt in the automatic locking mode. Refer to *Automatic locking mode* (passenger side front seat).

Mazda recommends the use of a child safety seat having a top tether strap. Install the child safety seat in a seating position which is capable of providing a tether anchorage. For more information on top tether straps, refer to *Attaching child safety seats with tether straps*.

WARNING: Carefully follow all of the manufacturer's instructions included with the safety seat you put in your vehicle. If you do not install and use the safety seat properly, the child may be injured in a sudden stop or collision.

Seating and Safety Restraints

Installing child safety seats with combination lap and shoulder belts (front outboard passenger seat only)

1. Position the child safety seat in a seat with a combination lap and shoulder belt.

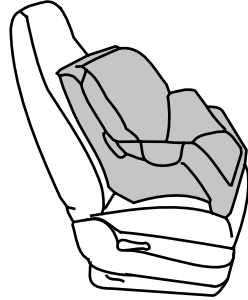

WARNING: If there is a tether on the child safety seat, attach it to the tether anchor point. Refer to *Attaching child safety seats with tether straps* in this chapter.

WARNING: Air bags can kill or injure a child in a child seat. Never place a rear facing child seat in the right front seat unless the air bag on/off switch is turned OFF. If you place a forward-facing child seat in the right front seat, turn the air bag on/off switch to OFF. See *Passenger air bag on/off switch* in this chapter.

WARNING: Rear facing child seats should NEVER be placed in the front seats unless the passenger air bag switch is turned off. Also, slide the front seat forward until the rear facing child seat contacts the dash board for maximum support. (All other children and forward facing child seats and booster seats should be on front seats that are slid back as far away as possible from the dashboard.)

Seating and Safety Restraints

2. Pull down on the shoulder belt and then grasp the shoulder belt and lap belt together.

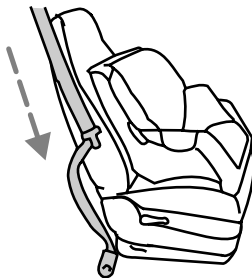

3. While holding the shoulder and lap belt portions together, route the tongue through the child seat according to the child seat manufacturer's instructions. Be sure the belt webbing is not twisted.

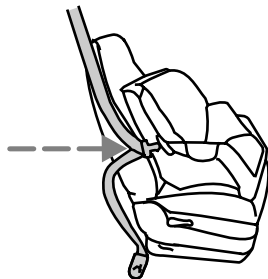

4. Insert the belt tongue into the proper buckle (the buckle closest to the direction the tongue is coming from) for that seating position until you hear and feel the latch engage. Make sure the tongue is latched securely by pulling on it.

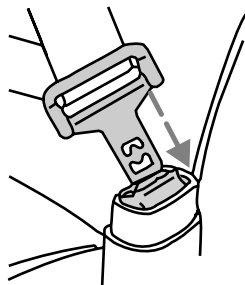

Seating and Safety Restraints

5. To put the retractor in the automatic locking mode, grasp the shoulder portion of the belt and pull downward until all of the belt is extracted and a click is heard.

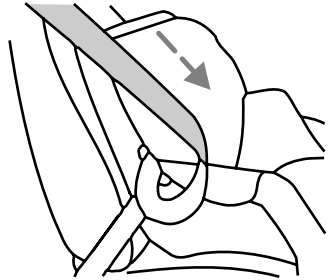

6. Allow the belt to retract. The belt will click as it retracts to indicate it is in the automatic locking mode.
7. Pull the lap belt portion across the child seat toward the buckle and pull up on the shoulder belt while pushing down with knee on the child seat.

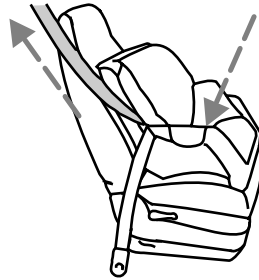

8. Allow the safety belt to retract to remove any slack in the belt.
9. Before placing the child in the seat, forcibly tilt the seat forward and back to make sure the seat is securely held in place. To check this, grab the seat at the belt path and attempt to move it side to side and forward. There should be no more than one inch of movement for proper installation.

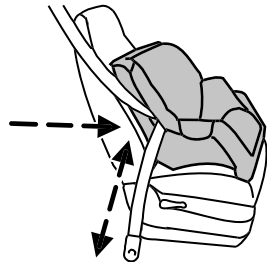

10. Try to pull the belt out of the retractor to make sure the retractor is in the automatic locking mode (you should not be able to pull more belt out). If the retractor is not locked, unbuckle the belt and repeat steps two through nine.
11. See *Attaching child safety seats with tether straps* in this chapter.

Seating and Safety Restraints

Check to make sure the child seat is properly secured before each use.

Attaching child safety seats with tether straps

Most new forward-facing child safety seats include a tether strap which goes over the back of the seat and hooks to an anchoring point. Tether straps are available as an accessory for many older safety seats. Contact the manufacturer of your child seat for information about ordering a tether strap.

The tether anchors in your vehicle are located on the back of the front seat cushion.

The tether strap anchors in your vehicle are in the following positions (shown from top view):

- **Bucket seats**

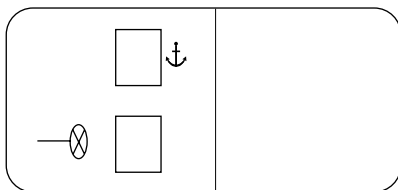

- **60/40 seats**

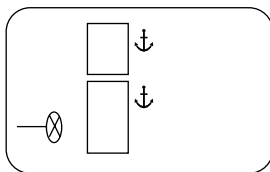

WARNING: Attach the tether strap only to the appropriate tether anchor as shown. The tether strap may not work properly if attached somewhere other than the correct tether anchor.

Seating and Safety Restraints

WARNING: This anchor information applies to child safety seats equipped with tether straps. For child safety seats equipped with LATCH anchors, refer to *Attaching safety seats with LATCH (Lower Anchors and Tethers for Children) attachments for child seat anchors* in this chapter.

WARNING: Never attach two child safety seat tethers to a single tether anchor. In a crash, an anchor may not be strong enough to hold two child safety seat attachments and may break, causing serious injury or death.

1. Position the child safety seat on the front seat cushion.
2. Route the child safety seat tether strap over the back of the seat.

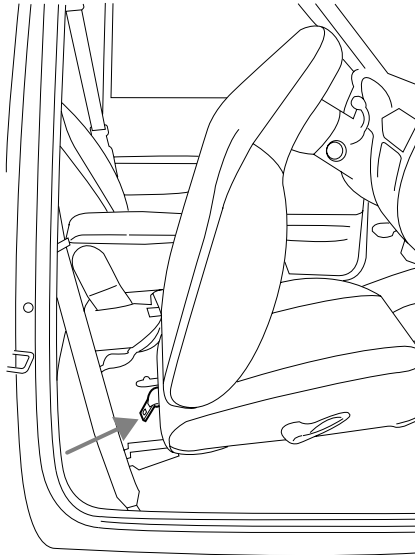

3. Locate the correct anchor for the selected seating position.

Seating and Safety Restraints

The tether anchor is located on the rear lower portion of the passenger seat.

4. Clip the tether strap to the anchor.

WARNING: If the tether strap is clipped incorrectly, the child safety seat may not be retained properly in the event of a collision.

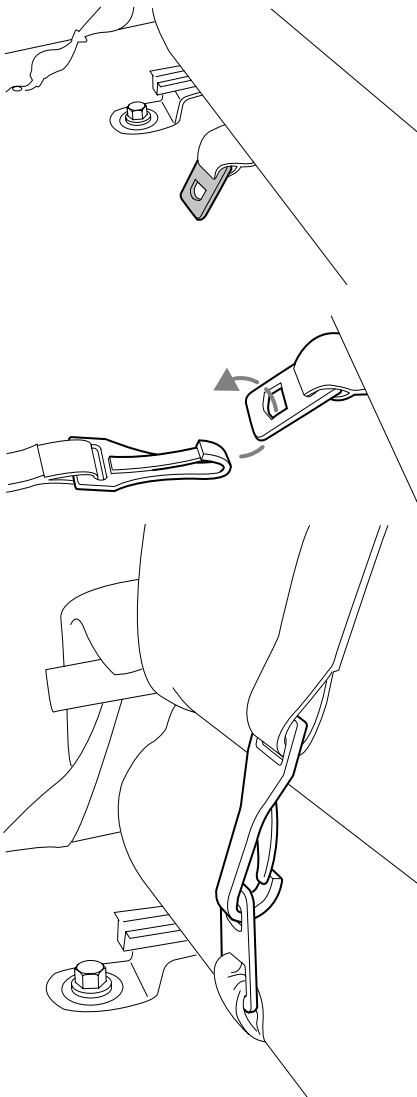

Seating and Safety Restraints

Center seating location 60/40 seats with folding armrest

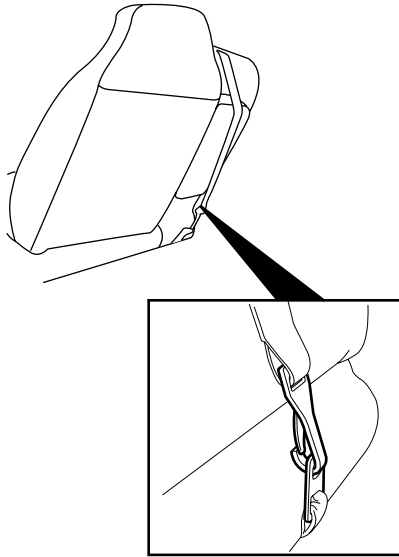

When installing a child safety seat in the center position, route the tether strap over the center arm rest and clip it to the center anchor.

See next page for center seating location of vinyl 60/40 seat.

WARNING: If the tether strap is clipped incorrectly, the child safety seat may not be retained properly in the event of a collision.

Seating and Safety Restraints

Center seating location 60/40 vinyl seats

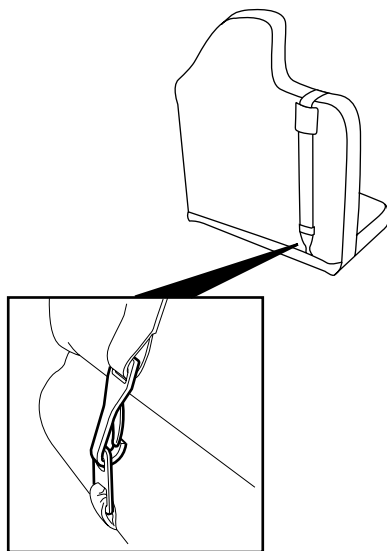

When installing a child safety seat in the center position on a 60/40 vinyl seat, route the tether strap through the guiding sleeve and clip it to the center anchor.

WARNING: If the tether strap is clipped incorrectly, the child safety seat may not be retained properly in the event of a collision.

5. Refer to the *Installing child safety seats in combination lap and shoulder belt seating positions* section of this chapter for further instructions to secure the child safety seat.
6. Tighten the child safety seat tether strap according to the manufacturer's instructions.

WARNING: If the safety seat is not anchored properly, the risk of a child being injured in a collision greatly increases.

Attaching safety seats with LATCH (Lower Anchors and Tethers for Children) attachments for child seat anchors

Some child safety seats have two rigid or webbing mounted attachments that connect to two anchors at certain seating positions in your vehicle.

Seating and Safety Restraints

This type of child seat eliminates the need to use seat belts to attach the child seat. For forward-facing child seats, the tether strap must also be attached to the proper tether anchor. See *Attaching safety seats with tether straps* in this chapter.

Your vehicle may be equipped with LATCH anchors for child seat installation at the following seating positions:

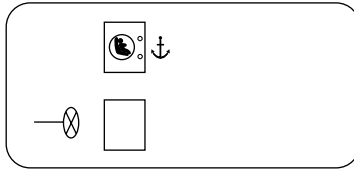

- Bucket seats

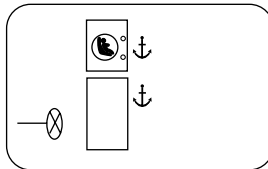

- 60/40 seats

 represents LATCH anchors.

 represents tether strap anchors.

To improve child seat protection, use the tether anchor when using the LATCH to install a child safety seat. See *Attaching child safety seats with tether straps in this section*.

WARNING: Never attach two LATCH child safety seats to the same anchor. In a crash, one anchor may not be strong enough to hold two child safety seat attachments and may break, causing serious injury or death.

WARNING: Do not put the LATCH type seat in the center seat position — it only has one possible anchor point and the seat will not be properly attached.

Seating and Safety Restraints

WARNING: If there are two LATCH seats to install — you can only mount one LATCH seat in this vehicle with the LATCH anchor bars. You need to mount the second seat with the center seat belt using the lap belt method and the child safety seat tether (if equipped).

WARNING: Do not attach two seats to one LATCH anchor bar.

The lower anchors for child seat installation are located at the rear section of the front passenger seat between the cushion and seat back. The LATCH anchors are below locator symbols on the seat back. Two plastic LATCH guides may be purchased from your local Mazda dealer (part number 1F60-57-751). They snap onto the latch lower anchor in the vehicle to help attach a child seat with rigid latch attachments. It will hold the seat foam away and expose the anchor making attachment of the child seat easier.

Make sure you attach the proper child safety seat tether after securing the LATCH.

WARNING: If the tether strap is clipped incorrectly, the child safety seat may not be retained properly in the event of a collision.

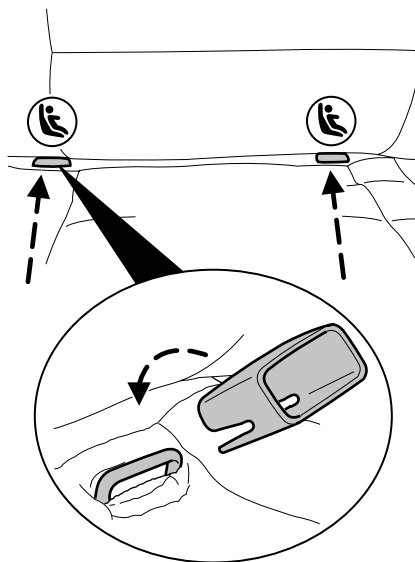

Follow the child seat manufacturer's instructions to properly install a child seat with LATCH attachments.

WARNING: Attach LATCH lower attachments of the child seat only to the anchors shown.

Seating and Safety Restraints

If you install a child seat with rigid LATCH attachments, do not tighten the tether strap enough to lift the child seat off the vehicle seat cushion when the child is seated in it. Keep the tether strap just snug without lifting the front of the child seat. Keeping the child seat just touching the vehicle seat gives the best protection in a severe crash.

Each time you use the safety seat, check that the seat is properly attached to the lower anchors and tether anchor. Try to tilt the child seat from side to side. Also try to tug the seat forward. Check to see if the anchors hold the seat in place.

WARNING: If the safety seat is not anchored properly, the risk of a child being injured in a crash greatly increases.

WARNING: If the tether strap is clipped incorrectly, the child safety seat may not be retained properly in the event of a collision.

STARTING

Positions of the ignition

1. ACCESSORY, allows the electrical accessories such as the radio to operate while the engine is not running.
2. LOCK, locks the steering wheel, automatic transmission gearshift lever and allows key removal.
3. OFF, shuts off the engine and all accessories without locking the steering wheel. This position also allows the automatic transmission shift lever to be moved from the P (Park) position without the brake pedal being depressed.

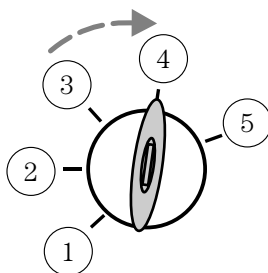

WARNING: When the key is in the ignition OFF position, the automatic transmission shift lever can be moved from the P (Park) position without the brake pedal depressed. To avoid unwanted vehicle movement, always set the parking brake.

4. ON, all electrical circuits operational. Warning lights illuminated. Key position when driving.
5. START, cranks the engine. Release the key as soon as the engine starts.

Preparing to start your vehicle

Engine starting is controlled by the powertrain control system.

Note: This system meets all Canadian Interference-Causing Equipment standard requirements regulating the impulse electrical field strength of radio noise.

When starting a fuel-injected engine, don't press the accelerator before or during starting. Only use the accelerator when you have difficulty starting the engine. For more information on starting the vehicle, refer to *Starting the engine* in this chapter.

WARNING: Extended idling at high engine speeds can produce very high temperatures in the engine and exhaust system, creating the risk of fire or other damage.

WARNING: Do not park, idle, or drive your vehicle in dry grass or other dry ground cover. The emission system heats up the engine compartment and exhaust system, which can start a fire.

WARNING: Do not start your vehicle in a closed garage or in other enclosed areas. Exhaust fumes can be toxic. Always open the garage door before you start the engine. See *Guarding against exhaust fumes* in this chapter for more instructions.

WARNING: If you smell exhaust fumes inside your vehicle, have your dealer inspect your vehicle immediately. Do not drive if you smell exhaust fumes.

Important safety precautions

When the engine starts, the idle RPM runs faster to warm the engine. If the engine idle speed does not slow down automatically, have the vehicle checked.

Before starting the vehicle:

1. Make sure all occupants buckle their safety belts. For more information on safety belts and their proper usage, refer to the *Seating and safety restraints* chapter.
2. Make sure the headlamps and electrical accessories are off.

If starting a vehicle with an automatic transmission:

- Make sure the parking brake is set.

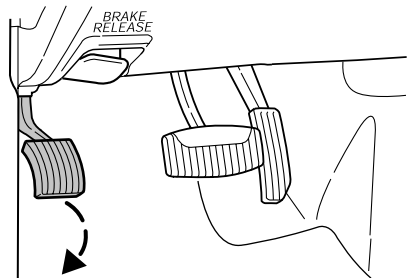

Driving

- Make sure the gearshift is in P (Park).



If starting a vehicle with a manual transmission:

1. Make sure the parking brake is set.
2. Push the clutch pedal to the floor.

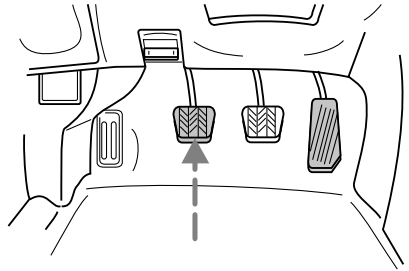

3. Turn the key to 4 (ON) without turning the key to 5 (START).

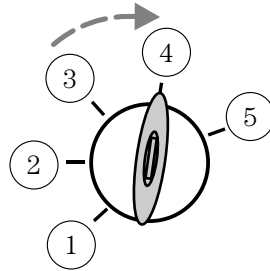

If there is difficulty in turning the key, firmly rotate the steering wheel left and right until the key turns freely. This condition may occur when:

- front wheels are turned
- front wheel is against the curb

- steering wheel is turned when getting in or out of the vehicle

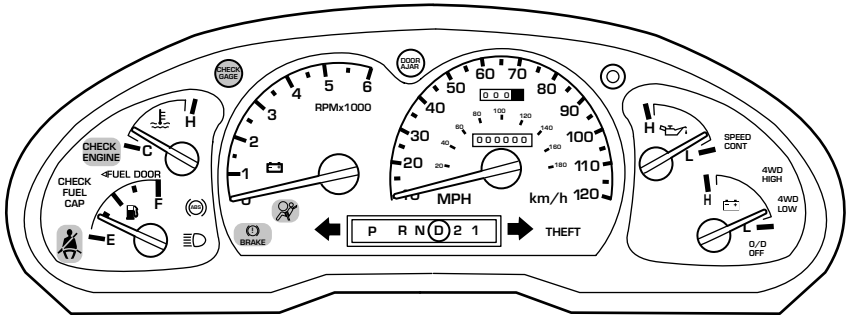

Make sure the corresponding lights illuminate or illuminate briefly. If a light fails to illuminate, have the vehicle serviced.

- If the driver's safety belt is fastened, the  light may not illuminate. Refer to the *Instrument Cluster* chapter for more information.

Starting the engine

Note: Whenever you start your vehicle, release the key as soon as the engine starts. Excessive cranking could damage the starter.

1. Turn the key to 4 (ON) without turning the key to 5 (START). If there is difficulty in turning the key, rotate the steering wheel until the key turns freely. This condition may occur when:

- the front wheels are turned
- a front wheel is against the curb

Turn the key to 5 (START), then release the key as soon as the engine starts. Excessive cranking could damage the starter.

Note: If the engine does not start within five seconds on the first try, turn the key to 3 (OFF), wait 10 seconds and try again.

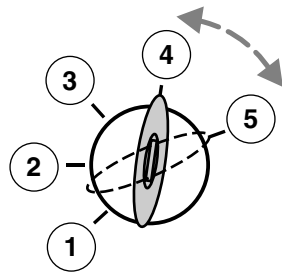

Cold weather starting (flexible fuel vehicles only)

In cold weather, ethanol fuel distributors should supply winter grade (E_d85) ethanol. If summer grade (E_d85) ethanol is used in cold weather, you may experience increased cranking times, rough idle or hesitation

Driving

until the engine has warmed up. Consult your fuel distributor for the availability of winter grade (E_d85) ethanol. High-quality blends of winter grade (E_d85) ethanol will produce satisfactory cold weather starting and driving results.

Cold starting performance can also be improved by using an engine block heater. Engine block heaters are available as an option and can be obtained from your Mazda dealer. Consult the engine block heater section for proper use of the engine block heater.

If you experience cold weather starting problems on (E_d85) ethanol, and neither an alternative brand of (E_d85) ethanol nor an engine block heater is available, adding unleaded gasoline to your tank will improve cold starting performance. Your vehicle is designed to operate on (E_d85) ethanol, unleaded gasoline alone, or any mixture of the two.

If the engine fails to start using the preceding instructions (flexible fuel vehicles only)

1. Press and hold down the accelerator 1/3 to 1/2 way to floor, then crank the engine.
2. When the engine starts, release the key, then gradually release the accelerator pedal as the engine speeds up. If the engine still fails to start, repeat Step 1.

Using the engine block heater (if equipped)

An engine block heater warms the engine coolant which aids in starting and heater/defroster performance. Use of an engine block heater is strongly recommended if you live in a region where temperatures reach -23° C (-10° F) or below. For best results, plug the heater in at least three hours before starting the vehicle. The heater can be plugged in the night before starting the vehicle.

WARNING: To reduce the risk of electrical shock, do not use your heater with ungrounded electrical systems or two-pronged (cheater) adapters.

Guarding against exhaust fumes

Carbon monoxide is present in exhaust fumes. Take precautions to avoid its dangerous effects.

WARNING: If you smell exhaust fumes inside your vehicle, have your dealer inspect your vehicle immediately. Do not drive if you smell exhaust fumes.

Important ventilating information

If the engine is idling while the vehicle is stopped for a long period of time, open the windows at least 2.5 cm (one inch) or adjust the heating or air conditioning to bring in fresh air.

BRAKES

Occasional brake noise is normal. If a metal-to-metal, continuous grinding or continuous squeal sound is present, the brake linings may be worn-out and should be inspected by a qualified service technician. If the vehicle has continuous vibration or shudder in the steering wheel while braking, the vehicle should be inspected by a qualified service technician.

Four-wheel anti-lock brake system (ABS)

This vehicle is equipped with an anti-lock braking system (ABS), a noise from the hydraulic pump motor and pulsation in the pedal may be observed during ABS braking events. Pedal pulsation coupled with noise while braking under panic conditions or on loose gravel, bumps, wet or snowy roads is normal and indicates proper functioning of the vehicle's anti-lock brake system.

NOTE: The ABS performs a self-check after you start the engine and begin to drive away.

A brief mechanical noise may be heard during this test. This is normal. If a malfunction is found, the ABS warning light will come on. If the vehicle has continuous vibration or shudder in the steering wheel while braking, the vehicle should be inspected by an authorized Mazda dealership.

The ABS operates by detecting the onset of wheel lockup during brake applications and compensates for this tendency. The wheels are prevented from locking even when the brakes are firmly applied. The accompanying illustration depicts the advantage of an ABS equipped vehicle (on bottom) to a non-ABS equipped vehicle (on top) during hard braking with loss of front braking traction.

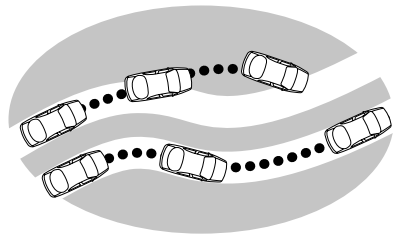

WARNING: The Anti-Lock system does not decrease the time necessary to apply the brakes or always reduce stopping distance. Always leave enough room between your vehicle and the vehicle in front of you to stop.

Using ABS

When hard braking is required, apply continuous force on the brake pedal; do not pump the brake pedal since this will reduce the effectiveness of the ABS and will increase your vehicle's stopping distance. The ABS will be activated immediately, allowing you to retain full steering control during hard braking and on slippery surfaces. However, the ABS does not decrease stopping distance.

ABS warning lamp (ABS)

The (ABS) lamp in the instrument cluster momentarily illuminates when the ignition is turned to ON. If the light does not illuminate during start up, remains on or flashes, the ABS may be disabled and may need to be serviced.

Even when the ABS is disabled, normal braking is still effective. (If your BRAKE warning lamp illuminates with the parking brake released, have your brake system serviced immediately.)

(!)
BRAKE

Parking brake (P)

Apply the parking brake whenever the vehicle is parked. To set the parking brake, press the parking brake pedal down until the pedal stops.

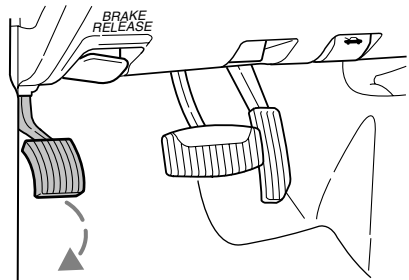

The BRAKE warning lamp in the instrument cluster illuminates and remains illuminated (when the ignition is turned ON) until the parking brake is released.



WARNING: Always set the parking brake fully and make sure that the gearshift is securely latched in P (Park) (automatic transmission) or in 1 (First) (manual transmission).

NOTE: The parking brake is not recommended to stop a moving vehicle. However, if the normal brakes fail, the parking brake can be used to stop your vehicle in an emergency. Since the parking brake applies only the rear brakes, the vehicle's stopping distance will increase greatly and the handling of your vehicle will be adversely affected.

Pull the release lever to release the brake.

Driving with the parking brake on will cause the brakes to wear out quickly and reduce fuel economy.

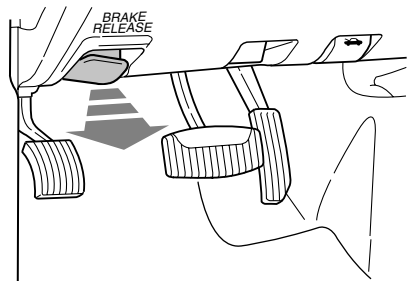

STEERING

Your vehicle is equipped with power steering. Power steering uses energy from the engine to decrease the driver's effort in steering the vehicle.

To prevent damage to the power steering pump:

- Never hold the steering wheel to the extreme right or the extreme left for more than a few seconds when the engine is running.
- Do not operate the vehicle with the power steering pump fluid level below the MIN mark on the reservoir.

If the power steering system breaks down (or if the engine is turned off), you can steer the vehicle manually, but it takes more effort.

If the steering wanders or pulls, check for:

- Underinflated tire(s) on any wheel(s)

Driving

- Uneven vehicle loading
- High crown in center of road
- High crosswinds
- Wheels out of alignment
- Loose or worn suspension components

TRACTION-LOK AXLE/LIMITED SLIP DIFFERENTIAL (IF EQUIPPED)

This axle provides added traction on slippery surfaces, particularly when one wheel is on a poor traction surface. Under normal conditions, the Traction-Lok axle functions like a standard rear axle.

PREPARING TO DRIVE YOUR VEHICLE

WARNING: Utility vehicles have a significantly higher rollover rate than other types of vehicles.

WARNING: In a rollover crash, an unbelted person is significantly more likely to die than a person wearing a safety belt.

Your vehicle has larger tires and increased ground clearance, giving the vehicle a higher center of gravity than a passenger car.

WARNING: Vehicles with a higher center of gravity such as utility and four-wheel drive vehicles handle differently than vehicles with a lower center of gravity. Utility and four-wheel drive vehicles are not designed for cornering at speeds as high as passenger cars any more than low-slung sports cars are designed to perform satisfactorily under off-road conditions. Avoid sharp turns, excessive speed and abrupt maneuvers in these vehicles. Failure to drive cautiously could result in an increased risk of loss of vehicle control, vehicle rollover, personal injury and death.

WARNING: Loaded vehicles, with a higher center of gravity, may handle differently than unloaded vehicles. Extra precautions, such as slower speeds and increased stopping distance, should be taken when driving a heavily loaded vehicle.

AUTOMATIC TRANSMISSION OPERATION (IF EQUIPPED)

Brake-shift interlock

This vehicle is equipped with a brake-shift interlock feature that prevents the gearshift lever from being moved from P (Park) when the ignition is in the ON position unless the brake pedal is depressed.

If you cannot move the gearshift lever out of P (Park) with ignition in the ON position and the brake pedal depressed:

1. Apply the parking brake, turn ignition key to LOCK, then remove the key.
2. Insert the key and turn it to OFF. **Apply the brake pedal and shift to N (Neutral).**

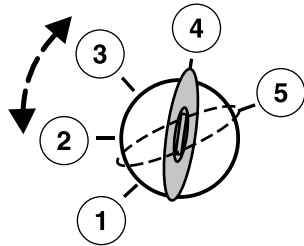

WARNING: When the key is in the ignition OFF position, the automatic transmission shift lever can be moved from the P (Park) position without the brake pedal depressed. To avoid unwanted vehicle movement, always set the parking brake.

3. Start the vehicle.

If it is necessary to use the above procedure to move the gearshift lever, it is possible that a fuse has blown or the vehicle's brakelamps are not operating properly. Refer to *Fuses and relays* in the *Roadside emergencies* chapter.

WARNING: Do not drive your vehicle until you verify that the brakelamps are working.

WARNING: Always set the parking brake fully and make sure the gearshift is latched in P (Park). Turn the ignition to the LOCK position and remove the key whenever you leave your vehicle.

Driving

WARNING: If the parking brake is fully released, but the brake warning lamp remains illuminated, the brakes may not be working properly. See your authorized Mazda dealership.

Driving with a 5–speed automatic transmission (if equipped)



Your transmission is equipped with an adaptive learning strategy found in the vehicle computer. This feature is designed to increase durability, and provide consistent shift feel over the life of the vehicle. A new vehicle or transmission may have firm and/or soft shifts. This operation is considered normal and will not affect function or durability of the transmission. Over time, the adaptive learning process will fully update transmission operation. Additionally, whenever the battery is disconnected or a new battery is installed, the strategy must relearn.

WARNING: Hold the brake pedal down while you move the gearshift lever from P (Park) to another position. If you do not hold the brake pedal down, your vehicle may move unexpectedly and injure someone.

P (Park)

This position locks the transmission and prevents the rear wheels from turning.

To put your vehicle in gear:

- Start the engine
- Depress the brake pedal
- Move the gearshift lever into the desired gear

To put your vehicle in P (Park):

- Come to a complete stop
- Move the gearshift lever and securely latch it in P (Park)

WARNING: Always set the parking brake fully and make sure the gearshift is latched in P (Park). Turn the ignition to the LOCK position and remove the key whenever you leave your vehicle.

R (Reverse)

With the gearshift lever in R (Reverse), the vehicle will move backward. Always come to a complete stop before shifting into and out of R (Reverse).

N (Neutral)

With the gearshift lever in N (Neutral), the vehicle can be started and is free to roll. Hold the brake pedal down while in this position.

D (Overdrive)

The normal driving position for the best fuel economy. Transmission operates in gears one through five. **D** (Overdrive) can be

deactivated by pressing the transmission control switch on the end of the gearshift lever. This will illuminate the O/D OFF lamp and activate Drive.

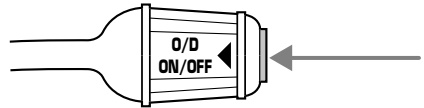

Drive (not shown)

Drive is activated when the transmission control switch is pressed.

- This position allows for all forward gears except overdrive.
- O/D OFF lamp is illuminated.
- Provides engine braking.
- Use when driving conditions cause excessive shifting from O/D to other gears. Examples: city traffic, hilly terrain, heavy loads, trailer towing and when engine braking is required.
- To return to O/D (overdrive mode), press the transmission control switch. The O/D OFF lamp will not be illuminated.
- O/D (Overdrive) is automatically returned each time the key is turned off.

2 (Second)

Use 2 (Second) to start-up on slippery roads or to provide additional engine braking on downgrades.

Driving

1 (First)

- Provides maximum engine braking.
- Allows upshifts by moving gearshift lever.
- Will not downshift into 1 (First) at high speeds; allows for 1 (First) when vehicle reaches slower speeds.

Forced downshifts

- Allowed in **D** (Overdrive) or Drive.
- Depress the accelerator to the floor.
- Allows transmission to select an appropriate gear.

MANUAL TRANSMISSION OPERATION (IF EQUIPPED)

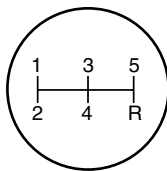

Using the clutch

The manual transmission has a starter interlock that prevents cranking the engine unless the clutch pedal is fully depressed.

To start the vehicle:

1. Make sure the parking brake is fully set.
2. Press the clutch pedal to the floor, then put the gearshift lever in the neutral position.
3. Start the engine, then press the brake pedal and release the parking brake.
4. Move the gearshift lever to the desired gear, then slowly release the clutch pedal while slowly pressing on the accelerator.

Do not drive with your foot resting on the clutch pedal or use the clutch pedal to hold your vehicle at a standstill while waiting on a hill. These actions will reduce the life of the clutch.

Recommended shift speeds

Downshift according to the following charts for your specific engine/drivetrain combination:

Upshifts when accelerating (for best fuel economy)		
Shift from:	Transfer case position (if equipped)	
	2H or 4H	4L
1 - 2	14 km/h (10 mph)	5 km/h (4 mph)
2 - 3	32 km/h (22 mph)	11 km/h (9 mph)
3 - 4	50 km/h (33 mph)	19 km/h (13 mph)
4 - 5 (Overdrive)	71 km/h (41 mph)	27 km/h (17 mph)
Upshifts when cruising (recommended for best fuel economy)		
Shift from:	Transfer case position (if equipped)	
	2H or 4H	4L
1 - 2	16 km/h (10 mph)	6 km/h (4 mph)
2 - 3	26 km/h (19 mph)	10 km/h (8 mph)
3 - 4	43 km/h (28 mph)	16 km/h (12 mph)
4 - 5 (Overdrive)	68 km/h (40 mph)	26 km/h (16 mph)
Maximum downshift speeds		
Shift from:	Transfer case position (if equipped)	
	2H or 4H	4L
5 (Overdrive) - 4	88 km/h (55 mph)	34 km/h (22 mph)
4 - 3	72 km/h (45 mph)	27 km/h (18 mph)
3 - 2	56 km/h (35 mph)	21 km/h (14 mph)
2 - 1	32 km/h (20 mph)	11 km/h (8 mph)

Reverse

1. Make sure that your vehicle is at a complete stop before you shift into R (Reverse). Failure to do so may damage the transmission.
 2. Move the gearshift lever into the neutral position and wait at least three seconds before shifting into R (Reverse).
- The gearshift lever can only be moved into R (Reverse) by moving it from left of 3 (Third) and 4 (Fourth) before shifting into R (Reverse). This is a lockout feature that protects the transmission from accidentally being shifted into R (Reverse) from 5 (Overdrive).

Parking your vehicle

1. Apply the brake and shift into the neutral position.
2. Fully apply the parking brake, then shift into 1 (First).

Driving

3. Turn the ignition off.

WARNING: Do not park your vehicle in Neutral, it may move unexpectedly and injure someone. Use 1 (First) gear and set the parking brake fully.

Removing the key

Turn the ignition off, push the release lever (located above the ignition), then turn the key toward you and remove the key.

If your vehicle gets stuck in mud or snow

If your vehicle gets stuck in mud or snow, it may be rocked out by shifting from forward and reverse gears, stopping between shifts in a steady pattern. Press lightly on the accelerator in each gear.

Do not rock the vehicle if the engine is not at normal operating temperature or damage to the transmission may occur.

Do not rock the vehicle for more than a minute or damage to the transmission and tires may occur, or the engine may overheat.

FOUR-WHEEL DRIVE (4WD) OPERATION (IF EQUIPPED)

WARNING: For important information regarding safe operation of this type of vehicle, see Preparing to drive your vehicle in this chapter.

Four-wheel drive (4WD) supplies power to all four wheels. 4WD should not be operated on dry pavement; driveline damage may occur.

If equipped with the Electronic Shift 4WD System, and 4WD Low is selected while the vehicle is moving, the 4WD system will not engage. This is normal and should be no reason for concern. Refer to *Shifting to/from 4WD Low* for proper operation.

4WD system indicator lights

- **4WD** - Illuminates when 4H (4WD High) is engaged.

4WD

- **4WD LOW** – Illuminates when 4L (4WD Low) is engaged.

**4WD
LOW**

Using the electronic shift 4WD system (if equipped)

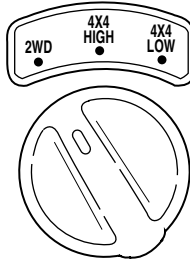

2WD (2WD High) - Power to the rear wheels only; used for street and highway driving.

4X4 HIGH (4WD High) - Used for extra traction such as in snow or icy roads or in off-road situations. Not intended for use on dry pavement.

4X4 LOW (4WD Low) - Uses extra gearing to provide maximum power to all four wheels. Intended only for off-road applications such as deep sand, steep grades or pulling heavy objects. 4X4 LOW (4WD Low) will not engage while the vehicle is moving; this is normal and should be no reason for concern. Refer to *Shifting to/from 4X4 (4WD Low)* for proper operation.

Shifting between 2WD (2WD High) and 4X4 HIGH (4WD High)

- Move the 4WD control between 2WD and 4X4 HIGH at any forward speed.

Note: Do not perform this operation if the rear wheels are slipping.

Shifting to/from 4X4 LOW (4WD Low)

1. Bring the vehicle to a complete stop
 2. Depress the brake
 3. On vehicles equipped with an automatic transmission, place the transmission in N (Neutral); on vehicles equipped with a manual transmission, depress the clutch.
 4. Move the 4WD control to the desired position.
- If shifting into 4X4 LOW (4WD Low), wait for the LOW RANGE light in the instrument cluster to turn **on** indicating the shift is complete.

Driving

- If shifting out of 4X4 LOW (4WD Low), wait for the LOW RANGE light in the instrument cluster to turn **off** indicating the shift is complete.

Driving off-road with 4WD

Your vehicle is specially equipped for driving on sand, snow, mud and rough terrain and has operating characteristics that are somewhat different from conventional vehicles, both on and off the road.

Maintain steering wheel control at all times, especially in rough terrain. Since sudden changes in terrain can result in abrupt steering wheel motion, make sure you grip the steering wheel from the outside. Do not grip the spokes.

Drive cautiously to avoid vehicle damage from concealed objects such as rocks and stumps.

You should either know the terrain or examine maps of the area before driving. Map out your route before driving in the area. For more information on driving off-road, read the “Four Wheeling” supplement in your owner’s portfolio.

If your vehicle gets stuck

If the vehicle is stuck it may be rocked out by shifting from forward and reverse gears, stopping between shifts, in a steady pattern. Press lightly on the accelerator in each gear.

Do not rock the vehicle if the engine is not at normal operating temperature or damage to the transmission may occur.

Do not rock the vehicle for more than a few minutes or damage to the transmission and tires may occur or the engine may overheat.

WARNING: Do not spin the wheels at over 56 km/h (35 mph). The tires may fail and injure a passenger or bystander.

Sand

When driving over sand, try to keep all four wheels on the most solid area of the trail. Do not reduce the tire pressures but shift to a lower gear and drive steadily through the terrain. Apply the accelerator slowly and avoid spinning the wheels.

Mud and water

If you must drive through high water, drive slowly. Traction or brake capability may be limited.

When driving through water, determine the depth; avoid water higher than the bottom of the hubs (if possible) and proceed slowly. If the ignition system gets wet, the vehicle may stall.

Once through water, always try the brakes. Wet brakes do not stop the vehicle as effectively as dry brakes. Drying can be improved by moving your vehicle slowly while applying light pressure on the brake pedal.

After driving through mud, clean off residue stuck to the driveshafts and tires. Excess mud stuck on tires and rotating driveshafts causes an imbalance that could damage drive components.

If the transmission, transfer case or front axle are submerged in water, their fluids should be checked and changed, if necessary.

Driving through deep water where the transmission vent tube is submerged may allow water into the transmission and cause internal transmission damage.

Replace rear axle lubricant any time the axle has been submerged in water. The rear axle does not normally require a lubricant change for the life of the vehicle. Rear axle lubricant quantities are not to be checked or changed unless a leak is suspected or repair is required.

Driving on hilly or sloping terrain

When driving on a hill, avoid driving crosswise or turning on steep slopes. You could lose traction and slip sideways. Drive straight up, straight down or avoid the hill completely. Know the conditions on the other side of a hill before driving over the crest.

When climbing a steep hill, start in a lower gear rather than downshifting to a lower gear from a higher gear once the ascent has started. This reduces strain on the engine and the possibility of stalling.

When descending a steep hill, avoid sudden braking. Shift to a lower gear when added engine braking is desired.

When speed control is on and you are driving uphill, your vehicle speed may drop considerably, especially if you are carrying a heavy load.

If vehicle speed drops more than 16 km/h (10 mph), the speed control will cancel automatically. Resume speed with accelerator pedal.

If speed control cancels after climbing the hill, reset speed by pressing and holding the SET ACCEL button (to resume speeds over 50 km/h [30 mph]).

Automatic transmissions may shift frequently while driving up steep grades. Eliminate frequent shifting by shifting out of **D** (Overdrive) into a lower gear.

Driving on snow and ice

A 4WD vehicle has advantages over 2WD vehicles in snow and ice but can skid like any other vehicle.

Avoid sudden applications of power and quick changes of direction on snow and ice. Apply the accelerator slowly and steadily when starting from a full stop.

When braking, apply the brakes as you normally would. In order to allow the anti-lock brake system (ABS) to operate properly, keep steady pressure on the brake pedal.

Make sure you allow sufficient distance between you and other vehicles for stopping. Drive slower than usual and consider using one of the lower gears.

DRIVING THROUGH WATER

If driving through deep or standing water is unavoidable, proceed very slowly especially if the depth is not known. Never drive through water that is higher than the bottom of the hubs (for trucks) or the bottom of the wheel rims (for cars). Traction or brake capability may be limited and your vehicle may stall. Water may also enter your engine's air intake and severely damage your engine.

Once through the water, always dry the brakes by moving your vehicle slowly while applying light pressure on the brake pedal. Wet brakes do not stop the vehicle as quickly as dry brakes. **Driving through deep water where the transmission vent tube is submerged may allow water into the transmission and cause internal transmission damage.**

SPECIAL LOADING INSTRUCTIONS FOR OWNERS OF PICKUP TRUCKS AND UTILITY-TYPE VEHICLES

WARNING: For important information regarding safe operation of this type of vehicle, see the Preparing to drive your vehicle section in this chapter.

WARNING: Loaded vehicles may handle differently than unloaded vehicles. Extra precautions, such as slower speeds and increased stopping distance, should be taken when driving a heavily loaded vehicle.

Your vehicle can haul more cargo and people than most passenger cars. Depending upon the type and placement of the load, hauling cargo and people may raise the center of gravity of the vehicle.

Vehicle loading

Before loading a vehicle, familiarize yourself with the following terms:

- **Base Curb Weight:** Weight of the vehicle including any standard equipment, fluids, lubricants, etc. It does not include occupants or aftermarket equipment.
- **Payload:** Combined maximum allowable weight of cargo, occupants and optional equipment. The payload equals the gross vehicle weight rating minus base curb weight.
- **GVW (Gross Vehicle Weight):** Base curb weight plus payload weight. The GVW is not a limit or a specification.
- **GVWR (Gross Vehicle Weight Rating):** Maximum permissible total weight of the base vehicle, occupants, optional equipment and cargo. The GVWR is specific to each vehicle and is listed on the Safety Certification Label on the driver's door pillar.
- **GAWR (Gross Axle Weight Rating):** Carrying capacity for each axle system. The GAWR is specific to each vehicle and is listed on the Safety Certification Label on the driver's door pillar.
- **GCW (Gross Combined Weight):** The combined weight of the towing vehicle (including occupants and cargo) and the loaded trailer.
- **GCWR (Gross Combined Weight Rating):** Maximum permissible combined weight of towing vehicle (including occupants and cargo) and the loaded trailer.
- **Maximum Trailer Weight Rating:** Maximum weight of a trailer the vehicle is permitted to tow. The maximum trailer weight rating is determined by subtracting the vehicle curb weight for each engine/transmission combination, any required option weight for trailer towing and the weight of the driver from the GCWR for the towing vehicle.
- **Maximum Trailer Weight:** Maximum weight of a trailer the loaded vehicle (including occupants and cargo) is permitted to tow. It is determined by subtracting the weight of the loaded trailer towing vehicle from the GCWR for the towing vehicle.
- **Trailer Weight Range:** Specified weight range that the trailer must fall within that ranges from zero to the maximum trailer weight rating.

NOTE: Remember to figure in the tongue load of your loaded trailer when figuring the total weight.

WARNING: Do not exceed the GVWR or the GAWR specified on the certification label, this could affect vehicle handling and cause an accident.

Do not use replacement tires with lower load carrying capacities than the originals because they may lower the vehicle's GVWR and GAWR limitations. Replacement tires with a higher limit than the originals do not increase the GVWR and GAWR limitations.

The Safety Certification Label, found on the driver's door pillar, lists several important vehicle weight rating limitations. Before adding any additional equipment, refer to these limitations. If you are adding weight to the front of your vehicle, (potentially including weight added to the cab), the weight added should not exceed the front axle reserve capacity (FARC). Additional frontal weight may be added to the front axle reserve capacity provided you limit your payload in other ways (i.e. restrict the number of occupants or amount of cargo carried).

You may add equipment throughout your vehicle if the total weight added is equal to or less than the total axle reserve capacity (TARC) weight. You should NEVER exceed the total axle reserve capacity.

Always ensure that the weight of occupants, cargo and equipment being carried is within the weight limitations that have been established for your vehicle including both gross vehicle weight and front and rear gross axle weight rating limits.

WARNING: Exceeding any vehicle weight rating limitation could result in serious damage to the vehicle loss of vehicle control, vehicle rollover, and/or personal injury.

Calculating the load your vehicle can carry/tow

1. Use the appropriate maximum GCWR chart (in the *Trailer Towing* section in this chapter) for your type of engine and rear axle ratio.
2. Weigh your vehicle without cargo. To obtain correct weights, take your vehicle to a shipping company or an inspection station for trucks.
3. Subtract your loaded weight from the maximum GCWR in the chart. This is the maximum trailer weight your vehicle can tow. It must be below the maximum trailer weight shown in the chart.

TRAILER TOWING

Your vehicle may tow a class I, II or III trailer provided the maximum trailer weight is less than or equal to the maximum trailer weight listed for your engine and rear axle ratio on the following charts.

Your vehicle's load capacity is designated by weight, not by volume, so you cannot necessarily use all available space when loading a vehicle.

Towing a trailer places an additional load on your vehicle's engine, transmission, axle, brakes, tires and suspension. Inspect these components carefully after any towing operation.

4x2 w/manual transmission			
Engine	Maximum GCWR - kg (lbs.)	Maximum trailer weight - kg (lbs.)	Maximum frontal area of trailer - m² (ft²)
Regular Cab			
2.3L	2,177 (4,800)	744 (1,640)	Equal to frontal area of vehicle
3.0L Dual Sport	2,722 (6,000)	1,161 (2,560)	4.64 (50)
Cab Plus/Cab Plus 4			
3.0L Dual Sport	2,722 (6,000)	1,070 (2,360)	4.64 (50)
4.0L Dual Sport	3,175 (7,000)	1,488 (3,380)	4.64 (50)
For high altitude operation, reduce GCW by 2% per 300 meters (1,000 ft.) elevation.			
For definition of terms used in this table see <i>Vehicle Loading</i> earlier in this chapter.			
To determine maximum trailer weight designed for your particular vehicle, see <i>Calculating the load</i> earlier in this chapter.			
Maximum trailer weight is shown. The combined weight of the completed towing vehicle (including hitch, passengers and cargo) and the loaded trailer must not exceed the Gross Combined Weight Rating (GCWR).			

Driving

4x4 w/manual transmission			
Engine	Maximum GCWR - kg (lbs.)	Maximum trailer weight - kg (lbs)	Maximum frontal area of trailer - m² (ft²)
Regular Cab			
3.0L	2,722 (6,000)	1,070 (2,360)	4.64 (50)
Cab Plus/Cab Plus 4			
3.0L	2,722 (6,000)	980 (2,160)	4.64 (50)
4.0L	3,175 (7,000)	1,388 (3,060)	4.64 (50)
For high altitude operation, reduce GCW by 2% per 300 meters (1,000 ft.) of elevation.			
For definition of terms used in this table, see <i>Vehicle loading</i> earlier in this chapter.			
To determine maximum trailer weight designed for your vehicle, see <i>Calculating the load</i> earlier in this chapter.			
Maximum trailer weight is shown. The combined weight of the completed towing vehicle (including hitch, passengers and cargo) and the loaded trailer must not exceed the Gross Combined Weight Rating (GCWR).			
4x2 w/automatic transmission			
Engine	Maximum GCWR - kg (lbs.)	Maximum trailer weight - kg (lbs.)	Maximum frontal area of trailer - m² (ft²)
Regular Cab			
2.3L	2,495 (5,500)	1,025 (2,260)	Equal to frontal area of vehicle
3.0L Dual Sport	3,402 (7,500)	1,823 (4,020)	4.64 (50)
Cab Plus/Cab Plus 4			
3.0L Dual Sport	3,402 (7,500)	1,733 (3,820)	4.64 (50)
4.0L Dual Sport	4,309 (9,500)	2,604 (5,740)	4.64 (50)
For high altitude operation, reduce GCW by 2% per 300 meters (1,000 ft.) elevation.			

4x2 w/automatic transmission

For definition of terms used in this table see *Vehicle Loading* earlier in this chapter.

To determine maximum trailer weight designed for your particular vehicle, see *Calculating the load* earlier in this chapter.

Maximum trailer weight is shown. The combined weight of the completed towing vehicle (including hitch, passengers and cargo) and the loaded trailer must not exceed the Gross Combined Weight Rating (GCWR).

4x4 w/automatic transmission

Engine	Maximum GCWR - kg (lbs.)	Maximum trailer weight - kg (lbs.)	Maximum frontal area of trailer - m ² (ft ²)
Regular Cab			
3.0L	3,402 (7,500)	1,742 (3,840)	4.64 (50)
Cab Plus/Cab Plus 4			
3.0L	3,402 (7,500)	1,651 (3,640)	4.64 (50)
4.0L	4,309 (9,500)	2,504 (5,520)	4.64 (50)
For high altitude operation, reduce GCW by 2% per 300 meters (1,000 ft.) of elevation.			
For definition of terms used in this table, see <i>Vehicle loading</i> earlier in this chapter.			
To determine maximum trailer weight designed for your vehicle, see <i>Calculating the load</i> earlier in this chapter.			
Maximum trailer weight is shown. The combined weight of the completed towing vehicle (including hitch, passengers and cargo) and the loaded trailer must not exceed the Gross Combined Weight Rating (GCWR).			

WARNING: Do not exceed the GVWR or the GAWR specified on the certification label.

The certification label is found on the driver's door latch pillar.

WARNING: Towing trailers beyond the maximum recommended gross trailer weight exceeds the limit of the vehicle and could result in engine damage, transmission damage, structural damage, loss of vehicle control, vehicle rollover and personal injury.

Preparing to tow

Use the proper equipment for towing a trailer and make sure it is properly attached to your vehicle. See your dealer or a reliable trailer dealer if you require assistance.

Hitches

For towing trailers up to 907 kg (2,000 lb), use a weight carrying hitch and ball which uniformly distributes the trailer tongue loads through the underbody structure. Use a frame-mounted weight distributing hitch for trailers over 907 kg (2,000 lb).

Do not install a single or multi-clamp type bumper hitch, or a hitch which attaches to the axle. Underbody mounted hitches are acceptable if they are installed properly. Follow the towing instructions of a reputable rental agency.

Whenever a trailer hitch and hardware are removed, make sure all mounting holes in the underbody are properly sealed to prevent noxious gases or water from entering.

Safety chains

Always connect the trailer's safety chains to the frame or hook retainers of the vehicle hitch. To connect the trailer's safety chains, cross the chains under the trailer tongue and allow slack for turning corners.

If you use a rental trailer, follow the instructions that the rental agency gives to you.

Do not attach safety chains to the bumper.

Trailer brakes

Electric brakes and manual, automatic or surge-type trailer brakes are safe if installed properly and adjusted to the manufacturer's specifications. The trailer brakes must meet local and Federal regulations.

WARNING: Do not connect a trailer's hydraulic brake system directly to your vehicle's brake system. Your vehicle may not have enough braking power and your chances of having a collision greatly increase.

The braking system of the tow vehicle is rated for operation at the GVWR not GCWR.

Trailer lamps

Trailer lamps are required on most towed vehicles. Make sure your trailer lamps conform to local and Federal regulations. See your dealer or trailer rental agency for proper instructions and equipment for hooking up trailer lamps.

Using a step bumper

The optional step bumper is equipped with an integral hitch and requires only a ball with a 19 mm (3/4 inch) shank diameter. The bumper has a 907 kg (2,000 lb.) trailer weight and 91 kg (200 lb.) tongue weight capability.

The rated capacities (as shown in this guide) for trailer towing with the factory bumper are only valid when the trailer hitch ball is installed directly into the ball hole in the bumper. Addition of bracketry to either lower the ball hitch position or extend the ball hitch rearward will significantly increase the loads on the bumper and its attachments. This can result in the failure of the bumper or the bumper attachments. Use of any type of hitch extensions should be considered abuse.

Trailer tow connector

The trailer tow connector is located under the rear bumper, on the driver's side of the vehicle.

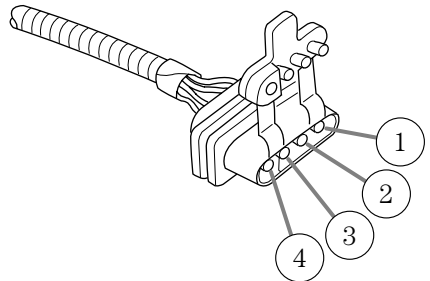

Driving

Refer to the following chart for information regarding the factory-equipped trailer tow connector:

Trailer tow connector		
Color	Function	Comment
1. Dark Green	Trailer right-hand turn signal	Circuit activated when brake pedal is depressed or when ignition is on and right-hand turn signal is applied.
2. Yellow	Trailer left-hand turn signal	Circuit activated when brake pedal is depressed or when ignition is on and left-hand turn signal is applied.
3. Tan/White	Tail lamp	Relay controlled circuit activated when the park lamps/headlamps are on.
4. White	Ground	Matching vehicle circuit returns to battery's negative ground.

Driving while you tow

When towing a trailer:

- Turn off the speed control. The speed control may shut off automatically when you are towing on long, steep grades.
- Consult your local motor vehicle speed regulations for towing a trailer.
- To eliminate excessive shifting, use a lower gear. This will also assist in transmission cooling. (For additional information, refer to the *Driving with a 5-speed automatic transmission* section in this chapter.
- Under extreme conditions with large frontal trailers, high outside temperatures and highway speeds, the coolant gauge may indicate higher than normal coolant temperatures. If this occurs, reduce speed until the coolant temperature returns to the normal range. Refer to *Engine coolant temperature gauge* in the *Instrument cluster* chapter.
- Anticipate stops and brake gradually.
- Do not exceed the GCWR rating or transmission damage may occur.

Servicing after towing

If you tow a trailer for long distances, your vehicle will require more frequent service intervals. Refer to your service maintenance section for more information.

Trailer towing tips

- Practice turning, stopping and backing up before starting on a trip to get the feel of the vehicle trailer combination. When turning, make wider turns so the trailer wheels will clear curbs and other obstacles.
- Allow more distance for stopping with a trailer attached.
- The trailer tongue weight should be 10–15% of the loaded trailer weight.
- After you have traveled 80 km (50 miles), thoroughly check your hitch, electrical connections and trailer wheel lug nuts.
- To aid in engine/transmission cooling and A/C efficiency during hot weather while stopped in traffic, place the gearshift lever in P (Park) (automatic transmission) or N (Neutral) (manual transmissions).
- Vehicles with trailers should not be parked on a grade. If you must park on a grade, place wheel chocks under the trailer's wheels.

Launching or retrieving a boat

Disconnect the wiring to the trailer before backing the trailer into the water. Reconnect the wiring to the trailer after the trailer is removed from the water.

When backing down a ramp during boat launching or retrieval:

- do not allow the static water level to rise above the bottom edge of the rear bumper.
- do not allow waves to break higher than 15 cm (6 inches) above the bottom edge of the rear bumper.

Exceeding these limits may allow water to enter vehicle components:

- causing internal damage to the components.
- affecting driveability, emissions and reliability.

Replace the rear axle lubricant any time the axle has been submerged in water. Rear axle lubricant quantities are not to be checked or changed unless a leak is suspected or repair required.

RECREATIONAL TOWING

Follow these guidelines if you have a need for recreational towing. An example of recreational towing would be towing your vehicle behind a motorhome. These guidelines are designed to ensure that your transmission is not damaged.

4x2 equipped with a manual transmission:

Before you have your vehicle towed:

- Release the parking brake.
- Move the gearshift to the neutral position.
- Turn the key in the ignition to the OFF/UNLOCKED position.
- The maximum recommended speed is 88 km/h (55 mph).
- The maximum recommended distance is unlimited.
- The vehicle must be towed in the forward position to ensure no damage is done to the internal transfer case components.

In addition, it is recommended that you follow the instructions provided by the aftermarket manufacturer of the towing apparatus if one has been installed.

4x2 equipped with automatic transmission and 4x4 vehicles:

4x2 vehicles with automatic transmissions or 4x4 vehicles with an electronic-shift transfer case and automatic transmission, follow these guidelines for recreational towing:

- Release the parking brake.
- Turn the key in the ignition to the OFF/UNLOCKED position.
- Place the transmission in N (Neutral).
- Do not exceed a distance of 80 km (50 miles).
- Do not exceed 56 km/h (35 mph) vehicle speed.
- The vehicle must be towed in the forward position to ensure no damage is done to the internal transfer case components.

If a distance of 80 km (50 miles) or a speed of 56 km/h (35 mph) must be exceeded, you must disconnect the front (4x4 only) and rear driveshafts. Mazda recommends the driveshafts be removed/installed only by a qualified technician. See your local dealer for driveshaft removal/installation.

Improper removal/installation of the driveshaft can cause transmission fluid or transfer case fluid loss, damage to the driveshaft and internal transmission and transfer case components.

CAMPER BODIES

Your pickup is not recommended for slide-in camper bodies.

HAZARD FLASHER

The hazard flasher is located on the steering column, just behind the steering wheel. The hazard flashers will operate when the ignition is in any position.

Push in the flasher control and all front and rear direction signals will flash. Press the flasher control again to turn them off. Use it when your vehicle is disabled and is creating a safety hazard for other motorists.

Note: With extended use, the flasher may run down your battery.

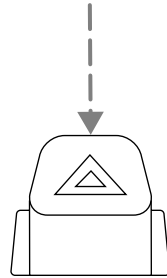

FUEL PUMP SHUT-OFF SWITCH FUEL RESET

This device stops the electric fuel pump from sending fuel to the engine when your vehicle has had a substantial jolt.

After an accident, if the engine cranks but does not start, this switch may have been activated.

Roadside Emergencies

This switch is located in the front passenger's footwell, by the kick panel access cover.

To reset the switch:

1. Turn the ignition OFF.
2. Check the fuel system for leaks.
3. If no leaks are apparent, reset the switch by pushing in on the reset button.
4. Turn the ignition ON.
5. Wait a few seconds and return the key to OFF.
6. Make another check of leaks.

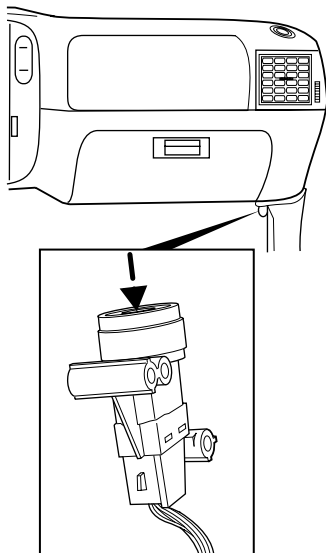

FUSES AND RELAYS

Fuses

If electrical components in the vehicle are not working, a fuse may have blown. Blown fuses are identified by a broken wire within the fuse. Check the appropriate fuses before replacing any electrical components.

Note: Always replace a fuse with one that has the specified amperage rating. Using a fuse with a higher amperage rating can cause severe wire damage and could start a fire.

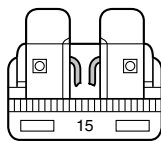

Roadside Emergencies

Standard fuse amperage rating and color

COLOR					
Fuse rating	Mini fuses	Standard fuses	Maxi fuses	Cartridge maxi fuses	Fuse link cartridge
2A	Grey	Grey	—	—	—
3A	Violet	Violet	—	—	—
4A	Pink	Pink	—	—	—
5A	Tan	Tan	—	—	—
7.5A	Brown	Brown	—	—	—
10A	Red	Red	—	—	—
15A	Blue	Blue	—	—	—
20A	Yellow	Yellow	Yellow	Blue	Blue
25A	Natural	Natural	—	—	—
30A	Green	Green	Green	Pink	Pink
40A	—	—	Orange	Green	Green
50A	—	—	Red	Red	Red
60A	—	—	Blue	—	Yellow
70A	—	—	Tan	—	Brown
80A	—	—	Natural	—	Black

Passenger compartment fuse panel

The fuse panel is located on the left-hand side of the instrument panel facing the driver's side door. Pull the panel cover outward to access the fuses.

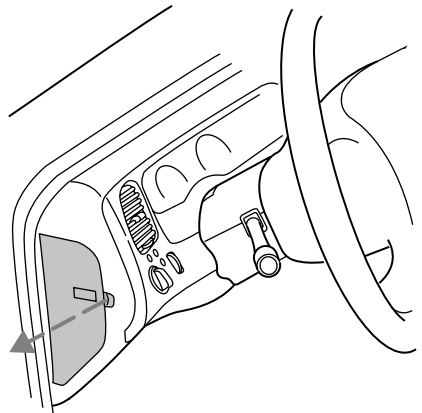

Roadside Emergencies

To remove a fuse use the fuse puller tool provided.

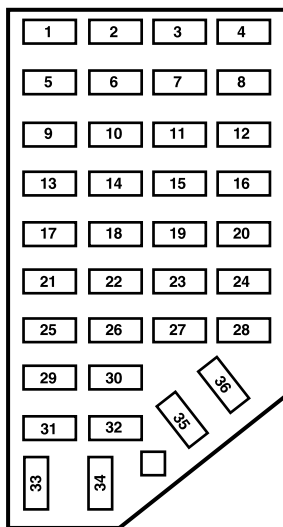

The fuses are coded as follows:

Fuse/Relay Location	Fuse Amp Rating	Passenger Compartment Fuse Panel Description
1	5A	Power mirror switch
2	10A	Daytime Running Lights (DRL), Back-up lamps, Transmission, Passenger air bag deactivation switch, Blower motor relay
3	7.5A	Left stop/turn trailer tow connector
4	—	Not used
5	15A	4x4 control module
6	2A	Brake pressure switch
7	7.5A	Right stop/turn trailer tow connector

Roadside Emergencies

Fuse/Relay Location	Fuse Amp Rating	Passenger Compartment Fuse Panel Description
8	—	Not used
9	7.5A	Brake pedal position switch
10	7.5A	Speed control servo/amplifier assembly, Generic Electronic Module (GEM), Shift lock actuator, Turn signals, 4x4
11	7.5A	Instrument cluster, 4x4, Main light switch, Central Security Module (CSM), Generic Electronic Module (GEM)
12	—	Not used
13	20A	Brake pedal position switch
14	10A	Anti-lock Brake System (ABS) control module
15	—	Not used
16	30A	Windshield wiper motor, Wiper HI/LO relay, Wiper run/park relay
17	20A	Cigar lighter, Data Link Connector (DLC)
18	—	Not used
19	25A	Powertrain Control Module (PCM) power diode, Ignition, PATS (Passive Anti-Theft System)
20	7.5A	Generic Electronic Module (GEM), Radio
21	15A	Hazard flasher
22	20A	Auxiliary power socket
23	—	Not used
24	7.5A	Clutch Pedal Position (CPP) switch, Starter interrupt relay
25	—	Not used

Roadside Emergencies

Fuse/Relay Location	Fuse Amp Rating	Passenger Compartment Fuse Panel Description
26	10A	Battery saver relay, Auxiliary relay box, Restraint Central Module (RCM), Generic Electronic Module (GEM), Instrument cluster
27	—	Not used
28	7.5A	Generic Electronic Module (GEM), Radio
29	20A	Radio
30	—	Not used
31	—	Not used
32	—	Not used
33	15A	Headlamps, Daytime Running Lamps (DRL) module, Instrument cluster
34	—	Not used
35	15A	Horn relay (if not equipped with a Central Security Module)
36	—	Not used

Power distribution box

The power distribution box is located in the engine compartment. The power distribution box contains high-current fuses that protect your vehicle's main electrical systems from overloads.

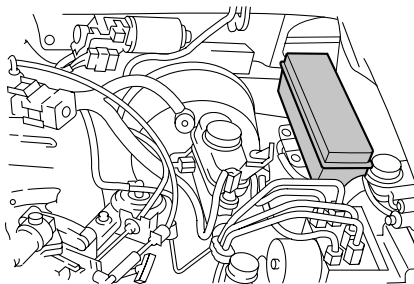

WARNING: Always disconnect the battery before servicing high current fuses.

Roadside Emergencies

WARNING: To reduce risk of electrical shock, always replace the cover to the Power Distribution Box before reconnecting the battery or refilling fluid reservoirs.

If the battery has been disconnected and reconnected, refer to the *Battery* section of the *Maintenance and specifications* chapter.

2.3L engine (if equipped)

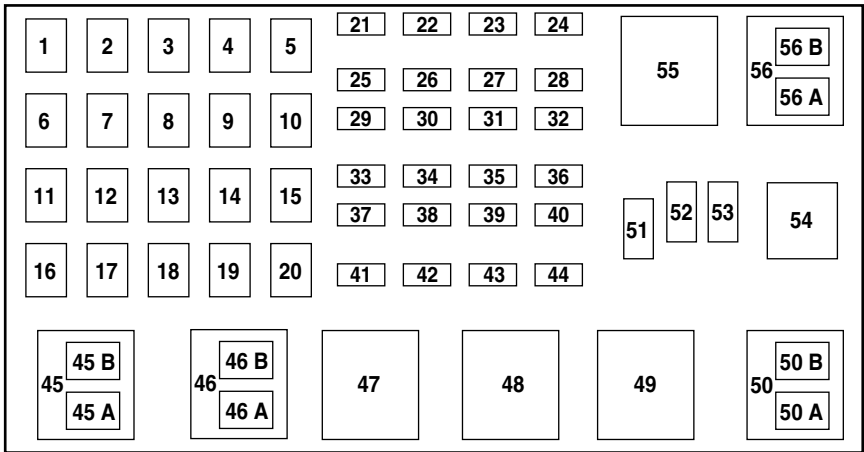

The high-current fuses are coded as follows:

Fuse/Relay Location	Fuse Amp Rating	Power Distribution Box Description
1	50A**	I/P fuse panel
2	—	Not used
3	—	Not used
4	—	Not used
5	—	Not used
6	50A**	Anti-lock Brake System (ABS) pump motor
7	30A*	Powertrain Control Module (PCM)

Roadside Emergencies

Fuse/Relay Location	Fuse Amp Rating	Power Distribution Box Description
8	20A*	Central security module, Power door locks, Remote entry
9	—	Not used
10	—	Not used
11	50A**	Starter relay, Ignition switch
12	20A*	Power windows
13	—	Not used
14	—	Not used
15	—	Not used
16	40A**	Blower motor
17	20A**	Auxiliary cooling fan
18	—	Not used
19	—	Not used
20	—	Not used
21	10A*	PCM memory
22	—	Not used
23	20A*	Fuel pump motor
24	30A*	Headlamps
25	10A*	A/C clutch relay
26	—	Not used
27	—	Not used
28	30A*	ABS module
29	—	Not used
30	15A*	Trailer Tow
31	20A*	Foglamp, Daytime Running Lamps (DRL)
32	—	Not used
33	15A*	Park lamp, Central security module
34	—	Not used
35	—	Not used

Roadside Emergencies

Fuse/Relay Location	Fuse Amp Rating	Power Distribution Box Description
36	—	Not used
37	—	Not used
38	10A*	Left headlamp low beam
39	—	Not used
40	—	Not used
41	20A*	Heated oxygen sensors
42	10A*	Right headlamp low beam
43	—	(Resistor)
44	—	Not used
45A	—	Wiper HI/LO relay
45B	—	Wiper park/run relay
46A	—	Fuel pump relay
46B	—	Trailer tow relay
47	—	Starter relay
48	—	Auxiliary cooling fan relay
49	—	Not used
50	—	Not used
51	—	Not used
52	—	Not used
53	—	PCM Diode
54	—	PCM Relay
55	—	Blower motor relay
56A	—	A/C clutch relay
56B	—	Front washer pump relay
* Mini Fuses ** Maxi Fuses		

Roadside Emergencies

3.0L and 4.0L engines (if equipped)

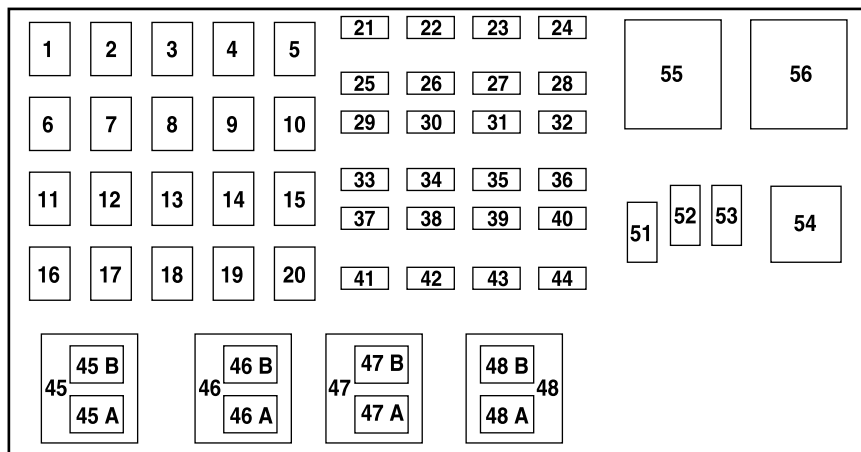

The high-current fuses are coded as follows:

Fuse/Relay Location	Fuse Amp Rating	Power Distribution Box Description
1	50A**	I/P fuse panel
2	—	Not used
3	—	Not used
4	—	Not used
5	—	Not used
6	50A**	Anti-lock Brake System (ABS) Pump Motor
7	30A*	Powertrain Control Module (PCM)
8	20A*	Power door locks, Remote entry
9	—	Not used
10	—	Not used
11	50A**	Starter relay, Ignition switch
12	20A*	Power windows
13	20A*	4x4 motor

Roadside Emergencies

Fuse/Relay Location	Fuse Amp Rating	Power Distribution Box Description
14	—	Not used
15	—	Not used
16	40A**	Blower motor
17	—	Not used
18	—	Not used
19	—	Not used
20	—	Not used
21	10A*	Powertrain Control Module (PCM) memory
22	—	Not used
23	20A*	Fuel pump motor
24	30A*	Headlamps
25	10A*	A/C clutch solenoid
26	—	Not used
27	—	Not used
28	30A*	Anti-lock Brake System (ABS) module
29	—	Not used
30	15A*	Trailer tow
31	20A*	Foglamps, Daytime Running Lamps (DRL)
32	—	Not used
33	15A*	Park lamp
34	—	Not used
35	—	Not used
36	—	Not used
37	—	Not used
38	10A*	Left headlamp low beam
39	—	Not used
40	—	Not used
41	20A*	Heated oxygen sensors

Roadside Emergencies

Fuse/Relay Location	Fuse Amp Rating	Power Distribution Box Description
42	10A*	Right headlamp low beam
43	—	Not used
44	—	Not used
45A	—	Wiper HI/LO relay
45B	—	Wiper park/run relay
46A	—	Fuel pump relay
46B	—	Trailer tow relay
47A	—	A/C clutch solenoid relay
47B	—	Front washer pump relay
48A	—	Fog lamps
48B	—	Fog lamp relay
51	—	Not used
52	—	Not used
53	—	Powertrain Control Module (PCM) Diode
54	—	Powertrain Control Module (PCM)
55	—	Blower relay
56	—	Starter relay
* Mini Fuses ** Maxi Fuses		

OVERHEATING

If the temperature gauge indicates overheating and you experience power loss, you hear a loud knocking or pinging noise, the engine is probably too hot.

If this happens:

1. Drive safely to the side of the road and park off the right-of-way.
2. Shift the automatic transmission into P (Park) or the manual transmission into the neutral position, and apply the parking brake.
3. Turn off the air conditioner.

WARNING: Steam from an overheated engine is dangerous. The escaping steam could seriously burn you. Open the hood ONLY after steam is no longer escaping from the engine.

Roadside Emergencies

4. Check whether coolant or steam is escaping from under the hood or from the engine compartment.
- **If steam is coming from the engine compartment:** do not go near the front of the vehicle. Stop the engine, then turn the ignition switch to the ON position without starting the engine. The radiator cooling fans will start to cool the engine.
- **If neither coolant nor steam is escaping:** open the hood and idle the engine until it cools. If this does not lower the temperature, stop the engine and let it cool.
5. Check the coolant level. If it is low, look for leaks in the radiator hoses and connections, heater hoses and connections, radiator and water pump.

If you find a leak or other damage, or if coolant is still leaking, stop the engine and call an Authorized Mazda dealer.

See *Adding coolant* in the *Maintenance and specifications* section. If you find no problems, the engine is cool and no leaks are obvious, carefully add coolant as required.

WARNING: When the engine and radiator are hot, scalding coolant and steam may shoot out under pressure and cause serious injury. Do not remove the cooling system cap when the engine and radiator are hot.

Note: If the engine continues to overheat or frequently overheats, have the cooling system inspected. The engine could be seriously damaged unless repairs are made.

CHANGING THE TIRES

If you get a flat tire while driving, do not apply the brake heavily. Instead, gradually decrease your speed. Hold the steering wheel firmly and slowly move to a safe place on the side of the road.

WARNING: The use of tire sealants is not recommended and may compromise the integrity of your tires.

Roadside Emergencies

Temporary spare tire information

Your vehicle may be equipped with a conventional spare tire that may be different in size (smaller diameter and narrower width) than other tires on your vehicle. If this is the case, your spare tire is considered “temporary” and the spare wheel will be labeled as such. Replace this tire with a tire of the same size, speed rating and load carrying capacity as the other road tires as soon as possible.

It is not recommended that the vehicle be operated in 4WD modes with a “temporary” (i.e. dissimilar size) spare. If 4WD operation is necessary, do not operate above speeds of 16 km/h (10 mph) or for distances above 80 km (50 miles).



If you use the temporary spare tire continuously or do not follow these precautions, the tire could fail, causing you to lose control of the vehicle, possibly injuring yourself or others.

When driving with the temporary spare tire **do not:**

- exceed 80 km/h (50 mph) or drive further than 3,200 km (2,000 miles) total under any circumstances
- load the vehicle beyond maximum vehicle load rating listed on the Safety Compliance Label
- tow a trailer
- use more than one temporary spare tire at a time

Use of a temporary spare tire at any one wheel location can lead to impairment of the following:

- Handling, stability and braking performance
- Comfort and noise
- Ground clearance and parking at curbs
- Winter driving capability

Conventional spare tire information

If you have the conventional spare tire, you can use it as a spare or a regular tire. The spare is identical to the other tires on your vehicle, although the wheel may not match.

Location of the spare tire and tools

The spare tire and tools for your vehicle are stowed in the following locations:

Tool	Location
Spare tire	Under the vehicle, just forward of the rear bumper
Jack, jack handle, wheel nut wrench	Regular Cab: behind seats and underneath the jack and tools cover
	Cab Plus: stowed in the passenger side rear cab compartment or behind the jump seat in a separate tool bag
	Cab Plus 4-Door: stowed behind the front seats, between jump seats and underneath jack and tools cover.
Key, spare tire lock (if equipped)	In the glove box

Removing the spare tire

1. Assemble the jack handle to the lug wrench as shown in the illustrations.

When connecting the jack handle, assemble the following:

- one handle extension and one typical extension. To assemble, slide parts together. To disconnect, depress button and pull apart.
- one wheel nut wrench. Depress button and slide together.

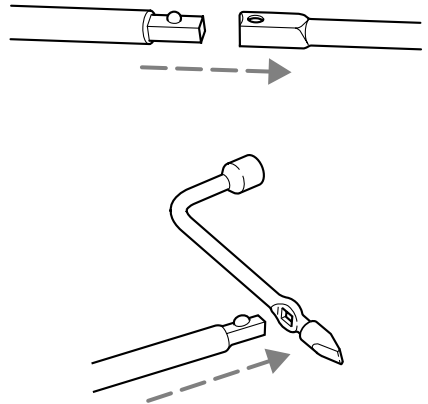

Roadside Emergencies

2. If equipped, unlock and remove the spare tire carrier lock from the rear access hole located just above the rear bumper and below the tailgate.

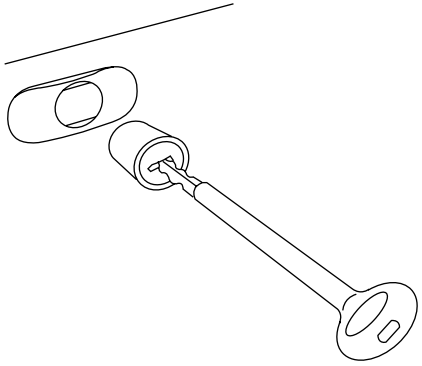

3. Insert the straight end of the jack handle into the rear access hole located just above the rear bumper and below the tailgate.

Forward motion will stop and resistance to turning will be felt when properly engaged.

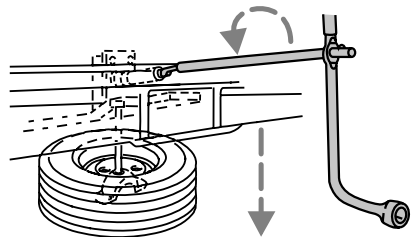

4. Turn the handle counterclockwise until tire is lowered to the ground and the cable is slightly slack.
5. Remove the retainer from the spare tire.

Stowing the spare tire

1. Lay the tire on the ground with the valve stem facing up.
2. Install the retainer through the wheel center and slide the wheel under the vehicle.
3. Turn the spare handle clockwise until the tire is raised to its original position underneath the vehicle. The spare handle ratchets when the tire is raised to the stowed position. It will not allow you to overtighten.

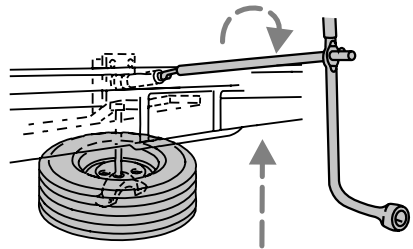

Roadside Emergencies

4. If your vehicle is equipped with P265/75 R15 AT tires, do not stow a flat or inflated full size spare tire in the spare tire carrier. The flat full size tire should be stowed and tied down in the pickup box bed until it can be repaired.
5. If removed, install the spare tire carrier lock on the access hole above the bumper.

Tire change procedure

WARNING: When one of the front wheels is off the ground, the transmission alone will not prevent the vehicle from moving or slipping off the jack, even if the vehicle is in P (Park) (automatic transmission) or R (Reverse) (manual transmission).

WARNING: To prevent the vehicle from moving when you change a tire, be sure the parking brake is set, then block (in both directions) the wheel that is diagonally opposite (other side and end of the vehicle) to the tire being changed.

WARNING: If the vehicle slips off the jack, you or someone else could be seriously injured.

1. Park on a level surface, activate hazard flashers and place gearshift lever in P (Park) (automatic transmission) or 1 (First) (manual transmission).
2. Set the parking brake and turn engine OFF.

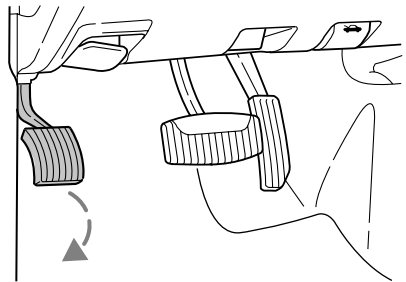

Roadside Emergencies

3. Block the diagonally opposite wheel.

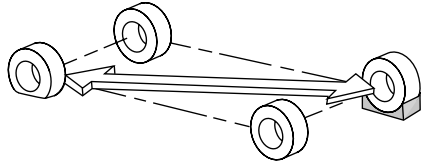

4. Insert tapered end of the lug wrench behind hub caps and twist them off.
5. Loosen each wheel lug nut one-half turn counterclockwise but do not remove them until the wheel is raised off the ground.
6. Position the jack according to the following guides and turn the jack handle clockwise until the tire is a maximum of 25 mm (1 inch) off the ground.

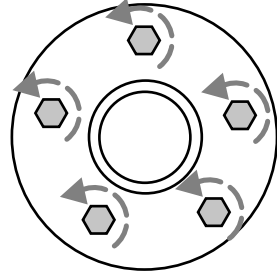

WARNING: To lessen the risk of personal injury, do not put any part of your body under the vehicle while changing a tire. Do not start the engine when your vehicle is on the jack. The jack is only meant for changing the tire.

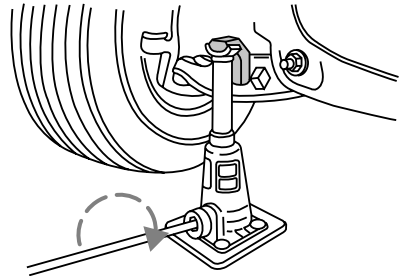

Roadside Emergencies

- Front

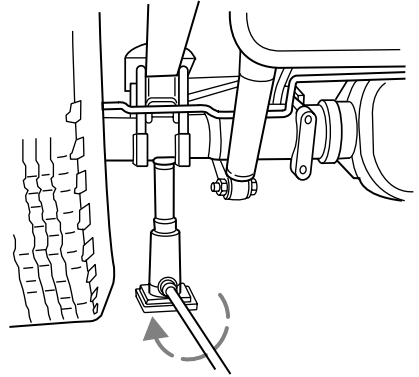

- Rear

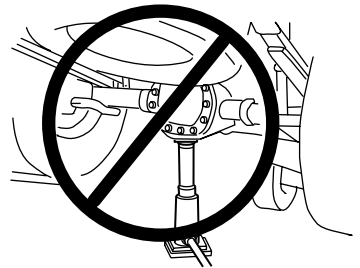

Never use the differential as a jacking point. It is too easy for the vehicle to tilt or fall and you can be injured.

7. Remove the wheel lug nuts with the lug wrench.
8. Replace the flat tire with the spare tire, making sure the valve stem is facing outward. Reinstall the lug nuts until the wheel is snug against the hub. Do not fully tighten the lug nuts until the wheel has been lowered.
9. Lower the wheel by turning the jack handle counterclockwise.

Roadside Emergencies

- Remove the jack and fully tighten the lug nuts, in the order shown, to 135 Nm (100 lb-ft). Note that these tightening specifications are for nut and bolt threads that are free of dirt and rust. Use only Mazda recommended (1/2–20) replacement fasteners.
- Stow the flat tire. Refer to *Stowing the spare tire*.
- Stow the jack and lug wrench. Make sure the jack is fastened so it does not rattle when you drive.
- Unblock the wheels.

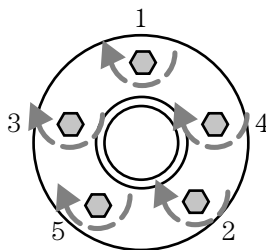

Stowing the flat/spare tire

- Lay the tire on the ground with the valve stem facing up.
- Slide the wheel partially under the vehicle and install the wire and retainer through the center of the wheel.
- Turn the jack handle clockwise until the tire is raised to its original position underneath the vehicle. The effort to turn the jack handle increases significantly as the tire contacts the frame. The spare tire carrier will ratchet when the tire is in the fully stowed position. The spare tire carrier has a built-in ratchet feature that will not allow you to overtighten. If the spare tire carrier ratchets with very little effort, take the vehicle to your dealer for assistance at your earliest convenience.
- Check that the tire lies flat against the frame assembly. Push against the tire to make sure it is tightly sealed under the vehicle. Loosen and retighten, if necessary. Failure to properly stow the spare tire may result in failure of the winch cable and loss of the spare tire.
- Repeat this tightness check procedure when servicing the spare tire pressure (every six months, per service maintenance section), or at any time that the spare tire is disturbed through service of other components.
- Install the spare tire lock (if equipped) into the access hole above the rear bumper with the spare tire lock key (if equipped) and jack handle.

JUMP STARTING YOUR VEHICLE

WARNING: The gases around the battery can explode if exposed to flames, sparks, or lit cigarettes. An explosion could result in injury or vehicle damage.

WARNING: Batteries contain sulfuric acid which can burn skin, eyes and clothing, if contacted.

Do not attempt to push-start your vehicle. Automatic transmissions do not have push-start capability; also, the catalytic converter may become damaged.

Preparing your vehicle

When the battery is disconnected or a new battery is installed, the transmission must relearn its shift strategy. As a result, the transmission may have firm and/or soft shifts. This operation is considered normal and will not affect function or durability of the transmission. Over time, the adaptive learning process will fully update transmission operation.

1. **Use only a 12-volt supply to start your vehicle.**
2. Do not disconnect the battery of the disabled vehicle as this could damage the vehicle's electrical system.
3. Park the booster vehicle close to the hood of the disabled vehicle making sure the two vehicles **do not** touch. Set the parking brake on both vehicles and stay clear of the engine cooling fan and other moving parts.
4. Check all battery terminals and remove any excessive corrosion before you attach the battery cables. Ensure that vent caps are tight and level.
5. Turn the heater fan on in both vehicles to protect any electrical surges. Turn all other accessories off.

Roadside Emergencies

Connecting the jumper cables

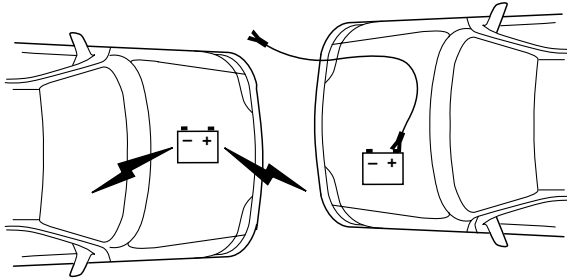

1. Connect the positive (+) jumper cable to the positive (+) terminal of the discharged battery.

Note: In the illustrations, *lightning bolts* are used to designate the assisting (boosting) battery.

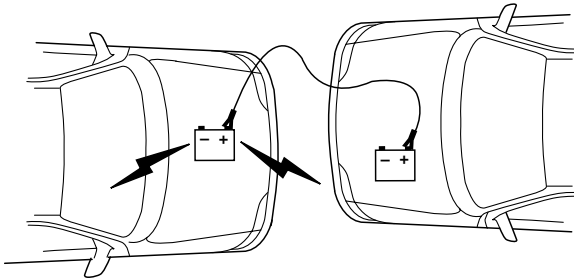

2. Connect the other end of the positive (+) cable to the positive (+) terminal of the assisting battery.

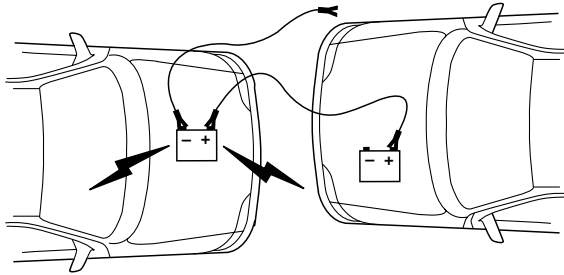

3. Connect the negative (-) cable to the negative (-) terminal of the assisting battery.

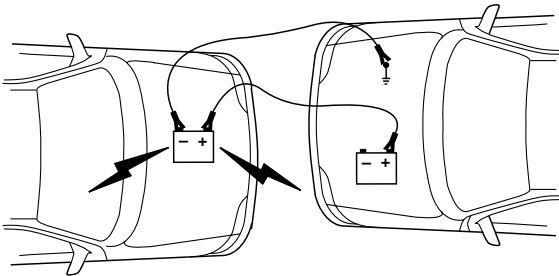

4. Make the final connection of the negative (-) cable to an exposed metal part of the stalled vehicle's engine, away from the battery and the carburetor/fuel injection system. **Do not** use fuel lines, engine rocker covers or the intake manifold as *grounding* points.

WARNING: Do not connect the end of the second cable to the negative (-) terminal of the battery to be jumped. A spark may cause an explosion of the gases that surround the battery.

5. Ensure that the cables are clear of fan blades, belts, moving parts of both engines, or any fuel delivery system parts.

Jump starting

1. Start the engine of the booster vehicle and run the engine at moderately increased speed.
2. Start the engine of the disabled vehicle.
3. Once the disabled vehicle has been started, run both engines for an additional three minutes before disconnecting the jumper cables.

Roadside Emergencies

Removing the jumper cables

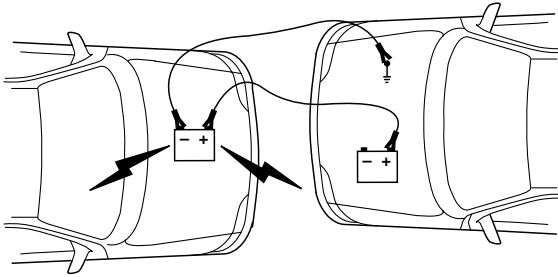

Remove the jumper cables in the reverse order that they were connected.

1. Remove the jumper cable from the *ground* metal surface.

Note: In the illustrations, *lightning bolts* are used to designate the assisting (boosting) battery.

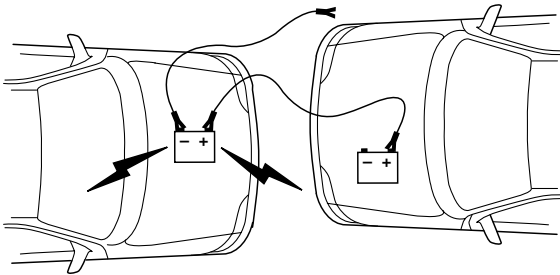

2. Remove the jumper cable on the negative (-) connection of the booster vehicle's battery.

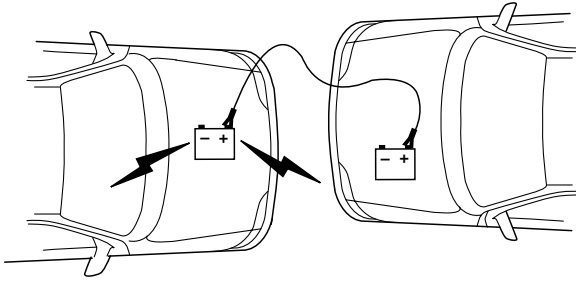

3. Remove the jumper cable from the positive (+) terminal of the booster vehicle's battery.

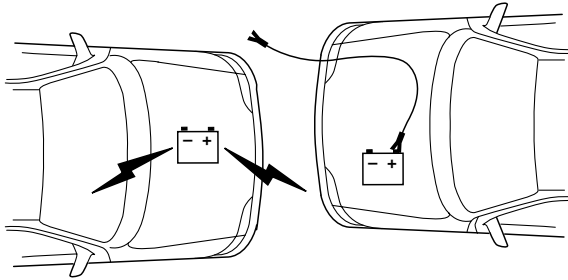

4. Remove the jumper cable from the positive (+) terminal of the disabled vehicle's battery.

After the disabled vehicle has been started and the jumper cables removed, allow it to idle for several minutes so the engine computer can *relearn* its idle conditions.

Roadside Emergencies

WRECKER TOWING

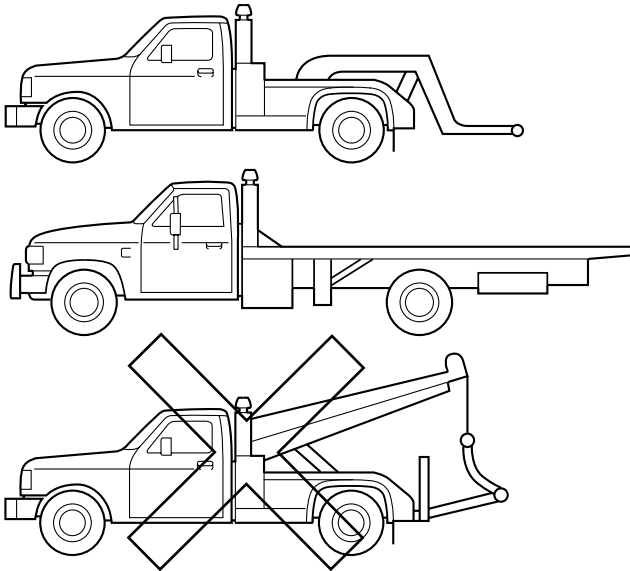

If you need to have your vehicle towed, contact a professional towing service or, if you are a member of a roadside assistance program, your roadside assistance service provider.

It is recommended that your vehicle be towed with a wheel lift or flatbed equipment. Do not tow with a slingbelt. Mazda has not approved a slingbelt towing procedure.

On 4x2 vehicles, it is acceptable to tow the vehicle with the front wheels on the ground and the rear wheels off the ground.

On 4x4 vehicles, it is recommended that your vehicle be towed with a wheel lift and dollies or flatbed equipment with all the wheels off the ground.

If the vehicle is towed by other means or incorrectly, vehicle damage may occur.

CUSTOMER ASSISTANCE (U.S.A.)

Your complete and permanent satisfaction is our business. We are here to serve you. All Authorized Mazda Dealers have the knowledge and the tools to keep your Mazda vehicle in top condition.

If you have any questions or recommendations for improvement regarding the service of your Mazda vehicle or servicing by Mazda Dealer personnel, we recommend that you take the following steps:

STEP 1: Contact Your Mazda Dealer

Discuss the matter with an Authorized Mazda Dealer. This is the quickest and best way to address the issue. If your concern has not been resolved by the CUSTOMER RELATIONS, SALES, SERVICE, or PARTS MANAGER, then please contact the GENERAL MANAGER of the dealership or the OWNER.

STEP 2: Call the Mazda National Customer Assistance Center

If for any reason you feel the need for further assistance after contacting your dealership management, call Mazda North American Operations' Customer Assistance Center toll-free at: **1 (800) 222-5500**

In order to serve you efficiently and effectively, please help us by providing the following information:

1. Your name, address, and telephone number
2. Year and model of vehicle
3. Vehicle Identification Number (17 digits, noted on your registration or title or located on the upper driver's side corner of the dash)
4. Purchase date and current mileage
5. Your dealer's name and location
6. Your question(s)

If you would like to write a letter, please address it to the following, Attn: Customer Assistance.

Mazda North American Operations
7755 Irvine Center Drive
Irvine, CA 92618-2922
P.O. Box 19734
Irvine, CA 92623-9734

This way, we can be sure to respond to you as efficiently as possible. That is our goal.

If you live outside the U.S.A., please contact your nearest Mazda Distributor.

Customer Assistance

CUSTOMER ASSISTANCE (CANADA)

Your complete and permanent satisfaction is our business. We are here to serve you. All Authorized Mazda Dealers have the knowledge and the tools to keep your Mazda vehicle in top condition.

In our experience, any questions, problems or complaints regarding the operation of your Mazda or any other general service transactions are most effectively resolved by your dealer. If the cause of your dissatisfaction cannot adequately be addressed by normal dealership procedures, we recommend that you take the following steps:

STEP 1: Contact Your Mazda Dealer

Discuss the matter with a member of dealership management. If the Service Manager has already reviewed your concerns, contact the owner of the dealership or its General Manager

STEP 2: Call the Mazda Regional Office

If you feel that you still require assistance, ask the dealer Service Manager to arrange for you to meet the local Mazda Service Representative. If more expedient, contact Mazda Canada Inc. Regional Office nearest you for such arrangements.

STEP 3: Contact the Mazda Customer Relations Department

If still not substantially satisfied, contact the Customer Relations Department, Mazda Canada Inc., 305 Milner Avenue, Suite 400 Scarborough, Ontario M1B 3V4 Canada TEL: 1 (800) 263-4680.

Provide the Department with the following information:

1. Your name, address, and telephone number
2. Year and model of vehicle
3. Vehicle Identification Number (VIN). Refer to the "Vehicle Identification Labels" page of section 10 of this manual for the location of the VIN.
4. Purchase date.
5. Present odometer reading.
6. Your dealer's name and location
7. The nature of your problem and/or cause of dissatisfaction.

The Department, in cooperation with the local Mazda Service Representative, will review the case to determine if everything possible has been done to ensure your satisfaction.

Please recognize that the resolution of service problems in most cases requires the use of your Mazda dealer's service facilities, personnel and

equipment. We urge you to follow the above three steps in sequence therefore for most effective results.

MEDIATION/ARBITRATION PROGRAM

Occasionally a customer concern cannot be resolved through Mazda's Customer Satisfaction Program. If after exhausting procedures in this manual, your concern is still not resolved, you have another option.

Mazda Canada Inc. participates in an arbitration program administered by the Canadian Motor Vehicle Arbitration Plan (CAMVAP). CAMVAP will advise you about how your concern may be reviewed and resolved by an independent third party through binding arbitration.

Your complete satisfaction is the goal of Mazda Canada Inc. and our dealers. Mazda's participation in CAMVAP makes a valuable contribution to our achieving that goal. There is no charge for using CAMVAP. CAMVAP results are fast, fair and final as the award is binding on both you and Mazda Canada Inc.

CANADIAN MOTOR VEHICLE ARBITRATION PLAN (CAMVAP)

If a specific item of concern arises, where a solution cannot be reached between an owner, Mazda, and/or one of its dealers (that all parties cannot agree upon), the owner may wish to use the services offered by the Canadian Motor Vehicle Arbitration Plan (CAMVAP).

CAMVAP uses the services of Provincial Administrators to assist consumers in scheduling and preparing for their arbitration hearings. However, before you can proceed with CAMVAP you must follow your Mazda dispute resolution process as outlined previously.

CAMVAP is fully implemented in all provinces and territories. Consumers wishing to obtain further information about the Program can obtain an information booklet from their dealer, the Provincial Administrator of the Canadian Motor Vehicle Arbitration Plan Office at the following address or telephone number.

Canadian Motor Vehicle Arbitration Office
235 Yorkland Boulevard, Suite 300
North York, Ontario
M2J 4Y8
1 (800) 207-0685

Customer Assistance

Provincial Administrators may be reached locally as listed below:

Province/Territory	CAMVAP Number
British Columbia & Yukon Territories	(604) 681-0312
Alberta & Northwest Territories	(403) 426-0650
Saskatchewan	(306) 352-9259
Manitoba	(204) 942-7166
Ontario	(416) 596-8824
Atlantic Canada	(902) 422-5413
Quebec	(418) 649-1330

REGIONAL OFFICES

Regional Offices	Areas Covered
Mazda Canada Inc. Western Region 8171 Ackroyd Road Suite 2000 Richmond, B.C. V6X 3K1 (604) 303-5670	Alberta, British Columbia, Manitoba, Saskatchewan, Yukon
Mazda Canada Inc. Central/Atlantic Region 305 Milner Avenue Suite 400 Scarborough, Ontario. M1B 3V4 1 (800) 263-4680	Ontario, New Brunswick, Nova Scotia, Prince Edward Island, Newfoundland
Mazda Canada Inc. Quebec Region 6111 Route Trans Canadienne Pointe Claire, Quebec H9R 5A5 (514) 694-6390	Quebec

CUSTOMER ASSISTANCE (PUERTO RICO)

Your complete and permanent satisfaction is our business. That is why all Authorized Mazda Dealers have the knowledge and the tools to keep your Mazda vehicle in top condition.

If you have any questions or recommendations for improvement regarding the service of your Mazda vehicle or servicing by Mazda Dealer personnel, we recommend that you take the following steps:

STEP 1

Discuss the matter with an Authorized Mazda Dealer. This is the quickest and best way to address the issue. If your concern has not been resolved by the CUSTOMER RELATIONS, SALES, SERVICE, or PARTS MANAGER, then please contact the GENERAL MANAGER of the dealership or the OWNER.

STEP 2

If, after following STEP 1, you feel the need for further assistance, please contact your area's Mazda representative (Indicated on the next page).

Please help us by providing the following information:

1. Your name, address, and telephone number
2. Year and model of vehicle
3. Vehicle Identification Number (17 digits, noted on your registration or title or located on the upper driver's side corner of the dash)
4. Purchase date and current mileage
5. Your dealer's name and location
6. Your question(s)

If you would like to write a letter, please address it to the following,
Attn: Customer Assistance

Plaza Motors Corp.

Mazda de Puerto Rico

P.O. Box 362722

San Juan, Puerto Rico

00936-2722

Tel: (787) 788-9300

This way, we can be sure to respond to you as efficiently as possible. That is our goal.

If you live outside the U.S.A., please contact your nearest Mazda Distributor.

Customer Assistance

MAZDA IMPORTERS/DISTRIBUTORS

U.S.A (Importer/Distributor)

Mazda North American Operations

7755 Irvine Center Drive

Irvine, CA 92618-2922

P.O. Box 19734

Irvine, CA 92623-9734

TEL: 1 (800) 222-5500 (in U.S.A.)

(949) 727-1990 (outside U.S.A.)

(Distributor in each area)

CANADA

Mazda Canada, Inc.

305 Milner Avenue, Suite 400

Scarborough, Ontario M1B 3V4 Canada

TEL: 1 (800) 263-4680 (in Canada)

(416) 609-9909 (outside Canada)

PUERTO RICO

Plaza Motors Corp. (Mazda de Puerto Rico)

P.O. Box 362722, San Juan, Puerto Rico 00936-2722

TEL: (787) 788-9300

GUAM

(d.b.a. Triple J. Enterprises, Inc.)

P.O. Box 6066 Tamuning, Guam

TEL: (671) 646-9216

SAIPAN

Pacific International Marianas, Inc.

(d.b.a. Midway Motors)

P.O. Box 887 Saipan, MP 96950

TEL: (670) 234-7524

Triple J Saipan, Inc.

(d.b.a. Triple J Motors)

Beach Road

Chalan LauLau

Saipan, MP 96950

TEL: (670) 235-4868

AMERICAN SAMOA

Polynesia Motors, Inc.

P.O. Box 1120, Pago Pago, American Samoa 96799

TEL: (684) 699-1854

ADD-ON NON-GENUINE PARTS AND ACCESSORIES

Non-genuine parts and accessories for Mazda vehicles can be found in stores. These may fit your vehicle, but they are not approved by the manufacturer for use with Mazda vehicles. When you install non-genuine parts or accessories, they could affect your vehicle's performance or safety system; the manufacturer's warranty doesn't cover this. Before you install any non-genuine parts or accessories, consult an Authorized Mazda Dealer.

WARNING: Installation of Non-Genuine Parts or Accessories: Installation of non-genuine parts or accessories could be dangerous. Improperly designed parts or accessories could seriously affect your vehicle's performance or safety system. This could cause you to have an accident or increase your chances of injuries in an accident. Always consult an Authorized Mazda Dealer before you install non-genuine parts or accessories.

WARNING: Add-On Electrical and Electronic Equipment: Incorrectly choosing or installing improper add-on equipment or choosing an improper installer could be dangerous. Essential systems could be damaged, causing engine stalling, air-bag (SRS) activation, ABS inactivation, or a fire in the vehicle. Be very careful in choosing and installing add-on electrical equipments, such as mobile telephones, two-way radios, stereo systems, and car alarm systems.

Mazda assumes no responsibility for death, injury, or expenses that may result from the installation of add-on non-genuine parts or accessories.

WARRANTIES FOR YOUR MAZDA

- New Vehicle Limited Warranty
- Safety Restraint System Limited Warranty
- Anti-perforation Limited Warranty
- Federal Emission Control Warranty
 - Emission Defect Warranty
 - Emission Performance Warranty

Customer Assistance

- California Emission Control Warranty (if applicable)
- Replacement Parts and Accessories Limited Warranty
- Tire Warranty

NOTE: Detailed warranty information is provided with your Mazda portfolio.

OUTSIDE THE UNITED STATES AND CANADA

Government regulations in the United States require that automobiles meet specific emission regulations and safety standards. Therefore, vehicles built for use in the United States, its territories, and Canada may differ from those sold in other countries.

The differences may make it difficult or even impossible for your vehicle to receive satisfactory servicing in other countries. We strongly recommend that you NOT take your Mazda outside these areas.

You may have these problems if you do:

- Recommended fuel may be unavailable. Any kind of leaded fuel or low-octane fuel will affect vehicle performance and damage the emission controls and engine.
- Proper repair facilities, tools, testing equipment, and replacement parts may not be available.

The manufacturer's warranty applies only to Mazda vehicles registered and normally operated in the United States, its territories, and Canada.

REPORTING SAFETY DEFECTS

If you believe that your vehicle has a defect which could cause a crash or could cause injury or death, you should immediately inform the National Highway Traffic Safety Administration (NHTSA) in addition to notifying your Mazda importer/distributor.

If NHTSA receives similar complaints, it may open an investigation, and if it finds that a safety defect exists in a group of vehicles, it may order a recall and remedy campaign. However NHTSA cannot become involved in individual problems between you, your dealer, or your Mazda importer/distributor).

To contact NHTSA, you may either call the Auto Safety Hotline toll-free at 1 (800) 424-9393 (or 366-0123 in Washington, D.C. area) or write to: NHTSA, U.S. Department of Transportation, Washington, D.C. 20590. You can also obtain other information about motor vehicle safety from the Hotline.

(Note)

If you live in the U.S.A., all correspondence to:

Mazda North American Operations
7755, Irvine Center Drive
Irvine, California 92618-2922
P.O. Box 19734
Irvine, CA 92623-9734
Customer Assistance Center
or toll free at 1 (800) 222-5500

If you live outside of the U.S.A., please contact the nearest Mazda Distributor. (See the *Mazda Importers/Distributors* section of this manual).

SERVICE PUBLICATIONS

Factory-authorized Mazda service publication are available for owners who wish to do some of their own maintenance and repair.

When requesting any of our publications through an Authorized Mazda Dealer, refer to the chart below.

If they don't have what you need in stock, they can order it for you.

PUBLICATION ORDER NUMBER	PUBLICATION DESCRIPTION
9999 95 022B 03	2003 WORKSHOP MANUAL
9999 95 020G 03	2003 WIRING DIAGRAM
9999 95 023C 03	2003 OWNER'S MANUAL

WORKSHOP MANUAL:

Covers recommended maintenance and repair procedures of the drive train, body and chassis.

WIRING DIAGRAM:

Provides electrical schematics as well as component location for the entire electrical system.

OWNER'S MANUAL:

This booklet contains information regarding the proper care and operation of your vehicle. This is not a technician's manual.

Please note that your Authorized Mazda Dealership has trained personnel and special service tools to correctly and safely maintain Mazda vehicles.

Customer Assistance

IN CALIFORNIA (U.S. ONLY)

California Civil Code Section 1793.2(d) requires that, if a manufacturer or its representative is unable to repair a motor vehicle to conform to the vehicle's applicable express warranty after a reasonable number of attempts, the manufacturer shall be required to either replace the vehicle with one substantially identical or repurchase the vehicle and reimburse the buyer in an amount equal to the actual price paid or payable by the consumer (less a reasonable allowance for consumer use). The consumer has the right to choose whether to receive a refund or replacement vehicle.

California Civil Code Section 1793.22(b) presumes that the manufacturer has had a reasonable number of attempts to conform the vehicle to its applicable express warranties if, within the first 18 months of ownership of a new vehicle or the first 29 000 km (18 000 miles), whichever occurs first:

1. Two or more repair attempts are made on the same nonconformity likely to cause death or serious bodily injury OR
2. Four or more repair attempts are made on the same nonconformity (a defect or condition that substantially impairs the use, value or safety of the vehicle) OR
3. The vehicle is out of service for repair of nonconformities for a total of more than 30 calendar days (not necessarily all at one time)

In the case of 1 or 2 above, the consumer must also notify the manufacturer of the need for the repair of the nonconformity at the following address:

Mazda North American Operations
7755, Irvine Center Drive
Irvine, CA 92618-2922

REPORTING SAFETY DEFECTS (U.S. ONLY)

If you believe that your vehicle has a defect that could cause a crash, or could cause injury or death, you should immediately inform the National Highway Traffic Safety Administration (NHTSA) in addition to notifying Mazda Corporation.

If NHTSA receives similar complaints, it may open an investigation, and if it finds that a safety defect exists in a group of vehicles, it may order a recall and remedy campaign. However, NHTSA cannot become involved in individual problems between you, your dealer or Mazda Corporation.

Customer Assistance

To contact NHTSA, you may either call the Auto Safety Hotline toll-free at 1-800-424-9393 (202-366-0123 in the Washington D.C. area) or write to:

NHTSA
U.S. Department of Transportation
400 Seventh Street
Washington D.C. 20590

You can also obtain other information about motor vehicle safety from the Hotline.

Cleaning

WASHING YOUR VEHICLE

Wash your vehicle regularly with cold or lukewarm water. Never use strong detergents or soap. If your vehicle is particularly dirty, use a quality car wash detergent. Always use a clean sponge, washing glove or similar device and plenty of water for best results. To avoid spots, avoid washing when the hood is still warm, immediately after or during exposure to strong sunlight.

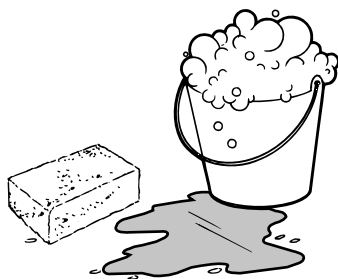

During winter months, it is especially important to wash the vehicle on a regular basis. Large quantities of dirt and road salt are difficult to remove and also cause damage to the vehicle.

Any gasoline spilled on the vehicle or deposits such as bird droppings should be washed and sponged off as soon as possible. Deposits not removed promptly can cause damage to the vehicle's paintwork.

Remove any exterior accessories, such as antennas, before entering a car wash. If you have wax applied to the vehicle at a commercial car wash, it is recommended that you clean the wiper blades and windshield as described in *Cleaning the wiper blades, windshield and rear window.*

After washing, apply the brakes several times to dry them.

WAXING YOUR VEHICLE

Waxing your vehicle on a regular basis will reduce minor scratches and paint damage.

Wax when water stops beading on the surface. This could be every three or four months, depending on operating conditions.

Use only carnauba or synthetic-based waxes. Use a cleaning fluid with a clean cloth to remove any bugs before waxing your vehicle. Use tar remover to remove any tar spots.

Avoid getting wax on the windshield, or on any surfaces which appear coarse or bumpy. If you have wax applied at a commercial car wash, it is recommended that you clean the wiper blades and windshield as described in *Cleaning the wiper blades, windshield and rear window.*

REPAIRING PAINT CHIPS

Minor scratches or paint damage from road debris may be repaired with Genuine Mazda Touch-Up Paint. Observe the application instructions on the products.

Remove particles such as bird droppings, tree sap, insect remains, tar spots, road salt and industrial fallout immediately.

CLEANING THE WHEELS

Wash with the same detergent as the body of your vehicle. Do not use acid-based or alcohol-based wheel cleaners, steel wool, fuel or strong detergents. Never use abrasives that will damage the finish of special wheel surfaces. Use a tar remover to remove grease and tar.

The brushes used in some automatic car washes may damage the finish on your wheels. Before going to a car wash, find out if the brushes are abrasive.

ENGINE

Engines are more efficient when they are clean because grease and dirt buildup keep the engine warmer than normal. When washing:

- Take care when using a power washer to clean the engine. The high-pressure fluid could penetrate the sealed parts and cause damage.
- Never spray the engine or other engine components with water. Water will damage the engine or other engine components.
- Spray Engine Shampoo and Degreaser, available at your authorized Mazda dealer, on all parts that require cleaning and pressure rinse clean.
- Cover the highlighted areas to prevent water damage when cleaning the engine.

Cleaning

- **2.3L Engine**

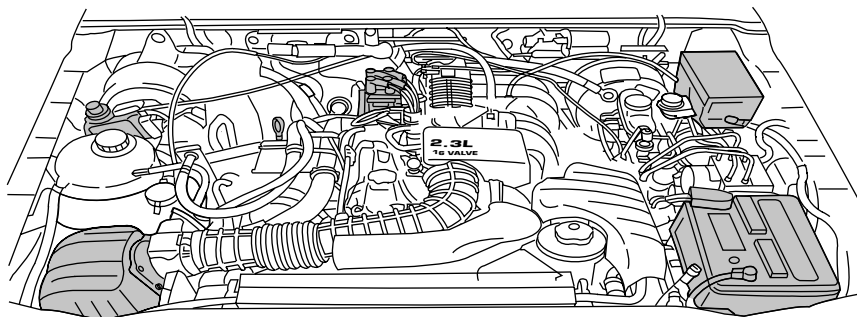

- **3.0L Engine**

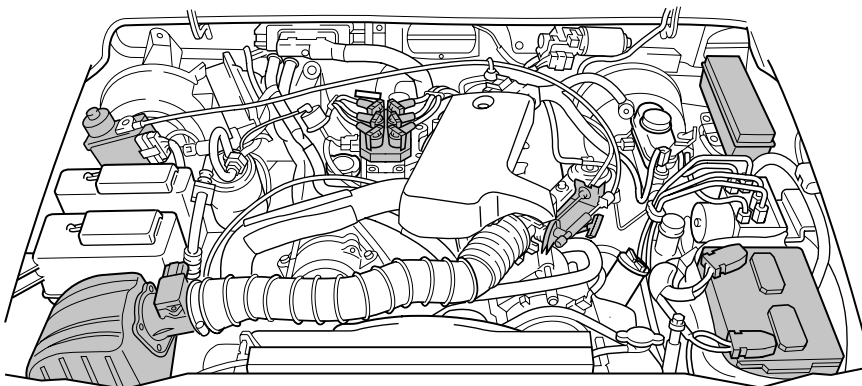

- **4.0L Engine**

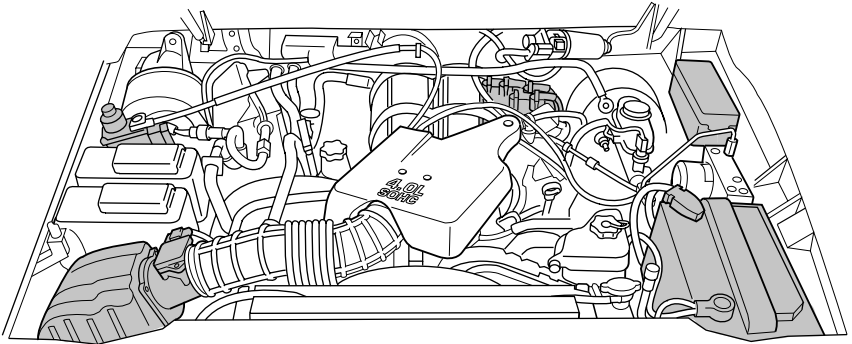

- Never wash or rinse the engine while it is running; water in the running engine may cause internal damage.

CLEANING NON-PAINTED PLASTIC EXTERIOR PARTS

Use vinyl cleaner for routine cleaning. Clean with a tar remover if necessary. Do not clean plastic parts with thinners, solvents or petroleum-based cleaners.

CLEANING MIRRORS

Do not clean your mirrors with a dry cloth or abrasive materials. Use a soft cloth and mild detergent and water. Be careful when removing ice from outside mirrors because you may damage the reflective surface.

CLEANING THE EXTERIOR LAMPS

Wash with the same detergent as the exterior of your vehicle. If necessary, use a tar remover.

To avoid scratching the lamps, do not use a dry paper towel, chemical solvents or abrasive cleaners.

CLEANING THE WIPER BLADES, WINDSHIELD AND REAR WINDOW

If the wiper blades do not wipe properly, clean the wiper blade rubber element with undiluted windshield washer solution or a mild detergent. To avoid damaging the blades, do not use fuel, kerosene, paint thinner or other solvents.

If the wiper still does not wipe properly, this could be caused by substances on the windshield or rear window such as tree sap and some

Cleaning

hot wax treatments used by commercial car washes. Clean the outside of the windshield or rear window with a non-abrasive cleaner. **Do not** use abrasive cleansers on glass as they may cause scratches. The windshield or rear window is clean if beads do not form when you rinse it with water. The windshield, rear window and wiper blades should be cleaned on a regular basis, and blades or rubber elements replaced when worn.

CLEANING THE INSTRUMENT PANEL

Clean the instrument panel with a damp cloth, then dry with a dry cloth.

Avoid cleaners or polish that increase the gloss of the upper portion of the instrument panel. The dull finish in this area helps protect the driver from undesirable windshield reflection.

Your vehicle is designed with painted controls and features which are particularly sensitive to certain products such as insect repellent and suntan lotion. When operating the various features on your vehicle, be certain to wash or wipe your hands clean if you have been in contact with any of these types of products in order to avoid possible damage to the painted surfaces.

WARNING: Do not use chemical solvents or strong detergents when cleaning the steering wheel or instrument panel to avoid contamination of the air bag system.

CLEANING THE INSTRUMENT CLUSTER LENS

Clean with a damp cloth, then dry with a dry cloth.

Do not use household or glass cleaners as these may damage the lens.

INTERIOR

For fabric, carpets, cloth seats, and safety belts:

- Remove dust and loose dirt with a vacuum cleaner.
- Remove light stains and soil with Extra Strength Upholstery Cleaner, available at your authorized Mazda dealer.
- If grease or tar is present on the material, spot-clean the area first with Spot and Stain Remover, available at your authorized Mazda dealer.
- Never saturate the seat covers with cleaning solution.
- Do not use household cleaning products or glass cleaners, which can stain and discolor the fabric and affect the flame retardant abilities of the seat materials.

INSIDE WINDOWS

Use glass cleaner for the inside windows if they become fogged.

Leather seats (if equipped)

Your leather seating surfaces have a clear, protective coating over the leather.

- To clean, use a soft cloth with Deluxe Leather and Vinyl Cleaner. Dry the area with a soft cloth.
- To help maintain its resiliency and color, use the Deluxe Leather Care Kit, available at your authorized Mazda dealer.
- Do not use household cleaning products, alcohol solutions, solvents or cleaners intended for rubber, vinyl and plastics, or oil/petroleum-based leather conditioners. These products may cause premature wearing of the clear, protective coating.

UNDERBODY

Flush the complete underside of vehicle frequently. Keep body drain holes unplugged. Inspect for road damage.

MAZDA CAR CARE PRODUCTS

Your Mazda dealer has many quality products available to clean your vehicle and protect its finishes. These quality products have been specifically engineered to fulfill your automotive needs; they are custom designed to complement the style and appearance of your vehicle. Each product is made from high quality materials that meet or exceed rigid specifications. For best results, use these products or products of equivalent quality. These products are available at your authorized Mazda dealer.

Maintenance and Specifications

INTRODUCTION

Be extremely careful to prevent injury to yourself and others and damage to your vehicle when using this manual for inspection and maintenance.

If you're unsure about any procedure it describes, we strongly urge you to have a reliable and qualified service shop perform the work, preferably an Authorized Mazda Dealer.

Factory-trained Mazda technicians and genuine Mazda parts are best for your vehicle. Without this expertise and the parts that have been designed and made especially for your Mazda, inadequate, incomplete, and insufficient servicing may result in problems. This could lead to vehicle damage or an accident and injuries.

For expert advice and quality service, consult an Authorized Mazda Dealer.

The owner should retain evidence that proper maintenance has been performed as prescribed.

Claims against the warranty resulting from lack of maintenance, as opposed to defective materials or authorized Mazda workmanship, will not be honored.

Any auto repair shop using parts equivalent to your Mazda's original equipment may perform maintenance. **But we recommend that it always be done by an Authorized Mazda Dealer using genuine Mazda parts.**

SCHEDULED MAINTENANCE

Schedule I — Normal Driving Conditions/Emission Control Systems

Follow Schedule I if the vehicle is operated mainly where none of the following conditions apply. If any do apply follow Schedule II.

- Repeated short-distance driving.
- Driving in dusty conditions.
- Towing a trailer.
- Operating in hot weather in stop-and-go “rush hour” traffic.
- Extended periods of idling or low-speed operation.
- High-speed operation with a fully loaded vehicle.
- Off-road operation.

NOTE: After the described period, continue to follow the described maintenance at the recommended intervals.

Maintenance and Specifications

CHART SYMBOLS

I: Inspect, and if necessary correct, clean or replace

A: Adjust

R: Replace

L: Lubricate

Normal driving service intervals – perform at the months or distances shown, whichever occurs first.

Maintenance Item	Maintenance Interval (Number of months or Miles (km), whichever comes first)												
	Months	4	8	12	16	20	24	28	32	36	40	44	48
	x 1000 miles	5	10	15	20	25	30	35	40	45	50	55	60
	(x 1000 km)	(8)	(16)	(24)	(32)	(40)	(48)	(56)	(64)	(72)	(80)	(88)	(96)
ENGINE													
Engine oil — every 6 months	R	R	R	R	R	R	R	R	R	R	R	R	R
Oil filter — every 6 months	R	R	R	R	R	R	R	R	R	R	R	R	R
PCV valve													
AIR CLEANER													
Air cleaner filter							R						R
IGNITION SYSTEM													
Spark plugs	*4												
COOLING SYSTEM													
Engine Coolant (green)	Replace at first 45,000 miles (72,000 km) or 36 months, after that, every 30,000 miles (48,000 km) or 24 months												
Engine Coolant (yellow)	Replace at first 100,000 miles (160,000 km) or 60 months; after that, every 50,000 miles (80,000 km) or 36 months												
Coolant condition and protection, hoses and clamps — annually —prior to cold weather every 12 months			I				I			I			I
CHASSIS AND BODY													
Wheel lug nut torque	*1	I	I	I	I	I	I	I	I	I	I	I	I
Inspect tires for wear and rotate (X = recommended interval for optimal tire life)	I	X	I	X	X	I	X	X	I	X	X	I	
Clutch reservoir fluid level	I		I		I		I		I		I		

Maintenance and Specifications

Maintenance Item	Maintenance Interval (Number of months or Miles (km), whichever comes first)												
	Months	4	8	12	16	20	24	28	32	36	40	44	48
	x 1000 miles	5	10	15	20	25	30	35	40	45	50	55	60
	(x 1000 km)	(8)	(16)	(24)	(32)	(40)	(48)	(56)	(64)	(72)	(80)	(88)	(96)
Front wheel bearings (4x2)													L
Disc brake system			I				I			I			I
Caliper slide rails			L				L			L			L
Drum brake system, lines and hoses			I				I			I			I
Exhaust system for leaks, damage, looseness							I						I
Manual transmission fluid													R
Automatic transmission fluid	*2						I						I
Exhaust system shielding (for trapped material)							I						I
Propeller shaft U-joints (if equipped with grease fittings)		L		L		L		L		L		L	
Parking brake system (for damage and operation)				I			I			I			I
Ball joints (4x2)				I/L			I/L			I/L			I/L
Transfer case fluid (4x4)		Replace every 150,000 miles (240,000 km)											
Rear axle lubricant		Does not require replacement unless rear axle submerged in water											
Accessory drive belts													
Fuel filter	*5						R						R
Steering linkage, ball joints, suspension and driveshaft				I			I			I			I

*1 The wheel lug nuts must be retightened to the proper specifications at 800 km (500 miles) of new vehicle operation, at any wheel change, or at any other time the wheel lug nuts have been loosened.

*2 Replace every 150,000 miles (240,000 km) unless submerged in water.

*3 At 60,000 miles (96,000 km), the dealer will replace the PCV valve at no cost, except Canada and California vehicles.

*4 Refer to vehicle emission control information label for spark plug and gap specifications.

Maintenance and Specifications

*5 The California Air Resources Board has determined that the failure to perform this maintenance item will not nullify the emission warranty nor limit recall liability prior to completion of the vehicle's useful life.

Schedule I continued

Maintenance Item	Maintenance Interval (Number of months or Miles (km), whichever comes first)												
	Months	52	56	60	64	68	72	76	80	84	88	92	96
	x 1000 miles	65	70	75	80	85	90	95	100	105	110	115	120
	(x 1000 km)	(104)	(112)	(121)	(128)	(136)	(144)	(152)	(160)	(168)	(176)	(184)	(192)
ENGINE													
Engine oil — every 6 months	R	R	R	R	R	R	R	R	R	R	R	R	R
Oil filter — every 6 months	R	R	R	R	R	R	R	R	R	R	R	R	R
PCV valve									R				
AIR CLEANER													
Air cleaner filter							R						R
IGNITION SYSTEM													
Spark plugs	*4								R				
COOLING SYSTEM													
Engine Coolant (green)	Replace at first 45,000 miles (72,000 km) or 36 months, after that, every 30,000 miles (48,000 km) or 24 months												
Engine Coolant (yellow)	Replace at first 100,000 miles (160,000 km) or 60 months; after that, every 50,000 miles (80,000 km) or 36 months												
Coolant condition and protection, hoses and clamps — annually — prior to cold weather every 12 months			I				I			I			I
CHASSIS AND BODY													
Wheel lug nut torque	*1	I	I	I	I	I	I	I	I	I	I	I	I
Inspect tires for wear and rotate (X = recommended interval for optimal tire life)	X	X	I	X	X	I	X	X	I	X	X	X	I
Clutch reservoir fluid level	I		I			I		I		I		I	
Front wheel bearings (4x2)													L
Disc brake system			I				I			I			I

Maintenance and Specifications

Maintenance Item	Maintenance Interval (Number of months or Miles (km), whichever comes first)												
	Months	52	56	60	64	68	72	76	80	84	88	92	96
	x 1000 miles	65	70	75	80	85	90	95	100	105	110	115	120
	(x 1000 km)	(104)	(112)	(121)	(128)	(136)	(144)	(152)	(160)	(168)	(176)	(184)	(192)
Caliper slide rails			L			L			L			L	
Drum brake system, lines and hoses			I			I			I			I	
Exhaust system for leaks, damage, looseness						I							I
Manual transmission fluid													R
Automatic transmission fluid	*2					I							I
Exhaust system shielding (for trapped material)						I							I
Propeller shaft U-joints (if equipped with grease fittings)	L		L		L		L		L		L		L
Parking brake system (for damage and operation)			I			I			I				I
Ball joints (4x2)			I/L			I/L			I/L				I/L
Transfer case fluid (4x4)	Replace every 150,000 miles (240,000 km)												
Rear axle lubricant	Does not require replacement unless rear axle submerged in water												
Accessory drive belts									I				
Fuel filter	*5					R							R
Steering linkage, ball joints, suspension and driveshaft			I			I			I				I

*1 The wheel lug nuts must be retightened to the proper specifications at 800 km (500 miles) of new vehicle operation, at any wheel change, or at any other time the wheel lug nuts have been loosened.

*2 Replace every 150,000 miles (240,000 km) unless submerged in water.

*3 At 60,000 miles (96,000 km), the dealer will replace the PCV valve at no cost, except Canada and California vehicles.

*4 Refer to vehicle emission control information label for spark plug and gap specifications.

*5 The California Air Resources Board has determined that the failure to perform this maintenance item will not nullify the emission warranty nor limit recall liability prior to completion of the vehicle's useful life.

SCHEDULE II — SPECIAL OPERATING CONDITIONS

If your driving habits **FREQUENTLY** include one or more of the following conditions:

- Short trips of less than 10 miles (16 km) when outside temperatures remain below freezing.
- Towing a trailer, or carrying maximum loads.
- Operating in severe dust conditions.
- Operating during **hot weather** in stop-and-go “rush hour” traffic.
- Extensive idling, such as police, taxi or door-to-door delivery service.
- High speed operation with a fully loaded vehicle (max. GVW).
- Off-road operation

Change **ENGINE OIL AND OIL FILTER** every 3 months or 3,000 miles (4,800 km) whichever occurs first.

NOTE: Idling the engine for extended periods will accumulate more hours of use on your vehicle than is actually indicated by the mileage odometer. Consequently, the odometer reading can be often misleading when determining the right time to change your engine oil and filter. If you are using your vehicle in a manner which allows it to remain stationary while the engine is running for long periods (door-to-door delivery, taxi, police, power/utility company trucks, or similar duty), then Mazda recommends you increase the frequency of oil and filter changes to an interval equivalent to 200 **ENGINE HOURS** or use. Since most vehicles are not equipped with hour-meters, it may be necessary for you to approximate your idle time and plan oil/filter changes accordingly.

Maintenance and Specifications

Special Operating Conditions	Replace Engine Oil and Filter	Inspect Brake System	Replace Fuel Filter	Change Automatic Transmission Fluid	Replace Spark Plugs	Replace Engine Air Filter	Change Manual Transmission Fluid	Inspect and Lubricate U-Joints	Lubricate Front Wheel Bearing (4x2)	Change Transfer Case Fluid (4x4)
Suggested Maintenance Interval	3,000 miles or 3 months	5,000 miles	15,000 miles	30,000 miles	60,000 miles	As required	As required	As required	30,000 miles	60,000 miles
Towing a trailer or using a camper or car top carrier	X			X		X	X			
Extensive idling or low-speed driving for long distances as in heavy commercial use such as delivery, taxi or patrol car	X	X	X	X	X				X	X
Operating in dusty conditions such as unpaved or dusty roads	X		X	X		X				
Off road operation				X				X		X

For specific recommendations see your authorized Mazda dealer or qualified service professional.

OWNER MAINTENANCE

Owner Maintenance Schedule

The owner or a qualified service technician should make these vehicle inspections at the indicated intervals to ensure safe and dependable operation.

Bring any problem to the attention of an Authorized Mazda Dealer or qualified service technician as soon as possible.

While operating your vehicle

- Note any changes in the sound of the exhaust or any smell or exhaust fumes in the vehicle.
- Check for vibrations in the steering wheel. Notice any increased steering effort or looseness in the steering wheel, or change in the straight ahead position.
- Notice if your vehicle constantly turns slightly or “pulls” to one side when traveling on a smooth, level road.
- When stopping, listen and check for strange sounds, pulling to one side, increased brake pedal travel or “hard to push” brake pedal.
- If any slipping or changes in the operation of your transmission occur, check the transmission fluid level.
- Check automatic transmission Park function.
- Check parking brake.

At least monthly

- Check function of all interior and exterior lights.
- Check tires for wear and proper air pressure.
- Check engine oil level.
- Check coolant level in the coolant reservoir.
- Check washer fluid level.

At least twice a year (for example, every spring and fall)

- Check power steering fluid level.
- Check clutch fluid level (if equipped).
- Check and clean body and door drain holes.
- Check and lubricate all hinges, latches, and outside locks.
- Check and lubricate door rubber weather strips.
- Check parking brake for proper operation.
- Check lap/shoulder belts and seat latches for wear and function.
- Check air pressure in spare tire.
- Check windshield washer spray and wiper operation. Clean wiper blades with clean cloth dampened with washer fluid.
- Check safety warning lamps (brake, ABS, air bag, safety belt) for operation.

Maintenance and Specifications

- Check cooling system fluid level and coolant strength.
- Check battery water level (non-maintenance free).
- Check battery connections and clean if necessary.

SERVICE RECOMMENDATIONS

To help you service your vehicle:

- We highlight do-it-yourself items in the engine compartment for easy location.
- We provide a Scheduled Maintenance section which makes tracking routine service easy.

If your vehicle requires professional service, your dealership can provide necessary parts and service. Check your “Warranty Information” to find out which parts and services are covered.

Use only recommended fuels, lubricants, fluids and service parts conforming to specifications. Genuine Mazda parts are designed and built to provide the best performance in your vehicle.

PRECAUTIONS WHEN SERVICING YOUR VEHICLE

- Do not work on a hot engine.
- Make sure that nothing gets caught in moving parts.
- Do not work on a vehicle with the engine running in an enclosed space, unless you are sure you have enough ventilation.
- Keep all open flames and other lit material away from the battery and all fuel related parts.

Working with the engine off

- Automatic transmission:
 1. Set the parking brake and shift to P (Park).
 2. Turn off the engine and remove the key.
 3. Block the wheels.
- Manual transmission:
 1. Set the parking brake, depress the clutch and place the gearshift in 1 (First).
 2. Turn off the engine and remove the key.
 3. Block the wheels.

Working with the engine on

- Automatic transmission:
 1. Set the parking brake and shift to P (Park).
 2. Block the wheels.
- Manual transmission:
 1. Set the parking brake, depress the clutch and place the gearshift in N (Neutral).
 2. Block the wheels.

Note: Do not start your engine with the air cleaner removed and do not remove it while the engine is running.

OPENING THE HOOD

1. Inside the vehicle, pull the hood release handle located under the bottom of the instrument panel near the steering column.
2. Go to the front of the vehicle and release the auxiliary latch that is located under the front center of the hood.
3. Lift the hood and support it with the prop rod.

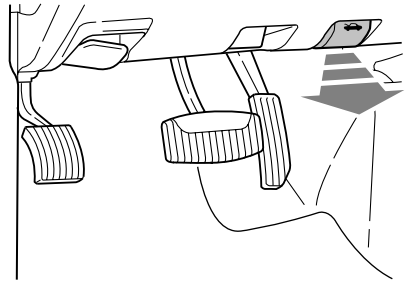

Maintenance and Specifications

IDENTIFYING COMPONENTS IN THE ENGINE COMPARTMENT

2.3L I4 engine

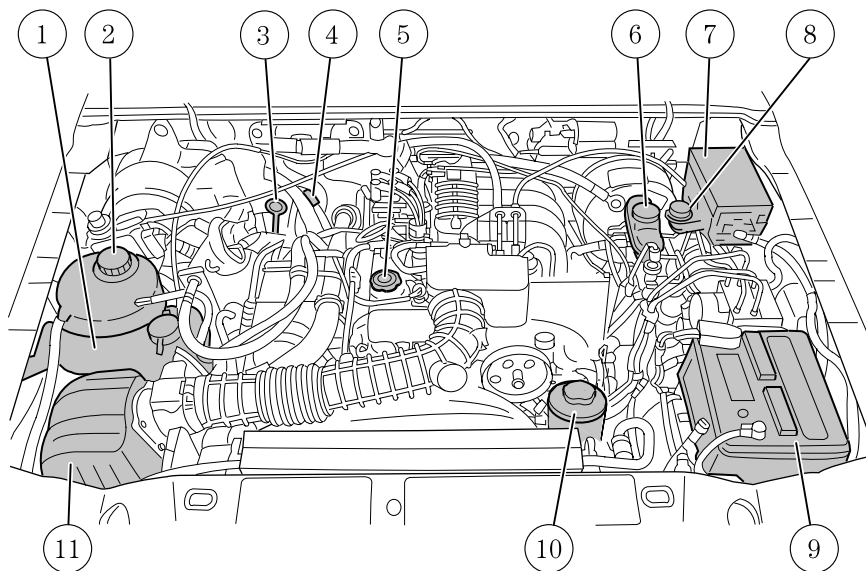

1. Windshield washer fluid reservoir
2. Engine coolant reservoir
3. Engine oil dipstick
4. Transmission fluid dipstick (automatic transmission)
5. Engine oil filler cap
6. Brake fluid reservoir
7. Power distribution box
8. Clutch fluid reservoir (manual transmission)
9. Battery
10. Power steering fluid reservoir
11. Air filter assembly

3.0L V6 engine

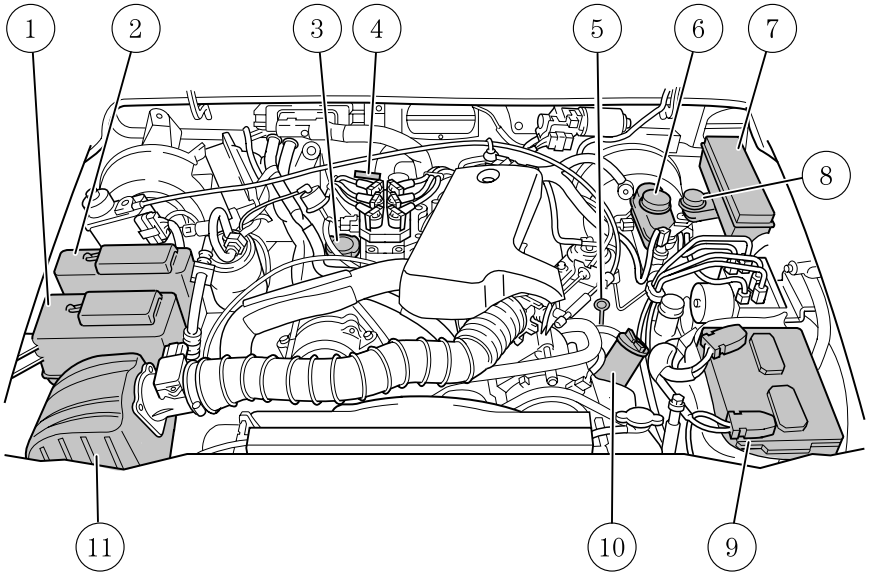

1. Engine coolant reservoir
2. Windshield washer fluid reservoir
3. Engine oil filler cap
4. Transmission fluid dipstick (automatic transmission)
5. Engine oil dipstick
6. Brake fluid reservoir
7. Power distribution box
8. Clutch fluid reservoir (manual transmission)
9. Battery
10. Power steering fluid reservoir
11. Air filter assembly

Maintenance and Specifications

4.0L SOHC V6 engine

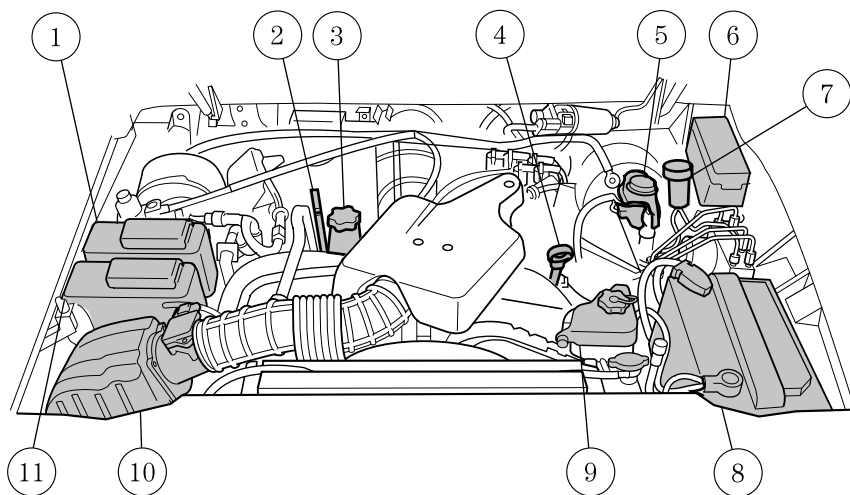

1. Windshield washer fluid reservoir
2. Transmission fluid dipstick (automatic transmission)
3. Engine oil filler cap
4. Engine oil dipstick
5. Brake fluid reservoir
6. Power distribution box
7. Clutch fluid reservoir (manual transmission)
8. Battery
9. Power steering fluid reservoir
10. Air filter assembly
11. Engine coolant reservoir

WINDSHIELD WASHER FLUID

Windshield washer fluid

Add fluid to fill the reservoir if the level is low. In very cold weather, do not fill the reservoir completely.

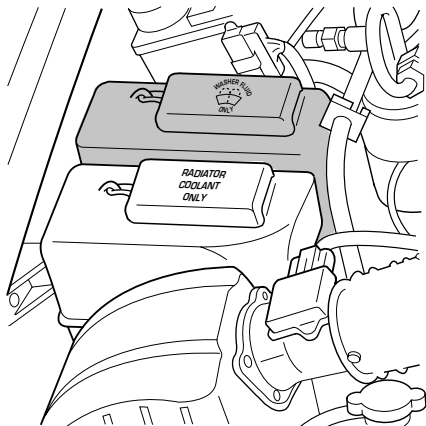

Only use a washer fluid that meets Mazda specification . Refer to *Lubricant specifications* in this chapter.

State or local regulations on volatile organic compounds may restrict the use of methanol, a common windshield washer antifreeze additive. Washer fluids containing non-methanol antifreeze agents should be used only if they provide cold weather protection without damaging the vehicle's paint finish, wiper blades or washer system.

WARNING: If you operate your vehicle in temperatures below 4.5° C (40° F), use washer fluid with antifreeze protection. Failure to use washer fluid with antifreeze protection in cold weather could result in impaired windshield vision and increase the risk of injury or accident.

Note: Do not put washer fluid in the engine coolant reservoir. Washer fluid placed in the cooling system may harm engine and cooling system components.

ENGINE OIL

Checking the engine oil

Refer to the service maintenance section for the appropriate intervals for checking the engine oil.

Maintenance and Specifications

1. Make sure the vehicle is on level ground.
 2. Turn the engine off and wait a few minutes for the oil to drain into the oil pan.
 3. Set the parking brake and ensure the gearshift is securely latched in P (Park) (automatic transmission) or 1 (First) (manual transmission).
 4. Open the hood. Protect yourself from engine heat.
 5. Locate and carefully remove the engine oil level indicator (dipstick).
- 2.3L I4 engine

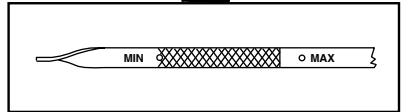
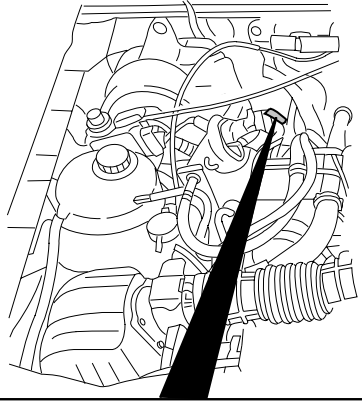

Maintenance and Specifications

- 3.0L V6 engine

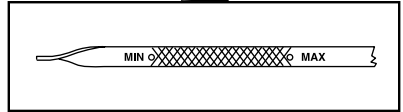
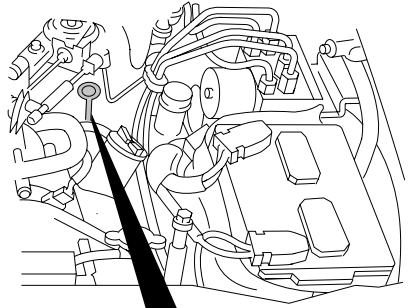

- 4.0L SOHC V6 engine
6. Wipe the indicator clean. Insert the indicator fully, then remove it again.
- If the oil level is **between the MIN and MAX marks**, the oil level is acceptable, **DO NOT ADD OIL.**
 - If the oil level is below the MIN mark, add enough oil to raise the level within the MIN-MAX range.

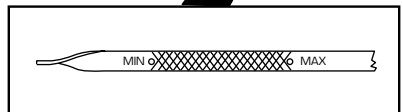
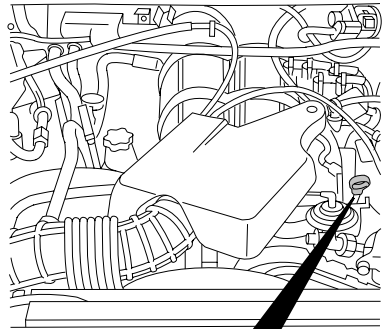

Maintenance and Specifications

- 2.3L I4 engine
SAE 5W-20

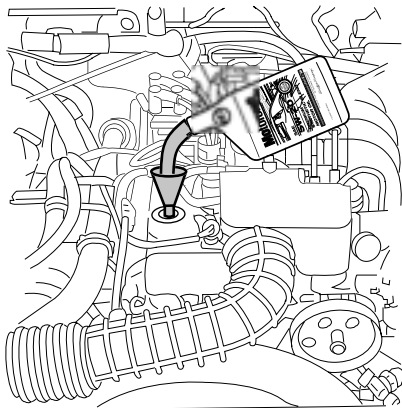

- 3.0L V6 engine
SAE 5W-20

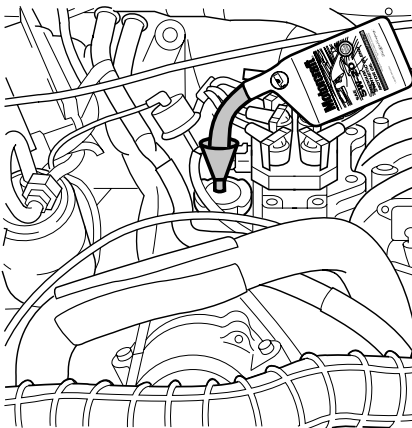

Maintenance and Specifications

- 4.0L SOHC V6 engine
SAE 5W-30

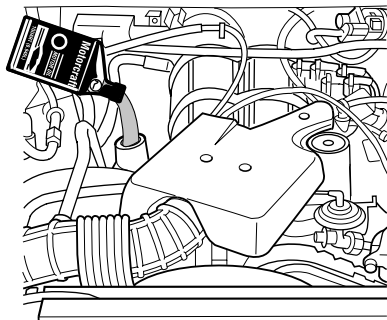

- Oil levels above the MAX mark may cause engine damage. Some oil must be removed from the engine by a service technician.
7. Put the indicator back in and ensure it is fully seated.

Adding engine oil

1. Check the engine oil. For instructions, refer to *Checking the engine oil* in this chapter.
2. If the engine oil level is not within the normal range, add only certified engine oil of the recommended viscosity. Remove the engine oil filler cap and use a funnel to pour the engine oil into the opening.
3. Recheck the engine oil level. Make sure the oil level is not above the MAX mark or the letter F in FULL on the engine oil level indicator (dipstick).
4. Install the indicator and ensure it is fully seated.
5. Fully install the engine oil filler cap by turning the filler cap clockwise until three clicks can be heard.

To avoid possible oil loss, DO NOT operate the vehicle with the engine oil level indicator and/or the engine oil filler cap removed.

Maintenance and Specifications

Engine Oil Recommendations

2.3L & 3.0L Engines

Look for this certification trademark.



SAE 5W-20 engine oil is recommended.

Only use oils “Certified For Gasoline Engines” by the American Petroleum Institute (API). Use an equivalent oil Mazda specification.

SAE 5W-20 oil provides optimum fuel economy and durability performance meeting all requirements for your vehicle’s engine.

Change your engine oil and filter according to the appropriate schedule listed in the service maintenance section.

Do not use supplemental engine oil additives, oil treatments or engine treatments. They are unnecessary and could, under certain conditions, lead to engine damage which is not covered by your warranty.

4.0L Engine

Look for this certification trademark.



SAE 5W-30 engine oil is recommended.

Only use oils “Certified For Gasoline Engines” by the American Petroleum Institute (API). Use an equivalent Mazda Specification.

Do not use supplemental engine oil additives, oil treatments or engine treatments. They are unnecessary and could, under certain conditions, lead to engine damage which is not covered by your warranty.

Change your engine oil according to the appropriate schedule listed in the service maintenance section.

Engine Oil Filter Recommendation

Change your engine oil filter according to the appropriate schedule listed in the service maintenance section. Mazda production and aftermarket (Mazda) oil filters are designed for added engine protection and long life. If a replacement oil filter is used that does not meet Mazda Material and design specifications, start-up engine noises or knock may be experienced.

It is recommended you use the appropriate Mazda oil filter (or another brand meeting Mazda specifications) for your engine.

Maintenance and Specifications

BATTERY

Your vehicle is equipped with a Mazda maintenance-free battery which normally does not require additional water during its life of service.

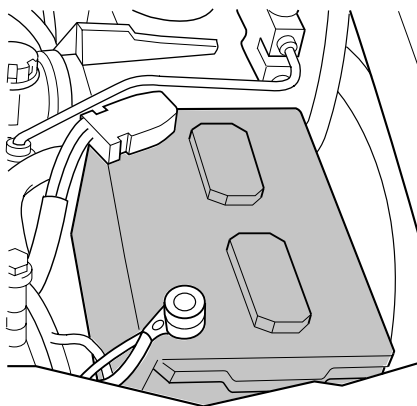

However, for severe usage or in high temperature climates, check the battery electrolyte level. Refer to the service maintenance section for the service interval schedules.

Keep the electrolyte level in each cell up to the “level indicator”. Do not overfill the battery cells.

If possible, try to only fill the battery cells with distilled water. If the battery needs water often, have the charging system checked.

If your battery has a cover/shield, make sure it is reinstalled after the battery has been cleaned or replaced.

For longer, trouble-free operation, keep the top of the battery clean and dry. Also, make certain the battery cables are always tightly fastened to the battery terminals.

If you see any corrosion on the battery or terminals, remove the cables from the terminals and clean with a wire brush. You can neutralize the acid with a solution of baking soda and water.

WARNING: Batteries normally produce explosive gases which can cause personal injury. Therefore, do not allow flames, sparks or lighted substances to come near the battery. When working near the battery, always shield your face and protect your eyes. Always provide proper ventilation.

Maintenance and Specifications

WARNING: When lifting a plastic-cased battery, excessive pressure on the end walls could cause acid to flow through the vent caps, resulting in personal injury and/or damage to the vehicle or battery. Lift the battery with a battery carrier or with your hands on opposite corners.

WARNING: Keep batteries out of reach of children. Batteries contain sulfuric acid. Avoid contact with skin, eyes or clothing. Shield your eyes when working near the battery to protect against possible splashing of acid solution. In case of acid contact with skin or eyes, flush immediately with water for a minimum of 15 minutes and get prompt medical attention. If acid is swallowed, call a physician immediately.

WARNING: Battery posts, terminals and related accessories contain lead and lead compounds. Wash hands after handling.

Because your vehicle's engine is electronically controlled by a computer, some control conditions are maintained by power from the battery. When the battery is disconnected or a new battery is installed, the engine must relearn its idle and fuel trim strategy for optimum driveability and performance. To begin this process:

1. With the vehicle at a complete stop, set the parking brake.
 2. Put the gearshift lever in P (Park), turn off all accessories and start the engine.
 3. Run the engine until it reaches normal operating temperature.
 4. Allow the engine to idle for at least one minute.
 5. Turn the A/C on and allow the engine to idle for at least one minute.
 6. Drive the vehicle to complete the relearning process.
- The vehicle may need to be driven to relearn the idle and fuel trim strategy.
 - **If you do not allow the engine to relearn its idle trim, the idle quality of your vehicle may be adversely affected until the idle trim is eventually relearned.**

When the battery is disconnected or a new battery installed, the transmission must relearn its adaptive strategy. As a result of this, the transmission may shift firmly. This operation is considered normal and

Maintenance and Specifications

will not affect function or durability of the transmission. Over time the adaptive learning process will fully update transmission operation to its optimum shift feel.

If the battery has been disconnected or a new battery has been installed, the clock and the preset radio stations must be reset once the battery is reconnected.

- Always dispose of automotive batteries in a responsible manner. Follow your local authorized standards for disposal. Call your local authorized recycling center to find out more about recycling automotive batteries.

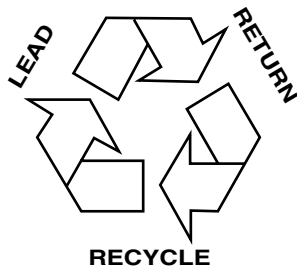

ENGINE COOLANT

Checking engine coolant

Your engine's cooling system has been factory-filled with a 50/50 mixture of distilled water and Mazda Genuine Engine Coolant, or an equivalent premium engine coolant that meets Mazda specification.

A **50/50 mixture** of distilled water and Mazda Genuine Engine Coolant provides:

- **maximum cooling system efficiency.**
- **freeze protection down to -36° C (-34° F).**
- **boiling protection up to 129° C (265° F).**
- **protection against rust and other forms of corrosion.**
- **an accurate temperature readout from the engine coolant gauge.**

The engine coolant must be maintained at the correct fluid level and concentration to work properly. If the engine coolant fluid level and concentration is not maintained correctly, damage to the engine and cooling system may result.

Maintenance and Specifications

- 2.3L engine

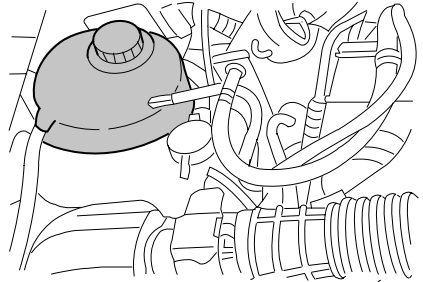

- 3.0L & 4.0L engines

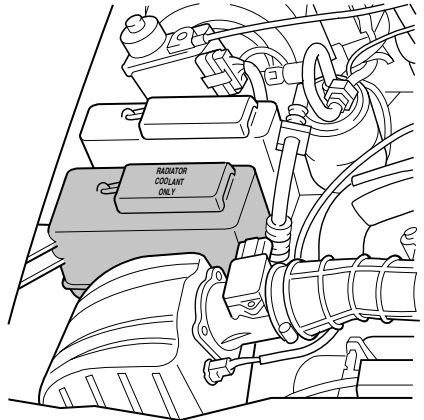

When the engine is cold, check the level of the engine coolant in the reservoir.

- The engine coolant should be at the “cold fill level” or within the “cold fill range” as listed on the engine coolant reservoir (depending upon application).
- Confirm the color and type of engine coolant before adding, to avoid mixing incompatible products.
- Refer to the service maintenance section for service interval schedules.
- Be sure to read and understand *Precautions when servicing your vehicle* in this chapter.

If the engine coolant has not been checked at the recommended interval, the engine coolant reservoir may become low or empty. If the reservoir is

Maintenance and Specifications

low or empty, add engine coolant to the reservoir. Refer to *Adding engine coolant* in this chapter.

WARNING: Automotive fluids are not interchangeable; do not use engine coolant, antifreeze or windshield washer fluid outside of its specified function and vehicle location.

Adding engine coolant

Use only Mazda Genuine Engine Coolant or a premium engine coolant that meets a Mazda specification.

- **DO NOT USE Extended Life Engine Coolant (orange in color).**
- **DO NOT USE a DEX-COOL® engine coolant or an equivalent engine coolant.**
- **DO NOT USE alcohol or methanol antifreeze or any engine coolants mixed with alcohol or methanol antifreeze.**
- **DO NOT USE supplemental coolant additives in your vehicle. These additives may harm your engine's cooling system.**
- **DO NOT MIX different colors or types of coolant in your vehicle. Make sure the correct coolant is used.**
- **DO NOT MIX recycled coolant and conventional coolant together in your vehicle. Mixing of engine coolants may harm your engine's cooling system.**
- **The use of an improper coolant may harm engine and cooling system components and may void the warranty of your vehicle's engine cooling system. If you are unsure which type of coolant your vehicle requires, contact your local dealer.**

WARNING: Do not put engine coolant in the windshield washer fluid reservoir. If engine coolant is sprayed onto the windshield, it could make it difficult to see through the windshield.

When the engine is cool, add a **50/50 mixture** of engine coolant and distilled water to the engine coolant reservoir, until the coolant is at the “cold fill level” or within the “cold fill range” as listed in the engine coolant reservoir (depending upon application).

- **NEVER increase the coolant concentration above 60%.**
- **NEVER decrease the coolant concentration below 40%.**
- **Engine coolant concentrations above 60% or below 40% will decrease the freeze protection characteristics of the engine coolant and may cause engine damage.**

Maintenance and Specifications

Plain water may be added in an emergency, but you **must** replace it with a 50/50 mixture of engine coolant and distilled water as soon as possible.

Check the coolant level in the reservoir before you drive your vehicle the next few times (with the engine cool). If necessary, add a **50/50 mixture** of engine coolant and distilled water to the engine coolant reservoir until the coolant level is at the “cold fill level” or within the “cold fill range” as listed on the reservoir (depending upon application).

Have your dealer check the engine cooling system for leaks if you have to add more than 1.0 liter (1.0 quart) of engine coolant per month.

WARNING: To avoid scalding hot steam or coolant from being released from the engine cooling system, never remove the reservoir cap while the engine is running or hot. Failure to follow this warning may result in damage to the engine’s cooling system and possible severe personal injury.

If you must remove the coolant cap, follow these steps to avoid personal injury:

1. Before you remove the cap, turn the engine off and let it cool.
2. When the engine is cool, wrap a thick cloth around the cap. Slowly turn cap counterclockwise until pressure begins to release.
3. Step back while the pressure releases.
4. When you are sure that all the pressure has been released, use the cloth to turn it counterclockwise and remove the cap.

Recycled engine coolant

Not all coolant recycling processes produce coolant which meets Mazda specification. Use of a recycled engine coolant which does not meet Mazda specifications may harm engine and cooling system components.



Always dispose of used automotive fluids in a responsible manner. Follow your community’s regulations and standards for recycling and disposing of automotive fluids.

Coolant refill capacity

To find out how much fluid your vehicle’s cooling system can hold, refer to *Refill capacities* in this chapter.

Fill your engine coolant reservoir as outlined in *Adding engine coolant* in this chapter.

Maintenance and Specifications

Severe climates

If you drive in extremely cold climates (less than -36°C [-34°F):

- **It may be necessary to increase the coolant concentration above 50%.**
- **NEVER increase the coolant concentration above 60%.**
- **Increased engine coolant concentrations above 60% will decrease the overheat protection characteristics of the engine coolant and may cause engine damage.**
- **Refer to the chart on the coolant container to ensure the coolant concentration in your vehicle will provide adequate freeze protection at the temperatures in which you drive in the winter months.**

If you drive in extremely hot climates:

- **It is still necessary to maintain the coolant concentration above 40%.**
- **NEVER decrease the coolant concentration below 40%.**
- **Decreased engine coolant concentrations below 40% will decrease the corrosion protection characteristics of the engine coolant and may cause engine damage.**
- **Decreased engine coolant concentrations below 40% will decrease the freeze protection characteristics of the engine coolant and may cause engine damage.**
- **Refer to the chart on the coolant container to ensure the coolant concentration in your vehicle will provide adequate protection at the temperatures in which you drive.**

Vehicles driven year-round in non-extreme climates should use a 50/50 mixture of engine coolant and distilled water for optimum cooling system and engine protection.

WHAT YOU SHOULD KNOW ABOUT AUTOMOTIVE FUELS

Important safety precautions

WARNING: Do not overfill the fuel tank. The pressure in an overfilled tank may cause leakage and lead to fuel spray and fire.

Maintenance and Specifications

WARNING: The fuel system may be under pressure. If the fuel filler cap is venting vapor or if you hear a hissing sound, wait until it stops before completely removing the fuel filler cap. Otherwise, fuel may spray out and injure you or others.

WARNING: If you do not use the proper fuel filler cap, excessive pressure or vacuum in the fuel tank may damage the fuel system or cause the fuel cap to disengage in a collision, which may result in possible personal injury.

WARNING: Automotive fuels can cause serious injury or death if misused or mishandled.

WARNING: Fuel ethanol and gasoline may contain benzene, which is a cancer-causing agent.

Observe the following guidelines when handling automotive fuel:

- Extinguish all smoking materials and any open flames before fueling your vehicle.
- Always turn off the vehicle before fueling.
- Automotive fuels can be harmful or fatal if swallowed. Fuels such as gasoline and ethanol are highly toxic and if swallowed can cause death or permanent injury. If fuel is swallowed, call a physician immediately, even if no symptoms are immediately apparent. The toxic effects of fuel may not be visible for hours.
- Avoid inhaling fuel vapors. Inhaling too much fuel vapor of any kind can lead to eye and respiratory tract irritation. In severe cases, excessive or prolonged breathing of fuel vapor can cause serious illness and permanent injury.
- Avoid getting fuel liquid in your eyes. If fuel is splashed in the eyes, remove contact lenses (if worn), flush with water for 15 minutes and seek medical attention. Failure to seek proper medical attention could lead to permanent injury.
- Fuels can also be harmful if absorbed through the skin. If fuel is splashed on the skin and/or clothing, promptly remove contaminated



Maintenance and Specifications

clothing and wash skin thoroughly with soap and water. Repeated or prolonged skin contact with fuel liquid or vapor causes skin irritation.

- Be particularly careful if you are taking “Antabuse” or other forms of disulfiram for the treatment of alcoholism. Breathing gasoline and/or ethanol vapors, or skin contact could cause an adverse reaction. In sensitive individuals, serious personal injury or sickness may result. If fuel is splashed on the skin, promptly wash skin thoroughly with soap and water. Consult a physician immediately if you experience an adverse reaction.
- FFV fuel tanks may contain zero to 85 percent ethanol. Any fuel blends containing gasoline and ethanol should be treated the same as “Fuel Ethanol”. To identify if your vehicle is an FFV, check your VIN or the label on the inside of your fuel filler door. When checking the VIN look for the engine type identifier (8th character). If your vehicle is an FFV, then the character will be labeled as a “K.”

Ethanol

Pure ethanol is the alcohol which is the intoxicating agent in liquor, beer and wine. It is distilled from the fermentation of plants such as field corn and sugar cane. When ethanol is used in the making of motor fuels, a small amount of a bad tasting chemical is added to discourage beverage use. The resulting fuel is called E_d100 meaning 100% pure ethanol diluted by 2% to 5% gasoline as the “denaturant.”

Fuel ethanol (summer blend_d) is then made by adding 15% more unleaded gasoline. The resulting fuel also has a higher octane rating than unleaded regular gasoline and other properties which allow engine designs with greater efficiency and power.

Winter blends may contain up to 30% (E70)unleaded gasoline (25% plus the denaturant) to enhance cold engine starts. Severely cold weather may require additional measures for reliable starting. Refer to *Cold Weather Starting* in the *Driving* chapter.

Ethanol is more chemically active than gasoline. It corrodes some metals and causes some plastic and rubber components to swell, break down or become brittle and crack, especially when mixed with gasoline. Special materials and procedures have been developed for flexible fuel vehicles and the dispensers used by ethanol fuel providers.

Maintenance and Specifications

WARNING: Flexible fuel components and standard unleaded gasoline fuel components are not interchangeable. If your vehicle is not serviced in accordance with flexible fuel vehicles procedures, damage may occur and your warranty may be invalidated.

WARNING: When refueling always shut the engine off and never allow sparks or open flames near the filler neck. Never smoke while refueling. Fuel vapor is extremely hazardous under certain conditions. Care should be taken to avoid inhaling excess fumes.

WARNING: The flow of fuel through a fuel pump nozzle can produce static electricity, which can cause a fire if fuel is pumped into an ungrounded fuel container.

Use the following guidelines to avoid static build-up when filling an ungrounded fuel container:

- Place approved fuel container on the ground.
- DO NOT fill a fuel container while it is in the vehicle (including the cargo area/pickup bed).
- Keep the fuel pump nozzle in contact with the fuel container while filling.
- DO NOT use a device that would hold the fuel pump handle in the fill position.



Fuel Filler Cap

Your fuel tank filler cap has an indexed design with a 1/8 turn on/off feature.

When fueling your vehicle:

1. Turn the engine off.
2. Carefully turn the filler cap counterclockwise 1/8 of a turn until it stops.
3. Pull to remove the cap from the fuel filler pipe.

Maintenance and Specifications

4. To install the cap, align the tabs on the cap with the notches on the filler pipe.
5. Turn the filler cap clockwise 1/8 of a turn until it stops.

“Check Fuel Cap” illuminates when the ignition is turned to the ON position to ensure your bulb is working. When this light turns on, check the fuel filler cap. Continuing to operate the vehicle with the Check Fuel Cap light on, can activate the Service Engine Soon warning. When the fuel filler cap is properly re-installed, the light(s) will turn off after a period of normal driving. **It may take a long period of time for the system to detect an improperly installed fuel filler cap.**

If you must replace the fuel filler cap, replace it with a fuel filler cap that is designed for your vehicle. The warranty may be void for any damage to the fuel tank or fuel system if the correct genuine Mazda fuel filler cap is not used.

WARNING: The fuel system may be under pressure. If the fuel filler cap is venting vapor or if you hear a hissing sound, wait until it stops before completely removing the fuel filler cap. Otherwise, fuel may spray out and injure you or others.

WARNING: If you do not use the proper fuel filler cap, excessive pressure or vacuum in the fuel tank may damage the fuel system or cause the fuel cap to disengage in a collision, which may result in possible personal injury.

Choosing the right fuel

Use only UNLEADED FUEL. The use of leaded fuel is prohibited by law and could damage your vehicle.

If your vehicle is a flexible fuel vehicle (FFV), use only UNLEADED FUEL and (E85) ETHANOL. The use of leaded fuel is prohibited by law and could damage your vehicle.

Do not use fuel containing methanol. It can damage critical fuel system components.

Your vehicle was not designed to use fuel or fuel additives with metallic compounds, including manganese-based compounds containing MMT.

Repairs to correct the effects of using a fuel for which your vehicle was not designed may not be covered by your warranty.

Octane recommendations

Do not be concerned if your engine sometimes knocks lightly. However, if it knocks heavily under most driving conditions while you are using fuel with the recommended octane rating, see your authorized Mazda dealership to prevent any engine damage.

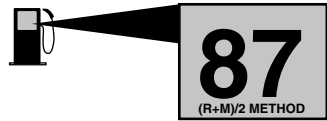

Unleaded Gasoline engines

Your vehicle is designed to use “Regular” unleaded gasoline with an (R+M)/2 octane rating of 87. We do not recommend the use of gasolines labeled as “Regular” that are sold with octane ratings of 86 or lower in high altitude areas.

FFV engine (if equipped)

Your vehicle is designed to use (E85) Fuel Ethanol, “Regular” unleaded gasoline or any percentage of the two fuels combined.

U.S. government regulations require fuel ethanol dispensing pumps to have a small, square, orange and black label with the common abbreviation or the appropriate percentage for that region. Use of other fuels such as Fuel Methanol may cause powertrain damage, a loss of vehicle performance, and your warranty may be invalidated.

Fuel quality

Many of the world’s automakers issued the World-wide Fuel Charter that recommends gasoline specifications to provide improved performance and emission control system protection for your vehicle. Gasolines that meet the World-wide Fuel Charter should be used when available. Ask your fuel supplier about gasolines that meet the World-wide Fuel Charter. In Canada, look for fuels that display the **Auto Makers’ Choice**[®] logo.



It should not be necessary to add any aftermarket products to your fuel tank if you continue to use high quality fuel of the recommended octane rating. Aftermarket products could cause damage to the fuel system.

Maintenance and Specifications

Repairs to correct the effects of using an aftermarket product in your fuel may not be covered by your warranty.

Unleaded Gasoline engines

If you are experiencing starting, rough idle or hesitation driveability problems during a cold start, try a different brand of “Regular” unleaded gasoline. “Premium” unleaded gasoline is not recommended (particularly in the United States) because it may cause these problems to become more pronounced. If the problems persist, see your authorized Mazda dealership.

FFV engine (if equipped)

Your FFV will operate well on ordinary “Regular” unleaded gasoline, but only the highest quality fuel ethanol will provide the same level of protection and performance. To identify if your vehicle is an FFV, check your VIN or the label on the inside of your fuel filler door. When checking the VIN, look for the engine type identifier (8th character). If your vehicle is an FFV, then the character will be labeled as a “K.”

If you operate your vehicle 50% or more of the time on ethanol, you should follow a different maintenance schedule. See the *Service Maintenance Section* for more information.

If you are experiencing a rough or rolling idle after start-up with the outside temperature above 27° C (80° F), the idle should improve within 10 to 30 seconds. If the problems persist below this temperature, see your authorized Mazda dealership.

Cleaner air

Mazda endorses the use of reformulated “cleaner-burning” gasolines to improve air quality.

Running out of fuel

Avoid running out of fuel because this situation may have an adverse affect on powertrain components.

If you have run out of fuel:

- You may need to cycle the ignition from OFF to ON several times after refueling, to allow the fuel system to pump the fuel from the tank to the engine.
- Your “Check Engine” indicator may come on. For more information on the “Check Engine” indicator, refer to the *Instrument Cluster* chapter.

Fuel Filter

For fuel filter replacement, see your authorized Mazda dealership. Refer to the service maintenance section for the appropriate intervals for changing the fuel filter.

Replace the fuel filter with an authorized Mazda part. The customer warranty may be void for any damage to the fuel system if an authorized Mazda fuel filter is not used.

ESSENTIALS OF GOOD FUEL ECONOMY

Measuring techniques

Your best source of information about actual fuel economy is you, the driver. You must gather information as accurately and consistently as possible. Fuel expense, frequency of fillups or fuel gauge readings are NOT accurate as a measure of fuel economy. We do not recommend taking fuel economy measurements during the first 1,600 km (1,000 miles) of driving (engine break-in period). You will get a more accurate measurement after 3,000 km–5,000 km (2,000 miles–3,000 miles).

Filling the tank

The advertised fuel capacity of the fuel tank on your vehicle is equal to the rated refill capacity of the fuel tank as listed in the *Refill capacities* section of this chapter.

The advertised capacity is the amount of the indicated capacity and the empty reserve combined. Indicated capacity is the difference in the amount of fuel in a full tank and a tank when the fuel gauge indicates empty. Empty reserve is the small amount of fuel remaining in the fuel tank after the fuel gauge indicates empty.

The amount of usable fuel in the empty reserve varies and should not be relied upon to increase driving range. When refueling your vehicle after the fuel gauge indicates empty, you might not be able to refuel the full amount of the advertised capacity of the fuel tank due to the empty reserve still present in the tank.

For consistent results when filling the fuel tank:

- Turn the engine/ignition switch to the off position prior to refueling, an error in the reading will result if the engine is left running.
- Use the same filling rate setting (low — medium — high) each time the tank is filled.
- Allow no more than 2 automatic click-offs when filling.
- Always use fuel with the recommended octane rating.
- Use a known quality gasoline, preferably a national brand.
- Use the same side of the same pump and have the vehicle facing the same direction each time you fill up.

Maintenance and Specifications

- Have the vehicle loading and distribution the same every time. Your results will be most accurate if your filling method is consistent.

Calculating fuel economy

1. Fill the fuel tank completely and record the initial odometer reading (in kilometers or miles).
2. Each time you fill the tank, record the amount of fuel added (in liters or gallons).
3. After at least three to five tank fill-ups, fill the fuel tank and record the current odometer reading.
4. Subtract your initial odometer reading from the current odometer reading.
5. Follow one of the simple calculations in order to determine fuel economy:

Calculation 1: **Multiply liters used by 100, then divide by total kilometers traveled.**

Calculation 2: **Divide total miles traveled by total gallons used.**

Keep a record for at least one month and record the type of driving (city or highway). This will provide an accurate estimate of the vehicle's fuel economy under current driving conditions. Additionally, keeping records during summer and winter will show how temperature impacts fuel economy. In general, lower temperatures give lower fuel economy.

Driving style — good driving and fuel economy habits

Give consideration to the lists that follow and you may be able to change a number of variables and improve your fuel economy.

Habits

- Smooth, moderate operation can yield up to 10% savings in fuel.
- Steady speeds without stopping will usually give the best fuel economy.
- Idling for long periods of time (greater than one minute) may waste fuel.
- Anticipate stopping; slowing down may eliminate the need to stop.
- Sudden or hard accelerations may reduce fuel economy.
- Slow down gradually.
- Driving at reasonable speeds (traveling at 88 km/h [55 mph] uses 15% less fuel than traveling at 105 km/h [65 mph]).

Maintenance and Specifications

- Revving the engine before turning it off may reduce fuel economy.
- Using the air conditioner or defroster may reduce fuel economy.
- You may want to turn off the speed control in hilly terrain if unnecessary shifting between third and fourth gear occurs. Unnecessary shifting of this type could result in reduced fuel economy.
- Warming up a vehicle on cold mornings is not required and may reduce fuel economy.
- Resting your foot on the brake pedal while driving may reduce fuel economy.
- Combine errands and minimize stop-and-go driving.

Maintenance

- Keep tires properly inflated and use only recommended size.
- Operating a vehicle with the wheels out of alignment will reduce fuel economy.
- Use recommended engine oil. Refer to *Lubricant specifications* in this chapter.
- Perform all regularly scheduled maintenance items. Follow the recommended maintenance schedule and owner maintenance checks found in your vehicle service maintenance section.

Conditions

- Heavily loading a vehicle or towing a trailer may reduce fuel economy at any speed.
- Carrying unnecessary weight may reduce fuel economy (approximately 0.4 km/L [1 mpg] is lost for every 180 kg [400 lb] of weight carried).
- Adding certain accessories to your vehicle (for example bug deflectors, rollbars/light bars, running boards, ski/luggage racks) may reduce fuel economy.
- Using fuel blended with alcohol may lower fuel economy.
- Fuel economy may decrease with lower temperatures during the first 12–16 km (8–10 miles) of driving.
- Driving on flat terrain offers improved fuel economy as compared to driving on hilly terrain.
- Transmissions give their best fuel economy when operated in the top cruise gear and with steady pressure on the gas pedal.

Maintenance and Specifications

- Four-wheel-drive operation (if equipped) is less fuel efficient than two-wheel-drive operation.
- Close windows for high speed driving.

EPA window sticker

Every new vehicle should have the EPA window sticker. Contact your dealer if the window sticker is not supplied with your vehicle. The EPA window sticker should be your guide for the fuel economy comparisons with other vehicles.

It is important to note the box in the lower left corner of the window sticker. These numbers represent the Range of L/100 km (MPG) expected on the vehicle under optimum conditions. Your fuel economy may vary depending upon the method of operation and conditions.

EMISSION CONTROL SYSTEM

Your vehicle is equipped with various emission control components and a catalytic converter which will enable your vehicle to comply with applicable exhaust emission standards. To make sure that the catalytic converter and other emission control components continue to work properly:

- Use only the specified fuel listed.
- Avoid running out of fuel.
- Do not turn off the ignition while your vehicle is moving, especially at high speeds.
- Have the items listed in your service maintenance section performed according to the specified schedule.

The scheduled maintenance items listed in the scheduled maintenance section are essential to the life and performance of your vehicle and to its emissions system.

If other than Mazda authorized parts are used for maintenance replacements or for service of components affecting emission control, such non-Mazda parts should be equivalent to genuine Mazda parts in performance and durability.

WARNING: Do not park, idle, or drive your vehicle in dry grass or other dry ground cover. The emission system heats up the engine compartment and exhaust system, which can start a fire.

Illumination of the  indicator, charging system warning light or the temperature warning light, fluid leaks, strange odors, smoke or loss of engine power, could indicate that the emission control system is not working properly.

WARNING: Exhaust leaks may result in entry of harmful and potentially lethal fumes into the passenger compartment.

Do not make any unauthorized changes to your vehicle or engine. By law, vehicle owners and anyone who manufactures, repairs, services, sells, leases, trades vehicles, or supervises a fleet of vehicles are not permitted to intentionally remove an emission control device or prevent it from working. Information about your vehicle's emission system is on the Vehicle Emission Control Information Decal located on or near the engine. This decal identifies engine displacement and gives some tune up specifications.

Please consult your “Warranty Information” for complete emission warranty information.

Readiness for Inspection/Maintenance (I/M) testing

In some localities, it may be a legal requirement to pass an I/M test of the on-board diagnostics system. If your “Check Engine/Service Engine Soon” light is on, refer to the description in the *Warning lights and chimes* section of the *Instrument cluster* chapter. Your vehicle may not pass the I/M test with the “Check Engine/Service Engine Soon” light on.

If the vehicle's powertrain system or its battery has just been serviced, the on-board diagnostics system is reset to a “not ready for I/M test” condition. To ready the on-board diagnostics system for I/M testing, a minimum of 30 minutes of city and highway driving is necessary as described below:

- First, at least 10 minutes of driving on an expressway or highway.
- Next, at least 20 minutes driving in stop-and-go, city-type traffic with at least four idle periods.

Allow the vehicle to sit for at least eight hours without starting the engine. Then, start the engine and complete the above driving cycle. The engine must warm up to its normal operating temperature. Once started, do not turn off the engine until the above driving cycle is complete.

Maintenance and Specifications

CHECKING AND ADDING POWER STEERING FLUID

- 2.3L I4 engine

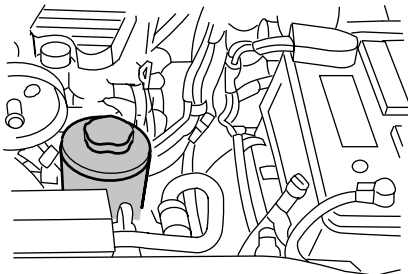

- 3.0L V6 engine

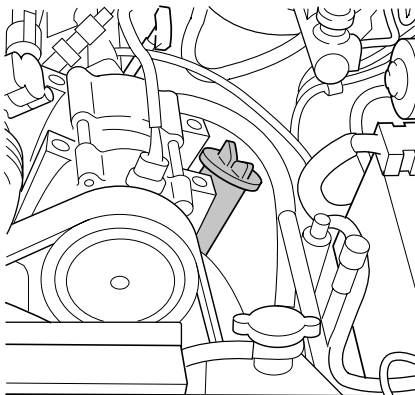

- 4.0L V6 engine

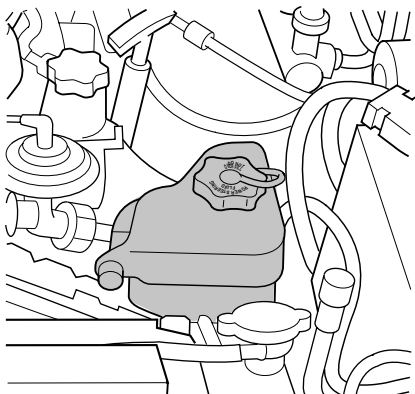

Maintenance and Specifications

Check the power steering fluid. Refer to the service maintenance section for the service interval schedules. If adding fluid is necessary, use only MERCON® ATF.

1. Start the engine and let it run until it reaches normal operating temperature (the engine coolant temperature gauge indicator will be near the center of the normal area between H and C).
2. While the engine idles, turn the steering wheel left and right several times.
3. Turn the engine off.
4. **If your vehicle is equipped with a 3.0L V6 engine**, check the fluid level on the dipstick. It should be within the FULL HOT range. Do not add fluid if the level is within this range.
5. **If your vehicle is equipped with a 4.0L SOHC V6 or 2.3L I4 engine**, check the fluid level in the reservoir. It should be between the MIN and MAX lines. Do not add fluid if the level is within this range.
6. If the fluid is low, add fluid in small amounts, continuously checking the level until it reaches the FULL HOT range. Be sure to put the dipstick back in the reservoir.

BRAKE FLUID

Checking and adding brake fluid

Brake fluid should be checked and refilled as needed. Refer to the service maintenance section for the service interval schedules.

1. Clean the reservoir cap before removal to prevent dirt or water from entering the reservoir.

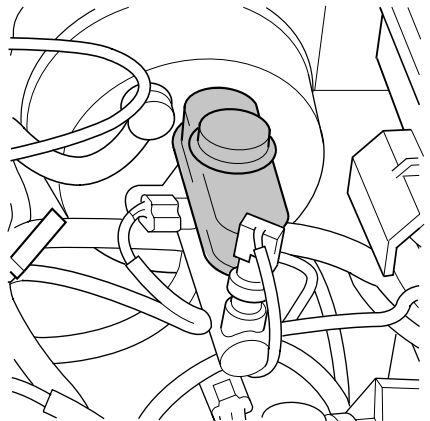

Maintenance and Specifications

2. Visually inspect the fluid level.
3. If necessary, add brake fluid from a clean un-opened container until the level reaches MAX. Do not fill above this line.
4. Use only a DOT 3 brake fluid certified to meet Mazda specification . Refer to *Lubricant specifications* in this chapter.

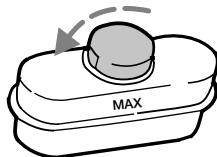

WARNING: Brake fluid is toxic. If brake fluid contacts the eyes, flush eyes with running water for 15 minutes. Seek medical attention if irritation persists. If taken internally, drink water and induce vomiting. Seek medical attention immediately.

WARNING: If you use a brake fluid that is not DOT 3, you will cause permanent damage to your brakes.

WARNING: Do not let the reservoir for the master cylinder run dry. This may cause the brakes to fail.

CLUTCH FLUID (IF EQUIPPED)

Check the fluid level. Refer to the service maintenance section for the service interval schedules.

During normal operation, the fluid level in the clutch reservoir should remain constant. If the fluid level drops, refill the fluid level to the step in the reservoir.

Use only a DOT 3 brake fluid designed to meet Mazda specification. Refer to *Lubricant Specifications* in this chapter.

WARNING: Brake fluid is toxic. If brake fluid contacts the eyes, flush eyes with running water for 15 minutes. Seek medical attention if irritation persists. If taken internally, drink water and induce vomiting. Seek medical attention immediately.

1. Clean the reservoir cap before removal to prevent dirt and water from entering the reservoir.
2. Remove cap and rubber diaphragm from reservoir.
3. Add fluid until the level reaches the step in the reservoir.
4. Reinstall rubber diaphragm and cap onto reservoir.

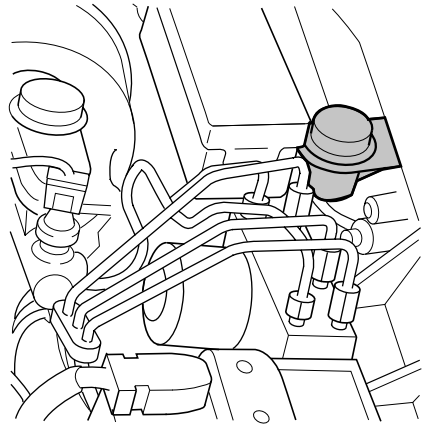

TRANSMISSION FLUID

Checking automatic transmission fluid (if equipped)

Refer to your service maintenance section for scheduled intervals for fluid checks and changes. Your transmission does not consume fluid. However, the fluid level should be checked if the transmission is not working properly, i.e., if the transmission slips or shifts slowly or if you notice some sign of fluid leakage.

Automatic transmission fluid expands when warmed. To obtain an accurate fluid check, drive the vehicle until it is at normal operating temperature (approximately 30 km [20 miles]). If your vehicle has been operated for an extended period at high speeds, in city traffic during hot weather or pulling a trailer, the vehicle should be turned off for about 30 minutes to allow fluid to cool before checking.

1. Drive the vehicle 30 km (20 miles) or until it reaches normal operating temperature.
2. Park the vehicle on a level surface and engage the parking brake.
3. With the parking brake engaged and your foot on the brake pedal, start the engine and move the gearshift lever through all of the gear ranges. Allow sufficient time for each gear to engage.
4. Latch the gearshift lever in P (Park) and leave the engine running.
5. Remove the dipstick, wiping it clean with a clean, dry lint free rag. If necessary, refer to *Identifying components in the engine compartment* in this chapter for the location of the dipstick.

Maintenance and Specifications

6. Install the dipstick making sure it is fully seated in the filler tube.
7. Remove the dipstick and inspect the fluid level. The fluid should be in the designated area for normal operating temperature or ambient temperature.

Low fluid level

Do not drive the vehicle if the fluid level is at the bottom of the dipstick and the ambient temperature is above 10°C (50°F).

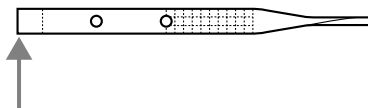

Correct fluid level

The transmission fluid should be checked at normal operating temperature 66°C-77°C (150°F-170°F) on a level surface. The normal operating temperature can be reached after approximately 30 km (20 miles) of driving.

You can check the fluid without driving if the ambient temperature is above 10°C (50°F). However, if fluid is added at this time, an overfill condition could result when the vehicle reaches normal operating temperature.

The transmission fluid should be in this range if at normal operating temperature (66°C-77°C [150°F-170°F]).

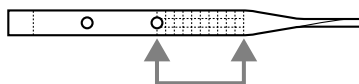

The transmission fluid should be in this range if at ambient temperature (10°C-35°C [50°F-95°F]).

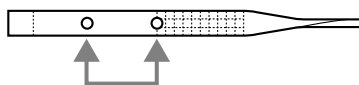

High fluid level

Fluid levels above the safe range may result in transmission failure. An overfill condition of transmission fluid may cause shift and/or engagement concerns and/or possible damage.

High fluid levels can be caused by an overheating condition.

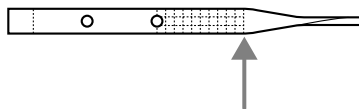

Adjusting automatic transmission fluid levels

Before adding any fluid, make sure the correct type is used. The type of fluid used is normally indicated on the dipstick and also in the *Lubricant specifications* section in this chapter.

Maintenance and Specifications

Use of a non-approved automatic transmission fluid may cause internal transmission component damage.

If necessary, add fluid in 250 ml (1/2 pint) increments through the filler tube until the level is correct.

If an overfill occurs, excess fluid should be removed by a qualified technician.

An overfill condition of transmission fluid may cause shift and/or engagement concerns and/or possible damage.

Do not use supplemental transmission fluid additives, treatments or cleaning agents. The use of these materials may affect transmission operation and result in damage to internal transmission components.

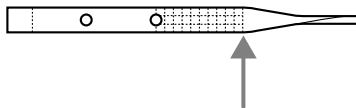

Checking and adding manual transmission fluid (if equipped)

1. Park the vehicle on a level surface.
2. Engage the parking brake fully – put in first gear.
3. Assure the vehicle cannot move.
4. Clean the filler plug.
5. Remove the filler plug and inspect the fluid level.

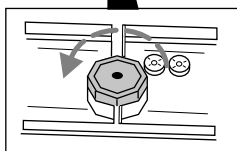
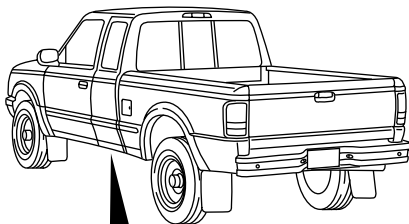

Maintenance and Specifications

6. Fluid level should be at the bottom of the opening.
7. Add enough fluid through the filler opening so that the fluid level is at the bottom of the opening.
8. Install and tighten the fill plug securely.

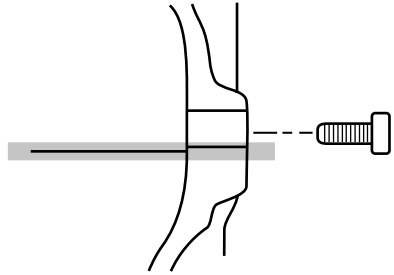

Use only fluid that meets Mazda specifications. Refer to *Lubricant Specifications* in this chapter.

Checking and adding transfer case fluid (if equipped)

Vehicle must be on level surface.

1. Clean the filler plug.
2. Remove the filler plug and inspect the fluid level.
3. Assure the vehicle cannot move.

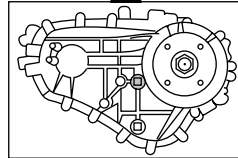
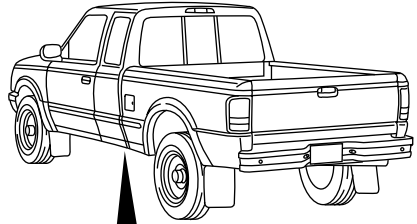

4. Add only enough fluid through the filler opening so that the fluid level is at the bottom of the opening.

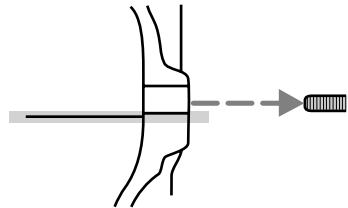

Maintenance and Specifications

Use only fluid that meets Mazda specifications. Refer to *Lubricant Specifications* in this chapter.

DRIVELINE UNIVERSAL JOINT AND SLIP YOKE

Your vehicle may be equipped with universal joints that require lubrication. If the original universal joints are replaced with universal joints equipped with grease fittings, lubrication will also be necessary.

INFORMATION ABOUT UNIFORM TIRE QUALITY GRADING

New vehicles are fitted with tires that have a rating on them called Tire Quality Grades. The Quality grades can be found where applicable on the tire sidewall between tread shoulder and maximum section width. For example:

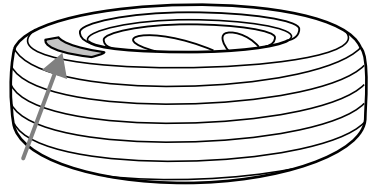

• Treadwear 200 Traction AA Temperature A

These Tire Quality Grades are determined by standards that the United States Department of Transportation has set.

Tire Quality Grades apply to new pneumatic tires for use on passenger cars. They do not apply to deep tread, winter-type snow tires, space-saver or temporary use spare tires, tires with nominal rim diameters of 10 to 12 inches or limited production tires as defined in Title 49 Code of Federal Regulations Part 575.104(c)(2).

U.S. Department of Transportation-Tire quality grades: The U.S. Department of Transportation requires Mazda to give you the following information about tire grades exactly as the government has written it.

Treadwear

The treadwear grade is a comparative rating based on the wear rate of the tire when tested under controlled conditions on a specified government test course. For example, a tire graded 150 would wear one and one-half (1 1/2) times as well on the government course as a tire graded 100. The relative performance of tires depends upon the actual conditions of their use, however, and may depart significantly from the norm due to variations in driving habits, service practices, and differences in road characteristics and climate.

Maintenance and Specifications

Traction AA A B C

The traction grades, from highest to lowest are AA, A, B, and C. The grades represent the tire's ability to stop on wet pavement as measured under controlled conditions on specified government test surfaces of asphalt and concrete. A tire marked C may have poor traction performance.

NOTE: The traction grade assigned to this tire is based on straight-ahead braking traction tests, and does not include acceleration, cornering, hydroplaning or peak traction characteristics.

Temperature A B C

The temperature grades are A (the highest), B, and C, representing the tire's resistance to the generation of heat and its ability to dissipate heat when tested under controlled conditions on a specified indoor laboratory test wheel. Sustained high temperature can cause the material of the tire to degenerate and reduce tire life, and excessive temperature can lead to sudden tire failure. The grade C corresponds to a level of performance which all passenger car tires must meet under the Federal Motor Vehicle Safety Standard No. 109. Grades B and A represent higher levels of performance on the laboratory test wheel than the minimum required by law.

WARNING: The temperature grade for this tire is established for a tire that is properly inflated and not overloaded. Excessive speed, underinflation, or excessive loading, either separately or in combination, can cause heat buildup and possible tire failure.

SERVICING YOUR TIRES

Checking the tire pressure

- Use an accurate tire pressure gauge.
- Check the tire pressure when tires are cold, after the vehicle has been parked for at least one hour or has been driven less than 5 km (3 miles).
- Adjust tire pressure to recommended specifications found on the Certification Label or the Tire Label.

Maintenance and Specifications

WARNING: Improperly inflated tires can affect vehicle handling and can fail suddenly, possibly resulting in loss of vehicle control, vehicle rollover and/or personal injury.

Tire rotation

Because your vehicle's tires perform different jobs, they often wear differently. To make sure your tires wear evenly and last longer, rotate them as indicated in the service maintenance section. If you notice that the tires wear unevenly, have them checked.

- Four tire rotation

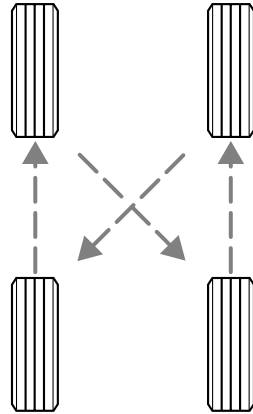

- Five tire rotation

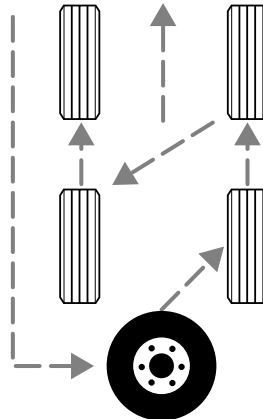

Note: Do not use a temporary spare tire for a five tire rotation.

Maintenance and Specifications

Replacing the tires

Replace the tires when the wear band is visible through the tire treads.

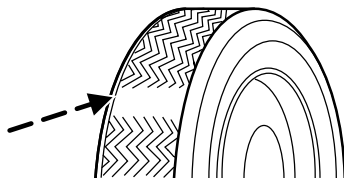

WARNING: When replacing full size tires, never mix radial bias-belted, or bias-type tires. Use only the tire sizes that are listed on the Certification Label. Make sure that all tires are the same size, speed rating, and load-carrying capacity. Use only the tire combinations recommended on the label. If you do not follow these precautions, your vehicle handling may be affected which can lead to loss of vehicle control, vehicle rollover and/or personal injury.

WARNING: Make sure that all replacement tires are of the same size, type, load-carrying capacity and tread (e.g., “All Terrain”, etc.), as originally offered by Mazda. Failure to do so can result in tire failure and a serious accident.

WARNING: Do not replace your tires with “high performance” tires or larger size tires.

WARNING: Failure to follow these precautions may adversely affect the handling of the vehicle, and increase the risk of loss of vehicle control, vehicle rollover and/or personal injury.

Tires that are larger or smaller than your vehicle’s original tires may also affect the accuracy of your speedometer.

SNOW TIRES AND CHAINS

WARNING: Driving too fast for conditions creates the possibility of loss of vehicle control. Driving at very high speeds for extended periods of time may result in damage to vehicle components.

Maintenance and Specifications

NOTE: Snow tires must be the same size and grade as the tires you currently have on your vehicle.

The tires on your vehicle have all weather treads to provide traction in rain and snow. However, in some climates, you may need to use snow tires and chains. If you need to use snow tires and chains, it is recommended that steel wheels are used of the same size and specifications as those originally installed.

Follow these guidelines when using snow tires and chains:

- Do not use tire chains on aluminum wheels. Chains may chip the wheels.
- Use only SAE Class S chains.
- Install chains securely, verifying that the chains do not touch any wiring, brake lines or fuel lines.

Drive cautiously. If you hear the cables rub or bang against the vehicle, stop and retighten them. If this does not work, remove the cables to prevent vehicle damage.

- If possible, avoid fully loading your vehicle.
- Remove the tire chains when they are no longer needed. Do not use tire chains on dry roads.
- The suspension insulation and bumpers will help prevent vehicle damage. Do not remove these components from your vehicle when using snow tires and chains.

REFILL CAPACITIES

Fluid	Mazda Part Name	Application	Capacity
Engine oil (includes filter change)	Mazda SAE 5W- 20 Super Premium Motor Oil	2.3L engine	3.8L (4.0 quarts.)
		3.0L V6 engines	4.3L (4.5 quarts)
	Mazda SAE 5W- 30 Super Premium Motor Oil	4.0L V6 engine	4.7L (5.0 quarts)

Maintenance and Specifications

Fluid	Mazda Part Name	Application	Capacity
Brake fluid	High Performance DOT 3 Motor Vehicle Brake Fluid	All	Fill to line on reservoir
Power steering fluid	Mazda MERCON® ATF	All	Fill to range on dipstick
Transmission fluid ¹	Mazda MERCON® ATF	5-speed manual	2.65L (2.8 quarts) ²
	Mazda MERCON®V ATF	4x2 vehicles with automatic and 2.3L I4 engine	9.4L (9.9 quarts) ³
		4x2 vehicles with automatic and 3.0L or 4.0L engines	9.5L (10.0 quarts) ³
		4x4 vehicles with automatic and 3.0L or 4.0L	9.8L (10.3 quarts) ³

Maintenance and Specifications

Fluid	Mazda Part Name	Application	Capacity
Engine coolant ⁴	Premium Engine Coolant	2.3 L I4 engine with manual transmission	10.0L (10.5 quarts)
		2.3L I4 engine with automatic transmission	9.7L (10.2 quarts)
		3.0L V6 engine with manual transmission	14.3L (15.1 quarts)
		3.0L V6 engine with automatic transmission	14.0L (14.8 quarts)
		4.0L V6 engine with manual transmission	13.0L (13.7 quarts)
		4.0L V6 engine with automatic transmission	12.5L (13.2 quarts)
Fuel tank	N/A	Regular cab (Short wheel base)	62.4L (16.5 gallons)
		Regular cab (Long wheel base)	75.7L (20.0 gallons)
		SuperCab	73.8L (19.5 gallons)
Transfer Case Fluid	Mazda MERCON® ATF	4x4 Vehicles	1.2L (1.25 quarts)
Front axle lubricant	Mazda SAE 80W-90 Premium Rear Axle Lubricant	4x4 Vehicles	1.7L (3.6 pints)

Maintenance and Specifications

Fluid	Mazda Part Name	Application	Capacity
Rear axle lubricant ⁵	Mazda SAE 80W-90 Premium Rear Axle Lubricant	All	2.4-2.5L (5.0-5.3 pints)
Windshield washer fluid	Ultra-Clear Windshield Washer Concentrate	All	2.6L (2.75 quarts)

¹Ensure the correct automatic transmission fluid is used. Transmission fluid requirements are indicated on the dipstick or on the dipstick handle. MERCON® and MERCON® V are not interchangeable. DO NOT mix MERCON® and MERCON®V. Refer to the service maintenance section to determine the correct service interval.

²Service refill capacity is determined by filling the transmission to the bottom of the filler hole with the vehicle on a level surface.

³Indicates only approximate dry-fill capacity. Some applications may vary based on cooler size and if equipped with an in-tank cooler. The amount of transmission fluid and fluid level should be set by the indication on the dipstick's normal operating range.

⁴Add the coolant type originally equipped in your vehicle. DO NOT MIX different colors or types of coolant. DO NOT USE Mazda Extended Life Engine Coolant (orange in color). Refer to *Adding engine coolant, in this chapter*.

⁵Traction-Lok axles use 2.2–2.4L (4.75–5.0 pints) of rear axle lubricant.

Add 118 ml (4 oz.) of Additive Friction Modifier meeting Mazda specifications for complete refill of Traction-Lok axles.

Service refill capacities are determined by filling the rear axle 6 mm to 14 mm (1/4 inch to 9/16 inch) below the bottom of the filler hole.

Maintenance and Specifications

LUBRICANT SPECIFICATIONS

Item	Mazda part name or equivalent
Front axle (4X4)	SAE 80W-90 Premium Rear Axle Lubricant
Rear axle	SAE 80W-90 Premium Rear Axle Lubricant ¹
Brake fluid and clutch fluid (if equipped)	High Performance DOT 3 Motor Vehicle Brake Fluid
Door weather strips	Silicone Lubricant
Engine coolant	Mazda Premium Engine Coolant ³
Engine oil 2.3L I4 and 3.0L V6 engines	SAE 5W-20 Premium Synthetic Blend Motor Oil
Engine oil 4.0L V6 engines	SAE 5W-30 Super Premium Motor Oil
Hinges, door checks, latches, striker plates, fuel filler door hinge and seat tracks	Multi-Purpose Grease
Transmission /steering/parking brake linkages and pivots, brake and clutch pedal shaft, clutch pilot bearing and input shaft spline (manual transmission).	Premium Long-Life Grease
Power steering fluid, transfer case fluid (4X4) and transmission fluid (manual)	MERCON® ATF
Automatic transmission (5R44E and 5R55E)	MERCON®V ATF ²
Windshield washer fluid	Ultra-clear Windshield Washer Concentrate

¹Add 118 ml (4 oz.) of Additive Friction Modifier meeting Mazda specifications for complete refill of Traction-Lok axles. If submerged in water, the rear axle lubricant should be changed.

²Ensure the correct automatic transmission fluid is used. Transmission fluid requirements are indicated on the dipstick or on the dipstick

Maintenance and Specifications

handle. MERCON® and MERCON® V are not interchangeable. DO NOT mix MERCON® and MERCON® V. Refer to your service maintenance section to determine the correct service interval.

³Do not mix different types or colors of engine coolant.

ENGINE SPECIFICATIONS

Engine	2.3L I4 engine	3.0L V6 engine	4.0L V6 engine
Cubic inches	138	182	245
Required fuel	87 octane	87 octane	87 octane
Firing order	1-3-4-2	1-4-2-5-3-6	1-4-2-5-3-6
Spark plug gap	1.04-1.19mm (0.041-0.047 inch)	1.07-1.17mm (0.042-0.046 inch)	1.3-1.4 mm (0.052-0.056 inch)
Ignition system	EDIS	EDIS	EDIS
Compression ratio	9.7:1	9.14:1	9.0:1

VEHICLE DIMENSIONS

Vehicle dimensions	Regular Cab mm (in)	SuperCab mm (in)
(1) Overall length	4 763 (187.5)	5 153 (202.9)
(2) Overall width	1 785 (70.3)	1 785 (70.3)
(3) Overall height 4x2/4x4	1 575 (62.0) / 1 655 (65.2)	1 585 (62.4) / 1 684 (66.3)
(4) Wheelbase	2 831 (111.4)	3 192 (125.7)
(5) Track - Front	1 486 (58.5)	1 485 (58.5)
(5) Track - Rear	1 455 (57.3)	1 455 (57.3)

Maintenance and Specifications

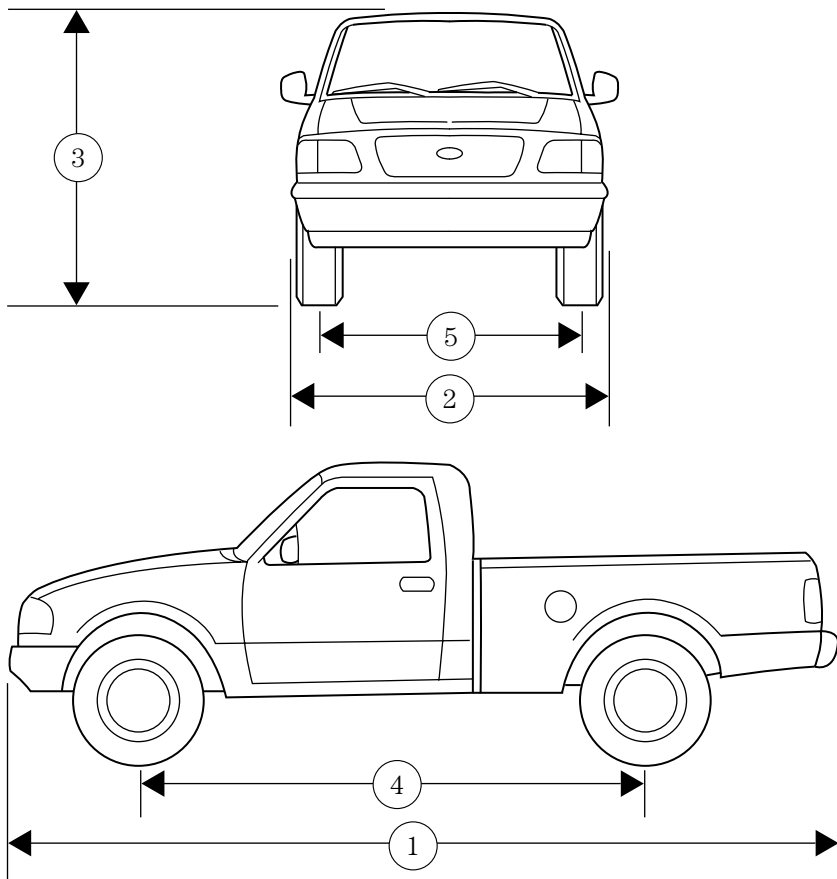

Maintenance and Specifications

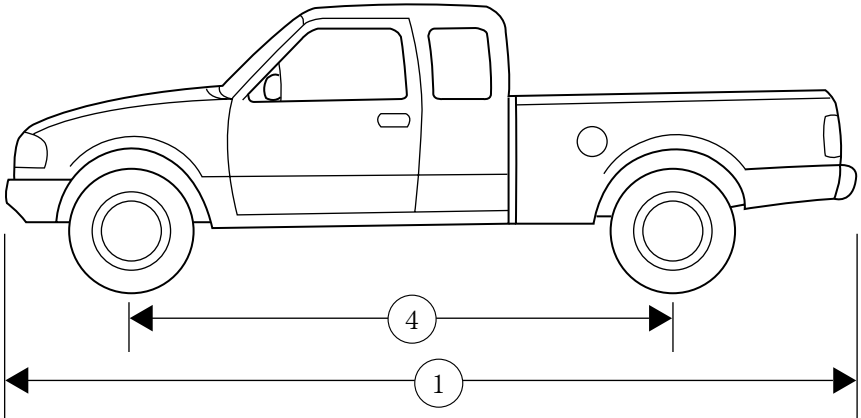

IDENTIFYING YOUR VEHICLE

Certification label

The National Highway Traffic Safety Administration Regulations require that a Certification Label be affixed to a vehicle and prescribe where the Certification Label may be located. The Certification Label is located on the front door latch pillar on the driver's side.

Vehicle identification number (VIN)

The vehicle identification number is attached to a metal tag and is located on the driver side instrument panel. (Please note that in the graphic XXXX is representative of your vehicle identification number.)

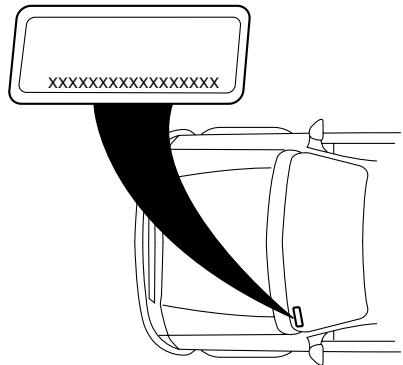

Engine number

The engine number (the last eight numbers of the vehicle identification number) is stamped on the engine block, transmission, frame and transfer case (if equipped).

CELL PHONES

Use of cell phones and other devices by driver:

WARNING: Use of any electrical devices such as cell phones, computers, portable radios, vehicle navigation or other devices by the driver while the vehicle is moving is dangerous. Dialing a number on a cell phone while driving also ties-up the driver's hands. Use of these devices will cause the driver to be distracted and could lead to a serious accident. If a passenger is unable to use the device, pull off the right-of-way to a safe area before use. If use of a cell phone is necessary despite this warning, use a hands-free system to at least allow the hands free to drive the vehicle. Never use a cell phone or other electrical device while the vehicle is moving and, instead, concentrate on the full-time job of driving.

Index

A

ABS (see Brakes)	115
Air bag supplemental restraint system	81
and child safety seats	84
description	81
disposal	87
driver air bag	85
indicator light	87
operation	85
passenger air bag	85
passenger deactivation switch	88
Ambulance packages	7
Antifreeze (see Engine coolant)	204
Anti-lock brake system (see Brakes)	115–116
Audio system	
6-CD in dash	24
AM/FM	19
MACH MP3	27
Single CD	21
Audio system (see Radio)	19, 21, 24, 27
Automatic dimming rear view mirror	50
Automatic transmission	119
driving an automatic overdrive	120
fluid, adding	223
fluid, checking	223
fluid, refill capacities	231
fluid, specification	236
Auxiliary power point	49
Axle	
lubricant specifications	235–236
refill capacities	231
traction lok	118

B

Battery	202
acid, treating emergencies	202
jumping a disabled battery	159
maintenance-free	202
servicing	202
Bed extender	57
BeltMinder	76
Brakes	115
anti-lock	115–116
anti-lock brake system (ABS) warning light	116
fluid, checking and adding	221
fluid, refill capacities	231
fluid, specifications	235–236
lubricant specifications	235–236
parking	116
shift interlock	119
Break-in period	5
Bulbs	40

C

Calculating load	130
Capacities for refilling fluids	231
Cassette tape player	21, 24
CD-single premium	19, 27
Cell phone warning	239
Certification Label	238
Changing a tire	151
Child safety restraints	94
child safety belts	94
Child safety seats	97
attaching with tether straps	102
in front seat	99
in rear seat	99
LATCH	106

- tether anchorage hardware ...102
 - Chimes (warning)16
 - Cleaning your vehicle
 - engine compartment177
 - exterior177, 181
 - exterior lamps179
 - instrument cluster lens180
 - instrument panel180
 - interior180
 - Mazda car care products181
 - mirrors179
 - plastic parts179
 - washing176
 - waxing176
 - wheels177
 - windows181
 - wiper blades179
 - Clock adjust
 - 6-CD in dash24
 - AM/FM19
 - MACH MP327
 - Single CD21
 - Clutch
 - fluid222
 - operation while driving122
 - recommended shift speeds123
 - Compass, electronic50–51
 - calibration52
 - set zone adjustment51
 - Console57
 - Coolant
 - checking and adding204
 - refill capacities207, 231
 - specifications235–236
 - Cruise control
 - (see Speed control)53
 - Customer Assistance165–166, 169
- D**
- Daytime running lamps
(see Lamps)38
 - Dipstick
 - automatic transmission
fluid223
 - engine oil195
 - Doors
 - lubricant specifications235
 - Driveline universal joint
and slip yoke227
 - Driving under special
conditions124, 126–127
 - mud126
 - sand126
 - snow and ice128
 - through water126, 128
- E**
- Emergencies, roadside
 - jump-starting159
 - Emergency Flashers139
 - Emission control system218
 - Engine236
 - cleaning177
 - coolant204
 - idle speed control202
 - lubrication
specifications235–236
 - refill capacities231
 - service points192–194
 - starting after a collision139
 - Engine block heater114
 - Engine oil195
 - checking and adding195
 - dipstick195
 - filter, specifications200

Index

- recommendations200
- refill capacities231
- specifications235–236
- Exhaust fumes114
- F**
- Flexible Fuel Vehicle (FFV)208
- Fluid capacities231
- Foglamps38
- Four-Wheel Drive vehicles124
 - driving off road126
 - electronic shift125
 - indicator light124
 - preparing to drive your vehicle118
- Fuel208
 - calculating fuel economy215
 - cap211
 - capacity231
 - choosing the right fuel212
 - comparisons with EPA fuel economy estimates218
 - detergent in fuel214
 - filling your vehicle
 - with fuel208, 211, 215
 - filter, specifications214
 - fuel pump shut-off switch139
 - improving fuel economy215
 - octane rating213, 236
 - quality213
 - running out of fuel214
 - safety information relating to automotive fuels208
- Fuel - flex fuel vehicle (FFV)208, 212–213
- Fuel pump shut-off switch139
- Fuses140–141
- G**
- Gas cap (see Fuel cap)211
- Gas mileage
 - (see Fuel economy)215
- Gauges16
- GAWR (Gross Axle Weight Rating)129
 - calculating130
 - definition129
 - driving with a heavy load129
 - location129
- GVWR (Gross Vehicle Weight Rating)129
 - calculating129–130
 - definition129
 - driving with a heavy load129
 - location129
- H**
- Hazard flashers139
- Headlamps38
 - aiming39
 - bulb specifications40
 - daytime running lights38
 - flash to pass39
 - high beam39
 - replacing bulbs41
 - turning on and off38
- Heating
 - heating and air conditioning system35–36
- Hood191
- I**
- Ignition110, 236
- Infant seats (see Safety seats) ..97
- Inspection/maintenance (I/M) testing219

- Instrument panel
 cleaning180
 cluster12, 180
 lighting up panel and interior ...39
 location of components12
- J**
- Jack151
 positioning151
 storage151–154
- Jump-starting your vehicle159
- K**
- Keyless remote entry system -
 see Remote entry system59
- Keys
 positions of the ignition110
- L**
- Lamps
 bulb replacement
 specifications chart40
 cargo lamps39
 courtesy40
 daytime running light38
 fog lamps38
 headlamps38
 headlamps, flash to pass39
 instrument panel, dimming39
 interior lamps40–41
 replacing bulbs .40–41, 43, 45–46
- Lane change indicator
 (see Turn signal)40
- LATCH anchors106
- Lights, warning and indicator12
 anti-lock brakes (ABS)116
- Limited slip axle
 (see Traction-Lok)118
- Load limits129
 GAWR129
 GVWR129
 trailer towing129
- Loading instructions128
- Lubricant specifications ...235–236
- Lumbar support, seats68
- M**
- Manual transmission122
 fluid capacities231
 lubricant specifications236
 reverse123
- Mirrors
 automatic dimming rearview
 mirror50
 cleaning179
 side view mirrors (power)53
- Motorcraft parts214
- O**
- Octane rating213
- Oil (see Engine oil)195
- Overdrive56
- Overheating150
- P**
- Parking brake116
- Passive anti-theft system
 (PATS)64
- Power distribution box
 (see Fuses)144
- Power door locks59

Index

- Power mirrors53
Power point49
Power steering117
 fluid, checking and adding220
 fluid, refill capacity231
 fluid, specifications235–236
Power Windows49
Preparing to drive
 your vehicle118
- R**
- Radio19, 21, 24, 27
 6-CD in dash24
 AM/FM19
 MACH MP327
 Single CD21
Relays140
Remote entry system59–60
 arming and disarming
 the anti-theft system61
 illuminated entry63
 locking/unlocking doors59–60
 replacement/additional
 transmitters62
 replacing the batteries61
- S**
- Safety Belt Maintenance80
Safety belts
 (see Safety restraints)69–73
Safety defects, reporting174
Safety restraints69–73
 belt minder76
 extension assembly76
 for adults70–72
 for children93–94
 lap belt74
 safety belt maintenance80
 warning light and chime76
Safety restraints - LATCH
 anchors106
Safety restraints - tether
 anchors102
Safety seats for children97
Seat belts
 (see Safety restraints)69
Seats67
 child safety seats97
Servicing your vehicle190
Snowplowing7
Spare tire (see
 Changing the Tire)152
Spark plugs, specifications236
Special notice
 ambulance conversions7
 utility-type vehicles7
Specification chart,
 lubricants235–236
Speed control53
Starting a flex fuel vehicle113
Starting your
 vehicle110–111, 113
 jump starting159
Steering wheel
 tilting48
Stereo
 6-CD in dash24
 AM/FM19
 MACH MP327
 Single CD21
- T**
- Tether anchors102

- Tilt steering wheel48
- Tires151, 227–228
 changing151–152, 155
 checking the pressure228
 replacing230
 rotating229
 snow tires and chains230
 tire grades228
 treadwear227
- Towing131
 recreational towing137
 trailer towing131
 wrecker164
- Traction-lok rear axle118
- Transfer case
 fluid checking226
- Transmission
 automatic operation119
 fluid, checking and adding
 (automatic)223
 fluid, checking and adding
 (manual)225
 fluid, refill capacities231
 lubricant specifications ..235–236
 manual operation122
- Turn signal40
- V**
- Vehicle dimensions236
- Vehicle Identification Number
 (VIN)238
- Vehicle loading129
 camper bodies138
- Ventilating your vehicle115
- W**
- Warning chimes16
- Warning lights (see Lights)12
- Washer fluid195
- Washing your vehicle176
- Water, Driving through128
- Waxing your vehicle176
- Windows
 power49
- Windshield washer fluid and
 wipers47
 checking and adding fluid195
 checking and cleaning47
 replacing wiper blades48
- Wrecker towing164

Part No.

9999-95-023C-03R1

© Mazda North American Operations

Printed in U.S.A.