

Table of Contents

Introduction 4

Instrument Cluster 12

Warning and control lights	12
Gauges	16

Entertainment Systems 18

AM/FM stereo	18
AM/FM stereo with single CD	19
AM/FM stereo tape/CD/MP3	22
Premium AM/FM stereo CD6/MP3	26

Climate Controls 31

Heater only	31
Manual heating and air conditioning	32

Lights 34

Headlamps	34
Turn signal control	36
Bulb replacement	36

Driver Controls 43

Windshield wiper/washer control	43
Steering wheel adjustment	44
Power windows	45
Speed control	49

Locks and Security 55

Keys	55
Locks	55
Anti-theft system	55

Table of Contents

Seating and Safety Restraints 63

Seating	63
Safety restraints	65
Air bags	77
Child restraints	89

Driving 105

Starting	105
Brakes	110
Transmission operation	114
Vehicle loading	124
Trailer towing	128
Recreational towing	135

Roadside Emergencies 137

Hazard flasher switch	137
Fuel pump shut-off switch	137
Fuses and relays	138
Overheating	148
Changing tires	149
Jump starting	157
Wrecker towing	162

Customer Assistance 163

Reporting safety defects (U.S. only)	173
--------------------------------------	-----

Cleaning 174

Table of Contents

Maintenance and Specifications **180**

Engine compartment	190
Engine oil	194
Battery	200
Fuel information	208
Refill capacities	240
Lubricant specifications	243
Engine data	244

Accessories **248**

Index **249**

All rights reserved. Reproduction by any means, electronic or mechanical including photocopying, recording or by any information storage and retrieval system or translation in whole or part is not permitted without written authorization from MNAO. MNAO may change the contents without notice and without incurring obligation.

Copyright © 2003 MNAO

Introduction

CALIFORNIA Proposition 65 Warning

WARNING: Engine exhaust, some of its constituents, and certain vehicle components contain or emit chemicals known to the State of California to cause cancer and birth defects or other reproductive harm. In addition, certain fluids contained in vehicles and certain products of component wear contain or emit chemicals known to the State of California to cause cancer and birth defects or other reproductive harm.

CONGRATULATIONS

Congratulations on acquiring your new Mazda product. Please take the time to get well acquainted with your vehicle by reading this handbook. The more you know and understand about your vehicle, the greater the safety and pleasure you will derive from driving it.

For more information on Mazda and its products visit the following website:

- In the United States: www.mazdausa.com
- In Canada: www.mazda.ca

Additional owner information is given in separate publications.

This Owner's Guide describes every option and model variant available and therefore some of the items covered may not apply to your particular vehicle. Furthermore, due to printing cycles it may describe options before they are generally available.

Remember to pass on the Owner's Guide when reselling the vehicle. It is an integral part of the vehicle.

WARNING: In the event of an accident the Fuel pump shut-off switch will automatically cut off the fuel supply to the engine. The switch can also be activated through sudden vibration (e.g. collision when parking). To reset the switch, refer to the *Fuel pump shut-off switch* in the *Roadside emergencies* chapter.

SAFETY AND ENVIRONMENT PROTECTION

Warning symbols in this guide

How can you reduce the risk of personal injury and prevent possible damage to others, your vehicle and its equipment? In this guide, answers to such questions are contained in comments highlighted by a bold **WARNING** statement. These comments should be read and observed.



Warning symbols on your vehicle

When you see this symbol, it is imperative that you consult the relevant section of this guide before touching or attempting adjustment of any kind.



Protecting the environment

We must all play our part in protecting the environment. Correct vehicle usage and the authorized disposal of waste, cleaning and lubrication materials are significant steps towards this aim. Information in this respect is highlighted in this guide with the tree symbol.



Always dispose of used automotive fluids in a responsible manner. Follow your community's regulations and standards for recycling and disposing of automotive fluids.

BREAKING-IN YOUR VEHICLE

There are no particular breaking-in rules for your vehicle. During the first 1,600 km (1,000 miles) of driving, vary speeds frequently. This is necessary to give the moving parts a chance to break in.

Introduction

SPECIAL NOTICES

Emission warranty

The New Vehicle Limited Warranty includes Bumper to Bumper Coverage, Safety Restraint Coverage and Corrosion Coverage. In addition, your vehicle is eligible for Emissions Defect and Emissions Performance Warranties. For a detailed description of what is covered and what is not covered, refer to the *Warranty Guide* that is provided to you along with your Owner's Guide.

Event Data Recorder

The computer in your vehicle is capable of recording detailed data potentially including but not limited to information such as:

- the use of restraint systems including seat belts by the driver and passengers,
- information about the performance of various systems and modules in the vehicle, and
- information related to engine, throttle, steering, brake or other system status potentially including information related to how the driver operates the vehicle including but not limited to vehicle speed.

This information may be stored during regular operation or in a crash or near crash event. This stored information may be read out and used by:

- service and repair facilities.
- law enforcement or government agencies.
- the Manufacturer and Distributor.

Special instructions

For your added safety, your vehicle is fitted with sophisticated electronic controls.

WARNING: Please read the section *Supplemental Restraint System (SRS)* in the *Seating and Safety Restraints* chapter. Failure to follow the specific warnings and instructions could result in personal injury.

WARNING: Front seat mounted rear facing child or infant seats should NEVER be used in front of a passenger side air bag unless the air bag can be and is turned OFF.

Notice to owners of pickup trucks and utility type vehicles

WARNING: Utility vehicles have a significantly higher rollover rate than other types of vehicles.

Before you drive your vehicle, please read this Owner's Guide carefully. Your vehicle is not a passenger car. As with other vehicles of this type, failure to operate this vehicle correctly may result in loss of vehicle control, vehicle rollover, personal injury or death.

Be sure to read *Driving off road* in the *Driving* chapter.

Using your vehicle with a snowplow

WARNING: Do not use this vehicle for snowplowing.

Your vehicle is not equipped with a snowplowing package.

Using your vehicle as an ambulance























WARNING: Do not use this vehicle as an ambulance.

Your vehicle is not equipped with the an ambulance preparation package.















Introduction

These are some of the symbols you may see on your vehicle.

Vehicle Symbol Glossary

Safety Alert		See Owner's Guide	
Protecting the Environment		Fasten Safety Belt	
Air Bag-Front		Air Bag-Side	
Child Seat		Child Seat Installation Warning	
Child Seat Lower Anchor		Child Seat Tether Anchor	
Brake System		Anti-Lock Brake System	
Brake Fluid - Non-Petroleum Based		Master Lighting Switch	
Hazard Warning Flasher		Fog Lamps-Front	
Fuse Compartment		Fuel Pump Reset	
Windshield Wash/Wipe		Windshield Defrost/Demist	
Rear Window Defrost/Demist		Power Windows	

Vehicle Symbol Glossary

Power Window Lockout		Personal Alarm System Feature	
Engine Oil		Engine Coolant	
Engine Coolant Temperature		Do Not Open When Hot	
Battery		Avoid Smoking, Flames, or Sparks	
Battery Acid		Explosive Gas	
Fan Warning		Power Steering Fluid	
Maintain Correct Fluid Level		Emission System	
Engine Air Filter		Passenger Compartment Air Filter	
Jack		Check fuel cap	

INFORMATION ABOUT THIS GUIDE

The information found in this guide was accurate at the time of printing. Mazda may change the contents without notice.

Instrument Cluster

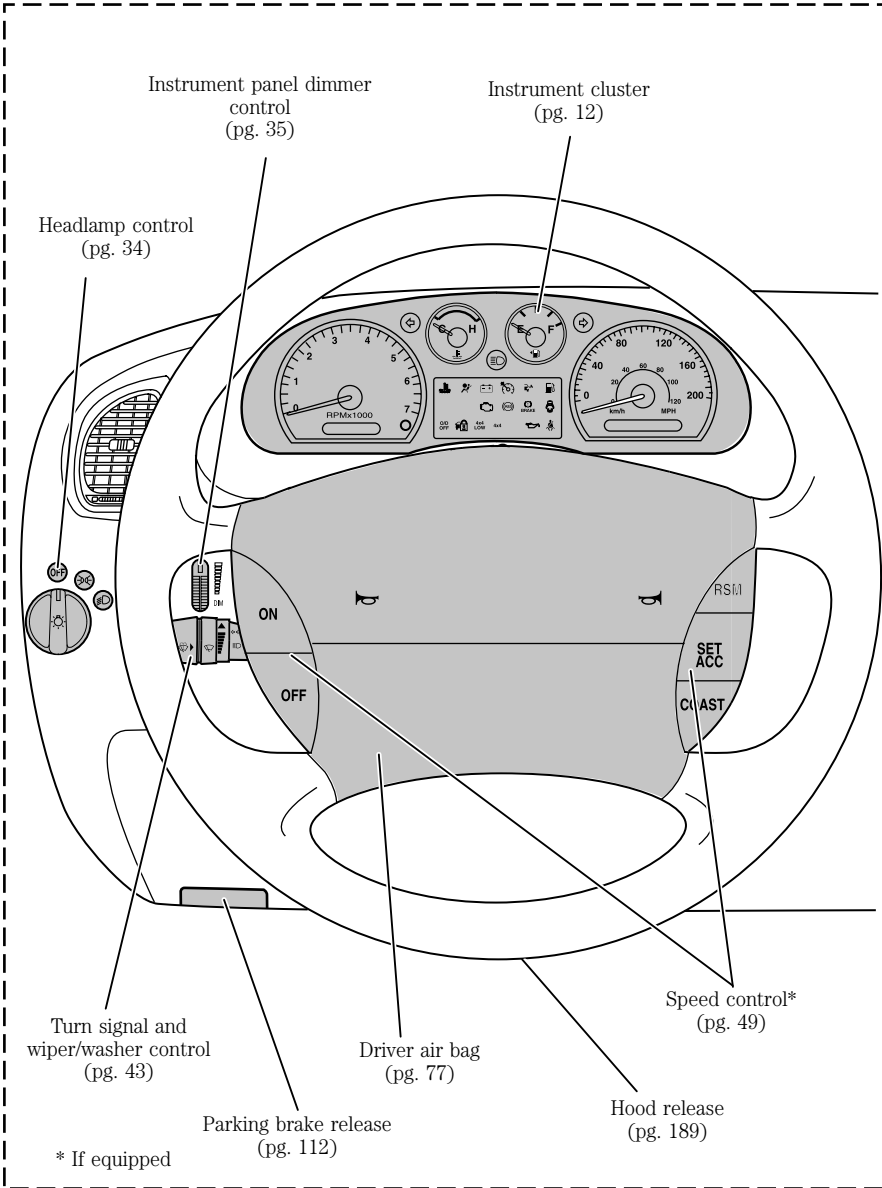

Instrument Cluster

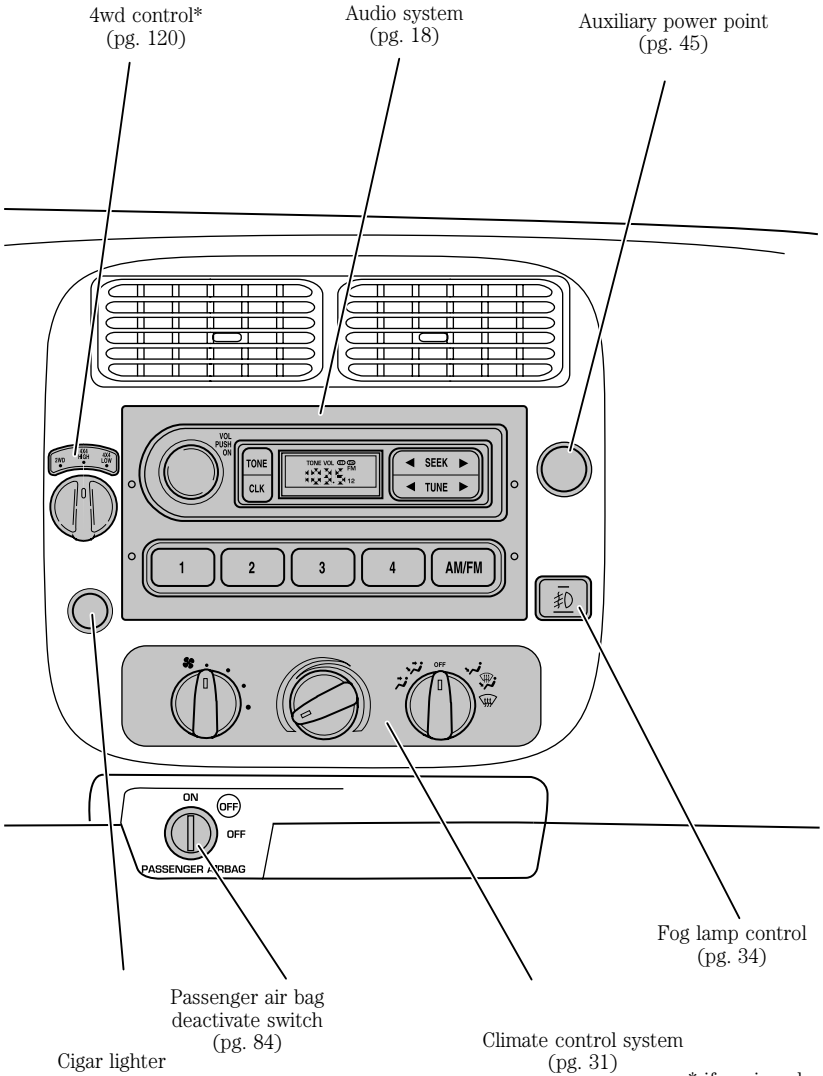

* if equipped

Instrument Cluster

WARNING LIGHTS AND CHIMES

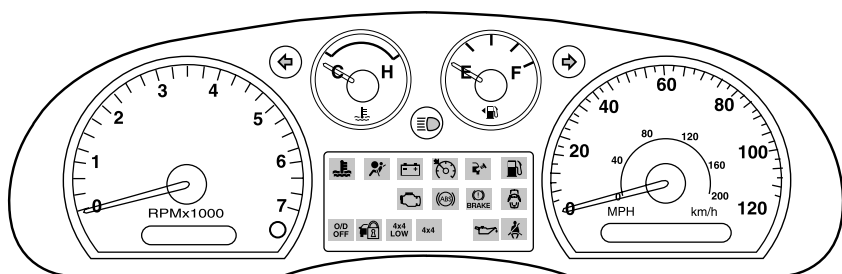

Warning lights and gauges can alert you to a vehicle condition that may become serious enough to cause expensive repairs. A warning light may illuminate when a problem exists with one of your vehicle's functions. Many lights will illuminate when you start your vehicle to make sure the bulb works. If any light remains on after starting the vehicle, have the respective system inspected immediately.

Check engine: The *Check Engine* indicator light illuminates when the ignition is first turned to the ON position to check the bulb. Solid

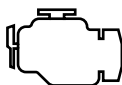

illumination after the engine is started indicates the On Board Diagnostics System (OBD-II) has detected a malfunction. Refer to *On board diagnostics (OBD-II)* in the *Maintenance and Specifications* chapter. If the light is blinking, engine misfire is occurring which could damage your catalytic converter. Drive in a moderate fashion (avoid heavy acceleration and deceleration) and have your vehicle serviced immediately.

WARNING: Under engine misfire conditions, excessive exhaust temperatures could damage the catalytic converter, the fuel system, interior floor coverings or other vehicle components, possibly causing a fire.

Check fuel cap: Illuminates when the fuel cap may not be properly installed. Check the fuel filler cap if this light remains on. Continued driving with this light on may cause the Check Engine warning light to come on.



It may take a long period of time for the system to detect an improperly installed or properly re-installed fuel filler cap depending on driving and fuel tank level conditions. Refer to *Fuel filler cap* in the *Maintenance and Specifications* chapter.

Brake system warning light: To confirm the brake system warning light is functional, it will momentarily illuminate when the ignition is turned to the ON position when the engine is not running, or in a position between ON and START, or by applying the parking brake when the ignition is turned to the ON position. If the brake system warning light does not illuminate at this time, seek service immediately from your dealership. Illumination after releasing the parking brake indicates low brake fluid level or a failure to brake proportioning and the brake system should be inspected immediately by your servicing dealership.



WARNING: Driving a vehicle with the brake system warning light on is dangerous. A significant decrease in braking performance may occur. It will take you longer to stop the vehicle. Have the vehicle checked by your dealer immediately.

Anti-lock brake system: If the ABS light stays illuminated or continues to flash, a malfunction has been detected; have the system serviced immediately. Normal braking is still functional unless the brake warning light also is illuminated.



Instrument Cluster

Air bag readiness: If this light fails to illuminate when ignition is turned to ON, continues to flash or remains on, have the system serviced immediately. A chime will also



sound when a malfunction in the supplemental restraint system has been detected.

Safety belt: Reminds you to fasten your safety belt. A chime will also sound to remind you to fasten your safety belt. Refer to the *Seating and safety restraints* chapter.



Charging system: Illuminates when the battery is not charging properly.



Engine oil pressure: Illuminates when the oil pressure falls below the normal range, refer to *Engine oil* in the *Maintenance and specifications* chapter.

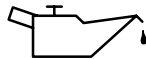

Engine coolant temperature:

Illuminates when the engine coolant temperature is high. Stop the



vehicle as soon as possible, switch off the engine and let cool. Refer to *Engine coolant* in the *Maintenance and specifications* chapter.

WARNING: Never remove the coolant recovery cap while the engine is running or hot.

Low fuel: Illuminates when the fuel level in the fuel tank is at or near empty (refer to *Fuel gauge* in this chapter).



Door ajar: Illuminates when the ignition is in the ON position and any door is open.



Instrument Cluster

Overdrive off (if equipped):

Illuminates when the overdrive function of the transmission has been turned off, refer to the

Driving chapter. **If the light does not come on or the light flashes steadily, have your vehicle serviced as soon as possible, damage to the transmission could occur.**

O/D
OFF

Four wheel drive low (if equipped): Illuminates when four-wheel drive low is engaged.

4x4
LOW

NOTE: If the light continues to flash have the system serviced.

Four wheel drive high (if equipped): Illuminates when four-wheel drive high is engaged. It may also illuminate when the 4WD LOW is engaged, refer to the *Driving* chapter for more information.

4x4

NOTE: If the light continues to flash have the system serviced.

Anti-theft system: Flashes when the Securilock™ Passive Anti-theft System has been activated.



Speed control: Illuminates when the speed control is engaged. Turns off when the speed control system is disengaged.



Turn signal: Illuminates when the left or right turn signal or the hazard lights are turned on. If the indicators stay on or flash faster, check for a burned out bulb.

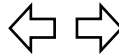

High beams: Illuminates when the high beam headlamps are turned on.



Key-in-ignition warning chime: Sounds when the key is left in the ignition in the OFF/LOCK or ACC position and the driver's door is opened.

Instrument Cluster

WARNING: Never remove the coolant reservoir cap and/or the radiator cap while the engine is running or hot, this may result in serious burns.

Odometer: Registers the total kilometers (miles) of the vehicle.

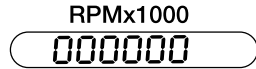

Trip odometer: Registers the kilometers (miles) of individual journeys. To reset, depress the control button.

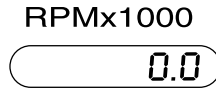

Tachometer: Indicates the engine speed in revolutions per minute. Driving with your tachometer pointer continuously at the top of the scale may damage the engine.

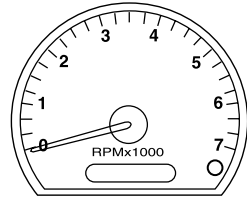

Fuel gauge: Indicates approximately how much fuel is left in the fuel tank (when the ignition is in the ON position). The fuel gauge may vary slightly when the vehicle is in motion or on a grade.

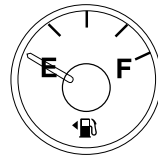

NOTE: The FUEL icon and arrow indicates which side of the vehicle the fuel filler door is located.

Refer to *Filling the tank* in the *Maintenance and Specifications* chapter for more information.

Entertainment Systems

AM/FM STEREO (IF EQUIPPED)

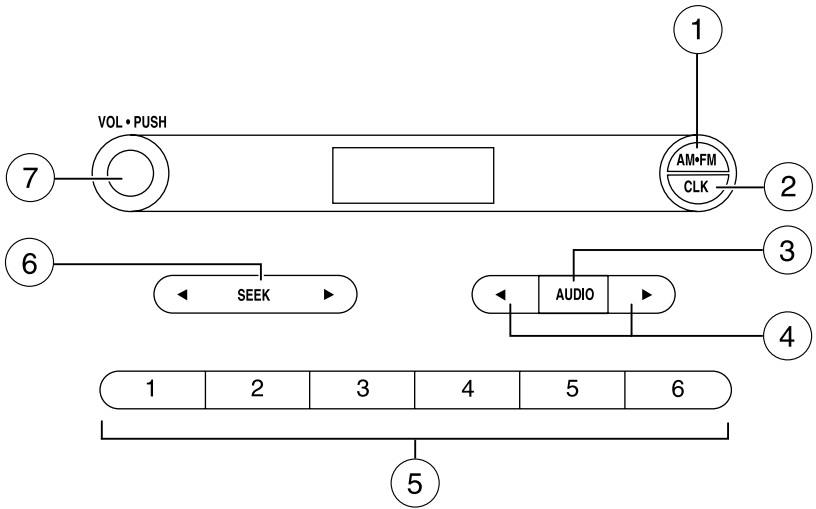

1. **AM/FM:** Press to select AM/FM1/FM2 frequency bands.



2. **CLK:** Press until SELECT HOUR / SELECT MINUTE appears.



Press ◀ AUDIO ▶ to adjust the hours/minutes.

Press CLK to display the time when the ignition is off.

3. **AUDIO:** Press AUDIO to toggle through the following modes and use ◀ / ▶ to make adjustments in those modes.



Bass: Press ◀ AUDIO ▶ to decrease/increase the bass setting.

Treble: Press ◀ AUDIO ▶ to decrease/increase the treble setting.

Balance: Press ◀ AUDIO ▶ to adjust the audio between the left and right speakers.

Entertainment Systems

4. **Tune:** Press to manually go down/up (◀/▶) the radio frequency and in audio mode to select various settings.

5. **Memory presets:** To set a station: Select frequency band AM/FM; tune to a station, press and hold a preset button until sound returns. To tune a preset station, press the desired memory preset.



6. **SEEK:** Press ◀ SEEK ▶ to access the previous or next radio station. If pressed for less than .5 seconds, the system will seek to the next or previous station.



7. **ON/OFF/Volume:** Press to turn the system ON/OFF. Turn to adjust the volume levels. If the volume is set above a certain level, and the ignition is turned off, the volume will come back to a “nominal” listening level when the ignition is turned back on.

VOL - PUSH



AM/FM STEREO CD

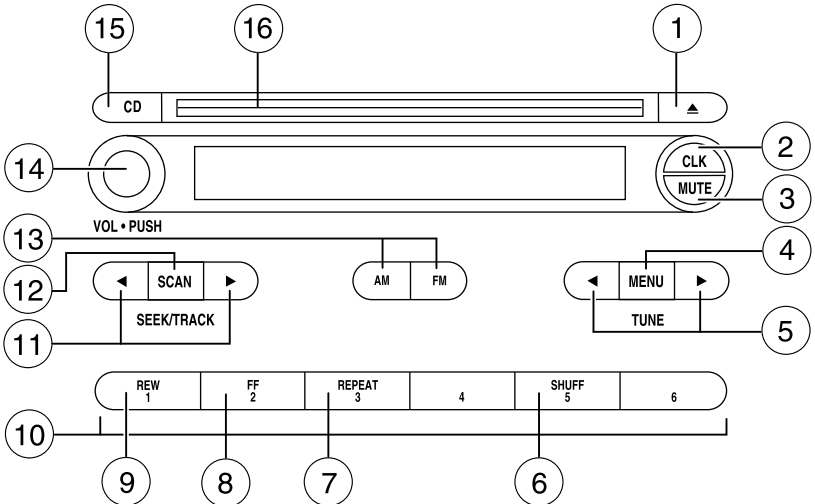

Entertainment Systems

1. **CD eject:** Press to eject the CD.



2. **CLK (Clock):** Press CLK until SELECT HOUR or SELECT MINUTE is displayed. Press



◀ TUNE ▶ to adjust the

hours/minutes. Press CLK to display the time when the ignition is off.

3. **MUTE:** Press to mute the playing media. Press again to return to the playing media.



4. **MENU:** Press MENU repeatedly to toggle through the following modes and use ◀ / ▶ to make adjustment in those modes.



Autoset: Press ◀ MENU ▶ to set the strongest local radio stations for AM/FM1/FM2 without losing your original manually set preset stations.

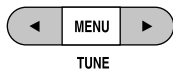

When the six strongest stations are filled, the station stored in preset 1 will begin playing. If there are less than six strong stations, the system will store the last one in the remaining presets.

Bass: Press ◀ MENU ▶ to decrease/increase the bass setting.

Treble: Press ◀ MENU ▶ to decrease/increase the treble setting.







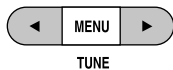

Balance: Press ◀ MENU ▶ to adjust the audio between the left and right speakers.

Fade: Press ◀ MENU ▶ to adjust the audio between the front and rear speakers.

5. **TUNE:** Press to manually go down/up (◀ / ▶) the radio frequency and also to select various settings in menu mode.



Entertainment Systems

6. **SHUFF (Shuffle):** Press to play the tracks on the current CD in random order. 
7. **REPEAT:** Press to repeat the current CD track. 
8. **FF (Fast forward):** Press to manually advance in a CD track. 
9. **REW (Rewind):** Press to manually reverse in a CD track. 
10. **Memory presets:** To set a station: Select frequency band AM/FM; tune to a station, press and hold a preset button until sound returns. To recall a previously set station, press the desired memory preset button briefly. 
11. **SEEK/TRACK:** Press to access the next/previous strong station. In CD mode, press to advance to the next/previous track.
12. **SCAN:** Press to toggle between SCAN ON and SCAN OFF. When activated, the system scans up through and plays a brief sampling of available radio stations or CD tracks. Press again to stop. 
13. **AM/FM:** Press to select AM/FM1/FM2 frequency band. 
14. **ON/OFF/Volume:** Press to turn ON/OFF. Turn to increase/decrease volume. If the volume is set above a certain level and the ignition is turned off, the volume will come back on at a “nominal” listening level when the ignition switch is turned back on. 
15. **CD:** Press to enter CD mode. If a CD is already present in the system, the disc will begin to play. 

Entertainment Systems

16. **CD slot:** Insert a CD label side up.



CD units are designed to play commercially pressed 12 cm (4.75 in) audio compact discs only. Due to technical incompatibility, certain recordable and re-recordable compact discs may not function correctly when used in Mazda CD players. Irregular shaped CDs, CDs with a scratch protection film attached, and CDs with homemade paper (adhesive) labels should not be inserted into the CD player. The label may peel and cause the CD to become jammed. It is recommended that homemade CDs be identified with permanent felt tip marker rather than adhesive labels. Ballpoint pens may damage CDs. Please contact your dealer for further information.

AM/FM STEREO TAPE/CD/MP3

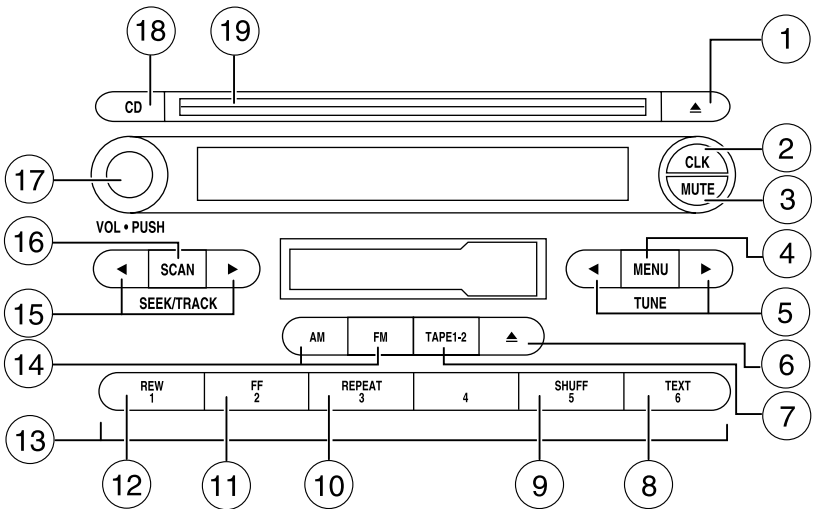

1. **CD eject:** Press to eject the CD.



Entertainment Systems

2. **CLK (Clock):** Press CLK until SELECT HOUR or SELECT MINUTE is displayed. Press ◀ MENU ▶ to adjust the hours/minutes. Press CLK to display the time of day when the ignition is off.



3. **MUTE:** Press to mute the playing media. Press again to return to the playing media.



4. **MENU:** Press MENU repeatedly to toggle through the following modes and use ◀ / ▶ to make adjustment in those modes.



Autoset: Press MENU to access the autoset setting. Allows you to set the strongest local radio stations without losing your original manually set preset stations for AM/FM1/FM2 . Use ◀ MENU ▶ to set.



When the six strongest stations are filled, the station stored in preset 1 will begin playing. If there are less than six strong stations, the system will store the last one in the remaining presets. Press again to disengage.

Bass: Press ◀ MENU ▶ to decrease/increase the level of bass.

Treble: Press ◀ MENU ▶ to decrease/increase the level of treble.

Balance: Press ◀ MENU ▶ to adjust the audio between the left and right speakers.

Fade: Press ◀ MENU ▶ to adjust the audio between the front and rear speakers.

Next/previous directory: In MP3 mode, press ◀ MENU ▶ to go to the previous or next MP3 directory.









Flat file/directory mode: Press ◀ MENU ▶ to select Flat file mode or Directory mode.

Track number/music name/file name: In MP3 mode, press ◀ MENU ▶ to view by track number, music name or file name.

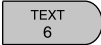



Dolby:  **Dolby® noise reduction:** Reduces tape noise and hiss. Press ◀ MENU ▶ to cycle Dolby ON/OFF. The Dolby® noise

Entertainment Systems

reduction system is manufactured under license from Dolby Laboratories Licensing Corporation. Dolby® and the double-D symbol are registered trademarks of Dolby® Laboratories Licensing Corporation.

5. **TUNE:** Press to manually go down/up (◀/▶) the radio frequency and also to select various settings in menu mode.

TUNE
6. **Tape eject:** Press to eject the tape.

7. **Tape 1-2:** Press to change playing sides of the tape.

8. **TEXT:** In MP3 mode, press to view the next 12 characters in the MP3 Music name/file name of the current MP3 track and directory.

9. **SHUFF (Shuffle):** In CD or MP3 mode, press to play the tracks on the current CD/MP3 in random order. In MP3 directory mode, press to play the tracks within the current directory in random order.

10. **REPEAT:** Press to repeat the current CD/MP3 track.

11. **FF (Fast forward):** In tape mode, press to fast forward the tape. In CD mode, press to manually advance in a CD track.

12. **REW (Rewind):** In tape mode, press to rewind the tape. In CD mode, press to manually reverse in a CD track.

13. **Memory presets:** To set a station: Select frequency band AM/FM; tune to a station, press and hold a preset button until sound returns. To select a preset station, press the desired memory preset button.

Entertainment Systems

14. **AM/FM:** Press to select AM/FM1/FM2 frequency band. 
15. **SEEK/TRACK:** In radio mode, press ► / ◀ to access the next/previous strong station. In CD and MP3 flat file mode, press to access the next track. In MP3 directory mode, press to select the next/previous track in the current directory.
16. **Scan:** In radio mode, scan through the available stations. In tape mode, you may set SCAN on or off. If activated, the player will scan the tape and plays a short Introduction of each song. In CD and MP3 flat file mode, you may set the scan on or off. If activated, the system will scan through each track. In MP3 directory mode, you may set scan on or off. If activated, the system will scan in the current directory. 
17. **ON/OFF/Volume:** Press to turn ON/OFF. Turn to increase/decrease volume. If the volume is set above a certain level and the ignition is turned off, the volume will come back on at a “nominal” listening level when the ignition switch is turned back on. 
VOL - PUSH
18. **CD:** Press to enter CD mode. If a CD is already in the system, the disc will begin play. 
19. **CD slot:** Insert a CD, label side up. 

CD units are designed to play commercially pressed 12 cm (4.75 in) audio compact discs only. Due to technical incompatibility, certain recordable and re-recordable compact discs may not function correctly when used in Mazda CD players. Irregular shaped CDs, CDs with a scratch protection film attached, and CDs with homemade paper (adhesive) labels should not be inserted into the CD player. The label may peel and cause the CD to become jammed. It is recommended that homemade CDs be identified with permanent felt tip marker rather than adhesive labels. Ballpoint pens may damage CDs. Please contact your dealer for further information.

Entertainment Systems

PREMIUM AM/FM STEREO CD6/MP3

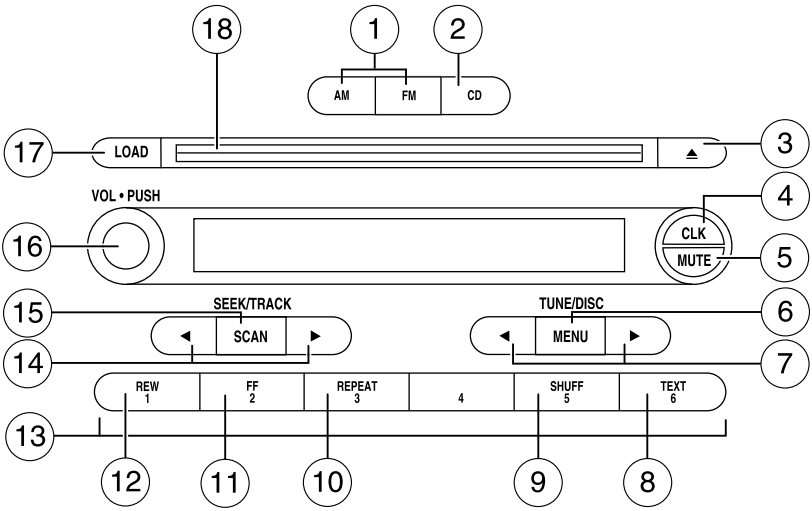

1. **AM/FM:** Press to select AM/FM1/FM2 frequency bands.



2. **CD:** Press to enter CD mode. If a CD is already in the system, the disc will start playing.



3. **EJ (CD eject):** Press to eject the CD. Press and hold to eject all CDs.



4. **CLK (Clock):** Press CLK until SELECT HOUR or SELECT MINUTE is displayed. Press ◀ MENU ▶ to adjust the hours/minutes. Press CLK to display the time when the ignition is off.



5. **MUTE:** Press to mute the playing media. Press again to return to the playing media.



6. **MENU:** Press MENU repeatedly to toggle through the following modes and use ◀/▶ to make adjustment in those modes.



Autoset: Allows you to set the strongest local radio stations without losing your original manually set preset stations for



AM/FM1/FM2 . Press MENU to access. Use ◀ MENU ▶ to set.

When the six strongest stations are filled, the station stored in preset 1 will begin playing. If there are less than six strong stations, the system will store the last one in the remaining presets.

Bass: Press ◀ MENU ▶ to decrease/increase the bass setting.

Treble: Press ◀ MENU ▶ to decrease/increase the treble setting.

Balance: Press ◀ MENU ▶ to adjust the audio between the left and right speakers.

Fade: Press ◀ MENU ▶ to adjust the audio between the front and rear speakers.







Next/previous directory: In MP3 mode, press MENU ◀/▶ to go to the previous/next directory.

Flat file/directory mode: In MP3 mode, press MENU to access this feature. Use ◀ MENU ▶ to select flat file mode or directory mode.

Track #/normal music name/file name: Press MENU to access and use ◀/▶ to scroll through MP3 display options (track #, normal music name or file name).

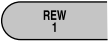
7. **TUNE/DISC:** Press to manually go down/up (◀/▶) the radio frequency, select the previous/next CD or to select various settings in menu mode. In MP3 directory mode, press ◀/▶ to access the previous/next directory
8. **TEXT:** In MP3 normal music name/file name mode, press to view the next 12 characters in the MP3 music name/filename of the current MP3 track and directory.

Entertainment Systems

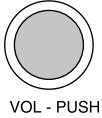
9. **SHUFF (Shuffle):** Press to play the tracks on the current CD/MP3 in random order. In MP3 directory mode, press to play the tracks within the current directory in random order.
- 
10. **REPEAT:** Press to repeat the current CD/MP3 track.
- 
11. **FF (Fast forward):** Press to manually advance in a CD track.
- 
12. **REW (Rewind):** Press to manually reverse in a CD track.
- 
13. **Memory presets:** To set a station: Select frequency band AM/FM; tune to a station, press and hold a preset button until sound returns. To select a preset station, press the desired memory preset.
- 
14. **SEEK/TRACK:** In radio, CD and MP3 flat file mode, press  /  to access the next/previous strong station or track. In MP3 directory mode, press to select the next/previous track in the current directory.
15. **SCAN:** In radio, CD and MP3 flat file mode, press for a brief sampling of radio stations or CD/MP3 tracks. In MP3 directory mode, press to hear a brief sampling of all tracks in the current directory. Press again to stop.
- 
16. **ON/OFF/Volume:** Press to turn ON/OFF. Turn to increase/decrease volume. If the volume is set above a certain level and the ignition is turned off, the volume will come back on at a “nominal” listening level when the ignition switch is turned back on.
- 
17. **LOAD:** Press to load a CD. Press and hold to autoload up to six discs.
18. **CD slot:** Insert a CD, label side up.

Entertainment Systems

CD units are designed to play commercially pressed 12 cm (4.75 in) audio compact discs only. Due to technical incompatibility, certain recordable and re-recordable compact discs may not function correctly when used in Mazda CD players. Irregular shaped CDs, CDs with a scratch protection film attached, and CDs with homemade paper (adhesive) labels should not be inserted into the CD player. The label may peel and cause the CD to become jammed. It is recommended that homemade CDs be identified with permanent felt tip marker rather than adhesive labels. Ballpoint pens may damage CDs. Please contact your dealer for further information.

RADIO FREQUENCIES

AM and FM frequencies are established by the Federal Communications Commission (FCC) and the Canadian Radio and Telecommunications Commission (CRTC). Those frequencies are:

AM - 530, 540–1700, 1710 kHz

FM- 87.7, 87.9–107.7, 107.9 MHz

RADIO RECEPTION FACTORS

There are three factors that can affect radio reception:

- Distance/strength: The further you travel from an FM station, the weaker the signal and the weaker the reception.
- Terrain: Hills, mountains, tall buildings, power lines, electric fences, traffic lights and thunderstorms can interfere with your reception.
- Station overload: When you pass a broadcast tower, a stronger signal may overtake a weaker one and play while the weak station frequency is displayed.

CASSETTE/PLAYER CARE

Do:

- Use only cassettes that are 90 minutes long or less.
- Tighten very loose tapes by inserting a finger or pencil into the hole and turning the hub.
- Remove loose labels before inserting tapes.
- Allow tapes which have been subjected to extreme heat, humidity or cold to reach a moderate temperature before playing.
- Clean the cassette player head with a cassette cleaning cartridge after 10–12 hours of play to maintain good sound/operation.

Entertainment Systems

Don't:

- Expose tapes to direct sunlight, extreme humidity, heat or cold.
- Leave tapes in the cassette player for a long time when not being played.

CD/CD PLAYER CARE

Do:

- Handle discs by their edges only. Never touch the playing surface.
- Inspect discs before playing. Clean only with an approved CD cleaner and wipe from the center out.

Don't:

- Expose discs to direct sunlight or heat sources for extended periods of time.
- Insert more than one disc into each slot of the CD changer magazine.
- Clean using a circular motion.

CD units are designed to play commercially pressed 12 cm (4.75 in) audio compact discs only. Due to technical incompatibility, certain recordable and re-recordable compact discs may not function correctly when used in Mazda CD players. Irregular shaped CDs, CDs with a scratch protection film attached, and CDs with homemade paper (adhesive) labels should not be inserted into the CD player. The label may peel and cause the CD to become jammed. It is recommended that homemade CDs be identified with permanent felt tip marker rather than adhesive labels. Ball point pens may damage CDs. Please contact your dealer for further information.

AUDIO SYSTEM WARRANTY AND SERVICE

Refer to the *Warranty Guide* for audio system warranty information. If service is necessary, see your authorized Mazda dealership.

Climate Controls

HEATER ONLY SYSTEM (IF EQUIPPED)

1. **Fan speed adjustment:**

Controls the volume of air circulated in the vehicle.

2. **Temperature selection:**

Controls the temperature of the airflow in the vehicle.

3. **Air flow selections:** Controls the direction of the airflow in the vehicle. See the following for a brief description on each control.

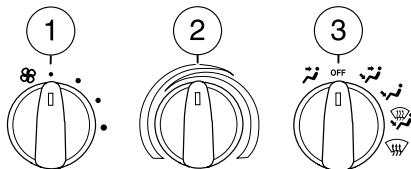



 : Distributes outside air through the instrument panel vents.

OFF: Outside air is shut out and the fan will not operate.

 : Distributes outside air through the instrument panel vents and the floor vents.

 : Distributes outside air through the floor vents.

 : Distributes outside air through the windshield defroster vents and floor vents.

 : Distributes outside air through the windshield defroster vents.

OPERATING TIPS

- To reduce fog build up on the windshield during humid weather, place the air flow selector in the  position.
- To reduce humidity build up inside the vehicle during cold or warm weather, do not drive with the air flow selector in the OFF position.
- Under normal weather conditions, do not leave the air flow selector in OFF when the vehicle is parked. This allows the vehicle to “breathe” using the outside air inlet vents.
- Do not put objects under the front seats that will interfere with the air flow to the back seats.
- Remove any snow, ice or leaves from the air intake area at the base of the windshield.

To aid in side window defogging/demisting in cold weather:

1. Select 
2. Set the temperature control to full heat
3. Set the fan speed to HI

Climate Controls

4. Direct the outer instrument panel vents towards the side windows

To increase airflow to the outer instrument panel vents, close the vents located in the middle of the instrument panel.

WARNING: Do not place objects on top of the instrument panel as these objects may become projectiles in a collision or sudden stop.

MANUAL HEATING AND AIR CONDITIONING SYSTEM (IF EQUIPPED)

- Fan speed adjustment:**
Controls the volume of air circulated in the vehicle.
- Temperature selection:**
Controls the temperature of the airflow in the vehicle.
- Air flow selections:** Controls the direction of the airflow in the vehicle. See the following for a brief description on each control.

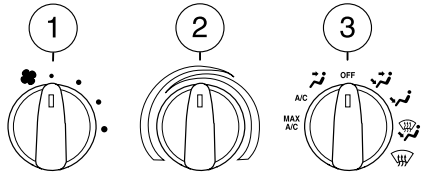



MAX A/C (if equipped): A/C compressor is ON. Recirculated air flows from the instrument panel vents only. Temperature of air is not adjustable (cold only).

A/C (if equipped): A/C compressor is ON. Outside air flows from the instrument panel vents only.

 : Distributes outside air through the instrument panel vents only. (A/C compressor is OFF).

OFF: Outside air is shut off and the fan motor does not operate.

 : Distributes outside air through the instrument panel vents and the floor vents. (A/C compressor is ON).

 : Distributes outside air through the floor vents. (A/C compressor is OFF).

 : Distributes outside air through the windshield defroster vents and the floor vents. (A/C compressor is ON).

 : Distributes outside air through the windshield defroster vents only. (A/C compressor is ON).

OPERATING TIPS

- To reduce fog build up on the windshield during humid weather, place the air flow selector in the  position.
- To reduce humidity build up inside the vehicle: do not drive with the air flow selector in the OFF position.
- Under normal weather conditions, do not leave the air flow selector in MAX A/C or OFF when the vehicle is parked. This allows the vehicle to “breathe” using the outside air inlet vents.
- Do not put objects under the front seats that will interfere with the airflow to the back seats.
- Remove any snow, ice or leaves from the air intake area at the base of the windshield.

To aid in side window defogging/demisting in cold weather:

1. Select .
2. Modulate the temperature control to maintain comfort.
3. Set the fan speed to HI
4. Direct the outer instrument panel vents towards the side windows

To increase airflow to the outer instrument panel vents, close the vents located in the middle of the instrument panel.

WARNING: Do not place objects on top of the instrument panel as these objects may become projectiles in a collision or sudden stop.

Lights

HEADLAMP CONTROL ☀

OFF Turns the lamps off.

☀ Turns on the parking lamps, instrument panel lamps, license plate lamps and tail lamps.

☀ Turns the headlamps on.

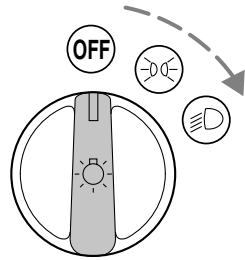

FOG LAMP CONTROL (IF EQUIPPED) ⌘

The fog lamps can only be turned on when the headlamp control is in the low beam position.

Press the foglamp control to activate the fog lamps. The fog lamp indicator light will illuminate. When the highbeams are activated, the fog lamps will not operate.

Press the fog lamp control again to deactivate the fog lamps.

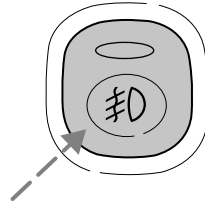

Daytime running lamps (DRL) (if equipped)

Turns the headlamps on with a reduced output.

To activate:

- the ignition must be in the ON position and
- the headlamp control is in the OFF or parking lamp.

WARNING: Always remember to turn on your headlamps at dusk or during inclement weather. The Daytime Running Lamp (DRL) system does not activate your parking lights or side marker lights and generally may not provide adequate lighting during these conditions. Failure to activate your headlamps under these conditions may result in a collision.

High beams

After turning the headlamps on, push the lever toward the instrument panel to activate. Pull the lever towards you to deactivate.

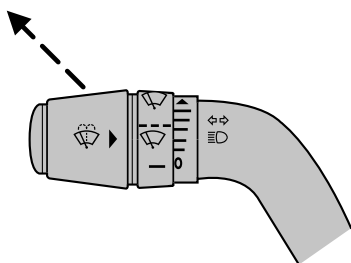

Flash to pass

Pull toward you slightly to activate and release to deactivate.

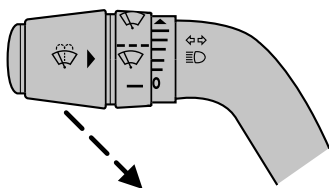

PANEL DIMMER CONTROL

Use to adjust the brightness of the instrument panel and all applicable switches in the vehicle during headlamp and parklamp operation.

Move the control up or down to adjust the intensity of the panel lighting.

Move the control to the full upright position, past detent, to turn on the interior lamps.

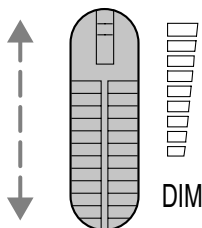

AIMING THE HEADLAMPS

The headlamps on your vehicle are properly aimed at the assembly plant. If your vehicle has been in an accident the alignment of your headlamps should be checked by your authorized Mazda dealer.

Lights

TURN SIGNAL CONTROL ⇐⇒

- Push down to activate the left turn signal.
- Push up to activate the right turn signal.

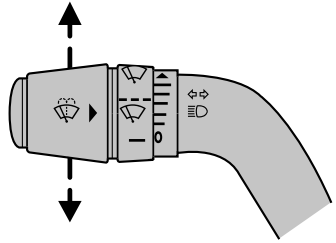

COURTESY/READING LAMPS (IF EQUIPPED)

The courtesy lamp lights when:

- any door is opened.
- the instrument panel dimmer switch is held up until the courtesy lamps come on.
- the remote entry controls are pressed and the ignition is OFF.

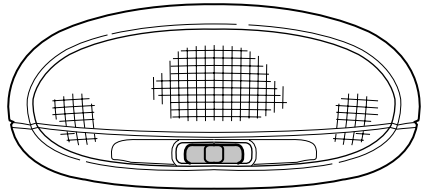

The reading lamps can be turned on by moving the switch on the dome lamp to either the left or the right.

BULBS

Replacing exterior bulbs

Check the operation of all the bulbs frequently.

Using the right bulbs

Replacement bulbs are specified in the chart below. Headlamp bulbs must be marked with an authorized "D.O.T." for North America to assure lamp performance, light brightness and pattern and safe visibility.

NOTE: The correct bulbs will not damage the lamp assembly or void the lamp assembly warranty and will provide quality bulb burn time.

Lights

Function	Number of bulbs	Trade number
Park/turn lamps (front)	2	3157 AK (amber)
Headlamps	2	9003
Rear stop/tail lamps	2	3157K
Rear turn lamps	2	3156K
Rear license plate lamps	2	3156K/168
Backup lamp	2	3156K
Rear/turn/sidemarkers	2	916NA (amber)
Fog lamp (if equipped)	2	899
Cargo lamp	1	211-2
Interior overhead lamp	1	912 (906)
Front door courtesy lamp	1	168
Map lamps	2	168 (T10)
Ashtray lamp	1	161
All replacement bulbs are clear in color except where noted.		
To replace all instrument panel lights - see your dealer.		

Replacing the interior bulbs

Check the operation of the following interior bulbs frequently:

- interior overhead lamp
- map lamp

For bulb replacement, see an authorized Mazda dealer.

Replacing headlamp bulbs

NOTE: The procedure can be difficult. Your Mazda dealer has the proper tools, training and parts to perform this task. If you have difficulty with this, visit your local Mazda dealer.

Lights

WARNING: Handling Halogen Bulbs: When a halogen bulb breaks, it is dangerous. These bulbs contain pressurized gas. If one is broken, it will explode and serious injuries could be caused by the flying glass. If the glass portion of the bulb is touched with bare hands, body oil could cause the bulb to overheat and explode when lit. Never touch the glass portion of the bulb with your bare hands and always wear eye protection when handling or working around halogen bulbs.

Children and Halogen Bulbs: Playing with a halogen bulb is dangerous. Serious injuries could be caused by dropping a halogen bulb or breaking in some other way. Always keep halogen bulbs out of the reach of children.

To remove the headlamp bulb:

1. Make sure headlamp switch is in OFF position, then open the hood.
2. At the back of the headlamp, pry up the two retainer pins to release the headlamp assembly from the vehicle and pull headlamp forward.
3. Remove the bulb retaining ring by rotating it counterclockwise (when viewed from the rear) to free it from the bulb socket, and slide the ring off the plastic base. Keep the ring to retain the new bulb.
4. Without turning, remove the old bulb by gently pulling it straight back out of the lamp assembly.

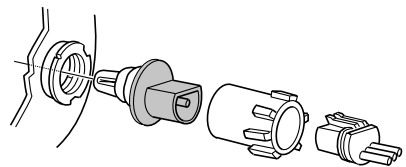
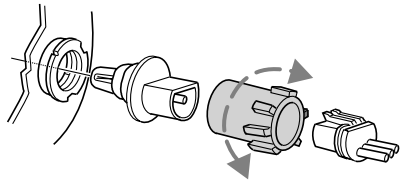
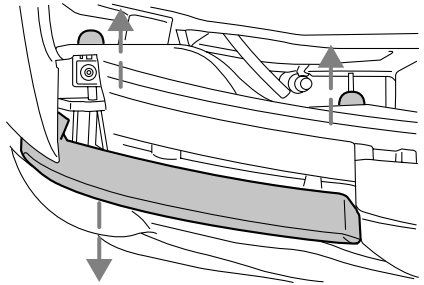

To install the new bulb:

Handle a halogen headlamp bulb carefully and keep out of children's reach. Grasp the bulb only by its plastic base and do not touch the glass. The oil from your hands could cause the bulb to break the next time the headlamps are operated. Always wear safety glasses while handling bulbs.

NOTE: If the bulb is accidentally touched, it should be cleaned with rubbing alcohol before being used.

1. With the flat side of the bulb's plastic base facing upward, insert the glass end of the bulb into the lamp assembly. You may need to turn the bulb left or right to align the grooves in the plastic base with the tabs in the lamp assembly. When the grooves are aligned, push the bulb into the lamp assembly until the plastic base contacts the rear of the lamp assembly.
2. Install the bulb retaining ring over the plastic base until it contacts the rear of the socket by rotating clockwise until you feel a "stop."
3. Install the electrical connector into the plastic base until it snaps, locking it into position.
4. Install the headlamp on vehicle, push rearward and secure with two retainer pins.
5. Turn the headlamps on and make sure they work properly. If the headlamp was correctly aligned before you changed the bulb, you should not need to align it again.

Replacing front side marker bulbs

1. Open the hood.
2. At the back of the headlamp, pry up the two retainer pins to release the headlamp assembly from the vehicle and pull headlamp forward.

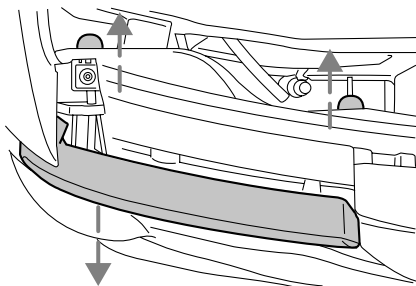

Lights

3. Remove screw(s) from lamp assembly.
4. Disengage lamp assembly (it has a snap fit).

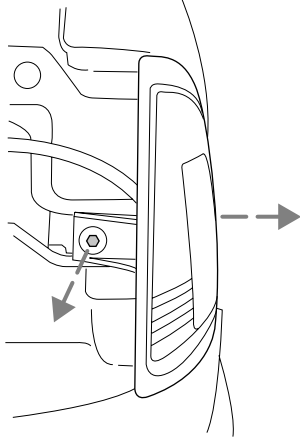

5. Rotate bulb socket counterclockwise and remove from lamp assembly.
6. Carefully pull bulb straight out of socket and push in the new bulb.
7. Install the bulb socket in lamp assembly by turning clockwise.

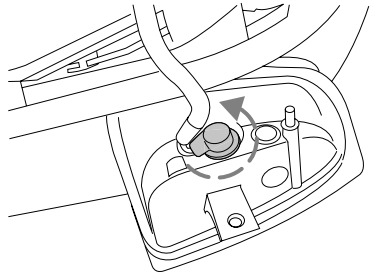

8. Align the lamp on the vehicle and push to snap in place.
9. Install screw(s) on lamp assembly.
10. Install the headlamp on vehicle, push rearward and secure with two retainer pins.

Replacing tail lamp/backup lamp bulbs

The tail lamp/backup lamp bulbs are located in the same portion of the tail lamp assembly, one just below the other. Follow the same steps to replace either bulb:

1. Open the tailgate to expose the lamp assemblies.
2. Remove the four screws and the lamp assembly from vehicle.

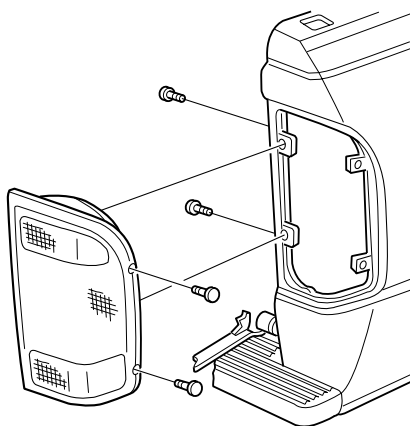

3. Rotate bulb socket counterclockwise turn and remove from lamp assembly.
4. Carefully pull the bulb straight out of the socket and push in the new bulb.
5. Install the bulb socket in lamp assembly by turning clockwise.
6. Install the lamp assembly and secure with four screws.

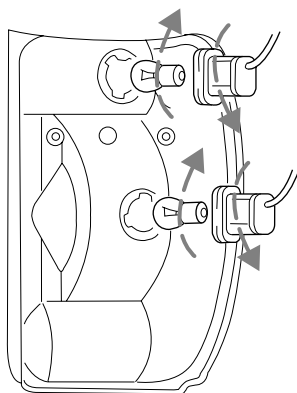

Replacing fog lamp bulbs

1. Remove the bulb socket from the fog lamp by turning counterclockwise.
2. Disconnect the electrical connector from the fog lamp bulb.
3. Connect the electrical connector to the new fog lamp bulb.

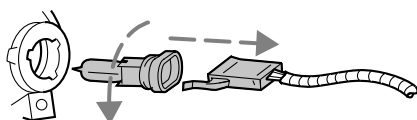

Lights

4. Install the bulb socket in the fog lamp turning clockwise.

Replacing high-mount brake lamp and cargo lamp bulbs

The replacement of the high-mount brake lamp bulb and cargo lamp bulb is basically the same. This procedure covers the high-mount brake lamp bulb.

To remove the brake lamp assembly:

1. Remove the two screws and lamp assembly from vehicle.
2. Remove the bulb socket from lamp assembly by rotating it counterclockwise.
3. Carefully pull bulb straight out of socket and push in the new bulb.



To install the brake lamp assembly:

1. Install the bulb socket into the lamp assembly by rotating clockwise.
2. Install the lamp assembly on the vehicle and secure with two screws.

Replacing license plate lamp bulbs

The license plate bulbs are located behind the rear bumper. To change the license plate lamp bulbs:

1. Reach behind the rear bumper to locate the bulb socket.
2. Twist the socket counterclockwise and remove.
3. Pull out the old bulb from socket and push in the new bulb.
4. Install the bulb socket in lamp assembly by turning it clockwise.

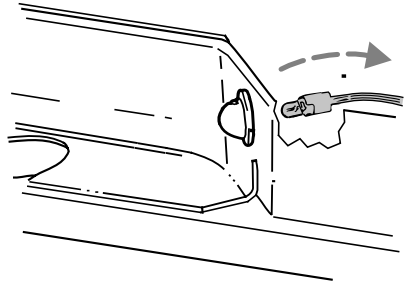

MULTI-FUNCTION LEVER

Windshield wiper: Rotate the end of the control away from you to increase the speed of the wipers (from desired interval to low or high speed position); rotate towards you to decrease the speed of the wipers.

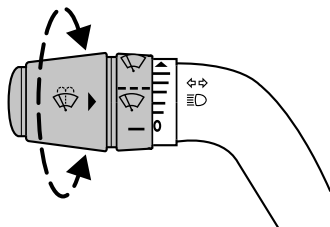

Windshield washer: Push the end of the stalk:

- briefly: causes a single swipe of the wipers without washer fluid.
- a quick push and hold: the wipers will swipe three times with washer fluid.
- a long push and hold: the wipers and washer fluid will be activated for up to ten seconds.

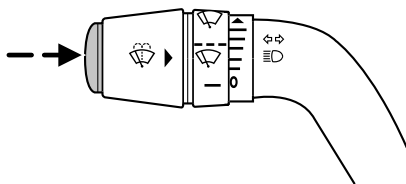

Windshield wiper blades

If the wiper blades do not wipe properly, clean both the windshield and wiper blades using undiluted windshield wiper solution or a mild detergent. Rinse thoroughly with clean water. To avoid damaging the blades, do not use fuel, kerosene, paint thinner or other solvents.

Check the wiper blades for wear at least twice a year or when they seem less effective. Substances such as tree sap and some hot wax treatments used by commercial car washes reduce the effectiveness of wiper blades.

Driver Controls

Changing the wiper blades

1. Pull the wiper arm away from the vehicle. Turn the blade at an angle from the wiper arm. Push the lock pin manually to release the blade and pull the wiper blade down toward the windshield to remove it from the arm.
2. Attach the new wiper to the wiper arm and press it into place until a click is heard.
3. Replace wiper blades every 6 months for optimum performance.

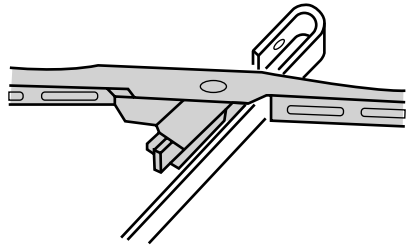

TILT STEERING WHEEL (IF EQUIPPED)

To adjust the steering wheel:

1. Pull and hold the steering wheel release control toward you.
2. Move the steering wheel up or down until you find the desired location.
3. Release the steering wheel release control. This will lock the steering wheel in position.

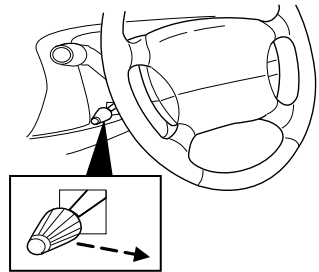

WARNING: Never adjust the steering wheel when the vehicle is moving.

AUXILIARY POWER POINT

Power outlets are designed for accessory plugs only. Do not hang any type of accessory or accessory bracket from the plugs. Improper use of the power outlets can cause damage not covered by your warranty.

The auxiliary power points are located on the instrument panel. Do not plug optional electrical accessories into the cigarette lighter. Use the power points.

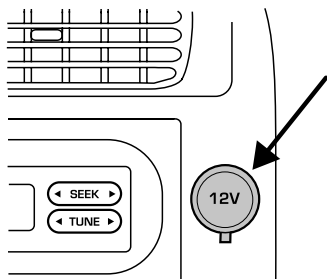

Do not use the power points for operating the cigarette lighter element.

The Maximum power each power point can supply depends on the fuse rating. For example: a 20A fuse should supply a maximum of 240 Watts, a 15A fuse should supply a maximum of 180 Watts and a 10A fuse should supply a maximum of 120 Watts. Exceeding these limits will result in a blown fuse. Refer to *Passenger Compartment Fuse Panel* in the *Roadside Emergencies* chapter for fuse ratings in your vehicle.

Always keep the power point caps closed when not being used.

POWER WINDOWS (IF EQUIPPED)

WARNING: When closing the power windows, you should verify they are free of obstructions and ensure that children and/or pets are not in the proximity of the window openings.

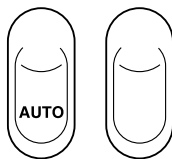

Press and hold the bottom part of the rocker switch to open the window.
Press and hold the top part of the rocker switch to close the window.

Driver Controls

One touch down

Allows the driver's window to open fully without holding the control down. Press completely down on AUTO and release quickly. Press again to stop.

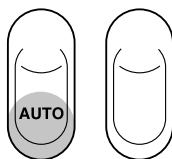

AUTOMATIC DIMMING REAR VIEW MIRRORS (IF EQUIPPED)

When the inside rear view mirror detects bright light from behind the vehicle, the inside rear view mirror will automatically darken to minimize glare.

Do not block the sensor on the backside of the inside rear view mirror since this may impair proper system performance.

Press the left button on the mirror to turn the auto dimming ON or OFF. The green indicator light left of the display will illuminate when this feature is ON.

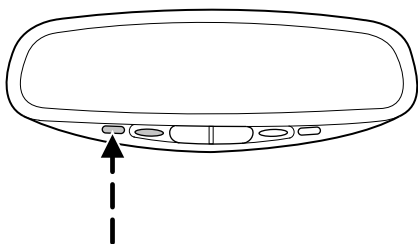

COMPASS/TEMPERATURE EC MIRROR (IF EQUIPPED)

The compass reading may be affected when you drive near large buildings, bridges, power lines and powerful broadcast antennas. Magnetic or metallic objects placed in, on or near the vehicle may also affect compass accuracy.

Usually, when something affects the compass readings, the compass will correct itself after a few days of operating your vehicle in normal conditions. If the compass still appears to be inaccurate, a manual calibration may be necessary. Refer to *Compass calibration adjustment*.

Most geographic areas (zones) have a magnetic north compass point that varies slightly from the northerly direction on maps. This variation is four degrees between adjacent zones and will become noticeable as the vehicle crosses multiple zones. A correct zone setting will eliminate this error. Refer to *Compass zone adjustment*.

Driver Controls

Outside air temperature

Display operation of the mirror with the compass feature:

- Press the right button to toggle the display between the compass direction and no display.

Display operation of mirror with temperature and compass feature:

- Press the right button once to display temperature °F and compass.
- Press the right button twice to display temperature °C and compass.
- Press the right button three times to turn the display OFF.

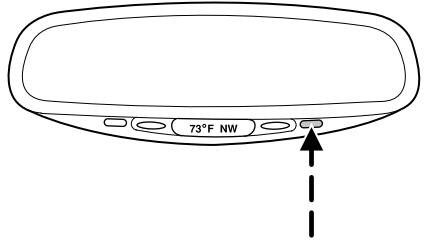

WARNING: The outside temperature indicator is not designed to serve as an ICE warning device and is therefore unsuitable for that purpose. Indicated temperatures just above the freezing point does not guarantee that the road surface is free of ice.

Compass zone adjustment

1. Determine which compass zone you are in by referring to the zone map.
2. Turn ignition to the ON position.

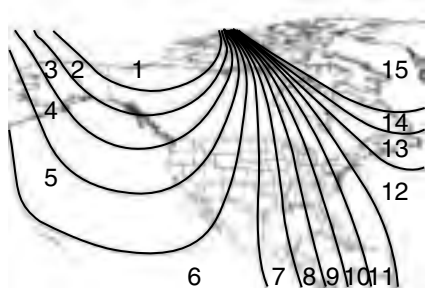

Driver Controls

3. To change the zone setting, push and hold the right button until ZONE appears in the display.
4. Press the right button repeatedly until desired compass zone number is displayed. The display will change back to the compass direction after 3 seconds when the button is not activated.

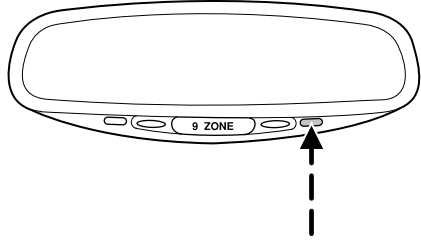

Compass calibration adjustment

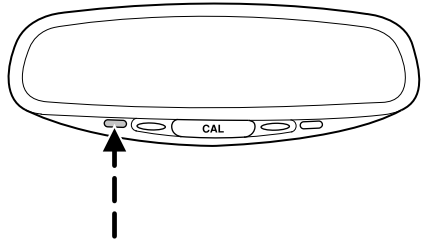

The compass calibrates itself under normal driving conditions. There is not a need for manual compass calibration. If calibration is still desired, follow these instructions:

1. Start the vehicle.
2. For optimum calibration, turn off all electrical accessories and make sure that all vehicle doors are shut.
3. Perform this adjustment in an open area free from steel structures and high voltage lines.
4. Press and hold the left button for approximately 3 seconds until CAL appears in the display. Release the left button to enter the calibration mode.
5. Drive the vehicle slowly (less than 5 km/h [3 mph] in a circle until CAL indicator disappears in the display (about two or three circles).
6. The compass is now calibrated.



POWER MIRROR CONTROL (IF EQUIPPED)

To adjust your mirrors:

1. Select  to adjust the left mirror or  to adjust the right mirror.
2. Move the control in the direction you wish to tilt the mirror.
3. Return to the center position to lock mirrors in place.

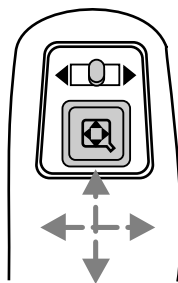

SPEED CONTROL (IF EQUIPPED)

With speed control set, you can maintain a speed of 48 km/h (30 mph) or more without keeping your foot on the accelerator pedal. Speed control does not work at speeds below 48 km/h (30 mph).

WARNING: Do not use the speed control in heavy traffic or on roads that are winding, slippery, or unpaved. You may lose control of the vehicle.

WARNING: Do not shift the gearshift lever into N (Neutral) with the speed control on. You may lose control of the vehicle or cause engine system damage.

Setting speed control

The controls for using your speed control are located on the steering wheel for your convenience.

1. Press the ON control and release it.
2. Accelerate to the desired speed.

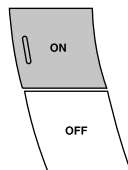

Driver Controls

3. Press the SET + control and release it.
4. Take your foot off the accelerator pedal.
5. The indicator light  on the instrument cluster will turn on.

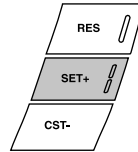

Note:

- Vehicle speed may vary momentarily when driving up and down a steep hill.
- If the vehicle speed increases above the set speed on a downhill, you may want to apply the brakes to reduce the speed.
- If the vehicle speed decreases more than 16 km/h (10 mph) below your set speed on an uphill, your speed control will disengage.
- If the vehicle speed decreases to 40 km/h (25 mph) or less, your speed control will disengage.

Disengaging speed control

To disengage the speed control:

- Depress the brake pedal or
- Depress the clutch pedal (if equipped).

Disengaging the speed control will not erase previous set speed.

Note: When you use the clutch pedal to disengage the speed control, the engine speed may briefly increase, this is normal.

Resuming a set speed

Press the RES (resume) control and release it. This will automatically return the vehicle to the previously set speed. The RES control will not work if the vehicle speed is not faster than 48 km/h (30 mph).

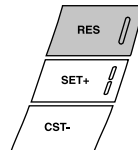

Increasing speed while using speed control

There are three ways to set a higher speed:

- Press and hold the SET + control until you get to the desired speed, then release the control.
- Press and release the SET + control to operate the Tap-Up function. Each tap will increase the set speed by 1.6 km/h (1 mph).
- Use the accelerator pedal to get to the desired speed. When the vehicle reaches that speed press and release the SET + control.

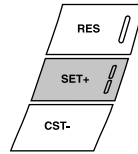

Reducing speed while using speed control

There are three ways to reduce a set speed:

- Press and hold the CST - control until you get to the desired speed, then release the control.
- Press and release the CST - control to operate the Tap-Down function. Each tap will decrease the set speed by 1.6 km/h (1 mph).
- Depress the brake pedal or the clutch pedal (if equipped) until the desired vehicle speed is reached, press the SET + control.

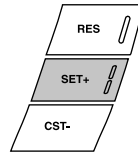
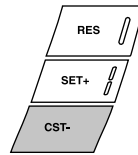

Turning off speed control

There are three ways to turn off the speed control:

- Depress the brake pedal or the clutch pedal (if equipped). This will not erase your vehicle's previously set speed.

Driver Controls

- Press the speed control OFF control.
- Turn OFF the ignition.

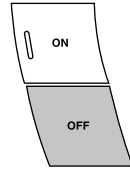

Note: When you turn off the speed control or the ignition, your speed control set speed memory is erased.

Note: Fully depressing the clutch pedal may cause a flare in engine RPM as the throttle is returned to idle. This is normal.

OVERDRIVE CONTROL (IF EQUIPPED)

Activating overdrive

D (Overdrive) is the normal drive position for the best fuel economy.

The overdrive function allows automatic upshifts and downshifts through all available gears.

Deactivating overdrive

Press the Transmission Control Switch (TCS) located on the end of the gearshift lever. The O/D Off indicator light will illuminate on the instrument cluster. The transmission will operate in all gears except overdrive.

To return to normal overdrive mode, press the Transmission Control Switch again. The O/D Off indicator light will no longer be illuminated.

When you shut off and re-start your vehicle, the transmission will automatically return to normal **D** (Overdrive) mode.

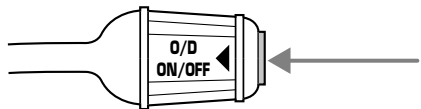
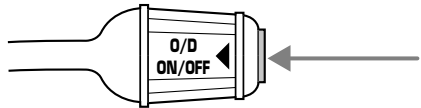

For additional information about the gearshift lever and the transmission control switch operation refer to the *Automatic Transmission Operation* section of the *Driving* chapter.

CENTER CONSOLE (IF EQUIPPED)

Your vehicle may be equipped with a variety of console features. These include:

- Utility compartment with cassette/compact disc storage
- Cupholders
- Coin holder slots
- Flip up armrest

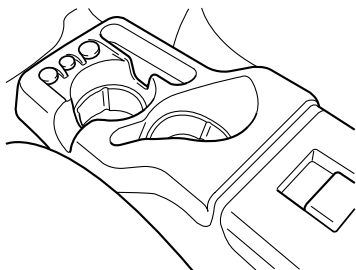

WARNING: Use only soft cups in the cupholder. Hard objects can injure you in a collision.

BED EXTENDER (IF EQUIPPED)

Your vehicle may be equipped with a bed extender designed to extend the pickup box for longer loads.

To extend the bed extender:

1. Lower tailgate.
2. Pull the round knobs on each side of the extender to release it from the pickup box.
3. Pivot extender on to the tailgate.
4. Evenly push down on the extender and push the round knobs in on each side locking it in place.

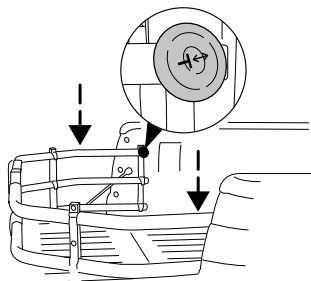
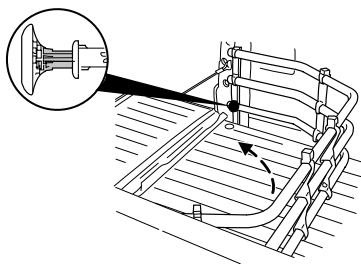

Green markings on the shaft indicate the locked position. The locking clip screws below the middle bar can be tightened counterclockwise for extra security.

Driver Controls

Note: If the red marking on the shaft is visible, the bed extender is not locked or properly secured.

To stow the bed extender, follow steps one through four in reverse order. The bed extender may be used to secure a load of up to 46 kg (100 lbs.) on the tailgate.

The bed extender should always be kept in the stowed position with the tailgate closed when not in use.

When driving the vehicle off road, the bed extender should be removed and the tailgate closed.

To remove the bed extender:

1. Extend the bed extender.
2. Pull the round knobs on each side of the extender to unlock it.

Make sure the locking clip screws are loose before removing the extender.

3. Press the locking clips below the middle bar on each side and lift the extender out of the bed.

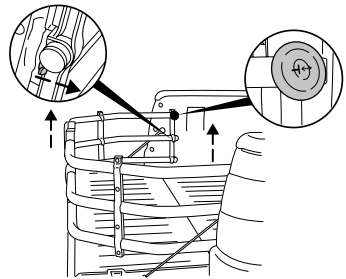

Note: Remove and store the bed extender when not in use.

To install the bed extender, follow the removal procedure in reverse order.

Locks and Security

KEYS

The key operates all locks on your vehicle. In case of loss, replacement keys are available from your dealer.

You should always carry a second key with you in a safe place in case you require it in an emergency.

Refer to *SecuriLock™ Passive Anti-Theft System* for more information.

POWER DOOR LOCKS (IF EQUIPPED)

Press the top of the control to unlock all doors and the bottom to lock all doors.

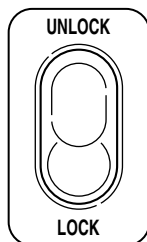

REMOTE ENTRY SYSTEM (IF EQUIPPED)

The remote entry system allows you to lock or unlock all vehicle doors without a key.

The remote entry features only operate with the ignition in the LOCK position.

If there is any potential remote keyless entry problem with your vehicle, ensure **ALL remote entry transmitters** are brought to the dealership, to aid in troubleshooting.

GENERAL INFORMATION: This device complies with part 15 of the FCC rules and with RS-210 of Industry Canada. Operation is subject to the following two conditions: (1) This device may not cause harmful interference, and (2) This device must accept any interference received, including interference that may cause undesired operation. Changes or modifications not expressly approved by the party responsible for compliance could void the user's authority to operate the equipment.

This device complies with part 15 of the FCC rules and with RS-210 of Industry Canada. Operation is subject to the following two conditions: (1) This device may not cause harmful interference, and (2) This device must accept any interference received, including interference that may cause undesired operation.

Locks and Security

Changes or modifications not expressly approved by the party responsible for compliance could void the user's authority to operate the equipment.

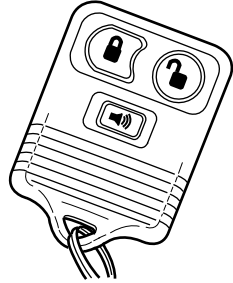

Your vehicle is equipped with a remote entry system which allows you to:

- unlock the vehicle doors without a key.
- lock all the vehicle doors without a key.
- activate the personal alarm.





If there is any potential remote keyless entry problem with your vehicle, ensure **ALL remote entry transmitters** are taken to the dealership, to aid in troubleshooting.

Unlocking the doors

1. Press  and release to unlock the driver's door. **Note:** The interior lamps will illuminate.
2. Press  and release again within three seconds to unlock all the doors.

Locking the doors

- Press  and release to lock all the doors. The park lamps will flash once to confirm lock; if any of the doors are not properly closed, the lamps will not flash.
- Pressing  a second time within two seconds will cause all doors to lock, the parking lamps to flash, and the horn to sound one time in order to confirm locking.

Power door lock disabled

The UNLOCK feature on your power door locks will not work from inside the vehicle when:

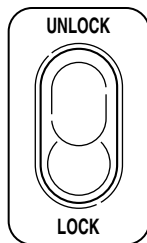

- the ignition has been turned to the OFF position, and
- 20 seconds elapse after all vehicle doors are closed and locked using the remote entry transmitter, or the power door lock control (while the accompanying door is open).

The UNLOCK feature will work again after:

- a door has become ajar,
- the ignition is turned to the ON position, or
- using the UNLOCK  control on your remote entry transmitter.

Sounding a personal alarm

Press  to activate the alarm. The horn will sound for a maximum of 30 seconds and the parklamps will flash for a maximum of 3 minutes. Press again or turn the ignition to ON to deactivate, or wait for the alarm to timeout in 3 minutes.

Note: The personal alarm will only operate when the ignition is in the OFF or ACC position.

Replacing the battery

The remote entry transmitter uses one coin type three-volt lithium battery CR2032 or equivalent. The typical operating range for your remote entry transmitter is approximately 10 meters (33 feet). A decrease in the operating range could be caused by:

- weather conditions,
- nearby radio towers,
- structures around the vehicle and
- other vehicles parked next to the vehicle.

Locks and Security

To replace the battery:

1. Twist a thin coin between the two halves of the remote entry transmitter near the key ring.

DO NOT TAKE THE FRONT PART OF THE REMOTE ENTRY TRANSMITTER APART. Damage to the transmitter may result in operation failure.

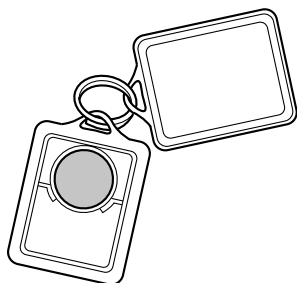

2. Remove the old battery.
3. Insert the new battery. Refer to the diagram inside the remote entry transmitter for the correct orientation of the battery.
4. Snap the two halves back together.

Note: Replacement of the battery will **not** cause the remote transmitter to become deprogrammed from your vehicle. The remote transmitter should operate normally after battery replacement.

Replacing lost remote entry transmitters

If you would like to have your remote entry transmitter reprogrammed because you lost one, or would like to buy additional remote entry transmitters, you can either reprogram them yourself, or take **all remote entry transmitters** to your authorized dealer for reprogramming.

How to reprogram your remote entry transmitters

You must have **all remote entry transmitters** (maximum of four) available before beginning this procedure.

To reprogram the remote entry transmitters:

1. Ensure the vehicle is electronically unlocked.
2. Put the key in the ignition.

Locks and Security

- Turn the key from the 2 (LOCK) position to 3 (OFF).

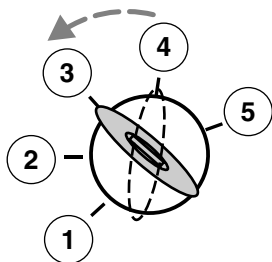

- Cycle eight times rapidly (within 10 seconds) between the 3 (OFF) position and 4 (ON). **Note:** The eighth turn must end in the 4 (ON) position. The instrument lights in the cluster will come on for a bulb check in the 4 (ON) position.
- The doors will lock, then unlock, to confirm that the programming mode has been activated.
- Within 20 seconds press any button on the remote entry transmitter. **Note:** If more than 20 seconds have passed you will need to start the procedure over again.
- The doors will lock, then unlock, to confirm that this remote entry transmitter has been programmed.
- Repeat Step 6 to program each additional remote entry transmitter.
- Turn the ignition to the 3 (OFF) position after you have finished programming all of the remote entry transmitters.
- The doors will lock, then unlock, to confirm that the programming mode has been exited.

Illuminated entry

The interior lamps illuminate when the remote entry system is used to unlock the door(s) or sound the personal alarm.

The illuminated entry system will turn off the interior lights if:

- the ignition switch is turned to the ON position, or
- the remote transmitter lock control is pressed, or
- after 25 seconds of illumination.

The dome lamp control (if equipped) must **not** be set to the OFF position for the illuminated entry system to operate.

Locks and Security

The inside lights will not turn off if:

- they have been turned on with the dimmer control, or
- any door is open.

The battery saver will shut off the interior lamps 30 minutes after the last door is closed, even if the dimmer control is on.

SECURILOCK™ PASSIVE ANTI-THEFT SYSTEM

SecuriLock™ passive anti-theft system is an engine immobilization system. This system is designed to prevent the engine from being started unless a **coded key programmed to your vehicle** is used.

The SecuriLock™ passive anti-theft system is not compatible with non-Mazda aftermarket remote start systems. Use of these systems may result in vehicle starting problems and a loss of security protection.

Your vehicle comes with two coded keys; additional coded keys may be purchased from your dealer. The dealer can program your spare keys to your vehicle or you can program the keys yourself. Refer to *Programming spare keys* for instructions on how to program the coded key.

Note: A maximum of eight keys can be coded to your vehicle.

Note: Large metallic objects, electronic devices that are used to purchase gasoline or similar items, or a second coded key on the same key chain may cause vehicle starting issues. You need to prevent these objects from touching the coded key while starting the engine. These objects will not cause damage to the coded key, but may cause a momentary issue if they are too close to the key when starting the engine. If a problem occurs, turn the ignition off, remove all objects on the key chain away from the coded key and restart the engine.

Theft indicator

The theft indicator is located in the instrument cluster.

- When the ignition is in the OFF position, the indicator will flash once every 2 seconds to indicate the SecuriLock™ system is functioning as a theft deterrent.
- When the ignition is in the ON position, the indicator will glow for 3 seconds, then turn off to indicate normal system functionality.

If a problem occurs with the SecuriLock™ system, the indicator will flash rapidly or glow steadily when the ignition is in the ON position. If this occurs, the vehicle should be taken to an authorized dealer for service.

Automatic arming

The vehicle is armed immediately after switching the ignition to the 3 (OFF) position.

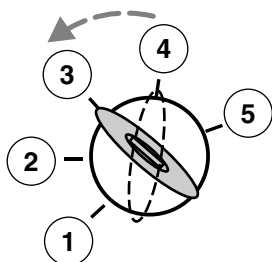

The theft indicator will flash every two seconds when the vehicle is armed.



Automatic disarming

Switching the ignition to the 4 (ON) position with a **coded key** disarms the vehicle.

The theft indicator will illuminate for three seconds and then go out.

Note: If the theft indicator stays on for an extended period of time or flashes rapidly, have the system serviced by your dealer.



Replacement keys

If your keys are lost or stolen and you don't have an extra coded key, you will need to have your vehicle towed to a dealership. The key codes need to be erased from your vehicle and new coded keys will need to be programmed.

Replacing coded keys can be very costly. Store an extra programmed key away from the vehicle in a safe place to help prevent any inconveniences. Please visit an authorized dealer to purchase additional spare or replacement keys.

Programming spare keys

You can program your own coded keys to your vehicle. Please read and understand the entire procedure before you begin.

Locks and Security

Tips:

- A maximum of eight keys can be coded to your vehicle.
- Only use Securilock™ keys.
- You must have two previously programmed coded keys (keys that already operate your vehicle's engine) and the new unprogrammed key(s) readily accessible.
- If you do not have at least 2 previously programmed keys, you must take your vehicle to your dealer to have the spare key(s) programmed.

1. Insert a previously programmed coded key into the ignition.
2. Turn the ignition from the 3 (OFF) position to the 4 (ON) position. Keep the ignition in the 4 (ON) position for at least one second, but no more than 10 seconds.
3. Turn the ignition to the 3 (OFF) position, and remove the coded key from the ignition.
4. Within ten seconds of removing the previously programmed coded key, insert the other previously programmed coded key into the ignition.
5. Turn the ignition from the 3 (OFF) position to the 4 (ON) position. Keep the ignition in the 4 (ON) position for at least one second but not more than 10 seconds.
6. Turn the ignition to the 3 (OFF) position, and remove the second key from the ignition.
7. Within twenty seconds of removing the previously programmed coded key, insert the unprogrammed key (new/valet key) into the ignition.
8. Turn the ignition from the 3 (OFF) position to the 4 (ON) position. Keep the ignition in the 4 (ON) position for at least one second.
9. Your new unprogrammed key is now programmed.

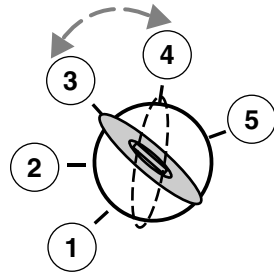

If the key has been successfully programmed it will start the vehicle's engine and the theft indicator light will illuminate for three seconds and then go out. If the key was not successfully programmed, it will not start your vehicle's engine and the theft indicator light will flash on and off. If failure repeats, bring your vehicle to your dealer to have the new key(s) programmed.

To program additional new unprogrammed key(s), repeat this procedure from step 1 for each additional key.

Seating and Safety Restraints

SEATING

Adjusting the front manual seat (if equipped)

WARNING: Never adjust the driver's seat or seatback when the vehicle is moving.

WARNING: Always drive and ride with your seatback upright and the lap belt snug and low across the hips.

Lift the release bar to move seat forward or backward. Ensure that the seat is locked into place.

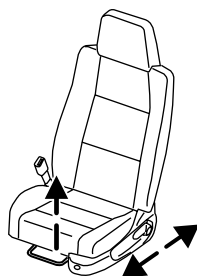

Pull lever located at the side of the seat cushion up to adjust seatback.

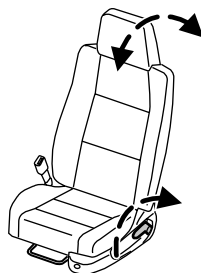

Seating and Safety Restraints

60/40 seat (if equipped)

To gain access to the storage compartment in your armrest (if equipped), lift the latch to open lid.

The 60/40 seat cupholder (if equipped) is detachable for cleaning.

- Firmly grasp the bottom of the cup holder and pull up.

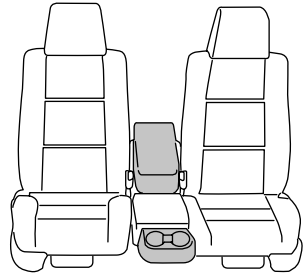

To re-attach:

- Slide the cupholder over the two pins located on the front of the 60% driver's seat.
- Press down until it is firmly latched into place.

Using the manual lumbar support (if equipped)

Turn the lumbar support control clockwise to increase firmness.

Turn the lumbar support control counterclockwise to increase softness.

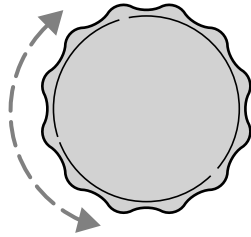

Passenger side rear access (if equipped)

Pull up on the recliner handle. The seat will lean forward. Lift the release bar to move the seat forward to access the rear area of the cab.

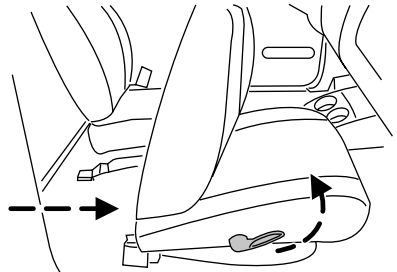

Seating and Safety Restraints

To return seat to original position, slide the seat bottom back, then push the seatback up to lock it in place. The seat will lock, and you will have to use the release bar to move the seat back to the original position.

REAR SEATS

Center facing jump seat (2-door Cab Plus) (if equipped)

To open, pull inboard and down on the seat handle.

To stow the seat, pull seat bottom back to the fully upright position.

WARNING: Do not install a child seat in a center facing jump seat.

Center facing jump seat (4 door CabPlus 4) (if equipped)

To open, pull seat assembly down, then raise seatback.

To stow the seat, fold seat back down and raise seat assembly to the fully upright position.

WARNING: Do not install a child seat in a center facing jump seat.

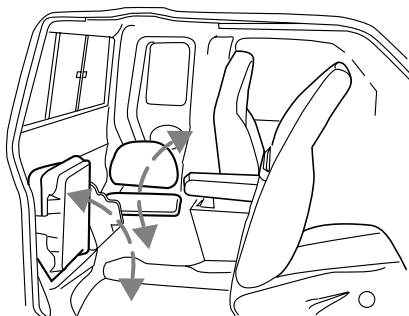

SAFETY RESTRAINTS

Safety restraints precautions

WARNING: Always drive and ride with your seatback upright and the lap belt snug and low across the hips.

WARNING: To reduce the risk of injury, make sure children sit where they can be properly restrained.

WARNING: Never let a passenger hold a child on his or her lap while the vehicle is moving. The passenger cannot protect the child from injury in a collision.

Seating and Safety Restraints

WARNING: All occupants of the vehicle, including the driver, should always properly wear their safety belts, even when an air bag (SRS) is provided.

WARNING: It is extremely dangerous to ride in a cargo area, inside or outside of a vehicle. In a collision, people riding in these areas are more likely to be seriously injured or killed. Do not allow people to ride in any area of your vehicle that is not equipped with seats and safety belts. Be sure everyone in your vehicle is in a seat and using a safety belt properly.

WARNING: In a rollover crash, an unbelted person is significantly more likely to die than a person wearing a safety belt.

WARNING: Each seating position in your vehicle has a specific safety belt assembly which is made up of one buckle and one tongue that are designed to be used as a pair. 1) Use the shoulder belt on the outside shoulder only. Never wear the shoulder belt under the arm. 2) Never swing the safety belt around your neck over the inside shoulder. 3) Never use a single belt for more than one person.

WARNING: On four-door Cab Plus 4 vehicles, do not open the rear door when the rear seat belt is still buckled.

Seating and Safety Restraints

Combination lap and shoulder belts

1. Insert the belt tongue into the proper buckle (the buckle closest to the direction the tongue is coming from) until you hear a snap and feel it latch. Make sure the tongue is securely fastened in the buckle.

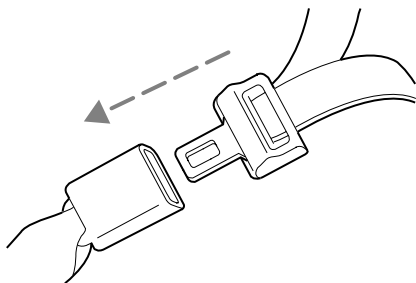

2. To unfasten, push the release button and remove the tongue from the buckle.

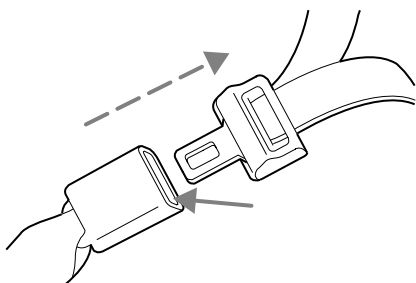

The front outboard safety restraints in the vehicle are combination lap and shoulder belts. The front passenger outboard safety belt has two types of locking modes described below:

Energy Management Feature

- This vehicle has a safety belt system with an energy management feature at the front outboard seating positions to help further reduce the risk of injury in the event of a head-on collision.
- This safety belt system has a retractor assembly that is designed to pay out webbing in a controlled manner. This feature is designed to help reduce the belt force acting on the occupant's chest.

Vehicle sensitive mode

This is the normal retractor mode, which allows free shoulder belt length adjustment to your movements and locking in response to vehicle movement. For example, if the driver brakes suddenly or turns a corner sharply, or the vehicle receives an impact of approximately 8 km/h (5 mph) or more, the combination safety belts will lock to help reduce forward movement of the driver and passengers.

Seating and Safety Restraints

Automatic locking mode (outboard front passenger seating position only) for use with child safety seats

In this mode, the shoulder belt is automatically pre-locked. The belt will still retract to remove any slack in the shoulder belt.

The automatic locking mode is not available on the driver safety belt.

When to use the automatic locking mode

- **Any time** a child safety seat is installed in a passenger front seat. Refer to *Safety Restraints for Children*, *Safety Seats for Children*, or *Passenger air bag On/Off switch* later in this chapter.

How to use the automatic locking mode (Outboard front passenger seating position only) for use with child safety seats

- Buckle the combination lap and shoulder belt.

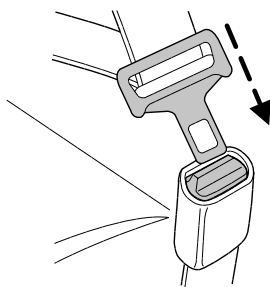

- Grasp the shoulder portion and pull downward until the entire belt is pulled out.



- Allow the belt to retract. As the belt retracts, you will hear a clicking sound. This indicates the safety belt is now in the automatic locking mode.

How to disengage the automatic locking mode

Disconnect the combination lap/shoulder belt and allow it to retract completely to disengage the automatic locking mode and activate the vehicle sensitive (emergency) locking mode.

Seating and Safety Restraints

WARNING: After any vehicle collision, the entire seat belt system should be checked for proper operation by a qualified technician. Verify that the "automatic locking retractors" in all outboard seating positions are functioning properly. Additionally check that the "automatic locking mode" feature for child safety seat in the passenger outboard seating position is functioning properly.

WARNING: BELT AND RETRACTOR ASSEMBLY MUST BE REPLACED if the seat belt assembly "automatic locking retractor" feature or any other seat belt function is not operating properly when checked according to the procedures in Workshop Manual.

WARNING: Failure to replace the Belt and Retractor assembly could increase the risk of injury in collisions.

Safety belt pretensioner

Your vehicle is equipped with safety belt pretensioners at the driver and front outboard passenger seating positions. Both pretensioners will fire if the front airbags fire, whether or not there is a belted occupant in either front outboard seat.

The safety belt pretensioners are designed to activate during certain frontal or near-frontal collisions with sufficient longitudinal deceleration. A safety belt pretensioner is a device which tightens the webbing of the lap and shoulder belts in such a way that they fit more snugly against the body.

The driver and front outboard passenger safety belt system (including retractors, buckle assembly, pretensioner assembly with seat and height adjusters) must be replaced if the vehicle is involved in a collision that results in the activation of the safety belt pretensioners. Refer to the *Safety belt maintenance* section in this chapter.

WARNING: Failure to replace the safety belt assembly after a crash has occurred could result in severe personal injuries in the event of a collision.

Seating and Safety Restraints

Front safety belt height adjustment

Your vehicle has safety belt height adjustments for the driver and front passenger. Adjust the height of the shoulder belt so the belt rests across the middle of your shoulder.

- Regular Cab and 4-door Cab Plus

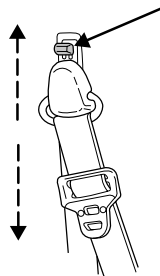

- 2-door Cab Plus

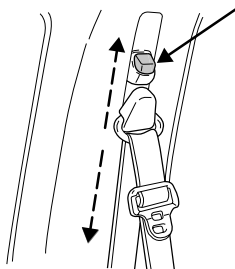

To lower the shoulder belt height, push the button and slide the height adjuster down. To raise the height of the shoulder belt, slide the height adjuster up. Pull down on the height adjuster to make sure it is locked in place.

WARNING: Position the safety belt height adjusters so that the belt rests across the middle of your shoulder. Failure to adjust the safety belt properly could reduce the effectiveness of the seat belt and increase the risk of injury in a collision.

Lap belts

Adjusting the center lap belt

The lap belt does not adjust automatically.

Seating and Safety Restraints

WARNING: The lap belts should fit snugly and as low as possible around the hips, not around the waist. Failure to position the lap belt correctly may cause serious injury in an accident.

Insert the tongue into the correct buckle (the buckle closest to the direction the tongue is coming from). To lengthen the belt, turn the tongue at a right angle to the belt and pull across your lap until it reaches the buckle.

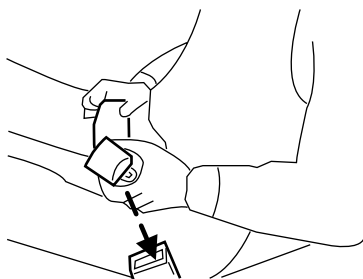

To tighten the belt, pull the loose end of the belt through the tongue until it fits snugly across the hips.

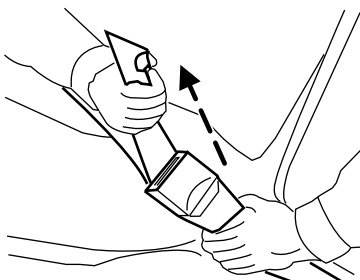

Shorten and fasten the belt when not in use to keep the belt away from door openings and available after unfolding the seats.

Adjusting the rear center facing jump seat lap belt (if equipped)

The center facing rear jump seat lap belt will adjust automatically. To fasten, grasp the tongue, and with a continuous motion, pull out enough webbing to buckle the tongue into the correct buckle. If you did not pull out enough webbing to reach the buckle, allow the tongue to retract fully before trying to pull it out again.

WARNING: The lap belts should fit snugly and as low as possible around the hips, not around the waist. Failure to position the lap belt correctly may cause serious injury in an accident.

Seating and Safety Restraints

If you need to lengthen the belt, unfasten it and repeat the procedure above.

To unfasten the belt, push in the release button prior to opening the rear door.

Safety belt extension assembly

If the safety belt assembly is too short for you, even when fully extended, 20 cm (8 inches) can be added to the safety belt assembly by adding a safety belt extension assembly. Safety belt extension assemblies can be obtained from your authorized Mazda dealership.

Use only extensions manufactured by the same supplier as the safety belt. Manufacturer identification is located at the end of the webbing on the label. Also, use the safety belt extension only if the safety belt is too short for you when fully extended.

NOTE: Do not use extensions to change the fit of the shoulder belt across the torso.

Safety belt warning light and indicator chime

The safety belt warning light illuminates in the instrument cluster and a chime sounds to remind the occupants to fasten their safety belts.

Conditions of operation

If...	Then...
The driver's safety belt is not buckled before the ignition switch is turned to the ON position...	The safety belt warning light illuminates 1-2 minutes and the warning chime sounds 4-8 seconds.
The driver's safety belt is buckled while the indicator light is illuminated and the warning chime is sounding...	The safety belt warning light and warning chime turn off.
The driver's safety belt is buckled before the ignition switch is turned to the ON position...	The safety belt warning light and indicator chime remain off.

Seating and Safety Restraints

BeltMinder

The BeltMinder feature is a supplemental warning to the safety belt warning function. This feature provides additional reminders to the driver that the driver's safety belt is unbuckled by intermittently sounding a chime and illuminating the safety belt warning lamp in the instrument cluster.

If...	Then...
The driver's safety belt is not buckled before the vehicle has reached at least 5 km/h (3 mph) and 1-2 minutes have elapsed since the ignition switch has been turned to ON...	The BeltMinder feature is activated - the safety belt warning light illuminates and the warning chime sounds for 6 seconds every 30 seconds, repeating for approximately 5 minutes or until driver's safety belt is buckled.
The driver's safety belt is buckled while the safety belt indicator light is illuminated and the safety belt warning chime is sounding...	The BeltMinder feature will not activate.
The driver's safety belt is buckled before the ignition switch is turned to the ON position...	The BeltMinder feature will not activate.

The following are reasons most often given for not wearing safety belts: (All statistics based on U.S. data)

Reasons given...	Consider...
"Crashes are rare events"	36,700 crashes occur every day. The more we drive, the more we are exposed to "rare" events, even for good drivers. <i>1 in 4 of us will be seriously injured in a crash during our lifetime.</i>
"I'm not going far"	3 of 4 fatal crashes occur within 25 miles of home.

Seating and Safety Restraints

Reasons given...	Consider...
"Belts are uncomfortable"	Safety belts are designed to enhance comfort. If you are uncomfortable - try different positions for the safety belt upper anchorage and seatback which should be as upright as possible; this can improve comfort.
"I was in a hurry"	Prime time for an accident. Safety Belt Warning Chime reminds us to take a few seconds to buckle up.
"Seat belts don't work"	Safety belts , when used properly, reduce risk of death to front seat occupants by 45% in cars , and by 60% in light trucks .
"Traffic is light"	Nearly 1 of 2 deaths occur in single-vehicle crashes , many when no other vehicles are around.
"Belts wrinkle my clothes"	Possibly, but a serious crash can do much more than wrinkle your clothes, particularly if you are unbelted.
"The people I'm with don't wear belts"	Set the example, teen deaths occur 4 times more often in vehicles with TWO or MORE people. Children and younger brothers/sisters imitate behavior they see.
"I have an air bag"	Air bags offer greater protection when used with safety belts. Frontal airbags are not designed to inflate in rear and side crashes or rollovers.
"I'd rather be thrown clear"	Not a good idea. People who are ejected are 40 times more likely to DIE . Safety belts help prevent ejection, WE CAN'T "PICK OUR CRASH".

Seating and Safety Restraints

WARNING: Always wear the safety belt. Do not be tempted to sit on top of the belt to fool police or to defeat the warning system. The safety belt and safety belt warning system are there to protect your life.

One time disable

Any time the safety belt is buckled and then unbuckled during an ignition ON cycle, the BeltMinder will be disabled for that ignition cycle only.

Deactivating/activating the BeltMinder feature

Read steps 1 - 9 thoroughly before proceeding with the deactivation/activation programming procedure.

The BeltMinder feature can be deactivated/activated by performing the following procedure:

Before following the procedure, ensure that the following conditions are met:

- The parking brake is set.
- The gearshift is in P (Park) (automatic transmission) or the neutral position (manual transmission).
- The ignition switch is in the OFF position.
- All vehicle doors are closed.
- The driver's safety belt is unbuckled.
- The parklamps/headlamps are in OFF position (If vehicle is equipped with Autolamps, this will not affect the procedure).

WARNING: To reduce the risk of injury, do not deactivate/activate the Belt Minder feature while driving the vehicle.

BeltMinder activation and deactivation procedure

1. Turn the ignition switch to the RUN (or ON) position. (DO NOT START THE ENGINE.)
 2. Wait until the safety belt warning light turns off. (Approximately 1–2 minutes.)
- Steps 3–5 must be completed within 60 seconds or the procedure will have to be repeated.

Seating and Safety Restraints

3. Buckle then unbuckle the safety belt three times, ending with the safety belt unbuckled. This can be done before or during BeltMinder warning activation.
 4. Turn on the parklamps/headlamps, turn off the parklamps/headlamps.
 5. Buckle then unbuckle the safety belt three times, ending with the safety belt unbuckled.
- After step 5 the safety belt warning light will be turned on for three seconds.
 - 6. Within seven seconds of the safety belt warning light turning off, buckle then unbuckle the safety belt.
 - This will disable BeltMinder if it is currently enabled, or enable BeltMinder if it is currently disabled.
 - 7. Confirmation of disabling BeltMinder is provided by the safety belt warning light flashing four times per second for three seconds.
 - 8. Confirmation of enabling BeltMinder is provided by:
 - The safety belt warning light flashing four times per second for three seconds.
 - Followed by three seconds with the safety belt warning light off.
 - Once again, the safety belt warning light will flash four times per second for three seconds.
 - 9. After receiving confirmation, the deactivation/activation procedure is complete.

Safety belt maintenance

Inspect the safety belt systems periodically to make sure they work properly and are not damaged.

NOTE: If unsure about the proper procedures, bring your vehicle to an authorized Mazda dealership for inspection. Inspect the safety belts to make sure there are no nicks, tears or cuts, replacing if necessary. Check all automatic locking retractors on all outboard seating positions as well as the automatic locking mode for child safety seats on the passenger front belt. All safety belt assemblies, including retractors, buckles, front seat belt buckle assemblies, buckle support assemblies (slide bar-if equipped), shoulder belt height adjusters (if equipped), shoulder belt guide on seatback (if equipped), child safety seat tether bracket assemblies (if equipped), LATCH child seat tether anchors and lower anchors (if equipped), and attaching hardware, should be inspected after

Seating and Safety Restraints

a collision. Mazda recommends that all safety belt assemblies used in vehicles involved in a collision be replaced. However, if the collision was minor and an authorized Mazda technician finds that the belts do not show damage and continue to operate properly, they do not need to be replaced. Safety belt assemblies not in use during a collision should also be inspected and replaced if either damage or improper operation is noted.

The energy absorbing functions may have been activated in a collision so the restraints should be examined; if the front air bags have deployed, the pretensioners have also deployed and must be replaced — regardless of whether there was an occupant in the passenger seat or not.

WARNING: Failure to inspect and if necessary replace the safety belt assembly under the above conditions could result in severe personal injuries in the event of a collision.

Refer to *Interior* in the *Cleaning* chapter.

AIR BAG SUPPLEMENTAL RESTRAINT SYSTEM (SRS)

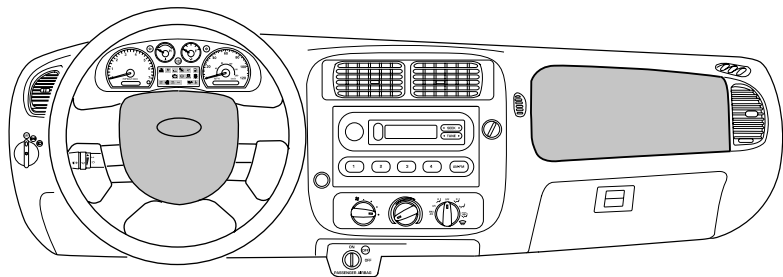

Important supplemental restraint system (SRS) precautions

The supplemental restraint system is designed to work with the safety belt to help protect the driver and right front passenger from certain upper body injuries.

Seating and Safety Restraints

WARNING: Air bags DO NOT inflate slowly or gently and the risk of injury from a deploying air bag is greatest close to the trim covering the air bag module. Always wear your safety belt.

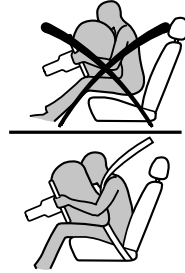

WARNING: Airbags have been known to kill or injure a child in front facing child restraints. When placing a child safety seat in a front seating position including the center (if equipped), you should turn off the passenger airbag switch after being certain the child is properly restrained. If the child safety seat is in the outboard seating position, slide the seat all the way back.

WARNING: Do not install a child seat in a center facing jump seat.

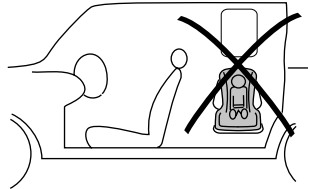

WARNING: Rear facing child seats should NEVER be placed in the front seats unless the passenger airbag switch is turned off. See *Passenger airbag ON/OFF switch* in this chapter.



WARNING: All occupants of the vehicle, including the driver, should always properly wear their safety belts, even when an air bag (SRS) is provided.

Seating and Safety Restraints

WARNING: National Highway Traffic Safety Administration (NHTSA) recommends a minimum distance of at least 25 cm (10 inches) between an occupant's chest and the driver air bag module.

WARNING: Never place your arm or feet over the air bag module as a deploying air bag can result in serious arm fractures or other injuries.

WARNING: Never place a rear facing infant seat in the front seat unless the passenger air bag is turned off.

Steps you can take to properly position yourself away from the airbag:

- Move your seat to the rear as far as you can while still reaching the pedals comfortably.
- Recline the seat slightly (one or two degrees) from the upright position.

WARNING: Do not put anything on or over the air bag module including hands or feet. Placing objects on or over the air bag inflation area may cause those objects to be propelled by the air bag into your face and torso causing serious injury.

WARNING: Do not attempt to service, repair, or modify the Air Bag Supplemental Restraint System or its fuses. See your authorized Mazda dealership.

WARNING: Modifications to the front end of the vehicle, including frame, bumper, front end body structure, tow hooks and snow plows may effect the performance of the air bag sensors increasing the risk of injury. Do not modify the front end of the vehicle.

WARNING: Additional equipment may effect the performance of the air bag sensors increasing the risk of injury. Consult your authorized Mazda dealership before installation of additional equipment.

Seating and Safety Restraints

WARNING: The front passenger air bag is not designed to offer protection to an occupant in the center front seating position.

Children and air bags

For additional important safety information, read all information on safety restraints in this guide.



WARNING: Never place a rearward facing child safety restraint in front of an activated airbag. Airbags have been known to kill or injure children in front facing child safety restraints. Whenever placing a child safety seat in a front seating position (including center if equipped), turn off the passenger side air bag switch after being certain the child is properly restrained. If using a forward facing child safety restraint in the front outboard seat, slide the seat all the way back, and turn off the passenger air bag. If using a rear facing child safety seat in the front outboard seating position, make sure the passenger airbag is turned off and slide the passenger seat all the way forward until the safety seat rests on the dashboard. See *Passenger air bag on/off switch* in this chapter.

WARNING: Do not install a child seat in a center facing jump seat.

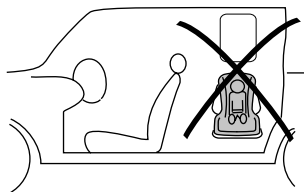

Seating and Safety Restraints

WARNING: An air bag can kill or injure a child in a child seat. Child seats should never be placed in the front seats, unless passenger air bag switch is turned off. See *Passenger air bag on/off switch* in this chapter.

WARNING: Rear facing child seats should NEVER be placed in the front seats unless the passenger airbag switch is turned off.

WARNING: Booster seats must be installed only in seating positions equipped with a combination lap/shoulder belt.

WARNING: To reduce the risk of injury, make sure children sit where they can be properly restrained.

How does the air bag supplemental restraint system work?

The air bag SRS is designed to activate when the vehicle sustains sufficient longitudinal deceleration.

The fact that the air bags did not inflate in a collision does not mean that something is wrong with the system. Rather, it means the forces were not of the type sufficient to cause activation. Air bags are designed to inflate in frontal and near-frontal collisions, not rollover, side-impact, or rear-impacts.

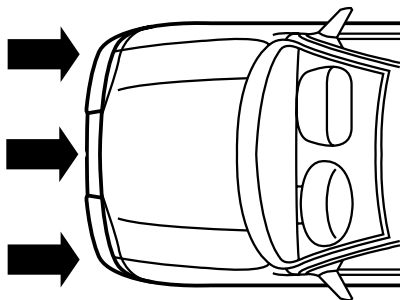

Seating and Safety Restraints

The air bags inflate and deflate rapidly upon activation. After air bag deployment, it is normal to notice a smoke-like, powdery residue or smell the burnt propellant. This may consist of cornstarch, talcum powder (to lubricate the bag) or sodium compounds (e.g., baking soda) that result from the combustion process that inflates the air bag. Small amounts of sodium hydroxide may be present which may irritate the skin and eyes, but none of the residue is toxic.



While the system is designed to help reduce serious injuries, it may also cause minor abrasions, swelling or temporary hearing loss. Because air bags must inflate rapidly and with considerable force, there is the risk of death or serious injuries such as fractures, facial and eye injuries or internal injuries, particularly to occupants who are not properly restrained or are otherwise out of position at the time of air bag deployment. Thus, it is extremely important that occupants be properly restrained as far away from the air bag module as possible while maintaining vehicle control.

WARNING: Several air bag system components get hot after inflation. Do not touch them after inflation or you may be burned.

WARNING: If the air bag has deployed, the air bag will not function again and must be replaced immediately. If the air bag is not replaced, the unrepaired area will increase the risk of injury in a collision.

The SRS consists of:

- driver and passenger air bag modules (which include the inflators and air bags),
- passenger air bag deactivation switch and restraint control module (RCM)
- a readiness light and tone,

Seating and Safety Restraints

- and the electrical wiring which connects the components.

The RCM (restraints control module) monitors its own internal circuits and the supplemental air bag electrical system wiring (including the passenger air bag deactivation switch, the system wiring, the air bag system readiness light, the air bag back up power and the air bag ignitors).

Determining if the system is operational

The SRS uses readiness lights in the instrument cluster and the passenger air bag deactivate switch or a tone to indicate the condition of the system. Refer to the *Air bag readiness* section in the *Instrumentation* chapter or *Passenger air bag deactivate switch* section in this chapter. Routine maintenance of the air bag is not required.

A difficulty with the system is indicated by one or more of the following:

- The readiness lights will either flash or stay lit.
- The readiness lights will not illuminate immediately after ignition is turned on.
- A series of five beeps will be heard. The tone pattern will repeat periodically until the problem and/or light are repaired.



If any of these things happen, even intermittently, have the SRS serviced at your authorized Mazda dealership immediately.

WARNING: Unless serviced, the system may not function properly in the event of a collision.

Disposal of air bags and air bag equipped vehicles (including safety belt pretensioners)

For disposal of safety belt pretensioners, air bags, or air bag equipped vehicles, see your authorized Mazda dealership or qualified technician. Air bags **MUST BE** disposed of by qualified personnel.

Seating and Safety Restraints

Passenger air bag ON/OFF switch

WARNING: An airbag ON/OFF switch has been installed in this vehicle. Before driving, *always* look at the face of the switch to be sure the switch is in the proper position in accordance with these instructions and warnings. Failure to put the switch in a proper position can increase the risk of serious injury or death in a collision.

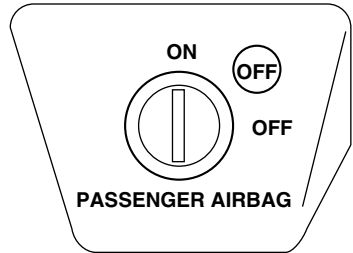

Turning the passenger air bag off

1. Ignition OFF.
2. Insert the ignition key, turn the switch to OFF position and hold in OFF position while removing the key.
3. When the ignition switch is turned to the ON position the OFF light illuminates briefly, momentarily shuts off and then turns back on. This indicates that the passenger air bag is deactivated. Do not use a second key to turn off the passenger airbag, as the lock position might be changed without your knowing.

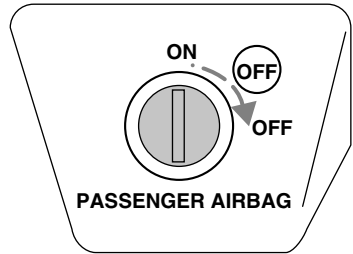

Seating and Safety Restraints

WARNING: You must turn the passenger air bag Off if you have a rear facing child seat in the front seat of the pickup (the center lapbelt on front split seats or the center facing rear seats do not accommodate child seats). Statistics show that children under 12 are more likely to suffer minor injuries in the front passenger seats than adults. If you must have a child in the front passenger seat, place the largest child in the front seat, make sure that the child is belted, the vehicle seat is all the way back, and the passenger airbag is turned OFF. The front seat center lap belt and the center facing rear seats do not accommodate child seats; therefore, you may not be able to put a larger child in the front passenger seat if a child seat is involved.

WARNING: If the OFF light fails to illuminate when the passenger air bag switch is in the OFF position and the ignition switch is in the ON position, have the passenger air bag switch serviced at your authorized Mazda dealership.

WARNING: In order to avoid inadvertent activation of the switch, always remove the ignition key from the passenger air bag ON/OFF switch.

Turning the passenger air bag back on

The passenger air bag remains OFF until you turn it back ON.

1. Insert the ignition key and turn the switch to ON.
2. The OFF light will briefly illuminate when the ignition is turned to ON. This indicates that the passenger air bag is operational.

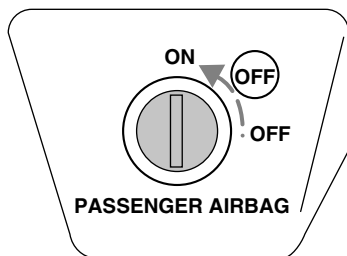

Seating and Safety Restraints

WARNING: If the light is illuminated when the passenger air bag ON/OFF switch is in the ON position and the ignition switch is ON, have the passenger air bag ON/OFF switch serviced at your authorized Mazda dealership immediately.

The passenger side air bag should always be ON (the air bag OFF light should *not* be illuminated) except for certain vulnerable persons. See guidance on following pages.

WARNING: The safety belts for the driver and right front passenger seating positions have been specifically designed to function together with the air bags in certain types of crashes. When you turn OFF your air bag, you not only lose the protection of the air bag, you also may reduce the effectiveness of your safety belt system, which was designed to work with the air bag. Most vehicles with full back seats do not have cut-off switches, but NHTSA and Transport Canada will allow a cut-off switch to be installed on request for a certain category of persons who must ride up front and there is a concern about riding there. Please see the guidance below.

WARNING: Always use safety belts and child restraints properly. If a child in a rear facing infant seat must be transported in front, the passenger air bag *must* be turned OFF. This is because the back of the infant seat is too close to the inflating air bag and the risk of a fatal injury to the infant when the air bag inflates is substantial.

The vast majority of drivers and passengers over the age of 12 years are much safer with an air bag than without. To do their job and reduce the risk of life threatening injuries, air bags must open with great force, and this force can pose a potentially deadly risk in some situations, particularly when a front seat occupant is not properly buckled up. The most effective way to reduce the risk of unnecessary air bag injuries without reducing the overall safety of the vehicle is to make sure all occupants are properly restrained in the vehicle, especially in the front seat. This provides the protection of safety belts and permits the air bags to provide the additional protection they were designed to provide. If you choose to deactivate your air bag, you are losing the very significant risk reducing benefits of the air bag and you are also reducing the

Seating and Safety Restraints

effectiveness of the safety belts, because safety belts in modern vehicles are designed to work as a safety system with the air bags.

Read all air bag Warning labels in the vehicle as well as the other important air bag instructions and Warnings in this Owner's Guide.

NHTSA gives permission to install airbag cut-off switches in the following terms:

1. **Infant.** An infant (less than 1 year old) must ride in the front seat because:
 - the vehicle has no rear seat;
 - the vehicle has a rear seat too small to accommodate a rear-facing infant seat; or
 - the infant has a medical condition which, according to the infant's physician, makes it necessary for the infant to ride in the front so that the driver can constantly monitor the child's condition.
2. **Child age 1 to 12.** A child age 1 to 12 must ride in the front seat because:
 - the vehicle has no rear seat;
 - although children ages 1 to 12 ride in the rear seat(s) whenever possible, children ages 1 to 12 sometimes must ride in the front because no space is available in the rear seat(s) of the vehicle; or
 - the child has a medical condition which, according to the child's physician, makes it necessary for the child to ride in the front seat so that the driver can constantly monitor the child's condition.
3. **Medical condition.** A passenger has a medical condition which, according to his or her physician:
 - causes the passenger air bag to pose a special risk for the passenger; and
 - makes the potential harm from the passenger air bag in a crash greater than the potential harm from turning OFF the air bag and allowing the passenger, even if belted, to hit the dashboard or windshield in a crash.

Seating and Safety Restraints

WARNING: This vehicle has special energy management safety belts for the driver and right front passenger. These particular belts are specifically designed to work with air bags to help reduce the risk of injury in a collision. The energy management safety belt is designed to give or release additional belt webbing in some accidents to reduce concentration of force on an occupant's chest and reduce the risk of certain bone fractures and injuries to underlying organs. In a crash, if the air bag is turned OFF, this energy management safety belt might permit the person wearing the belt to move forward enough to incur a serious or fatal injury. The more severe the crash, and the heavier the occupant, the greater the risk is. Be sure the air bag is turned ON for any person who does not qualify under the NHTSA deactivation criteria.

Transport Canada gives permission to install airbag cut-off switches in the following terms:

1. **Infant:** An infant (less than 1 year old) must ride in the front seat because:
 - my vehicle has no rear seat;
 - the rear seat in my vehicle cannot accommodate a rear-facing infant seat; or
 - the infant has a medical condition which, according to the infant's physician, makes it necessary for the infant to ride in the front seat so that the driver can monitor the infant's condition.
2. **Child age 12 or under:** A child age 12 or under must ride in the front seat because:
 - my vehicle has no rear seat;
 - although children age 12 and under ride in the rear seat whenever possible, children age 12 and under have no option but to sometimes ride in the front seat because rear seat space is insufficient; or
 - the child has a medical condition that, according to the child's physician, makes it necessary for the child to ride in the front seat so that the driver can monitor the child's condition.
3. **Medical condition:** A passenger has a medical condition that, according to his or her physician:
 - poses a special risk for the passenger if the air bag deploys; and
 - makes the potential harm from the passenger air bag deployment greater than the potential harm from turning OFF the air bag and experiencing a crash without the protection offered by the air bag

Seating and Safety Restraints

WARNING: This vehicle has special energy management safety belts for the driver and/or right front passenger. These particular belts are specifically designed to work with air bags to help reduce the risk of injury in a collision. The energy management safety belt is designed to give or release additional belt webbing in some accidents to reduce concentration of force on an occupant's chest and reduce the risk of certain bone fractures and injuries to underlying organs. In a crash, if the air bag is turned OFF, this energy management safety belt might permit the person wearing the belt to move forward enough to incur a serious or fatal injury. The more severe the crash, and the heavier the occupant, the greater the risk is. Be sure the air bag is turned ON for any person who does not qualify under the Transport Canada deactivation criteria.

SAFETY RESTRAINTS FOR CHILDREN

See the following sections for directions on how to properly use safety restraints for children. Also see *Air bag supplemental restraint system (SRS)* in this chapter for special instructions about using air bags.

Important child restraint precautions

NOTE: You are required by law to use a child-restraint system in the U.S. and Canada. Many states require that children use approved booster seats until they are eight years old. Check your local and state or provincial laws for specific requirements regarding the safety of children in your vehicle.

WARNING: Never let a passenger hold a child on his or her lap while the vehicle is moving. The passenger cannot protect the child from injury in a collision.

NOTE: Always follow the instructions and warnings that come with any infant or child restraint you might use.

WARNING: Air bags can kill or injure a child in a child seat. Never place a rear facing child seat in front of an active air bag. If you must use a forward facing child seat in the front seat, position the vehicle seat fully rearward and turn the passenger air bag off.

Seating and Safety Restraints

WARNING: An air bag can kill or injure a child in a child seat. Child seats should never be placed in the front seats, unless passenger air bag switch is turned off, See *Passenger air bag on/off switch*.

WARNING: Rear facing child seats should NEVER be placed in the front seats unless the passenger airbag switch is turned off. Also, slide the front seat forward until the rear facing child seat contacts the dash board for maximum support. (All other children and forward facing child seats and booster seats should be on front seats that are slid back as far away as possible from the dashboard.

WARNING: Do not install a child seat in a center facing jump seat.

Children and safety belts

If the child is the proper size, restrain the child in a safety seat.

Children who are too large for child safety seats (as specified by your child safety seat manufacturer) should always wear safety belts.

Follow all the important safety restraint and air bag precautions that apply to adult passengers in your vehicle.

If the shoulder belt portion of a combination lap and shoulder belt can be positioned so it does not cross or rest in front of the child's face or neck, the child should wear the lap and shoulder belt. Moving the child closer to the center of the vehicle may help provide a good shoulder belt fit.

WARNING: Do not leave children, unreliable adults, or pets unattended in your vehicle.

Seating and Safety Restraints

WARNING: Placing a child, 12 years or younger, in the front seat is dangerous. The child could be hit by a deploying air bag and be seriously injured or even killed. Never place a child safety seat in a center facing rear jump seat. If you must place a child safety seat in a front seating position, make sure the passenger airbag is turned off. See *Turning the airbag Off* in this section. Never use a rear-facing child restraint system in the front seat with an air bag that could deploy.

Child booster seats

Children outgrow a typical convertible or toddler seat when they weigh 40 pounds and are around 4 years of age. Although the lap/shoulder belt will provide some protection, these children are still too small for lap/shoulder belts to fit properly, which could increase the risk of serious injury.

To improve the fit of both the lap and shoulder belt on children who have outgrown child safety seats, Mazda recommends use of a belt-positioning booster.

Booster seats position a child so that safety belts fit better. They lift the child up so that the lap belt rests low across the hips and the knees bend comfortably. Booster seats also make the shoulder belt fit better and more comfortably for growing children.

When children should use booster seats

Children need to use booster seats from the time they outgrow the toddler seat until they are big enough for the vehicle seat and lap/shoulder belt to fit properly. Generally this is when they weigh about 80 lbs (about 8 to 12 years old).

Booster seats should be used until you can answer YES to ALL of these questions:

- Can the child sit all the way back against the vehicle seat back with knees bent comfortably at the edge of the seat without slouching?

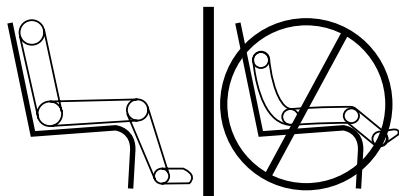

- Does the lap belt rest low across the hips?
- Is the shoulder belt centered on the shoulder and chest?

Seating and Safety Restraints

- Can the child stay seated like this for the whole trip?

WARNING: Booster seats must be installed only in seating positions equipped with a combination lap/shoulder belt.

Types of booster seats

There are two types of belt-positioning booster seats:

- Those that are backless.

If your backless booster seat has a removable shield, remove the shield and use the lap/shoulder belt. If a seating position has a low seat back and no head restraint, a backless booster seat may place your child's head (top of ear level) above the top of the seat. In this case, use a high-backed booster seat.



- Those with a high back.

If, with a backless booster seat, you cannot find a seating position that adequately supports your child's head, a high back booster seat would be a better choice.



Both can be used in any vehicle in a seating position equipped with lap/shoulder belts if your child is over 40 lbs.

The shoulder belt should cross the chest, resting snugly on the center of the shoulder. The lap belt should rest low and snug across the hips, never up high across the stomach.

If the booster seat slides on the vehicle seat, placing a rubberized mesh sold as shelf or carpet liner under the booster seat may improve this condition.

Seating and Safety Restraints

The importance of shoulder belts

Using a booster without a shoulder belt increases the risk of a child's head hitting a hard surface in a collision. For this reason, you should never use a booster seat with a lap belt only. It is best to use a booster seat with combination lap/shoulder belts.

WARNING: Follow all instructions provided by the manufacturer of the booster seat.

WARNING: Never put the shoulder belt under a child's arm or behind the back because it eliminates the protection for the upper part of the body and may increase the risk of injury or death in a collision.

WARNING: Never use pillows, books, or towels to boost a child. They can slide around and increase the likelihood of injury or death in a collision.

SAFETY SEATS FOR CHILDREN



Child and infant or child safety seats

Use a safety seat that is recommended for the size and weight of the child. Carefully follow all of the manufacturer's instructions with the safety seat you put in your vehicle. If you do not install and use the safety seat properly, the child may be injured in a sudden stop or collision.

Seating and Safety Restraints

When installing a child safety seat:

- Review and follow the information presented in the *Air Bag Supplemental Restraint System* section in this chapter.
- Use the correct safety belt buckle for that seating position (the buckle closest to the direction the tongue is coming from).
- Insert the belt tongue into the proper buckle until you hear a snap and feel it latch. Make sure the tongue is securely fastened in the buckle.

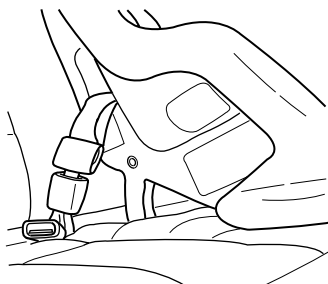

WARNING: Do not install a child seat in a center facing jump seat.

- Keep the buckle release button pointing up and away from the safety seat, with the tongue between the child seat and the release button, to prevent accidental unbuckling.
- Place seat back in upright position.
- Put the safety belt in the automatic locking mode. Refer to *Automatic locking mode* (passenger side front seat).
- LATCH lower anchors are recommended for use by children up to 22 kg (48 pounds) in a child restraint. Top tether anchors can be used for children up to 27 kg (60 pounds) in a child restraint, and to provide upper torso restraint for children up to 36 kg (80 pounds) using an upper torso harness and a belt-positioning booster.

Mazda recommends the use of a child safety seat having a top tether strap. Install the child safety seat in a seating position with LATCH and tether anchors. For more information on top tether straps and anchors, refer to *Attaching safety seats with tether straps* in this chapter. For more information of LATCH anchors refer to *Attaching safety seats with LATCH (Lower Anchors and Tethers for Children) attachments* in this chapter.

Seating and Safety Restraints

WARNING: Carefully follow all of the manufacturer's instructions included with the safety seat you put in your vehicle. If you do not install and use the safety seat properly, the child may be injured in a sudden stop or collision.

Installing child safety seats with combination lap and shoulder belts (front outboard passenger seat only)

1. Position the child safety seat in a seat with a combination lap and shoulder belt.

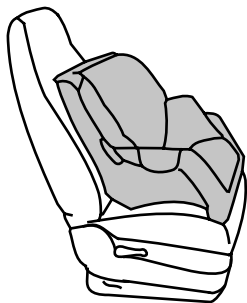

WARNING: If there is a tether on the child safety seat, attach it to the tether anchor point. Refer to *Attaching child safety seats with tether straps* in this chapter.

WARNING: Air bags can kill or injure a child in a child seat. Never place a rear facing child seat in the right front seat unless the air bag on/off switch is turned OFF. If you place a forward-facing child seat in the right front seat, turn the air bag on/off switch to OFF. See *Passenger air bag on/off switch* in this chapter.

WARNING: Rear facing child seats should NEVER be placed in the front seats unless the passenger air bag switch is turned off. Also, slide the front seat forward until the rear facing child seat contacts the dash board for maximum support. (All other children and forward facing child seats and booster seats should be on front seats that are slid back as far away as possible from the dashboard.)

Seating and Safety Restraints

2. Pull down on the shoulder belt and then grasp the shoulder belt and lap belt together.

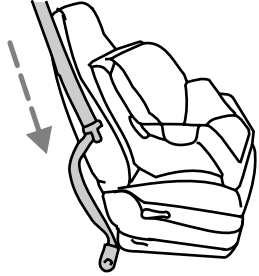

3. While holding the shoulder and lap belt portions together, route the tongue through the child seat according to the child seat manufacturer's instructions. Be sure the belt webbing is not twisted.

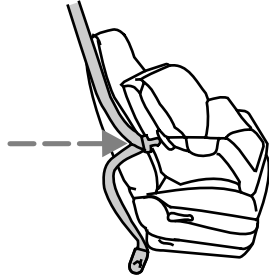

4. Insert the belt tongue into the proper buckle (the buckle closest to the direction the tongue is coming from) for that seating position until you hear and feel the latch engage. Make sure the tongue is latched securely by pulling on it.

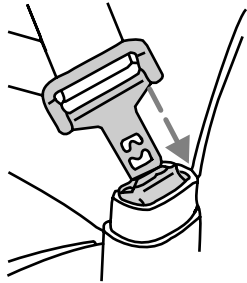

Seating and Safety Restraints

5. To put the retractor in the automatic locking mode, grasp the shoulder portion of the belt and pull downward until all of the belt is extracted and a click is heard.

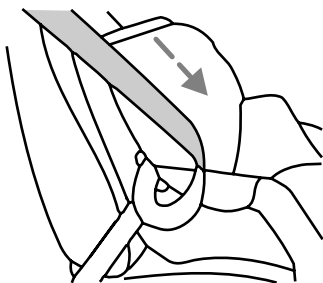

6. Allow the belt to retract. The belt will click as it retracts to indicate it is in the automatic locking mode.
7. Pull the lap belt portion across the child seat toward the buckle and pull up on the shoulder belt while pushing down with knee on the child seat.

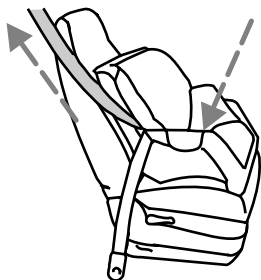

8. Allow the safety belt to retract to remove any slack in the belt.
9. Before placing the child in the seat, forcibly tilt the seat forward and back to make sure the seat is securely held in place. To check this, grab the seat at the belt path and attempt to move it side to side and forward. There should be no more than one inch of movement for proper installation.

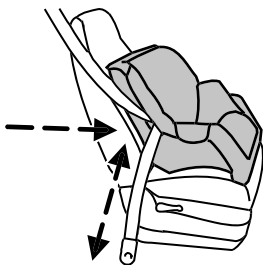

10. Try to pull the belt out of the retractor to make sure the retractor is in the automatic locking mode (you should not be able to pull more belt out). If the retractor is not locked, unbuckle the belt and repeat steps two through nine.

Seating and Safety Restraints

11. See *Attaching child safety seats with tether straps* in this chapter. Check to make sure the child seat is properly secured before each use.

Attaching child safety seats with tether straps

Most new forward-facing child safety seats include a tether strap which goes over the back of the seat and hooks to an anchoring point. Tether straps are available as an accessory for many older safety seats. Contact the manufacturer of your child seat for information about ordering a tether strap.

The tether anchors in your vehicle are located on the back of the front seat cushion.

The tether strap anchors in your vehicle are in the following positions (shown from top view):

- **Bucket seats**

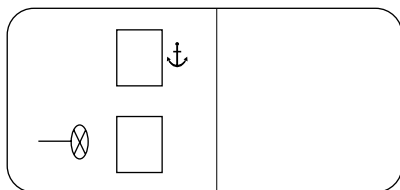

- **60/40 seats**

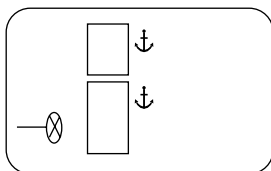

WARNING: Attach the tether strap only to the appropriate tether anchor as shown. The tether strap may not work properly if attached somewhere other than the correct tether anchor.

Seating and Safety Restraints

WARNING: This anchor information applies to child safety seats equipped with tether straps. For child safety seats equipped with LATCH anchors, refer to *Attaching safety seats with LATCH (Lower Anchors and Tethers for Children) attachments for child seat anchors* in this chapter.

WARNING: Never attach two child safety seat tethers to a single tether anchor. In a crash, an anchor may not be strong enough to hold two child safety seat attachments and may break, causing serious injury or death.

1. Position the child safety seat on the front seat cushion.
2. Route the child safety seat tether strap over the back of the seat.

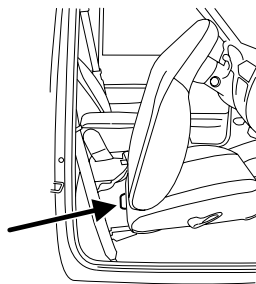

3. Locate the correct anchor for the selected seating position.

The tether anchor is located on the rear lower portion of the passenger seat.

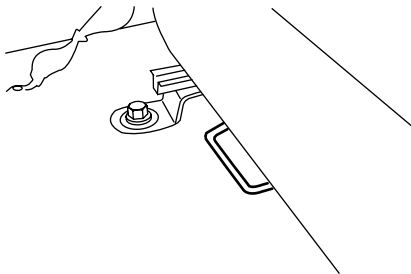

Seating and Safety Restraints

4. Clip the tether strap to the anchor.

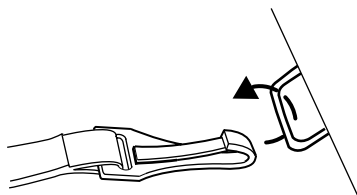

WARNING: If the tether strap is clipped incorrectly, the child safety seat may not be retained properly in the event of a collision.

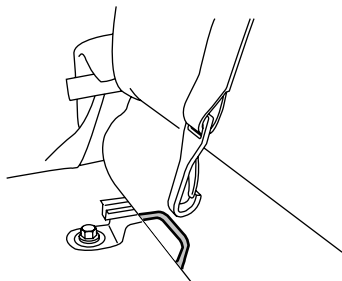

Center seating location 60/40 seats with folding armrest

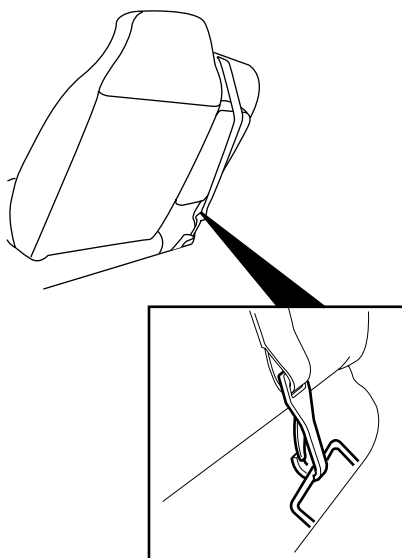

When installing a child safety seat in the center position, route the tether strap over the center arm rest and clip it to the center anchor.

Seating and Safety Restraints

See next page for center seating location of vinyl 60/40 seat.

WARNING: If the tether strap is clipped incorrectly, the child safety seat may not be retained properly in the event of a collision.

WARNING: If the tether strap is clipped incorrectly, the child safety seat may not be retained properly in the event of a collision.

5. Refer to the *Installing child safety seats in combination lap and shoulder belt seating positions* section of this chapter for further instructions to secure the child safety seat.
6. Tighten the child safety seat tether strap according to the manufacturer's instructions.

WARNING: If the safety seat is not anchored properly, the risk of a child being injured in a collision greatly increases.

Attaching safety seats with LATCH (Lower Anchors and Tethers for Children) attachments for child seat anchors

Some child safety seats have two rigid or webbing mounted attachments that connect to two anchors at certain seating positions in your vehicle. This type of child seat eliminates the need to use seat belts to attach the child seat. For forward-facing child seats, the tether strap must also be attached to the proper tether anchor. See *Attaching safety seats with tether straps* in this chapter.

Your vehicle may be equipped with LATCH anchors for child seat installation at the following seating positions:

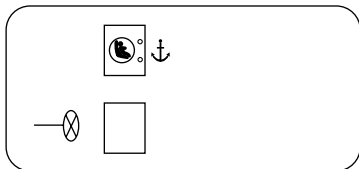

- Bucket seats

Seating and Safety Restraints

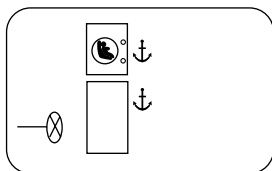

- 60/40 seats

 represents LATCH anchors.

 represents tether strap anchors.

To improve child seat protection, use the tether anchor when using the LATCH to install a child safety seat. See *Attaching child safety seats with tether straps in this section*.

WARNING: Never attach two LATCH child safety seats to the same anchor. In a crash, one anchor may not be strong enough to hold two child safety seat attachments and may break, causing serious injury or death.

WARNING: Do not put the LATCH type seat in the center seat position — it only has one possible anchor point and the seat will not be properly attached.

WARNING: If there are two LATCH seats to install — you can only mount one LATCH seat in this vehicle with the LATCH anchor bars. You need to mount the second seat with the center seat belt using the lap belt method and the child safety seat tether (if equipped).

WARNING: Do not attach two seats to one LATCH anchor bar.

Seating and Safety Restraints

The lower anchors for child seat installation are located at the rear section of the front passenger seat between the cushion and seat back. The LATCH anchors are below locator symbols on the seat back. Two plastic LATCH guides may be purchased from your local Mazda dealer (part number 1F60-57-751). They snap onto the latch lower anchor in the vehicle to help attach a child seat with rigid latch attachments. It will hold the seat foam away and expose the anchor making attachment of the child seat easier.

Make sure you attach the proper child safety seat tether after securing the LATCH.

WARNING: If the tether strap is clipped incorrectly, the child safety seat may not be retained properly in the event of a collision.

Follow the child seat manufacturer's instructions to properly install a child seat with LATCH attachments.

WARNING: Attach LATCH lower attachments of the child seat only to the anchors shown.

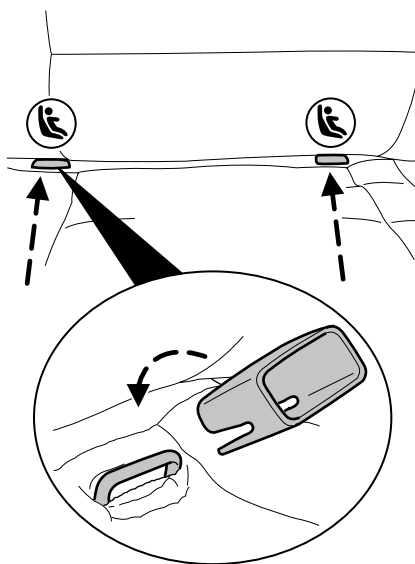

Seating and Safety Restraints

If you install a child seat with rigid LATCH attachments, do not tighten the tether strap enough to lift the child seat off the vehicle seat cushion when the child is seated in it. Keep the tether strap just snug without lifting the front of the child seat. Keeping the child seat just touching the vehicle seat gives the best protection in a severe crash.

Each time you use the safety seat, check that the seat is properly attached to the lower anchors and tether anchor. Try to tilt the child seat from side to side. Also try to tug the seat forward. Check to see if the anchors hold the seat in place.

WARNING: If the safety seat is not anchored properly, the risk of a child being injured in a crash greatly increases.

WARNING: If the tether strap is clipped incorrectly, the child safety seat may not be retained properly in the event of a collision.

STARTING

Positions of the ignition

1. ACCESSORY, allows the electrical accessories such as the radio to operate while the engine is not running.
2. LOCK, locks the steering wheel, automatic transmission gearshift lever and allows key removal.
3. OFF, shuts off the engine and all accessories without locking the steering wheel. This position also allows the automatic transmission shift lever to be moved from the P (Park) position without the brake pedal being depressed.

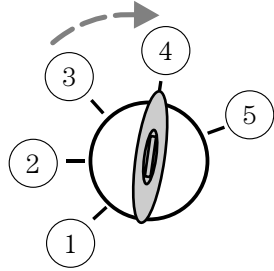

WARNING: When the key is in the ignition and in the OFF position, the automatic transmission shift lever can be moved from the P (Park) position without the brake pedal depressed. To avoid unwanted vehicle movement, always set the parking brake.

4. ON, all electrical circuits operational. Warning lights illuminated. Key position when driving.
5. START, cranks the engine. Release the key as soon as the engine starts.

Preparing to start your vehicle

Engine starting is controlled by the powertrain control system.

Note: This system meets all Canadian Interference-Causing Equipment standard requirements regulating the impulse electrical field strength of radio noise.

When starting a fuel-injected engine, don't press the accelerator before or during starting. Only use the accelerator when you have difficulty starting the engine. For more information on starting the vehicle, refer to *Starting the engine* in this chapter.

Driving

WARNING: Extended idling at high engine speeds can produce very high temperatures in the engine and exhaust system, creating the risk of fire or other damage.

WARNING: Do not park, idle, or drive your vehicle in dry grass or other dry ground cover. The emission system heats up the engine compartment and exhaust system, which can start a fire.

WARNING: Do not start your vehicle in a closed garage or in other enclosed areas. Exhaust fumes can be toxic. Always open the garage door before you start the engine. See *Guarding against exhaust fumes* in this chapter for more instructions.

WARNING: If you smell exhaust fumes inside your vehicle, have your dealer inspect your vehicle immediately. Do not drive if you smell exhaust fumes.

Important safety precautions

When the engine starts, the idle RPM runs faster to warm the engine. If the engine idle speed does not slow down automatically, have the vehicle checked.

Before starting the vehicle:

1. Make sure all occupants buckle their safety belts. For more information on safety belts and their proper usage, refer to the *Seating and Safety Restraints* chapter.
2. Make sure the headlamps and electrical accessories are off.

If starting a vehicle with an automatic transmission:

- Make sure the parking brake is set.

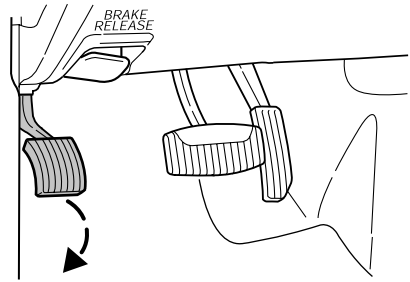

- Make sure the gearshift is in P (Park).

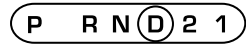

If starting a vehicle with a manual transmission:

1. Make sure the parking brake is set.
2. Push the clutch pedal to the floor.

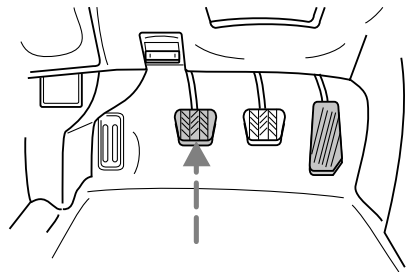

3. Turn the key to 4 (ON) without turning the key to 5 (START).

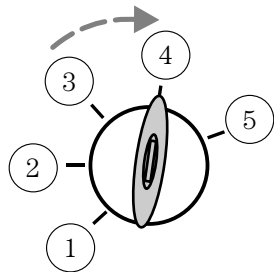

If there is difficulty in turning the key, firmly rotate the steering wheel left and right until the key turns freely. This condition may occur when:

- front wheels are turned
- front wheel is against the curb

Driving

- steering wheel is turned when getting in or out of the vehicle

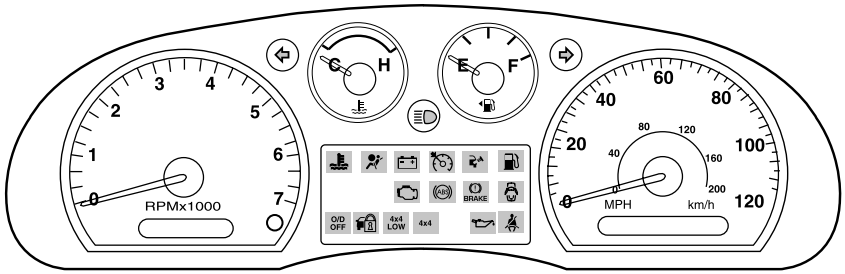

Make sure the corresponding lights illuminate or illuminate briefly. If a light fails to illuminate, have the vehicle serviced.

- If the driver's safety belt is fastened, the  light may not illuminate. Refer to the *Instrument Cluster* chapter for more information.

Starting the engine

Note: Whenever you start your vehicle, release the key as soon as the engine starts. Excessive cranking could damage the starter.

- Turn the key to 4 (ON) without turning the key to 5 (START). If there is difficulty in turning the key, rotate the steering wheel until the key turns freely. This condition may occur when:

- the front wheels are turned
- a front wheel is against the curb

Turn the key to 5 (START), then release the key as soon as the engine starts. Excessive cranking could damage the starter.

Note: If the engine does not start within five seconds on the first try, turn the key to OFF, wait 10 seconds and try again. If the engine still fails to start, press the accelerator to the floor and try again; this will allow the engine to crank with the fuel shut off in case the engine is flooded with fuel.

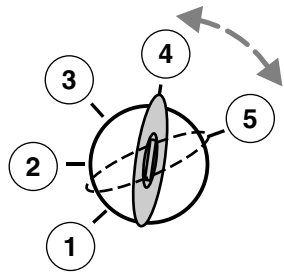

Cold weather starting (flexible fuel vehicles only)

In cold weather, ethanol fuel distributors should supply winter grade (E_d85) ethanol. If summer grade (E_d85) ethanol is used in cold weather, you may experience increased cranking times, rough idle or hesitation until the engine has warmed up. Consult your fuel distributor for the availability of winter grade (E_d85) ethanol. High-quality blends of winter grade (E_d85) ethanol will produce satisfactory cold weather starting and driving results.

Cold starting performance can also be improved by using an engine block heater. Engine block heaters are available as an option and can be obtained from your Mazda dealer. Consult the engine block heater section for proper use of the engine block heater.

If you experience cold weather starting problems on (E_d85) ethanol, and neither an alternative brand of (E_d85) ethanol nor an engine block heater is available, adding unleaded gasoline to your tank will improve cold starting performance. Your vehicle is designed to operate on (E_d85) ethanol, unleaded gasoline alone, or any mixture of the two.

If the engine fails to start using the preceding instructions (flexible fuel vehicles only)

1. Press and hold down the accelerator 1/3 to 1/2 way to floor, then crank the engine.
2. When the engine starts, release the key, then gradually release the accelerator pedal as the engine speeds up. If the engine still fails to start, repeat Step 1.

Using the engine block heater (if equipped)

An engine block heater warms the engine coolant which aids in starting and heater/defroster performance. Use of an engine block heater is strongly recommended if you live in a region where temperatures reach -23° C (-10° F) or below. For best results, plug the heater in at least three hours before starting the vehicle. The heater can be plugged in the night before starting the vehicle.

WARNING: To reduce the risk of electrical shock, do not use your heater with ungrounded electrical systems or two-pronged (cheater) adapters.

Driving

Guarding against exhaust fumes

Carbon monoxide is present in exhaust fumes. Take precautions to avoid its dangerous effects.

WARNING: If you smell exhaust fumes inside your vehicle, have your dealer inspect your vehicle immediately. Do not drive if you smell exhaust fumes.

Important ventilating information

If the engine is idling while the vehicle is stopped for a long period of time, open the windows at least 2.5 cm (one inch) or adjust the heating or air conditioning to bring in fresh air.

BRAKES

Occasional brake noise is normal. If a metal-to-metal, continuous grinding or continuous squeal sound is present, the brake linings may be worn-out and should be inspected by a qualified service technician. If the vehicle has continuous vibration or shudder in the steering wheel while braking, the vehicle should be inspected by a qualified service technician.

Refer to *Brake system warning light* in the *Instrument Cluster* chapter for information on the brake system warning light.



Four-wheel anti-lock brake system (ABS)

This vehicle is equipped with an anti-lock braking system (ABS), a noise from the hydraulic pump motor and pulsation in the pedal may be observed during ABS braking events. Pedal pulsation coupled with noise while braking under panic conditions or on loose gravel, bumps, wet or snowy roads is normal and indicates proper functioning of the vehicle's anti-lock brake system.

NOTE: The ABS performs a self-check after you start the engine and begin to drive away.

A brief mechanical noise may be heard during this test. This is normal. If a malfunction is found, the ABS warning light will come on. If the vehicle has continuous vibration or shudder in the steering wheel while braking, the vehicle should be inspected by an authorized Mazda dealership.

The ABS operates by detecting the onset of wheel lockup during brake applications and compensates for this tendency. The wheels are prevented from locking even when the brakes are firmly applied. The accompanying illustration depicts the advantage of an ABS equipped vehicle (on bottom) to a non-ABS equipped vehicle (on top) during hard braking with loss of front braking traction.

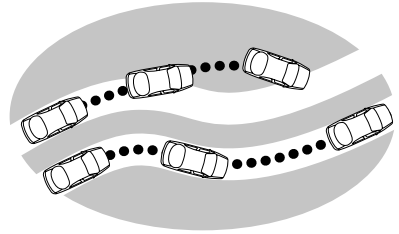

WARNING: The Anti-Lock system does not decrease the time necessary to apply the brakes or always reduce stopping distance. Always leave enough room between your vehicle and the vehicle in front of you to stop.

Using ABS

When hard braking is required, apply continuous force on the brake pedal; do not pump the brake pedal since this will reduce the effectiveness of the ABS and will increase your vehicle's stopping distance. The ABS will be activated immediately, allowing you to retain full steering control during hard braking and on slippery surfaces. However, the ABS does not decrease stopping distance.

ABS warning lamp

The ABS lamp in the instrument cluster momentarily illuminates when the ignition is turned to ON. If the light does not illuminate during start up, remains on or flashes, the ABS may be disabled and may need to be serviced.



Even when the ABS is disabled, normal braking is still effective. (If your BRAKE warning lamp illuminates with the parking brake released, have your brake system serviced immediately.)



Driving

Parking brake (P)

Apply the parking brake whenever the vehicle is parked. To set the parking brake, press the parking brake pedal down until the pedal stops.

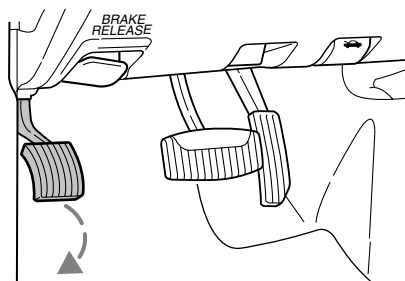

The BRAKE warning lamp in the instrument cluster illuminates and remains illuminated (when the ignition is turned ON) until the parking brake is released.



WARNING: Always set the parking brake fully and make sure that the gearshift is securely latched in P (Park) (automatic transmission) or in 1 (First) (manual transmission).

NOTE: The parking brake is not recommended to stop a moving vehicle. However, if the normal brakes fail, the parking brake can be used to stop your vehicle in an emergency. Since the parking brake applies only the rear brakes, the vehicle's stopping distance will increase greatly and the handling of your vehicle will be adversely affected.

Pull the release lever to release the brake.

Driving with the parking brake on will cause the brakes to wear out quickly and reduce fuel economy.

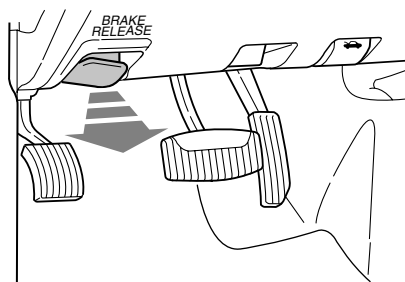

STEERING

Your vehicle is equipped with power steering. Power steering uses energy from the engine to decrease the driver's effort in steering the vehicle.

To prevent damage to the power steering pump:

- Never hold the steering wheel to the extreme right or the extreme left for more than a few seconds when the engine is running.
- Do not operate the vehicle with the power steering pump fluid level below the MIN mark on the reservoir.

If the power steering system breaks down (or if the engine is turned off), you can steer the vehicle manually, but it takes more effort.

If the steering wanders or pulls, check for:

- Underinflated tire(s) on any wheel(s)
- Uneven vehicle loading
- High crown in center of road
- High crosswinds
- Wheels out of alignment
- Loose or worn suspension components

TRACTION-LOK AXLE/LIMITED SLIP DIFFERENTIAL (IF EQUIPPED)

This axle provides added traction on slippery surfaces, particularly when one wheel is on a poor traction surface. Under normal conditions, the Traction-Lok axle functions like a standard rear axle.

PREPARING TO DRIVE YOUR VEHICLE

WARNING: Utility vehicles have a significantly higher rollover rate than other types of vehicles.

WARNING: In a rollover crash, an unbelted person is significantly more likely to die than a person wearing a safety belt.

Your vehicle has larger tires and increased ground clearance, giving the vehicle a higher center of gravity than a passenger car.

Driving

WARNING: Vehicles with a higher center of gravity such as utility and four-wheel drive vehicles handle differently than vehicles with a lower center of gravity. Utility and four-wheel drive vehicles are not designed for cornering at speeds as high as passenger cars any more than low-slung sports cars are designed to perform satisfactorily under off-road conditions. Avoid sharp turns, excessive speed and abrupt maneuvers in these vehicles. Failure to drive cautiously could result in an increased risk of loss of vehicle control, vehicle rollover, personal injury and death.

WARNING: Loaded vehicles, with a higher center of gravity, may handle differently than unloaded vehicles. Extra precautions, such as slower speeds and increased stopping distance, should be taken when driving a heavily loaded vehicle.

AUTOMATIC TRANSMISSION OPERATION (IF EQUIPPED)

Brake-shift interlock

This vehicle is equipped with a brake-shift interlock feature that prevents the gearshift lever from being moved from P (Park) when the ignition is in the ON position unless the brake pedal is depressed.

If you cannot move the gearshift lever out of P (Park) with ignition in the ON position and the brake pedal depressed:

1. Apply the parking brake, turn ignition key to LOCK, then remove the key.
2. Insert the key and turn it to OFF. **Apply the brake pedal and shift to N (Neutral).**

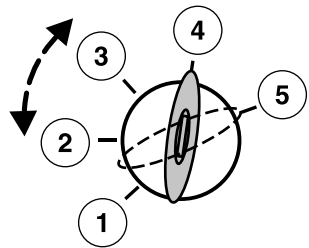

WARNING: When the key is in the ignition and in the OFF position, the automatic transmission shift lever can be moved from the P (Park) position without the brake pedal depressed. To avoid unwanted vehicle movement, always set the parking brake.

3. Start the vehicle.

If it is necessary to use the above procedure to move the gearshift lever, it is possible that a fuse has blown or the vehicle's brakelamps are not operating properly. Refer to *Fuses and relays* in the *Roadside emergencies* chapter.

WARNING: Do not drive your vehicle until you verify that the brakelamps are working.

WARNING: Always set the parking brake fully and make sure the gearshift is latched in P (Park). Turn the ignition to the LOCK position and remove the key whenever you leave your vehicle.

WARNING: If the parking brake is fully released, but the brake warning lamp remains illuminated, the brakes may not be working properly. See your authorized Mazda dealership.

Driving with a 5-speed automatic transmission (if equipped)

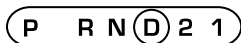

Your transmission is equipped with an adaptive learning strategy found in the vehicle computer. This feature is designed to increase durability, and provide consistent shift feel over the life of the vehicle. A new vehicle or transmission may have firm and/or soft shifts. This operation is considered normal and will not affect function or durability of the transmission. Over time, the adaptive learning process will fully update transmission operation. Additionally, whenever the battery is disconnected or a new battery is installed, the strategy must relearn.

WARNING: Hold the brake pedal down while you move the gearshift lever from P (Park) to another position. If you do not hold the brake pedal down, your vehicle may move unexpectedly and injure someone.

Driving

P (Park)

This position locks the transmission and prevents the rear wheels from turning.

To put your vehicle in gear:

- Start the engine
- Depress the brake pedal
- Move the gearshift lever into the desired gear

To put your vehicle in P (Park):

- Come to a complete stop
- Move the gearshift lever and securely latch it in P (Park)

WARNING: Always set the parking brake fully and make sure the gearshift is latched in P (Park). Turn the ignition to the LOCK position and remove the key whenever you leave your vehicle.

R (Reverse)

With the gearshift lever in R (Reverse), the vehicle will move backward. Always come to a complete stop before shifting into and out of R (Reverse).

N (Neutral)

With the gearshift lever in N (Neutral), the vehicle can be started and is free to roll. Hold the brake pedal down while in this position.

D (Overdrive)

The normal driving position for the best fuel economy. Transmission operates in gears one through five. **D** (Overdrive) can be

deactivated by pressing the transmission control switch on the end of the gearshift lever. This will illuminate the O/D OFF lamp and activate Drive.

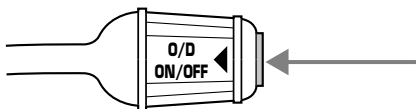

Drive (not shown)

Drive is activated when the transmission control switch is pressed.

- This position allows for all forward gears except overdrive.
- O/D OFF lamp is illuminated.
- Provides engine braking.

- Use when driving conditions cause excessive shifting from O/D to other gears. Examples: city traffic, hilly terrain, heavy loads, trailer towing and when engine braking is required.
- To return to O/D (overdrive mode), press the transmission control switch. The O/D OFF lamp will not be illuminated.
- O/D (Overdrive) is automatically returned each time the key is turned off.

2 (Second)

Use 2 (Second) to start-up on slippery roads or to provide additional engine braking on downgrades.

1 (First)

- Provides maximum engine braking.
- Allows upshifts by moving gearshift lever.
- Will not downshift into 1 (First) at high speeds; allows for 1 (First) when vehicle reaches slower speeds.

Forced downshifts

- Allowed in **D** (Overdrive) or Drive.
- Depress the accelerator to the floor.
- Allows transmission to select an appropriate gear.

MANUAL TRANSMISSION OPERATION (IF EQUIPPED)

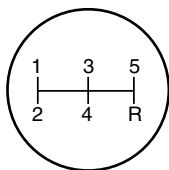

Using the clutch

The manual transmission has a starter interlock that prevents cranking the engine unless the clutch pedal is fully depressed.

To start the vehicle:

1. Make sure the parking brake is fully set.
2. Press the clutch pedal to the floor, then put the gearshift lever in the neutral position.

Driving

3. Start the engine, then press the brake pedal and release the parking brake.
4. Move the gearshift lever to the desired gear, then slowly release the clutch pedal while slowly pressing on the accelerator.

During each shift, the clutch pedal must be fully depressed to the floor. Failure to fully depress the clutch pedal to the floor may cause increased shift efforts and prematurely wear components in the transmission. Make sure the floor mat is properly positioned so it doesn't interfere with the full extension of the clutch pedal.

Do not drive with your foot resting on the clutch pedal or use the clutch pedal to hold your vehicle at a standstill while waiting on a hill. These actions will reduce the life of the clutch.

Recommended shift speeds

Downshift according to the following charts for your specific engine/drivetrain combination:

Upshifts		
Shift from:	Transfer case position (if equipped)	
	2WD and 4H	4L
1 - 2	16 km/h (10 mph)	6 km/h (4 mph)
2 - 3	26 km/h (19 mph)	10 km/h (8 mph)
3 - 4	43 km/h (28 mph)	16 km/h (12 mph)
4 - 5 (Overdrive)	68 km/h (40 mph)	26 km/h (16 mph)
Maximum downshift speeds		
Shift from:	Transfer case position (if equipped)	
	2WD and 4H	4L
5 (Overdrive) - 4	88 km/h (55 mph)	34 km/h (22 mph)
4 - 3	72 km/h (45 mph)	27 km/h (18 mph)
3 - 2	56 km/h (35 mph)	21 km/h (14 mph)
2 - 1	32 km/h (20 mph)	11 km/h (8 mph)

Reverse

1. Make sure that your vehicle is at a complete stop before you shift into R (Reverse). Failure to do so may damage the transmission.
 2. Move the gearshift lever into the neutral position and wait at least three seconds before shifting into R (Reverse).
- The gearshift lever can only be moved into R (Reverse) by moving it from left of 3 (Third) and 4 (Fourth) before shifting into R (Reverse).

This is a lockout feature that protects the transmission from accidentally being shifted into R (Reverse) from 5 (Overdrive).

Parking your vehicle

1. Apply the brake and shift into the neutral position.
2. Fully apply the parking brake, then shift into 1 (First).
3. Turn the ignition off.

WARNING: Do not park your vehicle in Neutral, it may move unexpectedly and injure someone. Use 1 (First) gear and set the parking brake fully.

Removing the key

Turn the ignition off, push the release lever (located above the ignition), then turn the key toward you and remove the key.



If your vehicle gets stuck in mud or snow

If your vehicle gets stuck in mud or snow, it may be rocked out by shifting from forward and reverse gears, stopping between shifts in a steady pattern. Press lightly on the accelerator in each gear.

Do not rock the vehicle if the engine is not at normal operating temperature or damage to the transmission may occur.

Do not rock the vehicle for more than a minute or damage to the transmission and tires may occur, or the engine may overheat.

FOUR-WHEEL DRIVE (4WD) OPERATION (IF EQUIPPED)

WARNING: For important information regarding safe operation of this type of vehicle, see Preparing to drive your vehicle in this chapter.

Four-wheel drive (4WD) supplies power to all four wheels. 4WD should not be operated on dry pavement; driveline damage may occur.

Driving

If equipped with the Electronic Shift 4WD System, and 4WD Low is selected while the vehicle is moving, the 4WD system will not engage. This is normal and should be no reason for concern. Refer to *Shifting to/from 4WD Low* for proper operation.

4WD system indicator lights

- **4x4** - Momentarily illuminates when the vehicle is started. **4x4**
Illuminates when 4H (4WD High) is engaged.
- **4x4 LOW** – Momentarily illuminates when the vehicle is started. **4x4 LOW**
Illuminates when 4L (4WD Low) is engaged.

Using the electronic shift 4WD system (if equipped)

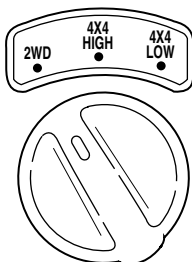

2WD - Power to the rear wheels only; used for street and highway driving.

4X4 HIGH - Used for extra traction such as in snow or icy roads or in off-road situations. Not intended for use on dry pavement.

4X4 LOW - Uses extra gearing to provide maximum power to all four wheels. Intended only for off-road applications such as deep sand, steep grades or pulling heavy objects. 4X4 LOW will not engage while the vehicle is moving; this is normal and should be no reason for concern. Refer to *Shifting to/from 4X4* for proper operation.

Shifting between 2WD and 4X4 HIGH

- Move the 4WD control between 2WD and 4X4 HIGH at any forward speed.

Note: Do not perform this operation if the rear wheels are slipping.

Shifting to/from 4X4 LOW

1. Bring the vehicle to a complete stop
 2. Depress the brake
 3. On vehicles equipped with an automatic transmission, place the transmission in N (Neutral); on vehicles equipped with a manual transmission, depress the clutch.
 4. Move the 4WD control to the desired position.
- If shifting into 4X4 LOW, wait for the 4WD LOW light in the instrument cluster to turn **on** indicating the shift is complete.
 - If shifting out of 4X4 LOW, wait for the 4WD LOW light in the instrument cluster to turn **off** indicating the shift is complete.

Driving off-road with 4WD

Your vehicle is specially equipped for driving on sand, snow, mud and rough terrain and has operating characteristics that are somewhat different from conventional vehicles, both on and off the road.

Maintain steering wheel control at all times, especially in rough terrain. Since sudden changes in terrain can result in abrupt steering wheel motion, make sure you grip the steering wheel from the outside. Do not grip the spokes.

Drive cautiously to avoid vehicle damage from concealed objects such as rocks and stumps.

You should either know the terrain or examine maps of the area before driving. Map out your route before driving in the area. For more information on driving off-road, read the “Four Wheeling” supplement in your owner’s portfolio.

If your vehicle gets stuck

If the vehicle is stuck it may be rocked out by shifting from forward and reverse gears, stopping between shifts, in a steady pattern. Press lightly on the accelerator in each gear.

Do not rock the vehicle if the engine is not at normal operating temperature or damage to the transmission may occur.

Do not rock the vehicle for more than a few minutes or damage to the transmission and tires may occur or the engine may overheat.

Driving

WARNING: Do not spin the wheels at over 56 km/h (35 mph). The tires may fail and injure a passenger or bystander.

Sand

When driving over sand, try to keep all four wheels on the most solid area of the trail. Do not reduce the tire pressures but shift to a lower gear and drive steadily through the terrain. Apply the accelerator slowly and avoid spinning the wheels.

Mud and water

If you must drive through high water, drive slowly. Traction or brake capability may be limited.

When driving through water, determine the depth; avoid water higher than the bottom of the hubs (if possible) and proceed slowly. If the ignition system gets wet, the vehicle may stall.

Once through water, always try the brakes. Wet brakes do not stop the vehicle as effectively as dry brakes. Drying can be improved by moving your vehicle slowly while applying light pressure on the brake pedal.

After driving through mud, clean off residue stuck to the driveshafts and tires. Excess mud stuck on tires and rotating driveshafts causes an imbalance that could damage drive components.

If the transmission, transfer case or front axle are submerged in water, their fluids should be checked and changed, if necessary.

Driving through deep water where the transmission vent tube is submerged may allow water into the transmission and cause internal transmission damage.

Replace rear axle lubricant any time the axle has been submerged in water. The rear axle does not normally require a lubricant change for the life of the vehicle. Rear axle lubricant quantities are not to be checked or changed unless a leak is suspected or repair is required.

Driving on hilly or sloping terrain

When driving on a hill, avoid driving crosswise or turning on steep slopes. You could lose traction and slip sideways. Drive straight up, straight down or avoid the hill completely. Know the conditions on the other side of a hill before driving over the crest.

When climbing a steep hill, start in a lower gear rather than downshifting to a lower gear from a higher gear once the ascent has started. This reduces strain on the engine and the possibility of stalling.

When descending a steep hill, avoid sudden braking. Shift to a lower gear when added engine braking is desired.

When speed control is on and you are driving uphill, your vehicle speed may drop considerably, especially if you are carrying a heavy load.

If vehicle speed drops more than 16 km/h (10 mph), the speed control will cancel automatically. Resume speed with accelerator pedal.

If speed control cancels after climbing the hill, reset speed by pressing and holding the SET ACCEL button (to resume speeds over 50 km/h [30 mph]).

Automatic transmissions may shift frequently while driving up steep grades. Eliminate frequent shifting by shifting out of **D** (Overdrive) into a lower gear.

Driving on snow and ice

A 4WD vehicle has advantages over 2WD vehicles in snow and ice but can skid like any other vehicle.

Avoid sudden applications of power and quick changes of direction on snow and ice. Apply the accelerator slowly and steadily when starting from a full stop.

When braking, apply the brakes as you normally would. In order to allow the anti-lock brake system (ABS) to operate properly, keep steady pressure on the brake pedal.

Make sure you allow sufficient distance between you and other vehicles for stopping. Drive slower than usual and consider using one of the lower gears.

DRIVING THROUGH WATER

If driving through deep or standing water is unavoidable, proceed very slowly especially if the depth is not known. Never drive through water that is higher than the bottom of the hubs (for trucks) or the bottom of the wheel rims (for cars). Traction or brake capability may be limited and your vehicle may stall. Water may also enter your engine's air intake and severely damage your engine.

Once through the water, always dry the brakes by moving your vehicle slowly while applying light pressure on the brake pedal. Wet brakes do not stop the vehicle as quickly as dry brakes. **Driving through deep water where the transmission vent tube or transfer case vent tube (4x4 vehicles only) are submerged may allow water into the transmission or transfer case and cause internal transmission/transfer case damage.**

Driving

SPECIAL LOADING INSTRUCTIONS FOR OWNERS OF PICKUP TRUCKS AND UTILITY-TYPE VEHICLES

WARNING: For important information regarding safe operation of this type of vehicle, see the Preparing to drive your vehicle section in this chapter.

WARNING: Loaded vehicles may handle differently than unloaded vehicles. Extra precautions, such as slower speeds and increased stopping distance, should be taken when driving a heavily loaded vehicle.

Your vehicle can haul more cargo and people than most passenger cars. Depending upon the type and placement of the load, hauling cargo and people may raise the center of gravity of the vehicle.

Vehicle Loading – with and without a trailer

This section will guide you in the proper loading of your vehicle and/or trailer, to keep your loaded vehicle weight within its design rating capability, with or without a trailer. Properly loading your vehicle will provide maximum return of vehicle design performance. Before loading your vehicle, familiarize yourself with the following terms for determining your vehicle's weight ratings, with or without a trailer, from the vehicle's Safety Certification Label and Tire and Load Information Label:

Base Curb Weight – is the weight of the vehicle including a full tank of fuel and all standard equipment. It does not include passengers, cargo, or optional equipment.

Vehicle Curb Weight – is the weight of your new vehicle when you picked it up from your dealer plus any aftermarket equipment.



+

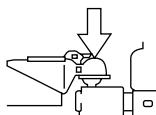

=

CARGO

Cargo Weight – includes all weight added to the Base Curb Weight, including cargo and optional equipment. When towing, trailer tongue load or king pin weight is also part of cargo weight.

GAW (Gross Axle Weight) – is the total weight placed on each axle (front and rear) – including vehicle curb weight and all payload.

GAWR (Gross Axle Weight Rating) – is the maximum allowable weight that can be carried by a single axle (front or rear). **These numbers are shown on the Safety Compliance Certification Label located on the driver's door or door pillar. The total load on each axle must never exceed its GAWR.**

WARNING: Exceeding the Safety Certification Label axle weight rating limits could result in substandard vehicle handling, performance, engine, transmission and/or structural damage, serious damage to the vehicle, loss of control and personal injury.

Note: For trailer towing information refer to *Trailer Towing* found in this chapter or the RV and Trailer Towing Guide provided by your dealership.

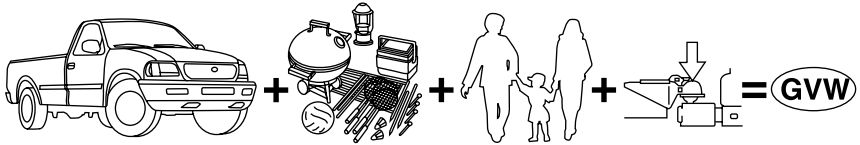

GVW (Gross Vehicle Weight) – is the Vehicle Curb Weight + cargo + passengers.

Driving

GVWR (Gross Vehicle Weight Rating) – is the maximum allowable weight of the fully loaded vehicle (including all options, equipment, passengers and cargo). **The GVWR is shown on the Safety Compliance Certification Label located on the driver’s door or door pillar. The GVW must never exceed the GVWR.**

Sample Truck Safety Compliance Certification Label
(Refer to actual label on your vehicle)

Front GAWR	GVWR	Rear GAWR					
MFD. BY FORD MOTOR CO. IN U.S.A.							
DATE: 06/95	GVWR: 6250 LB/2834 KG						
FRONT GAWR: 3450 LB 1564KG	WITH 1713KG	REAR GAWR: 3777 LB					
P265/75R15SL	TIRES P265/75R15SL	WITH TIRES					
15X7.5J	RIMS 15X7.5J	RIMS					
AT 30 PSI COLD	AT 30 PSI COLD						
THIS VEHICLE CONFORMS TO ALL APPLICABLE FEDERAL MOTOR VEHICLE SAFETY STANDARDS IN EFFECT ON THE DATE OF MANUFACTURE SHOWN ABOVE.							
XXXXXXXXXXXXXX							
VIN: 1FTEX14H 0 SKB 00000		F0018					
TYPE: XXXXXXXXXXXXXXXXX		TC183					
							
EXT PNT: XXXXXX XXXXXX							
WD	TYPE-GVW	BODY	TRANS	AXLE	TAPE	SPRINGS	DSC:
155		REM	E	HBB		M4	

WARNING: Exceeding the Safety Certification Label axle weight rating limits could result in substandard vehicle handling, performance, engine, transmission and/or structural damage, serious damage to the vehicle, loss of control and personal injury.

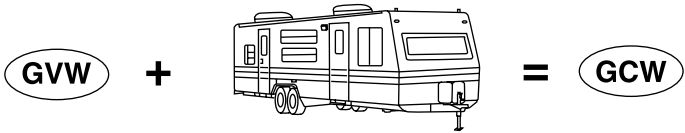

GCW (Gross Combined Weight) – is the weight of the loaded vehicle (GVW) plus the weight of the fully loaded trailer.

GCWR (Gross Combined Weight Rating) – is the maximum allowable weight of the vehicle and the loaded trailer – including all cargo and passengers – that the vehicle can handle without risking damage.

(Important: The towing vehicle’s braking system is rated for operation at GVWR, not at GCWR. Separate functional brakes should be used for safe control of towed vehicles and for trailers weighing more than 680 kg [1,500 lbs]). **The GCW must never exceed the GCWR.**

Maximum Loaded Trailer Weight – is the highest possible weight of a fully loaded trailer the vehicle can tow. It assumes a vehicle with only mandatory options, no cargo (internal or external), a tongue load of 10–15% (conventional trailer) or king pin weight of 15–25% (fifth wheel trailer), and driver only (68 kg [150 lbs]). **Consult your dealership (or the RV and Trailer Towing Guide provided by your dealership) for more detailed information.**

Tongue Load or Fifth Wheel King Pin Weight – refers to the amount of the weight that a trailer pushes down on a trailer hitch.

Examples: For a 2268 kg (5000 lbs.) conventional trailer, multiply 5000 by 0.10 and 0.15 to obtain a proper tongue load range of 227 to 340 kg (500 to 750 lbs.). For an 5216 kg (11,500 lbs.) fifth wheel trailer, multiply by 0.15 and 0.25 to obtain a proper king pin load range of 782 to 1304 kg (1,725 to 2,875 lbs.)

WARNING: Do not exceed the GVWR or the GAWR specified on the certification label.

WARNING: Do not use replacement tires with lower load carrying capacities than the originals because they may lower the vehicle's GVWR and GAWR limitations. Replacement tires with a higher limit than the originals do not increase the GVWR and GAWR limitations.

WARNING: Exceeding any vehicle weight rating limitation could result in serious damage to the vehicle and/or personal injury.

Calculating the load your vehicle can carry/tow

1. Use the appropriate maximum GCWR chart (in the *Trailer Towing* section in this chapter) for your type of engine and rear axle ratio.
2. Weigh your vehicle without cargo. To obtain correct weights, take your vehicle to a shipping company or an inspection station for trucks.
3. Subtract your loaded weight from the maximum GCWR in the chart. This is the maximum trailer weight your vehicle can tow. It must be below the maximum trailer weight shown in the chart.

Driving

TRAILER TOWING

Your vehicle may tow a class I, II or III trailer provided the maximum trailer weight is less than or equal to the maximum trailer weight listed for your engine and rear axle ratio on the following charts.

Your vehicle's load capacity is designated by weight, not by volume, so you cannot necessarily use all available space when loading a vehicle.

Towing a trailer places an additional load on your vehicle's engine, transmission, axle, brakes, tires and suspension. Inspect these components carefully after any towing operation.

4x2 w/manual transmission				
Engine	Rear axle ratio	Maximum GCWR - kg (lbs.)	Maximum trailer weight - kg (lbs.)	Maximum frontal area of trailer - m² (ft²)
Regular Cab				
2.3L	All	2,177 (4,800)	717 (1,580)	Equal to frontal area of vehicle
3.0L	3.73	2,722 (6,000)	1,207 (2,660)	4.64 (50)
3.0L Dual Sport	4.10	2,722 (6,000)	1,143 (2,520)	4.64 (50)
Cab Plus/Cab Plus 4				
2.3L	All	2,177 (4,800)	644 (1,420)	Equal to frontal area of vehicle
3.0L	3.73	2,722 (6,000)	1,125 (2,480)	4.64 (50)
3.0L Dual Sport	4.10	2,722 (6,000)	1,089 (2,400)	4.64 (50)
4.0L	All	3,175 (7,000)	1,542 (3,400)	4.64 (50)
4.0L Dual Sport	All	3,175 (7,000)	1,506 (3,320)	4.64 (50)
For high altitude operation, reduce GCW by 2% per 300 meters (1,000 ft.) elevation.				
For definition of terms used in this table see <i>Vehicle Loading</i> earlier in this chapter.				

4x2 w/manual transmission

Engine	Rear axle ratio	Maximum GCWR - kg (lbs.)	Maximum trailer weight - kg (lbs.)	Maximum frontal area of trailer - m ² (ft ²)
--------	-----------------	--------------------------	------------------------------------	---

To determine maximum trailer weight designed for your particular vehicle, see *Calculating the load your vehicle can carry/tow* earlier in this chapter.

Maximum trailer weight is shown. The combined weight of the completed towing vehicle (including hitch, passengers and cargo) and the loaded trailer must not exceed the Gross Combined Weight Rating (GCWR).

4x4 w/manual transmission

Engine	Rear axle ratio	Maximum GCWR - kg (lbs.)	Maximum trailer weight - kg (lbs)	Maximum frontal area of trailer - m ² (ft ²)
--------	-----------------	--------------------------	-----------------------------------	---

Regular Cab

3.0L	All	2,722 (6,000)	1,061 (2,340)	4.64 (50)
4.0L	All	3,175 (7,000)	1,479 (3,260)	4.64 (50)

Cab Plus/Cab Plus 4

4.0L	All	3,175 (7,000)	1,406 (3,100)	4.64 (50)
------	-----	---------------	---------------	-----------

For high altitude operation, reduce GCW by 2% per 300 meters (1,000 ft.) of elevation.

For definition of terms used in this table, see *Vehicle loading* earlier in this chapter.

To determine maximum trailer weight designed for your vehicle, see *Calculating the load your vehicle can carry/tow* earlier in this chapter.

Maximum trailer weight is shown. The combined weight of the completed towing vehicle (including hitch, passengers and cargo) and the loaded trailer must not exceed the Gross Combined Weight Rating (GCWR).

Driving

4x2 w/automatic transmission				
Engine	Rear axle ratio	Maximum GCWR - kg (lbs.)	Maximum trailer weight - kg (lbs.)	Maximum frontal area of trailer - m² (ft²)
Regular Cab				
2.3L	All	2,495 (5,500)	1,016 (2,240)	Equal to frontal area of vehicle
3.0L	3.73	2,722 (6,000)	1,188 (2,620)	4.64 (50)
3.0L Dual Sport	4.10	2,722 (6,000)	1,125 (2,480)	4.64 (50)
Cab Plus/Cab Plus 4				
3.0L	3.73	2,722 (6,000)	1,107 (2,440)	4.64 (50)
3.0L Dual Sport	4.10	2,722 (6,000)	1,070 (2,360)	4.64 (50)
4.0L	All	4,309 (9,500)	2,658 (5,860)	4.64 (50)
4.0L Dual Sport	All	4,309 (9,500)	2,604 (5,740)	4.64 (50)
For high altitude operation, reduce GCW by 2% per 300 meters (1,000 ft.) elevation.				
For definition of terms used in this table see <i>Vehicle Loading</i> earlier in this chapter.				
To determine maximum trailer weight designed for your particular vehicle, see <i>Calculating the load your vehicle can carry/tow</i> earlier in this chapter.				
Maximum trailer weight is shown. The combined weight of the completed towing vehicle (including hitch, passengers and cargo) and the loaded trailer must not exceed the Gross Combined Weight Rating (GCWR).				

4x4 w/automatic transmission

Engine	Rear axle ratio	Maximum GCWR - kg (lbs.)	Maximum trailer weight - kg (lbs.)	Maximum frontal area of trailer - m ² (ft ²)
Regular Cab				
3.0L	3.73	2,722 (6,000)	1,043 (2,300)	4.64 (50)
4.0L	All	4,309 (9,500)	2,595 (5,720)	4.64 (50)
Cab Plus/Cab Plus 4				
4.0L	All	4,309 (9,500)	2,522 (5,560)	4.64 (50)
For high altitude operation, reduce GCW by 2% per 300 meters (1,000 ft.) of elevation.				
For definition of terms used in this table, see <i>Vehicle loading</i> earlier in this chapter.				
To determine maximum trailer weight designed for your vehicle, see <i>Calculating the load your vehicle can carry/tow</i> earlier in this chapter.				
Maximum trailer weight is shown. The combined weight of the completed towing vehicle (including hitch, passengers and cargo) and the loaded trailer must not exceed the Gross Combined Weight Rating (GCWR).				

WARNING: Do not exceed the GVWR or the GAWR specified on the certification label.

The certification label is found on the driver's door latch pillar.

WARNING: Towing trailers beyond the maximum recommended gross trailer weight exceeds the limit of the vehicle and could result in engine damage, transmission damage, structural damage, loss of vehicle control, vehicle rollover and personal injury.

Preparing to tow

Use the proper equipment for towing a trailer and make sure it is properly attached to your vehicle. See your dealer or a reliable trailer dealer if you require assistance.

Driving

Hitches

For towing trailers up to 907 kg (2,000 lb), use a weight carrying hitch and ball which uniformly distributes the trailer tongue loads through the underbody structure. Use a frame-mounted weight distributing hitch for trailers over 907 kg (2,000 lb).

Do not install a single or multi-clamp type bumper hitch, or a hitch which attaches to the axle. Underbody mounted hitches are acceptable if they are installed properly. Follow the towing instructions of a reputable rental agency.

Whenever a trailer hitch and hardware are removed, make sure all mounting holes in the underbody are properly sealed to prevent noxious gases or water from entering.

Safety chains

Always connect the trailer's safety chains to the frame or hook retainers of the vehicle hitch. To connect the trailer's safety chains, cross the chains under the trailer tongue and allow slack for turning corners.

If you use a rental trailer, follow the instructions that the rental agency gives to you.

Do not attach safety chains to the bumper.

Trailer brakes

Electric brakes and manual, automatic or surge-type trailer brakes are safe if installed properly and adjusted to the manufacturer's specifications. The trailer brakes must meet local and Federal regulations.

WARNING: Do not connect a trailer's hydraulic brake system directly to your vehicle's brake system. Your vehicle may not have enough braking power and your chances of having a collision greatly increase.

The braking system of the tow vehicle is rated for operation at the GVWR not GCWR.

Trailer lamps

Trailer lamps are required on most towed vehicles. Make sure all running lights, brake lights, turn signals and hazard lights are working. See your dealer or trailer rental agency for proper instructions and equipment for hooking up trailer lamps.

Using a step bumper

The optional step bumper is equipped with an integral hitch and requires only a ball with a 19 mm (3/4 inch) shank diameter. The bumper has a 907 kg (2,000 lb.) trailer weight and 91 kg (200 lb.) tongue weight capability.

The rated capacities (as shown in this guide) for trailer towing with the factory bumper are only valid when the trailer hitch ball is installed directly into the ball hole in the bumper. Addition of bracketry to either lower the ball hitch position or extend the ball hitch rearward will significantly increase the loads on the bumper and its attachments. This can result in the failure of the bumper or the bumper attachments. Use of any type of hitch extensions should be considered abuse.

Trailer tow connector

The trailer tow connector is located under the rear bumper, on the driver's side of the vehicle.

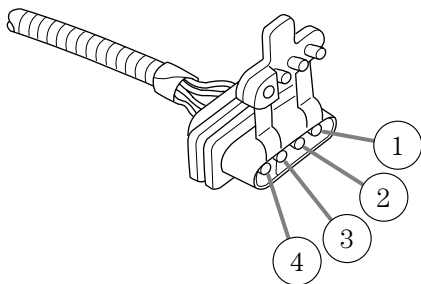

Refer to the following chart for information regarding the factory-equipped trailer tow connector:

Trailer tow connector		
Color	Function	Comment
1. Dark Green	Trailer right-hand turn signal	Circuit activated when brake pedal is depressed or when ignition is on and right-hand turn signal is applied.
2. Yellow	Trailer left-hand turn signal	Circuit activated when brake pedal is depressed or when ignition is on and left-hand turn signal is applied.

Driving

Trailer tow connector		
Color	Function	Comment
3. Tan/White	Tail lamp	Relay controlled circuit activated when the park lamps/headlamps are on.
4. White	Ground	Matching vehicle circuit returns to battery's negative ground.

Driving while you tow

When towing a trailer:

- Turn off the speed control. The speed control may shut off automatically when you are towing on long, steep grades.
- Consult your local motor vehicle speed regulations for towing a trailer.
- To eliminate excessive shifting, use a lower gear. This will also assist in transmission cooling. (For additional information, refer to the *Driving with a 5-speed automatic transmission* section in this chapter.)
- Under extreme conditions with large frontal trailers, high outside temperatures and highway speeds, the coolant gauge may indicate higher than normal coolant temperatures. If this occurs, reduce speed until the coolant temperature returns to the normal range. Refer to *Engine coolant temperature gauge* in the *Instrument cluster* chapter.
- Anticipate stops and brake gradually.
- Do not exceed the GCWR rating or transmission damage may occur.

Servicing after towing

If you tow a trailer for long distances, your vehicle will require more frequent service intervals. Refer to your service maintenance section for more information.

Trailer towing tips

- Practice turning, stopping and backing up before starting on a trip to get the feel of the vehicle trailer combination. When turning, make wider turns so the trailer wheels will clear curbs and other obstacles.
- Allow more distance for stopping with a trailer attached.
- The trailer tongue weight should be 10–15% of the loaded trailer weight.

- After you have traveled 80 km (50 miles), thoroughly check your hitch, electrical connections and trailer wheel lug nuts.
- To aid in engine/transmission cooling and A/C efficiency during hot weather while stopped in traffic, place the gearshift lever in P (Park) (automatic transmission) or N (Neutral) (manual transmissions).
- Vehicles with trailers should not be parked on a grade. If you must park on a grade, place wheel chocks under the trailer's wheels.

Launching or retrieving a boat

Disconnect the wiring to the trailer before backing the trailer into the water. Reconnect the wiring to the trailer after the trailer is removed from the water.

When backing down a ramp during boat launching or retrieval:

- do not allow the static water level to rise above the bottom edge of the rear bumper.
- do not allow waves to break higher than 15 cm (6 inches) above the bottom edge of the rear bumper.

Exceeding these limits may allow water to enter vehicle components:

- causing internal damage to the components.
- affecting driveability, emissions and reliability.

Replace the rear axle lubricant any time the axle has been submerged in water. Rear axle lubricant quantities are not to be checked or changed unless a leak is suspected or repair required.

RECREATIONAL TOWING

Follow these guidelines if you have a need for recreational towing. An example of recreational towing would be towing your vehicle behind a motorhome. These guidelines are designed to ensure that your transmission is not damaged.

4x2 equipped with a manual transmission:

Before you have your vehicle towed:

- Release the parking brake.
- Move the gearshift to the neutral position.
- Turn the key in the ignition to the OFF/UNLOCKED position.
- The maximum recommended speed is 88 km/h (55 mph).
- The maximum recommended distance is unlimited.

Driving

- The vehicle must be towed in the forward position to ensure no damage is done to the internal transfer case components.

In addition, it is recommended that you follow the instructions provided by the aftermarket manufacturer of the towing apparatus if one has been installed.

4x2 equipped with automatic transmission and 4x4 vehicles:

4x2 vehicles with automatic transmissions or 4x4 vehicles with an electronic-shift transfer case and automatic transmission, follow these guidelines for recreational towing:

- Release the parking brake.
- Turn the key in the ignition to the OFF/UNLOCKED position.
- Place the transmission in N (Neutral).
- Do not exceed a distance of 80 km (50 miles).
- Do not exceed 56 km/h (35 mph) vehicle speed.
- The vehicle must be towed in the forward position to ensure no damage is done to the internal transfer case components.

If a distance of 80 km (50 miles) or a speed of 56 km/h (35 mph) must be exceeded, you must disconnect the front (4x4 only) and rear driveshafts. Mazda recommends the driveshafts be removed/installed only by a qualified technician. See your local dealer for driveshaft removal/installation.

Improper removal/installation of the driveshaft can cause transmission fluid or transfer case fluid loss, damage to the driveshaft and internal transmission and transfer case components.

CAMPER BODIES

Your pickup is not recommended for slide-in camper bodies.

HAZARD FLASHER

The hazard flasher is located on the steering column, just behind the steering wheel. The hazard flashers will operate when the ignition is in any position or if the key is not in the ignition.

Push in the flasher control and all front and rear direction signals will flash. Press the flasher control again to turn them off. Use it when your vehicle is disabled and is creating a safety hazard for other motorists.

Note: With extended use, the flasher may run down your battery.

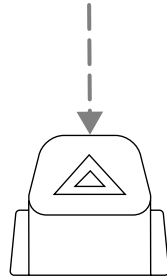

FUEL PUMP SHUT-OFF SWITCH

This device stops the electric fuel pump from sending fuel to the engine when your vehicle has had a substantial jolt.

After an accident, if the engine cranks but does not start, this switch may have been activated.

Roadside Emergencies

This switch is located under the right-hand side of the glove box, just above the carpet.

To reset the switch:

1. Turn the ignition OFF.
2. Check the fuel system for leaks.
3. If no leaks are apparent, reset the switch by pushing in on the reset button.
4. Turn the ignition ON.
5. Wait a few seconds and return the key to OFF.
6. Make another check of leaks.

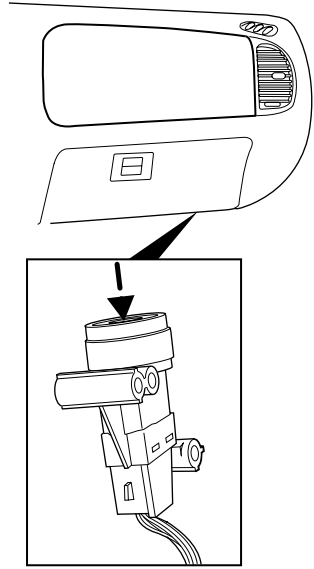

FUSES AND RELAYS

Fuses

If electrical components in the vehicle are not working, a fuse may have blown. Blown fuses are identified by a broken wire within the fuse. Check the appropriate fuses before replacing any electrical components.

Note: Always replace a fuse with one that has the specified amperage rating. Using a fuse with a higher amperage rating can cause severe wire damage and could start a fire.

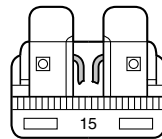

Roadside Emergencies

Standard fuse amperage rating and color

COLOR					
Fuse rating	Mini fuses	Standard fuses	Maxi fuses	Cartridge maxi fuses	Fuse link cartridge
2A	Grey	Grey	—	—	—
3A	Violet	Violet	—	—	—
4A	Pink	Pink	—	—	—
5A	Tan	Tan	—	—	—
7.5A	Brown	Brown	—	—	—
10A	Red	Red	—	—	—
15A	Blue	Blue	—	—	—
20A	Yellow	Yellow	Yellow	Blue	Blue
25A	Natural	Natural	—	—	—
30A	Green	Green	Green	Pink	Pink
40A	—	—	Orange	Green	Green
50A	—	—	Red	Red	Red
60A	—	—	Blue	—	Yellow
70A	—	—	Tan	—	Brown
80A	—	—	Natural	—	Black

Passenger compartment fuse panel

The fuse panel is located under the right-hand side of the instrument panel behind the kick panel.

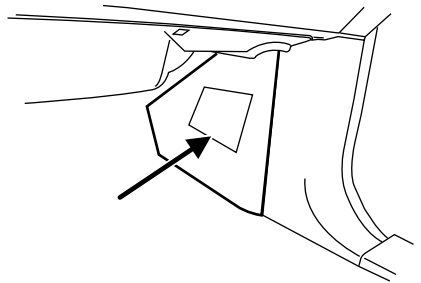

Roadside Emergencies

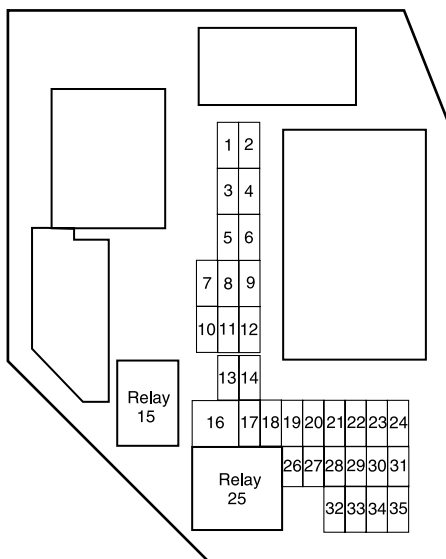

The fuses are coded as follows:

Fuse/Relay Location	Fuse Amp Rating	Passenger Compartment Fuse Panel Description
1	5A	Instrument panel dimmer switch
2	10A	Trailer tow park lamps
3	10A	Right low beam headlamp
4	10A	Left low beam headlamp
5	30A	Windshield wipers/washer
6	10A	Radio (RUN/ACCY)
7	5A	Headlamp illumination indicator
8	10A	Restraints Control Module (RCM), PADI (Passenger Air bag Deactivation Indicator)
9	5A	Cluster air bag indicator
10	10A	Cluster (RUN/START), 4x4 module (RUN/START)

Roadside Emergencies

Fuse/Relay Location	Fuse Amp Rating	Passenger Compartment Fuse Panel Description
11	10A	Passenger compartment fuse panel (Logic power)
12	—	Not used
13	15A	Horn, Interior lamps
14	15A	High beam headlamp, High beam indicator (cluster)
15	—	One-touch down relay
16	30A cartridge fuse	Power windows
17	15A	Turn signals/Hazards
18	—	Not used
19	20A	Center High-Mounted Stop Lamp (CHMSL)/Stop lamps
20	10A	Anti-lock Brake System (ABS) module, Brake-shift interlock, Speed control module, Back-up lamps, Overdrive cancel switch, Electronic flasher (turn/hazard)
21	5A	Starter relay
22	5A	Spare
23	30A	Headlamps (low and high beam)
24	20A	Radio
25	—	Accessory relay
26	2A	Brake pressure switch
27	10A	Climate control blower relay/blend doors, 4x4 module
28	15A	4x4 module B+
29	20A	Cigar lighter, Diagnostic connector (OBD II)
30	5A	Power mirrors
31	20A	Front park lamps, Rear park lamps, License plate lamps

Roadside Emergencies

Fuse/Relay Location	Fuse Amp Rating	Passenger Compartment Fuse Panel Description
32	5A	Brake switch (logic)
33	5A	Instrument cluster
34	20A	Power point
35	15A	Power locks

Power distribution box

The power distribution box is located in the engine compartment. The power distribution box contains high-current fuses that protect your vehicle's main electrical systems from overloads.

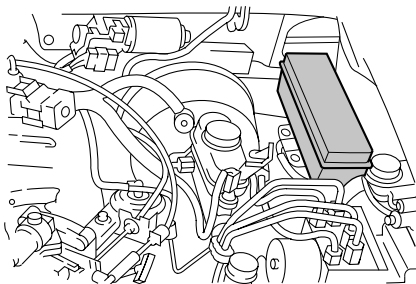

WARNING: Always disconnect the battery before servicing fuses.

WARNING: To reduce risk of electrical shock, always replace the cover to the Power Distribution Box before reconnecting the battery or refilling fluid reservoirs.

If the battery has been disconnected and reconnected, refer to the *Battery* section of the *Maintenance and specifications* chapter.

Roadside Emergencies

2.3L engine (if equipped)

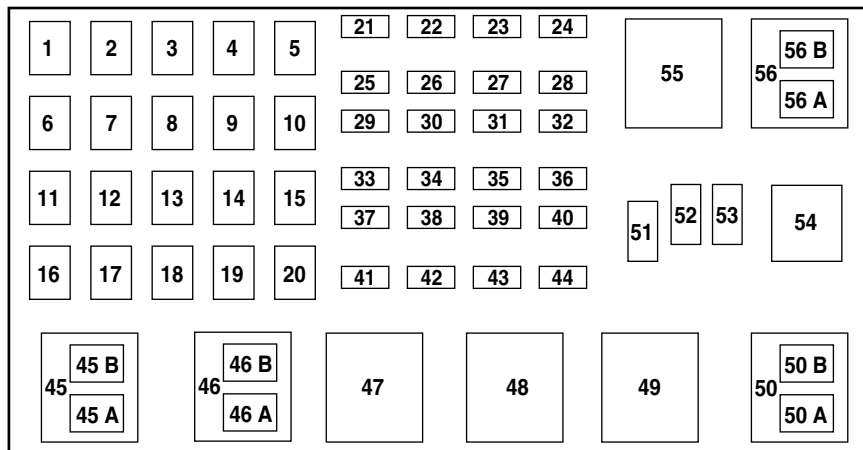

The high-current fuses are coded as follows:

Fuse/Relay Location	Fuse Amp Rating	Power Distribution Box Description
1	50A**	Passenger compartment fuse panel
2	—	Not used
3	50A**	Passenger compartment fuse panel
4	—	Not used
5	50A**	Passenger compartment fuse panel
6	—	Not used
7	40A**	Starter relay fuse
8	—	Not used
9	40A**	Ignition switch
10	—	Not used
11	30A**	Powertrain Control Module (PCM), Engine sensors

Roadside Emergencies

Fuse/Relay Location	Fuse Amp Rating	Power Distribution Box Description
12	—	Not used
13	30A**	Blower motor (climate control)
14	—	Not used
15	30A**	Anti-lock Brake System (ABS) (solenoids)
16	—	Not used
17	40A**	ABS (motor)
18	—	Not used
19	20A**	Engine fan
20	—	Not used
21	10A*	PCM
22	—	Not used
23	20A*	Fuel pump
24	—	Not used
25	10A*	A/C clutch solenoid
26	—	Not used
27	—	Not used
28	—	Not used
29	—	Not used
30	—	Not used
31	—	Not used
32	—	Not used
33	—	Not used
34	—	Not used
35	—	Not used
36	—	Not used
37	—	Not used
38	7.5A*	Trailer tow (right turn)
39	—	Not used
40	—	Not used
41	15A*	HEGOs

Roadside Emergencies

Fuse/Relay Location	Fuse Amp Rating	Power Distribution Box Description
42	7.5A*	Trailer tow (left turn)
43	—	Not used
44	—	Not used
45A	—	Wiper HI/LO relay
45B	—	Wiper Park/Run relay
46A	—	Fuel pump relay
46B	—	Washer pump relay
47	—	Engine fan relay
48	—	Starter relay
49	—	Not used
50	—	Not used
51	—	Not used
52	—	Not used
53	—	Not used
54	—	PCM relay
55	—	Blower relay
56A	—	A/C clutch solenoid relay
56B	—	Not used
* Mini Fuses ** Maxi Fuses		

Roadside Emergencies

3.0L and 4.0L engines (if equipped)

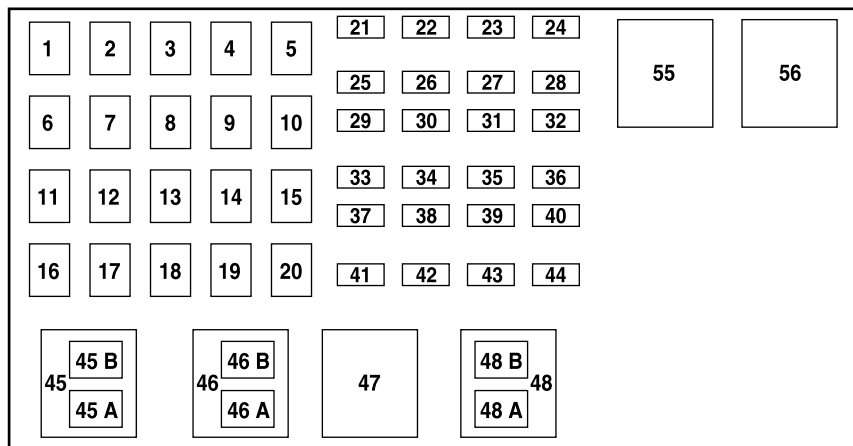

The high-current fuses are coded as follows:

Fuse/Relay Location	Fuse Amp Rating	Power Distribution Box Description
1	50A**	Passenger compartment fuse panel
2	—	Not used
3	50A**	Passenger compartment fuse panel
4	—	Not used
5	50A**	Passenger compartment fuse panel
6	—	Not used
7	40A**	Starter relay fuse
8	—	Not used
9	40A**	Ignition switch
10	—	Not used
11	30A**	Powertrain Control Module (PCM) relay fuse

Roadside Emergencies

Fuse/Relay Location	Fuse Amp Rating	Power Distribution Box Description
12	—	Not used
13	30A**	Blower motor (climate control)
14	—	Not used
15	30A**	Anti-lock Brake System (ABS) (solenoids)
16	—	Not used
17	40A**	ABS (motor)
18	—	Not used
19	—	Not used
20	—	Not used
21	10A*	PCM
22	—	Not used
23	20A*	Fuel pump
24	—	Not used
25	10A*	A/C clutch solenoid
26	—	Not used
27	20A*	4x4 module
28	—	Not used
29	—	Not used
30	—	Not used
31	15A*	Fog lamps
32	—	Not used
33	—	Not used
34	—	Not used
35	—	Not used
36	—	Not used
37	—	Not used
38	7.5A*	Trailer tow (right turn)
39	—	Not used
40	—	Not used
41	15A*	HEGOs

Roadside Emergencies

Fuse/Relay Location	Fuse Amp Rating	Power Distribution Box Description
42	7.5A*	Trailer tow (left turn)
43	—	Not used
44	—	Not used
45A	—	Wiper HI/LO relay
45B	—	Wiper Park/Run relay
46A	—	A/C clutch solenoid
46B	—	Washer pump relay
47	—	PCM relay
48A	—	Fuel pump relay
48B	—	Fog lamp relay
51	—	Not used
52	—	Not used
53	—	Not used
54	—	Not used
55	—	Blower relay
56	—	Starter relay

* Mini Fuses ** Maxi Fuses

OVERHEATING

If the temperature gauge indicates overheating and you experience power loss, you hear a loud knocking or pinging noise, the engine is probably too hot.

If this happens:

1. Drive safely to the side of the road and park off the right-of-way.
2. Shift the automatic transmission into P (Park) or the manual transmission into the neutral position, and apply the parking brake.
3. Turn off the air conditioner.

WARNING: Steam from an overheated engine is dangerous. The escaping steam could seriously burn you. Open the hood ONLY after steam is no longer escaping from the engine.

4. Check whether coolant or steam is escaping from under the hood or from the engine compartment.

Roadside Emergencies

- **If steam is coming from the engine compartment:** do not go near the front of the vehicle. Stop the engine, then turn the ignition switch to the ON position without starting the engine. The radiator cooling fans will start to cool the engine.
 - **If neither coolant nor steam is escaping:** open the hood and idle the engine until it cools. If this does not lower the temperature, stop the engine and let it cool.
5. Check the coolant level. If it is low, look for leaks in the radiator hoses and connections, heater hoses and connections, radiator and water pump.

If you find a leak or other damage, or if coolant is still leaking, stop the engine and call an Authorized Mazda dealer.

See *Adding coolant* in the *Maintenance and specifications* section. If you find no problems, the engine is cool and no leaks are obvious, carefully add coolant as required.

WARNING: When the engine and radiator are hot, scalding coolant and steam may shoot out under pressure and cause serious injury. Do not remove the cooling system cap when the engine and radiator are hot.

Note: If the engine continues to overheat or frequently overheats, have the cooling system inspected. The engine could be seriously damaged unless repairs are made.

CHANGING THE TIRES

If you get a flat tire while driving, do not apply the brake heavily. Instead, gradually decrease your speed. Hold the steering wheel firmly and slowly move to a safe place on the side of the road.

WARNING: The use of tire sealants is not recommended and may damage your tires.

Temporary spare tire information (if equipped)

Your vehicle may be equipped with a conventional spare tire that may be different in size (smaller diameter and narrower width) than other tires on your vehicle. If this is the case, your spare tire is considered “temporary” and the spare wheel will be labeled as such. Replace this tire with a tire of the same size, speed rating and load carrying capacity as the other road tires as soon as possible.

Roadside Emergencies

It is not recommended that the vehicle be operated in 4WD modes with a “temporary” (i.e. dissimilar size) spare. If 4WD operation is necessary, do not operate above speeds of 16 km/h (10 mph) or for distances above 80 km (50 miles).

WARNING: If you use the temporary spare tire continuously or do not follow these precautions, the tire could fail, causing you to lose control of the vehicle, possibly injuring yourself or others.

When driving with the temporary spare tire **do not:**

- exceed 80 km/h (50 mph) or drive further than 3,200 km (2,000 miles) total under any circumstances
- load the vehicle beyond maximum vehicle load rating listed on the Safety Compliance Label
- tow a trailer
- use more than one temporary spare tire at a time

Use of a temporary spare tire at any one wheel location can lead to impairment of the following:

- Handling, stability and braking performance
- Comfort and noise
- Ground clearance and parking at curbs
- Winter driving capability

Conventional spare tire information (if equipped)

If you have the conventional spare tire, you can use it as a spare or a regular tire. The spare is identical to the other tires on your vehicle, although the wheel may not match.

Location of the spare tire and tools

The spare tire and tools for your vehicle are stowed in the following locations:

Roadside Emergencies

Tool	Location
Spare tire	Under the vehicle, just forward of the rear bumper
Jack, jack handle, wheel nut wrench	Regular Cab: behind seats and underneath the jack and tools cover
	Cab Plus: stowed in the passenger side rear cab compartment or behind the jump seat in a separate tool bag
	Cab Plus 4-Door: stowed behind the front seats, between jump seats and underneath jack and tools cover.
Key, spare tire lock (if equipped)	In the glove box

Removing the spare tire

1. Assemble the jack handle to the lug wrench as shown in the illustrations.

When connecting the jack handle, assemble the following:

- one handle extension and one typical extension. To assemble, slide parts together. To disconnect, depress button and pull apart.
- one wheel nut wrench. Depress button and slide together.

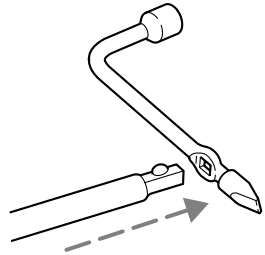
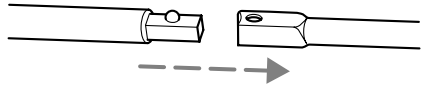

Roadside Emergencies

2. If equipped, unlock and remove the spare tire carrier lock from the rear access hole located just above the rear bumper and below the tailgate.

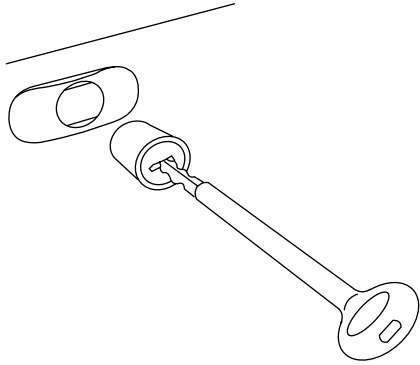

3. Insert the straight end of the jack handle into the rear access hole located just above the rear bumper and below the tailgate.

Forward motion will stop and resistance to turning will be felt when properly engaged.

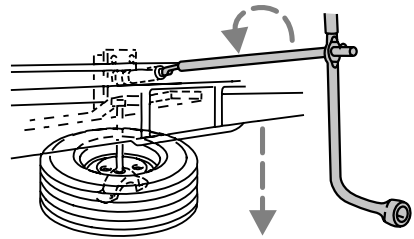

4. Turn the handle counterclockwise until tire is lowered to the ground and the cable is slightly slack.
5. Remove the retainer from the spare tire.

Stowing the spare tire

1. Lay the tire on the ground with the valve stem facing up.
2. Install the retainer through the wheel center and slide the wheel under the vehicle.
3. Turn the spare handle clockwise until the tire is raised to its original position underneath the vehicle. The spare handle ratchets when the tire is raised to the stowed position. It will not allow you to overtighten.

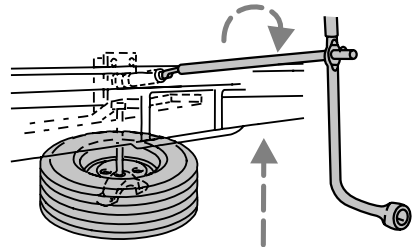

Roadside Emergencies

4. If your vehicle is equipped with P265/75 R15 AT tires, do not stow a flat or inflated full size spare tire in the spare tire carrier. The flat full size tire should be stowed and tied down in the pickup box bed until it can be repaired.
5. If removed, install the spare tire carrier lock on the access hole above the bumper.

Tire change procedure

WARNING: When one of the front wheels is off the ground, the transmission alone will not prevent the vehicle from moving or slipping off the jack, even if the vehicle is in P (Park) (automatic transmission) or R (Reverse) (manual transmission).

WARNING: To help prevent the vehicle from moving when you change a tire, be sure the parking brake is set, then block (in both directions) the wheel that is diagonally opposite (other side and end of the vehicle) to the tire being changed.

WARNING: If the vehicle slips off the jack, you or someone else could be seriously injured.

1. Park on a level surface, activate hazard flashers and place gearshift lever in P (Park) (automatic transmission) or 1 (First) (manual transmission).
2. Set the parking brake and turn engine OFF.

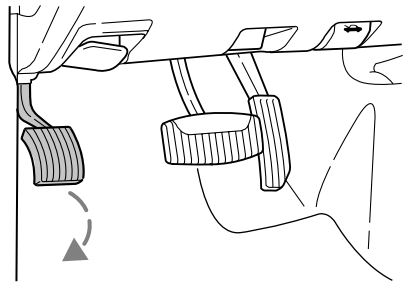

Roadside Emergencies

3. Block the diagonally opposite wheel.

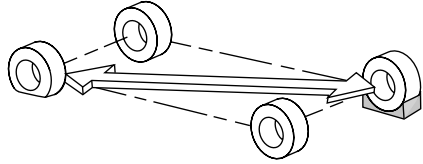

4. Insert tapered end of the lug wrench behind hub caps and twist them off.
5. Loosen each wheel lug nut one-half turn counterclockwise but do not remove them until the wheel is raised off the ground.
6. Position the jack according to the following guides and turn the jack handle clockwise until the tire is a maximum of 25 mm (1 inch) off the ground.

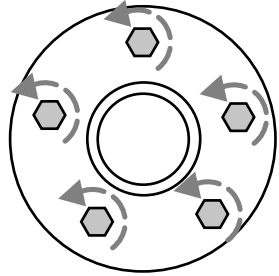

WARNING: To lessen the risk of personal injury, do not put any part of your body under the vehicle while changing a tire. Do not start the engine when your vehicle is on the jack. The jack is only meant for changing the tire.

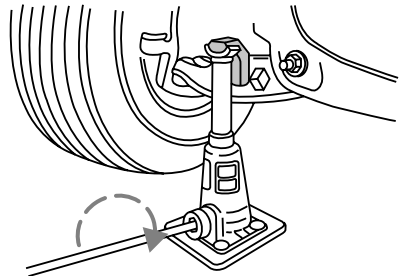

- Front

Roadside Emergencies

- Rear

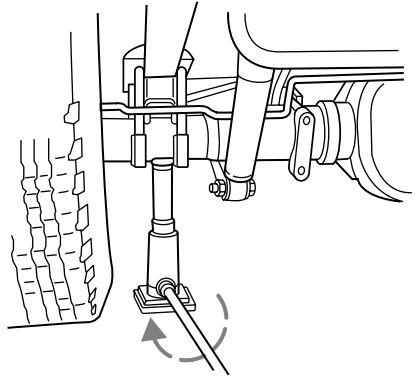

Never use the differential as a jacking point. It is too easy for the vehicle to tilt or fall and you can be injured.

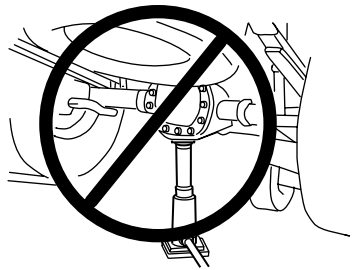

7. Remove the wheel lug nuts with the lug wrench.
8. Replace the flat tire with the spare tire, making sure the valve stem is facing outward. Reinstall the lug nuts until the wheel is snug against the hub. Do not fully tighten the lug nuts until the wheel has been lowered.
9. Lower the wheel by turning the jack handle counterclockwise.
10. Remove the jack and fully tighten the lug nuts, in the order shown, to 135 Nm (100 lb-ft). Note that these tightening specifications are for nut and bolt threads that are free of dirt and rust. Use only Mazda recommended (1/2–20) replacement fasteners.
11. Stow the flat tire. Refer to *Stowing the spare tire*.
12. Stow the jack and lug wrench. Make sure the jack is fastened so it does not rattle when you drive.

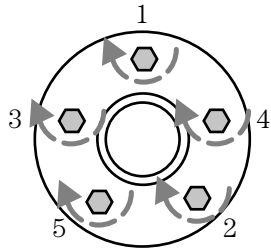

Roadside Emergencies

13. Unblock the wheels.

Stowing the flat/spare tire

Note: Failure to follow spare tire stowage instructions may result in failure of cable or loss of spare tire.

1. Lay the tire on the ground with the valve stem facing up.
2. Slide the wheel partially under the vehicle and install the wire and retainer through the center of the wheel.
3. Turn the jack handle clockwise until the tire is raised to its original position underneath the vehicle. The effort to turn the jack handle increases significantly as the tire contacts the frame. The spare tire carrier will ratchet when the tire is in the fully stowed position. The spare tire carrier has a built-in ratchet feature that will not allow you to overtighten. If the spare tire carrier ratchets with very little effort, take the vehicle to your dealer for assistance at your earliest convenience.
4. Check that the tire lies flat against the frame assembly. Push against the tire to make sure it is tightly sealed under the vehicle. Loosen and retighten, if necessary. Failure to properly stow the spare tire may result in failure of the winch cable and loss of the spare tire.
5. Repeat this tightness check procedure when servicing the spare tire pressure (every six months, per service maintenance section), or at any time that the spare tire is disturbed through service of other components.
6. Install the spare tire lock (if equipped) into the access hole above the rear bumper with the spare tire lock key (if equipped) and jack handle.

Wheel lug nut torque specifications

Retighten the lug nuts to the specified torque at 800 km (500 miles) after any wheel disturbance (rotation, flat tire, wheel removal, etc.).

Bolt size	Wheel lug nut torque*	
	Nm	Lb-ft
½ x 20	113-153	84-114

* Torque specifications are for nut and bolt threads free of dirt and rust. Use only Mazda recommended replacement fasteners.

Roadside Emergencies

WARNING: When a wheel is installed, always remove any corrosion, dirt or foreign materials present on the mounting surfaces of the wheel or the surface of the front disc brake hub and rotor that contacts the wheel. Installing wheels without correct metal-to-metal contact at the wheel mounting surfaces can cause the wheel nuts to loosen and the wheel to come off while the vehicle is in motion, resulting in loss of control.

JUMP STARTING YOUR VEHICLE

WARNING: The gases around the battery can explode if exposed to flames, sparks, or lit cigarettes. An explosion could result in injury or vehicle damage.

WARNING: Batteries contain sulfuric acid which can burn skin, eyes and clothing, if contacted.

Do not attempt to push-start your vehicle. Automatic transmissions do not have push-start capability; doing so may damage the catalytic converter.

Preparing your vehicle

When the battery is disconnected or a new battery is installed, the transmission must relearn its shift strategy. As a result, the transmission may have firm and/or soft shifts. This operation is considered normal and will not affect function or durability of the transmission. Over time, the adaptive learning process will fully update transmission operation.

1. **Use only a 12-volt supply to start your vehicle.**
2. Do not disconnect the battery of the disabled vehicle as this could damage the vehicle's electrical system.
3. Park the booster vehicle close to the hood of the disabled vehicle making sure the two vehicles **do not** touch. Set the parking brake on both vehicles and stay clear of the engine cooling fan and other moving parts.
4. Check all battery terminals and remove any excessive corrosion before you attach the battery cables. Ensure that vent caps are tight and level.
5. Turn the heater fan on in both vehicles to protect any electrical surges. Turn all other accessories off.

Roadside Emergencies

Connecting the jumper cables

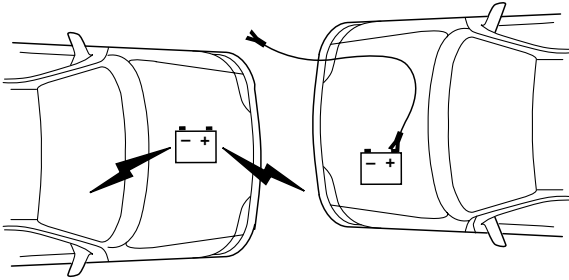

1. Connect the positive (+) jumper cable to the positive (+) terminal of the discharged battery.

Note: In the illustrations, *lightning bolts* are used to designate the assisting (boosting) battery.

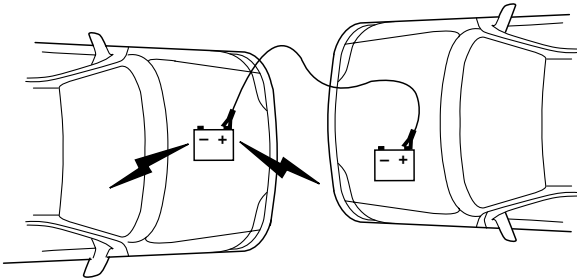

2. Connect the other end of the positive (+) cable to the positive (+) terminal of the assisting battery.

Roadside Emergencies

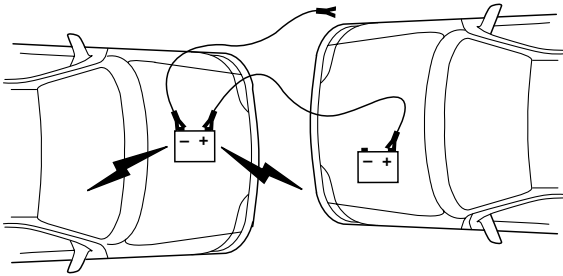

3. Connect the negative (-) cable to the negative (-) terminal of the assisting battery.

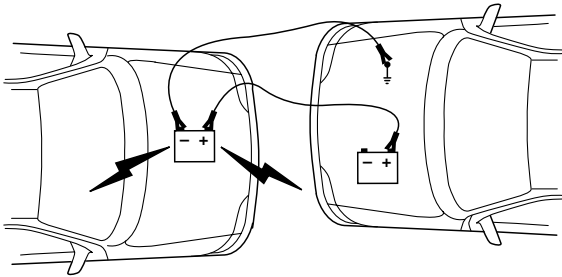

4. Make the final connection of the negative (-) cable to an exposed metal part of the stalled vehicle's engine, away from the battery and the fuel injection system. **Do not** use fuel lines, engine rocker covers or the intake manifold as *grounding* points.

WARNING: Do not connect the end of the second cable to the negative (-) terminal of the battery to be jumped. A spark may cause an explosion of the gases that surround the battery.

5. Ensure that the cables are clear of fan blades, belts, moving parts of both engines, or any fuel delivery system parts.

Roadside Emergencies

Jump starting

1. Start the engine of the booster vehicle and run the engine at moderately increased speed.
2. Start the engine of the disabled vehicle.
3. Once the disabled vehicle has been started, run both engines for an additional three minutes before disconnecting the jumper cables.

Removing the jumper cables

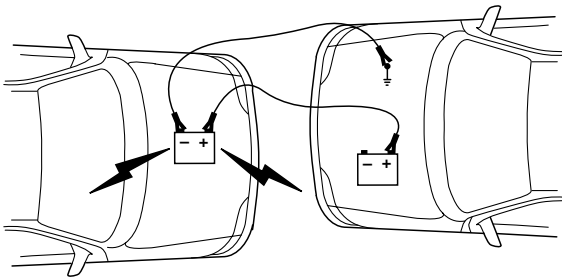

Remove the jumper cables in the reverse order that they were connected.

1. Remove the jumper cable from the *ground* metal surface.

Note: In the illustrations, *lightning bolts* are used to designate the assisting (boosting) battery.

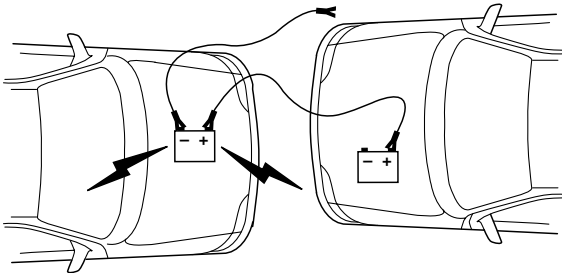

2. Remove the jumper cable on the negative (-) connection of the booster vehicle's battery.

Roadside Emergencies

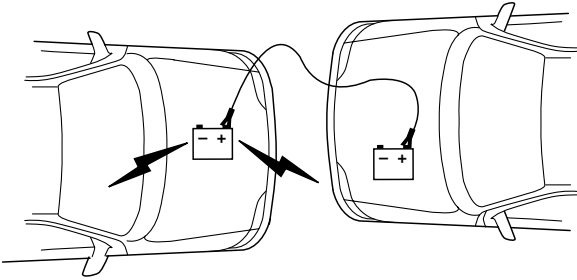

3. Remove the jumper cable from the positive (+) terminal of the booster vehicle's battery.

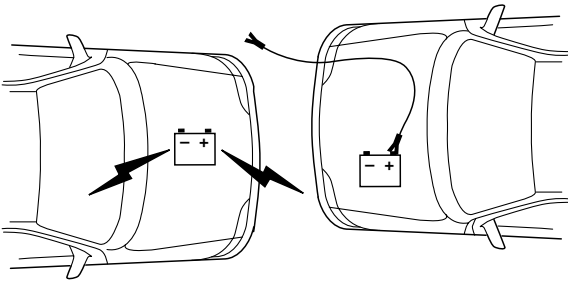

4. Remove the jumper cable from the positive (+) terminal of the disabled vehicle's battery.

After the disabled vehicle has been started and the jumper cables removed, allow it to idle for several minutes so the engine computer can *relearn* its idle conditions.

Roadside Emergencies

WRECKER TOWING

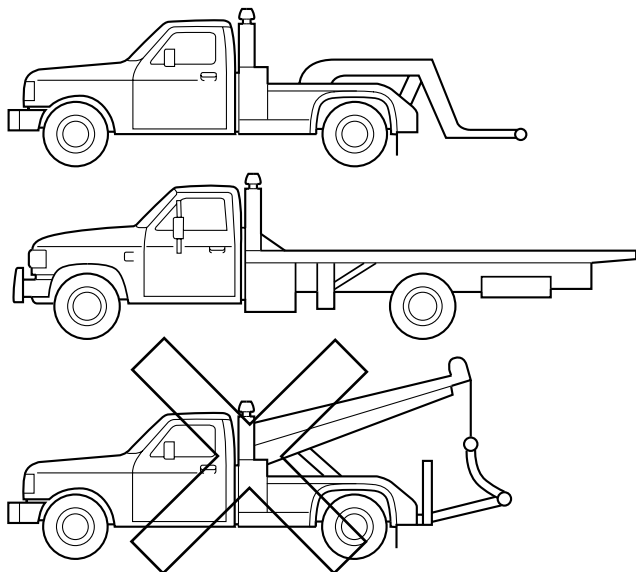

If you need to have your vehicle towed, contact a professional towing service or, if you are a member of a roadside assistance program, your roadside assistance service provider.

It is recommended that your vehicle be towed with a wheel lift or flatbed equipment. Do not tow with a slingbelt. Mazda has not approved a slingbelt towing procedure.

On 4x2 vehicles, it is acceptable to tow the vehicle with the front wheels on the ground and the rear wheels off the ground.

On 4x4 vehicles, it is recommended that your vehicle be towed with a wheel lift and dollies or flatbed equipment with all the wheels off the ground.

If the vehicle is towed by other means or incorrectly, vehicle damage may occur.

CUSTOMER ASSISTANCE (U.S.A.)

Your complete and permanent satisfaction is our business. We are here to serve you. All Authorized Mazda Dealers have the knowledge and the tools to keep your Mazda vehicle in top condition.

If you have any questions or recommendations for improvement regarding the service of your Mazda vehicle or servicing by Mazda Dealer personnel, we recommend that you take the following steps:

STEP 1: Contact Your Mazda Dealer

Discuss the matter with an Authorized Mazda Dealer. This is the quickest and best way to address the issue. If your concern has not been resolved by the CUSTOMER RELATIONS, SALES, SERVICE, or PARTS MANAGER, then please contact the GENERAL MANAGER of the dealership or the OWNER.

STEP 2: Contact Mazda North American Operations

If for any reason you feel the need for further assistance after contacting your dealership management, you can reach Mazda North American Operations by one of the following ways.

Log on at: www.mazdausa.com

Answers to many questions, including how to locate or contact a local Mazda Dealership in the U.S., can be found here.

By phone at: 1 (800) 222-5500

By letter at:

Attn: Customer Assistance
Mazda North American Operations
7755 Irvine Center Drive
Irvine, CA 92618-2922
P.O. Box 19734
Irvine, CA 92623-9734

Whatever way you contact us, please help us to serve you more efficiently and effectively by providing the following information:

1. Your name, address, and telephone number
2. Year and model of vehicle
3. Vehicle Identification Number (17 digits, noted on your registration or title or located on the upper driver's side corner of the dash)
4. Purchase date and current mileage
5. Your dealer's name and location
6. Your question(s)

Customer Assistance

If you live outside the U.S.A., please contact your nearest Mazda Distributor.

CUSTOMER ASSISTANCE (CANADA)

Your complete and permanent satisfaction is our business. We are here to serve you. All Authorized Mazda Dealers have the knowledge and the tools to keep your Mazda vehicle in top condition.

In our experience, any questions, problems or complaints regarding the operation of your Mazda or any other general service transactions are most effectively resolved by your dealer. If the cause of your dissatisfaction cannot adequately be addressed by normal dealership procedures, we recommend that you take the following steps:

STEP 1: Contact Your Mazda Dealer

Discuss the matter with a member of dealership management. If the Service Manager has already reviewed your concerns, contact the owner of the dealership or its General Manager

STEP 2: Call the Mazda Regional Office

If you feel that you still require assistance, ask the dealer Service Manager to arrange for you to meet the local Mazda Service Representative. If more expedient, contact Mazda Canada Inc. Regional Office nearest you for such arrangements.

STEP 3: Contact the Mazda Customer Relations Department

If still not substantially satisfied, contact the Customer Relations Department, Mazda Canada Inc., 305 Milner Avenue, Suite 400 Scarborough, Ontario M1B 3V4 Canada TEL: 1 (800) 263-4680.

Provide the Department with the following information:

1. Your name, address, and telephone number
2. Year and model of vehicle
3. Vehicle Identification Number (VIN). Refer to the "Vehicle Identification Labels" page of section 10 of this manual for the location of the VIN.
4. Purchase date.
5. Present odometer reading.
6. Your dealer's name and location
7. The nature of your problem and/or cause of dissatisfaction.

The Department, in cooperation with the local Mazda Service Representative, will review the case to determine if everything possible has been done to ensure your satisfaction.

Customer Assistance

Please recognize that the resolution of service problems in most cases requires the use of your Mazda dealer's service facilities, personnel and equipment. We urge you to follow the above three steps in sequence therefore for most effective results.

MEDIATION/ARBITRATION PROGRAM

Occasionally a customer concern cannot be resolved through Mazda's Customer Satisfaction Program. If after exhausting procedures in this manual, your concern is still not resolved, you have another option.

Mazda Canada Inc. participates in an arbitration program administered by the Canadian Motor Vehicle Arbitration Plan (CAMVAP). CAMVAP will advise you about how your concern may be reviewed and resolved by an independent third party through binding arbitration.

Your complete satisfaction is the goal of Mazda Canada Inc. and our dealers. Mazda's participation in CAMVAP makes a valuable contribution to our achieving that goal. There is no charge for using CAMVAP. CAMVAP results are fast, fair and final as the award is binding on both you and Mazda Canada Inc.

CANADIAN MOTOR VEHICLE ARBITRATION PLAN (CAMVAP)

If a specific item of concern arises, where a solution cannot be reached between an owner, Mazda, and/or one of its dealers (that all parties cannot agree upon), the owner may wish to use the services offered by the Canadian Motor Vehicle Arbitration Plan (CAMVAP).

CAMVAP uses the services of Provincial Administrators to assist consumers in scheduling and preparing for their arbitration hearings. However, before you can proceed with CAMVAP you must follow your Mazda dispute resolution process as outlined previously.

CAMVAP is fully implemented in all provinces and territories. Consumers wishing to obtain further information about the Program can obtain an information booklet from their dealer, the Provincial Administrator of the Canadian Motor Vehicle Arbitration Plan Office at the following address or telephone number.

Canadian Motor Vehicle Arbitration Office
235 Yorkland Boulevard, Suite 300
North York, Ontario
M2J 4Y8
1 (800) 207-0685

Customer Assistance

Provincial Administrators may be reached locally as listed below:

Province/Territory	CAMVAP Number
British Columbia & Yukon Territories	(604) 681-0312
Alberta & Northwest Territories	(403) 426-0650
Saskatchewan	(306) 352-9259
Manitoba	(204) 942-7166
Ontario	(416) 596-8824
Atlantic Canada	(902) 422-5413
Quebec	(418) 649-1330

REGIONAL OFFICES

Regional Offices	Areas Covered
Mazda Canada Inc. Western Region 8171 Ackroyd Road Suite 2000 Richmond, B.C. V6X 3K1 (604) 303-5670	Alberta, British Columbia, Manitoba, Saskatchewan, Yukon
Mazda Canada Inc. Central/Atlantic Region 305 Milner Avenue Suite 400 Scarborough, Ontario. M1B 3V4 1 (800) 263-4680	Ontario, New Brunswick, Nova Scotia, Prince Edward Island, Newfoundland
Mazda Canada Inc. Quebec Region 6111 Route Trans Canadienne Pointe Claire, Quebec H9R 5A5 (514) 694-6390	Quebec

Customer Assistance

CUSTOMER ASSISTANCE (PUERTO RICO)

Your complete and permanent satisfaction is our business. That is why all Authorized Mazda Dealers have the knowledge and the tools to keep your Mazda vehicle in top condition.

If you have any questions or recommendations for improvement regarding the service of your Mazda vehicle or servicing by Mazda Dealer personnel, we recommend that you take the following steps:

STEP 1

Discuss the matter with an Authorized Mazda Dealer. This is the quickest and best way to address the issue. If your concern has not been resolved by the CUSTOMER RELATIONS, SALES, SERVICE, or PARTS MANAGER, then please contact the GENERAL MANAGER of the dealership or the OWNER.

STEP 2

If, after following STEP 1, you feel the need for further assistance, please contact your area's Mazda representative (Indicated on the next page).

Please help us by providing the following information:

1. Your name, address, and telephone number
2. Year and model of vehicle
3. Vehicle Identification Number (17 digits, noted on your registration or title or located on the upper driver's side corner of the dash)
4. Purchase date and current mileage
5. Your dealer's name and location
6. Your question(s)

If you would like to write a letter, please address it to the following,
Attn: Customer Assistance

Plaza Motors Corp.

Mazda de Puerto Rico

P.O. Box 362722

San Juan, Puerto Rico

00936-2722

Tel: (787) 788-9300

This way, we can be sure to respond to you as efficiently as possible.
That is our goal.

If you live outside the U.S.A., please contact your nearest Mazda Distributor.

Customer Assistance

MAZDA IMPORTERS/DISTRIBUTORS

U.S.A (Importer/Distributor)

Mazda North American Operations

7755 Irvine Center Drive

Irvine, CA 92618-2922

P.O. Box 19734

Irvine, CA 92623-9734

TEL: 1 (800) 222-5500 (in U.S.A.)

(949) 727-1990 (outside U.S.A.)

(Distributor in each area)

CANADA

Mazda Canada, Inc.

305 Milner Avenue, Suite 400

Scarborough, Ontario M1B 3V4 Canada

TEL: 1 (800) 263-4680 (in Canada)

(416) 609-9909 (outside Canada)

PUERTO RICO

Plaza Motors Corp. (Mazda de Puerto Rico)

P.O. Box 362722, San Juan, Puerto Rico 00936-2722

TEL: (787) 788-9300

GUAM

(d.b.a. Triple J. Enterprises, Inc.)

P.O. Box 6066 Tamuning, Guam

TEL: (671) 646-9216

SAIPAN

Pacific International Marianas, Inc.

(d.b.a. Midway Motors)

P.O. Box 887 Saipan, MP 96950

TEL: (670) 234-7524

Triple J Saipan, Inc.

(d.b.a. Triple J Motors)

Beach Road

Chalan LauLau

Saipan, MP 96950

TEL: (670) 235-4868

AMERICAN SAMOA

Polynesia Motors, Inc.

P.O. Box 1120, Pago Pago, American Samoa 96799

TEL: (684) 699-1854

ADD-ON NON-GENUINE PARTS AND ACCESSORIES

Non-genuine parts and accessories for Mazda vehicles can be found in stores. These may fit your vehicle, but they are not approved by the manufacturer for use with Mazda vehicles. When you install non-genuine parts or accessories, they could affect your vehicle's performance or safety system; the manufacturer's warranty doesn't cover this. Before you install any non-genuine parts or accessories, consult an Authorized Mazda Dealer.

WARNING: Installation of Non-Genuine Parts or Accessories: Installation of non-genuine parts or accessories could be dangerous. Improperly designed parts or accessories could seriously affect your vehicle's performance or safety system. This could cause you to have an accident or increase your chances of injuries in an accident. Always consult an Authorized Mazda Dealer before you install non-genuine parts or accessories.

WARNING: Add-On Electrical and Electronic Equipment: Incorrectly choosing or installing improper add-on equipment or choosing an improper installer could be dangerous. Essential systems could be damaged, causing engine stalling, air-bag (SRS) activation, ABS inactivation, or a fire in the vehicle. Be very careful in choosing and installing add-on electrical equipment, such as mobile telephones, two-way radios, stereo systems, and car alarm systems.

Mazda assumes no responsibility for death, injury, or expenses that may result from the installation of add-on non-genuine parts or accessories.

WARRANTIES FOR YOUR MAZDA

- New Vehicle Limited Warranty
- Safety Restraint System Limited Warranty
- Anti-perforation Limited Warranty
- Federal Emission Control Warranty
 - Emission Defect Warranty
 - Emission Performance Warranty

Customer Assistance

- California Emission Control Warranty (if applicable)
- Replacement Parts and Accessories Limited Warranty
- Tire Warranty

NOTE: Detailed warranty information is provided with your Mazda portfolio.

OUTSIDE THE UNITED STATES

Government regulations in the United States require that automobiles meet specific emission regulations and safety standards. Therefore, vehicles built for use in the United States, may differ from those sold in other countries.

The differences may make it difficult or even impossible for your vehicle to receive satisfactory servicing in other countries. We strongly recommend that you NOT take your Mazda outside the United States. However, in the event that you are moving to Canada permanently, Mazda vehicles built for use in the United States could be eligible for exportation to Canada with specific vehicle modifications to comply with the Canadian Motor Vehicle Safety requirements.

Special Note: The above is applicable for permanent import/export situations and not related to travelers on vacation.

You may have the following problems if you do take your vehicle outside of the United States:

- Recommended fuel may be unavailable. Any kind of leaded fuel or low-octane fuel will affect vehicle performance and damage the emission controls and engine.
- Proper repair facilities, tools, testing equipment, and replacement parts may not be available.

Please refer to your manufacturers warranty booklet for more information.

OUTSIDE CANADA

Government regulations in Canada require that automobiles meet specific emission regulations and safety standards. Therefore, vehicles built for use in Canada, may differ from those sold in other countries.

The differences may make it difficult or even impossible for your vehicle to receive satisfactory servicing in other countries. We strongly recommend that you NOT take your Mazda outside Canada. However, in the event that you are moving to the United States permanently, Mazda

Customer Assistance

vehicles built for use in Canada could be eligible for exportation to the United States with specific vehicle modifications to comply with the United States Federal Motor Vehicle Safety requirements.

Special Note: The above is applicable for permanent import/export situations and not related to travelers on vacation.

You may have the following problems if you do take your vehicle outside of Canada:

- Recommended fuel may be unavailable. Any kind of leaded fuel or low-octane fuel will affect vehicle performance and damage the emission controls and engine.
- Proper repair facilities, tools, testing equipment, and replacement parts may not be available.

Please refer to your manufacturer's warranty booklet for more information.

REPORTING SAFETY DEFECTS

If you believe that your vehicle has a defect which could cause a crash or could cause injury or death, you should immediately inform the National Highway Traffic Safety Administration (NHTSA) in addition to notifying your Mazda importer/distributor.

If NHTSA receives similar complaints, it may open an investigation, and if it finds that a safety defect exists in a group of vehicles, it may order a recall and remedy campaign. However NHTSA cannot become involved in individual problems between you, your dealer, or your Mazda importer/distributor).

To contact NHTSA, you may either call the Auto Safety Hotline toll-free at 1 (800) 424-9393 (or 366-0123 in Washington, D.C. area) or write to: NHTSA, U.S. Department of Transportation, Washington, D.C. 20590. You can also obtain other information about motor vehicle safety from the Hotline.

(Note)

If you live in the U.S.A., all correspondence to:

Mazda North American Operations
7755, Irvine Center Drive
Irvine, California 92618-2922
P.O. Box 19734
Irvine, CA 92623-9734
Customer Assistance Center
or toll free at 1 (800) 222-5500

Customer Assistance

If you live outside of the U.S.A., please contact the nearest Mazda Distributor. (See the *Mazda Importers/Distributors* section of this manual).

SERVICE PUBLICATIONS

Factory-authorized Mazda service publication are available for owners who wish to do some of their own maintenance and repair.

When requesting any of our publications through an Authorized Mazda Dealer, refer to the chart below.

If they don't have what you need in stock, they can order it for you.

PUBLICATION ORDER NUMBER	PUBLICATION DESCRIPTION
9999 95 022B 04	WORKSHOP MANUAL
9999 95 020G 04	WIRING DIAGRAM
9999 95 023C 04	OWNER'S MANUAL

WORKSHOP MANUAL:

Covers recommended maintenance and repair procedures of the drive train, body and chassis.

WIRING DIAGRAM:

Provides electrical schematics as well as component location for the entire electrical system.

OWNER'S MANUAL:

This booklet contains information regarding the proper care and operation of your vehicle. This is not a technician's manual.

Please note that your Authorized Mazda Dealership has trained personnel and special service tools to correctly and safely maintain Mazda vehicles.

IN CALIFORNIA (U.S. ONLY)

California Civil Code Section 1793.2(d) requires that, if a manufacturer or its representative is unable to repair a motor vehicle to conform to the vehicle's applicable express warranty after a reasonable number of attempts, the manufacturer shall be required to either replace the vehicle with one substantially identical or repurchase the vehicle and reimburse the buyer in an amount equal to the actual price paid or payable by the consumer (less a reasonable allowance for consumer use). The consumer has the right to choose whether to receive a refund or replacement vehicle.

Customer Assistance

California Civil Code Section 1793.22(b) presumes that the manufacturer has had a reasonable number of attempts to conform the vehicle to its applicable express warranties if, within the first 18 months of ownership of a new vehicle or the first 29 000 km (18 000 miles), whichever occurs first:

1. Two or more repair attempts are made on the same nonconformity likely to cause death or serious bodily injury OR
2. Four or more repair attempts are made on the same nonconformity (a defect or condition that substantially impairs the use, value or safety of the vehicle) OR
3. The vehicle is out of service for repair of nonconformities for a total of more than 30 calendar days (not necessarily all at one time)

In the case of 1 or 2 above, the consumer must also notify the manufacturer of the need for the repair of the nonconformity at the following address:

Mazda North American Operations
7755, Irvine Center Drive
Irvine, CA 92618-2922

REPORTING SAFETY DEFECTS (U.S. ONLY)

If you believe that your vehicle has a defect that could cause a crash, or could cause injury or death, you should immediately inform the National Highway Traffic Safety Administration (NHTSA) in addition to notifying Mazda Corporation.

If NHTSA receives similar complaints, it may open an investigation, and if it finds that a safety defect exists in a group of vehicles, it may order a recall and remedy campaign. However, NHTSA cannot become involved in individual problems between you, your dealer or Mazda Corporation.

To contact NHTSA, you may either call the Auto Safety Hotline toll-free at 1-800-424-9393 (202-366-0123 in the Washington D.C. area) or write to:

NHTSA
U.S. Department of Transportation
400 Seventh Street
Washington D.C. 20590

You can also obtain other information about motor vehicle safety from the Hotline.

Cleaning

WASHING THE EXTERIOR

Wash your vehicle regularly with cool or lukewarm water and a neutral Ph shampoo, such as an approved shampoo available from your Mazda dealer.

- Never use strong household detergents or soap, such as dish washing or laundry liquid. These products can discolor and spot painted surfaces.
- Never wash a vehicle that is “hot to the touch” or during exposure to strong, direct sunlight.
- Always use a clean sponge or carwash mitt with plenty of water for best results.
- Dry the vehicle with a chamois or soft terry cloth towel in order to eliminate water spotting.
- It is especially important to wash the vehicle regularly during the winter months, as dirt and road salt are difficult to remove and cause damage to the vehicle.
- Immediately remove items such as gasoline, diesel fuel, bird droppings and insect deposits because they can cause damage to the vehicle’s paintwork and trim over time.
- Remove any exterior accessories, such as antennas, before entering a car wash.
- **Suntan lotions and insect repellents can damage any painted surface; if these substances come in contact with your vehicle, wash off as soon as possible.**

WAXING

Applying a polymer paint sealant to your vehicle every six months will assist in reducing minor scratches and paint damage.

- Wash the vehicle first.
- Do not use waxes that contain abrasives.
- Do not allow paint sealant to come in contact with any non-body (low-gloss black) colored trim, such as grained door handles, roof racks, bumpers, side moldings, mirror housings or the windshield cowl area. The paint sealant will “gray” or stain the parts over time.

PAINT CHIPS

Your dealer has touch-up paint to match your vehicle’s color. Touch-up paint can be used to repair minor scratches to painted surfaces.

- Remove particles such as bird droppings, tree sap, insect deposits, tar spots, road salt and industrial fallout before repairing paint chips.
- Always read the instructions before using the products.

ALUMINUM WHEELS AND COVERS

Aluminum wheel rims or covers are coated with a clearcoat paint finish. In order to maintain their shine:

- Clean with One Step Wash and Wax Concentrate, which is available from your authorized Mazda dealer.
- Never apply any cleaning chemical to hot or warm wheel rims or covers.
- Some automatic car washes may cause damage to the finish on your wheel rims or covers. Chemical-strength cleaners, or cleaning chemicals, in combination with brush agitation to remove brake dust and dirt, could wear away the clearcoat finish over time.
- Do not use hydrofluoric acid-based or high caustic-based wheel cleaners, steel wool, fuels or strong household detergent.
- To remove tar and grease, use Extra Strength Tar and Road Oil Removal, available from your authorized Mazda dealer.

ENGINE

Engines are more efficient when they are clean because grease and dirt buildup keep the engine warmer than normal. When washing:

- Take care when using a power washer to clean the engine. The high-pressure fluid could penetrate the sealed parts and cause damage.
- Never spray the engine or other engine components with water. Water will damage the engine or other engine components.
- Spray Engine Shampoo and Degreaser, available at your authorized Mazda dealer, on all parts that require cleaning and pressure rinse clean.
- Cover the highlighted areas to prevent water damage when cleaning the engine.

Cleaning

- **2.3L Engine**

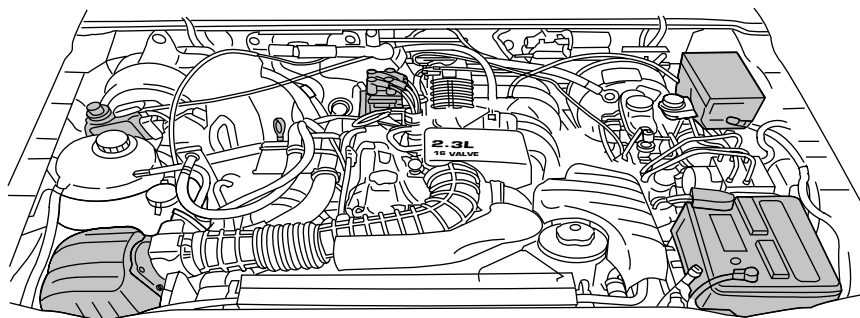

- **3.0L Engine**

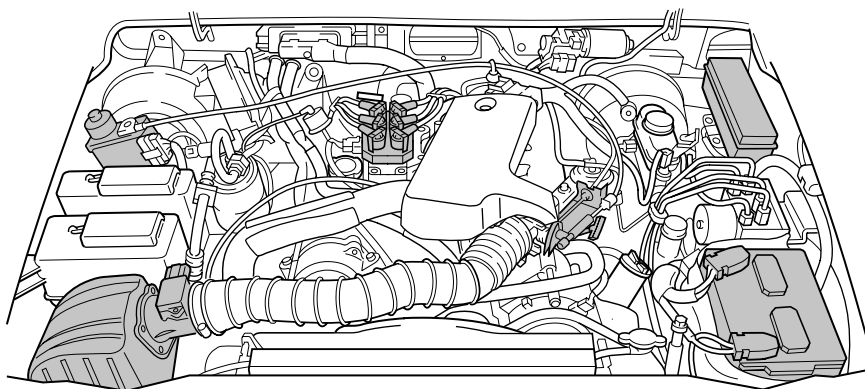

- **4.0L Engine**

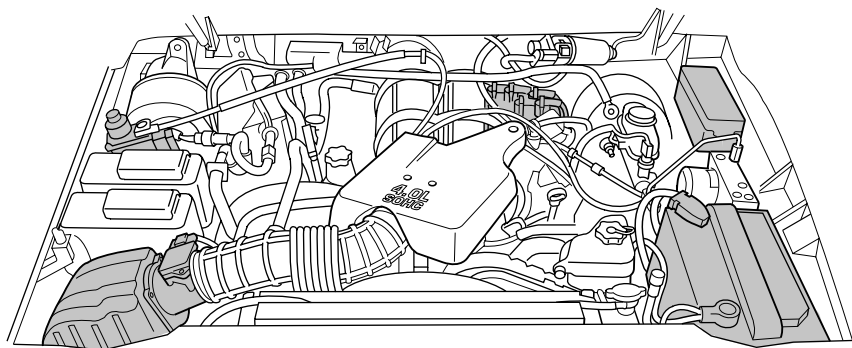

- Never wash or rinse the engine while it is running; water in the running engine may cause internal damage.

PLASTIC (NON-PAINTED) EXTERIOR PARTS

Use only approved products to clean plastic parts. These products are available from your dealer.

- For routine cleaning, use One Step Wash and Wax Concentrate, available at your authorized Mazda dealer.
- If tar or grease spots are present, use Extra Strength Tar and Road Oil Removal, available at your authorized Mazda dealer.

WINDOWS AND WIPER BLADES

The windshield, rear window and wiper blades should be cleaned regularly. If the wiper does not wipe properly, substances on the windshield, rear window or the wiper blades may be the cause. These may include hot wax treatments used by commercial car washes, tree sap, or other organic contamination. To clean these items, please follow these tips:

- The windshield or rear window may be cleaned with a non-abrasive cleaner such as Ultra Clear Spray Glass Cleaner, available from your authorized Mazda dealer.
- Do not use abrasives, as they may cause scratches.
- Do not use fuel, kerosene, or paint thinner to clean any parts.
- Wiper blades can be cleaned with isopropyl (rubbing) alcohol or windshield washer solution. Be sure to replace wiper blades when they appear worn or do not function properly.

Cleaning

INSTRUMENT PANEL AND CLUSTER LENS

Clean the instrument panel with a damp cloth, then dry with a dry cloth.

- Avoid cleaners or polish that increase the gloss of the upper portion of the instrument panel. The dull finish in this area helps protect the driver from undesirable windshield reflection.

WARNING: Do not use chemical solvents or strong detergents when cleaning the steering wheel or instrument panel to avoid contamination of the air bag system.

- Be certain to wash or wipe your hands clean if you have been in contact with certain products such as insect repellent and suntan lotion in order to avoid possible damage to the interior painted surfaces.

INTERIOR TRIM

- Clean the interior trim areas with a damp cloth, then dry by wiping with a dry, soft, clean cloth.
- Do not use household or glass cleaners as these may damage the finish.

INTERIOR

For fabric, carpets, cloth seats, and safety belts:

- Remove dust and loose dirt with a vacuum cleaner.
- Remove light stains and soil with Extra Strength Upholstery Cleaner, available at your authorized Mazda dealer.
- If grease or tar is present on the material, spot-clean the area first with Spot and Stain Remover, available at your authorized Mazda dealer.
- Never saturate the seat covers with cleaning solution.
- Do not use household cleaning products or glass cleaners, which can stain and discolor the fabric and affect the flame retardant abilities of the seat materials.

LEATHER SEATS (IF EQUIPPED)

Your leather seating surfaces have a clear, protective coating over the leather.

- To clean, use a soft cloth with Deluxe Leather and Vinyl Cleaner. Dry the area with a soft cloth.
- To help maintain its resiliency and color, use the Deluxe Leather Care Kit, available at your authorized Mazda dealer.
- Do not use household cleaning products, alcohol solutions, solvents or cleaners intended for rubber, vinyl and plastics, or oil/petroleum-based leather conditioners. These products may cause premature wearing of the clear, protective coating.

UNDERBODY

Flush the complete underside of your vehicle frequently. Keep body and door drain holes free from packed dirt.

MAZDA CAR CARE PRODUCTS

Your Mazda dealer has many quality products available to clean your vehicle and protect its finishes. These quality products have been specifically engineered to fulfill your automotive needs; they are custom designed to complement the style and appearance of your vehicle. Each product is made from high quality materials that meet or exceed rigid specifications. For best results, use these products or products of equivalent quality. These products are available at your authorized Mazda dealer.

Maintenance and Specifications

INTRODUCTION

Be extremely careful to prevent injury to yourself and others and damage to your vehicle when using this manual for inspection and maintenance.

If you're unsure about any procedure, we strongly urge you to have a reliable and qualified service shop perform the work, preferably an Authorized Mazda Dealer.

Factory-trained Mazda technicians and genuine Mazda parts are best for your vehicle. Without this expertise and the parts that have been designed and made especially for your Mazda, inadequate, incomplete, and insufficient servicing may result in problems. This could lead to vehicle damage or an accident and injuries.

For expert advice and quality service, consult an Authorized Mazda Dealer.

The owner should retain evidence that proper maintenance has been performed as prescribed.

Claims against the warranty resulting from lack of maintenance, as opposed to defective materials or authorized Mazda workmanship, will not be honored.

Any auto repair shop using parts equivalent to your Mazda's original equipment may perform maintenance. **But we recommend that it always be done by an Authorized Mazda Dealer using genuine Mazda parts.**

SCHEDULED MAINTENANCE

Schedule I — Normal Driving Conditions/Emission Control Systems

Follow Schedule I if the vehicle is operated mainly where none of the following conditions apply. If any do apply follow Schedule II.

- Repeated short-distance driving.
- Driving in dusty conditions.
- Towing a trailer.
- Operating in hot weather in stop-and-go "rush hour" traffic.
- Extended periods of idling or low-speed operation.
- High-speed operation with a fully loaded vehicle.
- Off-road operation.

NOTE: After the described period, continue to follow the described maintenance at the recommended intervals.

Maintenance and Specifications

CHART SYMBOLS

I: Inspect, and if necessary correct, clean or replace

A: Adjust

R: Replace

L: Lubricate

Normal driving service intervals – perform at the months or distances shown, whichever occurs first.

Maintenance Item	Maintenance Interval (Number of months or Miles (km), whichever comes first)												
	Months	4	8	12	16	20	24	28	32	36	40	44	48
	x 1000 miles	5	10	15	20	25	30	35	40	45	50	55	60
	(x 1000 km)	(8)	(16)	(24)	(32)	(40)	(48)	(56)	(64)	(72)	(80)	(88)	(96)
ENGINE													
Engine oil — every 6 months	R	R	R	R	R	R	R	R	R	R	R	R	R
Oil filter — every 6 months	R	R	R	R	R	R	R	R	R	R	R	R	R
PCV valve													
AIR CLEANER													
Air cleaner filter							R						R
IGNITION SYSTEM													
Spark plugs	*4												
COOLING SYSTEM													
Engine Coolant (green)	Replace at first 45,000 miles (72,000 km) or 36 months, after that, every 30,000 miles (48,000 km) or 24 months												
Engine Coolant (yellow)	Replace at first 100,000 miles (160,000 km) or 60 months; after that, every 50,000 miles (80,000 km) or 36 months												
Coolant condition and protection, hoses and clamps — annually —prior to cold weather every 12 months			I				I			I			I
CHASSIS AND BODY													
Wheel lug nut torque	*1	I	I	I	I	I	I	I	I	I	I	I	I
Inspect tires for wear and rotate (X = recommended interval for optimal tire life)	I	X	I	X	X	I	X	X	I	X	X	I	I
Clutch reservoir fluid level	I		I		I		I		I		I		I
Front wheel bearings (4x2)													L

Maintenance and Specifications

Maintenance Item	Maintenance Interval (Number of months or Miles (km), whichever comes first)												
	Months	4	8	12	16	20	24	28	32	36	40	44	48
	x 1000 miles	5	10	15	20	25	30	35	40	45	50	55	60
	(x 1000 km)	(8)	(16)	(24)	(32)	(40)	(48)	(56)	(64)	(72)	(80)	(88)	(96)
Disc brake system			I				I			I			I
Caliper slide rails			L				L			L			L
Drum brake system, lines and hoses			I				I			I			I
Exhaust system for leaks, damage, looseness							I						I
Manual transmission fluid													R
Automatic transmission fluid	*2						I						I
Exhaust system shielding (for trapped material)							I						I
Propeller shaft U-joints (if equipped with grease fittings)	L		L		L		L		L		L		
Parking brake system (for damage and operation)			I				I			I			I
Ball joints (4x2)			I/L				I/L			I/L			I/L
Transfer case fluid (4x4)		Replace every 150,000 miles (240,000 km)											
Rear axle lubricant		Does not require replacement unless rear axle submerged in water											
Accessory drive belts													
Fuel filter	*5						R						R
Steering linkage, ball joints, suspension and driveshaft			I				I			I			I

*1 The wheel lug nuts must be retightened to the proper specifications at 800 km (500 miles) of new vehicle operation, at any wheel change, or at any other time the wheel lug nuts have been loosened.

*2 Replace every 150,000 miles (240,000 km) unless submerged in water.

*3 At 60,000 miles (96,000 km), the dealer will replace the PCV valve at no cost, except Canada and California vehicles.

*4 Refer to vehicle emission control information label for spark plug and gap specifications.

*5 The California Air Resources Board has determined that the failure to perform this maintenance item will not nullify the emission warranty nor limit recall liability prior to completion of the vehicle's useful life.

Maintenance and Specifications

Schedule I continued

Maintenance Item	Maintenance Interval (Number of months or Miles (km), whichever comes first)												
	Months	52	56	60	64	68	72	76	80	84	88	92	96
	x 1000 miles	65	70	75	80	85	90	95	100	105	110	115	120
	(x 1000 km)	(104)	(112)	(121)	(128)	(136)	(144)	(152)	(160)	(168)	(176)	(184)	(192)
ENGINE													
Engine oil — every 6 months	R	R	R	R	R	R	R	R	R	R	R	R	R
Oil filter — every 6 months	R	R	R	R	R	R	R	R	R	R	R	R	R
PCV valve									R				
AIR CLEANER													
Air cleaner filter							R						R
IGNITION SYSTEM													
Spark plugs *4									R				
COOLING SYSTEM													
Engine Coolant (green)	Replace at first 45,000 miles (72,000 km) or 36 months, after that, every 30,000 miles (48,000 km) or 24 months												
Engine Coolant (yellow)	Replace at first 100,000 miles (160,000 km) or 60 months; after that, every 50,000 miles (80,000 km) or 36 months												
Coolant condition and protection, hoses and clamps — annually —prior to cold weather every 12 months			I			I				I			I
CHASSIS AND BODY													
Wheel lug nut torque *1	I	I	I	I	I	I	I	I	I	I	I	I	I
Inspect tires for wear and rotate (X = recommended interval for optimal tire life)	X	X	I	X	X	I	X	X	I	X	X	X	I
Clutch reservoir fluid level	I		I		I		I		I		I		
Front wheel bearings (4x2)													L

Maintenance and Specifications

Maintenance Item	Maintenance Interval (Number of months or Miles (km), whichever comes first)												
	Months	52	56	60	64	68	72	76	80	84	88	92	96
	x 1000 miles	65	70	75	80	85	90	95	100	105	110	115	120
	(x 1000 km)	(104)	(112)	(121)	(128)	(136)	(144)	(152)	(160)	(168)	(176)	(184)	(192)
Disc brake system			I			I			I			I	
Caliper slide rails			L			L			L			L	
Drum brake system, lines and hoses			I			I			I			I	
Exhaust system for leaks, damage, looseness						I							I
Manual transmission fluid													R
Automatic transmission fluid *2						I							I
Exhaust system shielding (for trapped material)						I							I
Propeller shaft U-joints (if equipped with grease fittings)	L		L		L		L		L		L		L
Parking brake system (for damage and operation)			I			I			I				I
Ball joints (4x2)			I/L			I/L			I/L				I/L
Transfer case fluid (4x4)	Replace every 150,000 miles (240,000 km)												
Rear axle lubricant	Does not require replacement unless rear axle submerged in water												
Accessory drive belts									I				
Fuel filter *5						R							R
Steering linkage, ball joints, suspension and driveshaft			I			I			I				I

*1 The wheel lug nuts must be retightened to the proper specifications at 800 km (500 miles) of new vehicle operation, at any wheel change, or at any other time the wheel lug nuts have been loosened.

*2 Replace every 150,000 miles (240,000 km) unless submerged in water.

*3 At 60,000 miles (96,000 km), the dealer will replace the PCV valve at no cost, except Canada and California vehicles.

Maintenance and Specifications

*4 Refer to vehicle emission control information label for spark plug and gap specifications.

*5 The California Air Resources Board has determined that the failure to perform this maintenance item will not nullify the emission warranty nor limit recall liability prior to completion of the vehicle's useful life.

SCHEDULE II — SPECIAL OPERATING CONDITIONS

If your driving habits **FREQUENTLY** include one or more of the following conditions:

- Short trips of less than 10 miles (16 km) when outside temperatures remain below freezing.
- Towing a trailer, or carrying maximum loads.
- Operating in severe dust conditions.
- Operating during **hot weather** in stop-and-go “rush hour” traffic.
- Extensive idling, such as police, taxi or door-to-door delivery service.
- High speed operation with a fully loaded vehicle (max. GVW).
- Off-road operation

Change ENGINE OIL AND OIL FILTER every 3 months or 3,000 miles (4,800 km) whichever occurs first.

NOTE: Idling the engine for extended periods will accumulate more hours of use on your vehicle than is actually indicated by the mileage odometer. Consequently, the odometer reading can be often misleading when determining the right time to change your engine oil and filter. If you are using your vehicle in a manner which allows it to remain stationary while the engine is running for long periods (door-to-door delivery, taxi, police, power/utility company trucks, or similar duty), then Mazda recommends you increase the frequency of oil and filter changes to an interval equivalent to 200 ENGINE HOURS or use. Since most vehicles are not equipped with hour-meters, it may be necessary for you to approximate your idle time and plan oil/filter changes accordingly.

Maintenance and Specifications

Special Operating Conditions	Replace Engine Oil and Filter	Inspect Brake System	Replace Fuel Filter	Change Automatic Transmission Fluid	Replace Spark Plugs	Replace Engine Air Filter	Change Manual Transmission Fluid	Inspect and Lubricate U-Joints	Lubricate Front Wheel Bearing (4x2)	Change Transfer Case Fluid (4x4)
Suggested Maintenance Interval	3,000 miles or 3 months	5,000 miles	15,000 miles	30,000 miles	60,000 miles	As required	As required	As required	30,000 miles	60,000 miles
Towing a trailer or using a camper or car top carrier	X			X		X	X			
Extensive idling or low-speed driving for long distances as in heavy commercial use such as delivery, taxi or patrol car	X	X	X	X	X				X	X
Operating in dusty conditions such as unpaved or dusty roads	X		X	X		X				
Off road operation				X				X		X

For specific recommendations see your authorized Mazda dealer or qualified service professional.

Maintenance and Specifications

OWNER MAINTENANCE

Owner Maintenance Schedule

The owner or a qualified service technician should make these vehicle inspections at the indicated intervals to ensure safe and dependable operation.

Bring any problem to the attention of an Authorized Mazda Dealer or qualified service technician as soon as possible.

While operating your vehicle

- Note any changes in the sound of the exhaust or any smell or exhaust fumes in the vehicle.
- Check for vibrations in the steering wheel. Notice any increased steering effort or looseness in the steering wheel, or change in the straight ahead position.
- Notice if your vehicle constantly turns slightly or “pulls” to one side when traveling on a smooth, level road.
- When stopping, listen and check for strange sounds, pulling to one side, increased brake pedal travel or “hard to push” brake pedal.
- If any slipping or changes in the operation of your transmission occur, check the transmission fluid level.
- Check automatic transmission Park function.
- Check parking brake.

At least monthly

- Check function of all interior and exterior lights.
- Check tires for wear and proper air pressure.
- Check engine oil level.
- Check coolant level in the coolant reservoir.
- Check washer fluid level.

At least twice a year (for example, every spring and fall)

- Check power steering fluid level.
- Check clutch fluid level (if equipped).
- Check and clean body and door drain holes.
- Check and lubricate all hinges, latches, and outside locks.
- Check and lubricate door rubber weather strips.
- Check parking brake for proper operation.

Maintenance and Specifications

- Check lap/shoulder belts and seat latches for wear and function.
- Check air pressure in spare tire.
- Check windshield washer spray and wiper operation. Clean wiper blades with clean cloth dampened with washer fluid.
- Check safety warning lamps (brake, ABS, air bag, safety belt) for operation.
- Check cooling system fluid level and verify coolant specific gravity is correct for summer or winter conditions.
- Check battery water level (non-maintenance free).
- Check battery connections and clean if necessary.

SERVICE RECOMMENDATIONS

To help you service your vehicle:

- We highlight do-it-yourself items in the engine compartment for easy location.
- We provide a Scheduled Maintenance section which makes tracking routine service easy.

If your vehicle requires professional service, your dealership can provide necessary parts and service. Check your “Warranty Information” to find out which parts and services are covered.

Use only recommended fuels, lubricants, fluids and service parts conforming to specifications. Genuine Mazda parts are designed and built to provide the best performance in your vehicle.

PRECAUTIONS WHEN SERVICING YOUR VEHICLE

- Do not work on a hot engine.
- Make sure that nothing gets caught in moving parts.
- Do not work on a vehicle with the engine running in an enclosed space, unless you are sure you have enough ventilation.
- Keep all open flames and other lit material away from the battery and all fuel related parts.

Maintenance and Specifications

Working with the engine off

- Automatic transmission:
 1. Set the parking brake and shift to P (Park).
 2. Turn off the engine and remove the key.
 3. Block the wheels.
- Manual transmission:
 1. Set the parking brake, depress the clutch and place the gearshift in 1 (First).
 2. Turn off the engine and remove the key.
 3. Block the wheels.

Working with the engine on

- Automatic transmission:
 1. Set the parking brake and shift to P (Park).
 2. Block the wheels.
- Manual transmission:
 1. Set the parking brake, depress the clutch and place the gearshift in N (Neutral).
 2. Block the wheels.

Note: Do not start your engine with the air cleaner removed and do not remove it while the engine is running.

OPENING THE HOOD

1. Inside the vehicle, pull the hood release handle located under the bottom of the instrument panel near the steering column.
2. Go to the front of the vehicle and release the auxiliary latch that is located under the front center of the hood.
3. Lift the hood and support it with the prop rod.

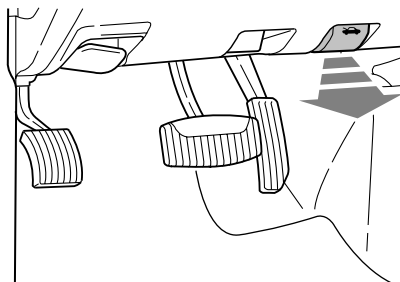

Maintenance and Specifications

IDENTIFYING COMPONENTS IN THE ENGINE COMPARTMENT

2.3L I4 engine

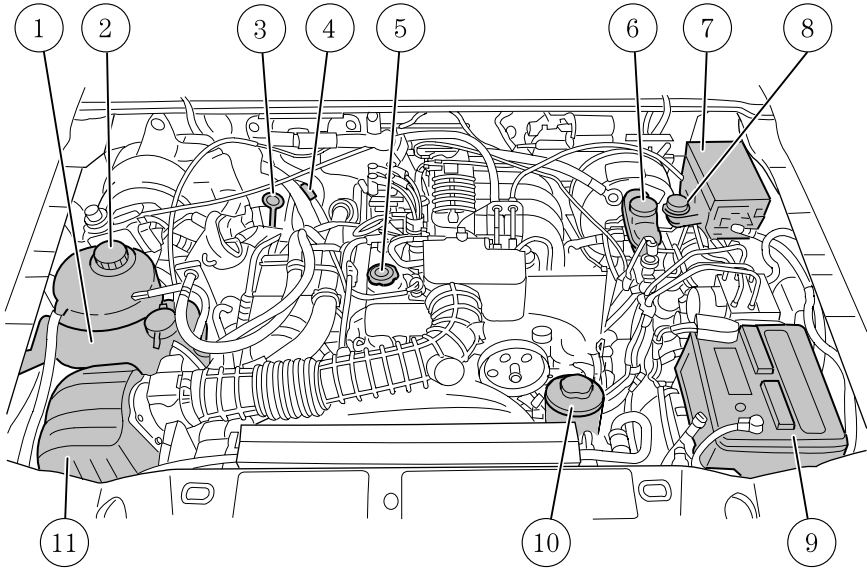

1. Windshield washer fluid reservoir
2. Engine coolant reservoir
3. Engine oil dipstick
4. Transmission fluid dipstick (automatic transmission)
5. Engine oil filler cap
6. Brake fluid reservoir
7. Power distribution box
8. Clutch fluid reservoir (manual transmission)
9. Battery
10. Power steering fluid reservoir
11. Air filter assembly

Maintenance and Specifications

3.0L V6 engine

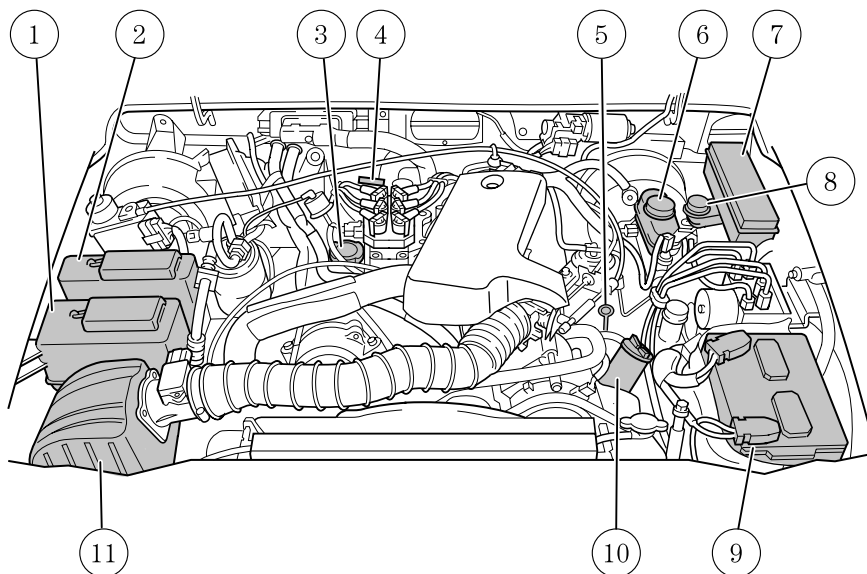

1. Engine coolant reservoir
2. Windshield washer fluid reservoir
3. Engine oil filler cap
4. Transmission fluid dipstick (automatic transmission)
5. Engine oil dipstick
6. Brake fluid reservoir
7. Power distribution box
8. Clutch fluid reservoir (manual transmission)
9. Battery
10. Power steering fluid reservoir
11. Air filter assembly

Maintenance and Specifications

4.0L SOHC V6 engine

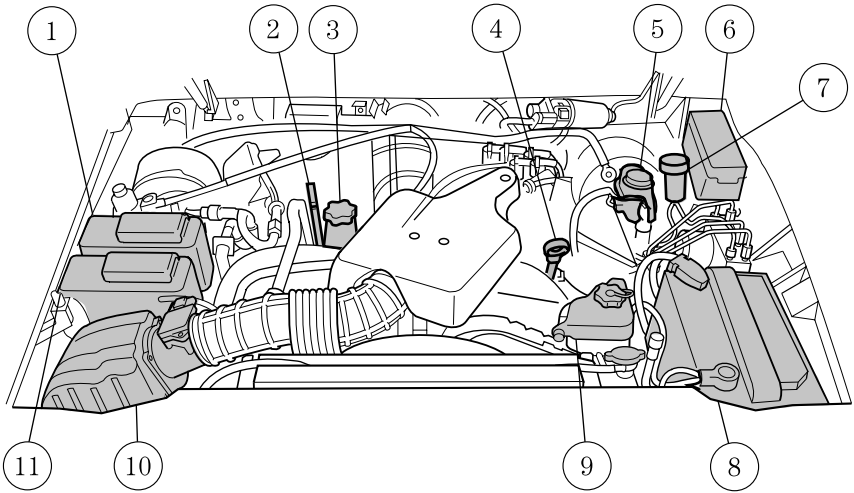

1. Windshield washer fluid reservoir
2. Transmission fluid dipstick (automatic transmission)
3. Engine oil filler cap
4. Engine oil dipstick
5. Brake fluid reservoir
6. Power distribution box
7. Clutch fluid reservoir (manual transmission)
8. Battery
9. Power steering fluid reservoir
10. Air filter assembly
11. Engine coolant reservoir

Maintenance and Specifications

WINDSHIELD WASHER FLUID

Windshield washer fluid

Add fluid to fill the reservoir if the level is low. In very cold weather, do not fill the reservoir completely.

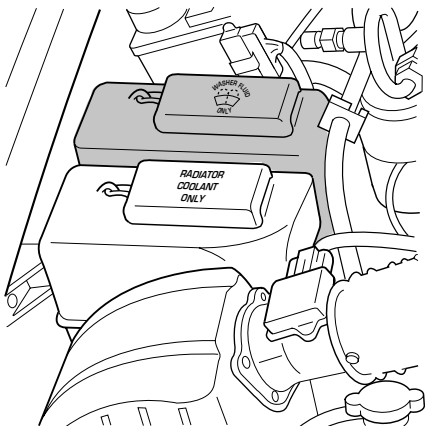

Only use a washer fluid that meets Mazda specification . Refer to *Lubricant specifications* in this chapter.

State or local regulations on volatile organic compounds may restrict the use of methanol, a common windshield washer antifreeze additive. Washer fluids containing non-methanol antifreeze agents should be used only if they provide cold weather protection without damaging the vehicle's paint finish, wiper blades or washer system.

WARNING: If you operate your vehicle in temperatures below 4.5° C (40° F), use washer fluid with antifreeze protection. Failure to use washer fluid with antifreeze protection in cold weather could result in impaired windshield vision and increase the risk of injury or accident.

Note: Do not put washer fluid in the engine coolant reservoir. Washer fluid placed in the cooling system may harm engine and cooling system components.

Maintenance and Specifications

ENGINE OIL

Checking the engine oil

Refer to the service maintenance section for the appropriate intervals for checking the engine oil.

1. Make sure the vehicle is on level ground.
 2. Turn the engine off and wait a few minutes for the oil to drain into the oil pan.
 3. Set the parking brake and ensure the gearshift is securely latched in P (Park) (automatic transmission) or 1 (First) (manual transmission).
 4. Open the hood. Protect yourself from engine heat.
 5. Locate and carefully remove the engine oil level indicator (dipstick).
- 2.3L I4 engine

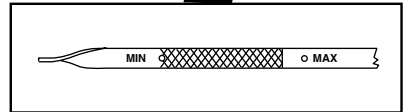
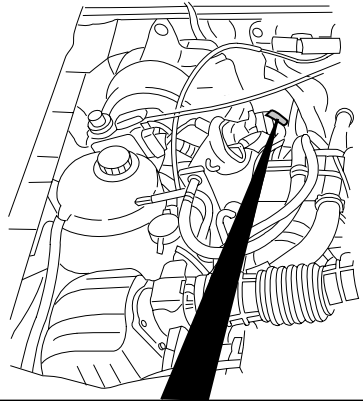

Maintenance and Specifications

- 3.0L V6 engine

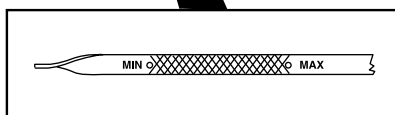
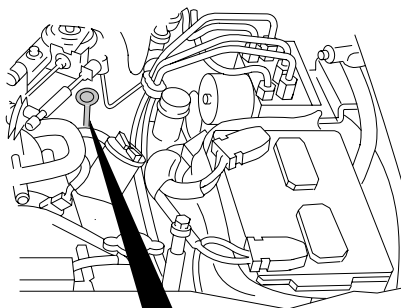

- 4.0L SOHC V6 engine

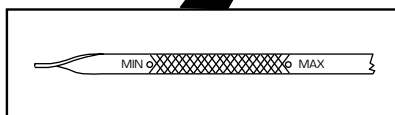
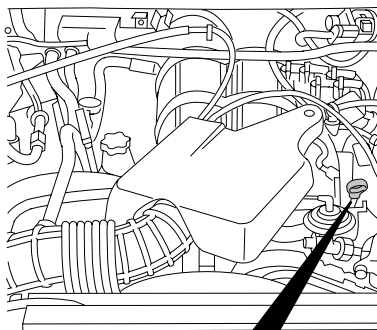

Maintenance and Specifications

6. Wipe the indicator clean. Insert the indicator fully, then remove it again.
- If the oil level is **between the MIN and MAX marks**, the oil level is acceptable, **DO NOT ADD OIL.**
 - If the oil level is below the MIN mark, add enough oil to raise the level within the MIN-MAX range.
 - 2.3L I4 engine
SAE 5W-20

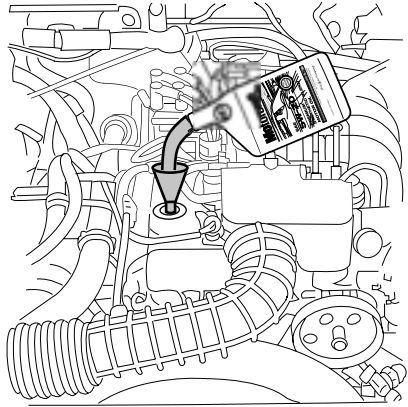

- 3.0L V6 engine
SAE 5W-20

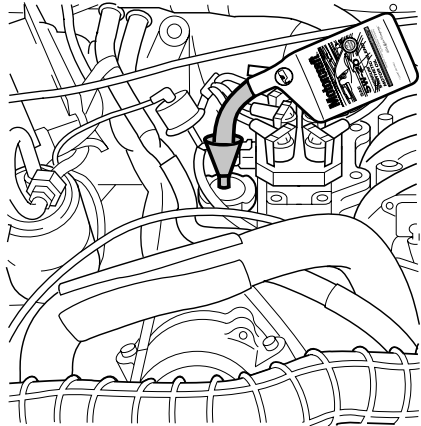

Maintenance and Specifications

- 4.0L SOHC V6 engine
SAE 5W-30

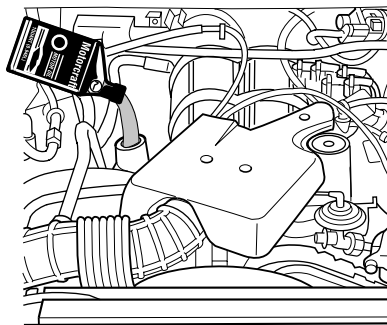

- Oil levels above the MAX mark may cause engine damage. Some oil must be removed from the engine by a service technician.
7. Put the indicator back in and ensure it is fully seated.

Adding engine oil

1. Check the engine oil. For instructions, refer to *Checking the engine oil* in this chapter.
2. If the engine oil level is not within the normal range, add only certified engine oil of the recommended viscosity. Remove the engine oil filler cap and use a funnel to pour the engine oil into the opening.
3. Recheck the engine oil level. Make sure the oil level is not above the MAX mark or the letter F in FULL on the engine oil level indicator (dipstick).
4. Install the indicator and ensure it is fully seated.
5. Fully install the engine oil filler cap by turning the filler cap 1/4 turn until it stops.

To avoid possible oil loss, DO NOT operate the vehicle with the engine oil level indicator and/or the engine oil filler cap removed.

Maintenance and Specifications

Engine Oil Recommendations

2.3L & 3.0L Engines

Look for this certification trademark.



SAE 5W-20 engine oil is recommended.

Only use oils “Certified For Gasoline Engines” by the American Petroleum Institute (API). Use an equivalent oil Mazda specification. **SAE 5W-20 oil provides optimum fuel economy and durability performance meeting all requirements for your vehicle’s engine.**

Change your engine oil and filter according to the appropriate schedule listed in the service maintenance section.

Do not use supplemental engine oil additives, oil treatments or engine treatments. They are unnecessary and could, under certain conditions, lead to engine damage which is not covered by your warranty.

Maintenance and Specifications

4.0L Engine

Look for this certification trademark.



SAE 5W-30 engine oil is recommended.

Only use oils “Certified For Gasoline Engines” by the American Petroleum Institute (API). Use an equivalent Mazda Specification.

Do not use supplemental engine oil additives, oil treatments or engine treatments. They are unnecessary and could, under certain conditions, lead to engine damage which is not covered by your warranty.

Change your engine oil according to the appropriate schedule listed in the service maintenance section.

Engine Oil Filter Recommendation

Change your engine oil filter according to the appropriate schedule listed in the service maintenance section. Mazda production and aftermarket (Mazda) oil filters are designed for added engine protection and long life. If a replacement oil filter is used that does not meet Mazda Material and design specifications, start-up engine noises or knock may be experienced.

It is recommended you use the appropriate Mazda oil filter (or another brand meeting Mazda specifications) for your engine.

Maintenance and Specifications

BATTERY

Your vehicle is equipped with a Mazda maintenance-free battery which normally does not require additional water during its life of service.

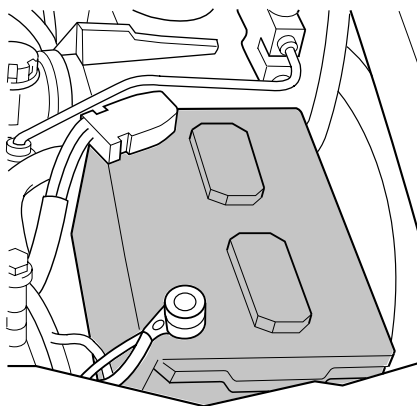

However, for severe usage or in high temperature climates, check the battery electrolyte level. Refer to the service maintenance section for the service interval schedules.

Keep the electrolyte level in each cell up to the “level indicator”. Do not overfill the battery cells.

If possible, try to only fill the battery cells with distilled water. If the battery needs water often, have the charging system checked.

If your battery has a cover/shield, make sure it is reinstalled after the battery has been cleaned or replaced.

For longer, trouble-free operation, keep the top of the battery clean and dry. Also, make certain the battery cables are always tightly fastened to the battery terminals.

If you see any corrosion on the battery or terminals, remove the cables from the terminals and clean with a wire brush. You can neutralize the acid with a solution of baking soda and water.

WARNING: Batteries normally produce explosive gases which can cause personal injury. Therefore, do not allow flames, sparks or lighted substances to come near the battery. When working near the battery, always shield your face and protect your eyes. Always provide proper ventilation.

Maintenance and Specifications

WARNING: When lifting a plastic-cased battery, excessive pressure on the end walls could cause acid to flow through the vent caps, resulting in personal injury and/or damage to the vehicle or battery. Lift the battery with a battery carrier or with your hands on opposite corners.

WARNING: Keep batteries out of reach of children. Batteries contain sulfuric acid. Avoid contact with skin, eyes or clothing. Shield your eyes when working near the battery to protect against possible splashing of acid solution. In case of acid contact with skin or eyes, flush immediately with water for a minimum of 15 minutes and get prompt medical attention. If acid is swallowed, call a physician immediately.

WARNING: Battery posts, terminals and related accessories contain lead and lead compounds. Wash hands after handling.

Because your vehicle's engine is electronically controlled by a computer, some control conditions are maintained by power from the battery. When the battery is disconnected or a new battery is installed, the engine must relearn its idle and fuel trim strategy for optimum driveability and performance. To begin this process:

1. With the vehicle at a complete stop, set the parking brake.
 2. Put the gearshift lever in P (Park), turn off all accessories and start the engine.
 3. Run the engine until it reaches normal operating temperature.
 4. Allow the engine to idle for at least one minute.
 5. Turn the A/C on and allow the engine to idle for at least one minute.
 6. Drive the vehicle to complete the relearning process.
- The vehicle may need to be driven to relearn the idle and fuel trim strategy.
 - **If you do not allow the engine to relearn its idle trim, the idle quality of your vehicle may be adversely affected until the idle trim is eventually relearned.**

Maintenance and Specifications

When the battery is disconnected or a new battery installed, the transmission must relearn its adaptive strategy. As a result of this, the transmission may shift firmly. This operation is considered normal and will not affect function or durability of the transmission. Over time the adaptive learning process will fully update transmission operation to its optimum shift feel.

If the battery has been disconnected or a new battery has been installed, the clock and the preset radio stations must be reset once the battery is reconnected.

- Always dispose of automotive batteries in a responsible manner. Follow your local authorized standards for disposal. Call your local authorized recycling center to find out more about recycling automotive batteries.

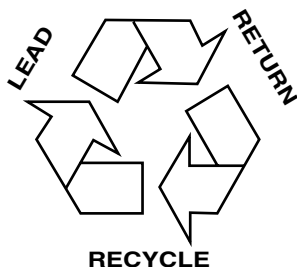

ENGINE COOLANT

Checking engine coolant

Your engine's cooling system has been factory-filled with a 50/50 mixture of distilled water and Mazda Genuine Engine Coolant, or an equivalent premium engine coolant that meets Mazda specification.

A **50/50 mixture** of distilled water and Mazda Genuine Engine Coolant provides:

- **maximum cooling system efficiency.**
- **freeze protection down to -36°C (-34°F).**
- **boiling protection up to 129°C (265°F).**
- **protection against rust and other forms of corrosion.**
- **an accurate temperature readout from the engine coolant gauge.**

The engine coolant must be maintained at the correct fluid level and concentration to work properly. If the engine coolant fluid level and concentration is not maintained correctly, damage to the engine and cooling system may result.

Maintenance and Specifications

- 2.3L engine

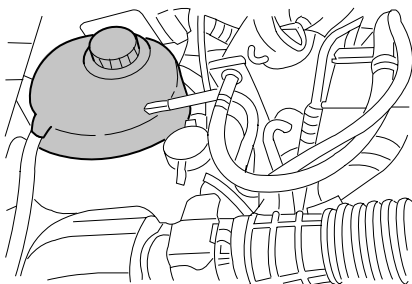

- 3.0L & 4.0L engines

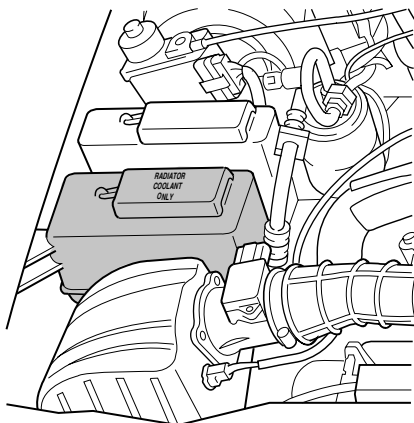

When the engine is cold, check the level of the engine coolant in the reservoir.

- The engine coolant should be at the “cold fill level” or within the “cold fill range” as listed on the engine coolant reservoir (depending upon application).
- Confirm the color and type of engine coolant before adding, to avoid mixing incompatible products.
- Refer to the service maintenance section for service interval schedules.
- Be sure to read and understand *Precautions when servicing your vehicle* in this chapter.

Maintenance and Specifications

If the engine coolant has not been checked at the recommended interval, the engine coolant reservoir may become low or empty. If the reservoir is low or empty, add engine coolant to the reservoir. Refer to *Adding engine coolant* in this chapter.

WARNING: Automotive fluids are not interchangeable; do not use engine coolant, antifreeze or windshield washer fluid outside of its specified function and vehicle location.

Adding engine coolant

Use only Mazda Genuine Engine Coolant or a premium engine coolant that meets a Mazda specification.

- **DO NOT USE Extended Life Engine Coolant (orange in color).**
- **DO NOT USE a DEX-COOL® engine coolant or an equivalent engine coolant.**
- **DO NOT USE alcohol or methanol antifreeze or any engine coolants mixed with alcohol or methanol antifreeze.**
- **DO NOT USE supplemental coolant additives in your vehicle. These additives may harm your engine's cooling system.**
- **DO NOT MIX different colors or types of coolant in your vehicle. Make sure the correct coolant is used.**
- **DO NOT MIX recycled coolant and conventional coolant together in your vehicle. Mixing of engine coolants may harm your engine's cooling system.**
- **The use of an improper coolant may harm engine and cooling system components and may void the warranty of your vehicle's engine cooling system. If you are unsure which type of coolant your vehicle requires, contact your local dealer.**

WARNING: Do not put engine coolant in the windshield washer fluid reservoir. If engine coolant is sprayed onto the windshield, it could make it difficult to see through the windshield.

When the engine is cool, add a **50/50 mixture** of engine coolant and distilled water to the engine coolant reservoir, until the coolant is at the "cold fill level" or within the "cold fill range" as listed in the engine coolant reservoir (depending upon application).

- **NEVER increase the coolant concentration above 60%.**

Maintenance and Specifications

- **NEVER decrease the coolant concentration below 40%.**
- **Engine coolant concentrations above 60% or below 40% will decrease the freeze protection characteristics of the engine coolant and may cause engine damage.**

Plain water may be added in an emergency, but you **must** replace it with a 50/50 mixture of engine coolant and distilled water as soon as possible.

Check the coolant level in the reservoir before you drive your vehicle the next few times (with the engine cool). If necessary, add a **50/50 mixture** of engine coolant and distilled water to the engine coolant reservoir until the coolant level is at the “cold fill level” or within the “cold fill range” as listed on the reservoir (depending upon application).

Have your dealer check the engine cooling system for leaks if you have to add more than 1.0 liter (1.0 quart) of engine coolant per month.

WARNING: To avoid scalding hot steam or coolant from being released from the engine cooling system, never remove the reservoir cap while the engine is running or hot. Failure to follow this warning may result in damage to the engine’s cooling system and possible severe personal injury.

If you must remove the coolant cap, follow these steps to avoid personal injury:

1. Before you remove the cap, turn the engine off and let it cool.
2. When the engine is cool, wrap a thick cloth around the cap. Slowly turn cap counterclockwise until pressure begins to release.
3. Step back while the pressure releases.
4. When you are sure that all the pressure has been released, use the cloth to turn it counterclockwise and remove the cap.

Recycled engine coolant

Not all coolant recycling processes produce coolant which meets Mazda specification. Use of a recycled engine coolant which does not meet Mazda specifications may harm engine and cooling system components.



Always dispose of used automotive fluids in a responsible manner. Follow your community’s regulations and standards for recycling and disposing of automotive fluids.

Coolant refill capacity

To find out how much fluid your vehicle’s cooling system can hold, refer to *Refill capacities* in this chapter.

Maintenance and Specifications

Fill your engine coolant reservoir as outlined in *Adding engine coolant* in this chapter.

Severe climates

If you drive in extremely cold climates (less than -36°C [-34°F):

- **It may be necessary to increase the coolant concentration above 50%.**
- **NEVER increase the coolant concentration above 60%.**
- **Increased engine coolant concentrations above 60% will decrease the overheat protection characteristics of the engine coolant and may cause engine damage.**
- **Refer to the chart on the coolant container to ensure the coolant concentration in your vehicle will provide adequate freeze protection at the temperatures in which you drive in the winter months.**

If you drive in extremely hot climates:

- **It is still necessary to maintain the coolant concentration above 40%.**
- **NEVER decrease the coolant concentration below 40%.**
- **Decreased engine coolant concentrations below 40% will decrease the corrosion protection characteristics of the engine coolant and may cause engine damage.**
- **Decreased engine coolant concentrations below 40% will decrease the freeze protection characteristics of the engine coolant and may cause engine damage.**
- **Refer to the chart on the coolant container to ensure the coolant concentration in your vehicle will provide adequate protection at the temperatures in which you drive.**

Vehicles driven year-round in non-extreme climates should use a 50/50 mixture of engine coolant and distilled water for optimum cooling system and engine protection.

What you should know about Limp to Safety cooling (2.3L I4 engines only)

If the engine coolant supply is depleted, this feature allows the vehicle to be driven temporarily to a place of safety. The distance it can be driven depends on ambient temperatures, vehicle load and terrain, so when the engine drops into this mode, it is because the engine has overheated and you need to take special care to avoid it shutting down.

Maintenance and Specifications

How Limp to Safety works

If the engine begins to overheat:

- The engine coolant temperature gauge will move to the red (hot) area.
- The  symbol will illuminate.
- The “Service Engine Soon” indicator light will illuminate.

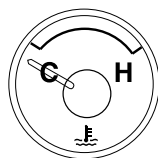

If the engine reaches a preset over-temperature condition, the engine will automatically switch to alternating cylinder operation. Each disabled cylinder acts as an air pump and cools the engine.

When this occurs the vehicle will still operate. However:

- The engine power will be limited.
- The air conditioning system will be disabled.

This system has given you an early warning of engine damage and you should immediately drive to a place of safety where the engine can be cooled or the vehicle towed to a service shop. Continuing to drive in this Limp to Safety mode will increase engine temperature some more, increasing the chance of engine damage, and:

- The engine will completely shut down.
- Steering and braking effort will increase.

If you have decided not to have the vehicle towed, and when the engine temperature cools, you try to re-start it and it appears to have returned to normal operation, don't delay in getting to a service facility as soon as possible to diagnose what caused the overheat and prevent further engine damage.

When Limp to Safety mode is activated

You have limited engine power when in the Limp to Safety mode, so drive the vehicle with caution. The vehicle will not be able to maintain high speed operation and the engine will run rough. Remember that the engine is capable of completely shutting down automatically to prevent engine damage, therefore:

1. Pull off the road as soon as safely possible and turn off the engine.
2. Arrange for the vehicle to be taken to a service facility.
3. If this is not possible, wait for the engine to cool down.

Maintenance and Specifications

4. When the engine has cooled down, first check the coolant level. If low, then use a rag and carefully turn the cap one notch counter-clockwise carefully to avoid being burned by hot steam. When there is no steam, keep your face back as you carefully remove the cap and then replenish the coolant to the full line.

WARNING: Never remove the coolant reservoir cap while the engine is running or hot.

5. Replace the cap and see if the engine starts and runs normally and drive it to a service place under reduced load and with the air conditioning off. If it quickly goes into Limp to Safety mode again, shut it down in a safe location and have the vehicle towed for service.

WHAT YOU SHOULD KNOW ABOUT AUTOMOTIVE FUELS

Important safety precautions

WARNING: Do not overfill the fuel tank. The pressure in an overfilled tank may cause leakage and lead to fuel spray and fire.

WARNING: The fuel system may be under pressure. If the fuel filler cap is venting vapor or if you hear a hissing sound, wait until it stops before completely removing the fuel filler cap. Otherwise, fuel may spray out and injure you or others.

WARNING: If you do not use the proper fuel filler cap, excessive pressure or vacuum in the fuel tank may damage the fuel system or cause the fuel cap to disengage in a collision, which may result in possible personal injury.

WARNING: Automotive fuels can cause serious injury or death if misused or mishandled.

WARNING: Fuel ethanol and gasoline may contain benzene, which is a cancer-causing agent.

Maintenance and Specifications

Observe the following guidelines when handling automotive fuel:

- Extinguish all smoking materials and any open flames before fueling your vehicle.
- Always turn off the vehicle before fueling.
- Automotive fuels can be harmful or fatal if swallowed. Fuels such as gasoline and ethanol are highly toxic and if swallowed can cause death or permanent injury. If fuel is swallowed, call a physician immediately, even if no symptoms are immediately apparent. The toxic effects of fuel may not be visible for hours.
- Avoid inhaling fuel vapors. Inhaling too much fuel vapor of any kind can lead to eye and respiratory tract irritation. In severe cases, excessive or prolonged breathing of fuel vapor can cause serious illness and permanent injury.
- Avoid getting fuel liquid in your eyes. If fuel is splashed in the eyes, remove contact lenses (if worn), flush with water for 15 minutes and seek medical attention. Failure to seek proper medical attention could lead to permanent injury.
- Fuels can also be harmful if absorbed through the skin. If fuel is splashed on the skin and/or clothing, promptly remove contaminated clothing and wash skin thoroughly with soap and water. Repeated or prolonged skin contact with fuel liquid or vapor causes skin irritation.
- Be particularly careful if you are taking “Antabuse” or other forms of disulfiram for the treatment of alcoholism. Breathing gasoline and/or ethanol vapors, or skin contact could cause an adverse reaction. In sensitive individuals, serious personal injury or sickness may result. If fuel is splashed on the skin, promptly wash skin thoroughly with soap and water. Consult a physician immediately if you experience an adverse reaction.
- FFV fuel tanks may contain zero to 85 percent ethanol. Any fuel blends containing gasoline and ethanol should be treated the same as “Fuel Ethanol”. To identify if your vehicle is an FFV, check your VIN or the label on the inside of your fuel filler door. When checking the VIN look for the engine type identifier (8th character). If your vehicle is an FFV, then the character will be labeled as a “V.”



Maintenance and Specifications

Ethanol

Pure ethanol is the alcohol which is the intoxicating agent in liquor, beer and wine. It is distilled from the fermentation of plants such as field corn and sugar cane. When ethanol is used in the making of motor fuels, a small amount of a bad tasting chemical is added to discourage beverage use. The resulting fuel is called E_d100 meaning 100% pure ethanol diluted by 2% to 5% gasoline as the “denaturant.”

Fuel ethanol (summer blend_d) is then made by adding 15% more unleaded gasoline. The resulting fuel also has a higher octane rating than unleaded regular gasoline and other properties which allow engine designs with greater efficiency and power.

Winter blends may contain up to 30% (E70) unleaded gasoline (25% plus the denaturant) to enhance cold engine starts. Severely cold weather may require additional measures for reliable starting. Refer to *Cold Weather Starting* in the *Driving* chapter.

Ethanol is more chemically active than gasoline. It corrodes some metals and causes some plastic and rubber components to swell, break down or become brittle and crack, especially when mixed with gasoline. Special materials and procedures have been developed for flexible fuel vehicles and the dispensers used by ethanol fuel providers.

WARNING: Flexible fuel components and standard unleaded gasoline fuel components are not interchangeable. If your vehicle is not serviced in accordance with flexible fuel vehicles procedures, damage may occur and your warranty may be invalidated.

WARNING: When refueling always shut the engine off and never allow sparks or open flames near the filler neck. Never smoke while refueling. Fuel vapor is extremely hazardous under certain conditions. Care should be taken to avoid inhaling excess fumes.

WARNING: The flow of fuel through a fuel pump nozzle can produce static electricity, which can cause a fire if fuel is pumped into an ungrounded fuel container.

Maintenance and Specifications

Use the following guidelines to avoid static build-up when filling an ungrounded fuel container:

- Place approved fuel container on the ground.
- DO NOT fill a fuel container while it is in the vehicle (including the cargo area/pickup bed).
- Keep the fuel pump nozzle in contact with the fuel container while filling.
- DO NOT use a device that would hold the fuel pump handle in the fill position.



Fuel Filler Cap

Your fuel tank filler cap has an indexed design with a 1/4 turn on/off feature.

When fueling your vehicle:

1. Turn the engine off.
2. Carefully turn the filler cap counterclockwise 1/4 of a turn until it stops.
3. Pull to remove the cap from the fuel filler pipe.
4. To install the cap, align the tabs on the cap with the notches on the filler pipe.
5. Turn the filler cap clockwise 1/4 of a turn until it stops.

“Check Fuel Cap” illuminates when the ignition is turned to the ON position to ensure your bulb is working. When this light turns on, check the fuel filler cap. Continuing to operate the vehicle with the Check Fuel Cap light on, can activate the Service Engine Soon warning. When the fuel filler cap is properly re-installed, the light(s) will turn off after a period of normal driving. **It may take a long period of time for the system to detect an improperly installed fuel filler cap.**

If you must replace the fuel filler cap, replace it with a fuel filler cap that is designed for your vehicle. The warranty may be void for any damage to the fuel tank or fuel system if the correct genuine Mazda fuel filler cap is not used.

Maintenance and Specifications

WARNING: The fuel system may be under pressure. If the fuel filler cap is venting vapor or if you hear a hissing sound, wait until it stops before completely removing the fuel filler cap. Otherwise, fuel may spray out and injure you or others.

WARNING: If you do not use the proper fuel filler cap, excessive pressure or vacuum in the fuel tank may damage the fuel system or cause the fuel cap to disengage in a collision, which may result in possible personal injury.

Choosing the right fuel

Use only UNLEADED FUEL. The use of leaded fuel is prohibited by law and could damage your vehicle.

If your vehicle is a flexible fuel vehicle (FFV), use only UNLEADED FUEL and (E85) FUEL ETHANOL. The use of leaded fuel is prohibited by law and could damage your vehicle.

Do not use fuel containing methanol. It can damage critical fuel system components.

Your vehicle was not designed to use fuel or fuel additives with metallic compounds, including manganese-based additives.

Repairs to correct the effects of using a fuel for which your vehicle was not designed may not be covered by your warranty.

Octane recommendations

Do not be concerned if your engine sometimes knocks lightly. However, if it knocks heavily under most driving conditions while you are using fuel with the recommended octane rating, see your authorized Mazda dealership to prevent any engine damage.

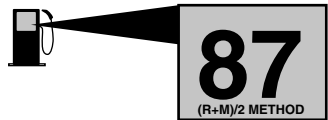

Unleaded Gasoline engines

Your vehicle is designed to use “Regular” unleaded gasoline with an (R+M)/2 octane rating of 87. We do not recommend the use of gasolines labeled as “Regular” that are sold with octane ratings of 86 or lower in high altitude areas.

Maintenance and Specifications

FFV engine (if equipped)

Your vehicle is designed to use (E85) Fuel Ethanol, “Regular” unleaded gasoline or any percentage of the two fuels combined.

U.S. government regulations require fuel ethanol dispensing pumps to have a small, square, orange and black label with the common abbreviation or the appropriate percentage for that region. Use of other fuels such as Fuel Methanol may cause powertrain damage, a loss of vehicle performance, and your warranty may be invalidated.

Fuel quality

Many of the world’s automakers approved the World-wide Fuel Charter that recommends gasoline specifications to provide improved performance and emission control system protection for your vehicle. Gasolines that meet the World-wide Fuel Charter should be used when available. Ask your fuel supplier about gasolines that meet the World-wide Fuel Charter.

It should not be necessary to add any aftermarket products to your fuel tank if you continue to use high quality fuel of the recommended octane rating. Aftermarket products could cause damage to the fuel system. Repairs to correct the effects of using an aftermarket product in your fuel may not be covered by your warranty.

Unleaded Gasoline engines

If you are experiencing starting, rough idle or hesitation driveability problems during a cold start, try a different brand of “Regular” unleaded gasoline. “Premium” unleaded gasoline is not recommended (particularly in the United States) because it may cause these problems to become more pronounced. If the problems persist, see your authorized Mazda dealership.

FFV engine (if equipped)

Your FFV will operate well on ordinary “Regular” unleaded gasoline, but only the highest quality fuel ethanol will provide the same level of protection and performance. To identify if your vehicle is an FFV, check your VIN or the label on the inside of your fuel filler door. When checking the VIN, look for the engine type identifier (8th character). If your vehicle is an FFV, then the character will be labeled as a “V.”

If you operate your vehicle 50% or more of the time on ethanol, you should follow a different maintenance schedule. See the *Service Maintenance Section* for more information.

Maintenance and Specifications

If you are experiencing a rough or rolling idle after start-up with the outside temperature above 27° C (80° F), the idle should improve within 10 to 30 seconds. If the problems persist below this temperature, see your authorized Mazda dealership.

Cleaner air

Mazda endorses the use of reformulated “cleaner-burning” gasolines to improve air quality.

Running out of fuel

Avoid running out of fuel because this situation may have an adverse affect on powertrain components.

If you have run out of fuel:

- You may need to cycle the ignition from OFF to ON several times after refueling, to allow the fuel system to pump the fuel from the tank to the engine.
- Your “Check Engine” indicator may come on. For more information on the “Check Engine” indicator, refer to the *Instrument Cluster* chapter.

Fuel Filter

For fuel filter replacement, see your authorized Mazda dealership. Refer to the service maintenance section for the appropriate intervals for changing the fuel filter.

Replace the fuel filter with an authorized Mazda part. The customer warranty may be void for any damage to the fuel system if an authorized Mazda fuel filter is not used.

ESSENTIALS OF GOOD FUEL ECONOMY

Measuring techniques

Your best source of information about actual fuel economy is you, the driver. You must gather information as accurately and consistently as possible. Fuel expense, frequency of fillups or fuel gauge readings are NOT accurate as a measure of fuel economy. We do not recommend taking fuel economy measurements during the first 1,600 km (1,000 miles) of driving (engine break-in period). You will get a more accurate measurement after 3,000 km–5,000 km (2,000 miles–3,000 miles).

Filling the tank

The advertised fuel capacity of the fuel tank on your vehicle is equal to the rated refill capacity of the fuel tank as listed in the *Refill capacities* section of this chapter.

Maintenance and Specifications

The advertised capacity is the amount of the indicated capacity and the empty reserve combined. Indicated capacity is the difference in the amount of fuel in a full tank and a tank when the fuel gauge indicates empty. Empty reserve is the small amount of fuel remaining in the fuel tank after the fuel gauge indicates empty.

The amount of usable fuel in the empty reserve varies and should not be relied upon to increase driving range. When refueling your vehicle after the fuel gauge indicates empty, you might not be able to refuel the full amount of the advertised capacity of the fuel tank due to the empty reserve still present in the tank.

For consistent results when filling the fuel tank:

- Turn the engine/ignition switch to the off position prior to refueling, an error in the reading will result if the engine is left running.
- Use the same filling rate setting (low — medium — high) each time the tank is filled.
- Allow no more than 2 automatic click-offs when filling.
- Always use fuel with the recommended octane rating.
- Use a known quality gasoline, preferably a national brand.
- Use the same side of the same pump and have the vehicle facing the same direction each time you fill up.
- Have the vehicle loading and distribution the same every time.

Your results will be most accurate if your filling method is consistent.

Calculating fuel economy

1. Fill the fuel tank completely and record the initial odometer reading (in kilometers or miles).
2. Each time you fill the tank, record the amount of fuel added (in liters or gallons).
3. After at least three to five tank fill-ups, fill the fuel tank and record the current odometer reading.
4. Subtract your initial odometer reading from the current odometer reading.
5. Follow one of the simple calculations in order to determine fuel economy:

Calculation 1: **Multiply liters used by 100, then divide by total kilometers traveled.**

Calculation 2: **Divide total miles traveled by total gallons used.**

Maintenance and Specifications

Keep a record for at least one month and record the type of driving (city or highway). This will provide an accurate estimate of the vehicle's fuel economy under current driving conditions. Additionally, keeping records during summer and winter will show how temperature impacts fuel economy. In general, lower temperatures give lower fuel economy.

Driving style — good driving and fuel economy habits

Give consideration to the lists that follow and you may be able to change a number of variables and improve your fuel economy.

Habits

- Smooth, moderate operation can yield up to 10% savings in fuel.
- Steady speeds without stopping will usually give the best fuel economy.
- Idling for long periods of time (greater than one minute) may waste fuel.
- Anticipate stopping; slowing down may eliminate the need to stop.
- Sudden or hard accelerations may reduce fuel economy.
- Slow down gradually.
- Driving at reasonable speeds (traveling at 88 km/h [55 mph] uses 15% less fuel than traveling at 105 km/h [65 mph]).
- Revving the engine before turning it off may reduce fuel economy.
- Using the air conditioner or defroster may reduce fuel economy.
- You may want to turn off the speed control in hilly terrain if unnecessary shifting between fourth and fifth gear occurs. Unnecessary shifting of this type could result in reduced fuel economy.
- Warming up a vehicle on cold mornings is not required and may reduce fuel economy.
- Resting your foot on the brake pedal while driving may reduce fuel economy.
- Combine errands and minimize stop-and-go driving.

Maintenance

- Keep tires properly inflated and use only recommended size.
- Operating a vehicle with the wheels out of alignment will reduce fuel economy.
- Use recommended engine oil. Refer to *Lubricant specifications* in this chapter.

Maintenance and Specifications

- Perform all regularly scheduled maintenance items. Follow the recommended maintenance schedule and owner maintenance checks found in your vehicle service maintenance section.

Conditions

- Heavily loading a vehicle or towing a trailer may reduce fuel economy at any speed.
- Carrying unnecessary weight may reduce fuel economy (approximately 0.4 km/L [1 mpg] is lost for every 180 kg [400 lb] of weight carried).
- Adding certain accessories to your vehicle (for example bug deflectors, rollbars/light bars, running boards, ski/luggage racks) may reduce fuel economy.
- Using fuel blended with alcohol may lower fuel economy.
- Fuel economy may decrease with lower temperatures during the first 12–16 km (8–10 miles) of driving.
- Driving on flat terrain offers improved fuel economy as compared to driving on hilly terrain.
- Transmissions give their best fuel economy when operated in the top cruise gear and with steady pressure on the gas pedal.
- Four-wheel-drive operation (if equipped) is less fuel efficient than two-wheel-drive operation.
- Close windows for high speed driving.

EPA window sticker

Every new vehicle should have the EPA window sticker. Contact your dealer if the window sticker is not supplied with your vehicle. The EPA window sticker should be your guide for the fuel economy comparisons with other vehicles.

It is important to note the box in the lower left corner of the window sticker. These numbers represent the Range of L/100 km (MPG) expected on the vehicle under optimum conditions. Your fuel economy may vary depending upon the method of operation and conditions.

EMISSION CONTROL SYSTEM

Your vehicle is equipped with various emission control components and a catalytic converter which will enable your vehicle to comply with applicable exhaust emission standards. To make sure that the catalytic converter and other emission control components continue to work properly:

Maintenance and Specifications

- Use only the specified fuel listed.
- Avoid running out of fuel.
- Do not turn off the ignition while your vehicle is moving, especially at high speeds.
- Have the items listed in your service maintenance section performed according to the specified schedule.

The scheduled maintenance items listed in the scheduled maintenance section are essential to the life and performance of your vehicle and to its emissions system.

If other than Mazda authorized parts are used for maintenance replacements or for service of components affecting emission control, such non-Mazda parts should be equivalent to genuine Mazda parts in performance and durability.

WARNING: Do not park, idle, or drive your vehicle in dry grass or other dry ground cover. The emission system heats up the engine compartment and exhaust system, which can start a fire.

Illumination of the **CHECK ENGINE** indicator, charging system warning light or the temperature warning light, fluid leaks, strange odors, smoke or loss of engine power, could indicate that the emission control system is not working properly.

WARNING: Exhaust leaks may result in entry of harmful and potentially lethal fumes into the passenger compartment.

Do not make any unauthorized changes to your vehicle or engine. By law, vehicle owners and anyone who manufactures, repairs, services, sells, leases, trades vehicles, or supervises a fleet of vehicles are not permitted to intentionally remove an emission control device or prevent it from working. Information about your vehicle's emission system is on the Vehicle Emission Control Information Decal located on or near the engine. This decal identifies engine displacement and gives some tune up specifications.

Please consult your "Warranty Information" for complete emission warranty information.

Maintenance and Specifications

Readiness for Inspection/Maintenance (I/M) testing

In some localities, it may be a legal requirement to pass an I/M test of the on-board diagnostics system. If your “Check Engine/Service Engine Soon” light is on, refer to the description in the *Warning lights and chimes* section of the *Instrument cluster* chapter. Your vehicle may not pass the I/M test with the “Check Engine/Service Engine Soon” light on.

If the vehicle’s powertrain system or its battery has just been serviced, the on-board diagnostics system is reset to a “not ready for I/M test” condition. To ready the on-board diagnostics system for I/M testing, a minimum of 30 minutes of city and highway driving is necessary as described below:

- First, at least 10 minutes of driving on an expressway or highway.
- Next, at least 20 minutes driving in stop-and-go, city-type traffic with at least four idle periods.

Allow the vehicle to sit for at least eight hours without starting the engine. Then, start the engine and complete the above driving cycle. The engine must warm up to its normal operating temperature. Once started, do not turn off the engine until the above driving cycle is complete.

Maintenance and Specifications

CHECKING AND ADDING POWER STEERING FLUID

- 2.3L I4 engine

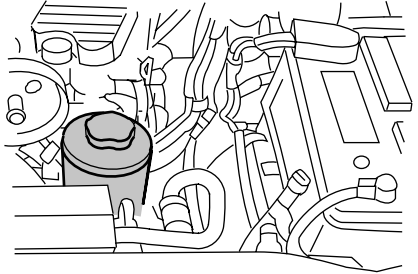

- 3.0L V6 engine

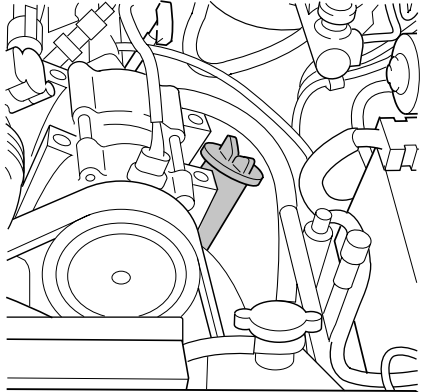

- 4.0L V6 engine

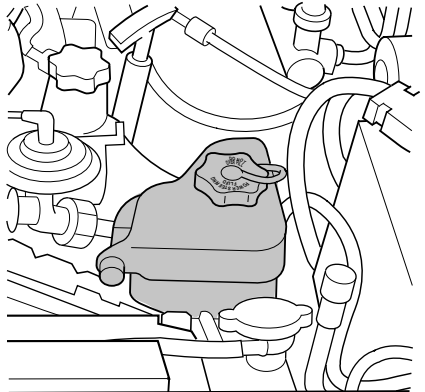

Maintenance and Specifications

Check the power steering fluid. Refer to the service maintenance section for the service interval schedules. If adding fluid is necessary, use only MERCON® ATF.

1. Start the engine and let it run until it reaches normal operating temperature (the engine coolant temperature gauge indicator will be near the center of the normal area between H and C).
2. While the engine idles, turn the steering wheel left and right several times.
3. Turn the engine off.
4. **If your vehicle is equipped with a 3.0L V6 engine**, check the fluid level on the dipstick. It should be within the FULL HOT range. Do not add fluid if the level is within this range.
5. **If your vehicle is equipped with a 4.0L SOHC V6 or 2.3L I4 engine**, check the fluid level in the reservoir. It should be between the MIN and MAX lines. Do not add fluid if the level is within this range.
6. If the fluid is low, add fluid in small amounts, continuously checking the level until it reaches the FULL HOT range. Be sure to put the dipstick back in the reservoir.

BRAKE FLUID RESERVOIR

The fluid level will drop slowly as the brakes wear, and will rise when the brake components are replaced. Fluid levels below the “MAX” line that do not trigger the brake system warning lamp are within the normal operating range, there is no need to add fluid. If the fluid levels are outside of the normal operating range, the performance of your brake system could be compromised, seek service from your Mazda dealer immediately.

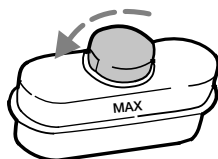

WARNING: Brake fluid is toxic. If brake fluid contacts the eyes, flush eyes with running water for 15 minutes. Seek medical attention if irritation persists. If taken internally, drink water and induce vomiting. Seek medical attention immediately.

Maintenance and Specifications

WARNING: If you use a brake fluid that is not DOT 3, you will cause permanent damage to your brakes.

WARNING: Do not let the reservoir for the master cylinder run dry. This may cause the brakes to fail.

CLUTCH FLUID (IF EQUIPPED)

Check the fluid level. Refer to the service maintenance section for the service interval schedules.

During normal operation, the fluid level in the clutch reservoir should remain constant. If the fluid level drops, refill the fluid level to the step in the reservoir.

Use only a DOT 3 brake fluid designed to meet Mazda specification. Refer to *Lubricant Specifications* in this chapter.

WARNING: Brake fluid is toxic. If brake fluid contacts the eyes, flush eyes with running water for 15 minutes. Seek medical attention if irritation persists. If taken internally, drink water and induce vomiting. Seek medical attention immediately.

1. Clean the reservoir cap before removal to prevent dirt and water from entering the reservoir.
2. Remove cap and rubber diaphragm from reservoir.
3. Add fluid until the level reaches the step in the reservoir.
4. Reinstall rubber diaphragm and cap onto reservoir.

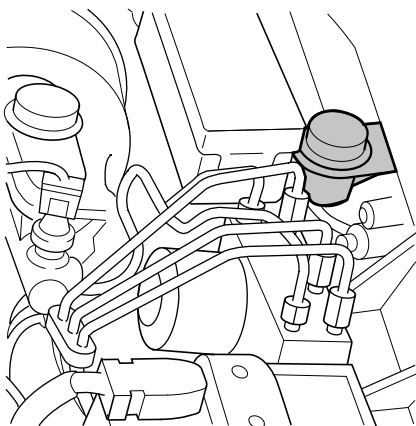

Maintenance and Specifications

TRANSMISSION FLUID

Checking automatic transmission fluid (if equipped)

Refer to your service maintenance section for scheduled intervals for fluid checks and changes. Your transmission does not consume fluid. However, the fluid level should be checked if the transmission is not working properly, i.e., if the transmission slips or shifts slowly or if you notice some sign of fluid leakage.

Automatic transmission fluid expands when warmed. To obtain an accurate fluid check, drive the vehicle until it is at normal operating temperature (approximately 30 km [20 miles]). If your vehicle has been operated for an extended period at high speeds, in city traffic during hot weather or pulling a trailer, the vehicle should be turned off for about 30 minutes to allow fluid to cool before checking.

- Refer to your *Service Maintenance Section* for scheduled check and change intervals.
- Transmission does not consume fluid.
- Check fluid when transmission is not operating properly or if you see a leak.
- Fluid level must be checked at normal operating temperature, 30 km (20 miles) of driving.
- DO NOT ADD fluid until the transmission is at normal operating temperatures or the transmission will be overfilled.

To check and add fluid:

1. Drive the vehicle 30 km (20 miles) to reach normal operating temperatures.
- If vehicle was driven in hot weather, city traffic, pulling a trailer, allow transmission to cool for 30 minutes before checking.
2. Engage parking brake, start engine.
3. Put your foot on the brake pedal and move the gearshift lever slowly through all of the gear ranges.
4. Shift to P (Park) and leave the engine running.
5. Remove the dipstick, wipe clean with a dry lint free rag.
6. Install and fully seat the dipstick into the filler tube.

Maintenance and Specifications

7. Remove the dipstick and inspect the fluid level. Level should be in the cross-hatched area.

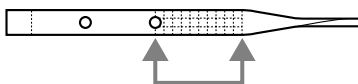

8. If necessary, add fluid in 250ml (1/2 pint) increments through the filler tube until the level is correct at normal operating temperatures. Refer to the *Lubricant Specifications* section in this chapter for the correct fluid type.

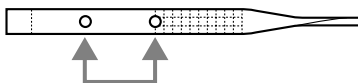

- The use of any other non-approved fluid may cause internal transmission damage.
- DO NOT ADD fluid until the transmission is at normal operating temperatures or the transmission will be overfilled.

Low fluid level

Do not drive the vehicle if the fluid level is at or below the bottom of the dipstick.

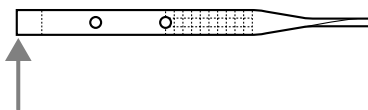

High fluid level

Fluid levels above the safe range may cause overheating, shift and/or engagement concerns and internal transmission damage. If an overfill condition occurs, excess fluid should be removed by a qualified technician.

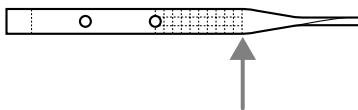

Maintenance and Specifications

Checking and adding manual transmission fluid (if equipped)

1. Park the vehicle on a level surface.
2. Engage the parking brake fully – put in first gear.
3. Assure the vehicle cannot move.
4. Clean the filler plug.
5. Remove the filler plug and inspect the fluid level.

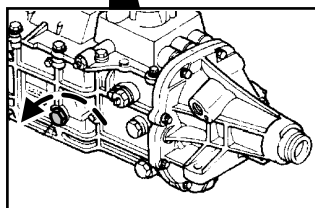
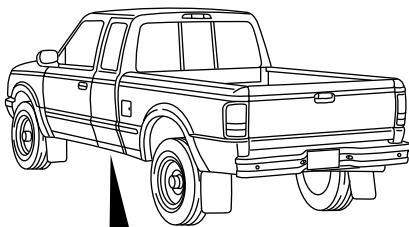

6. Fluid level should be at the bottom of the opening.
7. Add enough fluid through the filler opening so that the fluid level is at the bottom of the opening.
8. Install and tighten the fill plug securely.

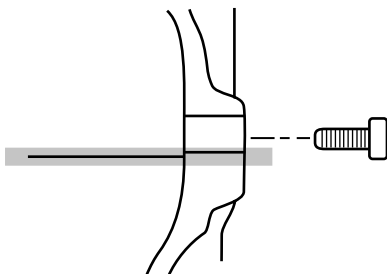

Use only fluid that meets Mazda specifications. Refer to *Lubricant Specifications* in this chapter.

Maintenance and Specifications

Checking and adding transfer case fluid (if equipped)

1. Park the vehicle on a level surface.
2. Engage the parking brake fully – put in first gear.
3. Assure the vehicle cannot move.
4. Clean the filler plug.
5. Remove the filler plug and inspect the fluid level.

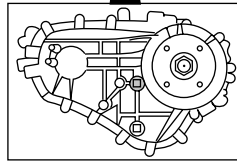
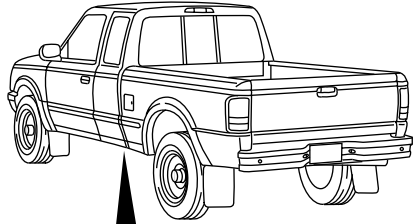

6. Fluid level should be at the bottom of the opening.
7. Add enough fluid through the filler opening so that the fluid level is at the bottom of the opening.
8. Install and tighten the fill plug securely.

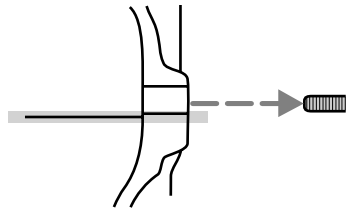

Use only fluid that meets Mazda specifications. Refer to *Lubricant Specifications* in this chapter.

DRIVELINE UNIVERSAL JOINT AND SLIP YOKE

Your vehicle may be equipped with universal joints that require lubrication. If the original universal joints are replaced with universal joints equipped with grease fittings, lubrication will also be necessary.

Maintenance and Specifications

CHECKING AND ADDING REAR DIFFERENTIAL FLUID

1. Park the vehicle on a level surface.
2. Engage the parking brake fully – put in first gear.
3. Assure the vehicle cannot move.
4. Clean the filler plug.
5. Remove the filler plug and inspect the fluid level.
6. Fluid level should be at the bottom of the opening.
7. Add enough fluid through the filler opening so that the fluid level is at the bottom of the opening.
8. Install and tighten the fill plug securely.

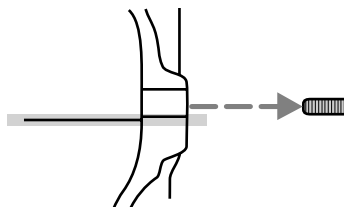
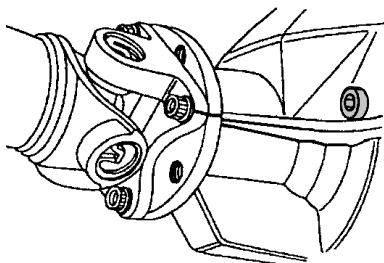

Use only fluid that meets Mazda specifications. Refer to *Lubricant Specifications* in this chapter.

INFORMATION ABOUT UNIFORM TIRE QUALITY GRADING

New vehicles are fitted with tires that have a rating on them called Tire Quality Grades. The Quality grades can be found where applicable on the tire sidewall between tread shoulder and maximum section width. For example:

- **Treadwear 200 Traction AA Temperature A**

These Tire Quality Grades are determined by standards that the United States Department of Transportation has set.

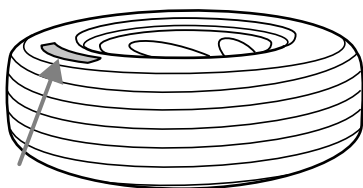

Maintenance and Specifications

Tire Quality Grades apply to new pneumatic tires for use on passenger cars. They do not apply to deep tread, winter-type snow tires, space-saver or temporary use spare tires, tires with nominal rim diameters of 10 to 12 inches or limited production tires as defined in Title 49 Code of Federal Regulations Part 575.104(c)(2).

U.S. Department of Transportation-Tire quality grades: The U.S. Department of Transportation requires Mazda to give you the following information about tire grades exactly as the government has written it.

Treadwear

The treadwear grade is a comparative rating based on the wear rate of the tire when tested under controlled conditions on a specified government test course. For example, a tire graded 150 would wear one and one-half (1 1/2) times as well on the government course as a tire graded 100. The relative performance of tires depends upon the actual conditions of their use, however, and may depart significantly from the norm due to variations in driving habits, service practices, and differences in road characteristics and climate.

Traction AA A B C

The traction grades, from highest to lowest are AA, A, B, and C. The grades represent the tire's ability to stop on wet pavement as measured under controlled conditions on specified government test surfaces of asphalt and concrete. A tire marked C may have poor traction performance.

NOTE: The traction grade assigned to this tire is based on straight-ahead braking traction tests, and does not include acceleration, cornering, hydroplaning or peak traction characteristics.

Temperature A B C

The temperature grades are A (the highest), B, and C, representing the tire's resistance to the generation of heat and its ability to dissipate heat when tested under controlled conditions on a specified indoor laboratory test wheel. Sustained high temperature can cause the material of the tire to degenerate and reduce tire life, and excessive temperature can lead to sudden tire failure. The grade C corresponds to a level of performance which all passenger car tires must meet under the Federal Motor Vehicle Safety Standard No. 109. Grades B and A represent higher levels of performance on the laboratory test wheel than the minimum required by law.

Maintenance and Specifications

WARNING: The temperature grade for this tire is established for a tire that is properly inflated and not overloaded. Excessive speed, underinflation, or excessive loading, either separately or in combination, can cause heat buildup and possible tire failure.

TIRES

Tires are designed to give many thousands of miles of service, but they must be maintained in order to get the maximum benefit from them.

Glossary of tire terminology

- **Tire label:** A label showing the OE (Original Equipment) tire sizes, recommended inflation pressure and the maximum weight the vehicle can carry.
- **Tire Identification Number (TIN):** A number on the sidewall of each tire providing information about the tire brand and manufacturing plant, tire size and date of manufacturer.
- **Inflation pressure:** A measure of the amount of air in a tire.
- **Standard load:** A class of P-metric or Metric tires designed to carry a maximum load at 35 psi [37 psi (2.5 bar) for Metric tires]. Increasing the inflation pressure beyond this pressure will not increase the tires load carrying capability.
- **Extra load:** A class of P-metric or Metric tires designed to carry a heavier maximum load at 41 psi [43 psi (2.9 bar) for Metric tires]. Increasing the inflation pressure beyond this pressure will not increase the tires load carrying capability.
- **kPa:** Kilopascal, a metric unit of air pressure.
- **PSI:** Pounds per square inch, a standard unit of air pressure.
- **B-pillar:** The structural member at the side of the vehicle behind the front door.
- **Bead area of the tire:** Area of the tire next to the rim.
- **Sidewall of the tire:** Area between the bead area and the tread.
- **Tread area of the tire:** Area of the perimeter of the tire that contacts the road when mounted on the vehicle.
- **Rim:** The metal support (wheel) for a tire or a tire and tube assembly upon which the tire beads are seated.

Maintenance and Specifications

INFORMATION CONTAINED ON THE TIRE SIDEWALL

Federal law requires tire manufacturers to place standardized information on the sidewall of all tires. This information identifies and describes the fundamental characteristics of the tire and also provides a tire identification number for safety standard certification and in case of a recall.

Information on “P” type tires

P215/65R15 95H is an example of a tire size, load index and speed rating. The definitions of these items are listed below. (Note that the tire size, load index and speed rating for your vehicle may be different than this example.)

1. **P:** Indicates a tire, designated by the Tire and Rim Association (T&RA), that maybe used for service on cars, SUVs, minivans and light trucks.

Note: If your tire size does not begin with a letter this may mean it is designated by either ETRTO

(European Tire and Rim Technical Organization) or JATMA (Japan Tire Manufacturing Association).

2. **215:** Indicates the nominal width of the tire in millimeters from sidewall edge to sidewall edge. In general, the larger the number, the wider the tire.
3. **65:** Indicates the aspect ratio which gives the tire’s ratio of height to width.
4. **R:** Indicates a “radial” type tire.
5. **15:** Indicates the wheel or rim diameter in inches. If you change your wheel size, you will have to purchase new tires to match the new wheel diameter.
6. **95:** Indicates the tire’s load index. It is an index that relates to how much weight a tire can carry. You may find this information in your owner’s guide. If not, contact a local tire dealer.

Note: You may not find this information on all tires because it is not required by federal law.

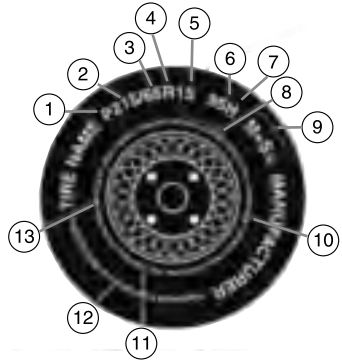

Maintenance and Specifications

7. **H:** Indicates the tire's speed rating. The speed rating denotes the speed at which a tire is designed to be driven for extended periods of time under a standard condition of load and inflation pressure. The tires on your vehicle may operate at different conditions for load and inflation pressure. These speed ratings may need to be adjusted for the difference in conditions. The ratings range from 159 km/h (99 mph) to 299 km/h (186 mph). These ratings are listed in the following chart.

Note: You may not find this information on all tires because it is not required by federal law.

Letter rating	Speed rating - km/h (mph)
Q	159 km/h (99 mph)
R	171 km/h (106 mph)
S	180 km/h (112 mph)
T	190 km/h (118 mph)
U	200 km/h (124 mph)
H	210 km/h (130 mph)
V	240 km/h (149 mph)
W	270 km/h (168 mph)
Y	299 km/h (186 mph)

Note: For tires with a maximum speed capability over 240 km/h (149 mph), tire manufacturers sometimes use the letters ZR. For those with a maximum speed capability over 299 km/h (186 mph), tire manufacturers always use the letters ZR.

8. **U.S. DOT Tire Identification Number (TIN):** This begins with the letters "DOT" and indicates that the tire meets all federal standards. The next two numbers or letters are the plant code where it was manufactured, the next two are the tire size code and the last four numbers represent the week and year the tire was built. For example, the numbers 317 mean the 31st week of 1997. After 2000 the numbers go to four digits. For example, 2501 means the 25th week of 2001. The numbers in between are marketing codes used at the manufacturer's discretion. This information is used to contact customers if a tire defect requires a recall.
9. **M+S or M/S:** Mud and Snow. or
AT: All Terrain. or
AS: All Season.

Maintenance and Specifications

10. **Tire Ply Composition and Material Used:** Indicates the number of plies or the number of layers of rubber-coated fabric in the tire tread and sidewall. Tire manufacturers also must indicate the ply materials in the tire and the sidewall, which include steel, nylon, polyester, and others.
11. **Maximum Load:** Indicates the maximum load in kilograms and pounds that can be carried by the tire. Refer to the tire label or the safety certification label, located on the B-Pillar or the driver's door, for the correct tire pressure for your vehicle
12. **Treadwear, Traction and Temperature Grades**
 - **Treadwear:** The treadwear grade is a comparative rating based on the wear rate of the tire when tested under controlled conditions on a specified government test course. For example, a tire graded 150 would wear one and one-half (1½) times as well on the government course as a tire graded 100.
 - **Traction:** The traction grades, from highest to lowest are AA, A, B, and C. The grades represent the tire's ability to stop on wet pavement as measured under controlled conditions on specified government test surfaces of asphalt and concrete. A tire marked C may have poor traction performance.
 - **Temperature:** The temperature grades are A (the highest), B and C, representing the tire's resistance to the generation of heat and its ability to dissipate heat when tested under controlled conditions on a specified indoor laboratory test wheel.
13. **Maximum Permissible Inflation Pressure:** Tire manufactures maximum permissible pressure and/or the pressure at which the maximum load can be carried by the tire. This pressure is normally higher than the manufacturer's recommended cold inflation pressure which can be found on either the tire label or certification label which is located on the structure by the trailing edge of the driver's door or the edge of the driver's door. The cold inflation pressure should never be set lower than the recommended pressure on the label.

Note: You may not find this information on all tires because it is not required by federal law.

The tire suppliers may have additional markings, notes or warnings such as standard load, radial tubeless, etc.

Maintenance and Specifications

Additional information contained on the tire sidewall for “LT” type tires

“LT” type tires have some additional information than those of “P” type tires; these differences are described below:

1. **LT:** Indicates a tire, designated by the Tire and Rim Association (T&RA), that is intended for service on light trucks.
2. **Load Range/Load Inflation Limits:** Indicates the tires load-carrying capabilities and its inflation limits.
3. **Maximum Load Dual kg (lbs.) at kPa (psi) cold:** Indicates the maximum load and tire pressure when the tire is used as a dual; a dual is defined as when four tires are put on the rear axle (a total of six or more tires on the vehicle).
4. **Maximum Load Single kg (lbs.) at kPa (psi) cold:** Indicates the maximum load and tire pressure when the tire is used as a single; a single is defined as when two tires (total) are put on the rear axle.

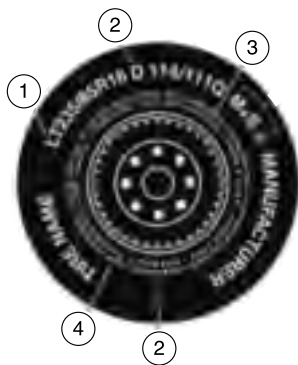

Maintenance and Specifications

Information on “T” type tires

T145/80D16 is an example of a tire size.

Note: The temporary tire size for your vehicle may be different than this example.

1. **T:** Indicates a type of tire, designated by the Tire and Rim Association (T&RA), that is intended for temporary service on cars, SUVs, minivans and light trucks.
2. **145:** Indicates the nominal width of the tire in millimeters from sidewall edge to sidewall edge. In general, the larger the number, the wider the tire.
3. **80:** Indicates the aspect ratio which gives the tires ratio of height to width. Numbers of 70 or lower indicate a short sidewall.
4. **D:** Indicates a “diagonal” type tire.
R: Indicates a “radial” type tire.
5. **16:** Indicates the wheel or rim diameter in inches. If you change your wheel size, you will have to purchase new tires to match the new wheel diameter.

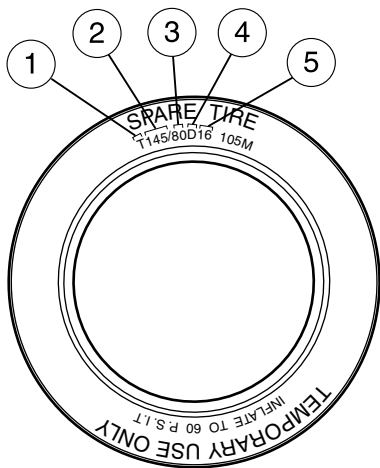

Location of the tire label

You will find a tire label containing tire inflation pressure by tire size and other important information located on the B-Pillar or the driver's door.

TIRE CARE

Improper or inadequate vehicle maintenance can also cause tires to wear abnormally. Here are some of the important maintenance items

Tire inflation pressure

Use a tire gauge to check the tire inflation pressure at least monthly (check the tire inflation in the spare tire every 6 months) and before long trips. You are strongly urged to buy a reliable tire pressure gauge, as automatic service station gauges may be inaccurate. Mazda recommends the use of a digital or dial type tire pressure gauge rather than a stick type of tire pressure gauge.

Maintenance and Specifications

Use the recommended cold inflation pressure for optimum tire performance and wear. Under-inflation or over-inflation may cause uneven treadwear patterns.

NOTE: If you are driving the vehicle at its maximum weight load, make sure the tire inflation pressure is correct for the weight load on the tires.

WARNING: Under-inflation is the most common cause of tire failures and may result in severe tire cracking, tread separation or "blowout", with unexpected loss of vehicle control and increased risk of injury. Under-inflation increases sidewall flexing and rolling resistance, resulting in heat buildup and internal damage to the tire. It also may result in unnecessary tire stress, irregular wear, loss of vehicle control and accidents. A tire can lose up to half of its air pressure and not appear to be flat!

When weather temperature changes occur, tire inflation pressures also change. A 10 degree temperature change causes a corresponding drop of 7 kPa (1 psi) in inflation pressure. Check your tire pressures frequently and adjust them to the proper pressure which can be found on the tire label or certification label.

If checking tire pressure when the tire is hot, (i.e. driven more than 1.6 km [1mile]), never "bleed" or reduce air pressure. The tires are hot from driving and it is normal for pressures to increase above recommended cold pressures. A hot tire at or below recommended cold inflation pressure could be significantly under-inflated.

To check the pressure in your tire(s):

1. Make sure the tires are cool, meaning they are not hot from driving even a mile.

Note: If you have to drive a distance to get air for your tire(s), check and record the tire pressure first and add the appropriate air pressure when you get to the pump. It is normal for tires to heat up and the air pressure inside to go up as you drive. Never "bleed" or reduce air pressure when tires are hot.

2. Remove the cap from the valve on one tire, then firmly press the tire gauge onto the valve.
3. Add air to reach the recommended air pressure

Note: If you overfill the tire, release air by pushing on the metal stem in the center of the valve. Then recheck the pressure with your tire gauge.

Maintenance and Specifications

4. Replace the valve cap.
5. Repeat this procedure for each tire, including the spare.

Note: Some spare tires require higher inflation pressure than the other tires.

6. Visually inspect the tires to make sure there are no nails or other objects embedded that could poke a hole in the tire and cause an air leak.
7. Check the sidewalls to make sure there are no gouges, cuts, bulges or other irregularities.

Tire and wheel alignment

A bad jolt from hitting a curb or pothole can cause the front end of your vehicle to become misaligned or damage to your tires. If your vehicle seems to pull to one side, vibrate or shake when you're driving, the wheels may be out of alignment. Have a qualified technician at a reputable repair facility check the wheel alignment periodically.

Wheel misalignment in the front or the rear can cause uneven and rapid treadwear of your tires and should be corrected by a qualified technician at a reputable repair facility. Front wheel drive (FWD) vehicles, and those with independent front suspension require alignment of all four wheels.

The tire should also be balanced periodically. An unbalanced tire and wheel assembly may result in irregular tire wear.

NOTE: When it is time to replace front tires with new ones, this is an ideal time to perform an alignment. New tires should be balanced at the time they are installed.

Tire rotation

Rotating your tires at the recommended interval (as indicated in the Service Maintenance Guide that comes with your vehicle) will help your tires wear more evenly providing better tire performance and longer tire life. Unless otherwise specified, rotate the tires approximately every 8,000 km (5,000 miles).

Maintenance and Specifications

- Front Wheel Drive (FWD) vehicles (front tires at top of diagram)

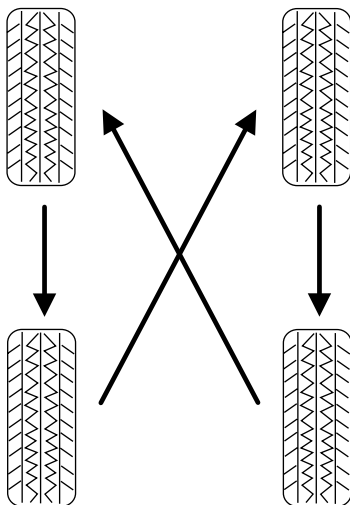

- Rear Wheel Drive (RWD) vehicles/Four Wheel Drive (4WD) vehicles (front tires at top of diagram)

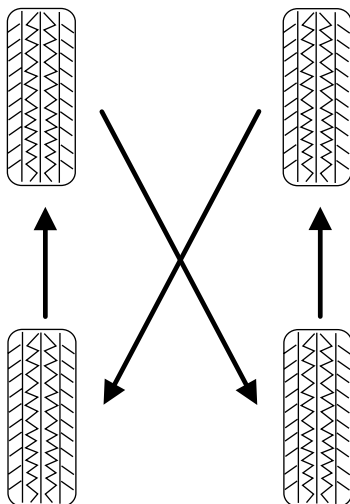

Maintenance and Specifications

Sometimes irregular tire wear can be corrected by rotating the tires.

Note: If your tires show uneven wear ask a qualified technician at a reputable repair facility to check for and correct any wheel misalignment, tire imbalance or mechanical problem involved before tire rotation.

Tire wear

Measure and inspect the tire tread on all your tires periodically. Advanced and unusual tire wear can reduce the ability of tread to grip the road in adverse (wet, snowy, etc.) conditions. Visually check your tires for uneven wear, looking for high and low areas or unusually smooth areas. Also check for signs of tire damage.

When the tread is worn down to 4 mm (1/16th of an inch), tires must be replaced to prevent your vehicle from skidding and hydroplaning.

Built-in treadwear indicators, or “wear bars”, which look like narrow strips of smooth rubber across the tread will appear on the tire when the tread is worn down to 4mm (1/16th of an inch). When you see these

“wear bars”, the tire is worn out and should be replaced.

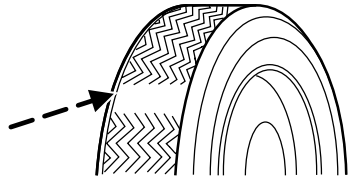

Inspect your tires frequently for any of the following conditions and replace them if one or more of the following conditions exist:

- Fabric showing through the tire rubber
- Bulges in the tread or sidewalls
- Cracks or cuts on the sidewalls
- Cracks in the tread groove
- Impact damage resulting from use
- Separation in the tread
- Separation in the sidewall
- Severe abrasion on the sidewall

If your vehicle has a leak in the exhaust system, a road tire or the spare tire may be exposed to hot exhaust temperatures requiring the tire to be replaced.

Maintenance and Specifications

Safety practices

Driving habits have a great deal to do with your tire mileage and safety.

- Observe posted speed limits
- Avoid fast starts, stops and turns
- Avoid potholes and objects on the road
- Do not run over curbs or hit the tire against a curb when parking

If your vehicle is stuck in snow, mud, sand, etc., **do not** rapidly spin the tires; spinning the tires can tear the tire and cause an explosion. A tire can explode in as little as three to five seconds.

WARNING: Tire explosions can cause death, personal injury or property damage. Do not allow anyone to stand near, or directly ahead or behind the spinning tire.

WARNING: Never spin the tires in excess of the 55 km/h (35 mph) point indicated on the speedometer.

Highway hazards

No matter how carefully you drive there's always the possibility that you may eventually have a flat tire on the highway. Drive slowly to the closest safe area out of traffic. This may further damage the flat tire, but your safety is more important.

If you feel a sudden vibration or ride disturbance while driving or you suspect your tire or vehicle has been damaged, immediately reduce your speed. Drive with caution until you can safely pull off the road. Stop and inspect the tire for damage. If the tire is under-inflated or damaged, deflate it, remove wheel and replace it with your spare tire and wheel. If you cannot detect a cause, have the vehicle towed to the nearest repair facility or tire dealer to have the vehicle inspected.

SNOW TIRES AND CHAINS

WARNING: Driving too fast for conditions creates the possibility of loss of vehicle control. Driving at very high speeds for extended periods of time may result in damage to vehicle components.

NOTE: Snow tires must be the same size and grade as the tires you currently have on your vehicle.

Maintenance and Specifications

The tires on your vehicle have all weather treads to provide traction in rain and snow. However, in some climates, you may need to use snow tires and chains. If you need to use snow tires and chains, it is recommended that steel wheels are used of the same size and specifications as those originally installed.

Follow these guidelines when using snow tires and chains:

- Do not use tire chains on aluminum wheels. Chains may chip the wheels.
- Use only SAE Class S chains.
- Install chains securely, verifying that the chains do not touch any wiring, brake lines or fuel lines.

Drive cautiously. If you hear the cables or chains rub or bang against the vehicle, stop and retighten them. If this does not work, remove the cables or chains to prevent vehicle damage.

- If possible, avoid fully loading your vehicle.
- Remove the tire chains when they are no longer needed. Do not use tire chains on dry roads.
- The suspension insulation and bumpers will help prevent vehicle damage. Do not remove these components from your vehicle when using snow tires and chains.

REFILL CAPACITIES

Fluid	Mazda Part Name	Application	Capacity
Engine oil (includes filter change)	Mazda SAE 5W-20 Premium Motor Oil	2.3L engine	3.8L (4.0 quarts.)
		3.0L V6 engines	4.3L (4.5 quarts)
	Mazda SAE 5W-30 Premium Motor Oil	4.0L V6 engine	4.7L (5.0 quarts)
Brake fluid	DOT 3 Brake Fluid	All	Fill to line on reservoir ⁶
Power steering fluid	Mazda MERCON® ATF	All	Fill to range on dipstick

Maintenance and Specifications

Fluid	Mazda Part Name	Application	Capacity
Transmission fluid ¹	Mazda MERCON® ATF	5-speed manual	2.65L (2.8 quarts) ²
	Mazda MERCON®V ATF	4x2 vehicles with automatic and 2.3L I4 engine	9.4L (9.9 quarts) ³
		4x2 vehicles with automatic and 3.0L or 4.0L engines	9.5L (10.0 quarts) ³
		4x4 vehicles with automatic and 3.0L or 4.0L	9.8L (10.3 quarts) ³
Engine coolant ⁴	Premium Engine Coolant	2.3 L I4 engine with manual transmission	10.0L (10.5 quarts)
		2.3L I4 engine with automatic transmission	9.7L (10.2 quarts)
		3.0L V6 engine with manual transmission	14.3L (15.1 quarts)
		3.0L V6 engine with automatic transmission	14.0L (14.8 quarts)
		4.0L V6 engine with manual transmission	13.0L (13.7 quarts)
		4.0L V6 engine with automatic transmission	12.5L (13.2 quarts)

Maintenance and Specifications

Fluid	Mazda Part Name	Application	Capacity
Fuel tank	N/A	Regular cab (Short wheel base)	64.4L (17 gallons)
		SuperCab	73.8L (19.5 gallons)
Transfer Case Fluid	Mazda MERCON® ATF	4x4 Vehicles	1.2L (1.25 quarts)
Front axle lubricant	Mazda SAE 80W-90 Premium Rear Axle Lubricant	4x4 Vehicles	1.7L (3.6 pints)
Rear axle lubricant ⁵	Mazda SAE 80W-90 Premium Rear Axle Lubricant	All	2.4-2.5L (5.0-5.3 pints)
Windshield washer fluid	Ultra-Clear Windshield Washer Concentrate	All	2.6L (2.75 quarts)

¹Ensure the correct automatic transmission fluid is used. Transmission fluid requirements are indicated on the dipstick or on the dipstick handle. MERCON® and MERCON® V are not interchangeable. DO NOT mix MERCON® and MERCON®V. Refer to the service maintenance section to determine the correct service interval.

²Service refill capacity is determined by filling the transmission to the bottom of the filler hole with the vehicle on a level surface.

³Indicates only approximate dry-fill capacity. Some applications may vary based on cooler size and if equipped with an in-tank cooler. The amount of transmission fluid and fluid level should be set by the indication on the dipstick's normal operating range.

⁴Add the coolant type originally equipped in your vehicle. DO NOT MIX different colors or types of coolant. DO NOT USE Mazda Extended Life Engine Coolant (orange in color). Refer to *Adding engine coolant, in this chapter*.

Maintenance and Specifications

⁵Traction-Lok axles use 2.2–2.4L (4.75–5.0 pints) of rear axle lubricant. Add 118 ml (4 oz.) of Additive Friction Modifier meeting Mazda specifications for complete refill of Traction-Lok axles. Service refill capacities are determined by filling the rear axle 6 mm to 14 mm (1/4 inch to 9/16 inch) below the bottom of the filler hole.

⁶Brake fluid will drop slowly as the brakes wear and will rise when brake components are replaced. Fluid levels below the MAX line that do not trigger the brake warning light are within the normal operating range, there is no need to add fluid. If the levels are outside the normal operating range, the performance of your brake system could be compromised, seek service from your local Mazda dealer immediately.

LUBRICANT SPECIFICATIONS

Item	Mazda part name or equivalent
Front axle (4X4)	SAE 80W-90 Premium Rear Axle Lubricant
Rear axle	SAE 80W-90 Premium Rear Axle Lubricant ¹
Brake fluid and clutch fluid (if equipped)	High Performance DOT 3 Motor Vehicle Brake Fluid ₄
Door weather strips	Silicone Lubricant
Engine coolant	Mazda Premium Engine Coolant ³
Engine oil 2.3L I4 and 3.0L V6 engines	SAE 5W-20 Motor Oil
Engine oil 4.0L V6 engines	SAE 5W-30 Motor Oil
Hinges, door checks, latches, striker plates, fuel filler door hinge and seat tracks	Multi-Purpose Grease
Transmission /steering/parking brake linkages and pivots, brake and clutch pedal shaft, clutch pilot bearing and input shaft spline (manual transmission).	Premium Long-Life Grease
Power steering fluid, transfer case fluid (4X4) and transmission fluid (manual)	MERCON® ATF
Automatic transmission (5R44E and 5R55E)	MERCON®V ATF ²
Windshield washer fluid	Ultra-clear Windshield Washer Concentrate

Maintenance and Specifications

¹Add 118 ml (4 oz.) of Additive Friction Modifier meeting Mazda specifications for complete refill of Traction-Lok axles. If submerged in water, the rear axle lubricant should be changed.

²Ensure the correct automatic transmission fluid is used. Transmission fluid requirements are indicated on the dipstick or on the dipstick handle. MERCON® and MERCON® V are not interchangeable. DO NOT mix MERCON® and MERCON® V. Refer to your service maintenance section to determine the correct service interval.

³Do not mix different types or colors of engine coolant.

⁴Brake fluid will drop slowly as the brakes wear and will rise when brake components are replaced. Fluid levels below the MAX line that do not trigger the brake warning light are within the normal operating range, there is no need to add fluid. If the levels are outside the normal operating range, the performance of your brake system could be compromised, seek service from your local Mazda dealer immediately.

ENGINE SPECIFICATIONS

Engine	2.3L I4 engine	3.0L V6 engine	4.0L V6 engine
Cubic inches	138	182	245
Required fuel	87 octane	87 octane	87 octane
Firing order	1-3-4-2	1-4-2-5-3-6	1-4-2-5-3-6
Spark plug gap	1.04-1.19mm (0.041-0.047 inch)	1.07-1.17mm (0.042-0.046 inch)	1.3-1.4 mm (0.052-0.056 inch)
Ignition system	EDIS	EDIS	EDIS
Compression ratio	9.7:1	9.14:1	9.7:1

Maintenance and Specifications

VEHICLE DIMENSIONS

Vehicle dimensions	Regular Cab mm (in)	SuperCab mm (in)
(1) Overall length	4 786 (188.4)	5 168 (203.4)
(2) Overall width	1 785 (70.3)	1 785 (70.3)
(3) Overall height 4x2/4x4	1 651 (65.0) / 1 727 (68.0)	1 651 (65.0) / 1 727 (68.0)
(4) Wheelbase	2 831 (111.4)	3 192 (125.7)
(5) Track - Front	1 486 (58.5)	1 485 (58.5)
(5) Track - Rear	1 455 (57.3)	1 455 (57.3)

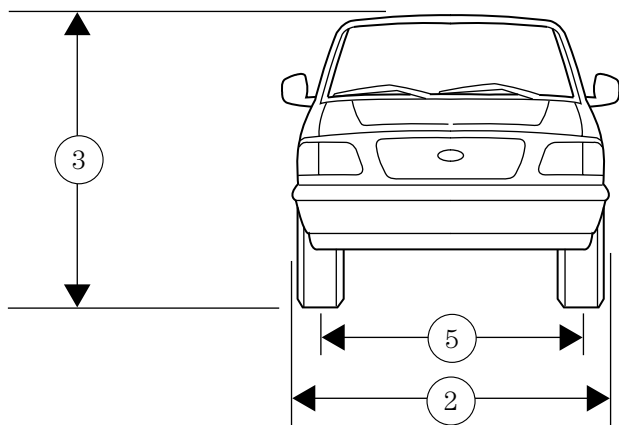

Maintenance and Specifications

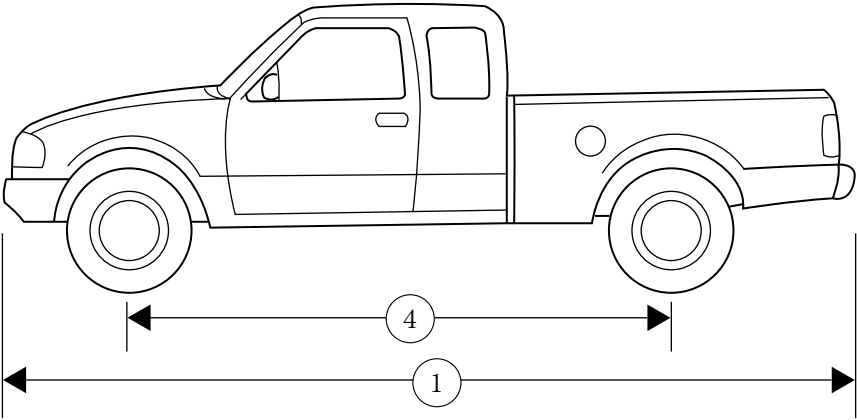
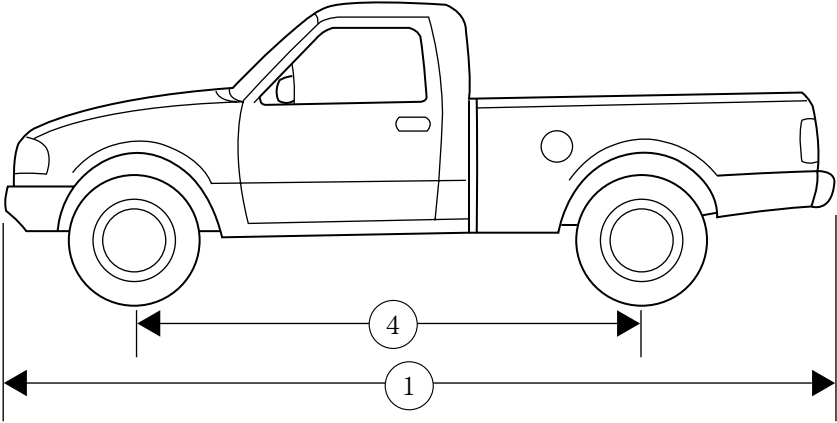

Maintenance and Specifications

IDENTIFYING YOUR VEHICLE

Certification label

The National Highway Traffic Safety Administration Regulations require that a Certification Label be affixed to a vehicle and prescribe where the Certification Label may be located. The Certification Label is located on the front door latch pillar on the driver's side.

Vehicle identification number (VIN)

The vehicle identification number is attached to a metal tag and is located on the driver side instrument panel. (Please note that in the graphic XXXX is representative of your vehicle identification number.)

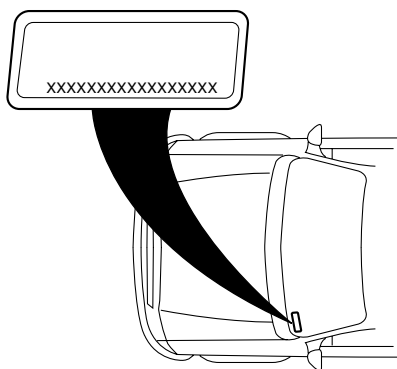

Engine number

The engine number (the last eight numbers of the vehicle identification number) is stamped on the engine block, transmission, frame and transfer case (if equipped).

Accessories

CELL PHONES

Use of cell phones and other devices by driver:

WARNING: Use of any electrical devices such as cell phones, computers, portable radios, vehicle navigation or other devices by the driver while the vehicle is moving is dangerous. Dialing a number on a cell phone while driving also ties-up the driver's hands. Use of these devices will cause the driver to be distracted and could lead to a serious accident. If a passenger is unable to use the device, pull off the right-of-way to a safe area before use. If use of a cell phone is necessary despite this warning, use a hands-free system to at least allow the hands free to drive the vehicle. Never use a cell phone or other electrical device while the vehicle is moving and, instead, concentrate on the full-time job of driving.

In addition, the gasoline distributors are warning against using cell phones during refueling procedures, due to their increased concern about static electricity fires in the self-service pump environment.

A

ABS (see Brakes)	110
Air bag supplemental restraint system	77
and child safety seats	80
description	77
disposal	83
driver air bag	81
indicator light	83
operation	81
passenger air bag	81
passenger deactivation switch	84
Ambulance packages	7
Antifreeze (see Engine coolant)	202
Anti-lock brake system (see Brakes)	110–111
Audio system	
6-CD in dash	22
Single CD	19
Audio system (see Radio)	18–19, 22, 26
Automatic dimming rear view mirror	46
Automatic transmission	114
driving an automatic overdrive	115
fluid, refill capacities	240
fluid, specification	244
Auxiliary power point	45
Axle	
lubricant specifications ..	243–244
refill capacities	240
traction lok	113

B

Battery	200
---------------	-----

acid, treating emergencies	200
jumping a disabled battery	157
maintenance-free	200
servicing	200
Bed extender	53
BeltMinder	73
Brakes	110
anti-lock	110–111
anti-lock brake system (ABS) warning light	111
fluid, checking and adding	221
fluid, refill capacities	240
fluid, specifications	243–244
lubricant specifications ..	243–244
parking	112
shift interlock	114
Break-in period	5
Bulbs	36

C

Calculating load	127
Capacities for refilling fluids	240
Cassette tape player	19, 22
Cell phone warning	248
Certification Label	247
Changing a tire	49, 149
Child safety restraints	90
child safety belts	90
Child safety seats	93
attaching with tether straps	98
in front seat	95
in rear seat	95
LATCH	101
tether anchorage hardware	98
Chimes (warning)	16

Index

- Cleaning your vehicle
 - engine compartment175
 - instrument panel178
 - interior178
 - interior trim178
 - Mazda car care products179
 - plastic parts177
 - washing174
 - waxing174
 - wheels175
 - wiper blades177
- Clock adjust
 - AM/FM Stereo18
 - AM/FM stereo CD20
 - AM/FM stereo tape/CD/MP323
 - Premium AM/FM stereo CD6/MP326
 - Single CD19
- Clutch
 - fluid222
 - operation while driving117
 - recommended shift speeds ...118
- Compass, electronic46–47
 - calibration48
 - set zone adjustment47
- Console53
- Coolant
 - checking and adding202
 - refill capacities205, 240
 - specifications243–244
- Cruise control
(see Speed control)49
- Customer Assistance163–164, 167
- D**
- Daytime running lamps
(see Lamps)34
- Dipstick
 - engine oil194
- Doors
 - lubricant specifications243
- Driveline universal joint and slip yoke226
- Driving under special conditions119, 121–122
 - mud122
 - sand122
 - snow and ice123
 - through water122–123
- E**
- Emergencies, roadside
 - jump-starting157
- Emergency Flashers137
- Emission control system217
- Engine245
 - cleaning175
 - coolant202
 - idle speed control200
 - limp to safety cooling206
 - lubrication
 - specifications243–244
 - refill capacities240
 - service points190–192
 - starting after a collision137
- Engine block heater109
- Engine oil194
 - checking and adding194
 - dipstick194
 - filter, specifications198
 - recommendations198
 - refill capacities240
 - specifications243–244
- Exhaust fumes110

F

- Flexible Fuel Vehicle (FFV)208
- Fluid capacities240
- Foglamps34
- Four-Wheel Drive vehicles119
 - driving off road121
 - electronic shift120
 - indicator light120
 - preparing to drive your vehicle113
- Fuel208
 - calculating fuel economy214
 - cap211
 - capacity240
 - choosing the right fuel212
 - comparisons with EPA fuel economy estimates217
 - detergent in fuel214
 - filling your vehicle with fuel208, 211, 214
 - filter, specifications214
 - fuel pump shut-off switch137
 - improving fuel economy214
 - octane rating212, 245
 - quality213
 - running out of fuel214
 - safety information relating to automotive fuels208

- Fuel - flex fuel vehicle (FFV)208, 212

- Fuel pump shut-off switch137
- Fuses138–139

G

- Gas cap (see Fuel cap)211
- Gas mileage (see Fuel economy)214
- Gauges16

- GAWR (Gross Axle Weight Rating) calculating127
- GVWR (Gross Vehicle Weight Rating) calculating127

H

- Hazard flashers137
- Headlamps34
 - aiming35
 - bulb specifications36
 - daytime running lights34
 - flash to pass35
 - high beam35
 - replacing bulbs37
 - turning on and off34
- Heating
 - heating and air conditioning system31–32

- Hood189

I

- Ignition105, 245
- Infant seats (see Safety seats) ..93
- Inspection/maintenance (I/M) testing219
- Instrument panel
 - cleaning178
 - cluster12
 - lighting up panel and interior35
 - location of components12

J

- Jack149
 - positioning149

Index

storage149–152
Jump-starting your vehicle157

K

Keyless remote entry system -
see Remote entry system55

Keys
positions of the ignition105

L

Lamps
bulb replacement
specifications chart36
courtesy36
daytime running light34
fog lamps34
headlamps34
headlamps, flash to pass35
instrument panel, dimming35
interior lamps36–37
replacing
bulbs36–37, 39, 41–42

Lane change indicator
(see Turn signal)36

LATCH anchors101

Lights, warning and indicator12
anti-lock brakes (ABS)111

Limited slip axle
(see Traction-Lok)113

Limp to Safety Cooling206

Load limits124

Loading instructions124

Lubricant specifications ...243–244

Lumbar support, seats64

M

Manual transmission117

fluid capacities240
lubricant specifications244
reverse118

Mirrors

automatic dimming rearview
mirror46
side view mirrors (power)49

Motorcraft parts214

O

Octane rating212

Oil (see Engine oil)194

Overdrive52

Overheating148

P

Parking brake112

Passive anti-theft system
(PATS)60

Power distribution box
(see Fuses)142

Power door locks55

Power point45

Power steering113
fluid, checking and adding ...220
fluid, refill capacity240
fluid, specifications243–244

Power Windows45

Preparing to drive your
vehicle113

R

Radio18–19, 22, 26
Single CD19

Relays138

Remote entry system55–56
 arming and disarming the
 anti-theft system57
 illuminated entry59
 locking/unlocking doors55–56
 replacement/additional
 transmitters58
 replacing the batteries57

S

Safety Belt Maintenance76
 Safety belts (see Safety
 restraints)65, 67–68, 70
 Safety defects, reporting173
 Safety restraints65, 67–70
 belt minder73
 extension assembly72
 for adults67–68
 for children89–90
 lap belt70
 safety belt maintenance76
 warning light and chime72
 Safety restraints - LATCH
 anchors101
 Safety restraints - tether
 anchors98
 Safety seats for children93
 Seat belts
 (see Safety restraints)65
 Seats63
 child safety seats93
 SecuriLock passive anti-theft
 system60
 Servicing your vehicle188
 Setting the clock
 AM/FM stereo18
 AM/FM stereo CD20

AM/FM stereo tape/CD/MP323
 Premium AM/FM stereo
 CD6/MP326
 Snowplowing7
 Spare tire (see Changing the
 Tire)149–150
 Spark plugs, specifications245
 Special notice
 ambulance conversions7
 utility-type vehicles7
 Specification chart,
 lubricants243–244
 Speed control49
 Starting a flex fuel vehicle109
 Starting your vehicle105–106,
 108
 jump starting157
 Steering wheel
 tilting44
 Stereo
 Single CD19

T

Tether anchors98
 Tilt steering wheel44
 Tires149, 227–228
 changing149–150, 153, 156
 snow tires and chains239
 tire grades228
 treadwear228
 Towing128
 recreational towing135
 trailer towing128
 wrecker162
 Traction-lok rear axle113

Index

- Transfer case
fluid checking226
- Transmission
automatic operation114
brake-shift interlock (BSI)114
fluid, checking and adding
(manual)225
fluid, refill capacities240
lubricant specifications ..243–244
manual operation117
- Turn signal36
- V**
- Vehicle dimensions245
- Vehicle Identification Number
(VIN)247
- Vehicle loading124
camper bodies136
- Ventilating your vehicle110
- W**
- Warning chimes16
- Warning lights (see Lights)12
- Washer fluid193
- Water, Driving through123
- Windows
power45
- Windshield washer fluid and
wipers43
checking and adding fluid193
checking and cleaning43
replacing wiper blades44
- Wrecker towing162

