

# A Word to Mazda Owners

---

Thank you for choosing a Mazda. We at Mazda design and build vehicles with complete customer satisfaction in mind.

To help ensure enjoyable and trouble-free operation of your Mazda, read this manual carefully and follow its recommendations.

An Authorized Mazda Dealer knows your vehicle best. So when maintenance or service is necessary, that's the place to go.

Our nationwide network of Mazda professionals is dedicated to providing you with the best possible service.

We assure you that all of us at Mazda have an ongoing interest in your motoring pleasure and in your full satisfaction with your Mazda product.

**Mazda Motor Corporation**  
HIROSHIMA, JAPAN

## **Important Notes About This Manual**

Keep this manual in the glove box as a handy reference for the safe and enjoyable use of your Mazda. Should you resell the vehicle, leave this manual with it for the next owner.

All specifications and descriptions are accurate at the time of printing. Because improvement is a constant goal at Mazda, we reserve the right to make changes in specifications at any time without notice and without obligation.

## **Air Conditioning and the Environment**

Your Mazda's genuine air conditioner is filled with HFC134a (R134a), a refrigerant that has been found not to damage the earth's ozone layer. If the air conditioner does not operate properly, consult an Authorized Mazda Dealer.

**Please be aware that this manual applies to all models, equipment and options. As a result, you may find some explanations for equipment not installed on your vehicle.**

©2003 Mazda Motor Corporation  
Printed in Japan Nov. 2003(Print1)

# How to Use This Manual

---

We want to help you get the most driving pleasure from your vehicle. Your owner's manual, when read from cover to cover, can do that in many ways.

Illustrations complement the words of the manual to best explain how to enjoy your Mazda. By reading your manual, you can find out about the features, important safety information, and driving under various road conditions.

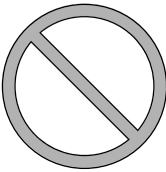

The above symbol in this manual means "Do not do this " or "Do not let this happen".

**Index:** A good place to start is the Index, an alphabetical listing of all information in your manual.

You'll find several **WARNINGS**, **CAUTIONS**, and **NOTES** in the manual.

## **WARNING**

*A **WARNING** indicates a situation in which serious injury or death could result if the warning is ignored.*

## **CAUTION**

A **CAUTION** indicates a situation in which bodily injury or damage to your vehicle, or both, could result if the caution is ignored.

## **NOTE**

A **NOTE** provides information and sometimes suggests how to make better use of your vehicle.



The above symbol, located on some parts of the vehicle, indicates that this manual contains information related to the part. Please refer to the manual for a detailed explanation.

# Table of Contents

---

## **Your Vehicle at a Glance**

Interior, exterior views and part identification of your Mazda.

**1**

---

## **Essential Safety Equipment**

Use of safety equipment, including seats, seat belt system, SRS air bags and child-restraint systems.

**2**

---

## **Knowing Your Mazda**

Explanation of basic operations and controls; opening/closing and adjustment of various parts.

**3**

---

## **Before Driving Your Mazda**

Important information about driving your Mazda.

**4**

---

## **Driving Your Mazda**

Explanation of instruments and controls.

**5**

---

## **Interior Comfort**

Use of various features for drive comfort, including air-conditioning and audio system.

**6**

---

## **In Case of an Emergency**

Helpful information on what to do in an emergency.

**7**

---

## **Maintenance and Care**

How to keep your Mazda in top condition.

**8**

---

## **Customer Information and Reporting Safety Defects**

Important consumer information including warranties and add-on equipment.

**9**

---

## **Specifications**

Technical information about your Mazda.

**10**

---

## **Index**

**11**



# 1

## Your Vehicle at a Glance

Interior, exterior views and part identification of your Mazda.

**Dashboard Overview** ..... 1-2

**Interior Overview** ..... 1-3

**Exterior Overview** ..... 1-4

# Dashboard Overview

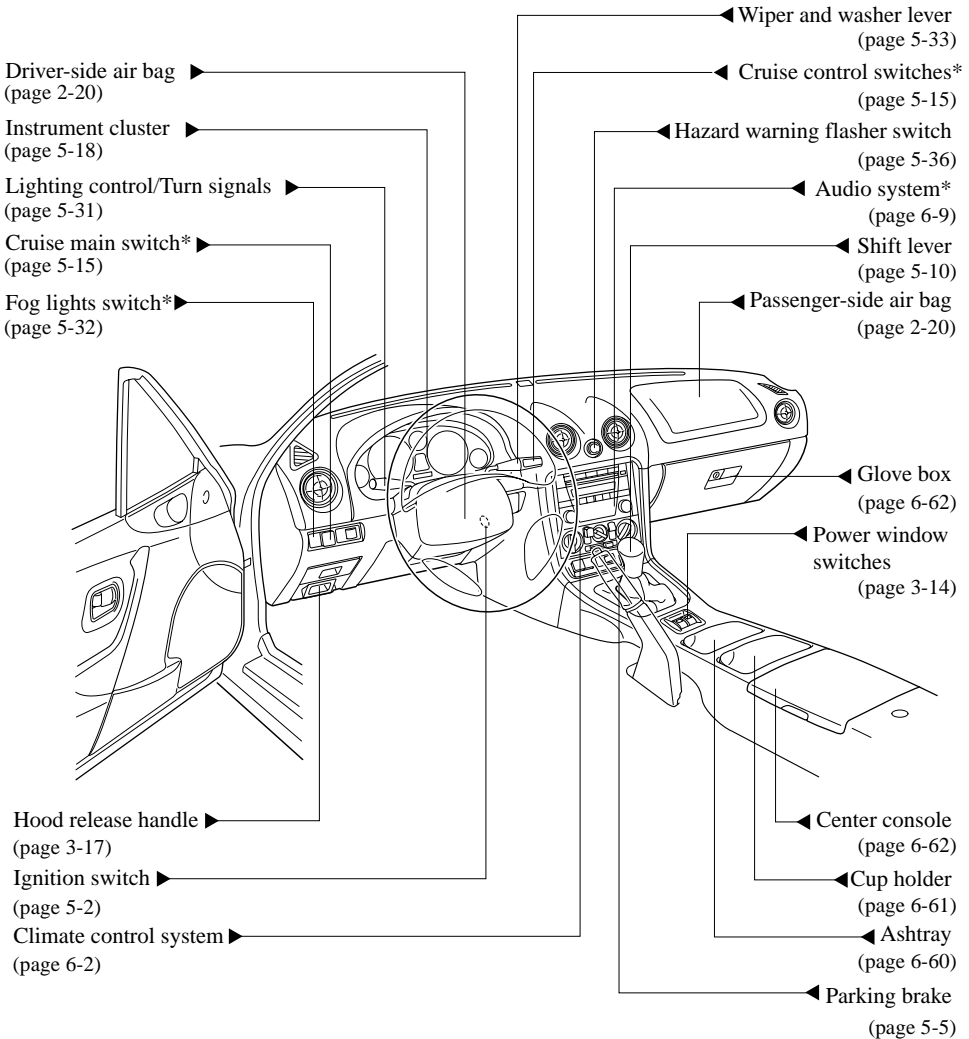

# Interior Overview

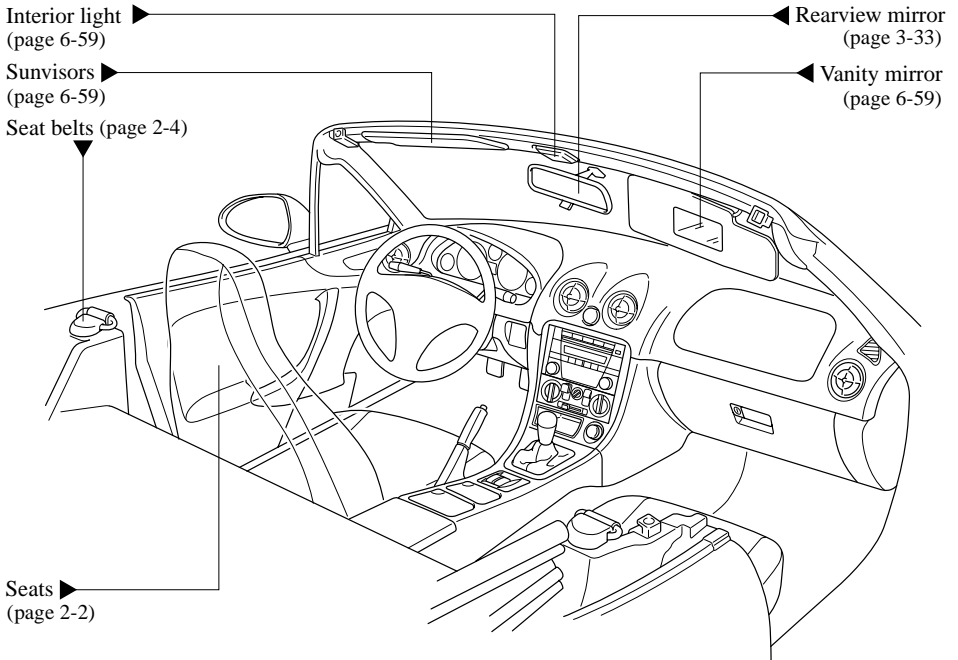

# Exterior Overview

---

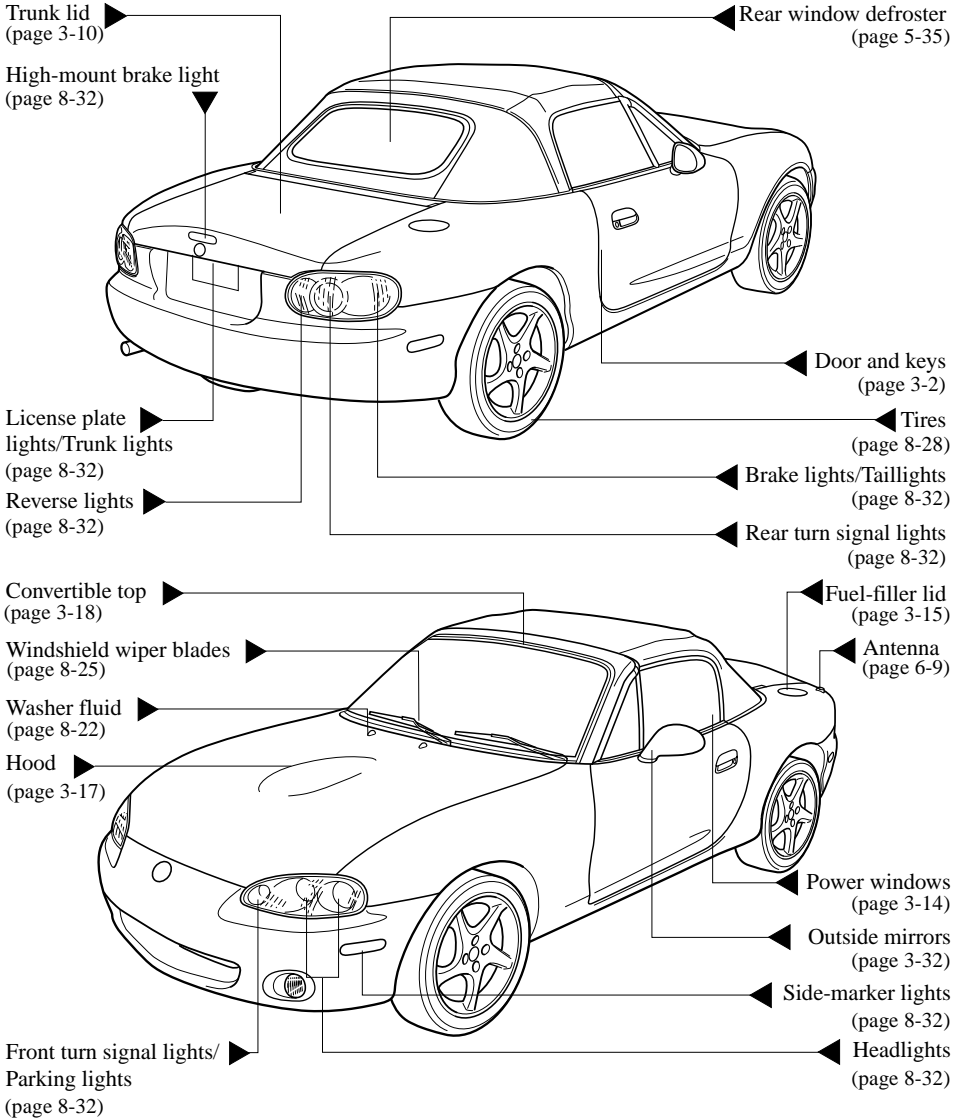



# 2

## Essential Safety Equipment

Use of safety equipment, including seats, seat belt system, SRS air bags and child-restraint systems.

<b>Seats</b> .....	2-2
Seats .....	2-2
<b>Seat Belt Systems</b> .....	2-4
Seat Belt Precautions .....	2-4
3-Point Type Seat Belt .....	2-7
Seat Belt Pretensioner and Load Limiting Systems .....	2-8
Seat Belt Extender .....	2-10
Seat Belt Warning Light .....	2-12
Seat Belt Warning Beep .....	2-12
<b>Child Restraint</b> .....	2-13
Child Restraint Precautions .....	2-13
Installing a Child-Restraint System .....	2-16
LATCH Child-Restraint Systems .....	2-18
<b>SRS Air Bags</b> .....	2-20
Supplemental Restraint Systems (SRS) Precautions .....	2-20
Passenger Air Bag Deactivation Switch .....	2-23
Air Bag System Description .....	2-26

# Seats

## Seats

### **WARNING**

#### Securing the Seats:

*Adjustable seats and seatbacks that are not securely locked are dangerous. In a sudden stop or collision, the seat or seatback could move, causing injury. Make sure the adjustable components of the seat are locked in place by attempting to slide the seat forward and backward and rocking the seatback.*

### ▼ Seat Slide

### **WARNING**

#### Driver's Seat Adjustment:

*Adjusting the driver's seat while the vehicle is moving is dangerous. The driver could lose control of the vehicle and have an accident. Adjust the driver's seat only when the vehicle is stopped.*

To move a seat forward or backward, raise the lever and slide the seat to the desired position and release the lever.

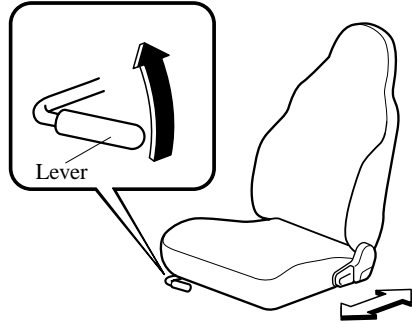

Make sure the lever returns to its original position and the seat is locked in place by attempting to push it forward and backward.

**▼ Seat Recline****⚠ WARNING****Reclining:**

*Sitting in a reclined position while the vehicle is moving is dangerous because you don't get the full protection from seat belts. During sudden braking or a collision, you can slide under the lap belt and suffer serious internal injuries. For maximum protection, sit well back and upright.*

**Unlocked Seatback:**

*The seatback plays an important role in your protection in a vehicle. Leaving the seatback unlocked is dangerous as it can allow passengers to be ejected or thrown around and baggage to strike occupants in a sudden stop or collision, resulting in severe injury. After adjusting the seatback at any time, even when there are no other passengers, rock the seatback to make sure it is locked in place.*

To change the seatback angle, lean forward slightly while raising the lever. Then lean back to the desired position and release the lever.

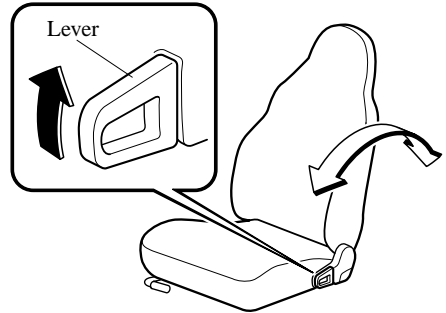

Make sure the lever returns to its original position and the seatback is locked in place by attempting to push it forward and backward.

**⚠ CAUTION**

When returning a rear-reclined seatback to its upright position, make sure you support the seatback while operating the seatback lever. If the seatback is not supported, it will flip forward suddenly and could cause injury.

# Seat Belt Systems

---

## Seat Belt Precautions

Seat belts help to decrease the possibility of severe injury during accidents and sudden stops. Mazda recommends that the driver and passenger always wear seat belts.

All of the seat belt retractors are designed to keep the lap/shoulder belts out of the way when not in use.

The driver's seat belt has no provisions for child-restraint systems and has only an emergency locking mode. The driver may wear it comfortably, and it will lock during a collision.

However, the passenger's seat lap/shoulder belt retractors operate in two modes: emergency locking mode, and for child-restraint systems, automatic locking mode.

## Seat Belt Systems

### **WARNING**

#### Not Wearing Seat Belts:

*Not wearing a seat belt is extremely dangerous. During a collision, occupants not wearing seat belts could hit someone or things inside the vehicle or even be thrown out of the vehicle. They could be seriously injured or even killed. In the same collision, occupants wearing seat belts would be much safer. Always wear your seat belt and make sure all occupants are properly restrained.*

#### Seat Belt Damaged During an Accident:

*Using a damaged seat belt is dangerous. An accident could damage the belt webbing of the seat belt in use. A damaged seat belt cannot provide adequate protection in a collision. Whether a seat was occupied or not, if the air bags deployed the seat belt pretensioners also deployed and both seat belts must be replaced. Have an Authorized Mazda Dealer inspect all seat belt systems in use during an accident before they are used again.*

#### Twisted Seat Belts:

*Twisted seat belts are dangerous. In a collision, the full width of the belt isn't available to absorb the impact. This puts more force on the bones beneath the belt, which could cause serious injury or death. Don't wear twisted seat belts.*

#### One Belt, One Passenger:

*Using one seat belt for more than one person at a time is dangerous. A seat belt used in this way can't spread the impact forces properly and the two passengers could be crushed together and seriously injured or even killed. Never use one belt for more than one person at a time.*

### **CAUTION**

Belt retraction may become difficult if the belts and rings are soiled, so try to keep them clean.

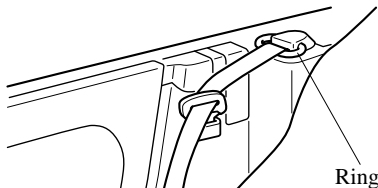

# Seat Belt Systems

---

## ▼ Pregnant Women and Persons with Serious Medical Conditions

Pregnant women should wear seat belts. Ask your doctor for specific recommendations. The lap belt should be worn **SNUGLY AND AS LOW AS POSSIBLE OVER THE HIPS**. The shoulder belt should be worn across your shoulder properly, but never across the stomach area.

Persons with serious medical conditions also should wear seat belts. Check with your doctor for any special instructions regarding specific medical conditions.



## ▼ Emergency Locking Mode

If the belt has fully retracted, it will always be in the emergency locking mode until you move it into automatic locking mode by pulling the belt all the way out to its full length. In the emergency locking mode, the belt remains comfortable on the occupant and the retractor will lock in position during a collision.

If the belt feels tight and hinders comfortable movement while the vehicle is stopped or in motion, you may be in the automatic locking mode because you have pulled the belt too far out. To return to the more comfortable emergency locking mode, wait until you can stop the vehicle in a safe level area, retract the belt fully to convert it back to emergency locking mode and then again extend it around you.

## ▼ Automatic Locking Mode

Always use the automatic locking mode to keep the child-restraint system from shifting to an unsafe position in the event of an accident. To get the seat belt into the automatic locking mode, pull it all the way out and connect it as instructed on the child-restraint system. It will retract down to the child-restraint system and stay locked on it. See the section on child restraint (page 2-13).

# Seat Belt Systems

## 3-Point Type Seat Belt

### ▼ Fastening the Seat Belts

1. Grasp the buckle and tongue.
2. Slowly pull out the lap/shoulder belt.

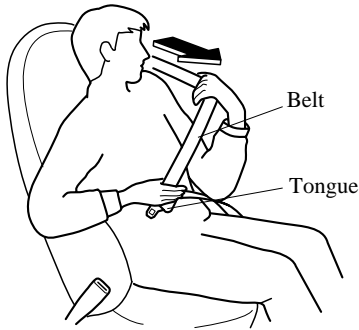

3. Insert the tongue into the buckle until you hear a click.

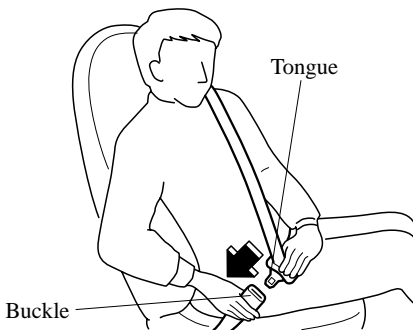

### ⚠ WARNING

#### Positioning the Shoulder Portion of the Seat Belt:

*Improper positioning of the shoulder portion of the seat belt is dangerous. Always make sure the shoulder portion of the seat belt is positioned across your shoulder and near your neck, but never under your arm, on your neck, or on your upper arm.*

4. Make sure the shoulder belt is snugly fitted against your body.

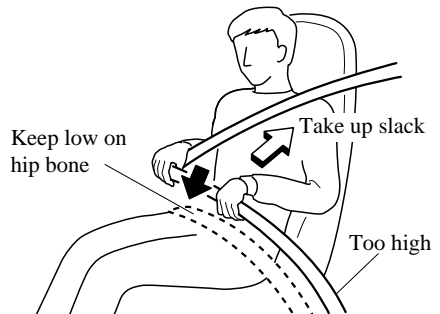

### ⚠ WARNING

#### Positioning the Lap Portion of the Seat Belt:

*The lap portion of the seat belt worn too high is dangerous. In a collision, this would concentrate the impact force directly on the abdominal area, causing serious injury. Wear the lap portion of the belt snugly and as low as possible.*

# Seat Belt Systems

## ▼ Unfastening the Seat Belts

Depress the button on the buckle.

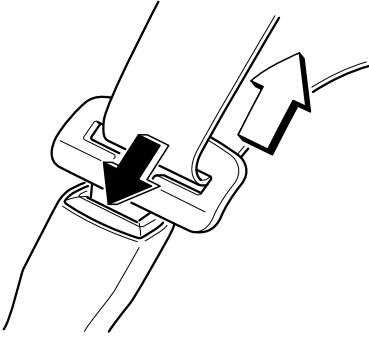

### NOTE

If a belt does not fully retract, inspect it for kinks and twists. If it is still not retracting properly, have it inspected at an Authorized Mazda Dealer.

To secure the passenger's seat belt when not in use, insert the belt tongue into the slot.

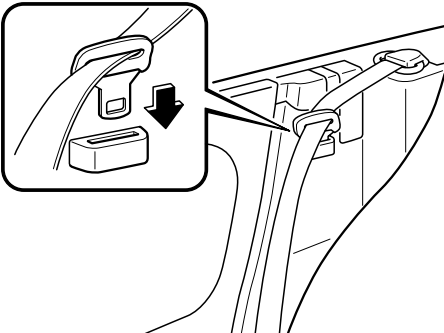

## Seat Belt Pretensioner and Load Limiting Systems

For optimum protection, the driver and passenger seat belts are equipped with pretensioner and load limiting systems. In moderate or greater frontal or near-frontal accidents, the air bag and pretensioner systems deploy simultaneously. The pretensioners take up slack in the seat belts as the air bags are expanding. The seat belt pretensioner system will not activate if the seat belt is not fastened, only you can be sure it is worn properly. The load limiting system releases belt webbing in a controlled manner to reduce belt force on the occupant's chest.

### **WARNING**

**Incorrect Positioning of the Driver and Passenger Seat Belts:**  
*Incorrect positioning of the driver and passenger seat belts is dangerous. Without proper positioning, the pretensioner and load limiting systems cannot provide adequate protection in an accident and this could result in serious injury. Wear seat belts only as recommended in this owner's manual.*



# Seat Belt Systems

## **WARNING**

**Expended Seat Belt Pretensioners:**  
Use of front seat belts with the pretensioner system expended is dangerous.

The seat belt pretensioners will only function once. After they are expended, they will not work again and must be replaced immediately. If the seat belt pretensioners are not replaced, the risk of injury in a collision will increase.

Always have an Authorized Mazda Dealer inspect the seat belt pretensioners and air bags after any collision. The seat belt pretensioners and air bags must be replaced after any collision, which causes them to deploy.

**Modification or Testing of the Pretensioner System:**

Modifying the components or wiring of the pretensioner system, including the use of electronic testing devices is dangerous. You could accidentally activate it or make it inoperable which would prevent it from activating in an accident. The occupants or repairers could be seriously injured. Never modify the components or wiring, or use electronic testing devices on the pretensioner system.

## **WARNING**

**Pretensioner System Disposal:**  
Improper disposal of the pretensioner system or a vehicle with non-deactivated pretensioners is dangerous. Unless all safety procedures are followed, injury could result. Ask an Authorized Mazda Dealer how to safely dispose of the pretensioner system or how to scrap a pretensioner-equipped vehicle.

## **NOTE**

- The pretensioner system will only activate in a moderate or greater frontal or near-frontal collision. It will not activate in most rollovers, side or rear impacts.
- Some smoke (non-toxic gas) will be released when the air bags and pretensioners deploy. This does not indicate a fire. This gas normally has no effect on occupants, however, those with sensitive skin may experience light skin irritation. If residue from the deployment of the air bags or the pretensioner system gets on the skin or in the eyes, wash it off as soon as possible.

## Seat Belt Systems

---

### ▼ Air Bag/Seat Belt Pretensioner System Warning Light



If the air bag/seat belt pretensioner system is normal, the warning light illuminates when the ignition switch is turned to the ON position or after the engine is cranked. After about 6 seconds it goes out.

A system malfunction is indicated when the warning light constantly flashes, illuminates or doesn't illuminate at all when the ignition switch is turned to the ON position. If any of these occur, consult an Authorized Mazda Dealer as soon as possible. The system may not work in an accident.

### **WARNING**

#### **Self-Servicing the Air Bag/ Pretensioner Systems:**

***Self-servicing or tampering with the systems is dangerous. An air bag/pretensioner could accidentally activate or become disabled. This could cause serious injuries. Never tamper with the systems and always have an Authorized Mazda Dealer perform all servicing and repairs.***

### Seat Belt Extender

If your seat belt is not long enough, even when fully extended, a seat belt extender may be available to you at no charge from your Authorized Mazda Dealer.

This extender will be only for you and for the particular vehicle and seat. Even if it plugs into other seat belts, it may not hold in the critical moment of a crash.

When ordering an extender, only order one that provides the necessary additional length to fasten the seat belt properly.

Please contact your Authorized Mazda Dealer for more information.

**WARNING****Unnecessary Use of an Extender:**

*Using a seat belt extender when not necessary is dangerous. The seat belt will be too long and not fit properly. In an accident, the seat belt will not provide adequate protection and you could be seriously injured. Only use the extender when it is required to fasten the seat belt properly.*

**Using an Improper Extender:**

*Using a seat belt extender that is for another person or a different vehicle or seat is dangerous. The seat belt will not provide adequate protection and the user could be seriously injured in an accident. Only use the extender provided for you and for the particular vehicle and seat. NEVER use the extender in a different vehicle or seat.*

**Using an Extender That is Too Long:**

*Using an extender that is too long is dangerous. The seat belt will not fit properly. In an accident, the seat belt will not provide adequate protection and you could be seriously injured. Don't use the extender or choose one shorter in length if the distance between the extender's buckle and the center of the user's body is less than 15cm (6 in).*

**NOTE**

When not in use, remove the seat belt extender and store it in the vehicle. If the seat belt extender is left connected, the seat belt warning light will not illuminate and function properly.

# Seat Belt Systems

---

## Seat Belt Warning Light



If the driver's seat belt is not fastened when the ignition switch is turned to the ON position, the seat belt warning light will remain on until the belt is fastened. If the system does not operate correctly, consult an Authorized Mazda Dealer.

## Seat Belt Warning Beep

If the driver's seat belt is not fastened when the ignition switch is turned to the ON position, a beep sound will be heard for about 6 seconds.

## Child Restraint Precautions

Mazda strongly urges the use of child-restraint systems for children small enough to use them.

You are required by law to use a child-restraint system for children in the U.S. and Canada. Check your local and state or provincial laws for specific requirements regarding the safety of children riding in your vehicle.

Whatever child-restraint system you consider, please pick the appropriate one for the age and size of the child, obey the law and follow the instructions that come with the individual child-restraint system.

A child who has outgrown child-restraint systems should use seat belts, both lap and shoulder. If the shoulder belt crosses the neck or face, move the child closer to the center of the vehicle .

A rear-facing child-restraint system should **NEVER** be used in the front seat with the air bag system activated.

We have installed lower LATCH anchor points for LATCH style booster seats and infant carriers that work without tethers only. Any other child-restraint system that has an upper tether cannot be used in this vehicle because there is no tether anchor. Do not try to connect a tether, the seat and head restraint combination allows you maximum adult space but any attempt to install a tether point will result in too much slack in an accident or a very skewed child seat location and pose a serious risk of injury or death to your child. Use the seat belts to properly secure the non-tethered child-restraint systems other than the LATCH booster seats and non-tethered infant carriers. Turn off the passenger air bag deactivation switch. To expose and use the lower LATCH anchor points, which are affixed to the body and not the seat, slide the seat all the way rearward which is the optimal vehicle seat position for all children in this two seat car.

We have provided a deactivation switch that will disable passenger air bag inflation. Do not switch off the passenger air bag without reading the "Passenger Air Bag Deactivation Switch" (page 2-23).

### **WARNING**

***Proper Size of Child-Restraint System:***

***For effective protection in vehicle accidents and sudden stops, a child must be properly restrained using a seat belt or child-restraint system depending on age and size. If not, the child could be seriously injured or even killed in an accident.***

# Child Restraint

## **WARNING**

### **Follow the Manufacturer's Instructions and Always Keep the Child-Restraint System Buckled Down:**

*An unsecured child-restraint system is dangerous. In a sudden stop or a collision it could move causing serious injury or death to the child or other occupants. Make sure the child-restraint system is properly secured in place according to the child-restraint system manufacturer's instructions. When not in use, remove it from the vehicle or fasten it with a seat belt, or latch it down to BOTH LATCH lower anchors for LATCH child-restraint systems.*

### **Holding a Child While the Vehicle is Moving:**

*Holding a child in your arms while the vehicle is moving is extremely dangerous. No matter how strong the person may be, he or she cannot hold onto a child in a sudden stop or collision and it could result in serious injury or death to the child or other occupants. Even in a moderate accident, the child may be exposed to air bag forces that could result in serious injury or death to the child, or the child may be slammed into the adult, injuring the adult. Always secure a child in a proper child-restraint system.*

### **Rear-Facing Child-Restraint System:**

*When a rear-facing child-restraint system is installed on the passenger's seat and the passenger air bag deactivation switch is not in the OFF position, it is extremely dangerous. In an accident, the air bag could inflate and cause serious injuries or even death to the child in the rear-facing child-restraint system. When using a rear-facing child-restraint system, always set the passenger air bag deactivation switch to OFF position.*

Deploying air bag

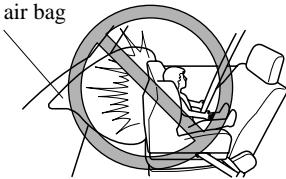

 **WARNING****One Belt, One Passenger:**

*Using one seat belt for more than one person at a time is dangerous. A seat belt used in this way can't spread the impact forces properly and the two passengers could be crushed together and seriously injured or even killed. Never use one belt for more than one person at a time.*

**Child-Restraint Tether:**

*Using a child-restraint system that requires a tether is dangerous. Your Mazda doesn't have a child-restraint tether. The child-restraint system cannot be properly secured. In a collision, it could move and cause serious injury or even death to the child or someone else. Always use a child-restraint system designed for use without a tether.*

 **CAUTION**

A seat belt or child-restraint system can become very hot in a closed vehicle during warm weather. To avoid burning yourself or a child, check them before you or your child touches them.

**NOTE**

Your Mazda is equipped with LATCH lower anchors for attachment of specially designed LATCH child-restraint systems behind the passenger seat. When using these anchors to secure a child-restraint system, refer to "LATCH Child-Restraint Systems" (page 2-18).

# Child Restraint

## Installing a Child-Restraint System

The passenger lap/shoulder belt can easily be converted into the automatic locking mode, which must be done to hold the child-restraint system.

Some child-restraint systems also employ specially designed LATCH attachments; refer to "LATCH Child-Restraint Systems" (page 2-18).

Follow these manufacturer's instructions when installing a child-restraint system on the passenger's seat, unless you are attaching a LATCH-equipped child-restraint system to the LATCH lower anchors. Refer to "LATCH Child-Restraint Systems" (page 2-18).

### NOTE

Follow the child-restraint system manufacturer's instructions carefully. If you are not sure whether you have a LATCH system, check in the child-restraint system manufacturer's instructions and follow them accordingly. Depending on the type of child-restraint system, it may not employ seat belts which are in automatic locking mode, however if it uses an upper tether, it cannot be mounted properly in this vehicle as there is no safe way to anchor the tether.

Before installing a rear-facing child-restraint system, the passenger air bag must be deactivated (page 2-23).

### NOTE

Before installing a child-restraint system, refer to "Passenger Air Bag Deactivation Switch" (page 2-23).

1. Make sure to remove articles from behind the passenger seat that would prevent the seat from sliding back fully, and then slide the seat as far back as possible.



2. Secure the child-restraint system with the lap portion of the lap/shoulder belt. See the instructions on the child-restraint system for belt routing instructions.
3. To get the retractor into the automatic locking mode, pull the shoulder belt portion of the seat belt until the entire length of the belt is out of the retractor.
4. Push the child-restraint system firmly into the vehicle seat. Be sure the belt retracts as snugly as possible. Clicking from the retractor will be heard during retraction if the system is in automatic locking mode. If the belt does not lock the seat down tight, repeat this step.



**NOTE**

- Inspect this function before each use of the child-restraint system. You should not be able to pull the shoulder belt out of the retractor while the system is in the automatic locking mode. When you remove the child-restraint system, be sure the belt fully retracts to return the system to emergency locking mode before occupants use the seat belts.
- Follow the child-restraint system manufacturer's instructions carefully. Depending on the type of child-restraint system, it may not employ seat belts which are in automatic locking mode, however if it uses an upper tether, it cannot be mounted properly in this vehicle as there is no safe way to anchor the tether.

# Child Restraint

## LATCH Child-Restraint Systems

Your Mazda is equipped with LATCH lower anchors for attachment of specially designed LATCH child-restraint systems behind the passenger seat. Only LATCH booster seats and infant carriers without upper tethers can be used in this position, as there is no good place to anchor the tether due to this vehicle's design. Both anchors must be used when installing these lower anchor only child-restraint systems, otherwise the seat will bounce around and put the child in danger.

### **WARNING**

#### **Manufacturer's Instructions for Child-Restraint System:**

*An unsecured child-restraint system is dangerous. In a sudden stop or a collision it could move causing serious injury or death to the child or other occupants. Make sure the child-restraint system does not rely on an upper tether and then properly secure those non-tethered seats according to the child-restraint system manufacturer's instructions.*

#### **Unsecured Child-Restraint System:**

*An unsecured child-restraint system is dangerous. In a sudden stop or a collision it could move causing serious injury or death to the child or other occupants. Follow the child-restraint system manufacturer's instructions on belt routing to secure the seat just as you would with a child in it so that nobody is tempted to put a child in an improperly secured seat later on. When not in use, remove it from the vehicle or fasten it with a seat belt, or latch it down to BOTH LATCH lower anchors for LATCH child-restraint systems.*

#### **LATCH Child-Restraint Systems:**

*Not following the child-restraint system manufacturer's instructions when installing the child-restraint system is dangerous. If seat belts or a foreign object prevent the child-restraint system from being securely attached to the LATCH lower anchors and the child-restraint system is installed improperly, the child-restraint system could move in a sudden stop or collision causing serious injury or death to the child or other occupants. When installing the child-restraint system, make sure there are no seat belts or foreign objects near or around the LATCH lower anchors. Always follow the child-restraint system manufacturer's instructions.*

### ▼ LATCH Child-Restraint System Installation Procedure

Before installing a rear-facing child-restraint system, the passenger air bag must be deactivated (page 2-23).

#### NOTE

Before installing a child-restraint system, refer to "Passenger Air Bag Deactivation Switch" (page 2-23).

1. Make sure to remove articles from behind the passenger seat that would prevent the seat from sliding back fully, and then slide the seat as far back as possible to insert the LATCH lower anchors between the seat bottom and the seatback.
2. Expand the area between the seat bottom and the seatback slightly to verify the locations of the LATCH lower anchors.

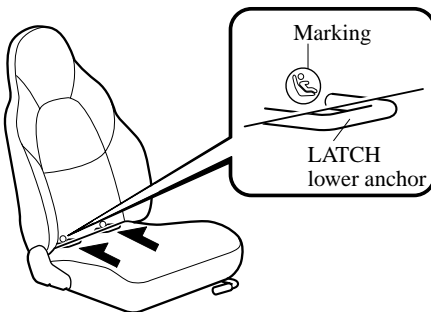

#### NOTE

The markings above the LATCH lower anchors indicate the locations of the LATCH lower anchors for the attachment of a child-restraint system.

3. Secure the child-restraint system using BOTH LATCH lower anchors, following the child-restraint system manufacturer's instruction, however if it uses an upper tether, it cannot be mounted properly in this vehicle as there is no safe way to anchor the tether.

## SRS Air Bags

---

### Supplemental Restraint Systems (SRS) Precautions

The supplemental restraint systems (SRS) include up to 2 air bags (verify "SRS AIRBAG" location indicator marks).

They are located in:

- The steering wheel hub (driver air bag)
- The passenger dashboard (front passenger air bag)

The air bag supplemental restraint systems are designed to provide supplemental protection only in the front seats in certain situations, so seat belts are always important in the following ways:

Without seat belt usage, the air bags cannot provide adequate protection during an accident. Seat belt usage is necessary to:

- Keep the passenger away from an inflating air bag.
- Reduce the possibility of injuries during an accident that is not designed for air bag inflation, such as roll-over or rear impact.
- Reduce the possibility of injuries in frontal collisions that are not severe enough to activate the air bags.
- Reduce the possibility of being thrown from your vehicle.
- Reduce the possibility of injuries to lower body and legs during an accident because the air bags provide no protection to these parts.
- Hold the driver in a position which allows better control of the vehicle.

Children should be protected by a child-restraint system. Laws vary on the size a child must be to use a child-restraint system (page 2-13).

We have provided a deactivation switch that will disable passenger air bag inflation. Do not switch off the passenger air bag without reading the "Passenger Air Bag Deactivation Switch" (page 2-23).

Carefully consider which child-restraint system is necessary for your child and follow the installation directions in this Owner's Manual as well as the child-restraint system manufacturer's instructions.

Please be aware that there is no good way to anchor an upper tether, so do not pick a child restraint system that uses upper tethers at all.

**⚠ WARNING****Air Bags without Seat Belts:**

*Depending only on the air bags for protection during an accident is dangerous. Alone, air bags may not prevent serious injuries. The appropriate air bags can be expected to inflate only in collisions with frontal or near frontal forces that are at least moderate. Vehicle occupants should always wear seat belts.*

**Rear-Facing Child-Restraint System:**

*When a rear-facing child-restraint system is installed on the passenger's seat and the passenger air bag deactivation switch is not in the OFF position, it is extremely dangerous. In an accident, the air bag could inflate and cause serious injuries or even death to the child in the rear-facing child-restraint system. When using a rear-facing child-restraint system, always set the passenger air bag deactivation switch to OFF position.*

Deploying air bag

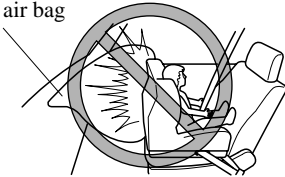
**Seating Position with Air Bags:**

*Sitting too close to the air bag modules or placing hands or feet on them is extremely dangerous. Air bags inflate with great force and speed. Serious injuries could occur if someone is too close. The driver should always hold onto only the rim of the steering wheel. The passenger should keep both feet on the floor. Seat occupants should adjust their seats as far back as possible and always sit upright against the seatbacks with seat belts worn properly.*

**Air Bag Modules:**

*Attaching an object to the air bag modules or placing something in front of them is dangerous. In an accident, the object could interfere with air bag inflation and injure the occupants.*

*Always keep the air bag modules free of objects.*

**Hot Air Bag Inflators:**

*Hot air bag inflators are dangerous. Immediately after inflation, the inflators in the steering wheel or the dashboard are very hot. You could get burned. Don't touch the internal components of the air bag modules after the bags have inflated.*

# SRS Air Bags

---

## **WARNING**

### **Installation of Front-End Equipment:**

*Installation of front-end equipment, such as frontal protection bar (kangaroo bar, bull bar, push bar, etc.), snowplow, or winches, is dangerous. The air bag crash sensor system could be affected. This could cause air bags to inflate unexpectedly, or it could prevent the air bags from inflating during an accident. Occupants could be seriously injured. Never install any front-end equipment to your vehicle.*

### **Suspension Adjustment:**

*Adjusting the vehicle suspension is dangerous. If the vehicle's height or the suspension is changed, the vehicle will be unable to accurately detect a collision resulting in incorrect or unexpected air bag deployment and the possibility of serious injuries.*

### **Modification of the Supplemental Restraint System:**

*Modifying the components or wiring of the supplemental restraint system is dangerous. You could accidentally activate it or make it inoperable. Don't make any modifications to the supplemental restraint system. This includes installing trim, badges, or anything else over the air bag modules. It also includes installing extra electric equipment on or near system components or wiring.*

## **NOTE**

- When an air bag deploys, a loud inflation noise can be heard and some smoke will be released. Neither is likely to cause injury, however, the texture of the air bags may cause light skin injuries on body parts not covered with clothing through friction.
- Should you sell your Mazda, we urge you to tell the new owner of its air bag systems and that familiarization with all instructions about them, from the Owner's Manual, is important.

## Passenger Air Bag Deactivation Switch

### **WARNING**

**Unnecessary Deactivation of Passenger Air Bag:**  
*Unnecessary deactivation of the passenger air bag is dangerous. If turned off unnecessarily, the passenger will not receive the added protection of the air bag. Serious injuries or even death could occur. With the exception of passengers fitting the categories described below, do not turn the air bag deactivation switch to the OFF position.*



Your vehicle is equipped with a passenger air bag deactivation switch. The switch is located in the center console. The switch must be used to deactivate the passenger air bag and the passenger seat belt pretensioner system when the occupant of the passenger seat fits into one of the following categories (as described in the request form for the air bag on-off switch, the appendix B to part 595 of National Highway Traffic Safety Administration [NHTSA]):

- Infants (less than one year old; for all types of restraint, but particularly the rear-facing child restraint.)
- Children aged 1 to 12
- People with certain medical conditions which, according to his/her physician, could be adversely affected by air-bag activation

For more government release information on air bag deactivation, contact your Authorized Mazda Dealer for the occupant categories as described in the request form for the air bag deactivation switch in the NHTSA rules.

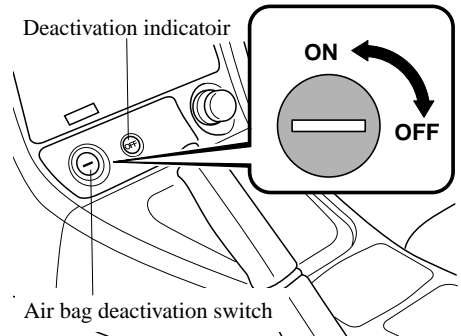
The air bag deactivation switch turns off the passenger air bag. Make sure the passenger air bag deactivation switch is in the ON position except when a passenger fitting the previous categories occupies the front passenger seat.



Passenger Air Bag Deactivation Switch	Passenger Air Bag Operation	Air Bag Deactivation Indicator Light
OFF position 	Deactivate	ON
ON position 	Ready	OFF

# SRS Air Bags

---

When the ignition switch is turned to the ON position, the passenger air bag deactivation indicator light comes on for about 6 seconds.

If the passenger air bag deactivation switch is in the OFF position, the indicator light remains on to warn that the passenger air bag has been deactivated.

## NOTE

Have the passenger air bag deactivation switch inspected by an Authorized Mazda Dealer if any of these conditions occur:

- The indicator doesn't come on when the ignition switch is turned to the ON position.
- The indicator doesn't remain on when the ignition switch is in the ON position and the passenger air bag deactivation switch is in the OFF position.
- The indicator remains on when the ignition switch is in the ON position and the passenger air bag deactivation switch is in the ON position.

## ▼ To Deactivate The Passenger Air Bag

### **WARNING**

#### **Leaving the Key in the Passenger Air Bag Deactivation Switch:**

***Unintentional deactivation of the passenger air bag is dangerous. In an accident, the passenger will not be properly protected. Serious injuries or even death could occur. To avoid unintentional deactivation, always use the same key to operate the passenger air bag deactivation switch and the ignition switch, that way you won't leave the key in the passenger air bag deactivation switch.***

1. Insert the key into the switch.
2. Turn the key clockwise until the key points to OFF.
3. Remove the key.
4. Make sure the air bag deactivation indicator light remains on when the ignition is in the ON position.

The passenger air bag will remain deactivated until the passenger air bag deactivation switch is turned to the ON position.



**▼ To Ready The Passenger Air Bag**

1. Insert the key into the switch.
2. Turn the key counterclockwise until the key points to ON.
3. Remove the key.
4. Make sure the air bag deactivation indicator light goes off after 6 seconds when the ignition switch is turned to the ON position.

# SRS Air Bags

## Air Bag System Description

The supplemental restraint systems (SRS) have two basic subsystems:

- The air bag system with inflators and air bags.
- The electric system with crash sensors and diagnostic module.

The air bags are mounted in the following locations: the center of the steering wheel, the passenger-side of the dashboard. They are out of sight until activated.

The passenger air bag has a deactivation switch located on the center console (page 2-23).

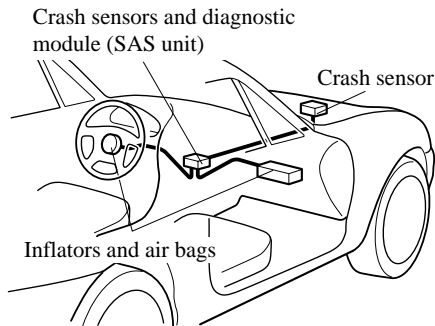

### ▼ How the Air Bags Work

When air bag crash sensors detect a frontal impact of greater than moderate force, an electrical current is sent to the inflators.

Gases are produced to inflate the air bags and after the inflation, the air bags quickly deflate.

The air bags will function only once. After that, **the air bags will not work again and must be replaced.**

Only an Authorized Mazda Dealer can replace the systems.

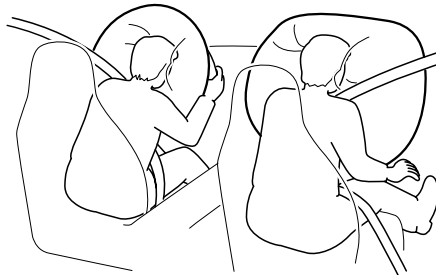

**▼ Air Bag Activation/Deactivation****Air bag activation**

A greater than moderate impact will cause the air bags to inflate in the following cases:

Hitting a solid wall straight on at greater than about 22 km/h (14 mph).

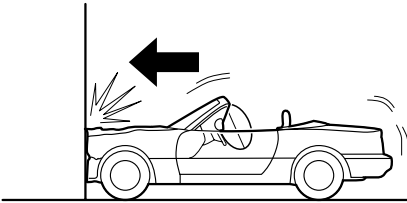

Frontal impact within about a 30 degree range from head-on to the vehicle.

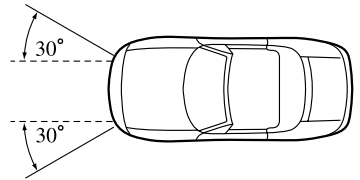

Hitting a curb, pavement edge or hard object.

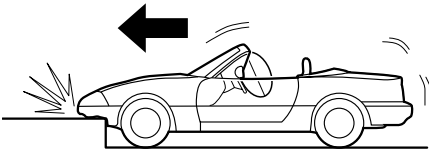

Driving into a big hole or hitting the far side of a hole.

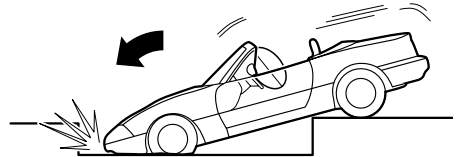

Landing hard or the vehicle falling.

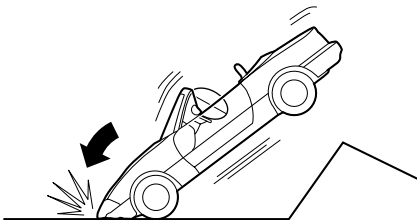

# SRS Air Bags

---

## Limitations to air bag activation

Depending on the severity of impact, the air bags may not inflate in the following cases:

Impacts involving trees or poles cause severe cosmetic damage but may not have enough impact to activate the air bag.

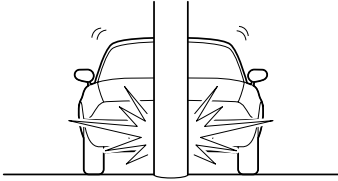

Frontal offset impact to the vehicle may not provide the stopping force necessary for air bag deployment.

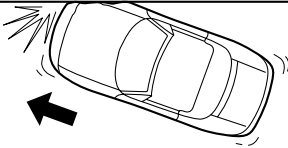

Rear-ending or running under a truck's tail gate may not provide the stopping force necessary for air bag deployment.

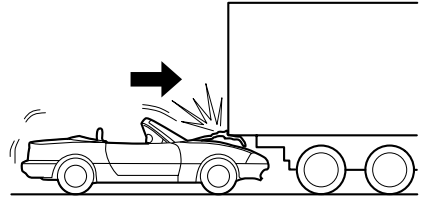

## Non-activation of air bags

Air bags will not normally inflate in the following cases:

Collision from the rear.

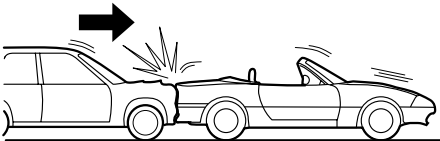

Vehicle roll-over.



Impact to the side.

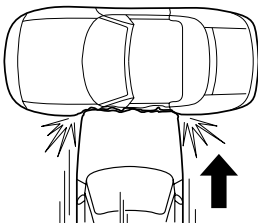

**▼ Constant Monitoring**

The following components of the air bag systems are monitored by a diagnostic system:

- SAS unit
- Crash sensor
- Air bag modules
- Seat belt pretensioners
- Related wiring
- Passenger air bag deactivation switch

A diagnostic module continuously monitors the systems' readiness. This begins when the ignition switch is turned to the ON position and continues while the vehicle is being driven.

**▼ Air Bag/Seat Belt Pretensioner System Warning Light**

If the air bag/seat belt pretensioner system is normal, the warning light illuminates when the ignition switch is turned to the ON position or after the engine is cranked. After about 6 seconds it goes out.

A system malfunction is indicated when the warning light constantly flashes, illuminates or doesn't illuminate at all when the ignition switch is turned to the ON position. If any of these occur, consult an Authorized Mazda Dealer as soon as possible. The system may not work in an accident.

 **WARNING**

**Self-Servicing the Air Bag/  
Pretensioner Systems:**

***Self-servicing or tampering with the systems is dangerous. An air bag/pretensioner could accidentally activate or become disabled. This could cause serious injuries. Never tamper with the systems and always have an Authorized Mazda Dealer perform all servicing and repairs.***

# SRS Air Bags

---

## ▼ Maintenance

The air bag systems do not require regular maintenance. But if any of the following occurs, take your vehicle to an Authorized Mazda Dealer as soon as possible:

- The air bag system warning light flashes.
- The air bag system warning light remains illuminated.
- The air bag system warning light remains off when the ignition switch is turned to the ON position.
- The air bags inflate.

### **WARNING**

**Damaged Air Bag Sensors:**  
*Driving with damaged air bag sensors is dangerous. A collision, even one not strong enough to inflate the air bags, could damage the sensors. If there was a subsequent collision, a damaged sensor would not inflate the air bags. Always have an Authorized Mazda Dealer inspect the air bag systems after a collision.*

**Removing Interior Parts:**  
*Removing any components such as the front dashboard, the steering wheel or parts containing air bag parts or sensors is dangerous. These parts contain essential air bag parts. The air bag could accidentally activate and cause serious injuries. Always have an Authorized Mazda Dealer remove these parts.*

**Air Bag Disposal:**  
*Improper disposal of an air bag or a vehicle with live air bags in it can be extremely dangerous. Unless all safety procedures are followed, injury can result. Ask an Authorized Mazda Dealer how to safely dispose of an air bag or how to scrap an air bag equipped vehicle.*

# 3

## Knowing Your Mazda

Explanation of basic operations and controls; opening/closing and adjustment of various parts.

<b>Doors and Locks</b> .....	3-2
Keys .....	3-2
Keyless Entry System* .....	3-3
Door Locks .....	3-7
Trunk Lid .....	3-10
Inside Trunk Release Handle .....	3-12
Power Windows .....	3-14
Fuel-Filler Lid and Cap .....	3-15
Hood .....	3-17
Convertible Top .....	3-18
Detachable Hardtop* .....	3-23
<b>Security System</b> .....	3-29
Immobilizer System* .....	3-29
<b>Mirrors</b> .....	3-32
Mirrors .....	3-32

# Doors and Locks

---

## Keys

### **WARNING**

**Keys and Children:**

*Leaving children in a vehicle with the key is dangerous. This could result in someone being badly injured or even killed. They could play with power windows or other controls, or even make the vehicle move. Don't leave the keys in your vehicle with children and keep them in a place where your children will not find or play with them.*

### **NOTE**

**(With immobilizer system)**

Refer to Immobilizer System (page 3-29) for information regarding keys and engine starting on vehicles equipped with the immobilizer system.

The keys operate all locks.

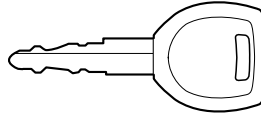

 — Key code number plate

A code number is stamped on the plate attached to the key set; detach this plate and store it in a safe place (not in the vehicle) for use if you need to make a replacement key.

Also write down the code number and keep it in another safe and handy place, but not in the vehicle.

If your key is lost, consult your Authorized Mazda Dealer with the code number ready.



## Keyless Entry System\*

This system locks and unlocks the doors and opens the trunk.

It can also help you signal for attention in an emergency.

Press the button slowly and accurately.

### CAUTION

To avoid damage to the transmitter, do not:

- Drop it.
- Get it wet.
- Disassemble it.
- Expose it to heat or sunlight.

### NOTE

- The keyless entry system is designed to operate up to about 2.5 m (8 ft) from the center of the vehicle, but this may vary because of local conditions.
- The system doesn't operate when the ignition switch is in the ON position.
- If the transmitter does not operate when pressing a button or the operation range becomes too small, the battery may be dead. To install a new battery, refer to Maintenance (page 3-5).
- Additional transmitters can be obtained at an Authorized Mazda Dealer. Up to 3 transmitters can be used with the keyless entry system per vehicle. Bring all transmitters to an Authorized Mazda Dealer when the electronic codes need to be reset.

# Doors and Locks

## ▼ Transmitter

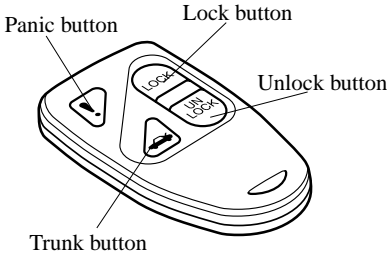

### NOTE

- **(U.S.A.)**  
This device complies with part 15 of the FCC Rules. Operation is subject to the following two conditions: (1) This device may not cause harmful interference, and (2) this device must accept any interference received, including interference that may cause undesired operation.
- **(CANADA)**  
This device complies with RSS-210 of Industry CANADA. Operation is subject to the following two conditions: (1) this device may not cause interference, and (2) this device must accept any interference, including interference that may cause undesired operation of the device.

### NOTE

If the LOCK and UNLOCK buttons are pressed sequentially, the hazard warning lights may not flash correctly.

## Lock button

To lock the doors, press the LOCK button and the hazard warning lights will flash once.

To confirm that all the doors have been locked, press the LOCK button again within 5 seconds. If they are closed and locked, the horn will sound and the hazard warning lights will flash once.

### NOTE

Confirm that all the doors are locked visually or audibly by use of the double click.

## Unlock button

To unlock the driver's door, press the UNLOCK button and the hazard warning lights will flash twice.

To unlock all the doors, press the UNLOCK button again within 5 seconds and the hazard warning lights will flash twice.

### NOTE

After unlocking with the transmitter, all doors will automatically lock if one of the doors is not opened within about 30 seconds.

## Trunk button

To open the trunk, press the  button.

**!Panic button**

You can use the ! button to turn on the alarm, which allows you to signal for attention in an emergency.

**NOTE**

The alarm will work whether any door is open or closed.

**Turning on the alarm**

Pressing the ! button once will trigger the alarm for about 2 minutes and 30 seconds, and do the following:

- The horn sounds intermittently.
- The hazard warning lights flash.

**Turning off the alarm**

Press any button on the transmitter.

**▼ Transmitter Maintenance**** CAUTION**

- Make sure the battery is installed with the correct pole facing upward. Battery leakage could occur if it is not installed correctly.
- When replacing the battery, be careful not to bend the electrical terminals or get oil on them. Also be careful not to get dirt in the transmitter as it could damage it.
- Danger of battery explosion if it is incorrectly replaced.
- Replace only with the same type battery (CR2025 or equivalent).
- Dispose of used batteries according to the following instructions.
  - Insulate the plus and minus terminals of the battery using cellophane or equivalent tape.
  - Never disassemble.
  - Never throw the battery into fire and/or water.
  - Never deform or crush.

# Doors and Locks

## Replacing the transmitter battery

1. Insert a small screwdriver into the slot and gently pry open the transmitter.

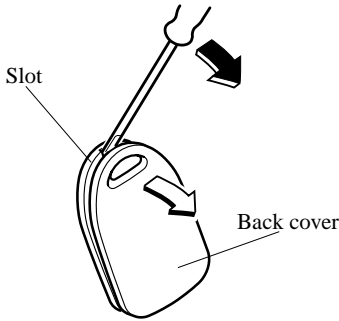

2. Press the portion of the battery indicated by A and remove the battery.

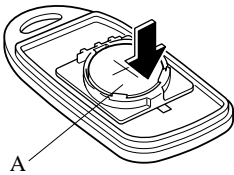

3. Install a new battery (CR2025 or equivalent) into the front portion of the holder with the positive pole (+) facing up. Press on the B portion of the battery to set the battery.

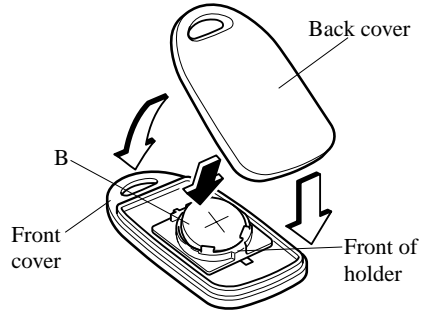

### **⚠ CAUTION**

Do not press any buttons when replacing the battery. The electronic code could be altered and cause the keyless entry system to malfunction. If the keyless entry system fails to operate, contact an Authorized Mazda Dealer.

4. Align the front and back covers and snap the transmitter shut.

## Doors and Locks

### ▼ Service

If you have a problem with the keyless entry system, consult an Authorized Mazda Dealer.

If your transmitter is lost or stolen, bring all remaining transmitters to an Authorized Mazda Dealer as soon as possible for a replacement and to make the lost or stolen transmitter inoperative.

### CAUTION

Changes or modifications not expressly approved by the party responsible for compliance could void the user's authority to operate the equipment.

### Door Locks

#### WARNING

##### **Unattended Children and Pets:**

*Leaving a child or an animal unattended in a parked vehicle is dangerous. In hot weather, temperatures inside a vehicle can become high enough to cause brain damage or even death. Always take all children and animals with you or leave a responsible person with them.*

##### **Keys and Children:**

*Leaving children in a vehicle with the key is dangerous. This could result in someone being badly injured or even killed. They could play with power windows or other controls, or even make the vehicle move. Don't leave the keys in your vehicle with children and keep them in a place where your children will not find or play with them.*

##### **Unlocked Doors:**

*Unlocked doors in a moving vehicle are dangerous. Passengers can fall out if a door is accidentally opened and can more easily be thrown out in an accident. So keep all doors locked when driving.*

#### NOTE

Always remove the key from the ignition switch, close all windows, and lock all doors and the trunk lid when leaving your vehicle unattended. This discourages intruders and thieves.

# Doors and Locks

## ▼ Locking, Unlocking with Key

Either door can be locked/unlocked with the key.

Turn the key toward the front to unlock, toward the back to lock.

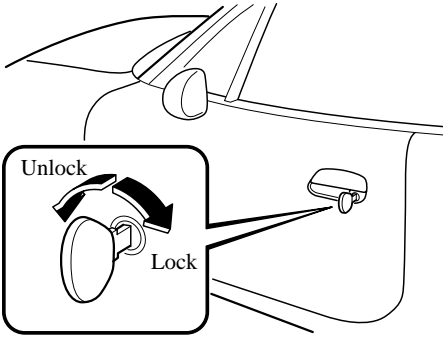

## ▼ Locking, Unlocking with Transmitter\*

The doors can be locked/unlocked by operating the keyless entry system transmitter, refer to keyless entry system (page 3-3).

## ▼ Locking, Unlocking with Door-Lock Knob

To lock any door from the inside, push the door-lock knob.

To unlock, pull it out.

This does not operate the other door lock.

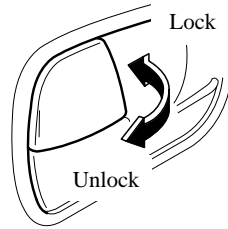

To lock any door with the door-lock knob from the outside, push the door-lock knob to the lock position and close the door.

This does not operate the other door lock.

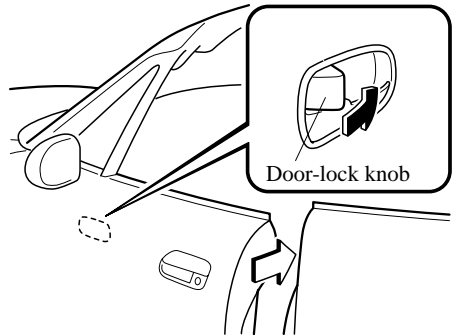

### NOTE

When locking the doors this way, be careful not to leave the key inside the vehicle.

# Doors and Locks

## ▼ Power Door Locks\*

### Locking, unlocking with key

Both doors lock automatically when either door is locked with the key. Both doors unlock when the driver's door is unlocked and the key is held in the unlock position a second longer. Also, both doors unlock when the passenger's door is unlocked.

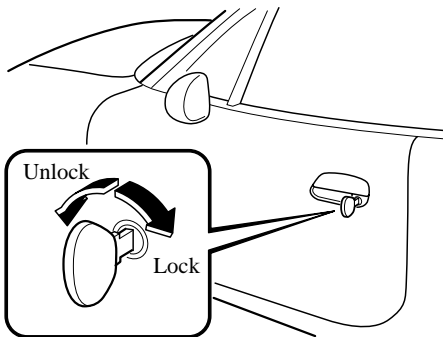

### NOTE

Holding the key in the unlocked position in the driver's door lock for about a second unlocks both doors. To unlock only the driver's door, insert the key into the driver's door lock and turn the key briefly to the unlock position and then immediately return it to the center position.

### Locking, unlocking with door-lock switch

Both doors lock automatically when LOCK is pushed. They all unlock when the unmarked part of the door-lock switch is pushed.

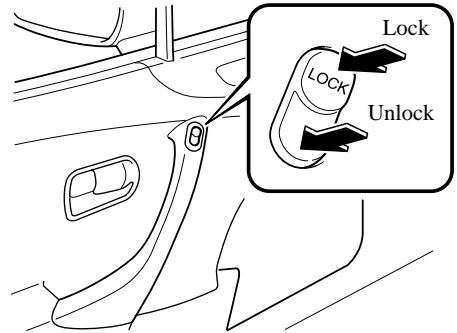

# Doors and Locks

## Trunk Lid

### **WARNING**

**Open Trunk and Exhaust Gas:**  
*Exhaust gas in the cabin of a vehicle is dangerous. This gas contains CO (carbon monoxide), which is colorless, odorless, and highly poisonous. If inhaled, it can cause loss of consciousness and death. Because exhaust gas can get into the cabin through an open trunk, keep the trunk closed when driving.*

### ▼ Opening and Closing the Trunk

### **WARNING**

**Open Trunk Lid and Children:**  
*Leaving the trunk lid open or leaving children in the vehicle with the keys is dangerous. Children could open the trunk lid and climb inside resulting in possible injury or death from heat exposure. Close the trunk lid and do not allow children to play inside the vehicle.*

### **WARNING**

**Unattended Children and Pets:**  
*Leaving children or animals unattended in a parked vehicle is dangerous. Babies left sleeping and kids who lock themselves in cars or trunks can die very quickly from heat prostration. Don't leave your children or pets alone in a car at any time. Don't leave the car or the trunk unlocked. Always keep the car from being a tempting place to play by locking doors and the trunk, and keeping the keys where children won't play with them.*

### **Opening the trunk lid with the key**

Insert the key into the slot and turn it clockwise.

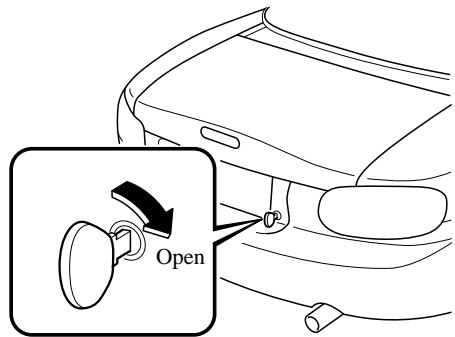

### **Opening the trunk lid with the transmitter**

The trunk lid can be opened by operating the keyless entry system transmitter, refer to Keyless Entry System (page 3-3).



### **Opening the trunk lid with the remote release lever**

The remote trunk lid release is mounted in the center console.

To open the console, unlock it and pull the release catch.

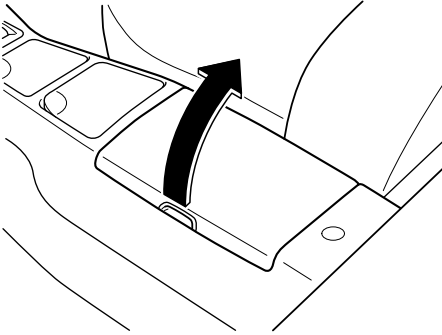

To release the trunk lid, pull up on the trunk lid release lever.

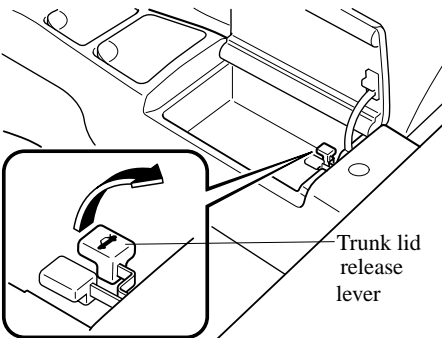

### **Closing the trunk lid**

Use both hands to push the trunk lid down until the lock snaps shut. Do not slam it. Pull up on the trunk lid to make sure it is secure.

### **▼ Remote Trunk Lid Release Lock-Out**

The remote release may be canceled to prevent anyone in the vehicle from opening the trunk.

Close the trunk, insert the key, and turn it counterclockwise, then return the key to the center position and remove it.

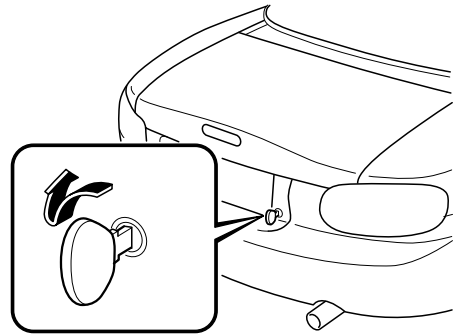

To activate the remote release, insert the key, turn it clockwise and open the trunk lid at the same time.

#### **NOTE**

If the remote trunk lid release does not work, insert the key and turn it clockwise.

# Doors and Locks

## ▼ Trunk Light

The trunk light is on when the lid is open and off when it's closed.

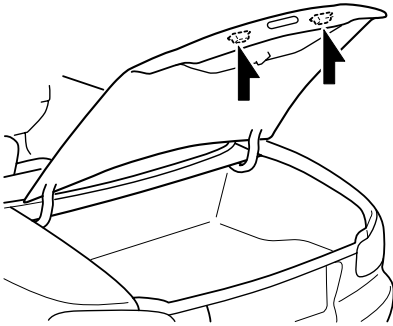

### NOTE

- To prevent the battery from being discharged, do not leave the trunk open for a long period when the engine is not running.
- The trunk and license plate lights share the same light bulbs.

## Inside Trunk Release Handle

Your vehicle is equipped with an inside trunk release handle that provides a means of escape for children and adults in the event they become locked inside the trunk.

No matter how careful adults might be with keys and locking their cars, parents should be aware that children may be tempted to play around vehicles and use the trunk as a hiding place.

Adults are advised to familiarize themselves with the operation and location of the inside release handle so that all children can be told about it in an appropriate way, keeping in mind that most vehicles don't have such handles.

## Doors and Locks

### **WARNING**

#### **Open Trunk Lid and Children:**

*Leaving the trunk lid open or leaving children in the vehicle with the keys is dangerous. Children could open the trunk lid and climb inside resulting in possible injury or death from heat exposure. Close the trunk lid and do not allow children to play inside the vehicle.*

#### **Unattended Children and Pets:**

*Leaving children or animals unattended in a parked vehicle is dangerous. Babies left sleeping and kids who lock themselves in cars or trunks can die very quickly from heat prostration. Don't leave your children or pets alone in a car at any time. Don't leave the car or the trunk unlocked. Always keep the car from being a tempting place to play by locking doors and the trunk, and keeping the keys where children won't play with them.*

### ▼ **Opening the Trunk Lid from the Inside**

Pull the illuminated "T" shaped handle. The handle is made of material that will glow for hours in the darkness of the trunk following a brief exposure to ambient light.

The "T" shaped handle is located on the inside of the trunk end trim.

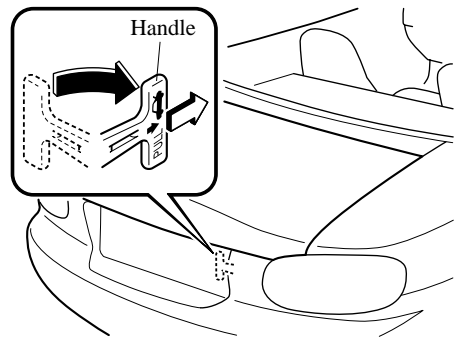

### **CAUTION**

Always keep the handle firmly attached to the holder and in the recessed position. Not securing the handle this way could allow it to snag luggage in the trunk and open the trunk lid.

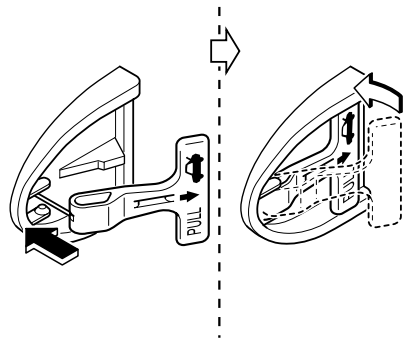

# Doors and Locks

## Power Windows

The ignition switch must be in the ON position for the power windows to operate.

### **WARNING**

**Closing Power Windows:**  
*Closing power windows are dangerous. A person's hands, head, or even neck could be caught by the window and result in serious injury or even death.*  
*This warning applies especially to children. Make sure the opening is clear before closing a window.*

**Keys and Children:**  
*Leaving children in a vehicle with the key is dangerous. This could result in someone being badly injured or even killed. They could play with power windows or other controls, or even make the vehicle move. Don't leave the keys in your vehicle with children and keep them in a place where your children will not find or play with them.*

## ▼ Operating the Driver's Side Power Window

### Manual opening/closing

To open the window to the desired position, lightly hold down the switch. To close the window to the desired position, lightly pull up the switch.

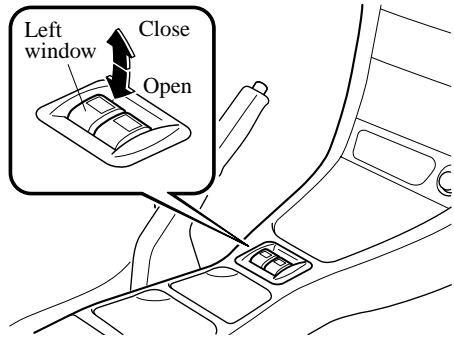

### Auto-opening

To fully open the window automatically, press the switch completely down.

To stop the window partway, lightly pull up the switch and then release it.

### ▼ Operating the Passenger Power Window

To open the window to the desired position, hold down the switch.

To close the window to the desired position, pull up the switch.

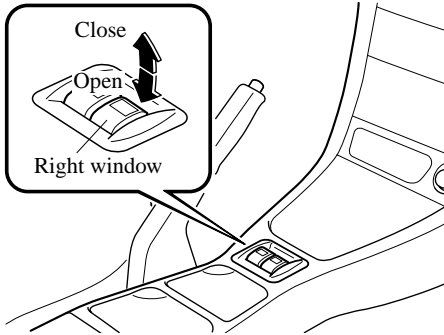

### Fuel-Filler Lid and Cap

#### **WARNING**

##### Fuel Spray:

*Fuel spray is dangerous. Fuel can burn skin and eyes and cause illness when ingested. Fuel spray is released when there is pressure in the fuel tank and the fuel cap is removed too quickly. When removing the fuel cap, loosen the cap slightly and wait for any hissing to stop. Then remove it.*

##### Fuel Vapor:

*Fuel vapor is dangerous. It could be ignited by sparks or flames causing serious burns and injuries. Before refueling, stop the engine, and always keep sparks and flames away from the filler neck. Additionally, use of the incorrect fuel filler cap or not using a fuel filler cap may result in fuel leak, which could result in serious burns or death in an accident.*

#### **CAUTION**

Always use only a genuine Mazda fuel cap or an approved equivalent, available at Authorized Mazda Dealers. The wrong cap can result in a serious malfunction of the fuel and emission control systems. It may also cause the check engine light in the instrument cluster to illuminate.

# Doors and Locks

## ▼ Fuel-Filler Lid

The remote fuel-filler lid release is mounted in the center console. To open the console, unlock it and pull the release catch.

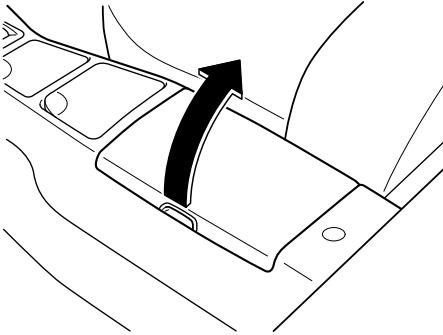

To open the fuel-filler lid, pull up on the remote fuel-filler lid release.

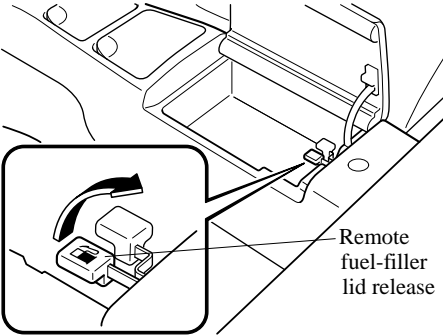

## ▼ Fuel-Filler Cap

To remove the filler cap, turn it counterclockwise.

To close the filler cap, turn it clockwise until it clicks.

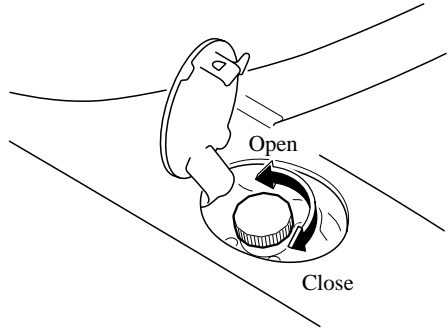

### ⚠ CAUTION

Make sure the fuel-filler cap is tightened securely. The check engine light may illuminate on when the cap isn't tightened securely. If the light remains on (even after you have tightened the cap securely, driven, and restarted the engine several times), it may indicate a different problem. Contact an Authorized Mazda Dealer as soon as possible.

## Hood

### ⚠ WARNING

***Closed and Securely Locked Hood:***  
*A hood that is not closed and securely locked is dangerous as it could fly open while the vehicle is moving and block the driver's vision which could result in a serious accident. Always check that the hood is closed and securely locked.*

### ▼ Opening the Hood

1. With the vehicle parked, pull the release handle to unlock the hood.

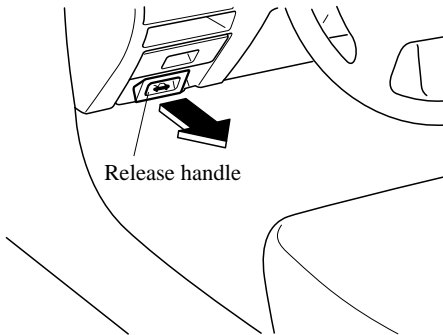

2. Pull the hood latch up and lift the hood.

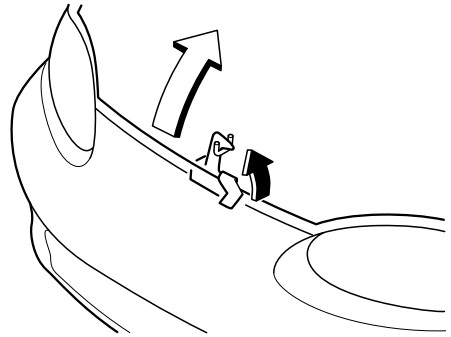

3. Use the support rod to hold the hood open.

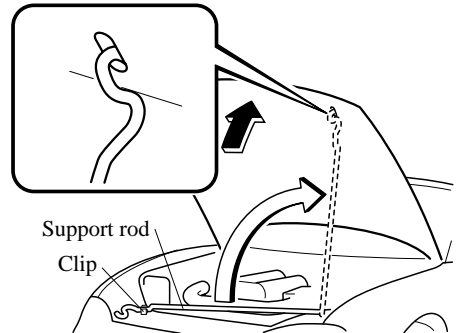

### ▼ Closing the Hood

1. Check under the hood area to make certain all filler caps are in place and all loose items (e.g. tools, oil containers, etc.) have been removed.
2. Insert the support rod in its clip while holding up the hood. Verify that the support rod is secured in the clip before closing the hood.
3. Close the hood so that it locks securely.

# Doors and Locks

## Convertible Top

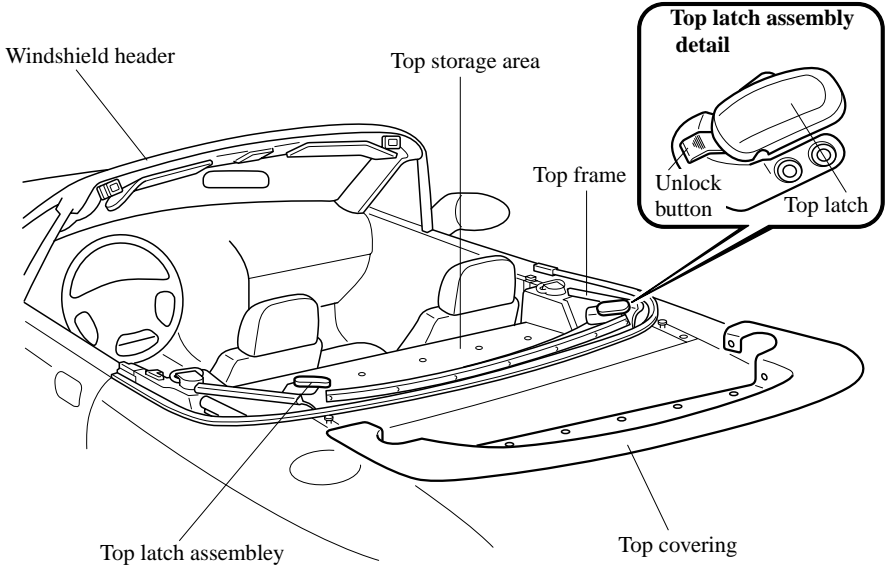

### ▼ Convertible Top Precautions

#### **⚠ WARNING**

**Standing in a Moving Vehicle:**  
*Standing in the vehicle, or sitting on the convertible top storage area or center console when it's moving is a dangerous way to ride. During a sudden maneuver or collision you could be seriously injured or even killed.  
Sit in the seat with the seat belt on when the vehicle is moving.*

#### **⚠ WARNING**

**Fastening Mechanisms:**  
*It is dangerous to place your hands or fingers near the fastening mechanisms. Your hands or fingers could be caught and injured by the mechanism. Always keep your hands and fingers away from the fastening mechanisms when moving the top.*

#### **⚠ CAUTION**

Remove leaves that accumulate on and around the convertible top. If the leaves are not removed, they may block the water drainage outlets.



## Doors and Locks

- Before lowering or raising the top, stop in a safe place off the right-of-way and park on a level surface.
- Make sure nothing is on the top or near the back window when raising or lowering the top.  
Even small objects may interfere and cause damage.
- When lowering the top, make sure objects inside the vehicle aren't blown away by the wind.
- Secure all loose objects inside before driving with the top down.
- To help prevent burglary or vandalism and to ensure that the passenger compartment stays dry, close the top securely and lock all doors when leaving the vehicle.
- Don't drive through an automatic car wash; it may damage the top.
- Don't raise or lower the top when the temperature is below 5 °C (41 °F) ; this will damage the top material.
- Don't lower the top when it's wet. If the top dries while folded, it will deteriorate and shrink.
- Lowering the top while it's wet can also cause water to drip into the passenger compartment.
- Don't raise or lower the top when the wind is strong; the wind could damage the top.

### ▼ Lowering the Convertible Top

1. Park the vehicle on a level surface and firmly set the parking brake.
2. Lower the side windows, then turn off the ignition.
3. Pull down the sunvisors.

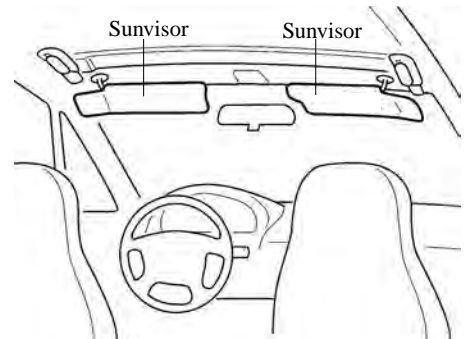

4. Remove all objects in the top storage area.

### **WARNING**

***Objects in the Storage Area:***  
***Putting heavy or sharp objects in the top storage area is dangerous. During a sudden stop or collision, they can become projectiles that might hit and injure passengers. Don't place heavy or sharp objects in the top storage area.***

# Doors and Locks

5. Push the unlock buttons and fully release the top latches.

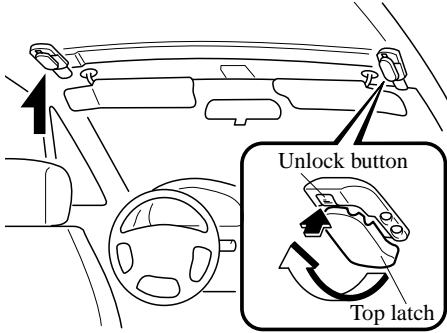

6. Lift up on the front section of the top to release it from the windshield header.

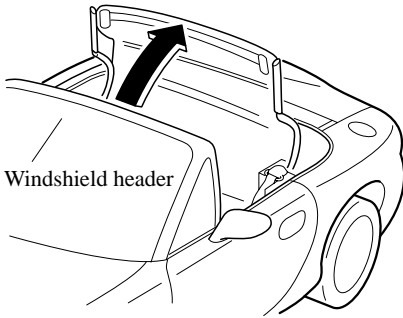

7. Fold back the front and carefully lower it to the storage area, then put the latches in the locked position.

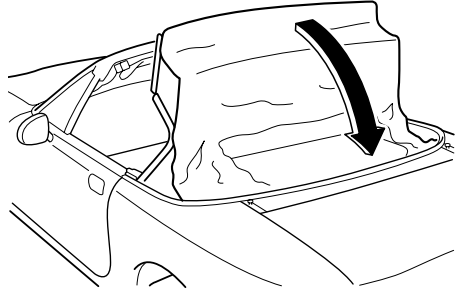

## ▼ Covering the Convertible Top

1. Cover the convertible top with the top covering, stored in the trunk.
2. Feed the straps on the bottom of the covering through the lower links and snap them into position.

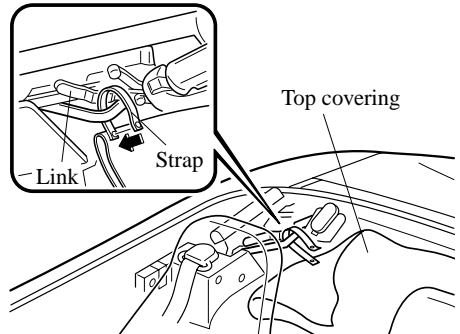

3. Secure the top covering with the straps.
4. Affix the top covering fasteners.

## Doors and Locks

5. Insert the top covering's rear edge into the groove in the body molding.

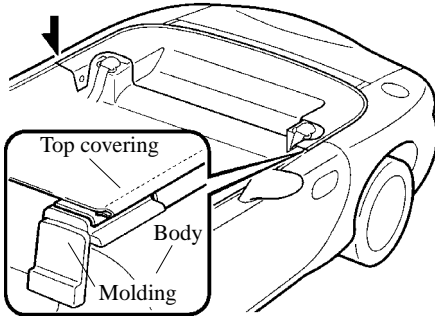

### ⚠ CAUTION

Never drive with the top partially folded or uncovered. Otherwise the top and/or the top covering could be damaged.

### ▼ Raising the Convertible Top

1. Park the vehicle on a level surface and firmly set the parking brake.
2. Lower the side windows, then turn off the ignition.
3. Pull down the sunvisors.

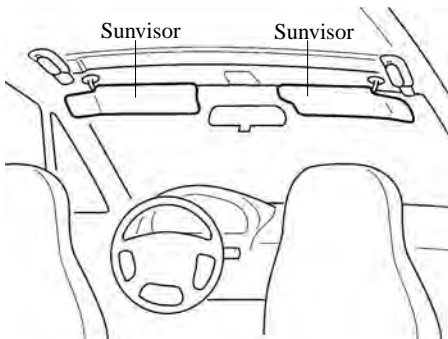

4. Undo the fasteners and straps.

5. Remove the top covering and store it properly in the trunk.
6. Unlock the top latches and open them fully.
7. Hold the top lift handle and pull the top up and forward until it's against the windshield header.

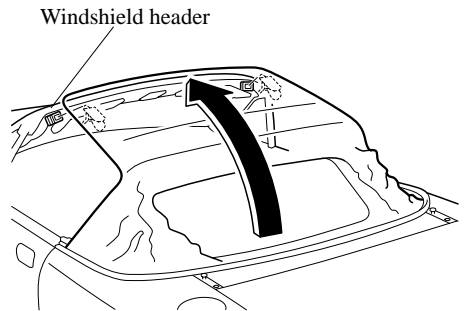

8. After securely hooking the top latches onto the windshield header, push each latch up with the palm of your hand until the lock buttons click and the latches are locked.

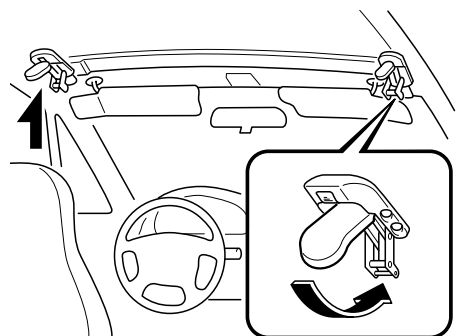

# Doors and Locks

---

## CAUTION

Make sure the top is securely locked by pushing up on it.  
Driving with the top unlocked could damage the top.

## NOTE

Make sure the top is securely locked by pushing up on it. If it still sounds loose (rattles) after being locked by the top latches, have it inspected at an Authorized Mazda Dealer.

9. If the rear window defroster coupler is disconnected, connect the coupler.

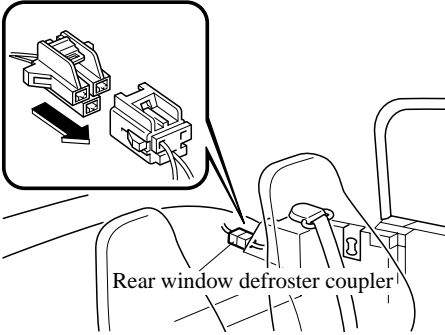

## ▼ Taking Care of the Top

Refer to convertible top maintenance (page 8-45) for information on taking care of the top.

## Detachable Hardtop\*

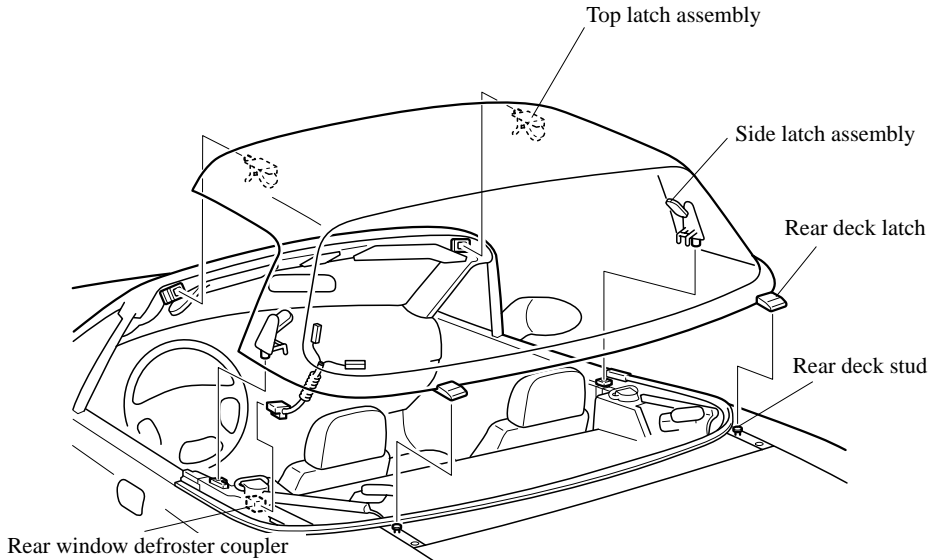

### ▼ Detachable Hardtop Precautions

#### **WARNING**

**Standing in a Moving Vehicle:**  
*Standing in the vehicle, or sitting on the convertible top storage area or center console when it's moving is a dangerous way to ride. During a sudden maneuver or collision you could be seriously injured or even killed.*  
*Sit in the seat with the seat belt on when the vehicle is moving.*

#### **WARNING**

**Hardtop and Rollover Accidents:**  
*Rollover accidents on a hardtop vehicle are dangerous. The hardtop is not as strong as a regular steel roof. Rollover accidents could dislodge or crush the hardtop and cause serious injuries or even death, just as with no top or a soft top.*  
*Always drive safely and observe the speed limit.*

# Doors and Locks

## **WARNING**

### ***Fastening Mechanisms:***

***It is dangerous to place your hands or fingers near the fastening mechanisms. Your hands or fingers could be caught and injured by the mechanism. Always keep your hands and fingers away from the fastening mechanisms when moving the top.***

- When removing the hardtop, make sure the operation is performed by 2 persons.
- Before removing or installing the hardtop, be sure you are parked out of traffic in a flat area near the location your top is to be stored.
- When removing the hardtop, make sure objects inside the vehicle aren't blown away by the wind.
- Secure all loose objects inside before driving with the hardtop removed.
- Don't drive through an automatic car wash; it may damage the hardtop.
- Don't remove or install the hardtop when the wind is strong; the wind could damage the hardtop.
- Before removing the hardtop, lower the antenna.
- Removing the hardtop while it's wet can cause water to drip into the passenger compartment.

## ▼ **Removing the Detachable Hardtop**

1. Park the vehicle on a level surface and firmly set the parking brake.
2. Lower the side windows, then turn off the ignition.
3. Pull down the sunvisors.

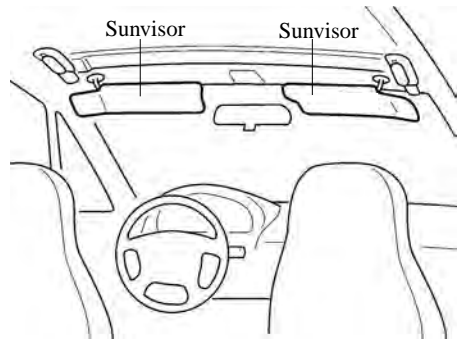

4. Push the unlock buttons and fully release the top latches.

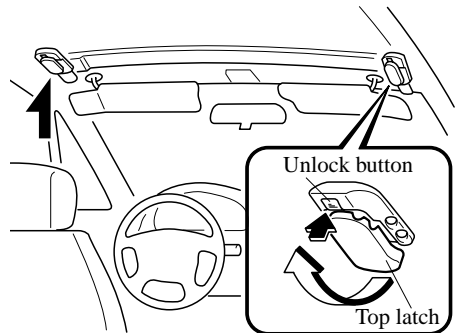

## Doors and Locks

5. Push the unlock buttons and fully release the side latches.

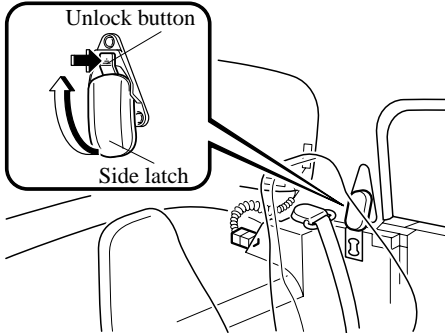

6. Disconnect the rear window defroster coupler.

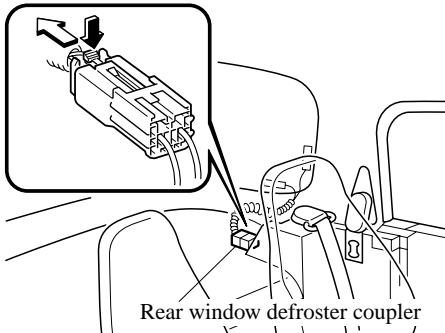

7. Slide the hardtop rearward while pressing down on the rear deck latches to unlock the latches.

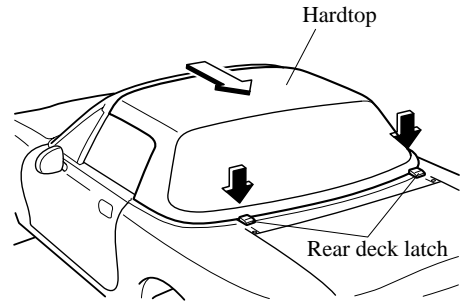

8. Lift the hardtop straight off the body to prevent damage to the rear deck latches and studs.

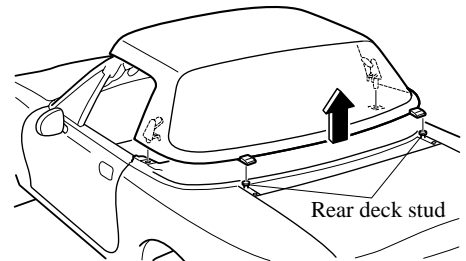

### **⚠ WARNING**

**Windshield's Edges:**

*Not being careful of the windshield's edges when getting into or out of the vehicle is dangerous. The windshield's edges could scratch and cause injuries.*

*Be careful of the windshield's edges when getting into or out of the vehicle.*

# Doors and Locks

## ⚠ CAUTION

- Be careful not to strike the body with any of the protruding hardtop latches.
- Use extreme care when carrying the hardtop to prevent scratching or other damage to it.

## NOTE

Points to remember when storing the detachable hardtop.

- Do not place the hardtop on a hard surface, such as concrete or asphalt. Place it on a cushioning material, such as an old blanket.
- Be sure the top and side latches are locked.
- Do not lean the hardtop against a wall or stand it in an unstable way.
- Store the hardtop in a dry clean area, and cover it with a soft material, such as an old blanket.

## ▼ Installing the Detachable Hardtop

## ⚠ CAUTION

Do not attempt to install the hardtop with the convertible top also up. Lower the convertible top before installing the hardtop, otherwise damage will occur to the convertible top.

## NOTE

- Be sure to place the convertible top latches in the locked position.
- Make sure the convertible top is completely lowered before installing the hardtop. Also confirm that the rear window defroster coupler is disconnected.

1. Park the vehicle on a level surface and firmly set the parking brake.
2. Lower the side windows, then turn off the ignition.
3. Pull down the sunvisors.

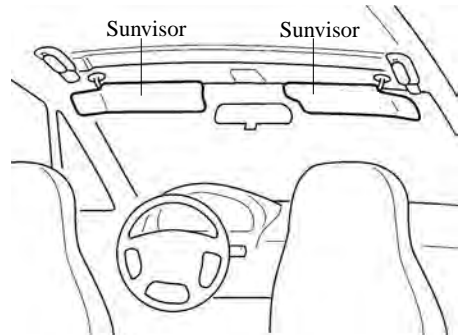



## Doors and Locks

4. Unlock the top latches and the side latches on the hardtop.

Top latch assembly

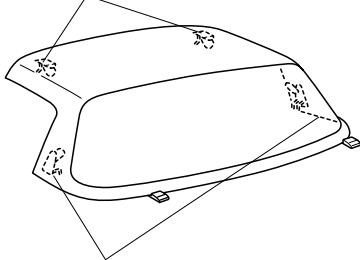

Slide latch assembly

5. Align the rear deck latches with the rear deck studs and set the hardtop squarely onto the body.

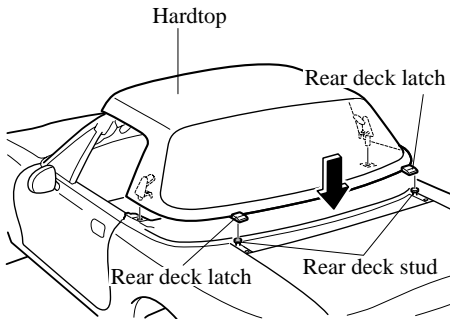

6. Slide the hardtop forward while pressing down on the rear deck latches to lock the latches, and then verify that they are secure by attempting to lift the rear of the hardtop.

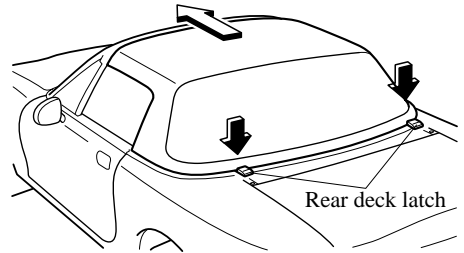

### ⚠ CAUTION

- Be careful not to strike the body with any of the protruding hardtop latches.
- The rear defogger grid and the defogger cord could be damaged when removing or installing the top. Make sure the rear defogger grid isn't folded and the defogger cord isn't caught between the vehicle's body and the top.

# Doors and Locks

7. Push each top latch up with the palm of your hand until the lock buttons click and the latches are locked.

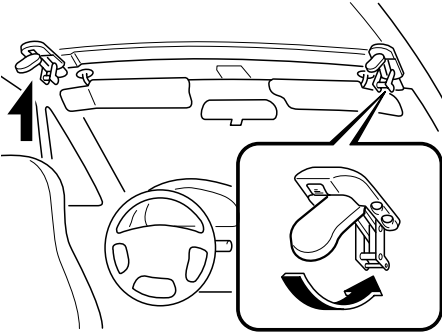

8. Push each side latch down with the palm of your hand until the lock buttons click and the latches are locked.

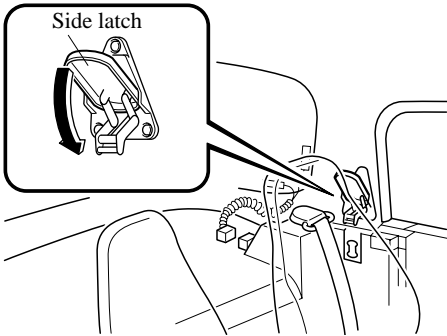

## **⚠ CAUTION**

After installation, verify that all latches are secure. Operating the vehicle with unlocked latches may cause hardtop damage or loss.

9. Reconnect the rear window defroster coupler.

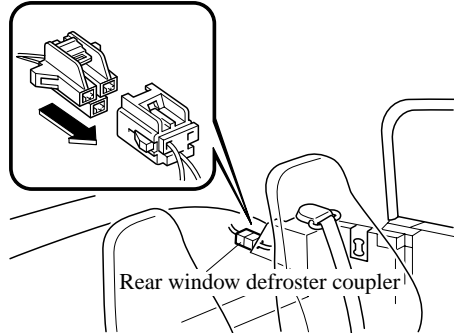

## **NOTE**

If the top rattles even when all latches are secure, drive slowly and contact an Authorized Mazda Dealer for inspection.

## **▼ Detachable Hardtop Appearance Care**

Refer to detachable hardtop maintenance (page 8-46) for information on detachable hardtop appearance care.

**Immobilizer System\***

The optional immobilizer system allows the engine to start only with a key the system recognizes.

If someone attempts to start the engine with an unrecognized key, the engine will not start, thereby helping to prevent the theft of your vehicle.

**⚠ CAUTION**

- Changes or modifications not expressly approved by the party responsible for compliance could void the user's authority to operate the equipment.
- To avoid damage to the key, do not:
  - Drop the key.
  - Get the key wet.
  - Expose the key to any kind of magnetic field.
  - Expose the key to high temperatures on places such as the dashboard or hood, under direct sunlight.

**⚠ CAUTION**

- When starting the engine do not allow the following, as the engine may not start due to the electronic signal from the ignition key not being transmitted correctly.
  - A key ring rests on the key grip.

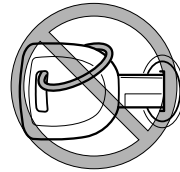

- Metal parts of other keys or metal objects touch the key grip.

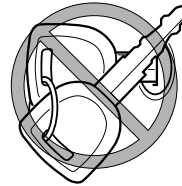

- Spare keys or keys for other vehicles equipped with an immobilizer system touch or come near the key grip.

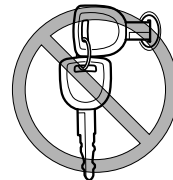

- Devices for electronic purchases, or security passage touch or come near the key.

# Security System

---

## NOTE

- **(U.S.A.)**  
This device complies with part 15 of the FCC Rules. Operation is subject to the following two conditions: (1) This device may not cause harmful interference, and (2) this device must accept any interference received, including interference that may cause undesired operation.
- **(CANADA)**  
This device complies with RSS-210 of Industry CANADA. Operation is subject to the following two conditions: (1) this device may not cause interference, and (2) this device must accept any interference, including interference that may cause undesired operation of the device.

## ▼ Immobilizer System Warning Light



If the immobilizer system is working properly, the light will come on when the ignition switch is turned to the ON or START position. The light will go out when confirmation by the immobilizer system is completed.

If the light flashes rapidly, fails to come on, or comes on and stays on, it indicates a system malfunction. If any of these occur, contact an Authorized Mazda Dealer as soon as possible.

## Security System

### NOTE

- If the warning light comes on and stays on when the ignition switch is turned to the ON position, the engine will not start.
- Signals from a TV or radio station, or from a transceiver or a mobile telephone, could interfere with your immobilizer system. If you are using the proper key and your engine fails to start, check the warning light. If it is flashing, remove the ignition key and wait 2 seconds or more, then reinsert it and try starting the engine again. If it doesn't start after 3 or more tries, contact an Authorized Mazda Dealer.
- If the warning light flashes continuously while you are driving, don't shut off the engine. Go to an Authorized Mazda Dealer and have it checked. If you shut off the engine while the light is flashing you won't be able to restart it.
- Since the electronic codes are reset when repairing the immobilizer system, the keys are needed. Bring all the existing keys to the Authorized Mazda Dealer.

### ▼ Maintenance

If you have a problem with the immobilizer system or the key, consult an Authorized Mazda Dealer.

### NOTE

- The keys carry a unique electronic code. For this reason, and to assure your safety, obtaining replacement key requires some waiting time. They are only available through an Authorized Mazda Dealer.
- Always keep a spare key, in case one is lost. If a key is lost, contact an Authorized Mazda Dealer as soon as possible.
- If you lose a key, an Authorized Mazda Dealer will reset the electronic codes of your remaining keys and immobilizer system. Bring all the remaining keys to the Authorized Mazda Dealer to reset. Starting the vehicle with a key that has not been reset is not possible.

### ▼ Modification and Add-On Equipment

Mazda cannot guarantee the immobilizer system's operation if the system has been modified or if any add-on equipment has been installed to it.

### CAUTION

To avoid damage to your vehicle, do not modify the system or install any add-on equipment to it.

# Mirrors

## Mirrors

### ▼ Outside Mirrors

Check the mirrors' angles before driving.

**⚠ WARNING**

***Convex Mirror (Passenger Side):***  
*Changing lanes without taking into account the actual distance of the vehicle in the convex mirror is dangerous. You could have a serious accident. What you see in the convex mirror is closer than it appears. Be sure to look over your shoulder before changing lanes.*

### Power control mirror

The ignition switch must be in the ACC or ON position.

To adjust:

1. Move the selector switch to the left or right to choose the mirror.
2. Depress the mirror switch in the appropriate direction.

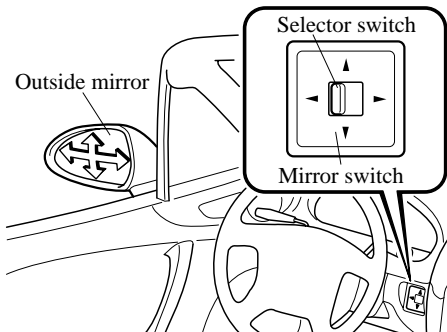

### Folding the mirror

Fold the outside mirror rearward until it is flush with the vehicle.

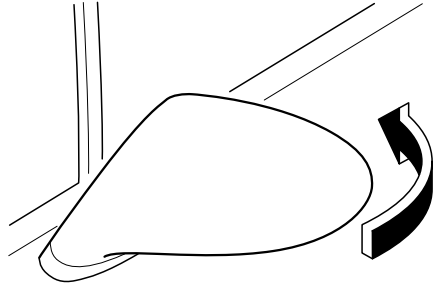

**⚠ WARNING**

***Driving with Mirrors Folded In:***  
*Driving with the outside mirrors folded in is dangerous. Your rear view will be restricted, and you could have an accident. Always return the outside mirrors to the driving position before you start driving.*

### ▼ Rearview Mirror (With Day/ Night Function)

Before driving, adjust the rearview mirror to center on the scene through the rear window.

Do this with the day/night lever in the day position.

Push the lever forward for day driving. Pull it back to reduce glare from headlights.

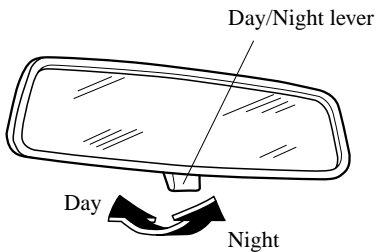

### **! WARNING**

#### **Blocked View:**

*Cargo stacked higher than the seatbacks is dangerous. It can block your view in the rearview mirror, which might cause you to hit another car when changing lanes. Don't stack things higher than the seatbacks.*

#### **Objects in the Storage Area:**

*Putting heavy or sharp objects in the top storage area is dangerous. During a sudden stop or collision, they can become projectiles that might hit and injure passengers. Don't place heavy or sharp objects in the top storage area.*

#### **Standing in a Moving Vehicle:**

*Standing in the vehicle, or sitting on the convertible top storage area or center console when it's moving is a dangerous way to ride. During a sudden maneuver or collision you could be seriously injured or even killed.*

*Sit in the seat with the seat belt on when the vehicle is moving.*





# 4

## Before Driving Your Mazda

Important information about driving your Mazda.

<b>Fuel and Engine Exhaust Precautions</b> .....	4-2
Fuel Requirements .....	4-2
Emission Control System .....	4-4
Engine Exhaust (Carbon Monoxide) .....	4-5
<b>Before Starting the Engine</b> .....	4-6
Before Getting In .....	4-6
After Getting In .....	4-6
<b>Driving Tips</b> .....	4-7
Break-In Period .....	4-7
Money-Saving Suggestions .....	4-7
Hazardous Driving .....	4-8
Rocking the Vehicle .....	4-8
Winter Driving .....	4-9
Driving In Flooded Area .....	4-11
Overloading .....	4-11
Turbocharger Information (MAZDASPEED MX-5) .....	4-12
<b>Towing</b> .....	4-13
Trailer Towing .....	4-13

# Fuel and Engine Exhaust Precautions

## Fuel Requirements

Vehicles with catalytic converters or oxygen sensors must use **ONLY UNLEADED FUEL**, which will reduce exhaust emissions and keep spark plug fouling to a minimum.

### MX-5/miata

Your Mazda will perform best with fuel listed in the table.

Fuel	Octane Rating* (Anti-knock index)
Premium unleaded fuel	91 [(R+M)/2 method] or above (96 RON or above)

\* U.S. federal law requires that octane ratings be posted on gasoline station pumps. You may use a regular unleaded fuel with an Octane Rating from 87 to 90 (91 to 95 RON) but this will slightly reduce performance. Fuel with a rating lower than 87 octane (91 RON) could cause the emission control system to lose effectiveness. It could also cause engine knocking and serious engine damage.

### MAZDASPEED MX-5

Use only premium unleaded fuel listed in the table.

Fuel	Octane Rating* (Anti-knock index)
Premium unleaded fuel	91 [(R+M)/2 method] or above (96 RON or above)

\* U.S. federal law requires that octane ratings be posted on gasoline station pumps.

## CAUTION

- **USE ONLY UNLEADED FUEL.**  
Leaded fuel is harmful to the catalytic converter or the oxygen sensor. The lead will accumulate on the oxygen sensor and the catalyst inside the converter. This will result in a malfunction of the emission control system, causing poor performance.
- Your vehicle can only use oxygenated fuels containing no more than 10% ethanol by volume. Damage to your vehicle may occur when ethanol exceeds this recommendation, or if the gasoline contains any methanol. Stop using gasohol of any kind if your vehicle engine is performing poorly.
- Never add fuel system additives. Never add cleaning agents other than those specified by Mazda. Other cleaning agents and additives may damage the system. Consult an Authorized Mazda Dealer.
- **(MAZDASPEED MX-5)**  
Never use fuel other than premium unleaded fuel for your vehicle. Use of other fuel could cause poor engine performance and serious engine knocking.

## Fuel and Engine Exhaust Precautions

---

Gasoline blended with oxygenates such as alcohol or ether compounds are generally referred to as oxygenated fuels. The common gasoline blend that can be used with your vehicle is ethanol blended at no more than 10%. Gasoline containing alcohol, such as ethanol or methanol, may be marketed under the name "Gasohol".

Vehicle damage and drivability problems resulting from the use of the following may not be covered by the Mazda warranty.

- Gasohol containing more than 10% ethanol.
- Gasoline or gasohol containing methanol.
- Leaded fuel or leaded gasohol.

# Fuel and Engine Exhaust Precautions

---

## Emission Control System

Your vehicle is equipped with an emission control system (the catalytic converter is part of this system) that enables your vehicle to comply with existing exhaust emissions requirements.

### **WARNING**

**Parking Over Flammable Objects:**

*Parking over or near anything flammable, such as dry grass, is dangerous. Even with the engine turned off, the exhaust system could ignite it because the exhaust system gets very hot during normal use. A resulting fire could cause serious injury or death. Never park over or near anything flammable.*

### **CAUTION**

Ignoring the following precautions could cause lead to accumulate on the catalyst inside the converter or cause the converter to get very hot. Either condition will damage the converter and cause poor performance.

- USE ONLY UNLEADED FUEL.
- Don't drive your Mazda with any sign of engine malfunction.
- Don't coast with the ignition switch turned off.
- Don't descend steep grades in gear with the ignition switch turned off.
- Don't operate the engine at high idle for more than 5 minutes.
- Don't tamper with the emission control system. All inspections and adjustments must be made by a qualified technician.
- Don't try to push-start or pull-start your vehicle.

### **NOTE**

Under U.S. federal law, any modification to the original-equipment emission control system before the first sale and registration of a vehicle is subject to penalties. In some states, such modification made on a used vehicle is also subject to penalties.

### **NOTE**

After driving some distance and turning off the engine, the sound of a valve opening and closing can be heard behind the passenger seat, however this does not indicate an abnormality. Your vehicle has a self-checking device and it operates after turning off the engine.

# Fuel and Engine Exhaust Precautions

## Engine Exhaust (Carbon Monoxide)

### **WARNING**

#### **Carbon Monoxide:**

*Engine exhaust gas is dangerous. This gas contains carbon monoxide (CO), which is colorless, odorless, and poisonous. When inhaled, it can cause loss of consciousness and death. If you smell exhaust gas inside your vehicle, keep all windows fully open and contact an Authorized Mazda Dealer immediately.*

#### **Exhaust Gas in Enclosed Area:**

*Running the engine inside an enclosed area, such as a garage, is dangerous. Exhaust gas, which contains poisonous carbon monoxide, could easily enter the cabin. Loss of consciousness or even death could occur. Don't run the engine when inside an enclosed area.*

#### **Idling with the Windows Closed:**

*Exhaust gas is dangerous. When your vehicle is stopped with the windows closed and the engine running for a long time even in an open area, exhaust gas, which contains poisonous carbon monoxide, could enter the cabin. Loss of consciousness or even death could occur. Open the windows or adjust the heating or cooling system to draw fresh air.*

#### **Snow Blocking the Exhaust Gas:**

*Running the engine when a vehicle is stopped in deep snow is dangerous. The exhaust pipe could be blocked by the snow, allowing exhaust gas to enter the cabin. Because exhaust gas contains poisonous carbon monoxide, anyone in the cabin could be injured or killed. Clear the snow from underneath and around your vehicle, particularly the tail pipe, before starting the engine.*

# Before Starting the Engine

---

## Before Getting In

- Be sure the windows, outside mirrors, and outside lights are clean.
- Inspect inflation pressures and condition of tires.
- Look under the vehicle for any sign of a leak.
- If you plan to back up, make sure nothing will be in your way.

<b>NOTE</b>
Engine oil, engine coolant, brake/clutch fluid, washer fluid, and other fluid levels should be inspected. See Maintenance, Section 8.

## After Getting In

- Are all doors closed and locked?
- Is the seat adjusted properly?
- Are the inside and outside mirrors adjusted?
- Is everyone's seat belt fastened?
- Do all the lights work?
- Check all gauges.
- Check all warning lights when the ignition switch is turned to the ON position.
- Release the parking brake and make sure the parking brake warning light goes off.

Always be thoroughly familiar with your Mazda.

## Break-In Period

No special break-in is necessary, but a few precautions in the first 1,000 km (600 miles) may add to the performance, economy, and life of your Mazda.

- Don't race the engine.
- Don't maintain one constant speed, either slow or fast, for a long period of time.
- Don't drive constantly at full-throttle or high engine rpm for extended periods of time.
- Avoid unnecessary hard stops.
- Avoid full-throttle starts.

## Money-Saving Suggestions

How you operate your Mazda determines how far it will travel on a tank of fuel. Use these suggestions to help save money on fuel and repairs.

- Avoid long warm-ups. Once the engine runs smoothly, begin driving.
- Avoid fast starts.
- Keep the engine tuned. Follow the maintenance schedule (page 8-3) and have an Authorized Mazda Dealer perform inspections and servicing.
- Use the air conditioner only when necessary.
- Slow down on rough roads.
- Keep the tires properly inflated.
- Don't carry unnecessary weight.
- Don't rest your foot on the brake pedal while driving.
- Keep the wheels in correct alignment.
- Keep windows closed at high speeds.
- Slow down when driving in crosswinds and headwinds.

### **WARNING**

#### **Coasting:**

***Stopping the engine when going down a hill is dangerous. This causes the loss of power steering and power brake control, and may cause damage to the drivetrain. Any loss of steering or braking control could cause an accident. Never stop the engine when going down a hill.***

# Driving Tips

## Hazardous Driving

### **WARNING**

***Downshifting on Slippery Surfaces:***  
*Downshifting into lower gear while driving on slippery surfaces is dangerous. The sudden change in tire speed could cause the tires to skid. This could lead to loss of vehicle control and an accident. If it is necessary to downshift on slippery surfaces, be very careful.*

When driving on ice or in water, snow, mud, sand, or similar hazard:

- Be cautious and allow extra distance for braking.
- Avoid sudden braking and quick steering.
- If your vehicle is not equipped with ABS, brake with the pedal by using a light up-down motion. Don't hold the pedal down constantly.  
If your vehicle is equipped with ABS, don't pump the brakes. Continue to press down on the brake pedal.
- If you get stuck, select a lower gear and accelerate slowly. Don't spin the rear wheels.
- For more traction in starting on slippery surfaces such as ice or packed snow, use sand, rock salt, chains, carpeting, or other nonslip material under the rear wheels.

### **NOTE**

Use snow chains only on the rear wheels.

## Rocking the Vehicle

### **WARNING**

***Spinning the Wheels:***  
*When the vehicle is stuck, spinning the wheels at high speed is dangerous. The spinning tire could overheat and explode. This could cause serious injuries. Don't spin the wheels at more than 56 km/h (35 mph), and don't allow anyone to stand behind a wheel when pushing the vehicle.*

### **CAUTION**

Too much rocking may cause engine overheating, transmission failure, and tire damage.

If you must rock the vehicle to free it from snow, sand, or mud, depress the accelerator slightly and slowly move the shift lever from 1 (D) to R.



## Winter Driving

- Carry emergency gear, including tire chains, window scraper, flares, a small shovel, jumper cables, and a small bag of sand or salt.

Ask an Authorized Mazda Dealer to perform the following precautions:

- Have the proper ratio of antifreeze in the radiator.
- Inspect the battery and its cables. Cold reduces battery capacity.
- Use only cold-weather engine oil (page 8-13).
- Inspect the ignition system for damage and loose connections.
- Use washer fluid made with antifreeze—but don't use engine coolant antifreeze for washer fluid (page 8-22).
- Don't use the parking brake in freezing weather as the parking brake may freeze. Instead, shift to P with an automatic transmission and to 1 or R with a manual transmission. Block the rear wheels.

## ▼ Snow Tires

### **WARNING**

#### Mixing Tire Types:

*Using tires different in size or type is dangerous. Your vehicle's handling could be greatly affected and result in an accident. Use only the same size and type tires (snow, radial, or non-radial) on all four wheels.*

### **CAUTION**

Check local regulations before using studded tires.

#### Use snow tires on all four wheels

Don't go faster than 120 km/h (75 mph) while driving with snow tires. Inflate snow tires 30 kPa (0.3 kgf/cm<sup>2</sup>, 4.3 psi) more than recommended on the tire pressure label (driver's door), but never more than the maximum cold-tire pressure shown on the tires.

Your vehicle is originally equipped with summer tires designed for optimum traction on wet and dry roads. If your vehicle is to be used on snow and ice covered roads, you may find it necessary to replace the original equipment tires with snow tires, during the winter months.

# Driving Tips

---

## ▼ Tire Chains

Check local regulations before using tire chains.

### CAUTION

- Chains may scratch or chip aluminum wheels. Install tire chains on steel wheels only.
- Chains may affect handling.
- Don't go faster than 50 km/h (30 mph) or the chain manufacturer's recommended limit, whichever is lower.
- Drive carefully and avoid bumps, holes, and sharp turns.
- Avoid locked-wheel braking.
- Don't use chains on a temporary spare tire; it may result in damage to the vehicle and to the tire.
- Don't use chains on roads that are free of snow or ice. The tires and chains could be damaged.

### NOTE

Use of tire chains on a vehicle equipped with 205/40R17 specification tires could cause interference with the vehicle body and scratching. If tire chains are to be used, replace both front and rear tires with 205/45R16 tires. Please consult an Authorized Mazda Dealer.

Install the chains on the rear tires.  
Don't use chains on the front tires.  
Use only SAE Class "S" chains, and make sure they fit.

## Installing the chains

1. Remove the wheel covers, or the chain bands will scratch them.
2. Secure the chains on the rear tires as tightly as possible. Always follow the chain manufacturer's instructions.
3. Retighten the chains after driving 1/2—1 km (1/4—1/2 mile).

**Driving In Flooded Area** **WARNING**

***Driving with Wet Brakes:***  
*Driving with wet brakes is dangerous. Increased stopping distance or the vehicle pulling to one side when braking could result in a serious accident. Light braking will indicate whether the brakes have been affected. Dry the brakes by driving very slowly and applying the brakes lightly until brake performance returns to normal.*

 **CAUTION**

Make sure water does not enter the vehicle interior or the engine area. The vehicle interior could become wet or the engine could be damaged.

**Overloading** **WARNING**

***Vehicle Load Weight:***  
*The gross axle weight rating (GAWR) and the gross vehicle weight rating (GVWR) of your vehicle are on the Motor Vehicle Safety Standard Label on the driver's door frame. Exceeding these ratings can cause an accident or vehicle damage. You can estimate the weight of your load by weighing the items (or people) before putting them in the vehicle. Be careful not to overload your vehicle.*

## Driving Tips

---

### Turbocharger Information (MAZDASPEED MX-5)

The turbocharger greatly enhances engine power. Its advanced design provides better operation and requires minimum additional maintenance. To get maximum performance from your turbocharged engine, take note of the following tips:

- The turbocharged engine is designed for optimal operation with premium unleaded gasoline (page 4-2). Do not use fuel with a lower octane rating. Extra fuel additives are NOT recommended.
- Change the engine oil and filter using the turbo engine interval outlined in the maintenance schedule (for your driving condition).
- Use only the recommended engine oil (page 8-13). Extra oil additives are NOT recommended.
- After driving at freeway speeds or up a long hill, idle the engine at least 30 seconds to cool the turbo. Avoid simply shutting the engine off abruptly after a hard or long drive. Damage to the turbocharger may result.
- Don't race or over-rev the engine when starting. This should not be done with ANY engine, especially not with one that's turbocharged.
- Do not add any aftermarket devices to alter the engine's ignition timing, fuel delivery, or turbo boost pressure. This may lead to serious engine damage and may void your warranty.

## **Trailer Towing**

Never tow a trailer with your Mazda.



Explanation of instruments and controls.

<b>Starting and Driving</b> .....	5-2
Ignition Switch .....	5-2
Starting the Engine .....	5-3
Brake System .....	5-4
Manual Transmission Operation .....	5-9
Automatic Transmission Controls .....	5-10
Power Steering .....	5-14
Cruise Control* .....	5-15
<b>Instrument Cluster and Indicators</b> .....	5-18
Meters and Gauges .....	5-18
<b>Warning/Indicator Lights and Beep Sounds</b> .....	5-23
Warning/Indicator Lights .....	5-23
Beep Sounds .....	5-30
<b>Switches and Controls</b> .....	5-31
Lighting Control .....	5-31
Turn and Lane-Change Signals .....	5-32
Fog Lights* .....	5-32
Daytime Running Lights (Canada) .....	5-33
Windshield Wipers and Washer .....	5-33
Rear Window Defroster .....	5-35
Horn .....	5-35
Hazard Warning Flasher .....	5-36

# Starting and Driving

## Ignition Switch

### ▼ Ignition Switch Positions

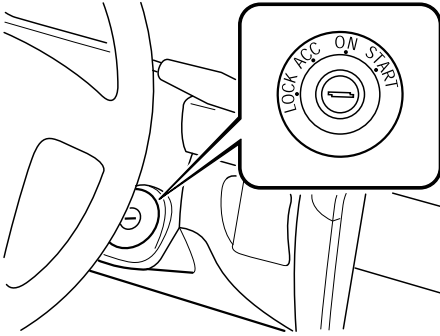

### LOCK

The steering wheel locks to protect against theft. Only in this position can the key be removed.

### Manual transmission

To turn the key from the ACC to the LOCK position, push the key in at the ACC position, then turn it to the LOCK position.

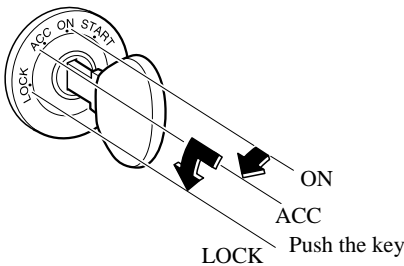

### Automatic transmission

To turn the key from the ACC to the LOCK position, the shift lever must be in the P position.

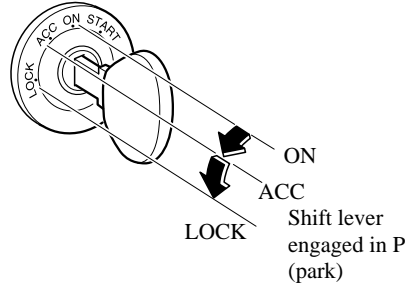

## **⚠ WARNING**

### Removing the Key:

*It's dangerous to remove the key from the ignition switch while the vehicle is moving. Removing the key allows the steering wheel to lock. You will lose steering control and a serious accident could occur.*

*Remove the key only when the vehicle is parked.*

### Not Setting the Parking Brake:

*Leaving the driver's seat without setting the parking brake is dangerous. Unexpected vehicle movement could occur if the parking brake is not set. This could cause an accident. Before leaving the driver's seat, always set the parking brake and make sure the shift lever is in P with an automatic transmission or in 1 or R with a manual transmission.*



# Starting and Driving

## NOTE

If turning the key is difficult, jiggle the steering wheel from side to side.

## ACC (Accessory)

The steering wheel unlocks and some electrical accessories will operate.

## ON

This is the normal running position after the engine is started. The warning lights (except brakes) should be inspected before the engine is started (page 5-23).

## NOTE

When the ignition switch is turned to the ON position, the sound of the fuel pump motor operating near the fuel tank can be heard. This does not indicate an abnormality.

## START

The engine is started in this position. It will crank until you release the key; then it returns to the ON position. The brake warning light can be checked after the engine is started (page 5-23).

## ▼ Ignition Key Reminder

If the ignition switch is in the LOCK or ACC position, a beep sound will be heard when any door is opened.

## Starting the Engine

### NOTE

Engine-starting is controlled by the spark ignition system. This system meets all Canadian Interference-Causing Equipment Standard requirements regulating the impulse electrical field strength of radio noise.

1. Occupants should fasten their seat belts.
2. Make sure the parking brake is on.
3. Depress the brake pedal.
4. **(Manual transmission)**  
Depress the clutch pedal all the way and shift into neutral.  
Keep the pedal depressed while cranking the engine.

### NOTE

The starter will not operate if the clutch pedal is **not** pushed down all the way.

### **(Automatic transmission)**

Put the vehicle in park (P). If you must restart the engine while the vehicle is moving, shift into neutral (N).

### NOTE

The starter will not operate if the shift lever is **not** in P or N.

# Starting and Driving

---

5. Turn the ignition switch to the START position and hold (up to 10 seconds at a time) until the engine starts.

 <b>CAUTION</b>
--

Don't try the starter for more than 10 seconds at a time. If the engine stalls or fails to start, wait 10 seconds before trying again. Otherwise, you may damage the starter and drain the battery.
---

6. After starting the engine, let it idle for about 10 seconds.

<b>NOTE</b>
-------------

- |  |
|--|
| <ul style="list-style-type: none"><li>• In extremely cold weather, below <math>-18^{\circ}\text{C}</math> (<math>0^{\circ}\text{F}</math>), or after the vehicle has not been driven in several days, let the engine warm up without operating the accelerator.</li><li>• Whether the engine is cold or warm, it should be started without use of the accelerator.</li></ul> |
|--|

## Brake System

### ▼ Foot Brake

Your Mazda has power-assisted brakes that adjust automatically through normal use.

Should power-assist fail, you can stop by applying greater force than normal to the brake pedal. But the distance required to stop will be greater than usual.

## ⚠ WARNING

### Coasting with the Engine Off:

*Continuing to coast when the engine is stalled or turned off is dangerous. Braking will require more effort, and the brake's power-assist could be depleted if you pump the brake. This will cause longer stopping distances or even an accident. Don't continue coasting when the engine is stalled or turned off, find a safe place to stop.*

### Riding the Brakes:

*Driving with your foot continuously on the brake pedal or steadily applying the brakes for long distances is dangerous. This causes overheated brakes, resulting in longer stopping distances or even total brake failure. This could cause loss of vehicle control and a serious accident. Avoid continuous application of the brakes. Shift to a lower gear when going down steep hills.*

### Driving with Wet Brakes:

*Driving with wet brakes is dangerous. Increased stopping distance or the vehicle pulling to one side when braking could result in a serious accident. Light braking will indicate whether the brakes have been affected. Dry the brakes by driving very slowly and applying the brakes lightly until brake performance is normal.*

## ▼ Parking Brake

## ⚠ CAUTION

Driving with the parking brake on will cause excessive wear of the brake linings or pads.

## NOTE

For parking in snow, refer to Winter Driving (page 4-9) regarding parking brake use.

### Setting the parking brake

Depress the brake pedal, then pull the brake handle fully upward.

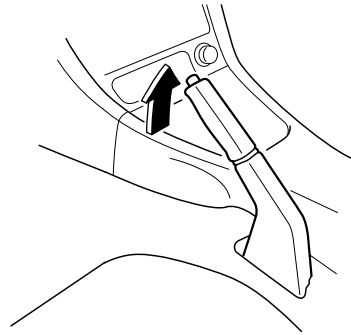

# Starting and Driving

---

## **Releasing the parking brake**

Depress the brake pedal, then pull the handle up and press the button. Lower the handle all the way down while holding in the button.

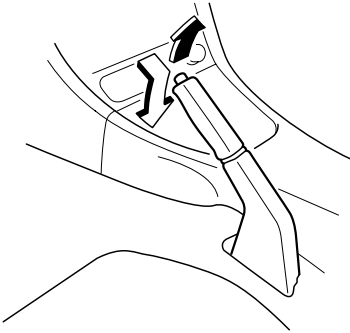

## **▼ Brake System Warning Light**



This warning has the following functions:

### **Parking brake warning**

The light comes on when the parking brake is applied with the ignition switch in the START or ON position. It goes off when the parking brake is fully released.

### **Low brake fluid level warning/ Electronic brake force distribution system warning**

If the light stays on after the parking brake is fully released, you may have a brake problem.

Drive to the side of the road and park off the right-of-way.

## **Low brake fluid level warning**

You may notice that the pedal is harder to push or that it may go closer to the floor. In either case, it will take longer to stop the vehicle.

1. With the engine stopped, check the brake fluid level immediately and add fluid as required (page 8-18).
2. After adding fluid, check the light again.

If the warning light remains on, or if the brakes do not operate properly, do not drive the vehicle. Have it towed to an Authorized Mazda Dealer.

Even if the light goes off, have your brake system inspected as soon as possible.

## **Electronic brake force distribution system warning**

If the electronic brake force distribution control unit determines that some components are operating incorrectly, the control unit may turn the brake system warning light on.

In this case, the ABS warning light comes on at the same time (page 5-27).

 **WARNING**
**Brake Warning Light:**

*Driving with the brake system warning light on is dangerous. It indicates that your brakes may not work at all or that they could completely fail at any time.*

*If this light remains on, after checking that the parking brake is fully released, have the brakes inspected immediately. Don't drive with this light on, and contact an Authorized Mazda Dealer to have the brakes inspected as soon as possible.*

**ABS Warning Light and Brake Warning Light on at the Same Time:**

*Driving when the brake system warning light and ABS warning light are on at the same time is dangerous. When both lights are on, the rear wheels could lock more quickly in an emergency stop than under normal circumstances.*

*Don't drive with both lights on, and contact an Authorized Mazda Dealer to have the brakes inspected as soon as possible.*

▼ **Anti-Lock Brake System (ABS)\***

The ABS control unit continuously monitors the speed of each wheel. If one is about to lock up, the ABS responds by automatically releasing and reapplying that wheel's brake.

The driver will feel a slight vibration in the brake pedal and may hear a chattering noise from the brake system. This is normal when the ABS operates. Don't pump the brakes, continue to press down on the brake pedal.

 **WARNING**
**ABS:**

*The ABS cannot compensate for unsafe and reckless driving, excessive speed, tailgating (following another vehicle too closely), and hydroplaning (reduced tire friction and road contact because of water on the road surface). You can still have an accident. So don't rely on ABS as a substitute for safe driving.*

**NOTE**

Braking distances may be longer on loose surfaces (snow or gravel, for example) which usually have a hard foundation. A vehicle with a normal braking system may require less distance to stop under these conditions because the tires will build up a wedge of surface layer when the wheels skid.

# Starting and Driving

## ▼ ABS Warning Light\*



The warning light stays on for a few seconds when the ignition switch is turned to the ON position.

If the ABS warning light stays on while you're driving, the ABS control unit has detected a system malfunction. If this occurs, your brakes will function normally as if the vehicle had no ABS. Should this happen, consult an Authorized Mazda Dealer as soon as possible.

### **WARNING**

**ABS Warning Light and Brake Warning Light on at the Same Time:**  
*Driving when the brake system warning light and ABS warning light are on at the same time is dangerous. When both lights are on, the rear wheels could lock more quickly in an emergency stop than under normal circumstances. Don't drive with both lights on, and contact an Authorized Mazda Dealer to have the brakes inspected as soon as possible.*

### **NOTE**

When the engine is jump-started to charge the battery, uneven rpm occurs and the ABS warning light comes on. This is due to a weak battery, not a malfunction. Recharge the battery.

## ▼ Brake Pad Wear Indicator

When the disc brake pads become worn, the built-in wear indicators contact the disc plates. This causes a screeching noise to warn that the pads should be replaced.

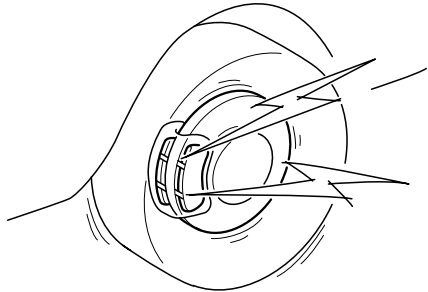

When you hear this noise, consult an Authorized Mazda Dealer as soon as possible.

### **WARNING**

**Driving with Worn Disc Pads:**  
*Driving with worn disc pads is dangerous. The brakes could fail and cause a serious accident. As soon as you hear a screeching noise consult an Authorized Mazda Dealer.*

# Starting and Driving

## Manual Transmission Operation

### ▼ Manual Transmission Shift Pattern

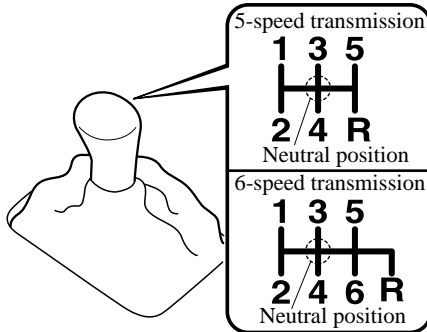

The shift pattern of the transmission is conventional, as shown.

Press the clutch pedal all the way down while shifting; then release it slowly.

#### (5-speed transmission)

A safety feature prevents accidental shifting from 5 to R (reverse). The shift lever must be put in neutral before being shifted to R.

#### (6-speed transmission)

Vehicles with 6-speed transmission are equipped with a device to prevent shifting to R (reverse) by mistake. Apply greater than normal force when shifting to R.

## ⚠ WARNING

**Sudden Engine-Braking:** Shifting down while driving on wet, snowy, or frozen roads, or while driving at high speeds causes sudden engine braking, which is dangerous. The sudden change in tire speed could cause the tires to skid. This could lead to loss of vehicle control and an accident. Do not use sudden engine braking on slippery road surfaces or at high speeds.

## ⚠ CAUTION

- Keep your foot off the clutch pedal except when shifting gears. Also, don't use the clutch to hold the vehicle on an upgrade. Riding the clutch will cause needless clutch wear and damage.
- Make sure the vehicle comes to a complete stop before shifting to R. Shifting to R while the vehicle is still moving may damage the transmission.

## NOTE

If shifting to R is difficult, shift back into neutral, release the clutch pedal, and try again.

# Starting and Driving

## ▼ Recommendations for Shifting

### Upshifting

For normal acceleration, we recommend these shift points.

	5-speed transmission	6-speed transmission
1 to 2	24 km/h (15 mph)	23 km/h (14 mph)
2 to 3	42 km/h (26 mph)	37 km/h (23 mph)
3 to 4	55 km/h (34 mph)	50 km/h (31 mph)
4 to 5	66 km/h (41 mph)	56 km/h (35 mph)
5 to 6	—	66 km/h (41 mph)

For cruising

	5-speed transmission	6-speed transmission
1 to 2	15 km/h (9 mph)	18 km/h (11 mph)
2 to 3	29 km/h (18 mph)	32 km/h (20 mph)
3 to 4	47 km/h (29 mph)	44 km/h (27 mph)
4 to 5	61 km/h (38 mph)	56 km/h (35 mph)
5 to 6	—	68 km/h (42 mph)

### Downshifting

When you must slow down in heavy traffic or on a steep **upgrade**, downshift before the engine starts to overwork. This reduces the chance of stalling and gives better acceleration when you need more speed.

On a steep **downgrade**, downshifting helps maintain safe speed and prolongs brake life.

## Automatic Transmission Controls

**Lock-release button**  
To prevent unsafe shifting

**Overdrive button**  
For turning the overdrive off or on

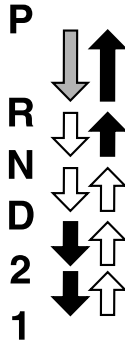
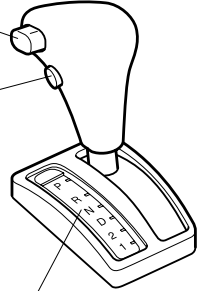

**Shift pattern indicator**  
Shows shift lever position

Various Lockouts:

	Indicates that you must depress the brake pedal and hold in the lock-release button to shift (The ignition switch must be in the ON position).
	Indicates the shift lever can be shifted freely into any position.
	Indicates that you must hold in the lock-release button to shift.



# Starting and Driving

## ▼ Transmission Ranges

The shift lever must be in P or N to operate the starter.

### P (Park)

P locks the transmission and prevents the rear wheels from rotating.

### **WARNING**

**Holding the Vehicle with P:**  
Only setting the shift lever to the P position without using the parking brake to hold the vehicle is dangerous. If P fails to hold, the vehicle could move and cause an accident. To hold the vehicle, set the shift lever to P AND set the parking brake.

### **CAUTION**

- Shifting into P, N or R while the vehicle is moving can damage your transmission.
- Shifting into a driving gear or reverse when the engine is running faster than idle can damage the transmission.

### R (Reverse)

In position R, the vehicle moves only backward. You must be at a complete stop before shifting to or from R, except under rare circumstances as explained in Rocking the Vehicle (page 4-8).

### N (Neutral)

In N, the wheels and transmission are not locked. The vehicle will roll freely even on the slightest incline unless the parking brake or brakes are on.

### **WARNING**

**Shifting from N or P:**  
It's dangerous to shift from N or P into a driving gear when the engine is running faster than idle. If this is done, the vehicle could move suddenly, causing an accident or serious injury. If the engine is running faster than idle, don't shift from N or P into a driving gear.

**Shifting into N while Driving:**  
Shifting into N while driving is dangerous. Engine braking cannot be applied when decelerating which could lead to an accident or serious injury. Do not shift into N when driving the vehicle.

### **CAUTION**

Do not shift into N when driving the vehicle. Doing so can cause transmission damage.

### D (Drive)

D is the normal driving position. From a stop, the transmission will automatically shift through a 4-gear sequence.

### 2 (Second)

The 2 position is helpful when driving in heavy, slow-moving traffic and climbing hills, for engine braking assist when going down hills, or for starting on slick surfaces and other situations where gentle acceleration may be necessary. Do not exceed 104 km/h (64 mph) in the 2 position.

# Starting and Driving

## 1 (Low)

Use the 1 position for maximum power in hard-pulling situations, or for climbing and descending very steep grades. Do not exceed 59 km/h (36 mph) in the 1 position.

### **WARNING**

***Sudden Engine-Braking:***  
*Shifting down while driving on wet, snowy, or frozen roads, or while driving at high speeds causes sudden engine braking, which is dangerous. The sudden change in tire speed could cause the tires to skid. This could lead to loss of vehicle control and an accident. Do not use sudden engine braking on slippery road surfaces or at high speeds.*

## ▼ Shift-Lock System

The shift-lock system prevents shifting out of P unless the brake pedal is depressed.

To shift from P:

1. Depress and hold the brake pedal.
2. Start the engine.
3. Push and hold the lock-release button.
4. Move the shift lever.

## NOTE

- When the ignition switch is in the ACC or LOCK position, the shift lever cannot be shifted from P.
- If the brake is pumped with the shift lever in P, a chattering near the shift lever may be heard. This does not indicate an abnormality.
- To be sure the vehicle is in park, **the ignition key cannot be removed unless the shift lever is in P.**

## ▼ Shift-Lock Override

If the shift lever won't move from P using the proper shift procedure, continue to hold down the pedal.

1. Remove the shift-lock override cover with a screwdriver.
2. Insert a screwdriver and push it down.

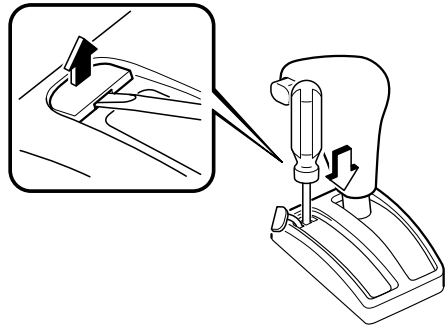

3. Push and hold the lock-release button.
4. Move the shift lever.
5. Take the vehicle to an Authorized Mazda Dealer to have the system checked.

# Starting and Driving

## ▼ Overdrive

### Overdrive operation

In D, the transmission automatically shifts to overdrive, which improves fuel economy and reduces noise.

To allow engine braking when going down a steep grade, make sure the overdrive button is in the off position.

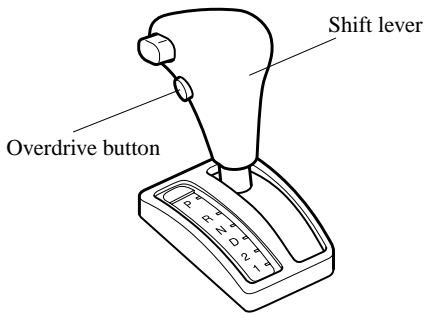

And for a smoother ride with less shifting, don't use it when:

- Going up a steep grade.
- Driving in stop-and-go traffic.
- Pulling heavy loads.

**To turn off the overdrive, push the button.**

The transmission will then shift through a 3-gear sequence in D.

Shift patterns without overdrive:

D = 1st, 2nd, 3rd

2 = 2nd

1 = 1st

**To turn it on, push the button again.**

Shift patterns with overdrive:

D = 1st, 2nd, 3rd, 4th

2 = 2nd

1 = 1st

### O/D OFF indicator light

**O/D  
OFF**

This light comes on when the overdrive has been turned off.

### **⚠ CAUTION**

If the overdrive-off indicator light flashes, the transmission has an electrical problem. Continuing to drive your Mazda in this condition could cause damage to your transmission. Consult an Authorized Mazda Dealer as soon as possible.

# Starting and Driving

---

## ▼ Driving Tips

### Passing

For extra power when passing another vehicle or climbing steep grades, depress the accelerator fully. The transmission will shift to a lower gear, depending on vehicle speed.

### Climbing steep grades from a stop

To climb a steep grade from a stopped position:

1. Depress the brake pedal.
2. Shift to D or 1, depending on the load weight and grade steepness.
3. Release all brakes while gradually accelerating.

### Descending steep grades

When descending a steep grade, shift to 2 or 1, depending on load weight and grade steepness. Descend slowly, using the brakes only occasionally to prevent them from overheating.

## Power Steering

Power steering is only operable when the engine is running. If the engine is off or if the power steering system is inoperable, you can still steer, but it requires more physical effort.

If the steering feels rigid during normal driving, consult an Authorized Mazda Dealer.

### CAUTION

Never hold the steering wheel to the extreme left or right for more than 5 seconds with the engine running. This could damage the power steering system.

# Starting and Driving

## Cruise Control\*

With cruise control, you can set and automatically maintain any speed of more than about 40 km/h (25 mph).

### **WARNING**

#### **Cruise Control Use:**

*Using cruise control in the following conditions could cause you to lose control of the vehicle:*

- *Hilly terrain*
- *Steep inclines*
- *Heavy or unsteady traffic*
- *Slippery or winding roads*
- *Similar restrictions that require inconsistent speed*

*Don't use cruise control in these situations.*

### ▼ Cruise Set Indicator Light

# CRUISE

This light comes on when a cruising speed is set.

### ▼ Activation/Deactivation

To activate the system, press the CRUISE MAIN switch.

To deactivate the system, push the switch again.

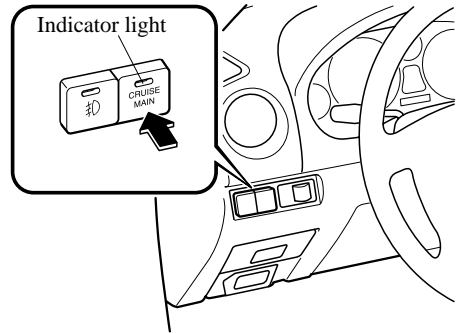

### **WARNING**

#### **Cruise Main Switch:**

*Leaving the CRUISE MAIN switch on when not using the cruise control is dangerous as it may be switched on accidentally. This could result in loss of vehicle control. Keep the CRUISE MAIN switch off when cruise control is not in use.*

# Starting and Driving

## ▼ To Set Speed

1. Activate the cruise control system.
2. Accelerate to the desired speed, which must be more than 40 km/h (25 mph).
3. Turn the control knob to SET/COAST and release it at the speed you want. Release the accelerator at the same time.

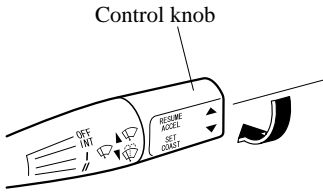

Don't continue to hold the knob. Until you release it, speed will continue to drop (unless you continue to accelerate) and you'll miss the desired speed.

### NOTE

- The SET function can't be activated until about 2 seconds after the CRUISE MAIN switch has been engaged.
- On a steep grade, the vehicle may momentarily slow down going up or speed up while going down.

## ▼ To Increase Cruising Speed

Follow either of these procedures.

- Turn the control knob to RESUME/ACCEL and hold it. Your vehicle will accelerate. Release the knob at the speed you want.

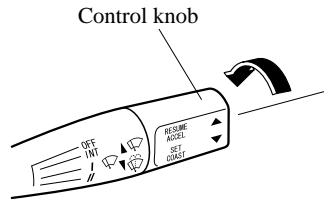

- Accelerate to the desired speed. Turn the control knob to SET/COAST and release it immediately.

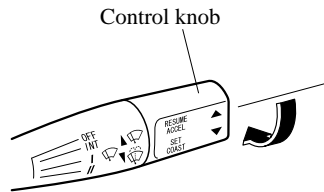

### NOTE

Accelerate if you want to speed up temporarily when the cruise control is on. Greater speed will not interfere with it or change the set speed. Take your foot off the accelerator to return to the set speed.

# Starting and Driving

## ▼ To Decrease Cruising Speed

Turn the control knob to SET/COAST and hold it. The vehicle will gradually slow. Release the knob at the speed you want.

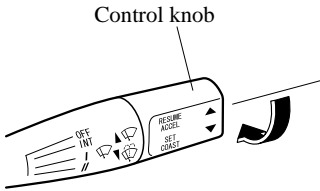

## ▼ To Resume Cruising Speed at More Than 40 km/h (25 mph)

If some other method besides the CRUISE MAIN switch was used to cancel cruising speed and the system is still activated, the most recent set speed will automatically resume when the control knob is turned to RESUME/ACCEL.

If vehicle speed is below 40 km/h (25 mph), increase the vehicle speed up to 40 km/h (25 mph) and turn the control knob to RESUME/ACCEL.

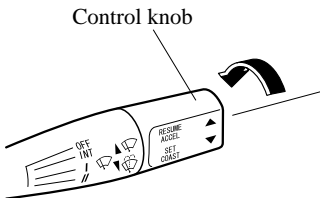

## ▼ To Cancel

To turn off the system, use **one** of these methods:

- Press the CRUISE MAIN switch.
- Slightly depress the brake pedal.
- Depress the clutch pedal. (Manual transmission only)

The system is off when the ignition is off.

### NOTE

Cruise control will cancel at about 15 km/h (9 mph) below the preset speed or below 40 km/h (25 mph).

# Instrument Cluster and Indicators

## Meters and Gauges

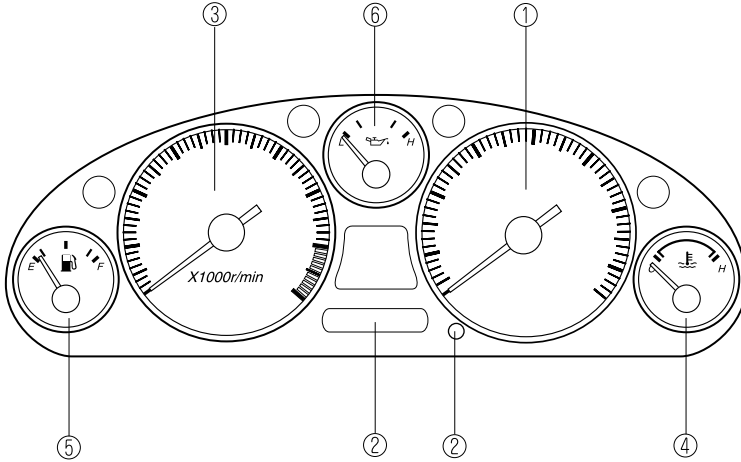

① Speedometer .....	5-19
② Odometer, Trip Meter and Selector .....	5-19
③ Tachometer .....	5-20
④ Engine Coolant Temperature Gauge .....	5-20
⑤ Fuel Gauge .....	5-21
⑥ Engine Oil Pressure Gauge .....	5-21



# Instrument Cluster and Indicators

## ▼ Speedometer

The speedometer indicates the speed of the vehicle.

## ▼ Odometer, Trip Meter and Selector

The ignition switch must be in the ON position.

The display mode can be changed from odometer to trip meter A to trip meter B and then back to odometer by pressing the selector while one of them is displayed. The selected mode will be displayed.

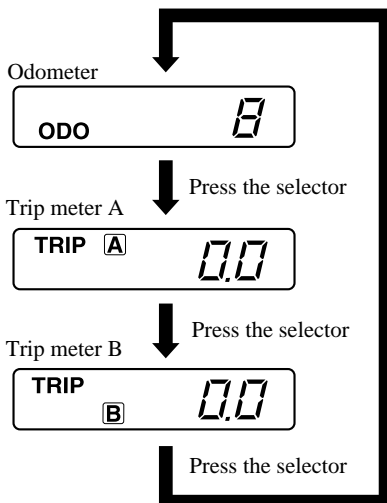
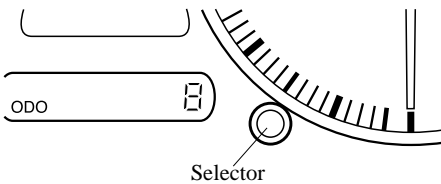

## Odometer

When this mode is selected, ODO will be displayed.

The odometer records the total distance the vehicle has been driven.

## Trip meter

The trip meter can record the total distance of two trips. One is recorded in trip meter A, and the other is recorded in trip meter B.

For instance, trip meter A can record the distance from the point of origin, and trip meter B can record the distance from where the fuel tank is filled.

When trip meter A is selected, pressing the selector again within one second will change to trip meter B mode.

When trip meter A is selected, TRIP A will be displayed. When trip meter B is selected, TRIP B will be displayed.

The trip meter records the total distance the vehicle is driven until the meter is again reset. Return it to "0.0" by holding the selector depressed for more than 1 second. Use this meter to measure trip distances and to compute fuel consumption.

# Instrument Cluster and Indicators

## NOTE

- Only the trip meters record tenths of kilometers (miles).
- The trip record will be erased when;
  - The power supply is interrupted (blown fuse or the battery is disconnected).
  - The vehicle is driven over 999.9 km (mile).

## ▼ Tachometer

The tachometer shows engine speed in thousands of revolutions per minute (rpm).

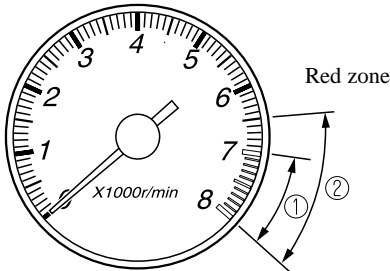

- ① MX-5/miata
- ② MAZDASPEED MX-5

## ⚠ CAUTION

Don't run the engine with the tachometer needle in the RED ZONE. This may cause severe engine damage.

## ▼ Engine Coolant Temperature Gauge

The engine coolant temperature gauge shows the temperature of the engine coolant.

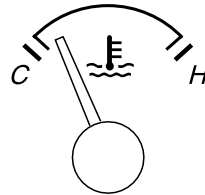

If the needle exceeds normal range toward H, it indicates overheating.

## ⚠ CAUTION

Driving with an overheated engine can cause serious engine damage (page 7-11).

## Instrument Cluster and Indicators

### ▼ Fuel Gauge

The fuel gauge shows approximately how much fuel is in the tank. We recommend keeping the tank over 1/4 full. When the low fuel warning light illuminates or when the needle is near E, refuel as soon as possible.

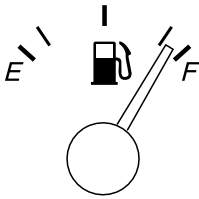

### ▼ Engine Oil Pressure Gauge

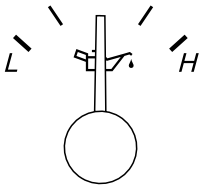

Engine oil pressure is normal when the engine oil pressure gauge needle points halfway between L and H with the engine running.

If the needle on the gauge doesn't move after starting the engine, follow steps 1 through 3.

If the engine oil pressure gauge moves to L (low) while you are driving, drive to the side of the road and park off the right-of-way. Set the parking brake. Then follow steps 1 through 3.

1. Turn off the engine and inspect the engine oil level (page 8-13). If it's low, add oil.
2. Start the engine.
3. If the needle still doesn't move, have your vehicle checked at an Authorized Mazda Dealer.



### CAUTION

Don't run the engine if the oil pressure is low. It could result in extensive engine damage.

# Instrument Cluster and Indicators

---

## ▼ Dashboard Illumination

When the headlight switch is in the  or  position, rotate the thumb-wheel to adjust the brightness of the dashboard lights.

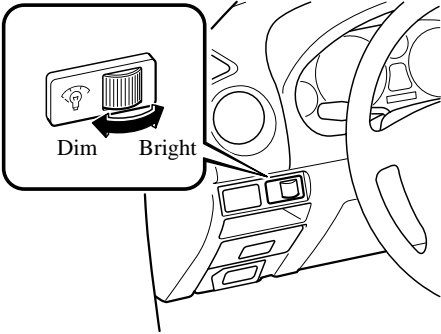





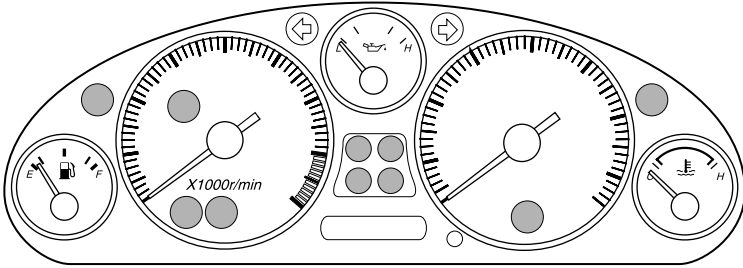

# Warning/Indicator Lights and Beep Sounds

## Warning/Indicator Lights







Warning/Indicator lights will appear in any of the highlighted areas

Signal	Warning/Indicator Lights	Page
	Brake System Warning Light	5-25
	Charging System Warning Light	5-26
	Check Engine Light	5-27
	ABS Warning Light	5-27
	Air Bag/Seat Belt Pretensioner System Warning Light	5-28
	Low Fuel Warning Light	5-28
	Seat Belt Warning Light	5-28

# Warning/Indicator Lights and Beep Sounds

---

Signal	Warning/Indicator Lights	Page
	Immobilizer System Warning Light	5-29
	Headlight High-Beam Indicator Light	5-29
	O/D OFF Indicator Light	5-29
	Cruise Set Indicator Light	5-29
	Turn-Signal/Hazard Warning Indicator Lights	5-30

# Warning/Indicator Lights and Beep Sounds

## ▼ Brake System Warning Light



This warning has the following functions:

### **Parking brake warning**

The light comes on when the parking brake is applied with the ignition switch in the START or ON position. It goes off when the parking brake is fully released.

### **Low brake fluid level warning/ Electronic brake force distribution system warning**

If the light stays on after the parking brake is fully released, you may have a brake problem.

Drive to the side of the road and park off the right-of-way.

### **Low brake fluid level warning**

You may notice that the pedal is harder to push or that it may go closer to the floor. In either case, it will take longer to stop the vehicle.

1. With the engine stopped, check the brake fluid level immediately and add fluid as required (page 8-18).
2. After adding fluid, check the light again.

If the warning light remains on, or if the brakes do not operate properly, do not drive the vehicle. Have it towed to an Authorized Mazda Dealer.

Even if the light goes off, have your brake system inspected as soon as possible.

### **Electronic brake force distribution system warning**

If the electronic brake force distribution control unit determines that some components are operating incorrectly, the control unit may turn the brake system warning light on.

In this case, the ABS warning light comes on at the same time (page 5-27).

# Warning/Indicator Lights and Beep Sounds

## **WARNING**

### Brake Warning Light:

*Driving with the brake system warning light on is dangerous. It indicates that your brakes may not work at all or that they could completely fail at any time. If this light remains on, after checking that the parking brake is fully released, have the brakes inspected immediately. Don't drive with this light on, and contact an Authorized Mazda Dealer to have the brakes inspected as soon as possible.*

### ABS Warning Light and Brake Warning Light on at the Same Time:

*Driving when the brake system warning light and ABS warning light are on at the same time is dangerous. When both lights are on, the rear wheels could lock more quickly in an emergency stop than under normal circumstances.*

*Don't drive with both lights on, and contact an Authorized Mazda Dealer to have the brakes inspected as soon as possible.*

## ▼ Charging System Warning Light



This warning light illuminates when the ignition switch is turned to the ON position and turns off when the engine is started.

If the warning light illuminates while driving, it indicates a malfunction of the alternator or of the charging system. Drive to the side of the road and park off the right-of-way. Consult an Authorized Mazda Dealer.

## **CAUTION**

Don't continue driving when the charging system warning light is illuminated.



# Warning/Indicator Lights and Beep Sounds

## ▼ Check Engine Light



If this light comes on while driving, the vehicle may have a problem. It is important to note the driving conditions when the light came on and consult an Authorized Mazda Dealer.

The check engine light may come on in the following cases:

- The fuel tank level being very low or approaching empty.
- The engine's electrical system has a problem.
- The emission control system has a problem.
- The fuel-filler cap is missing or not tightened securely.

If the check engine light remains on or flashes continuously, do not drive at high speeds and consult an Authorized Mazda Dealer as soon as possible.

## ▼ ABS Warning Light\*



The warning light stays on for a few seconds when the ignition switch is turned to the ON position.

If the ABS warning light stays on while you're driving, the ABS control unit has detected a system malfunction. If this occurs, your brakes will function normally as if the vehicle had no ABS. Should this happen, consult an Authorized Mazda Dealer as soon as possible.

### **WARNING**

**ABS Warning Light and Brake Warning Light on at the Same Time:**  
***Driving when the brake system warning light and ABS warning light are on at the same time is dangerous. When both lights are on, the rear wheels could lock more quickly in an emergency stop than under normal circumstances. Don't drive with both lights on, and contact an Authorized Mazda Dealer to have the brakes inspected as soon as possible.***

# Warning/Indicator Lights and Beep Sounds

---

**NOTE**

When the engine is jump-started to charge the battery, uneven rpm occurs and the ABS warning light comes on. This is due to a weak battery, not a malfunction. Recharge the battery.

**▼ Air Bag/Seat Belt Pretensioner System Warning Light**



If the air bag/seat belt pretensioner system is normal, the warning light illuminates when the ignition switch is turned to the ON position or after the engine is cranked. After about 6 seconds it goes out.

A system malfunction is indicated when the warning light constantly flashes, illuminates or doesn't illuminate at all when the ignition switch is turned to the ON position. If any of these occur, consult an Authorized Mazda Dealer as soon as possible. The system may not work in an accident.

**! WARNING**

**Self-Servicing the Air Bag/Pretensioner Systems:**  
*Self-servicing or tampering with the systems is dangerous. An air bag/pretensioner could accidentally activate or become disabled. This could cause serious injuries. Never tamper with the systems and always have an Authorized Mazda Dealer perform all servicing and repairs.*

**▼ Low Fuel Warning Light**



This warning light signals that the fuel tank will soon be empty. Refuel as soon as possible.

**▼ Seat Belt Warning Light**



If the driver's seat belt is not fastened when the ignition switch is turned to the ON position, the seat belt warning light will remain on until the belt is fastened. If the system does not operate correctly, consult an Authorized Mazda Dealer.

## Warning/Indicator Lights and Beep Sounds

### ▼ Immobilizer System Warning Light\*



If the immobilizer system is working properly, the light will come on when the ignition switch is turned to the ON or START position. The light will go out when confirmation by the immobilizer system is completed.

If the light flashes rapidly, fails to come on, or comes on and stays on, it indicates a system malfunction. If any of these occur, contact an Authorized Mazda Dealer as soon as possible.

### ▼ Headlight High-Beam Indicator Light



This light indicates one of two things:

- The high-beam headlights are on.
- The turn signal lever is in the flash-to-pass position.

### ▼ O/D OFF Indicator Light (Automatic transmission)



This light comes on when the overdrive has been turned off.

#### ⚠ CAUTION

If the overdrive-off indicator light flashes, the transmission has an electrical problem. Continuing to drive your Mazda in this condition could cause damage to your transmission. Consult an Authorized Mazda Dealer as soon as possible.

### ▼ Cruise Set Indicator Light\*



This light comes on when a cruising speed is set.

# Warning/Indicator Lights and Beep Sounds

---

## ▼ Turn-Signal/Hazard Warning Indicator Lights

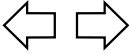

When operating the turn-signal lights, the left or right turn-signal indicator light flashes to indicate which turn-signal light is operating (page 5-32).

When operating the hazard warning lights, both turn-signal indicator lights flash (page 5-36).

<b>NOTE</b>
If an indicator light remains illuminated (does not flash) or if it flashes abnormally, the turn signal bulb may be burned out.

## Beep Sounds

### ▼ Seat Belt Warning Beep

If the driver's seat belt is not fastened when the ignition switch is turned to the ON position, a beep sound will be heard for about 6 seconds.

### ▼ Ignition Key Reminder

If the ignition switch is in the LOCK or ACC position, a beep sound will be heard when any door is opened.

### ▼ Lights-On Reminder

If lights are on and the key is removed from the ignition switch, a beep sound will be heard when any door is opened.

# Switches and Controls

## Lighting Control

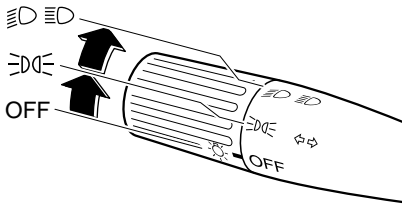

### ▼ Headlights

To turn on the lights, turn the headlight switch on the end of the control lever.

Switch Position	OFF	☰☱☲	☰☱☲☳
Headlights	Off	Off	On
Taillights Parking lights License lights Side-marker lights	Off	On	On

#### NOTE

To prevent discharging the battery, don't leave the lights on while the engine is off.

### ▼ Lights-On Reminder

If lights are on and the key is removed from the ignition switch, a beep sound will be heard when any door is opened.

### ▼ Headlight High-Low Beam

Push the lever forward for high beam. Pull it back for low.

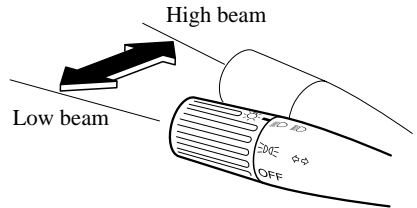

### ▼ Flashing the Headlights

To flash the headlights, pull the lever fully toward you. The headlight switch need not be on, and the lever will return to the normal position when released.

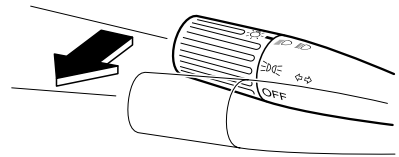

# Switches and Controls

## Turn and Lane-Change Signals

### ▼ Turn Signal

Move the signal lever down (for a left turn) or up (for a right turn) to the stop position. The signal will self-cancel after the turn is completed.

If the indicator light continues to flash after a turn, manually return the lever to its original position.

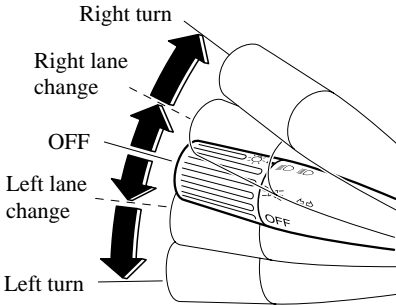

Green indicators on the dashboard show which signal is working.

### Lane-change signals

Move the lever slightly toward the direction of the change —until the indicator flashes— and hold it there. It will return to the off position when released.

#### NOTE

If an indicator light stays on without flashing or if it flashes abnormally, the turn signal bulb may be burned out.

## Fog Lights\*

Use this switch to turn on the fog lights. They help you to see as well as to be seen.

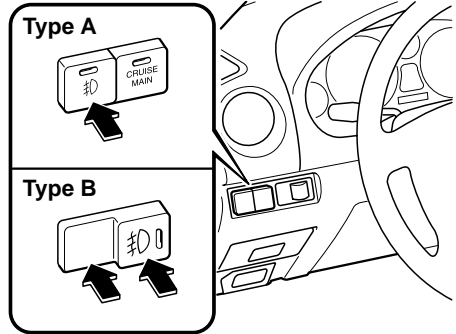

To turn on the fog lights, first turn the headlight switch to the  $\text{D}\text{D}\text{D}$  position. Then press the fog light switch. To turn the fog lights off:

#### (Type A)

Press the fog light switch again or turn the headlight switch to the  $\text{D}\text{D}\text{D}$  or OFF position.

#### (Type B)

Press the left part of the fog light switch or turn the headlight switch to the  $\text{D}\text{D}\text{D}$  or OFF position.

#### NOTE

The fog lights will turn off when the headlights are set at high beam.

## Switches and Controls

### Daytime Running Lights (Canada)

In Canada, vehicles must be driven with the headlights on during daytime operation.

For that reason, the daytime running lights automatically turn on when the ignition switch is turned to the ON position.

#### NOTE

The running lights go off when the parking brake is applied.

### Windshield Wipers and Washer

The ignition switch must be in the ON position.

#### **WARNING**

#### ***Frozen Washer Fluid:***

***Using windshield washer fluid without anti-freeze protection in freezing temperatures is dangerous. The washer fluid could freeze on the windshield and block your vision. You could have an accident. Don't use the washer without first warming the windshield and never use plain tap water.***

#### NOTE

Because heavy ice and snow can jam the wiper blades, the wiper motor is protected from motor breakdown, overheating and possible fire by a circuit breaker. This mechanism will automatically stop operation of the blades, but only for about 5 minutes. If this happens, turn off the wiper switch and park off the right-of-way, and remove the snow and ice. After 5 minutes, turn on the switch and the blades should operate normally. If they don't resume functioning, consult an Authorized Mazda Dealer as soon as possible.

# Switches and Controls

## ▼ Windshield Wipers

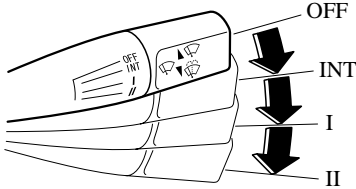

Turn the wipers on by pulling the lever down.

**INT** — Intermittent

**I** — Normal

**II** — Fast

### One-touch wipers

For a single wiping cycle, push the lever forward and release it.

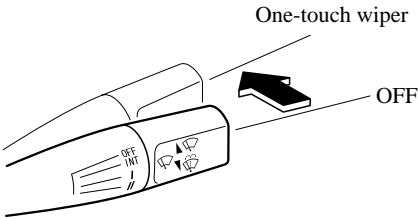

## ▼ Windshield Washer

Pull the lever toward you and hold it to spray washer fluid.

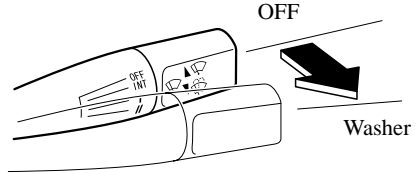

### **NOTE**

With the wiper lever in the OFF or INT position, the wipers will operate continuously until the lever is released.

If the washer doesn't work, inspect the fluid level (page 8-22). If it's OK, consult an Authorized Mazda Dealer.



# Switches and Controls

## Rear Window Defroster

The rear window defroster clears frost, fog, and thin ice from the rear window.

The ignition switch must be in the ON position.

Press the switch to turn on the rear window defroster, the indicator light will illuminate.

Press the switch again to turn it off.

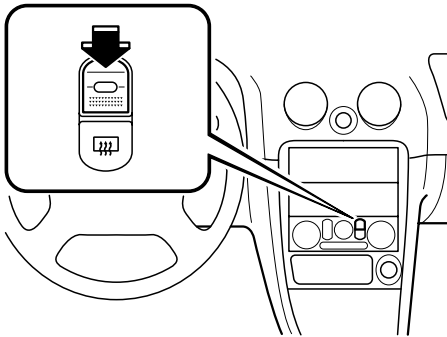

### ⚠ CAUTION

Don't use sharp instruments or window cleaners with abrasives to clean the inside of the rear window surface. They may damage the defroster grid inside the window.

### NOTE

This defroster is not designed for melting snow. If there is an accumulation of snow on the rear window, remove it before using the defroster.

## Horn

To sound the horn, press around the  mark on the steering wheel.

# Switches and Controls

---

## Hazard Warning Flasher

The hazard warning lights should always be used when you stop on or near a roadway.

The hazard warning lights warn other drivers that your vehicle is a traffic hazard and that they must take extreme caution when near it.

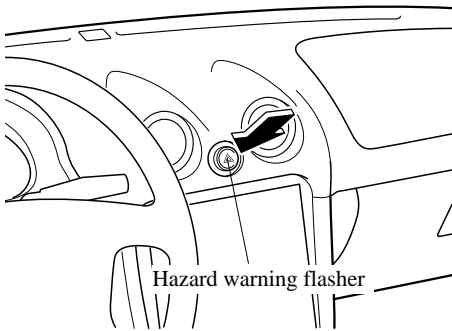

Depress the hazard warning flasher and all four turn signals will flash.

<b>NOTE</b>
<ul style="list-style-type: none"><li>• The turn signals don't work when the hazard warning lights are on.</li><li>• Check local regulations about the use of hazard warning lights while the vehicle is being towed. They may forbid it.</li></ul>

Use of various features for drive comfort, including air-conditioning and audio system.

<b>Climate Control System</b> .....	6-2
Operating Tips .....	6-2
Vent Operation .....	6-3
Control Panel .....	6-5
<b>Audio System</b> .....	6-9
Antenna .....	6-9
Operating Tips for Audio System .....	6-9
Types of the Audio Set .....	6-16
Audio Set (Type A)* .....	6-17
Audio Set (Type B)* .....	6-37
Safety Certification .....	6-58
<b>Interior Equipment</b> .....	6-59
Sunvisors .....	6-59
Interior Light .....	6-59
Lighter .....	6-60
Ashtray .....	6-60
Cup Holder .....	6-61
Storage Compartments .....	6-62
Windblocker* .....	6-63

# Climate Control System

---

## Operating Tips

### ▼ Operating the Climate Control System

Operate the climate control system with the engine running.

#### NOTE

To prevent the battery from being discharged, do not leave the fan control dial on for a long period of time when the engine is not running.

### ▼ Clearing the Air Inlet

Clear all obstructions like leaves, snow and ice from the hood and the air inlet in the cowl grille to improve the system efficiency.

### ▼ Foggy Windows

The windows may fog up easily in humid weather. Use the climate control system to defog the windows.

To help defog the windows, operate the air conditioner to dehumidify the air.

### ▼ Outside/Recirculated Air Position

Use the outside air position in normal conditions. The recirculated air position should be used only when driving on dusty roads or for quick cooling of the interior.

### ▼ Parking in Direct Sunlight

If the vehicle has been parked in direct sunlight during hot weather, open the windows to let warm air escape, then run the climate control system.

### ▼ Not Using for a Long Period

Run the air conditioner about 10 minutes at least once a month to keep internal parts lubricated.

### ▼ Check the Refrigerant before the Weather Gets Hot

Have the air conditioner checked before the weather gets hot. Lack of refrigerant may make the air conditioner less efficient. Consult an Authorized Mazda Dealer for refrigerant inspection.

The air conditioner is filled with HFC134a (R134a), a refrigerant that will not damage the ozone layer. If the air conditioner is low on refrigerant or has a malfunction, consult an Authorized Mazda Dealer.

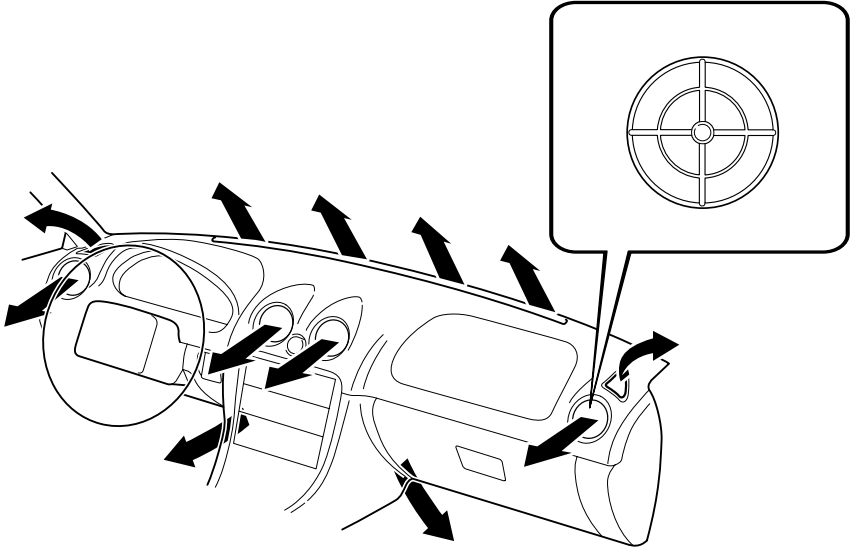
**Vent Operation****▼ Adjusting the Vents****Directing airflow**

You can direct air flow by moving the adjustment knob.

**NOTE**

When using the air conditioner, mist may come out from the vents. This is not a sign of trouble but a result of humid air being suddenly cooled.

# Climate Control System

---

## ▼ Selecting the Airflow Mode

### Dashboard Vents

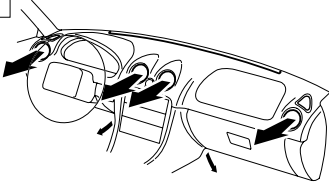

### Defroster and Floor Vents

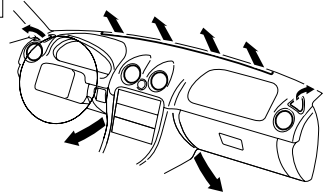

### Dashboard and Floor Vents

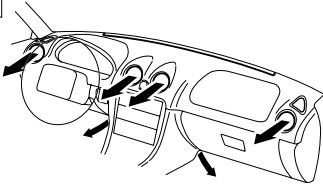

### Defroster Vents

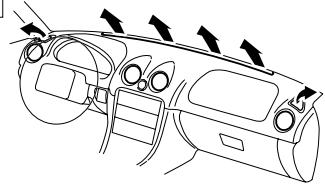

### Floor Vents

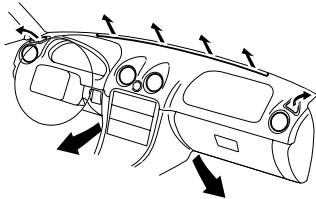

# Climate Control System

## Control Panel

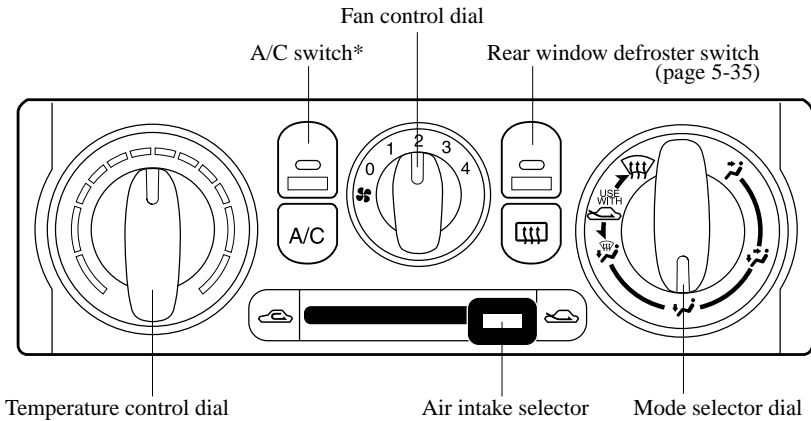

### ▼ Control Switches

#### Temperature control dial

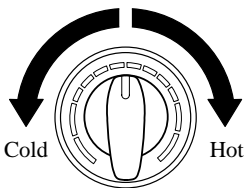

This dial controls temperature. Turn it clockwise for hot and counterclockwise for cold.

#### Fan control dial

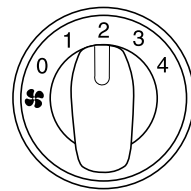

This dial allows variable fan speeds.

- 0—Fan off
- 1—Low speed
- 2—Medium low speed
- 3—Medium high speed
- 4—High speed

# Climate Control System

## Mode selector dial

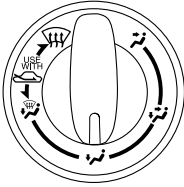

Turn the mode selector dial to select airflow mode (page 6-4).

## A/C switch\*

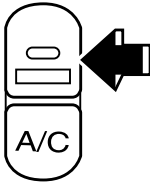

Push the switch to turn the air conditioner on. The indicator light on the switch will illuminate when the fan control dial is set at position 1, 2, 3, or 4.

Push the switch once again to turn the air conditioner off.

### NOTE

The air conditioner may not function when the outside temperature approaches 0 °C (32 °F).

## Air intake selector

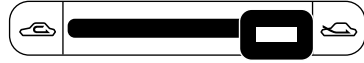

This lever controls the source of air entering the vehicle.

It is recommended that under normal conditions the lever be kept in the outside air position.

### **Outside air position ( )**



Outside air is taken into the vehicle. Use this position for normal ventilation and heating.

### **Recirculated air position ( )**

Outside air is shut off. Air within the vehicle is recirculated.

This position can be used when driving on a dusty road or in similar conditions. It also helps to provide quicker cooling of the interior.



## **WARNING**

**The Recirculated Air Position:**  
*Using the  position in cold or rainy weather will cause the windows to fog up. Your vision will be hampered, which could lead to a serious accident. Do not use the  position in cold or rainy weather.*





# Climate Control System

## ▼ Heating

1. Set the mode selector dial to the  position.
2. Set the air intake selector to the  position.
3. Set the temperature control dial to the hot position.
4. Set the fan control dial to the desired speed.
5. If dehumidified heating is desired, turn on the air conditioner.

### NOTE

- If the windshield fogs up easily, set the mode selector dial to the  position.
- If cooler air is desired at face level, set the mode selector dial at the  position and adjust the temperature control dial to maintain maximum comfort.
- The air to the floor is warmer than air to the face (except when the temperature control dial is set at the extreme hot or cold position).



## ▼ Cooling (With Air Conditioner)\*

1. Set the mode selector dial to the  position.
2. Set the temperature control dial to the cold position.
3. Set the fan control dial to the desired speed.
4. Turn on the air conditioner.
5. Adjust the fan control dial and temperature control dial to maintain maximum comfort.

### CAUTION



When using the air conditioner while driving up long hills or in heavy traffic, closely monitor the temperature gauge (page 5-20).  
The air conditioner may cause engine overheating. If the gauge indicates overheating, turn the air conditioner off.

### NOTE



- When maximum cooling is desired, set the temperature control dial to the extreme cold position and set the air intake selector to the  position, then set the fan control dial to position 4.
- If warmer air is desired at floor level, set the mode selector dial at the  position and adjust the temperature control dial to maintain maximum comfort.
- The air to the floor is warmer than air to the face (except when the temperature control dial is set at the extreme hot or cold position).

# Climate Control System

## ▼ Ventilation



1. Set the mode selector dial to the  position.
2. Set the air intake selector to the  position.
3. Set the temperature control dial to the desired position.
4. Set the fan control dial to the desired speed.

## ▼ Windshield Defrosting and Defogging

1. Set the mode selector dial to the  position.
2. Set the air intake selector to the  position.
3. Set the temperature control dial to the desired position.
4. Set the fan control dial to the desired speed.

### **WARNING**

#### **Foggy Windshield:**

*Using the  position with the temperature control set to the cold position will cause the outside of the windshield to fog up. Your vision will be hampered, which could lead to a serious accident. Set the temperature control to the hot or warm position when using the  position.*

### NOTE

- For maximum defrosting, set the temperature control dial to the extreme hot position and the fan control dial to position 4.
- If warm air is desired at the floor, set the mode selector dial to the  position.

## ▼ Dehumidifying (With Air Conditioner)\*

Operate the air conditioner in cool or cold weather to help defog the windshield and side windows.

1. Set the mode selector dial to the desired position.
2. Set the air intake selector to the  position.
3. Set the temperature control dial to the desired position.
4. Set the fan control dial to the desired speed.
5. Turn on the air conditioner.

## Antenna

### ▼ Power Antenna

The antenna automatically rises when the radio is turned on, and lowers when it is turned off.

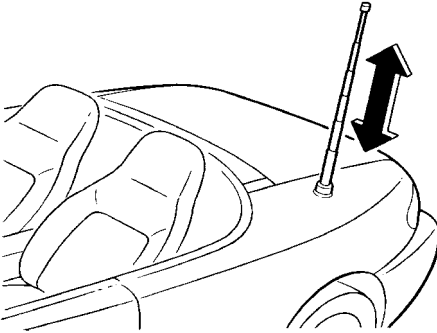

### ⚠ CAUTION

- To prevent damaging the antenna, retract it before entering a car wash facility or passing beneath a low overhead clearance.
- Make sure no one is near the antenna before turning on the radio to prevent injury or damage to the antenna.

## Operating Tips for Audio System

### ⚠ WARNING

#### *Do Not Adjust Audio While Driving the Vehicle:*

*Adjusting the audio while driving the vehicle is dangerous as it could distract your attention from the vehicle operation which could lead to a serious accident. Always adjust the audio while the vehicle is stopped.*

### ⚠ CAUTION

For the purposes of safe driving, adjust the audio volume to a level that allows you to hear sounds outside of the vehicle.

### NOTE

- Do not use the audio for long periods of time while the engine is off. Otherwise the battery could go dead.
- If a digital cellular phone or CB radio is used in or near the vehicle, it could cause noise to occur from the audio system, however, this does not indicate that the system has been damaged.

# Audio System

## ▼ Radio Reception

### AM characteristics

AM signals bend around such things as buildings or mountains and bounce off the ionosphere. Therefore, they can reach longer distances than FM signals. Because of this, two stations may sometimes be picked up on the same frequency at the same time.

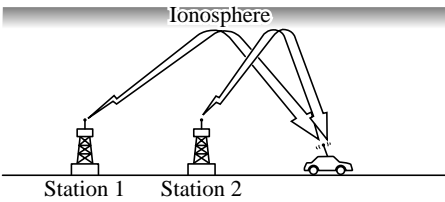

### FM characteristics

An FM broadcast range is usually about 40—50 km (25—30 miles) from the source. Because of extra coding needed to break the sound into two channels, stereo FM has even less range than monaural (non-stereo) FM.

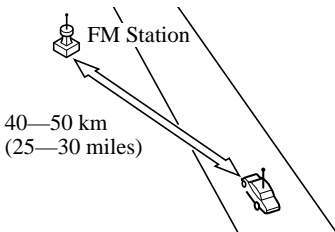

Signals from an FM transmitter are similar to beams of light because they do not bend around corners, but they do reflect. Unlike AM signals, FM signals cannot travel beyond the horizon. Therefore, FM stations cannot be received at the great distances possible with AM reception.

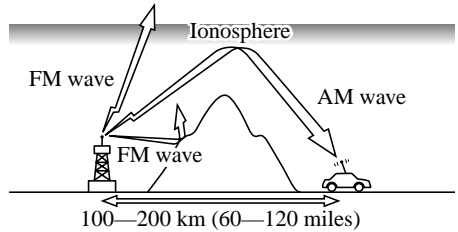

Atmospheric conditions can also affect FM reception. High humidity will cause poor reception. However, cloudy days may provide better reception than clear days.

### **Multipath noise**

Since FM signals can be reflected by obstructions, it is possible to receive both the direct signal and the reflected signal at the same time. This causes a slight delay in reception and may be heard as a broken sound or a distortion. This problem may also be encountered when in close proximity to the transmitter.

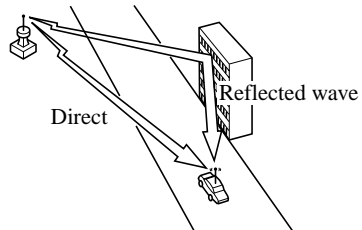

## Flutter/Skip noise

Signals from an FM transmitter move in straight lines and become weak in valleys between tall buildings, mountains, and other obstacles. When a vehicle passes through such an area, the reception conditions may change suddenly, resulting in annoying noise.

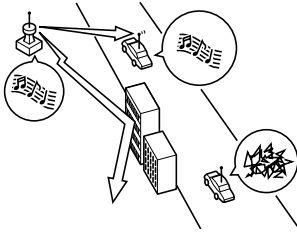

## Weak signal noise

In suburban areas, broadcast signals become weak because of distance from the transmitter. Reception in such fringe areas is characterized by sound breakup.

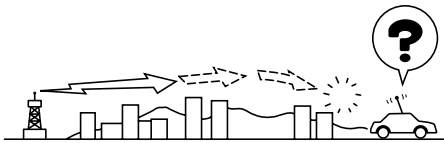

## Strong signal noise

This occurs very close to a transmitter tower. The broadcast signals are extremely strong, so the result is noise and sound breakup at the radio receiver.

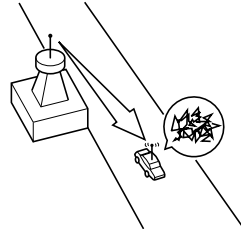

## Station drift noise

When a vehicle reaches the area of two strong stations broadcasting at similar frequencies, the original station may be temporarily lost and the second station picked up. At this time there will be some noise from this disturbance.

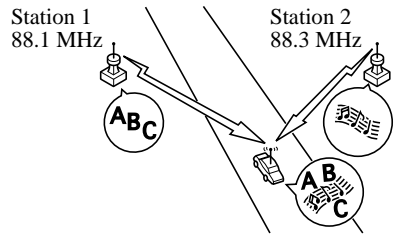

# Audio System

---

## ▼ Operating Tips for Cassette Tape Player

### Cleaning the cassette tape player

The tape head, capstans, and pinch rollers will gather oxide residue from cassette tapes. This can cause weak or wavering sounds and damage to the cassette tapes and player. Use a good quality head-cleaning tape or a liquid cleaner cassette tape to remove it.

Should the unit not operate normally, consult an Authorized Mazda Dealer. Never attempt to repair it or insert a screwdriver or anything else.

### Handling the cassette tape player

The following precautions should be observed.

- Do not spill any liquid on the audio system.

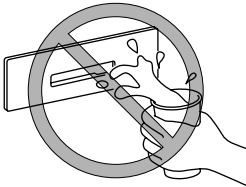

- Do not insert any objects, other than cassette tape, into the slot.

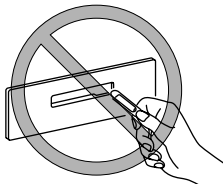

- If the cassette tape is loose, it may produce poor sound or performance during playback. Use a pencil or something similar to remove any slack.

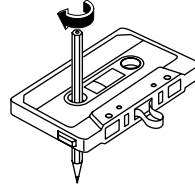

- Only cassette tapes that play no longer than 90 minutes should be used. Cassette tape exceeding 90 minutes are thin and may easily break.
- Do not leave a cassette tape in the tape player slot when not in use. Remove it completely to permit the slot door to close and to protect the mechanism from dust.
- Store cassette tapes away from extreme heat, magnetic fields, and direct sunlight. Protect the exposed cassette tape from dirt and damage. Store cassette tapes in their original cases or other protective cases.

## ▼ Operating Tips for Mini Disc (MD) Player

The following precautions should be observed.

- Do not spill any liquid on the audio system.

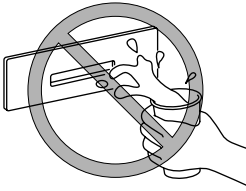

- Do not insert any objects, other than MDs, into the slot.

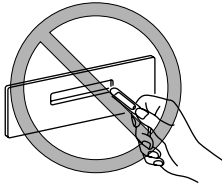

- The MD player has been designed to play MDs bearing the identification logo as shown. No other MDs can be played.



- The MD player can also play MDLPs that have been recorded in MDLP mode. (MDLPs bearing the identification logo as shown below).

# MDLP

- When inserting the MD, make sure the MD label is facing up, and the MD is oriented to the insertion slot in the direction of the arrow. If not inserted correctly, the MD will be ejected, or may remain stuck in the MD deck.

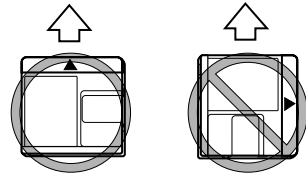

- Do not touch the internal part of the MD. If the MD shutter is slid open for no reason, it may be broken.

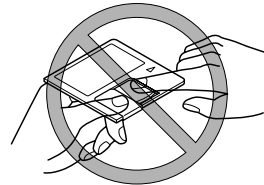

- Store MDs in their cases and away from direct sunlight.

# Audio System

## ▼ Operating Tips for CD Player/In-Dash CD Changer

### Condensation phenomenon

Immediately after turning on the heater when the vehicle is cold, the CD or optical components (prism and lens) in the CD player/changer may become clouded with condensation. At this time, the CD will eject immediately when placed in the unit. A clouded CD can be corrected simply by wiping it with a soft cloth. Clouded optical components will clear naturally in about an hour. Wait for normal operation to return before attempting to use the unit.

### Handling the CD player/In-dash CD changer

The following precautions should be observed.

- Do not spill any liquid on the audio system.

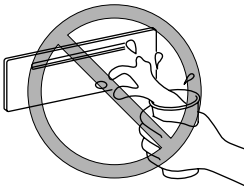

- Do not insert any objects, other than CDs, into the slot.

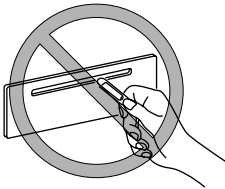

- The CD revolves at high speed within the unit. Defective (cracked or badly bent) CDs should never be used.

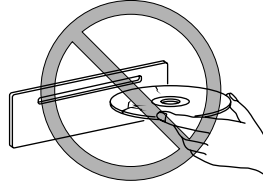

- Do not use non-conventional discs such as heart-shaped, octagonal discs, etc. The CD player/changer could be damaged.

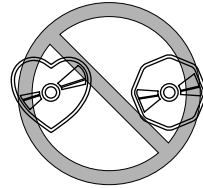

- A new CD may have rough edges on its inner and outer perimeters. If a disc with rough edges is used, proper setting will not be possible and the CD player/changer will not play the CD. Remove the rough edges in advance by using a ball-point pen or pencil as shown below. To remove the rough edges, rub the side of the pen or pencil against the inner and outer perimeter of the CD.

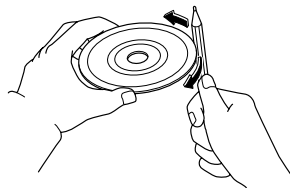



# Audio System

- When driving over uneven surfaces, the sound may jump.

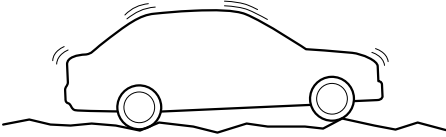

- The CD player/changer has been designed to play CDs bearing the identification logo as shown. No other discs can be played.



- Be sure never to touch the signal surface when handling the CDs. Pick up a CD by grasping the outer edge or the edge of the hole and the outer edge.

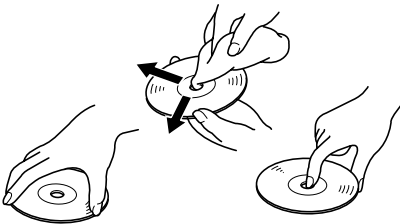

- Do not stick paper or tape on the CD. Avoid scratching the reverse side (the side without a label).

- Dust, finger smudges, and dirt can decrease the amount of light reflected from the signal surface, thus affecting sound quality. If the CD should become soiled, gently wipe it with a soft cloth from the center of the CD to the edge.
- Do not use record sprays, antistatic agents, or household spray cleaners. Volatile chemicals such as benzine and thinner can also damage the surface of the CD and must not be used. Anything that can damage, warp, or fog plastic should never be used to clean CDs.
- CDs, like traditional audio records, are made of plastic. To avoid warping, keep the CDs in their cases and do not store them where they will be exposed to direct sunlight.
- The CD player/changer ejects the CD if the CD is inserted upside down. Also dirty and/or defective CDs may be ejected.
- 8 cm (3 in) CDs and CD accessories (e.g. 8 cm disc adapter) cannot be used in the CD player/changer.
- Do not insert cleaning discs in the CD player/changer.
- Do not insert any disc with a peel-off or seal on it.

# Audio System

## Types of the Audio Set

Type A ..... 6-17

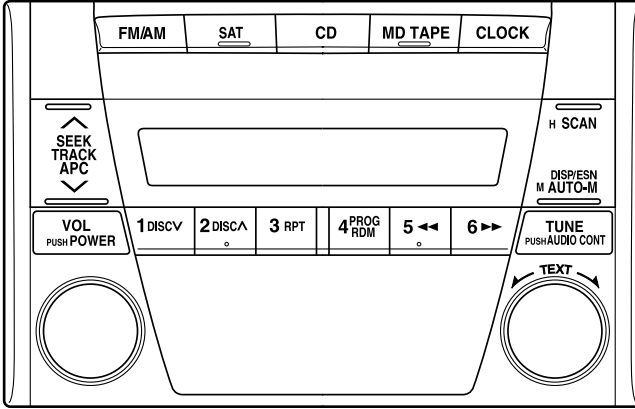

Type B ..... 6-37

(Some countries.)

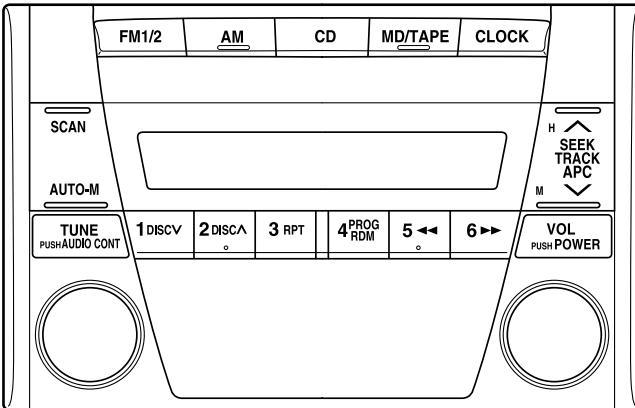

## Audio Set (Type A)\*

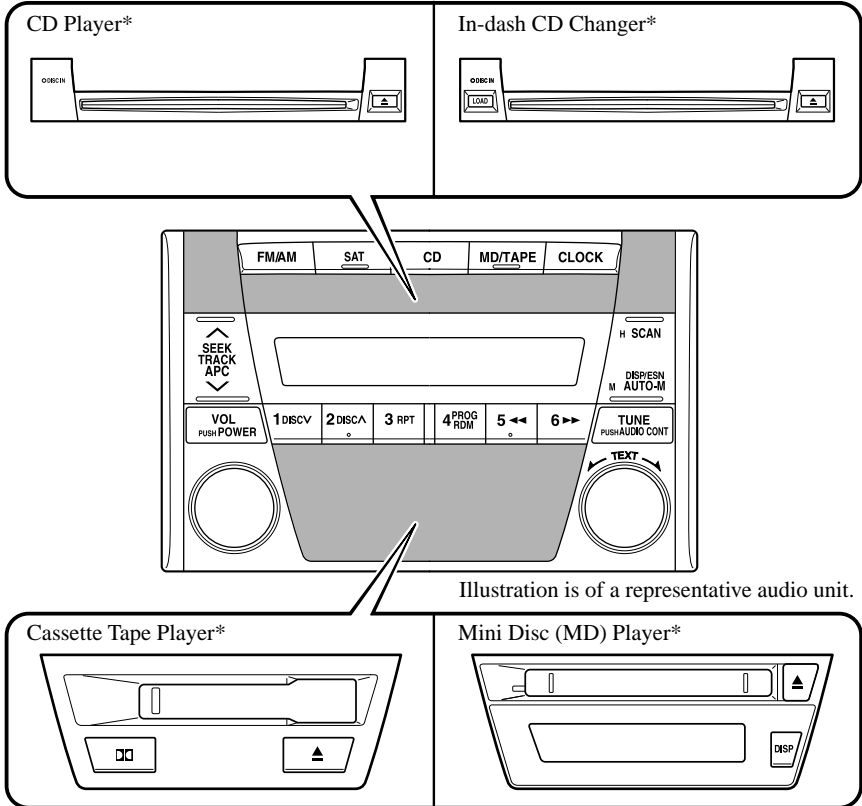
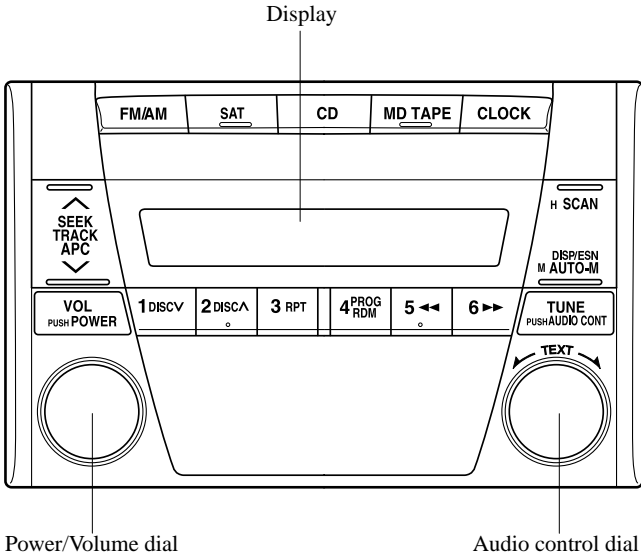

Illustration is of a representative audio unit.

Power/Volume/Sound Controls .....	6-18
Clock .....	6-22
Operating the Radio .....	6-24
Operating the Cassette Tape Player* .....	6-26
Operating the Mini Disc (MD) Player* .....	6-28
Operating the Compact Disc (CD) Player* .....	6-30
Operating the In-Dash CD Changer* .....	6-32
Error Indications .....	6-36

# Audio System

## ▼ Power/Volume/Sound Controls



### Power ON/OFF

Turn the ignition switch to the ACC or ON position.

Press the power/volume dial to turn the audio system on.

Press the power/volume dial again to turn the audio system off.

#### **NOTE**

To prevent the battery from being discharged, do not leave the audio system on for a long period of time when the engine is not running.

### Volume adjustment

To adjust the volume, turn the power/volume dial.

Turn the power/volume dial to the right to increase volume, to the left to decrease it.

### Audio sound adjustment

1. Press the audio control dial to select the function. The selected function will be indicated.
2. Turn the audio control dial to adjust the selected functions as follows:

## BOSE Sound System-equipped model

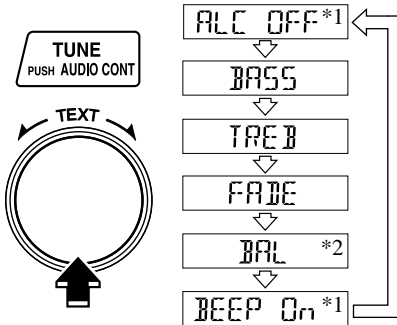

- \*1 Depending on the mode selected, the indication changes.
- \*2 BAL function is available only for the front speakers.

Indication	Turn Left	Turn Right
ALC	Select mode	Select mode
BASS	Decrease bass	Increase bass
TREB	Decrease treble	Increase treble
FADE	Shift the sound to the front	Shift the sound to the rear
BAL (front speakers only)	Shift the sound to the left	Shift the sound to the right
BEEP	OFF	ON

## Standard audio-equipped model

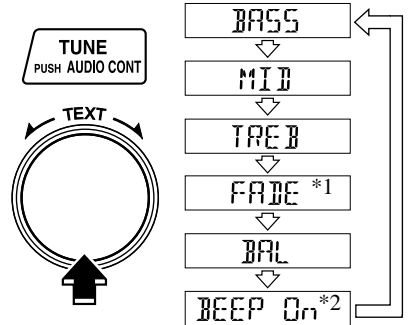

- \*1 If your vehicle is not equipped with rear speakers, adjust the power/volume dial so the level is even.
- \*2 Depending on the mode selected, the indication changes.

Indication	Turn Left	Turn Right
BASS	Decrease bass	Increase bass
MID	Decrease mid-range	Increase mid-range
TREB	Decrease treble	Increase treble
FADE	Shift the sound to the front	Shift the sound to the rear
BAL	Shift the sound to the left	Shift the sound to the right
BEEP	OFF	ON

# Audio System

## NOTE

About 5 seconds after selecting any mode, the volume function will be automatically selected. To reset bass, mid-range, treble, fade and balance, press the audio control dial for 2 seconds. The unit will beep and "CLEAR" will be displayed.

## Automatic Level Control (ALC)

### (BOSE Sound System-equipped model)

The automatic level control is a feature that automatically adjusts audio volume and sound quality according to the vehicle speed.

The volume increases in accordance with the increase in vehicle speed, and decreases as vehicle speed decreases.

The following 7 modes are available.

Select the desired mode according to use.

Mode	Use	Volume change
ALC OFF	ALC does not operate.	No change
TOP UP 1	Use when the convertible top is open. Three levels are available.	Minimum
TOP UP 2		Medium
TOP UP 3		Maximum
TOP DWN 1	Use when the convertible top is closed. Three levels are available.	Minimum
TOP DWN 2		Medium
TOP DWN 3		Maximum

Turn the audio control dial to select the desired mode. The selected mode will be indicated.

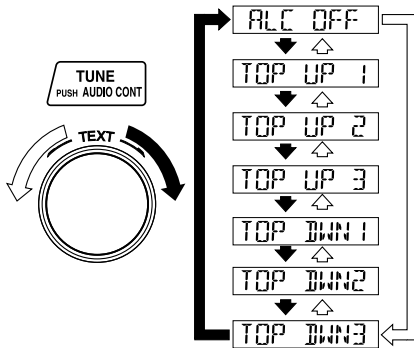

### **BEEP setting**

The beep-sound when operating the audio system can be set on or off.

# Audio System

## ▼ Clock

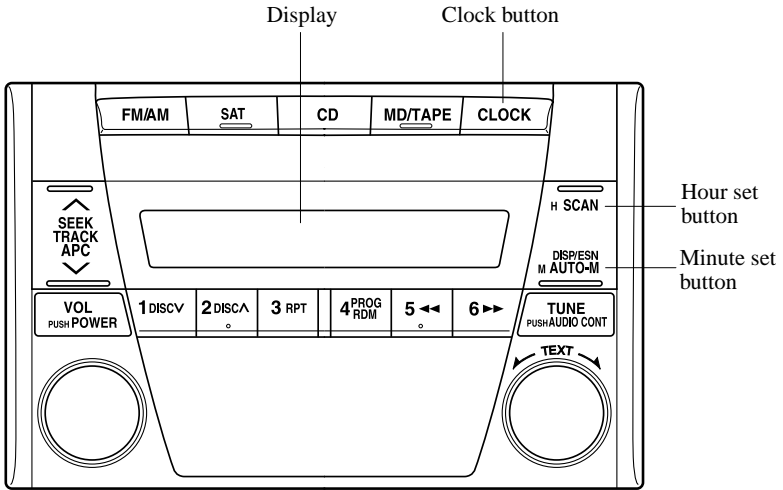

### Setting the time

The clock can be set at any time when the ignition switch is in the ACC or ON position.

1. To adjust the time, press the clock button (**CLOCK**) for about 2 seconds until a beep is heard.  
The clock's current time will flash.

#### **NOTE**

To select 12-hour or 24-hour clock time, turn the audio control dial while the clock display is flashing. After selecting the desired display, press the audio control dial to return to the flashing clock display.

2. To advance the hours, press the hour set button (**H**). To advance the minutes, press the minute set button (**M**) while the time is flashing.
3. Press the clock button (**CLOCK**) again to start the clock.



**Exact hour adjustment**

1. To set the exact hour, press the clock button ( **CLOCK** ) for about 2 seconds until a beep is heard.  
The clock's current time will flash.
2. Press the clock button ( **CLOCK** ) again and the time will be adjusted as follows:  
(Example)  
12:01—12:29→12:00  
12:30—12:59→1:00

**NOTE**

- When the clock button ( **CLOCK** ) is released, the seconds are reset to "00".
- If the power supply to the unit is interrupted (if the fuse blows or the vehicle's battery is disconnected), the clock will need to be reset.

**Changing the display mode**

The display on the unit can be changed by pressing the clock button ( **CLOCK** ). This alternates the display between clock mode and normal mode. When the clock mode has been selected, the time will be displayed.

**NOTE**

The displays when using the audio differ in clock mode and normal mode.

# Audio System

## ▼ Operating the Radio

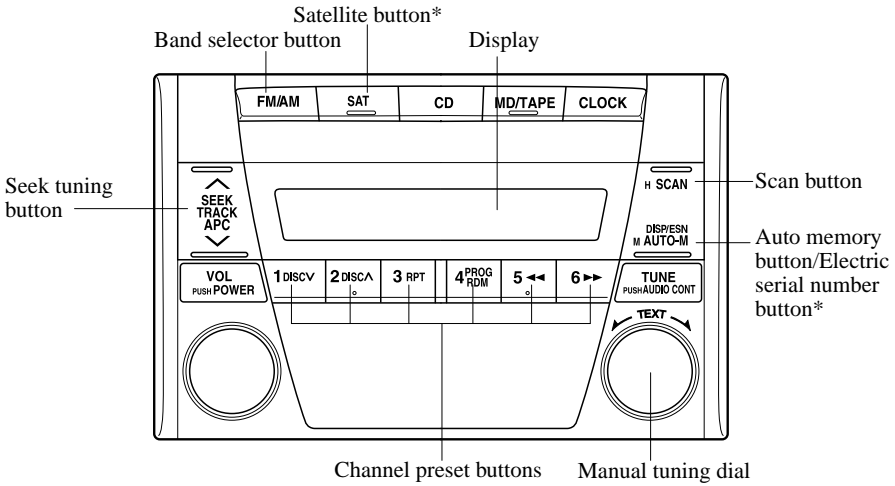

\*For reception of optional Sirius digital satellite radio.  
Used on vehicles equipped with the separately sold Sirius digital satellite radio unit.  
For information on use, read the manual accompanying the Sirius unit.  
Subscription of Sirius digital satellite radio service is available in the U.S. (Except Alaska and Hawaii).

### Radio ON

Press a band selector button (**FM/AM**) to turn the radio on.

### Band selection

Successively pressing the band selector button (**FM/AM**) switches the bands as follows: FM1 → FM2 → AM.

The selected mode will be indicated. If FM stereo is being received, "ST" will be displayed.

#### **NOTE**

If the FM broadcast signal becomes weak, reception automatically changes from STEREO to MONO for reduced noise, and the "ST" indicator will go out.

### Tuning

The radio has the following tuning methods: Manual, Seek, Scan, Preset channel, and Auto memory tuning. The easiest way to tune stations is to set them on preset channels.

#### **NOTE**

If the power supply is interrupted (fuse blows or the battery is disconnected), the preset channels will be canceled.

### Manual tuning

Turning the manual tuning dial will change the frequency higher or lower.

## Seek tuning

Pressing the seek tuning button (  $\wedge$  ,  $\vee$  ) will cause the tuner to seek a higher or lower frequency automatically.

### NOTE

If you continue to press and hold the button, the frequency will continue changing without stopping.

## Scan tuning

Press the scan button ( **SCAN** ) to automatically sample strong stations. Scanning stops at each station for about 5 seconds. To hold a station, merely press the scan button ( **SCAN** ) again during this interval.

## Preset channel tuning

The 6 preset channels can be used to store 6 AM and 12 FM stations.

1. To set a channel first select AM, FM1, or FM2. Tune to the station you want.
2. Depress a channel preset button for about 2 seconds until a beep is heard. The preset channel number and station frequency will be displayed. The station is now held in the memory.

### NOTE

When the clock is displayed, the preset channel number will not be displayed.

3. Repeat this operation for the other stations and bands you want to store. To tune one in the memory, select AM, FM1, or FM2 and then press its channel preset button. The station frequency and the channel number will be displayed.

### NOTE

If the power supply is interrupted (fuse blows or the battery is disconnected), the preset channels will be canceled.

## Auto memory tuning

This is especially useful when driving in an area where the local stations are not known. Additional AM/FM stations can be stored without disturbing the previously set channels.

Press and hold the auto memory button ( **AUTO-M** ) for about 2 seconds until a beep is heard; the system will automatically scan and temporarily store up to 6 stations with the strongest frequencies in each selected band in that area.

After scanning is completed, the station with the strongest frequency will be tuned and its frequency displayed.

Press and release the auto memory button ( **AUTO-M** ) to recall stations from the auto-stored stations. One stored station will be selected each time; its frequency and channel number will be displayed.

### NOTE

- When the clock is displayed, the preset channel number will not be displayed.
- If no stations can be tuned after scanning operations, "A" will be displayed.

# Audio System

## ▼ Operating the Cassette Tape Player\*

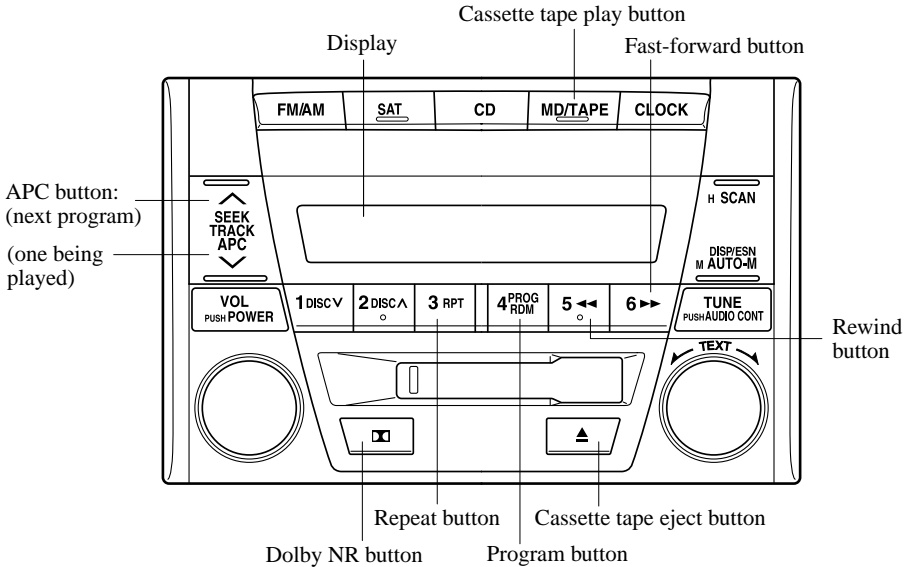

### Cassette tape insert

Insert the cassette tape into the slot, open edge to the right and cassette tape will begin play and "TAPE" will be displayed. At the end of the cassette tape, the unit automatically reverses cassette tape play. When **⏮...⏭** is lit, the cassette tape's top side is playing. When **⏮...⏭** is lit, the bottom side is on.

#### **NOTE**

When a metal tape is inserted, the player will automatically compensate for it.

### Playing

Press the cassette tape play button (**MD/TAPE**) to start playing when a cassette tape is in the unit. If there isn't a cassette tape in the unit when the cassette tape play button (**MD/TAPE**) is pressed, "No TAPE" will flash on and off in sequence.

### Dolby noise reduction

When using a tape with Dolby NR\*, push the Dolby NR button (**DD**). The **DD** symbol will be displayed. To play a tape without Dolby NR, push the button once again.

\* Noise reduction system manufactured under license from Dolby Laboratories Licensing Corporation. Dolby and the double-D symbol **DD** are trademarks of Dolby Laboratories Licensing Corporation.

**Ejecting the cassette tape**

Press the cassette tape eject button (▲) to eject the cassette tape.

**NOTE**

The cassette tape can be ejected when the ignition switch is in the OFF position.

**Fast-forward/Rewind**

Press the fast-forward button (▶▶) to fast-forward.

Press the rewind button (◀◀) to rewind. To stop this operation and play the cassette tape, press the button again.

**NOTE**

When the cassette tape ends during fast-forward or rewind, it automatically stops and starts playing.

**Reversing**

Press the program button (PROG) to change cassette tape-playing direction.

**NOTE**

When the cassette tape ends, the unit automatically reverses play.

**Automatic program control (APC)**

APC is used to find the beginning of either the next program or the one being played.

Press the APC button (∧) to the beginning of the next selection.

Press the APC button (∨) to the beginning of the one being played. To stop this operation and play the cassette tape, press the button again.

If APC detects 4 seconds of blank space it will automatically advance the tape to the next selection.

**NOTE**

APC may not operate properly if

- A tape was recorded at a low level.
- A tape has long, silent intervals.
- A tape is a live recording.
- A tape has very short intervals of less than 3 seconds.

**Repeat play**

This operation makes it possible to listen to a selection repeatedly.

Press the repeat button (RPT) during play. The current selection playing will be repeated ("RPT" will be displayed). Press the repeat button (RPT) once again to cancel repeat play.

**NOTE**

RPT may not operate properly if

- A tape was recorded at a low level.
- A tape has long, silent intervals.
- A tape is a live recording.
- A tape has very short intervals of less than 3 seconds.

# Audio System

## ▼ Operating the Mini Disc (MD) Player\*

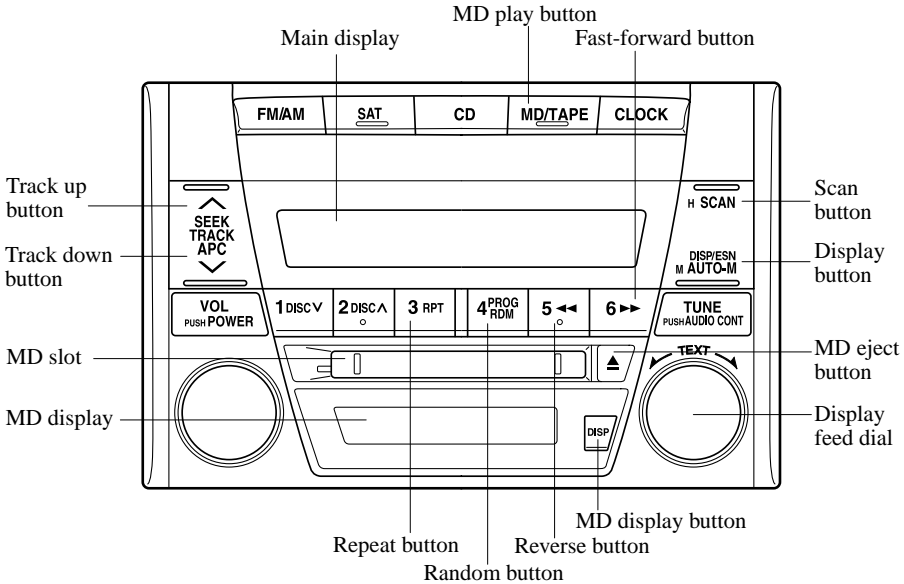

### Inserting the MD

Insert the MD, label-side up with the arrow pointed to the slot. The auto-loading mechanism will set the MD and begin play. There will be a short lapse before play begins while the player reads the digital signals on the MD.

The track number and the elapsed play back time for the current track will be displayed on the display.

#### **NOTE**

When the clock is displayed, the elapsed play back time will not be displayed. To display the elapsed play back time, turn the audio control dial to the right. Turn the dial to the left to return to the previous display.

### Playing

Press the MD play button ( **MD/TAPE** ) to start playing when a MD is in the unit.

### Ejecting the MD

Press the MD eject button ( **▲** ) to eject the MD.

### Fast-forward/Reverse

Press and hold the fast-forward button ( **▶▶** ) to advance through a track at high speed.

Press and hold the reverse button ( **◀◀** ) to reverse through a track at high speed.

## Track search

Press the track up button (  $\wedge$  ) once to skip forward to the beginning of the next track.

Press the track down button (  $\vee$  ) once to skip back to the beginning of the current track.

## Music scan

This feature helps to find a program by playing about the first 10 seconds of each track.

Press the scan button ( **SCAN** ) during play to start scan play operation (the track number will flash).

Press the scan button ( **SCAN** ) once again to cancel scan play.

### NOTE

If the unit is left in scan, normal play will resume where scan was selected.

## Repeat play

This feature makes it possible to listen to a selection repeatedly.

Press the repeat button ( **RPT** ) during play. The current selection will be repeated ("RPT" will be displayed).

Press the repeat button ( **RPT** ) once again to cancel repeat play.

## Random play

This feature allows the MD player to randomly select the order of the songs.

Press the random button ( **RDM** ) during play. The next selection will be randomly selected ("RDM" will be displayed).

Press the random button ( **RDM** ) once again to cancel random play.

## Changing the display

### Display

To change the display during MD play, press the display button ( **DISP** ) to advance through each of the following displays: Track number/Elapsed play back time→Song title→Disc title.

### NOTE

- If there is no song or disc title recorded on the MD, "No TITLE" will be displayed.
- The display can only display English (including numerals) one-byte characters. If any other character is included "No TITLE" will be displayed.

When long disc or song titles cannot be completely displayed, rotate the display feed dial ( **TEXT** ) to the right.

The remainder of the title will proceed and appear on the display to the end of the title.

### MD display

To change the MD display during MD play, press and hold the MD display button ( **DISP** ) for about half a second to advance through each of the following displays:

Song title→Disc title→No display.

### NOTE

If there is no song or disc title recorded on the MD, "No TITLE" will be displayed.

When long disc or song titles cannot be completely displayed, press the MD display button ( **DISP** ) to display the remaining part of the title.

# Audio System

## ▼ Operating the Compact Disc (CD) Player\*

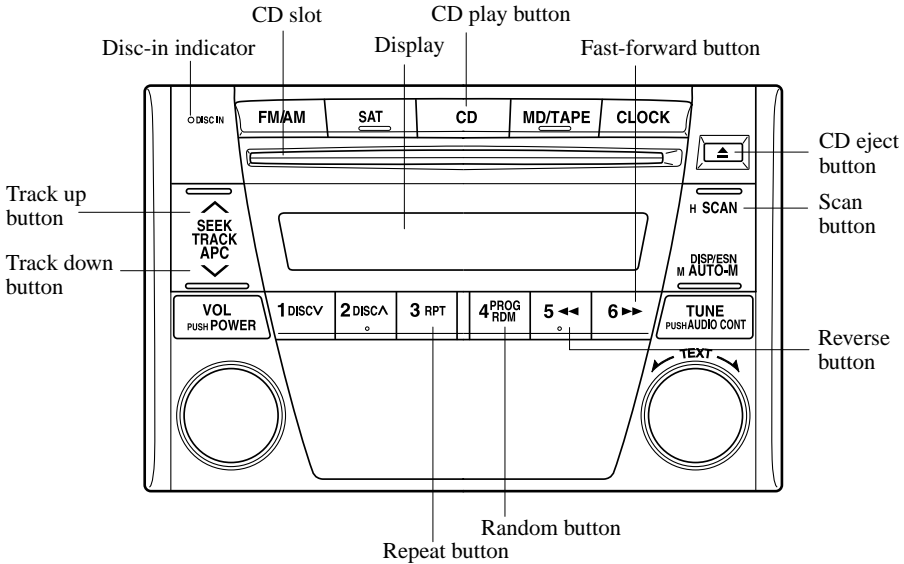

### Inserting the CD

Insert the CD into the slot, label-side up. The auto-loading mechanism will set the CD and begin play. There will be a short lapse before play begins while the player reads the digital signals on the CD. The disc-in indicator will illuminate, and the track number and the elapsed play back time for the current track will be displayed.

#### **NOTE**

When the clock is displayed, the elapsed play back time will not be displayed. To display the elapsed play back time, turn the audio control dial to the right. Turn the dial to the left to return to the previous display.

### Playing

Press the CD play button ( **CD** ) to start playing when a CD is in the unit.

### Ejecting the CD

Press the CD eject button ( **▲** ) to eject the CD.

### Fast-forward/Reverse

Press and hold the fast-forward button ( **▶▶** ) to advance through a track at high speed.

Press and hold the reverse button ( **◀◀** ) to reverse through a track at high speed.



**Track search**

Press the track up button (  ) once to skip forward to the beginning of the next track.

Press the track down button (  ) once to skip back to the beginning of the current track.

**Music scan**

This feature helps to find a program by playing about the first 10 seconds of each track.

Press the scan button ( **SCAN** ) during play to start scan play operation (the track number will flash).

Press the scan button ( **SCAN** ) once again to cancel scan play.

<b>NOTE</b>
-------------

If the unit is left in scan, normal play will resume where scan was selected.
---

**Repeat play**

This feature makes it possible to listen to a selection repeatedly.

Press the repeat button ( **RPT** ) during play. The current selection will be repeated ("RPT" will be displayed).

Press the repeat button ( **RPT** ) once again to cancel repeat play.

**Random play**

This feature allows the CD player to randomly select the order of the songs.

Press the random button ( **RDM** ) during play. The next selection will be randomly selected ("RDM" will be displayed).

Press the random button ( **RDM** ) once again to cancel random play.

# Audio System

## ▼ Operating the In-Dash CD Changer\*

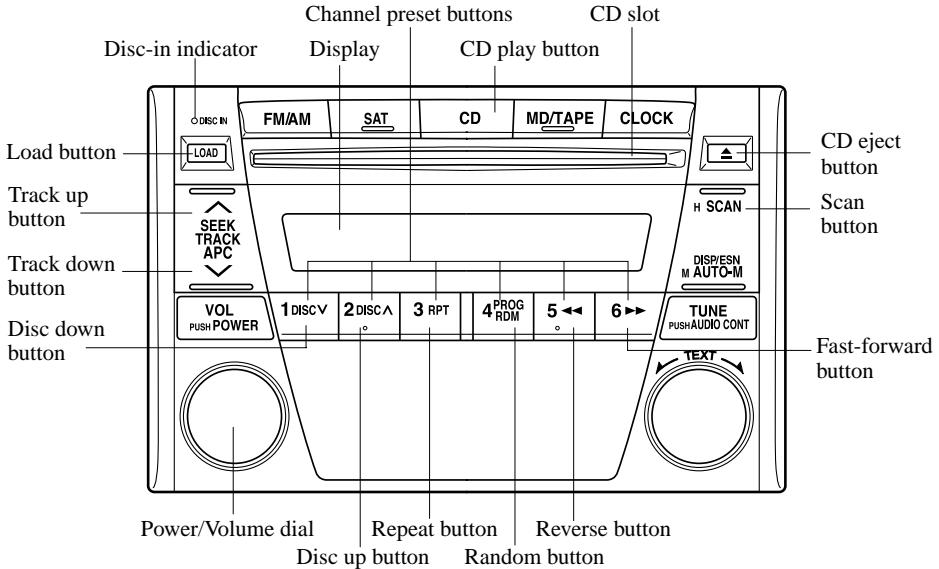

### Inserting the CD

The CD must be label-side up when inserting. The auto-loading mechanism will set the CD and begin play. There will be a short lapse before play begins while the player reads the digital signals on the CD.

The disc number, the track number and the elapsed play back time for the current track will be displayed.

### **NOTE**

- When the clock is displayed, the elapsed play back time will not be displayed. To display the elapsed play back time, turn the audio control dial to the right. Turn the dial to the left to return to the previous display.
- A CD cannot be inserted while the display reads "WAIT". A beeping sound can be heard during this waiting time. Simultaneously pressing the power/volume dial and the load button (LOAD) for about 2 seconds will turn this beeping sound ON or OFF.

**Normal insertion**

1. Press the load button (**LOAD**).
2. When "In" is displayed, insert the CD.

**Inserting CDs into desired tray number**

1. Press and hold the load button (**LOAD**) for about 2 seconds until a beep is heard.
2. Press the channel preset button for the desired tray number within 3 seconds after the beep is heard.
3. When "In" is displayed, insert the CD.

**NOTE**

The CD cannot be inserted to the desired tray number if the number is already occupied.

**Multiple insertion**

1. Press and hold the load button (**LOAD**) for about 2 seconds until a beep is heard.
2. When "In" is displayed, insert the CD.
3. When "In" is displayed again, insert the next CD.

**NOTE**

The first-inserted CD will be played automatically when:

- No other CD is inserted within 15 seconds after "In" is displayed.
- The CD trays are full.

# Audio System

---

## Ejecting the CD

### Normal ejection

1. Press the CD eject button (▲). The disc number and "DISC OUT" will be displayed.
2. Pull out the CD.

<b>NOTE</b>
When the CD is ejected during play, the next CD will be played automatically.

### Ejecting CDs from desired tray number

1. Press and hold the CD eject button (▲) for about 2 seconds until a beep is heard.
2. Press the channel preset button for the desired CD number within 3 seconds after the beep is heard.
3. Pull out the CD.

### Multiple ejection

1. Press and hold the CD eject button (▲) for about 2 seconds until a beep is heard.
2. Wait 3 seconds or press the CD eject button (▲) again within 3 seconds after the beep is heard.
3. Pull out the CD, then the next CD will be ejected.

<b>NOTE</b>
<ul style="list-style-type: none"><li>• CDs will be ejected starting with the one with the lowest number.</li><li>• All CDs in the tray will be ejected continuously.</li><li>• CDs can be ejected when the ignition switch is off. Press and hold the CD eject button (▲) for about 2 seconds and all CDs will eject.</li></ul>



### Playing

Press the CD play button (CD) to start playing when a CD is in the unit.

### Fast-forward/Reverse

Press and hold the fast-forward button (▶▶) to advance through a track at high speed.

Press and hold the reverse button (◀◀) to reverse through a track at high speed.

### Track search

Press the track up button (∧) once to skip forward to the beginning of the next track.

Press the track down button (∨) once to skip back to the beginning of the current track.

### Disc search

Press the disc up button (DISC∧) to skip forward to the beginning of the next CD.

Press the disc down button (DISC∨) to skip back to the beginning of the previous CD.

**Music scan**

This feature helps to find a program by playing about the first 10 seconds of each track.

Press the scan button (**SCAN**) during play to start scan play operation (the track number will flash).

Press the scan button (**SCAN**) once again to cancel scan play.

**NOTE**

If the unit is left in scan, normal play will resume where scan was selected.

**Repeat play**

This feature makes it possible to listen to a selection repeatedly.

Press the repeat button (**RPT**) during play. The current selection will be repeated ("RPT" will be displayed).

Press the repeat button (**RPT**) once again to cancel repeat play.

**Random play**

This feature allows the CD player to randomly select the order of the songs.

Press the random button (**RDM**) during play. The next selection will be randomly selected ("RDM" will be displayed).

Press the random button (**RDM**) once again to cancel random play.

# Audio System

---

## ▼ Error Indications

If you see an error indication on the display, find the cause in the chart. If you cannot clear the error indication, take the vehicle to an Authorized Mazda Dealer.

Indication	Cause	Solution
CHECK MD	MD is inserted upside down	Insert the MD properly. If the error indication does not disappear, consult an Authorized Mazda Dealer
CHECK MD	MD is defective	Insert another MD properly. If the error indication does not disappear, consult an Authorized Mazda Dealer
CHECK CD	CD is inserted upside down	Insert the CD properly. If the error indication does not disappear, consult an Authorized Mazda Dealer
CHECK CD	CD is defective	Insert another CD properly. If the error indication does not disappear, consult an Authorized Mazda Dealer

## Audio Set (Type B)\*

(Some countries.)

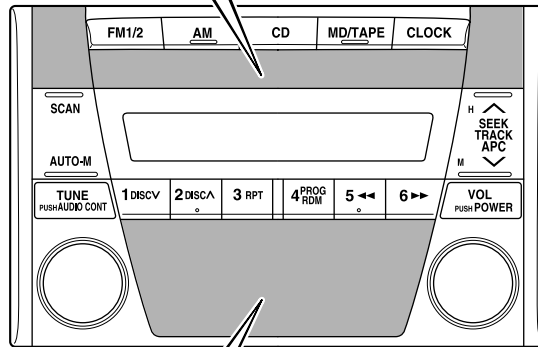
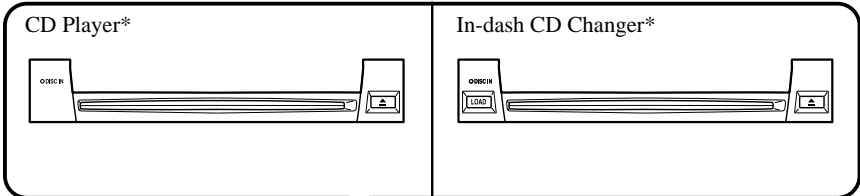
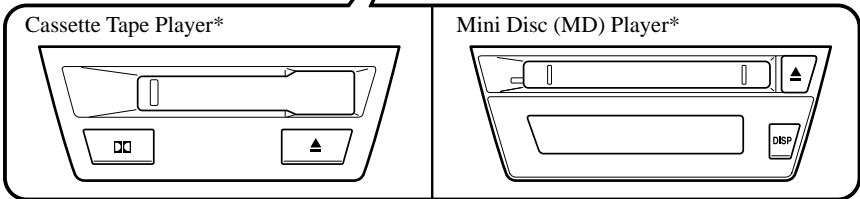

Illustration is of a representative audio unit.



Antitheft System*	6-38
Power/Volume/Sound Controls	6-42
Clock	6-44
Operating the Radio	6-46
Operating the Cassette Tape Player*	6-48
Operating the Mini Disc (MD) Player*	6-50
Operating the Compact Disc (CD) Player*	6-52
Operating the In-Dash CD Changer*	6-54
Error Indications	6-57

# Audio System

## ▼ Antitheft System\*

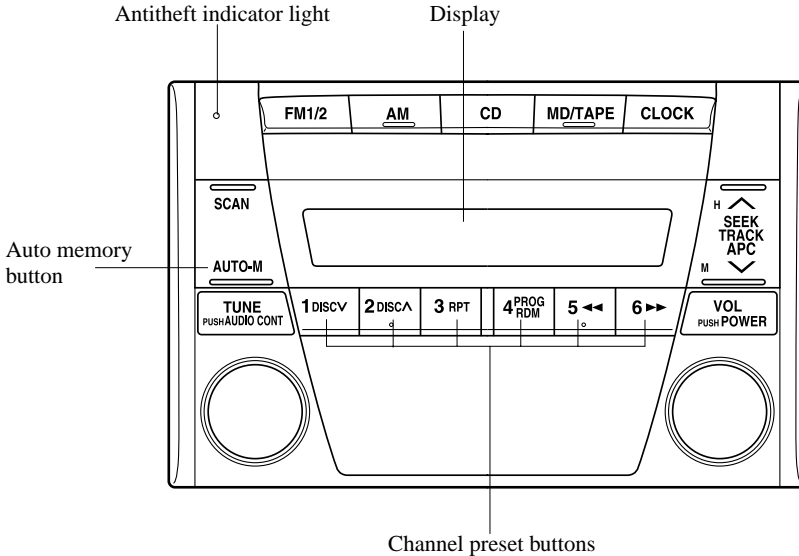

To deter theft of your vehicle's audio unit, it has an integrated antitheft system. The system is designed to accept a code number that makes the unit inoperable if it is stolen.

This system will be activated if the power source is ever disconnected from or in any way interrupted to the audio unit. When the system is activated, the audio system will not operate when reconnected to a power supply, and "CODE" will flash on the display until the correct code number is input. If the antitheft system is activated, reset the unit.

### CAUTION

Read and understand all code setting procedures before attempting to input your personal code number.

The personal code number is only shown on the audio unit display while it is being set. Once it is input and stored by the unit, it is never again displayed. For that reason, be very careful to immediately record your personal code number, and never let an unauthorized person set a code.

### NOTE

Although the audio unit is operable without the code number being set, we recommend that you set your personal code number.



## Setting procedure

1. Begin with the audio unit off and the ignition switch is in the ACC position.
2. Press the auto memory button (**AUTO-M**) and the channel preset button 6 simultaneously for about 2 seconds until "CODE" is displayed.

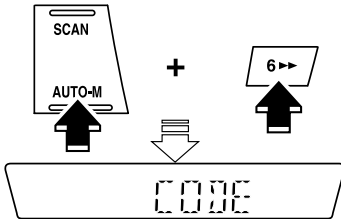

3. Again press the auto memory button (**AUTO-M**) and the channel preset button 6 simultaneously while "CODE" is displayed (within 10 seconds). The display will exhibit bars.

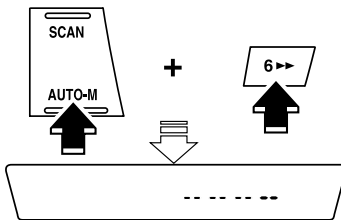

4. While the bars are displayed, input your personal code number by pressing channel preset buttons 1, 2, 3, and 4.

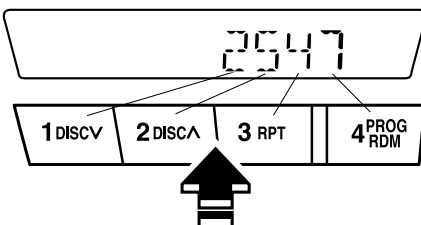

Press 1 for the first digit, 2 for the second, 3 for the third, and 4 for the last digit. For example, if your number is 2547, press 1 three times, 2 six times, 3 five times, and 4 eight times. If the display goes off while inputting, begin from Step 1.

## NOTE

We recommend that your code number be associated with something easy to remember. You should also file a copy of the code numbers with your important papers.

5. While the code number is displayed, press the auto memory button (**AUTO-M**) and the channel preset button 6 simultaneously for about 2 seconds and "CODE" begins to flash. After about 5 seconds, "CODE" will disappear. This indicates the system is set.

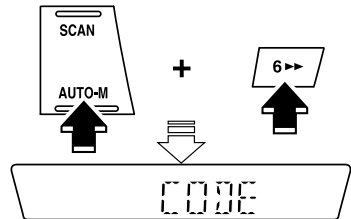

# Audio System

## Canceling code number

1. Begin with the audio unit off and the ignition switch is in the ACC position.
2. Press the auto memory button (AUTO-M) and the channel preset button 6 simultaneously for about 2 seconds until "CODE" is displayed.

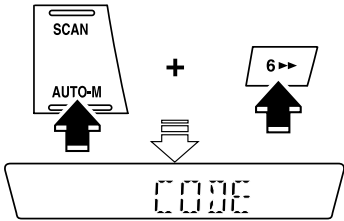

3. Again press the auto memory button (AUTO-M) and the channel preset button 6 simultaneously while "CODE" is displayed (within 10 seconds). The display will exhibit bars.

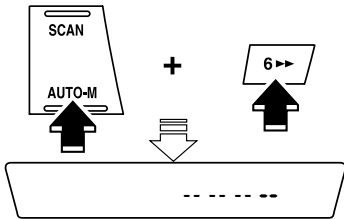

4. While the bars are displayed, input the current code number as described in setting procedure Step 4. (2547, for example).

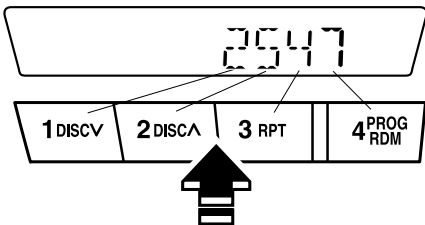

5. While the code number is displayed, press the auto memory button (AUTO-M) and the channel preset button 6 simultaneously for about 2 seconds and "CODE" appears.

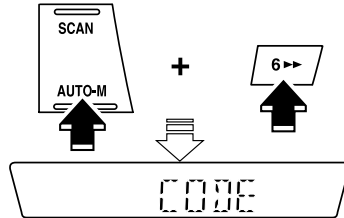

6. After 5 seconds, "CODE" will disappear. This indicates the code number is canceled.

### NOTE

If Err (error) appears on the display, begin from Step 4.

## Changing code number

To change the code number, first cancel the number. Then set the new number by following the setting procedures.

## System activation

When the power supply is disconnected or interrupted, the antitheft system is activated and the unit is rendered inoperative. In this condition, when power is again supplied, "CODE" will be displayed and flash unless the correct code number is input.

To deactivate the antitheft system and reset the audio unit, input your personal code number.

1. Press the auto memory button (**AUTO-M**) and the channel preset button 6 simultaneously until bars are displayed.

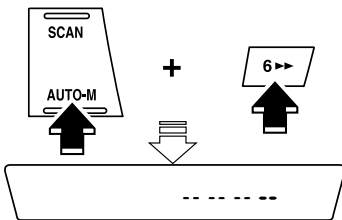

2. While the bars are displayed, input the code number as described in the setting procedure.

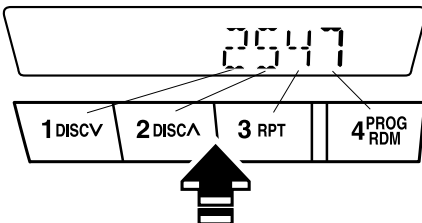

3. Press the auto memory button (**AUTO-M**) and the channel preset button 6 for about 2 seconds. "CODE" will be flashed for 5 seconds, then disappear to indicate that the system is operable. If Err (error) appears, begin from Step 1.

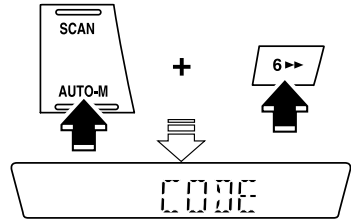

## **!** CAUTION

- Three consecutive errors will activate the antitheft system, and the audio unit will be completely inoperable and Err (error) will flash. When this happens, the unit must be replaced by an Authorized Mazda Dealer at the owner's expense.
- Do not allow an unauthorized person to attempt to input a code number.

# Audio System

## ▼ Power/Volume/Sound Controls

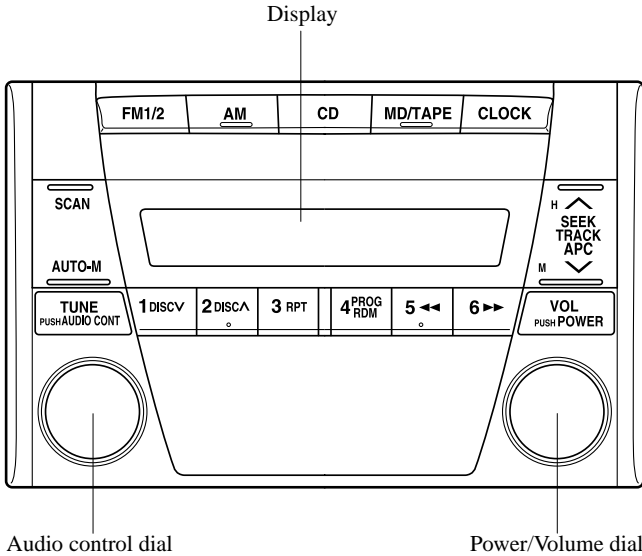

### Power ON/OFF

Turn the ignition switch to the ACC or ON position.

Press the power/volume dial to turn the audio system on.  
Press the power/volume dial again to turn the audio system off.

#### **NOTE**

To prevent the battery from being discharged, do not leave the audio system on for a long period of time when the engine is not running.

### Volume adjustment

To adjust the volume, turn the power/volume dial.

Turn the power/volume dial to the right to increase volume, to the left to decrease it.

## Audio sound adjustment

1. Press the audio control dial to select the function. The selected function will be indicated.

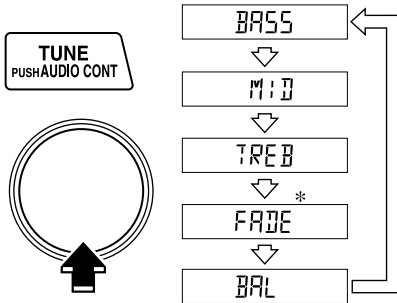

\*If your vehicle is not equipped with rear speakers, adjust the power/volume dial so level is even.

2. Turn the audio control dial to adjust the selected functions as follows:

Indication	Turn Left	Turn Right
BASS	Decrease bass	Increase bass
MID	Decrease mid-range	Increase mid-range
TREB	Decrease treble	Increase treble
FADE	Shift the sound to the front	Shift the sound to the rear
BAL	Shift the sound to the left	Shift the sound to the right

### NOTE

About 5 seconds after selecting any mode, the volume function will be automatically selected. To reset bass, mid-range, treble, fade, and balance, press the audio control dial for 2 seconds. The unit will beep and "CL" will be displayed.

# Audio System

## ▼ Clock

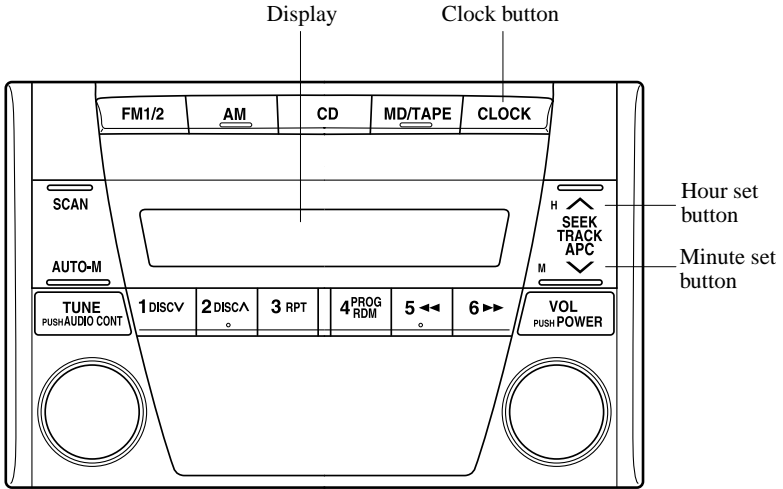

### Setting the time

The clock can be set at any time when the ignition switch is in the ACC or ON position.

1. To adjust the time, press the clock button (**CLOCK**) for about 2 seconds until a beep is heard. The clock's current time will flash.
2. To advance the hours, press the hour set button (**H**). To advance the minutes, press the minute set button (**M**) while the time is flashing.
3. Press the clock button (**CLOCK**) again to start the clock.

### Exact hour adjustment

1. To set the exact hour, press the clock button (**CLOCK**) for about 2 seconds until a beep is heard. The clock's current time will flash.
2. Press the clock button (**CLOCK**) again and the time will be adjusted as follows:  
(Example)  
12:01—12:29→12:00  
12:30—12:59→1:00

#### **NOTE**

If the power supply to the unit is interrupted (if the fuse blows or the vehicle's battery is disconnected), the clock will need to be reset.

**Changing the display mode**

The display on the unit can be changed by pressing the clock button ( **CLOCK** ). This alternates the display between time and audio. When the clock mode has been selected, the time will be displayed.

**NOTE**

If audio operation is selected while the time mode is on, the selected audio mode will be displayed for 10 seconds, then the display will revert to the time mode.

# Audio System

## ▼ Operating the Radio

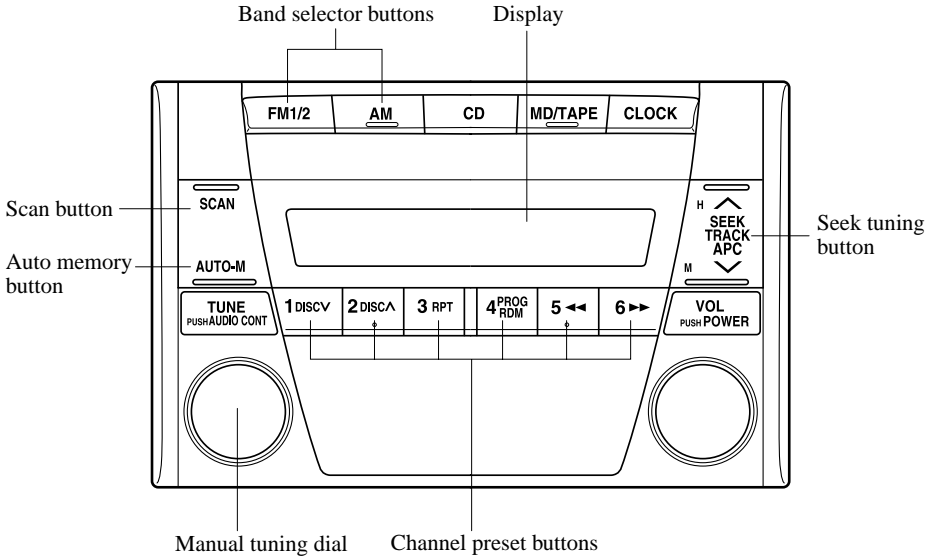

### Radio ON

Press a band selector button (**AM** or **FM1/2**) to turn the radio on.

### Band selection

Choose AM by pressing the AM button (**AM**) and FM by pressing the FM1/2 button (**FM1/2**).

The selected mode will be indicated. If FM stereo is being received, "ST" will be displayed.

#### **NOTE**

If the FM broadcast signal becomes weak, reception automatically changes from STEREO to MONO for reduced noise, and the "ST" indicator will go out.

### Tuning

The radio has the following tuning methods: Manual, Seek, Scan, Preset channel, and Auto memory tuning. The easiest way to tune stations is to set them on preset channels.

#### **NOTE**

If the power supply is interrupted (fuse blows or the battery is disconnected), the preset channels will be canceled.

### Manual tuning

Turning the manual tuning dial will change the frequency higher or lower.



**Seek tuning**

Pressing the seek tuning button (  $\wedge$  ,  $\vee$  ) will cause the tuner to seek a higher or lower frequency automatically.

**NOTE**

If you continue to press and hold the button, the frequency will continue changing without stopping.

**Scan tuning**

Press the scan button ( **SCAN** ) to automatically sample strong stations. Scanning stops at each station for about 5 seconds. To hold a station, merely press the scan button ( **SCAN** ) again during this interval.

**Preset channel tuning**

The 6 preset channels can be used to store 6 AM and 12 FM stations.

1. To set a channel first select AM, FM1, or FM2. Tune to the station you want.
2. Depress a channel preset button for about 2 seconds until a beep is heard. The preset channel number and station frequency will be displayed. The station is now held in the memory.
3. Repeat this operation for the other stations and bands you want to store. To tune one in the memory, select AM, FM1, or FM2 and then press its channel preset button. The station frequency and the channel number will be displayed.

**NOTE**

If the power supply is interrupted (fuse blows or the battery is disconnected), the preset channels will be canceled.

**Auto memory tuning**

This is especially useful when driving in an area where the local stations are not known. Additional AM/FM stations can be stored without disturbing the previously set channels.

Press and hold the auto memory button ( **AUTO-M** ) for about 2 seconds until a beep is heard; the system will automatically scan and temporarily store up to 6 stations with the strongest frequencies in each selected band in that area.

After scanning is completed, the station with the strongest frequency will be tuned and its frequency displayed.

Press and release the auto memory button ( **AUTO-M** ) to recall stations from the auto-stored stations. One stored station will be selected each time; its frequency and channel number will be displayed.

**NOTE**

If no stations can be tuned after scanning operations, "A" will be displayed.

# Audio System

## ▼ Operating the Cassette Tape Player\*

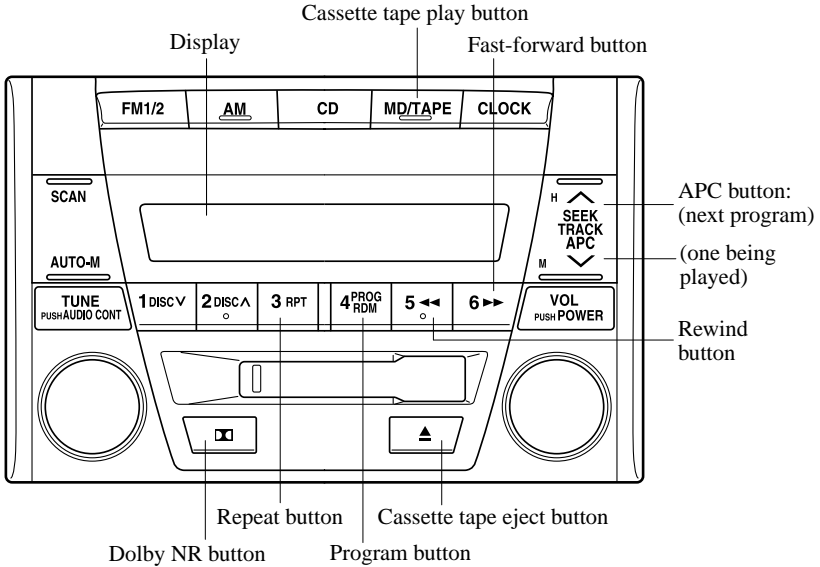

### Cassette tape insert

Insert the cassette tape into the slot, open edge to the right and cassette tape will begin play and "TAPE" will be displayed. At the end of the cassette tape, the unit automatically reverses cassette tape play. When ▲ is lit, the cassette tape's top side is playing. When ▼ is lit, the bottom side is on.

#### **NOTE**

When a metal tape is inserted, the player will automatically compensate for it and "MTL" will be displayed.

### Playing

Press the cassette tape play button (**MD/TAPE**) to start playing when a cassette tape is in the unit. If there isn't a cassette tape in the unit when the cassette tape play button (**MD/TAPE**) is pressed, "NO TAPE" will flash on and off in sequence.

### Dolby noise reduction

When using a tape with Dolby NR\*, push the Dolby NR button (■). The ■ symbol will be displayed. To play a tape without Dolby NR, push the button once again.

\* Noise reduction system manufactured under license from Dolby Laboratories Licensing Corporation. Dolby and the double-D symbol ■ are trademarks of Dolby Laboratories Licensing Corporation.

**Ejecting the cassette tape**

Press the cassette tape eject button (▲) to eject the cassette tape.

**NOTE**

The cassette tape can be ejected when the ignition switch is in the OFF position.

**Fast-forward/Rewind**

Press the fast-forward button (▶▶) to fast-forward.

Press the rewind button (◀◀) to rewind. To stop this operation and play the cassette tape, press the button again.

**NOTE**

When the cassette tape ends during fast-forward or rewind, it automatically stops and starts playing.

**Reversing**

Press the program button (PROG) to change cassette tape-playing direction.

**NOTE**

When the cassette tape ends, the unit automatically reverses play.

**Automatic program control (APC)**

APC is used to find the beginning of either the next program or the one being played.

Press the APC button (∧) to the beginning of the next selection. Press the APC button (∨) to the beginning of the one being played. To stop this operation and play the cassette tape, press the button again.

If APC detects 4 seconds of blank space it will automatically advance the tape to the next selection.

**NOTE**

APC may not operate properly if

- A tape was recorded at a low level.
- A tape has long, silent intervals.
- A tape is a live recording.
- A tape has very short intervals of less than 3 seconds.

**Repeat play**

This operation makes it possible to listen to a selection repeatedly.

Press the repeat button (RPT) during play. The current selection playing will be repeated ("RPT" will be displayed). Press the repeat button (RPT) once again to cancel repeat play.

**NOTE**

RPT may not operate properly if

- A tape was recorded at a low level.
- A tape has long, silent intervals.
- A tape is a live recording.
- A tape has very short intervals of less than 3 seconds.

# Audio System

## ▼ Operating the Mini Disc (MD) Player\*

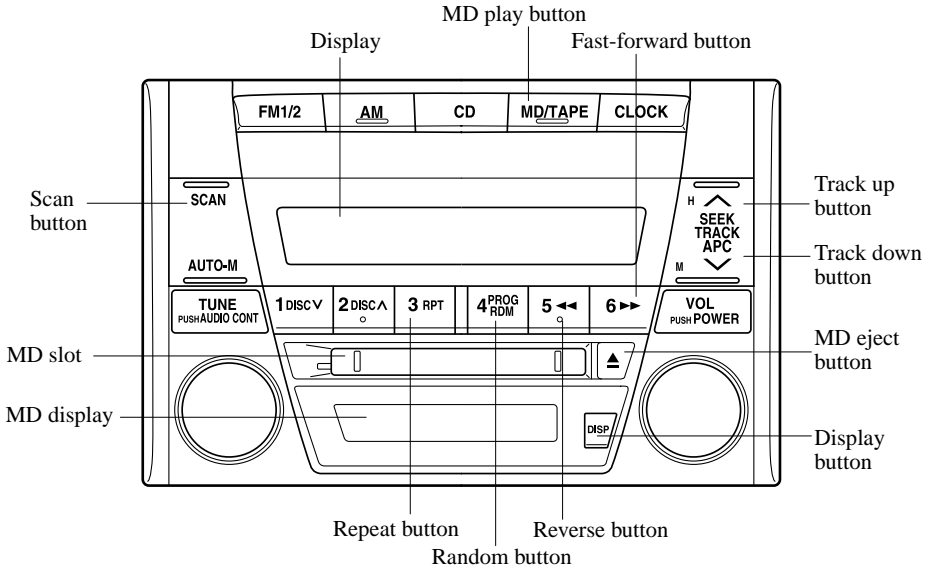

### Inserting the MD

Insert the MD, label-side up with the arrow pointed to the slot. The auto-loading mechanism will set the MD and begin play. There will be a short lapse before play begins while the player reads the digital signals on the MD.

### Playing

Press the MD play button (**MD/TAPE**) to start playing when a MD is in the unit.

### Ejecting the MD

Press the MD eject button (**▲**) to eject the MD.

### Fast-forward/Reverse

Press and hold the fast-forward button (**►►**) to advance through a track at high speed.

Press and hold the reverse button (**◀◀**) to reverse through a track at high speed.

### Track search

Press the track up button (**^**) once to skip forward to the beginning of the next track.

Press the track down button (**v**) once to skip back to the beginning of the current track.

**Music scan**

This feature helps to find a program by playing about the first 10 seconds of each track.

Press the scan button (**SCAN**) during play to start scan play operation (the track number will flash).

Press the scan button (**SCAN**) once again to cancel scan play.

**NOTE**

If the unit is left in scan, normal play will resume where scan was selected.

**Repeat play**

This feature makes it possible to listen to a selection repeatedly.

Press the repeat button (**RPT**) during play. The current selection will be repeated ("RPT" will be displayed).

Press the repeat button (**RPT**) once again to cancel repeat play.

**Random play**

This feature allows the MD player to randomly select the order of the songs.

Press the random button (**RDM**) during play. The next selection will be randomly selected ("RDM" will be displayed).

Press the random button (**RDM**) once again to cancel random play.

**Changing the MD display**

To change the MD display during MD play, press and hold the display button (**DISP**) for about half a second to advance through each of the following displays: Song title→Disc title→No display.

**NOTE**

If there is no song or disc title recorded on the MD, "NO TITLE" will be displayed.

When disc or song titles cannot be completely displayed, press the display button (**DISP**) to display the remaining part of the title.

# Audio System

## ▼ Operating the Compact Disc (CD) Player\*

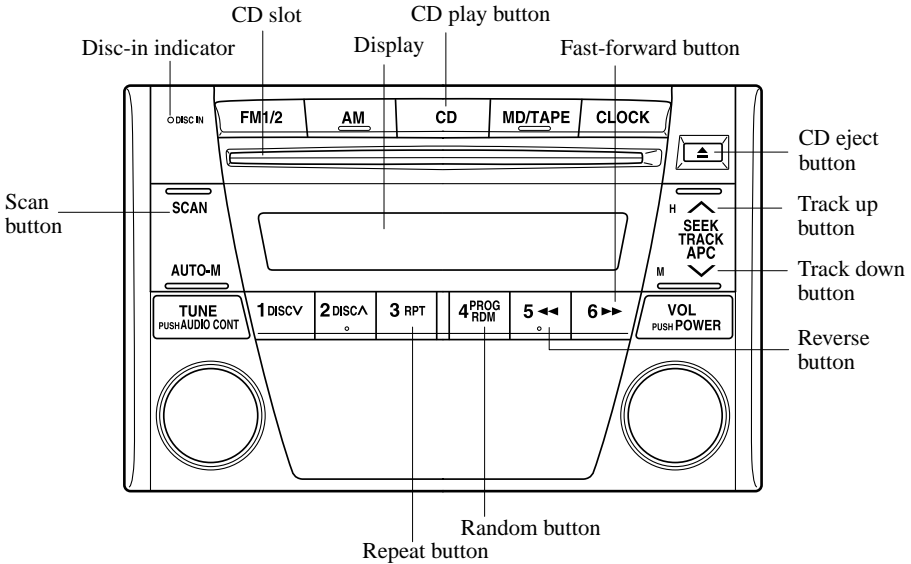

### Inserting the CD

Insert the CD into the slot, label-side up. The auto-loading mechanism will set the CD and begin play. There will be a short lapse before play begins while the player reads the digital signals on the CD. The disc-in indicator will illuminate and the track number will be displayed.

### Playing

Press the CD play button (CD) to start playing when a CD is in the unit.

### Ejecting the CD

Press the CD eject button (▲) to eject the CD.

### Fast-forward/Reverse

Press and hold the fast-forward button (►►) to advance through a track at high speed.

Press and hold the reverse button (◀◀) to reverse through a track at high speed.

### Track search

Press the track up button (∧) once to skip forward to the beginning of the next track.

Press the track down button (∨) once to skip back to the beginning of the current track.

**Music scan**

This feature helps to find a program by playing about the first 10 seconds of each track.

Press the scan button (**SCAN**) during play to start scan play operation (the track number will flash).

Press the scan button (**SCAN**) once again to cancel scan play.

**NOTE**

If the unit is left in scan, normal play will resume where scan was selected.

**Repeat play**

This feature makes it possible to listen to a selection repeatedly.

Press the repeat button (**RPT**) during play. The current selection will be repeated ("RPT" will be displayed).

Press the repeat button (**RPT**) once again to cancel repeat play.

**Random play**

This feature allows the CD player to randomly select the order of the songs.

Press the random button (**RDM**) during play. The next selection will be randomly selected ("RDM" will be displayed).

Press the random button (**RDM**) once again to cancel random play.

# Audio System

## ▼ Operating the In-Dash CD Changer\*

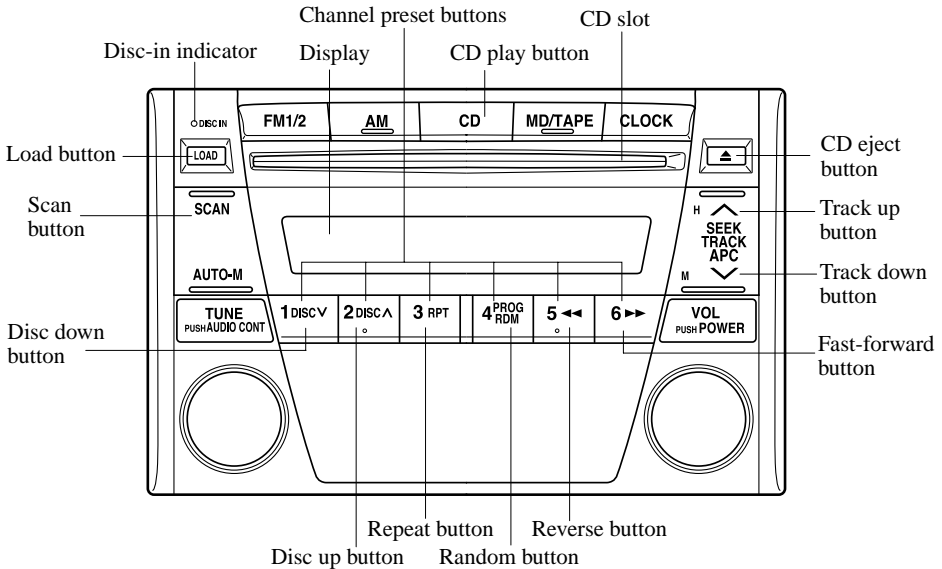

### Inserting the CD

The CD must be label-side up when inserting. The auto-loading mechanism will set the CD and begin play. There will be a short lapse before play begins while the player reads the digital signals on the CD.

The disc number and the track number will be displayed.

#### **NOTE**

A CD cannot be inserted while the display reads "WAIT". A beeping sound can be heard during this waiting time. Simultaneously pressing the power/volume dial and the load button (LOAD) for about 2 seconds will turn this beeping sound ON or OFF.

### **Normal insertion**

1. Press the load button (LOAD).
2. When "In" is displayed, insert the CD.

### **Inserting CDs into desired tray number**

1. Press and hold the load button (LOAD) for about 2 seconds until a beep is heard.
2. Press the channel preset button for the desired tray number within 3 seconds after the beep is heard.
3. When "In" is displayed, insert the CD.

#### **NOTE**

The CD cannot be inserted to the desired tray number if the number is already occupied.



**Multiple insertion**

1. Press and hold the load button (**LOAD**) for about 2 seconds until a beep is heard.
2. When "In" is displayed, insert the CD.
3. When "In" is displayed again, insert the next CD.

**NOTE**

The first-inserted CD will be played automatically when:

- No other CD is inserted within 15 seconds after "In" is displayed.
- The CD trays are full.

**Ejecting the CD****Normal ejection**

1. Press the CD eject button (**▲**). The disc number and "OUT" will be displayed.
2. Pull out the CD.

**NOTE**

When the CD is ejected during play, the next CD will be played automatically.

**Ejecting CDs from desired tray number**

1. Press and hold the CD eject button (**▲**) for about 2 seconds until a beep is heard.
2. Press the channel preset button for the desired CD number within 3 seconds after the beep is heard.
3. Pull out the CD.

**Multiple ejection**

1. Press and hold the CD eject button (**▲**) for about 2 seconds until a beep is heard.
2. Wait 3 seconds or press the CD eject button (**▲**) again within 3 seconds after the beep is heard.
3. Pull out the CD, then the next CD will be ejected.

**NOTE**

- CDs will be ejected starting with the one with the lowest number.
- All CDs in the tray will be ejected continuously.
- CDs can be ejected when the ignition switch is off. Press and hold the CD eject button (**▲**) for about 2 seconds and all CDs will eject.

**Playing**

Press the CD play button (**CD**) to start playing when a CD is in the unit.

**Fast-forward/Reverse**

Press and hold the fast-forward button (**▶▶**) to advance through a track at high speed.

Press and hold the reverse button (**◀◀**) to reverse through a track at high speed.

**Track search**

Press the track up button (**∧**) once to skip forward to the beginning of the next track.

Press the track down button (**∨**) once to skip back to the beginning of the current track.

# Audio System

---

## Disc search

Press the disc up button ( **DISCA** ) to skip forward to the beginning of the next CD. Press the disc down button ( **DISCV** ) to skip back to the beginning of the previous CD.

## Music scan

This feature helps to find a program by playing about the first 10 seconds of each track.

Press the scan button ( **SCAN** ) during play to start scan play operation (the track number will flash).

Press the scan button ( **SCAN** ) once again to cancel scan play.

<b>NOTE</b>
If the unit is left in scan, normal play will resume where scan was selected.

## Repeat play

This feature makes it possible to listen to a selection repeatedly.

Press the repeat button ( **RPT** ) during play. The current selection will be repeated ("RPT" will be displayed).

Press the repeat button ( **RPT** ) once again to cancel repeat play.

## Random play

This feature allows the CD player to randomly select the order of the songs.

Press the random button ( **RDM** ) during play. The next selection will be randomly selected ("RDM" will be displayed).

Press the random button ( **RDM** ) once again to cancel random play.

**▼ Error Indications**

If you see an error indication on the display, find the cause in the chart. If you cannot clear the error indication, take the vehicle to an Authorized Mazda Dealer.

Indication	Cause	Solution
CHECK MD	MD is inserted upside down	Insert the MD properly. If the error indication does not disappear, consult an Authorized Mazda Dealer
CHECK MD	MD is defective	Insert another MD properly. If the error indication does not disappear, consult an Authorized Mazda Dealer
CHECK CD	CD is inserted upside down	Insert the CD properly. If the error indication does not disappear, consult an Authorized Mazda Dealer
CHECK CD	CD is defective	Insert another CD properly. If the error indication does not disappear, consult an Authorized Mazda Dealer

# Audio System

---

## Safety Certification

This CD player is made and tested to meet exacting safety standards. It meets FCC requirements and complies with safety performance standards of the U.S. Department of Health and Human Services.

### CAUTION

- This CD player should not be adjusted or repaired by anyone except qualified service personnel.  
If servicing is required, contact an Authorized Mazda Dealer.
- Use of controls or adjustments or performance of procedures other than those specified herein may result in hazardous laser exposure. Never operate the CD player with the top case of the unit removed.
- Changes or modifications not expressly approved by the party responsible for compliance could void the user's authority to operate this equipment.

### NOTE

For CD player section:

This device complies with part 15 of the FCC Rules. Operation is subject to the following two conditions: (1) This device may not cause harmful interference, and (2) this device must accept any interference received, including interference that may cause undesired operation.

### NOTE

This equipment has been tested and found to comply with the limits for a Class B digital device, pursuant to part 15 of the FCC Rules. These limits are designed to provide reasonable protection against harmful interference in a residential installation. This equipment generates, uses, and can radiate radio frequency energy and, if not installed and used in accordance with the instructions, may cause harmful interference to radio communications. However, there is no guarantee that interference will not occur in a particular installation.

## Sunvisors

When you need a sunvisor, lower it for use in front or swing it to the side.

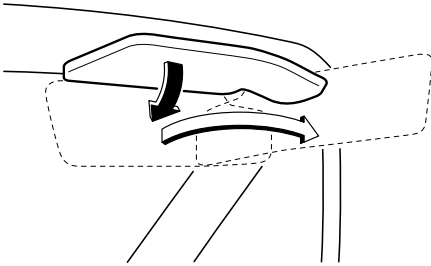

## ▼ Vanity Mirror

To use the vanity mirror, lower the sunvisor.

## Interior Light

### ▼ Overhead Light

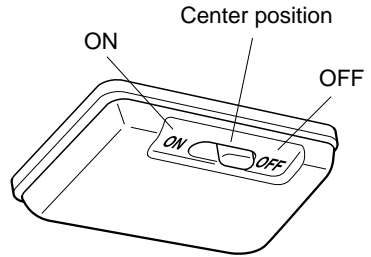

OFF	Light off
Center	Light on when any door is open
ON	Light on

# Interior Equipment

## Lighter

The ignition switch must be in the ACC or ON position.

Press the lighter in and release it. When ready for use, it automatically pops out.

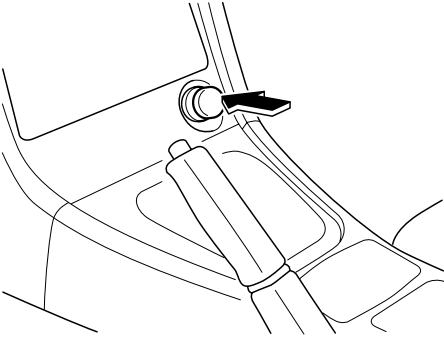

### ⚠ CAUTION

- Don't touch the metal part of the lighter, you may burn yourself.
- Don't hold the lighter in because it will overheat.
- Don't use the lighter socket for plug-in accessories such as shavers and coffee pots. They may damage it or cause electrical failure. Use only a genuine Mazda lighter or the equivalent.
- If the lighter doesn't pop out within 30 seconds, remove it to prevent overheating.

## Ashtray

### ⚠ CAUTION

Don't use the ashtray for trash. You might start a fire.

To remove, open and pull up the ashtray.

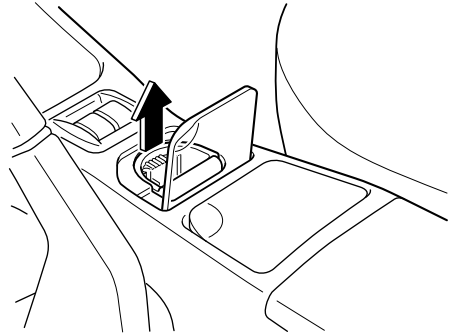

## Cup Holder

### **⚠ WARNING**

#### Using Cup Holder:

*Using a cup holder to hold hot liquids while the vehicle is moving is dangerous. If the contents spill, you could be scalded. Never use a cup holder to hold hot liquids while the vehicle is moving.*

#### Don't Put Anything Other Than Cups or Drink-cans in Cup Holder:

*Putting objects other than cups or drink-cans in a cup holder is dangerous.*

*During sudden braking or maneuvering, occupants could be hit and injured, or objects could be thrown around the vehicle, causing interference with the driver and the possibility of an accident. Only use a cup holder for cups or drink-cans.*

#### Using Cup Holder as Ashtray:

*Using a cup holder as an ashtray is dangerous because it could cause a fire or damage the cup holder. Be sure the removable ashtray is in place before smoking and never use the cup holder as an ashtray.*

### **⚠ CAUTION**

To reduce the possibility of injury in an accident or a sudden stop, keep cup holders closed when not in use.

### **NOTE**

Replacement ashtrays are available from an Authorized Mazda Dealer if they are missing.

To use, open the cover.

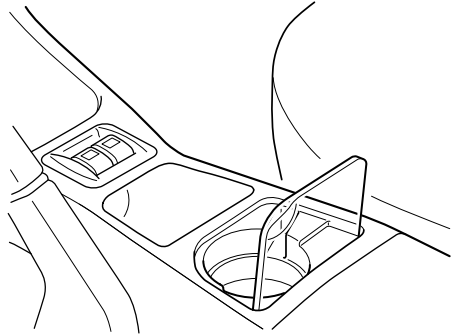

### **⚠ CAUTION**

If your arm or elbow bumps into the cup while shifting, don't use the hole for an additional cup holder.

### **NOTE**

The ashtray can be used as an additional cup holder with the ashtray removed.

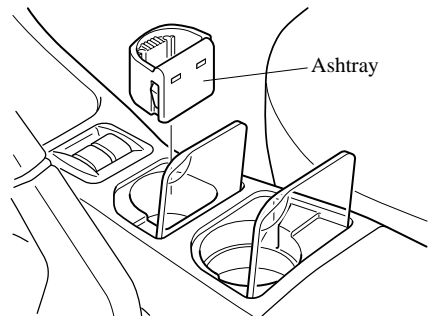

# Interior Equipment

## Storage Compartments

### **WARNING**

**Open Storage Boxes:**  
*Driving with the storage boxes open is dangerous. To reduce the possibility of injury in an accident or a sudden stop, keep the storage boxes closed when driving.*

### **CAUTION**

Don't leave eyeglasses or lighters in the storage boxes while parked under the sun. A lighter could explode or the plastic material in eyeglasses could deform and crack from high temperature.

## ▼ Glove Box

To open the glove box, pull the latch toward you.  
Insert the key and turn it clockwise to lock, counterclockwise to unlock.

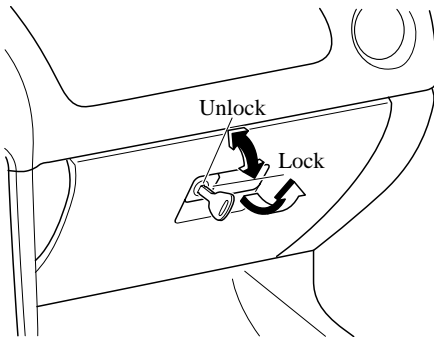

## ▼ Center Console

To open, pull the release catch.

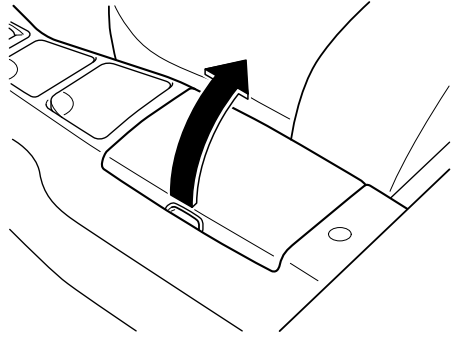

The center console has a lockable lid, insert the key into the slot; then turn the key clockwise to lock, counterclockwise to unlock.

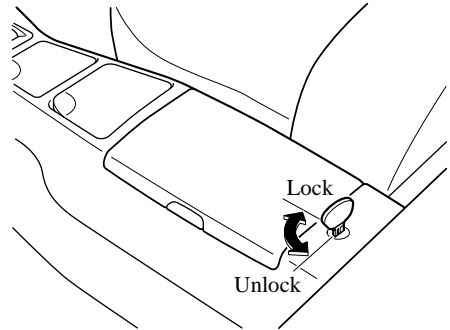



## ▼ Mesh Pocket\*

Maps or pamphlets can be placed in the mesh pocket.

Pull up the fastener to release it.

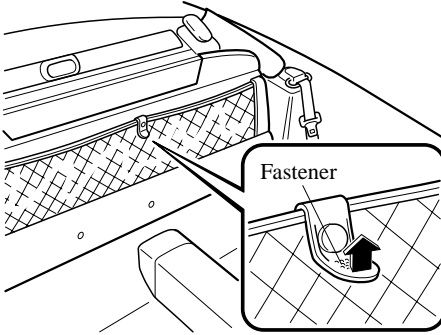

### ⚠ CAUTION

Make sure the fastener is securely fastened when the top is open; otherwise, objects placed in the mesh pocket could be blown away by the wind.

## Windblocker\*

This windblocker prevents the wind from coming into the cabin from behind when driving with the top opened.

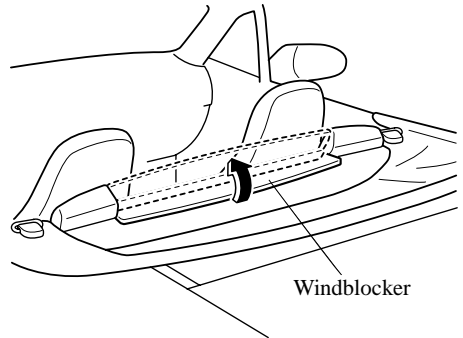



Helpful information on what to do in an emergency.

<b>Parking in an Emergency</b> .....	7-2
Parking in an Emergency .....	7-2
<b>Flat Tire</b> .....	7-3
Spare Tire and Tool Storage .....	7-3
Changing a Flat Tire .....	7-5
<b>Overheating</b> .....	7-11
Overheating .....	7-11
<b>Emergency Starting</b> .....	7-13
Starting a Flooded Engine .....	7-13
Jump-Starting .....	7-13
Push-Starting .....	7-15
<b>Emergency Towing</b> .....	7-16
Towing Description .....	7-16
Tiedown Hooks .....	7-17
Recreational Towing .....	7-17

# Parking in an Emergency

---

## Parking in an Emergency

The hazard warning lights should always be used when you stop on or near a roadway.

The hazard warning lights warn other drivers that your vehicle is a traffic hazard and that they must take extreme caution when near it.

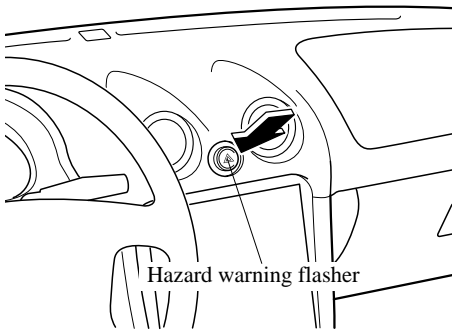

Depress the hazard warning flasher and all four turn signals will flash.

<b>NOTE</b>
<ul style="list-style-type: none"><li>• The turn signals don't work when the hazard warning lights are on.</li><li>• Check local regulations about the use of hazard warning lights while the vehicle is being towed. They may forbid it.</li></ul>

## Spare Tire and Tool Storage

Spare tire and tools are stored in the locations illustrated in the diagram.

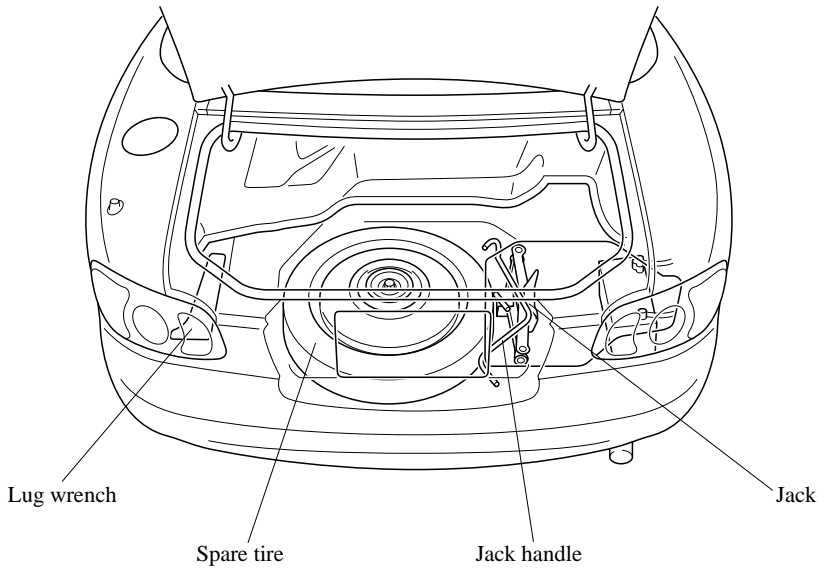

# Flat Tire

## ▼ Jack

### To remove the jack

Turn the wing bolt counterclockwise.

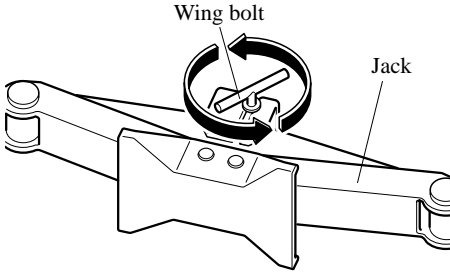

### To secure the jack

Perform the removal procedure in reverse.

## ▼ Spare Tire

Your Mazda has a temporary spare tire. The temporary spare tire is lighter and smaller than a conventional tire, and is designed only for emergency use and should be used only for VERY short periods. Temporary spares should NEVER be used for long drives or extended periods.

## ⚠ WARNING

### Driving with a Temporary Spare Tire on Ice or Snow:

*Driving with a spare tire on the rear (driving) wheels on ice or snow is dangerous. Handling will be affected. You could lose control of the vehicle and have an accident. Put the spare tire on the front axle and move a regular tire to the rear.*

## ⚠ CAUTION

To avoid damage to the temporary spare or to the vehicle, observe the following precautions:

- Don't exceed 80 km/h (50 mph).
- Avoid driving over obstacles. Also, don't drive through an automatic car wash. This tire's diameter is smaller than a conventional tire's, so the ground clearance is reduced about 25 mm (1 in).
- Don't use a tire chain on this tire because it won't fit properly.
- Don't use your temporary spare on any other vehicle; it has been designed only for your Mazda.
- Use only one temporary spare tire on your vehicle at the same time.

### **(With limited slip differential)**

When using the temporary spare tire on the rear axle, replace it with a standard tire as soon as possible. The size difference between the spare and the standard tire will cause the limited slip differential to malfunction.

**To remove the spare tire**

Turn the tire hold-down bolt counterclockwise with the lug wrench.

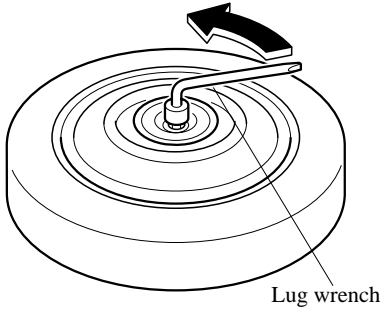
**Changing a Flat Tire****NOTE**

If the following occurs while driving, it could indicate a flat tire.

- Steering becomes difficult.
- The vehicle begins to vibrate excessively.
- The vehicle pulls in one direction.

If you have a flat tire, drive slowly to a level spot that is well off the road and out of the way of traffic to change the tire. Stopping in traffic or on the shoulder of a busy road is dangerous.

**⚠ WARNING****Jacking a Vehicle:**

*Changing a tire is dangerous if not done properly. The vehicle can slip off the jack and seriously injure someone.*

*Be sure to follow the directions for changing a tire, and never get under a vehicle that is supported only by a jack.*

**Passenger in Vehicle Supported by a Jack:**

*Allowing someone to remain in a vehicle supported by a jack is dangerous. The occupant could cause the vehicle to fall resulting in serious injury. Never allow anyone inside a vehicle supported by a jack.*

# Flat Tire

## NOTE

Make sure the jack is well lubricated before using it.

1. Park on a level surface off the right-of-way and firmly set the parking brake.
2. Put a vehicle with an automatic transmission in Park (P), a manual transmission in Reverse (R) or 1, and turn off the engine.
3. Turn on the hazard warning flasher.
4. Have everyone get out of the vehicle and away from the vehicle and traffic.
5. Remove the jack, tool, and spare tire (page 7-3).
6. Block the wheel diagonally opposite the flat tire. When blocking a wheel, place a block both in front and behind the tire.

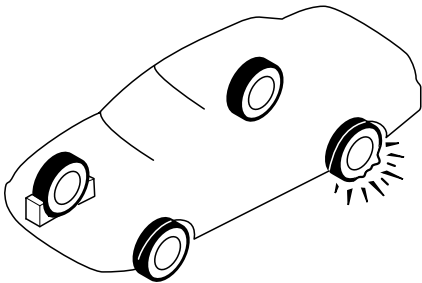

## NOTE

When blocking a tire, use rocks or wood blocks of sufficient size to hold the tire in place.

## ▼ Removing a Flat Tire

1. Loosen the lug nuts by turning them counterclockwise one turn each, but don't remove any lug nuts until the tire has been raised off the ground.

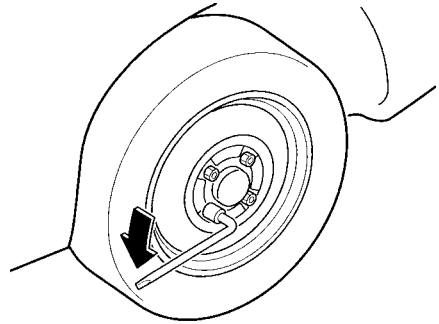

2. Place the jack under the jacking position closest to the tire being changed.

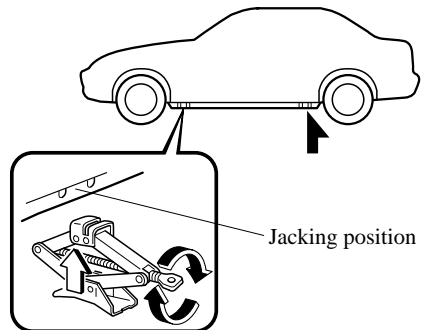



**⚠ WARNING**

**Incorrect Jacking Position:**  
*Attempting to jack the vehicle in positions other than those recommended in this manual is dangerous. The vehicle could slip off the jack and seriously injure or even kill someone. Use only the front and rear jacking positions recommended in this manual.*

**Improper Jack:**  
*Using a jack that isn't designed for your Mazda is dangerous. The vehicle could slip off the jack and seriously injure someone. Use only the jack provided with your Mazda.*

**Placing Objects Under the Jack:**  
*Jacking the vehicle with an object under the jack is dangerous. The jack could slip and someone could be seriously injured by the jack or the falling vehicle. Never place objects under the jack.*

3. Insert the jack handle into the jack.

4. Turn the jack handle clockwise and raise the vehicle high enough so that the spare tire can be installed. Before removing the lug nuts, make sure your Mazda is firmly in position and that it cannot slip or move.

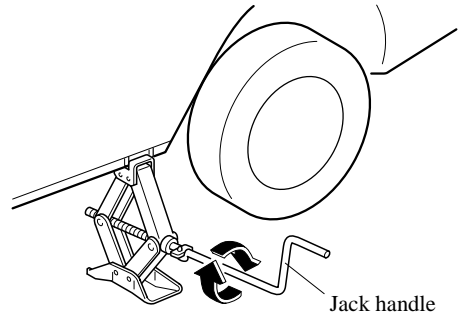

5. Remove the lug nuts by turning them counterclockwise; then remove the wheel.

# Flat Tire

## ▼ Locking Lug Nuts\*

If your vehicle has optional antitheft wheel lug nuts, one on each wheel will lock the tires and you must use a special key to unlock them. This key is attached to the lug wrench and is stored with the spare tire. Register them with the lock manufacturer by filling out the card provided in the glove box and mailing it in the accompanying envelope. If you lose your key, consult an Authorized Mazda Dealer or use the lock manufacturer's order form, which is with the registration card.

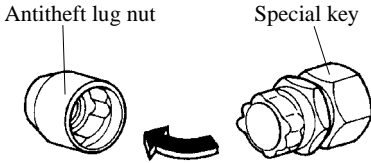

### **To remove an antitheft lug nut**

1. Get the key for the locking lug nut.
2. Place it on top of the nut, and be sure to hold the key square to it. If you hold the key at an angle, you may damage both key and nut. Don't use a power impact wrench.
3. Place the lug wrench on top of the key and apply pressure. Turn the wrench counterclockwise.

### **To replace the nut**

1. Place the key on top of the nut.
2. Place the lug wrench on top of the key, apply pressure, and turn it clockwise.

## ▼ Mounting the Spare Tire

1. Remove dirt and grime from the mounting surfaces of the wheel and hub, including the hub bolts, with a cloth.

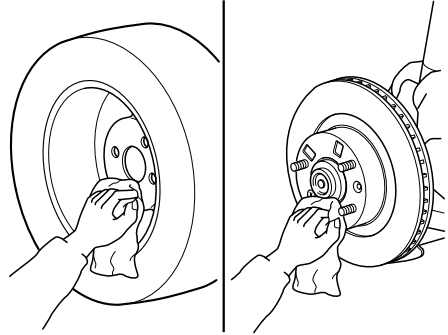

### **! WARNING**

#### **Removing Dirt and Grime from Wheels, Hubs and Hub Bolts:**

*When changing or replacing a tire, not removing dirt and grime from the mounting surfaces of the wheel, hub and hub bolts is dangerous. The lug nuts could loosen while driving and cause the tire to come off, resulting in an accident. Make sure the mounting surfaces of the wheel, hub and lug nuts are clean before changing or replacing tires.*

2. Mount the spare tire.

# Flat Tire

3. Install the lug nuts with the beveled edge inward; tighten them by hand.

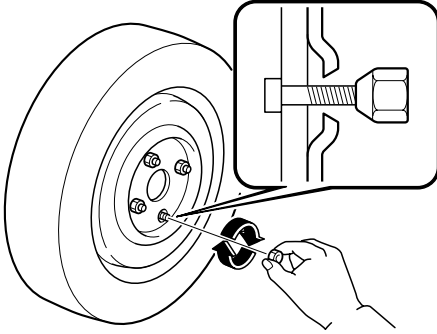

## **⚠ WARNING**

### **Don't Apply Oil or Grease to Lug Nuts, Bolts:**

*Applying oil or grease to lug nuts and bolts is dangerous. The lug nuts could loosen while driving and cause the tire to come off, resulting in an accident. In addition, lug nuts and bolts could be damaged if tightened more than necessary. Do not apply oil or grease to lug nuts and bolts and do not tighten the lug nuts beyond the recommended tightening torque.*

4. Turn the jack handle counterclockwise and lower the vehicle. Use the lug wrench to tighten the nuts in the order shown.

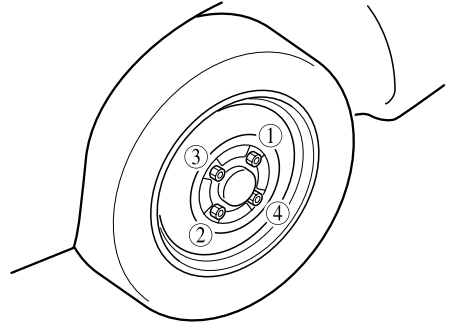

If you're unsure of how tight the nuts should be, have them inspected at an Authorized Mazda Dealer.

### **Nut tightening torque:**

N·m (kgf·m, ft·lbf)	88—118 (9—12, 65—87)
---------------------	----------------------

# Flat Tire

---

 **WARNING**

**Loose Lug Nuts:**

*Improperly or loosely tightened lug nuts are dangerous. The wheel could wobble or come off. This could result in loss of vehicle control and cause a serious accident. Always securely and correctly tighten the lug nuts.*

**Metric Studs and Lug Nuts:**

*Because the wheel studs and lug nuts on your Mazda have metric threads, using a non-metric nut is dangerous. On a metric stud, it would not secure the wheel and would damage the stud, which could cause the wheel to slip off and cause an accident. Be sure to reinstall the same nuts you removed or replace them with metric nuts of the same configuration.*

**Incorrect Tire Air Pressure:**

*Driving on tires with incorrect air pressure is dangerous. Tires with incorrect pressure could affect handling and result in an accident. Don't drive with any tires that have incorrect air pressure. When you check the regular tires' air pressure, check the spare tire, too.*

5. Store the damaged tire in the trunk.  
Have the damaged tire repaired as soon as possible.

**NOTE**

To prevent the jack and tool from rattling, store them properly.

**Overheating**

If the temperature gauge indicates overheating, the vehicle loses power, or you hear a loud knocking or pinging noise, the engine is probably too hot.

**⚠ WARNING****Cooling Fan and Engine****Inspection:**

*Inspecting the engine with the ignition switch in the ON position is dangerous. The cooling fan could turn on unexpectedly even when the engine isn't running. You could be seriously injured by the fan. Turn the ignition switch off and remove the key from the ignition switch when you inspect the engine.*

**Cooling System Cap:**

*When the engine and radiator are hot, scalding coolant and steam may shoot out under pressure and cause serious injury. Don't remove the cooling system cap when the engine and radiator are hot.*

**Steam from Overheated Engine:**

*Steam from an overheated engine is dangerous. The escaping steam could seriously burn you. Open the hood ONLY after steam is no longer escaping from the engine.*

If the temperature gauge indicates overheating:

1. Drive safely to the side of the road and park off the right-of-way.
2. Put a vehicle with an automatic transmission in park (P), a manual transmission in neutral. Apply the parking brake.
3. Turn off the air conditioner.
4. Check whether coolant or steam is escaping from under the hood or from the engine compartment.

**If steam is coming from the engine compartment:**

Don't go near the front of the vehicle. Stop the engine. Wait until the steam dissipates, then open the hood and start the engine.

**If neither coolant nor steam is escaping:**

Open the hood and idle the engine until it cools.

**⚠ CAUTION**

If the cooling fan does not operate while the engine is running, the engine temperature will increase. Stop the engine and call an Authorized Mazda Dealer.

5. Make sure the cooling fan is operating, then turn off the engine after the temperature has decreased.

# Overheating

---

6. When cool, check the coolant level.  
If it's low, look for coolant leaks from the radiator and hoses.

**If you find a leak or other damage, or if coolant is still leaking:**

Stop the engine and call an Authorized Mazda Dealer.

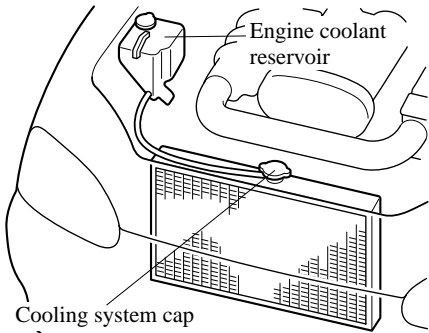

**If you find no problems, the engine is cool, and no leaks are obvious:**

Carefully add coolant as required (page 8-15).

**⚠ CAUTION**

If the engine continues to overheat or frequently overheats, have the cooling system inspected. The engine could be seriously damaged unless repairs are made. Consult an Authorized Mazda Dealer.

## Emergency Starting

### Starting a Flooded Engine

If the engine fails to start, it may be flooded (excessive fuel in the engine).

Follow this procedure:

1. Depress the accelerator all the way and hold it there.
2. Turn the ignition switch to the START position and hold it there—for up to 10 seconds. If the engine starts, release the key and accelerator immediately because the engine will suddenly rev up.
3. If the engine fails to start, crank it without depressing the accelerator—for up to 10 seconds.

### Jump-Starting

The battery is in the trunk. Jump-starting is dangerous if done incorrectly. So follow the procedure carefully. If you feel unsure about jump-starting, we strongly recommend that you have a competent service technician do the work.

#### **WARNING**

**Battery-Related Explosion:**  
*Flames and sparks near open battery cells are dangerous. Hydrogen gas, produced during normal battery operation, could ignite and cause the battery to explode. An exploding battery can cause serious burns and injuries. Keep all flames, including cigarettes, and sparks away from open battery cells.*

**Frozen Battery:**  
*Jump-starting a frozen battery is dangerous. It may rupture or explode, causing serious injury. Don't jump-start a frozen battery.*

#### **CAUTION**

Use only a 12 V booster system. You can damage a 12 V starter, ignition system, and other electrical parts beyond repair with a 24 V power supply (two 12 V batteries in series or a 24 V motor generator set).

# Emergency Starting

1. Make sure the booster battery is 12 V and that its negative terminal is grounded.
2. If the booster battery is in another vehicle, don't allow the vehicles to touch. Turn off the engine of the vehicle with the booster battery and all unnecessary electrical loads in both vehicles.
3. Connect the jumper cables in the exact sequence as in the illustration.
  - Connect one end of a cable to the positive terminal on the discharged battery (1).
  - Attach the other end to the positive terminal on the booster battery (2).
  - Connect one end of the other cable to the negative terminal of the booster battery (3).
  - Connect the other end to a solid, stationary, exposed metallic point (for example, the trunk latch catch) away from the discharged battery (4).

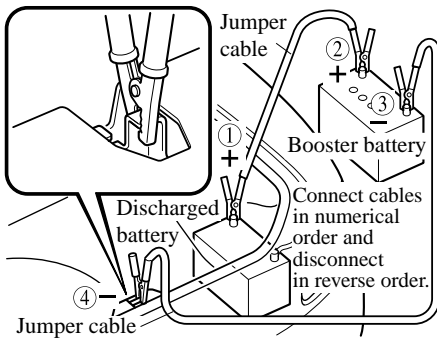

## **WARNING**

**Connecting to Negative Terminal:**  
***Connecting the end of the second cable to the negative ( - ) terminal of the discharged battery is dangerous. A spark could cause the gas around the battery to explode and injure someone. Connect the cable to a point away from the battery.***

4. Start the engine of the booster vehicle and run it a few minutes. Then start the engine of the other vehicle.
5. When finished, carefully disconnect the cables in the reverse order described in Step3.



## Push-Starting

### **WARNING**

**Towing a Vehicle to Start It:**  
*Towing a vehicle to start it is dangerous. The vehicle being towed could surge forward when its engine starts, causing the two vehicles to collide. The occupants could be injured. Never tow a vehicle to start it.*

You can't start a vehicle with an automatic transmission by pushing it.

### **CAUTION**

You shouldn't push-start a vehicle that has a manual transmission. It can damage the emission control system.

# Emergency Towing

## Towing Description

We recommend that towing be done only by an Authorized Mazda Dealer or a commercial tow-truck service.

Proper lifting and towing are necessary to prevent damage to the vehicle. Government and local laws must be followed.

A towed vehicle usually should have its rear wheels off the ground. If excessive damage or other conditions prevent this, use wheel dollies.

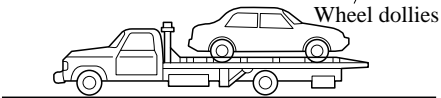
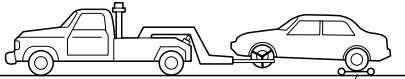
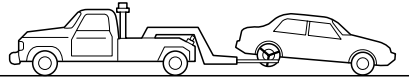

**⚠ CAUTION**

Don't tow the vehicle pointed forward with driving wheels on the ground. This may cause internal damage to the transmission.

A line drawing of a tow truck towing a sedan forward with its front left wheel on the ground. A large grey circle with a diagonal slash is superimposed over the entire scene, indicating this is a prohibited action.

**⚠ CAUTION**

Don't tow with sling-type equipment. This could damage your vehicle. Use wheel-lift or flatbed equipment.

A line drawing of a tow truck with a sling-type attachment towing a sedan. A large grey circle with a diagonal slash is superimposed over the entire scene, indicating this is a prohibited action.

**Tiedown Hooks****⚠ CAUTION**

Don't use the tiedown hooks under the front and rear for towing. They are designed **ONLY** for tying down the vehicle when it's being transported. Using them for towing will damage the bumper.

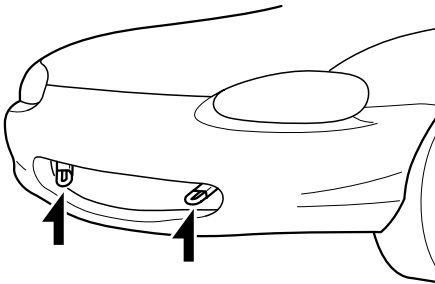
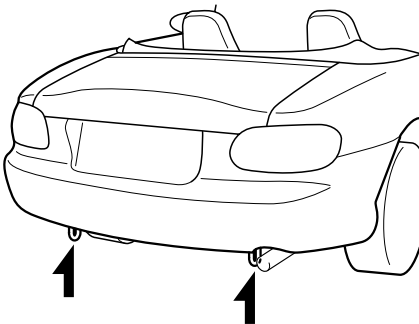
**▼ Tiedown Hooks-Front****▼ Tiedown Hooks-Rear****Recreational Towing**

An example of “recreational towing” is towing your vehicle behind a motorhome. The transmission is not designed for towing this vehicle on all 4 wheels. When doing recreational towing refer to “Towing Description” (page 7-16) and “Tiedown Hooks” (page 7-17) and carefully follow the instructions.



How to keep your Mazda in top condition.

<b>Introduction</b> .....	8-2
Introduction .....	8-2
<b>Scheduled Maintenance</b> .....	8-3
Scheduled Maintenance (North America) .....	8-3
Scheduled Maintenance (Except North America) .....	8-7
<b>Owner Maintenance</b> .....	8-10
Owner Maintenance Schedule .....	8-10
Owner Maintenance Precautions .....	8-11
Engine Compartment Overview .....	8-12
Engine Oil .....	8-13
Engine Coolant .....	8-15
Brake Fluid .....	8-18
Clutch Fluid .....	8-19
Power Steering Fluid .....	8-20
Automatic Transmission Fluid (ATF) .....	8-21
Washer Fluid .....	8-22
Body Lubrication .....	8-23
Air Filter .....	8-24
Wiper Blades .....	8-25
Battery .....	8-27
Tires .....	8-28
Light Bulbs .....	8-32
Fuses .....	8-36
<b>Appearance Care</b> .....	8-40
How to Minimize Environmental Paint Damage .....	8-40
Exterior Care .....	8-42
Interior Care .....	8-47

# Introduction

---

## Introduction

Be extremely careful and prevent injury to yourself and others or damage to your vehicle when using this manual for inspection and maintenance.

If you're unsure about any procedure it describes, we strongly urge you to have a reliable and qualified service shop perform the work, preferably an Authorized Mazda Dealer.

Factory-trained Mazda technicians and genuine Mazda parts are best for your vehicle. Without this expertise and the parts that have been designed and made especially for your Mazda, inadequate, incomplete, and insufficient servicing may result in problems. This could lead to vehicle damage or an accident and injuries.

For expert advice and quality service, consult an Authorized Mazda Dealer.

The owner should retain evidence that proper maintenance has been performed as prescribed.

Claims against the warranty resulting from lack of maintenance, as opposed to defective materials or authorized Mazda workmanship, will not be honored.

Any auto repair shop using parts equivalent to your Mazda's original equipment may perform maintenance. **But we recommend that it always be done by an Authorized Mazda Dealer using genuine Mazda parts.**

## Scheduled Maintenance

---

### Scheduled Maintenance (North America)

Follow Schedule 1 if the vehicle is operated mainly where none of the following conditions apply.

If any do apply, follow Schedule 2 (Canada and Puerto Rico residents follow Schedule 2).

- Repeated short-distance driving
- Driving in dusty conditions
- Driving with extended use of brakes
- Driving in areas where salt or other corrosive materials are being used
- Driving on rough or muddy roads
- Extended periods of idling or low-speed operation
- Driving for long periods in cold temperatures or extremely humid climates

<b>NOTE</b>
After the prescribed period, continue to follow the described maintenance at the recommended intervals.

# Scheduled Maintenance

## ▼ Schedule 1

**I** : Inspect: Inspect and clean, repair, adjust, or replace if necessary.

**R**: Replace

**C**: Clean

**L**: Lubricate

Maintenance Interval (Number of months or kilometers (miles), whichever comes first)	Months	6	12	18	24	30	36	42	48
	×1000 km	12	24	36	48	60	72	84	96
	×1000 miles	7.5	15	22.5	30	37.5	45	52.5	60

### ENGINE

Engine valve clearance									<b>I</b>
Engine timing belt	<b>Replace every 96,000km (60,000miles)</b>								
Drive belt (tension)					<b>I</b>				<b>I</b>
Engine oil	MX-5/miata	<b>R</b>	<b>R</b>	<b>R</b>	<b>R</b>	<b>R</b>	<b>R</b>	<b>R</b>	<b>R</b>
	MAZDASPEED MX-5	<b>Replace every 8,000km (5,000miles) or 5 months</b>							
Engine oil filter	MX-5/miata	<b>R</b>	<b>R</b>	<b>R</b>	<b>R</b>	<b>R</b>	<b>R</b>	<b>R</b>	<b>R</b>
	MAZDASPEED MX-5	<b>Replace every 8,000km (5,000miles) or 5 months</b>							

### COOLING SYSTEM

Cooling system					<b>I</b>				<b>I</b>
Engine coolant	<b>Replace at first 96,000 km (60,000 miles) or 48 months ; after that, every 24 months</b>								

### FUEL SYSTEM

Idle speed					<b>I</b>				<b>I</b>
Air filter		<b>C</b>			<b>C</b>	<b>R</b>		<b>C</b>	
Fuel lines and hoses*					<b>I</b>				<b>I</b>
Hoses and tubes for emission*									<b>I</b>

### IGNITION SYSTEM

Spark plugs	MX-5/miata				<b>R</b>				<b>R</b>
	MAZDASPEED MX-5	<b>Replace every 160,000km (100,000miles)</b>							

### CHASSIS and BODY

Brake lines, hoses and connections					<b>I</b>				<b>I</b>
Disc brakes		<b>I</b>			<b>I</b>		<b>I</b>		<b>I</b>
Tire (Rotation)	<b>Rotate every 12,000km (7,500miles)</b>								
Steering operation and linkages					<b>I</b>				<b>I</b>
Manual transmission oil									<b>R</b>
Rear differential oil									<b>R</b>
Front and rear suspension ball joints					<b>I</b>				<b>I</b>
Driveshaft dust boots					<b>I</b>				<b>I</b>
Exhaust system and heat shields	<b>Inspect every 72,000km (45,000miles) or 60 months</b>								
All locks and hinges	<b>L</b>	<b>L</b>	<b>L</b>	<b>L</b>	<b>L</b>	<b>L</b>	<b>L</b>	<b>L</b>	<b>L</b>

\* According to state / provincial and federal regulations, failure to perform maintenance on these items will not void your emissions warranties. However, Mazda recommends that all maintenance services be performed at the recommended time or mileage / kilometer period to ensure long-term reliability.



# Scheduled Maintenance

## ▼ Schedule 2

**I** : Inspect: Inspect and clean, repair, adjust, or replace if necessary.  
**R**: Replace  
**C**: Clean

Maintenance Interval (Number of months or kilometers (miles), whichever comes first)	Months	4	8	12	16	20	24	28	32	36	40	44	48
	×1000 km	8	16	24	32	40	48	56	64	72	80	88	96
	×1000 miles	5	10	15	20	25	30	35	40	45	50	55	60

### ENGINE

Engine valve clearance														I
Engine timing belt	Replace every 96,000km (60,000miles)													
Drive belts (tension)							I							I
Engine oil (Except Puerto Rico)	MX-5/miata	R	R	R	R	R	R	R	R	R	R	R	R	R
	MAZDASPEED MX-5	Replace every 5,000km (3,000miles) or 3 months												
Engine oil (Puerto Rico)	Replace every 5,000km (3,000miles) or 3 months													
Engine oil filter	MX-5/miata	R	R	R	R	R	R	R	R	R	R	R	R	R
	MAZDASPEED MX-5	Replace every 5,000km (3,000miles) or 3 months												

### COOLING SYSTEM

Cooling system							I							I
Engine coolant	Replace at first 96,000 km (60,000 miles) or 48 months ; after that, every 24 months													
Engine coolant level	I	I	I	I	I	I	I	I	I	I	I	I	I	I

### FUEL SYSTEM

Idle speed							I							I
Air filter			C				C	R			C			
Fuel lines and hoses*							I							I
Hoses and tubes for emission*														I

### IGNITION SYSTEM

Spark plugs	MX-5/miata						R							R
	MAZDASPEED MX-5	Replace every 160,000km (100,000miles)												

### ELECTRICAL SYSTEM

Function of all lights	I	I	I	I	I	I	I	I	I	I	I	I	I	I
------------------------	---	---	---	---	---	---	---	---	---	---	---	---	---	---

\* According to state / provincial and federal regulations, failure to perform maintenance on these items will not void your emissions warranties. However, Mazda recommends that all maintenance services be performed at the recommended time or mileage / kilometer period to ensure long-term reliability.

# Scheduled Maintenance

**I** : Inspect: Inspect and clean, repair, adjust, or replace if necessary.  
**R**: Replace  
**L**: Lubricate

Maintenance Interval (Number of months or kilometers (miles), whichever comes first)	Months	4	8	12	16	20	24	28	32	36	40	44	48
	×1000 km	8	16	24	32	40	48	56	64	72	80	88	96
	×1000 miles	5	10	15	20	25	30	35	40	45	50	55	60

## CHASSIS and BODY

Brake lines, hoses and connections							I						I
Brake and clutch fluid level	I	I	I	I	I	I	I	I	I	I	I	I	I
Disc brakes			I				I			I			I
Tire (Rotation)	Rotate every 8,000km (5,000miles)												
Tire inflation pressure and tire wear	I	I	I	I	I	I	I	I	I	I	I	I	I
Steering operation and linkages							I						I
Power steering fluid level	I	I	I	I	I	I	I	I	I	I	I	I	I
Manual transmission oil							R						R
Rear differential oil							R						R
Front and rear suspension ball joints							I						I
Driveshaft dust boots							I						I
Exhaust system and heat shields	Inspect every 72,000km (45,000miles) or 60 months												
All locks and hinges	L	L	L	L	L	L	L	L	L	L	L	L	L
Washer fluid level	I	I	I	I	I	I	I	I	I	I	I	I	I

## Scheduled Maintenance

---

### Scheduled Maintenance (Except North America)

**NOTE**

- After the prescribed period, continue to follow the described maintenance at the recommended intervals.
- As the result of visual examination or functional measurement of a system's operation (performance), correct, clean, or replace as required. (Inspect, and if necessary replace the air filter)

**Emission control and related systems**

The ignition and fuel systems are highly important to the emission control system and to efficient engine operation. Don't tamper with them.

All inspections and adjustments must be made by an Authorized Mazda Dealer.

# Scheduled Maintenance

**I** : Inspect: Inspect and clean, repair, adjust, or replace if necessary.  
**R**: Replace  
**C**: Clean

Maintenance Interval (Number of months or kilometers (miles), whichever comes first)	Months	6	12	18	24	30	36	42	48	54	60	66	72	78	84	90	96
	×1000 km	10	20	30	40	50	60	70	80	90	100	110	120	130	140	150	160
	×1000 miles	6.25	12.5	18.75	25	31.25	37.5	43.75	50	56.25	62.5	68.75	75	81.25	87.5	93.75	100

## ENGINE

Engine valve clearance	Inspect every 100,000 km (62,500 miles) or 60 months																
Drive belts * <sup>1</sup>	I	I	I	I	I	I	I	I	I	I	I	I	I	I	I	I	I
Engine timing belt * <sup>2</sup>	Replace every 100,000 km (62,500 miles)																
Engine oil * <sup>3</sup>	R	R	R	R	R	R	R	R	R	R	R	R	R	R	R	R	R
Engine oil filter * <sup>3</sup>	R	R	R	R	R	R	R	R	R	R	R	R	R	R	R	R	R

## COOLING SYSTEM

Cooling system		I		I		I		I		I		I		I		I	
Engine coolant	except Australia, New Zealand	Replace every 24 months															
	Australia, New Zealand	Replace at first 80,000 km (50,000 miles) or 48 months ; after that, every 24 months															

## FUEL SYSTEM

Idle speed		I		I		I		I		I		I		I		I	
Air filter * <sup>4</sup>	except Australia, New Zealand	C		C		R		C		C		R		C		C	
	Australia, New Zealand		C			R			C		R			C			
Fuel filter	except Australia, New Zealand			R				R				R					R
	Australia, New Zealand					R					R					R	
Fuel lines and hoses		I		I		I		I		I		I		I		I	

## IGNITION SYSTEM

Spark plugs	Replace every 40,000km (25,000miles)																
-------------	--------------------------------------	--	--	--	--	--	--	--	--	--	--	--	--	--	--	--	--

\*1 Also inspect and adjust the power steering and air conditioner drive belts, if installed.

\*2 Replacement of the timing belt is required at every 100,000 km {62,500 miles}. Failure to replace the timing belt may result in damage to the engine.

\*3 If the vehicle is operated under any of the following conditions, change the engine oil and oil filter more often than recommended intervals.

a) Driving in dusty conditions.

b) Extended periods of idling or low speed operation.

c) Driving for long period in cold temperatures or driving regularly at short distance only.

\*4 If the vehicle is operated in very dusty or sandy areas, inspect and if necessary, clean or replace the air filter more often than the recommended intervals.

# Scheduled Maintenance

**I** : Inspect: Inspect and clean, repair, adjust, or replace if necessary.  
**R**: Replace  
**T**: Tighten

Maintenance Interval (Number of months or kilometers (miles), whichever comes first)	Months	6	12	18	24	30	36	42	48	54	60	66	72	78	84	90	96
	×1000 km	10	20	30	40	50	60	70	80	90	100	110	120	130	140	150	160
	×1000 miles	6.25	12.5	18.75	25	31.25	37.5	43.75	50	56.25	62.5	68.75	75	81.25	87.5	93.75	100

## EMISSION CONTROL SYSTEM

Evaporative system		I		I		I		I		I		I		I		I
--------------------	--	---	--	---	--	---	--	---	--	---	--	---	--	---	--	---

## ELECTRICAL SYSTEM

All electrical system* <sup>5</sup>		I		I		I		I		I		I		I		I
-------------------------------------	--	---	--	---	--	---	--	---	--	---	--	---	--	---	--	---

## CHASSIS and BODY

Brake pedals and clutch pedals	I	I	I	I	I	I	I	I	I	I	I	I	I	I	I	I	I
Brake lines, hoses and connections		I		I		I		I		I		I		I		I	
Clutch fluid	I	I	I	I	I	I	I	I	I	I	I	I	I	I	I	I	I
Brake fluid* <sup>6</sup>	I	I	I	R	I	I	I	R	I	I	I	R	I	I	I	I	R
Parking brake	I	I	I	I	I	I	I	I	I	I	I	I	I	I	I	I	I
Power brake unit and hoses		I		I		I		I		I		I		I		I	
Disc brakes	I	I	I	I	I	I	I	I	I	I	I	I	I	I	I	I	I
Power steering fluid and lines	I	I	I	I	I	I	I	I	I	I	I	I	I	I	I	I	I
Steering operation and gear housing		I		I		I		I		I		I		I		I	
Steering linkages, tie rod ends and arms		I		I		I		I		I		I		I		I	
Manual transmission oil										R							
Rear differential oil									R								R
Front and rear suspension and ball joints				I				I				I					I
Automatic transmission fluid level		I		I		I		I		I		I		I		I	
Drive shaft dust boots				I				I				I					I
Bolts and nuts on chassis and body		T		T		T		T		T		T		T		T	
Body condition (for rust, corrosion and perforation) (except Australian model)	<b>Inspect annually</b>																
Exhaust system heat shields	<b>Inspect every 80,000 km (50,000 miles)</b>																
Tire (including spare tire)(with inflation pressure adjustment)		I		I		I		I		I		I		I		I	

\*5 This is a full function check of electrical systems such as lights, wiper and washer systems (including wiper blades), and power windows.

\*6 If the brakes are used extensively (for example, continuous hard driving or mountain driving) or if the vehicle is operated in extremely humid climates, change the brake fluid annually.

# Owner Maintenance

---

## Owner Maintenance Schedule

The owner or a qualified service technician should make these vehicle inspections at the indicated intervals to ensure safe and dependable operation.

Bring any problem to the attention of an Authorized Mazda Dealer or qualified service technician as soon as possible.

### ▼ When Refueling

- Brake and clutch fluid level (page 8-18)
- Engine coolant level (page 8-15)
- Engine oil level (page 8-13)
- Washer fluid level (page 8-22)

### ▼ At Least Monthly

- Tire inflation pressures (page 8-28)

### ▼ At Least Twice a Year (For Example, Every Spring and Fall)

- Automatic transmission fluid level (page 8-21)
- Power steering fluid level (page 8-20)

You can do the following scheduled maintenance items if you have some mechanical ability and a few basic tools and if you closely follow the directions in this manual.

- Air filter (page 8-24)
- Engine coolant (page 8-15)
- Engine oil (page 8-14)

## Owner Maintenance Precautions

Improper or incomplete service may result in problems. This section gives instructions only for items that are easy to perform.

As explained in the Introduction (page 8-2), several procedures can be done only by a qualified service technician with special tools.

Improper owner maintenance during the warranty period may affect warranty coverage. For details, read the separate Mazda Warranty statement provided with the vehicle. If you're unsure about any servicing or maintenance procedure, have it done by an Authorized Mazda Dealer.

There are strict environmental laws regarding the disposal of waste oil and fluids. Please dispose of your waste properly and with due regard to the environment.

We recommend that you entrust the oil and fluid changes of your vehicle to an Authorized Mazda Dealer.

### **WARNING**

#### **Maintenance Procedures:**

*Performing maintenance work on a vehicle is dangerous if not done properly. You can be seriously injured while performing some maintenance procedures. If you lack sufficient knowledge and experience or the proper tools and equipment to do the work, have it done by a qualified technician.*

#### **Running the Engine:**

*Working under the hood with the engine running is dangerous. It becomes even more dangerous when you wear jewelry or loose clothing.*

*Either can become entangled in moving parts and result in injury.*

*Therefore, if you must run the engine while working under the hood, make certain that you remove all jewelry (especially rings, bracelets, watches, and necklaces) and all neckties, scarves, and similar loose clothing before getting near the engine or cooling fan which may turn on unexpectedly.*

#### **Electrical Fan and Engine Inspection:**

*Inspecting the engine with the ignition switch in the ON position is dangerous. The cooling fan could come on unexpectedly even when the engine isn't running. You could be seriously injured by the fan. Turn the ignition switch off and remove the key from the ignition switch when you inspect the engine.*

# Owner Maintenance

## Engine Compartment Overview

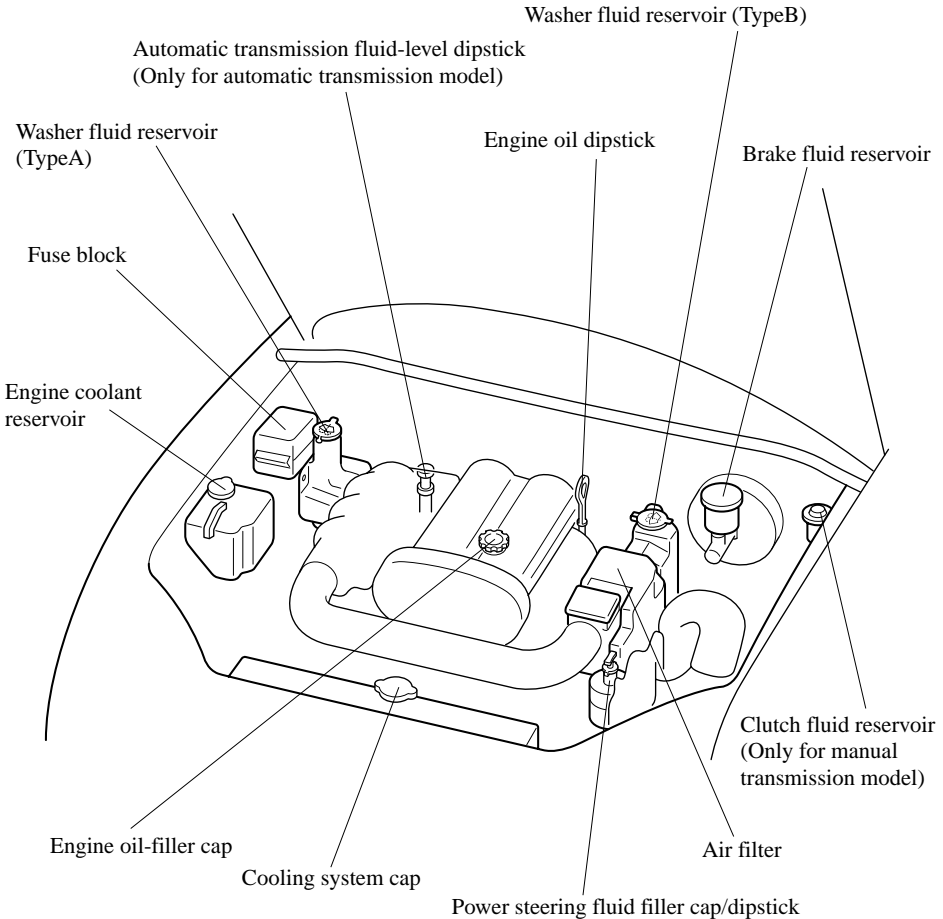

**The battery is in the trunk**



# Owner Maintenance

## Engine Oil

### ▼ Recommended Oil

Oil container labels provide important information.



(ILSAC)

The quality designation **SG, SH, SJ, SL**, or **ILSAC** must be on the label.

Engine oil viscosity, or thickness, has an effect on fuel economy and cold-weather operation (starting and oil flow). Low-viscosity engine oils can provide improved fuel economy and cold-weather performance. But high-temperature weather conditions require higher-viscosity engine oils for satisfactory lubrication.

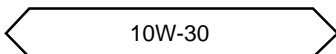
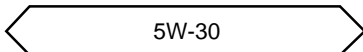
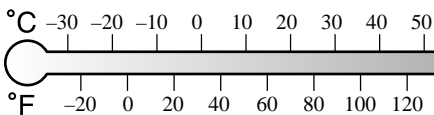

When choosing an oil, consider the temperature range your vehicle will operate in before the next oil change. Then select the recommended viscosity from this chart.

### ⚠ CAUTION

Using oils of viscosity besides those recommended for specific temperature ranges could result in engine damage.

Energy conserving oils are recommended. A chief contribution they make to fuel economy is reducing the amount of fuel necessary to overcome engine friction.

### ▼ Inspecting Engine Oil Level

1. Be sure the vehicle is on a level surface.
2. Warm up the engine to normal operating temperature.
3. Turn it off and wait at least 5 minutes for the oil to return to the oil pan.
4. Pull out the dipstick, wipe it clean, and reinsert it fully.

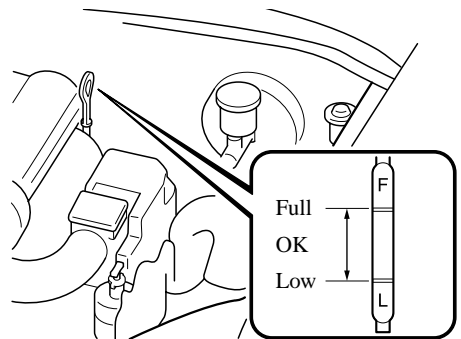

# Owner Maintenance

5. Pull it out again and examine the level. It's OK between L and F. But if it's near or below L, add enough oil to bring the level to F.

## ⚠ CAUTION

Don't add engine oil over F. This may cause engine damage.

6. Make sure the O-ring is positioned properly before reinserting the dipstick.

The distance between L and F on the dipstick represents the following:

L (US qt, Imp qt)	0.8 (0.85, 0.70)
-------------------	------------------

## ▼ Changing Engine Oil and Filter

Change engine oil and filter according to Scheduled Maintenance (page 8-3).

Please act responsibly—protect the environment and take used oil to a recycling facility. Ask your dealer or a service station for information.

## ⚠ WARNING

**Handling Used Engine Oil:** Continuous contact with used engine oil is dangerous. It could cause skin cancer. Always wash with soap and water immediately after changing oil and filter.

## Changing engine oil

### ⚠ WARNING

**Checking or Changing Engine Oil:** Hot engine oil is dangerous. If the engine has been running, the engine oil becomes very hot. You could be seriously burned. Don't check or change the engine oil when the engine is hot.

1. Warm up the engine for a few minutes and turn it off. Remove the oil-filler cap.
2. Remove the drain plug and drain the oil into a suitable container.
3. Replace the drain plug washer after the oil has thoroughly drained.
4. Reinstall the plug tightly.
5. Fill the engine with new oil to the F mark on the dipstick.
6. Securely reinstall the oil-filler cap.

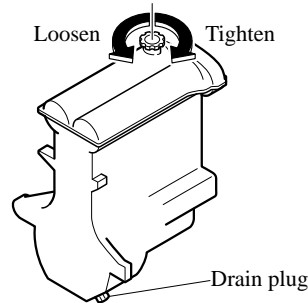

7. Start the engine and inspect around the drain plug for leaks.
8. Turn it off and wait 5 minutes for the oil to return to the oil pan.

# Owner Maintenance

Check the oil level and fill to the F mark if necessary.

**Oil capacity (General reference only, refer to Specifications section for capacities.)**

### NOTE

- The indicated engine oil capacities are for general reference purposes only. When adding or changing oil, verify the engine oil level with the oil dipstick.
- Use only specified engine oil (page 10-4).

### Changing oil filter

Because you need a special tool to retighten the filter, an Authorized Mazda Dealer should do the work.

## Engine Coolant

### ▼ Inspecting Coolant Level

### **WARNING**

#### Hot Engine:

*A hot engine is dangerous. If the engine has been running, parts of the engine compartment can become very hot. You could be burned. Carefully inspect the engine coolant in the coolant reservoir, but do not open it. Do not use a match or live flame in the engine compartment. **DO NOT ADD COOLANT WHEN THE ENGINE IS HOT.***



#### Cooling Fan and Engine

#### Inspection:

*Inspecting the engine with the ignition switch in the ON position is dangerous. The cooling fan could turn on unexpectedly even when the engine isn't running. You could be seriously injured by the fan. Turn the ignition switch off and remove the key from the ignition switch when you inspect the engine.*



#### Cooling System Cap:

*When the engine and radiator are hot, scalding coolant and steam may shoot out under pressure and cause serious injury. Don't remove the cooling system cap when the engine and radiator are hot.*

# Owner Maintenance

Inspect the antifreeze protection and coolant level in the coolant reservoir at least once a year—at the beginning of the winter season—and before traveling where temperatures may drop below freezing.

Inspect the condition and connections of all cooling system and heater hoses. Replace any that are swollen or deteriorated.

The coolant should be at full in the radiator and between the FULL and LOW marks on the coolant reservoir when the engine is cool.

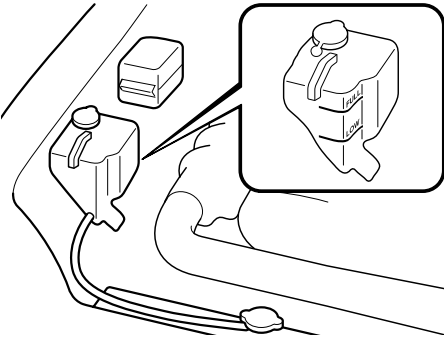

If it's at or near LOW, add enough coolant to the coolant reservoir to provide freezing and corrosion protection and to bring the level to FULL.

<b>⚠ CAUTION</b>
Radiator coolant will damage paint. Rinse it off quickly if spilled.

**Do not overfill.**

If new coolant is required frequently, consult an Authorized Mazda Dealer.

## ▼ Changing Coolant

Change coolant according to Scheduled Maintenance (page 8-3).

<b>⚠ CAUTION</b>
<ul style="list-style-type: none"> <li>• Use only soft (demineralized) water in the coolant mixture. Water that contains minerals will cut down on the coolant's effectiveness.</li> <li>• Don't add only water. Always add a proper coolant mixture.</li> <li>• The engine has aluminum parts and must be protected by an ethylene-glycol-based coolant to prevent corrosion and freezing.</li> <li>• <b>DO NOT USE</b> alcohol or methanol antifreeze. <b>DO NOT MIX</b> alcohol or methanol with the coolant. This could damage the cooling system.</li> <li>• Don't use a solution that contains more than 60 % antifreeze. This would reduce effectiveness.</li> </ul>

For mixture percentage:

Protection	Volume	
	Antifreeze solution	Demineralized water
Above -16°C (3°F)	35%	65%
Above -26°C (-15°F)	45%	55%
Above -40°C (-40°F)	55%	45%

## To change coolant

### **WARNING**

***Removing the Cooling System Cap:***  
*Removing the cooling system cap while the engine is running or hot is dangerous. This might lead to cooling system and engine damage and could result in serious injury from escaping hot coolant or steam. Turn off the engine and wait until it's cool. Even then, be very careful when removing the cap. Wrap a thick cloth around the cap and slowly turn it counterclockwise to the first stop. Step back while the pressure escapes. When you're sure all the pressure is gone, press down on the cap — still using a cloth — turn the cap, and remove it.*

1. Remove the cooling system cap.

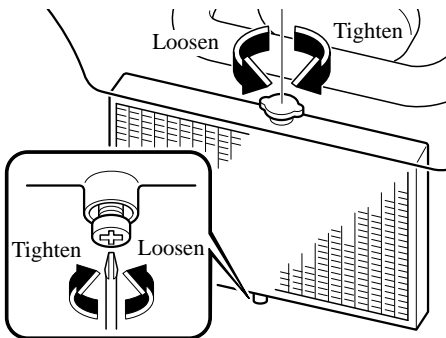

2. Only when the engine is cool, remove the radiator drain plug and drain the coolant into a suitable container. Properly dispose of the used coolant.
3. Flush out the system with running water.

4. Drain the system completely. Insert and tighten the plug. Add as much ethylene-glycol-based coolant mixture and water as necessary to provide freezing and corrosion protection.
5. In extremely cold climates, add the mixture percentage recommended in the coolant mixture percentage table.
6. Run the engine at idle with the cooling system cap off. Slowly add additional coolant if necessary.
7. At this point, wait until the engine reaches normal operating temperature; then depress the accelerator two or three times. Add more coolant, if necessary, until the system is full.
8. Install the cooling system cap. Inspect all connections for leaks. Inspect the level in the coolant reservoir one more time.

# Owner Maintenance

## Brake Fluid

### ▼ Inspecting Brake Fluid Level

Inspect the fluid level in the reservoir regularly. It should be kept at MAX. The level normally drops with accumulated distance, a condition associated with wear of brake linings. If it is excessively low, have the brake system inspected by an Authorized Mazda Dealer.

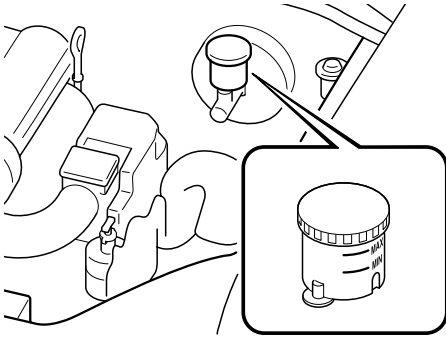

### ▼ Adding Brake Fluid

#### **⚠ WARNING**

##### **Spilled Brake Fluid:**

***Spilled brake fluid is dangerous. If it gets in your eyes, they could be seriously injured. If this happens, immediately flush your eyes with water and get medical attention. Brake fluid spilled on a hot engine could cause a fire. Be careful not to spill brake fluid on yourself or on the engine.***

##### **Low Brake Fluid Levels:**

***Low brake fluid levels are dangerous. Low levels could signal brake lining wear or a brake system leak. Your brakes could fail and cause an accident. If you find a low fluid level, have the brakes inspected.***

If the fluid level is low, add fluid until it reaches MAX.

Before adding fluid, thoroughly clean the area around the cap.

#### **⚠ CAUTION**

- Brake fluid will damage painted surfaces. If brake fluid does get on a painted surface, wipe it off immediately.
- Using nonspecified brake fluids (page 10-4) will damage the system. Mixing different fluids will also damage it.  
If the brake system frequently requires new fluid, consult an Authorized Mazda Dealer.

**Clutch Fluid****▼ Inspecting Clutch Fluid Level**

Inspect the level in the clutch fluid reservoir regularly. It should be kept at MAX.

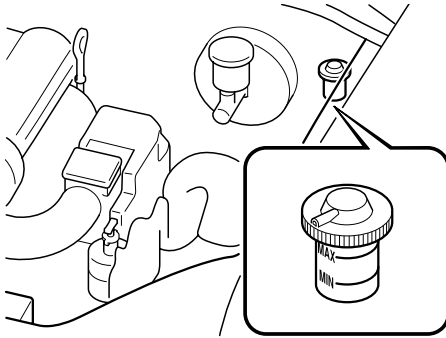
**▼ Adding Clutch Fluid****! WARNING**

***Spilled Clutch Fluid:***  
*Spilled clutch fluid is dangerous. If it gets in your eyes, they could be seriously injured. If this happens, immediately flush your eyes with water and get medical attention. Clutch fluid spilled on a hot engine could cause a fire. Be careful not to spill clutch fluid on yourself or on the engine.*

If the fluid level is low, add fluid until it reaches MAX.  
 Before adding fluid, thoroughly clean the area around the cap.

**! CAUTION**

- Clutch fluid will damage painted surfaces. If clutch fluid does get on a painted surface, wipe it off immediately.
- Using nonspecified clutch fluids (page 10-4) will damage the system. Mixing different fluids will also damage it.  
 If the clutch system frequently requires new fluid, it should be inspected. Consult an Authorized Mazda Dealer immediately.

**NOTE**

Low clutch fluid level may signal a fluid leak. If you find a low fluid level, have the clutch inspected.

# Owner Maintenance

## Power Steering Fluid

### ▼ Inspecting Power Steering Fluid Level

**⚠ CAUTION**

To avoid damage to the power steering pump, don't operate the vehicle for long periods when the power steering fluid level is low.

**NOTE**

Use specified power steering fluid (page 10-4).

Inspect the fluid level at each engine oil change. Add fluid if necessary; it does not require periodic changing.

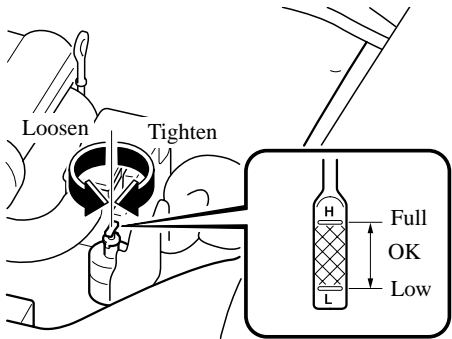

The level must be kept between the H and L marks.

Visually examine the lines and hoses for leaks and damage.

1. Park on a level surface, well off the right-of-way, and set the parking brake firmly.
2. Turn off the engine and allow it to cool.

3. Remove the filler cap and attached dipstick.
4. Wipe them clean and put them back.
5. Remove again and inspect the level.
6. It must be between H and L. Add fluid if necessary.

### Don't overfill.

If new fluid is required frequently, consult an Authorized Mazda Dealer.



## Automatic Transmission Fluid (ATF)

### ▼ Inspecting Automatic Transmission Fluid Level

The automatic transmission fluid level should be inspected regularly. Measure it as described below.

The volume of fluid changes with the temperature. For that reason, it is best to examine the level after having driven the vehicle for 15 minutes. If necessary, however, it can also be inspected without driving when the outside temperature is above 20°C (70°F).

### ⚠ CAUTION

- Low fluid level causes transmission slippage. Overfilling can cause foaming, loss of fluid, and transmission malfunction.
- Use specified fluid (page 10-4). A nonspecified fluid could result in transmission malfunction and failure.
- The vehicle should not be driven if the fluid level is below the bottom of the dipstick and the outside temperature is above 20°C (70°F), or if evident automatic transmission fluid leaks are found.

1. Park on a level surface and set the parking brake firmly.
2. Idle the engine. Push down on the brake pedal.
3. Move the shift lever through all ranges and set it at P.

### ⚠ WARNING

***Sudden Vehicle Movement:***  
*Shifting the shift lever without first depressing the brake pedal is dangerous. The vehicle could move suddenly and cause an accident. Make sure the brake pedal is applied before shifting the shift lever.*

4. With the engine still idling, pull out the dipstick, wipe it clean.
5. Put the dipstick back into the filler tube and make sure it is fully seated.
6. Pull the dipstick out and read the fluid level.

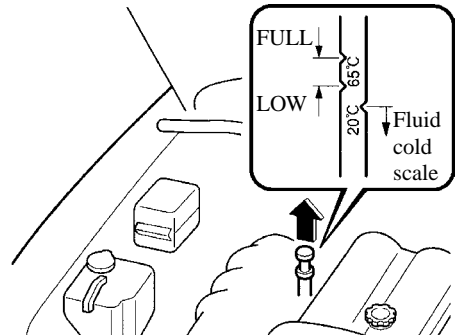

The proper fluid level is marked on the dipstick as follows.

### **Fluid hot scale**

When checking the fluid level at normal operating temperature, the fluid level should be within the FULL and LOW marks on the dipstick.

# Owner Maintenance

---

## Fluid cold scale

When the vehicle has not been driven but the engine is idling, and the outside temperature is above 20°C (70°F), the fluid level should be close to, but not above, the bottom notch on the dipstick.

**NOTE**

Use the cold scale as a reference.

Fully insert the dipstick. When adding fluid, inspect with the dipstick to make sure it doesn't pass full.

**NOTE**

Inspect the fluid on both sides of the dipstick in a well lit area for an accurate reading.

## Washer Fluid

### ▼ Inspecting Washer Fluid Level

 **WARNING**

**Substitute Washer Fluid:**  
*Using radiator antifreeze as washer fluid is dangerous. If sprayed on the windshield, it will dirty the windshield, affect your visibility, and could result in an accident. Use only windshield washer fluid or plain water in the reservoir.*

**Using Washer Fluid Without Anti-freeze Protection in Cold Weather:**  
*Operating your vehicle in temperatures below 4 degrees C (40 degrees F) using washer fluid without anti-freeze protection is dangerous as it could cause impaired windshield vision and result in an accident. In cold weather, always use washer fluid with anti-freeze protection.*

**NOTE**

State or local regulations may restrict the use of volatile organic compounds (VOCs), which are commonly used as anti-freeze agents in washer fluid. A washer fluid with limited VOC content should be used only if it provides adequate freeze resistance for all regions and climates in which the vehicle will be operated.

# Owner Maintenance

Inspect fluid level in the washer fluid reservoir; add fluid if necessary.

## Type A

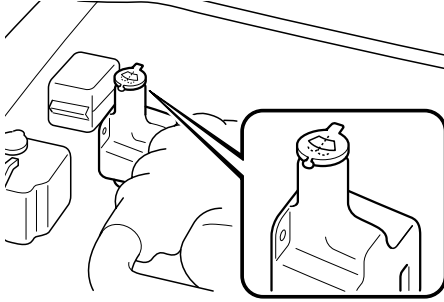

## Type B

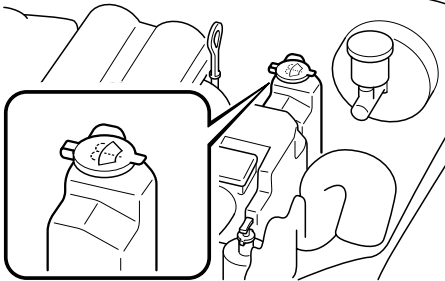

Use plain water if washer fluid is unavailable.

But use only washer fluid in cold weather to prevent it from freezing.

## Body Lubrication

All moving points of the body, such as door and hood hinges and locks, should be lubricated each time the engine oil is changed. Use a nonfreezing lubricant on locks during cold weather.

Make sure the engine hood's secondary latch keeps the hood from opening when the primary latch is released.

# Owner Maintenance

## Air Filter

### ⚠ CAUTION

Don't drive without an air filter. This could result in excessive engine wear.

This air filter may be cleaned with compressed air and reused, or replaced, depending on its condition. Unless it is very dirty, simply shake it to remove foreign particles. Each time you inspect it, wipe inside the air cleaner housing with a damp cloth.

### ▼ Replacing the Air Filter

#### NOTE

If the vehicle is operated in very dusty or sandy areas, replace the filter more often than recommended intervals.

1. Loosen the bolt and remove the hose.

#### MAZDASPEED MX-5

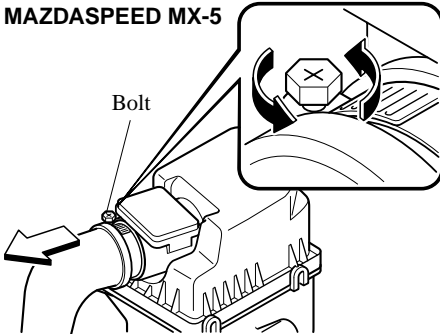

2. Unfasten the clamps.

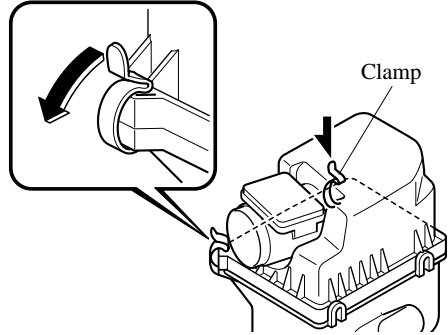

3. Lift off the air filter cover and remove the filter.

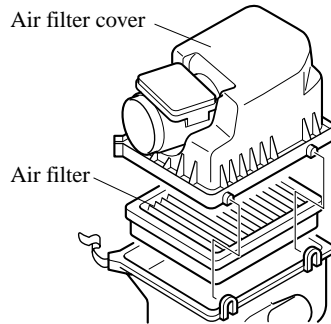

4. Wipe inside the air cleaner housing with a damp cloth.
5. Clean or replace the filter.
6. Install in the reverse order of removal.

Replace the filter according to Scheduled Maintenance (page 8-3).

# Owner Maintenance

## Wiper Blades

### ⚠ CAUTION

- Hot waxes applied by automatic car washers have been known to affect the cleanability of windows.
- To prevent damage to the wiper blades, don't use gasoline, kerosene, paint thinner, or other solvents on or near them.

Contamination of either the windshield or the blades with foreign matter can reduce wiper effectiveness. Common sources are insects, tree sap, and hot wax treatments used by some commercial car washes.

If the blades are not wiping properly, clean the window and blades with a good cleaner or mild detergent; then rinse thoroughly with clean water. Repeat if necessary.

### ▼ Replacing Windshield Wiper Blades

When the wipers no longer clean well, the blades are probably worn or cracked. Replace them.

### ⚠ CAUTION

To prevent damage to the wiper arms and other components, don't move the wipers by hand.

1. Raise the wiper arm and turn the blade assembly to expose the plastic locking clip. Compress the clip and slide the assembly downward; then lift it off the arm.

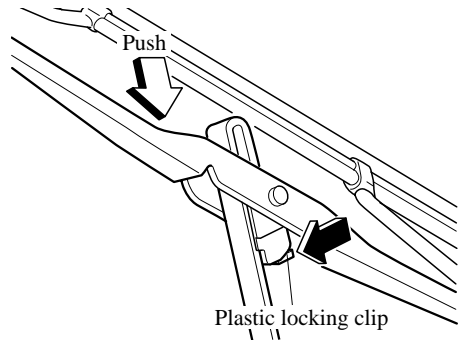

### ⚠ CAUTION

To prevent damage to the windshield, don't let the wiper arm fall on it.

# Owner Maintenance

2. Hold the end of the rubber and pull until the tabs are free of the metal support.

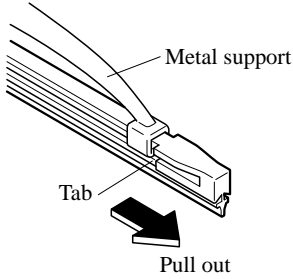

3. Remove the metal stiffeners from the blade rubber and install them in new blades.

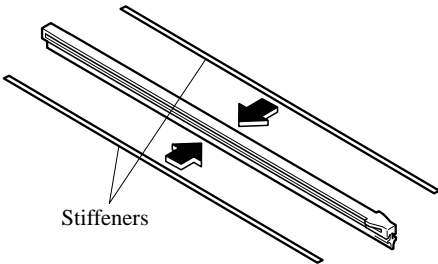

<b>⚠ CAUTION</b>
<ul style="list-style-type: none"><li>• Don't bend or discard the stiffeners. You need to use them again.</li><li>• If the metal stiffeners are switched, the blade's wiping efficiency could be reduced. So don't use the driver's side metal stiffeners on the passenger's side, or vice versa.</li><li>• Be sure to reinstall the metal stiffeners in the new blade rubber so that the curve is the same as it was in the old blade rubber.</li></ul>

4. Carefully insert the new blade rubber. Then install the blade assembly in the reverse order of removal.

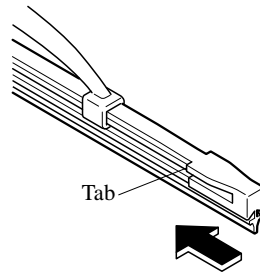

<b>NOTE</b>
Install the blade so that the tabs are toward the bottom of the wiper arm.

## Battery

### **WARNING**

**Battery-Related Lead Materials:**

*Battery posts, terminals and related accessories contain lead and lead compounds, chemicals known to the State of California to cause cancer and reproductive harm.*

*Wash hands after handling.*

**Battery-Related Explosion:**

*Flames and sparks near open battery cells are dangerous. Hydrogen gas, produced during normal battery operation, could ignite and cause the battery to explode. An exploding battery can cause serious burns and injuries. Keep all flames, including cigarettes, and sparks away from open battery cells.*

**Children and Batteries:**

*Allowing children to play near batteries is dangerous. Battery fluid could cause serious injuries if it gets in the eyes or on the skin. Always keep batteries out of the reach of children.*

### NOTE

The battery in this vehicle is unique and should only be replaced with the appropriate Mazda battery. For more details, contact an Authorized Mazda Dealer.

The battery is in the trunk.

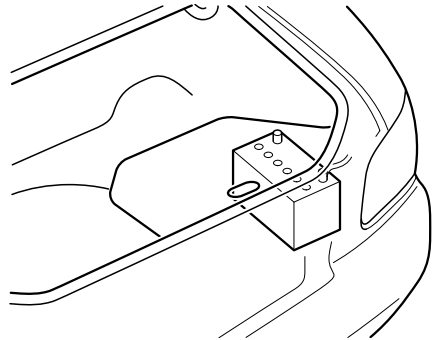

### ▼ Battery Maintenance

To get the best service from a battery:

- Keep it securely mounted.
- Keep the top clean and dry.
- Keep terminals and connections clean, tight, and coated with petroleum jelly or terminal grease.
- Rinse off spilled electrolyte immediately with a solution of water and baking soda.
- If the vehicle will not be used for an extended time, disconnect the battery cables.

# Owner Maintenance

## Tires

For reasons of proper performance, safety, and better fuel economy, always maintain recommended tire inflation pressures and stay within the recommended load limits and weight distribution.

### **WARNING**

**Using Different Tire Types:**  
*Driving your vehicle with different types of tires is dangerous. It could cause poor handling and poor braking; leading to loss of control. Except for the limited use of the temporary spare tire, use only the same type tires (radial, bias-belted, bias-type) on all four wheels.*

**Using Wrong-Sized Tires:**  
*Using any other tire size than what is specified for your Mazda (page 10-6) is dangerous. It could seriously affect ride, handling, ground clearance, tire clearance, and speedometer calibration. This could cause you to have an accident. Use only tires that are the correct size specified for your Mazda.*

## ▼ Tire Inflation Pressure

### **WARNING**

**Incorrect Tire Inflation:**  
*Overinflation or underinflation of tires is dangerous. Adverse handling or unexpected tire failure could result in a serious accident. Always inflate the tires to the correct pressure (page 10-6).*

Inspect all tire pressures monthly (including the spare) when the tires are cold. Maintain recommended pressures for the best ride, top handling, and minimum tire wear.

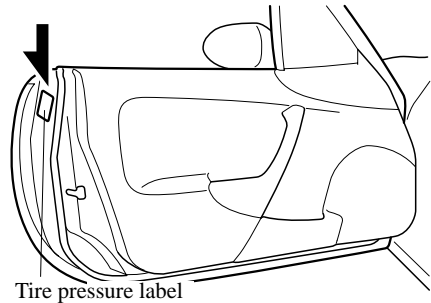

Refer to the specification charts (page 10-6).



# Owner Maintenance

## NOTE

- Warm tires normally exceed recommended pressures. Don't release air from warm tires to adjust the pressure.
- Underinflation can cause reduced fuel economy and poor sealing of the tire bead, which will deform the wheel and cause separation of tire from rim.
- Overinflation can produce a harsh ride and a greater possibility of damage from road hazards. Keep your tire pressure at the correct levels. If one frequently needs inflating, have it inspected.

## ▼ Tire Rotation

To equalize tread wear, rotate the tires every 12,000 km (7,500 miles)/8,000 km\* (5,000 miles) or sooner if irregular wear develops. During rotation, inspect them for correct balance.

\*Unique driving conditions for USA, Canada and Puerto Rico

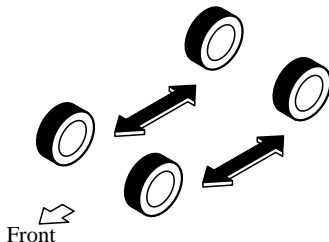

Do not include (TEMPORARY USE ONLY) spare tire in rotation.

Also, inspect them for uneven wear and damage. Abnormal wear is usually caused by one or a combination of the following:

- Incorrect tire pressure
- Improper wheel alignment
- Out-of-balance wheel
- Severe braking

After rotation, inflate all tire pressures to specification (page 10-6) and inspect the lug nuts for tightness.

## ⚠ CAUTION

Rotate unidirectional tires and radial tires that have an asymmetrical tread pattern or studs only from front to rear, not from side to side. Tire performance will be weakened if rotated from side to side.

## ⚠ CAUTION

Limited-Slip Differential system; don't use the following:

- Tires not of the designated size
- Tires of different sizes or types at the same time
- Tires not sufficiently inflated

If these instructions aren't followed, the rotation of the left and right wheels will be different and will thus apply a constant load on the limited-slip differential.

This will cause a malfunction.

# Owner Maintenance

## ▼ Replacing a Tire

### **WARNING**

#### **Worn Tires:**

***Driving with worn tires is dangerous. Reduced braking, steering, and traction could result in an accident. Always use tires that are in good condition.***

If a tire wears evenly, a wear indicator will appear as a solid band across the tread. Replace the tire when this happens.

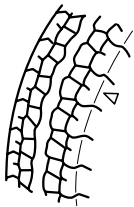

New tread

Tread wear indicator

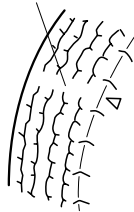

Worn tread

You should replace it before the band is across the entire tread.

## ▼ Temporary Spare Tire

Inspect the temporary spare tire at least monthly to make sure it's properly inflated and stored.

The temporary spare tire is easier to handle because of its construction. It is lighter and smaller than a conventional tire and should be used only for an emergency and only for a short distance.

Use the temporary only until the conventional tire is repaired, which should be as soon as possible.

Maintain its pressure at 420 kPa (4.2 kgf/cm<sup>2</sup> or bar, 60 psi).

### **CAUTION**

- Don't use your temporary spare tire rim with a snow tire or a conventional tire. Neither will properly fit and could damage both tire and rim.
- The temporary spare tire has a tread life of up to 5,000 km (3,000 miles), depending on road conditions and driving habits.
- The temporary spare tire is for limited use, however, if the tread wear solid-band indicator appears, replace the tire with the same type of temporary spare (page 8-30).

**▼ Replacing a Wheel**** WARNING**

**Using a Wrong-Sized Wheel:**  
*Using a wrong-sized wheel is dangerous. Braking and handling could be affected, leading to loss of control and an accident. Always use wheels of the correct size on your vehicle.*

** CAUTION**

A wrong-sized wheel may adversely affect:

- Tire fit
- Wheel and bearing life
- Ground clearance
- Snow-chain clearance
- Speedometer calibration
- Headlight aim
- Bumper height
- Limited-Slip Differential System

When replacing a wheel, make sure the new one is the same as the original factory wheel in diameter, rim width, and offset.

Proper tire balancing provides the best riding comfort and helps reduce tread wear. Out-of-balance tires can cause vibration and uneven wear, such as cupping and flat spots.

# Owner Maintenance

## Light Bulbs

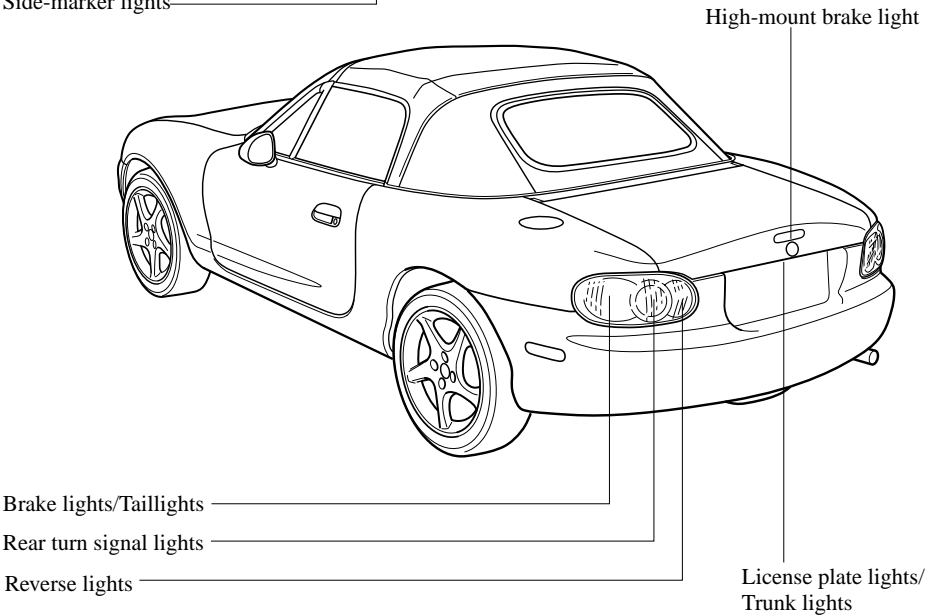
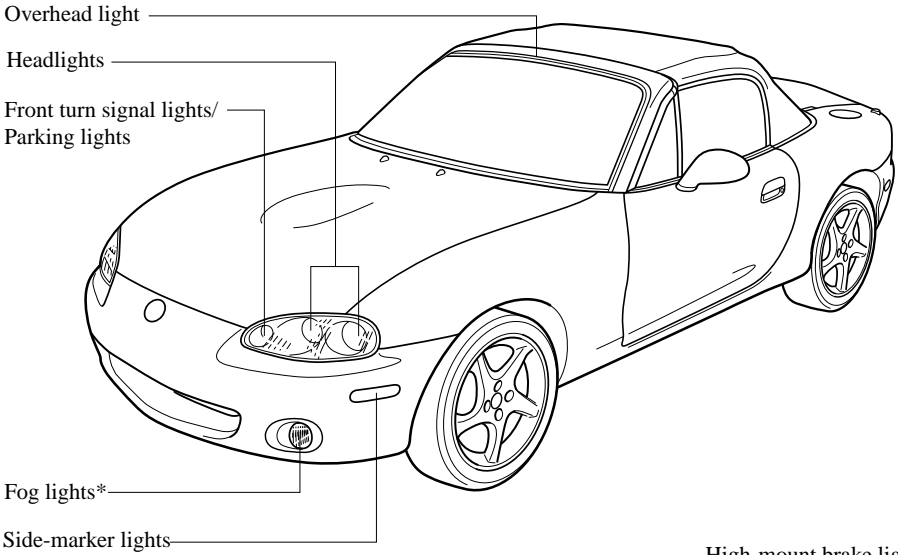

# Owner Maintenance

Your Mazda's headlights and fog lights have replaceable halogen bulbs.

## **WARNING**

### **Handling Halogen Bulbs:**

*When a halogen bulb breaks, it is dangerous. These bulbs contain pressurized gas. If one is broken, it will explode and serious injuries could be caused by the flying glass. If the glass portion is touched with bare hands, body oil could cause the bulb to overheat and explode when lit. Never touch the glass portion of the bulb with your bare hands and always wear eye protection when handling or working around halogen bulbs.*

### **Children and Halogen Bulbs:**

*Playing with a halogen bulb is dangerous. Serious injuries could be caused by dropping a halogen bulb or breaking it some other way. Always keep halogen bulbs out of the reach of children.*

## ▼ Replacing Exterior Light Bulbs

### **Replacing a headlight bulb**

1. Make sure the ignition switch is turned off and the headlight switch is off.
2. Lift the hood and find the high and low beam bulbs in the rear of the headlight unit.  
The outboard bulb is the LOW beam, and the inboard one is the HIGH beam. Refer to Light Bulbs (page 8-32).
3. Turn the socket and bulb assembly counterclockwise and remove it while holding the rubber socket cover in place. Carefully remove the headlight bulb from its socket in the reflector by gently pulling it straight backward out of the socket.
4. Disconnect the bulb from the electrical connector by pressing the tab on the connector with your finger and pulling the bulb upward.

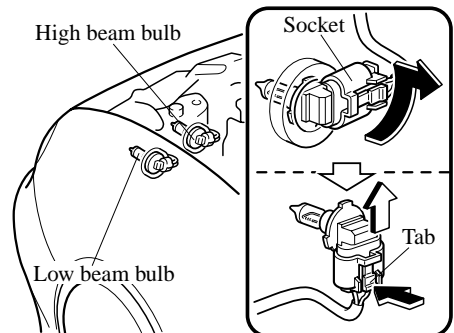

5. Install the new bulb in the reverse order of removal.

# Owner Maintenance

## NOTE

Use the protective cover and carton for the replacement bulb to dispose of the old bulb promptly and out of the reach of children.

### Replacing a fog light bulb\*

Due to the complexity and difficulty of the procedure, the bulbs should be replaced by an Authorized Mazda Dealer.

### Front turn signal lights/Parking lights

1. Turn the socket and bulb assembly counterclockwise and remove it.
2. Remove the bulb by pushing it in slightly and turning it counterclockwise.

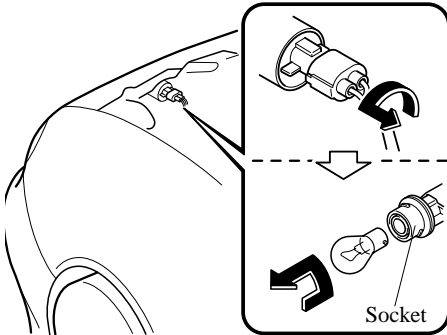

3. Install the new bulb in the reverse order of removal.

### Side-marker lights

1. Remove the bolts with a Phillips screwdriver and remove the side-marker light unit.
2. Turn the socket and bulb assembly counterclockwise and remove it.
3. Disconnect the bulb from the socket.

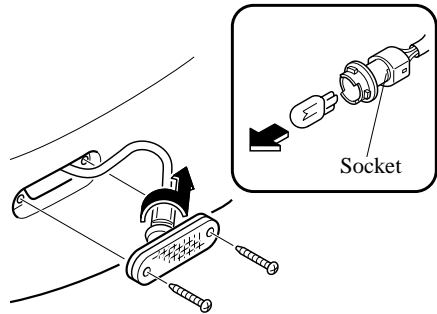

4. Install the new bulb in the reverse order of removal.

# Owner Maintenance

## Brake lights/Taillights, Rear turn signal lights, Reverse lights

1. Pull the center section of the plastic retainer and remove the retainers and remove the trunk end trim.

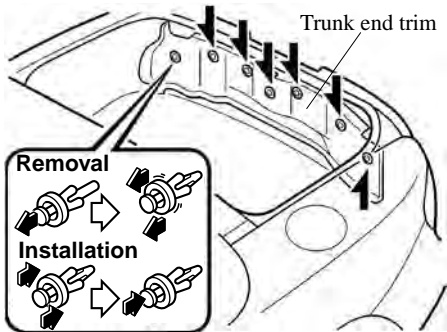

2. Turn the socket and bulb assembly counterclockwise and remove it.
3. Disconnect the bulb from the socket.

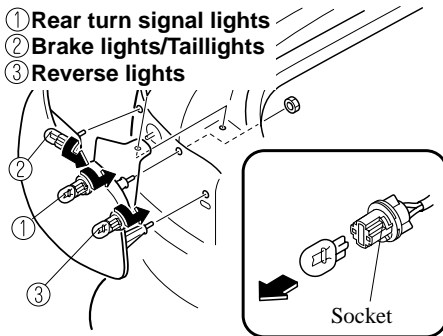

4. Install the new bulb in the reverse order of removal.

## High-mount brake light

1. Turn the socket and bulb assembly counterclockwise and remove it.
2. Remove the bulb by pushing it in slightly and turning it counterclockwise.

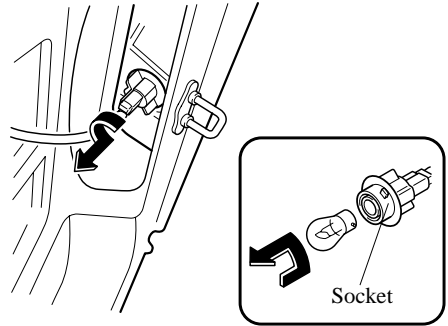

3. Install the new bulb in the reverse order of removal.

## License plate lights/Trunk lights

1. Slide the unit as shown in the figure to remove it.
2. Turn the socket and bulb assembly counterclockwise and remove it.
3. Disconnect the bulb from the socket.

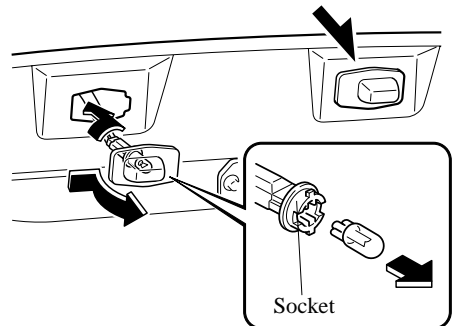

# Owner Maintenance

4. Install the new bulb in the reverse order of removal.

## ▼ Replacing Interior Light Bulbs

### Overhead light

1. Wrap a flathead screwdriver with a soft cloth to prevent damage to the trim and gently insert it in the overhead light as shown in the figure, and then remove the cover.
2. Disconnect the bulb by pulling it out.

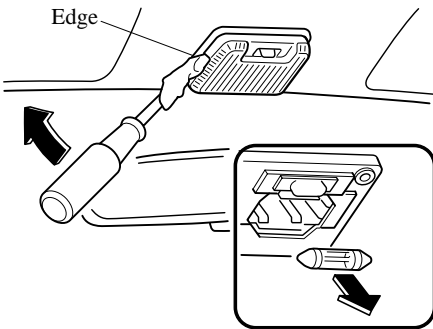

3. Install the new bulb in the reverse order of removal.

## Fuses

Your vehicle's electrical system is protected by fuses.

If any lights, accessories, or controls don't work, inspect the appropriate circuit protector. If a fuse has blown, the inside element will be melted.

If the same fuse blows again, avoid using that system and consult an Authorized Mazda Dealer as soon as possible.

## ▼ Fuse Replacement

If the electrical system doesn't work, first inspect fuses on the driver's side.

1. Turn off the ignition switch and other switches.
2. Open the fuse panel cover.

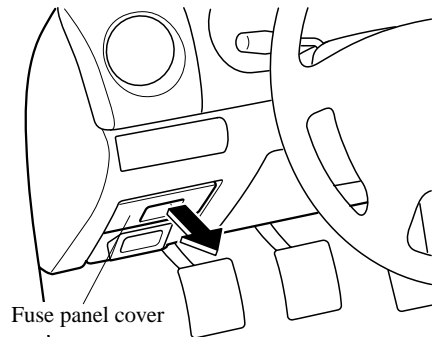



# Owner Maintenance

3. Pull the fuse straight out with the fuse puller provided on the fuse panel.

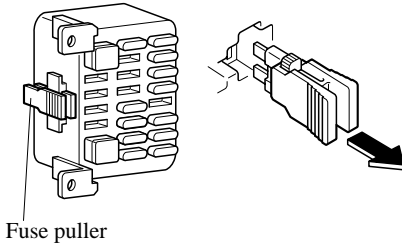

4. Inspect it and replace if it's blown.

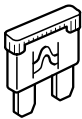

Normal



Blown

5. Push in a new fuse of the same rating, and make sure it fits tightly. If it doesn't, have an Authorized Mazda Dealer install it.

If you have no spare fuses, borrow one of the same rating from a circuit not essential to vehicle operation, such as the RADIO circuit.

## ⚠ CAUTION

Always replace a fuse with one of the same rating. Otherwise you may damage the electric system.

If the headlights or other electrical components don't work and the fuses in the cabin are OK, inspect the fuse block under the hood. If a fuse is blown, it must be replaced. Follow these steps:

1. Turn off the ignition switch and all other switches.
2. Remove the fuse block cover.

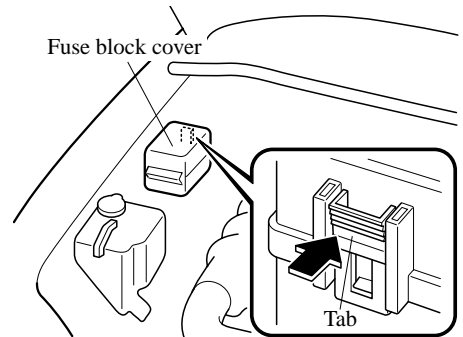

3. If a fuse is blown, replace it with a new one **of the same rating**.

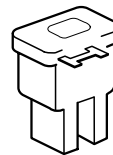

Normal

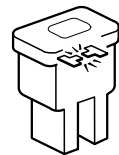

Blown

## NOTE

To replace the MAIN fuse, contact an Authorized Mazda Dealer (page 8-38).

# Owner Maintenance

## ▼ Fuse Panel Description

### Fuse block (Engine compartment)

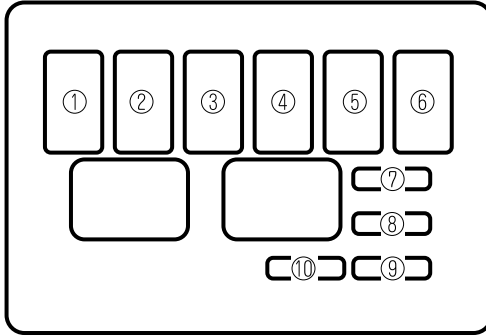

DESCRIPTION		FUSE RATING	PROTECTED COMPONENT
1	HEAD	40A	Headlights, Rear defroster, Auto antenna
2	FUEL INJ	30A	Fuel injection
3	MAIN	100A	For protection of all circuits
4	IG KEY	60A	All ignition related circuits
5	BLOWER	30A	Blower motor
6	FAN	30A <sup>*1</sup>	Cooling fan, Additional fan (air conditioner)
		40A <sup>*2</sup>	
7	BTN 1	30A	Taillights, Dashboard illumination
8	BTN 2	20A	Audio amp <sup>*</sup> , Turn signal lights
9	ABS	20A	Antilock brake system <sup>*</sup>
10	STOP	15A	Brake lights, Horn, Shift lock

<sup>\*1</sup> MX-5/miata

<sup>\*2</sup> MAZDASPEED MX-5

# Owner Maintenance

## Fuse panel (Driver's side)

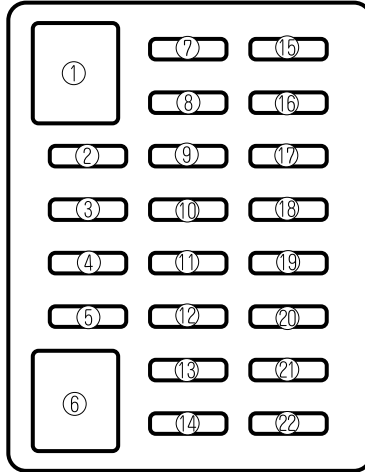

DESCRIPTION	FUSE RATING	PROTECTED COMPONENT
1 AD FAN* <sup>1</sup>	20A	Add fan motor, Magnet clutch
2 HEAD.LH	15A	Headlights (LH)
3 HEAD.RH	15A	Headlights (RH)
4 —	—	—
5 ST.SIG	7.5A	Instrument cluster, Cruise control*
6 FAN* <sup>2</sup>	30A	Cooling fan, Additional fan (air conditioner)
7 CIGAR	20A	Cigar lighter
8 RADIO	10A	Audio*
9 F.FOG	15A	Fog lights*
10 TAIL	15A	Taillights, Front parking lights, Side-marker lights
11 ENGINE	15A	Engine control system
12 METER	15A	Instrument cluster

DESCRIPTION	FUSE RATING	PROTECTED COMPONENT
13 TURN	7.5A	Turn signal lights
14 A/B	10A	Supplemental restraint system, Antilock brake system*
15 WIPER	20A	Windshield wipers and washer
16 P.WIND	30A	Power windows
17 A/C	7.5A	Air conditioner*
18 HAZARD	10A	Turn signal lights
19 D.LOCK	10A	Power door lock*
20 AUDIO	20A	Audio amp*
21 DEFOG	15A	Rear defroster
22 ROOM	10A	Interior light, Auto antenna, Warning buzzers

\*<sup>1</sup> MX-5/miata

\*<sup>2</sup> MAZDASPEED MX-5

\*Some models.

# Appearance Care

---

## How to Minimize Environmental Paint Damage

The paintwork on your Mazda represents the latest technical developments in composition and methods of application.

Environmental hazards, however, can harm the paint's protective properties, if proper care is not taken.

Here are some examples of possible damage, with tips on how to prevent them.

### ▼ Etching Caused by Acid Rain or Industrial Fallout

#### Occurrence

Industrial pollutants and vehicle emissions drift into the air and mix with rain or dew to form acids. These acids can settle on a vehicle's finish. As the water evaporates, the acid becomes concentrated and can damage the finish.

And the longer the acid remains on the surface, the greater the chance is for damage.

#### Prevention

It is necessary to wash and wax your vehicle to preserve its finish according to the instructions in this section. These steps should be taken immediately after you suspect that acid rain has settled on your vehicle's finish.

### ▼ Damage Caused by Bird Dropping, Insects, or Tree Sap

#### Occurrence

Bird droppings contain acids. If these aren't removed they can eat away the clear and color base coat of the vehicle's paintwork.

When insects stick to the paint surface and decompose, corrosive compounds form. These can erode the clear and color base coat of the vehicle's paintwork if they are not removed.

Tree sap will harden and adhere permanently to the paint finish. If you scratch the sap off while it is hard, some vehicle paint could come off with it.

#### Prevention

It is necessary to have your Mazda washed and waxed to preserve its finish according to the instructions in this section. This should be done as soon as possible.

Bird droppings can be removed with a soft sponge and water. If you are traveling and these are not available, a moistened tissue may also take care of the problem. The cleaned area should be waxed according to the instructions in this section. Insects and tree sap are best removed with a soft sponge and water or a commercially available chemical cleaner.

Another method is to cover the affected area with dampened newspaper for one to two hours. After removing the newspaper, rinse off the loosened debris with water.

## ▼ Water Marks

### Occurrence

Rain, fog, dew, and even tap water can contain harmful minerals such as salt and lime. If moisture containing these minerals settles on the vehicle and evaporates, the minerals will concentrate and harden to form white rings. The rings can damage your vehicle's finish.

### Prevention

It is necessary to wash and wax your vehicle to preserve its finish according to the instructions in this section. These steps should be taken immediately after you find water marks on your vehicle's finish.

## ▼ Paint Chipping

### Occurrence

Paint chipping occurs when gravel thrown in the air by another vehicle's tires hits your vehicle.

### How to avoid paint chipping

Keeping a safe distance between you and the vehicle ahead reduces the chances of having your paint chipped by flying gravel.

### **NOTE**

- The paint chipping zone varies with the speed of the vehicle. For example, when traveling at 90 km/h (56 mph), the paint chipping zone is 50 m (164 ft).
- In low temperatures a vehicle's finish hardens. This increases the chance of paint chipping.
- Chipped paint can lead to rust forming on your Mazda. Before this happens, repair the damage by using Mazda touch-up paint according to the instructions in this section. Failure to repair the affected area could lead to serious rusting and expensive repairs.

# Appearance Care

---

## Exterior Care

Follow **all** label and container directions when using a chemical cleaner or polish. Read all warnings and cautions.

### ▼ Maintaining the Finish

#### Washing

To help protect the finish from rust and deterioration, wash your Mazda thoroughly and frequently, at least once a month, with lukewarm or cold water.

If the vehicle is washed improperly, the paint surface could be scratched. Here are some examples of how scratching could occur.

Scratches occur on the paint surface when:

- The vehicle is washed without first rinsing off dirt and other foreign matter.
- The vehicle is washed with a rough, dry, or dirty cloth.
- The vehicle is washed at a car wash that uses brushes that are dirty or too stiff.
- Cleansers or wax containing abrasives are used.

#### NOTE

- Mazda is not responsible for scratches caused by automatic car washes or improper washing.
- Scratches are more noticeable on vehicles with darker paint finishes.

To minimize scratches on the vehicle's paint finish:

- Rinse off any dirt or other foreign matter using lukewarm or cold water before washing.
- Use plenty of lukewarm or cold water and a soft cloth when washing the vehicle. Do not use a nylon cloth.
- Rub gently when washing or drying the vehicle.
- Take your vehicle only to a car wash that keeps its brushes well maintained.
- Don't use abrasive cleansers or wax that contain abrasives.

#### CAUTION

- Don't use steel wool, abrasive cleaners, or strong detergents containing highly alkaline or caustic agents on chrome-plated or anodized aluminum parts. This may damage the protective coating; also, cleaners and detergents may discolor or deteriorate the paint.
- To prevent damaging the antenna, retract it before entering a car wash facility or passing beneath a low overhead clearance.

## Appearance Care

Pay special attention to removing salt, dirt, mud, and other foreign material from the underside of the fenders, and make sure the drain holes in the lower edges of the doors and rocker panels are clean.

Insects, tar, tree sap, bird droppings, industrial fallout, and similar deposits can damage the finish if not removed immediately. When prompt washing with plain water is ineffective, use a mild soap made for use on vehicles.

Thoroughly rinse off all soap with lukewarm or cold water. Don't allow soap to dry on the finish.

After washing the vehicle, dry it with a clean chamois to prevent water spots from forming.

### **WARNING**

**Driving with Wet Brakes:**  
***Driving with wet brakes is dangerous. Increased stopping distance or the vehicle pulling to one side when braking could result in a serious accident. Light braking will indicate whether the brakes have been affected. Dry the brakes by driving very slowly and applying the brakes lightly until brake performance is normal.***

### **Waxing**

Your vehicle needs to be waxed when water no longer beads on the finish. Always wash and dry the vehicle before waxing it. In addition to the vehicle body, wax the metal trim to maintain its luster.

1. Use wax which contains no abrasives. Waxes containing abrasive will remove paint and could damage bright metal parts.
2. Use a good grade of natural wax for metallic, mica, and solid colors.
3. When waxing, coat evenly with the sponge supplied or a soft cloth.
4. Wipe off the wax with a soft cloth.

### **NOTE**

A spot remover to remove oil, tar, and similar materials will usually also take off the wax. Rewax these areas even if the rest of the vehicle doesn't need it.

### **▼ Repairing Damage to the Finish**

Deep scratches or chips on the finish should be repaired promptly. Exposed metal quickly rusts and can lead to major repairs.

### **CAUTION**

If your Mazda is damaged and needs metal parts repaired or replaced, make sure the body shop applies anti-corrosion materials to all parts, both repaired and new. This will prevent them from rusting.

# Appearance Care

---

## ▼ Bright-Metal Maintenance

- Use tar remover to remove road tar and insects. Never do this with a knife or similar tool.
- To prevent corrosion on bright-metal surfaces, apply wax or chrome preservative and rub it to a high luster.
- During cold weather or in coastal areas, cover bright-metal parts with a coating of wax or preservative heavier than usual. It would also help to coat them with noncorrosive petroleum jelly or some other protective compound.

### CAUTION

Don't use steel wool, abrasive cleaners, or strong detergents containing highly alkaline or caustic agents on chrome-plated or anodized aluminum parts. This may result in damage to the protective coating and cause discoloration or paint deterioration.

## ▼ Underbody Maintenance

Road chemicals and salt used for ice and snow removal and solvents used for dust control may collect on the underbody. If not removed, they will speed up rusting and deterioration of such underbody parts as fuel lines, frame, floor pan, and exhaust system, even though these parts may be coated with anti-corrosive material.

Thoroughly flush the underbody and wheel housings with lukewarm or cold water at the end of each winter. Try also to do this every month.

Pay special attention to these areas because they easily hide mud and dirt. **It will do more harm than good to wet down the road grime without removing it.**

The lower edges of doors, rocker panels, and frame members have drain holes that should not be clogged. Water trapped there will cause rusting.

### WARNING

***Driving with Wet Brakes:***  
***Driving with wet brakes is dangerous. Increased stopping distance or the vehicle pulling to one side when braking could result in a serious accident. Light braking will indicate whether the brakes have been affected. Dry the brakes by driving very slowly and applying the brakes lightly until brake performance is normal.***



## Appearance Care

### ▼ Aluminum Wheel Maintenance

A protective coating is provided over the aluminum wheels. Special care is needed to protect this coating.

#### NOTE

- Don't use a wire brush or any abrasive cleaner, polishing compound, or solvent on aluminum wheels. They may damage the coating.
- Only use a mild soap or neutral detergent and always use a sponge or soft cloth to clean the wheels. Rinse thoroughly with lukewarm or cold water. Also, be sure to clean the wheels after driving on dusty or salted roads. This helps prevent corrosion.
- Avoid washing your vehicle in an automatic car wash that uses high-speed or hard brushes.
- If your aluminum wheels lose luster, wax the wheels.

### ▼ Convertible Top Maintenance

The convertible top is made of a special high-grade material, but if it's not taken good care of, hardening, staining, and loss of luster will result. Maintain it under these guidelines.

#### Washing

Don't wait until the top gets really dirty before cleaning it. Dirt that's there too long will cause deterioration.

1. Before washing, remove dust and coarse particulate with a soft brush.
2. Gently clean the top with a synthetic neutral detergent, lots of water, and a soft brush.
3. Rinse it thoroughly with clean water to remove all the soap.
4. Wipe it as dry as you can before the water dries on it.
5. Then allow it to dry completely before lowering it.

#### CAUTION

- Automatic and high-pressure car washes are harmful to a convertible top. Avoid them.
- Don't spray water directly on the area where the window glass and the top meet. This would probably cause water to enter the cabin.

# Appearance Care

---

## Appearance(Polyvinyl only)

Dress the top once a month after washing and drying it well. For best results, use a water-based leather treatment or vinyl top dressing. This will help maintain good appearance and material condition of the top.

### CAUTION

- Some leather treatment products can ruin the top's gloss. Be careful of the one you choose.
- Test on an inconspicuous, small corner of the top if you are not sure.
- Don't get any car wax on the top. If you do, remove it with a good leather cleaner.
- Too much treatment on the top can be as damaging as too little. Follow the manufacturer's directions. Don't overdo it!
- Let the top dry completely before lowering after applying treatment or dressing.

## ▼ Detachable Hardtop Maintenance\*

### Washing

To help protect the hardtop's finish, use a soft cloth or sponge to wash it. Insects, tar, tree sap, bird droppings, industrial fallout, and similar deposits can damage the finish if they are not removed immediately. When prompt washing with plain water is ineffective use a mild soap made for use on vehicles.

### CAUTION

- Don't use an automatic car wash.
- Don't use strong soap, chemical detergents, or hot water, and don't wash the hardtop in direct sunlight or when the surface is warm.

Thoroughly rinse with lukewarm or cold water. Don't allow soap to dry on the finish.

### Waxing

Wax the hardtop when water no longer beads on the paint. Always wash and dry it before waxing.

### CAUTION

- Wiping off dust or dirt with a dry cloth will scratch the finish.
- Don't use abrasive wax. This may damage the protective coating and discolor or deteriorate the paint.

### NOTE

A spot remover to remove oil, tar, and similar materials will usually also take off the wax. Rewax these areas.

# Appearance Care

## Interior Care

### ▼ Dashboard Precautions

Prevent caustic solutions such as perfume and cosmetic oils from contacting the dashboard. They'll damage and discolor it. If these solutions get on the dashboard, wipe them off immediately.

#### CAUTION

Do not use glazing agents. Glazing agents contain ingredients which may cause discoloration, wrinkling, cracks and peeling.

### ▼ Cleaning the Upholstery and Interior Trim

#### Vinyl

Remove dust and loose dirt from vinyl with a whisk broom or vacuum cleaner. Clean vinyl with a leather-and-vinyl cleaner.

#### Leather\*

Real leather isn't uniform and may have scars, scratches, and wrinkles. Clean it with a leather cleaner or mild soap.

If the leather gets wet from rain, remove the moisture as soon as possible and dry in a shaded area.

If the seats get wet, promptly remove moisture with a dry cloth and allow it to further dry in a shaded area.

If moisture is not removed, it will cause hardening and shrinkage of the leather. Do not leave vinyl products on the seats for long periods as they may affect the leather quality and coloring.

### Fabric

Remove dust and loose dirt from fabric with a whisk broom or vacuum cleaner. Clean it with a mild soap solution good for upholstery and carpets. Remove fresh spots immediately with a fabric spot cleaner.

To keep the fabric looking clean and fresh, take care of it. Otherwise its color will be affected, it can be stained easily, and its fire-resistance may be reduced.

#### CAUTION

Use only recommended cleaners and procedures. Others may affect appearance and fire-resistance.

### ▼ Cleaning the Lap/Shoulder Belt Webbing

Clean the webbing with a mild soap solution recommended for upholstery or carpets. Follow instructions. Don't bleach or dye the webbing; this may weaken it.

After cleaning the belts, thoroughly dry the belt webbing and make sure there is no remaining moisture before retracting them.

#### WARNING

**Damaged Seat Belt:**  
*Using damaged seat belts is dangerous. In a collision, damaged belts cannot provide adequate protection. Have an Authorized Mazda Dealer replace damaged belts immediately.*

# Appearance Care

---

## ▼ Cleaning the Window Interiors

If the windows become covered with an oily, greasy, or waxy film, clean them with glass cleaner. Follow the directions on the container.

 <b>CAUTION</b>
--

Don't scrape or scratch the inside of the rear window. You may damage the rear window defroster grid.
---

# Customer Information and Reporting Safety Defects

Important consumer information including warranties and add-on equipment.

<b>Customer Assistance</b> .....	9-2
Customer Assistance (U.S.A.) .....	9-2
Customer Assistance (Canada) .....	9-4
Customer Assistance (Puerto Rico) .....	9-7
<b>Mazda Importer/Distributors</b> .....	9-8
Importer/Distributor .....	9-8
Distributor in Each Area .....	9-8
<b>Warranty</b> .....	9-9
Warranties for Your Mazda .....	9-9
Outside the United States .....	9-10
Outside Canada .....	9-11
Add-On Non-Genuine Parts and Accessories .....	9-12
<b>Cell Phones</b> .....	9-13
Cell Phones Warning .....	9-13
<b>Uniform Tire Quality Grading System (UTQGS)</b> .....	9-14
Uniform Tire Quality Grading System (UTQGS) .....	9-14
<b>Reporting Safety Defects</b> .....	9-16
Reporting Safety Defects .....	9-16
<b>Service Publications</b> .....	9-17
Service Publications .....	9-17

# Customer Assistance

---

## Customer Assistance (U.S.A.)

Your complete and permanent satisfaction is our business. We are here to serve you. All Authorized Mazda Dealers have the knowledge and the tools to keep your Mazda vehicle in top condition.

If you have any questions or recommendations for improvement regarding the service of your Mazda vehicle or servicing by Mazda Dealer personnel, we recommend that you take the following steps:

### ▼ STEP 1: Contact Your Mazda Dealer

Discuss the matter with an Authorized Mazda Dealer. This is the quickest and best way to address the issue. If your concern has not been resolved by the CUSTOMER RELATIONS, SALES, SERVICE, or PARTS MANAGER, then please contact the GENERAL MANAGER of the dealership or the OWNER.

### ▼ STEP 2: Contact Mazda North American Operations

If for any reason you feel the need for further assistance after contacting your dealership management, you can reach Mazda North American Operations by one of three ways.

**Log on at: [www.mazdausa.com](http://www.mazdausa.com)**

**Answers to many questions, including how to locate or contact a local Mazda dealership in the U.S., can be found here. You can also send e-mail to Mazda by clicking "contact" at this site.**

By phone at: 1 (800) 222-5500

By letter at:

Attn: Customer Assistance

Mazda North American Operations

7755 Irvine Center Drive

Irvine, CA 92618-2922

P.O. Box 19734

Irvine, CA 92623-9734

## Customer Assistance

---

In order to serve you efficiently and effectively, please help us by providing the following information:

1. Your name, address, and telephone number
2. Year and model of vehicle
3. Vehicle Identification Number (17 digits, noted on your registration or title or located on the upper driver's side corner of the dash)
4. Purchase date and current mileage
5. Your dealer's name and location
6. Your question(s)

If you live outside the U.S.A., please contact your nearest Mazda Distributor.

# Customer Assistance

---

## Customer Assistance (Canada)

### ▼ Satisfaction Review Process

Your complete and permanent satisfaction is of primary concern to Mazda. All Authorized Mazda Dealers have both the knowledge and tools to keep your Mazda in top condition. In our experience, any questions, problems, or complaints regarding the operation of your Mazda or any other general service transactions are most effectively resolved by your dealer. If the cause of your dissatisfaction cannot adequately be addressed by normal dealership procedures, we recommend that you take the following steps:

### ▼ STEP 1: Contact the Mazda Dealer

Discuss the matter with a member of dealership management. If the Service Manager has already reviewed your concerns, contact the owner of the dealership or its General Manager.

### ▼ STEP 2: Contact the Mazda Regional Office

If you feel that you still require assistance, ask the dealer Service Manager to arrange for you to meet the local Mazda Service Representative. If more expedient, contact Mazda Canada Inc. Regional Office nearest you for such arrangements. Regional Office address and phone numbers are shown (page 9-6).

### ▼ STEP 3: Contact the Mazda Customer Relations Department

If still not substantially satisfied, contact the Customer Relations Department, Mazda Canada Inc., 305 Milner Avenue, Suite 400 Scarborough, Ontario M1B 3V4 Canada TEL:1 (800) 263-4680.

Provide the Department with the following information:

1. Your name, address and telephone number
2. Year and model of vehicle
3. Vehicle Identification Number (VIN). Refer to the "Vehicle Identification Labels" page of section 10 of this manual for the location of the VIN.
4. Purchase date
5. Present odometer reading
6. Your dealer's name and location
7. The nature of your problem and/or cause of dissatisfaction

The Department, in cooperation with the local Mazda Service Representative, will review the case to determine if everything possible has been done to ensure your satisfaction.



## Customer Assistance

---

Please recognize that the resolution of service problems in most cases requires the use of your Mazda dealer's service facilities, personnel and equipment. We urge you to follow the above three steps in sequence therefore for most effective results.

### ▼ Mediation/Arbitration Program

Occasionally a customer concern cannot be resolved through Mazda's Customer Satisfaction Program. If after exhausting the procedures in this manual your concern is still not resolved, you have another option.

Mazda Canada Inc. participates in an arbitration program administered by the Canadian Motor Vehicle Arbitration Plan (CAMVAP). CAMVAP will advise you about how your concern may be reviewed and resolved by an independent third party through binding arbitration.

Your complete satisfaction is the goal of Mazda Canada Inc. and our dealers. Mazda's participation in CAMVAP makes a valuable contribution to our achieving that goal. There is no charge for using CAMVAP. CAMVAP results are fast, fair and final as the award is binding on both you and Mazda Canada Inc.

### ▼ Canadian Motor Vehicle Arbitration Plan (CAMVAP)

If a specific item of concern arises, where a solution cannot be reached between an owner, Mazda, and/or one of its dealers (that all parties cannot agree upon), the owner may wish to use the services offered by the Canadian Motor Vehicle Arbitration Plan (CAMVAP).

CAMVAP uses the services of Provincial Administrators to assist consumers in scheduling and preparing for their arbitration hearings. However, before you can proceed with CAMVAP you must follow your Mazda dispute resolution process as outlined previously.

CAMVAP is fully implemented in all provinces and territories.

Consumers wishing to obtain further information about the Program can obtain an information booklet from your dealer, the Provincial Administrator or the Canadian Motor Vehicle Arbitration Plan Office at the following address or telephone number.

Canadian Motor Vehicle Arbitration Office  
235 Yorkland Boulevard, suite 300  
North York, Ontario  
M2J 4Y8  
1 (800) 207-0685

# Customer Assistance

Provincial Administrators may be reached locally as listed below:

Province/Territory	CAMVAP Number
British Columbia & Yukon Territories	(604) 681-0312
Alberta & Northwest Territories	(403) 426-0650
Saskatchewan	(306) 352-9259
Manitoba	(204) 942-7166
Ontario	(416) 596-8824
Atlantic Canada	(902) 422-5413
Quebec	(418) 649-1330

## ▼ Regional Offices

REGIONAL OFFICES	AREAS COVERED
MAZDA CANADA INC. WESTERN REGION 8171 ACKROYD ROAD SUITE 2000 RICHMOND B.C. V6X 3K1 (604) 303-5670	ALBERTA, BRITISH COLUMBIA, MANITOBA, SASKATCHEWAN, YUKON
MAZDA CANADA INC. CENTRAL/ATLANTIC REGION 305 MILNER AVENUE SUITE 400 SCARBOROUGH, ONTARIO M1B 3V4 1 (800) 263-4680	ONTARIO, NEW BRUNSWICK, NOVA SCOTIA, PRINCE EDWARD ISLAND, NEWFOUNDLAND
MAZDA CANADA INC. QUEBEC REGION 6111 ROUTE TRANS CANADIENNE POINTE CLAIRE, QUEBEC H9R 5A5 (514) 694-6390	QUEBEC

### Customer Assistance (Puerto Rico)

Your complete and permanent satisfaction is our business. That is why all Authorized Mazda Dealers have the knowledge and the tools to keep your Mazda vehicle in top condition.

If you have any questions or recommendations for improvement regarding the service of your Mazda vehicle or servicing by Mazda Dealer personnel, we recommend that you take the following steps:

#### ▼ STEP 1

Discuss the matter with an Authorized Mazda Dealer. This is the quickest and best way to address the issue. If your concern has not been resolved by the CUSTOMER RELATIONS, SALES, SERVICE, or PARTS MANAGER, then please contact the GENERAL MANAGER of the dealership or the OWNER.

#### ▼ STEP 2

If, after following STEP 1, you feel the need for further assistance, please contact your area's Mazda representative (Indicated on the next page).

Please help us by providing the following information:

1. Your name, address, and telephone number
2. Year and model of vehicle
3. Vehicle Identification Number (17 digits, noted on your registration or title or located on the upper driver's side corner of the dash)
4. Purchase date and current mileage
5. Your dealer's name and location
6. Your question(s)

# Mazda Importer/Distributors

---

## Importer/Distributor

### ▼ U.S.A.

#### **Mazda North American Operations**

7755 Irvine Center Drive  
Irvine, CA 92618-2922 U.S.A.  
P.O. Box 19734  
Irvine, CA 92623-9734 U.S.A.  
TEL: 1 (800) 222-5500 (in U.S.A.)  
(949) 727-1990 (outside U.S.A.)

## Distributor in Each Area

### ▼ CANADA

#### **Mazda Canada Inc.**

305 Milner Avenue, Suite 400  
Scarborough, Ontario M1B 3V4 Canada  
TEL: 1 (800) 263-4680 (in Canada)  
(416) 609-9909 (outside Canada)

### ▼ PUERTO RICO

#### **Plaza Motors Corp. (Mazda de Puerto Rico)**

P.O. Box 362722, San Juan, Puerto Rico  
00936-2722  
TEL: (787) 641-9300

### ▼ GUAM

#### **Triple J Motors**

157 South Marine Drive, Tamuning,  
GUAM 96911 USA  
P.O. Box 6066 Tamuning, Guam 96931  
TEL: (671) 649-6555

### ▼ SAIPAN

#### **Pacific International Marianas, Inc. (d.b.a. Midway Motors)**

P.O. Box 887 Saipan, MP 96950  
TEL: (670) 234-7524

#### **Triple J Saipan, Inc.**

**(d.b.a. Triple J Motors)**  
P.O. Box 500487 Saipan, MP 96950-0487  
TEL: (670) 234-7133/3051

### ▼ AMERICAN SAMOA

#### **Polynesia Motors, Inc.**

P.O. Box 1120, Pago Pago, American  
Samoa 96799  
TEL: (684) 699-9347

## Warranties for Your Mazda

- New Vehicle Limited Warranty
- Distributor Major Component Limited Warranty (Canada only)
- Safety Restraint System Limited Warranty
- Anti-perforation Limited Warranty
- Federal Emission Control Warranty (U.S.A. only)
  - Emission Defect Warranty
  - Emission Performance Warranty
- California Emission Control Warranty (U.S.A. only)
- Emission Control Warranty (Canada only)
- Replacement Parts and Accessories Limited Warranty
- Tire Warranty

<b>NOTE</b>
Detailed warranty information is provided with your Mazda.

# Warranty

---

## Outside the United States

Government regulations in the United States require that automobiles meet specific emission regulations and safety standards. Therefore, vehicles built for use in the United States may differ from those sold in other countries.

The differences may make it difficult or even impossible for your vehicle to receive satisfactory servicing in other countries. We strongly recommend that you NOT take your Mazda outside the United States. However, in the event that you are moving to Canada permanently, Mazda vehicles built for use in the United States could be eligible for exportation to Canada with specific vehicle modifications to comply with the Canadian Motor Vehicle Safety requirements (CMVSS).

<b>NOTE</b>
The above is applicable for a permanent import/export situation and not related to travelers on vacation.

You may have the following problems if you do take your vehicle outside of the United States:

- Recommended fuel may be unavailable. Any kind of leaded fuel or low-octane fuel will affect vehicle performance and damage the emission controls and engine.
- Proper repair facilities, tools, testing equipment, and replacement parts may not be available.

Please refer to your Manufacturer's Warranty Booklet for more information.

## Outside Canada

Government regulations in Canada require that automobiles meet specific emission regulations and safety regulations. Therefore, vehicles built for use in Canada may differ from those sold in other countries.

The differences may make it difficult or even impossible for your vehicle to receive satisfactory servicing in other countries. We strongly recommend that you NOT take your Mazda outside Canada. However, in the event that you are moving to the United States permanently, Mazda vehicles built for use in Canada could be eligible for exportation to the United States with specific vehicle modifications to comply with the United States Federal Motor Vehicle Safety Standards (FMVSS).

**NOTE**

The above is applicable for a permanent import/export situation and not related to travelers on vacation.

You may have the following problems if you do take your vehicle outside of Canada:

- Recommended fuel may be unavailable. Any kind of leaded fuel or low-octane fuel will affect vehicle performance and damage the emission controls and engine.
- Proper repair facilities, tools, testing equipment, and replacement parts may not be available.

Please refer to your Manufacturer's Warranty Booklet for more information.

# Warranty

---

## Add-On Non-Genuine Parts and Accessories

Non-genuine parts and accessories for Mazda vehicles can be found in stores. These may fit your vehicle, but they are not approved by Mazda for use with Mazda vehicles. When you install non-genuine parts or accessories, they could affect your vehicle's performance or safety system; the Mazda warranty doesn't cover this. Before you install any non-genuine parts or accessories, consult an Authorized Mazda Dealer.

### **WARNING**

**Installation of Non-Genuine Parts or Accessories:**

***Installation of non-genuine parts or accessories is dangerous. Improperly designed parts or accessories could seriously affect your vehicle's performance or safety system. This could cause you to have an accident or increase your chances of injuries in an accident. Always consult an Authorized Mazda Dealer before you install non-genuine parts or accessories.***

**Add-On Electrical and Electronic Equipment:**

***Incorrectly choosing or installing improper add-on equipment or choosing an improper installer is dangerous. Essential systems could be damaged, causing engine stalling, air-bag (SRS) activation, ABS inactivation, or a fire in the vehicle. Be very careful in choosing and installing add-on electrical equipment, such as mobile telephones, two-way radios, stereo systems, and car alarm systems.***

Mazda assumes no responsibility for death, injury, or expenses that may result from the installation of add-on non-genuine parts or accessories.



**Cell Phones Warning** **WARNING****Use of Cell Phones and Other Devices by Driver:**

*Use of any electrical devices such as cell phones, computers, portable radios, vehicle navigation or other devices by the driver while the vehicle is moving is dangerous.*

*Dialing a number on a cell phone while driving also ties-up the driver's hands. Use of these devices will cause the driver to be distracted and could lead to a serious accident.*

*If a passenger is unable to use the device, pull off the right-of-way to a safe area before use. If use of a cell phone is necessary despite this warning, use a hands-free system to at least leave the hands free to drive the vehicle. Never use a cell phone or other electrical devices while the vehicle is moving and, instead, concentrate on the full-time job of driving.*

*Please comply to the legal regulations concerning the use of communication equipment in vehicles in your country.*

# Uniform Tire Quality Grading System (UTQGS)

---

## Uniform Tire Quality Grading System (UTQGS)

This information relates to the tire grading system developed by the U.S. National Highway Traffic Safety Administration for grading tires by tread wear, traction, and temperature performance.

### ▼ Tread Wear

The tread wear grade is a comparative rating based on the wear rate of the tire when tested under controlled conditions on a specified government test course.

For example, a tire graded 150 would wear one-and-a-half times as well on the government course as a tire graded 100.

The relative performance of tires depends upon the actual conditions of their use, however, and may depart significantly from the norm because of variations in driving habits, service practices and differences in road characteristics and climate.

### ▼ Traction-AA, A, B, C

The traction grades, from highest to lowest, are AA, A, B, and C. These grades represent the tire's ability to stop on wet pavement as measured under controlled conditions on specified government test surfaces of asphalt and concrete. A tire marked C may have poor traction performance.

## **WARNING**

*The traction grade assigned to this tire is based on braking (straight ahead) traction tests and does not include acceleration cornering (turning), hydroplaning, or peak traction characteristics.*

### ▼ Temperature-A, B, C

The temperature grades A (the highest), B, and C, represent the tire's resistance to the generation of heat and its ability to dissipate heat when tested under controlled conditions on a specified indoor laboratory test wheel.

Sustained high temperature can cause the material of the tire to degenerate and reduce tire life, and excessive temperatures can lead to sudden tire failure.

Grade C corresponds to a level of performance which all passenger vehicle tires must meet under the Federal Motor Vehicle Safety Standard No. 109. Grades B and A represent higher levels of performance on the laboratory test wheel than the minimum required by law.

# Uniform Tire Quality Grading System (UTQGS)

## **WARNING**

*The temperature grade for this tire is established for a tire that is properly inflated and not overloaded. Excessive speed, underinflation, or excessive loading, either separately or in combination, can cause heat buildup and possible tire failure.*

These grades will be added to the sidewalls of passenger vehicle tires over the next several years according to a schedule established by the NHTSA and the tire manufacturers.

The grade of tires available as standard or optional equipment on Mazda vehicle may vary with respect to grade.

**ALL PASSENGER VEHICLE TIRES MUST CONFORM TO THESE GRADES AND TO ALL OTHER FEDERAL TIRE-SAFETY REQUIREMENTS.**

### ▼ Uniform Tire Quality Grading

Quality grades can be found where applicable on the tire sidewall between tread shoulder and maximum section width.

For example:

**Treadwear 200 Traction AA Temperature A**

**UTQGS MARK (example)**

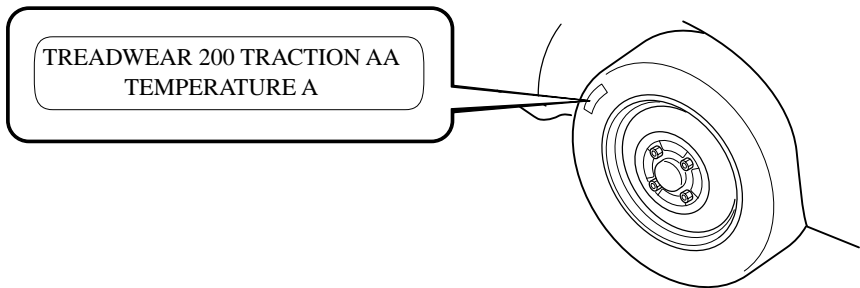

# Reporting Safety Defects

---

## Reporting Safety Defects

If you believe that your vehicle has a defect which could cause a crash or could cause injury or death, you should immediately inform the National Highway Traffic Safety Administration (NHTSA) in addition to notifying Mazda Motor Corporation (Your Mazda Importer/Distributor).

If NHTSA receives similar complaints, it may open an investigation, and if it finds that a safety defect exists in a group of vehicles, it may order a recall and remedy campaign. However, NHTSA cannot become involved in individual problems between you, your dealer, or Mazda Motor Corporation (Your Mazda Importer/Distributor).

To contact NHTSA, you may either call the Auto Safety Hotline toll-free at 1 (800) 424-9393 (or 366-0123 in Washington, D.C. area) or write to: NHTSA, U.S. Department of Transportation, Washington, D.C. 20590. You can also obtain other information about motor vehicle safety from the Hotline.

<p><b>NOTE</b></p> <p>If you live in the U.S.A., all correspondence to Mazda Motor Corporation should be forwarded to:</p> <p>Mazda North American Operations 7755, Irvine Center Drive Irvine, California 92618-2922 P.O. Box 19734 Irvine, CA 92623-9734 Customer Assistance Center or toll free at 1 (800) 222-5500</p> <p>If you live outside of the U.S.A., please contact the nearest Mazda Distributor shown (page 9-8) in this booklet.</p>
---

## Service Publications

### Service Publications

Factory-authorized Mazda service publications are available for owners who wish to do some of their own maintenance and repair.

When requesting any of our publications through an Authorized Mazda Dealer, refer to the chart below.

If they don't have what you need in stock, they can order it for you.

PUBLICATION ORDER NUMBER	PUBLICATION DESCRIPTION
9999-95-042B-04S	2004 WORKSHOP MANUAL (English)
9999-95-026G-04	2004 WIRING DIAGRAM (English)
9999-95-031C-04R1 (U.S.A. only)	2004 OWNER'S MANUAL
9999-EC-031C-04R1 (Canada only)	2004 OWNER'S MANUAL

#### ▼ WORKSHOP MANUAL:

Covers recommended maintenance and repair procedures of the drive train, body and chassis.

#### ▼ WIRING DIAGRAM:

Provides electrical schematics as well as component location for the entire electrical system.

#### ▼ OWNER'S MANUAL:

This booklet contains information regarding the proper care and operation of your vehicle. This is not a technician's manual.



# 10

## Specifications

Technical information about your Mazda.

- Identification Numbers** ..... 10-2
  - Vehicle Information Labels ..... 10-2
  
- Specifications** ..... 10-4
  - Specifications ..... 10-4

# Identification Numbers

---

## Vehicle Information Labels

### ▼ Vehicle Identification Number

The vehicle identification number legally identifies your vehicle. The number is on a plate attached to the left top side of the dashboard. This plate can easily be seen through the windshield.

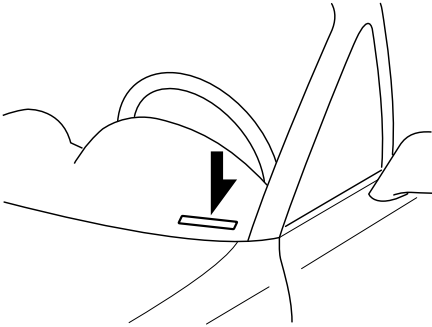

### ▼ Motor Vehicle Safety Standard Label

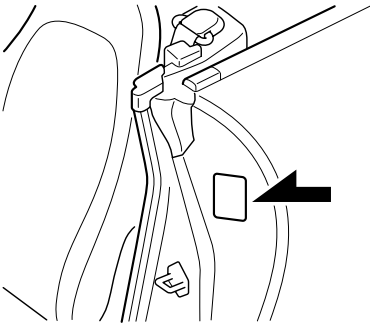

### ▼ Chassis Number

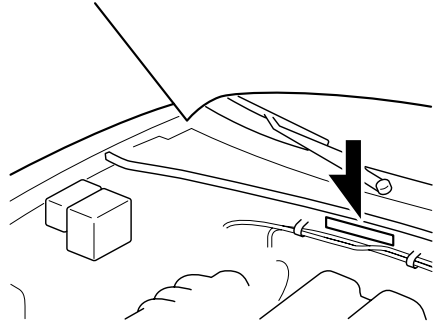

### ▼ Vehicle Emission Control Information Label

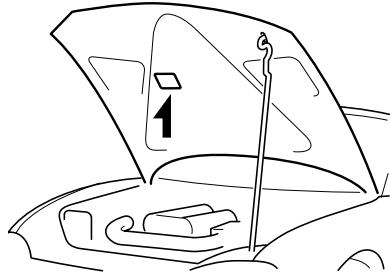

### ▼ Tire Pressure Label

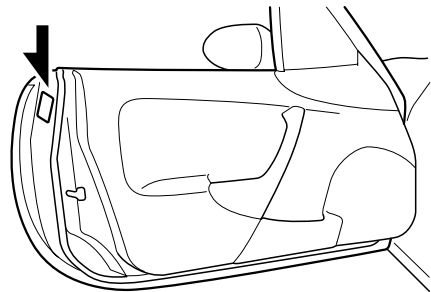



## ▼ Engine Number

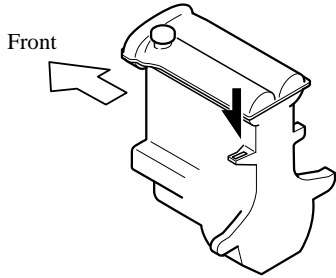

# Specifications

## Specifications

### ▼ Engine

Item		Specification
Type		DOHC-16V in-line, 4-cylinder
Bore×Stroke		83.0 mm × 85.0 mm (3.3 × 3.4 in)
Displacement		1,840 ml (1,840 cc, 112.2 cu in)
Compression ratio	MX-5/miata	10.0
	MAZDASPEED MX-5	9.5

### ▼ Electrical System

Item			Specification
Battery			Maintenance-free, 12V-32AH/5HR
Alternator			12 V - 80 A
Starter			12 V - 1.0 kW
Spark-plug number	MX-5/miata	NGK	BKR5E11, BKR6E11
		DENSO	K16PR-U11, K20PR-U11
Spark-plug gap	MAZDASPEED MX-5	DENSO	SK16PR-F8
		MX-5/miata	1.0—1.1mm (0.040—0.043 in)
		MAZDASPEED MX-5	0.7—0.8mm (0.027—0.031 in)

### ▼ Lubricant Quality

Lubricant	Classification	
	API Service	ILSAC
Engine oil*	SG (Energy Conserving II)	—
	SH (Energy Conserving II)	GF-I
	SJ	GF-II
	SL	GF-III

\* Refer to the recommended SAE viscosity numbers on page 8-13 .

Lubricant	Classification		
		API Service	GL-4 or GL-5
Manual transmission oil	Any temperature	SAE	75W-90
		API Service	GL-4 or GL-5
	Above 10 °C (50 °F)	SAE	80W-90
		API Service	GL-4 or GL-5
Automatic transmission fluid	ATF M-III or equivalent (e.g. Dexron® III)		
Rear differential oil	API Service	GL-5	
	SAE	90	
Power steering fluid	ATF M-III or equivalent (e.g. Dexron® III)		
Brake/Clutch fluid	SAE J1703 or FMVSS116 DOT-3		

## ▼ Capacities

(Approximate Quantities)

Item		Unit		
		L	US qt	Imp qt
Engine oil	With oil filter	3.8	4	3.3
	Without oil filter	3.6	3.8	3.2
Coolant	MX-5/miata	6.0	6.3	5.3
	MAZDASPEED MX-5	6.2	6.6	5.5
Manual transmission oil	5-Speed transmission	2.0	2.1	1.8
	6-Speed transmission	1.8	1.9	1.6
Automatic transmission fluid		6.7	7.1	5.9
Rear differential oil	MX-5/miata	1.0	1.1	0.9
	MAZDASPEED MX-5	0.8	0.85	0.7
Fuel tank		48.0	12.7 (US gal)	10.6 (Imp gal)

Check oil and fluid levels with dipsticks or reservoir gauges.

## ▼ Dimensions

Item		Vehicle specification
Overall length	MX-5/miata	3,945 mm (155.3 in), 3,963 mm (156.0 in)*
	MAZDASPEED MX-5	3,964 mm (156.1 in), 3,983 mm (156.8 in)*
Overall width		1,678 mm (66.1 in)
Overall height		1,228 mm (48.4 in)
Front tread		1,415 mm (55.7 in)
Rear tread		1,440 mm (56.7 in)
Wheelbase		2,265 mm (89.2 in)

\* With license plate holder

## ▼ Weights

Item		Weight
GVWR (Gross Vehicle Weight Rating)		1,337 kg (2,948 lb)
GAWR (Gross Axle Weight Rating)	Front	685 kg (1,510 lb)
	Rear	675 kg (1,488 lb)

## ▼ Air Conditioner

Gas complies with SAE J639	Maximum operating charge
HFC134a (R134a)	0.4 kg (14.1 oz)

# Specifications

## ▼ Light Bulbs

### Exterior light

Light bulb		Wattage	Category	
			ECE R	SAE
Headlights	High beam	60	HB3	—
	Low beam	51	HB4	—
Front turn signal lights/Parking lights		27/8	—	#1157NA
Fog lights*		55	H11	—
Side-marker lights		3.8	—	#194
Rear turn signal lights		21	WY21W	—
Brake lights/Taillights		21/5	W21/5W	#7443
High-mount brake light		21	P21W	—
Reverse lights		21	W21W	#7440
License plate lights/Trunk lights		5	W5W	—

### Interior light

Light bulb	Wattage
Overhead light	8

## ▼ Tires

### NOTE

The tires have been optimally matched with the chassis of your vehicle. When replacing tires, Mazda recommends that you replace tires of the same type originally fitted to your vehicle. For details, contact an Authorized Mazda Dealer.

Check the tire pressure label for tire size and inflation pressure. Refer to Tire Inflation Pressure on page 8-28

### Standard tire

Tire size	Inflation pressure	
	Front	Rear
195/50 R15 82V	180 kPa (1.8 kgf/cm <sup>2</sup> , 26 psi)	180 kPa (1.8 kgf/cm <sup>2</sup> , 26 psi)
205/45 R16 83W		
205/40 R17 80W	200 kPa (2.0 kgf/cm <sup>2</sup> , 29 psi)	220 kPa (2.2 kgf/cm <sup>2</sup> , 32 psi)

### Temporary spare tire

Tire size	Inflation pressure
T115/70 D14 88M	420 kPa (4.2 kgf/cm <sup>2</sup> , 60 psi)
T105/70 D15 85M	420 kPa (4.2 kgf/cm <sup>2</sup> , 60 psi)

## ▼ Fuses

Refer to the fuse rating on page 8-36



# Index

---

## A

- Add-On Non-Genuine Parts and Accessories ..... 9-12
- Air Bag Systems ..... 2-20
- Air Filter ..... 8-24
- Antenna ..... 6-9
- Anti-Lock Brake System (ABS) ..... 5-7
  - Warning light ..... 5-8
- Appearance Care ..... 8-40
- Ashtray ..... 6-60
- Audio System ..... 6-9
  - Audio set ..... 6-17, 6-37
  - Operating tips for audio system ..... 6-9
  - Safety certification ..... 6-58
- Automatic Transmission
  - Driving tips ..... 5-14
  - Fluid ..... 8-21
  - Overdrive ..... 5-13
  - Shift-lock override ..... 5-12
  - Shift-lock system ..... 5-12
  - Transmission ranges ..... 5-11

## B

- Battery
  - Emergency starting ..... 7-13
  - Maintenance ..... 8-27
  - Specifications ..... 10-4
- Beep Sounds
  - Ignition key reminder ..... 5-30
  - Lights-on reminder ..... 5-30
  - Seat belt warning beep ..... 5-30
- Before Starting the Engine ..... 4-6
  - After getting in ..... 4-6
  - Before getting in ..... 4-6
- Body Lubrication ..... 8-23
- Brake
  - Fluid ..... 8-18

## B

- Brakes
  - Anti-lock brake system (ABS) .... 5-7
  - Foot brake ..... 5-4
  - Pad wear indicator ..... 5-8
  - Parking brake ..... 5-5
  - Warning light ..... 5-6
- Break-In Period ..... 4-7
- Bulb Replacement ..... 8-32

## C

- Capacities ..... 10-5
- Carbon Monoxide ..... 4-5
- Catalytic Converter ..... 4-4
- Cell Phones ..... 9-13
- Center Console ..... 6-62
- Child Restraint
  - Child restraint precautions ..... 2-13
  - LATCH child-restraint systems ..... 2-18
- Cigarette Lighter ..... 6-60
- Climate Control System ..... 6-2
  - Gas specification ..... 10-5
- Clutch
  - Fluid ..... 8-19
- Convertible Top ..... 3-18
- Cruise Control ..... 5-15
- Cup Holder ..... 6-61
- Customer Assistance ..... 9-2

## D

- Dashboard Illumination ..... 5-22
- Daytime Running Lights ..... 5-33
- Defroster
  - Rear window ..... 5-35
- Detachable Hardtop ..... 3-23
- Dimensions ..... 10-5

**D**

- Door Locks .....3-7
- Driving In Flooded Area .....4-11
- Driving Tips .....4-7
  - Automatic transmission .....5-14
  - Break-in period .....4-7
  - Driving in flooded area .....4-11
  - Hazardous driving .....4-8
  - Money-saving suggestions .....4-7
  - Rocking the vehicle .....4-8
  - Turbocharged vehicles .....4-12
  - Winter driving .....4-9

**E**

- Emergency Starting .....7-13
  - Flooded engine .....7-13
  - Jump-starting .....7-13
  - Push-starting .....7-15
- Emergency Towing .....7-16
- Emission Control System .....4-4
- Engine
  - Coolant .....8-15
  - Exhaust gas .....4-5
  - Hood release .....3-17
  - Oil .....8-13
  - Overheating .....7-11
  - Starting .....5-3
- Engine Compartment Overview .....8-12
- Engine Coolant
  - Overheating .....7-11
- Engine Coolant Temperature
- Gauge .....5-20
- Exhaust Gas .....4-5
- Exterior Care .....8-42

**F**

- Flasher
  - Hazard warning .....5-36
  - Headlights .....5-31
- Flat Tire .....7-3
  - Changing .....7-5
  - Spare tire and tool storage .....7-3
- Fluids
  - Classification .....10-4
  - Owner maintenance .....8-10
- Fog Lights .....5-32
- Foot Brake .....5-4
- Front seats .....2-2
- Fuel
  - Filler lid and cap .....3-15
  - Gauge .....5-21
  - Requirements .....4-2
  - Tank capacity .....10-5
- Fuses .....8-36
  - Panel description .....8-38
  - Replacement .....8-36

**G**

- Gauges .....5-18
- Glove Box .....6-62

**H**

- Hazard Warning Flasher .....5-36
- Hazardous Driving .....4-8
- Headlights
  - Control .....5-31
  - Flashing .....5-31
  - High-low beam .....5-31
  - On reminder .....5-31
- Hood Release .....3-17
- Horn .....5-35

# Index

---

## I

Ignition	
Keys .....	3-2
Switch .....	5-2
Immobilizer System .....	3-29
Indicator Lights .....	5-23
Cruise set .....	5-29
Headlight high-beam .....	5-29
O/D OFF .....	5-29
Turn-signal/hazard warning .....	5-30
Instrument Cluster .....	5-18
Interior Care .....	8-47
Interior Light .....	6-59

## J

Jump-Starting .....	7-13
---------------------	------

## K

Keyless Entry System .....	3-3
Keys .....	3-2

## L

Label Information .....	10-2
Lane-Change Signals .....	5-32
Light Bulbs	
Replacement .....	8-32
Specifications .....	10-6
Lighter .....	6-60
Lighting Control .....	5-31
Lubricant Quality .....	10-4

## M

Maintenance	
Introduction .....	8-2

## M

Owner maintenance	
precautions .....	8-11
Owner maintenance schedule .....	8-10
Scheduled .....	8-3
Manual Transmission Operation .....	5-9
Recommendations for	
shifting .....	5-10
Mesh Pocket .....	6-63
Meters and Gauges .....	5-18
Mirrors	
Outside mirrors .....	3-32
Rearview mirror .....	3-33
Money-Saving Suggestions .....	4-7

## O

Odometer and Trip Meter .....	5-19
Outside Mirrors .....	3-32
Overhead Light .....	6-59
Overheating .....	7-11
Overloading .....	4-11

## P

Paint Damage .....	8-40
Parking Brake .....	5-5
Parking in an Emergency .....	7-2
Power Door Locks .....	3-9
Power Steering .....	5-14
Fluid .....	8-20
Power Windows .....	3-14
Push-Starting .....	7-15

## R

Rear Window Defroster .....	5-35
Rearview Mirror .....	3-33
Recreational Towing .....	7-17



## R

Rocking the Vehicle .....4-8

## S

Safety Defects, Reporting .....9-16

Seat Belt System

3-point type .....2-7

Automatic locking .....2-6

Emergency locking .....2-6

Extender .....2-10

Pregnant women .....2-6

Pretensioner and load limiting ....2-8

Seat belt precautions .....2-4

Warning beep .....2-12

Warning light .....2-12

Seats

Front seat .....2-2

Security System

Immobilizer system .....3-29

Service Publications .....9-17

Spare Tire and Tool Storage .....7-3

Specifications .....10-4

Speedometer .....5-19

SRS Air Bags

Air bag system description .....2-26

Supplemental restraint systems

precautions .....2-20

Warning light .....2-29

Starting the Engine .....5-3

Steering Wheel

Horn .....5-35

Storage Compartments .....6-62

Center console .....6-62

Glove box .....6-62

Mesh pocket .....6-63

Sunvisors .....6-59

## T

Tachometer .....5-20

Temporary Spare Tire .....8-30

Tiedown

Hook .....7-17

Tires

Flat tire .....7-3

Inflation pressure .....8-28

Replacement .....8-30

Rotation .....8-29

Snow tires .....4-9

Spare tire and tool storage .....7-3

Specifications .....10-6

Tire chains .....4-10

Uniform tire quality grading system

(UTQGS) .....9-14

Tool .....7-3

Towing

Description .....7-16

Emergency towing .....7-16

Recreational towing .....7-17

Trailer towing .....4-13

Trailer Towing .....4-13

Trip Meter .....5-19

Trunk Lid .....3-10

Trunk Light .....3-12

Trunk Release Handle .....3-12

Turn and Lane-Change Signals .....5-32

## V

Vanity Mirrors .....6-59

Vehicle Information Labels .....10-2

## W

Warning Lights .....5-23

ABS .....5-27

Air bag system .....5-28

# Index

---

## W

Brake system .....	5-25
Charging system .....	5-26
Check engine .....	5-27
Immobilizer system .....	5-29
Low fuel .....	5-28
Seat belt .....	5-28
Seat belt pretensioner system .....	5-28
Warranty .....	9-9
Washer Fluid .....	8-22
Weights .....	10-5
Wheel Replacement .....	8-31
Windblocker .....	6-63
Windows	
Power windows .....	3-14
Windshield Washer .....	5-34
Windshield Wipers .....	5-34
Blades replacement .....	8-25
Winter Driving .....	4-9