

## **Zoom-Zoom**

**All children instinctively know it.**

**A few adults still remember it.**

**One unique car company refuses to outgrow it.**

**In grown-up language, it means the exhilaration and**

**liberation that come from experiencing sheer motion.**

**But as usual, children put it much better and simply call it " Go Zoom-Zoom."**

**We practice it every day.**

**It's why we build the kind of cars we do.**

**Zoom-Zoom.**

**Can we re-awaken it in you today?**



# A Word to Mazda Owners

---

Thank you for choosing a Mazda. We at Mazda design and build vehicles with complete customer satisfaction in mind.

To help ensure enjoyable and trouble-free operation of your Mazda, read this manual carefully and follow its recommendations.

An Authorized Mazda Dealer knows your vehicle best. So when maintenance or service is necessary, that's the place to go.

Our nationwide network of Mazda professionals is dedicated to providing you with the best possible service.

We assure you that all of us at Mazda have an ongoing interest in your motoring pleasure and in your full satisfaction with your Mazda product.

**Mazda Motor Corporation**  
HIROSHIMA, JAPAN

## **Important Notes About This Manual**

Keep this manual in the glove box as a handy reference for the safe and enjoyable use of your Mazda. Should you resell the vehicle, leave this manual with it for the next owner.

All specifications and descriptions are accurate at the time of printing. Because improvement is a constant goal at Mazda, we reserve the right to make changes in specifications at any time without notice and without obligation.

## **Air Conditioning and the Environment**

Your Mazda's genuine air conditioner is filled with HFC134a (R134a), a refrigerant that has been found not to damage the earth's ozone layer. If the air conditioner does not operate properly, consult an Authorized Mazda Dealer.

**Please be aware that this manual applies to all models, equipment and options. As a result, you may find some explanations for equipment not installed on your vehicle.**

©2003 Mazda Motor Corporation  
Printed in Japan Jan. 2004(Print6)

# How to Use This Manual

---

We want to help you get the most driving pleasure from your vehicle. Your owner's manual, when read from cover to cover, can do that in many ways.

Illustrations complement the words of the manual to best explain how to enjoy your Mazda. By reading your manual, you can find out about the features, important safety information, and driving under various road conditions.

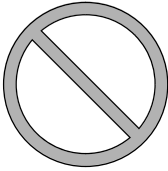

The above symbol in this manual means "Do not do this" or "Do not let this happen".

**Index:** A good place to start is the Index, an alphabetical listing of all information in your manual.

You'll find several **WARNINGS**, **CAUTIONS**, and **NOTES** in the manual.

## **WARNING**

*A **WARNING** indicates a situation in which serious injury or death could result if the warning is ignored.*

## **CAUTION**

A **CAUTION** indicates a situation in which bodily injury or damage to your vehicle, or both, could result if the caution is ignored.

## **NOTE**

A **NOTE** provides information and sometimes suggests how to make better use of your vehicle.



The above symbol, located on some parts of the vehicle, indicates that this manual contains information related to the part. Please refer to the manual for a detailed explanation.

# Table of Contents

---

## **Your Vehicle at a Glance**

Interior, exterior views and part identification of your Mazda.

**1**

---

## **Essential Safety Equipment**

Use of safety equipment, including seats, seat belt system, SRS air bags and child-restraint systems.

**2**

---

## **Knowing Your Mazda**

Explanation of basic operations and controls; opening/closing and adjustment of various parts.

**3**

---

## **Before Driving Your Mazda**

Important information about driving your Mazda.

**4**

---

## **Driving Your Mazda**

Explanation of instruments and controls.

**5**

---

## **Interior Comfort**

Use of various features for drive comfort, including climate control and audio system.

**6**

---

## **In Case of an Emergency**

Helpful information on what to do in an emergency.

**7**

---

## **Maintenance and Care**

How to keep your Mazda in top condition.

**8**

---

## **Customer Information and Reporting Safety Defects**

Important consumer information including warranties and add-on equipment.

**9**

---

## **Specifications**

Technical information about your Mazda.

**10**

---

## **Index**

**11**

---

## **Navigation System**



# 1

## Your Vehicle at a Glance

Interior, exterior views and part identification of your Mazda.

<b>Dashboard Overview</b> .....	1-2
<b>Interior Overview</b> .....	1-3
<b>Exterior Overview</b> .....	1-4

# Dashboard Overview

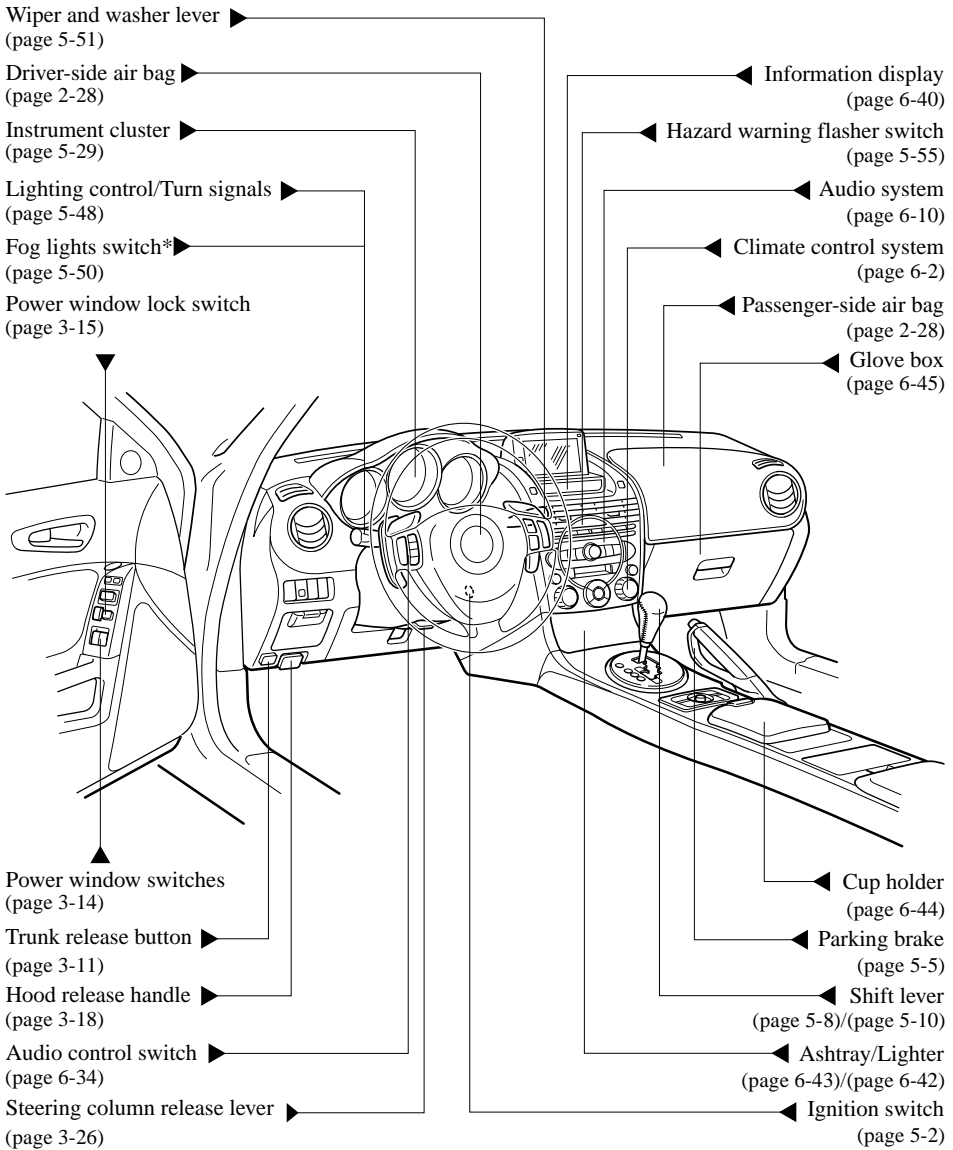



# Interior Overview

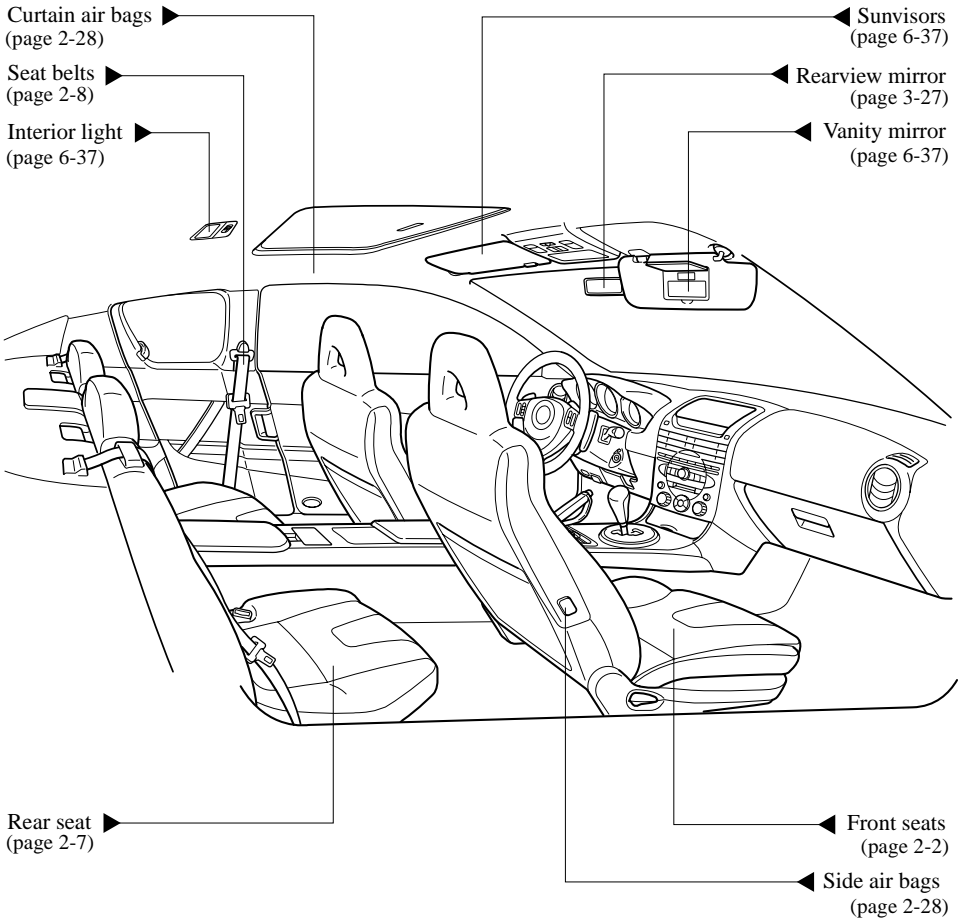

# Exterior Overview

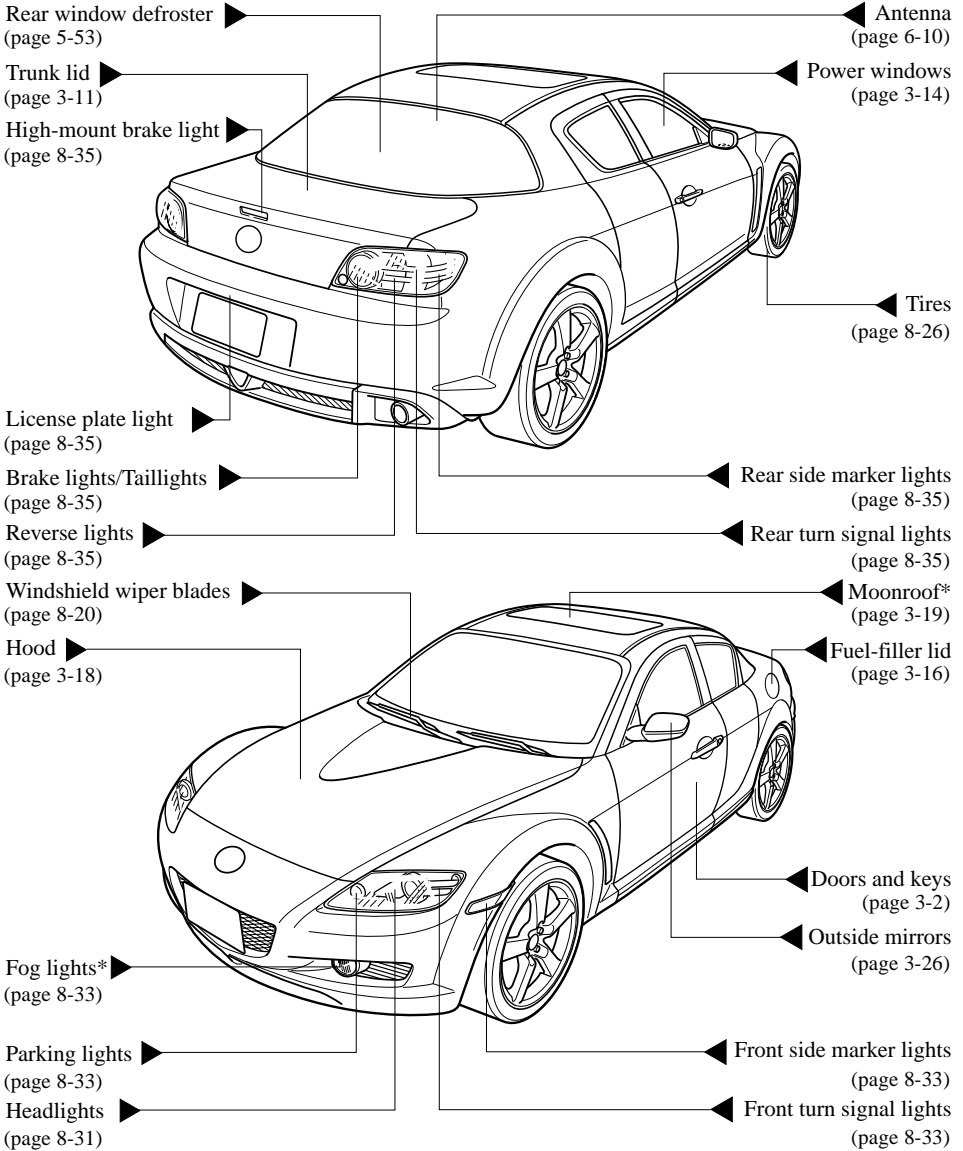

# 2

## Essential Safety Equipment

Use of safety equipment, including seats, seat belt system, SRS air bags and child-restraint systems.

<b>Seats</b> .....	2-2
Front Seats .....	2-2
Rear Seat .....	2-7
<b>Seat Belt Systems</b> .....	2-8
Seat Belt Precautions .....	2-8
Location of Seat Belt .....	2-11
3-Point Type Seat Belt .....	2-12
Front Seat Belt Pretensioner and Load Limiting Systems .....	2-13
Seat Belt Extender .....	2-15
Seat Belt Warning Light .....	2-16
Seat Belt Warning Beep .....	2-17
<b>Child Restraint</b> .....	2-18
Child Restraint Precautions .....	2-18
Installing Child-Restraint Systems .....	2-21
LATCH Child-Restraint Systems .....	2-26
<b>SRS Air Bags</b> .....	2-28
Supplemental Restraint Systems (SRS) Precautions .....	2-28
Air Bag System Description .....	2-33

# Seats

## Front Seats

### **WARNING**

**Modification of the Front Seats:**  
*Removing and reinstalling the front seats for modification purposes is dangerous. The front seats contain air bag components or essential to the supplemental restraint system. Such modification could damage the supplemental restraint system and result in serious injury. Consult an Authorized Mazda Dealer if there is any need to remove or reinstall the front seats.*

**Damaged Front Seats:**  
*Driving with damaged front seats is dangerous. A collision, even one not strong enough to inflate the air bags, could damage the front seats which contain essential air bag components. If there was a subsequent collision, the air bag may not deploy and which could lead to injuries. Always have an Authorized Mazda Dealer inspect the front seats after a collision.  
(Manually operated seats)*

**Securing the Seats:**  
*Adjustable seats and seatbacks that are not securely locked are dangerous. In a sudden stop or collision, the seat or seatback could move, causing injury. Make sure the adjustable components of the seat are locked in place by attempting to slide the seat forward and backward and rocking the seatback.*

### (Electrically operated seats)

### **CAUTION**

- The seat-bottom power adjustment is operated by motors. Avoid extended operation because excessive use can damage the motors.
- To prevent the battery from running down, avoid using the power adjustment when the engine is stopped. The adjuster uses a great amount of electric power.
- Don't use the switch to make more than one adjustment at a time.

### ▼ Seat Slide

### (Manually operated seats)

### **WARNING**

**Driver's Seat Adjustment:**  
*Adjusting the driver's seat while the vehicle is moving is dangerous. The driver could lose control of the vehicle and have an accident. Adjust the driver's seat only when the vehicle is stopped.*

To move a seat forward or backward, raise the lever and slide the seat to the desired position and release the lever.

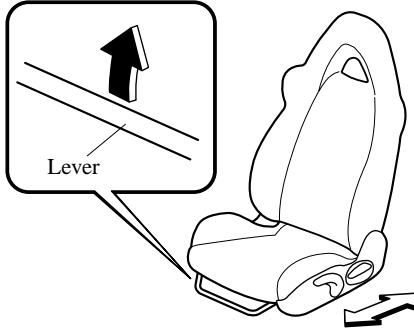

Make sure the lever returns to its original position and the seat is locked in place by attempting to push it forward and backward.

#### **(Electrically operated seats)**

To slide the seat, move the slide lifter switch on the outside of the seat to the front or back and hold it. Release the switch at the desired position.

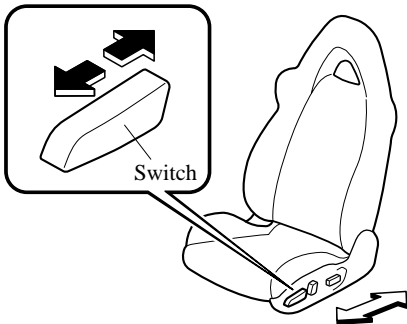

### ▼ Seat Recline

#### **⚠ WARNING**

##### **Reclining:**

*Sitting in a reclined position while the vehicle is moving is dangerous because you don't get the full protection from seat belts. During sudden braking or a collision, you can slide under the lap belt and suffer serious internal injuries. For maximum protection, sit well back and upright.*

##### **Unlocked Seatback:**

*The seatback plays an important role in your protection in a vehicle. Leaving the seatback unlocked is dangerous as it can allow passengers to be ejected or thrown around and baggage to strike occupants in a sudden stop or collision, resulting in severe injury. After adjusting the seatback at any time, even when there are no other passengers, rock the seatback to make sure it is locked in place.*

# Seats

## (Manually operated seats)

To change the seatback angle, lean forward slightly while raising the lever. Then lean back to the desired position and release the lever.

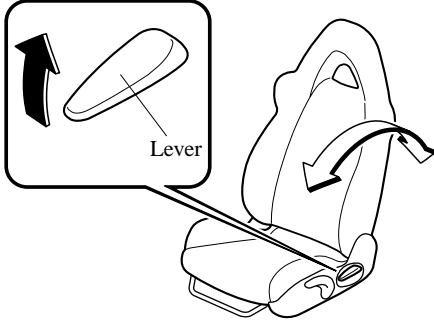

Make sure the lever returns to its original position and the seatback is locked in place by attempting to push it forward and backward.

### CAUTION

When returning a rear-reclined seatback to its upright position, make sure you support the seatback while operating the seatback lever. If the seatback is not supported, it will flip forward suddenly and could cause injury.

## (Electrically operated seats)

Change the seatback angle by pressing the front or rear side of the reclining switch. When the seatback is at the desired angle, release the switch.

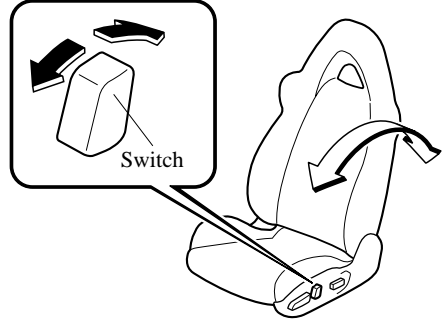

## ▼ Height Adjustment (Driver's Seat)\*

### (Manually operated seats)

To raise the seat-bottom, pull up the lever. Release the lever at the desired position.

To lower the seat-bottom, push down the lever. Release the lever at the desired position.

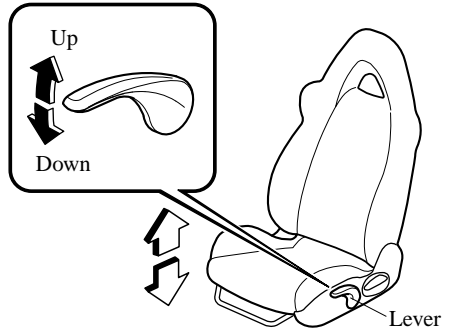

**(Electrically operated seats)****Front height adjustment**

To adjust the front height of the seat-bottom, raise or lower the front of the slide lifter switch on the left side of the seat.

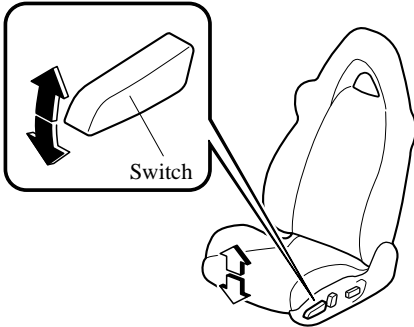
**Rear height adjustment**

Raise or lower the back of the switch to adjust the rear height of the seat-bottom.

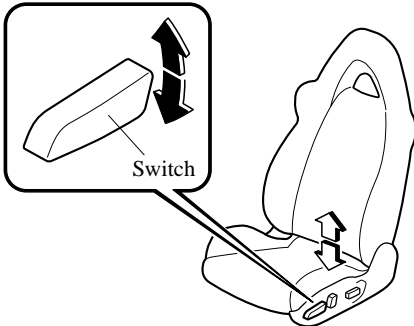
**▼ Lumbar Support Adjustment (Driver's Seat)\***

The amount of lumbar support can be adjusted by pressing the switch. To increase the seat firmness, press and hold the front part of the switch to the desired position, then release it. Press the rear part of the switch to increase softness.

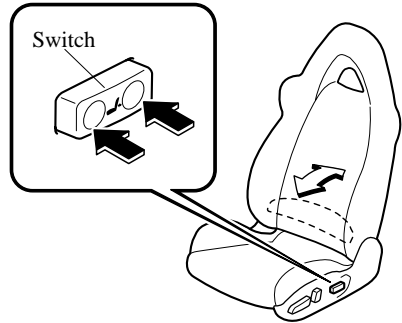

# Seats

## ▼ Folding the Passenger's Seat

### **WARNING**

#### Unlocked Seatback:

*A seatback plays an important role in your protection in a vehicle. Leaving the seatback unlocked is dangerous as it can allow passengers to be ejected or thrown around and baggage to strike occupants in a sudden stop or collision, resulting in severe injury. After adjusting the seatback at any time, even when there are no other passengers, rock the seatback to make sure it is locked in place.*

To fold the seatback, pull the strap and lower the seatback forward.

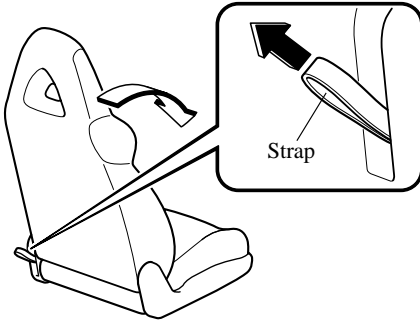

To return it to the upright position, lift the seatback and push it into place. Rock the seatback to make sure it is locked.

## ▼ Seat Warmer\*

The front seats are electrically heated. The ignition switch must be in the ON position.

Press the switch to turn the seat warmer on or off. When the switch is in the ON position, the indicator light will come on.

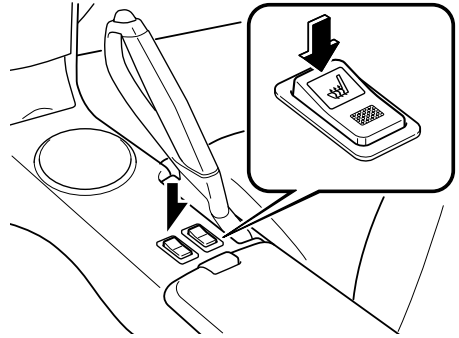

### **NOTE**

The thermostat regulates seat temperature by turning the current on and off.



## Rear Seat

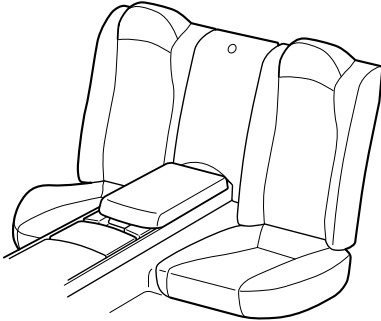

### **WARNING**

#### Stacking Cargo:

*Stacking luggage or other cargo higher than the seatbacks, and placing articles on the rear package tray is dangerous. During sudden braking or a collision, objects can fly around and become projectiles that may hit and injure passengers. Don't stack cargo higher than the seatbacks or place articles on the rear package tray.*

#### Not Securing Luggage and Cargo:

*Not securing cargo while driving is dangerous as it could move or be crushed during sudden braking or a collision and cause injury. Make sure luggage and cargo is secured before driving.*

### **WARNING**

#### Do Not Sit on the Rear Center Console:

*Allowing someone to sit on the rear center console between the rear seats is dangerous. The rear center console is not designed for occupant seating. During a collision, occupants not wearing a seat belt could be thrown from the vehicle and seriously injured or even killed. Do not allow anyone to sit on the center console between the rear seats.*

## Seat Belt Systems

---

### Seat Belt Precautions

Seat belts help to decrease the possibility of severe injury during accidents and sudden stops. Mazda recommends that the driver and all passengers always wear seat belts.

All of the seat belt retractors are designed to keep the lap/shoulder belts out of the way when not in use.

The driver's seat belt has no provisions for child-restraint systems and has only an emergency locking mode. The driver may wear it comfortably, and it will lock during a collision.

However, the front passenger's seat and all rear lap/shoulder belt retractors operate in two modes: emergency locking mode, and for child-restraint systems, automatic locking mode. While we recommend you put all children in the rear seats, if you must use the front passenger seat for a child, slide the front passenger seat as far back as possible and make sure the child-restraint system is secured properly.

#### **WARNING**

##### **Not Wearing Seat Belts:**

*Not wearing a seat belt is extremely dangerous. During a collision, occupants not wearing seat belts could hit someone or things inside the vehicle or even be thrown out of the vehicle. They could be seriously injured or even killed. In the same collision, occupants wearing seat belts would be much safer. Always wear your seat belt and make sure all occupants are properly restrained.*

##### **Seat Belt Damaged During an Accident:**

*Using a damaged seat belt is dangerous. An accident could damage the belt webbing of the seat belt in use. A damaged seat belt cannot provide adequate protection in a collision. Whether a front seat was occupied or not, if the front air bags deployed the seat belt pretensioners also deployed and both front seat belts must be replaced. Have an Authorized Mazda Dealer inspect all seat belt systems in use during an accident before they are used again.*

##### **Twisted Seat Belts:**

*Twisted seat belts are dangerous. In a collision, the full width of the belt isn't available to absorb the impact. This puts more force on the bones beneath the belt, which could cause serious injury or death. Don't wear twisted seat belts.*

## Seat Belt Systems

### **WARNING**

#### **One Belt, One Passenger:**

*Using one seat belt for more than one person at a time is dangerous. A seat belt used in this way can't spread the impact forces properly and the two passengers could be crushed together and seriously injured or even killed. Never use one belt for more than one person at a time.*

#### **Seat Belt Caught or Pinched in the Door:**

*Wearing a seat belt that is caught or pinched in the door is dangerous. The seat belt could become loose and not provide adequate protection in a sudden stop or collision. Always make sure the seat belt is not caught or pinched in the door.*

#### **Seat Belt with Seat Belt Slide Bar:**

*Placing your foot or other objects such as an umbrella on the seat belt slide bar is dangerous. The front seat belt is built in the rear door and the lower part of the seat belt slides forward or backward along the seat belt slide bar as the rear door opens or closes. If the seat belt slider is blocked, the seat belt could be improperly positioned and would provide little or no protection in a collision. Always make sure nothing is placed on the seat belt slide bar.*

### **CAUTION**

Belt retraction may become difficult if the belts and rings are soiled, so try to keep them clean.

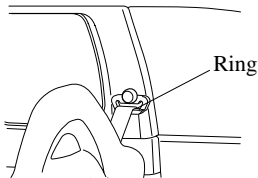

## Seat Belt Systems

---

### ▼ Pregnant Women and Persons with Serious Medical Conditions

Pregnant women should wear seat belts. Ask your doctor for specific recommendations. The lap belt should be worn **SNUGLY AND AS LOW AS POSSIBLE OVER THE HIPS**. The shoulder belt should be worn across your shoulder properly, but never across the stomach area.

Persons with serious medical conditions also should wear seat belts. Check with your doctor for any special instructions regarding specific medical conditions.



### ▼ Emergency Locking Mode

If the belt has fully retracted, it will always be in the emergency locking mode until you move it into automatic locking mode by pulling the belt all the way out to its full length. In the emergency locking mode, the belt remains comfortable on the occupant and the retractor will lock in position during a collision.

If the belt feels tight and hinders comfortable movement while the vehicle is stopped or in motion, you may be in the automatic locking mode because you have pulled the belt too far out. To return to the more comfortable emergency locking mode, wait until you can stop the vehicle in a safe level area, retract the belt fully to convert it back to emergency locking mode and then again extend it around you.

### ▼ Automatic Locking Mode

Always use the automatic locking mode to keep the child-restraint system from shifting to an unsafe position in the event of an accident. To get the seat belt into the automatic locking mode, pull it all the way out and connect it as instructed on the child-restraint system. It will retract down to the child-restraint system and stay locked on it. See the section on child restraint (page 2-18).

## Location of Seat Belt

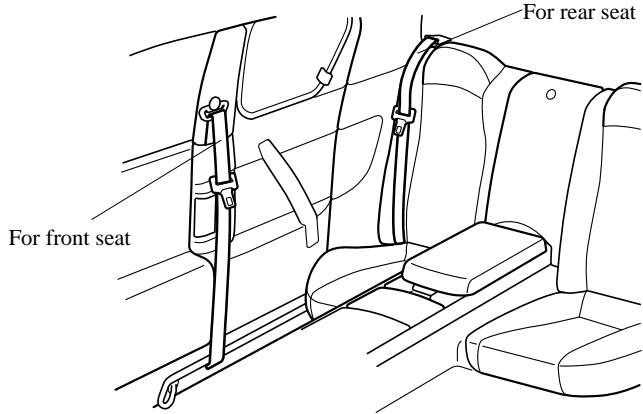

# Seat Belt Systems

## 3-Point Type Seat Belt

### ▼ Fastening the Seat Belts

1. Grasp the buckle and tongue.
2. Slowly pull out the lap/shoulder belt.

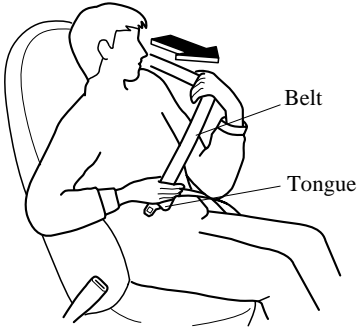

3. Insert the tongue into the buckle until you hear a click.

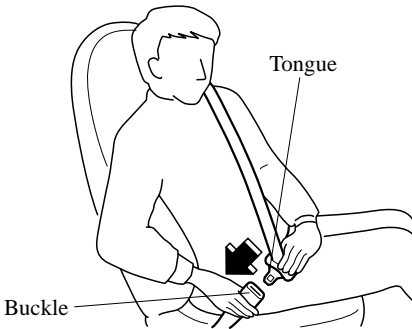

### ⚠ WARNING

#### Positioning the Shoulder Portion of the Seat Belt:

*Improper positioning of the shoulder portion of the seat belt is dangerous. Always make sure the shoulder portion of the seat belt is positioned across your shoulder and near your neck, but never under your arm, on your neck, or on your upper arm.*

4. Make sure the shoulder belt is snugly fitted against your body.

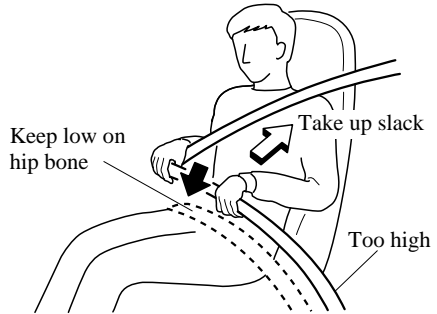

### ⚠ WARNING

#### Positioning the Lap Portion of the Seat Belt:

*The lap portion of the seat belt worn too high is dangerous. In a collision, this would concentrate the impact force directly on the abdominal area, causing serious injury. Wear the lap portion of the belt snugly and as low as possible.*

### ▼ Unfastening the Seat Belts

Depress the button on the buckle.

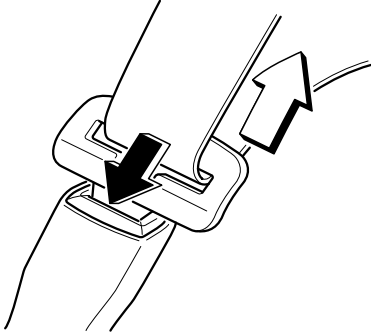

#### NOTE

If a belt does not fully retract, inspect it for kinks and twists. If it is still not retracting properly, have it inspected at an Authorized Mazda Dealer.

## Front Seat Belt Pretensioner and Load Limiting Systems

For optimum protection, the driver and front passenger seat belts are equipped with pretensioner and load limiting systems.

In moderate or greater frontal or near-frontal accidents, the front air bag and pretensioner systems deploy simultaneously. The pretensioners take up slack in the front seat belts as the air bags are expanding. The seat belt pretensioner system will not activate if the seat belt is not fastened, only you can be sure it is worn properly. The load limiting system releases belt webbing in a controlled manner to reduce belt force on the occupant's chest.

### **WARNING**

**Incorrect Positioning of the Driver and Front Passenger Seat Belts:**  
***Incorrect positioning of the driver and passenger seat belts is dangerous. Without proper positioning, the pretensioner and load limiting systems cannot provide adequate protection in an accident and this could result in serious injury. Wear seat belts only as recommended in this owner's manual.***

## Seat Belt Systems

### **WARNING**

**Expendable Seat Belt Pretensioners:**

*Use of front seat belts with the pretensioner system expended is dangerous.*

*The seat belt pretensioners will only function once. After they are expended, they will not work again and must be replaced immediately.*

*If the seat belt pretensioners are not replaced, the risk of injury in a collision will increase.*

*Always have an Authorized Mazda Dealer inspect the seat belt pretensioners and air bags after any collision. The seat belt pretensioners and air bags must be replaced after any collision, which causes them to deploy.*

**Modification or Testing of the Pretensioner System:**

*Modifying the components or wiring of the pretensioner system, including the use of electronic testing devices is dangerous. You could accidentally activate it or make it inoperable which would prevent it from activating in an accident. The occupants or repairers could be seriously injured. Never modify the components or wiring, or use electronic testing devices on the pretensioner system.*

### **WARNING**

**Pretensioner System Disposal:**

*Improper disposal of the pretensioner system or a vehicle with non-deactivated pretensioners is dangerous. Unless all safety procedures are followed, injury could result. Ask an Authorized Mazda Dealer how to safely dispose of the pretensioner system or how to scrap a pretensioner-equipped vehicle.*

### **NOTE**

- The pretensioner system will only activate in a moderate or greater frontal or near-frontal collision. It will not activate in most rollovers, side or rear impacts.
- Some smoke (non-toxic gas) will be released when the air bags and pretensioners deploy. This does not indicate a fire. This gas normally has no effect on occupants, however, those with sensitive skin may experience light skin irritation. If residue from the deployment of the air bags or the front pretensioner system gets on the skin or in the eyes, wash it off as soon as possible.



### ▼ Air Bag/Front Seat Belt Pretensioner System Warning Light



If the air bag/front seat belt pretensioner system is normal, the warning light illuminates when the ignition switch is turned to the ON position or after the engine is cranked. After about 6 seconds it goes out.

A system malfunction is indicated when the warning light constantly flashes, illuminates or doesn't illuminate at all when the ignition switch is turned to the ON position. If any of these occur, consult an Authorized Mazda Dealer as soon as possible. The system may not work in an accident.

#### **WARNING**

##### **Self-Servicing the Air Bag/Pretensioner Systems:**

*Self-servicing or tampering with the systems is dangerous. An air bag/pretensioner could accidentally activate or become disabled. This could cause serious injuries. Never tamper with the systems and always have an Authorized Mazda Dealer perform all servicing and repairs.*

### Seat Belt Extender

If your seat belt is not long enough, even when fully extended, a seat belt extender may be available to you at no charge from your Authorized Mazda Dealer.

This extender will be only for you and for the particular vehicle and seat. Even if it plugs into other seat belts, it may not hold in the critical moment of a crash.

When ordering an extender, only order one that provides the necessary additional length to fasten the seat belt properly. Please contact your Authorized Mazda Dealer for more information.

#### **WARNING**

**Unnecessary Use of an Extender:**  
*Using a seat belt extender when not necessary is dangerous. The seat belt will be too long and not fit properly. In an accident, the seat belt will not provide adequate protection and you could be seriously injured. Only use the extender when it is required to fasten the seat belt properly.*

**Using an Improper Extender:**  
*Using a seat belt extender that is for another person or a different vehicle or seat is dangerous. The seat belt will not provide adequate protection and the user could be seriously injured in an accident. Only use the extender provided for you and for the particular vehicle and seat. NEVER use the extender in a different vehicle or seat.*

## Seat Belt Systems

---

### **WARNING**

***Using an Extender That is Too Long:***  
*Using an extender that is too long is dangerous. The seat belt will not fit properly. In an accident, the seat belt will not provide adequate protection and you could be seriously injured. Don't use the extender or choose one shorter in length if the distance between the extender's buckle and the center of the user's body is less than 15cm (6 in).*

### **NOTE**

When not in use, remove the seat belt extender and store it in the vehicle. If the seat belt extender is left connected, the rear door cannot be opened because the seat belt does not fully retract and the seat belt warning light will not illuminate and function properly.

### Seat Belt Warning Light



If the driver's seat belt is not fastened when the ignition switch is turned to the ON position, the seat belt warning light will remain on until the belt is fastened. If the system does not operate correctly, consult an Authorized Mazda Dealer.

## Seat Belt Warning Beep

If the driver's seat belt is not fastened when the ignition switch is turned to the ON position, a beep sound will be heard for about 6 seconds.

## Child Restraint

### Child Restraint Precautions

Mazda strongly urges the use of child-restraint systems for children small enough to use them.

You are required by law to use a child-restraint system for children in the U.S. and Canada. Check your local and state or provincial laws for specific requirements regarding the safety of children riding in your vehicle.

Whatever child-restraint system you consider, please pick the appropriate one for the age and size of the child, obey the law and follow the instructions that come with the individual child-restraint system.

A child who has outgrown child-restraint systems should sit in the rear and use seat belts, both lap and shoulder. If the shoulder belt crosses the neck or face, move the child closer to the center of the vehicle.

Statistics confirm that the rear seat is the best place for all children up to 12 years of age, and more so with a supplemental restraint system (air bags).

A rear-facing child-restraint system should **NEVER** be used on the front seat with the air bag system activated. The front passenger's seat is also the least preferred seat for other child-restraint systems.

#### **WARNING**

**Proper Size of Child-Restraint System:**

*For effective protection in vehicle accidents and sudden stops, a child must be properly restrained using a seat belt or child-restraint system depending on age and size. If not, the child could be seriously injured or even killed in an accident.*

**Follow the Manufacturer's Instructions and Always Keep the Child-Restraint System Buckled Down:**

*An unsecured child-restraint system is dangerous. In a sudden stop or a collision it could move causing serious injury or death to the child or other occupants. Make sure the child-restraint system is properly secured in place according to the child-restraint system manufacturer's instructions. When not in use, remove it from the vehicle or fasten it with a seat belt, or latch it down to **BOTH LATCH** lower anchors for **LATCH** child-restraint systems.*

**⚠ WARNING****Holding a Child While the Vehicle is Moving:**

*Holding a child in your arms while the vehicle is moving is extremely dangerous. No matter how strong the person may be, he or she cannot hold onto a child in a sudden stop or collision and it could result in serious injury or death to the child or other occupants. Even in a moderate accident, the child may be exposed to air bag forces that could result in serious injury or death to the child, or the child may be slammed into the adult, injuring the adult. Always secure a child in a proper child-restraint system.*

**Rear-Facing Child-Restraint System:**

*Rear-facing child-restraint systems on the front seat are particularly dangerous. The child-restraint system can be hit by a deploying air bag and moved violently backward resulting in serious injury or death to the child. NEVER use a rear-facing child-restraint system in the front seat with an air bag that could deploy even in a moderate collision.*

Deploying air bag

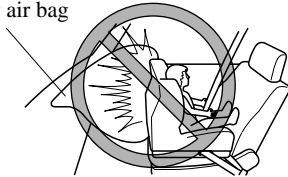
**Front Passenger Seat Position:**

*A front-facing child-restraint system should only be put on the front seat when it is unavoidable. Always move the seat as far back as possible, because the force of a deploying air bag could cause serious injury or death to the child.*



## Child Restraint

---

### **WARNING**

**Children and Seating Position with Side and Curtain Air Bags:**

*Allowing anyone to lean over or against the front or rear doors is dangerous. If the vehicle is equipped with side and curtain air bags, the impact of inflation could cause serious injury or death to the person. Children are more likely to sleep in the vehicle; when they do, they are more at risk in the front passenger's seat that have a side air bag because they may slump over into the path of the air bags. Furthermore, leaning over or against the doors could block the side and curtain air bags and eliminate the advantages of supplemental protection. With the front air bag and the additional side air bag that comes out of the front seat, the rear seat is always a better location for children who are prone to sleeping. Do not allow a child to lean over or against the doors, even if the child is seated in a child-restraint system.*

**One Belt, One Passenger:**

*Using one seat belt for more than one person at a time is dangerous. A seat belt used in this way can't spread the impact forces properly and the two passengers could be crushed together and seriously injured or even killed. Never use one belt for more than one person at a time.*

### **CAUTION**

A seat belt or child-restraint system can become very hot in a closed vehicle during warm weather. To avoid burning yourself or a child, check them before you or your child touches them.

### **NOTE**

Your Mazda is equipped with LATCH lower anchors for attachment of specially designed LATCH child-restraint systems in the rear seat. When using these anchors to secure a child-restraint system, refer to "LATCH Child-Restraint Systems" (page 2-26).

## Installing Child-Restraint Systems

Accident statistics reveal that a child is safer in the rear seat. The front passenger's seat is clearly the worst choice for any child under 12, and with rear-facing child-restraint systems it is clearly unsafe due to air bags.

Some child-restraint systems now come with tethers and therefore must be installed on the seats that take tethers to be effective. In your Mazda, tethered child-restraint systems can only be accommodated in the two positions on the rear seat.

Some child-restraint systems also employ specially designed LATCH attachments; refer to "LATCH Child-Restraint Systems" (page 2-26).

### **WARNING**

**Tethered Child-Restraint Systems**  
**Work Only on Tether-Equipped Rear Seats:**

*Installation of a tether equipped child-restraint system in the front passenger's seat defeats the safety design of the system and will result in an increased chance of serious injury if the child-restraint system goes forward without benefit of being tethered.*

*Place tether equipped child-restraint systems where there are tether anchors.*

## ▼ Rear Seat Child-Restraint System Installation

Follow these instructions when using a child-restraint system, unless you are attaching a LATCH-equipped child-restraint system to the rear LATCH lower anchors. Refer to "LATCH Child-Restraint Systems" (page 2-26).

### NOTE

Follow the child-restraint system manufacturer's instructions carefully. If you are not sure whether you have a LATCH system or tether, check in the child-restraint system manufacturer's instructions and follow them accordingly. Depending on the type of child-restraint system, it may not employ seat belts which are in automatic locking mode.

1. Secure the child-restraint system with the lap portion of the lap/shoulder belt. See the manufacturer's instructions on the child-restraint system for belt routing instructions.
2. To get the retractor into the automatic locking mode, pull the shoulder belt portion of the seat belt until the entire length of the belt is out of the retractor.

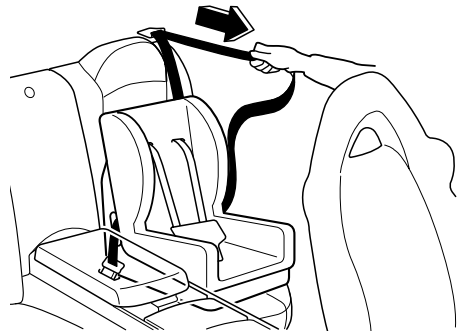

# Child Restraint

3. Push the child-restraint system firmly into the vehicle seat. Be sure the belt retracts as snugly as possible. Clicking from the retractor will be heard during retraction if the system is in the automatic locking mode. If the belt does not lock the seat down tight, repeat this step.

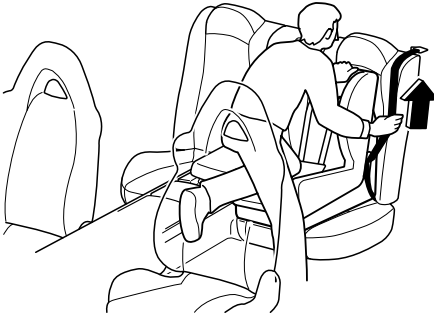

4. If your child-restraint system requires the use of a tether strap, hook and tighten the tether strap by following the manufacturer's instructions.

### Anchor bracket location

For rear right seat      For rear left seat

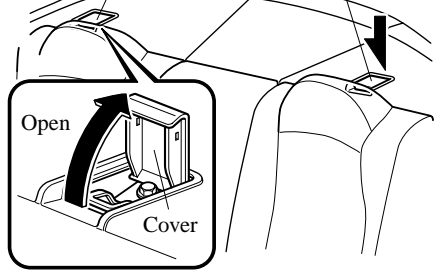

### Tether strap position

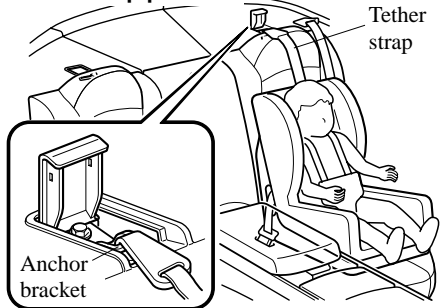

### NOTE

Inspect this function before each use of the child-restraint system. You should not be able to pull the shoulder belt out of the retractor while the system is in the automatic locking mode. When you remove the child-restraint system, be sure the belt fully retracts to return the system to emergency locking mode before occupants use the seat belts.

### **WARNING**

***Child-Restraint Tether Usage:***  
*Using the tether or tether anchor to secure anything but a child-restraint system is dangerous. This could weaken or damage the tether or tether anchor and result in injury. Use the tether and tether anchor only for a child-restraint system.*



**▼ If You Must Use the Front Seat for Children**

If you cannot put all children in the rear seat, at least put the smallest children in the rear and be sure the largest child up front uses the shoulder belt over the shoulder.

Do not put rear-facing child-restraint systems on the front passenger's seat. This seat is also not set up for tethered child-restraint systems, put them in one of the rear seat positions set up with tether anchors.

Likewise the LATCH child-restraint system cannot be secured in the front passenger's seat and should be used in the rear seat.

Don't allow anyone to sleep against the right front or rear doors if you have an optional side and curtain air bag, it could cause serious injuries to an out of position occupant. As children more often sleep in cars, it is better to put them in the rear seat. If installing the child-restraint system on the front seat is unavoidable, follow these instructions when using a front-facing child-restraint system in the front passenger's seat.

**NOTE**

- To check if your front seats have side air bags:  
Every Mazda side air bag will have a "SRS-Air Bag" label on the outboard shoulder of the front seats.
- To check if your vehicle has curtain air bags:  
Every Mazda curtain air bag will have an "SRS-Air Bag" marking on the front and rear window pillars along the roof edge.

** WARNING****Front Passenger's Seat Position:**

*As your vehicle has front air bags and doubly so if your vehicle has side air bags, a front-facing child-restraint system should be put on the front seat only when it is unavoidable.*

*Always move the seat as far back as possible, because the force of a deploying air bag could cause serious injury or death to the child.*

**Rear-Facing Child-Restraint System:**

*Rear-facing child-restraint systems on the front seat are particularly dangerous.*

*The child-restraint system can be hit by a deploying air bag and moved violently backward resulting in serious injury or death to the child.*

*NEVER use a rear-facing child-restraint system in the front seat with an air bag that could deploy even in a moderate collision.*

# Child Restraint

## **WARNING**

### **Children and Seating Position with Side and Curtain Air Bags:**

*Allowing anyone to lean over or against the front door, the area of front seat, front and rear window pillars and the roof edge along both sides which the side and curtain air bags deploy even though using a child-restraint system is dangerous. If the vehicle is equipped with side and curtain air bags, the impact of inflation could cause serious injury or death to the child. Furthermore, leaning over or against the front door could block the side and curtain air bags and eliminate the advantages of supplemental protection. With the front air bag and the additional side air bag that comes out of the front seat, the rear seat is always a better location for children. Do not allow a child to lean over or against the doors, even if the child is seated in a child-restraint system.*

## ▼ **Front Passenger's Seat Child-Restraint System Installation**

1. Slide the seat as far back as possible.



2. Secure the child-restraint system with the lap portion of the lap/shoulder belt. See the manufacturer's instructions on the child-restraint system for belt routing instructions.
3. To get the retractor into the automatic locking mode, pull the shoulder belt portion of the seat belt until the entire length of the belt is out of the retractor.
4. Push the child-restraint system firmly into the vehicle seat. Be sure the belt retracts as snugly as possible. Clicking from the retractor will be heard during retraction if the system is in automatic locking mode. If the belt does not lock the seat down tight, repeat the previous step and also this one.

**NOTE**

- Inspect this function before each use of the child-restraint system. You should not be able to pull the shoulder belt out of the retractor while the system is in the automatic locking mode. When you remove the child-restraint system, be sure the belt fully retracts to return the system to emergency locking mode before occupants use the seat belts.
- Follow the child-restraint system manufacturer's instructions carefully. Depending on the type of child-restraint system, it may not employ seat belts which are in automatic locking mode.

# Child Restraint

## LATCH Child-Restraint Systems

Your Mazda is equipped with LATCH lower anchors for attachment of specially designed LATCH child-restraint systems in the rear seat. Both anchors must be used, otherwise the seat will bounce around and put the child in danger. Some LATCH child-restraint systems must also be used in conjunction with a tether to be effective. If they have a tether you must use it to better assure your child's safety.

### **WARNING**

#### **Manufacturer's Instructions for Child-Restraint System:**

*An unsecured child-restraint system is dangerous. In a sudden stop or a collision it could move causing serious injury or death to the child or other occupants. Make sure the child-restraint system is properly secured in place according to the child-restraint system manufacturer's instructions.*

#### **Unsecured Child-Restraint System:**

*An unsecured child-restraint system is dangerous. In a sudden stop or a collision it could move causing serious injury or death to the child or other occupants. Follow the child-restraint system manufacturer's instructions on belt routing to secure the seat just as you would with a child in it so that nobody is tempted to put a child in an improperly secured seat later on. When not in use, remove it from the vehicle or fasten it with a seat belt, or latch it down to BOTH LATCH lower anchors for LATCH child-restraint systems.*

#### **LATCH Child-Restraint Systems:**

*Not following the child-restraint system manufacturer's instructions when installing the child-restraint system is dangerous. If seat belts or a foreign object prevent the child-restraint system from being securely attached to the LATCH lower anchors and the child-restraint system is installed improperly, the child-restraint system could move in a sudden stop or collision causing serious injury or death to the child or other occupants. When installing the child-restraint system, make sure there are no seat belts or foreign objects near or around the LATCH lower anchors. Always follow the child-restraint system manufacturer's instructions.*

### ▼ LATCH Child-Restraint System Installation Procedure (Rear Seats)

1. Expand the open seams on the rear of the seat bottom slightly to verify the locations of the LATCH lower anchors.

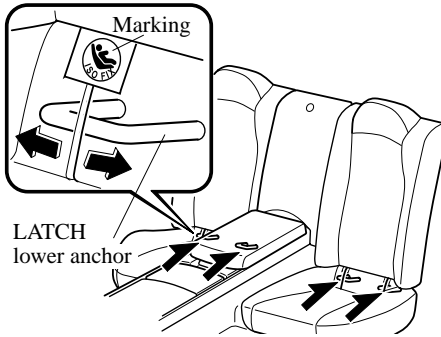

#### NOTE

The markings above the LATCH lower anchors indicate the locations of LATCH lower anchors for the attachment of a child-restraint system.

2. Secure the child-restraint system using BOTH LATCH lower anchors, following the child-restraint system manufacturer's instruction.

3. If your child-restraint system came equipped with a tether, that probably means it is very important to properly secure the tether for child safety, please carefully follow the child-restraint system manufacturer's instructions when installing tethers.

#### Anchor bracket location

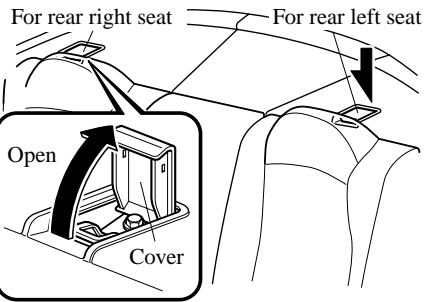

#### Tether strap position

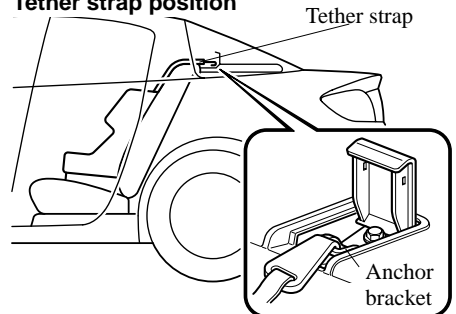

### **⚠ WARNING**

**Child-Restraint Tether Usage:**  
Using the tether or tether anchor to secure anything but a child-restraint system is dangerous. This could weaken or damage the tether or tether anchor and result in injury. Use the tether and tether anchor only for a child-restraint system.

## SRS Air Bags

---

### Supplemental Restraint Systems (SRS) Precautions

The front and side supplemental restraint systems (SRS) include up to 6 air bags (verify "SRS AIRBAG" location indicator marks).

They are located in:

- The steering wheel hub (driver air bag)
- The front passenger dashboard (front passenger air bag)
- The outboard sides of the front seatbacks (side air bags)
- The front and rear window pillars, and the roof edge along both sides (curtain air bags)

These systems operate independently depending on the type of accident encountered; if you have side and curtain air bags, the side and curtain air bags are not likely to deploy on both sides in the same accident because a vehicle is not often hit from both sides. The side and curtain air bags and the frontal air bag system will not normally deploy during the same type of accident unless a combination of frontal and side impacts occur.

The air bag supplemental restraint systems are designed to provide supplemental protection only in the front seats in certain situations and the rear outside passenger positions only in same-side collisions, so seat belts are always important in the following ways:

Without seat belt usage, the air bags cannot provide adequate protection during an accident. Seat belt usage is necessary to:

- Keep the occupant from being thrown into an inflating air bag.
- Reduce the possibility of injuries during an accident that is not designed for air bag inflation, such as roll-over or rear impact.
- Reduce the possibility of injuries in frontal or side collisions that are not severe enough to activate the air bags.
- Reduce the possibility of being thrown from your vehicle.
- Reduce the possibility of injuries to lower body and legs during an accident because the air bags provide no protection to these parts of the body.
- Hold the driver in a position which allows better control of the vehicle.

Children should be protected by a child-restraint system. Laws vary on the size a child must be to use a child-restraint system (page 2-18).

Carefully consider which child-restraint system is necessary for your child and follow the installation directions in this Owner's Manual as well as the child-restraint system manufacturer's instructions.

## **WARNING**

### **Air Bags without Seat Belts:**

*Depending only on the air bags for protection during an accident is dangerous. Alone, air bags may not prevent serious injuries. The appropriate air bags can be expected to inflate only in collisions with frontal, near frontal or side forces that are at least moderate. Vehicle occupants should always wear seat belts.*

### **Child in the Front Seat:**

*Placing a child, 12 years or under, in the front seat is dangerous. The child could be hit by a deploying air bag and be seriously injured or even killed. A sleeping child is more likely to lean against the door and be hit by the side air bag in a moderate, right-side collision. Whenever possible, always secure a child 12 years and under on the rear seat with an appropriate child-restraint system for the child's age and size.*

### **Rear-Facing Child-Restraint System:**

*Rear-facing child-restraint systems on the front seat are particularly dangerous. The child-restraint system can be hit by a deploying air bag and moved violently backward resulting in serious injury or death to the child. NEVER use a rear-facing child-restraint system in the front seat with an air bag that could deploy even in a moderate collision.*

Deploying air bag

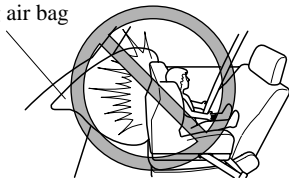

### **Seating Position with Front Air Bags:**

*Sitting too close to the air bag modules or placing hands or feet on them is extremely dangerous. Front Air bags inflate with great force and speed. Serious injuries could occur if someone is too close. The driver should always hold onto only the rim of the steering wheel. The front seat passenger should keep both feet on the floor. Front seat occupants should adjust their seats as far back as possible and always sit upright against the seatbacks with seat belts worn properly.*

## SRS Air Bags

### **WARNING**

#### Seating Position with Side and Curtain Air Bags:

*Sitting too close to the side air bag modules or placing hands on them is extremely dangerous. The side air bags inflate with great force and speed directly out of the outboard side of the front seat and expand along the front door on the side the car is hit. Serious injury could occur if someone is sitting too close to the door or leaning against a window, or if rear seat occupants grab the sides of the front seatbacks. Furthermore, sleeping up against the door or hanging out the windows in the vehicle could block the side and curtain air bags and eliminate the advantages of supplemental protection. Give the side and curtain air bags room to work by sitting in the center of the seat while the vehicle is moving with seat belts worn properly.*

#### Front Air Bag Modules:

*Attaching an object to the front air bag modules or placing something in front of them is dangerous. In an accident, the object could interfere with front air bag inflation and injure the occupants.*

*Always keep the front air bag modules free of objects.*

#### Side Air Bag Modules:

*Attaching things to the front seat in such a way as to cover the outboard side of the seat in any way is dangerous. In an accident the object could interfere with the side air bag, which inflates from the outboard side of the front seats, impeding the added protection of the side air bag system or redirecting the air bag in a way that is dangerous. Furthermore, the bag could be cut open spewing exhaust.*

*Do not hang net bags, map pouches or backpacks with side straps on the front seats. Never use seat covers on the front seats. Always keep the side air bag modules in your front seats free to deploy in the event of a side collision.*

#### Curtain Air Bag Modules:

*Attaching objects to the areas where the curtain air bag activates such as on the windshield glass, side door glass, front and rear window pillars and along the roof edge and assist grips is dangerous. In an accident the object could interfere with the curtain air bag, which inflates from the front and rear window pillars and along the roof edge, impeding the added protection of the curtain air bag system or redirecting the air bag in a way that is dangerous. Furthermore, the bag could be cut open spewing exhaust.*

*Do not place hangers or any other objects on the assist grips. When hanging clothes, hang them on the coat hook directly. Always keep the curtain air bag modules free to deploy in the event of a side collision.*



 **WARNING****Hot Air Bag Inflators:**

*Hot air bag inflators are dangerous. Immediately after inflation, the inflators in the steering wheel, dashboard, seatbacks, or the front and rear window pillars and along the roof edge are very hot. You could get burned. Don't touch the internal components of the air bag modules after the bags have inflated.*

**Installation of Front-End Equipment:**

*Installation of front-end equipment, such as frontal protection bar (kangaroo bar, bull bar, push bar, etc.), snowplow, or winches, is dangerous. The air bag crash sensor system could be affected. This could cause air bags to inflate unexpectedly, or it could prevent the air bags from inflating during an accident. Front occupants could be seriously injured. Never install any front-end equipment to your vehicle.*

**Suspension Adjustment:**

*Adjusting the vehicle suspension is dangerous. If the vehicle's height or the suspension is changed, the vehicle will be unable to accurately detect a collision resulting in incorrect or unexpected air bag deployment and the possibility of serious injuries.*

**Modification of the Supplemental Restraint System:**

*Modifying the components or wiring of the supplemental restraint system is dangerous. You could accidentally activate it or make it inoperable. Don't make any modifications to the supplemental restraint system. This includes installing trim, badges, or anything else over the air bag modules. It also includes installing extra electrical equipment on or near system components or wiring. An Authorized Mazda Dealer can provide the special care needed in the removal and installation of front seats. It is important to protect the side and curtain air bag wiring and connections to assure that the bags do not accidentally deploy and that the seats retain an undamaged air bag connection.*

 **CAUTION**

To prevent damage to the side and curtain air bag wiring, don't place luggage or other objects under the front seats.

## SRS Air Bags

---

### NOTE

- When an air bag deploys, a loud inflation noise can be heard and some smoke will be released. Neither is likely to cause injury, however, the texture of the air bags may cause light skin injuries on body parts not covered with clothing through friction.
- Should you sell your Mazda, we urge you to tell the new owner of its air bag systems and that familiarization with all instructions about them, from the Owner's Manual, is important.

## Air Bag System Description

The supplemental restraint systems (SRS) have two basic subsystems:

- The air bag system with inflators and air bags.
- The electrical system with crash sensors and diagnostic module.

The air bags are mounted in the following locations: the center of the steering wheel, the passenger-side of the dashboard, in the outboard sides of the front seatbacks and the front and rear window pillars, along the roof edge. They are out of sight until activated.

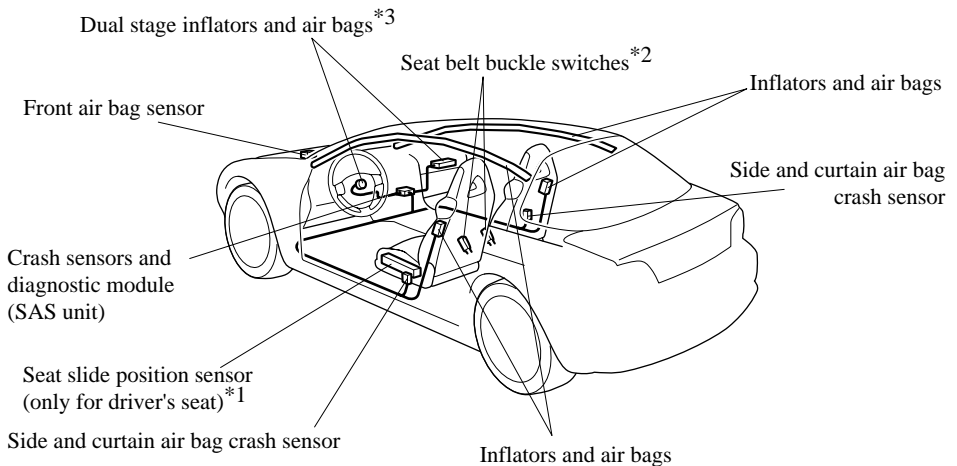

\*1The driver's seat slide position sensor determines whether the driver's seat is fore or aft of a reference position. The sensor is designed to control the deployment of the driver's air bag depending on how close the driver's seat is to the steering wheel.

\*2The buckle switches on the front seat belts determine whether or not the front seat belts are securely fastened and further control the deployment of the air bags on the front seats.

\*3The front, dual stage air bags control air bag inflation in two energy stages. During an impact of moderate severity the front air bags deploy with lesser energy, whereas during more severe impacts, they deploy with more energy.

Deployment of the front air bags may differ between the driver and the front passenger depending on the driver's seat position and front seat belt usage, which allow for further controlling of the system.

# SRS Air Bags

---

## ▼ How the Air Bags Work

When air bag crash sensors detect a frontal or side impact of greater than moderate force, an electrical current is sent to the inflators.

Gases are produced to inflate the air bags and after the inflation, the air bags quickly deflate.

The air bags will function only once. After that, **the air bags will not work again and must be replaced.**

Only an Authorized Mazda Dealer can replace the systems.

The front air bags will deploy only on the frontal impact.

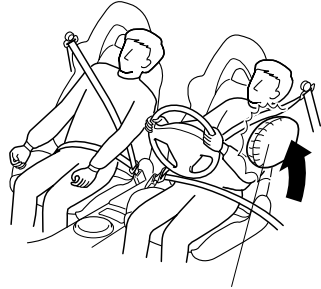

The side air bag will deploy only on the side the vehicle receives the force of the impact.



The curtain air bag will deploy only on the side the vehicle receives the force of the impact. The side and curtain air bags will deploy together on the same side.

## ▼ Air Bag Activation/Deactivation

### Front air bag activation

A greater than moderate impact will cause the front air bags to inflate in the following cases:

Hitting a solid wall straight on at greater than about 22 km/h (14 mph).

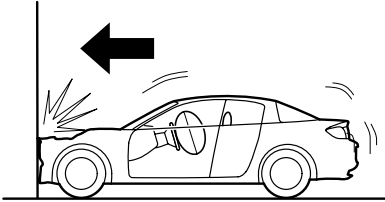

Frontal impact within about a 30 degree range from head-on to the vehicle.

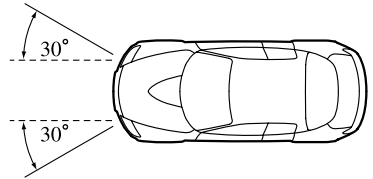

Hitting a curb, pavement edge or hard object.

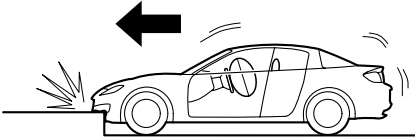

Driving into a big hole or hitting the far side of a hole.

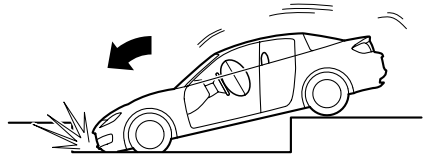

Landing hard or the vehicle falling.

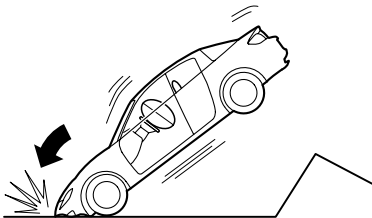

# SRS Air Bags

---

## Limitations to front air bag activation

Depending on the severity of impact, the front air bags may not inflate in the following cases:

Impacts involving trees or poles cause severe cosmetic damage but may not have enough impact to activate the air bag.

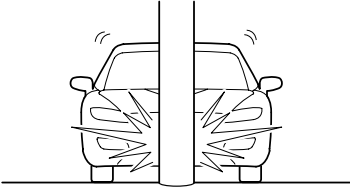

Frontal offset impact to the vehicle may not provide the stopping force necessary for air bag deployment.

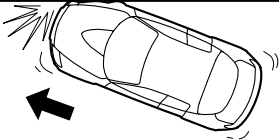

Rear-ending or running under a truck's tail gate may not provide the stopping force necessary for air bag deployment.

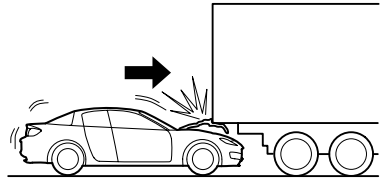

## Non-activation of front air bags

Front air bags will not normally inflate in the following cases:

Collision from the rear.

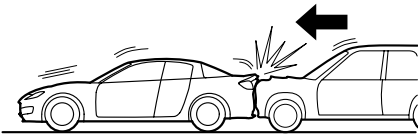

Impact to the side, but it may deploy the side and curtain air bags.

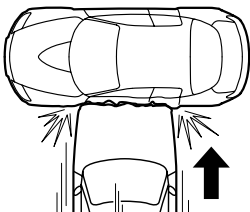

Vehicle roll-over, may deploy the side and curtain air bags but not the front air bags.



**Side and curtain air bag activation**

Greater than moderate impact to one side of the vehicle (driver or passenger side areas) will cause the side and curtain air bags to inflate, but it will not normally deploy the front air bags.

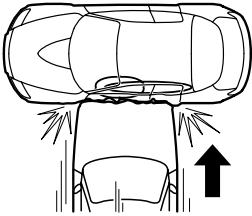
**Limitations to side and curtain air bag activation**

Depending on the severity of impact, the side and curtain air bags may not inflate in the following cases:

Frontal offset impact may not provide enough side impact to deploy the side and curtain air bags.

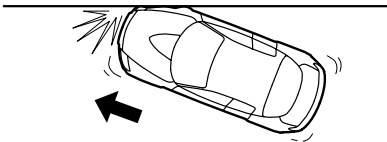

Side impacts involving trees or poles can cause severe cosmetic damage but may not have enough impact force to activate the side and curtain air bags.

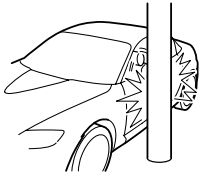

Vehicle roll-over may not provide enough side force to deploy the side and curtain air bags.



Side impacts with two-wheeled vehicles may not provide enough force to deploy the side and curtain air bags.



# SRS Air Bags

---

## Non-activation of side and curtain air bags

The side and curtain air bags will not normally inflate in the following cases:

Collision from the rear.

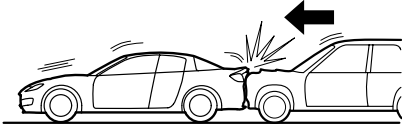

Collision from the front, but it may deploy the front air bags.

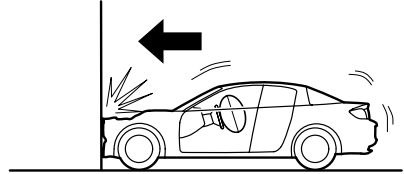



**▼ Constant Monitoring**

The following components of the air bag systems are monitored by a diagnostic system:

- SAS unit
- Front air bag sensor
- Air bag modules
- Side and curtain air bag crash sensor
- Front seat belt pretensioners
- Related wiring
- Driver's seat slide position sensor
- Front seat belt buckle switches

A diagnostic module continuously monitors the systems' readiness. This begins when the ignition switch is turned to the ON position and continues while the vehicle is being driven.

**▼ Air Bag/Front Seat Belt Pretensioner System Warning Light**

If the air bag/front seat belt pretensioner system is normal, the warning light illuminates when the ignition switch is turned to the ON position or after the engine is cranked. After about 6 seconds it goes out.

A system malfunction is indicated when the warning light constantly flashes, illuminates or doesn't illuminate at all when the ignition switch is turned to the ON position. If any of these occur, consult an Authorized Mazda Dealer as soon as possible. The system may not work in an accident.

 <b>WARNING</b>
<p><b><u>Self-Servicing the Air Bag/Pretensioner Systems:</u></b>  <i>Self-servicing or tampering with the systems is dangerous. An air bag/pretensioner could accidentally activate or become disabled. This could cause serious injuries. Never tamper with the systems and always have an Authorized Mazda Dealer perform all servicing and repairs.</i></p>

## SRS Air Bags

---

### ▼ Maintenance

The air bag systems do not require regular maintenance. But if any of the following occurs, take your vehicle to an Authorized Mazda Dealer as soon as possible:

- The air bag system warning light flashes.
- The air bag system warning light remains illuminated.
- The air bag system warning light remains off when the ignition switch is turned to the ON position.
- The air bags inflate.

### **WARNING**

**Damaged Air Bag Sensors:**  
*Driving with damaged air bag sensors is dangerous. A collision, even one not strong enough to inflate the air bags, could damage the sensors. If there was a subsequent collision, a damaged sensor would not inflate the air bags. Always have an Authorized Mazda Dealer inspect the air bag systems after a collision.*

**Removing Interior Parts:**  
*Removing any components such as the front seat, front dashboard, the steering wheel or parts on the front and rear window pillars\* and along the roof edge\*, containing air bag parts or sensors is dangerous. These parts contain essential air bag parts. The air bag could accidentally activate and cause serious injuries. Always have an Authorized Mazda Dealer remove these parts.*

**Air Bag Disposal:**  
*Improper disposal of an air bag or a vehicle with live air bags in it can be extremely dangerous. Unless all safety procedures are followed, injury can result. Ask an Authorized Mazda Dealer how to safely dispose of an air bag or how to scrap an air bag equipped vehicle.*

Explanation of basic operations and controls; opening/closing and adjustment of various parts.

<b>Doors and Locks</b> .....	3-2
Keys .....	3-2
Keyless Entry System .....	3-3
Door Locks .....	3-7
Trunk Lid .....	3-11
Inside Trunk Release Slide Lever .....	3-13
Power Windows .....	3-14
Rear Quarter Windows .....	3-16
Fuel-Filler Lid and Cap .....	3-16
Hood .....	3-18
Moonroof* .....	3-19
<b>Security System</b> .....	3-21
Immobilizer System .....	3-21
Theft-Deterrent System* .....	3-24
<b>Steering Wheel and Mirrors</b> .....	3-26
Steering Wheel .....	3-26
Mirrors .....	3-26

# Doors and Locks

## Keys

### **WARNING**

**Keys and Children:**

*Leaving children in a vehicle with the key is dangerous. This could result in someone being badly injured or even killed. They could play with power windows or other controls, or even make the vehicle move. Don't leave the keys in your vehicle with children and keep them in a place where your children will not find or play with them.*

**NOTE**

Refer to Immobilizer System (page 3-21) for information regarding keys and engine starting on vehicles equipped with the immobilizer system.

Your Mazda has two kinds of keys.

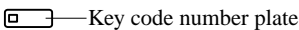
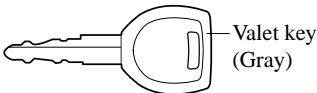
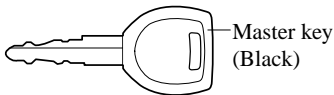

Here's what the keys are used for:

Lock Operates	Master key	Valet key
Ignition switch and steering column lock	Yes	Yes
Driver's door	Yes	Yes
Glove box	Yes	No
Storage box	Yes	No
Trunk lid	Yes	No

If you must leave your vehicle with another person, such as a parking attendant, protect items by locking the glove box, storage box and trunk lid with the master key. Keep that key and give the other person only the valet key.

A code number is stamped on the plate attached to the key set; detach this plate and store it in a safe place (not in the vehicle) for use if you need to make a replacement key.

Also write down the code number and keep it in another safe and handy place, but not in the vehicle.

If your key is lost, consult your Authorized Mazda Dealer with the code number ready.

## Keyless Entry System

This system locks and unlocks the doors and opens the trunk.

It can also help you signal for attention in an emergency.

Press the button slowly and accurately.

### CAUTION

To avoid damage to the transmitter, do not:

- Drop it.
- Get it wet.
- Disassemble it.
- Expose it to heat or sunlight.

### NOTE

- The keyless entry system is designed to operate up to about 2.5 m (8 ft) from the center of the vehicle, but this may vary because of local conditions.
- The system doesn't operate when the key is in the ignition switch.
- Doors cannot be locked by pressing the LOCK button while any other door is open. The hazard warning lights will also not flash.
- If the transmitter does not operate when pressing a button or the operation range becomes too small, the battery may be dead. To install a new battery, refer to Maintenance (page 3-5).
- Additional transmitters can be obtained at an Authorized Mazda Dealer. Up to 3 transmitters can be used with the keyless entry system per vehicle. Bring all transmitters to an Authorized Mazda Dealer when the electronic codes need to be reset.

# Doors and Locks

## ▼ Transmitter

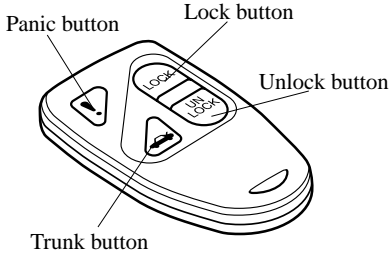

## Lock button

To lock the doors, press the LOCK button and the hazard warning lights will flash once.

To confirm that all the doors have been locked, press the LOCK button again within 5 seconds. If they are closed and locked, the horn will sound and the hazard warning lights will flash once.

<b>NOTE</b>
Confirm that all the doors are locked visually or audibly by use of the double click.

## Unlock button

To unlock the driver's door, press the UNLOCK button and the hazard warning lights will flash twice.

To unlock all the doors, press the UNLOCK button again within 5 seconds and the hazard warning lights will flash twice.

<b>NOTE</b>
After unlocking with the transmitter, all doors will automatically lock if one of the doors is not opened within about 30 seconds.

<b>NOTE</b>
<ul style="list-style-type: none"><li>• <b>(U.S.A.)</b> This device complies with part 15 of the FCC Rules. Operation is subject to the following two conditions: (1) This device may not cause harmful interference, and (2) this device must accept any interference received, including interference that may cause undesired operation.</li><li>• <b>(CANADA)</b> This device complies with RSS-210 of Industry CANADA. Operation is subject to the following two conditions: (1) this device may not cause interference, and (2) this device must accept any interference, including interference that may cause undesired operation of the device.</li></ul>

<b>NOTE</b>
If the LOCK and UNLOCK buttons are pressed sequentially, the hazard warning lights may not flash correctly.

**Trunk button**

To open the trunk, press the  button.

**NOTE**

The trunk button is disabled when the glove box-mounted trunk lid release lock-out button is in the OFF position (page 3-12).

**!Panic button**

You can use the **!** button to turn on the alarm, which allows you to signal for attention in an emergency.

**NOTE**

The alarm will work whether any door is open or closed.

**Turning on the alarm**

Pressing the **!** button once will trigger the alarm for about 2 minutes and 30 seconds, and do the following:

- The horn sounds intermittently.
- The hazard warning lights flash.

**Turning off the alarm**

Press any button on the transmitter or insert the key into the ignition switch.

**▼ Transmitter Maintenance**** CAUTION**

- Make sure the battery is installed with the correct pole facing upward. Battery leakage could occur if it is not installed correctly.
- When replacing the battery, be careful not to bend the electrical terminals or get oil on them. Also be careful not to get dirt in the transmitter as it could damage it.
- Danger of battery explosion if it is incorrectly replaced.
- Replace only with the same type battery (CR2025 or equivalent).
- Dispose of used batteries according to the following instructions.
  - Insulate the plus and minus terminals of the battery using cellophane or equivalent tape.
  - Never disassemble.
  - Never throw the battery into fire and/or water.
  - Never deform or crush.

## Doors and Locks

### Replacing the transmitter battery

1. Insert a small screwdriver into the slot and gently pry open the transmitter.

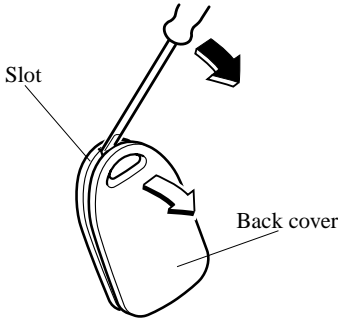

2. Press the portion of the battery indicated by A and remove the battery.

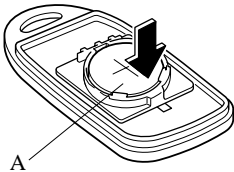

3. Install a new battery (CR2025 or equivalent) into the front portion of the holder with the positive pole (+) facing up. Press on the B portion of the battery to set the battery.

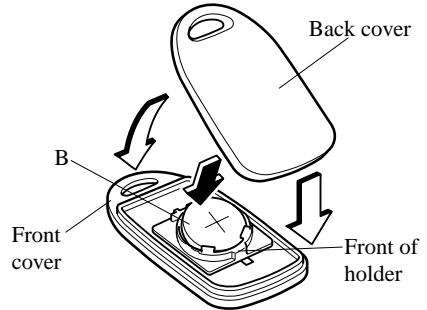

4. Align the front and back covers and snap the transmitter shut.

### ▼ Service

If you have a problem with the keyless entry system, consult an Authorized Mazda Dealer.

If your transmitter is lost or stolen, bring all remaining transmitters to an Authorized Mazda Dealer as soon as possible for a replacement and to make the lost or stolen transmitter inoperative.

### ⚠ CAUTION

Changes or modifications not expressly approved by the party responsible for compliance could void the user's authority to operate the equipment.



## Door Locks

### **WARNING**

**Unattended Children and Pets:**  
Leaving a child or an animal unattended in a parked vehicle is dangerous. In hot weather, temperatures inside a vehicle can become high enough to cause brain damage or even death. Always take all children and animals with you or leave a responsible person with them.

**Keys and Children:**  
Leaving children in a vehicle with the key is dangerous. This could result in someone being badly injured or even killed. They could play with power windows or other controls, or even make the vehicle move. Don't leave the keys in your vehicle with children and keep them in a place where your children will not find or play with them.

**Unlocked Doors:**  
Unlocked doors in a moving vehicle are dangerous. Passengers can fall out if a door is accidentally opened and can more easily be thrown out in an accident. So keep all doors locked when driving.

### **NOTE**

Always remove the key from the ignition switch, close all windows, and lock all doors and the trunk lid when leaving your vehicle unattended. This discourages intruders and thieves.

### ▼ Locking, Unlocking with Key

The driver's door can be locked/unlocked with the key.

Turn the key toward the front to unlock, toward the back to lock.

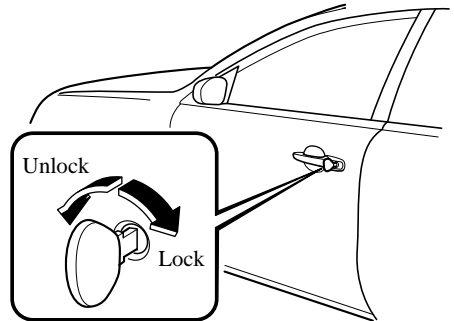

### ▼ Locking, Unlocking with Transmitter

The doors can be locked/unlocked by operating the keyless entry system transmitter, refer to keyless entry system (page 3-3).

### ▼ Locking, Unlocking with Door-Lock Knob

To lock either front door from the inside, push the door-lock knob.

To unlock, pull it out.

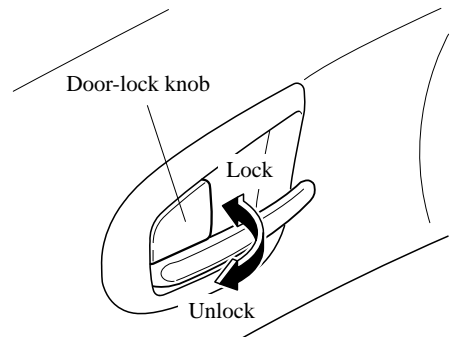

# Doors and Locks

To lock either front door with the door-lock knob from the outside, push the door-lock knob to the lock position and close the door.

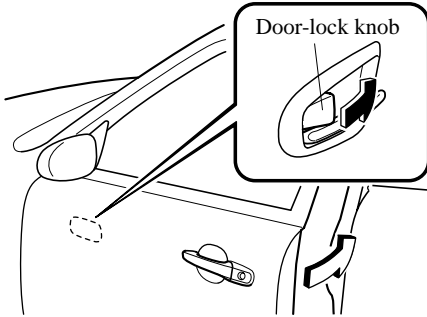

**NOTE**  
When locking the doors this way, be careful not to leave the key inside the vehicle.

## ▼ Power Door Locks

### Locking, unlocking with key

All doors lock automatically when the driver's door is locked with the key. All doors unlock when the driver's door is unlocked and the key is held in the unlock position a second longer.

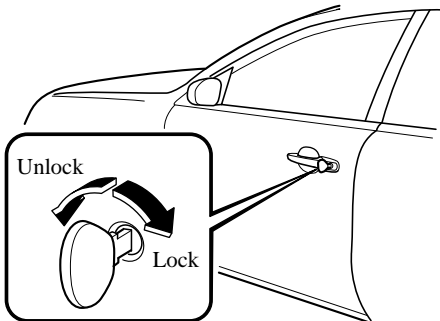

### **NOTE**

Holding the key in the unlocked position in the driver's door lock for about a second unlocks all doors. To unlock only the driver's door, insert the key into the driver's door lock and turn the key briefly to the unlock position and then immediately return it to the center position.

### Locking, unlocking with door-lock switch

All doors lock automatically when LOCK is pushed. They all unlock when the unmarked part of the door-lock switch is pushed.

#### Driver's door

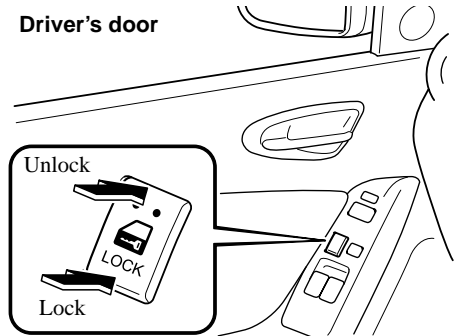

#### Passenger's door

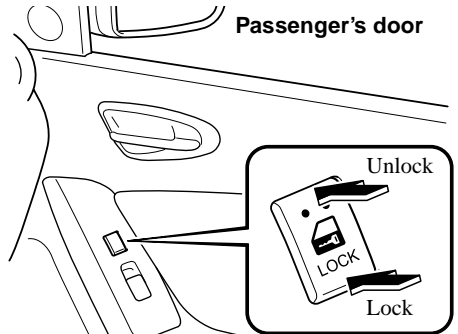

## Doors and Locks

### ▼ Freestyle Doors

The pillarless freestyle doors are front and rear-hinged for ease of ingress and egress to the rear seat.

#### Opening the freestyle doors

1. Open the front door first.

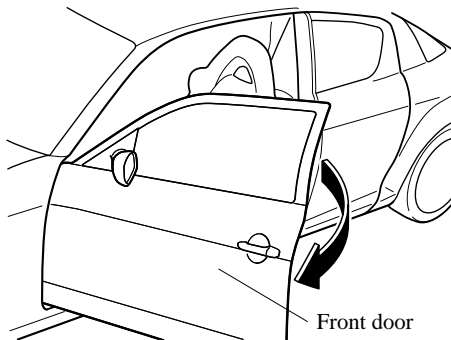

2. Pull the rear door handle and open the rear door.

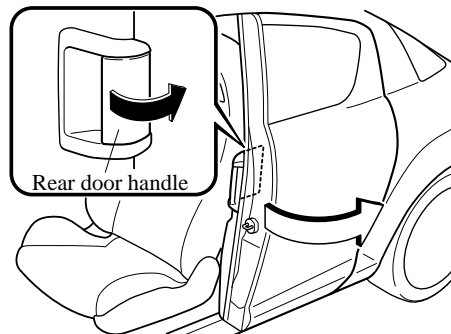

### ⚠ CAUTION

Before closing a front door make sure other passengers are not operating a rear door and a rear passenger's head or hands are away from the rear door. If the front door is closed while a passenger is operating the rear door handle, a hand or fingers could be injured if the handle is forced back. Also, a rear passenger could hit their head against the door during access to the rear seat.

### NOTE

- The rear door cannot be opened while the front door is closed.
- Make sure the front seatbelt is unfastened before the rear door is opened. The rear door can't be opened with the front seatbelt fastened because the front seatbelt may lock.
- If any door is left open for more than about an hour, the front seatbelt will lock, and the rear door cannot be opened. If this happens, close all doors and open the rear door again.
- This vehicle is not equipped with child safety locks due to the design of the front and rear doors. The rear doors must be closed before the front doors, and the rear doors cannot be opened until the front doors are opened.

## Doors and Locks

### **Closing the freestyle doors**

1. Close the rear door first, and then close the front door.

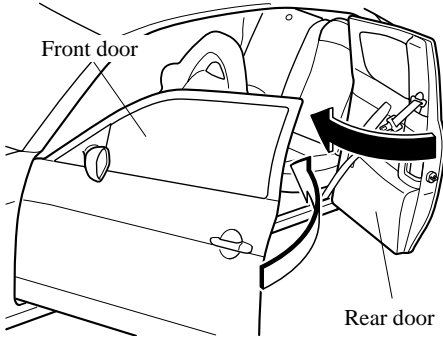

### **! CAUTION**

Before closing a front door make sure other passengers are not operating a rear door and a rear passenger's head or hands are away from the rear door. If the front door is closed while a passenger is operating the rear door handle, a hand or fingers could be injured if the handle is forced back. Also, a rear passenger could hit their head against the door during access to the rear seat.

### **NOTE**

The front door cannot latch or lock while the rear door is opened.

2. Make sure the freestyle doors are securely closed.

### **! WARNING**

***Driving with Doors Not Secured:***  
*Driving with the doors not securely closed is dangerous. If the rear door is not completely closed, the front door will not be securely closed. This could cause the front door to open unexpectedly while driving and may result in an accident. Make sure the rear door is closed securely before closing the front door.*

## Doors and Locks

### Trunk Lid

#### **WARNING**

**Open Trunk and Exhaust Gas:**  
Exhaust gas in the cabin of a vehicle is dangerous. This gas contains CO (carbon monoxide), which is colorless, odorless, and highly poisonous. If inhaled, it can cause loss of consciousness and death. Because exhaust gas can get into the cabin through an open trunk, keep the trunk closed when driving.

#### ▼ Opening and Closing the Trunk

#### **WARNING**

**Open Trunk Lid and Children:**  
Leaving the trunk lid open or leaving children in the vehicle with the keys is dangerous. Children could open the trunk lid and climb inside resulting in possible injury or death from heat exposure. Close the trunk lid and do not allow children to play inside the vehicle.

#### **WARNING**

**Unattended Children and Pets:**  
Leaving children or animals unattended in a parked vehicle is dangerous. Babies left sleeping and kids who lock themselves in cars or trunks can die very quickly from heat prostration. Don't leave your children or pets alone in a car at any time. Don't leave the car or the trunk unlocked. Always keep the car from being a tempting place to play by locking doors and the trunk, and keeping the keys where children won't play with them.

#### **Opening the trunk lid with the key**

Insert the master key into the slot and turn it clockwise.

The valet key will not operate this lock (page 3-2).

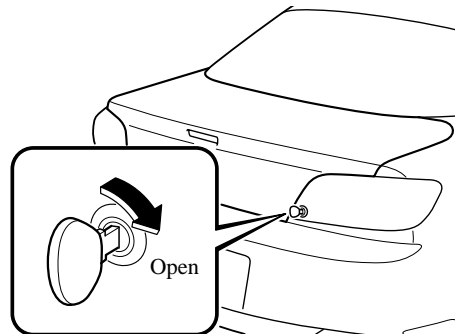

#### **Opening the trunk lid with the transmitter**

The trunk lid can be opened by operating the keyless entry system transmitter, refer to Keyless Entry System (page 3-3).

## Doors and Locks

### Opening the trunk lid with the remote release button

Push the release button.

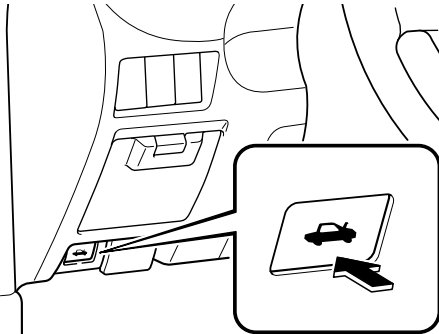

### Closing the trunk lid

Grasp the inner handle and pull the trunk lid down, then push the trunk lid down until it locks securely. Be careful not to slam it. Pull up on the trunk lid to make sure it is secured.

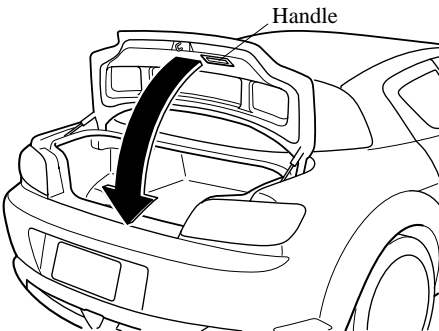

### ▼ Remote Trunk Lid Release Lock-Out

As an added security feature, the remote release may be canceled to prevent anyone from opening the trunk without the master key.

With the switch in the OFF position, the remote trunk lid release cannot be operated.

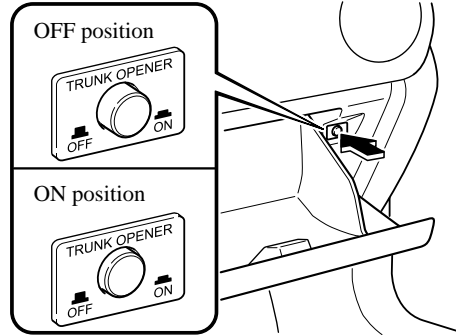

With the switch in the ON position, the remote trunk lid release can be operated.

### ▼ Trunk Light

The trunk light is on when the lid is open and off when it's closed.

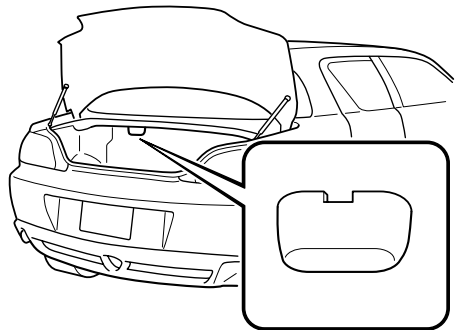

### NOTE

To prevent the battery from being discharged, do not leave the trunk open for a long period when the engine is not running.

## Doors and Locks

### Inside Trunk Release Slide Lever

Your vehicle is equipped with an inside trunk release slide lever that provides a means of escape for children and adults in the event they become locked inside the trunk.

No matter how careful adults might be with keys and locking their cars, parents should be aware that children may be tempted to play around vehicles and use the trunk as a hiding place.

Adults are advised to familiarize themselves with the operation and location of the inside trunk release slide lever so that all children can be told about it in an appropriate way, keeping in mind that most vehicles don't have such levers.

### **WARNING**

**Open Trunk Lid and Children:**  
*Leaving the trunk lid open or leaving children in the vehicle with the keys is dangerous. Children could open the trunk lid and climb inside resulting in possible injury or death from heat exposure. Close the trunk lid and do not allow children to play inside the vehicle.*

### **WARNING**

**Unattended Children and Pets:**  
*Leaving children or animals unattended in a parked vehicle is dangerous. Babies left sleeping and kids who lock themselves in cars or trunks can die very quickly from heat prostration. Don't leave your children or pets alone in a car at any time. Don't leave the car or the trunk unlocked. Always keep the car from being a tempting place to play by locking doors and the trunk, and keeping the keys where children won't play with them.*

### ▼ **Opening the Trunk Lid from the Inside**

Slide the illuminated inside trunk release slide lever in the direction of the arrow. The lever is made of material that will glow for hours in the darkness of the trunk following a brief exposure to ambient light.

The inside trunk release slide lever is located on the inside of the trunk end trim.

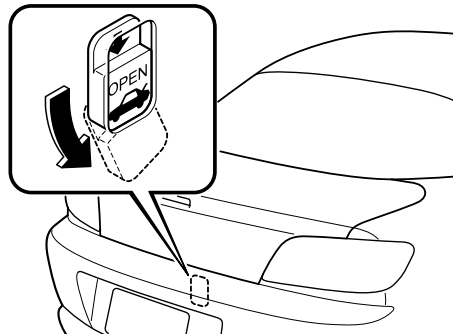

## Doors and Locks

### Power Windows

The ignition switch must be in the ON position for the power windows to operate.

#### **WARNING**

##### Closing Power Windows:

*Closing power windows are dangerous. A person's hands, head, or even neck could be caught by the window and result in serious injury or even death.*

*This warning applies especially to children. Make sure the opening is clear before closing a window.*

##### Children and Power Windows:

*Leaving the power window switches unlocked while children are in the vehicle is dangerous. Power window switches that are not locked with the power window lock switch would allow children to operate power windows unintentionally which could result in serious injury if a child's hands, head or neck becomes caught by the window. Always lock all passenger power windows with the power window lock switch on the driver's side while children are in the vehicle, and never allow children to play with power window switches.*

### ▼ Operating the Driver's Side Power Window

#### Manual opening/closing

To open the window to the desired position, lightly hold down the switch. To close the window to the desired position, lightly pull up the switch.

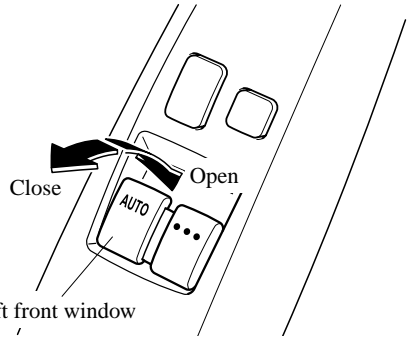

#### Auto-opening

To fully open the window automatically, press the switch completely down.

To stop the window partway, lightly pull up the switch and then release it.



## Doors and Locks

### ▼ Operating the Passenger Power Windows

The power window may be operated when the power window lock switch on the driver's door is in the unlocked position.

The passenger window may be opened or closed by the power window master control switches on the driver's door.

Power window lock switch

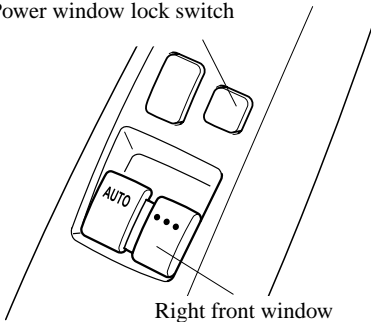

To open the window to the desired position, hold down the switch.

To close the window to the desired position, pull up the switch.

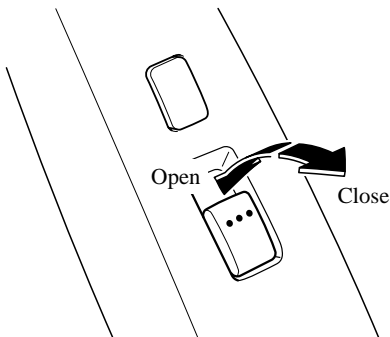

### ▼ Power Window Lock Switch

With the lock switch in the unlocked position, all power windows on each door can be operated.

With the lock switch in the locked position, only the driver's side power window can be operated.

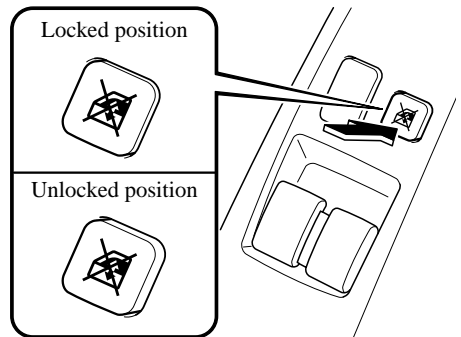

### **WARNING**

**Unintentional Window Operation:**  
*Unintentional window operation is dangerous. A person's hands, head, or neck could be caught by the window and result in serious injury. Unless a passenger needs to operate a window, keep the power window lock switch in the locked position.*

## Doors and Locks

### Rear Quarter Windows

Open or close a swing-out rear quarter window by releasing the latch and moving the window.

#### NOTE

When parked in public areas, it is best to keep the rear quarter windows closed for security.

#### ▼ Opening a Window

Pull the latch inward and then push the window outward.

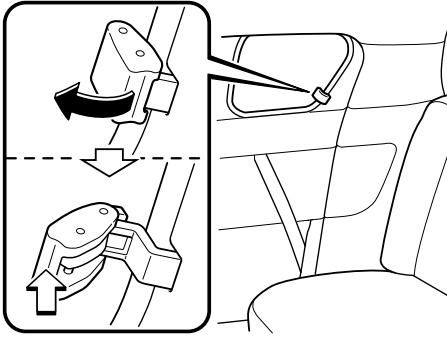

#### ▼ Closing a Window

Pull the latch inward and then push it backward until it snaps shut. Make sure the window is securely closed.

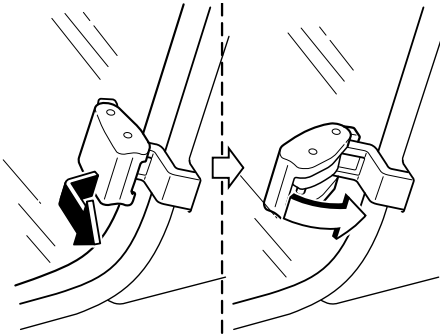

### Fuel-Filler Lid and Cap

#### ⚠ WARNING

##### Fuel Spray:

*Fuel spray is dangerous. Fuel can burn skin and eyes and cause illness when ingested. Fuel spray is released when there is pressure in the fuel tank and the fuel cap is removed too quickly. When removing the fuel cap, loosen the cap slightly and wait for any hissing to stop. Then remove it.*

##### Fuel Vapor:

*Fuel vapor is dangerous. It could be ignited by sparks or flames causing serious burns and injuries. Before refueling, stop the engine, and always keep sparks and flames away from the filler neck. Additionally, use of the incorrect fuel filler cap or not using a fuel filler cap may result in fuel leak, which could result in serious burns or death in an accident.*

#### ⚠ CAUTION

Always use only a genuine Mazda fuel cap or an approved equivalent, available at Authorized Mazda Dealers. The wrong cap can result in a serious malfunction of the fuel and emission control systems. It may also cause the check engine light in the instrument cluster to illuminate.

### ▼ Fuel-Filler Lid

To open, pull up the remote fuel-filler lid release.

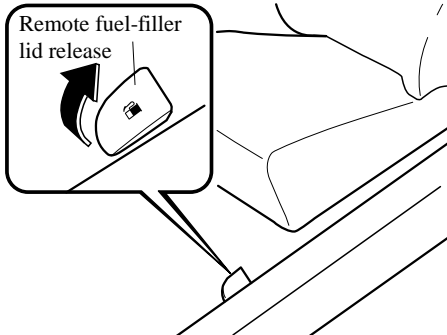

### ▼ Fuel-Filler Cap

To remove the filler cap, turn it counterclockwise.

To close the filler cap, turn it clockwise until it clicks.

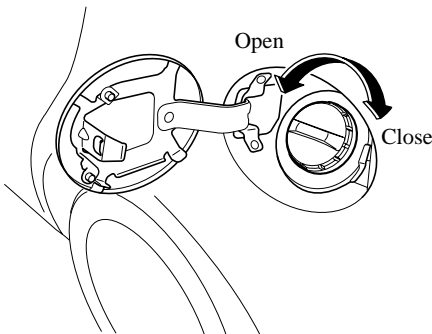

### ⚠ CAUTION

Make sure the fuel-filler cap is tightened securely. The check engine light may illuminate on when the cap isn't tightened securely. If the light remains on (even after you have tightened the cap securely, driven, and restarted the engine several times), it may indicate a different problem. Contact an Authorized Mazda Dealer as soon as possible.

# Doors and Locks

## Hood

### **WARNING**

***Closed and Securely Locked Hood:***  
*A hood that is not closed and securely locked is dangerous as it could fly open while the vehicle is moving and block the driver's vision which could result in a serious accident. Always check that the hood is closed and securely locked.*

### ▼ Opening the Hood

1. With the vehicle parked, pull the release handle to unlock the hood.

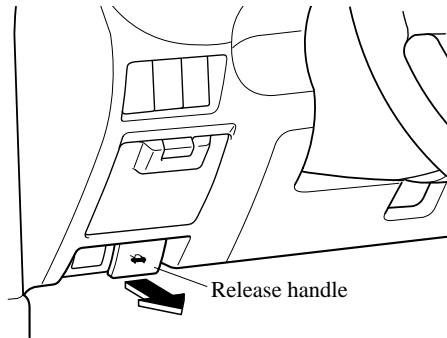

2. Slide the hood latch to the right and lift the hood.

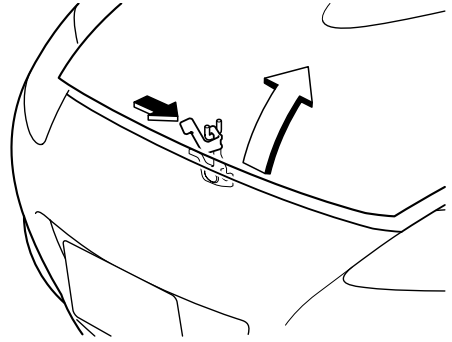

3. Use the support rod to hold the hood open.

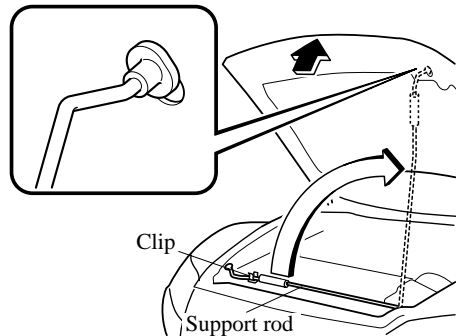

### ▼ Closing the Hood

1. Check under the hood area to make certain all filler caps are in place and all loose items (e.g. tools, oil containers, etc.) have been removed.
2. Insert the support rod in its clip while holding up the hood. Verify that the support rod is secured in the clip before closing the hood.
3. Close the hood so that it locks securely.

## Moonroof\*

The moonroof can be opened or closed electrically only when the ignition switch is in the ON position.

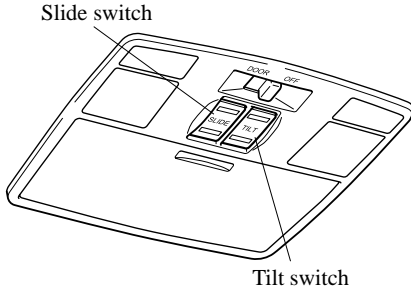

### NOTE

After washing your Mazda or after a rain, wipe the water off the moonroof before operating it to avoid water penetration which could cause rust and water damage to your headliner.

### ▼ Tilt Operation

The rear of the moonroof can be tilted open to provide more ventilation.

To fully tilt automatically, push the rear of the tilt switch.

To stop tilting partway, push any part of the tilt or slide switch.

To close to the desired position, push the front of the tilt or slide switch.

## ⚠ WARNING

### Extending the Head or Arms Through the Moonroof:

*Extending the head, arms, or other parts of the body through the moonroof is dangerous. The head or arms could hit something while the vehicle is moving. This could cause death or serious injury. Don't let passengers stand up or extend anything through the open moonroof while the vehicle is moving.*

### Closing the Moonroof:

*A closing moonroof is dangerous. The hands, head, or even neck of a person —especially a child— could be caught in it as it closes, causing serious injury or even death. Make sure the opening is clear before closing the moonroof.*

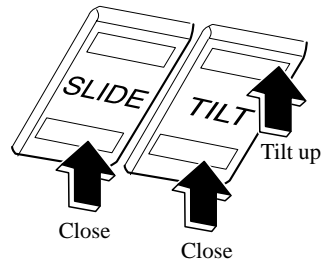

## Doors and Locks

### ▼ Slide Operation

To fully open automatically, push the rear of the slide switch.

To stop sliding partway, push any part of the tilt or slide switch.

To close to the desired position, push the front of the tilt or slide switch.

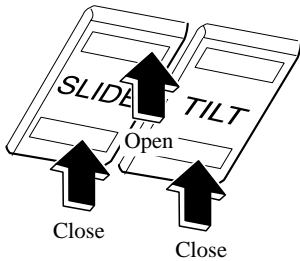

### ▼ Sunshade

The sunshade can be opened and closed by hand.

The sunshade opens automatically when the moonroof is opened, but must be closed by hand.

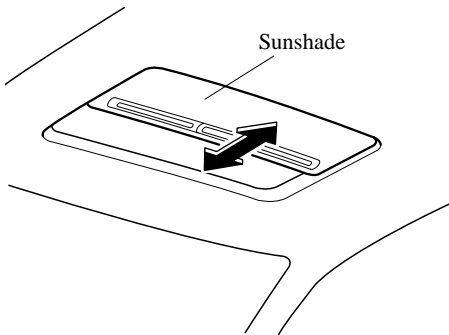

### ⚠ CAUTION

The sunshade doesn't tilt. To avoid damaging the sunshade, don't push up on it.

## Immobilizer System

The immobilizer system allows the engine to start only with a key the system recognizes.

If someone attempts to start the engine with an unrecognized key, the engine will not start, thereby helping to prevent the theft of your vehicle.

### CAUTION

- Changes or modifications not expressly approved by the party responsible for compliance could void the user's authority to operate the equipment.
- To avoid damage to the key, do not:
  - Drop the key.
  - Get the key wet.
  - Expose the key to any kind of magnetic field.
  - Expose the key to high temperatures on places such as the dashboard or hood, under direct sunlight.

### CAUTION

When starting the engine do not allow the following, as the engine may not start due to the electronic signal from the ignition key not being transmitted correctly.

- A key ring rests on the key grip.

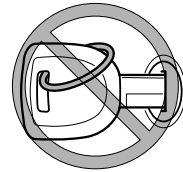

- Metal parts of other keys or metal objects touch the key grip.

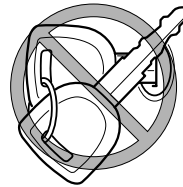

- Spare keys or keys for other vehicles equipped with an immobilizer system touch or come near the key grip.

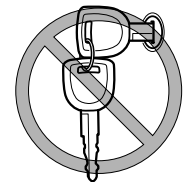

- Devices for electronic purchases, or security passage touch or come near the key.

# Security System

---

## NOTE

- **(U.S.A.)**  
This device complies with part 15 of the FCC Rules. Operation is subject to the following two conditions: (1) This device may not cause harmful interference, and (2) this device must accept any interference received, including interference that may cause undesired operation.
- **(CANADA)**  
This device complies with RSS-210 of Industry CANADA. Operation is subject to the following two conditions: (1) this device may not cause interference, and (2) this device must accept any interference, including interference that may cause undesired operation of the device.

## ▼ Operation

### Arming

The system is armed when the ignition switch is turned from the ON to the ACC position.

The security indicator light in the instrument panel flashes every 2 seconds until the system is disarmed.



### Disarming

The system is disarmed when the ignition switch is turned to the ON position with the correct ignition key.

The security indicator light illuminates for about 3 seconds and goes out.

If the engine doesn't start with the correct ignition key, and the security indicator light keeps illuminating or flashing, the system may have a malfunction. Consult an Authorized Mazda Dealer.



# Security System

## NOTE

- If the security indicator light comes on and stays on when the ignition switch is turned to the ON position, the engine will not start.
- Signals from a TV or radio station, or from a transceiver or a mobile telephone, could interfere with your immobilizer system. If you are using the proper key and your engine fails to start, check the security indicator light. If it is flashing, remove the ignition key and wait 2 seconds or more, then reinsert it and try starting the engine again. If it doesn't start after 3 or more tries, contact an Authorized Mazda Dealer.
- If the security indicator light flashes continuously while you are driving, don't shut off the engine. Go to an Authorized Mazda Dealer and have it checked. If you shut off the engine while the light is flashing you won't be able to restart it.
- Since the electronic codes are reset when repairing the immobilizer system, the keys are needed. Bring all the existing keys to the Authorized Mazda Dealer.

## ▼ Maintenance

If you have a problem with the immobilizer system or the key, consult an Authorized Mazda Dealer.

## NOTE

- The keys carry a unique electronic code. For this reason, and to assure your safety, obtaining replacement key requires some waiting time. They are only available through an Authorized Mazda Dealer.
- Always keep a spare key, in case one is lost. If a key is lost, contact an Authorized Mazda Dealer as soon as possible.
- If you lose a key, an Authorized Mazda Dealer will reset the electronic codes of your remaining keys and immobilizer system. Bring all the remaining keys to the Authorized Mazda Dealer to reset. Starting the vehicle with a key that has not been reset is not possible.

## ▼ Modification and Add-On Equipment

Mazda cannot guarantee the immobilizer system's operation if the system has been modified or if any add-on equipment has been installed to it.

## CAUTION

To avoid damage to your vehicle, do not modify the system or install any add-on equipment to it.

# Security System

## Theft-Deterrent System\*

The optional theft-deterrent system is designed to prevent your vehicle or its contents from being stolen when all the doors, hood, and trunk lid are locked.

If forcible entry is attempted, the system sounds the horn and flashes the hazard warning lights.

### NOTE

- The theft-deterrent system operates with the key or the keyless entry system transmitter.
- The system will not function unless it is properly armed. To properly secure the vehicle, always make sure all the windows are completely closed and all doors are locked before leaving the vehicle. Remember to take your key and transmitter.

## ▼ Operation

### System triggering conditions

The horn sounds intermittently and the hazard warning lights flash for about 3 minutes when the system is triggered by any one of the following:

- Forcing open a door, the hood or the trunk lid.
- Opening a door, the hood or the trunk lid by operating an inside door-lock knob, the hood release handle or the trunk lid release button.

If the system is triggered again, the lights and horn will activate until a door is unlocked or the trunk lid is opened with the key or with the transmitter.

## ▼ How to Arm the System

1. Remove the key from the ignition switch.
2. Close the hood. Then close and lock all doors and the trunk lid from the outside using the key or press the LOCK button on your keyless entry system transmitter. The hazard warning lights will flash once to indicate that the system is armed.

The following method will also arm the theft-deterrent system:

Close the hood and the trunk lid . Press the area on the door-lock switch marked "LOCK" once. Close all doors.

### NOTE

Locking the doors with the inside door-lock knob will not arm the system.

## ▼ To Turn off an Armed System

An armed system can be turned off by any one of the following methods:

- Unlock a door with the key.
- Press the UNLOCK button on the keyless entry system transmitter.
- Insert the key into the ignition switch and turn it to the ON position.

The hazard warning lights will flash twice to indicate that the system is turned off.

### NOTE

The trunk lid can be opened with the key or the transmitter even when the system is armed. The alarm will not come on and the system will remain armed.

## ▼ To Stop an Alarm

A triggered alarm can be turned off by any one of the following methods:

- Unlock a door or the trunk lid with the key.
- Press the UNLOCK button or  button on the keyless entry system transmitter.

### NOTE

If you have any problem with the theft-deterrent system, consult an Authorized Mazda Dealer.

## ▼ Theft-Deterrent Labels



Labels indicating that your vehicle is equipped with a Theft-Deterrent System are in the glove box.

Mazda recommends that you affix them to the lower rear corner of the front door windows.

# Steering Wheel and Mirrors

## Steering Wheel

### **WARNING**

**Adjusting the Steering Wheel:**  
*Adjusting the steering wheel while the vehicle is moving is dangerous. Moving it can very easily cause the driver to abruptly turn to the left or right. This can lead to loss of control or an accident. Never adjust the steering wheel while the vehicle is moving.*

### ▼ **Tilt Steering Wheel**

To change the angle of the steering wheel, stop the vehicle, pull the tilt wheel release lever under the steering column down, adjust the wheel, then push the release lever up to lock the column.

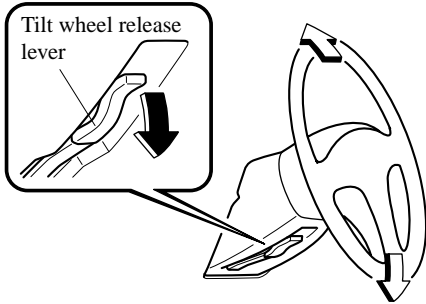

After adjusting, push the wheel up and down to be certain it's locked before driving.

## Mirrors

### ▼ **Outside Mirrors**

Check the mirrors' angles before driving.

### **WARNING**

**Convex Mirror (Passenger Side):**  
*Changing lanes without taking into account the actual distance of the vehicle in the convex mirror is dangerous. You could have a serious accident. What you see in the convex mirror is closer than it appears. Be sure to look over your shoulder before changing lanes.*

### **Power control mirror**

The ignition switch must be in the ACC or ON position.

To adjust:

1. Press the left or right side of the selector switch to choose the left or right side mirror.
2. Depress the mirror switch in the appropriate direction.

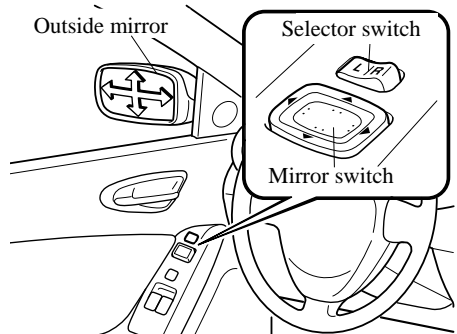

# Steering Wheel and Mirrors

After adjusting the mirror, lock the control by placing the selector switch in the middle position.

## Folding the mirror

Fold the outside mirror rearward until it is locked.

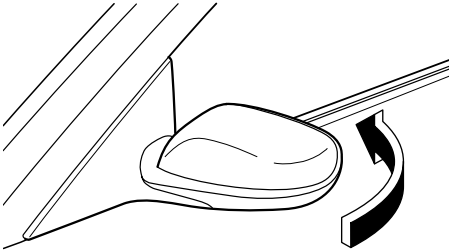

## **! WARNING**

***Driving with Mirrors Folded In:***  
*Driving with the outside mirrors folded in is dangerous. Your rear view will be restricted, and you could have an accident. Always return the outside mirrors to the driving position before you start driving.*

## Mirror defroster\*

If your vehicle has mirror defrosters, turn them on by turning the ignition switch to the ON position and pushing the rear window defroster switch (page 5-53).

## ▼ Rearview Mirror

### **! WARNING**

#### **Blocked View:**

***Cargo stacked higher than the seatbacks is dangerous. It can block your view in the rearview mirror, which might cause you to hit another car when changing lanes. Don't stack things higher than the seatbacks.***

### **Rearview mirror adjustment**

Before driving, adjust the rearview mirror to center on the scene through the rear window.

### **NOTE**

For the manual day/night mirror, perform the adjustment with the day/night lever in the day position.

### **Reducing glare from headlights**

#### **Manual day/night mirror**

Push the day/night lever forward for day driving. Pull it back to reduce glare of headlights from cars at the rear.

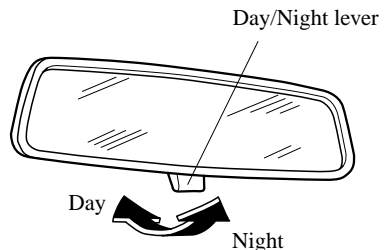

# Steering Wheel and Mirrors

## Auto-dimming mirror

The auto-dimming mirror automatically reduces glare of headlights from cars at the rear when the ignition switch is in the ON position.

Press the OFF button (○) to cancel the automatic dimming function. The indicator light will go off.

To reactivate the automatic dimming function, press the ON button (⬆). The indicator light will illuminate.

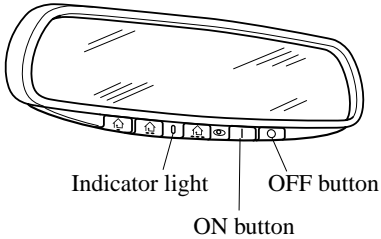

### NOTE

- Do not use glass cleaner or suspend objects on or around the light sensor. Otherwise, light sensor sensitivity will be affected and may not operate normally.

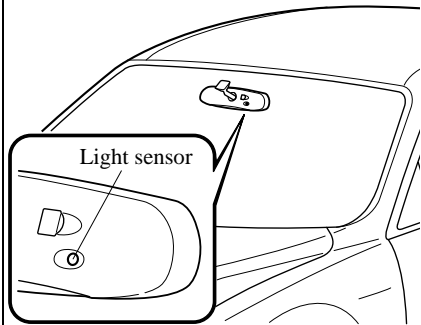
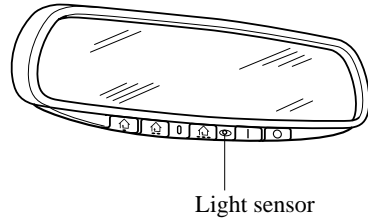

- For information regarding the 3 buttons (⬆, ⬆, ⬆) on the auto-dimming mirror, refer to HomeLink Wireless Control System (page 5-55).

Important information about driving your Mazda.

<b>Fuel and Engine Exhaust Precautions</b> .....	4-2
Fuel Requirements .....	4-2
Emission Control System .....	4-3
Engine Exhaust (Carbon Monoxide) .....	4-5
<b>Before Starting the Engine</b> .....	4-6
Before Getting In .....	4-6
After Getting In .....	4-6
<b>Driving Tips</b> .....	4-7
Break-In Period .....	4-7
Money-Saving Suggestions .....	4-7
Hazardous Driving .....	4-8
Rocking the Vehicle .....	4-8
Winter Driving .....	4-9
Driving In Flooded Area .....	4-10
Overloading .....	4-11
<b>Towing</b> .....	4-12
Trailer Towing .....	4-12

## Fuel and Engine Exhaust Precautions

### Fuel Requirements

Vehicles with catalytic converters or oxygen sensors must use **ONLY UNLEADED FUEL**, which will reduce exhaust emissions and keep spark plug fouling to a minimum.

Your Mazda will perform best with fuel listed in the table.

Fuel	Octane Rating* (Anti-knock index)
Premium unleaded fuel	91 [(R+M)/2 method] or above (96 RON or above)

\* U.S. federal law requires that octane ratings be posted on gasoline station pumps. You may use a regular unleaded fuel with an Octane Rating from 87 to 90 (91 to 95 RON) but this will slightly reduce performance.

Fuel with a rating lower than 87 octane (91 RON) could cause the emission control system to lose effectiveness. It could also cause engine knocking and serious engine damage.

### CAUTION

- **USE ONLY UNLEADED FUEL.**  
Leaded fuel is harmful to the catalytic converter or the oxygen sensor. The lead will accumulate on the oxygen sensor and the catalyst inside the converter. This will result in a malfunction of the emission control system, causing poor performance.
- Your vehicle can only use oxygenated fuels containing no more than 10% ethanol by volume. Damage to your vehicle may occur when ethanol exceeds this recommendation, or if the gasoline contains any methanol. Stop using gasohol of any kind if your vehicle engine is performing poorly.
- Never add fuel system additives. Never add cleaning agents other than those specified by Mazda. Other cleaning agents and additives may damage the system. Consult an Authorized Mazda Dealer.

Gasoline blended with oxygenates such as alcohol or ether compounds are generally referred to as oxygenated fuels. The common gasoline blend that can be used with your vehicle is ethanol blended at no more than 10%. Gasoline containing alcohol, such as ethanol or methanol, may be marketed under the name "Gasohol".

Vehicle damage and drivability problems resulting from the use of the following may not be covered by the Mazda warranty.

- Gasohol containing more than 10% ethanol.
- Gasoline or gasohol containing methanol.
- Leaded fuel or leaded gasohol.



# Fuel and Engine Exhaust Precautions

## Emission Control System

Your vehicle is equipped with an emission control system (the catalytic converter is part of this system) that enables your vehicle to comply with existing exhaust emissions requirements.

### **WARNING**

#### **Parking Over Flammable Objects:**

*Parking over or near anything flammable, such as dry grass, is dangerous. Even with the engine turned off, the exhaust system could ignite it because the exhaust system gets very hot during normal use. A resulting fire could cause serious injury or death. Never park over or near anything flammable.*

### **CAUTION**

Ignoring the following precautions could cause lead to accumulate on the catalyst inside the converter or cause the converter to get very hot. Either condition will damage the converter and cause poor performance.

- USE ONLY UNLEADED FUEL.
- Don't drive your Mazda with any sign of engine malfunction.
- Don't coast with the ignition switch turned off.
- Don't descend steep grades in gear with the ignition switch turned off.
- Don't operate the engine at high idle for more than 5 minutes.
- Don't tamper with the emission control system. All inspections and adjustments must be made by a qualified technician.
- Don't try to push-start or pull-start your vehicle.

### **NOTE**

Under U.S. federal law, any modification to the original-equipment emission control system before the first sale and registration of a vehicle is subject to penalties. In some states, such modification made on a used vehicle is also subject to penalties.

## Fuel and Engine Exhaust Precautions

---

**NOTE**

After driving some distance and turning off the engine, the sound of a valve opening and closing can be heard from inside and outside of the cabin interior, however this does not indicate an abnormality. Your vehicle has a self-checking device and it operates after turning off the engine.

## Fuel and Engine Exhaust Precautions

### Engine Exhaust (Carbon Monoxide)

#### WARNING

##### **Carbon Monoxide:**

*Engine exhaust gas is dangerous. This gas contains carbon monoxide (CO), which is colorless, odorless, and poisonous. When inhaled, it can cause loss of consciousness and death. If you smell exhaust gas inside your vehicle, keep all windows fully open and contact an Authorized Mazda Dealer immediately.*

##### **Exhaust Gas in Enclosed Area:**

*Running the engine inside an enclosed area, such as a garage, is dangerous. Exhaust gas, which contains poisonous carbon monoxide, could easily enter the cabin. Loss of consciousness or even death could occur. Don't run the engine when inside an enclosed area.*

##### **Idling with the Windows Closed:**

*Exhaust gas is dangerous. When your vehicle is stopped with the windows closed and the engine running for a long time even in an open area, exhaust gas, which contains poisonous carbon monoxide, could enter the cabin. Loss of consciousness or even death could occur. Open the windows or adjust the heating or cooling system to draw fresh air.*

##### **Snow Blocking the Exhaust Gas:**

*Running the engine when a vehicle is stopped in deep snow is dangerous. The exhaust pipe could be blocked by the snow, allowing exhaust gas to enter the cabin. Because exhaust gas contains poisonous carbon monoxide, anyone in the cabin could be injured or killed. Clear the snow from underneath and around your vehicle, particularly the tail pipe, before starting the engine.*

## Before Starting the Engine

---

### Before Getting In

- Be sure the windows, outside mirrors, and outside lights are clean.
- Inspect inflation pressures and condition of tires.
- Look under the vehicle for any sign of a leak.
- If you plan to back up, make sure nothing will be in your way.

<b>NOTE</b>
Engine oil, engine coolant, brake/clutch fluid, washer fluid, and other fluid levels should be inspected. See Maintenance, Section 8.

### After Getting In

- Are all doors closed and locked?
- Is the seat adjusted properly?
- Are the inside and outside mirrors adjusted?
- Is everyone's seat belt fastened?
- Check all gauges.
- Check all warning lights when the ignition switch is turned to the ON position.
- Release the parking brake and make sure the brake warning light goes off.

Always be thoroughly familiar with your Mazda.

## Break-In Period

No special break-in is necessary, but a few precautions in the first 1,000 km (600 miles) may add to the performance, economy, and life of your Mazda.

- Don't race the engine.
- Don't maintain one constant speed, either slow or fast, for a long period of time.
- Don't drive constantly at full-throttle or high engine rpm (over 7,000 rpm) for extended periods of time.
- Avoid unnecessary hard stops.
- Avoid full-throttle starts.

## Money-Saving Suggestions

How you operate your Mazda determines how far it will travel on a tank of fuel. Use these suggestions to help save money on fuel and repairs.

- Avoid long warm-ups. Once the engine runs smoothly, begin driving.
- Avoid fast starts.
- Keep the engine tuned. Follow the maintenance schedule (page 8-3) and have an Authorized Mazda Dealer perform inspections and servicing.
- Use the air conditioner only when necessary.
- Slow down on rough roads.
- Keep the tires properly inflated.
- Don't carry unnecessary weight.
- Don't rest your foot on the brake pedal while driving.
- Keep the wheels in correct alignment.
- Keep windows closed at high speeds.
- Slow down when driving in crosswinds and headwinds.

### **WARNING**

#### **Coasting:**

***Stopping the engine when going down a hill is dangerous. This causes the loss of power steering and power brake control, and may cause damage to the drivetrain. Any loss of steering or braking control could cause an accident. Never stop the engine when going down a hill.***

# Driving Tips

## Hazardous Driving

### **WARNING**

***Downshifting on Slippery Surfaces:***  
*Downshifting into lower gear while driving on slippery surfaces is dangerous. The sudden change in tire speed could cause the tires to skid. This could lead to loss of vehicle control and an accident. If it is necessary to downshift on slippery surfaces, be very careful.*

When driving on ice or in water, snow, mud, sand, or similar hazard:

- Be cautious and allow extra distance for braking.
- Avoid sudden braking and quick steering.
- If your vehicle is not equipped with ABS, brake with the pedal by using a light up-down motion. Don't hold the pedal down constantly. If your vehicle is equipped with ABS, don't pump the brakes. Continue to press down on the brake pedal.
- If you get stuck, select a lower gear and accelerate slowly. Don't spin the rear wheels.
- For more traction in starting on slippery surfaces such as ice or packed snow, use sand, rock salt, chains, carpeting, or other nonslip material under the rear wheels.

### **NOTE**

Use snow chains only on the rear wheels.

## Rocking the Vehicle

### **WARNING**

***Spinning the Wheels:***  
*When the vehicle is stuck, spinning the wheels at high speed is dangerous. The spinning tire could overheat and explode. This could cause serious injuries. Don't spin the wheels at more than 56 km/h (35 mph), and don't allow anyone to stand behind a wheel when pushing the vehicle.*

### **CAUTION**

Too much rocking may cause engine overheating, transmission failure, and tire damage.

If you must rock the vehicle to free it from snow, sand, or mud, depress the accelerator slightly and slowly move the shift lever from 1 (D) to R.

## Winter Driving

- Carry emergency gear, including tire chains, window scraper, flares, a small shovel, jumper cables, and a small bag of sand or salt.

Ask an Authorized Mazda Dealer to perform the following precautions:

- Have the proper ratio of antifreeze in the radiator.
- Inspect the battery and its cables. Cold reduces battery capacity.
- Inspect the ignition system for damage and loose connections.
- Use washer fluid made with antifreeze—but don't use engine coolant antifreeze for washer fluid (page 8-18).
- Don't use the parking brake in freezing weather as the parking brake may freeze. Instead, shift to P with an automatic transmission and to 1 or R with a manual transmission. Block the rear wheels.

## ▼ Snow Tires

### **WARNING**

#### **Mixing Tire Types:**

*Using tires different in size or type is dangerous. Your vehicle's handling could be greatly affected and result in an accident. Use only the same size and type tires (snow, radial, or non-radial) on all four wheels.*

### **CAUTION**

Check local regulations before using studded tires.

### **NOTE**

If your vehicle is equipped with the tire pressure monitoring system, the system may not function correctly when using tires with steel wire reinforcement in the sidewalls (page 5-26).

### **Use snow tires on all four wheels**

Don't go faster than 120 km/h (75 mph) while driving with snow tires. Inflate snow tires 30 kPa (0.3 kgf/cm<sup>2</sup>, 4.3 psi) more than recommended on the tire pressure label (driver's door), but never more than the maximum cold-tire pressure shown on the tires.

Your vehicle is originally equipped with summer tires designed for optimum traction on wet and dry roads. If your vehicle is to be used on snow and ice covered roads, you may find it necessary to replace the original equipment tires with snow tires, during the winter months.

## Driving Tips

### ▼ Tire Chains

Check local regulations before using tire chains.

#### CAUTION

- Chains may scratch or chip aluminum wheels. Install tire chains on steel wheels only.
- Chains may affect handling.
- Don't go faster than 50 km/h (30 mph) or the chain manufacturer's recommended limit, whichever is lower.
- Drive carefully and avoid bumps, holes, and sharp turns.
- Avoid locked-wheel braking.
- Don't use chains on a temporary spare tire; it may result in damage to the vehicle and to the tire. Your vehicle is not equipped with a factory installed temporary spare tire.
- Don't use chains on roads that are free of snow or ice. The tires and chains could be damaged.

#### NOTE

If your vehicle is equipped with the tire pressure monitoring system, the system may not function correctly when using tire chains.

Install the chains on the rear tires.  
Don't use chains on the front tires.  
Use only SAE Class "S" chains, and make sure they fit.

#### Installing the chains

1. Secure the chains on the rear tires as tightly as possible. Always follow the chain manufacturer's instructions.
2. Retighten the chains after driving 1/2—1 km (1/4—1/2 mile).

### Driving In Flooded Area

#### WARNING

***Driving with Wet Brakes:***  
***Driving with wet brakes is dangerous. Increased stopping distance or the vehicle pulling to one side when braking could result in a serious accident. Light braking will indicate whether the brakes have been affected. Dry the brakes by driving very slowly and applying the brakes lightly until brake performance returns to normal.***

#### CAUTION

Make sure water does not enter the vehicle interior or the engine area. The vehicle interior could become wet or the engine could be damaged.



## Overloading

### **WARNING**

#### **Vehicle Load Weight:**

*The gross axle weight rating (GAWR) and the gross vehicle weight rating (GVWR) of your vehicle are on the Motor Vehicle Safety Standard Label on the driver's door frame. Exceeding these ratings can cause an accident or vehicle damage. You can estimate the weight of your load by weighing the items (or people) before putting them in the vehicle. Be careful not to overload your vehicle.*

# Towing

---

## Trailer Towing

Never tow a trailer with your Mazda.

Explanation of instruments and controls.

<b>Starting and Driving</b> .....	5-2
Ignition Switch .....	5-2
Starting the Engine .....	5-3
Brake System .....	5-4
Manual Transmission Operation .....	5-8
Automatic Transmission Controls .....	5-10
Power Steering .....	5-16
Cruise Control .....	5-17
Traction Control System (TCS)* .....	5-20
Dynamic Stability Control (DSC)* .....	5-21
Tire Pressure Monitoring System* .....	5-24
<b>Instrument Cluster and Indicators</b> .....	5-29
Meters and Gauges .....	5-29
<b>Warning/Indicator Lights and Beeps</b> .....	5-35
Warning/Indicator Lights .....	5-35
Beeps .....	5-47
<b>Switches and Controls</b> .....	5-48
Lighting Control .....	5-48
Turn and Lane-Change Signals .....	5-50
Fog Lights* .....	5-50
Windshield Wipers and Washer .....	5-51
Headlight Washer* .....	5-53
Rear Window Defroster .....	5-53
Horn .....	5-54
Hazard Warning Flasher .....	5-55
HomeLink Wireless Control System* .....	5-55

# Starting and Driving

## Ignition Switch

### ▼ Ignition Switch Positions

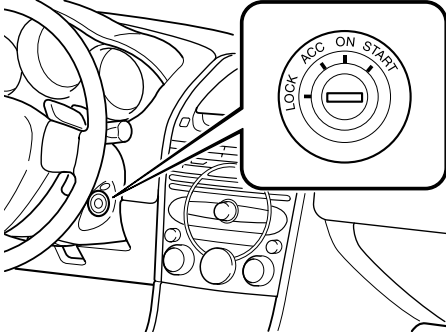

### **LOCK**

The steering wheel locks to protect against theft. Only in this position can the key be removed.

### **Manual transmission**

To turn the key from the ACC to the LOCK position, push the key in at the ACC position, then turn it to the LOCK position.

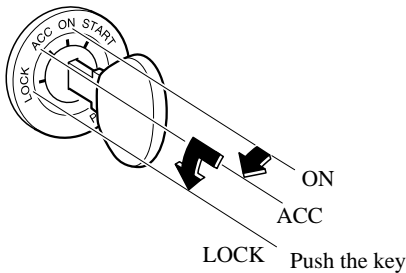

### **Automatic transmission**

To turn the key from the ACC to the LOCK position, the shift lever must be in the P position.

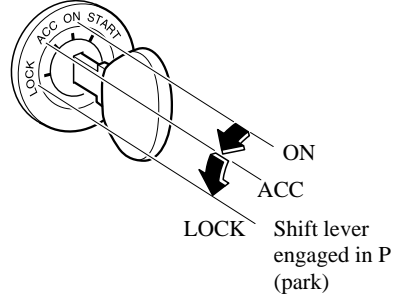

## **⚠ WARNING**

### **Removing the Key:**

*It's dangerous to remove the key from the ignition switch while the vehicle is moving. Removing the key allows the steering wheel to lock. You will lose steering control and a serious accident could occur.*

*Remove the key only when the vehicle is parked.*

### **Not Setting the Parking Brake:**

*Leaving the driver's seat without setting the parking brake is dangerous. Unexpected vehicle movement could occur if the parking brake is not set. This could cause an accident. Before leaving the driver's seat, always set the parking brake and make sure the shift lever is in P with an automatic transmission or in 1 or R with a manual transmission.*

**NOTE**

If turning the key is difficult, jiggle the steering wheel from side to side.

**ACC (Accessory)**

The steering wheel unlocks and some electrical accessories will operate.

**ON**

This is the normal running position after the engine is started. The warning lights (except brakes) should be inspected before the engine is started (page 5-35).

**NOTE****(With headlight auto-leveling)**

When the ignition switch is turned to the ON position, the sound of the headlight leveling motors operating at the front of the engine compartment can be heard. This does not indicate an abnormality.

**START**

The engine is started in this position. It will crank until you release the key; then it returns to the ON position. The brake warning light can be checked after the engine is started (page 5-35).

**▼ Ignition Key Reminder**

If the ignition switch is in the LOCK or ACC position, a beep sound will be heard when the driver's door is opened.

**Starting the Engine****NOTE**

Engine-starting is controlled by the spark ignition system. This system meets all Canadian Interference-Causing Equipment Standard requirements regulating the impulse electrical field strength of radio noise.

1. Occupants should fasten their seat belts.
2. Make sure the parking brake is on.
3. Depress the brake pedal.
4. **(Manual transmission)**  
Depress the clutch pedal all the way and shift into neutral.  
Keep the pedal depressed while cranking the engine.  
  
**(Automatic transmission)**  
Put the vehicle in park (P). If you must restart the engine while the vehicle is moving, shift into neutral (N).

**NOTE****(Manual transmission)**

The starter will not operate if the clutch pedal is **not** pushed down all the way.

**(Automatic transmission)**

The starter will not operate if the shift lever is **not** in P or N.

# Starting and Driving

5. Turn the ignition switch to the START position and hold (up to 10 seconds at a time) until the engine starts.

## CAUTION

Don't try the starter for more than 10 seconds at a time. If the engine stalls or fails to start, wait 10 seconds before trying again. Otherwise, you may damage the starter and drain the battery.

6. After starting the engine, let it idle for about 10 seconds.

## NOTE

- In extremely cold weather, below  $-18^{\circ}\text{C}$  ( $0^{\circ}\text{F}$ ), or after the vehicle has not been driven in several days, let the engine warm up without operating the accelerator.
- Whether the engine is cold or warm, it should be started without use of the accelerator.
- To protect the engine, when the engine coolant temperature is low, the engine does not run at high speeds. The fuel supply will be cut at an rpm lower than the red zone.

## Brake System

### ▼ Foot Brake

Your Mazda has power-assisted brakes that adjust automatically through normal use.

Should power-assist fail, you can stop by applying greater force than normal to the brake pedal. But the distance required to stop will be greater than usual.

## WARNING

**Coasting with the Engine Off:**  
*Continuing to coast when the engine is stalled or turned off is dangerous. Braking will require more effort, and the brake's power-assist could be depleted if you pump the brake. This will cause longer stopping distances or even an accident. Don't continue coasting when the engine is stalled or turned off, find a safe place to stop.*

**Riding the Brakes:**  
*Driving with your foot continuously on the brake pedal or steadily applying the brakes for long distances is dangerous. This causes overheated brakes, resulting in longer stopping distances or even total brake failure. This could cause loss of vehicle control and a serious accident. Avoid continuous application of the brakes. Shift to a lower gear when going down steep hills.*

# Starting and Driving

## **WARNING**

### Driving with Wet Brakes:

*Driving with wet brakes is dangerous. Increased stopping distance or the vehicle pulling to one side when braking could result in a serious accident. Light braking will indicate whether the brakes have been affected. Dry the brakes by driving very slowly and applying the brakes lightly until brake performance is normal.*

### ▼ Parking Brake

## **CAUTION**

Driving with the parking brake on will cause excessive wear of the brake linings or pads.

### NOTE

For parking in snow, refer to Winter Driving (page 4-9) regarding parking brake use.

### Setting the parking brake

Depress the brake pedal, then pull the brake handle fully upward.

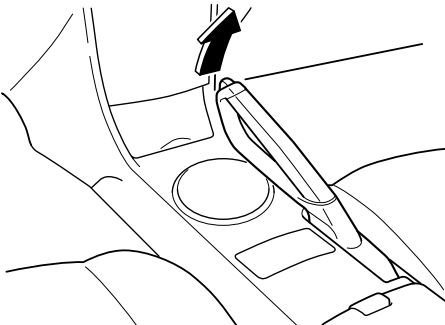

### Releasing the parking brake

Depress the brake pedal, then pull the handle up and press the button. Lower the handle all the way down while holding in the button.

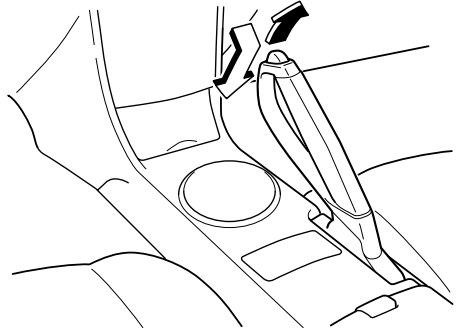

### ▼ Brake System Warning Light



This warning has the following functions:

### Parking brake warning

The light comes on when the parking brake is applied with the ignition switch in the START or ON position. It goes off when the parking brake is fully released.

## Starting and Driving

---

### **Low brake fluid level warning/ Electronic brake force distribution system warning**

If the light stays on after the parking brake is fully released, you may have a brake problem.

Drive to the side of the road and park off the right-of-way.

### **Low brake fluid level warning**

You may notice that the pedal is harder to push or that it may go closer to the floor. In either case, it will take longer to stop the vehicle.

1. With the engine stopped, check the brake fluid level immediately and add fluid as required (page 8-15).
2. After adding fluid, check the light again.

If the warning light remains on, or if the brakes do not operate properly, do not drive the vehicle. Have it towed to an Authorized Mazda Dealer.

Even if the light goes off, have your brake system inspected as soon as possible.

### **Electronic brake force distribution system warning**

If the electronic brake force distribution control unit determines that some components are operating incorrectly, the control unit may turn the brake system warning light on.

In this case, the ABS warning light comes on at the same time (page 5-40).

## **WARNING**

### **Brake Warning Light:**

*Driving with the brake system warning light on is dangerous. It indicates that your brakes may not work at all or that they could completely fail at any time. If this light remains on, after checking that the parking brake is fully released, have the brakes inspected immediately. Don't drive with this light on, and contact an Authorized Mazda Dealer to have the brakes inspected as soon as possible.*

### **ABS Warning Light and Brake**

### **Warning Light on at the Same Time:**

*Driving when the brake system warning light and ABS warning light are on at the same time is dangerous. When both lights are on, the rear wheels could lock more quickly in an emergency stop than under normal circumstances.*

*Don't drive with both lights on, and contact an Authorized Mazda Dealer to have the brakes inspected as soon as possible.*



## ▼ Anti-Lock Brake System (ABS)

The ABS control unit continuously monitors the speed of each wheel. If one is about to lock up, the ABS responds by automatically releasing and reapplying that wheel's brake.

The driver will feel a slight vibration in the brake pedal and may hear a chattering noise from the brake system. This is normal when the ABS operates. Don't pump the brakes, continue to press down on the brake pedal.

### **WARNING**

#### **ABS:**

*The ABS cannot compensate for unsafe and reckless driving, excessive speed, tailgating (following another vehicle too closely), and hydroplaning (reduced tire friction and road contact because of water on the road surface). You can still have an accident. So don't rely on ABS as a substitute for safe driving.*

#### **NOTE**

Braking distances may be longer on loose surfaces (snow or gravel, for example) which usually have a hard foundation. A vehicle with a normal braking system may require less distance to stop under these conditions because the tires will build up a wedge of surface layer when the wheels skid.

## ▼ ABS Warning Light



The warning light stays on for a few seconds when the ignition switch is turned to the ON position.

If the ABS warning light stays on while you're driving, the ABS control unit has detected a system malfunction. If this occurs, your brakes will function normally as if the vehicle had no ABS. Should this happen, consult an Authorized Mazda Dealer as soon as possible.

### **WARNING**

**ABS Warning Light and Brake Warning Light on at the Same Time:**  
*Driving when the brake system warning light and ABS warning light are on at the same time is dangerous. When both lights are on, the rear wheels could lock more quickly in an emergency stop than under normal circumstances. Don't drive with both lights on, and contact an Authorized Mazda Dealer to have the brakes inspected as soon as possible.*

# Starting and Driving

## NOTE

When the engine is jump-started to charge the battery, uneven rpm occurs and the ABS warning light comes on. This is due to a weak battery, not a malfunction. Recharge the battery.

## ▼ Brake Pad Wear Indicator

When the disc brake pads become worn, the built-in wear indicators contact the disc plates. This causes a screeching noise to warn that the pads should be replaced.

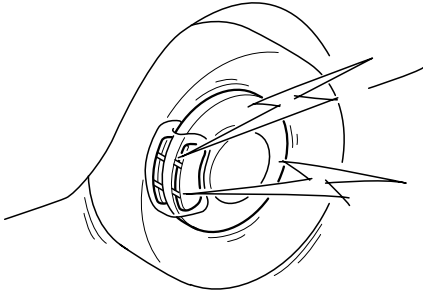

When you hear this noise, consult an Authorized Mazda Dealer as soon as possible.

## **WARNING**

***Driving with Worn Disc Pads:***  
*Driving with worn disc pads is dangerous. The brakes could fail and cause a serious accident. As soon as you hear a screeching noise consult an Authorized Mazda Dealer.*

## Manual Transmission Operation

### ▼ Manual Transmission Shift Pattern

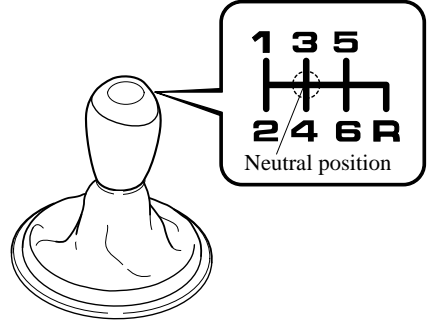

The shift pattern of the transmission is conventional, as shown.

Press the clutch pedal all the way down while shifting; then release it slowly.

Your vehicle is equipped with a device to prevent shifting to R (reverse) by mistake. Push the shift lever downward and shift to R.

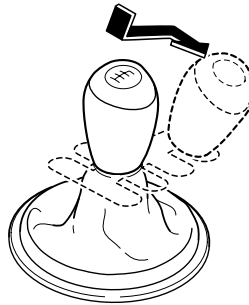

## WARNING

**Sudden Engine-Braking:**  
*Shifting down while driving on wet, snowy, or frozen roads, or while driving at high speeds causes sudden engine braking, which is dangerous. The sudden change in tire speed could cause the tires to skid. This could lead to loss of vehicle control and an accident. Do not use sudden engine braking on slippery road surfaces or at high speeds.*

## CAUTION

- Keep your foot off the clutch pedal except when shifting gears. Also, don't use the clutch to hold the vehicle on an upgrade. Riding the clutch will cause needless clutch wear and damage.
- Make sure the vehicle comes to a complete stop before shifting to R. Shifting to R while the vehicle is still moving may damage the transmission.

## NOTE

If shifting to R is difficult, shift back into neutral, release the clutch pedal, and try again.

## ▼ Recommendations for Shifting

### Upshifting

For normal acceleration, we recommend these shift points.

1 to 2	23 km/h (14 mph)
2 to 3	35 km/h (22 mph)
3 to 4	47 km/h (29 mph)
4 to 5	58 km/h (36 mph)
5 to 6	74 km/h (46 mph)

For cruising

1 to 2	23 km/h (14 mph)
2 to 3	34 km/h (21 mph)
3 to 4	45 km/h (28 mph)
4 to 5	56 km/h (35 mph)
5 to 6	68 km/h (42 mph)

### Downshifting

When you must slow down in heavy traffic or on a steep **upgrade**, downshift before the engine starts to overwork. This reduces the chance of stalling and gives better acceleration when you need more speed.

On a steep **downgrade**, downshifting helps maintain safe speed and prolongs brake life.

# Starting and Driving

## Automatic Transmission Controls

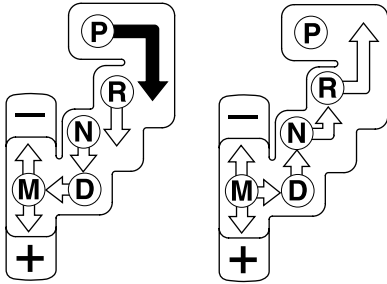
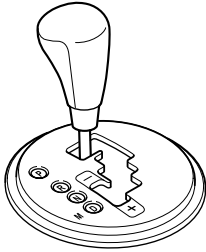

Various Lockouts:

	Indicates that you must depress the brake pedal to shift (The ignition switch must be in the ACC or ON position).
	Indicates the shift lever can be shifted freely into any position.

### ▼ Transmission Ranges

The shift lever must be in P or N to operate the starter.

#### P (Park)

P locks the transmission and prevents the rear wheels from rotating.

### **WARNING**

***Holding the Vehicle with P: Only setting the shift lever to the P position without using the parking brake to hold the vehicle is dangerous. If P fails to hold, the vehicle could move and cause an accident. To hold the vehicle, set the shift lever to P AND set the parking brake.***

### **CAUTION**

- Shifting into P, N or R while the vehicle is moving can damage your transmission.
- Shifting into a driving gear or reverse when the engine is running faster than idle can damage the transmission.

#### R (Reverse)

In position R, the vehicle moves only backward. You must be at a complete stop before shifting to or from R, except under rare circumstances as explained in Rocking the Vehicle (page 4-8).

#### N (Neutral)

In N, the wheels and transmission are not locked. The vehicle will roll freely even on the slightest incline unless the parking brake or brakes are on.

# Starting and Driving

## ⚠ WARNING

### Shifting from N or P:

*It's dangerous to shift from N or P into a driving gear when the engine is running faster than idle. If this is done, the vehicle could move suddenly, causing an accident or serious injury. If the engine is running faster than idle, don't shift from N or P into a driving gear.*

### Shifting into N while Driving:

*Shifting into N while driving is dangerous. Engine braking cannot be applied when decelerating which could lead to an accident or serious injury. Do not shift into N when driving the vehicle.*

## ⚠ CAUTION

Do not shift into N when driving the vehicle. Doing so can cause transmission damage.

### D (Drive)

D is the normal driving position. From a stop, the transmission will automatically shift through a 4-gear sequence.

### M (Manual)

M is the manual shift mode position. Gears can be shifted up or down by operating the shift lever or steering shift switches. Refer to Manual Shift Mode (page 5-11).

## ▼ Shift-Lock System

The shift-lock system prevents shifting out of P unless the brake pedal is depressed.

To shift from P:

1. Depress and hold the brake pedal.
2. Start the engine.
3. Move the shift lever.

## NOTE

- When the ignition switch is in the LOCK position, the shift lever cannot be shifted from P.
- To be sure the vehicle is in park, **the ignition key cannot be removed unless the shift lever is in P.**

## ▼ Manual Shift Mode

This mode gives you the feel of driving a manual transmission vehicle by operating the shift lever or steering shift switches and allows you to control engine rpm and torque to the rear wheels much like a manual transmission when more control is desired.

To change to manual shift mode, shift the lever from D to M.

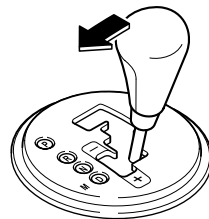

To return to automatic shift mode, shift the lever from M to D.

# Starting and Driving

## NOTE

- If you change to manual shift mode when the vehicle is stopped, the gear will shift to M1.
- If you shift up once when the vehicle is stopped and the gear is at M1, the gear will shift to M2. M2 is helpful for starting on slippery surfaces.

## Indicators

### Shift position indicator

In manual shift mode, the "M" of the shift position indicator in the instrument panel illuminates.

### Gear position indicator

The numeral for the selected gear illuminates.

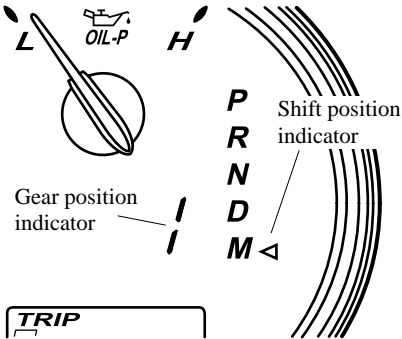

## NOTE

If the gears cannot be shifted down when driving at higher speeds, the gear position indicator will flash twice to signal that the gears cannot be shifted down.

## Shifting

You can shift gears up and down by operating the shift lever or the steering shift switches.

## NOTE

- If the steering shift switches on both sides (left and right) are operated simultaneously, the gear will shift once.
- The gear will not shift if:
  - The steering shift switch and the shift lever are operated simultaneously.
  - The UP switch and DOWN switch are operated simultaneously.

# Starting and Driving

## Manually shifting up

(M1→M2→M3→M4)

### NOTE

- When driving slowly, the gears may not shift up depending on vehicle speed.
- In manual shift mode, gears do not shift up automatically. Don't run the engine with the tachometer needle in the RED ZONE. If the tachometer needle enters the RED ZONE, you may feel engine-braking because the fuel delivery will be stopped to protect the engine. However, this does not indicate an abnormality.
- Gears may not be shifted from M1 to M2 right after shifting the lever from D to M. Wait a few seconds and then shift up to M2.
- When depressing the accelerator fully, the transmission will shift to a lower gear, depending on vehicle speed.

To shift up to a higher gear with the shift lever, tap the shift lever back (+) once.

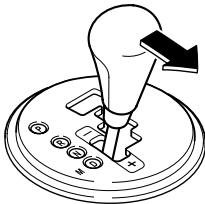

To shift up to a higher gear with the steering shift switches, tap either of the UP switches toward you once with your fingers.

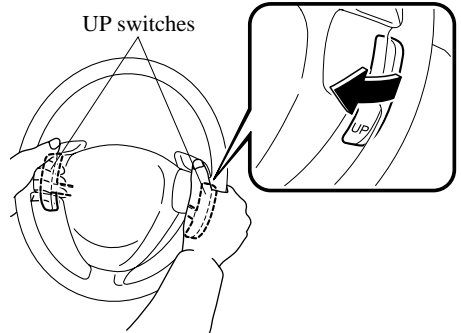

### **WARNING**

#### **Hand Position When Using Steering Shift Switches:**

*Putting your hands inside the rim of the steering wheel when using the steering shift switches is dangerous. If the driver air bag were to deploy in a collision, your hands could be impacted causing injury. Keep your hands on the steering wheel rim when using fingers or thumbs on the steering shift switches.*

# Starting and Driving

## Manually shifting down

(M4→M3→M2→M1)

### **WARNING**

**Sudden Engine-Braking:**  
*Shifting down while driving on wet, snowy, or frozen roads, or while driving at high speeds causes sudden engine braking, which is dangerous. The sudden change in tire speed could cause the tires to skid. This could lead to loss of vehicle control and an accident. Do not use sudden engine braking on slippery road surfaces or at high speeds.*

### **NOTE**

- When driving at high speeds, the gear may not shift down depending on vehicle speed.
- During deceleration, the gear may automatically shift down depending on vehicle speed.
- When depressing the accelerator fully, the transmission will shift to a lower gear, depending on vehicle speed.

To shift down to a lower gear with the shift lever, tap the shift lever forward (-) once.

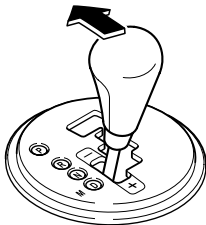

To shift down to a lower gear with the steering shift switches, press either of the DOWN switches away from you once with your thumb.

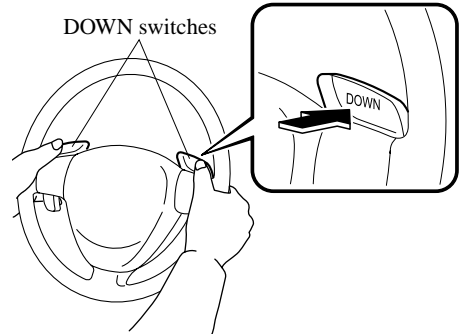

### **WARNING**

**Hand Position When Using Steering Shift Switches:**  
*Putting your hands inside the rim of the steering wheel when using the steering shift switches is dangerous. If the driver air bag were to deploy in a collision, your hands could be impacted causing injury. Keep your hands on the steering wheel rim when using fingers or thumbs on the steering shift switches.*



# Starting and Driving

## Shifting specification

### Shifting up

If the vehicle speed is lower than the speed specified for each gear, the gear cannot be shifted up to a higher gear.

Gear	Vehicle speed
M1→M2	You can shift up to M2 whether the vehicle is stopped or moving.
M2→M3	20 km/h (12 mph)
M3→M4	31 km/h (19 mph)

### Shifting down

If the vehicle speed is higher than the speed specified for each gear, the gear cannot be shifted down to a lower gear.

Gear	Vehicle speed
M4→M3	163 km/h (101 mph)
M3→M2	110 km/h (68 mph)
M2→M1	45 km/h (28 mph)

During deceleration, the gears shift down automatically when speed is reduced to the following:

Gear	Vehicle speed
M4→M3	31 km/h (19 mph)
M3 or M2→M1	8 km/h (5 mph)

### NOTE

If the vehicle is driven at a low speed from a standing start while in M2, the gear may not shift down to M1 automatically.

If the vehicle is kicked down at the following speeds or lower, the gears shift down automatically:

Gear	Vehicle speed
M4→M3	149 km/h (93 mph)
M4→M2	56 km/h (35 mph)
M3→M2	56 km/h (35 mph)

## Recommendations for shifting

### Upshifting

For normal acceleration and cruising, we recommend these shift points.

M1 to M2	24 km/h (15 mph)
M2 to M3	40 km/h (25 mph)
M3 to M4	65 km/h (40 mph)

### Downshifting

When you must slow down in heavy traffic or on a steep **upgrade**, downshift before the engine starts to overwork. This gives better acceleration when you need more speed.

On a steep **downgrade**, downshifting helps maintain safe speed and prolongs brake life.

### ▼ Driving Tips

#### Passing

For extra power when passing another vehicle or climbing steep grades, depress the accelerator fully. The transmission will shift to a lower gear, depending on vehicle speed.

#### Climbing steep grades from a stop

To climb a steep grade from a stopped position:

1. Depress the brake pedal.
2. Shift to D or M1, depending on the load weight and grade steepness.
3. Release all brakes while gradually accelerating.

#### Descending steep grades

When descending a steep grade, shift to lower gears, depending on load weight and grade steepness. Descend slowly, using the brakes only occasionally to prevent them from overheating.

# Starting and Driving

---

## Power Steering

Power steering is only operable when the engine is running. If the engine is off or if the power steering system is inoperable, you can still steer, but it requires more physical effort.

If the steering feels rigid during normal driving, consult an Authorized Mazda Dealer.

### NOTE

The steering may feel rigid if you continuously attempt to steer when the vehicle is stopped or moving extremely slowly. This has been designed to protect the system and doesn't indicate a malfunction. If you don't attempt to steer for a minute, power steering will be restored.

## ▼ Power Steering Malfunction Indicator Light



This indicator light illuminates when the ignition switch is turned to the ON position and goes off when the engine is started.

If this light illuminates while driving, it indicates a malfunction of the power steering system. Consult an Authorized Mazda Dealer.

### NOTE

The power steering system is inoperable when the power steering malfunction indicator light illuminates. Steering is possible, but requires more physical effort.

## Cruise Control

With cruise control, you can set and automatically maintain any speed of more than about 30 km/h (19 mph).

### **WARNING**

#### **Cruise Control Use:**

*Using cruise control in the following conditions could cause you to lose control of the vehicle:*

- *Hilly terrain*
- *Steep inclines*
- *Heavy or unsteady traffic*
- *Slippery or winding roads*
- *Similar restrictions that require inconsistent speed*

*Don't use cruise control in these situations.*

### ▼ Cruise Main Indicator Light

## CRUISE MAIN

This light comes on when the ON/OFF switch is pressed and the cruise control system is activated.

### ▼ Cruise Set Indicator Light

## CRUISE

This light comes on when a cruising speed is set.

### ▼ Activation/Deactivation

To activate the system, press the ON/OFF switch. The cruise main indicator light illuminates.

To deactivate the system, press the switch again. The cruise main indicator light turns off.

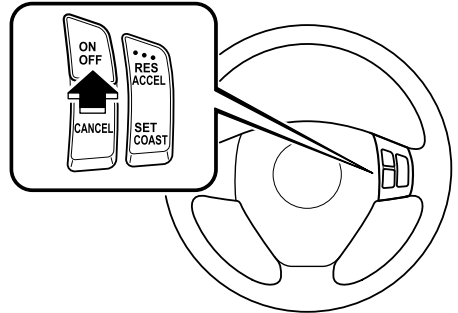

### **WARNING**

#### **Cruise Main Switch:**

*Leaving the ON/OFF switch on when not using the cruise control is dangerous as it may be switched on accidentally. This could result in loss of vehicle control. Keep the ON/OFF switch off when cruise control is not in use.*

# Starting and Driving

## ▼ To Set Speed

1. Activate the cruise control system.
2. Accelerate to the desired speed, which must be more than 30 km/h (19 mph).
3. Press the SET/COAST button and release it at the speed you want. Release the accelerator at the same time.

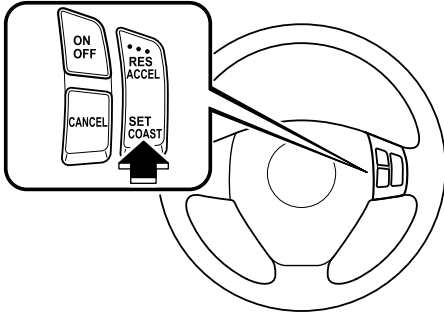

Don't continue to hold in the button. Until you release it, speed will continue to drop (unless you continue to accelerate) and you'll miss the desired speed.

### NOTE

- The SET function can't be activated until about 2 seconds after the ON/OFF switch has been engaged.
- On a steep grade, the vehicle may momentarily slow down going up or speed up while going down.

## ▼ To Increase Cruising Speed

Follow either of these procedures.

- Press the RES/ACCEL button and hold it. Your vehicle will accelerate. Release the button at the speed you want.

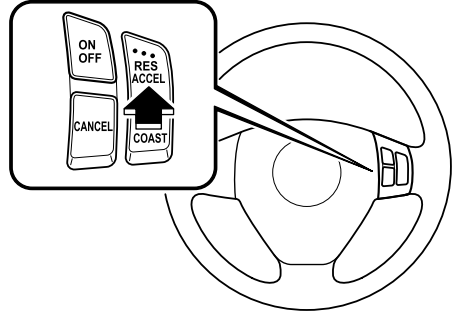

Your vehicle has a tap-up feature that allows you to increase your current speed in increments of 1.6 km/h (1 mph) by a momentary tap of the RES/ACCEL button. Multiple taps will increase your vehicle speed 1.6 km/h (1 mph) for each tap.

- Accelerate to the desired speed. Press the SET/COAST button and release it immediately.

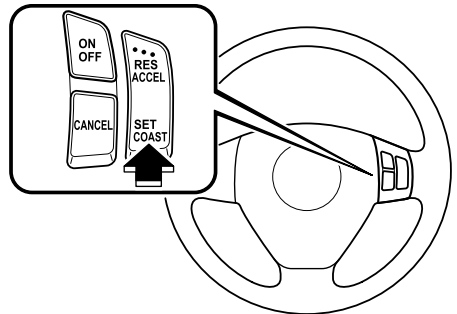

## Starting and Driving

### NOTE

Accelerate if you want to speed up temporarily when the cruise control is on. Greater speed will not interfere with it or change the set speed. Take your foot off the accelerator to return to the set speed.

### ▼ To Decrease Cruising Speed

Press the SET/COAST button and hold it. The vehicle will gradually slow. Release the button at the speed you want.

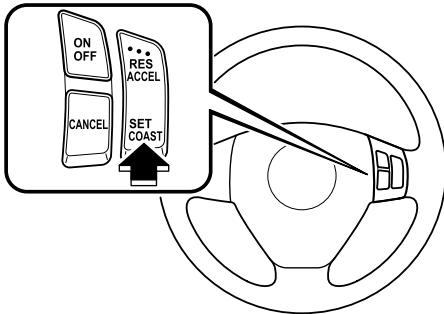

Your vehicle has a tap-down feature that allows you to decrease your current speed in decrements of 1.6 km/h (1 mph) by a momentary tap of the SET/COAST button. Multiple taps will decrease your vehicle speed 1.6 km/h (1 mph) for each tap.

### ▼ To Resume Cruising Speed at More Than 30 km/h (19 mph)

If some other method besides the ON/OFF switch was used to cancel cruising speed and the system is still activated, the most recent set speed will automatically resume when the RES/ACCEL button is pressed.

If vehicle speed is below 30 km/h (19 mph), increase the vehicle speed up to 30 km/h (19 mph) and press the RES/ACCEL button.

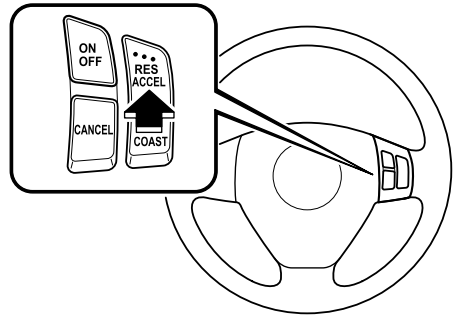

# Starting and Driving

## ▼ To Cancel

To turn off the system, use **one** of these methods:

- Press the ON/OFF switch.
- Slightly depress the brake pedal.
- Depress the clutch pedal. (Manual transmission only)
- Press the CANCEL button.

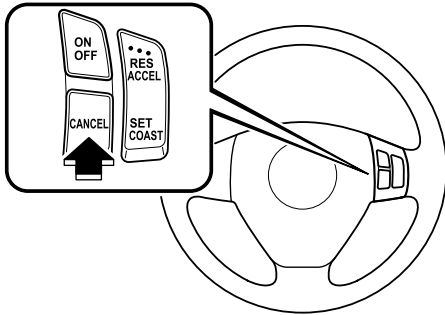

The system is off when the ignition is off.

### NOTE

Cruise control will cancel at about 15 km/h (9 mph) below the preset speed or below 30 km/h (19 mph).

## Traction Control System (TCS)\*

The Traction Control System (TCS) enhances traction and safety by controlling engine torque and braking. When the TCS detects driving wheel slippage, it lowers engine torque and operates the brakes to prevent loss of traction.

This means that on a slick surface, the engine adjusts automatically to provide optimum power to the drive wheels without causing them to spin and lose traction.

### **WARNING**

#### **TCS and Unsafe Driving:**

***The traction control system (TCS) cannot compensate for unsafe and reckless driving, excessive speed, tailgating (following another vehicle too closely), and hydroplaning (reduced tire friction and road contact because of water on the road surface). You can still have an accident. So don't rely on the traction control system as a substitute for safe driving.***

#### **TCS and Snow and Ice:**

***Driving without proper traction devices on snow and/or ice-covered roads is dangerous. The traction control system (TCS) alone cannot provide adequate traction and you could still have an accident. Use snow tires or tire chains and drive at reduced speeds when roads are covered with ice and/or snow.***

**NOTE**

To turn off the TCS, press the DSC OFF switch (page 5-23).

**▼ TCS/DSC Indicator Light**

This indicator light stays on for a few seconds when the ignition switch is turned to the ON position. If the TCS or DSC is operating, the indicator light flashes.

If the light stays on, the TCS or DSC may have a malfunction and they may not operate correctly. Take your vehicle to an Authorized Mazda Dealer.

**NOTE**

- In addition to the indicator light flashing, a slight lugging sound will come from the engine. This indicates that the TCS is operating properly.
- On slippery surfaces, such as fresh snow, it will be impossible to achieve high rpm when the TCS is on.

**Dynamic Stability Control (DSC)\***

The Dynamic Stability Control (DSC) automatically controls braking and engine torque in conjunction with systems such as ABS and TCS to control side slip when driving on slippery surfaces, or during sudden or evasive maneuvering, enhancing vehicle the safety.

Refer to ABS (page 5-7) and TCS (page 5-20).

**⚠ WARNING*****DSC and Unsafe Driving:***

*The dynamic stability control (DSC) cannot compensate for unsafe and reckless driving excessive speed, tailgating (following another vehicle too closely), and hydroplaning (reduced tire friction and road contact because of water on the road surface). You can still have an accident. So don't rely on the dynamic stability control as a substitute for safe driving.*

## Starting and Driving

### CAUTION

- The DSC may not operate correctly unless the following are observed:
  - Use tires of the correct size specified for your Mazda on all four wheels.
  - Use tires of the same manufacturer, brand and tread pattern on all four wheels.
  - Do not mix worn tires.
- The DSC may not operate correctly when using tire chains or the temporary spare tire.
- If repair or replacement of the steering or other surrounding equipment is necessary, have it done at an Authorized Mazda Dealer. If the center position of the steering deviates, the DSC may not operate correctly because there is a sensor in the steering which detects driving conditions.

### ▼ TCS/DSC Indicator Light



This indicator light stays on for a few seconds when the ignition switch is turned to the ON position. If the TCS or DSC is operating, the indicator light flashes.

If the light stays on, the TCS or DSC may have a malfunction and they may not operate correctly. Take your vehicle to an Authorized Mazda Dealer.

### ▼ DSC OFF Indicator Light

## DSC OFF

This indicator light stays on for a few seconds when the ignition switch is turned to the ON position.

It also comes on when the DSC OFF switch is pressed and TCS/DSC is switched off.

If the light stays on when the TCS/DSC is not switched off, take your vehicle to an Authorized Mazda Dealer. The dynamic stability control may have a malfunction.

### NOTE

If the battery is disconnected, the DSC will be inoperable. In this case, the DSC OFF indicator light flashes and the TCS/DSC indicator light illuminates. To make the DSC operable, do the following procedure.

1. Turn the ignition switch to the ON position.
2. Turn the steering clockwise fully, then turn it counterclockwise fully.
3. Make sure the DSC OFF indicator goes off.
4. Turn the ignition switch to the OFF position, then turn it to the ON position again.
5. Make sure the TCS/DSC indicator light goes off.

If the TCS/DSC indicator light and the DSC OFF indicator light remain illuminated even after turning the ignition switch to the ON position, consult an Authorized Mazda Dealer.



### ▼DSC OFF Switch

Press the DSC OFF switch to turn off the TCS/DSC. The DSC OFF indicator light will illuminate.

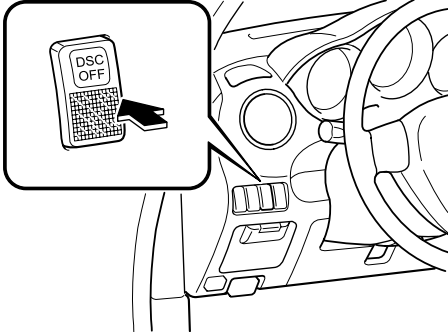

Press the switch again to turn the TCS/DSC back on. The DSC OFF indicator light will go out.

#### NOTE

- When DSC is on and you attempt to free the vehicle when it is stuck, or drive it out of freshly fallen snow, the TCS (part of the DSC system) will activate. Depressing the accelerator will not increase engine power and freeing the vehicle may be difficult. When this happens, turn off the TCS/DSC.
- If the TCS/DSC is off when the engine is turned off, it automatically activates when the ignition switch is turned on.
- Leaving the TCS/DSC on will provide the best stability. When the TCS/DSC is off, the TCS/DSC does not activate but the brake LSD function remains.
- If the DSC OFF switch is pressed and held for a second or more, the TCS/DSC system may become inoperative due to the system detecting switch trouble. If the TCS/DSC system becomes inoperative, the TCS/DSC and the DSC OFF indicator lights illuminate simultaneously. In this case, turn off the engine and restart it to restore the TCS/DSC.

## Starting and Driving

### Tire Pressure Monitoring System\*

The tire pressure monitoring system (TPMS) monitors the pressure for each tire.

If tire pressure is too low or too high in one or more tires, the system will inform the driver via the warning light in the instrument panel and by the warning beep sound.

The tire pressure sensors installed on each wheel send tire pressure data by radio signal to the receiver unit in the vehicle.

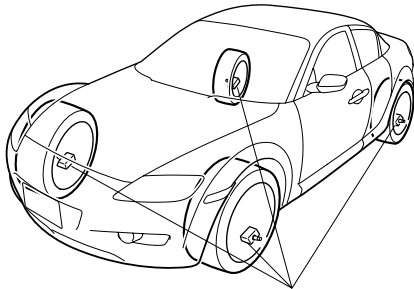

Tire pressure sensors

TPMS does not alleviate your need to check the pressure and condition of all four tires before you drive each day.

### ⚠ CAUTION

- When the tire pressure monitoring system warning light is lit, one or more of your tires is significantly under-inflated. You should stop and check your tires as soon as possible, and inflate them to the proper pressure as indicated on the vehicle's tire information placard. Driving on a significantly under-inflated tire causes the tire to overheat and can lead to tire failure. Under-inflation also reduces fuel efficiency and tire tread life, and may affect the vehicle's handling and stopping ability. Each tire, including the spare, should be checked monthly when cold and set to the recommended inflation pressure as specified in the vehicle placard and owner's manual.
- To avoid false readings, the system samples for a little while before indicating a problem. As a result it will not instantaneously register a rapid tire deflation or blow out.

### NOTE

This device complies with part 15 of the FCC Rules. Operation is subject to the following two conditions: (1) This device may not cause harmful interference, and (2) this device must accept any interference received, including interference that may cause undesired operation.

## ▼ Tire Pressure Monitoring System Warning Light



This warning light illuminates for a few seconds when the ignition switch is turned to the ON position.

Thereafter, the warning light illuminates when tire pressure is too low or too high in one or more tires, and flashes when there is a system malfunction.

### **⚠ WARNING**

#### **Vehicle Handling When Tire Pressure Monitoring System Warning Light Illuminates/Flashes:**

*When the tire pressure monitoring system warning light illuminates or flashes, or the tire pressure warning beep sound is heard, it is dangerous to drive the vehicle at high speeds, or perform sudden maneuvering or braking. Vehicle drivability could worsen and result in an accident.*

*When the tire pressure monitoring system warning light illuminates or flashes, or the tire pressure warning beep sound is heard, decrease vehicle speed immediately and avoid sudden maneuvering and braking. Have the system and tires checked or perform the appropriate repair as soon as possible.*

### **⚠ WARNING**

***Ignoring the Warning Light:***  
*Ignoring the warning light is dangerous, even if you know why it is illuminated. Have the problem taken care of as soon as possible before it develops into a more serious situation that could lead to tire failure and a dangerous accident.*

#### **Warning light illuminates/Warning beep sounds**

When the warning light illuminates, and the warning beep sound is heard (about 3 seconds), tire pressure is too low or too high in one or more tires.

Adjust the tire pressure to the correct tire pressure at an Authorized Mazda Dealer or the nearest service station. Refer to the specification charts (page 10-7).

### **⚠ CAUTION**

When replacing/repairing the tires or wheels or both, have the work done by an Authorized Mazda Dealer, or the tire pressure sensors may be damaged.

If the warning light illuminates again even after the tire pressures are adjusted, there may be a tire puncture.

#### **Vehicles with Instant Mobility System (IMS) emergency flat tire repair kit**

If an emergency tire repair is needed, repair the punctured tire with the emergency flat tire repair kit (page 7-5).

# Starting and Driving

---

 <b>CAUTION</b>
--

Do not use non-genuine tire sealant. It may damage the tire pressure sensor.
--

## Vehicles with optional temporary spare tire

If you have bought the optional temporary spare tire, replace the punctured tire with the temporary spare tire. Refer to the manufacturer's instructions.

<b>NOTE</b>
-------------

A tire pressure sensor is not installed to the temporary spare tire. The warning light will flash continuously while the temporary spare tire is being used.
--

## Warning light flashes

When the warning light flashes, there may be a system malfunction. Consult an Authorized Mazda Dealer.

## ▼ System Error Activation

When the warning light flashes, there may be a system malfunction. Consult an Authorized Mazda Dealer.

A system error activation may occur in the following cases:

- When there is equipment or a device near the vehicle using the same radio frequency as that of the tire pressure sensors.
- When a metallic device such as a non-genuine navigation system is equipped near the center of the dashboard, which may block radio signals from the tire pressure sensor to the receiver unit.
- When using the following devices in the vehicle that may cause radio interference with the receiver unit.
  - A digital device such as a personal computer.
  - A current converter device such as a DC-AC converter.
- When excess snow or ice adheres to the vehicle, especially around the wheels.
- When the tire pressure sensor batteries are exhausted.
- When using a wheel with no tire pressure sensor installed.
- When using tires with steel wire reinforcement in the side walls.
- When using tire chains

**▼ Tires and Wheels****Changing tires and wheels**

The following procedure allows the TPMS to recognize a tire pressure sensor's unique ID signal code whenever tires or wheels are changed, such as changing to and from winter tires.

**NOTE**

Each tire pressure sensor has a unique ID signal code. The signal code must be registered with the TPMS before it can work. The easiest way to do it is to have an Authorized Mazda Dealer change your tire and complete ID signal code registration.

**When having tires changed at an Authorized Mazda Dealer**

Tire pressure sensor ID signal code registration is completed when an Authorized Mazda Dealer changes your vehicle's tires.

**When changing tires yourself**

If you or someone else changes tires, you or someone else can also undertake the steps for the TPMS to complete the ID signal code registration.

1. After tires have been changed, turn the ignition switch to the ON position, then turn it back to the ACC or LOCK position.
2. Wait for about 15 minutes.
3. After about 15 minutes, drive the vehicle at a speed of at least 20 km/h (12 mph) for several minutes and the tire pressure sensor ID signal code will be registered automatically.

**NOTE**

If the vehicle is driven within about 15 minutes of changing tires, the tire pressure monitoring system warning light will flash because the sensor ID signal code would not have been registered. If this happens, park the vehicle for about 15 minutes, after which the sensor ID signal code will register upon driving the vehicle for several minutes.

**Replacing tires and wheels**** CAUTION**

- When replacing/repairing the tires or wheels or both, have the work done by an Authorized Mazda Dealer, or the tire pressure sensors may be damaged.
- The wheels equipped on your Mazda are specially designed for installation of the tire pressure sensors. Do not use non-genuine wheels, otherwise it may not be possible to install the tire pressure sensors.

Be sure to have the tire pressure sensors installed whenever tires or wheels are replaced.

When having a tire or wheel or both replaced, the following types of tire pressure sensor installation are possible.

- The tire pressure sensor is removed from the old wheel and installed to the new one.
- The same tire pressure sensor is used with the same wheel. Only the tire is replaced.

## Starting and Driving

---

- A new tire pressure sensor is installed to a new wheel.

NOTE
<ul style="list-style-type: none"><li>• The tire pressure sensor ID signal code must be registered when a new tire pressure sensor is purchased. For purchase of a tire pressure sensor and registration of the tire pressure sensor ID signal code, consult an Authorized Mazda Dealer.</li><li>• When reinstalling a previously removed tire pressure sensor to a wheel, replace the grommet for the tire pressure sensor.</li></ul>

# Instrument Cluster and Indicators

## Meters and Gauges

When the ignition switch is in the ON position, the dashboard gauges illuminate.

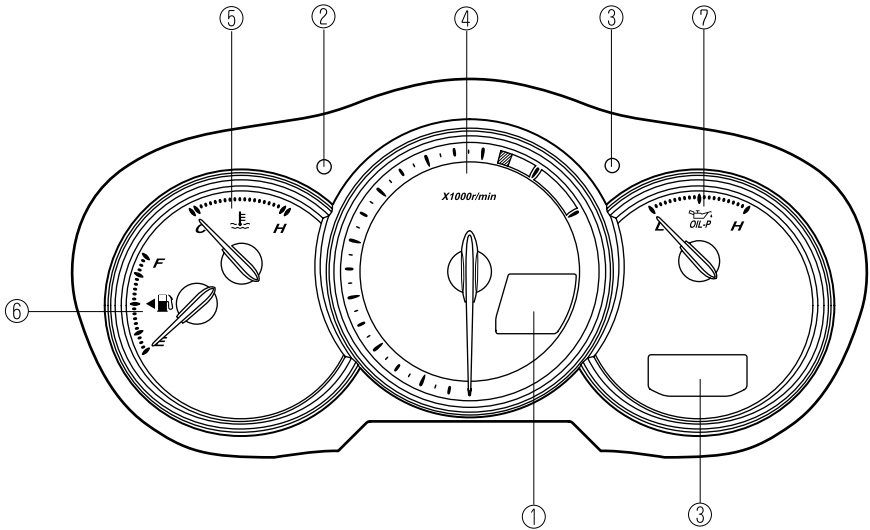

① Speedometer .....	5-30
② Speed Unit Selector .....	5-30
③ Odometer, Trip Meter and Trip Meter Selector .....	5-30
④ Tachometer .....	5-31
⑤ Engine Coolant Temperature Gauge .....	5-32
⑥ Fuel Gauge .....	5-33
⑦ Engine Oil Pressure Gauge .....	5-33

# Instrument Cluster and Indicators

## ▼ Speedometer

The speedometer indicates the speed of the vehicle.

## ▼ Speed Unit Selector

In some countries, you may have to change the speed units between km/h and mph.

Press the speed unit selector for 2 second or more.

The speed units for the speedometer will change between km/h and mph.

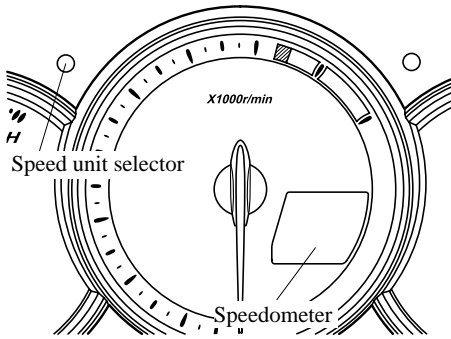

**NOTE**  
Odometer and trip meter distance units will change between kilometers and miles in accordance with the speed unit.

## ▼ Odometer, Trip Meter and Trip Meter Selector

The display mode can be changed between trip meter A and trip meter B by pressing the selector while one of them is displayed. The selected mode will be displayed.

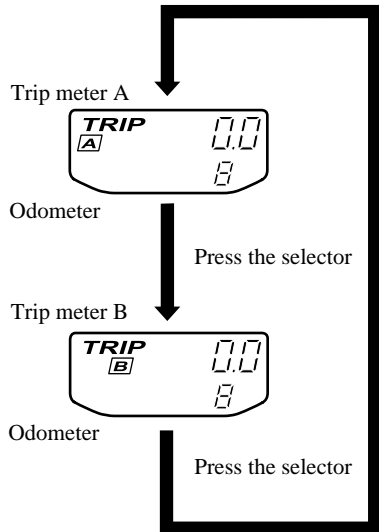
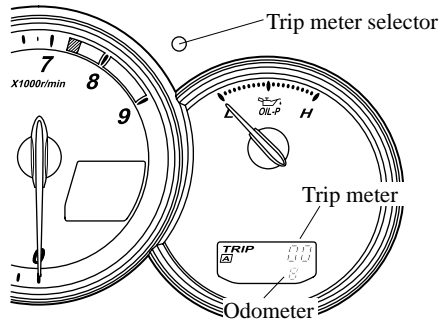



## Instrument Cluster and Indicators

### NOTE

When the ignition switch is in the ACC or LOCK position, the odometer or trip meters cannot be displayed, however, pressing the selector button can inadvertently switch the trip meters or reset them during an approximate ten-minute period in the following cases:

- After the ignition switch is turned to the ACC or LOCK position from the ON position.
- After any door is opened.

### Odometer

The odometer records the total distance the vehicle has been driven.

### Trip meter

The trip meter can record the total distance of two trips. One is recorded in trip meter A, and the other is recorded in trip meter B.

For instance, trip meter A can record the distance from the point of origin, and trip meter B can record the distance from where the fuel tank is filled.

When trip meter A is selected, pressing the selector again within one second will change to trip meter B mode.

When trip meter A is selected, TRIP A will be displayed. When trip meter B is selected, TRIP B will be displayed.

The trip meter records the total distance the vehicle is driven until the meter is again reset. Return it to "0.0" by holding the selector depressed for more than 1 second. Use this meter to measure trip distances and to compute fuel consumption.

### NOTE

- Only the trip meters record tenths of kilometers (miles).
- The trip record will be erased when:
  - The power supply is interrupted (blown fuse or the battery is disconnected).
  - The vehicle is driven over 999.9 km (mile).

### ▼ Tachometer

The tachometer shows engine speed in thousands of revolutions per minute (rpm).

#### Automatic transmission

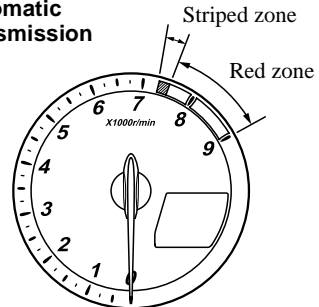

# Instrument Cluster and Indicators

## Manual transmission

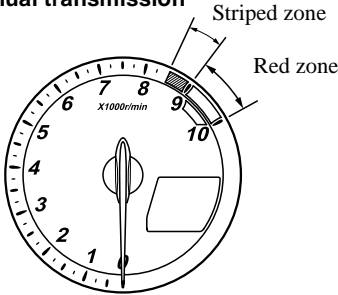

### CAUTION

Don't run the engine with the tachometer needle in the RED ZONE. This may cause severe engine damage.

### NOTE

- The beep sounds to indicate engine overrev when the tachometer needle enters the striped zone.
- To protect the engine, when the engine coolant temperature is low, the engine does not run at high speeds. The fuel supply will be cut at an rpm lower than the red zone.

## ▼ Engine Coolant Temperature Gauge

The engine coolant temperature gauge shows the temperature of the engine coolant.

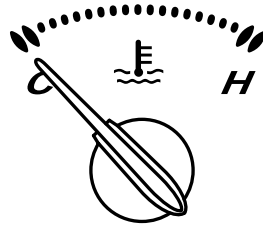

If the needle exceeds normal range toward H, it indicates overheating.

### CAUTION

Driving with an overheated engine can cause serious engine damage (page 7-18).

## Instrument Cluster and Indicators

### ▼ Fuel Gauge

The fuel gauge shows approximately how much fuel is in the tank. We recommend keeping the tank over 1/4 full. When the low fuel warning light illuminates or when the needle is near E, refuel as soon as possible.

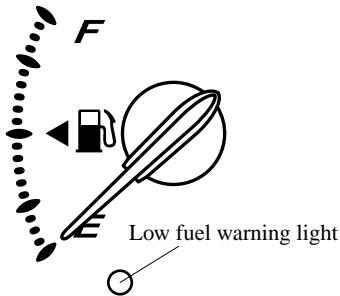

### ▼ Engine Oil Pressure Gauge

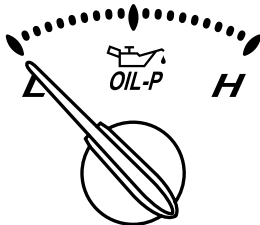

Engine oil pressure is normal when the engine oil pressure gauge needle points halfway between L and H with the engine running.

If the needle on the gauge doesn't move after starting the engine, follow steps 1 through 3.

If the engine oil pressure gauge moves to L (low) while you are driving, drive to the side of the road and park off the right-of-way. Set the parking brake. Then follow steps 1 through 3.

1. Turn off the engine and inspect the engine oil level (page 8-11). If it's low, add oil.
2. Start the engine.
3. If the needle still doesn't move, have your vehicle checked at an Authorized Mazda Dealer.

### ⚠ CAUTION

Don't run the engine if the oil pressure is low. It could result in extensive engine damage.

### NOTE

The Mazda RX-8 requires regular checking of the engine oil level. The compact, high performance RENESIS rotary engine in your vehicle consumes a small amount of engine oil due to its structural design. An oil pump optimizes the amount of oil injected to lubricate the rotor seals in the combustion cycle. Although your vehicle is equipped with an engine oil level warning light and an engine oil pressure gauge, it is best to keep the engine oil level in the range between full and low by checking the oil dipstick regularly. Mazda recommends checking the oil level at every second fuel filling. The oil consumption of the engine depends on engine speed and engine load. Under extreme driving conditions, oil consumption can be higher.

# Instrument Cluster and Indicators

## ▼ Dashboard Illumination

Rotate the thumb wheel to adjust the brightness of the instrument cluster and other illuminations in the dashboard.

### NOTE

- The brightness of dashboard illuminations (except instrument cluster) can be adjusted when the headlight switch is in the ● or ≡D position.
- The brightness of the instrument cluster illumination can be adjusted when the headlight switch is in any position.

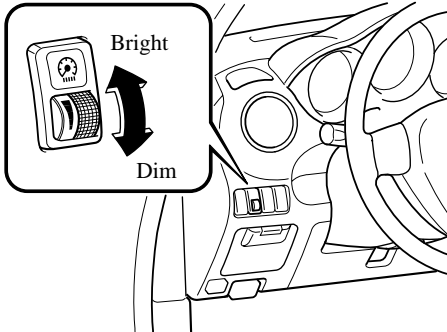

### Canceling the illumination dimmer

When the headlight switch is in the ● or ≡D position, the illumination of the instrument cluster and the information display dims (the instrument cluster illumination color turns to red).

When driving on snowy or foggy roads, or in other situations when the instrument cluster or information display's visibility is reduced due to glare from surrounding brightness, cancel the illumination dimmer and increase the illumination intensity.

To cancel the illumination dimmer, rotate the thumb wheel upward fully. You may hear a click sound and the illumination dimmer will be canceled (instrument cluster illumination color turns to white).

### NOTE





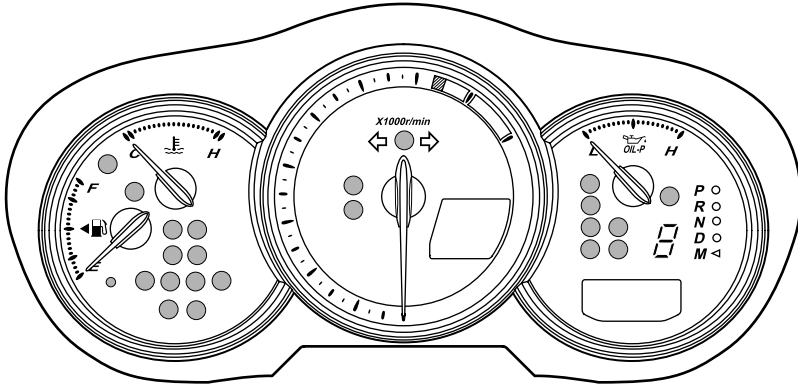

If the dashboard illumination switch is kept at the illumination dimmer cancel position, the instrument cluster and the information display will not dim when the headlight switch is turned to the ● or ≡D position again.

# Warning/Indicator Lights and Beeps









## Warning/Indicator Lights



Warning/Indicator lights will appear in any of the highlighted areas

Signal	Warning/Indicator Lights	Page
	Brake System Warning Light	5-37
	Charging System Warning Light	5-38
	Engine Oil Level Warning Light	5-38
	Engine Coolant Level Warning Light	5-39
	Check Engine Light	5-39
	ABS Warning Light	5-40
	Air Bag/Front Seat Belt Pretensioner System Warning Light	5-40

# Warning/Indicator Lights and Beeps

Signal	Warning/Indicator Lights	Page
	Low Fuel Warning Light	5-41
	Seat Belt Warning Light	5-41
	Door-Ajar Warning Light	5-41
	Low Washer Fluid Level Warning Light	5-41
<b>AT</b>	Automatic Transmission Warning Light	5-42
	Tire Pressure Monitoring System Warning Light	5-42
	Security Indicator Light	5-43
	Headlight High-Beam Indicator Light	5-43
<i>PRNDM</i>	Shift Position Indicator Light	5-44
	TCS/DSC Indicator Light	5-44
<b>DSC OFF</b>	DSC OFF Indicator Light	5-44
<b>CRUISE MAIN</b>	Cruise Main Indicator Light	5-45
<b>CRUISE</b>	Cruise Set Indicator Light	5-45
	Light-On Indicator Light	5-45
	Power Steering Malfunction Indicator Light	5-45
	Headlight Auto-Leveling Malfunction Indicator Light	5-46
	Turn-Signal/Hazard Warning Indicator Lights	5-46

## Warning/Indicator Lights and Beeps

### ▼ Brake System Warning Light



This warning has the following functions:

#### **Parking brake warning**

The light comes on when the parking brake is applied with the ignition switch in the START or ON position. It goes off when the parking brake is fully released.

#### **Low brake fluid level warning/**

#### **Electronic brake force distribution system warning**

If the light stays on after the parking brake is fully released, you may have a brake problem.

Drive to the side of the road and park off the right-of-way.

#### **Low brake fluid level warning**

You may notice that the pedal is harder to push or that it may go closer to the floor. In either case, it will take longer to stop the vehicle.

1. With the engine stopped, check the brake fluid level immediately and add fluid as required (page 8-15).
2. After adding fluid, check the light again.

If the warning light remains on, or if the brakes do not operate properly, do not drive the vehicle. Have it towed to an Authorized Mazda Dealer.

Even if the light goes off, have your brake system inspected as soon as possible.

#### **Electronic brake force distribution system warning**

If the electronic brake force distribution control unit determines that some components are operating incorrectly, the control unit may turn the brake system warning light on.

In this case, the ABS warning light comes on at the same time (page 5-40).

### **WARNING**

#### **Brake Warning Light:**

*Driving with the brake system warning light on is dangerous. It indicates that your brakes may not work at all or that they could completely fail at any time. If this light remains on, after checking that the parking brake is fully released, have the brakes inspected immediately. Don't drive with this light on, and contact an Authorized Mazda Dealer to have the brakes inspected as soon as possible.*

## Warning/Indicator Lights and Beeps

---

### **WARNING**

**ABS Warning Light and Brake Warning Light on at the Same Time:**  
*Driving when the brake system warning light and ABS warning light are on at the same time is dangerous. When both lights are on, the rear wheels could lock more quickly in an emergency stop than under normal circumstances.  
Don't drive with both lights on, and contact an Authorized Mazda Dealer to have the brakes inspected as soon as possible.*

### ▼ **Charging System Warning Light**

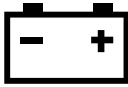

This warning light illuminates when the ignition switch is turned to the ON position and turns off when the engine is started.

If the warning light illuminates while driving, it indicates a malfunction of the alternator or of the charging system. Drive to the side of the road and park off the right-of-way. Consult an Authorized Mazda Dealer.

### **CAUTION**

Don't continue driving when the charging system warning light is illuminated.

### ▼ **Engine Oil Level Warning Light**



This warning light indicates low engine oil level.

If the light illuminates while driving:

1. Drive to the side of the road and park off the right-of-way.
2. Turn off the engine and inspect the engine oil level (page 8-11). If it's low, add oil.
3. Check the light.

If the engine oil level warning light is illuminated and you are unable to immediately add engine oil, do not drive at high speed, keep the engine speed low and get to a location where oil can be added as soon as possible. We recommend an Authorized Mazda Dealer.

If the light remains illuminated even after you add oil, have your vehicle checked at an Authorized Mazda Dealer.

### **CAUTION**

Don't run the engine if the oil level is low. It could result in extensive engine damage.



## Warning/Indicator Lights and Beeps

### NOTE

The Mazda RX-8 requires regular checking of the engine oil level. The compact, high performance RENESIS rotary engine in your vehicle consumes a small amount of engine oil due to its structural design. An oil pump optimizes the amount of oil injected to lubricate the rotor seals in the combustion cycle. Although your vehicle is equipped with an engine oil level warning light and an engine oil pressure gauge, it is best to keep the engine oil level in the range between full and low by checking the oil dipstick regularly. Mazda recommends checking the oil level at every second fuel filling. The oil consumption of the engine depends on engine speed and engine load. Under extreme driving conditions, oil consumption can be higher.

### ▼ Engine Coolant Level Warning Light



This warning light indicates low engine coolant level.

If the light illuminates while driving:

1. Drive to the side of the road and park off the right-of-way.
2. Turn off the engine and inspect the engine coolant level (page 8-13). If it's low, add engine coolant.

3. Check the light.

If the light remains illuminated even after you add engine coolant, have your vehicle towed to an Authorized Mazda Dealer.

### ⚠ CAUTION

Don't run the engine if the engine coolant level is low. It could result in extensive engine damage.

### ▼ Check Engine Light



If this light comes on while driving, the vehicle may have a problem. It is important to note the driving conditions when the light came on and consult an Authorized Mazda Dealer.

The check engine light may come on in the following cases:

- The fuel tank level being very low or approaching empty.
- The engine's electrical system has a problem.
- The emission control system has a problem.
- The fuel-filler cap is missing or not tightened securely.

If the check engine light remains on or flashes continuously, do not drive at high speeds and consult an Authorized Mazda Dealer as soon as possible.

## Warning/Indicator Lights and Beeps

### ▼ ABS Warning Light



The warning light stays on for a few seconds when the ignition switch is turned to the ON position.

If the ABS warning light stays on while you're driving, the ABS control unit has detected a system malfunction. If this occurs, your brakes will function normally as if the vehicle had no ABS. Should this happen, consult an Authorized Mazda Dealer as soon as possible.

### **WARNING**

**ABS Warning Light and Brake Warning Light on at the Same Time:**  
***Driving when the brake system warning light and ABS warning light are on at the same time is dangerous. When both lights are on, the rear wheels could lock more quickly in an emergency stop than under normal circumstances. Don't drive with both lights on, and contact an Authorized Mazda Dealer to have the brakes inspected as soon as possible.***

### NOTE

When the engine is jump-started to charge the battery, uneven rpm occurs and the ABS warning light comes on. This is due to a weak battery, not a malfunction. Recharge the battery.

### ▼ Air Bag/Front Seat Belt Pretensioner System Warning Light



If the air bag/front seat belt pretensioner system is normal, the warning light illuminates when the ignition switch is turned to the ON position or after the engine is cranked. After about 6 seconds it goes out.

A system malfunction is indicated when the warning light constantly flashes, illuminates or doesn't illuminate at all when the ignition switch is turned to the ON position. If any of these occur, consult an Authorized Mazda Dealer as soon as possible. The system may not work in an accident.

# Warning/Indicator Lights and Beeps

## **WARNING**

### Self-Servicing the Air Bag/ Pretensioner Systems:

*Self-servicing or tampering with the systems is dangerous. An air bag/pretensioner could accidentally activate or become disabled. This could cause serious injuries. Never tamper with the systems and always have an Authorized Mazda Dealer perform all servicing and repairs.*

### ▼ Low Fuel Warning Light

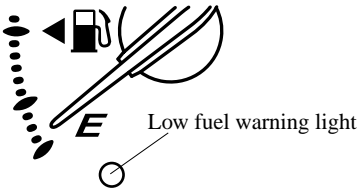

This warning light in the fuel gauge signals that the fuel tank will soon be empty.

Refuel as soon as possible.

### ▼ Seat Belt Warning Light



If the driver's seat belt is not fastened when the ignition switch is turned to the ON position, the seat belt warning light will remain on until the belt is fastened. If the system does not operate correctly, consult an Authorized Mazda Dealer.

### ▼ Door-Ajar Warning Light



This warning light comes on when any door isn't securely closed.

### ▼ Low Washer Fluid Level Warning Light\*



This warning light indicates that little washer fluid remains. Add fluid (page 8-18).

## Warning/Indicator Lights and Beeps

### ▼ Automatic Transmission Warning Light

# AT

This warning light stays on for a few seconds when the ignition switch is turned to the ON position. The light illuminates when the transmission has a problem.

#### CAUTION

If the automatic transmission warning light illuminates, the transmission has an electrical problem. Continuing to drive your Mazda in this condition could cause damage to your transmission. Consult an Authorized Mazda Dealer as soon as possible.

### ▼ Tire Pressure Monitoring System Warning Light\*



This warning light illuminates for a few seconds when the ignition switch is turned to the ON position.

Thereafter, the warning light illuminates when tire pressure is too low or too high in one or more tires, and flashes when there is a system malfunction.

#### WARNING

#### Vehicle Handling When Tire Pressure Monitoring System Warning Light Illuminates/Flashes:

*When the tire pressure monitoring system warning light illuminates or flashes, or the tire pressure warning beep sound is heard, it is dangerous to drive the vehicle at high speeds, or perform sudden maneuvering or braking. Vehicle drivability could worsen and result in an accident.*

*When the tire pressure monitoring system warning light illuminates or flashes, or the tire pressure warning beep sound is heard, decrease vehicle speed immediately and avoid sudden maneuvering and braking. Have the system and tires checked or perform the appropriate repair as soon as possible.*

*Ignoring the Warning Light:*  
*Ignoring the warning light is dangerous, even if you know why it is illuminated. Have the problem taken care of as soon as possible before it develops into a more serious situation that could lead to tire failure and a dangerous accident.*

#### Warning light illuminates/Warning beep sounds

When the warning light illuminates, and the warning beep sound is heard (about 3 seconds), tire pressure is too low or too high in one or more tires.

Adjust the tire pressure to the correct tire pressure at an Authorized Mazda Dealer or the nearest service station. Refer to the specification charts (page 10-7).

## Warning/Indicator Lights and Beeps

### CAUTION

When replacing/repairing the tires or wheels or both, have the work done by an Authorized Mazda Dealer, or the tire pressure sensors may be damaged.

If the warning light illuminates again even after the tire pressures are adjusted, there may be a tire puncture.

### Vehicles with Instant Mobility System (IMS) emergency flat tire repair kit

If an emergency tire repair is needed, repair the punctured tire with the emergency flat tire repair kit (page 7-5).

### CAUTION

Do not use non-genuine tire sealant. It may damage the tire pressure sensor.

### Vehicles with optional temporary spare tire

If you have bought the optional temporary spare tire, replace the punctured tire with the temporary spare tire. Refer to the manufacturer's instructions.

### NOTE

A tire pressure sensor is not installed to the temporary spare tire. The warning light will flash continuously while the temporary spare tire is being used.

### Warning light flashes

When the warning light flashes, there may be a system malfunction. Consult an Authorized Mazda Dealer.

### ▼ Security Indicator Light



This indicator light starts flashing every 2 seconds when the ignition switch is turned from the ON to the ACC position and the immobilizer system is armed.

The light stops flashing when the ignition switch is turned to the ON position with the correct ignition key. At this time, the immobilizer system is disarmed and the light illuminates for about 3 seconds and then goes out.

If the engine doesn't start with the correct ignition key, and the security indicator light keeps illuminating or flashing, the system may have a malfunction. Consult an Authorized Mazda Dealer.

### ▼ Headlight High-Beam Indicator Light



This light indicates one of two things:

- The high-beam headlights are on.
- The turn signal lever is in the flash-to-pass position.

## Warning/Indicator Lights and Beeps

---

### ▼ Shift Position Indicator Light (Automatic Transmission)

This indicates the selected shift position when the ignition switch is in the ON position.

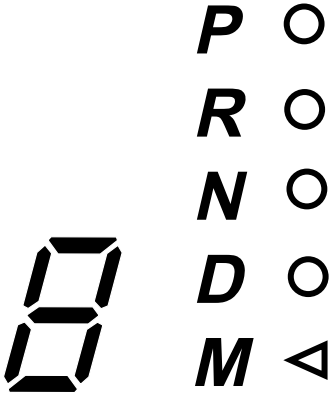

Gear position indicator

### Gear position indicator

When the shift lever is in the D or M position, the numeral for the selected gear illuminates.

### ▼ TCS/DSC Indicator Light\*



This indicator light stays on for a few seconds when the ignition switch is turned to the ON position. If the TCS or DSC is operating, the indicator light flashes.

If the light stays on, the TCS or DSC may have a malfunction and they may not operate correctly. Take your vehicle to an Authorized Mazda Dealer.

### ▼ DSC OFF Indicator Light\*

**DSC  
OFF**

This indicator light stays on for a few seconds when the ignition switch is turned to the ON position.

It also comes on when the DSC OFF switch is pressed and TCS/DSC is switched off.

If the light stays on when the TCS/DSC is not switched off, take your vehicle to an Authorized Mazda Dealer. The dynamic stability control may have a malfunction.

## Warning/Indicator Lights and Beeps

### NOTE

If the battery is disconnected, the DSC will be inoperable. In this case, the DSC OFF indicator light flashes and the TCS/DSC indicator light illuminates.

To make the DSC operable, do the following procedure.

1. Turn the ignition switch to the ON position.
2. Turn the steering clockwise fully, then turn it counterclockwise fully.
3. Make sure the DSC OFF indicator goes off.
4. Turn the ignition switch to the OFF position, then turn it to the ON position again.
5. Make sure the TCS/DSC indicator light goes off.

If the TCS/DSC indicator light and the DSC OFF indicator light remain illuminated even after turning the ignition switch to the ON position, consult an Authorized Mazda Dealer.

### ▼ Cruise Main Indicator Light

## CRUISE MAIN

This light comes on when the ON/OFF switch is pressed and the cruise control system is activated.

### ▼ Cruise Set Indicator Light

## CRUISE

This light comes on when a cruising speed is set.

### ▼ Light-On Indicator Light



This indicator light comes on when the exterior lights are on.

### ▼ Power Steering Malfunction Indicator Light



This indicator light illuminates when the ignition switch is turned to the ON position and goes off when the engine is started.

If this light illuminates while driving, it indicates a malfunction of the power steering system. Consult an Authorized Mazda Dealer.

## Warning/Indicator Lights and Beeps

---

### NOTE

The power steering system is inoperable when the power steering malfunction indicator light illuminates. Steering is possible, but requires more physical effort.

### ▼ Headlight Auto-Leveling Malfunction Indicator Light\*

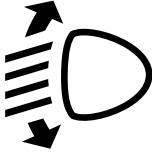

This indicator light stays on for a few seconds when the ignition switch is turned to the ON position.

Thereafter, the indicator light will illuminate when the headlight auto-leveling system has a malfunction.

If the indicator light illuminates, contact an Authorized Mazda Dealer.

### ▼ Turn-Signal/Hazard Warning Indicator Lights

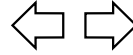

When operating the turn-signal lights, the left or right turn-signal indicator light flashes to indicate which turn-signal light is operating (page 5-50).

When operating the hazard warning lights, both turn-signal indicator lights flash (page 5-55).

### NOTE

If an indicator light remains illuminated (does not flash) or if it flashes abnormally, the turn signal bulb may be burned out.



## Warning/Indicator Lights and Beeps

---

### Beeps

#### ▼ Seat Belt Warning Beep

If the driver's seat belt is not fastened when the ignition switch is turned to the ON position, a beep sound will be heard for about 6 seconds.

#### ▼ Ignition Key Reminder

If the ignition switch is in the LOCK or ACC position, a beep sound will be heard when the driver's door is opened.

#### ▼ Lights-On Reminder

If lights are on and the key is removed from the ignition switch, a beep sound will be heard when the driver's door is opened.

#### ▼ Engine Overrev Warning Beep

The beep sounds to indicate engine overrev when the tachometer needle enters the striped zone (page 5-31).

#### ▼ Tire Inflation Pressure Warning Beep\*

The warning beep sound will be heard for about 3 seconds when there is any abnormality in tire inflation pressures (page 5-24).

# Switches and Controls

## Lighting Control

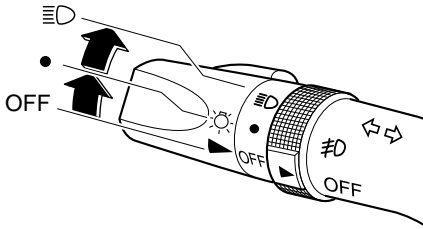

### ▼ Headlights

To turn on the lights, turn the headlight switch on the end of the control lever.

Switch Position	OFF	●	☰☷
Headlights	Off	Off	On
Taillights Parking lights License lights Side-marker lights	Off	On	On

#### NOTE

To prevent discharging the battery, don't leave the lights on while the engine is off.

### Xenon fusion headlight bulbs\*

The low-beam bulbs of the headlights have xenon fusion bulbs that produce a bright white beam over a wide area.

## ⚠ WARNING

**Xenon Fusion Bulb Replacement:** Replacing the xenon fusion bulbs by yourself is dangerous. Because the xenon fusion bulbs require high voltage, you could receive an electric shock if the bulbs are handled incorrectly. Do not replace the xenon fusion bulbs by yourself. Consult an Authorized Mazda Dealer when the replacement is necessary.

#### NOTE

If the headlights flash, or the brightness weakens, the bulb-life may be depleted and a replacement is necessary. Consult an Authorized Mazda Dealer.

### ▼ Lights-On Reminder

If lights are on and the key is removed from the ignition switch, a beep sound will be heard when the driver's door is opened.

### ▼ Headlight High-Low Beam

Push the lever forward for high beam.  
Pull it back for low.

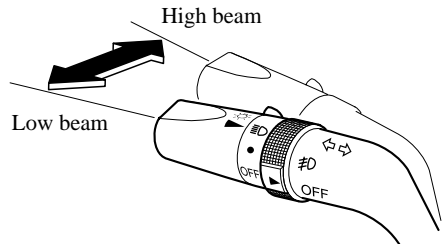

## Switches and Controls

### ▼ Flashing the Headlights

To flash the headlights, pull the lever fully toward you. The headlight switch need not be on, and the lever will return to the normal position when released.

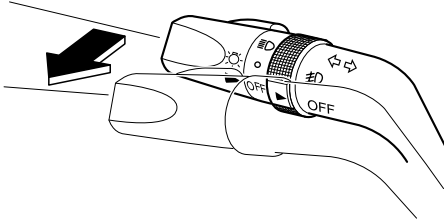

### ▼ Headlight Leveling\*

The number of riders and weight of cargo in the luggage compartment change the angle of the headlights.

The angle of the headlights will be automatically adjusted when turning on the headlights.

### Headlight auto-leveling malfunction indicator light

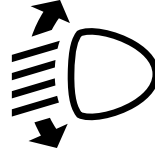

This indicator light stays on for a few seconds when the ignition switch is turned to the ON position.

Thereafter, the indicator light will illuminate when the headlight auto-leveling system has a malfunction.

If the indicator light illuminates, contact an Authorized Mazda Dealer.

### ▼ Daytime Running Lights (Canada)

In Canada, vehicles must be driven with the headlights on during daytime operation.

For that reason, the daytime running lights automatically turn on when the ignition switch is turned to the ON position.

#### NOTE

The Daytime Running Lights turn off when the parking brake is applied.

# Switches and Controls

## Turn and Lane-Change Signals

### ▼ Turn Signal

Move the signal lever down (for a left turn) or up (for a right turn) to the stop position. The signal will self-cancel after the turn is completed.

If the indicator light continues to flash after a turn, manually return the lever to its original position.

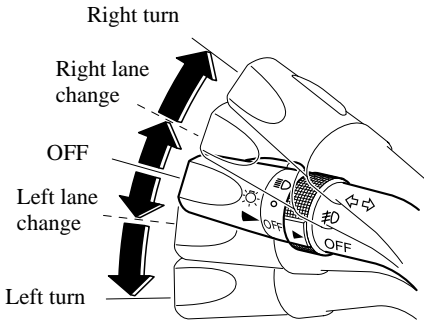

Green indicators on the dashboard show which signal is working.



### Lane-change signals

Move the lever slightly toward the direction of the change —until the indicator flashes— and hold it there. It will return to the off position when released.

<b>NOTE</b>
If an indicator light stays on without flashing or if it flashes abnormally, the turn signal bulb may be burned out.

## Fog Lights\*

Use this switch to turn on the fog lights. They help you to see as well as to be seen.

To turn the front fog lights on, rotate the fog light switch to the  position. The headlight switch must be in the  position to turn on the front fog lights.

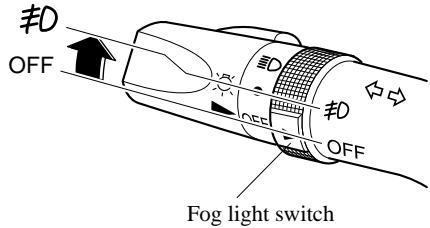

To turn them off, rotate the fog light switch to the ● or OFF position or turn the headlight switch to the OFF position.

<b>NOTE</b>
The fog lights will turn off when the headlights are set at high beam.

## Switches and Controls

### Windshield Wipers and Washer

The ignition switch must be in the ON position.

#### **WARNING**

##### **Frozen Washer Fluid:**

*Using windshield washer fluid without anti-freeze protection in freezing temperatures is dangerous. The washer fluid could freeze on the windshield and block your vision. You could have an accident. Don't use the washer without first warming the windshield and never use plain tap water.*

#### **NOTE**

Because heavy ice and snow can jam the wiper blades, the wiper motor is protected from motor breakdown, overheating and possible fire by a circuit breaker. This mechanism will automatically stop operation of the blades, but only for about 5 minutes. If this happens, turn off the wiper switch and park off the right-of-way, and remove the snow and ice. After 5 minutes, turn on the switch and the blades should operate normally. If they don't resume functioning, consult an Authorized Mazda Dealer as soon as possible.

### ▼ Windshield Wipers

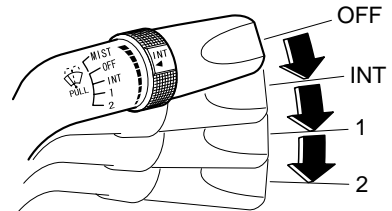

Turn the wipers on by pulling the lever down.

**INT** — Intermittent

**1** — Normal

**2** — Fast

#### **Variable-speed intermittent wipers**

Set the lever to INT and choose the interval timing by rotating the ring.

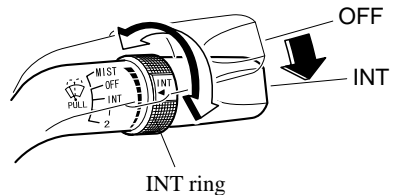

# Switches and Controls

## One-touch wipers

For a single wiping cycle, push the lever up to MIST.

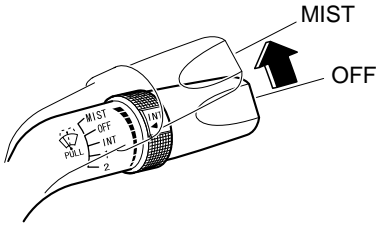

## ▼ Windshield Washer

Pull the lever toward you and hold it to spray washer fluid.

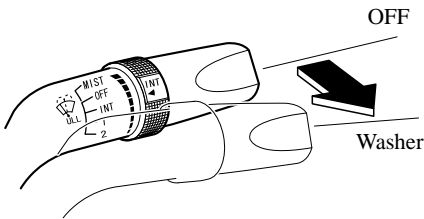

### NOTE

#### (With headlight washers)

When the headlights are on, the headlight washers operate automatically once every fifth time the windshield washer operates. Refer to Headlight Washer (page 5-53).

### NOTE

With the wiper lever in the OFF or INT position, the wipers will operate continuously until the lever is released.

If the washer doesn't work, inspect the fluid level (page 8-18). If it's OK, consult an Authorized Mazda Dealer.

## Switches and Controls

### Headlight Washer\*

The ignition switch must be in the ON position and the headlights must be turned on.

The headlight washers operate automatically once every fifth time the windshield wiper lever operates.

If you want to operate only the headlight washers, pull the windshield wiper lever toward you twice rapidly.

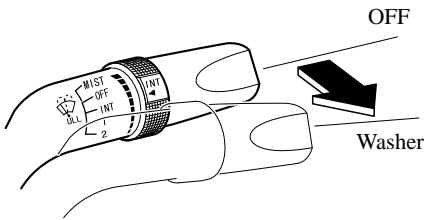

#### NOTE

When you pull the windshield wiper lever twice, the windshield washer may spray a little.

### Rear Window Defroster

The rear window defroster clears frost, fog, and thin ice from the rear window.

The ignition switch must be in the ON position.

Press the switch to turn on the rear window defroster. The rear window defroster operates for about 15 minutes and turns off automatically. The indicator light illuminates during operation.

To turn off the rear window defroster before the 15 minutes has elapsed, press the switch again.

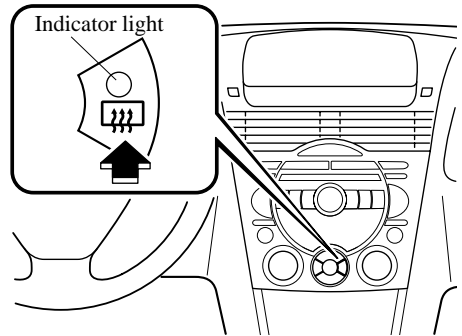

#### ⚠ CAUTION

Don't use sharp instruments or window cleaners with abrasives to clean the inside of the rear window surface. They may damage the defroster grid inside the window.

## Switches and Controls

---

### NOTE

This defroster is not designed for melting snow. If there is an accumulation of snow on the rear window, remove it before using the defroster.

### Horn

To sound the horn, press around the  mark on the steering wheel.



## Switches and Controls

### Hazard Warning Flasher

The hazard warning lights should always be used when you stop on or near a roadway.

The hazard warning lights warn other drivers that your vehicle is a traffic hazard and that they must take extreme caution when near it.

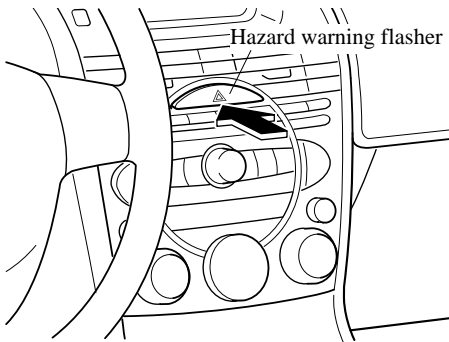

Depress the hazard warning flasher and all four turn signals will flash.

#### NOTE

- The turn signals don't work when the hazard warning lights are on.
- Check local regulations about the use of hazard warning lights while the vehicle is being towed. They may forbid it.

### HomeLink Wireless Control System\*

#### NOTE

HomeLink and HomeLink house are registered trademarks of Johnson Controls.

The HomeLink system replaces up to 3 hand-held transmitters with a single built-in component in the auto-dimming mirror. Pressing the HomeLink button on the auto-dimming mirror activates garage doors, gates and other devices surrounding your home.

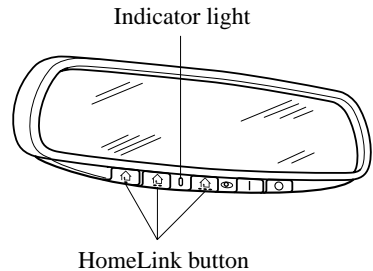

## Switches and Controls

### **WARNING**

**Safety Stop and Reverse Feature:**  
*Using the HomeLink system with any garage door opener that lacks the safety stop and reverse feature as required by federal safety standards is dangerous. (This includes garage doors manufactured before April 1, 1982.)*

*Using these garage door openers can increase the risk of serious injury or death. For further information, contact HomeLink at 1-800-355-3515 or [www.homelink.com](http://www.homelink.com) or your Authorized Mazda Dealer.*

**Safety While Programming or Operating HomeLink System:**  
*Programming or operating the HomeLink system without verifying the safety of areas surrounding garage doors and gates is dangerous and could result in an unexpected accident and serious injury if someone were to be hit. Always check the areas surrounding garage doors and gates for people or obstructions before programming or during operation of the HomeLink system.*

### **CAUTION**

HomeLink has been tested and complies with FCC and Industry Canada rules. Changes or modifications not expressly approved by the party responsible for compliance could void the user's authority to operate the device.

### **NOTE**

FCC ID: NZLSTDHL3  
CANADA:4112104541A  
This device complies with FCC rules part 15. Operation is subject to the following conditions:  
1- This device may not cause any harmful interference and  
2- This device must accept any interference that may be received including interference that may cause undesired operation.

### **NOTE**

The programming will not be erased even if the battery is disconnected.

### ▼ **Pre-programming the HomeLink System**

### **NOTE**

It is recommended that a new battery be placed in the hand-held transmitter of the device being programmed to HomeLink for quicker training and accurate transmission of the radio-frequency signal.

- Verify that there is a remote control transmitter available for the device you would like to program.
- Disconnect the power to the device.

## Switches and Controls

### ▼ Programming the HomeLink System

#### CAUTION

When programming a garage door opener or a gate, disconnect the power to these devices before performing programming, as continuous operation of the devices could damage the motor.

The HomeLink system provides 3 buttons which can be individually selected and programmed using the transmitters for current, on-market devices as follows:

1. Press and hold the two outer HomeLink buttons (buttons one and three) - releasing only when the indicator light begins to flash (after 20 seconds). **Do not** hold the buttons for longer than 30 seconds and **do not repeat step 1** to program a second and/or third hand-held transmitter to the remaining two HomeLink buttons.
2. Position the end of your hand-held transmitter 2.5—7.5 cm (1—3 inches) away from the HomeLink button you wish to program while keeping the indicator light in view.
3. Simultaneously press and hold both the chosen HomeLink and hand-held transmitter buttons. **Do not release the buttons until step 4 has been completed.**

#### NOTE

Some gate operators and garage door openers may require you to replace this Programming Step 3 with procedures noted in the "Gate Operator/Canadian Programming" section.

4. After the HomeLink indicator light changes from a slow to a rapidly blinking light, release both the HomeLink and hand-held transmitter buttons.

#### NOTE

If the HomeLink indicator light does not change to a rapidly blinking light, contact HomeLink at [www.homelink.com](http://www.homelink.com) or call 1-800-355-3515 for assistance.

5. Press and hold the just-trained HomeLink button and observe the indicator light.

If the indicator light **stays on constantly, programming is complete** and your device should activate when the HomeLink button is pressed and released.

#### NOTE

To program the remaining two HomeLink buttons, begin with "Programming" - **step 2. Do not repeat step 1.**

If the indicator light blinks **rapidly for two seconds and then turns to a constant light, continue with "Programming" steps 6—8** to complete the programming of a rolling code equipped device (most commonly a garage door opener).

6. At the garage door opener receiver (motor-head unit) in the garage, locate the "learn" or "smart" button. This can usually be found where the hanging antenna wire is attached to the motor-head unit.

## Switches and Controls

---

7. Firmly press and release the "learn" or "smart" button. (The name and color of the button may vary by manufacturer.)

<b>NOTE</b>
-------------

There are 30 seconds in which to initiate step 8.
---

8. Return to the vehicle and firmly **press, hold for two seconds and release** the programmed HomeLink button. Repeat the "**press/hold/release**" sequence a second time, and, depending on the brand of the garage door opener (or other rolling code equipped device), repeat this sequence a third time to complete the programming process.

HomeLink should now activate your rolling code equipped device.

<b>NOTE</b>
-------------

To program the remaining two HomeLink buttons, begin with "Programming" - <b>step 2. Do not repeat step 1.</b>
--

For questions or comments, please contact HomeLink at [www.homelink.com](http://www.homelink.com) or **1-800-355-3515**.

### ▼ Gate operator/Canadian Programming

Canadian radio-frequency laws require transmitter signals to "time-out" (or quit) after several seconds of transmission - which may not be long enough for HomeLink to pick up the signal during programming. Similar to this Canadian law, some U.S. gate operators are designed to "time-out" in the same manner.

If you live in Canada or you are having difficulties programming a gate operator by using the "Programming" procedures (regardless of where you live), **replace "Programming HomeLink" step 3** with the following:

<b>NOTE</b>
-------------

If programming a garage door opener or gate operator, it is advised to unplug the device during the "cycling" process to prevent possible overheating.
--

Continue to press and hold the HomeLink button while you **press and release - every two seconds** ("cycle") your hand-held transmitter until the frequency signal has successfully been accepted by HomeLink. (The indicator light will flash slowly and then rapidly.) Proceed with "Programming" step 4 to complete.

### ▼ Operating the HomeLink System



Press the programmed HomeLink button to operate a programmed device. The code will continue being transmitted for a maximum of 20 seconds.

### ▼ Reprogramming the HomeLink system

To program a device to HomeLink using a HomeLink button previously trained, follow these steps:

1. Press and hold the desired HomeLink button. **DO NOT** release the button.
2. The indicator light will begin to flash after 20 seconds. Without releasing the HomeLink button, proceed with "Programming" - step 2.

### ▼ Erasing Programmed HomeLink Buttons

To erase the existing programming from all three operating channels, press and hold the two outside buttons (  ,  ) on the auto-dimming mirror until the HomeLink indicator light begins to flash after approximately 20 seconds. Verify that the programming has been erased when you resell the vehicle.



Use of various features for drive comfort, including climate control and audio system.

<b>Climate Control System</b> .....	6-2
Operating Tips .....	6-2
Vent Operation .....	6-3
Control Panel .....	6-5
<b>Audio System</b> .....	6-10
Antenna .....	6-10
Operating Tips for Audio System .....	6-10
Audio Set .....	6-17
Audio Control Switch Operation .....	6-34
Safety Certification .....	6-36
<b>Interior Equipment</b> .....	6-37
Sunvisors .....	6-37
Interior Lights .....	6-37
Information Display .....	6-40
Lighter .....	6-42
Ashtray .....	6-43
Cup Holder .....	6-44
Storage Compartments .....	6-45
Accessory Socket .....	6-48

## Climate Control System

---

### Operating Tips

#### ▼ Operating the Climate Control System

Operate the climate control system with the engine running.

#### NOTE

To prevent the battery from being discharged, do not leave the fan control dial on for a long period of time when the engine is not running.

#### ▼ Clearing the Air Inlet

Clear all obstructions like leaves, snow and ice from the hood and the air inlet in the cowl grille to improve the system efficiency.

#### ▼ Foggy Windows

The windows may fog up easily in humid weather. Use the climate control system to defog the windows.

To help defog the windows, operate the air conditioner to dehumidify the air.

#### ▼ Outside/Recirculated Air Position

Use the outside air position in normal conditions. The recirculated air position should be used only when driving on dusty roads or for quick cooling of the interior.

#### ▼ Parking in Direct Sunlight

If the vehicle has been parked in direct sunlight during hot weather, open the windows to let warm air escape, then run the climate control system.

#### ▼ Not Using for a Long Period

Run the air conditioner about 10 minutes at least once a month to keep internal parts lubricated.

#### ▼ Check the Refrigerant before the Weather Gets Hot

Have the air conditioner checked before the weather gets hot. Lack of refrigerant may make the air conditioner less efficient. Consult an Authorized Mazda Dealer for refrigerant inspection.

The air conditioner is filled with HFC134a (R134a), a refrigerant that will not damage the ozone layer.

If the air conditioner is low on refrigerant or has a malfunction, consult an Authorized Mazda Dealer.

#### ▼ Replacement of the Cabin Air Filter

If your vehicle is equipped with an air filter for the air conditioner, it is necessary to change the filter periodically as indicated in scheduled maintenance (page 8-3). Consult an Authorized Mazda Dealer for replacement of the cabin air filter.



## Vent Operation

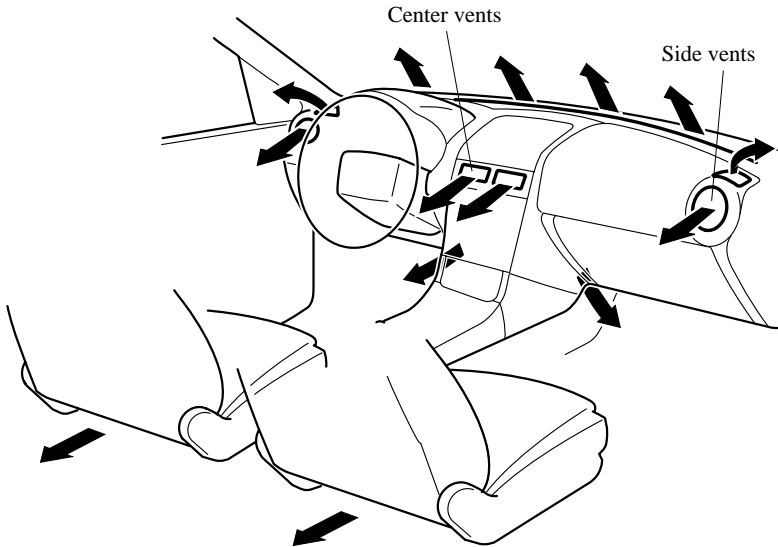

### ▼ Adjusting the Vents

#### Directing airflow

##### Side Vents

To adjust the direction of airflow, open the vents and rotate them left and right.

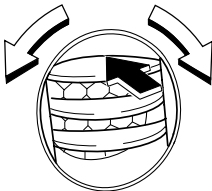

##### Center Vents

To adjust the direction of airflow, move the adjustment knob.

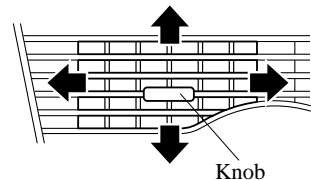

#### **NOTE**

When using the air conditioner, mist may come out from the vents. This is not a sign of trouble but a result of humid air being suddenly cooled.

# Climate Control System

---

## ▼ Selecting the Airflow Mode

### Dashboard Vents

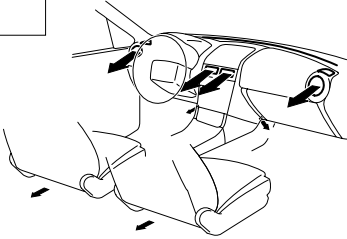

### Defroster and Floor Vents

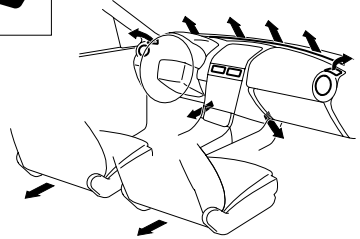

### Dashboard and Floor Vents

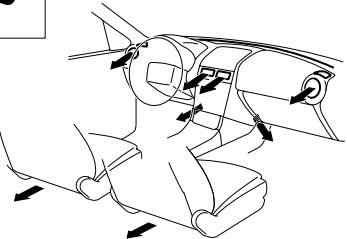

### Defroster Vents

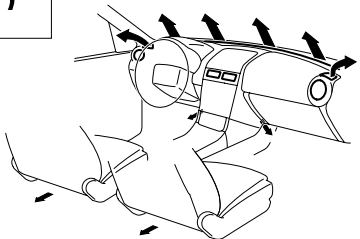

### Floor Vents

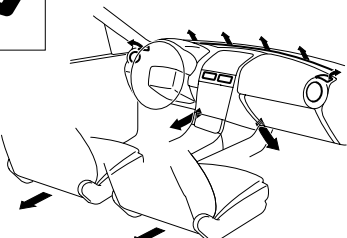

# Climate Control System

## Control Panel

Climate control information is displayed on the information display.

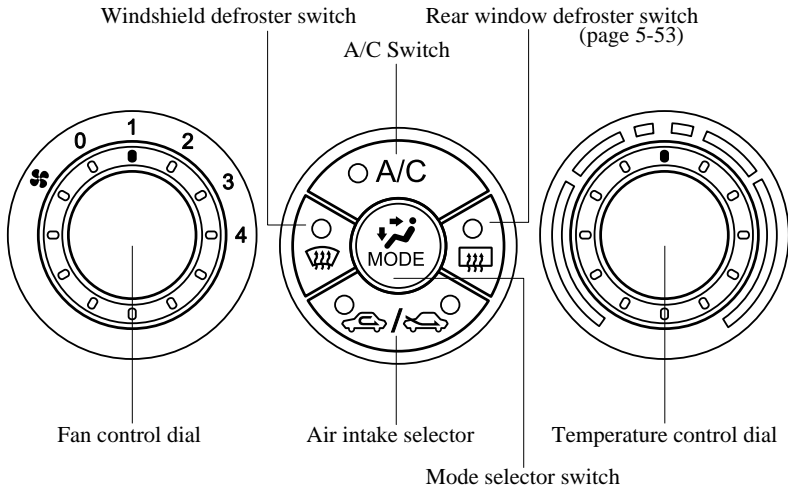

### ▼ Control Switches

#### Temperature control dial

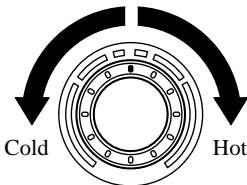

This dial controls temperature. Turn it clockwise for hot and counterclockwise for cold.

#### Fan control dial

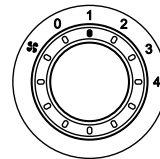

This dial allows variable fan speeds.

- 0—Fan off
- 1—Low speed
- 2—Medium low speed
- 3—Medium high speed
- 4—High speed

# Climate Control System

---

## Mode selector switch



Press the mode selector switch to select airflow mode (page 6-4).

### **NOTE**

To set the air vent to , press the windshield defroster switch.

## A/C switch

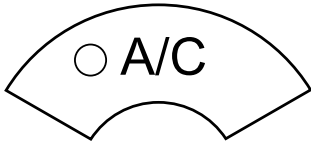

Push the switch to turn the air conditioner on. The indicator light on the switch will illuminate when the fan control dial is set at position 1, 2, 3, or 4.

Push the switch once again to turn the air conditioner off.



### **NOTE**

The air conditioner may not function when the outside temperature approaches 0 °C (32 °F).

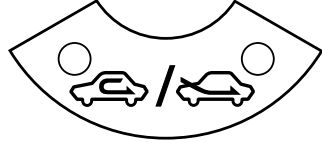
## Air intake selector



This switch controls the source of air entering the vehicle.

Press the switch to alternate between the  and  positions. The indicator light for the selected mode will illuminate.

It is recommended that under normal conditions the switch be kept in the outside air position.

### **Outside air position** ()

Outside air is taken into the vehicle. Use this position for normal ventilation and heating.



### **Recirculated air position** ()

Outside air is shut off. Air within the vehicle is recirculated.

This position can be used when driving on a dusty road or in similar conditions. It also helps to provide quicker cooling of the interior.

## ⚠ WARNING

### The Recirculated Air Position:

Using the  position in cold or rainy weather will cause the windows to fog up. Your vision will be hampered, which could lead to a serious accident. Do not use the  position in cold or rainy weather.

### Windshield defroster switch







Press the switch to defrost the windshield and front door windows.

### ▼ Heating

1. Press the mode selector switch to the  position.
2. Set the temperature control dial to the hot position.
3. Set the fan control dial to the desired speed.

### NOTE

- If the windshield fogs up easily, set the mode selector switch to the  position.
- If cooler air is desired at face level, set the mode selector switch at the  position and adjust the temperature control dial to maintain maximum comfort.
- The air to the floor is warmer than air to the face (except when the temperature control dial is set at the extreme hot or cold position).
- In the  position, air conditioning is automatically turned on to defrost the windshield (however, the indicator light does not illuminate) and the  position is automatically selected.

### ▼ Cooling (With Air Conditioner)

1. Press the mode selector switch to the  position.
2. Set the temperature control dial to the cold position.
3. Set the fan control dial to the desired speed.
4. Turn on the air conditioner.
5. Adjust the fan control dial and temperature control dial to maintain maximum comfort.



# Climate Control System

## CAUTION



When using the air conditioner while driving up long hills or in heavy traffic, closely monitor the temperature gauge (page 5-32).

The air conditioner may cause engine overheating. If the gauge indicates overheating, turn the air conditioner off.

## NOTE

- When maximum cooling is desired, set the temperature control dial to the extreme cold position and set the air intake selector to the  position, then set the fan control dial to position 4.
- If warmer air is desired at floor level, set the mode selector switch at the  position and adjust the temperature control dial to maintain maximum comfort.
- The air to the floor is warmer than air to the face (except when the temperature control dial is set at the extreme hot or cold position).

## ▼ Ventilation



1. Press the mode selector switch to the  position.
2. Set the air intake selector to the  position.
3. Set the temperature control dial to the desired position.
4. Set the fan control dial to the desired speed.

## ▼ Windshield Defrosting and Defogging





1. Press the windshield defroster switch.
2. Set the temperature control dial to the desired position.
3. Set the fan control dial to the desired speed.

## WARNING

### Foggy Windshield:

*Using the  position with the temperature control set to the cold position will cause the outside of the windshield to fog up. Your vision will be hampered, which could lead to a serious accident. Set the temperature control to the hot or warm position when using the  position.*

## NOTE

- For maximum defrosting, set the temperature control dial to the extreme hot position and the fan control dial to position 4.
- If warm air is desired at the floor, set the mode selector switch to the  position.
- In the  or  position, air conditioning is automatically turned on to defrost the windshield quickly (however, the indicator light does not illuminate) and the  position is automatically selected. The air intake selector switch cannot be changed to the  position.

### ▼ Dehumidifying (With Air Conditioner)

Operate the air conditioner in cool or cold weather to help defog the windshield and side windows.

1. Press the mode selector switch to the desired position.
2. Set the air intake selector to the  position.
3. Set the temperature control dial to the desired position.
4. Set the fan control dial to the desired speed.
5. Turn on the air conditioner.

# Audio System

---

## Antenna

### ▼ Rear Window Antenna

The rear window antenna receives both AM and FM signals.

#### CAUTION

When washing the inside rear window, use a soft cloth dampened in lukewarm water, gently wiping the antenna lines. Use of glass cleaning products could damage the antenna.

## Operating Tips for Audio System

#### WARNING

#### **Do Not Adjust Audio While Driving the Vehicle:**

*Adjusting the audio while driving the vehicle is dangerous as it could distract your attention from the vehicle operation which could lead to a serious accident. Always adjust the audio while the vehicle is stopped.*

#### CAUTION

For the purposes of safe driving, adjust the audio volume to a level that allows you to hear sounds outside of the vehicle.

#### NOTE

- Do not use the audio for long periods of time while the engine is off. Otherwise the battery could go dead.
- If a digital cellular phone or CB radio is used in or near the vehicle, it could cause noise to occur from the audio system, however, this does not indicate that the system has been damaged.



**▼ Radio Reception****AM characteristics**

AM signals bend around such things as buildings or mountains and bounce off the ionosphere. Therefore, they can reach longer distances than FM signals. Because of this, two stations may sometimes be picked up on the same frequency at the same time.

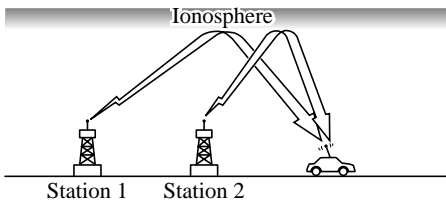
**FM characteristics**

An FM broadcast range is usually about 40–50 km (25–30 miles) from the source. Because of extra coding needed to break the sound into two channels, stereo FM has even less range than monaural (non-stereo) FM.

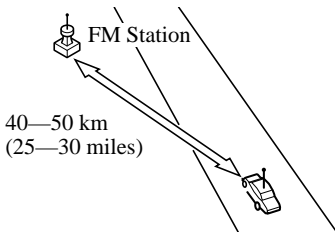

Signals from an FM transmitter are similar to beams of light because they do not bend around corners, but they do reflect. Unlike AM signals, FM signals cannot travel beyond the horizon. Therefore, FM stations cannot be received at the great distances possible with AM reception.

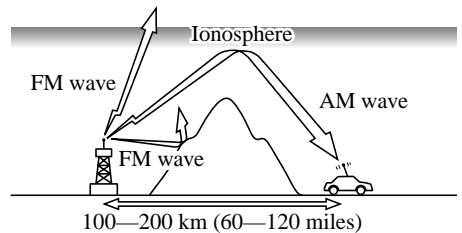

Atmospheric conditions can also affect FM reception. High humidity will cause poor reception. However, cloudy days may provide better reception than clear days.

**Multipath noise**

Since FM signals can be reflected by obstructions, it is possible to receive both the direct signal and the reflected signal at the same time. This causes a slight delay in reception and may be heard as a broken sound or a distortion. This problem may also be encountered when in close proximity to the transmitter.

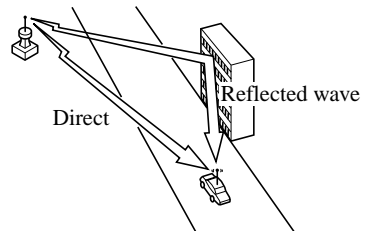

# Audio System

## Flutter/Skip noise

Signals from an FM transmitter move in straight lines and become weak in valleys between tall buildings, mountains, and other obstacles. When a vehicle passes through such an area, the reception conditions may change suddenly, resulting in annoying noise.

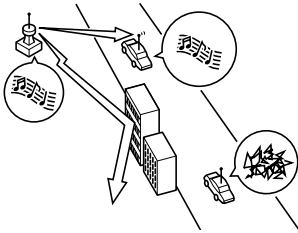

## Weak signal noise

In suburban areas, broadcast signals become weak because of distance from the transmitter. Reception in such fringe areas is characterized by sound breakup.

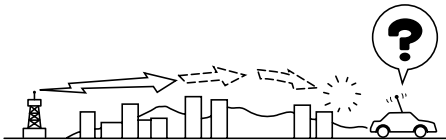

## Strong signal noise

This occurs very close to a transmitter tower. The broadcast signals are extremely strong, so the result is noise and sound breakup at the radio receiver.

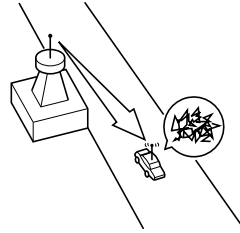

## Station drift noise

When a vehicle reaches the area of two strong stations broadcasting at similar frequencies, the original station may be temporarily lost and the second station picked up. At this time there will be some noise from this disturbance.

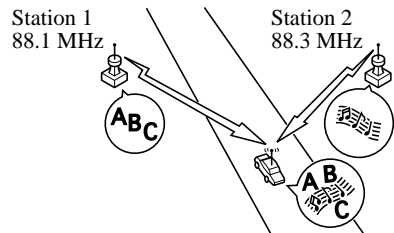

## ▼ Operating Tips for Cassette Tape Player

### Cleaning the cassette tape player

The tape head, capstans, and pinch rollers will gather oxide residue from cassette tapes. This can cause weak or wavering sounds and damage to the cassette tapes and player. Use a good quality head-cleaning tape or a liquid cleaner cassette tape to remove it.

Should the unit not operate normally, consult an Authorized Mazda Dealer. Never attempt to repair it or insert a screwdriver or anything else.

### Handling the cassette tape player

The following precautions should be observed.

- Do not spill any liquid on the audio system.

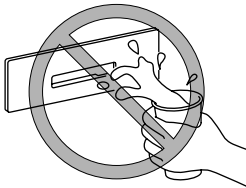

- Do not insert any objects, other than cassette tape, into the slot.

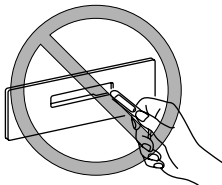

- If the cassette tape is loose, it may produce poor sound or performance during playback. Use a pencil or something similar to remove any slack.

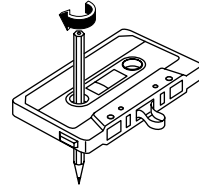

- Only cassette tapes that play no longer than 90 minutes should be used. Cassette tape exceeding 90 minutes are thin and may easily break.
- Do not leave a cassette tape in the tape player slot when not in use. Remove it completely to permit the slot door to close and to protect the mechanism from dust.
- Store cassette tapes away from extreme heat, magnetic fields, and direct sunlight. Protect the exposed cassette tape from dirt and damage. Store cassette tapes in their original cases or other protective cases.

## Audio System

---

### ▼ Operating Tips for Mini Disc (MD) Player

The following precautions should be observed.

- Do not spill any liquid on the audio system.

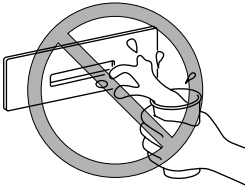

- Do not insert any objects, other than MDs, into the slot.

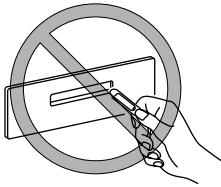

- The MD player has been designed to play MDs bearing the identification logo as shown. No other MDs can be played.



- The MD player can also play MDLPs that have been recorded in MDLP mode. (MDLPs bearing the identification logo as shown below).

**MDLP**

- When inserting the MD, make sure the MD label is facing up, and the MD is oriented to the insertion slot in the direction of the arrow. If not inserted correctly, the MD will be ejected, or may remain stuck in the MD deck.

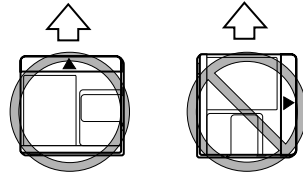

- Do not touch the internal part of the MD. If the MD shutter is slid open for no reason, it may be broken.

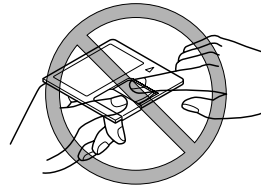

- Store MDs in their cases and away from direct sunlight.

## ▼ Operating Tips for CD Player/In-Dash CD Changer

### Condensation phenomenon

Immediately after turning on the heater when the vehicle is cold, the CD or optical components (prism and lens) in the CD player/changer may become clouded with condensation. At this time, the CD will eject immediately when placed in the unit. A clouded CD can be corrected simply by wiping it with a soft cloth. Clouded optical components will clear naturally in about an hour. Wait for normal operation to return before attempting to use the unit.

### Handling the CD player/In-dash CD changer

The following precautions should be observed.

- Do not spill any liquid on the audio system.

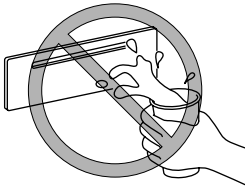

- Do not insert any objects, other than CDs, into the slot.

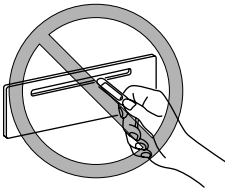

- The CD revolves at high speed within the unit. Defective (cracked or badly bent) CDs should never be used.

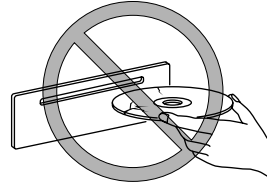

- Do not use non-conventional discs such as heart-shaped, octagonal discs, etc. The CD player/changer could be damaged.

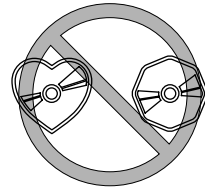

- A new CD may have rough edges on its inner and outer perimeters. If a disc with rough edges is used, proper setting will not be possible and the CD player/changer will not play the CD. Remove the rough edges in advance by using a ball-point pen or pencil as shown below. To remove the rough edges, rub the side of the pen or pencil against the inner and outer perimeter of the CD.

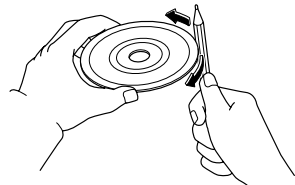

## Audio System

---

- When driving over uneven surfaces, the sound may jump.

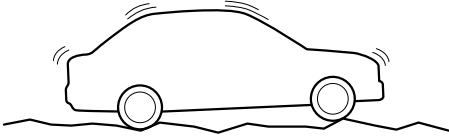

- The CD player/changer has been designed to play CDs bearing the identification logo as shown. No other discs can be played.



- Be sure never to touch the signal surface when handling the CDs. Pick up a CD by grasping the outer edge or the edge of the hole and the outer edge.

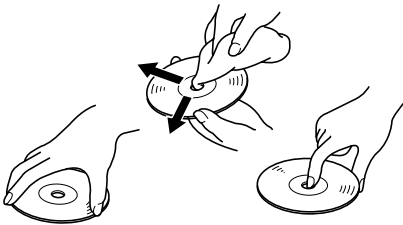

- Do not stick paper or tape on the CD. Avoid scratching the reverse side (the side without a label).
- Dust, finger smudges, and dirt can decrease the amount of light reflected from the signal surface, thus affecting sound quality. If the CD should become soiled, gently wipe it with a soft cloth from the center of the CD to the edge.
- Do not use record sprays, antistatic agents, or household spray cleaners. Volatile chemicals such as benzine and thinner can also damage the surface of the CD and must not be used. Anything that can damage, warp, or fog plastic should never be used to clean CDs.
- CDs, like traditional audio records, are made of plastic. To avoid warping, keep the CDs in their cases and do not store them where they will be exposed to direct sunlight.
- The CD player/changer ejects the CD if the CD is inserted upside down. Also dirty and/or defective CDs may be ejected.
- 8 cm (3 in) CDs and CD accessories (e.g. 8 cm disc adapter) cannot be used in the CD player/changer.
- Do not insert cleaning discs in the CD player/changer.
- Do not insert any disc with a peel-off or seal on it.

**Audio Set**

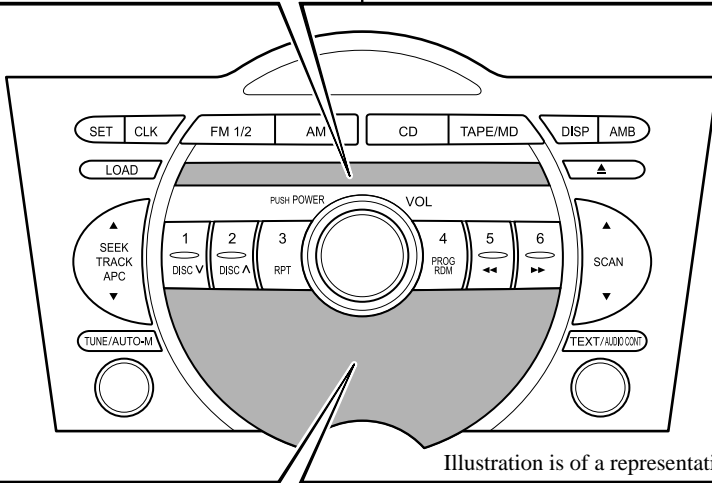
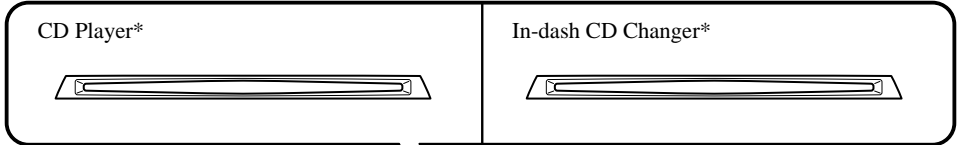
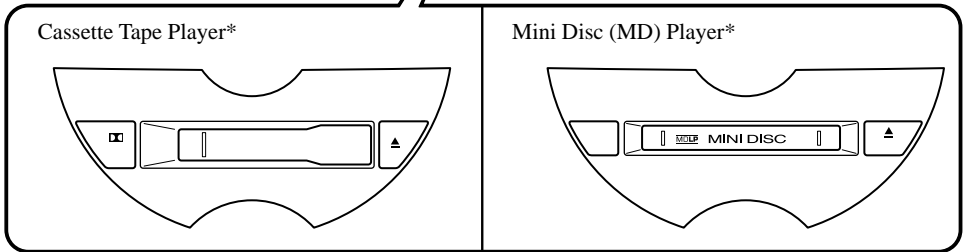

Illustration is of a representative audio unit.



Power/Volume/Sound Controls .....6-18

Operating the Radio .....6-22

Operating the Cassette Tape Player\* .....6-24

Operating the Mini Disc (MD) Player\* .....6-26

Operating the Compact Disc (CD) Player\* .....6-28

Operating the In-Dash CD Changer\* .....6-30

Error Indications .....6-33

# Audio System

## ▼ Power/Volume/Sound Controls

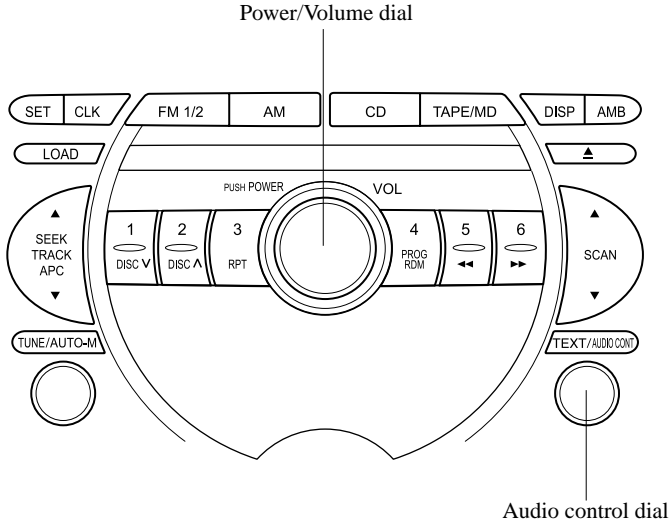

### **Power ON/OFF**

Turn the ignition switch to the ACC or ON position.

Press the power/volume dial to turn the audio system on.

Press the power/volume dial again to turn the audio system off.

#### **NOTE**

To prevent the battery from being discharged, do not leave the audio system on for a long period of time when the engine is not running.

### **Volume adjustment**

To adjust the volume, turn the power/volume dial.

Turn the power/volume dial to the right to increase volume, to the left to decrease it.



**Audio sound adjustment**

1. Press the audio control dial to select the function. The selected function will be indicated.

**Standard audio-equipped model**

TEXT/AUDIO CONT

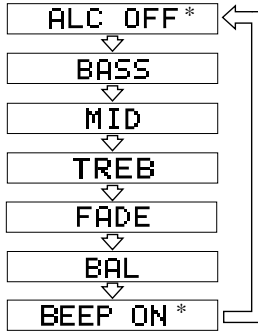
**BOSE Sound System-equipped model**

TEXT/AUDIO CONT

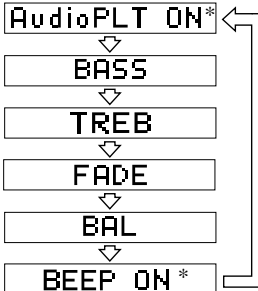

\* Depending on the mode selected, the indication changes.

2. Turn the audio control dial to adjust the selected functions as follows:

**Standard audio-equipped model**

Indication	Turn Left	Turn Right
<b>ALC</b>	Select mode	Select mode
<b>BASS</b>	Decrease bass	Increase bass
<b>MID</b>	Decrease mid-range	Increase mid-range
<b>TREB</b>	Decrease treble	Increase treble
<b>FADE</b>	Shift the sound to the front	Shift the sound to the rear
<b>BAL</b>	Shift the sound to the left	Shift the sound to the right
<b>BEEP</b>	OFF	ON

**BOSE Sound System-equipped model**

Indication	Turn Left	Turn Right
<b>AudioPLT</b>	OFF	ON
<b>BASS</b>	Decrease bass	Increase bass
<b>TREB</b>	Decrease treble	Increase treble
<b>FADE</b>	Shift the sound to the front	Shift the sound to the rear
<b>BAL</b>	Shift the sound to the left	Shift the sound to the right
<b>BEEP</b>	OFF	ON

# Audio System

## NOTE

About 5 seconds after selecting any mode, the volume function will be automatically selected. To reset bass, mid-range, treble, fade, and balance, press the audio control dial for 2 seconds. The unit will beep and "CLEAR" will be displayed.

## Automatic Level Control (ALC)

### (Standard audio-equipped model)

The automatic level control is a feature that automatically adjusts audio volume and sound quality according to the vehicle speed.

The volume increases in accordance with the increase in vehicle speed, and decreases as vehicle speed decreases.

The following four modes are available. Select the desired mode.

Mode	Volume change
ALC OFF	No change
ALC LEVEL 1	Minimum
ALC LEVEL 2	Medium
ALC LEVEL 3	Maximum

Turn the audio control dial to select the ALC OFF, ALC LEVEL1—3 mode. The selected mode will be indicated.

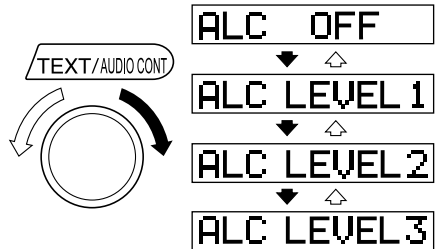

**\*AudioPilot (BOSE Sound System-equipped model)**

AudioPilot automatically adjusts audio volume and sound quality in accordance with the level of noise entering the vehicle interior while driving. When AudioPilot is turned ON, the system automatically calculates the conditions for optimum hearing of sound which may be difficult to hear depending on exterior noise.

\* AudioPilot is a registered trademark of BOSE Corporation.

**BEEP setting**

The beep-sound when operating the audio system can be set on or off.

# Audio System

## ▼ Operating the Radio

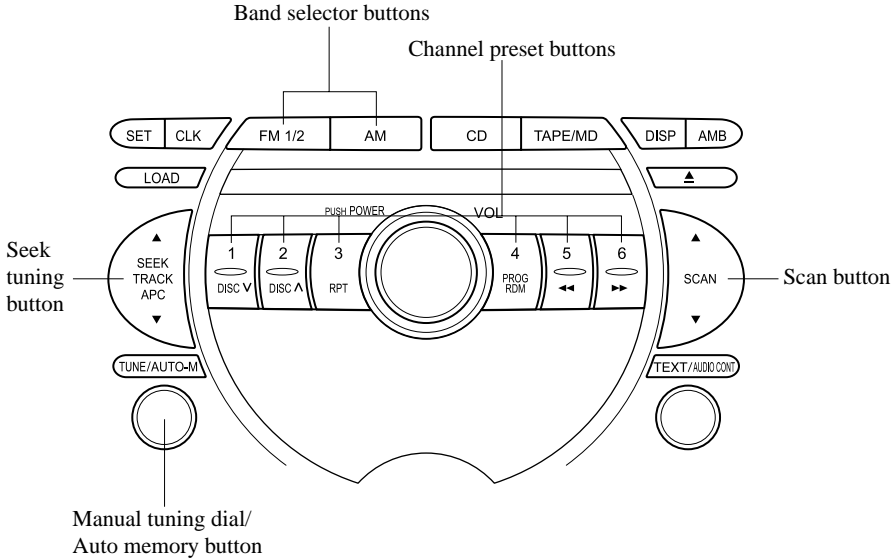

### Radio ON

Press a band selector button (**AM**, **FM1/2**) to turn the radio on.

### Band selection

Choose AM by pressing the AM button (**AM**) and FM by pressing the FM1/2 button (**FM1/2**).

The selected mode will be indicated. If FM stereo is being received, "ST" will be displayed.

#### **NOTE**

If the FM broadcast signal becomes weak, reception automatically changes from STEREO to MONO for reduced noise, and the "ST" indicator will go out.

### Tuning

The radio has the following tuning methods: Manual, Seek, Scan, Preset channel, and Auto memory tuning. The easiest way to tune stations is to set them on preset channels.

#### **NOTE**

If the power supply is interrupted (fuse blows or the battery is disconnected), the preset channels will be canceled.

**Manual tuning**

Turning the manual tuning dial will change the frequency higher or lower.

**Seek tuning**

Pressing the seek tuning button (▲, ▼) will cause the tuner to seek a higher or lower frequency automatically.

**NOTE**

If you continue to press and hold the button, the frequency will continue changing without stopping.

**Scan tuning**

Press the scan button (▲, ▼) to automatically sample strong stations. Scanning stops at each station for about 5 seconds. To hold a station, press the scan button (▲, ▼) again during this interval.

**Preset channel tuning**

The 6 preset channels can be used to store 6 AM and 12 FM stations.

1. To set a channel first select AM, FM1, or FM2. Tune to the desired station.
2. Depress a channel preset button for about 2 seconds until a beep is heard. The preset channel number and station frequency will be displayed. The station is now held in the memory.
3. Repeat this operation for the other stations and bands you want to store. To tune one in the memory, select AM, FM1, or FM2 and then press its channel preset button. The station frequency and the channel number will be displayed.

**NOTE**

If the power supply is interrupted (fuse blows or the battery is disconnected), the preset channels will be canceled.

**Auto memory tuning**

This is especially useful when driving in an area where the local stations are not known. Additional AM/FM stations can be stored without disturbing the previously set channels.

Press and hold the auto memory button (AUTO-M) for about 2 seconds until a beep is heard; the system will automatically scan and temporarily store up to 6 stations with the strongest frequencies in each selected band in that area.

After scanning is completed, the station with the strongest frequency will be tuned and its frequency displayed.

Press and release the auto memory button (AUTO-M) to recall stations from the auto-stored stations. One stored station will be selected each time; its frequency and channel number will be displayed.

**NOTE**

If no stations can be tuned after scanning operations, "A" will be displayed.

# Audio System

## ▼ Operating the Cassette Tape Player\*

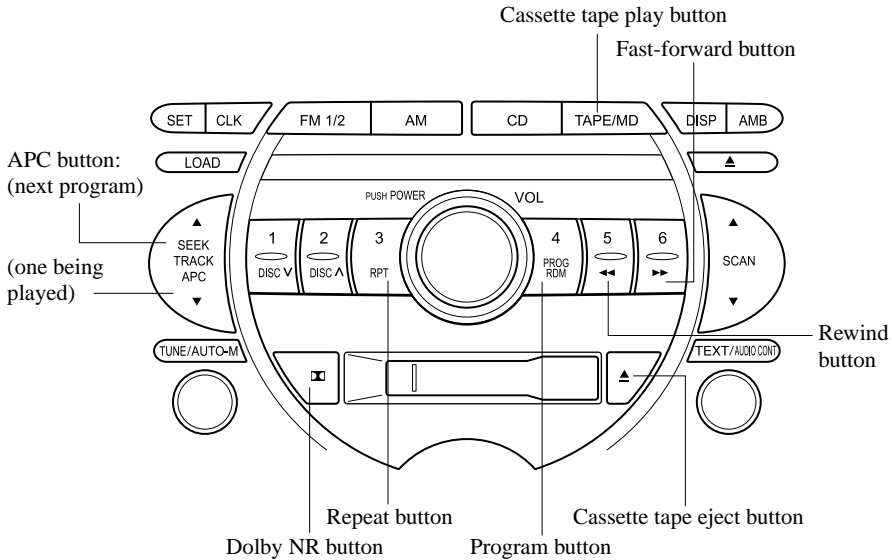

### Cassette tape insert

Insert the cassette tape into the slot, open edge to the right and cassette tape will begin play, and "TAPE PLAY" will be displayed. At the end of the cassette tape, the unit automatically reverses cassette tape play. When ▲ is lit, the cassette tape's top side is playing. When ▼ is lit, the bottom side is on.

### Playing

Press the cassette tape play button ( **TAPE/MD** ) to start play when a cassette tape is in the unit. If there isn't a cassette tape in the unit when the cassette tape play button ( **TAPE/MD** ) is pressed, "NO TAPE" will flash on and off.

### Dolby noise reduction

When using a tape with Dolby NR\*, push the Dolby NR button ( **DR** ). The **DR** symbol will be displayed. To play a tape without Dolby NR, push the button once again.

\* Noise reduction system manufactured under license from Dolby Laboratories Licensing Corporation. Dolby and the double-D symbol **DR** are trademarks of Dolby Laboratories Licensing Corporation.

### Ejecting the cassette tape

Press the cassette tape eject button ( ▲ ) to eject the cassette tape.

## NOTE

The cassette tape can be ejected when the ignition switch is in the OFF position.

### Fast-forward/Rewind

Press the fast-forward button (▶▶) to fast-forward.

Press the rewind button (◀◀) to rewind.

To stop this operation and play the cassette tape, press the button again.

## NOTE

When the cassette tape ends during fast-forward or rewind, it automatically stops and starts playing.

### Reversing

Press the program button (PROG) to change cassette tape-play direction.

## NOTE

When the cassette tape ends, the unit automatically reverses play.

### Automatic program control (APC)

APC is used to find the beginning of either the next program or the one being played.

Press the APC button (▲) to the beginning of the next selection.

Press the APC button (▼) to the beginning of the one being played. To stop this operation and play the cassette tape, press the button again.

## NOTE

APC may not operate properly if:

- A tape was recorded at a low level.
- A tape has long, silent intervals.
- A tape is a live recording.
- A tape has very short intervals of less than 3 seconds.

### Repeat play

This operation makes it possible to listen to a selection repeatedly.

Press the repeat button (RPT) during play.

The current selection playing will be repeated ("RPT" will be displayed).

Press the repeat button (RPT) once again to cancel repeat play.

## NOTE

RPT may not operate properly if:

- A tape was recorded at a low level.
- A tape has long, silent intervals.
- A tape is a live recording.
- A tape has very short intervals of less than 3 seconds.

# Audio System

## ▼ Operating the Mini Disc (MD) Player\*

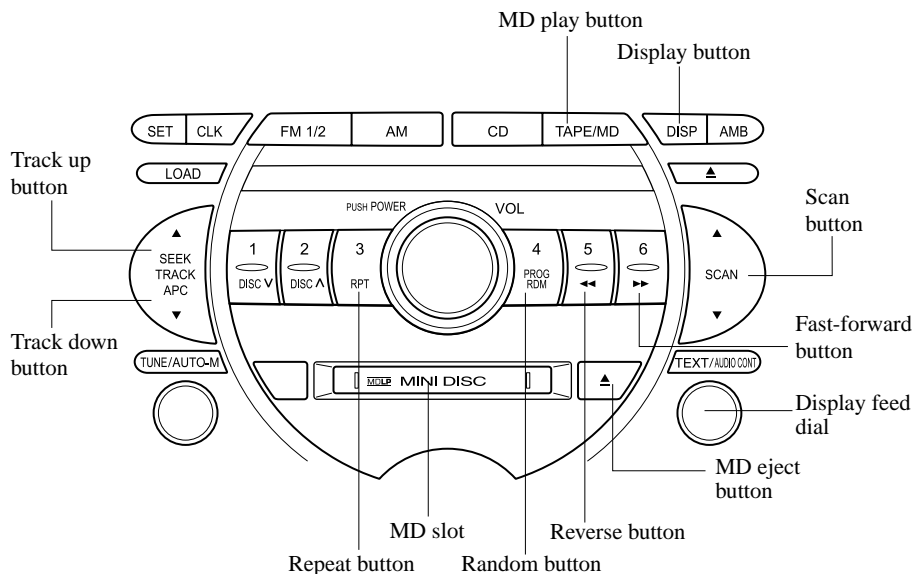

### Inserting the MD

Insert the MD, label-side up with the arrow pointed to the slot. The auto-loading mechanism will set the MD and begin play. There will be a short lapse before play begins while the player reads the digital signals on the MD.

### Playing

Press the MD play button ( **TAPE/MD** ) to start play when a MD is in the unit.

If there isn't a MD in the unit when the MD play button ( **TAPE/MD** ) is pressed, "NO DISC" will flash on and off.

### Ejecting the MD

Press the MD eject button ( **▲** ) to eject the MD.

### Fast-forward/Reverse

Press and hold the fast-forward button ( **▶▶** ) to advance through a track at high speed.

Press and hold the reverse button ( **◀◀** ) to reverse through a track at high speed.

### Track search

Press the track up button ( **▲** ) once to skip forward to the beginning of the next track. Press the track down button ( **▼** ) once to skip back to the beginning of the current track.



**Music scan**

This feature helps to find a program by playing about the first 10 seconds of each track.

Press the scan button (**▲**, **▼**) during play to start scan play operation (the track number will flash).

Press the scan button (**▲**, **▼**) once again to cancel scan play.

**NOTE**

If the unit is left in scan, normal play will resume where scan was selected.

**Repeat play**

This feature makes it possible to listen to a selection repeatedly.

Press the repeat button (**RPT**) during play. The current selection will be repeated ("RPT" will be displayed).

Press the repeat button (**RPT**) once again to cancel repeat play.

**Random play**

This feature allows the MD player to randomly select the order of the songs.

Press the random button (**RDM**) during play. The next selection will be randomly selected ("RDM" will be displayed).

Press the random button (**RDM**) once again to cancel random play.

**Changing the display**

To change the display during MD play, press the display button (**DISP**) to advance through each of the following displays:

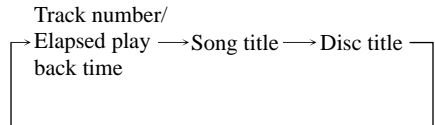
**NOTE**

If there is no song or disc title recorded on the MD, "NO TITLE" will be displayed.

**Long disc or song titles**

When long disc or song titles cannot be completely displayed, rotate the display feed dial (**TEXT**) to the right.

The remainder of the title will proceed and appear on the display to the end of the title.

# Audio System

## ▼ Operating the Compact Disc (CD) Player\*

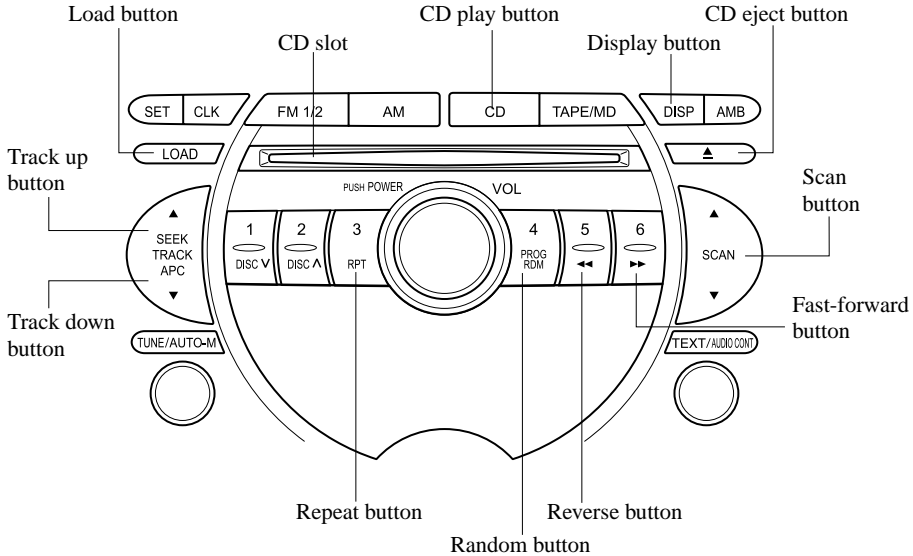

### Inserting the CD

Insert the CD into the slot, label-side up. The auto-loading mechanism will set the CD and begin play. There will be a short lapse before play begins while the player reads the digital signals on the CD.

### Playing

Press the CD play button (**CD**) to start play when a CD is in the unit. If there isn't a CD in the unit when the CD play button (**CD**) is pressed, "NO DISC" will flash on and off.

#### NOTE

When the load button (**LOAD**) is pressed, the CD will load and play even if the CD eject button (**▲**) had been previously pressed.

### Ejecting the CD

Press the CD eject button (**▲**) to eject the CD.

### Fast-forward/Reverse

Press and hold the fast-forward button (**▶▶**) to advance through a track at high speed.

Press and hold the reverse button (**◀◀**) to reverse through a track at high speed.

### Track search

Press the track up button (**▲**) once to skip forward to the beginning of the next track. Press the track down button (**▼**) once to skip back to the beginning of the current track.

**Music scan**

This feature helps to find a program by playing about the first 10 seconds of each track.

Press the scan button (▲, ▼) during play to start scan play operation (the track number will flash).

Press the scan button (▲, ▼) once again to cancel scan play.

**NOTE**

If the unit is left in scan, normal play will resume where scan was selected.

**Repeat play**

This feature makes it possible to listen to a selection repeatedly.

Press the repeat button (**RPT**) during play. The current selection will be repeated ("RPT" will be displayed).

Press the repeat button (**RPT**) once again to cancel repeat play.

**Random play**

This feature allows the CD player to randomly select the order of the songs.

Press the random button (**RDM**) during play. The next selection will be randomly selected ("RDM" will be displayed).

Press the random button (**RDM**) once again to cancel random play.

# Audio System

## ▼ Operating the In-Dash CD Changer\*

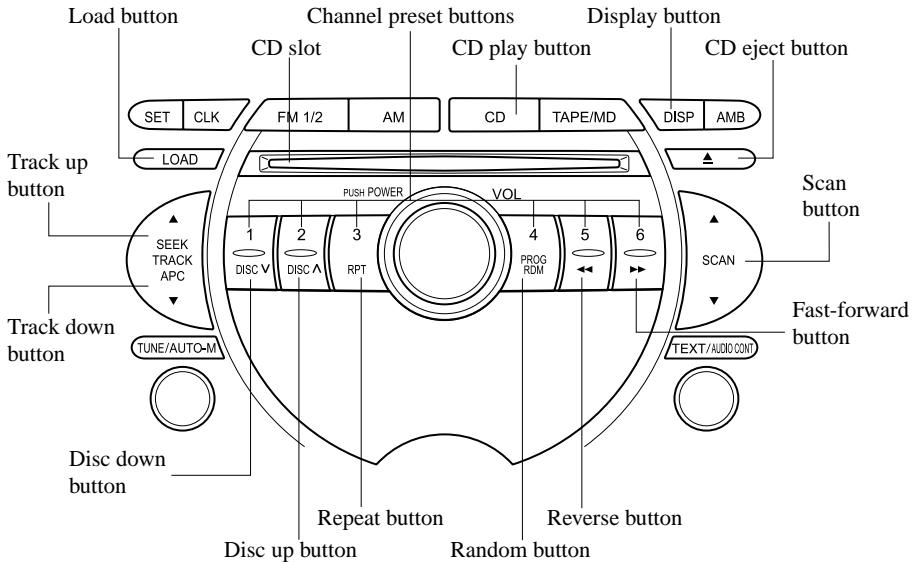

### Inserting the CD

The CD must be label-side up when inserting. The auto-loading mechanism will set the CD and begin play. There will be a short lapse before play begins while the player reads the digital signals on the CD.

The disc number and the track number will be displayed.

#### **NOTE**

A CD cannot be inserted while the display reads "WAIT". A beeping sound can be heard during this waiting time. Simultaneously pressing the power/volume dial and the load button (LOAD) for about 2 seconds will turn this beeping sound ON or OFF.

### **Normal insertion**

1. Press the load button (LOAD).
2. When "IN" is displayed, insert the CD.

### **Inserting CDs into desired tray number**

1. Press and hold the load button (LOAD) for about 2 seconds until a beep is heard.
2. Press the channel preset button for the desired tray number within 3 seconds after the beep is heard.
3. When "IN" is displayed, insert the CD.

#### **NOTE**

The CD cannot be inserted to the desired tray number if the number is already occupied.

**Multiple insertion**

1. Press and hold the load button ( **LOAD** ) for about 2 seconds until a beep is heard.
2. Wait 3 seconds or press the load button ( **LOAD** ) again within 3 seconds after the beep is heard.
3. When "IN" is displayed, insert the CD.
4. When "IN" is displayed again, insert the next CD.

**NOTE**

The first-inserted CD will be played automatically when:

- No other CD is inserted within 15 seconds after "IN" is displayed.
- The CD trays are full.

**Displaying the CD-inserted tray number**

When you want to know the number for a CD-inserted tray, press the display button ( **DISP** ). The tray number will be displayed for 5 seconds.

**Ejecting the CD****Normal ejection**

1. Press the CD eject button ( **▲** ). The disc number and "DISC" "OUT" will be displayed.
2. Pull out the CD.

**NOTE**

When the CD is ejected during play, the next CD will be played automatically.

**Ejecting CDs from desired tray number**

1. Press and hold the CD eject button ( **▲** ) for about 2 seconds until a beep is heard.
2. Press the channel preset button for the desired CD number within 3 seconds after the beep is heard.
3. Pull out the CD.

**Multiple ejection**

1. Press and hold the CD eject button ( **▲** ) for about 2 seconds until a beep is heard.
2. Wait 3 seconds or press the CD eject button ( **▲** ) again within 3 seconds after the beep is heard.
3. Pull out the CD, then the next CD will be ejected.

**NOTE**

- CDs will be ejected starting with the one with the lowest number.
- All CDs in the tray will be ejected continuously.
- CDs can be ejected when the ignition switch is off. Press and hold the CD eject button ( **▲** ) for about 2 seconds and all CDs will eject.

**Playing**

Press the CD play button ( **CD** ) to start play when a CD is in the unit.

If there isn't a CD in the unit when the CD play button ( **CD** ) is pressed, "NO DISC" will flash on and off.

# Audio System

---

## **Fast-forward/Reverse**

Press and hold the fast-forward button (▶▶) to advance through a track at high speed.

Press and hold the reverse button (◀◀) to reverse through a track at high speed.

## **Track search**

Press the track up button (▲) once to skip forward to the beginning of the next track. Press the track down button (▼) once to skip back to the beginning of the current track.

## **Disc search**

Press the disc up button (DISC▲) to skip forward to the beginning of the next CD. Press the disc down button (DISC▼) to skip back to the beginning of the previous CD.

## **Music scan**

This feature helps to find a program by playing about the first 10 seconds of each track.

Press the scan button (▲, ▼) during play to start scan play operation (the track number will flash).

Press the scan button (▲, ▼) once again to cancel scan play.

<b>NOTE</b>
If the unit is left in scan, normal play will resume where scan was selected.

## **Repeat play**

This feature makes it possible to listen to a selection repeatedly.

Press the repeat button (RPT) during play. The current selection will be repeated ("RPT" will be displayed).

Press the repeat button (RPT) once again to cancel repeat play.

## **Random play**

This feature allows the CD player to randomly select the order of the songs.

Press the random button (RDM) during play. The next selection will be randomly selected ("RDM" will be displayed).

Press the random button (RDM) once again to cancel random play.

**▼ Error Indications**

If you see an error indication on the display, find the cause in the chart. If you cannot clear the error indication, take the vehicle to an Authorized Mazda Dealer.

Indication	Cause	Solution
CHECK MD	MD is inserted upside down	Insert the MD properly. If the error indication does not disappear, consult an Authorized Mazda Dealer
CHECK MD	MD is defective	Insert another MD properly. If the error indication does not disappear, consult an Authorized Mazda Dealer
CHECK CD	CD is inserted upside down	Insert the CD properly. If the error indication does not disappear, consult an Authorized Mazda Dealer
CHECK CD	CD is defective	Insert another CD properly. If the error indication does not disappear, consult an Authorized Mazda Dealer

# Audio System

## Audio Control Switch Operation

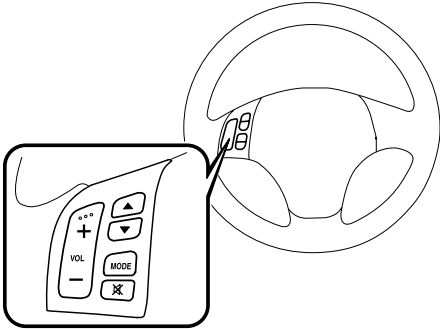

**NOTE**

Mazda installed this system to help you avoid being too distracted using audio controls on the dashboard. Always make safe driving your first priority.

### ▼ Adjusting the Volume

To increase the volume, press volume button (+).

To decrease the volume, press volume button (-).

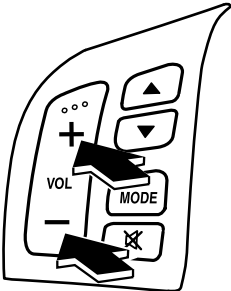

### ▼ Changing the Source

Press the mode switch (MODE) to change the audio source (FM1 radio>FM2 radio>AM radio>CD player or CD changer>Cassette tape player or MD player>cyclical).

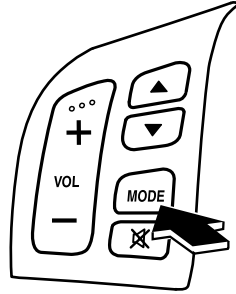

**NOTE**

Cassette tape, MD, CD and CD changer modes cannot be selected in the following cases:

- A cassette deck, MD, CD, or CD changer is not equipped on the audio system.
- A cassette tape, MD or CD has not been inserted.

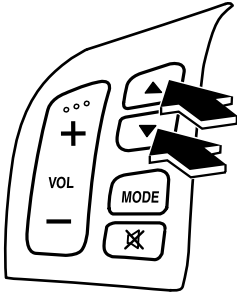

**▼ Seek Switch****When listening to the radio**

Press the seek switch (▲, ▼), the radio switches to the next/previous stored station in the order that it was stored (1—6).

Press the seek switch (▲, ▼) for about 2 seconds until a beep is heard to seek a higher or lower frequency automatically.

**When playing a cassette tape**

Press the seek switch (▲), release, and it will advance to the next selection.

Press the seek switch (▼), release, and it will repeat the selection being played.

**When playing a CD or MD**

Press the seek switch (▲) to skip to the next track.

Press the seek switch (▼) to repeat the current track.

**▼ Mute Switch**

Press the mute switch (⌘) once to mute audio, press it again to resume audio output.

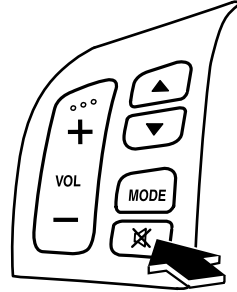

## Audio System

---

### Safety Certification

This CD player is made and tested to meet exacting safety standards. It meets FCC requirements and complies with safety performance standards of the U.S. Department of Health and Human Services.

#### CAUTION

- This CD player should not be adjusted or repaired by anyone except qualified service personnel.  
If servicing is required, contact an Authorized Mazda Dealer.
- Use of controls or adjustments or performance of procedures other than those specified herein may result in hazardous laser exposure. Never operate the CD player with the top case of the unit removed.
- Changes or modifications not expressly approved by the party responsible for compliance could void the user's authority to operate this equipment.

#### NOTE

For CD player section:

This device complies with part 15 of the FCC Rules. Operation is subject to the following two conditions: (1) This device may not cause harmful interference, and (2) this device must accept any interference received, including interference that may cause undesired operation.

#### NOTE

This equipment has been tested and found to comply with the limits for a Class B digital device, pursuant to part 15 of the FCC Rules. These limits are designed to provide reasonable protection against harmful interference in a residential installation. This equipment generates, uses, and can radiate radio frequency energy and, if not installed and used in accordance with the instructions, may cause harmful interference to radio communications. However, there is no guarantee that interference will not occur in a particular installation.

## Sunvisors

When you need a sunvisor, lower it for use in front or swing it to the side.

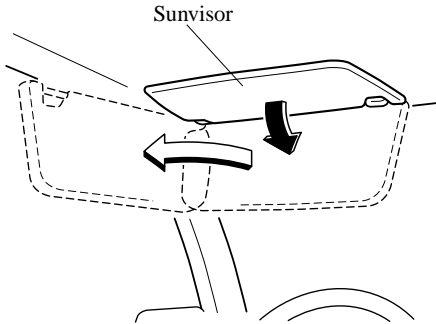

## ▼ Vanity Mirrors

To use the vanity mirror, lower the sunvisor.

The vanity mirror light will illuminate when you open the cover.

## Interior Lights

### ▼ Illuminated Entry System

When the illuminated entry system operates, the overhead light (switch is in the DOOR position) and the courtesy lights turn on for:

- About 30 seconds after the driver's door is unlocked and the ignition key is removed.
- About 15 seconds after all doors are closed.
- About 15 seconds after the key is removed from the ignition with all doors closed.

The light also turns off when:

- The ignition switch is turned to the ON position and all doors are closed.
- The driver's door is locked.

### NOTE

If any door is left opened, the light goes out after about 5 minutes. The light turns on again when the ignition switch is turned to the ON position, or when any door is opened after all doors have been closed.

# Interior Equipment

## ▼ Overhead Lights

### Front

With sunroof

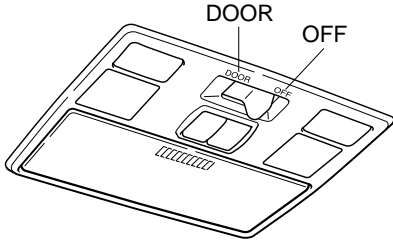

Without sunroof

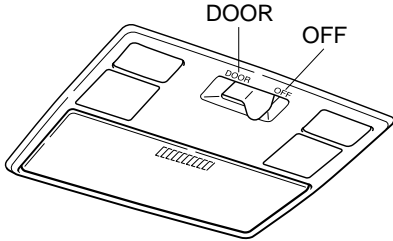

OFF	Light off
DOOR	<ul style="list-style-type: none"> <li>• Light on when any door is open</li> <li>• Light on or off when the illuminated entry system is on</li> </ul>

### Rear

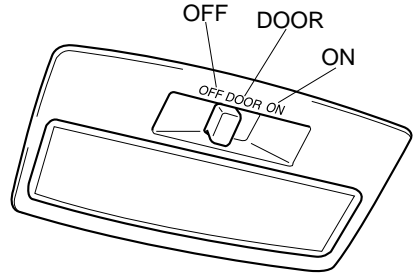

OFF	Light off
DOOR	<ul style="list-style-type: none"> <li>• Light on when any door is open</li> <li>• Light on or off when the illuminated entry system is on</li> </ul>
ON	Light on

**▼ Map Lights**

The map lights are switched on or off by pressing the switches.

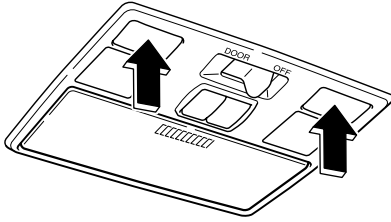
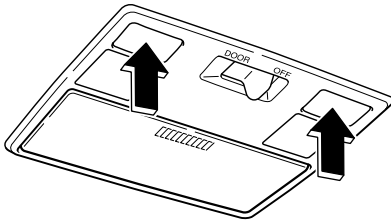
**With sunroof****Without sunroof****▼ Courtesy Lights**

Turns on when any door is open or the illuminated entry system is on.

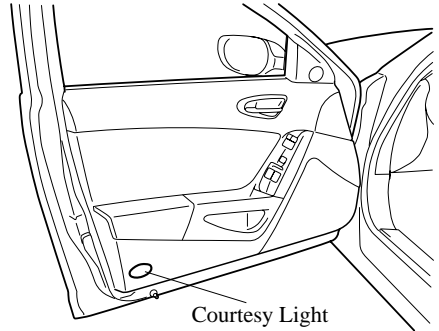

# Interior Equipment

## Information Display

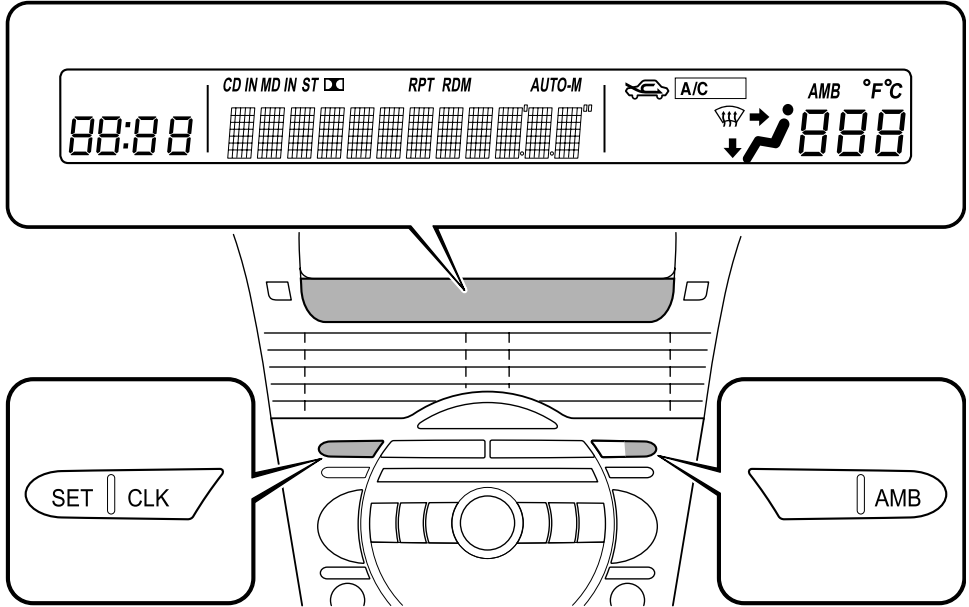

### ▼ Information Display Functions

The information display has the following functions:

- Clock
- Ambient Temperature Display (Outside Temperature Display)
- Climate Control Display
- Audio Display

### ▼ Clock

When the ignition switch is in the ACC or ON position, the time is displayed.



### Time setting

1. Press the CLK button until a beep sounds, and "12Hr" and "24Hr" will be displayed.
2. Press the SET button to switch between "12Hr" and "24Hr" displays. The selected display will flash. To select the desired clock setting, press the CLK button again while the preferred setting is flashing.
3. "Hr. ADJUST" will be displayed next, and the hour portion of the display will flash. Press the SET button to set the hour, then press the CLK button.
4. "Min. ADJUST" will be displayed next, and the minutes portion of the display will flash. Press the SET button to set the minutes, then press the CLK button.

### Time resetting

While the clock is displayed, press the SET button 1.5 seconds or more. When the button is released, a beep will sound and the clock will be reset as follows:

(Example)

12:01—12:29→12:00

12:30—12:59→1:00

#### NOTE

When the SET button is released, the seconds are reset to "00".

### ▼ Ambient Temperature Display

When the ignition switch is in the ON position, press the AMB button to display the ambient temperature.

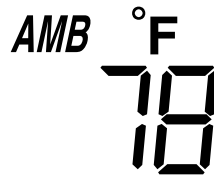

#### NOTE

- The displayed ambient temperature may vary from the actual ambient temperature depending on the surrounding area and vehicle conditions.
- Press the AMB button 2 seconds or more to switch the display from Fahrenheit to Centigrade or vice versa.

## Interior Equipment

---

### ▼ Climate Control Display

The climate control system status is displayed. To operate the climate control system, refer to "Climate Control System" (page 6-2).

### ▼ Audio Display

The audio system status is displayed. To operate the audio system, refer to "Audio System" (page 6-10).

### Lighter

The ignition switch must be in the ACC or ON position.

1. Open the cover.

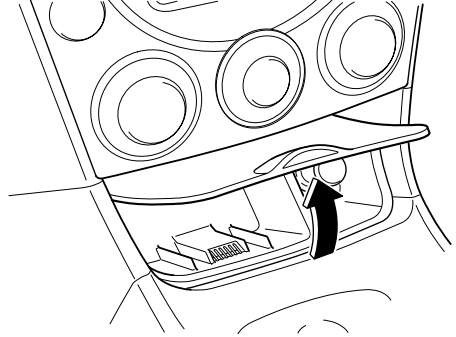

2. Press the lighter in and release it. When ready for use, it automatically pops out.

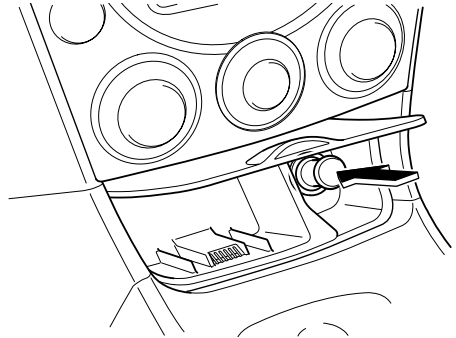



**⚠ CAUTION**

- Don't touch the metal part of the lighter, you may burn yourself.
- Don't hold the lighter in because it will overheat.
- Don't use the lighter socket for plug-in accessories such as shavers and coffee pots. They may damage it or cause electrical failure. Use only a genuine Mazda lighter or the equivalent.
- If the lighter doesn't pop out within 30 seconds, remove it to prevent overheating.

**Ashtray****⚠ CAUTION**

Don't use the ashtray for trash. You might start a fire.

To use, open the cover.

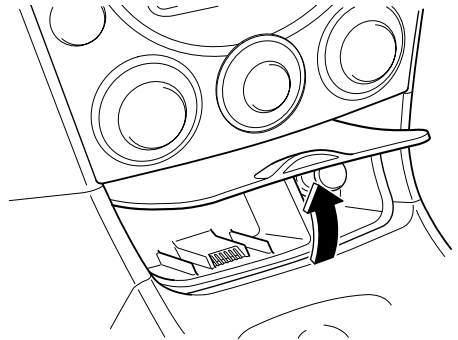

To remove, open the cover and pull up the ashtray.

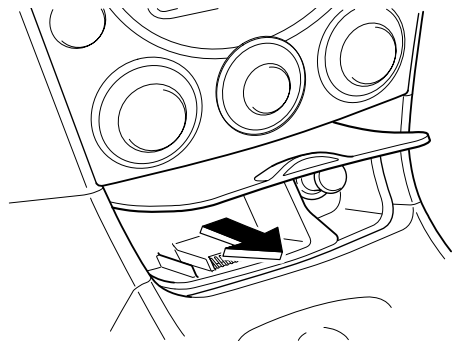

# Interior Equipment

## Cup Holder

### **⚠ WARNING**

#### Using Cup Holder:

*Using a cup holder to hold hot liquids while the vehicle is moving is dangerous. If the contents spill, you could be scalded. Never use a cup holder to hold hot liquids while the vehicle is moving.*

#### Don't Put Anything Other Than Cups or Drink cans in Cup Holder:

*Putting objects other than cups or drink cans in a cup holder is dangerous.*

*During sudden braking or maneuvering, occupants could be hit and injured, or objects could be thrown around the vehicle, causing interference with the driver and the possibility of an accident. Only use a cup holder for cups or drink cans.*

### **⚠ CAUTION**

To reduce the possibility of injury in an accident or a sudden stop, keep cup holders closed when not in use.

### ▼ Front

To use, slide the lid while pushing the button until you hear a click sound.

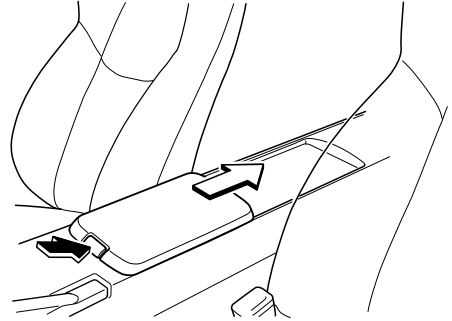

### **⚠ CAUTION**

Do not use a cup holder with the lid unlocked. During sudden braking or maneuvering, the lid could slide forward causing the cup contents to spill.

### ▼ Rear

To use, pull the lid up.

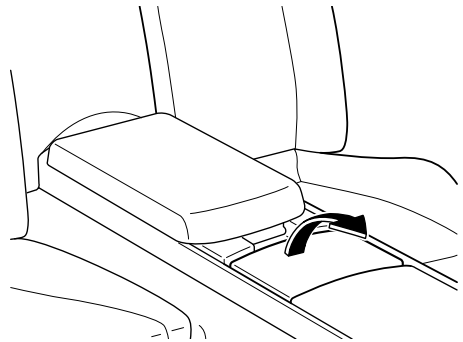

## Storage Compartments

### ⚠ WARNING

***Open Storage Boxes:***  
*Driving with the storage boxes open is dangerous. To reduce the possibility of injury in an accident or a sudden stop, keep the storage boxes closed when driving.*

### ⚠ CAUTION

Don't leave eyeglasses or lighters in the storage boxes while parked under the sun. A lighter could explode or the plastic material in eyeglasses could deform and crack from high temperature.

### ▼ Overhead Console

This console box is designed to store accessories. Push and release to open.

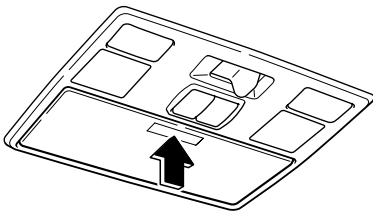

### ▼ Coin Box

To open, press the release catch down and pull the lid downward.

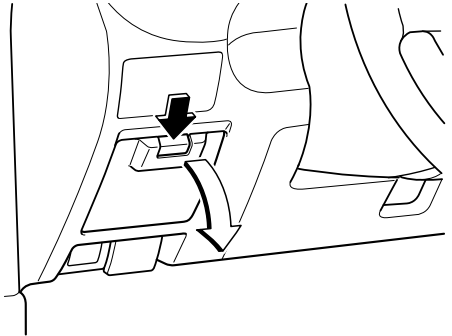

### ▼ Glove Box

To open the glove box, pull the latch toward you. Insert the master key and turn it clockwise to lock, counterclockwise to unlock.

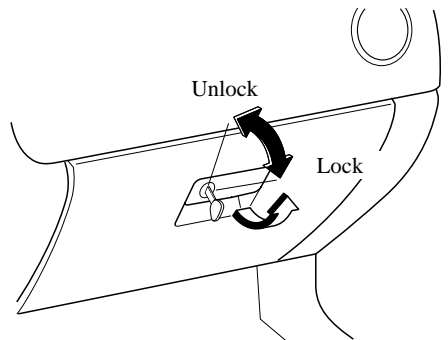

# Interior Equipment

## ▼ Center Console

### Front

1. Slide the lid while pushing the button until you hear a click sound.

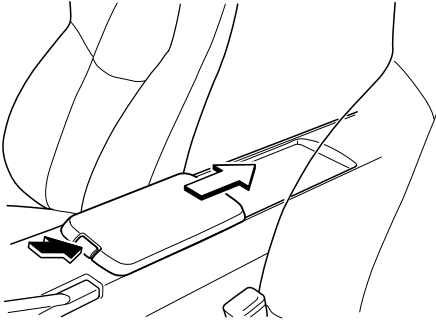

2. Open the lid.

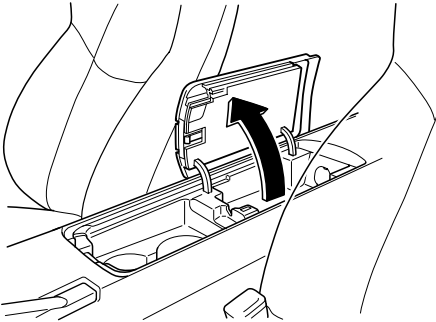

### Rear

To open, pull the release catch.

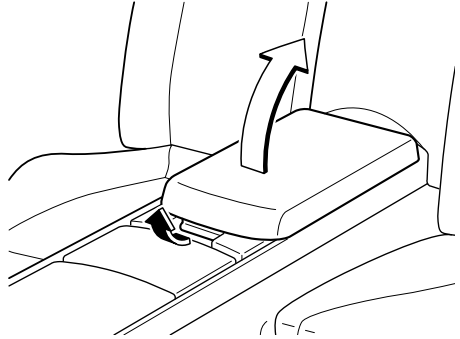

### ⚠ CAUTION

Do not place bottles filled with fluid (e.g. cosmetic fragrance) in the console box. If the fluid leaks, it could damage the navigation system or the electrical wiring, or both.

## ▼ Storage Box

The storage box is designed to store accessories.

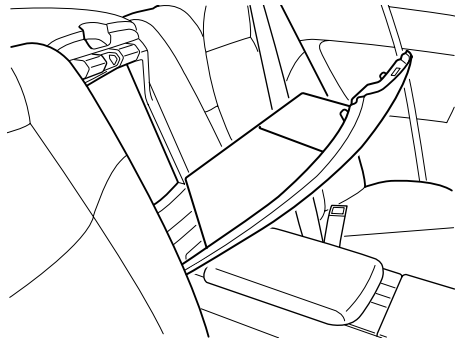

## Interior Equipment

To open, squeeze the latch and pull the lid down.

When closing the storage box, put the storage box back in its original position until you hear a click sound.

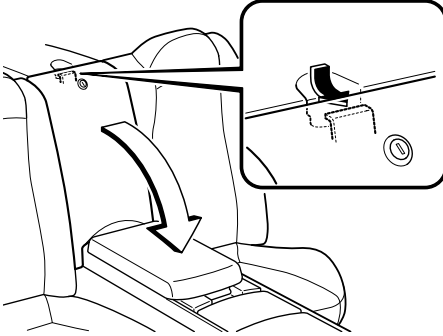

### NOTE

When using the storage box to store heavy accessories, remove the storage box before placing or removing the accessories.

Insert the master key and turn it clockwise to lock, counterclockwise to unlock.

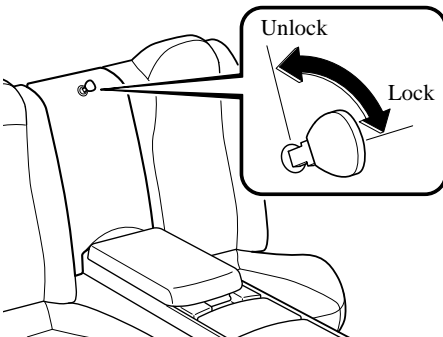

### Loading long objects with storage box removed

The storage box can be removed for convenient loading of long objects such as skis placed through the trunk.

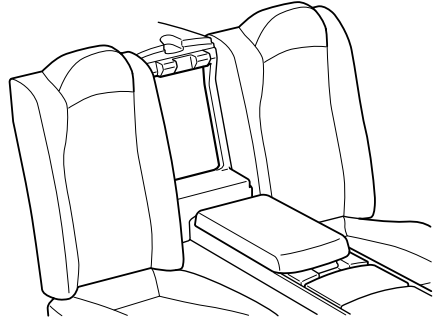

### **⚠ WARNING**

**Loading Long Objects Through Removed Storage Box Area:**  
Sudden braking or maneuvering while long objects are loaded through the removed storage box area and into the trunk is dangerous. Operation of the shift/selector lever could be obstructed resulting in a serious accident. Secure long objects in the trunk so that they cannot be thrown forward in the cabin and avoid sudden braking or maneuvering.

## Interior Equipment

### Accessory Socket

The ignition switch must be in the ACC or ON position.

Only use genuine Mazda accessories or the equivalent requiring no greater than 120 W (DC12 V, 10 A).

The accessory socket is in the center console.

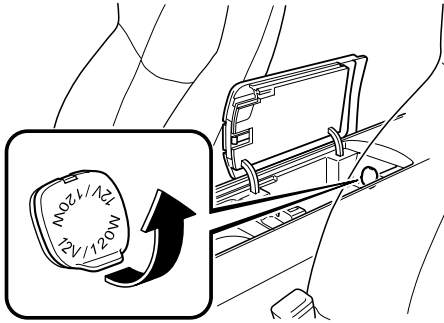

### CAUTION

To prevent accessory socket damage or electrical failure, pay attention to the following:

- Don't use accessories that require more than 120 W (DC12 V, 10 A).
- Don't use accessories that are not genuine Mazda accessories or the equivalent.
- Close the cover when the accessory socket is not in use.
- Correctly insert the plug into the accessory socket.

### NOTE

To prevent discharging the battery, don't use the socket for long periods with the engine off or idling.

Helpful information on what to do in an emergency.

<b>Parking in an Emergency</b> .....	7-2
Parking in an Emergency .....	7-2
<b>Flat Tire</b> .....	7-3
Spare Tire and Tool Storage .....	7-3
Instant Mobility System (IMS) Emergency Flat Tire Repair Kit .....	7-5
Changing the Tire .....	7-13
<b>Overheating</b> .....	7-18
Overheating .....	7-18
<b>Emergency Starting</b> .....	7-20
Starting a Flooded Engine .....	7-20
Jump-Starting .....	7-21
Push-Starting .....	7-24
<b>Emergency Towing</b> .....	7-25
Towing Description .....	7-25
Tiedown Hooks .....	7-26
Recreational Towing .....	7-28

## Parking in an Emergency

---

### Parking in an Emergency

The hazard warning lights should always be used when you stop on or near a roadway.

The hazard warning lights warn other drivers that your vehicle is a traffic hazard and that they must take extreme caution when near it.

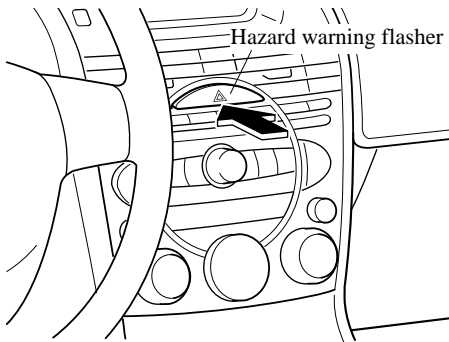

Depress the hazard warning flasher and all four turn signals will flash.

#### NOTE

- The turn signals don't work when the hazard warning lights are on.
- Check local regulations about the use of hazard warning lights while the vehicle is being towed. They may forbid it.



## Spare Tire and Tool Storage

Tools are stored in the locations illustrated in the diagram.

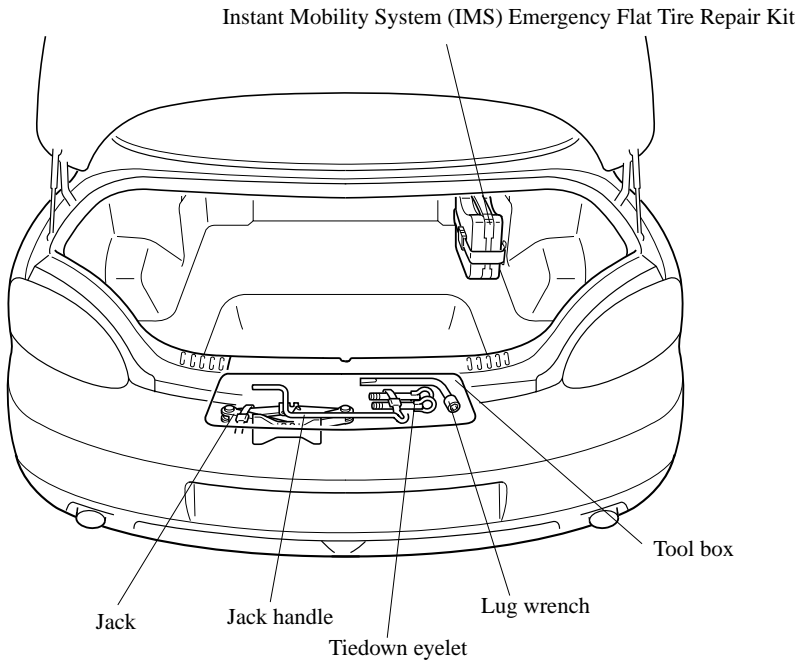

# Flat Tire

## ▼ Jack

### To remove the jack

1. Open the tool box.

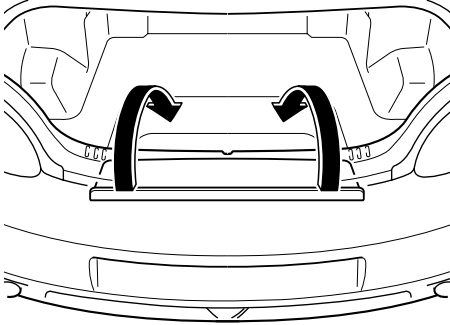

2. Turn the jack screw counterclockwise.

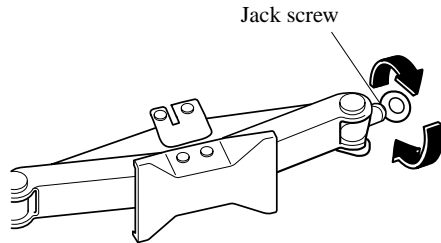

### To secure the jack

Perform the removal procedure in reverse.

## ▼ Spare Tire

A temporary spare tire is not equipped with your Mazda. If an emergency tire repair is needed, repair the flat tire with the emergency flat tire repair kit (page 7-5). If you require a temporary spare tire, consult an Authorized Mazda Dealer. When installing a temporary spare tire, follow the manufacturer's instructions for the temporary spare tire.

The temporary spare tire is lighter and smaller than a conventional tire, and is designed only for emergency use and should be used only for VERY short periods. Temporary spares should NEVER be used for long drives or extended periods.

## **WARNING**

### *Driving with a Temporary Spare Tire on Ice or Snow:*

*Driving with a spare tire on the rear (driving) wheels on ice or snow is dangerous. Handling will be affected. You could lose control of the vehicle and have an accident. Put the spare tire on the front axle and move a regular tire to the rear.*

**⚠ CAUTION**

To avoid damage to the temporary spare or to the vehicle, observe the following precautions:

- Don't exceed 80 km/h (50 mph).
- Avoid driving over obstacles. Also, don't drive through an automatic car wash. This tire's diameter is smaller than a conventional tire's, so the ground clearance is reduced about 25 mm (1 in).
- Don't use a tire chain on this tire because it won't fit properly.
- Don't use your temporary spare on any other vehicle; it has been designed only for your Mazda.
- Use only one temporary spare tire on your vehicle at the same time.

**(With limited slip differential)**

When using the temporary spare tire on the rear axle, replace it with a standard tire as soon as possible. The size difference between the spare and the standard tire will cause the limited slip differential to malfunction.

**NOTE****(With Tire Pressure Monitoring System)**

A tire pressure sensor is not installed to the temporary spare tire. The warning light will flash continuously while the temporary spare tire is being used (page 5-25).

**Instant Mobility System (IMS) Emergency Flat Tire Repair Kit**

The IMS emergency flat tire repair kit included with your Mazda is for a temporary repair of a slightly damaged flat tire resulting from running over nails or similar sharp objects on the road surface.

**NOTE**

Your vehicle is not equipped with a spare tire. In the event of a flat tire, use the emergency flat tire repair kit to repair the tire temporarily. When doing the repair, refer to the instructions included in the emergency flat tire repair kit. After temporarily repairing a tire with the emergency flat tire repair kit, take your vehicle to an Authorized Mazda Dealer to have the tire replaced.

# Flat Tire

## ▼ About the IMS Emergency Flat Tire Repair Kit

The IMS emergency flat tire repair kit includes the following items.

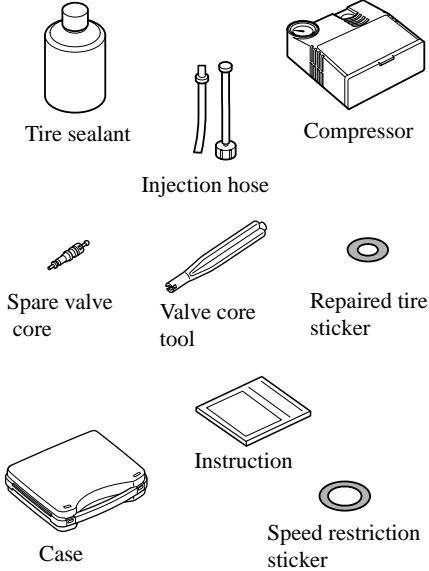

### **WARNING**

**Ingestion of Tire Sealant:**  
*Ingestion of tire sealant is dangerous. In the event tire sealant is accidentally swallowed, drink large amounts of water immediately and seek medical assistance. Do not allow children to touch the tire sealant.*

**Tire Sealant Contacting Eyes and Skin:**  
*Tire sealant that comes into contact with the eyes and skin is dangerous. If tire sealant enters the eyes or contacts the skin, flush immediately with large amounts of water and seek medical assistance. Do not allow children to touch the tire sealant.*

**NOTE**

- The tire sealant cannot be reused. Purchase new tire sealant at an Authorized Mazda Dealer.
- The emergency flat tire repair kit cannot be used in the following cases. Consult an Authorized Mazda Dealer.
  - The period of effective use for the tire sealant has expired. (The period of effectiveness is indicated on the bottle label.)
  - The tear or puncture exceeds about 4 mm (0.16 in).
  - The damage has occurred to an area of the tire other than the tread.
  - The vehicle has been driven with nearly no air remaining in the tire.
  - The tire has come off the wheel rim.
  - Damage to the wheel rim has occurred.
  - The tire has two or more punctures.

### ▼ Using the IMS Emergency Flat Tire Repair Kit

1. Park on a level surface off the right-of-way and set the parking brake.
2. Put a vehicle with an automatic transmission in Park (P), a manual transmission in Reverse (R) or 1, and turn off the engine.
3. Turn on the hazard warning flasher.

4. Unload passengers and luggage, and remove the emergency flat tire repair kit.

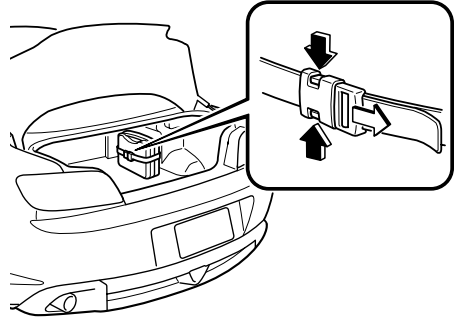

5. Shake the tire sealant well.

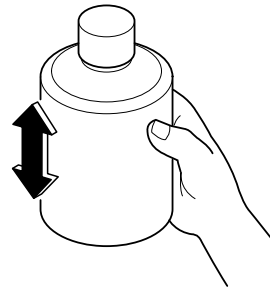

### **⚠ CAUTION**

If the bottle is shaken after the injection hose is screwed on, tire sealant could spray out from the injection hose. Tire sealant contacting clothing or other objects may be impossible to remove. Shake the bottle before screwing on the injection hose.

# Flat Tire

## NOTE

The tire sealant can be used at outside temperatures down to  $-30^{\circ}\text{C}$ . In extremely cold temperatures ( $0^{\circ}\text{C}$  ( $32^{\circ}\text{F}$ ) or below), the tire sealant hardens easily and injection of the sealant will be difficult. Warm the sealant inside the vehicle before doing the injection work.

6. Remove the cap from the bottle. Screw on the injection hose with the bottle's inner cap left on to break the inner cap.

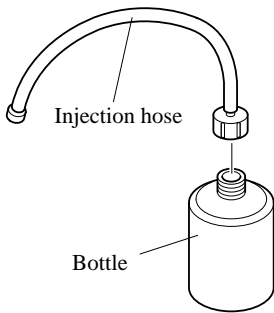

7. Remove the valve cap from the flat tire. Press the back of a valve core tool to the core of the tire valve and bleed all the remaining air.

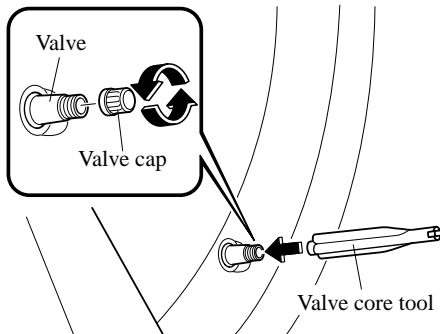

## ⚠ CAUTION

If there is air remaining in the tire when the valve core is removed, the valve core could fly out. Remove the valve core carefully.

8. Turn the valve core counterclockwise with the valve core tool and remove the valve core.

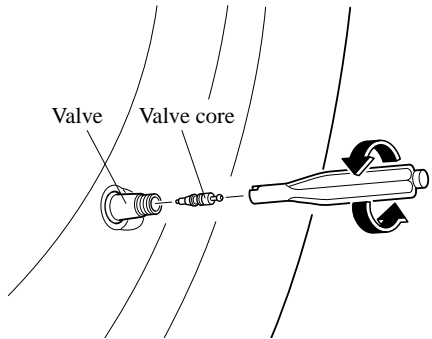

## NOTE

Store the valve core in a place where it won't get dirty.

9. Remove the plug from the injection hose and insert the injection hose into the valve.

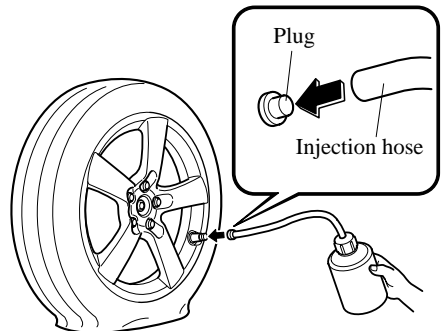

# Flat Tire

10. Hold the bottom of the bottle upright, squeeze the bottle with your hands, and inject the entire amount of tire sealant into the tire.

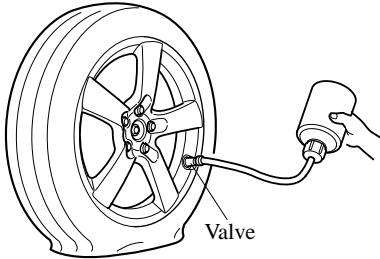

## NOTE

The tire sealant cannot be reused. Purchase new tire sealant at an Authorized Mazda Dealer.

11. Pull out the injection hose from the valve. Reinsert the valve core into the valve and turn it clockwise to install it.
12. Attach the sticker that indicates completion of the tire repair on a flat outer surface of the repaired tire.

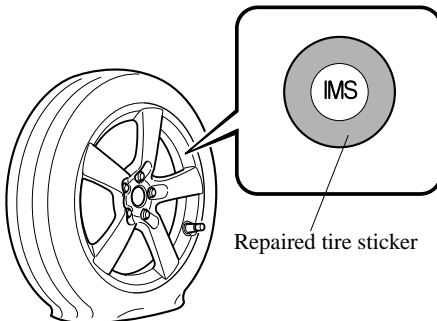

## NOTE

Do not throw away the empty tire sealant bottle as the sealant in the bottle can be replenished when replacing the tire. Take the bottle to an Authorized Mazda Dealer.

13. Attach the vehicle speed restriction sticker in a place where the driver can easily see it.

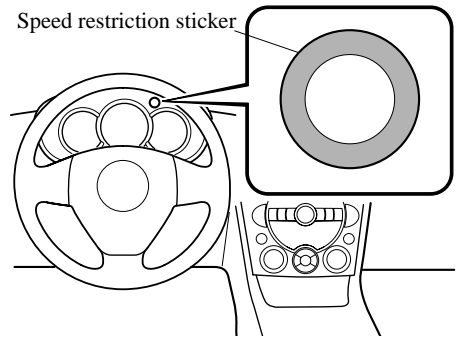

## **!** WARNING

### Attaching Sticker to the Steering Wheel Pad:

*Attaching the vehicle speed restriction sticker to the steering wheel pad is dangerous. The sticker could interfere with air bag inflation and cause serious injury. Also, do not attach the sticker to the meter panel, as it would obstruct vision of areas such as warning light indicators or the speedometer.*

# Flat Tire

14. Install the compressor hose to the tire valve.

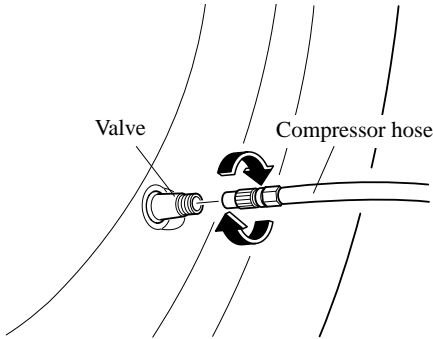

15. Insert the compressor plug into the interior accessory socket and turn the ignition switch to the ACC position (page 6-48).

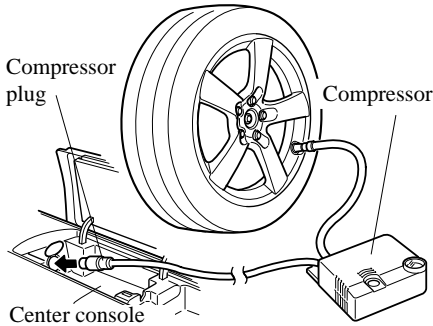

16. Turn the compressor switch on and inflate the tire carefully to the correct inflation pressure.

## **WARNING**

**Operating the Compressor:**  
*Operating the compressor above 300 kPa (3.1 kgf/cm<sup>2</sup>, 3 bar, 43.5 psi) is dangerous. When the inflation pressure rises above 300 kPa (3.1 kgf/cm<sup>2</sup>, 3 bar, 43.5 psi), heated air will be exhausted from the back of the compressor and you could be burned. Never operate the compressor above 300 kPa (3.1 kgf/cm<sup>2</sup>, 3 bar, 43.5 psi).*

## **CAUTION**

If the compressor operates slowly or becomes hot, it indicates overheating. Turn the compressor off immediately and leave it turned off for 30 minutes or longer.

## **CAUTION**

- Before pulling out the compressor plug from the electrical socket, make sure the compressor power switch is off.
- The compressor turns on and off with the push-button switch.



**NOTE**

- Check the tire inflation pressure label (driver's door) for the correct tire inflation pressure.
  - Do not use the compressor for longer than 10 minutes because using the compressor for long periods could damage it.
  - If the tire does not inflate, repair of the tire may not be possible. If the tire does not reach the correct inflation pressure within a 10-minute period, it probably has received more extensive damage. When this happens, the emergency flat tire repair kit cannot be used to repair the tire. Contact an Authorized Mazda Dealer.
  - If the tire has been over-inflated, loosen the screw cap on the compressor and bleed some of the air out.
17. When the tire has been inflated to the proper inflation pressure, turn the compressor switch off and remove the compressor hose from the tire valve.
  18. Install the tire valve cap.
  19. Put the emergency flat tire repair kit in the trunk and continue driving.

 **CAUTION**

- Drive carefully to an Authorized Mazda Dealer and keep the vehicle speed below 80 km/h (50 mph).
- If the vehicle is driven 80 km/h (50 mph) or higher, the vehicle might begin to vibrate.

**NOTE****(With Tire Pressure Monitoring System)**

If the tire is not properly inflated, the tire pressure monitoring system warning light will illuminate (page 5-25).

20. After driving the vehicle for 10 minutes or 5 km (3 miles), check the tire pressure with the tire pressure gauge equipped with the compressor. If the tire pressure has fallen below the correct tire pressure, inflate the tire to the correct pressure again following the steps from number 15.

# Flat Tire

---

## CAUTION

- If the tire inflation pressure falls below 130 kPa (1.3 kgf/cm<sup>2</sup> or bar, 18.9 psi), repair cannot be done with the repair kit. Park the vehicle on a level surface off the right-of-way and contact an Authorized Mazda Dealer.
- If the tire inflation pressure continues to remain low after repeating steps 14 to 21, park the vehicle on a level surface off the right-of-way and contact an Authorized Mazda Dealer.

## NOTE

When checking the tire inflation pressure with the tire pressure gauge on the compressor unit, make sure the compressor switch is turned off.

21. If the tire inflation pressure remains stable, the tire repair is complete. Drive the vehicle with care to an Authorized Mazda Dealer to have the tire replaced.

## CAUTION

- A tire that has been temporarily repaired with the tire sealant cannot be reused. Mazda recommends replacing the tire with a new one.
- The wheel can be reused after any sealant adhering to it is wiped off and carefully inspected. However, replace the tire valve with a new one.

## ▼ Inspecting the IMS Emergency Flat Tire Repair Kit

Inspect the emergency tire repair kit at regular intervals.

- Check the tire sealant period of effective use.
- Check the operation of the tire compressor.

## NOTE

The tire sealant has a period of effective use. Check the period of effective use indicated on the bottle label and do not use it if it has expired. Have the tire sealant replaced at an Authorized Mazda Dealer before the period of effective use has expired.

**Changing the Tire****⚠ WARNING****Jacking a Vehicle:**

*Changing a tire is dangerous if not done properly. The vehicle can slip off the jack and seriously injure someone.*

*Be sure to follow the directions for changing a tire, and never get under a vehicle that is supported only by a jack.*

**Passenger in Vehicle Supported by a Jack:**

*Allowing someone to remain in a vehicle supported by a jack is dangerous. The occupant could cause the vehicle to fall resulting in serious injury. Never allow anyone inside a vehicle supported by a jack.*

**⚠ CAUTION****(With Tire Pressure Monitoring System)**

The wheels equipped on your Mazda are specially designed for installation of the tire pressure sensors. Do not use non-genuine wheels, otherwise it may not be possible to install the tire pressure sensors.

**NOTE**

- Make sure the jack is well lubricated before using it.

**(With Tire Pressure Monitoring System)**

- Be sure to register the tire pressure sensor ID signal code whenever tires or wheels are changed (page 5-27).

1. Park on a level surface off the right-of-way and firmly set the parking brake.
2. Put a vehicle with an automatic transmission in Park (P), a manual transmission in Reverse (R) or 1, and turn off the engine.
3. Turn on the hazard warning flasher.
4. Have everyone get out of the vehicle and away from the vehicle and traffic.
5. Remove the jack, and tool (page 7-3).
6. Block the wheel diagonally opposite the tire to be changed. When blocking a wheel, place a block both in front and behind the tire.

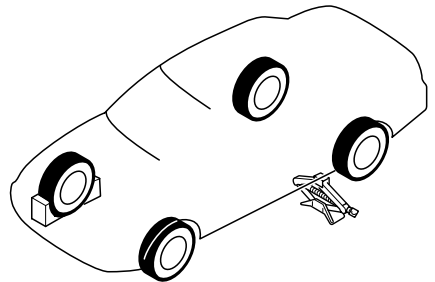

# Flat Tire

## NOTE

When blocking a tire, use rocks or wood blocks of sufficient size to hold the tire in place.

## ▼ Removing the Tire

1. Loosen the lug nuts by turning them counterclockwise one turn each, but don't remove any until the tire has been raised off the ground.

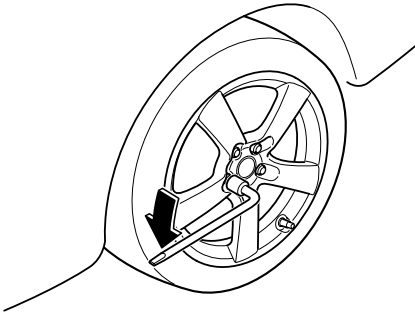

2. Place the jack under the jacking position closest to the tire being changed.

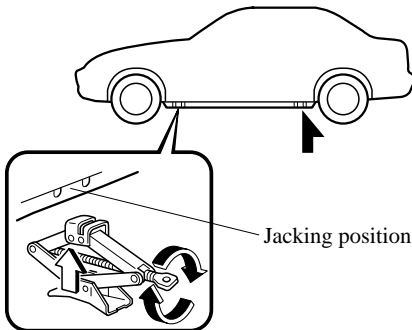

## ⚠ WARNING

**Incorrect Jacking Position:**  
*Attempting to jack the vehicle in positions other than those recommended in this manual is dangerous. The vehicle could slip off the jack and seriously injure or even kill someone. Use only the front and rear jacking positions recommended in this manual.*

**Improper Jack:**  
*Using a jack that isn't designed for your Mazda is dangerous. The vehicle could slip off the jack and seriously injure someone. Use only the jack provided with your Mazda.*

**Placing Objects Under the Jack:**  
*Jacking the vehicle with an object under the jack is dangerous. The jack could slip and someone could be seriously injured by the jack or the falling vehicle. Never place objects under the jack.*

3. Insert the jack handle into the jack.

- Turn the jack handle clockwise and raise the vehicle high enough so that the tire can be installed. Before removing the lug nuts, make sure your Mazda is firmly in position and that it cannot slip or move.

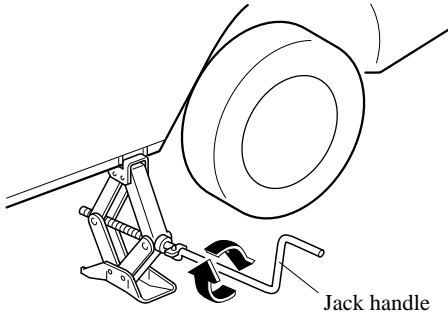

- Remove the lug nuts by turning them counterclockwise, then remove the wheel.

### ▼ Locking Lug Nuts

If your vehicle has optional antitheft wheel lug nuts, one on each wheel will lock the tires and you must use a special key to unlock them. This key is attached to the lug wrench and is stored with the spare tire. Register them with the lock manufacturer by filling out the card provided in the glove box and mailing it in the accompanying envelope. If you lose your key, consult an Authorized Mazda Dealer or use the lock manufacturer's order form, which is with the registration card.

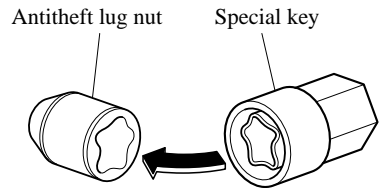

### To remove an antitheft lug nut

- Get the key for the locking lug nut.
- Place it on top of the nut, and be sure to hold the key square to it. If you hold the key at an angle, you may damage both key and nut. Don't use a power impact wrench.
- Place the lug wrench on top of the key and apply pressure. Turn the wrench counterclockwise.

# Flat Tire

## **To replace the nut**

1. Place the key on top of the nut.
2. Place the lug wrench on top of the key, apply pressure, and turn it clockwise.

## **▼ Mounting the Tire**

1. Remove dirt and grime from the mounting surfaces of the wheel and hub, including the hub bolts, with a cloth.

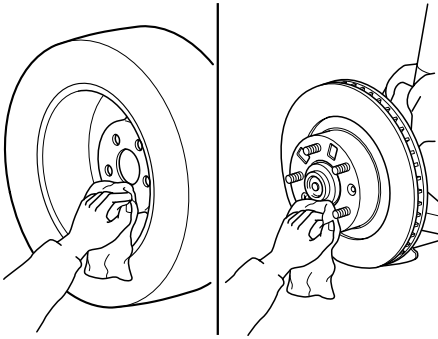

### **⚠ WARNING**

#### **Removing Dirt and Grime from Wheels, Hubs and Hub Bolts:**

*When changing or replacing a tire, not removing dirt and grime from the mounting surfaces of the wheel, hub and hub bolts is dangerous. The lug nuts could loosen while driving and cause the tire to come off, resulting in an accident. Make sure the mounting surfaces of the wheel, hub and lug nuts are clean before changing or replacing tires.*

2. Mount the tire.

3. Install the lug nuts with the beveled edge inward; tighten them by hand.

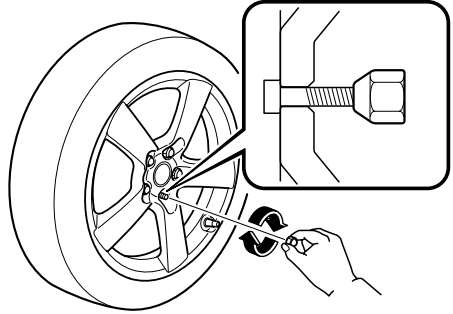

### **⚠ WARNING**

#### **Don't Apply Oil or Grease to Lug Nuts, Bolts:**

*Applying oil or grease to lug nuts and bolts is dangerous. The lug nuts could loosen while driving and cause the tire to come off, resulting in an accident. In addition, lug nuts and bolts could be damaged if tightened more than necessary. Do not apply oil or grease to lug nuts and bolts and do not tighten the lug nuts beyond the recommended tightening torque.*

4. Turn the jack handle counterclockwise and lower the vehicle. Use the lug wrench to tighten the nuts in the order shown.

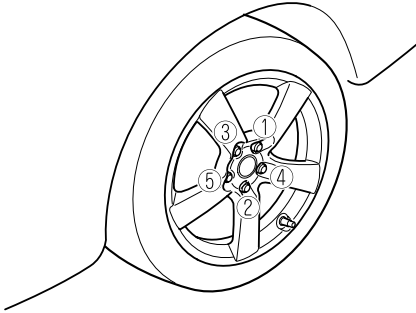

If you're unsure of how tight the nuts should be, have them inspected at an Authorized Mazda Dealer.

#### Nut tightening torque:

N·m (kgf·m, ft·lbf)	88—118 (9—12, 65—87)
---------------------	----------------------

## WARNING

### Loose Lug Nuts:

*Improperly or loosely tightened lug nuts are dangerous. The wheel could wobble or come off. This could result in loss of vehicle control and cause a serious accident. Always securely and correctly tighten the lug nuts.*

### Metric Studs and Lug Nuts:

*Because the wheel studs and lug nuts on your Mazda have metric threads, using a non-metric nut is dangerous. On a metric stud, it would not secure the wheel and would damage the stud, which could cause the wheel to slip off and cause an accident. Be sure to reinstall the same nuts you removed or replace them with metric nuts of the same configuration.*

### Incorrect Tire Air Pressure:

*Driving on tires with incorrect air pressure is dangerous. Tires with incorrect pressure could affect handling and result in an accident. Don't drive with any tires that have incorrect air pressure.*

## NOTE

To prevent the jack and tool from rattling, store them properly.

# Overheating

## Overheating

If the temperature gauge indicates overheating, the vehicle loses power, or you hear a loud knocking or pinging noise, the engine is probably too hot.

### **WARNING**



#### **Electrical Fan and Engine**

##### **Inspection:**

*Working near the electrical cooling fan when it is running is dangerous. You could be hit by the fan and seriously injured. Turn off the ignition switch and make sure the fan is not running before attempting to work near the electrical cooling fan.*



#### **Cooling System Cap:**

*When the engine and radiator are hot, scalding coolant and steam may shoot out under pressure and cause serious injury. Don't remove the cooling system cap when the engine and radiator are hot.*

##### **Steam from Overheated Engine:**

*Steam from an overheated engine is dangerous. The escaping steam could seriously burn you. Open the hood ONLY after steam is no longer escaping from the engine.*

### **NOTE**

Once the engine coolant exceeds a preset temperature, an electrical cooling fan turns on. It will continue running for about 10 minutes after the ignition switch is turned to off.

If the temperature gauge indicates overheating:

1. Drive safely to the side of the road and park off the right-of-way.
2. Put a vehicle with an automatic transmission in park (P), a manual transmission in neutral. Apply the parking brake.
3. Turn off the air conditioner.
4. Check whether coolant or steam is escaping from under the hood or from the engine compartment.

#### **If steam is coming from the engine compartment:**

Don't go near the front of the vehicle. Stop the engine. Wait until the steam dissipates, then open the hood and start the engine.

#### **If neither coolant nor steam is escaping:**

Open the hood and idle the engine until it cools.

### **CAUTION**

If the cooling fan does not operate while the engine is running, the engine temperature will increase. Stop the engine and call an Authorized Mazda Dealer.



5. Make sure the cooling fan is operating, then turn off the engine after the temperature has decreased.
6. When cool, check the coolant level. If it's low, look for coolant leaks from the radiator and hoses.

**If you find a leak or other damage,  
or if coolant is still leaking:**

Stop the engine and call an Authorized Mazda Dealer.

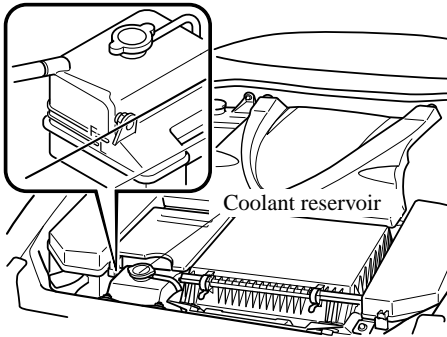

**If you find no problems, the engine is  
cool, and no leaks are obvious:**

Carefully add coolant as required (page 8-13).

**⚠ CAUTION**

If the engine continues to overheat or frequently overheats, have the cooling system inspected. The engine could be seriously damaged unless repairs are made. Consult an Authorized Mazda Dealer.

## Emergency Starting

---

### Starting a Flooded Engine

If the engine does not start the first time, perform the following procedure to start the engine.

1. While the accelerator pedal is fully depressed, turn the ignition switch to the START position and crank the engine for about 7 to 8 seconds.
2. Release the ignition switch and accelerator pedal.
3. Start the engine as normally without depressing the accelerator.
  - The fuel injection is cut by fully depressing the accelerator pedal.
  - If the engine starts during Step 1, the engine will rev up. Release the ignition switch and accelerator pedal immediately.
  - Avoid racing the engine or driving the vehicle right after starting the engine.
  - Do not hold the ignition switch in the START position for over 10 seconds. It may damage the starter and drain the battery.
  - If the engine still does not start using the above procedure, have your vehicle inspected by an Authorized Mazda Dealer.

## Jump-Starting

Jump-starting is dangerous if done incorrectly. So follow the procedure carefully. If you feel unsure about jump-starting, we strongly recommend that you have a competent service technician do the work.

### **WARNING**



#### **Follow These Precautions Carefully:**

*To ensure safe and correct handling of the battery, read the following precautions carefully before using the battery or inspecting it.*



#### **Eye Protection:**

*Working without eye protection is dangerous. Battery fluid contains **SULFURIC ACID** which could cause blindness if splashed into in your eyes. Also, hydrogen gas produced during normal battery operation, could ignite and cause the battery to explode. Always wear eye protection when working near the battery.*



#### **Spilled Battery Fluid:**

*Spilled battery fluid is dangerous.*

*Battery fluid contains **SULFURIC ACID** which could cause serious injuries if it gets in eyes, skin or clothing. If this happens, immediately flush your eyes with water for 15 minutes or wash your skin thoroughly and get medical attention. Wear eye protection and protective gloves to prevent contact with battery fluid.*



#### **Children and Batteries:**

*Allowing children to play near batteries is dangerous. Battery fluid could cause serious injuries if it gets in the eyes or on the skin. Always keep batteries out of the reach of children.*

## Emergency Starting

### **WARNING**



#### **Keep Flames Away:**

*Flames and sparks near open battery cells are dangerous. Hydrogen gas, produced during normal battery operation, could ignite and cause the battery to explode. An exploding battery can cause serious burns and injuries. Keep all flames including cigarettes and sparks away from open battery cells. When working near a battery, do not allow metal tools to contact the positive (+) or negative (-) terminal of the battery. Do not allow the positive (+) terminal to contact the vehicle body.*



#### **Battery-Related Explosion:**

*Flames and sparks near open battery cells are dangerous. Hydrogen gas, produced during normal battery operation, could ignite and cause the battery to explode. An exploding battery can cause serious burns and injuries. Keep all flames, including cigarettes, and sparks away from open battery cells.*

#### **Low Fluid Level or Frozen Battery:**

*Jump-starting a frozen battery or one with a low fluid level is dangerous. It may rupture or explode, causing serious injury.*

*Don't jump-start a frozen battery or one with a low fluid level.*

#### **Connecting to Negative Terminal:**

*Connecting the end of the second cable to the negative (-) terminal of the discharged battery is dangerous.*

*A spark could cause the gas around the battery to explode and injure someone.*

*Connect the cable to a point away from the battery.*

#### **Connecting Jumper Cable to Moving Parts:**

*Connecting a jumper cable near or to moving parts (cooling fans, belts) is dangerous.*

*The cable could get caught when the engine starts and cause serious injury. Never connect a jumper cable to or near any part that moves.*

### **CAUTION**

Use only a 12 V booster system. You can damage a 12 V starter, ignition system, and other electrical parts beyond repair with a 24 V power supply (two 12 V batteries in series or a 24 V motor generator set).

# Emergency Starting

1. Remove the engine cover.

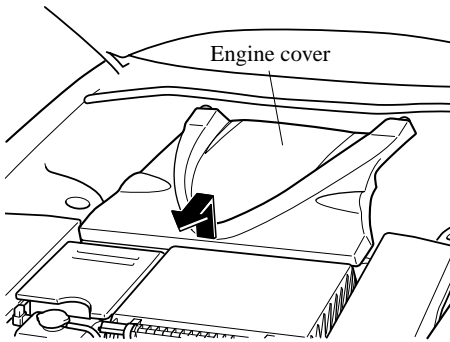

2. Remove the rubber hose from the battery cover.

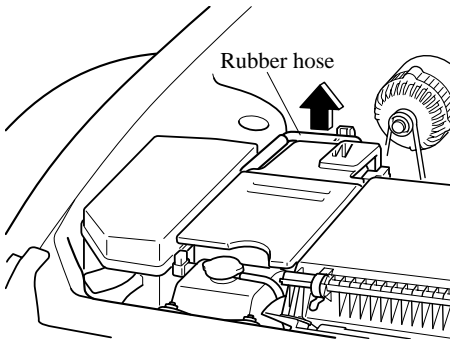

3. Remove the battery cover from its rear side.

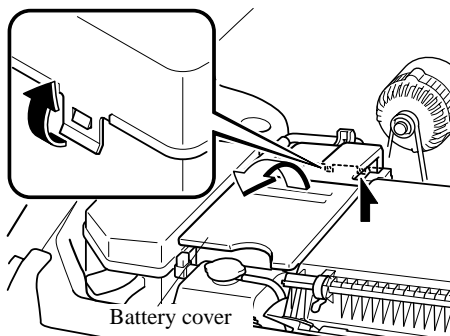

4. Make sure the booster battery is 12 V and that its negative terminal is grounded.
5. If the booster battery is in another vehicle, don't allow the vehicles to touch. Turn off the engine of the vehicle with the booster battery and all unnecessary electrical loads in both vehicles.
6. Connect the jumper cables in the exact sequence as in the illustration.
  - Connect one end of a cable to the positive terminal on the discharged battery (1).
  - Attach the other end to the positive terminal on the booster battery (2).
  - Connect one end of the other cable to the negative terminal of the booster battery (3).
  - Connect the other end to a solid, stationary, exposed metallic point (for example, the tightening bolt) away from the discharged battery (4).

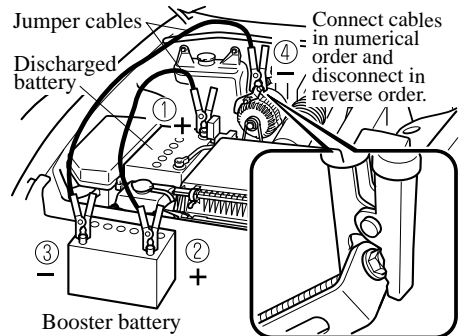

7. Start the engine of the booster vehicle and run it a few minutes. Then start the engine of the other vehicle.

# Emergency Starting

---

- When finished, carefully disconnect the cables in the reverse order described in Step 6.

<b>NOTE</b>
Verify that the engine cover is securely installed.

## Push-Starting

 <b>WARNING</b>
<i><b>Towing a Vehicle to Start It:</b> Towing a vehicle to start it is dangerous. The vehicle being towed could surge forward when its engine starts, causing the two vehicles to collide. The occupants could be injured. Never tow a vehicle to start it.</i>

You can't start a vehicle with an automatic transmission by pushing it.

 <b>CAUTION</b>
You shouldn't push-start a vehicle that has a manual transmission. It can damage the emission control system.

# Emergency Towing

## Towing Description

We recommend that towing be done only by an Authorized Mazda Dealer or a commercial tow-truck service.

Proper lifting and towing are necessary to prevent damage to the vehicle. Government and local laws must be followed.

A towed vehicle usually should have its rear wheels off the ground. If excessive damage or other conditions prevent this, use wheel dollies.

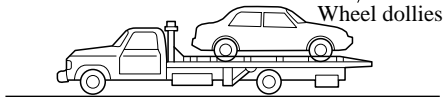
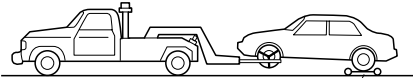
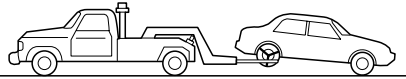

### CAUTION

Don't tow the vehicle pointed forward with driving wheels on the ground. This may cause internal damage to the transmission.

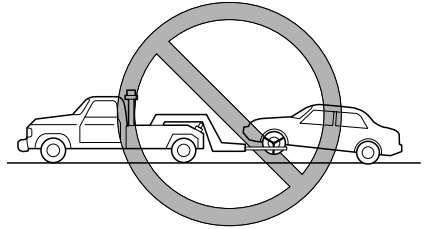

### CAUTION

Don't tow with sling-type equipment. This could damage your vehicle. Use wheel-lift or flatbed equipment.

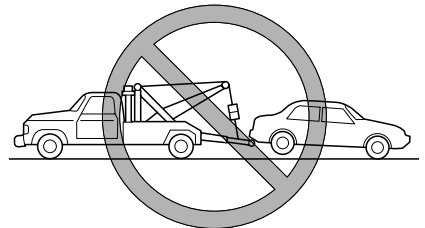

# Emergency Towing

## Tiedown Hooks

### ⚠ CAUTION

Don't use the tiedown hooks under the front and rear for towing. They are designed **ONLY** for tying down the vehicle when it's being transported. Using them for towing will damage the bumper.

## ▼ Tiedown Hooks

1. Remove the tiedown eyelet and the lug wrench from the trunk (page 7-3).
2. Wrap the lug wrench with a soft cloth to prevent damage to the bumper and open the cap located on the front and rear bumper.

Front

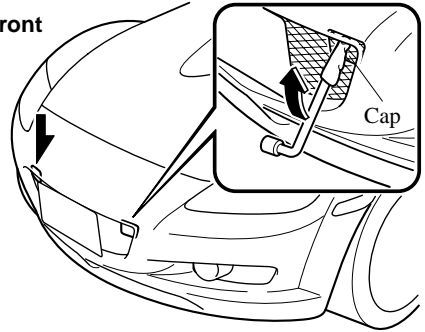

Rear

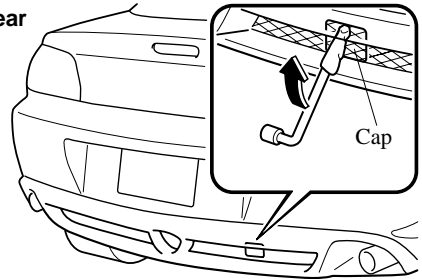

### ⚠ CAUTION

The cap cannot be completely removed. Do not use excessive force as it may damage the cap or scratch the painted bumper surface.



# Emergency Towing

3. Securely install the tiedown eyelet using the lug wrench.

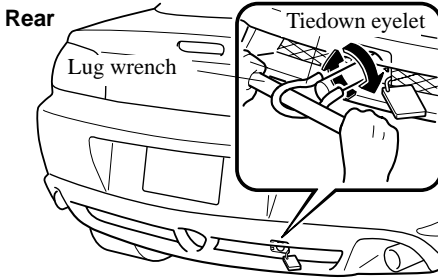
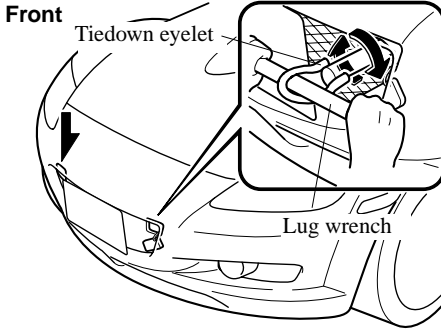

4. Hook the tying rope to the tiedown eyelet.

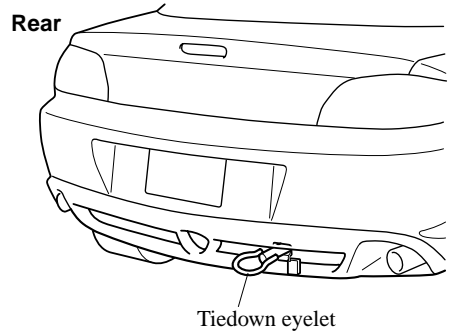
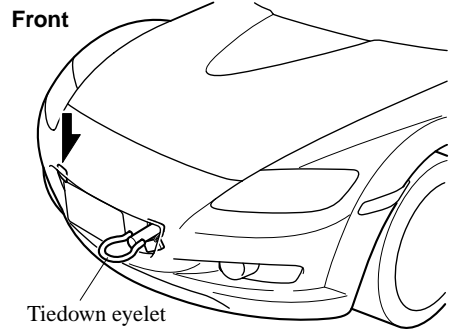

## CAUTION

If the tiedown eyelet is not securely tightened, it may loosen or disengage from the bumper when tying down the vehicle. Make sure that the tiedown eyelet is securely tightened to the bumper.

## Emergency Towing

---

### Recreational Towing

An example of “recreational towing” is towing your vehicle behind a motorhome. The transmission is not designed for towing this vehicle on all 4 wheels. When doing recreational towing refer to “Towing Description” (page 7-25) and “Tiedown Hooks” (page 7-26) and carefully follow the instructions.

How to keep your Mazda in top condition.

<b>Introduction</b> .....	8-2
Introduction .....	8-2
<b>Scheduled Maintenance</b> .....	8-3
Scheduled Maintenance .....	8-3
<b>Owner Maintenance</b> .....	8-7
Owner Maintenance Schedule .....	8-7
Owner Maintenance Precautions .....	8-8
Engine Compartment Overview .....	8-9
Engine Oil .....	8-10
Engine Coolant .....	8-13
Brake/Clutch Fluid .....	8-15
Automatic Transmission Fluid (ATF) .....	8-16
Washer Fluid .....	8-18
Body Lubrication .....	8-19
Air Filter .....	8-19
Wiper Blades .....	8-20
Battery .....	8-23
Tires .....	8-26
Light Bulbs .....	8-30
Fuses .....	8-36
<b>Appearance Care</b> .....	8-42
How to Minimize Environmental Paint Damage .....	8-42
Exterior Care .....	8-44
Interior Care .....	8-47

## Introduction

---

### Introduction

Be extremely careful and prevent injury to yourself and others or damage to your vehicle when using this manual for inspection and maintenance.

If you're unsure about any procedure it describes, we strongly urge you to have a reliable and qualified service shop perform the work, preferably an Authorized Mazda Dealer.

Factory-trained Mazda technicians and genuine Mazda parts are best for your vehicle. Without this expertise and the parts that have been designed and made especially for your Mazda, inadequate, incomplete, and insufficient servicing may result in problems. This could lead to vehicle damage or an accident and injuries.

For expert advice and quality service, consult an Authorized Mazda Dealer.

The owner should retain evidence that proper maintenance has been performed as prescribed.

Claims against the warranty resulting from lack of maintenance, as opposed to defective materials or authorized Mazda workmanship, will not be honored.

Any auto repair shop using parts equivalent to your Mazda's original equipment may perform maintenance. **But we recommend that it always be done by an Authorized Mazda Dealer using genuine Mazda parts.**

## Scheduled Maintenance

---

### Scheduled Maintenance

Follow Schedule 1 if the vehicle is operated mainly where none of the following conditions apply.

If any do apply, follow Schedule 2 (Canada and Puerto Rico residents follow Schedule 2).

- Repeated short-distance driving
- Driving in dusty conditions
- Driving with extended use of brakes
- Driving in areas where salt or other corrosive materials are being used
- Driving on rough or muddy roads
- Extended periods of idling or low-speed operation
- Driving for long periods in cold temperatures or extremely humid climates

<b>NOTE</b>
After the prescribed period, continue to follow the described maintenance at the recommended intervals.

# Scheduled Maintenance

## ▼ Schedule 1

**I** : Inspect and repair, clean, adjust, or replace if necessary.

**R** : Replace

**L** : Lubricate

**C** : Clean

Maintenance Interval (Number of months or kilometers (miles), whichever comes first)	Months	6	12	18	24	30	36	42	48
	×1000 km	12	24	36	48	60	72	84	96
	×1000 miles	7.5	15	22.5	30	37.5	45	52.5	60

### ENGINE

Engine oil	R	R	R	R	R	R	R	R	R
Engine oil filter	R	R	R	R	R	R	R	R	R
Drive belt					I				I

### AIR FILTER

Air filter		C			C	R		C	
------------	--	---	--	--	---	---	--	---	--

### IGNITION SYSTEM

Spark plugs						R			
-------------	--	--	--	--	--	---	--	--	--

### FUEL SYSTEM

Fuel filter	Replace every 160,000km (100,000miles)								
Fuel lines, hoses and connections* <sup>1</sup>					I				I

### COOLING SYSTEM

Cooling system					I				I
Engine coolant	Replace at first 96,000km (60,000miles) or 48 months ; after that, every 24 months								

### CHASSIS & BODY

Brake line, hoses and connection					I				I
Disk brakes		I			I		I		I
Tire (Rotation)	Rotate every 12,000km (7,500miles)								
Steering operation and linkages					I				I
Front and rear suspension and ball joints					I				I
Manual transmission oil									R
Rear differential oil									R
Driveshaft dust boots					I				I
Exhaust system and heat shields	Inspect every 72,000km (45,000miles) or 60 months								
All locks and hinges	L	L	L	L	L	L	L	L	L
Flat tire repair kit* <sup>2</sup>	Inspect every year								

### AIR CONDITIONER SYSTEM

Cabin air filter (If installed)	Replace every 40,000km (25,000miles) or 24 months								
---------------------------------	---	--	--	--	--	--	--	--	--

\*1 According to state / provincial and federal regulations, failure to perform maintenance on these items will not void your emissions warranties. However, Mazda recommends that all maintenance services be performed at the recommended time or mileage / kilometer period to ensure long-term reliability.

\*2 Check the tire repair fluid expiration date every year when performing the periodic maintenance. Replace the tire repair fluid bottle with new one before the expiration date.

# Scheduled Maintenance

## ▼ Schedule 2

**I** : Inspect and repair, clean, adjust, or replace if necessary.

**R** : Replace

**C** : Clean

Maintenance Interval (Number of months or kilometers (miles), whichever comes first)	Months	4	8	12	16	20	24	28	32	36	40	44	48
	×1000 km	8	16	24	32	40	48	56	64	72	80	88	96
	×1000 miles	5	10	15	20	25	30	35	40	45	50	55	60

### ENGINE

Engine oil	Puerto Rico	Replace every 5,000km (3,000miles) or 3 months												
	Others	R	R	R	R	R	R	R	R	R	R	R	R	R
Engine oil filter		R	R	R	R	R	R	R	R	R	R	R	R	R
Drive belt							I							I

### AIR FILTER

Air filter			C			C	R			C			
------------	--	--	---	--	--	---	---	--	--	---	--	--	--

### IGNITION SYSTEM

Spark plugs							R						
-------------	--	--	--	--	--	--	---	--	--	--	--	--	--

### FUEL SYSTEM

Fuel filter	Replace every 160,000km (100,000miles)												
Fuel lines, hoses and connections*1							I						I

### COOLING SYSTEM

Cooling system							I							I
Engine coolant	Replace at first 96,000km (60,000miles) or 48 months ; after that, every 24 months													
Engine coolant level	I	I	I	I	I	I	I	I	I	I	I	I	I	I

### ELECTRICAL SYSTEM

Function of all lights	I	I	I	I	I	I	I	I	I	I	I	I	I	I
------------------------	---	---	---	---	---	---	---	---	---	---	---	---	---	---

\*1 According to state / provincial and federal regulations, failure to perform maintenance on these items will not void your emissions warranties. However, Mazda recommends that all maintenance services be performed at the recommended time or mileage / kilometer period to ensure long-term reliability.

# Scheduled Maintenance

**I** : Inspect and repair, clean, adjust, or replace if necessary.  
**R** : Replace  
**L** : Lubricate

Maintenance Interval (Number of months or kilometers (miles), whichever comes first)	Months	4	8	12	16	20	24	28	32	36	40	44	48
	×1000 km	8	16	24	32	40	48	56	64	72	80	88	96
	×1000 miles	5	10	15	20	25	30	35	40	45	50	55	60

## CHASSIS & BODY

Brake line, hoses and connection								I						I
Brake and clutch fluid level	I	I	I	I	I			I	I	I	I	I		
Brake fluid								R						R
Disk brakes				I				I			I			I
Tire (Rotation)	Rotate every 8,000km (5,000miles)													
Tire inflation pressure and tire wear	I	I	I	I	I	I	I	I	I	I	I	I	I	I
Steering operation and linkages								I						I
Front and rear suspension and ball joints								I						I
Manual transmission oil								R						R
Rear differential oil								R						R
Driveshaft dust boots								I						I
Exhaust system and heat shields	Inspect every 72,000km (45,000miles) or 60 months													
All locks and hinges	L	L	L	L	L	L	L	L	L	L	L	L	L	L
Washer fluid level	I	I	I	I	I	I	I	I	I	I	I	I	I	I
Flat tire repair kit <sup>*2</sup>	Inspect every year													

## AIR CONDITIONER SYSTEM

Cabin air filter (If installed)	Replace every 40,000km (25,000miles) or 24 months
---------------------------------	---

\*2 Check the tire repair fluid expiration date every year when performing the periodic maintenance. Replace the tire repair fluid bottle with new one before the expiration date.



## Owner Maintenance Schedule

The owner or a qualified service technician should make these vehicle inspections at the indicated intervals to ensure safe and dependable operation.

Bring any problem to the attention of an Authorized Mazda Dealer or qualified service technician as soon as possible.

### ▼ When Refueling

- Brake and clutch fluid level (page 8-15)
- Engine coolant level (page 8-13)
- Engine oil level (page 8-11)
- Washer fluid level (page 8-18)

### ▼ At Least Monthly

- Tire inflation pressures (page 8-26)

### ▼ At Least Twice a Year (For Example, Every Spring and Fall)

- Automatic transmission fluid level (page 8-16)

You can do the following scheduled maintenance items if you have some mechanical ability and a few basic tools and if you closely follow the directions in this manual.

- Air filter (page 8-19)
- Engine coolant (page 8-13)
- Engine oil (page 8-11)

## Owner Maintenance

---

### Owner Maintenance Precautions

Improper or incomplete service may result in problems. This section gives instructions only for items that are easy to perform.

As explained in the Introduction (page 8-2), several procedures can be done only by a qualified service technician with special tools.

Improper owner maintenance during the warranty period may affect warranty coverage. For details, read the separate Mazda Warranty statement provided with the vehicle. If you're unsure about any servicing or maintenance procedure, have it done by an Authorized Mazda Dealer.

There are strict environmental laws regarding the disposal of waste oil and fluids. Please dispose of your waste properly and with due regard to the environment.

We recommend that you entrust the oil and fluid changes of your vehicle to an Authorized Mazda Dealer.

#### **WARNING**

##### **Maintenance Procedures:**

*Performing maintenance work on a vehicle is dangerous if not done properly. You can be seriously injured while performing some maintenance procedures. If you lack sufficient knowledge and experience or the proper tools and equipment to do the work, have it done by a qualified technician.*

##### **Running the Engine:**

*Working under the hood with the engine running is dangerous. It becomes even more dangerous when you wear jewelry or loose clothing.*

*Either can become entangled in moving parts and result in injury.*

*Therefore, if you must run the engine while working under the hood, make certain that you remove all jewelry (especially rings, bracelets, watches, and necklaces) and all neckties, scarves, and similar loose clothing before getting near the engine or cooling fan which may turn on unexpectedly.*

##### **Electrical Fan and Engine Inspection:**

*Working near the electrical cooling fan when it is running is dangerous. You could be hit by the fan and seriously injured. Turn off the ignition switch and make sure the fan is not running before attempting to work near the electrical cooling fan.*

#### **NOTE**

Once the engine coolant exceeds a preset temperature, an electrical cooling fan turns on. It will continue running for about 10 minutes after the ignition switch is turned to off.

## Engine Compartment Overview

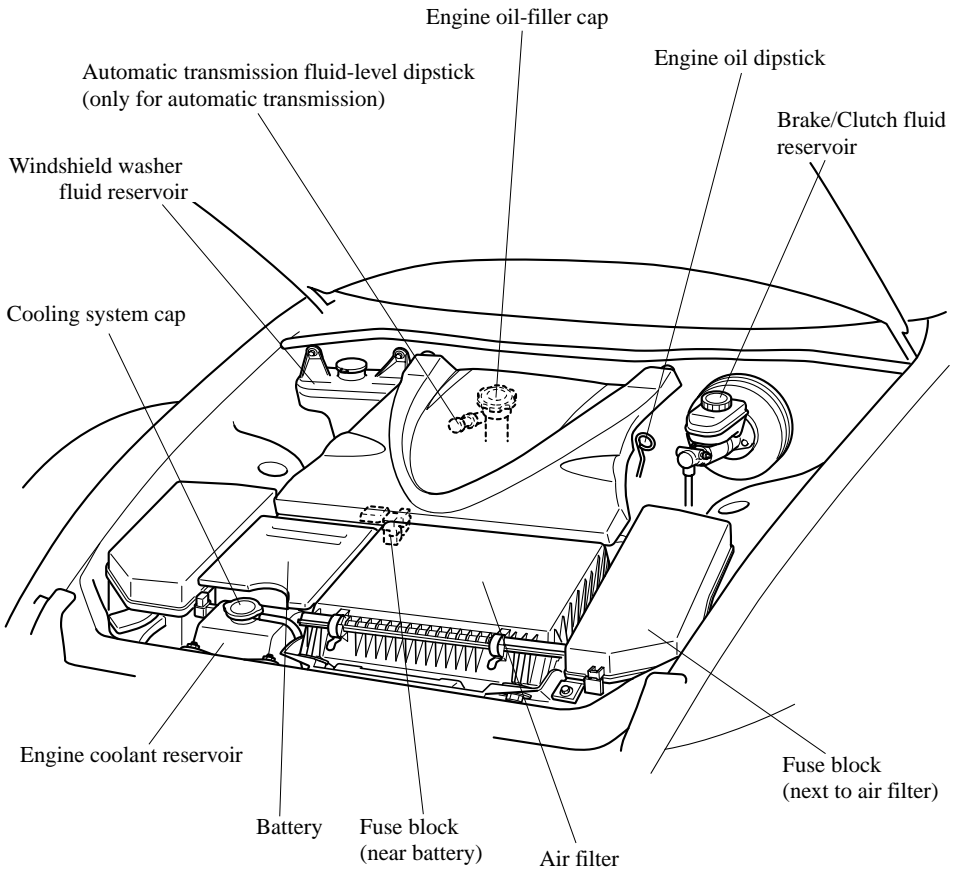

# Owner Maintenance

## Engine Oil

### NOTE

The Mazda RX-8 requires regular checking of the engine oil level. The compact, high performance RENESIS rotary engine in your vehicle consumes a small amount of engine oil due to its structural design. An oil pump optimizes the amount of oil injected to lubricate the rotor seals in the combustion cycle. Although your vehicle is equipped with an engine oil level warning light and an engine oil pressure gauge, it is best to keep the engine oil level in the range between full and low by checking the oil dipstick regularly. Mazda recommends checking the oil level at every second fuel filling. The oil consumption of the engine depends on engine speed and engine load. Under extreme driving conditions, oil consumption can be higher.

### ▼ Recommended Oil

Oil container labels provide important information.



(ILSAC)

The quality designation **SL** or **ILSAC** must be on the label.

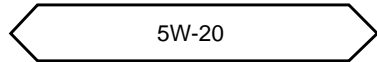
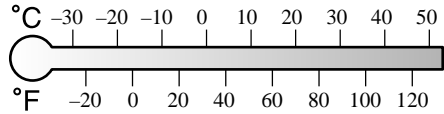

Energy conserving oils are recommended. A chief contribution they make to fuel economy is reducing the amount of fuel necessary to overcome engine friction.

# Owner Maintenance

## ▼ Inspecting Engine Oil Level

1. Be sure the vehicle is on a level surface.
2. Warm up the engine to normal operating temperature.
3. Turn it off and wait at least 5 minutes for the oil to return to the oil pan.
4. Remove the engine cover.

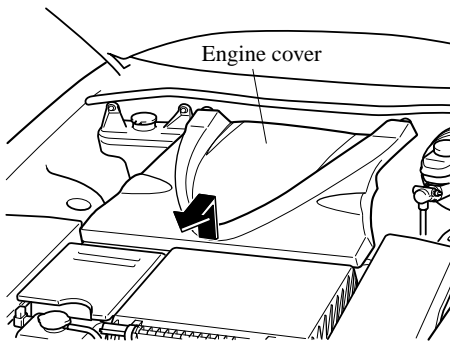

5. Pull out the dipstick, wipe it clean, and reinsert it fully.

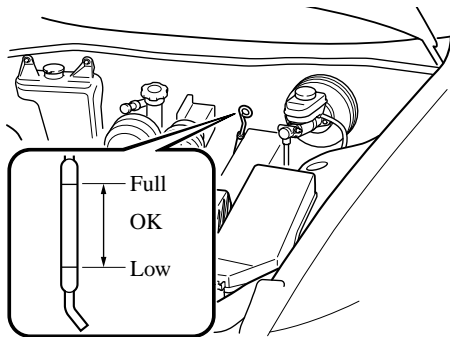

6. Pull it out again and examine the level. It's OK between L and F. But if it's near or below L, add enough oil to bring the level to F.

## ⚠ CAUTION

Don't add engine oil over F. This may cause engine damage.

The distance between L and F on the dipstick represents the following:

L (US qt, Imp qt)	1.7 (1.8, 1.5)
-------------------	----------------

## NOTE

Verify that the engine cover is securely installed.

## ▼ Changing Engine Oil and Filter

Change engine oil and filter according to Scheduled Maintenance (page 8-3).

Please act responsibly—protect the environment and take used oil to a recycling facility. Ask your dealer or a service station for information.

## ⚠ WARNING

***Handling Used Engine Oil:***  
*Continuous contact with used engine oil is dangerous. It could cause skin cancer. Always wash with soap and water immediately after changing oil and filter.*

# Owner Maintenance

## Changing engine oil

### **WARNING**

***Checking or Changing Engine Oil:***  
***Hot engine oil is dangerous. If the engine has been running, the engine oil becomes very hot. You could be seriously burned. Don't check or change the engine oil when the engine is hot.***

1. Remove the engine cover.

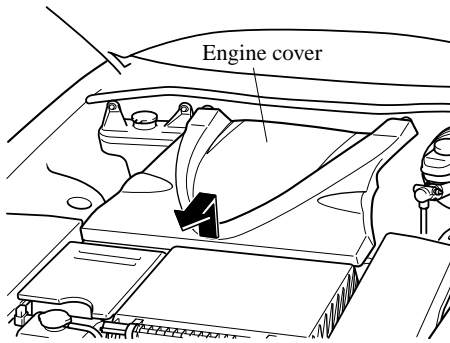

2. Warm up the engine for a few minutes and turn it off. Remove the oil-filler cap.
3. Remove the drain plug and drain the oil into a suitable container.
4. Replace the plug tightly after the oil has thoroughly drained.
5. Fill the engine with new oil to the F mark on the dipstick.

6. Securely reinstall the oil-filler cap.

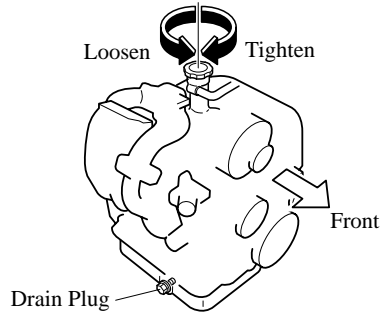

7. Start the engine and inspect around the drain plug for leaks.
8. Turn it off and wait 5 minutes for the oil to return to the oil pan.

Check the oil level and fill to the F mark if necessary.

**Oil capacity (General reference only, refer to Specifications section for capacities.)**

### **NOTE**

- The indicated engine oil capacities are for general reference purposes only. When adding or changing oil, verify the engine oil level with the oil dipstick.
- Use only specified engine oil (page 10-5).
- Verify that the engine cover is securely installed.

### **Changing oil filter**

Because you need a special tool to retighten the filter, an Authorized Mazda Dealer should do the work.

# Owner Maintenance

## Engine Coolant

### ▼ Inspecting Coolant Level

#### **WARNING**

##### Hot Engine:

*A hot engine is dangerous. If the engine has been running, parts of the engine compartment can become very hot. You could be burned. Carefully inspect the engine coolant in the coolant reservoir, but do not open it. Do not use a match or live flame in the engine compartment. **DO NOT ADD COOLANT WHEN THE ENGINE IS HOT.***



##### Electrical Fan and Engine

##### Inspection:

*Working near the electrical cooling fan when it is running is dangerous. You could be hit by the fan and seriously injured. Turn off the ignition switch and make sure the fan is not running before attempting to work near the electrical cooling fan.*



##### Cooling System Cap:

*When the engine and radiator are hot, scalding coolant and steam may shoot out under pressure and cause serious injury. Don't remove the cooling system cap when the engine and radiator are hot.*

#### **NOTE**

Once the engine coolant exceeds a preset temperature, an electrical cooling fan turns on. It will continue running for about 10 minutes after the ignition switch is turned to off.

Inspect the antifreeze protection and coolant level in the coolant reservoir at least once a year—at the beginning of the winter season—and before traveling where temperatures may drop below freezing.

Inspect the condition and connections of all cooling system and heater hoses. Replace any that are swollen or deteriorated.

The coolant should be at full in the radiator and between the F and L marks on the coolant reservoir when the engine is cool.

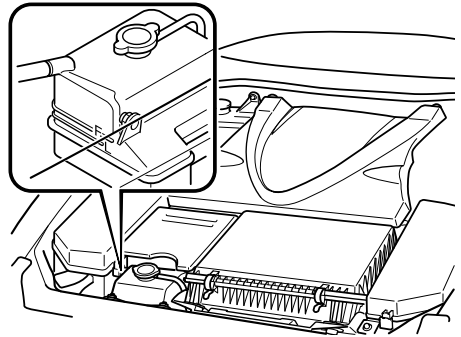

If it's at or near L, add enough coolant to the coolant reservoir to provide freezing and corrosion protection and to bring the level to F.

# Owner Maintenance

## ⚠ CAUTION

Radiator coolant will damage paint. Rinse it off quickly if spilled.

### Do not overfill.

If new coolant is required frequently, consult an Authorized Mazda Dealer.

### ▼ Changing Coolant

Change coolant according to Scheduled Maintenance (page 8-3).

## ⚠ CAUTION

- Use only soft (demineralized) water in the coolant mixture. Water that contains minerals will cut down on the coolant's effectiveness.
- Don't add only water. Always add a proper coolant mixture.
- The engine has aluminum parts and must be protected by an ethylene-glycol-based coolant to prevent corrosion and freezing.
- DO NOT USE alcohol or methanol antifreeze. DO NOT MIX alcohol or methanol with the coolant. This could damage the cooling system.
- Don't use a solution that contains more than 60 % antifreeze. This would reduce effectiveness.

For mixture percentage:

Protection	Volume	
	Antifreeze solution	Demineralized water
Above -16°C (3°F)	35%	65%
Above -26°C (-15°F)	45%	55%
Above -40°C (-40°F)	55%	45%

### To change coolant

## ⚠ WARNING

**Removing the Cooling System Cap:**  
*Removing the cooling system cap while the engine is running or hot is dangerous. This might lead to cooling system and engine damage and could result in serious injury from escaping hot coolant or steam. Turn off the engine and wait until it's cool. Even then, be very careful when removing the cap. Wrap a thick cloth around the cap and slowly turn it counterclockwise to the first stop. Step back while the pressure escapes. When you're sure all the pressure is gone, press down on the cap — still using a cloth — turn the cap, and remove it.*

1. Remove the cooling system cap.
2. Only when the engine is cool, loosen the radiator drain plug and drain the coolant into a suitable container. Properly dispose of the used coolant.
3. With the drain plug loose but not fully removed, flush out the system with running water.

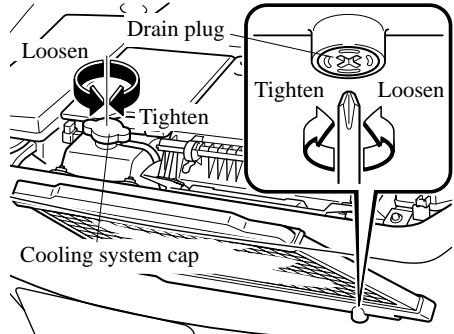



4. Drain the system completely and retighten the plug. Add as much ethylene-glycol-based coolant mixture and water as necessary to provide freezing and corrosion protection.
5. In extremely cold climates, add the mixture percentage recommended in the coolant mixture percentage table.
6. Reinstall the cooling system cap.
7. Run the engine at idle for about 10 minutes, then turn it off. If the coolant level warning light comes on during this time, turn the engine off. After turning off the engine, inspect the drain plug and the water hoses for leaks.
8. After the engine has cooled, remove the cooling system cap and inspect the coolant level. If it's low, repeat steps 5 to 7.

**NOTE**

Because this procedure requires technical expertise, we recommend that it be done by an Authorized Mazda Dealer.

**Brake/Clutch Fluid****▼ Inspecting Brake/Clutch Fluid Level**

The brakes and clutch draw fluid from the same reservoir.

Inspect the fluid level in the reservoir regularly. It should be kept at MAX.

The level normally drops with accumulated distance, a condition associated with wear of brake and clutch linings. If it is excessively low, have the brake/clutch system inspected by an Authorized Mazda Dealer.

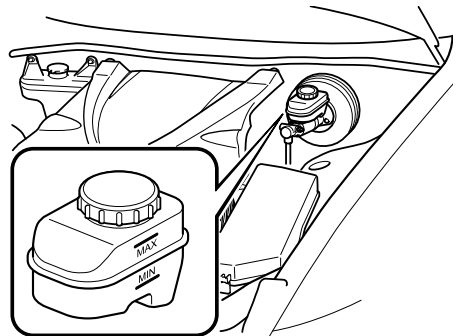

# Owner Maintenance

## ▼ Adding Brake/Clutch Fluid

### **WARNING**

#### Spilled Brake Fluid:

*Spilled brake fluid is dangerous. If it gets in your eyes, they could be seriously injured. If this happens, immediately flush your eyes with water and get medical attention. Brake fluid spilled on a hot engine could cause a fire. Be careful not to spill brake fluid on yourself or on the engine.*

#### Low Brake/Clutch Fluid Levels:

*Low brake/clutch fluid levels are dangerous. Low levels could signal brake lining wear or a brake system leak. Your brakes could fail and cause an accident. If you find a low fluid level, have the brakes and clutch inspected.*

If the fluid level is low, add fluid until it reaches MAX.

Before adding fluid, thoroughly clean the area around the cap.

### **CAUTION**

- Brake and clutch fluid will damage painted surfaces. If brake or clutch fluid does get on a painted surface, wipe it off immediately.
- Using nonspecified brake and clutch fluids (page 10-5) will damage the systems. Mixing different fluids will also damage them.  
If the brake/clutch system frequently requires new fluid, consult an Authorized Mazda Dealer.

## Automatic Transmission Fluid (ATF)

### ▼ Inspecting Automatic Transmission Fluid Level

The automatic transmission fluid level should be inspected regularly. Measure it as described below.

The volume of fluid changes with the temperature. Fluid must be checked at idle without driving at normal operating temperature.

### **CAUTION**

- Low fluid level causes transmission slippage. Overfilling can cause foaming, loss of fluid, and transmission malfunction.
- Use specified fluid (page 10-5). A nonspecified fluid could result in transmission malfunction and failure.

1. Park on a level surface and set the parking brake firmly.
2. Idle the engine about two minutes. Push down on the brake pedal.
3. Move the shift lever through all ranges and set it at P.

# Owner Maintenance

## ⚠ WARNING

**Sudden Vehicle Movement:**  
*Shifting the shift lever without first depressing the brake pedal is dangerous. The vehicle could move suddenly and cause an accident. Make sure the brake pedal is applied before shifting the shift lever.*

4. Remove the engine cover.

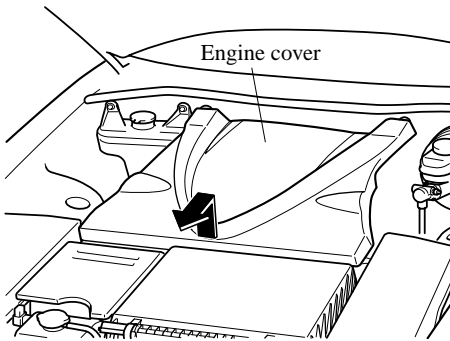

5. With the engine still idling, pull out the dipstick, wipe it clean, and put it back.  
 6. Pull it out again.  
 The proper fluid level is marked on the dipstick as follows.

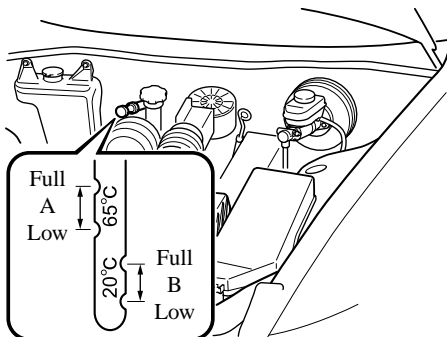

### Fluid hot scale A

When the vehicle has been driven and the fluid is at normal operating temperature, about 65°C (150°F), the level must be between Full and Low.

### Fluid cold scale B

When the engine has not been running and the outside temperature is about 20°C (70°F), the level must be between Full and Low.

## ⚠ CAUTION

- Use the cold scale only as a reference.
- If outside temperature is lower than about 20°C (70°F), start the engine and inspect the fluid level after the engine reaches operating temperature.
- If the vehicle has been driven for an extended period at high speeds or in city traffic in hot weather, inspect the level only after stopping the engine and allowing the fluid to cool for 30 minutes.

Fully insert the dipstick. When adding fluid, inspect with the dipstick to make sure it doesn't pass full.

### NOTE

- Inspect the fluid on both sides of the dipstick in a well lit area for an accurate reading.
- Verify that the engine cover is securely installed.

# Owner Maintenance

## Washer Fluid

### ▼ Inspecting Washer Fluid Level

#### **! WARNING**

##### Substitute Washer Fluid:

*Using radiator antifreeze as washer fluid is dangerous. If sprayed on the windshield, it will dirty the windshield, affect your visibility, and could result in an accident. Use only windshield washer fluid or plain water in the reservoir.*

##### Using Washer Fluid Without Anti-freeze Protection in Cold Weather:

*Operating your vehicle in temperatures below 4 degrees C (40 degrees F) using washer fluid without anti-freeze protection is dangerous as it could cause impaired windshield vision and result in an accident. In cold weather, always use washer fluid with anti-freeze protection.*

#### **NOTE**

State or local regulations may restrict the use of volatile organic compounds (VOCs), which are commonly used as anti-freeze agents in washer fluid. A washer fluid with limited VOC content should be used only if it provides adequate freeze resistance for all regions and climates in which the vehicle will be operated.

Inspect fluid level in the washer fluid reservoir; add fluid if necessary.

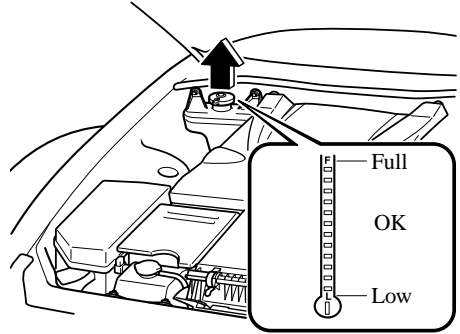

Use plain water if washer fluid is unavailable.

But use only washer fluid in cold weather to prevent it from freezing.

# Owner Maintenance

## Body Lubrication

All moving points of the body, such as door and hood hinges and locks, should be lubricated each time the engine oil is changed. Use a nonfreezing lubricant on locks during cold weather.

Make sure the hood's secondary latch keeps the hood from opening when the primary latch is released.

## Air Filter

### ⚠ CAUTION

Don't drive without an air filter. This could result in excessive engine wear.

This air filter may be cleaned with compressed air and reused, or replaced, depending on its condition. Unless it is very dirty, simply shake it to remove foreign particles. Each time you inspect it, wipe inside the air cleaner housing with a damp cloth.

### ▼ Replacing the Air Filter

#### NOTE

If the vehicle is operated in very dusty or sandy areas, replace the filter more often than recommended intervals.

1. Make sure the ignition switch is turned off.
2. Disconnect the electrical connector.

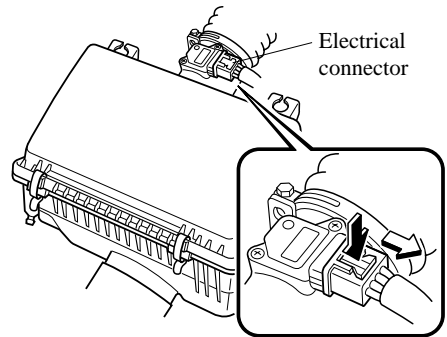

# Owner Maintenance

3. Unfasten the clamps.

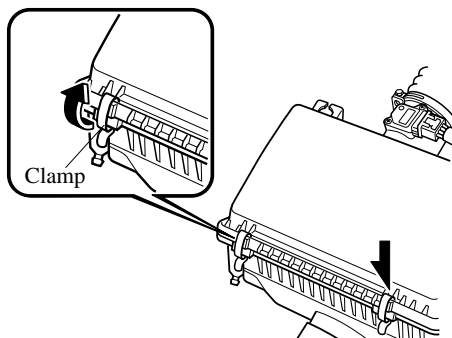

4. Lift off the air filter cover and remove the filter.

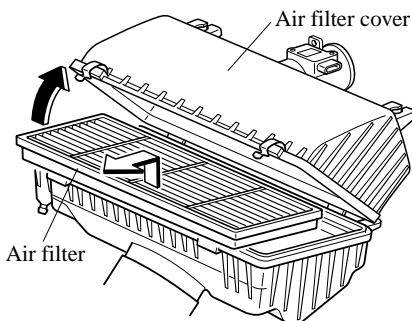

5. Wipe inside the air cleaner housing with a damp cloth.
6. Clean or replace the filter.
7. Install in the reverse order of removal.

Replace the filter according to Scheduled Maintenance (page 8-3).

### NOTE

After installing the air filter cover, make sure the electrical connector is securely connected.

## Wiper Blades

### ⚠ CAUTION

- Hot waxes applied by automatic car washers have been known to affect the wiper's ability to clean windows.
- To prevent damage to the wiper blades, don't use gasoline, kerosene, paint thinner, or other solvents on or near them.

Contamination of either the windshield or the blades with foreign matter can reduce wiper effectiveness. Common sources are insects, tree sap, and hot wax treatments used by some commercial car washes.

If the blades are not wiping properly, clean the window and blades with a good cleaner or mild detergent; then rinse thoroughly with clean water. Repeat if necessary.

### ▼ Replacing Windshield Wiper Blades

When the wipers no longer clean well, the blades are probably worn or cracked. Replace them.

### ⚠ CAUTION

To prevent damage to the wiper arms and other components, don't move the wipers by hand.

# Owner Maintenance

## NOTE

To prevent damage to the wiper arm blades when raising both the driver and passenger side wiper arms, raise the driver side wiper arm first. Conversely, when setting down the wiper arms, set the passenger side wiper arm down first.

1. Raise the wiper arm and turn the blade assembly to expose the plastic locking clip. Compress the clip and slide the assembly downward; then lift it off the arm.

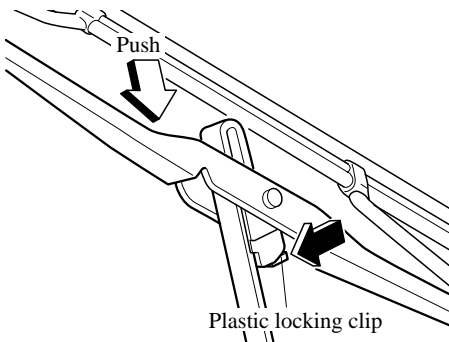

## ⚠ CAUTION

To prevent damage to the windshield, don't let the wiper arm fall on it.

2. Hold the end of the rubber and pull until the tabs are free of the metal support.

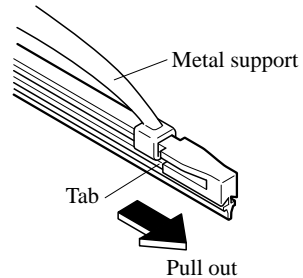

3. Remove the metal stiffeners from the blade rubber and install them in new blades.

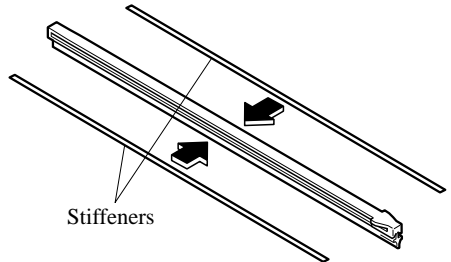

# Owner Maintenance

---

## CAUTION

- Don't bend or discard the stiffeners. You need to use them again.
- If the metal stiffeners are switched, the blade's wiping efficiency could be reduced.  
So don't use the driver's side metal stiffeners on the passenger's side, or vice versa.
- Be sure to reinstall the metal stiffeners in the new blade rubber so that the curve is the same as it was in the old blade rubber.

4. Carefully insert the new blade rubber. Then install the blade assembly in the reverse order of removal.

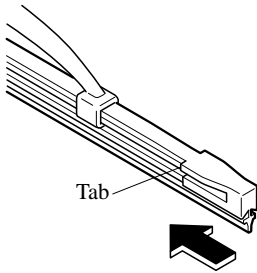

## NOTE

Install the blade so that the tabs are toward the bottom of the wiper arm.



**Battery****⚠ WARNING****Battery-Related Lead Materials:**

*Battery posts, terminals and related accessories contain lead and lead compounds, chemicals known to the State of California to cause cancer and reproductive harm. Wash hands after handling.*

**Follow These Precautions Carefully:**

*To ensure safe and correct handling of the battery, read the following precautions carefully before using the battery or inspecting it.*

**Eye Protection:**

*Working without eye protection is dangerous. Battery fluid contains **SULFURIC ACID** which could cause blindness if splashed into in your eyes. Also, hydrogen gas produced during normal battery operation, could ignite and cause the battery to explode. Always wear eye protection when working near the battery.*

**Spilled Battery Fluid:**

*Spilled battery fluid is dangerous.*

*Battery fluid contains **SULFURIC ACID** which could cause serious injuries if it gets in eyes, skin or clothing. If this happens, immediately flush your eyes with water for 15 minutes or wash your skin thoroughly and get medical attention. Wear eye protection and protective gloves to prevent contact with battery fluid.*

**Children and Batteries:**

*Allowing children to play near batteries is dangerous. Battery fluid could cause serious injuries if it gets in the eyes or on the skin. Always keep batteries out of the reach of children.*

## Owner Maintenance

---

### **WARNING**



#### **Keep Flames Away:**

*Flames and sparks near open battery cells are dangerous. Hydrogen gas, produced during normal battery operation, could ignite and cause the battery to explode. An exploding battery can cause serious burns and injuries. Keep all flames including cigarettes and sparks away from open battery cells. When working near a battery, do not allow metal tools to contact the positive (+) or negative (-) terminal of the battery. Do not allow the positive (+) terminal to contact the vehicle body.*



#### **Battery-Related Explosion:**

*Flames and sparks near open battery cells are dangerous. Hydrogen gas, produced during normal battery operation, could ignite and cause the battery to explode. An exploding battery can cause serious burns and injuries. Keep all flames, including cigarettes, and sparks away from open battery cells.*

# Owner Maintenance

## NOTE

- Remove the engine and battery covers before performing battery maintenance.

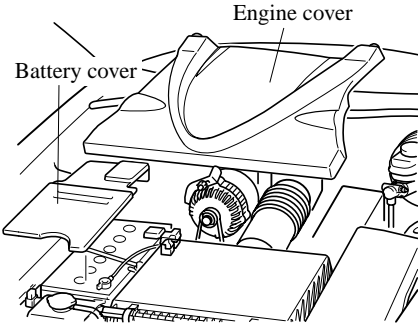

- Verify that the engine cover is securely installed.

## ▼ Battery Maintenance

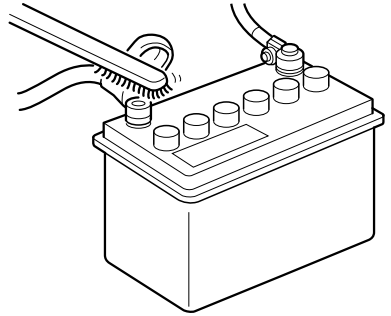

To get the best service from a battery:

- Keep it securely mounted.
- Keep the top clean and dry.
- Keep terminals and connections clean, tight, and coated with petroleum jelly or terminal grease.
- Rinse off spilled electrolyte immediately with a solution of water and baking soda.
- If the vehicle will not be used for an extended time, disconnect the battery cables.

# Owner Maintenance

## Tires

For reasons of proper performance, safety, and better fuel economy, always maintain recommended tire inflation pressures and stay within the recommended load limits and weight distribution.

### **WARNING**

#### Using Different Tire Types:

*Driving your vehicle with different types of tires is dangerous. It could cause poor handling and poor braking; leading to loss of control. Use all radial, all bias-belted, or all bias-type tires.*

#### Using Wrong-Sized Tires:

*Using any other tire size than what is specified for your Mazda (page 10-7) is dangerous. It could seriously affect ride, handling, ground clearance, tire clearance, and speedometer calibration. This could cause you to have an accident. Use only tires that are the correct size specified for your Mazda.*

### ▼ Tire Inflation Pressure

### **WARNING**

#### Incorrect Tire Inflation:

*Overinflation or underinflation of tires is dangerous. Adverse handling or unexpected tire failure could result in a serious accident. Always inflate the tires to the correct pressure (page 10-7).*

The Tire Pressure Monitoring System\* does not alleviate the need to check the tire condition every day, including whether the tires all look inflated properly. Inspect all tire pressure monthly (including the spare\*) when the tires are cold. Maintain recommended pressures for the best ride, top handling, and minimum tire wear.

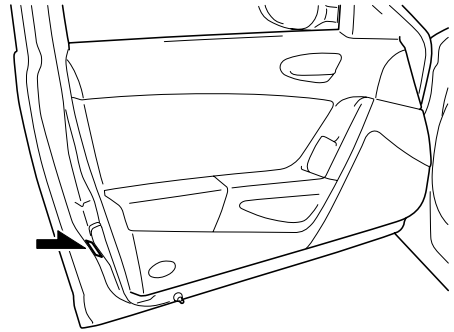

Refer to the specification charts (page 10-7).

### **NOTE**

- Always check tire pressure when tires are cold.
- Warm tires normally exceed recommended pressures. Don't release air from warm tires to adjust the pressure.
- Underinflation can cause reduced fuel economy and poor sealing of the tire bead, which will deform the wheel and cause separation of tire from rim.
- Overinflation can produce a harsh ride and a greater possibility of damage from road hazards. Keep your tire pressure at the correct levels. If one frequently needs inflating, have it inspected.

## Owner Maintenance

### ▼ Tire Rotation

To equalize tread wear, rotate the tires every 12,000 km (7,500 miles)/8,000 km\* (5,000 miles) or sooner if irregular wear develops. During rotation, inspect them for correct balance.

\* Unique driving conditions for USA, Canada and Puerto Rico

#### NOTE

Because your vehicle is not equipped with a spare tire, you cannot do a tire rotation safely with the jack that comes with your vehicle. Have an Authorized Mazda Dealer perform tire rotation.

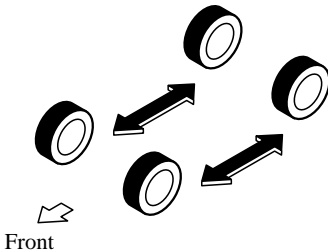

Also, inspect them for uneven wear and damage. Abnormal wear is usually caused by one or a combination of the following:

- Incorrect tire pressure
- Improper wheel alignment
- Out-of-balance wheel
- Severe braking

After rotation, inflate all tire pressures to specification (page 10-7) and inspect the lug nuts for tightness.

### ⚠ CAUTION

Rotate unidirectional tires and radial tires that have an asymmetrical tread pattern or studs only from front to rear, not from side to side. Tire performance will be weakened if rotated from side to side.

### ⚠ CAUTION

Limited-Slip Differential system; don't use the following:

- Tires not of the designated size
- Tires of different sizes or types at the same time
- Tires not sufficiently inflated

If these instructions aren't followed, the rotation of the left and right wheels will be different and will thus apply a constant load on the limited-slip differential.

This will cause a malfunction.

### ▼ Replacing a Tire

### ⚠ WARNING

#### Worn Tires:

***Driving with worn tires is dangerous. Reduced braking, steering, and traction could result in an accident. Always use tires that are in good condition.***

# Owner Maintenance

## CAUTION

### (With Tire Pressure Monitoring System)

When replacing/repairing the tires or wheels or both, have the work done by an Authorized Mazda Dealer, or the tire pressure sensors may be damaged.

## NOTE

### (With Tire Pressure Monitoring System)

- When tires with steel wire reinforcement in the sidewalls are used, the system may not function correctly even with a genuine wheel.(page 5-26)
- Be sure to install the tire pressure sensors whenever tires or wheels are replaced.(page 5-27)

If a tire wears evenly, a wear indicator will appear as a solid band across the tread. Replace the tire when this happens.

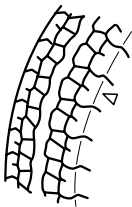

New tread

Tread wear indicator

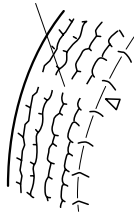

Worn tread

You should replace it before the band is across the entire tread.

## ▼ Temporary Spare Tire

Your Mazda is not equipped with a spare tire. If you require a spare tire, consult an Authorized Mazda Dealer.

Inspect the temporary spare tire at least monthly to make sure it's properly inflated and stored.

The temporary spare tire is easier to handle because of its construction. It is lighter and smaller than a conventional tire and should be used only for an emergency and only for a short distance.

Use the temporary only until the conventional tire is repaired, which should be as soon as possible.

Maintain its pressure at 420 kPa (4.2 kgf/cm<sup>2</sup> or bar, 60 psi).

## CAUTION

- Don't use your temporary spare tire rim with a snow tire or a conventional tire. Neither will properly fit and could damage both tire and rim.
- The temporary spare tire has a tread life of up to 5,000 km (3,000 miles), depending on road conditions and driving habits.
- The temporary spare tire is for limited use, however, if the tread wear solid-band indicator appears, replace the tire with the same type of temporary spare (page 8-27).

**▼ Replacing a Wheel****⚠ WARNING**

***Using a Wrong-Sized Wheel:***  
*Using a wrong-sized wheel is dangerous. Braking and handling could be affected, leading to loss of control and an accident. Always use wheels of the correct size on your vehicle.*

**⚠ CAUTION**

- A wrong-sized wheel may adversely affect:
  - Tire fit
  - Wheel and bearing life
  - Ground clearance
  - Snow-chain clearance
  - Speedometer calibration
  - Headlight aim
  - Bumper height
  - Tire Pressure Monitoring System
  - Limited-Slip Differential System
- **(With Tire Pressure Monitoring System)**
  - When replacing/repairing the tires or wheels or both, have the work done by an Authorized Mazda Dealer, or the tire pressure sensors may be damaged.
  - The wheels equipped on your Mazda are specially designed for installation the tire pressure sensors. Do not use non-genuine wheels, otherwise it may not be possible to install the tire pressure sensors.

**NOTE**

Be sure to install the tire pressure sensors whenever tires or wheels are replaced.(page 5-27)

When replacing a wheel, make sure the new one is the same as the original factory wheel in diameter, rim width, and offset.

Proper tire balancing provides the best riding comfort and helps reduce tread wear. Out-of-balance tires can cause vibration and uneven wear, such as cupping and flat spots.

# Owner Maintenance

## Light Bulbs

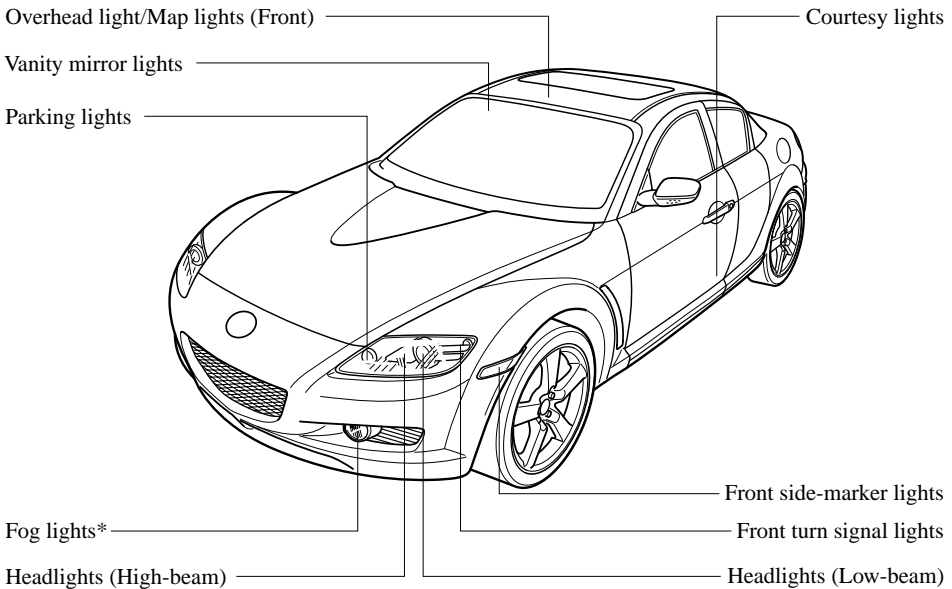
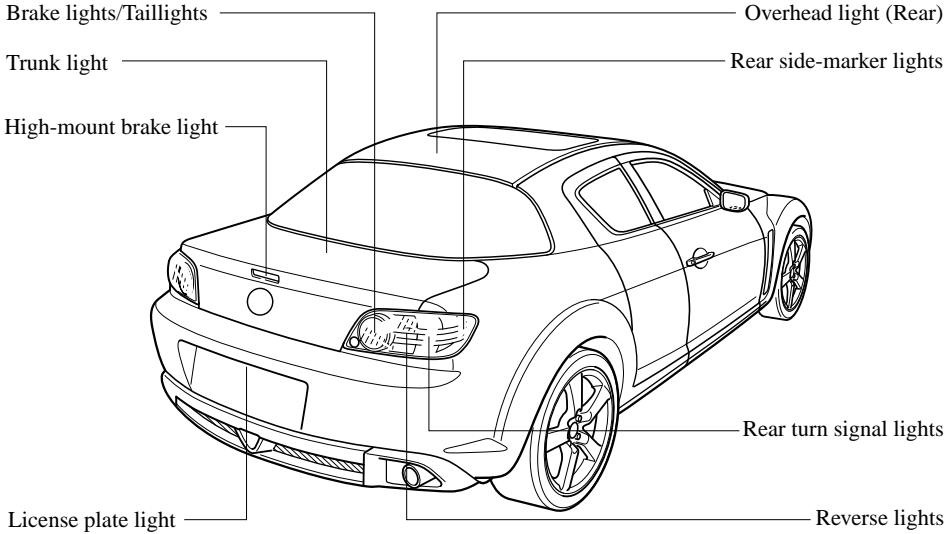



Your Mazda's headlights and fog lights have replaceable halogen bulbs.

## **WARNING**

**Xenon Fusion Bulb Replacement:**  
*Replacing the xenon fusion bulbs by yourself is dangerous. Because the xenon fusion bulbs require high voltage, you could receive an electric shock if the bulbs are handled incorrectly. Do not replace the xenon fusion bulbs by yourself. Consult an Authorized Mazda Dealer when the replacement is necessary.*

**Handling Halogen Bulbs:**  
*When a halogen bulb breaks, it is dangerous. These bulbs contain pressurized gas. If one is broken, it will explode and serious injuries could be caused by the flying glass. If the glass portion is touched with bare hands, body oil could cause the bulb to overheat and explode when lit. Never touch the glass portion of the bulb with your bare hands and always wear eye protection when handling or working around halogen bulbs.*

**Children and Halogen Bulbs:**  
*Playing with a halogen bulb is dangerous. Serious injuries could be caused by dropping a halogen bulb or breaking it some other way. Always keep halogen bulbs out of the reach of children.*

## ▼ Replacing a Headlight Bulb

1. Make sure the ignition switch is turned off and the headlight switch is off.
2. Lift the hood and find the high and low beam bulbs in the rear of the headlight unit.  
 The outboard bulb is the LOW beam, and the inboard one is the HIGH beam.(page 8-30)
3. If you are changing the right headlight bulb, start the engine, turn the steering wheel all the way to the right, and turn off engine. If you are changing the left headlight bulb, turn the steering wheel to the left.
4. Turn the center section of the plastic retainer counterclockwise and remove the retainers and partially peel back the mudguard.

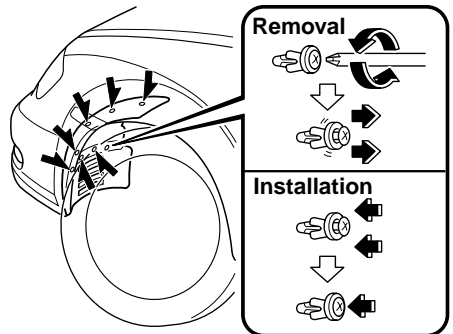

# Owner Maintenance

## High-beam bulb

1. Turn the socket and bulb assembly counterclockwise and remove it. Carefully remove the headlight bulb from its socket in the reflector by gently pulling it straight backward out of the socket.
2. Disconnect the bulb from the electrical connector by pressing the tab on the connector with your finger and pulling the bulb upward.

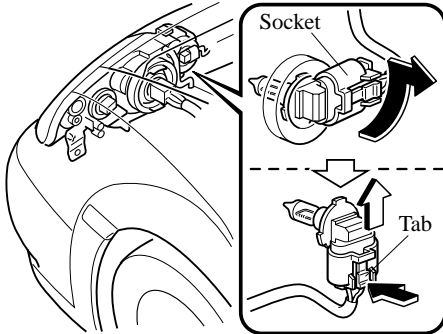

3. Install the new bulb in the reverse order of removal.

### NOTE

Use the protective cover and carton of the replacement bulb to dispose of the old bulb promptly out of the reach of children.

## Low-beam bulb

### (Xenon fusion bulb)

You cannot replace the low beam bulbs by yourself.

The bulbs must be replaced at an Authorized Mazda Dealer.

### (Halogen bulbs)

1. Detach the electrical connector from the sealing cover by pulling it to the rear.

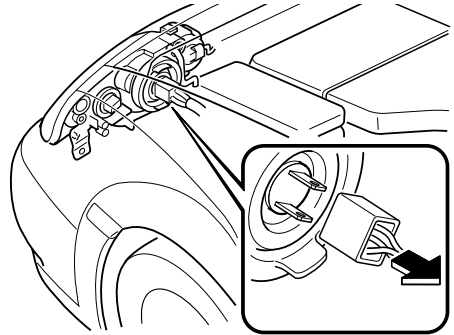

2. Detach the sealing cover from the bulb.
3. Unhook the bulb retaining spring.

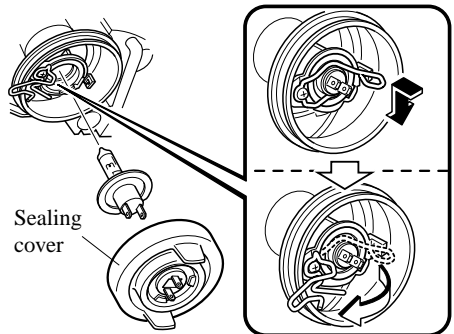

4. Swing the retaining spring out and away to free the headlight bulb.

- Carefully remove the headlight bulb from the socket by pulling it straight back.
- Replace the bulb.
- Install the new bulb in the reverse order of removal.

## NOTE

Use the protective cover and carton of the replacement bulb to dispose of the old bulb promptly out of the reach of children.

### ▼ Replacing a Fog Light Bulb\*

Due to the complexity and difficulty of the procedure, the bulbs should be replaced by an Authorized Mazda Dealer.

### ▼ Replacing a Bulb (Front)

- If you are changing the right bulb, start the engine, turn the steering wheel all the way to the right, and turn off engine. If you are changing the left bulb, turn the steering wheel to the left.
- Turn the center section of the plastic retainer counterclockwise and remove the retainers and partially peel back the mudguard.

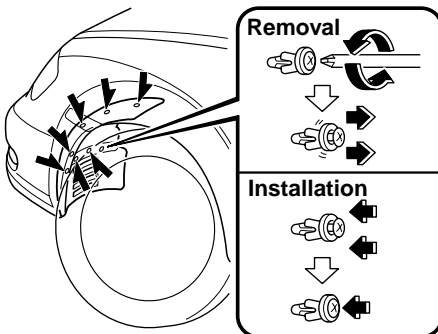

### Front turn signal lights, Parking lights, Front side-marker lights

- Turn the socket and bulb assembly counterclockwise and remove it.
- Disconnect the bulb from the socket.

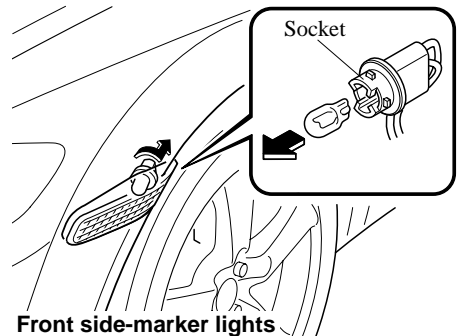
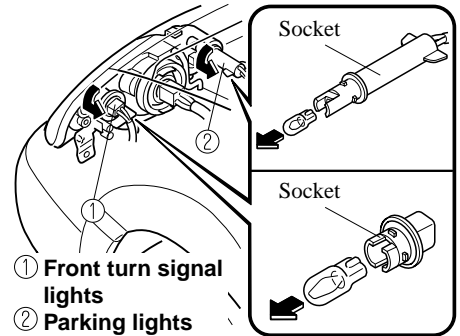

- Install the new bulb in the reverse order of removal.

# Owner Maintenance

## ▼ Replacing a Bulb (Interior)

### Overhead light/Map lights (Front)

1. Remove the screws with a Phillips screwdriver.
2. Wrap a flathead screwdriver with a soft cloth to prevent damage to the trim and gently insert it in the overhead light as shown in the figure, and then remove the overhead light unit.

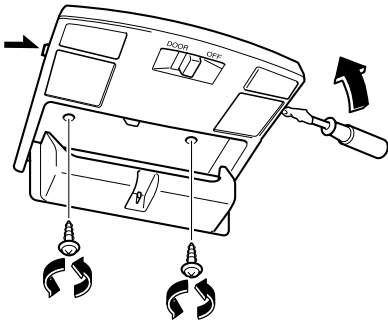

3. Turn the socket and bulb assembly counterclockwise and remove it.
4. Disconnect the bulb from the socket.

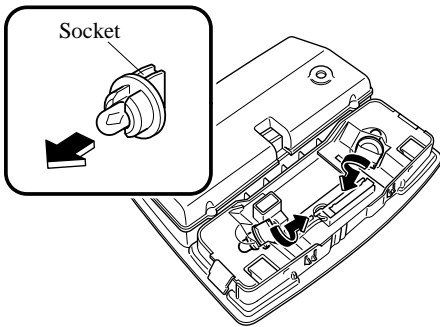

5. Install the new bulb in the reverse order of removal.

### Overhead light (Rear), Courtesy lights, Vanity mirror lights

1. Wrap a small flathead screwdriver with a soft cloth to prevent damage to the lens and remove the lens by carefully prying on the edge of the lens with the screwdriver.
2. Disconnect the bulb by pulling it out.

#### Overhead light (Rear)

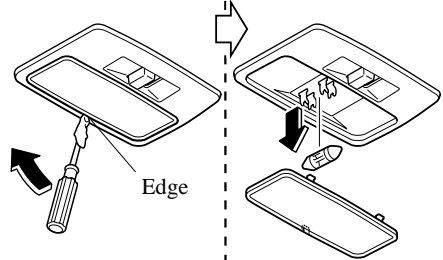

#### Courtesy lights

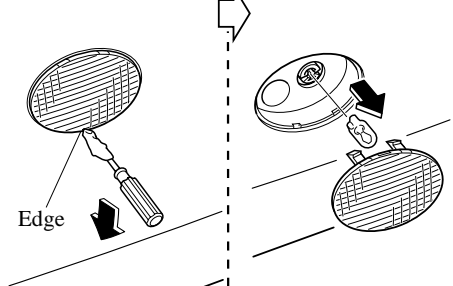

#### Vanity mirror lights

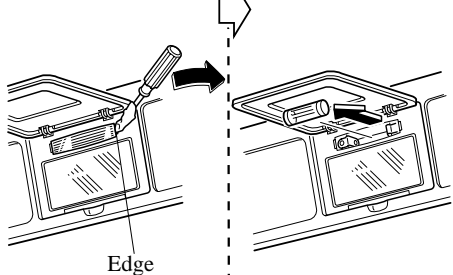

# Owner Maintenance

3. Install the new bulb in the reverse order of removal.

## Trunk light

1. Press both sides of the lens cap to remove it.
2. Disconnect the bulb by pulling it out.

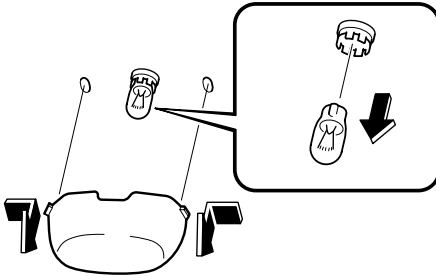

3. Install the new bulb in the reverse order of removal.

## ▼ Replacing a Bulb (Rear)

### Rear turn signal lights, Brake lights/ Taillights, Reverse lights

1. Pull the center section of the plastic retainer and remove the retainers and partially open the trunk side trim.

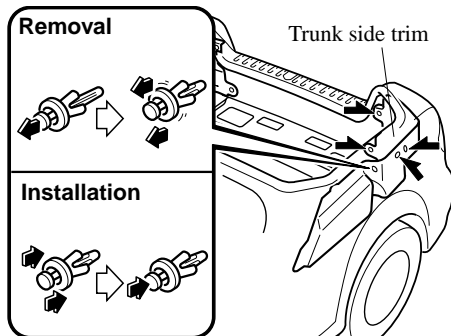

2. Turn the socket and bulb assembly counterclockwise and remove it.
3. Disconnect the bulb from the socket.

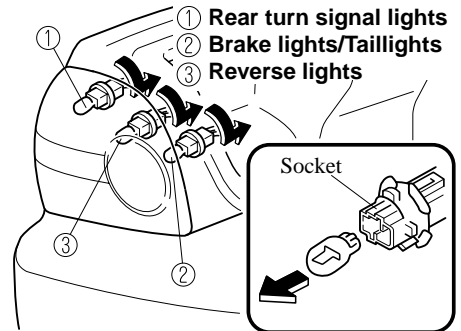

4. Install the new bulb in the reverse order of removal.

### Rear side-marker lights

Due to the complexity and difficulty of the procedure, the bulbs should be replaced by an Authorized Mazda Dealer.

### High-mount brake light

1. Turn the center section of the plastic retainer counterclockwise and remove the retainers and trunk rear trim.

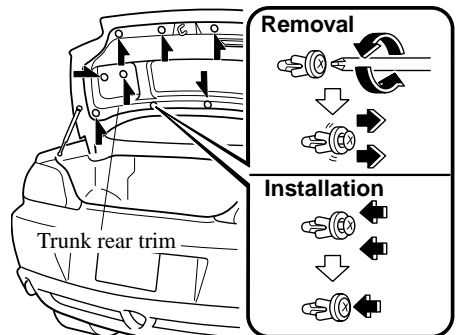

2. Turn the socket and bulb assembly counterclockwise and remove it.

# Owner Maintenance

3. Disconnect the bulb from the socket.

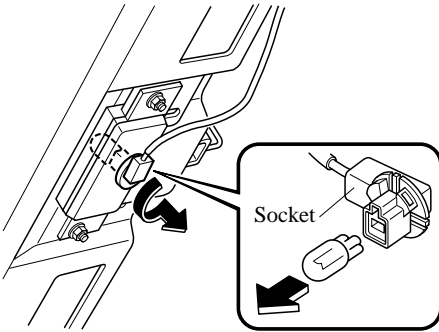

4. Install the new bulb in the reverse order of removal.

## License plate light

1. Press the front of the lens to detach the front tabs.
2. Wrap a flathead screwdriver with a soft cloth to prevent damage to the lens and remove the lens by carefully prying on the edge of the lens with a flathead screwdriver.
3. Disconnect the bulb by pulling it out.

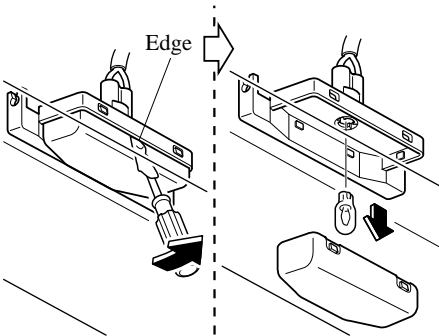

4. Install the new bulb in the reverse order of removal.

## Fuses

Your vehicle's electrical system is protected by fuses.

If any lights, accessories, or controls don't work, inspect the appropriate circuit protector. If a fuse has blown, the inside element will be melted.

If the same fuse blows again, avoid using that system and consult an Authorized Mazda Dealer as soon as possible.

### ▼ Fuse Replacement

#### Replacing the fuses on the driver's side

If the electrical system doesn't work, first inspect fuses on the driver's side.

1. Turn off the ignition switch and other switches.
2. Open the fuse panel cover.

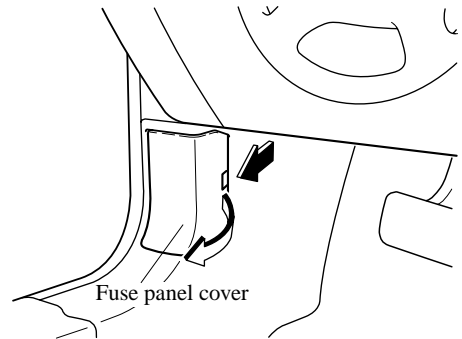

# Owner Maintenance

- Pull the fuse straight out with the fuse puller provided on the inside of the engine compartment fuse block cover.

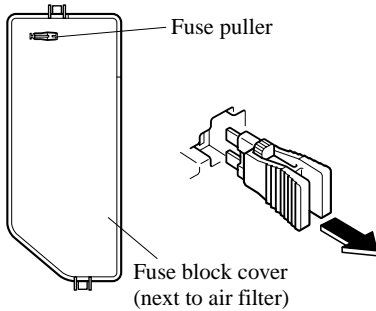

- Inspect it and replace if it's blown.

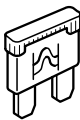

Normal



Blown

- Push in a new fuse of the same amperage rating, and make sure it fits tightly. If it doesn't, have an Authorized Mazda Dealer install it. If you have no spare fuses, borrow one of the same rating from a circuit not essential to vehicle operation, such as the AUDIO or CIGAR circuit.

## ⚠ CAUTION

Always replace a fuse with one of the same rating. Otherwise you may damage the electric system.

## Replacing the fuses under the hood

If the headlights or other electrical components don't work and the fuses in the cabin are OK, inspect the fuse block under the hood. If a fuse is blown, it must be replaced. Follow these steps:

- Turn off the ignition switch and all other switches.
- Remove the fuse block cover.

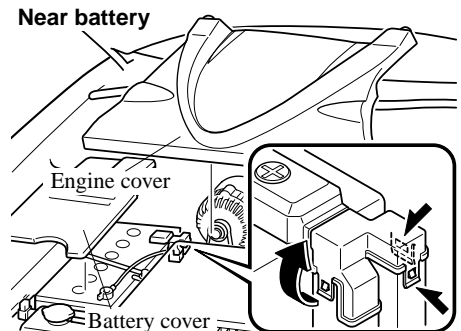
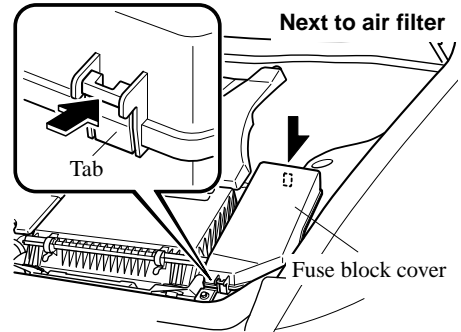

## NOTE

Remove the engine and battery covers before removing the fuse block cover near the battery.

## Owner Maintenance

---

3. If a fuse is blown, replace it with a new one **of the same amperage rating** .

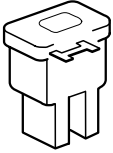

Normal

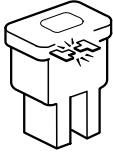

Blown

NOTE
<ul style="list-style-type: none"><li>• To replace the MAIN fuse, contact an Authorized Mazda Dealer (page 8-39).</li><li>• Verify that the engine cover is securely installed.</li></ul>

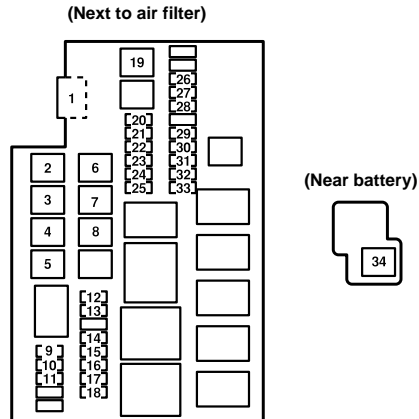

**▼ Fuse Panel Description****Fuse block (Engine compartment)**

DESCRIPTION	FUSE RATING	PROTECTED COMPONENT
1	120A	For protection of all circuits
2	40A	Heater
3	60A	Air pump
4	30A	Power windows, Power door locks, Illuminated entry system, Moonroof*
5	50A	Rear window defroster
6	40A	Electric fan
7	60A	ABS, DSC*
8	30A	Lighter, Power control mirror, Accessory socket, Audio system

DESCRIPTION	FUSE RATING	PROTECTED COMPONENT
9	15A	Headlight high beams*, Headlight cleaner*
10	15A	Headlight low beam (RH)
11	15A	Headlight low beam (LH)
12	15A	DRL* (Headlight high beams)
13	30A	DSC*
14	20A	Seat warmer*
15	20A	Headlight cleaner*
16	10A	—
17	15A	Fog lights*
18	10A	Air conditioner

# Owner Maintenance

---

DESCRIPTION		FUSE RATING	PROTECTED COMPONENT
19	IG	30A	For protection of various circuits
20	IG KEY	15A	For protection of various circuits
21	STOP	15A	Brake lights
22	FUEL PUMP	20A	Fuel pump
23	HORN	15A	Horn
24	HAZARD	15A	Hazard warning flashers, Turn signals
25	ETV	15A	Electric throttle valve
26	WIPER	20A	Windshield wiper and washer
27	P.WIND	20A	Power windows
28	ENGINE	15A	Engine control system, Supplemental restraint system, ABS, Power steering
29	TAIL	10A	Taillights, License plate light, Parking lights, Front side-maker lights, Rear side-marker lights
30	ILLUMI	10A	Illuminated entry system
31	EGI COMP1	10A	Engine control system
32	EGI COMP2	10A	Engine control system
33	EGI INJ	15A	Fuel injector
34	EPS	60A	Power steering

# Owner Maintenance

## Fuse panel (Driver's side)

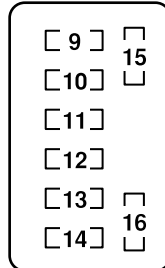
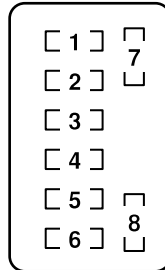

DESCRIPTION	FUSE RATING	PROTECTED COMPONENT	
1	CIGAR	15A	Lighter
2	ACC	7.5A	Audio system, Power control mirror
3	AUX PWR	20A	Accessory socket
4	A/C	7.5A	Air conditioner
5	—	—	—
6	—	—	—
7	SPARE	7.5A	—
8	SPARE	20A	—
9	M.DEF	10A	Mirror defroster*
10	DSC	7.5A	DSC*
11	AUDIO	20A	Audio system*
12	D.LOCK	30A	Power door locks, Moonroof*
13	P.WIND	30A	Power windows
14	ROOM	15A	Interior lights
15	SPARE	15A	—
16	SPARE	10A	—

## Appearance Care

---

### How to Minimize Environmental Paint Damage

The paintwork on your Mazda represents the latest technical developments in composition and methods of application.

Environmental hazards, however, can harm the paint's protective properties, if proper care is not taken.

Here are some examples of possible damage, with tips on how to prevent them.

#### ▼ Etching Caused by Acid Rain or Industrial Fallout

##### Occurrence

Industrial pollutants and vehicle emissions drift into the air and mix with rain or dew to form acids. These acids can settle on a vehicle's finish. As the water evaporates, the acid becomes concentrated and can damage the finish.

And the longer the acid remains on the surface, the greater the chance is for damage.

##### Prevention

It is necessary to wash and wax your vehicle to preserve its finish according to the instructions in this section. These steps should be taken immediately after you suspect that acid rain has settled on your vehicle's finish.

#### ▼ Damage Caused by Bird Dropping, Insects, or Tree Sap

##### Occurrence

Bird droppings contain acids. If these aren't removed they can eat away the clear and color base coat of the vehicle's paintwork.

When insects stick to the paint surface and decompose, corrosive compounds form. These can erode the clear and color base coat of the vehicle's paintwork if they are not removed.

Tree sap will harden and adhere permanently to the paint finish. If you scratch the sap off while it is hard, some vehicle paint could come off with it.

##### Prevention

It is necessary to have your Mazda washed and waxed to preserve its finish according to the instructions in this section. This should be done as soon as possible.

Bird droppings can be removed with a soft sponge and water. If you are traveling and these are not available, a moistened tissue may also take care of the problem. The cleaned area should be waxed according to the instructions in this section.

Insects and tree sap are best removed with a soft sponge and water or a commercially available chemical cleaner.

Another method is to cover the affected area with dampened newspaper for one to two hours. After removing the newspaper, rinse off the loosened debris with water.

**▼ Water Marks****Occurrence**

Rain, fog, dew, and even tap water can contain harmful minerals such as salt and lime. If moisture containing these minerals settles on the vehicle and evaporates, the minerals will concentrate and harden to form white rings. The rings can damage your vehicle's finish.

**Prevention**

It is necessary to wash and wax your vehicle to preserve its finish according to the instructions in this section. These steps should be taken immediately after you find water marks on your vehicle's finish.

**▼ Paint Chipping****Occurrence**

Paint chipping occurs when gravel thrown in the air by another vehicle's tires hits your vehicle.

**How to avoid paint chipping**

Keeping a safe distance between you and the vehicle ahead reduces the chances of having your paint chipped by flying gravel.

**NOTE**

- The paint chipping zone varies with the speed of the vehicle. For example, when traveling at 90 km/h (56 mph), the paint chipping zone is 50 m (164 ft).
- In low temperatures a vehicle's finish hardens. This increases the chance of paint chipping.
- Chipped paint can lead to rust forming on your Mazda. Before this happens, repair the damage by using Mazda touch-up paint according to the instructions in this section. Failure to repair the affected area could lead to serious rusting and expensive repairs.

# Appearance Care

## Exterior Care

Follow **all** label and container directions when using a chemical cleaner or polish. Read all warnings and cautions.

### ▼ Maintaining the Finish

#### Washing

To help protect the finish from rust and deterioration, wash your Mazda thoroughly and frequently, at least once a month, with lukewarm or cold water.

If the vehicle is washed improperly, the paint surface could be scratched. Here are some examples of how scratching could occur.

Scratches occur on the paint surface when:

- The vehicle is washed without first rinsing off dirt and other foreign matter.
- The vehicle is washed with a rough, dry, or dirty cloth.
- The vehicle is washed at a car wash that uses brushes that are dirty or too stiff.
- Cleansers or wax containing abrasives are used.

#### NOTE

- Mazda is not responsible for scratches caused by automatic car washes or improper washing.
- Scratches are more noticeable on vehicles with darker paint finishes.

To minimize scratches on the vehicle's paint finish:

- Rinse off any dirt or other foreign matter using lukewarm or cold water before washing.
- Use plenty of lukewarm or cold water and a soft cloth when washing the vehicle. Do not use a nylon cloth.
- Rub gently when washing or drying the vehicle.
- Take your vehicle only to a car wash that keeps its brushes well maintained.
- Don't use abrasive cleansers or wax that contain abrasives.

#### CAUTION

Don't use steel wool, abrasive cleaners, or strong detergents containing highly alkaline or caustic agents on chrome-plated or anodized aluminum parts. This may damage the protective coating; also, cleaners and detergents may discolor or deteriorate the paint.

## Appearance Care

Pay special attention to removing salt, dirt, mud, and other foreign material from the underside of the fenders, and make sure the drain holes in the lower edges of the doors and rocker panels are clean.

Insects, tar, tree sap, bird droppings, industrial fallout, and similar deposits can damage the finish if not removed immediately. When prompt washing with plain water is ineffective, use a mild soap made for use on vehicles.

Thoroughly rinse off all soap with lukewarm or cold water. Don't allow soap to dry on the finish.

After washing the vehicle, dry it with a clean chamois to prevent water spots from forming.



### WARNING

#### **Driving with Wet Brakes:**

***Driving with wet brakes is dangerous. Increased stopping distance or the vehicle pulling to one side when braking could result in a serious accident. Light braking will indicate whether the brakes have been affected. Dry the brakes by driving very slowly and applying the brakes lightly until brake performance is normal.***

### **Waxing**

Your vehicle needs to be waxed when water no longer beads on the finish. Always wash and dry the vehicle before waxing it. In addition to the vehicle body, wax the metal trim to maintain its luster.

1. Use wax which contains no abrasives. Waxes containing abrasive will remove paint and could damage bright metal parts.
2. Use a good grade of natural wax for metallic, mica, and solid colors.
3. When waxing, coat evenly with the sponge supplied or a soft cloth.
4. Wipe off the wax with a soft cloth.

### **NOTE**

A spot remover to remove oil, tar, and similar materials will usually also take off the wax. Rewax these areas even if the rest of the vehicle doesn't need it.

### **▼ Repairing Damage to the Finish**

Deep scratches or chips on the finish should be repaired promptly. Exposed metal quickly rusts and can lead to major repairs.



### CAUTION

If your Mazda is damaged and needs metal parts repaired or replaced, make sure the body shop applies anti-corrosion materials to all parts, both repaired and new. This will prevent them from rusting.

## Appearance Care

---

### ▼ Bright-Metal Maintenance

- Use tar remover to remove road tar and insects. Never do this with a knife or similar tool.
- To prevent corrosion on bright-metal surfaces, apply wax or chrome preservative and rub it to a high luster.
- During cold weather or in coastal areas, cover bright-metal parts with a coating of wax or preservative heavier than usual. It would also help to coat them with noncorrosive petroleum jelly or some other protective compound.

#### CAUTION

Don't use steel wool, abrasive cleaners, or strong detergents containing highly alkaline or caustic agents on chrome-plated or anodized aluminum parts. This may result in damage to the protective coating and cause discoloration or paint deterioration.

### ▼ Underbody Maintenance

Road chemicals and salt used for ice and snow removal and solvents used for dust control may collect on the underbody. If not removed, they will speed up rusting and deterioration of such underbody parts as fuel lines, frame, floor pan, and exhaust system, even though these parts may be coated with anti-corrosive material.

Thoroughly flush the underbody and wheel housings with lukewarm or cold water at the end of each winter. Try also to do this every month.

Pay special attention to these areas because they easily hide mud and dirt. **It will do more harm than good to wet down the road grime without removing it.**

The lower edges of doors, rocker panels, and frame members have drain holes that should not be clogged. Water trapped there will cause rusting.

#### WARNING

***Driving with Wet Brakes:***  
***Driving with wet brakes is dangerous. Increased stopping distance or the vehicle pulling to one side when braking could result in a serious accident. Light braking will indicate whether the brakes have been affected. Dry the brakes by driving very slowly and applying the brakes lightly until brake performance is normal.***



## Appearance Care

### ▼ Aluminum Wheel Maintenance

A protective coating is provided over the aluminum wheels. Special care is needed to protect this coating.

#### NOTE

- Don't use a wire brush or any abrasive cleaner, polishing compound, or solvent on aluminum wheels. They may damage the coating.
- Only use a mild soap or neutral detergent and always use a sponge or soft cloth to clean the wheels. Rinse thoroughly with lukewarm or cold water. Also, be sure to clean the wheels after driving on dusty or salted roads. This helps prevent corrosion.
- Avoid washing your vehicle in an automatic car wash that uses high-speed or hard brushes.
- If your aluminum wheels lose luster, wax the wheels.

### Interior Care

#### ▼ Dashboard Precautions

Prevent caustic solutions such as perfume and cosmetic oils from contacting the dashboard. They'll damage and discolor it. If these solutions get on the dashboard, wipe them off immediately.

#### CAUTION

Do not use glazing agents. Glazing agents contain ingredients which may cause discoloration, wrinkling, cracks and peeling.

#### ▼ Cleaning the Upholstery and Interior Trim

##### Vinyl

Remove dust and loose dirt from vinyl with a whisk broom or vacuum cleaner. Clean vinyl with a leather-and-vinyl cleaner.

##### Leather\*

Real leather isn't uniform and may have scars, scratches, and wrinkles. Clean it with a leather cleaner or mild soap.

If the leather gets wet from rain, remove the moisture as soon as possible and dry in a shaded area.

If the seats get wet, promptly remove moisture with a dry cloth and allow it to further dry in a shaded area.

If moisture is not removed, it will cause hardening and shrinkage of the leather. Do not leave vinyl products on the seats for long periods as they may affect the leather quality and coloring.

## Appearance Care

---

### **Fabric\***

Remove dust and loose dirt from fabric with a whisk broom or vacuum cleaner. Clean it with a mild soap solution good for upholstery and carpets. Remove fresh spots immediately with a fabric spot cleaner.

To keep the fabric looking clean and fresh, take care of it. Otherwise its color will be affected, it can be stained easily, and its fire-resistance may be reduced.

 <b>CAUTION</b>
--

Use only recommended cleaners and procedures. Others may affect appearance and fire-resistance.
---

### **Suede-like material\***

Stains which are not treated immediately will be difficult to remove later, and may cause fading or discoloration. Remove stains as soon as possible.

**To clean**, wipe with a soft, damp cloth. Then buff with a soft, dry cloth.

If stains cannot be removed, using plain water, try wiping with soapy water or a mild detergent.

 <b>CAUTION</b>
--

Don't clean the suede with leather cleaner, a detergent, or soap. It will cause discoloration.
--

**To dry away any water**, wipe with a soft, dry cloth.

 <b>CAUTION</b>
--

Sharp or pointed metal objects can damage the suede beyond repair.
--

### **Piano black panel**

The center panel and door switch panels have been treated with a special coating that resists scratching.

When the panel needs to be cleaned, use a soft cloth to wipe off dirt from the surface.

<b>NOTE</b>
-------------

Scratches or nicks on the center and door switch panels resulting from the use of a hard brush or cloth may not be repairable.
--

### ▼ Cleaning the Lap/Shoulder Belt Webbing

Clean the webbing with a mild soap solution recommended for upholstery or carpets. Follow instructions. Don't bleach or dye the webbing; this may weaken it.

After cleaning the belts, thoroughly dry the belt webbing and make sure there is no remaining moisture before retracting them.

#### **WARNING**

***Damaged Seat Belt:***  
*Using damaged seat belts is dangerous. In a collision, damaged belts cannot provide adequate protection. Have an Authorized Mazda Dealer replace damaged belts immediately.*

### ▼ Cleaning the Window Interiors

If the windows become covered with an oily, greasy, or waxy film, clean them with glass cleaner. Follow the directions on the container.

#### **CAUTION**

- Don't scrape or scratch the inside of the rear window. You may damage the rear window defroster grid.
- When washing the inside rear window, use a soft cloth dampened in lukewarm water, gently wiping the antenna lines.  
Use of glass cleaning products could damage the antenna.



## Customer Information and Reporting Safety Defects

Important consumer information including warranties and add-on equipment.

<b>Customer Assistance</b> .....	9-2
Customer Assistance (U.S.A.) .....	9-2
Customer Assistance (Canada) .....	9-3
Customer Assistance (Puerto Rico) .....	9-6
<b>Mazda Importer/Distributors</b> .....	9-7
Importer/Distributor .....	9-7
Distributor in Each Area .....	9-7
<b>Warranty</b> .....	9-8
Warranties for Your Mazda .....	9-8
Outside the United States .....	9-9
Outside Canada .....	9-10
Registering Your Vehicle in A Foreign Country (Except United States and Canada) .....	9-11
Add-On Non-Genuine Parts and Accessories .....	9-12
<b>Cell Phones</b> .....	9-13
Cell Phones Warning .....	9-13
<b>Type Approval of Equipment</b> .....	9-14
Type Approval of Equipment .....	9-14
<b>Uniform Tire Quality Grading System (UTQGS)</b> .....	9-15
Uniform Tire Quality Grading System (UTQGS) .....	9-15
<b>Reporting Safety Defects</b> .....	9-17
Reporting Safety Defects .....	9-17
<b>Service Publications</b> .....	9-18
Service Publications .....	9-18

## Customer Assistance

---

### Customer Assistance (U.S.A.)

Your complete and permanent satisfaction is our business. We are here to serve you. All Authorized Mazda Dealers have the knowledge and the tools to keep your Mazda vehicle in top condition.

If you have any questions or recommendations for improvement regarding the service of your Mazda vehicle or servicing by Mazda Dealer personnel, we recommend that you take the following steps:

#### ▼ STEP 1: Contact Your Mazda Dealer

Discuss the matter with an Authorized Mazda Dealer. This is the quickest and best way to address the issue. If your concern has not been resolved by the CUSTOMER RELATIONS, SALES, SERVICE, or PARTS MANAGER, then please contact the GENERAL MANAGER of the dealership or the OWNER.

#### ▼ STEP 2: Contact Mazda North American Operations

If for any reason you feel the need for further assistance after contacting your dealership management, you can reach Mazda North American Operations by one of three ways.

**Log on at: [www.mazdausa.com](http://www.mazdausa.com)**

**Answers to many questions, including how to locate or contact a local Mazda dealership in the U.S., can be found here. You can also send e-mail to Mazda by clicking "contact" at this site.**

By phone at: 1 (800) 222-5500

By letter at:

Attn: Customer Assistance

Mazda North American Operations  
7755 Irvine Center Drive  
Irvine, CA 92618-2922  
P.O. Box 19734  
Irvine, CA 92623-9734

In order to serve you efficiently and effectively, please help us by providing the following information:

1. Your name, address, and telephone number
2. Year and model of vehicle
3. Vehicle Identification Number (17 digits, noted on your registration or title or located on the upper driver's side corner of the dash)
4. Purchase date and current mileage
5. Your dealer's name and location
6. Your question(s)

If you live outside the U.S.A., please contact your nearest Mazda Distributor.

## Customer Assistance (Canada)

### ▼ Satisfaction Review Process

Your complete and permanent satisfaction is of primary concern to Mazda. All Authorized Mazda Dealers have both the knowledge and tools to keep your Mazda in top condition. In our experience, any questions, problems, or complaints regarding the operation of your Mazda or any other general service transactions are most effectively resolved by your dealer. If the cause of your dissatisfaction cannot adequately be addressed by normal dealership procedures, we recommend that you take the following steps:

### ▼ STEP 1: Contact the Mazda Dealer

Discuss the matter with a member of dealership management. If the Service Manager has already reviewed your concerns, contact the owner of the dealership or its General Manager.

### ▼ STEP 2: Contact the Mazda Regional Office

If you feel that you still require assistance, ask the dealer Service Manager to arrange for you to meet the local Mazda Service Representative. If more expedient, contact Mazda Canada Inc. Regional Office nearest you for such arrangements. Regional Office address and phone numbers are shown (page 9-5).

### ▼ STEP 3: Contact the Mazda Customer Relations Department

If still not substantially satisfied, contact the Customer Relations Department, Mazda Canada Inc., 305 Milner Avenue, Suite 400 Scarborough, Ontario M1B 3V4 Canada TEL: 1 (800) 263-4680.

Provide the Department with the following information:

1. Your name, address and telephone number
2. Year and model of vehicle
3. Vehicle Identification Number (VIN). Refer to the "Vehicle Identification Labels" page of section 10 of this manual for the location of the VIN.
4. Purchase date
5. Present odometer reading
6. Your dealer's name and location
7. The nature of your problem and/or cause of dissatisfaction

## Customer Assistance

---

The Department, in cooperation with the local Mazda Service Representative, will review the case to determine if everything possible has been done to ensure your satisfaction.

Please recognize that the resolution of service problems in most cases requires the use of your Mazda dealer's service facilities, personnel and equipment. We urge you to follow the above three steps in sequence for most effective results.

### ▼ Mediation/Arbitration Program

Occasionally a customer concern cannot be resolved through Mazda's Customer Satisfaction Program. If after exhausting the procedures in this manual your concern is still not resolved, you have another option.

Mazda Canada Inc. participates in an arbitration program administered by the Canadian Motor Vehicle Arbitration Plan (CAMVAP). CAMVAP will advise you about how your concern may be reviewed and resolved by an independent third party through binding arbitration.

Your complete satisfaction is the goal of Mazda Canada Inc. and our dealers. Mazda's participation in CAMVAP makes a valuable contribution to our achieving that goal. There is no charge for using CAMVAP. CAMVAP results are fast, fair and final as the award is binding on both you and Mazda Canada Inc.

### ▼ Canadian Motor Vehicle Arbitration Plan (CAMVAP)

If a specific item of concern arises, where a solution cannot be reached between an owner, Mazda, and/or one of its dealers (that all parties cannot agree upon), the owner may wish to use the services offered by the Canadian Motor Vehicle Arbitration Plan (CAMVAP).

CAMVAP uses the services of Provincial Administrators to assist consumers in scheduling and preparing for their arbitration hearings. However, before you can proceed with CAMVAP you must follow your Mazda dispute resolution process as outlined previously.

CAMVAP is fully implemented in all provinces and territories.

Consumers wishing to obtain further information about the Program can obtain an information booklet from your dealer, the Provincial Administrator or the Canadian Motor Vehicle Arbitration Plan Office at the following address or telephone number.

Canadian Motor Vehicle Arbitration Office  
235 Yorkland Boulevard, suite 300  
North York, Ontario  
M2J 4Y8  
1 (800) 207-0685



## Customer Assistance

Provincial Administrators may be reached locally as listed below:

Province/Territory	CAMVAP Number
British Columbia & Yukon Territories	(604) 681-0312
Alberta & Northwest Territories	(403) 426-0650
Saskatchewan	(306) 352-9259
Manitoba	(204) 942-7166
Ontario	(416) 596-8824
Atlantic Canada	(902) 422-5413
Quebec	(418) 649-1330

### ▼ Regional Offices

REGIONAL OFFICES	AREAS COVERED
MAZDA CANADA INC. WESTERN REGION 8171 ACKROYD ROAD SUITE 2000 RICHMOND B.C. V6X 3K1 (604) 303-5670	ALBERTA, BRITISH COLUMBIA, MANITOBA, SASKATCHEWAN, YUKON
MAZDA CANADA INC. CENTRAL/ATLANTIC REGION 305 MILNER AVENUE SUITE 400 SCARBOROUGH, ONTARIO M1B 3V4 1 (800) 263-4680	ONTARIO, NEW BRUNSWICK, NOVA SCOTIA, PRINCE EDWARD ISLAND, NEWFOUNDLAND
MAZDA CANADA INC. QUEBEC REGION 6111 ROUTE TRANS CANADIENNE POINTE CLAIRE, QUEBEC H9R 5A5 (514) 694-6390	QUEBEC

## Customer Assistance

---

### Customer Assistance (Puerto Rico)

Your complete and permanent satisfaction is our business. That is why all Authorized Mazda Dealers have the knowledge and the tools to keep your Mazda vehicle in top condition.

If you have any questions or recommendations for improvement regarding the service of your Mazda vehicle or servicing by Mazda Dealer personnel, we recommend that you take the following steps:

#### ▼STEP 1

Discuss the matter with an Authorized Mazda Dealer. This is the quickest and best way to address the issue. If your concern has not been resolved by the CUSTOMER RELATIONS, SALES, SERVICE, or PARTS MANAGER, then please contact the GENERAL MANAGER of the dealership or the OWNER.

#### ▼STEP 2

If, after following STEP 1, you feel the need for further assistance, please contact your area's Mazda representative (Indicated on the next page).

Please help us by providing the following information:

1. Your name, address, and telephone number
2. Year and model of vehicle
3. Vehicle Identification Number (17 digits, noted on your registration or title or located on the upper driver's side corner of the dash)
4. Purchase date and current mileage
5. Your dealer's name and location
6. Your question(s)

## Mazda Importer/Distributors

### Importer/Distributor

#### ▼ U.S.A.

##### **Mazda North American Operations**

7755 Irvine Center Drive

Irvine, CA 92618-2922 U.S.A.

P.O. Box 19734

Irvine, CA 92623-9734 U.S.A.

TEL: 1 (800) 222-5500 (in U.S.A.)

(949) 727-1990 (outside U.S.A.)

### Distributor in Each Area

#### ▼ CANADA

##### **Mazda Canada Inc.**

305 Milner Avenue, Suite 400

Scarborough, Ontario M1B 3V4 Canada

TEL: 1 (800) 263-4680 (in Canada)

(416) 609-9909 (outside Canada)

#### ▼ PUERTO RICO

##### **Plaza Motors Corp. (Mazda de Puerto Rico)**

P.O. Box 362722, San Juan, Puerto Rico

00936-2722

TEL: (787) 641-9300

#### ▼ GUAM

##### **Triple J Motors**

157 South Marine Drive, Tamuning,

GUAM 96911 USA

P.O. Box 6066 Tamuning, Guam 96931

TEL: (671) 649-6555

#### ▼ SAIPAN

##### **Pacific International Marianas, Inc.**

**(d.b.a. Midway Motors)**

P.O. Box 887 Saipan, MP 96950

TEL: (670) 234-7524

##### **Triple J Saipan, Inc.**

**(d.b.a. Triple J Motors)**

P.O. Box 500487 Saipan, MP 96950-0487

TEL: (670) 234-7133/3051

#### ▼ AMERICAN SAMOA

##### **Polynesia Motors, Inc.**

P.O. Box 1120, Pago Pago, American

Samoa 96799

TEL: (684) 699-9347

# Warranty

---

## Warranties for Your Mazda

- New Vehicle Limited Warranty
- Distributor Major Component Limited Warranty (Canada only)
- Safety Restraint System Limited Warranty
- Anti-perforation Limited Warranty
- Federal Emission Control Warranty (U.S.A. only)
  - Emission Defect Warranty
  - Emission Performance Warranty
- California Emission Control Warranty (U.S.A. only)
- Emission Control Warranty (Canada only)
- Replacement Parts and Accessories Limited Warranty
- Tire Warranty

<b>NOTE</b>
Detailed warranty information is provided with your Mazda.

## Outside the United States

Government regulations in the United States require that automobiles meet specific emission regulations and safety standards. Therefore, vehicles built for use in the United States may differ from those sold in other countries.

The differences may make it difficult or even impossible for your vehicle to receive satisfactory servicing in other countries. We strongly recommend that you NOT take your Mazda outside the United States. However, in the event that you are moving to Canada permanently, Mazda vehicles built for use in the United States could be eligible for exportation to Canada with specific vehicle modifications to comply with the Canadian Motor Vehicle Safety requirements (CMVSS).

<b>NOTE</b>
The above is applicable for a permanent import/export situation and not related to travelers on vacation.

You may have the following problems if you do take your vehicle outside of the United States:

- Recommended fuel may be unavailable. Any kind of leaded fuel or low-octane fuel will affect vehicle performance and damage the emission controls and engine.
- Proper repair facilities, tools, testing equipment, and replacement parts may not be available.

Please refer to your Manufacturer's Warranty Booklet for more information.

# Warranty

---

## Outside Canada

Government regulations in Canada require that automobiles meet specific emission regulations and safety regulations. Therefore, vehicles built for use in Canada may differ from those sold in other countries.

The differences may make it difficult or even impossible for your vehicle to receive satisfactory servicing in other countries. We strongly recommend that you NOT take your Mazda outside Canada. However, in the event that you are moving to the United States permanently, Mazda vehicles built for use in Canada could be eligible for exportation to the United States with specific vehicle modifications to comply with the United States Federal Motor Vehicle Safety Standards (FMVSS).

<b>NOTE</b>
The above is applicable for a permanent import/export situation and not related to travelers on vacation.

The above is applicable for a permanent import/export situation and not related to travelers on vacation.

You may have the following problems if you do take your vehicle outside of Canada:

- Recommended fuel may be unavailable. Any kind of leaded fuel or low-octane fuel will affect vehicle performance and damage the emission controls and engine.
- Proper repair facilities, tools, testing equipment, and replacement parts may not be available.

Please refer to your Manufacturer's Warranty Booklet for more information.

## **Registering Your Vehicle in A Foreign Country (Except United States and Canada)**

Government regulations in your country could require that automobiles meet specific emission and safety standards.

Vehicles built for your country may differ from those built for other countries. In addition to registration problems, satisfactory service may be difficult or even impossible in another country.

The fuel specified for your vehicle may be unavailable.

Parts, servicing techniques, and tools necessary to maintain and repair your vehicle may be unavailable.

There might not be an Authorized Mazda Dealer in the country you plan to take your vehicle.

The Mazda warranty is valid only in certain countries.

## Warranty

---

### Add-On Non-Genuine Parts and Accessories

Non-genuine parts and accessories for Mazda vehicles can be found in stores. These may fit your vehicle, but they are not approved by Mazda for use with Mazda vehicles. When you install non-genuine parts or accessories, they could affect your vehicle's performance or safety system; the Mazda warranty doesn't cover this. Before you install any non-genuine parts or accessories, consult an Authorized Mazda Dealer.

#### **WARNING**

**Installation of Non-Genuine Parts or Accessories:**

***Installation of non-genuine parts or accessories is dangerous. Improperly designed parts or accessories could seriously affect your vehicle's performance or safety system. This could cause you to have an accident or increase your chances of injuries in an accident. Always consult an Authorized Mazda Dealer before you install non-genuine parts or accessories.***

**Add-On Electrical and Electronic Equipment:**

***Incorrectly choosing or installing improper add-on equipment or choosing an improper installer is dangerous. Essential systems could be damaged, causing engine stalling, air-bag (SRS) activation, ABS inactivation, or a fire in the vehicle. Be very careful in choosing and installing add-on electrical equipment, such as mobile telephones, two-way radios, stereo systems, and car alarm systems.***

Mazda assumes no responsibility for death, injury, or expenses that may result from the installation of add-on non-genuine parts or accessories.



**Cell Phones Warning** **WARNING****Use of Cell Phones and Other Devices by Driver:**

*Use of any electrical devices such as cell phones, computers, portable radios, vehicle navigation or other devices by the driver while the vehicle is moving is dangerous. Dialing a number on a cell phone while driving also ties-up the driver's hands. Use of these devices will cause the driver to be distracted and could lead to a serious accident. If a passenger is unable to use the device, pull off the right-of-way to a safe area before use. If use of a cell phone is necessary despite this warning, use a hands-free system to at least leave the hands free to drive the vehicle. Never use a cell phone or other electrical devices while the vehicle is moving and, instead, concentrate on the full-time job of driving. Please comply to the legal regulations concerning the use of communication equipment in vehicles in your country.*

# Type Approval of Equipment

---

## Type Approval of Equipment

### Immobilizer system

Type approval of the Antenna Coil Transceiver	
Country	Approval Number
<del>CDN</del>	Canada: 3043104475A5 3
<del>USA</del>	FCC ID: NT8-15607PAT3XCVR

# Uniform Tire Quality Grading System (UTQGS)

## Uniform Tire Quality Grading System (UTQGS)

This information relates to the tire grading system developed by the U.S. National Highway Traffic Safety Administration for grading tires by tread wear, traction, and temperature performance.

### ▼ Tread Wear

The tread wear grade is a comparative rating based on the wear rate of the tire when tested under controlled conditions on a specified government test course.

For example, a tire graded 150 would wear one-and-a-half times as well on the government course as a tire graded 100.

The relative performance of tires depends upon the actual conditions of their use, however, and may depart significantly from the norm because of variations in driving habits, service practices and differences in road characteristics and climate.

### ▼ Traction-AA, A, B, C

The traction grades, from highest to lowest, are AA, A, B, and C. These grades represent the tire's ability to stop on wet pavement as measured under controlled conditions on specified government test surfaces of asphalt and concrete. A tire marked C may have poor traction performance.

## **WARNING**

*The traction grade assigned to this tire is based on braking (straight ahead) traction tests and does not include acceleration cornering (turning), hydroplaning, or peak traction characteristics.*

### ▼ Temperature-A, B, C

The temperature grades A (the highest), B, and C, represent the tire's resistance to the generation of heat and its ability to dissipate heat when tested under controlled conditions on a specified indoor laboratory test wheel.

Sustained high temperature can cause the material of the tire to degenerate and reduce tire life, and excessive temperatures can lead to sudden tire failure.

Grade C corresponds to a level of performance which all passenger vehicle tires must meet under the Federal Motor Vehicle Safety Standard No. 109. Grades B and A represent higher levels of performance on the laboratory test wheel than the minimum required by law.

## Uniform Tire Quality Grading System (UTQGS)

---

### **WARNING**

*The temperature grade for this tire is established for a tire that is properly inflated and not overloaded. Excessive speed, underinflation, or excessive loading, either separately or in combination, can cause heat buildup and possible tire failure.*

These grades will be added to the sidewalls of passenger vehicle tires over the next several years according to a schedule established by the NHTSA and the tire manufacturers.

The grade of tires available as standard or optional equipment on Mazda vehicle may vary with respect to grade.

**ALL PASSENGER VEHICLE TIRES MUST CONFORM TO THESE GRADES AND TO ALL OTHER FEDERAL TIRE-SAFETY REQUIREMENTS.**

### ▼ **Uniform Tire Quality Grading**

Quality grades can be found where applicable on the tire sidewall between tread shoulder and maximum section width.

For example:

**Treadwear 200 Traction AA Temperature A**

**UTQGS MARK (example)**

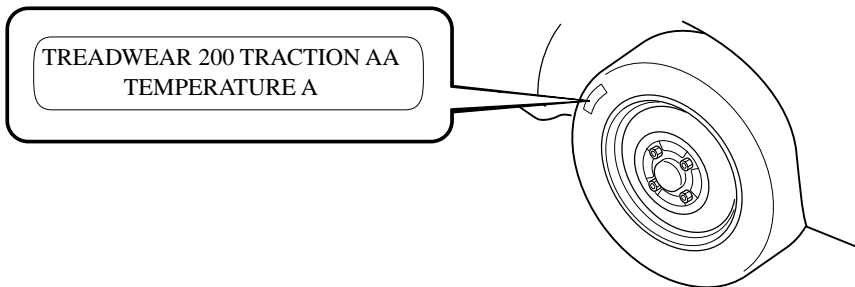

## Reporting Safety Defects

### Reporting Safety Defects

If you believe that your vehicle has a defect which could cause a crash or could cause injury or death, you should immediately inform the National Highway Traffic Safety Administration (NHTSA) in addition to notifying Mazda Motor Corporation (Your Mazda Importer/Distributor).

If NHTSA receives similar complaints, it may open an investigation, and if it finds that a safety defect exists in a group of vehicles, it may order a recall and remedy campaign. However, NHTSA cannot become involved in individual problems between you, your dealer, or Mazda Motor Corporation (Your Mazda Importer/Distributor).

To contact NHTSA, you may either call the Auto Safety Hotline toll-free at 1 (800) 424-9393 (or 366-0123 in Washington, D.C. area) or write to: NHTSA, U.S. Department of Transportation, Washington, D.C. 20590. You can also obtain other information about motor vehicle safety from the Hotline.

#### NOTE

If you live in the U.S.A., all correspondence to Mazda Motor Corporation should be forwarded to:

Mazda North American Operations  
7755, Irvine Center Drive  
Irvine, California 92618-2922  
P.O. Box 19734  
Irvine, CA 92623-9734  
Customer Assistance Center or toll free at 1 (800) 222-5500

If you live outside of the U.S.A., please contact the nearest Mazda Distributor shown (page 9-7) in this booklet.

## Service Publications

---

### Service Publications

Factory-authorized Mazda service publications are available for owners who wish to do some of their own maintenance and repair.

When requesting any of our publications through an Authorized Mazda Dealer, refer to the chart below.

If they don't have what you need in stock, they can order it for you.

PUBLICATION ORDER NUMBER	PUBLICATION DESCRIPTION
9999-95-064B-04	2004 WORKSHOP MANUAL (English)
99999-95-040G-04	2004 WIRING DIAGRAM (English)
9999-95-079C-04 (U.S.A. only)	2004 OWNER'S MANUAL
9999-EC-079C-04 (Canada only)	2004 OWNER'S MANUAL
9999-PR-079C-04 (Puerto Rico only)	2004 OWNER'S MANUAL

#### ▼ WORKSHOP MANUAL:

Covers recommended maintenance and repair procedures of the drive train, body and chassis.

#### ▼ WIRING DIAGRAM:

Provides electrical schematics as well as component location for the entire electrical system.

#### ▼ OWNER'S MANUAL:

This booklet contains information regarding the proper care and operation of your vehicle. This is not a technician's manual.

# 10

## Specifications

Technical information about your Mazda.

- Identification Numbers** ..... 10-2
  - Vehicle Information Labels ..... 10-2
  
- Specifications** ..... 10-4
  - Specifications ..... 10-4



# Identification Numbers

## Vehicle Information Labels

### ▼ Vehicle Identification Number

The vehicle identification number legally identifies your vehicle. The number is on a plate attached to the left top side of the dashboard. This plate can easily be seen through the windshield.

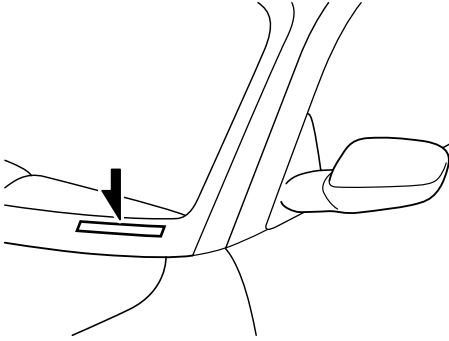

### ▼ Motor Vehicle Safety Standard Label

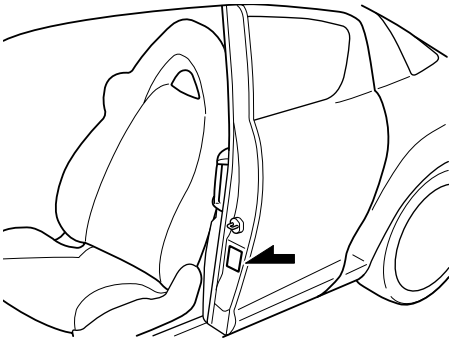

### ▼ Chassis Number

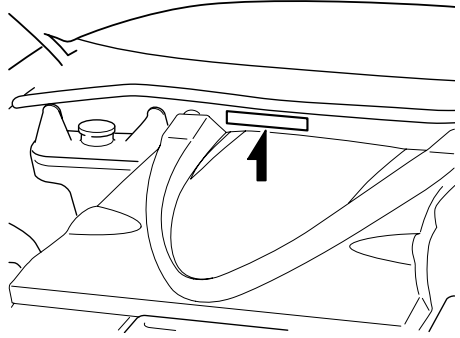

### ▼ Vehicle Emission Control Information Label

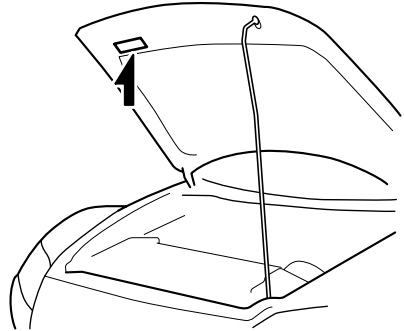

### ▼ Tire Pressure Label

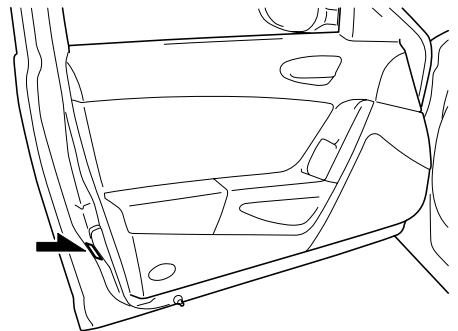



## ▼ Engine Number

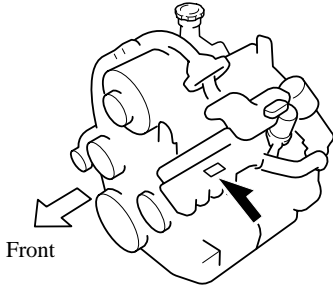

# Specifications

## Specifications

### ▼ Engine

Item	Model
Type	Rotary engine
Displacement	654 ml × 2 (654 cc × 2, 40.0 cu in × 2)
Compression ratio	10.0

### ▼ Electrical System

Item		Model	
Battery	Manual transmission	12V-40AH/5HR, 12V-52AH/5HR <sup>*1</sup>	
	Automatic transmission	12V-48AH/5HR, 12V-52AH/5HR <sup>*1</sup>	
Alternator		12 V - 100 A	
Starter	Manual transmission	12 V - 1.4 kW	
	Automatic transmission	12 V - 1.8 kW	
Spark-plug number	NGK	Trailing side	RE9B-T <sup>*2</sup>
		Leading side	RE6A-L, RE7A-L <sup>*2</sup>
Spark-plug gap		1.15—1.25mm (0.045—0.049 in)	

<sup>\*1</sup>Cold areas

<sup>\*2</sup>Standard

### CAUTION

When cleaning the iridium plugs, do not use a wire brush. The fine particulate coating on the iridium alloy and platinum tips could be damaged.

## ▼ Lubricant Quality

Lubricant	Classification	
	API Service	ILSAC
Engine oil*	SL	GF-III

\*Refer to the recommended SAE viscosity numbers on page 8-10.

Lubricant	Classification
Manual transmission oil	API Service GL-4 or GL-5 (SAE 75W-90)
Automatic transmission fluid	ATF M-III or equivalent (e.g. Dexron® III)
Rear differential oil	API Service GL-5 (SAE 90)
Brake/Clutch fluid	SAE J1703 or FMVSS116 DOT-3

## ▼ Capacities

(Approximate Quantities)

Item		Unit		
		L	US qt	Imp qt
Engine oil	With oil filter replacement	3.5	3.7	3.1
	Without oil filter replacement	3.3	3.5	2.9
Coolant		9.8	10.4	8.6
Manual transmission oil		1.75	1.8	1.5
Automatic transmission fluid		8.7	9.2	7.7
Rear differential oil		1.3	1.4	1.1
Fuel tank		60	15.9 (US gal)	13.2 (Imp gal)

Check oil and fluid levels with dipsticks or reservoir gauges.

## ▼ Dimensions

Item	Model
Overall length	4,425 mm (174.2 in), 4,430 mm* (174.4 in)
Overall width	1,770 mm (69.7 in)
Overall height	1,340 mm (52.8 in)
Front tread	1,500 mm (59.1 in)
Rear tread	1,505 mm (59.3 in)
Wheelbase	2,700 mm (106.3 in)

\*With license plate holder

# Specifications

## ▼ Weights

Item		Weight	
		Manual transmission	Automatic transmission
GVWR (Gross Vehicle Weight Rating)		1,728 kg (3,809 lb)	1,748 kg (3,854 lb)
GAWR (Gross Axle Weight Rating)	Front	827 kg (1,823 lb)	841 kg (1,854 lb)
	Rear	901 kg (1,986 lb)	907 kg (2,000 lb)
CW (Curb Weight)	USA	1,374 kg (3,029 lb)	1,385 kg (3,053 lb)
	Canada	1,384 kg (3,051 lb)	1,394 kg (3,073 lb)

## ▼ Air Conditioner

Gas complies with SAE J639	Maximum operating charge
HFC134a (R-134a)	0.42 kg (14.8 oz)

## ▼ Light Bulbs

### Exterior light

Light bulb			Wattage	Category	
				ECE R	SAE
Headlights	High beam		65	H9	—
	Low beam	Halogen	55	H7	—
		Xenon fusion	35	D2S	—
Front turn signal lights			21	WY21W	—
Parking lights			5	W5W	—
Fog lights*			55	H11	—
Front side-marker lights			3.8	—	#194
High-mount brake light			21	W21W	#7440
Rear turn signal lights			21	WY21W	—
Brake lights/Taillights			21/5	W21/5W	#7443
Reverse lights			21	W21W	#7440
License plate light			5	W5W	—
Rear side-marker lights			0.57	—	—

The rear side-marker light bulbs cannot be replaced because they are an LED-type bulb. The rear combination component must be replaced.

### Interior light

Light bulb	Wattage	Category
		ECE R
Trunk light	5	W5W
Overhead light/Map lights (Front)	5	W5W
Overhead light (Rear)	10	—
Courtesy lights	5	W5W
Vanity mirror lights	1.8	—

## ▼ Tires

<b>NOTE</b>
The tires have been optimally matched with the chassis of your vehicle. When replacing tires, Mazda recommends that you replace tires of the same type originally fitted to your vehicle. For details, contact an Authorized Mazda Dealer.

Check the tire pressure label for tire size and inflation pressure. Refer to Tire Inflation Pressure on page 8-26.

Tire size	Inflation pressure	
	Front	Rear
225/55R16 94V	220 kPa (2.2 kgf/cm <sup>2</sup> , 32 psi or lb/po <sup>2</sup> )	220 kPa (2.2 kgf/cm <sup>2</sup> , 32 psi or lb/po <sup>2</sup> )
225/45R18 91W		

Vehicle capacity weight:308 kg (680 lb)

## ▼ Fuses

Refer to the fuse rating on page 8-36.





# Index

---

## A

- Accessory Socket ..... 6-48
- Add-On Non-Genuine Parts and Accessories ..... 9-12
- Air Bag Systems ..... 2-28
- Air Filter ..... 8-19
- Ambient Temperature Display ..... 6-41
- Antenna ..... 6-10
- Anti-Lock Brake System (ABS) ..... 5-7
  - Warning light ..... 5-7
- Appearance Care ..... 8-42
- Ashtray ..... 6-43
- Audio System ..... 6-10
  - Audio control switch ..... 6-34
  - Audio set ..... 6-17
  - Operating tips for audio system ..... 6-10
  - Safety certification ..... 6-36
- Automatic Transmission
  - Driving tips ..... 5-15
  - Fluid ..... 8-16
  - Manual shift mode ..... 5-11
  - Shift-lock system ..... 5-11
  - Transmission ranges ..... 5-10

## B

- Battery
  - Emergency starting ..... 7-20
  - Maintenance ..... 8-23
  - Specifications ..... 10-4
- Beeps
  - Engine overrev warning beep ... 5-47
  - Ignition key reminder ..... 5-47
  - Lights-on reminder ..... 5-47
  - Seat belt warning beep ..... 5-47
  - Tire inflation pressure warning beep ..... 5-47

## B

- Before Starting the Engine ..... 4-6
  - After getting in ..... 4-6
  - Before getting in ..... 4-6
- Body Lubrication ..... 8-19
- Brake/Clutch
  - Fluid ..... 8-15
- Brakes
  - Anti-lock brake system (ABS) .... 5-7
  - Foot brake ..... 5-4
  - Pad wear indicator ..... 5-8
  - Parking brake ..... 5-5
  - Warning light ..... 5-5
- Break-In Period ..... 4-7
- Bulb Replacement ..... 8-30

## C

- Capacities ..... 10-5
- Carbon Monoxide ..... 4-5
- Catalytic Converter ..... 4-3
- Cell Phones ..... 9-13
- Center Console ..... 6-46
- Child Restraint
  - Child restraint precautions ..... 2-18
  - Installing child-restraint systems ..... 2-21
  - LATCH child-restraint systems ..... 2-26
- Cigarette Lighter ..... 6-42
- Climate Control System ..... 6-2
  - Gas specifications ..... 10-6
- Clock ..... 6-41
- Coin Box ..... 6-45
- Courtesy Lights ..... 6-39
- Cruise Control ..... 5-17
- Cup Holder ..... 6-44
- Customer Assistance ..... 9-2



## D

- Dashboard Illumination .....5-34
- Daytime Running Lights .....5-49
- Defroster
  - Rear window .....5-53
- Dimensions .....10-5
- Door Locks .....3-7
- Driving In Flooded Area .....4-10
- Driving Tips .....4-7
  - Automatic transmission .....5-15
  - Break-in period .....4-7
  - Driving in flooded area .....4-10
  - Hazardous driving .....4-8
  - Money-saving suggestions .....4-7
  - Rocking the vehicle .....4-8
  - Winter driving .....4-9
- Dynamic Stability Control (DSC) ....5-21
  - DSC OFF indicator light .....5-22
  - DSC OFF switch .....5-23
  - TCS/DSC Indicator light .....5-22

## E

- Emergency Starting .....7-20
  - Flooded engine .....7-20
  - Jump-starting .....7-21
  - Push-starting .....7-24
- Emergency Towing .....7-25
- Emission Control System .....4-3
- Engine
  - Coolant .....8-13
  - Exhaust gas .....4-5
  - Hood release .....3-18
  - Oil .....8-10
  - Overheating .....7-18
  - Starting .....5-3
- Engine Compartment Overview .....8-9
- Engine Coolant
  - Overheating .....7-18

## E

- Engine Coolant Temperature
  - Gauge .....5-32
- Exhaust Gas .....4-5
- Exterior Care .....8-44

## F

- Flasher
  - Hazard warning .....5-55
  - Headlights .....5-48
- Flat Tire .....7-3
  - Changing .....7-13
  - Instant Mobility System (IMS)
    - Emergency Flat Tire Repair
      - Kit .....7-5
      - Spare tire and tool storage .....7-3
- Fluids
  - Classification .....10-5
  - Owner maintenance .....8-7
- Fog Lights .....5-50
- Foot Brake .....5-4
- Front seats .....2-2
- Fuel
  - Filler lid and cap .....3-16
  - Gauge .....5-33
  - Requirements .....4-2
  - Tank capacity .....10-5
- Fuses .....8-36
  - Panel description .....8-39
  - Replacement .....8-36

## G

- Gauges .....5-29
- Glove Box .....6-45

# Index

---

## H

- Hazard Warning Flasher ..... 5-55
- Hazardous Driving ..... 4-8
- Headlight Washer ..... 5-53
- Headlights
  - Control ..... 5-48
  - Flashing ..... 5-49
  - High-low beam ..... 5-48
  - Leveling ..... 5-49
  - On reminder ..... 5-48
- HomeLink Wireless Control System ..... 5-55
- Hood Release ..... 3-18
- Horn ..... 5-54

## I

- Ignition
  - Keys ..... 3-2
  - Switch ..... 5-2
- Illuminated Entry System ..... 6-37
- Immobilizer System ..... 3-21
- Indicator Lights ..... 5-35
  - Cruise main ..... 5-45
  - Cruise set ..... 5-45
  - DSC OFF ..... 5-44
  - Headlight auto-leveling malfunction ..... 5-46
  - Headlight high-beam ..... 5-43
  - Power steering malfunction ..... 5-45
  - Security ..... 5-43
  - Shift position ..... 5-44
  - TCS/DSC ..... 5-44
  - Turn-signal/hazard warning ..... 5-46
- Information Display ..... 6-40
  - Ambient temperature display ... 6-41
  - Audio display ..... 6-42
  - Climate control display ..... 6-42
  - Clock ..... 6-41

## I

- Information display
  - functions ..... 6-40
- Instrument Cluster ..... 5-29
- Interior Care ..... 8-47
- Interior Lights ..... 6-37

## J

- Jump-Starting ..... 7-21

## K

- Keyless Entry System ..... 3-3
- Keys ..... 3-2

## L

- Label Information ..... 10-2
- Lane-Change Signals ..... 5-50
- Light Bulbs
  - Replacement ..... 8-30
  - Specifications ..... 10-6
- Lighter ..... 6-42
- Lighting Control ..... 5-48
- Lubricant Quality ..... 10-5

## M

- Maintenance
  - Introduction ..... 8-2
  - Owner maintenance
    - precautions ..... 8-8
    - Owner maintenance schedule ..... 8-7
    - Scheduled ..... 8-3
- Manual Transmission Operation ..... 5-8
  - Recommendations for shifting ..... 5-9
- Map Lights ..... 6-39
- Meters and Gauges ..... 5-29

## M

- Mirrors
  - Outside mirrors ..... 3-26
  - Rearview mirror ..... 3-27
- Money-Saving Suggestions ..... 4-7
- Moonroof ..... 3-19

## O

- Odometer and Trip Meter ..... 5-30
- Outside Mirrors ..... 3-26
- Overhead Console ..... 6-45
- Overhead Lights ..... 6-38
- Overheating ..... 7-18
- Overloading ..... 4-11

## P

- Paint Damage ..... 8-42
- Parking Brake ..... 5-5
- Parking in an Emergency ..... 7-2
- Power Door Locks ..... 3-8
- Power Steering ..... 5-16
  - Power steering malfunction  
indicator light ..... 5-16
- Power Windows ..... 3-14
- Push-Starting ..... 7-24

## R

- Rear Quarter Windows ..... 3-16
- Rear Seat ..... 2-7
- Rear Window Defroster ..... 5-53
- Rearview Mirror ..... 3-27
- Recreational Towing ..... 7-28
- Registering Your Vehicle in  
A Foreign Country ..... 9-11
- Rocking the Vehicle ..... 4-8

## S

- Safety Defects, Reporting ..... 9-17
- Seat Belt System
  - 3-point type ..... 2-12
  - Automatic locking ..... 2-10
  - Emergency locking ..... 2-10
  - Extender ..... 2-15
  - Location of seat belt ..... 2-11
  - Pregnant women ..... 2-10
  - Pretensioner and load  
limiting ..... 2-13
  - Seat belt precautions ..... 2-8
  - Warning beep ..... 2-17
  - Warning light ..... 2-16
- Seats
  - Front seat ..... 2-2
  - Rear seat ..... 2-7
- Security System
  - Immobilizer system ..... 3-21
  - Theft-deterrent system ..... 3-24
- Service Publications ..... 9-18
- Spare Tire and Tool Storage ..... 7-3
- Specifications ..... 10-4
- Speed Unit Selector ..... 5-30
- Speedometer ..... 5-30
- SRS Air Bags
  - Air bag system description ..... 2-33
  - Supplemental restraint systems  
precautions ..... 2-28
  - Warning light ..... 2-39
- Starting the Engine ..... 5-3
- Steering Wheel ..... 3-26
  - Horn ..... 5-54
- Storage Box ..... 6-46
- Storage Compartments ..... 6-45
  - Center console ..... 6-46
  - Coin box ..... 6-45
  - Glove box ..... 6-45
  - Overhead console ..... 6-45

# Index

---

## S

- Storage box ..... 6-46
- Sunshade ..... 3-20
- Sunvisors ..... 6-37

## T

- Tachometer ..... 5-31
- Temporary Spare Tire ..... 8-28
- Theft-Deterrent System ..... 3-24
- Tiedown
  - Hook ..... 7-26
- Tire Pressure Monitoring System .... 5-24
  - System error activation ..... 5-26
  - Tire pressure monitoring system warning light ..... 5-25
  - Tires and wheels ..... 5-27
- Tires
  - Flat tire ..... 7-3
  - Inflation pressure ..... 8-26
  - Replacement ..... 8-27
  - Rotation ..... 8-27
  - Snow tires ..... 4-9
  - Spare tire and tool storage ..... 7-3
  - Specifications ..... 10-7
  - Tire chains ..... 4-10
  - Uniform tire quality grading system (UTQGS) ..... 9-15
- Tool ..... 7-3
- Towing
  - Description ..... 7-25
  - Emergency towing ..... 7-25
  - Recreational towing ..... 7-28
  - Trailer towing ..... 4-12
- Traction Control System (TCS) ..... 5-20
  - TCS/DSC indicator light ..... 5-21
- Trailer Towing ..... 4-12
- Trip Meter ..... 5-30
- Trunk Lid ..... 3-11

## T

- Trunk Light ..... 3-12
- Trunk Release Slide Lever ..... 3-13
- Turn and Lane-Change Signals ..... 5-50

## V

- Vanity Mirrors ..... 6-37
- Vehicle Information Labels ..... 10-2

## W

- Warning Lights ..... 5-35
  - ABS ..... 5-40
  - Air bag system ..... 5-40
  - Automatic transmission ..... 5-42
  - Brake system ..... 5-37
  - Charging system ..... 5-38
  - Check engine ..... 5-39
  - Door-ajar ..... 5-41
  - Engine coolant level ..... 5-39
  - Engine oil level ..... 5-38
  - Front seat belt pretensioner system ..... 5-40
  - Low fuel ..... 5-41
  - Low washer fluid level ..... 5-41
  - Seat belt ..... 5-41
  - Tire pressure monitoring system ..... 5-42
- Warranty ..... 9-8
- Washer Fluid ..... 8-18
- Weights ..... 10-6
- Wheel Replacement ..... 8-29
- Windows
  - Power windows ..... 3-14
  - Rear quarter windows ..... 3-16
- Windshield Washer ..... 5-52

## W

Windshield Wipers .....	5-51
Blades replacement .....	8-20
Winter Driving .....	4-9



# NAVIGATION SYSTEM



# Contents, Accessories, and Laser

## Accessories

Please contact an Authorized Mazda Dealer if you are missing any of the following accessories.

- Map Disc

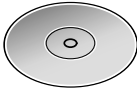

- Owner's Manual

### **CAUTION:**

**THIS PRODUCT IS A CLASS I LASER PRODUCT .  
HOWEVER THIS PRODUCT USES A VISIBLE/INVISIBLE LASER BEAM  
WHICH COULD CAUSE HAZARDOUS RADIATION EXPOSURE IF DIRECTED.  
BE SURE TO OPERATE THIS PRODUCT CORRECTLY AS INSTRUCTED.  
USE OF CONTROLS OR ADJUSTMENTS OR PERFORMANCE OF  
PROCEDURES OTHER THAN THOSE SPECIFIED HEREIN MAY RESULT IN  
HAZARDOUS RADIATION EXPOSURE. DO NOT OPEN COVERS AND DO  
NOT REPAIR YOURSELF. REFER SERVICING TO QUALIFIED PERSONNEL.**

### **Laser products:**

Wave length: 650 nm

Laser power: No hazardous radiation is emitted with safety protection.

**Prepa-  
ration**

**Imme-  
diate**  
use

**Advanced**  
use

**If**  
necessary



# Product

Accessories .....	2
Laser Product .....	2
Contents .....	3
Safety Information .....	4
Introduction .....	8
Names and Functions .....	10

## Before Use

● Activation .....	12
● Pop Up Menu .....	14
● System Operation Verification .....	15
● Screen Quality Adjustment .....	16
● Map Display .....	18
● Changing the map Orientation/Scale .....	19

Before Use

## Destination Entry and Route Search ... 20

- Destination by address
- Destination by intersection
- Destination by Point of Interest (POI) categories
- Destination by history
- Destination by a marked point
- Destination by the map

## Character Entry ..... 22

## POI Icons on Maps / Zipcode Entry ... 23

## Direct Destination Input ..... 24

## After Routing ● Route Search Cancellation, Whole Route display, Route guidance cancellation ..... 25

## Route Changes ..... 26

Routing

## Marked Point ..... 28

Marking

## Setup ..... 30

User setting

## Precautions/System Performance

● Voice Guidance .....	34
● Automatic Distance Correction .....	34
● GPS .....	35
● Map Matching .....	35
● Positioning Accuracy .....	36
● Route Guide .....	36
● Route Search .....	37
● Verification First .....	38
● Error Messages .....	40

## Troubleshooting

## Maintenance ..... 41

As  
necessary

# Safety Information

- Read this owner's manual for your Navigation System carefully before using the system. They contain instructions about how to use the system in a safe and effective manner. Mazda assumes no responsibility for any problems resulting from failure to observe the instructions given in this manual.
- This manual uses pictographs to show you how to use the product safely and to alert you to potential dangers resulting from improper connections and operation. The meanings of the pictographs are explained below. It is important that you fully understand the pictographs and explanations in order to use this manual and the system properly.



Warning

## Warning

The presence of this Warning symbol in the text is intended to alert you to the importance of heeding the operation instructions. Failure to heed the instructions may result in severe injury or death.



Warnings

### ■ Do not keep your eyes fixed on the monitor screen or operate the system while driving.

Do not change the settings and destination locations while driving. Minimize the time spent on viewing the monitor screen and listening to the voice guidance while driving. Operating the system will distract the driver from looking ahead of the vehicle and can cause accidents. Always stop the vehicle in a safe location and use the parking brake before operating the system.

### ■ Always obey local traffic regulations.

Your guided route may include roads that are not open to vehicles or are closed due to traffic regulations. Comply with the local traffic regulations and take another route.

### ■ Do not use the unit when it is out of order.

If the unit is out of order (no image, no sound) or in an abnormal state (has foreign matter in it, is exposed to water, is smoking, or smells), then turn it off immediately and consult with an Authorized Mazda Dealer. Using the unit in out-of-order condition may lead to accidents, fires, or electric shocks.

### ■ Use the proper power supply.

This product is designed for operation with a negative grounded 12 V DC battery system.

### ■ Leaving children in a vehicle with the ignition key is dangerous.

This could result in someone being badly injured or even killed. They could play with power windows or other controls, or even make the vehicle move. Don't leave the keys in your vehicle with children.



Warning

## Warning

The presence of this Warning symbol in the text is intended to alert you to the importance of heeding the operation instructions. Failure to heed the instructions may result in severe injury or death.



Warnings

■ **Do not disassemble.**

Do not disassemble the product or attempt to repair it yourself. If the product needs to be repaired, take it to an Authorized Mazda Dealer.

■ **Never attempt to play the map disc on an audio player.**

Do not attempt to play the map disc on other CD (DVD) player. The loud sound produced may damage your hearing and your speakers.

# Safety Information



Caution

## Caution

The presence of this Caution symbol in the text is intended to alert you to the importance of heeding the operation instructions. Failure to heed the instructions may result in injury or material damage.



Cautions

■ **Do not use the product where it is exposed to water, moisture, or dust.**

Exposure to water, moisture, or dust may lead to smoke, fire, or other damage to the unit. Make especially sure that the unit does not get wet in car washes or on rainy days.

■ **Keep the voice guidance volume at an appropriate level.**

Keep the volume level low enough to be aware of road and traffic conditions while driving.

■ **Protect the Deck Mechanism.**

Do not insert any foreign objects into the slot of this unit.

■ **This navigation system is designed use for exclusively in automobiles.**

This navigation system should only be installed in an automobile. Do not install it in a ship, aircraft, or any other vehicles except an automobile. Do not use it detached from the vehicle.

■ **Do not insert or allow your hand or fingers to be caught in the unit.**

To prevent injury, do not get your hand or fingers caught in moving parts or in the disc slot. Especially watch out for infants.

## SOFTWARE (MAP DISC) LICENCE AGREEMENT

### PLEASE READ THIS AGREEMENT CAREFULLY BEFORE USING NAVTECH PRODUCT

This software and data ("Software") is provided for your personal, non-commercial use only. Copyright and other Laws protect it.

By using this Software you agree to the following terms and conditions.

You agree to use this Software for solely personal use or, if applicable, for use in your business' internal operations, and not for service bureau, time-sharing or other similar purposes. Except to save it on your hard drive, you may not copy or reproduce this Software, and may not distribute it in any form, for any purpose. You agree not to disassemble, decompile or otherwise reverse engineer the Software, except to the extent expressly permitted by mandatory laws.

**Further Restrictions.** You may not use this Software with: (i) any positioning devices, including without limitation, any GPS receivers, compasses, wheel sensors, or any other distance or direction sensors; or (ii) any products, systems or applications installed in or otherwise connected to or in communication with vehicles, or capable of vehicle navigation, positioning, dispatch, real time route guidance, fleet management or similar applications; or (iii) any hand-held computer devices, cell phones or similar mobile devices.

**No warranty.** This Software is provided to you "as is," and you agree to use it at your own risk. Mazda and its suppliers and licensors make no guarantees, representations or warranties of any kind, express or implied, arising by law or otherwise, including but not limited to, content, quality, accuracy, completeness, effectiveness, reliability, fitness for a particular purpose, usefulness, use or results to be obtained from this Software will be uninterrupted or error-free.

**Disclaimer of Warranty:** Mazda AND ITS SUPPLIERS AND LICENSORS DISCLAIM ANY WARRANTIES, EXPRESS OR IMPLIED, OF QUALITY, PERFORMANCE, MERCHANTABILITY, FITNESS FOR A PARTICULAR PURPOSE OR NON-INFRINGEMENT. Some States, Territories and Countries do not allow certain warranty exclusions, so to that extent the above exclusion may not apply to you.

**Disclaimer of Liability:** Mazda AND ITS SUPPLIERS AND LICENSORS SHALL NOT BE LIABLE TO YOU: IN RESPECT OF ANY CLAIM, DEMAND OR ACTION, IRRESPECTIVE OF THE NATURE OF THE CAUSE OF THE CLAIM, DEMAND OR ACTION ALLEGING ANY LOSS, INJURY OR DAMAGES, DIRECT OR INDIRECT, WHICH MAY RESULT FROM THE USE OR POSSESSION OF THE SOFTWARE; OR FOR ANY LOSS OF PROFIT, REVENUE, CONTRACTS OR SAVINGS, OR ANY OTHER DIRECT, INDIRECT, INCIDENTAL, SPECIAL OR CONSEQUENTIAL DAMAGES ARISING OUT OF YOUR USE OF OR INABILITY TO USE THIS SOFTWARE, ANY DEFECT IN THE SOFTWARE, OR THE BREACH OF THESE TERMS OR CONDITIONS, WHETHER IN AN ACTION IN CONTRACT OR TORT OR BASED ON A WARRANTY, EVEN IF Panasonic OR ITS LICENSORS HAVE BEEN ADVISED OF THE POSSIBILITY OF SUCH DAMAGES. Some states, Territories and Countries do not allow certain liability exclusions or damages limitations, so to that extent the above may not apply to you.

**Indemnity.** You agree to indemnify and hold Mazda and its suppliers and licensors harmless from any liability or loss of any kind arising out of or in connection with any use by you of this Software.

**Export Control.** You agree not to export from anywhere any part of the Software provided to you or any direct product thereof except in compliance with applicable export laws, rules and regulations.

**Governing Law.** The above terms and conditions shall be governed by the laws of the Netherlands, without giving effect to (i) its conflict of laws provisions, or (ii) the United Nations Convention for contracts for the international Sale of Goods.

# Introduction

## Features

This DVD Navigation System combined with the NAVTECH's MAP Disc has following special features:

- **Detailed maps are used.**  
Selected destinations will be displayed for easy viewing.
- **Desired places or facilities can be stored in the memory.**

### Notes

- DVD audio and video will not work by this unit.
- This unit does not support all Video CD and CD formats.



### ■ Map Disc

This unit supports only DVD-SDAL-formatted map disc (SEAMLESS) that NAVTECH has specifically designed for this unit. Mazda shall not be liable for any damages caused by using other formatted discs. Make sure to use only the discs specified for this product.

## Use This Product Safety

### ■ Avoid excessive moisture

Do not expose the product to water or excessive moisture. This could cause electrical shorts, fire or other damage.

### ■ Extremely low or high temperatures may interfere with normal operation

The inside of the vehicle can become very hot or cold when it is parked for extended periods in direct sunlight or in cold places with the engine turned off. The navigation system may not operate normally under such circumstances. Turn off the navigation system until the inside of the vehicle has cooled down or warmed up. If the system does not operate thereafter, consult an Authorized Mazda Dealer.

## Navigation System

This navigation system utilizes GPS\* satellite signals, Speed sensor and Gyrosensor to track and display your vehicle's current position, and to guide you from your starting point to your destination along a calculated route.

\* : GPS (Global Positioning System) is a position detecting system utilizing the signals from GPS satellites deployed by the U.S. Defense Department.

## Map Related Issues

### Customer Service

If you need help with the operation your Mazda navigation system, want to report a map database error or wish to obtain a new map DVD, please call 1-888-NAV-MAPS (1-888-628-6277).

### Latest map DVD

Map content is constantly changing due to the addition of new roads, points of interest, traffic restrictions, etc. While every effort is made to supply the most accurate DVD map, it is not always possible for the DVD map to match the current roadways. Not all map areas are covered to the same level of detail. Some areas that include private roads may not be included on the database. Map DVD's are updated on a regular basis to check availability, please call 1-888-NAV-MAPS (1-888-628-6277).



### Notes

- Please have the map and software version numbers available in advance. This information can be found by using the following procedure:
  - ① Press **MENU** on the remote control.
  - ② Select **Setup Menu** and press **ENTER**
  - ③ Use the remote control joystick to scroll through the menu options, select **System information** and press **ENTER**
  - ④ Select **Version** and press **ENTER**  
**Map and software versions are now displayed.**
- For further assistance please refer to pages 30 in the instruction book.

# Names and Functions

**MENU key**  
Displays menu.

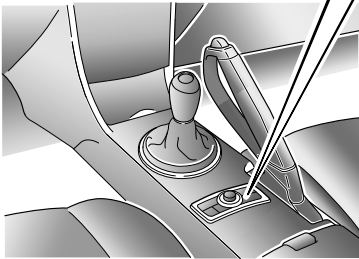
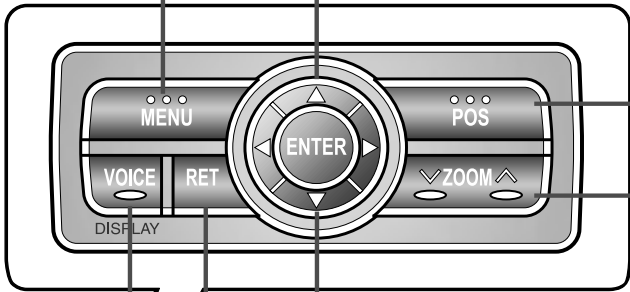

**VOICE key**

- Initiates vocal guidance for route maneuvers.
- Adjusts screen quality. (👉 page 16)



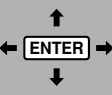

**Joystick**

- Selects items by tilting it up, down, right, and left.
- Scrolls map.



**POS (Position) key**  
Displays your current position.  
(👉 page 18)



**ZOOM key**  
Changes the map scale.  
(👉 page 19)



**ENTER key**

- Executes a selected item.
- Displays pop up menu.  
(👉 page 14)



**RET key**  
Returns to the previous screen.

# Before Use Activation

Insert the map disc into the unit to start the Mobile Navigation System.



Caution

## ■ Map Disc

- Only map discs with a NAVTECH DVD-SDAL format that are seamless supported can be used with this unit. Use DVD-SDAL-formatted map discs (SEAMLESS) that NAVTECH has specifically designed for this unit.
- Refer to "Handling and Care of Map Discs" to know how to handle a map disc (☞ page 41).

## Notes

- The map disc cannot be inserted or ejected while the ignition switch is in the OFF position.
- Remember that the battery can run down if the ignition switch is kept in the ON or ACC position for a long time while the engine not running.

- 1** Turn the ignition switch to the ON position and press OPEN to open the display.

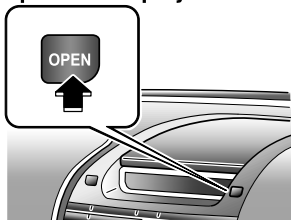

## Notes

- The display angle can be adjusted by pressing TILT.

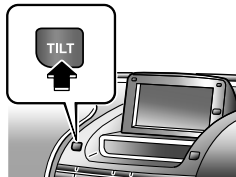

When the TILT is pressed, the display angle changes in stages.

- Press OPEN to close the display.

- 2** Slide the front cover down of the unit.

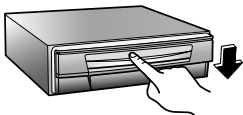

## Notes

- The main unit is located in the Center Console(Rear).
- Condensation may form on the optical lens or the map disc inside the unit when the temperature in the vehicle increases in a short time such as when heating the car on a cold day. This condensation may cause malfunctions. If so, then unload the map disc and do not operate the unit for approximately 1 hour. Wipe the condensation off the map disc with a soft cloth. If the unit does not operate correctly after 1 hour, then consult an Authorized Mazda Dealer.

- 3** Insert the map disc with the printed side facing up, and close the front cover by pushing it up.



Opening screen

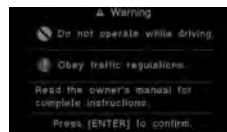

[Warning] screen

## 4 Read the [Warning] **ENTER**



- Current position map appears.

### Note

The map displayed when you first turn on the unit might show a different area than where your vehicle is currently located. The map display will change to your current area once GPS positioning signals are received.

## 5 Select a language (Default: English). For details ( page 33)

**MENU** → Select **Setup Menu** → **ENTER** → Select **System Setup** →  
**ENTER** → Select a Language → **ENTER**

### Notes

- The following languages are available for the display and voice guidance:  
English (Default), French
- Once selected, the system should stay with your language choice.

## Removing the Map Disc

When the ignition switch is in the ACC position, slide the front cover, and press **▲ (EJECT)**.

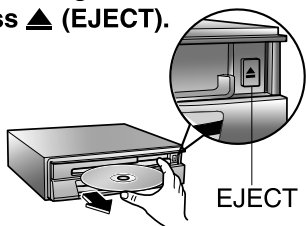

Caution

- Do not get your hand or fingers caught in moving parts or in the disc slot. This can cause injuries. Children are inquisitive, try to install or remove the map disc without infants looking on.
- Keep the front panel of the navigation system closed except when loading or unloading a map disc. Dust can cause malfunction.

## Pop Up Menu

Pop Up menu appears when pressing **ENTER** .

This function is mainly used during route searches.

■ When route has been set or route in operation

North Up

←

Detour	Route change (  page 26)
Route Preview	Route display (  page 25)
Maneuver List	Route list display
Marked Point	Marked point registration (  page 28)
Head Up	Map orientation change (  page 19)
Stop Calc	Stop route Search (  page 25)
Reroute	Rerouting
Calc Method	<b>Note</b> Appears only when the auto reroute function (  page 32) is inactivated.
Volume	Change of routing Search method (  page 21)
Delete Dest.	Change volume Delete Destination (  page 25)

■ When scroll map is displayed

Marked Point	
Destination	Direct destination input with the joystick (  page 24)
Nearest POI	Near POI (Point of Interest) search (within a radius of about 6 mile) (  page 24)

● Example : When **Detour** is selected.

Highlighted

Detour	All Roads	AVE
Route Preview	Detour: 5 Miles	
Maneuver List	Route: 10 Miles	
Marked Point	Via Point	
Head Up		
Calc Method		
Volume		
Delete Dest.		

Detour submenu

**Note**

This function is not available on intersection zoom maps.

# Before Use System Operation Verification

## Automatic distance correction

The mobile navigation system uses GPS data for distance correction automatically. It must be properly calibrated for accurate operation. Perform calibration in any of the following circumstances:

1. When using the navigation system for the very first time after installing the system.
2. When the navigation system is transferred to another vehicle.
3. When the tire pressure is changed, tires are rotated, the spare tire is used, tire size, or wheel diameter is changed.
4. When deleting the position correction learning results.

### Notes

- Start the driving after closing the opening screen as much as possible. The system is ready to start during opening screen.
- The vehicle position indicator may disappear temporarily after the speed is increased depending on the vehicle model. This is a normal phenomenon indicating that the system is calculating the distance correction.

### ■ **Resetting automatic distance correction**

Drive the vehicle in an open area for approximately 30-minutes at a speed over 20 kph (12.5 MPH) while receiving GPS signals.

### Notes

Make sure the GPS reception indicator is illuminated on the map screen.



— GPS reception indicator

# Before Use Screen Quality Adjustment

1

**VOICE**

Press and hold

2

**ENTER**



**ENTER**

Before Use

Screen quality adjustment

Open [Display Menu]



Select **ADJ.**



Screen off

Select **DISP OFF**



Screen display turns off. Press any button to return to screen display.

Day / Night mode selector

Select **DAY MODE** / **NIGHTMODE**

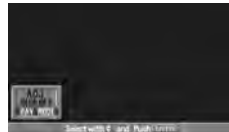

headlights OFF - DAY MODE  
headlights ON - NIGHT MODE

When the headlights are on, daytime mode can also be selected (if extra screen brightness is required under certain nighttime conditions). This selection can only be done when the headlights are on. Press **ENTER** to switch between day and night modes.

# 3

ENTER

**BRIGHT** → ← ENTER →

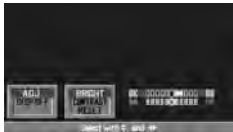

Adjust screen brightness.

**CONTRAST** → ← ENTER →

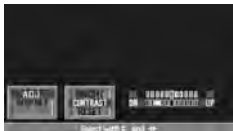

Adjust screen contrast.

**RESET** → ENTER → ENTER

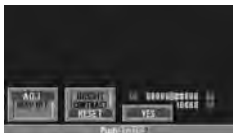

Returns screen to initial settings.

# Before Use Understanding Map Display

## Current position map

Shows the current position of your vehicle on the scale selected.

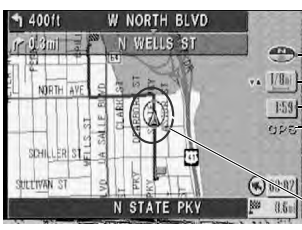

- Map orientation
- Map scale
- Clock
- GPS reception indicator
- Lights up when receiving signals from 3 or more satellites.
- Vehicle position

## Route and flags

When the route has been set, the blue line represents the route and the following two flags appear on the map.

- Destination point flag (black/white)
- Start point flag (green)

POS Changeover

## Guide mode map

(en route guidance)  
Shows the road you are driving on in an enlarged scale.

- It is necessary to set this function ( page 32).



- Distance to the next turn
- Distance to the turn after the next turn.
- Arrow guidance for the next turn
- Distance to the next turn
- Destination direction
- Estimated travel time
- Destination distance

## Intersection zoom map

(en route guidance)  
Shows an enlarged map as you approach an intersection.

- It is necessary to set this function ( page 32).

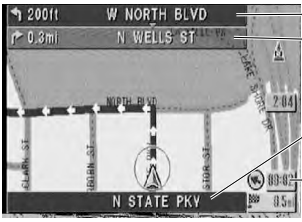

- Distance to the next turn
- Distance to the turn after the next turn.
- Current Road Name
- Estimated travel time

## Point of divergence map

(en route guidance)  
Shows an approaching point of divergence such as a turning point or exit while on an expressway.

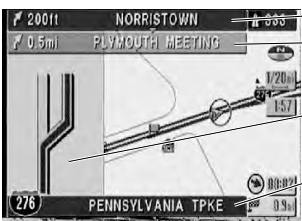

- Distance to the next turn
- Distance to the turn after the next turn.
- Point of divergence map
- Current Road Name

## Scroll map

Appears when operating during displaying a current position map.

- This map can be scrolled with the crosshair cursor.

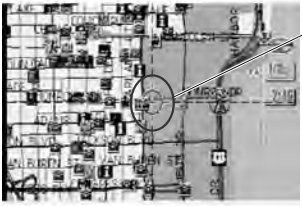

- Crosshair cursor
- Move the crosshair cursor to a road, and press ENTER to display the road name.

### Note

- When the system shows no route available to reach your designated point, the destination may be set near the designated point. If so, please be aware that a point with a destination flag is not the point that you designated as your destination.



# Changing the Map Orientation/Scale



## Do not keep your eyes fixed on the monitor screen or operate the system while driving

Do not change the settings and destination locations while driving. Minimize the time spent viewing the monitor screen and listening to the voice guidance while driving. Operating the system will distract the driver from looking ahead of the vehicle and may cause an accident. Always stop the vehicle in a safe location and use the parking brake before operating the system.

## Map orientation

1 **ENTER** Open the pop up menu  
(while in current position map)



2 **ENTER** Select **North Up** or **Head Up** and press **ENTER**

● North Up :  
Geographic north is up.



● Head Up :  
The direction you are heading is up.



## Map scale

1 **ZOOM**

● The map can be displayed in twelve steps with scales from



● ZOOM OUT: Enlarges the map.



**ZOOM**

● ZOOM IN: Reduces the map.  
(more detail.)



# Destination Entry and Route Search

● If you would like to go back to your start point, select the [History] in the [Select Destination] Menu, after that, select a green flag icon as a destination.



Destination by address

Open the [Select Destination] Menu



Select Address



Street  
City  
Zip Code

Destination by intersection

Select Area

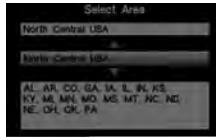

※ Default: North Central USA

Select Intersection



Street  
City

Destination by POI

Character entry (page 22)

To enter the street name, city name, zip code, and other.

Select Point of Interest

Select a destination from the POI categories.

● POI icon chart (page 23)

City  
Name  
Nearest

Destination by history

Open the [Select Destination] Menu

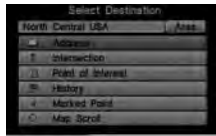

Select History

Select Marked Point

● Refer to page 28 for information about marked points.

Select Map Scroll

Destination by the map



- **Do not keep your eyes fixed on the monitor screen or operate the system while driving.** Do not change the settings and destination locations while driving. Minimize the time spent viewing the monitor screen and listening to the voice guidance while driving. Operating the system will distract the driver from looking ahead of the vehicle and may cause an accident. Always stop the vehicle in a safe location before operating the system.
- Route searches with the navigation system can include roads that you can not drive on and roads that you are prohibited from driving on due to traffic regulations. Please comply with the traffic regulations.

**3**Character entry or selection  
( page 22)**ENTER****4****ENTER**

Enter/Select the street name.

Enter/Select the city name.\*1

Enter the Zipcode.\*2

Select the city name.

Enter/Select the street name.

Select the house number

\*1 The memory stores up to 10 cities visited recently, and these city names can be selected.  
 \*2 Depending on the area, zipcode search may not be possible.

Enter the name of the city where your target intersection is.

Enter the name of a street that is part of the intersection.

Enter the other street name that makes up the intersection.

Enter the target city name.

Enter the target name.

Enter the target name.

(The 20 closest destinations to the current position appear (within a radius of about 30 mile..))

Select a desired destination from the list.

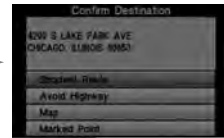
Select a destination from the list of recent destinations.  
(Up to 50 points including the latest starting point are in the system memory.)Select a destination from the list of Marked points  
(Up to 100 points).Move the crosshair cursor to the destination and press **ENTER**.Select **Destination****Search method****Shortest Route**

This is the route that reaches the destination in the shortest time.

**Avoid Highway**

This route reduces the use of highways (if there are highways on the way).

**Map**You can designate a destination on the map. (Move the crosshair cursor to the destination.) The following menu will be displayed when **ENTER** is pressed on the map display.  
[Marked Point]  
[Destination]  
[Nearest POI]... ( page 24)**Marked Point**

Marks the destination resulting from the search.

**Note**

The results from the route search are not always the shortest routes. You cannot always avoid the highways even if the highway is set to [Avoid Highway]. For example, you will be on the highway when your vehicle is on the highway or when your destination exists on the highway.

# Character Entry



To enter the street name, city name, and other.

Select the first several characters on the screen.



**BS** : Move the cursor to the previous position and delete a character.

**OK** : The list appears.

● Up to 10 characters can be entered.



Caution

■ **Entry of a street name**

Do not enter the type of street such as ST, AVE, PL, LN, or RD as the search may not perform successfully.

● **Examples**

**Street : 33RD ST**

Enter by selecting characters:



Select your target in the list, and press **ENTER**

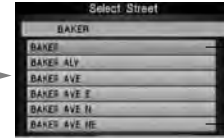

Names of which spelling starts with the entered character appear.

● If a desired name is not in the list, go back to the step 1, and try fewer characters.

To enter the zip code, house number, and other.



Select the characters on the screen.



**Space** : Space

Select **OK** and press **ENTER**









**BS** : Move the cursor to the previous position and delete a character.

# POI Icons on Maps / Zipcode Entry

## POI (Point of Interest) Icons

The following are POI icons shown on maps.

### AUTO SERVICES

-  AUTO REPAIR
-  AUTOMOBILE ASSOCIATION
-  GAS STATION
-  PARK & RIDE
-  PARKING GARAGE
-  PARKING LOT
-  RENTAL CAR FACILITY
-  REST AREA

### BANKING

-  ATM
-  BANK

### BORDER CROSSING

### BUSINESS FACILITY

### EMERGENCY

-  HOSPITAL
-  POLICE STATION

### HOTEL OR MOTEL

### LEISURE/ RECREATION

-  AMUSEMENT PARK
-  CASINO
-  GOLF COURSE
-  HISTORICAL MONUMENT
-  MARINA
-  MUSEUM
-  PARKS AND RECREATION
-  SKI RESORT
-  STADIUM / ARENA
-  THEATER
-  TOURIST ATTRACTION
-  TOURIST INFORMATION
-  WINERY

### NAMED PLACE

### PUBLIC FACILITY





-  CITY HALL
-  COMMUNITY CENTER
-  COURT HOUSE
-  EXHIBITION OR CONFERENCE CENTER
-  LIBRARY
-  SCHOOL
-  UNIVERSITY OR COLLEGE

### RESTAURANT

### SHOPPING

-  GROCERY STORE
-  SHOPPING CENTER

### TRANS - PORTATION

-  AIRPORT
-  BUS STATION
-  FERRY TERMINAL
-  LIGHT RAIL STATION
-  TRAIN STATION

# Direct destination input

## Direct destination input



**Position the cursor on your destination on the map**

Scroll the map and change the map scale if necessary.



→ **Select a route search method** (👉 page 21)

- You can determine whether or not to use a highway if there is a highway within a radius of about 300ft from the crosshair cursor position.  
[Choose Highway]

**Yes** : Highway is used.

**No** : Highway is not used.

### Notes

- A point near the crosshair cursor position can be a destination if there is not a destination point at the specified point.
- A POI icon will be a destination if there is a POI icon close to the crosshair cursor.

## Driving to the nearest POI (within a radius of about 6 mile)



→ **Select the POI category**

- Icon list (👉 page 23)

→ **Select an icon from the list that you would like to go to.**

- The 20 closest destinations to your current position appear.

→ **Select a route search method** (👉 page21)

### Note

When there is no POI that you would like to go to, then [POI Not Found] will appear.

# After routing

Route search cancellation

During route search



Route Calculation Halted

Whole route display (while on current position map)

After route search

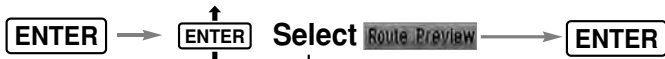

Delete destination (while on current position map)



# Route Changes

● This function allows you to search for alternative routes to the same destination.

1 ENTER

2  ENTER

Alternative route search

Open Pop up Menu (while on current position map)



Detour

Alt Route

Avoid streets

Avoid Streets

Via point

Via Point

■ Select the first point that you would like to go by on the way to your destination.

Detour distance

Detour 5 Miles

Routing



**Do not keep your eyes fixed on the monitor screen or operate the system while driving**

Do not change the settings and destination locations while driving. Minimize the time spent viewing the monitor screen and listening to the voice guidance while driving. Operating the system will distract the driver from looking ahead of the vehicle and may cause an accident. Always stop the vehicle in a safe location and use the parking brake before operating the system.

## Select a route



- Maximum 3 routes (including the current one) appear.

## Select streets to avoid



- Streets to avoid become gray

### Select the second and following via points

**Add**

When adding a new point between the current position and the first point



When adding a new point between the first point and the destination

### Delete a via point

**Delete**

Select a point that you would like to delete.

Use the point search and entry by following the same steps in "Destination Entry and Route Search"

(👉 page 20, 21)

- Refer to page 32 for designating the detour distance.

## Notes

- The detour may be longer than the distance you specified.
- You can set up to five Via points. If you try to add a sixth point, then the [Delete] menu opens. It will prompt you to delete a currently selected point.
- If you add a Via point near your current position when adding points, then Avoid Highway may not be selected with the route search method in some cases.

# Marked Point

- Up to 100 points can be stored.
- Each stored point is memorized with its name and icon, and shown on the map.

**1** **POS** /  **2** **ENTER**

**Marking your current position**

---

**Marking any point on the map**

Press **POS** to display the current position



Move  to position the crosshair cursor on a point to be marked

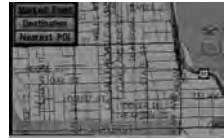

**1** **MENU** →  select **Setup Menu** → **ENTER** **2**  → **ENTER**

**Changing a marked point icon**

---

**Renaming a marked point (User POI)**

---

**Deleting a marked point**

Open [Setup Menu]



Select **Edit Marked Point**



Select **Edit**

# 3

ENTER

ENTER

Marked Point



### Stop your vehicle before doing the following operations:

Do not change the settings and destination locations while driving. Minimize the time spent viewing the monitor screen and listening to the voice guidance while driving. Operating the system will distract the driver from looking ahead of the vehicle and may cause an accident. Always stop the vehicle in a safe location and use the parking brake before operating the system.

### Note

If the same point is stored in "Marking Your Current Position", then it is registered with one local name on the list. If the same point is stored in different processes, for example, as in "Marking Your Current Position" and "Marking Any Point on the Map", then two local names, identical to each other, will be shown on the list.

# 3

ENTER

ENTER

## Select a marked point from the list

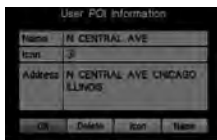

- Information about the marked point appears.

Icon

### Select an icon

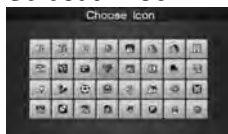

OK

Name

### Enter a name



OK

Delete

Yes



# Setup

●The setting is a variable to suit your preferences.



Warning

## ■ Stop your vehicle before the following operations

Do not change the settings and destination locations while driving. Minimize the time spent viewing the monitor screen and listening to the voice guidance while driving. Operating the system will distract the driver from looking ahead of the vehicle and may cause an accident.

Always stop the vehicle in a safe location and put the parking brake on before operating the system.



: Default

## Open [Setup Menu]

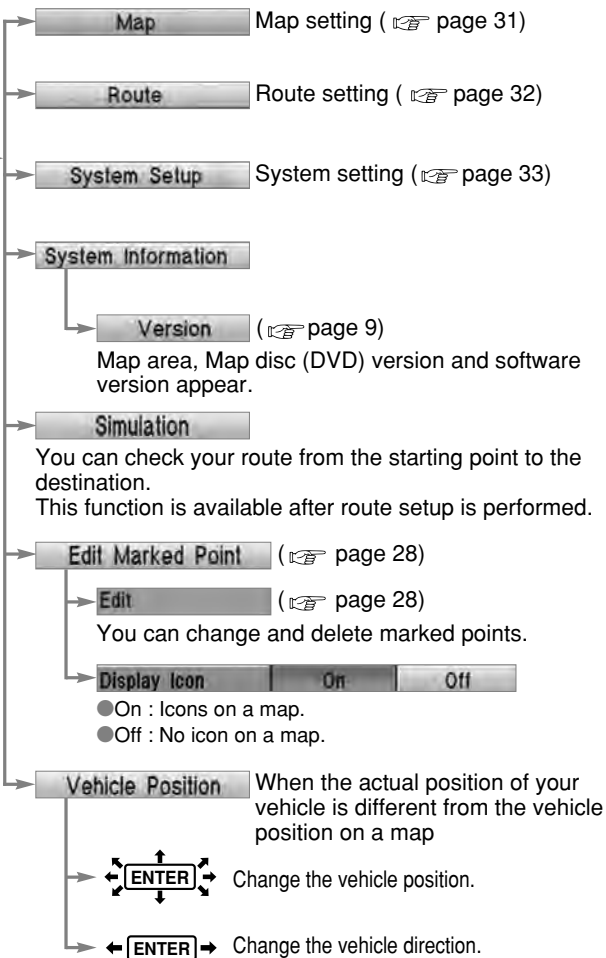
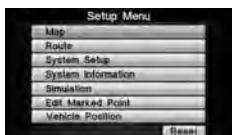

## ■ Restoring defaults

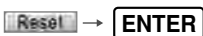

→ : Rotation in a clockwise direction by 11.25°.  
← : Rotation in a counterclockwise direction by 11.25°.

# Setup

## Map



■ : Default

### Open the [Map] screen



ENTER



#### ■ Color (daytime)



#### ■ Color (nighttime)

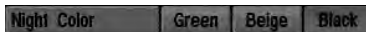

#### ■ Map Direction



- North Up : Geographic north is always up on the map.
- Head Up : The direction you are going is always up on the map.

#### ■ Vehicle Position

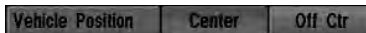

- Center : The current vehicle position indicator is displayed in the center of the screen.
- Off Ctr : The current vehicle position indicator is displayed at the bottom of the screen.

#### ■ POI Icon



- On : POI icons appear in their marked positions.
- Off : POI icons do not appear in their marked positions.

#### ■ Trace Mark



- On : The traced route is marked.
- Off : The traced route is not marked.

#### ■ How to exit



# Setup

## Route

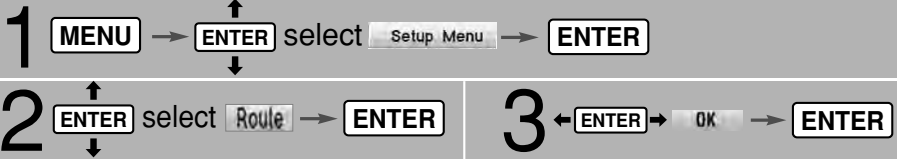

 : Default

### Open the [Route] screen



#### ■ Detour (mile/km)

**Detour(m)** 1 2 5 10 20

The detouring distance is specified.

- 1 : 1 mile/km ● 10 : 10 mile/km
- 2 : 2 mile/km ● 20 : 20 mile/km
- 5 : 5 mile/km

#### ■ Auto Re-route

**Auto Re-route** On Off

- On : Searching for another route is activated to go back to the original route when you drive away from it.
- Off : No search takes place.

Usually, this function should be set to [ON].

#### ■ System Mode

**System Mode** Map Guide

- Map : The map mode
- Guide : The guide mode map

#### ■ Zoom

**Zoom** On Off

- On : The intersection zoom map appears automatically when approaching an intersection.
- Off : The zoom function is not activated when approaching an intersection.

#### ■ Estimated Travel Time

**Est. Travel Time** On Off

- On : The estimated travel time is announced by voice guidance, and displayed on the current vehicle map.
- Off : No announce

#### ■ How to exit

**OK** → **ENTER**

# Setup

## System



 : Default

### Open the [System Setup] screen

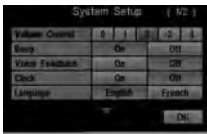

#### ■ Volume control for voice guidance (5 levels)

Volume Control 

Adjust the volume control at the monitor as well.

#### ■ Beep

Beep 

- On : Beep activated when pressing buttons in the remote control.
- Off : Beep inactivated when pressing buttons in the remote control.

#### ■ Voice Feedback

Voice Feedback 

- On : Activates voice feedback.
- Off : Cancels voice feedback.

#### ■ Clock

Clock 

#### ■ Language

Language 

#### ■ Changeover meter/mile

Meter/Mile Switch 

- Metric : Meters
- English : Miles

#### ■ Daylight Saving Time(Summer Time)

DST 

- On : Daylight saving time mode is enabled.  
(The navigation internal clock gains 1 hour).
- Off : Daylight saving time mode is disabled.

#### ■ How to exit

**OK** → **ENTER**

# Precautions/System Performance

## Voice Guidance



- The navigation system is just a support system for the driver. The driver should always pay attention to the traffic situation to safely make decisions. You may be unable at times to arrive at your destination due to out-of-date information on a map disc. You should be especially careful when selecting an urgent destination such as a hospital or a police station.
- Your route may sometimes include roads that are not open to vehicles or are closed due to traffic regulations. Please comply with the local traffic regulations.
- Do not change the settings and destination locations while driving. Minimize the time spent viewing the monitor screen and listening to the voice guidance while driving. Operating the system will distract the driver from looking ahead of the vehicle and may cause an accident. Always stop the vehicle in a safe location and use the parking brake before operating the system.

Voice guidance has the following functions:

### ■ Intersection guidance

- The system voice announces the distance to an upcoming turn and the turning direction.
  - ➔ This guidance function is automatic. Therefore, you do not have to set it, and it cannot be disabled.
- The system vocally announces the distance to an upcoming highway branching point or junction.
  - ➔ This guidance function can be set in the [Setup menu]. For details, see page 32.

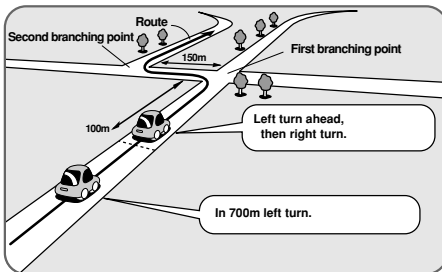

When two intersections are close together, the voice guidance may be late.

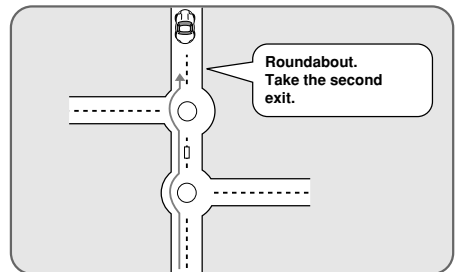

When two roundabouts are close together, the voice guidance for the second may be late.

## Automatic Distance Correction

- The mobile navigation system calculates and indicates the vehicle position on the map by multiplying the speed pulse emitted by the vehicle with a correction coefficient. The speed pulse emitted varies with the type of vehicle and with differences in tire pressure and wear. A different correction coefficient might even be required for the same type of vehicle.
- Using a spare tire in place of the regular one may cause vehicle position deviations.



## GPS

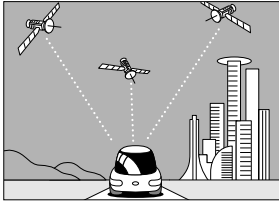

GPS is a position detecting system utilizing the signals from GPS satellites deployed by the U.S. Department of Defense. The Mobile Navigation System uses input from three or more satellites and calculates the vehicle position based on the principle of triangulation. The positioning accuracy of the system corresponds to the error display of the GPS which is from about 30 to 200 meters.

- If you are using the system for the first time, or if you have not used it for some time, it takes about 5 minutes (or about 2 minutes in open areas) to calculate your vehicle's position.

### ■ GPS signal reception is poor in the following places

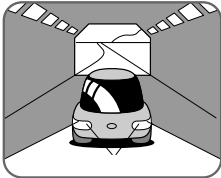

In tunnels

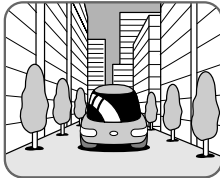

Among high-rise buildings

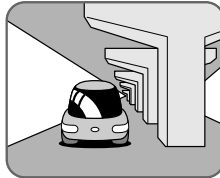

Under elevated roads

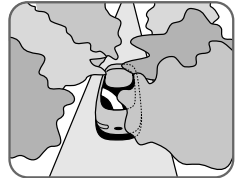

In wooded areas

- The GPS satellites are controlled by the U.S. Defense Department, which may intentionally lower positioning accuracy. In such cases, there may be vehicle position deviations.
- There may be vehicle position deviations for some time until GPS signals are received after turning on the ignition.

## Map Matching

This function compares your vehicle's tracking data with the road data on the map disc, applies dead reckoning to determine the road you are driving on, and displays your vehicle on that road on the map.

- Intelligent map matching addresses the following problems to achieve high accuracy in vehicle positioning.

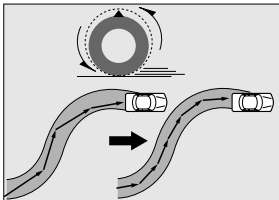

### Position Correction for Elevated Roads

Position accuracy is improved by detecting if the vehicle is running on or under an elevated road.

### Position Correction for Parking Garages

Position accuracy is improved by detecting if the vehicle is driving in an elevated or underground parking garage.

### High-precision Gyrosensor

A gyro detects turns with an accuracy of  $0.05^\circ$  per second. Combined with a speed sensor, it enables the system to display the current vehicle position even where GPS signals may be blocked.

- Using a spare tire in place of the regular one may cause vehicle position deviations.
- Any difference between the direction which your vehicle actually travels and that shown on the map is automatically eliminated by azimuth correction.

# Precautions/System Performance

## Positioning Accuracy

In the following situations, your vehicle position may not be displayed correctly on the map. But, as you keep driving, your vehicle position will be automatically corrected utilizing map matching and GPS data.

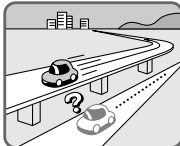

Running on an elevated road

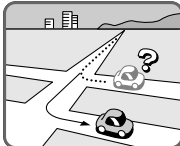

Making a turn after driving on a long straight road



Running on a steep mountain road

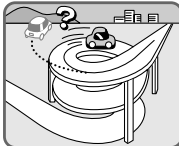

Running on a spiral road

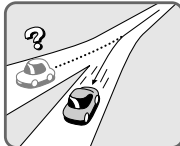

Entering an intersection where a road branches off at a small angle

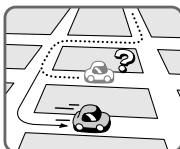

Running on gridiron layout of roads



Running on a slippery road with tire chains

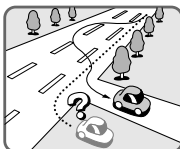

Snaking on a wide road



When your vehicle is on a turntable with the ignition turned off



After getting off a ferryboat or vehicle train

## Route Guide

Although you may encounter the following problems in route guide, there is nothing wrong with the system.

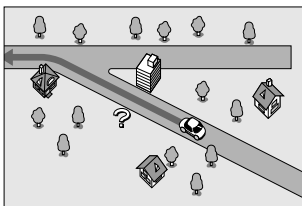

For certain intersection shapes, the upcoming turn or the name of the intersection may not be announced.

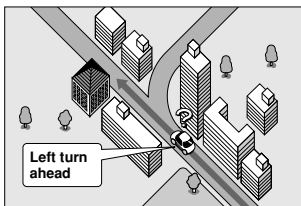

For certain intersection shapes, you may be prompted to turn right or left when you should actually stay on the same road.

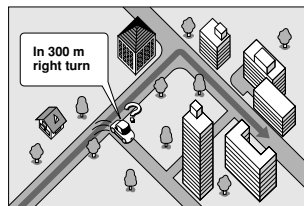

Voice guidance for the planned route may continue even after you have deviated from that route such as having turned too early.

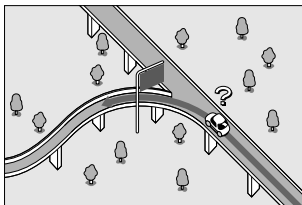

Some points where the road divides on highways or toll roads may not be displayed or announced.

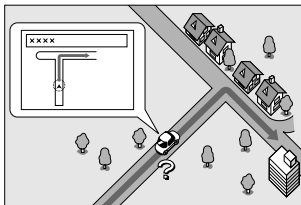

The Intersection Zoom Map may not always agree with the actual shape of the intersection.

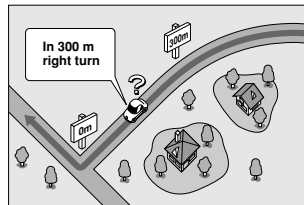

The announced distance to an upcoming turn may differ slightly from reality.



The navigation system is just a support system for the driver. The driver should always pay attention to the traffic situation to safely make decisions. You may be unable to arrive at your destination due to out-of-date information on a map disc. You should be especially careful when selecting an urgent destination such as a hospital or a police station.

## Route Search

Although you may encounter the following problems in a route search, there is nothing wrong with the system.

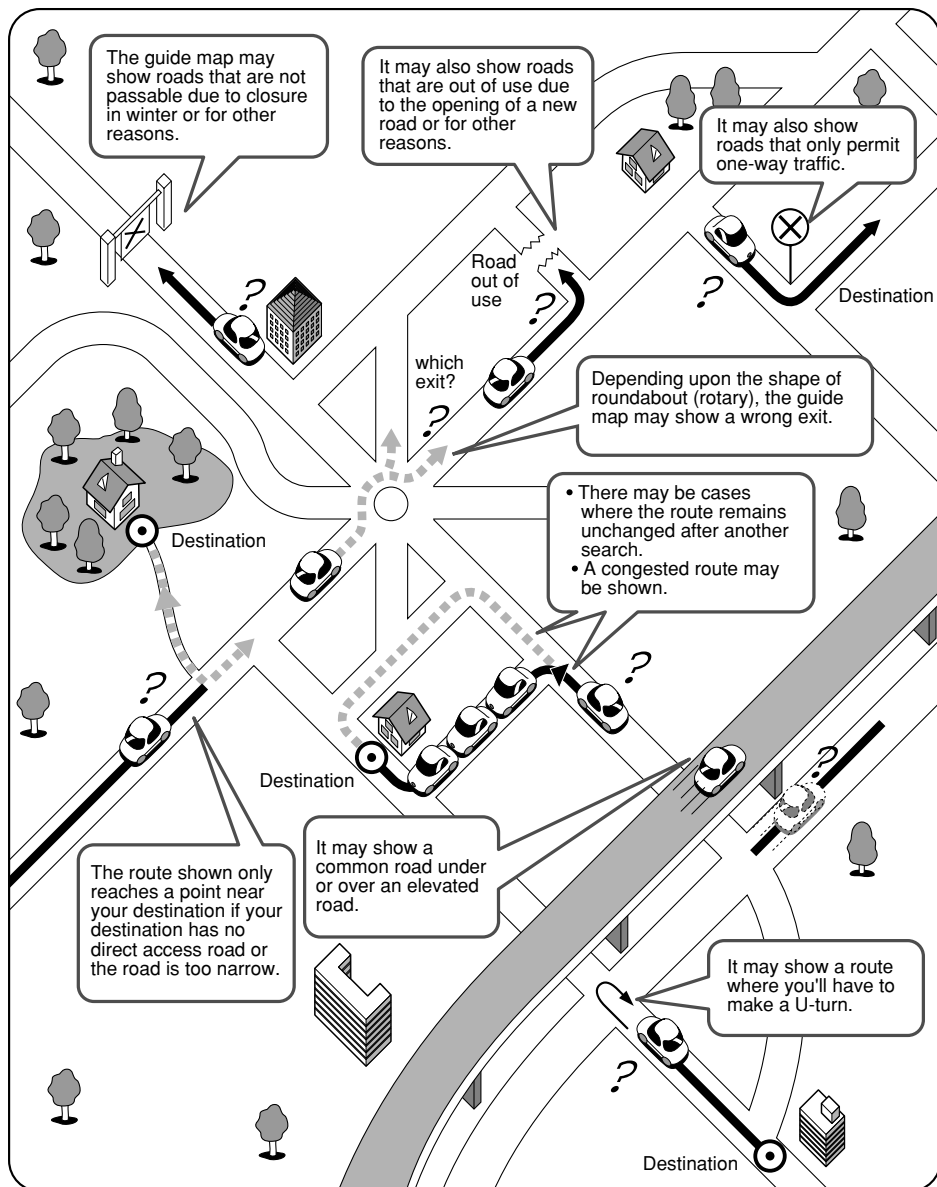

# Troubleshooting

## Verification First

### Note

There may be some problems due to operational errors or mistakes. Please read this manual again and verify that there really is a problem before calling an Authorized Mazda Dealer to ask for repair services.

Symptom	Check point
No picture	<ul style="list-style-type: none"><li>● Check if a fuse has been blown. ➔ Consult an Authorized Mazda Dealer.</li><li>● Check if the voltage level of the vehicle battery is low. ➔ Recharge the battery or change batteries.</li></ul>
The vehicle position is not correct	<ul style="list-style-type: none"><li>● Check if the vehicle position changed when ACC was set to OFF. When, for example,<ul style="list-style-type: none"><li>● The vehicle was transported by a ferry boat.</li><li>● The vehicle was rotated on a turn table in a parking lot.</li><li>● The vehicle was transported by a tow track or other such vehicle. ➔ Drive the vehicle for a while where you are receiving GPS signals.</li></ul></li></ul>

Symptom	Check point
<p><b>No GPS symbols are displayed</b></p>	<ul style="list-style-type: none"> <li>● GPS signals may not be received because of obstructions. After moving the vehicle away from obstructions, the GPS signals can be received.</li> </ul>
<p><b>The vehicle position is not displayed</b></p>	<ul style="list-style-type: none"> <li>● Check if the mode is set to the map mode. <ul style="list-style-type: none"> <li>➔ Press <b>POS</b></li> </ul> </li> </ul>
<p><b>No voice guidance</b></p>	<ul style="list-style-type: none"> <li>● Check if the volume control for the voice guidance is adjusted to zero.</li> <li>● Check if the vehicle is off the route. <ul style="list-style-type: none"> <li>➔ Repeat the route search while checking the route guide screen.</li> </ul> </li> <li>● Check if you are driving the vehicle in the wrong direction on the route. <ul style="list-style-type: none"> <li>➔ Repeat the route search checking the direction of the destination.</li> </ul> </li> </ul>
<p><b>Buttons in the remote control do not beep</b></p>	<ul style="list-style-type: none"> <li>● Check if [Beep] is set to [Off] (  page 33).</li> </ul>
<p><b>No map displayed (blank screen)</b></p>	<ul style="list-style-type: none"> <li>● Check if the disc is wet, scratched, or dewy.</li> </ul>

# Troubleshooting

## Error Messages

Error message	Solution
<b>Route Calculation failed</b>	<ul style="list-style-type: none"><li>● Change your destination and route, and repeat the route search.</li></ul>
<b>Cannot Read Disc</b>	<ul style="list-style-type: none"><li>● The disc is wet, dirty, scratched, or upside down, or the disc cannot be played with this unit.<ul style="list-style-type: none"><li>➔ Eject the disc and check it.</li></ul></li></ul>
<b>Accessing Data Please wait....</b>	<ul style="list-style-type: none"><li>● When the message appears in the opening screen:<ul style="list-style-type: none"><li>➔ Check if the map disc is wet from condensation, scratched, or dirty. If the same message is displayed when this operation is repeated after checking, then consult an Authorized Mazda Dealer.</li></ul></li><li>● When the message appears during operation:<ul style="list-style-type: none"><li>➔ If the same message appears after repeating the operation, then consult an Authorized Mazda Dealer.</li></ul></li></ul>
<b>Please Select another point.</b> * When entering your destination Unable to select Destination.	<ul style="list-style-type: none"><li>● Change your destination and route, and repeat the route search.</li></ul>

# Maintenance

## Care of the Product

### ■ Cleaning this product

Use a dry, soft cloth to wipe it.

### ■ Cautions for cleaning

Never use solvents such as benzene and thinners they may mar the surface of the unit.

### ■ Map disc

If you require the latest map disc, consult an Authorized Mazda Dealer. For latest map disc information, please refer to "Map Related Issues" on page 9.

## Handling and Care of Map Discs



Caution

### ■ Map Disc

This unit supports only DVD-SDAL-formatted map disc (SEAMLESS) that NAVTECH has specifically designed for this unit. Mazda shall not be liable for any damages caused by using other formatted discs. Make sure to specify that a disc should be exclusively used for this product when you purchase it.

### ■ How to hold the disc

- Do not touch the underside of the disc.
- Do not make scratches on the disc.
- Do not bend the disc.
- When not in use, keep the disc in the case.

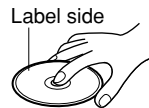

### ■ Disc Cleaning

- Use a dry, soft cloth to wipe from the center outward.



<Right >



<Wrong >

### ■ Do not leave discs in the following places:

- Direct sunlight
- Near car heaters
- In dirty, dusty and damp areas
- On seats and dashboards





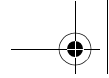

## **Zoom-Zoom**

**All children instinctively know it.**

**A few adults still remember it.**

**One unique car company refuses to outgrow it.**

**In grown-up language, it means the exhilaration and**

**liberation that come from experiencing sheer motion.**

**But as usual, children put it much better and simply call it "Go Zoom-Zoom."**

**We practice it every day.**

**It's why we build the kind of cars we do.**

**Zoom-Zoom.**

**Can we re-awaken it in you today?**

