

Table of Contents

Introduction	3
---------------------	----------

Instrument Cluster	10
---------------------------	-----------

Warning and control lights	10
Gauges	15

Entertainment Systems	17
------------------------------	-----------

AM/FM stereo with CD	17
AM/FM stereo with cassette and in-dash six CD	27

Climate Controls	44
-------------------------	-----------

Manual heating and air conditioning	44
-------------------------------------	----

Lights	48
---------------	-----------

Headlamps	48
Turn signal control	50
Bulb replacement	51

Driver Controls	56
------------------------	-----------

Windshield wiper/washer control	56
Steering wheel adjustment	58
Power windows	61
Mirrors	62
Speed control	63

Locks and Security	70
---------------------------	-----------

Keys	70
Locks	70
Anti-theft system	75

Seating and Safety Restraints	80
--------------------------------------	-----------

Seating	80
Safety restraints	90
Air bags	100
Child restraints	110

Driving	121
----------------	------------

Starting	121
----------	-----

Table of Contents

Brakes	125
Transmission operation	129
Vehicle loading	148
Trailer towing	151
Recreational towing	156

Roadside Emergencies 157

Hazard flasher switch	157
Fuses and relays	158
Overheating	164
Jump starting	171
Wrecker towing	177

Customer Assistance 179

Reporting safety defects (U.S. only)	189
--------------------------------------	-----

Cleaning 190

Maintenance and Specifications 196

Engine compartment	204
Engine oil	206
Battery	210
Fuel information	217
Air filter(s)	231
Refill capacities	244
Engine data	246

Accessories 250

Index 251

All rights reserved. Reproduction by any means, electronic or mechanical including photocopying, recording or by any information storage and retrieval system or translation in whole or part is not permitted without written authorization from MNAO. MNAO may change the contents without notice and without incurring obligation.

Copyright © 2003 MNAO

CALIFORNIA Proposition 65 Warning

WARNING: Engine exhaust, some of its constituents, and certain vehicle components contain or emit chemicals known to the State of California to cause cancer and birth defects or other reproductive harm. In addition, certain fluids contained in vehicles and certain products of component wear contain or emit chemicals known to the State of California to cause cancer and birth defects or other reproductive harm.

CONGRATULATIONS

Congratulations on acquiring your new Mazda product. Please take the time to get well acquainted with your vehicle by reading this handbook. The more you know and understand about your vehicle, the greater the safety and pleasure you will derive from driving it.

For more information on Mazda and its products visit the following website:

- In the United States: www.mazdausa.com
- In Canada: www.mazda.ca

Additional owner information is given in separate publications.

This *Owner's Guide* describes every option and model variant available and therefore some of the items covered may not apply to your particular vehicle. Furthermore, due to printing cycles it may describe options before they are generally available.

Remember to pass on the *Owner's Guide* when reselling the vehicle. It is an integral part of the vehicle.

WARNING: In the event of an accident the Fuel pump shut-off switch will automatically cut off the fuel supply to the engine. The switch can also be activated through sudden vibration (e.g. collision when parking). To reset the switch, refer to the *Fuel pump shut-off switch* in the *Roadside Emergencies* chapter.

Introduction

SAFETY AND ENVIRONMENT PROTECTION

Warning symbols in this guide

How can you reduce the risk of personal injury and prevent possible damage to others, your vehicle and its equipment? In this guide, answers to such questions are contained in comments highlighted by a bold **WARNING** statement. These comments should be read and observed.



Warning symbols on your vehicle

When you see this symbol, it is imperative that you consult the relevant section of this guide before touching or attempting adjustment of any kind.



Protecting the environment

We must all play our part in protecting the environment. Correct vehicle usage and the authorized disposal of waste, cleaning and lubrication materials are significant steps towards this aim. Information in this respect is highlighted in this guide with the tree symbol.



Always dispose of used automotive fluids in a responsible manner. Follow your community's regulations and standards for recycling and disposing of automotive fluids.

BREAKING-IN YOUR VEHICLE

There are no particular breaking-in rules for your vehicle. During the first 1,600 km (1,000 miles) of driving, vary speeds frequently. This is necessary to give the moving parts a chance to break in.

SPECIAL NOTICES

Event Data Recorder

The computer in your vehicle is capable of recording detailed data potentially including but not limited to information such as:

- the use of restraint systems including seat belts by the driver and passengers,
- information about the performance of various systems and modules in the vehicle, and
- information related to engine, throttle, steering, brake or other system status potentially including information related to how the driver operates the vehicle including but not limited to vehicle speed.

This information may be stored during regular operation or in a crash or near crash event. This stored information may be read out and used by:

- service and repair facilities.
- law enforcement or government agencies.
- the Manufacturer and Distributor.

Emission warranty

The New Vehicle Limited Warranty includes Bumper to Bumper Coverage, Safety Restraint Coverage and Corrosion Coverage. In addition, your vehicle is eligible for Emissions Defect and Emissions Performance Warranties. For a detailed description of what is covered and what is not covered, refer to the *Warranty Guide* that is provided to you along with your Owner's Guide.

Using your vehicle as an ambulance

WARNING: Do not use this vehicle as an ambulance.

Your vehicle is not equipped with the an ambulance preparation package.



Introduction

These are some of the symbols you may see on your vehicle.

Vehicle Symbol Glossary

Safety Alert		See Owner's Guide	
Protecting the Environment		Fasten Safety Belt	
Air Bag-Front		Air Bag-Side	
Child Seat		Child Seat Installation Warning	
Child Seat Lower Anchor		Child Seat Tether Anchor	
Brake System		Anti-Lock Brake System	
Brake Fluid - Non-Petroleum Based		Master Lighting Switch	
Hazard Warning Flasher		Fog Lamps-Front	
Fuse Compartment		Fuel Pump Reset	
Windshield Wash/Wipe		Windshield Defrost/Demist	
Rear Window Defrost/Demist		Power Windows	

Vehicle Symbol Glossary

Power Window Lockout		Personal Alarm System Feature	
Engine Oil		Engine Coolant	
Engine Coolant Temperature		Do Not Open When Hot	
Battery		Avoid Smoking, Flames, or Sparks	
Battery Acid		Explosive Gas	
Fan Warning		Power Steering Fluid	
Maintain Correct Fluid Level		Emission System	
Engine Air Filter		Traction Control	
Passenger Compartment Air Filter		Jack	
Check fuel cap			

INFORMATION ABOUT THIS GUIDE

The information found in this guide was accurate at the time of printing. Mazda may change the contents without notice.

Instrument Cluster

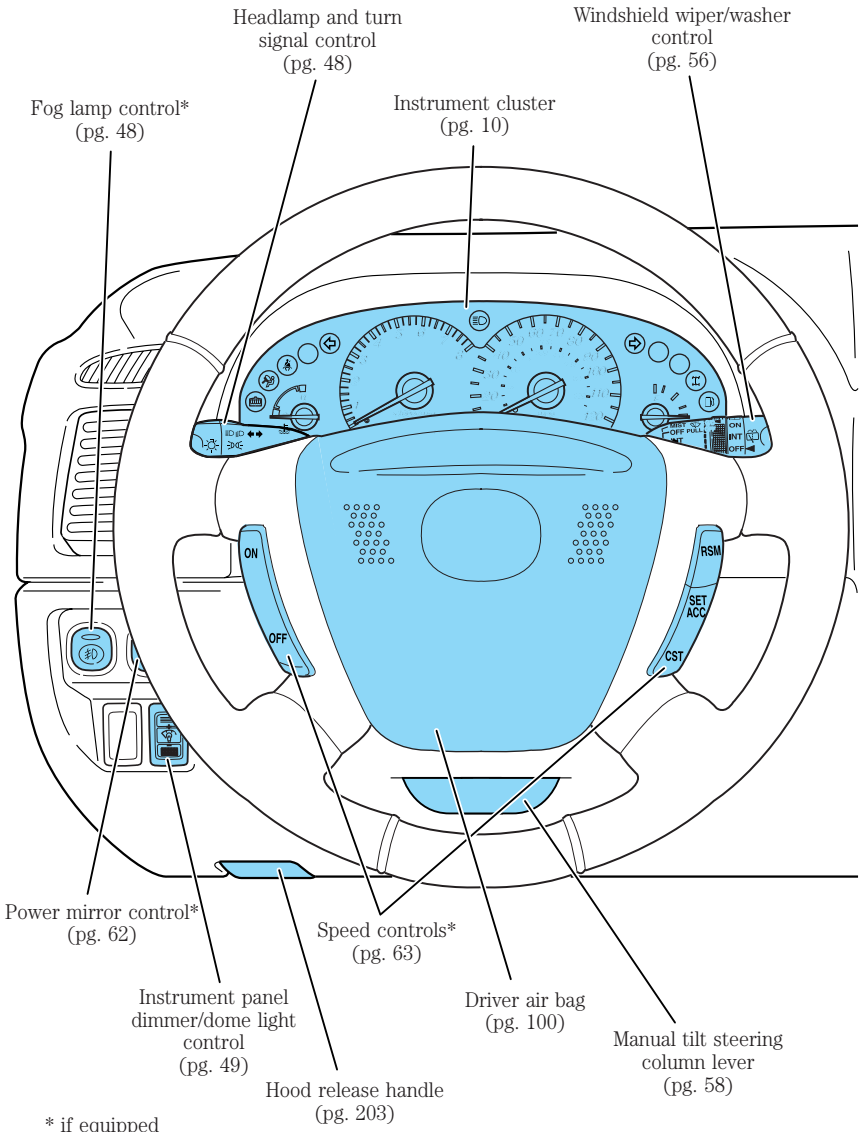

* if equipped

Instrument Cluster

Rear window defroster control (pg. 47)

Hazard flasher control (pg. 157)

Audio system (pg. 17)

4WD control* (pg. 138)

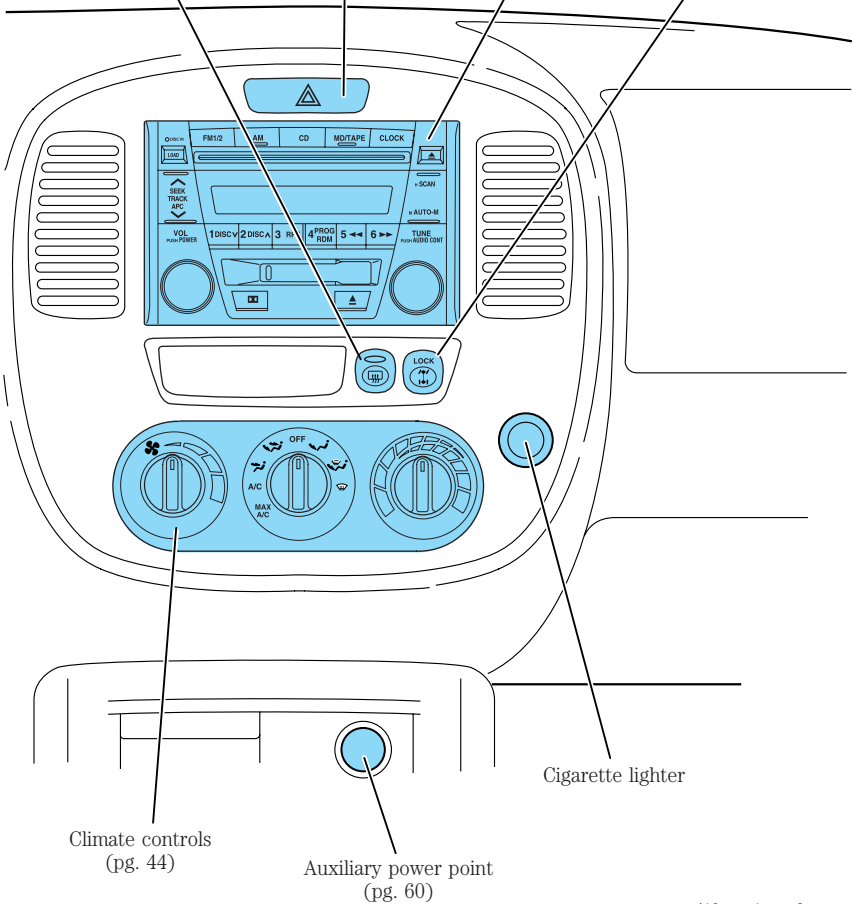

Climate controls (pg. 44)

Auxiliary power point (pg. 60)

Cigarette lighter

*if equipped

Instrument Cluster

WARNING LIGHTS AND CHIMES

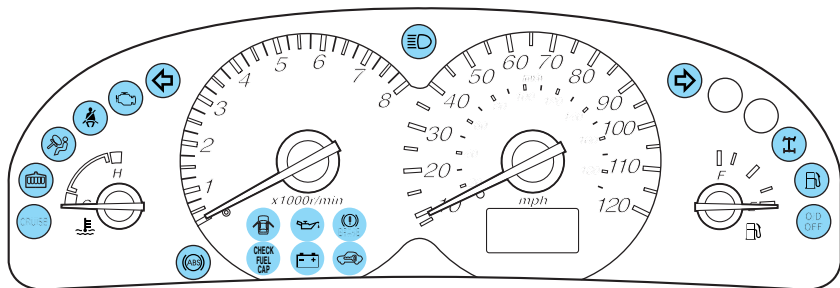

Warning lights and gauges can alert you to a vehicle condition that may become serious enough to cause expensive repairs. A warning light may illuminate when a problem exists with one of your vehicle's functions. Many lights will illuminate when you start your vehicle to make sure the bulb works. If any light remains on after starting the vehicle, have the respective system inspected immediately.

Service engine soon: Your vehicle is equipped with a computer that monitors the engine's emission

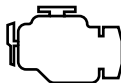

control system. This system is commonly known as the On Board Diagnostics System (OBD II). The OBD II system protects the environment by ensuring that your vehicle continues to meet government emission standards. The OBD II system also assists the service technician in properly servicing your vehicle.

The  indicator light illuminates when the ignition is first turned to the RUN position to check the bulb. If it comes on after the engine is started, one of the engine's emission control systems may be malfunctioning. The light may illuminate without a driveability concern being noted. The vehicle will usually be drivable and will not require towing.

What you should do if the  light illuminates

Light turns on (without blinking):

This means that the OBD II system has detected a malfunction.

Temporary malfunctions may cause your  light to illuminate. Examples are:

1. The vehicle has run out of fuel. (The engine may misfire or run poorly.)

Instrument Cluster

2. Poor fuel quality or water in the fuel.
3. The fuel cap may not have been properly installed and securely tightened.

These temporary malfunctions can be corrected by filling the fuel tank with high quality fuel of the recommended octane and/or properly installing and securely tightening the fuel cap. After three driving cycles without these or any other temporary malfunctions present, the  light should turn off. (A driving cycle consists of a cold engine startup followed by mixed city/highway driving.) No additional vehicle service is required.

If the  light remains on, have your vehicle serviced at the first available opportunity.

Note: The  light will illuminate if vehicle refueling is conducted with the engine running.

WARNING: Never refuel vehicle with the engine running.

Light is blinking:

Engine misfire is occurring which could damage your catalytic converter. You should drive in a moderate fashion (avoid heavy acceleration and deceleration) and have your vehicle serviced at the first available opportunity.

WARNING: Under engine misfire conditions, excessive exhaust temperatures could damage the catalytic converter, the fuel system, interior floor coverings or other vehicle components, possibly causing a fire.

Check fuel cap: Momentarily illuminates when the ignition is turned to the ON position to ensure your bulb is working. When this light turns on, check the fuel filler cap. Continuing to operate the vehicle with the check fuel cap light on, can activate the  warning light. When the fuel filler cap is properly re-installed, the light(s) will turn off after a period of normal driving. This period will vary depending on driving conditions.

**CHECK
FUEL
CAP**

Instrument Cluster

It may take a long period of time for the system to detect an improperly installed fuel filler cap.

For more information, refer to *Fuel filler cap* in the *Maintenance and specifications* chapter.

Brake system warning light: To confirm the brake system warning light is functional, it will momentarily illuminate when the ignition is turned to the ON position

when the engine is not running, or in a position between ON and START, or by applying the parking brake when the ignition is turned to the ON position. If the brake system warning light does not illuminate at this time, seek service immediately from an authorized Mazda dealer. Illumination after releasing the parking brake indicates low brake fluid level and the brake system should be inspected immediately by an authorized Mazda dealer.



WARNING: Driving a vehicle with the brake system warning light on is dangerous. A significant decrease in braking performance may occur. It will take you longer to stop the vehicle. Have the vehicle checked immediately by an authorized Mazda dealer.

Anti-lock brake system (ABS) (if equipped): If the ABS light

stays illuminated or continues to flash, a malfunction has been detected, have the system serviced

immediately by an authorized Mazda dealer. Normal braking is still functional unless the brake system warning light also is illuminated.



WARNING: If the light remains on, continues to flash or fails to illuminate, have the system serviced immediately by an authorized Mazda dealer. With the ABS light on, the anti-lock brake system is disabled but normal braking is still effective unless the brake warning light also remains illuminated with the parking brake released.

Instrument Cluster

Air bag readiness: If this light fails to illuminate when ignition is turned to ON, continues to flash or remains on, have the system serviced immediately by an authorized Mazda dealer. A chime will also sound when a malfunction in the supplemental restraint system has been detected.



Safety belt: Reminds you to fasten your safety belt. A chime will also sound to remind you to fasten your safety belt.



Charging system: Illuminates when the battery is not charging properly.



Engine oil pressure: Illuminates when the oil pressure falls below the normal range, refer to *Engine oil* in the *Maintenance and specifications* chapter.

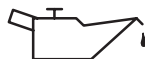

Low coolant (if equipped): Illuminates when the coolant level in the coolant reservoir is low and more needs to be added, refer to *Engine coolant* in the *Maintenance and specifications* chapter.

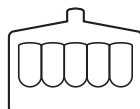

Low fuel: Illuminates when the fuel level in the fuel tank is at or near empty (refer to *Fuel gauge* in this chapter).



Overdrive off: Illuminates when the overdrive function of the transmission has been turned off, refer to the *Driving* chapter. **If the light flashes steadily or does not illuminate, have the transmission serviced soon, or damage may occur.**



Instrument Cluster

Four wheel drive indicator (if equipped): Illuminates when four-wheel drive is engaged, refer to the *Driving* chapter.

Note: If the light continues to flash, have the system serviced by an authorized Mazda dealer.

Anti-theft system: Flashes when the Securilock™ Passive Anti-theft System has been activated. Refer to *SecuriLock™ passive anti-theft system* in the *Locks and Security* chapter.

Speed control: Illuminates when the speed control is activated. Turns off when the speed control system is deactivated, refer to the *Driver Controls* chapter.

Door ajar: Illuminates when the ignition is in the ON position and any door, liftgate, or liftgate window is open.

Turn signals: Illuminates when the left or right turn signal or the hazard lights are turned on. If the indicators stay on or flash faster, check for a burned out bulb.

High beams: Illuminates when the high beam headlamps are turned on.

Safety belt warning chime:  Sounds to remind you to fasten your safety belts.

Key-in-ignition warning chime: Sounds when the key is left in the ignition in the OFF/LOCK or ACC position and the driver's door is opened.

Headlamps on warning chime: Sounds when the headlamps or parking lamps are on, the ignition is off (the key is not in the ignition) and the driver's door is opened.



CRUISE

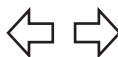

Instrument Cluster

GAUGES

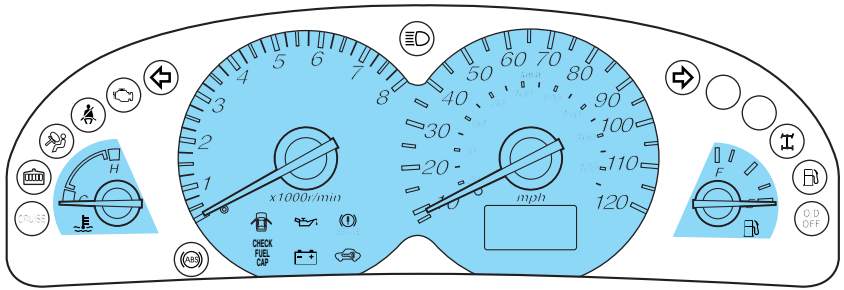

Speedometer: Indicates the current vehicle speed.

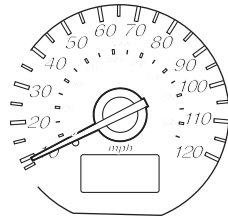

Engine coolant temperature

gauge: Indicates engine coolant temperature. At normal operating temperature, the needle will be in the normal range (between “H” and “C”). **If it enters the red section,**

the engine is overheating. Stop the vehicle as soon as safely possible, switch off the engine and let the engine cool. Refer to *Engine coolant* in the *Maintenance and Specifications* chapter.

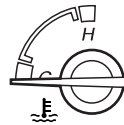

WARNING: When the engine and radiator are hot, scalding coolant and steam may shoot out under pressure and cause serious injury. Do not remove the cooling system cap when the engine and radiator are hot.

NOTE: This gauge indicates the temperature of the engine coolant, not the coolant level. If the coolant is not at its proper level the gauge indication will not be accurate.

Instrument Cluster

Odometer: Registers the total kilometers (miles) of the vehicle.



Trip odometer: Registers the kilometers (miles) of individual journeys. Press and hold the button for 1 or more seconds to reset. Press and release the button in less than 1 second to toggle between odometer and trip odometer.

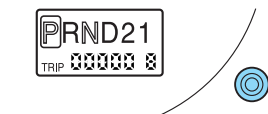

Tachometer: Indicates the engine speed in revolutions per minute. Driving with your tachometer pointer continuously at the top of the scale may damage the engine.

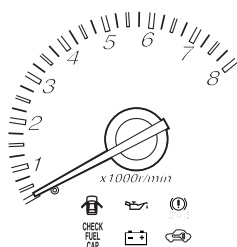

Fuel gauge: Displays approximately how much fuel is in the fuel tank. The fuel gauge may vary slightly when the vehicle is in motion or on a grade.

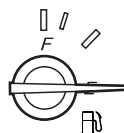

When refueling the vehicle from empty indication, the amount of fuel that can be added will be less than the advertised capacity due to the reserve fuel.

Note: The fuel filler door is located on the driver's side of the vehicle.

Entertainment Systems

AM/FM RADIO WITH COMPACT DISC PLAYER

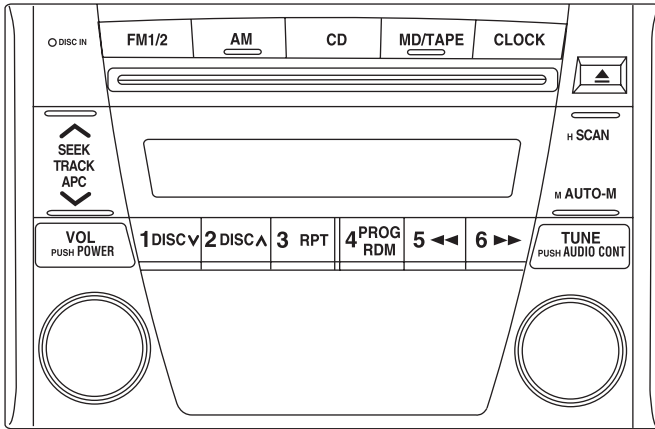

Volume/power control

Ensure that the ignition is either in the ACC or ON position for the audio system to function.

Press the control to turn the audio system on or off.

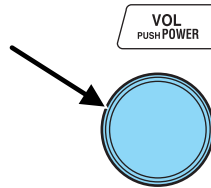

Turn the control to raise or lower the volume.

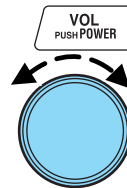

NOTE: To prevent the battery from being discharged, do not leave the audio system on for a long period when the engine is not running.

NOTE: Once the system is turned off, press the VOL control again to listen to the frequency last tuned to.

Entertainment Systems

AM/FM select

Ensure that the ignition is in the ACC or ON position for the radio to operate. Press the AM or FM1/2 control to enter radio mode.

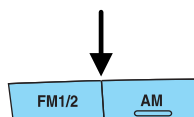

Band selection

Select AM by pressing the AM button and FM1 or FM2 by pressing the FM1/2 button.

The selected mode will be indicated. If FM stereo is being received, ST will be displayed.

Note: If the FM broadcast signal becomes weak, reception automatically changes from STEREO to MONO for reduced noise and the ST indicator will go out.

Tune audio control

The TUNE control is a multi-functional control which works in radio, tape and CD modes to adjust the levels of bass, treble, balance, fade and mid-range.

Press the TUNE control to select the desired function.

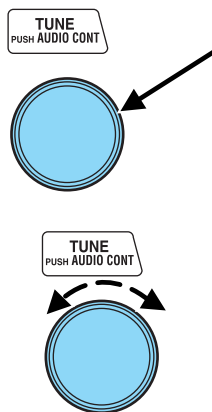

Turn the TUNE control to adjust the desired levels.

Refer to *Treble adjust* for specific instructions on level adjustments.

The TUNE control will also work in radio mode to manually increase or decrease the frequency.

Entertainment Systems

Turn the TUNE control to the left for a lower frequency.

Turn the TUNE control to the right for a higher frequency.

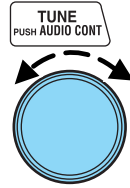

Scan function

The scan function works in radio and CD mode.

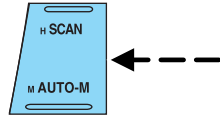

Scan function in radio mode

Press the SCAN control to hear a brief sampling of all listenable stations on the frequency band. Press the SCAN control again to disable scan mode.

Scan function in CD mode

Press the SCAN control during CD play to hear the first ten seconds of each track. Press the SCAN control again to stop the scan mode.

NOTE: If the unit is left in scan mode, normal play will resume where scan was selected.

Seek function

The seek function control works in radio mode.

Seek function in radio mode

Press and momentarily hold the SEEK control.

- Press ▲ to find the next listenable station up the frequency band.
- Press ▼ to find the next listenable station down the frequency band.

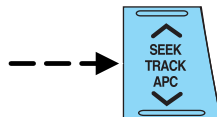

NOTE: If you continue to press and hold the control, the frequency will continue changing without stopping. Release the control after the beep sounds.

Entertainment Systems

Treble adjust

The treble adjust control allows you to increase or decrease the audio system's treble output.

Press the audio control until TREB is displayed.

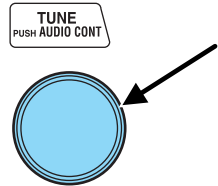

Turn the control to increase (right) or decrease (left) the amount of treble output.

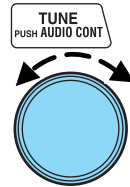

Bass adjust

The bass adjust control allows you to increase or decrease the audio system's bass output.

Press the audio control until BASS appears.

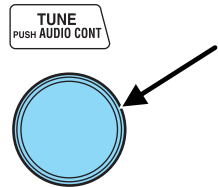

Turn the control to increase (right) or decrease (left) the amount of bass output.

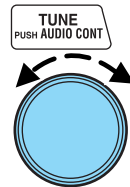

Speaker fade adjust

Speaker sound can be adjusted between the front and rear speakers.

Press the audio control until FADE appears.

TUNE
PUSH AUDIO CONT

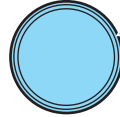

Turn the control (right or left) to adjust between the front and rear speakers.

TUNE
PUSH AUDIO CONT

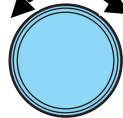

Speaker balance adjust

Speaker sound distribution can be adjusted between the right and left speakers.

Press the audio control until BAL appears.

TUNE
PUSH AUDIO CONT

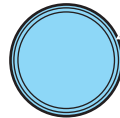

Turn the control (right or left) to adjust between the right and left speakers.

TUNE
PUSH AUDIO CONT

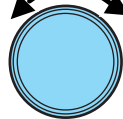

Mid-range adjust (if equipped)

Your vehicle may be equipped with a mid-range adjust. The TUNE control allows you to adjust the mid-range levels.

Entertainment Systems

Press the audio control until MID appears in the display.

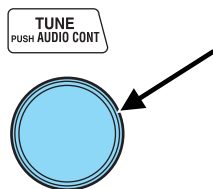

Turn the control to the right to increase the mid-range.

Turn the control to the left to decrease the mid-range.

The level will display.

Release the TUNE control when the desired level is reached.



NOTE: Approximately 5 seconds after selecting any mode, the volume function will be automatically selected. To reset the mid-range, press the TUNE control for approximately 2 seconds. The unit will beep and CL will appear in the display.

Radio station memory preset

The radio is equipped with six station memory preset controls. These controls can be used to select up to six preset AM stations and 12 FM stations (six in FM1 and six in FM2).

Setting memory preset stations

1. Select the frequency band with the AM/FM control.
2. Select a station.
3. Press and momentarily hold the desired preset control until a beep sound is heard.

The preset control number will illuminate in the display. This indicates the station is held in memory on the control you selected. Repeat this procedure to store other stations in memory.

To tune one in the memory, select AM, FM1 or FM2 and then press its channel preset button. The station frequency and the channel number will be displayed.

Auto memory tuning

Auto memory tuning allows you to set strong radio stations without losing your original manually set preset stations. This feature is helpful on trips when you travel between cities with different radio stations.

Starting autoset memory preset

1. Press the AM or FM1/2 control to select a frequency.
2. Press and momentarily hold the AUTO-M (Auto memory) control. The system will beep.
3. When the first six strong stations are filled, the strongest station will start playing.
4. Press the AUTO-M (Auto memory) control to select from the stored stations. One stored station will be selected and played each time the control is pressed. The frequency and channel number will be displayed.

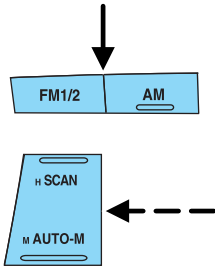

NOTE: If no stations can be tuned after scanning operations, A will appear in the display.

NOTE: If the power supply is interrupted, (fuse blows or the battery is disconnected), the preset channels will be canceled.

Tape select (if equipped)

To begin tape play, insert a cassette tape into the cassette slot, with the open edge facing the right. Once inserted, the cassette tape will automatically begin play and TAPE will appear in the display. At the end of the cassette tape, the unit will automatically reverse the cassette tape play.

To begin tape play (with a tape loaded into the audio system), press the TAPE control. If there is not a cassette tape in the cassette slot, NO TAPE will flash in the display.

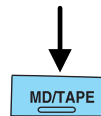

The cassette's top side is playing when ▲ is illuminated in the display.

The cassette's bottom side is playing when ▼ is illuminated in the display.

NOTE: When a metal tape is inserted, the player will automatically compensate and MTL will appear in the display.

Entertainment Systems

Press the VOL (Volume) control to stop cassette play.

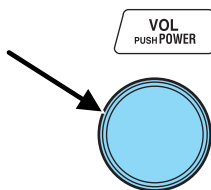

CD select

To begin CD play:

1. Insert a CD into the slot, label side up. The system will auto-load the CD and begin play after a short pause. The disc number and the track number will illuminate in the display.

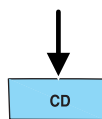

Rewind

The rewind control works in CD mode.

In CD mode, press and hold the rewind control to reverse through a track at a high speed.



Repeat play

The repeat play feature works in CD mode and allows you to listen to a selection repeatedly.

Repeat play in CD mode

Press the RPT control during play. RPT will illuminate in the display.

The current selection will be repeated.

To disengage repeat play, press the RPT control again.



Track search

Track search works in CD mode.

Press the ▲ on the TRACK control to skip forward to the beginning of the next track.

Press the ▼ on the TRACK control to skip back to the beginning of the current track.

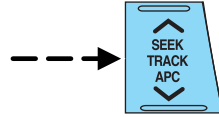

Disc search

Disc search works in CD mode.

Press the DISC up control to skip forward to the beginning of the next CD.

Press the DISC down control to skip back to the beginning of the previous CD.

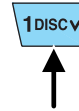

Ejecting a CD

The eject feature works in CD mode.

1. Press the control to stop and eject a CD. The disc number and OUT will appear in the display.
2. Remove the CD.



NOTE: When a CD is ejected during play, the next CD will be played automatically.

Random play

The random play feature works in CD mode and plays the selections on the current CD in random order.

Entertainment Systems

Random play in CD mode

Press the RDM control during play. RDM will illuminate in the display.

The next selection will be randomly selected.

To disengage random play, press the RDM control again.



Setting the clock

The clock can be set at any time when the ignition switch is in the ACC or ON position.

1. Press and hold the CLOCK control for approximately 2 seconds until a beep sound is heard. The clock's current time will flash.
2. Press SCAN on the hour set control to adjust the hours.
3. Press AUTO-M on the minute set control to adjust the minutes.
4. Press the CLOCK control again to start the clock.

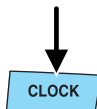
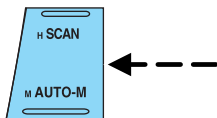
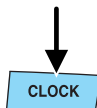

NOTE: If the power supply to the unit is interrupted (if the fuse blows or the vehicle's battery is disconnected), the clock will need to be reset.

NOTE: If the time is not adjusted while the clock's current time is flashing (if neither H nor M is pressed), and the clock control is pressed a second time, the minutes will be set to 00. If the clock's current time setting is within the latter part of the hour (from 30 to 59 min), the hour setting will automatically advance one hour.

Changing the display mode

The display can be changed to alternate between the clock and the audio. When the clock mode is selected, the time is displayed.

Entertainment Systems

Press the **CLOCK** control to alternate the display.

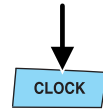

NOTE: If the audio operation is selected while the clock mode is on, the selected audio mode will be displayed for ten seconds, then the display will revert to the clock mode.

AM/FM RADIO WITH CASSETTE TAPE AND COMPACT DISC PLAYER/CHANGER (IN-DASH CD CHANGER)

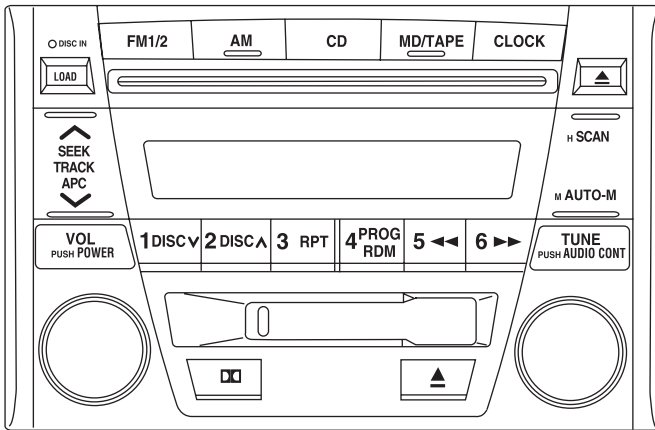

Volume/power control

Ensure that the ignition is either in the ACC or ON position for the audio system to function.

Press the control to turn the audio system on or off.

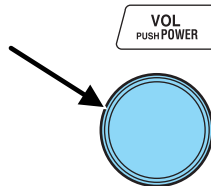

Entertainment Systems

Turn the control to raise or lower the volume.

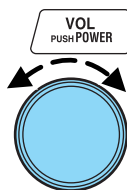

NOTE: To prevent the battery from being discharged, do not leave the audio system on for a long period when the engine is not running.

NOTE: Once the system is turned off, press the VOL control again to listen to the frequency last tuned to.

AM/FM select

Ensure that the ignition is in the ACC or ON position for the radio to operate. Press the AM or FM1/2 control to enter radio mode.

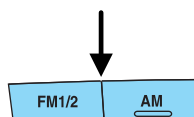

Band selection

Select AM by pressing the AM button and FM1 or FM2 by pressing the FM1/2 button.

The selected mode will be indicated. If FM stereo is being received, ST will be displayed.

Note: If the FM broadcast signal becomes weak, reception automatically changes from STEREO to MONO for reduced noise and the ST indicator will go out.

Tune audio control

The TUNE control is a multi-functional control which works in radio, tape and CD modes to adjust the levels of bass, treble, balance, fade and mid-range.

Entertainment Systems

Press the TUNE control to select the desired function.

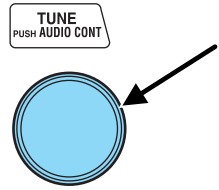

Turn the TUNE control to adjust the desired levels.

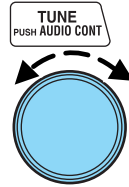

Refer to *Treble adjust* for specific instructions on level adjustments.

The TUNE control will also work in radio mode to manually increase or decrease the frequency.

Turn the TUNE control to the left for a lower frequency.

Turn the TUNE control to the right for a higher frequency.

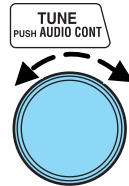

Scan function

The scan function works in radio and CD mode.

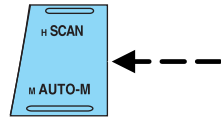

Scan function in radio mode

Press the SCAN control to hear a brief sampling of all listenable stations on the frequency band. Press the SCAN control again to disable scan mode.

Entertainment Systems

Scan function in CD mode

Press the SCAN control during CD play to hear the first ten seconds of each track. Press the SCAN control again to stop the scan mode.

NOTE: If the unit is left in scan mode, normal play will resume where scan was selected.

Seek function

The seek function control works in radio mode.

Seek function in radio mode

Press and momentarily hold the SEEK control.

- Press ▲ to find the next listenable station up the frequency band.
- Press ▼ to find the next listenable station down the frequency band.

NOTE: If you continue to press and hold the control, the frequency will continue changing without stopping. Release the control after the beep sounds.

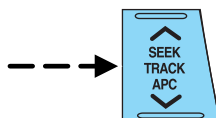

Treble adjust

The treble adjust control allows you to increase or decrease the audio system's treble output.

Press the audio control until TREB is displayed.

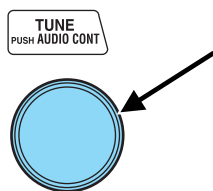

Turn the control to increase (right) or decrease (left) the amount of treble output.

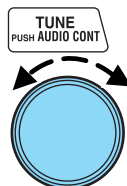

Bass adjust

The bass adjust control allows you to increase or decrease the audio system's bass output.

Press the audio control until BASS appears.

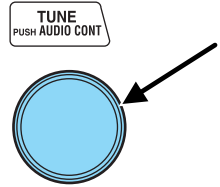

Turn the control to increase (right) or decrease (left) the amount of bass output.

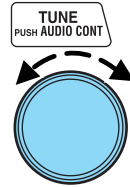

Speaker fade adjust

Speaker sound can be adjusted between the front and rear speakers.

Press the audio control until FADE appears.

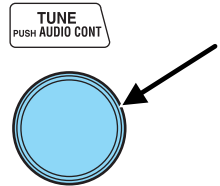

Turn the control (right or left) to adjust between the front and rear speakers.

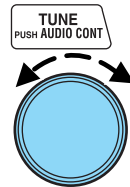

Speaker balance adjust

Speaker sound distribution can be adjusted between the right and left speakers.

Entertainment Systems

Press the audio control until BAL appears.

Turn the control (right or left) to adjust between the right and left speakers.

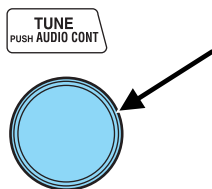

Mid-range adjust (if equipped)

Your vehicle may be equipped with a mid-range adjust. The TUNE control allows you to adjust the mid-range levels.

Press the audio control until MID appears in the display.

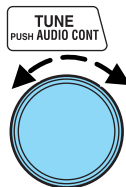
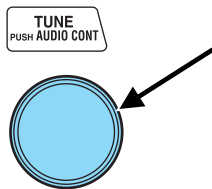

Turn the control to the right to increase the mid-range.

Turn the control to the left to decrease the mid-range.

The level will display.

Release the TUNE control when the desired level is reached.

NOTE: Approximately 5 seconds after selecting any mode, the volume function will be automatically selected. To reset the mid-range, press the TUNE control for approximately 2 seconds. The unit will beep and CL will appear in the display.

Radio station memory preset

The radio is equipped with six station memory preset controls. These controls can be used to select up to six preset AM stations and 12 FM stations (six in FM1 and six in FM2).

Setting memory preset stations

1. Select the frequency band with the AM/FM control.
2. Select a station.
3. Press and momentarily hold the desired preset control until a beep sound is heard.

The preset control number will illuminate in the display. This indicates the station is held in memory on the control you selected. Repeat this procedure to store other stations in memory.

To tune one in the memory, select AM, FM1 or FM2 and then press its channel preset button. The station frequency and the channel number will be displayed.

Auto memory tuning

Auto memory tuning allows you to set strong radio stations without losing your original manually set preset stations. This feature is helpful on trips when you travel between cities with different radio stations.

Starting autoset memory preset

1. Press the AM or FM1/2 control to select a frequency.
2. Press and momentarily hold the AUTO-M (Auto memory) control. The system will beep.
3. When the first six strong stations are filled, the strongest station will start playing.
4. Press the AUTO-M (Auto memory) control to select from the stored stations. One stored station will be selected and played each time the control is pressed. The frequency and channel number will be displayed.

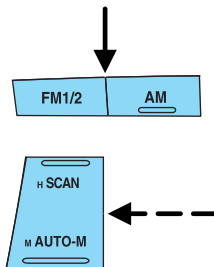

NOTE: If no stations can be tuned after scanning operations, A will appear in the display.

Entertainment Systems

NOTE: If the power supply is interrupted, (fuse blows or the battery is disconnected), the preset channels will be canceled.

Tape select (if equipped)

To begin tape play, insert a cassette tape into the cassette slot, with the open edge facing the right. Once inserted, the cassette tape will automatically begin play and TAPE will appear in the display. At the end of the cassette tape, the unit will automatically reverse the cassette tape play.

To begin tape play (with a tape loaded into the audio system), press the TAPE control. If there is not a cassette tape in the cassette slot, NO TAPE will flash in the display.

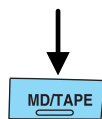

The cassette's top side is playing when ▲ is illuminated in the display.

The cassette's bottom side is playing when ▼ is illuminated in the display.

NOTE: When a metal tape is inserted, the player will automatically compensate and MTL will appear in the display.

Press the VOL (Volume) control to stop cassette play.

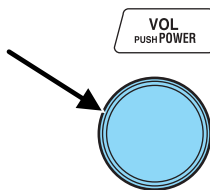

CD select

To begin CD play:

1. Insert a CD into the slot, label side up. The system will auto-load the CD and begin play after a short pause. The disc number and the track number will illuminate in the display.

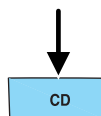

Tape direction select

Press the PROG RDM control to play the alternate side of a tape.

NOTE: When the end of the cassette is reached, the audio system will automatically reverse play.



Repeat play

The repeat play feature works in tape and CD modes and allows you to listen to a selection repeatedly.

Repeat play in tape mode

Press the RPT control during play. RPT will illuminate in the display.

The current selection will be repeated.

To disengage repeat play, press the RPT control again.

NOTE: RPT may not operate properly if:

- A tape was recorded at a low level.
- A tape has long, silent intervals.
- A tape is a live recording.
- A tape has very short intervals of less than 3 seconds.



Repeat play in CD mode

Press the RPT control during play. RPT will illuminate in the display.

The current selection will be repeated.

To disengage repeat play, press the RPT control again.



Entertainment Systems

Track search

Track search works in CD mode.

Press the ▲ on the TRACK control to skip forward to the beginning of the next track.

Press the ▼ on the TRACK control to skip back to the beginning of the current track.

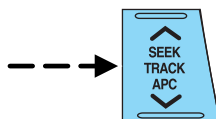

Disc search

Disc search works in CD mode.

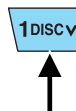

Press the DISC up control to skip forward to the beginning of the next CD.

Press the DISC down control to skip back to the beginning of the previous CD.



Dolby® noise reduction

Dolby® noise reduction operates only in tape mode. Dolby® noise reduction reduces the amount of hiss and static during tape playback.

When using a tape with Dolby NR*, press the  control to activate (and deactivate) Dolby® noise reduction. When engaged,  will appear in the display.

The Dolby® noise reduction system is manufactured under license from Dolby Laboratories Licensing Corporation. Dolby® and the double-D symbol are trademarks of Dolby® Laboratories Licensing Corporation.

Auto program control (APC)

Auto program control (APC) works in tape mode and is used to find the beginning of either the next program or the one being played.

APC in tape mode

Press the ▲ APC control to advance to the beginning of the next selection.

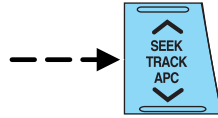

Press the ▼ APC control to reverse to the beginning of the current selection.

To disengage APC, press the APC control again.

If APC detects 15 seconds of blank space, it will automatically advance the tape to the next selection.

NOTE: APC may not operate properly if:

- A tape was recorded at a low level.
- A tape has long, silent intervals.
- A tape is a live recording.
- A tape has very short intervals of less than 3 seconds.

CD loading

The load feature allows you to load up to six single CDs into the audio system.

1. Press the LOAD control.
2. IN will appear in the display when the system is ready to receive a CD.
3. Load the CD into the player.

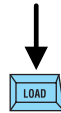

Multiple CD loading

This feature allows you to autoloading up to 6 discs into the internal multi disc CD player.

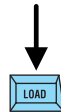

1. Press and hold the LOAD control until a beep sound is heard.
2. When IN is displayed, insert the CD.
3. When IN is displayed again, insert the next CD.

NOTE: The first CD will automatically play when:

- there is not a CD inserted for 15 seconds after IN is displayed
- the CD tray is full

Entertainment Systems

Inserting CDs into desired tray number

1. Press and hold the LOAD control until a beep sound is heard.
2. Press the memory preset control for the desired CD tray within 5 seconds after the beep is heard.
3. When IN is displayed, insert the CD.

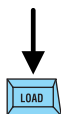

NOTE: The CD cannot be inserted to the desired tray number if the number is already occupied.

Eject feature

The eject feature works in both tape and CD mode.

Ejecting a tape

Press the control to stop and eject a tape.

NOTE: The cassette tape can be ejected when the ignition switch is in the OFF position.

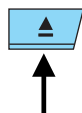

Ejecting a CD

1. Press the control to stop and eject a CD. The disc number and OUT will appear in the display.
2. Remove the CD.



NOTE: When a CD is ejected during play, the next CD will be played automatically.

Ejecting CDs from a desired tray

1. Press and hold the CD eject control for approximately 2 seconds until a beep sound is heard.
2. Press the memory preset control of the desired CD within 5 seconds of the beep.
3. Remove the CD.



Multiple ejection

1. Press and hold the CD eject control for approximately 2 seconds until a beep sound is heard.
2. Wait approximately 5 seconds or press the CD eject control again within 5 seconds after the beep is heard.
3. Remove the CD. The next CD will then be ejected.



NOTE:

- CDs will be ejected in numerical order, lowest number first.
- All CDs in the tray will be ejected continuously.
- CDs can be ejected when the ignition switch is OFF. Press and hold the CD eject control for approximately 2 seconds and all CDs will eject.

Random play

The random play feature works in CD mode and plays the selections on the current CD in random order.

Random play in CD mode

Press the RDM control during play. RDM will illuminate in the display.

The next selection will be randomly selected.

To disengage random play, press the RDM control again.



Setting the clock

The clock can be set at any time when the ignition switch is in the ACC or ON position.

1. Press and hold the CLOCK control for approximately 2 seconds until a beep sound is heard. The clock's current time will flash.

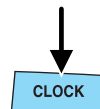

Entertainment Systems

2. Press SCAN on the hour set control to adjust the hours.
3. Press AUTO-M on the minute set control to adjust the minutes.
4. Press the CLOCK control again to start the clock.

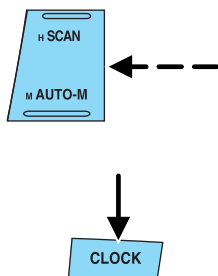

NOTE: If the power supply to the unit is interrupted (if the fuse blows or the vehicle's battery is disconnected), the clock will need to be reset.

NOTE: If the time is not adjusted while the clock's current time is flashing (if neither H nor M is pressed), and the clock control is pressed a second time, the minutes will be set to 00. If the clock's current time setting is within the latter part of the hour (from 30 to 59 min), the hour setting will automatically advance one hour.

Changing the display mode

The display can be changed to alternate between the clock and the audio. When the clock mode is selected, the time is displayed.

Press the CLOCK control to alternate the display.

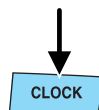

NOTE: If the audio operation is selected while the clock mode is on, the selected audio mode will be displayed for ten seconds, then the display will revert to the clock mode.

TROUBLESHOOTING THE CD CHANGER (IF EQUIPPED)

If sound skips:

- You may be traveling on a rough road, playing badly scratched discs or the disc may be dirty. Skipping will not scratch the discs or damage the player.

If your changer does not work, it may be that:

- A disc is already loaded where you want to insert a disc.
- The disc is inserted with the label surface downward.
- The disc is dusty or defective.

Entertainment Systems

- The player's internal temperature is above 60°C (140°F). Allow the player to cool down before operating.
- A disc with format and dimensions not within industry standards is inserted.

CD units are designed to play commercially pressed 12 cm (4.75 in) audio compact discs only. Due to technical incompatibility, certain recordable and re-recordable compact discs may not function correctly when used in Mazda CD players. Irregular shaped CDs, CDs with a scratch protection film attached, and CDs with homemade paper (adhesive) labels should not be inserted into the CD player. The label may peel and cause the CD to become jammed. It is recommended that homemade CDs be identified with permanent felt tip marker rather than adhesive labels. Ballpoint pens may damage CDs. Please contact your dealer for further information.

CD TIPS - CONDENSATION PHENOMENON

Immediately after turning on the heater when the vehicle is cold, the CD or optical components (prism and lens) in the CD player/changer may become clouded with condensation. When this happens, the CD will eject immediately when placed in the unit. A clouded CD can be corrected simply by wiping it with a soft cloth. Clouded optical components will clear naturally in about an hour. Wait for normal operation to return before attempting to use the unit.

HANDLING THE IN-DASH CD PLAYER

- Do not spill any liquid on the audio system.
- Do not insert any objects, other than CDs, into the slot.
- The CD revolves at a high speed within the unit. Defective (cracked or badly bent) CDs should never be used.
- Do not use non-conventional discs such as heart-shaped, octagonal discs, etc. The CD player could be damaged.
- A new CD may have rough edges on its inner and outer perimeters. If a disc with rough edges is used, proper setting will not be possible and the CD player will not play the CD. Remove the rough edges in advance by using a ballpoint pen or pencil as shown above. To remove the rough edges, rub the side of the pen or pencil against the inner and outer perimeter of the CD.
- When driving over rough or uneven surfaces, the audio sound may jump.

Entertainment Systems

- The CD player has been designed to play CDs bearing the identification logo as shown. No other discs can be played.
- Do not stick paper or tape on the CD. Avoid scratching the reverse side of the CD (the side without a label).
- Dust, finger smudges, and dirt can decrease the amount of light reflected from the signal surface, thereby effecting sound quality. Gently wipe a soiled CD with a soft cloth from the center to the edge.
- Do not use record sprays, antistatic agents, or household spray cleaners. Volatile chemicals such as benzine and thinner can also damage the surface of the CD and must not be used. Do not use anything that can damage, warp or fog CDs.
- Keep CDs in their cases and avoid direct sunlight to avoid warping.
- The CD player ejects the CD if inserted upside down. Also dirty and/or defective CDs may be ejected.
- Do not insert cleaning discs into the CD player.

CD units are designed to play commercially pressed 12 cm (4.75 in) audio compact discs only. Due to technical incompatibility, certain recordable and re-recordable compact discs may not function correctly when used in Mazda CD players. Irregular shaped CDs, CDs with a scratch protection film attached, and CDs with homemade paper (adhesive) labels should not be inserted into the CD player. The label may peel and cause the CD to become jammed. It is recommended that homemade CDs be identified with permanent felt tip marker rather than adhesive labels. Ball point pens may damage CDs. Please contact your dealer for further information.

CD AND CD CHANGER CARE

- Handle discs by their edges only. Never touch the playing surface.
- Do not expose discs to direct sunlight or heat sources for extended periods of time.

RADIO FREQUENCY INFORMATION

The Federal Communications Commission (FCC) and the Canadian Radio and Telecommunications Commission (CRTC) establish the frequencies AM and FM stations may use for their broadcasts. Allowable frequencies are:

AM 530, 540–1600, 1610 kHz

FM 87.7, 87.9–107.7, 107.9 MHz

Not all frequencies are used in a given area.

Radio reception factors

Three factors can affect radio reception:

- **Distance/strength.** The further an FM signal travels, the weaker it is. The listenable range of the average FM station is approximately 40 km (24 miles). This range can be affected by “signal modulation.” Signal modulation is a process radio stations use to increase their strength/volume relative to other stations.
- **Terrain.** Hills, mountains and tall buildings between your vehicle’s antenna and the radio station signal can cause FM reception problems. Static can be caused on AM stations by power lines, electric fences, traffic lights and thunderstorms. Moving away from an interfering structure (out of its “shadow”) returns your reception to normal.
- **Station overload.** Weak signals are sometimes captured by stronger signals when you pass a broadcast tower. A stronger signal may temporarily overtake a weaker signal and play while the weak station frequency is displayed.

The audio system automatically switches to single channel reception if it will improve the reception of a station normally received in stereo.

AUDIO SYSTEM WARRANTIES AND SERVICE

Refer to the “Warranty Guide” for audio system warranty information.

If service is necessary, see your dealer.

Climate Controls

MANUAL HEATING AND AIR CONDITIONING SYSTEM

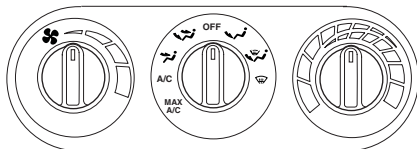

Fan speed control

Controls the volume of air circulated in the vehicle.



Temperature control knob



Controls the temperature of the airflow inside the vehicle.

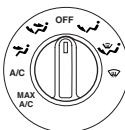

Mode selector control

Controls the direction of the airflow to the inside of the vehicle.







The air conditioning compressor will operate in all modes except  ,  , and  . However, the air conditioning will only function if the outside temperature is about 6°C (43°F) or higher.

Since the air conditioner removes considerable moisture from the air during operation, it is normal if clear water drips on the ground under the air conditioner drain while the system is working and even after you have stopped the vehicle.

Under normal conditions, your vehicle's climate control system should be left in any position other than MAX A/C or OFF when the vehicle is parked. This allows the vehicle to "breathe" through the outside air inlet duct.

Climate Controls

- MAX A/C- Uses recirculated air to cool the vehicle. MAX A/C is noisier than A/C but more economical and will cool the inside of the vehicle faster. Airflow will be from the instrument panel registers. This mode can also be used to prevent undesirable odors from entering the vehicle.
- A/C-Uses outside air to cool the vehicle. It is quieter than MAX A/C but not as economical. Airflow will be from the instrument panel registers.
-  (Panel)-Distributes outside air through the instrument panel registers. However, the air will not be cooled below the outside temperature because the air conditioning does not operate in this mode.
- OFF-Outside air is shut out and the fan will not operate. For short periods of time only, use this mode to prevent undesirable odors from entering the vehicle.
-  (Panel and floor)-Distributes outside air through the instrument panel registers and the floor ducts. Heating capabilities are provided in this mode. For added customer comfort, when the temperature control knob is anywhere in between the full hot and full cold positions, the air distributed through the floor ducts will be slightly warmer than the air sent to the instrument panel registers. However, the air will not be cooled below the outside temperature because the air conditioning does not operate in this mode.
-  (Floor)-Allows for maximum heating by distributing outside air through the floor ducts. However, the air will not be cooled below the outside temperature because the air conditioning does not operate in this mode.
-  (Floor and defrost)-Distributes outside air through the windshield defroster ducts and the floor ducts. Heating and air conditioning capabilities are provided in this mode. For added customer comfort, when the temperature control knob is anywhere in between the full hot and full cold positions, the air distributed through the floor ducts will be slightly warmer than the air sent to the windshield defrost ducts. If the temperature is about 6°C (43°F) or higher, the air conditioner will automatically dehumidify the air to reduce fogging.
-  (Defrost)-Distributes outside air through the windshield defroster ducts. It can be used to clear ice or fog from the windshield. If the temperature is about 6°C (43°F) or higher, the air conditioner will automatically dehumidify the air to reduce fogging.

Climate Controls

Operating tips

- In humid weather conditions, place the climate control system in Defrost mode before driving. This will reduce fogging on your windshield. Once the windshield has been cleared, operate the climate control system as desired.
- To reduce humidity buildup inside the vehicle in cold weather conditions, don't drive with the climate control system in the OFF or MAX A/C position.
- To reduce humidity buildup inside the vehicle in warm weather conditions, don't drive with the climate control system in the OFF position.
- Under normal weather conditions, your vehicle's climate control system should be left in any position other than the MAX A/C or OFF when the vehicle is parked. This allows the vehicle to "breathe" through the outside air inlet duct.
- Under snowy or dirty weather conditions, your vehicle's climate control system should be left in the OFF position when the vehicle is parked. This allows the climate control system to be free from contamination of outside pollutants.
- If your vehicle has been parked with the windows closed during warm weather conditions, the air conditioner will perform more efficiently in cooling the vehicle if driven for two or three minutes with the windows open. This will force most of the hot, stale air out of the vehicle. Once the vehicle has been "aired out", operate the climate control system as desired.
- Do not put objects under the front seat which may interfere with the airflow to the rear seats.
- Remove any snow, ice or leaves from the air intake area (at the bottom of the windshield and underneath the hood).
- Do not place objects over the defroster outlets. These objects can block airflow and reduce visibility through your windshield. Avoid placing small objects on top of the instrument panel. These objects may fall down into the defroster outlets and block airflow, in addition to, damaging the climate control system.

To aid in side window defogging/demisting in cold weather conditions:

1. Select the position that distributes air through the Panel and Floor.
2. Set the temperature control to full heat.
3. Set the fan speed to full fan.

Climate Controls

4. Direct the outer panel vents towards the side windows.
5. To increase airflow to the outer panel vents, close the central panel vents.

WARNING: Do not place objects on top of the instrument panel as these objects may become projectiles in a collision or sudden stop.

REAR WINDOW DEFROSTER CONTROL

The rear defroster control is located on the instrument panel.

Press the rear defroster control to clear the rear window of thin ice and fog.

- The small LED will illuminate when the rear defroster is activated.

The ignition must be in the ON position to operate the rear window defroster.

The defroster turns off automatically after 15 minutes or when the ignition is turned to the OFF position. To manually turn off the defroster before 15 minutes have passed, push the control again.

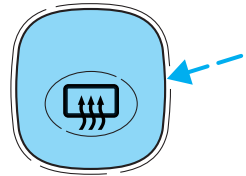

Lights

HEADLAMP CONTROL ☀️

OFF Turns the lamps off.

☀️ Turns on the parking lamps, instrument panel lamps, license plate lamps and tail lamps.

☀️ Turns the headlamps on.

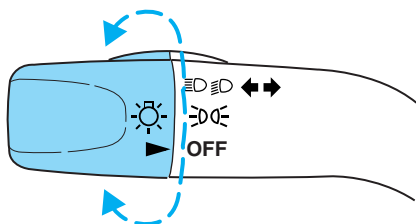

BATTERY SAVER

Your vehicle is equipped with a battery saver feature which, if you leave the headlamps on, automatically turns off the headlamps after 30 seconds when the ignition is in the OFF position.

FOG LAMP CONTROL (IF EQUIPPED) ⌘

The fog lamps can only be turned on when the headlamp control is in the low beam position.

Press the foglamp control to activate the fog lamps. The fog lamp indicator light will illuminate. When the highbeams are activated, the fog lamps will not operate.

Press the fog lamp control again to deactivate the fog lamps.

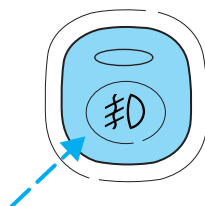

Daytime running lamps (DRL) (if equipped)

Turns the headlamps on with a reduced output.

To activate:

- the ignition must be in the ON position and
- the headlamp control is in the OFF or parking lamp.

WARNING: Always remember to turn on your headlamps at dusk or during inclement weather. The Daytime Running Lamp (DRL) system does not activate your parking lights or side marker lights and generally may not provide adequate lighting during these conditions. Failure to activate your headlamps under these conditions may result in a collision.

High beams

After turning the headlamps on, push the lever toward the instrument panel to activate. Pull the lever towards you to deactivate.

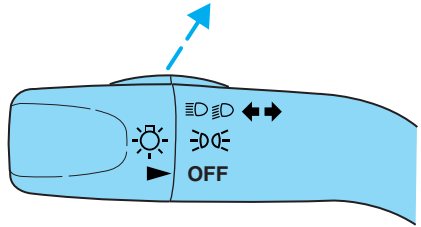

Flash to pass

Pull toward you slightly to activate and release to deactivate.

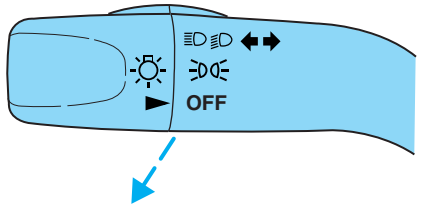

INSTRUMENT PANEL DIMMER CONTROL

Use to adjust the brightness of the instrument panel.

- Push and hold top of control to brighten.

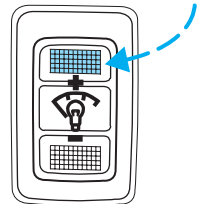

- Push and hold bottom of control to dim.

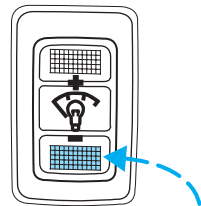

Lights

AIMING THE HEADLAMPS

The headlamps on your vehicle are properly aimed at the assembly plant. If your vehicle has been in an accident the alignment of your headlamps should be checked by your authorized Mazda dealer.

TURN SIGNAL CONTROL ⇄

- Push down to activate the left turn signal.
- Push up to activate the right turn signal.

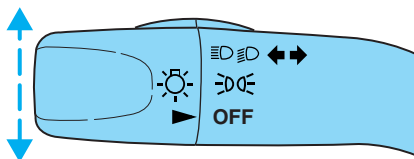

INTERIOR LAMPS

Cargo and dome lamp

Rear cargo lamp equipped with an ON/OFF/DOOR control will light when:

- the doors are closed and the control is in the ON position.
- the control is in the DOOR position and any door is open.

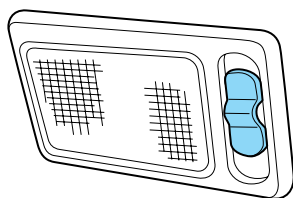

When the control is in the OFF position, it will not illuminate when you open the doors.

Dome lamps and map lamps

The front dome lamp is located overhead between the driver and passenger seats.

The dome lamp will stay on if the control is moved to the passenger side position. When the control is in the middle position, the lamp will only come on when a door is opened. If the control is moved to the driver's side position, the lamp will not come on at all.

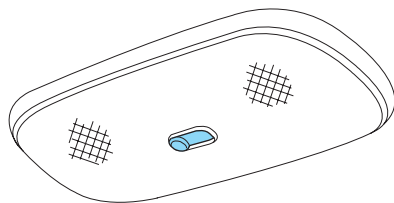

With the control in the middle position, the dome lamp will illuminate whenever any door is opened. If any door has been opened from the outside, the lamp will remain on for 25 seconds after the door is shut.

The map lamp controls (without moon roof) are located on the dome lamp. Press the controls on either side of each map lamp to activate the lamps.

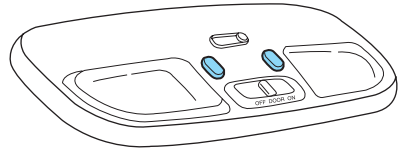

If equipped with a moon roof, the map lamps are located on the moon roof control panel. Press the controls on either side of each map lamp to activate the lamps.

This map lamp will illuminate whenever any door is opened. If any door has been opened from the outside, the lamp will remain on for 25 seconds after the door is closed.

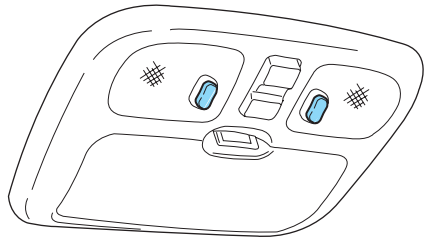

BULBS

Replacing exterior bulbs

Check the operation of all the bulbs frequently.

Replacing the interior bulbs

Check the operation of the following interior bulbs frequently:

- interior overhead lamp
- map lamp

For bulb replacement, see an authorized Mazda dealer.

Using the right bulbs

Replacement bulbs are specified in the chart below. Headlamp bulbs must be marked with an authorized "D.O.T." for North America to assure lamp performance, light brightness and pattern and safe visibility.

NOTE: The correct bulbs will not damage the lamp assembly or void the lamp assembly warranty and will provide quality bulb burn time.

Lights

Function	Number of bulbs	Trade number
Park/turn lamps (front)	2	3157 AK (amber)
Headlamps	2	9003
Rear stop/tail lamps	2	3157K
Rear turn lamps	2	3156K
Rear license plate lamps	2	3156K/168
Backup lamp	2	3156K
Rear/turn/sidemarkers	2	916NA (amber)
Fog lamp (if equipped)	2	899
Cargo lamp	1	211-2
Interior overhead lamp	1	912 (906)
Front door courtesy lamp	1	168
Map lamps	2	168 (T10)
Ashtray lamp	1	161
All replacement bulbs are clear in color except where noted.		
To replace all instrument panel lights - see your dealer.		

Replacing headlamp bulbs

NOTE: This procedure can be difficult. Your Mazda dealer has the proper tools, training and parts to perform this task. If you have difficulty with this procedure, visit your local Mazda dealer.

1. Make sure that the headlamp control is in the OFF position.
2. Open the hood.

3. Disconnect the electrical connector from the bulb by pulling rearward.
4. Remove the rubber boot from the lamp assembly by pulling on one of the tabs.
5. Squeeze the retainer spring together releasing it from bulb hooks and rotate it away from the bulb.
6. Without turning, carefully pull bulb out of headlamp assembly.

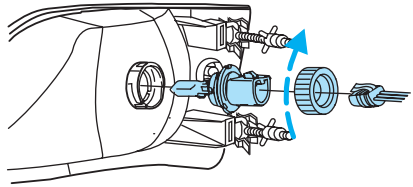

WARNING: Handle a halogen headlamp bulb carefully and keep out of children's reach. Grasp the bulb only by its plastic base and do not touch the glass. The oil from your hands could cause the bulb to break the next time the headlamps are operated. Always wear safety glasses while handling bulbs.

NOTE: If the bulb is accidentally touched, it should be cleaned with rubbing alcohol before being used.

7. Insert the glass end of the new bulb into the headlamp assembly. When the bulb's three metal tabs are aligned with the grooves in the plastic base, push the bulb into the lamp assembly until the bulb's metal base contacts the rear of the lamp assembly.
8. Rotate the retainer spring over the bulb plastic base and secure it on the bulb hooks.
9. Install rubber boot on the lamp assembly.
10. Connect the electrical connector into the rear of the plastic base until it "snaps."

Lights

Replacing brake/tail/turn/backup lamps bulbs

The brake/tail/turn/backup lamp bulbs are located in the tail lamp assembly, one just below the other. Follow the same steps to replace either bulb:

1. Open the liftgate to expose the lamp assemblies.
2. Remove the two screws from the lamp assembly.
3. Carefully remove the lamp assembly by pulling it rearward.
4. Twist the bulb socket counterclockwise and remove from lamp assembly.

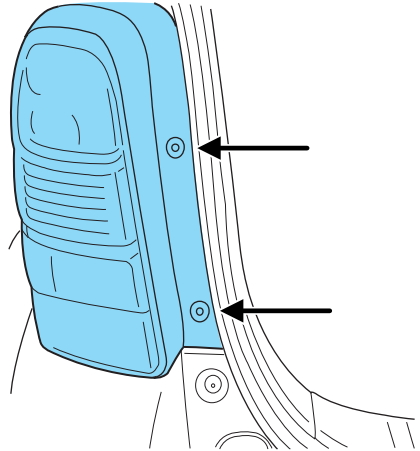

5. Pull the bulb straight out of the socket and push in the new bulb.
6. To complete installation, follow the removal procedure in reverse order.

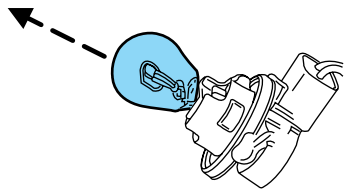

Replacing front parking/turn signal lamp bulbs

1. Make sure that the headlamp control is in the OFF position.
2. Open the hood. The position lamps are located on the bottom half of each headlamp.
3. Disconnect the electrical connector from the bulb by pulling rearward.
4. Remove the bulb socket from the lamp assembly by turning counterclockwise.

5. Pull the bulb straight out of the socket and push in the new bulb.
6. To complete installation, follow the removal procedure in reverse order.

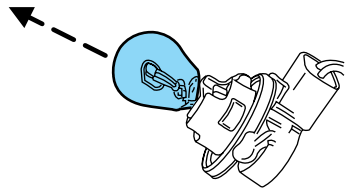

Replacing fog lamp bulbs (if equipped)

1. Remove the bulb socket from the fog lamp by turning counterclockwise.
2. Disconnect the electrical connector from the fog lamp bulb.
3. Connect the electrical connector to the new fog lamp bulb.
4. Install the bulb socket in the fog lamp turning clockwise.

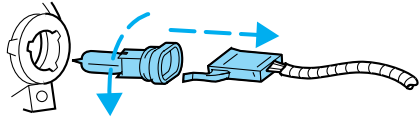

WARNING: Handle a halogen headlamp bulb carefully and keep out of children's reach. Grasp the bulb only by its plastic base and do not touch the glass. The oil from your hands could cause the bulb to break the next time the headlamps are operated. Always wear safety glasses while handling bulbs.

NOTE: If the bulb is accidentally touched, it should be cleaned with rubbing alcohol before being used.

Replacing license plate lamp bulbs

1. Remove two screws and the license plate lamp assembly (located above the license plate) from the liftgate.
2. Remove bulb socket from lamp assembly by turning counterclockwise.
3. Pull the bulb out from the socket and push in the new bulb.
4. Install the bulb socket in lamp assembly turning it clockwise,
5. Install the lamp assembly on liftgate with two screws.

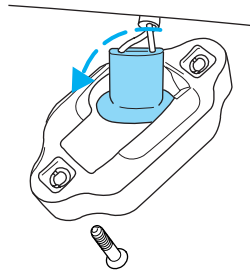

Replacing high-mount brake lamp bulbs

For bulb replacement, see an authorized Mazda dealer.

Driver Controls

MULTI-FUNCTION LEVER

Windshield wiper: For intermittent operation, move control down one position.

Adjust the rotary control to the desired speed setting.

For normal or low speed wiper operation, move control down two positions from OFF.

For high speed wiper operation, move control down three positions from OFF.

Mist function: To mist, push control up from the OFF position and release to get one wipe.

Windshield washer: To activate the windshield washer, pull control toward you. Release control to stop washer fluid spray.

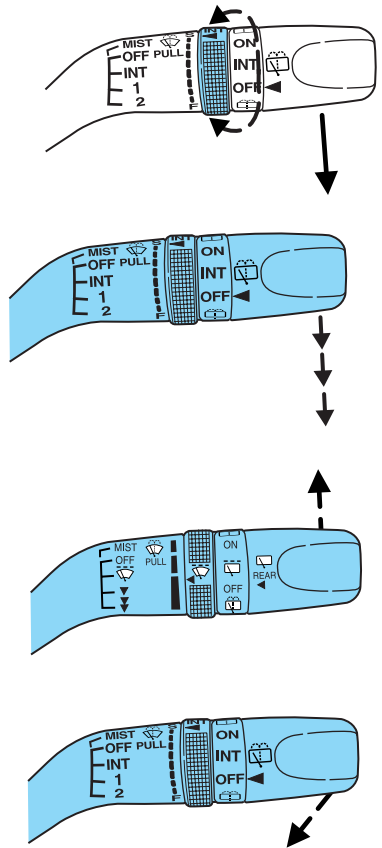

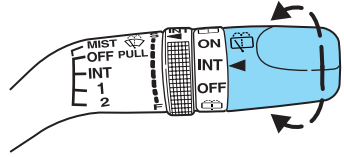

Rear window wiper/washer controls

For intermittent operation of rear wiper, rotate end of control upward to the INT position.

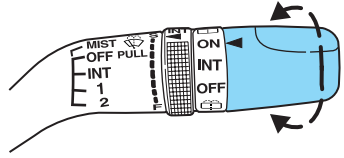

For normal speed rear wiper operation, rotate control upward to ON.



To activate the rear washer, rotate the control to the  position and release.

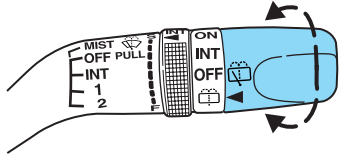

Windshield wiper blades

Check the wiper blades for wear at least twice a year or when they seem less effective. Substances such as tree sap and some hot wax treatments used by commercial car washes reduce the effectiveness of wiper blades.

Checking the wiper blades

If the wiper blades do not wipe properly, clean both the windshield and wiper blades using undiluted windshield wiper solution or a mild detergent. Rinse thoroughly with clean water. To avoid damaging the blades, do not use fuel, kerosene, paint thinner or other solvents.

Driver Controls

Changing the wiper blades

1. Pull the wiper arm away from the vehicle. Turn the blade at an angle from the wiper arm. Push the lock pin manually to release the blade and pull the wiper blade down toward the windshield to remove it from the arm.
2. Attach the new wiper to the wiper arm and press it into place until a click is heard.
3. Replace wiper blades every 6 months for optimum performance.

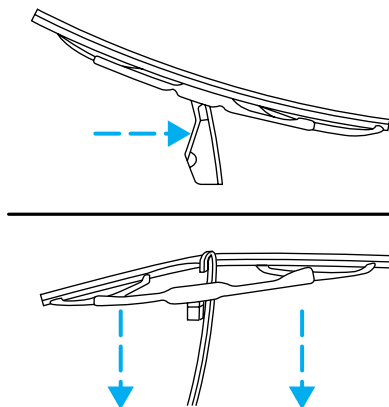

MANUAL TILT STEERING COLUMN

To adjust the steering wheel:

1. Pull down and hold the steering wheel release control toward you.
2. Move the steering wheel up or down until you find the desired location.
3. Pull the steering wheel release control up. This will lock the steering wheel in position.

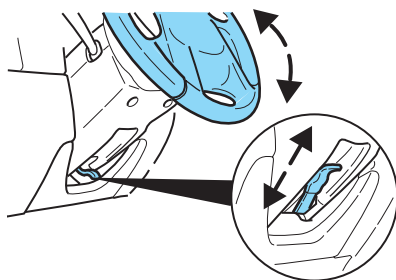

WARNING: Adjusting the steering wheel while the vehicle is moving is dangerous. Moving it can very easily cause the driver to abruptly turn to the left or right. This can lead to loss of control or an accident. Never adjust the steering wheel while the vehicle is moving.

OVERHEAD CONSOLE (IF EQUIPPED)

The appearance of your vehicle's overhead console will vary according to your option package.

Storage compartment (if equipped)

Press the OPEN control to open the storage compartment. The door will open slightly and can be moved to full open.

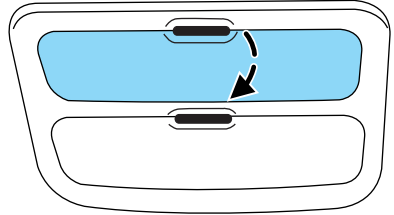

Installing a garage door opener (if equipped)

The storage compartment can be converted to accommodate a variety of aftermarket garage door openers:

- Remove the Velcro pad (2) from the storage compartment door (3).
- Place Velcro (5) on aftermarket transmitter (6) opposite of actuator control (8).
- Measure the thickness (4) of the aftermarket transmitter (6).
- Remove the rubber actuator (1) from the storage compartment (7) by pulling the rubber actuator (1) forward and twisting at the same time.

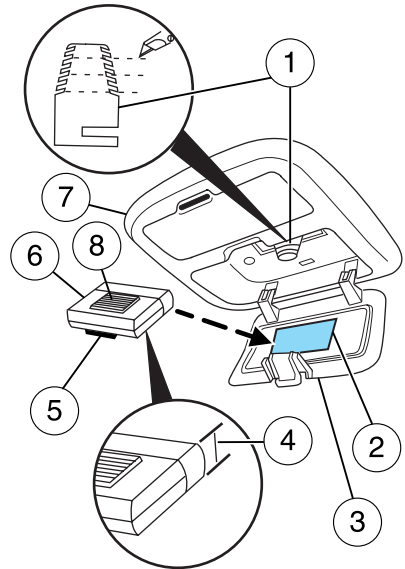

Note: The length of the rubber actuator (1) is critical. Use care in cutting it to length. If the rubber actuator (1) is cut too much the aftermarket transmitter (6) will not activate the garage door opener. If the rubber actuator (1) is cut too long, the storage compartment door (3) will not close properly. Excessive force to close the storage compartment door (3) may cause the door latch to break.

- Per the table below, cut the rubber actuator (1) to the proper length based on the thickness (4) measured in the third step.

Driver Controls

Approximate Thickness of Transmitter (GDO)		
inches	mm	Cut to Bottom of Notch
Less Than		
1/4	6.35	No Cut
7/8	22.00	Notch 2
1.0	26.00	Notch 4
1-3/16	32.00	Notch 6

- Reinstall the rubber actuator (1) in the storage compartment (7) by twisting and pushing it back into the slot.
- Install the transmitter (6) on to storage compartment door (3) aligning the actuator control (8) with the rubber plunger (1). Close the storage compartment door (3) to verify proper fit. Do not force the storage compartment door (3) or you may break the door latch. If the rubber actuator (1) is the proper length the storage compartment door will close. Press the storage compartment door (3) to activate the transmitter (6).

Illuminated visor mirror (if equipped)

Lift the mirror cover to turn on the visor mirror lamps.

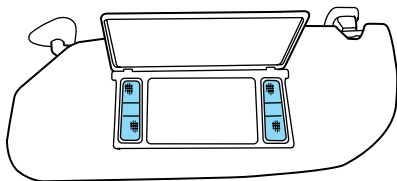

AUXILIARY POWER POINT

WARNING: Power outlets are designed for accessory plugs only. Do not hang any type of accessory or accessory bracket from the plug. Improper use of the power outlet can cause damage not covered by your warranty.

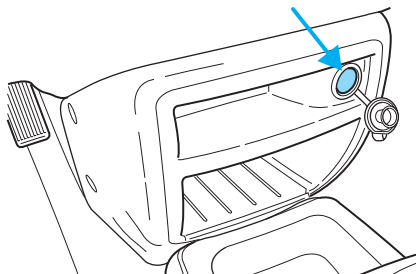

Driver Controls

The auxiliary power point is located on the instrument panel below the radio.

Do not plug optional electrical accessories into the cigarette lighter. Use the power point.

Do not use the power point for operating the cigarette lighter element.

The Maximum power each power point can supply depends on the fuse rating. For example: a 20A fuse should supply a maximum of 240 Watts, a 15A fuse should supply a maximum of 180 Watts and a 10A fuse should supply a maximum of 120 Watts. Exceeding these limits will result in a blown fuse.

Always keep the power point caps closed when not being used.

Cargo area auxiliary power point

An additional auxiliary power point is located in the cargo area.

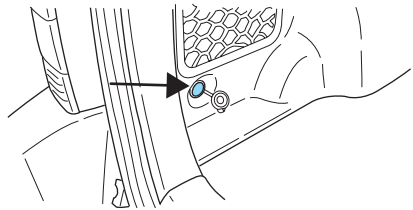

POWER WINDOWS

WARNING: When closing the power windows, you should verify they are free of obstructions and ensure that children and/or pets are not in the proximity of the window openings.

The ignition must be in the ON position to adjust the power windows. Press and hold the bottom part of the rocker switch to open the window. Press and hold the top part of the rocker switch to close the window.

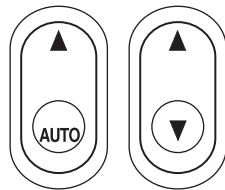

Driver Controls

One touch down

Allows the driver's window to open fully without holding the control down. Press completely down on AUTO and release quickly. Press again to stop.

Note: This feature will only operate the driver's side window.

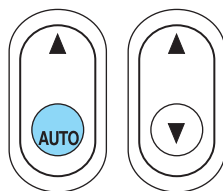

Window lock

The window lock feature disables all the power windows except the driver's.

To lock out all the window controls except for the driver's window press the right side of the control.

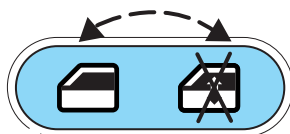

NOTE: The window switches will not illuminate when the window control is in the LOCKED position.

Press the left side to restore the window controls.

Accessory delay

With accessory delay, power windows and moonroof operate for up to ten minutes after the ignition switch is turned from the ACC or ON to the OFF position or until any door is opened.

WARNING: Do not let children play with the power windows or moon roof. They may seriously injure themselves.

MIRRORS

Power side view mirrors

The ignition must be in the ACC or ON position to adjust the power side view mirrors.

To adjust your mirrors:

1. Rotate the control clockwise to adjust the right mirror and rotate the control counterclockwise to adjust the left mirror.
2. Move the control in the direction you wish to tilt the mirror.
3. Return to the center position to lock mirrors in place.

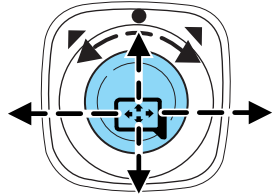

Fold-away mirrors

Pull the side mirrors in carefully when driving through a narrow space, like an automatic car wash.

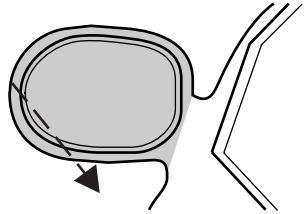

Heated outside mirrors (if equipped)

Both mirrors are heated automatically to remove ice, mist and fog when the rear window defrost is activated.

Do not remove ice from the mirrors with a scraper or attempt to readjust the mirror glass if it is frozen in place.

These actions could cause damage to the glass and mirrors.

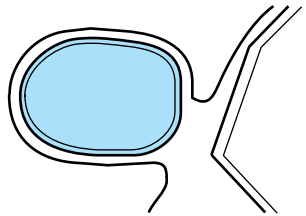

SPEED CONTROL (IF EQUIPPED)

With speed control set, you can maintain a speed of 48 km/h (30 mph) or more without keeping your foot on the accelerator pedal. Speed control does not work at speeds below 48 km/h (30 mph).

Driver Controls

WARNING: Using cruise control in the following conditions could cause you to lose control of the vehicle:

- Heavy or unsteady traffic
 - Slippery or winding roads
 - Similar restrictions that require inconsistent speed
- Don't use cruise control in these situations.

Setting speed control

The controls for using your speed control are located on the steering wheel for your convenience.

1. Press the ON control and release it.
2. Accelerate to the desired speed.
3. Press the SET ACC control and release it.
4. Take your foot off the accelerator pedal.

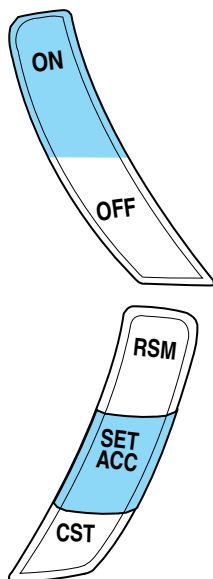

Note:

- Vehicle speed may vary momentarily when driving up and down a steep hill.
- If the vehicle speed increases above the set speed on a downhill, you may want to apply the brakes to reduce the speed.
- If the vehicle speed decreases more than 16 km/h (10 mph) below your set speed on an uphill, your speed control will disengage.

Resuming a set speed

Press the RSM (resume) control and release it. This will automatically return the vehicle to the previously set speed. The RSM control will not work if the vehicle speed is not faster than 48 km/h (30 mph).

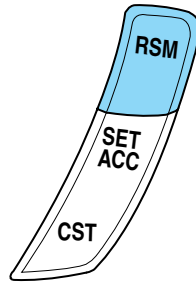

Increasing speed while using speed control

There are two ways to set a higher speed:

- Press and hold the SET ACC control until you get to the desired speed, then release the control. You can also use the SET ACCEL control to operate the Tap-Up function. Press and release this control to increase the vehicle set speed in small amounts by 1.6 km/h (1 mph).
- Use the accelerator pedal to get to the desired speed. When the vehicle reaches that speed press and release the SET ACC control.

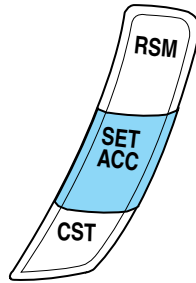

Reducing speed while using speed control

There are two ways to reduce a set speed:

- Press and hold the CST control until you get to the desired speed, then release the control. You can also use the CST control to operate the Tap-Down function. Press and release this control to decrease the vehicle set speed in small amounts by 1.6 km/h (1 mph).

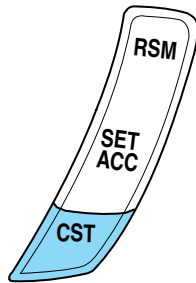

Driver Controls

- Depress the brake pedal until the desired vehicle speed is reached, press the SET ACC control.

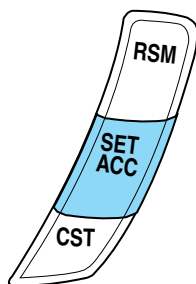

Turning off speed control

There are two ways to turn off the speed control:

- Depress the brake pedal or the clutch pedal (if equipped). This will not erase your vehicle's previously set speed.
- Press the speed control OFF control.

Note: When you turn off the speed control or the ignition, your speed control set speed memory is erased.

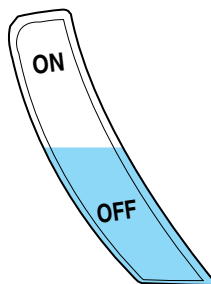

FUEL FILLER DOOR RELEASE HANDLE

Your vehicle is equipped with a locking fuel filler door. To open the door, pull the handle up located on the driver's side floor.

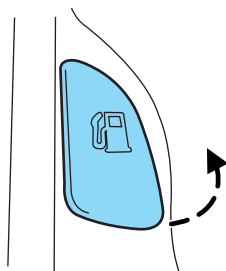

MOON ROOF (IF EQUIPPED)

To operate the moon roof:

- The moon roof is equipped with an automatic, one-touch, express opening feature. Press and release the rear portion of the control. To stop motion at any time during the one-touch opening, press the control a second time.
- To close, press and hold the front portion of the control.

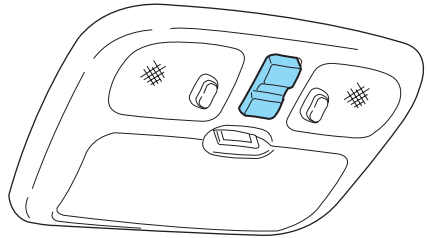

To operate the moon roof vent position:

- To open, press and hold the front portion of the control. This will open the vent.
- To close, press and hold the rear portion of the control.

NOTE: If the battery is disconnected, discharged, or a new battery is installed, the moon roof needs to be opened to the vent position to reset the moon roof positions.

NOTE: If you open and close the moon roof repeatedly, the moon roof motor may overheat and shut down for 45 seconds while the motor cools.

WARNING: Do not let children play with the moon roof. They may seriously injure themselves.

CENTER CONSOLE

Your vehicle may be equipped with a variety of console features. These include:

- Utility compartment
- Cupholders
- Power point
- Ashcup

WARNING: Use only soft cups in the cupholder. Hard objects can injure you in a collision.

Driver Controls

CARGO SHADE (IF EQUIPPED)

If your vehicle has a cargo shade, you can use it to cover items in the cargo area of your vehicle.

To install the shade:

- Insert the ends of the cargo shade into the mounting features located behind the rear seat on the rear trim panels.

To operate the shade:

1. Grasp the pull tube at the rearward edge of the shade and pull rearward.
2. Secure both ends of the pull tube in the retention slots located on the rear trim panels.

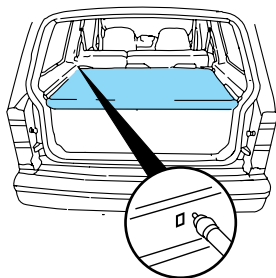

WARNING: Ensure that the posts are properly latched in mounting features. The cover may cause injury in a sudden stop or accident if it is not securely installed.

WARNING: Do not place any objects on the cargo area shade. They may obstruct your vision or strike occupants of vehicle in the case of a sudden stop or collision.

LIFTGATE

To open the rear window, pull the right side of the liftgate handle.

To open the liftgate, pull the left side of the liftgate handle.

- Do not open the liftgate or liftgate glass in a garage or other enclosed area with a low ceiling. If the liftgate glass is raised and the liftgate is also opened, both liftgate and glass could be damaged against a low ceiling.
- Do not leave the liftgate or liftgate glass open while driving. Doing so could cause serious damage to the liftgate and its components as well as allowing carbon monoxide to enter the vehicle.

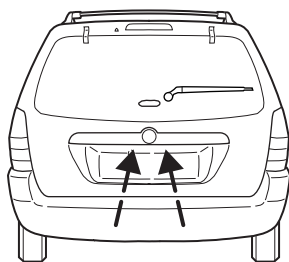

WARNING: Make sure that the liftgate door and/or window are closed to prevent exhaust fumes from being drawn into the vehicle. This will also prevent passengers and cargo from falling out. If you must drive with the liftgate door or window open, keep the vents open so outside air comes into the vehicle.

LUGGAGE RACK

The maximum load for the roof rack is 44 kg (100 lbs), evenly distributed on the crossbars. If it is not possible to evenly distribute the load, position it in the center or as far forward on the crossbars (if equipped) as possible. Always use the adjustable tie down loops to secure the load.

To adjust the cross-bar (if equipped) position:

1. Loosen the thumbwheel at both ends of the cross-bar (both cross-bars are adjustable).
2. Slide the cross-bar to the desired location.
3. Tighten the thumbwheel at both ends of the cross-bar.

To remove the cross-bar assembly (if equipped) from the roof rack side rails:

1. Loosen the thumbwheel at both ends of the cross-bar (both cross-bars are adjustable).
2. Slide the cross-bar to the end of the rail.
3. Use a long, flat object to depress the tongue in the endcaps on both sides of the cross-bar.
4. Slide the cross-bar assembly off the end of the rail.

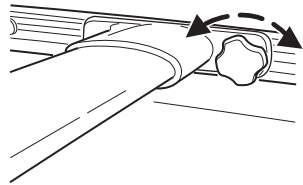

To reinstall the cross-bar assembly (if equipped) to the roof rack side rails:

1. Slide the cross-bar assemblies over the end cap tongue and into the side rails.
2. Tighten thumbwheel at both ends of the cross-bar.

Locks and Security

KEYS



The key operates all locks on your vehicle. In case of loss, replacement keys are available from your dealer.

You should always carry a second key with you in a safe place in case you require it in an emergency.

Refer to *SecuriLock™ Passive Anti-Theft System* for more information.

POWER DOOR LOCKS

The power door lock control is located on the driver door panel.

Pressing the  will unlock all the doors. Pressing the  will lock all the doors.

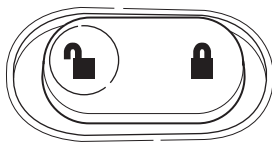

Door key unlocking/locking

Unlocking the doors

1. Turn the key in the door cylinder to unlock the driver's door. **Note:** The interior lamps will illuminate, if the control on the overhead lamp is in the DOOR position the perimeter alarm system (if equipped) will deactivate.
2. Turn the key in the door cylinder again within three seconds to unlock the passenger doors, the liftgate and liftgate glass.

This two step unlocking feature activates the illuminated entry feature. This feature turns on all the interior lamps for 30 seconds or until the ignition is turned to the RUN position. If the dome lamp control (if equipped) is in the **off** position, the illuminated entry feature will not work.

The inside lights will not turn off if:

- they have been turned on using the dome lamp control or
- any door is open.

The battery saver feature will turn off the interior lamps 30 minutes after the ignition is turned to the OFF position.

Locking the doors

Turn the key in the door cylinder to lock all the doors. The perimeter alarm (if equipped) will start the arming process. For more information concerning the perimeter alarm, refer to *Perimeter alarm system (if equipped)* later in this chapter.

Childproof door locks

- When these locks are set, the rear doors cannot be opened from the inside.
- The rear doors can be opened from the outside when the doors are unlocked.

The childproof locks are located on rear edge of each rear door and must be set **separately** for each door. Setting the lock for one door will **not** automatically set the lock for both doors.

- Rotate lock control in the direction of arrow to engage the lock.
- Rotate control in the opposite direction to disengage childproof locks.

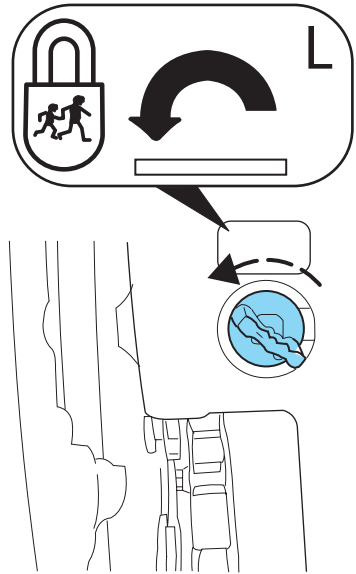

REMOTE ENTRY SYSTEM (IF EQUIPPED)

This device complies with part 15 of the FCC rules and with RS-210 of Industry Canada. Operation is subject to the following two conditions: (1) This device may not cause harmful interference, and (2) This device must accept any interference received, including interference that may cause undesired operation.

Changes or modifications not expressly approved by the party responsible for compliance could void the user's authority to operate the equipment.

The typical operating range for your remote entry transmitter is approximately 10 meters (33 feet). A decrease in operating range could be caused by:

- weather conditions,
- nearby radio towers,
- structures around the vehicle, or
- other vehicles parked next to your vehicle.



Locks and Security

The remote entry system allows you to lock or unlock all vehicle doors without a key. The remote feature will only operate when the ignition is in the 1 (LOCK) or 2 (ACC) position.

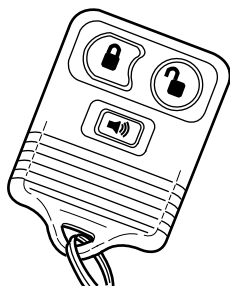
If there is a problem with the remote entry system make sure to take **ALL remote entry transmitters** with you to the dealership, this will aid in troubleshooting the problem.



Unlocking the doors

1. Press  and release to unlock the driver's door. **Note:** The interior lamps will illuminate, if the control on the overhead lamp is in the DOOR position, the flashers will flash twice, and the perimeter alarm system (if equipped) will deactivate.
2. Press  and release again within three seconds to unlock the passenger doors, the liftgate and liftgate glass.



The remote entry system activates the illuminated entry feature. This feature turns on all the interior lamps for 30 seconds or until the ignition is turned to the RUN position. If the dome lamp control (if equipped) is in the **off** position, the illuminated entry feature will not work.

The inside lights will not turn off if:

- they have been turned on using the dome lamp control or
- any door is open.

The battery saver feature will turn off the interior lamps 40 minutes after the ignition is turned to the OFF position.

Locking the doors

1. Press  and release to lock all the doors. The park lamps will flash once and the perimeter alarm (if equipped) will be start the arming process. For more information concerning the perimeter alarm, refer to *Perimeter alarm system (if equipped)* later in this chapter.
2. Press  and release again within three seconds to confirm that all the doors are closed and locked.

If any of the doors or the hood are not properly closed the horn will not sound and the park lamps will not flash.

Sounding a personal alarm

Press  to activate the alarm. The horn will sound for a maximum of 30 seconds and the parklamps will flash for a maximum of 3 minutes. Press again or turn the ignition to ON to deactivate, or wait for the alarm to timeout in 3 minutes.

Note: The personal alarm will only operate when the ignition is in the OFF or ACC position.

Replacing the battery

The remote entry transmitter uses one coin type three-volt lithium battery CR2032 or equivalent.

To replace the battery:

1. Twist a thin coin between the two halves of the remote entry transmitter near the key ring.

DO NOT TAKE THE FRONT PART OF THE REMOTE ENTRY TRANSMITTER APART. Damage to the transmitter may result in operation failure.

2. Remove the old battery.
3. Insert the new battery. Refer to the diagram inside the remote entry transmitter for the correct orientation of the battery.
4. Snap the two halves back together.

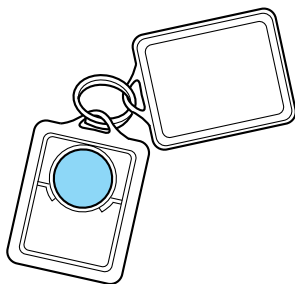

Note: Replacement of the battery will **not** cause the remote transmitter to become deprogrammed from your vehicle. The remote transmitter should operate normally after battery replacement.

Replacing lost remote entry transmitters

If you would like to have your remote entry transmitter reprogrammed because you lost one, or would like to buy additional remote entry transmitters, you can either reprogram them yourself, or take **all remote entry transmitters** to your authorized Mazda dealer for reprogramming.

How to reprogram your remote entry transmitters

You must have **all remote entry transmitters** (maximum of four) available before beginning this procedure.

Locks and Security

Note: This procedure must be completed within the specified times. If not completed within the specified time period, reprogramming procedures must be restarted from the beginning.

To reprogram the remote entry transmitters:

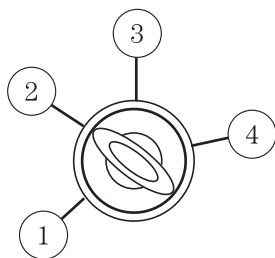

1. Ensure the vehicle is electronically unlocked.
2. Put the key in the ignition.
3. Turn the key from the 1 (LOCK) position to 3 (ON).
4. Cycle eight times rapidly (within 10 seconds) between the 1 (LOCK) position and 3 (ON). **Note:** The eighth turn must end in the 3 (ON) position.
5. The doors will lock, then unlock, to confirm that the programming mode has been activated.
6. Within 20 seconds press any button on the remote entry transmitter. **Note:** If more than 20 seconds have passed you will need to start the procedure over again.
7. The doors will lock, then unlock, to confirm that this remote entry transmitter has been programmed.
8. Repeat Step 6 to program each additional remote entry transmitter.
9. Turn the ignition to the 1 (LOCK) position after you have finished programming all of the remote entry transmitters.
10. The doors will lock, then unlock, to confirm that the programming mode has been exited.

Illuminated entry

The interior lamps illuminate when the remote entry system is used to unlock the door(s) or sound the personal alarm.

The illuminated entry system will turn off the interior lights if:

- the ignition switch is turned to the RUN position, or
- the remote transmitter lock control is pressed, or
- after 30 seconds of illumination.

NOTE: The dome lamp control (if equipped) must **not** be set to the OFF position for the illuminated entry system to operate.

The inside lights will not turn off if:

- they have been turned on with the dimmer control, or
- any door is open.

NOTE: The battery saver will shut off the interior lamps 30 minutes after the ignition has been turned to the OFF position.

SECURILOCK™ PASSIVE ANTI-THEFT SYSTEM

SecuriLock™ passive anti-theft system is an engine immobilization system. This system is designed to prevent the engine from being started unless a **coded key programmed to your vehicle** is used.

The SecuriLock™ passive anti-theft system is not compatible with non-Mazda aftermarket remote start systems. Use of these systems may result in vehicle starting problems and a loss of security protection.

Your vehicle comes with two coded keys; additional coded keys may be purchased from your dealer. The dealer can program your spare keys to your vehicle or you can program the keys yourself. Refer to *Programming spare keys* for instructions on how to program the coded key.

Note: A maximum of eight keys can be coded to your vehicle.

Note: Large metallic objects, electronic devices that are used to purchase gasoline or similar items, or a second coded key on the same key chain may cause vehicle starting issues. You need to prevent these objects from touching the coded key while starting the engine. These objects will not cause damage to the coded key, but may cause a momentary issue if they are too close to the key when starting the engine. If a problem occurs, turn the ignition off, remove all objects on the key chain away from the coded key and restart the engine.

Theft indicator

The theft indicator is located in the instrument cluster.

- When the ignition is in the OFF position, the indicator will flash once every 2 seconds to indicate the SecuriLock™ system is functioning as a theft deterrent.
- When the ignition is in the ON position, the indicator will glow for 3 seconds, then turn off, to indicate normal system functionality.

If a problem occurs with the SecuriLock™ system, the indicator will flash rapidly or glow steadily when the ignition is in the ON position. If this occurs, the vehicle should be taken to an authorized Mazda dealer for service.

Locks and Security

Automatic arming

The vehicle is armed immediately after switching the ignition to the 2 (ACC) position.

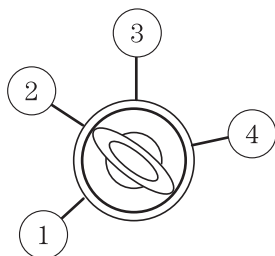

The light in the instrument cluster will flash every two seconds when the vehicle is armed.



Automatic disarming

Switching the ignition to the 3 (ON) position with a **coded key** disarms the vehicle.

- The indicator will illuminate for three seconds and then go out.
- If the indicator stays on for an extended period of time or flashes rapidly, have the system serviced by your authorized Mazda dealer.



Replacement keys

If your keys are lost or stolen and you don't have an extra coded key, you will need to have your vehicle towed to a dealership. The key codes need to be erased from your vehicle and new coded keys and key codes will need to be programmed.

Replacing coded keys can be very costly. Store an extra programmed key away from the vehicle in a safe place to help prevent any inconveniences. Please visit an authorized Mazda dealer to purchase additional spare or replacement keys.

WARNING: If an unprogrammed key is used in the ignition it will cause a “no start” condition.

Programming spare keys

You can program your own coded keys to your vehicle. Please read and understand the entire procedure before you begin.

Tips:

- Only use Securilock™ keys.
- You must have two previously programmed coded keys (keys that already operate your vehicle's engine) and the new unprogrammed key(s) readily accessible.
- If you do not have at least 2 previously programmed keys, you must take your vehicle to your authorized Mazda dealer to have the spare key(s) programmed.

1. Insert a previously programmed **coded key** into the ignition.

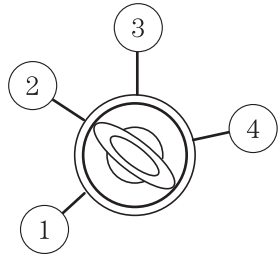

2. Turn the ignition from the 1 (LOCK) position to the 3 (ON) position. Keep the ignition in the 3 (ON) position for at least one second, but no more than 10 seconds.
3. Turn the ignition to the 1 (LOCK) position and remove the **coded key** from the ignition.
4. Within ten seconds, insert the second previously **coded key** into the ignition.
5. Turn the ignition from the 1 (LOCK) position to the 3 (ON) position. Keep the ignition in the 3 (ON) position for at least one second, but no more than 10 seconds.
6. Turn the ignition to the 1 (LOCK) position and remove the second previously programmed **coded key** from the ignition.
7. Within twenty seconds of removing the previously programmed **coded key**, insert the new unprogrammed key into the ignition.

Locks and Security

- Turn the ignition from the 1 (LOCK) position to the 3 (ON) position. Keep the ignition in the 3 (ON) position for at least one second but not more than 10 seconds.
- Remove the newly programmed coded key from the ignition.

If the key has been successfully programmed it will start the vehicle's engine and the theft indicator light will illuminate for three seconds and then go out.

If the key was not successfully programmed, it will not start your vehicle's engine and the theft indicator light will flash on and off, or stay on for more than three seconds. If failure repeats, bring your vehicle to your authorized Mazda dealer to have the new key(s) programmed.

To program additional new unprogrammed key(s), repeat this procedure from step 1 for each additional key.

PERIMETER ALARM SYSTEM (IF EQUIPPED)

The perimeter anti-theft system will warn you in the event of an unauthorized entry to your vehicle.

If there is any potential perimeter anti-theft problem with your vehicle, ensure **ALL remote entry transmitters** are taken to the dealership to aid in troubleshooting.

Arming the system

When armed, this system will respond if unauthorized entry is attempted. When unauthorized entry occurs, the system will flash the headlamps, parking lamps and will sound the horn.

The system is ready to arm whenever key is removed from the ignition. Either of the following actions will prearm the alarm system:



- Press the  control on the remote entry transmitter.
- Lock the doors using the key.

NOTE: If a door is open, the system is not armed.

- The system will become prearmed, when all doors are closed. When the system becomes prearmed the flashers will flash to confirm the prearming.
- Once the system is prearmed, the system will arm in 20 seconds. If any door is opened during these 20 seconds, the arming will be canceled.

Disarming the system

You can disarm the system by any of the following actions:

- Unlock the doors by pressing the  control on your remote entry transmitter.
- Unlock the doors with a key.
- Pressing the  control on the remote entry transmitter. This will disarm the system only if the alarm is sounding.

Seating and Safety Restraints

SEATING

Adjusting the front manual seat

WARNING: Never adjust the driver's seat or seatback when the vehicle is moving. Sudden braking or a collision could cause serious injury. Adjust the seat only when the vehicle is stopped.

WARNING: Do not pile cargo higher than the seatbacks to reduce the risk of injuring people in a collision or sudden stop.

WARNING: Always drive and ride with your seatback upright and the lap belt snug and low across the hips.

WARNING: Sitting in a reclined position while the vehicle is moving is dangerous because you don't get the full protection from seat belts. During sudden braking or a collision, you can slide under the lap belt and suffer serious internal injury, or in a rear end collision you could fly up and out of the vehicle. For maximum protection, sit well back and upright.

Lift handle to move seat forward or backward.

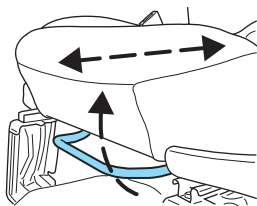

Pull lever up to adjust seatback.

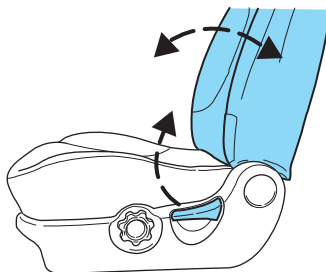

Seating and Safety Restraints

Adjustable head restraints (if equipped)

The purpose of these head restraints is to help limit head motion in the event of a rear collision. To properly adjust your head restraints, lift the head restraint so that it is located directly behind your head or as close to that position as possible.

The head restraints can be moved up and down.

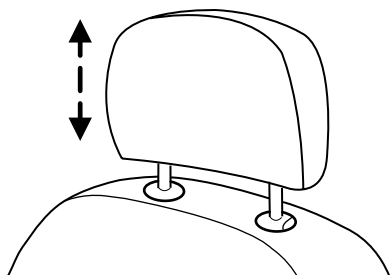

Push side control and push down on head restraint to lower it.

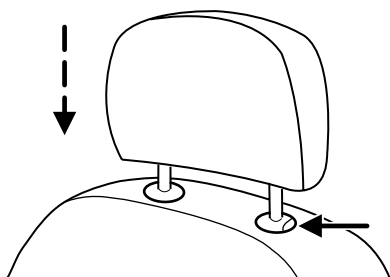

Using the manual lumbar support (if equipped)

The lumbar support control is located on the inboard side of the driver's seat.

Turn the lumbar support control clockwise to increase firmness.

Turn the lumbar support control counterclockwise to increase softness.

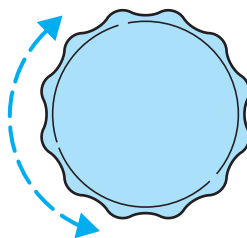

Seating and Safety Restraints

Adjusting the front power seat (if equipped)

WARNING: Never adjust the driver's seat or seatback when the vehicle is moving. Sudden braking or a collision could cause serious injury. Adjust the seat only when the vehicle is stopped.

WARNING: Do not pile cargo higher than the seatbacks to reduce the risk of injuring people in a collision or sudden stop.

WARNING: Always drive and ride with your seatback upright and the lap belt snug and low across the hips.

WARNING: Sitting in a reclined position while the vehicle is moving is dangerous because you don't get the full protection from seat belts. During sudden braking or a collision, you can slide under the lap belt and suffer serious internal injury, or in a rear end collision you could fly up and out of the vehicle. For maximum protection, sit well back and upright.

The control is located on the outboard side of the seat cushion.

Move the front of the control up or down to raise or lower the front portion of the seat cushion.

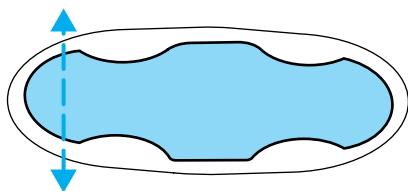

Move the rear of the control up or down to raise or lower the rear portion of the seat cushion.

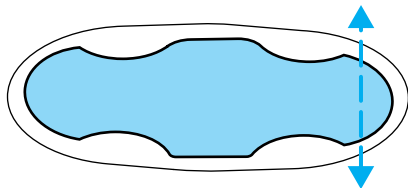

Seating and Safety Restraints

Move the control in the directions shown to move the seat forward, backward, up or down.

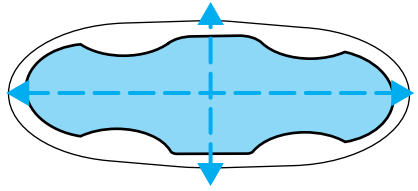

Heated seats (if equipped)

To operate the heated seats:

- Push the control located on the seat to activate.
- Push again to deactivate.



The heated seats will activate when the ignition is in the RUN position. When activated, they will turn off automatically after 10 minutes or when the ignition is turned to the OFF position.

REAR SEATS

Head restraints (if equipped)

The purpose of these head restraints is to help limit head motion in the event of a rear collision. To properly adjust your head restraints, lift the head restraint so that it is located directly behind your head or as close to that position as possible.

The head restraints can be moved up and down.

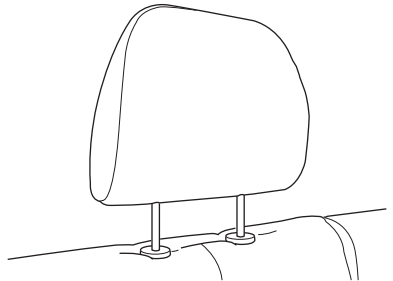

Seating and Safety Restraints

Push control to lower head restraint.

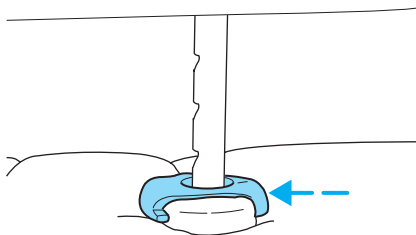

Reclining the second row seatback

Locate the release strip located on the outboard side of the seat cushion bottom and lift gently to allow the seatback to be adjusted to the desired position.

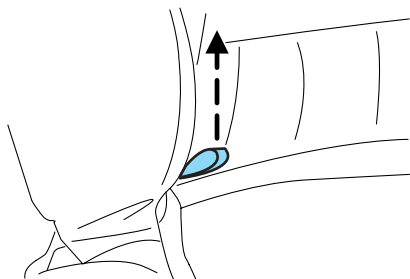

WARNING: Sitting in a reclined position while the vehicle is moving is dangerous because you don't get the full protection from seat belts. During sudden braking or a collision, you can slide under the lap belt and suffer serious internal injury, or in a rear end collision you could fly up and out of the vehicle. For maximum protection, sit well back and upright.

Folding down rear seats (60/40 split bench)

1. Raise the rear seat head restraint and remove.

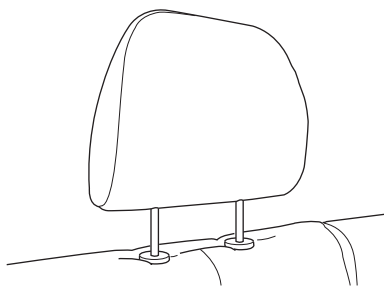

Seating and Safety Restraints

2. Place the head restraints under the front passenger seat for storage.
3. Pull the seat release control.

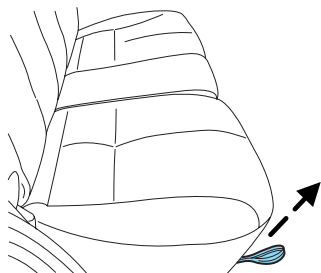

4. Flip seat forward.

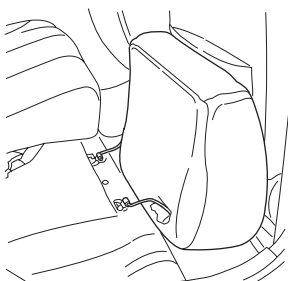

5. Pull the seatback release strap toward the front seat. Make sure the seat belt buckle heads are fully extended towards the front of the vehicle and are away from the seatback.

NOTE: When the seatback release strap is pulled use your other hand to guide the seatback.

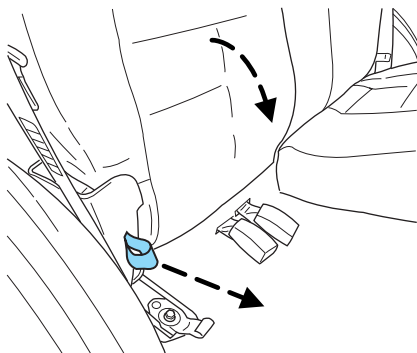

Seating and Safety Restraints

6. Rotate seatback down into load floor position.

WARNING: Make sure seat belt buckle heads are not trapped underneath the seatback and that the seat belt buckle heads are fully extended towards the front of the vehicle. Seat belt buckle heads may break if they are trapped underneath the seatback as the seatback is rotated down.

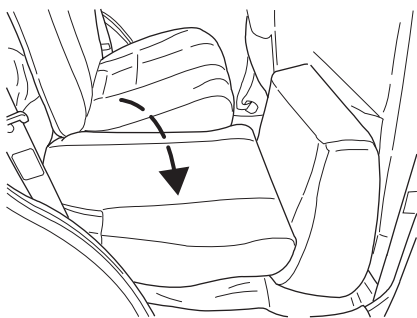

NOTE: Make sure the floor is clear of all objects before folding the seatback.

Returning the rear seats to upright position

1. Pull seatback up and into upright position making sure seatback locks into place. While holding the seatback, pull the release and push seatback backward into the desired position.

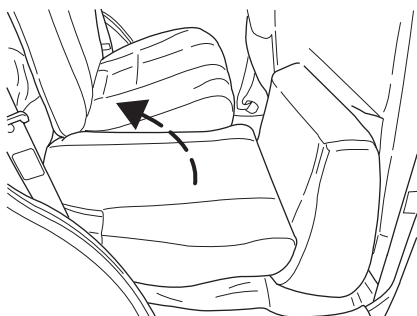

Seating and Safety Restraints

2. Rotate seat cushion down into the seating position making sure that the seat cushion is locked into place and that the seat belt buckles are exposed.

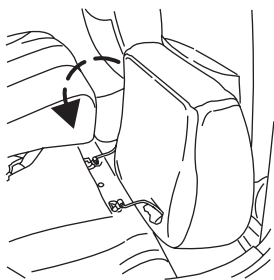

3. Remove the head restraints stored under the front passenger seat and return them to the original position on the seat backs.

To remove the rear cushion

1. Pull the Yellow tab
2. Pull the cushion to the outboard side of the vehicle.

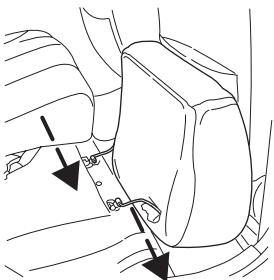

To install the rear cushion

1. Push the cushion to the inboard side of the vehicle.
2. Make sure that the hinges are locked into place.

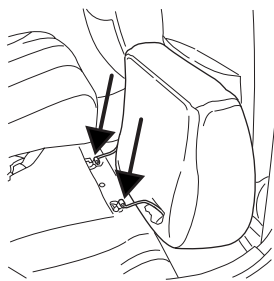

Seating and Safety Restraints

Folding down rear seats (bench)

1. Raise the rear seat head restraint and remove.

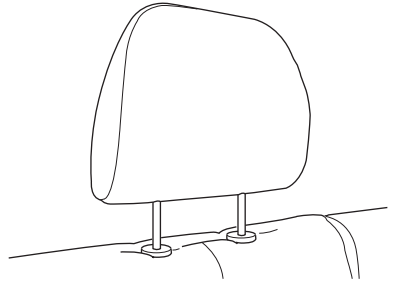

2. Place the head restraints under the front passenger seat for storage.
3. Pull the seat release control on each side of the seat to release the locks.

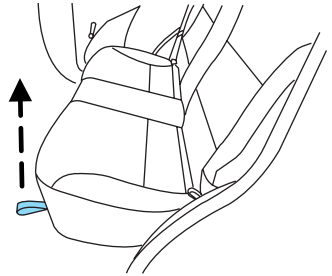

4. Flip seat forward.

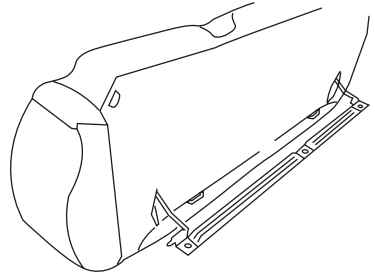

Seating and Safety Restraints

5. Pull the seatback release strap toward the front seat. Make sure the seat belt buckle heads are fully extended towards the front of the vehicle and are away from the seatback.

NOTE:When the seatback release strap is pulled use your other hand to guide the seatback.

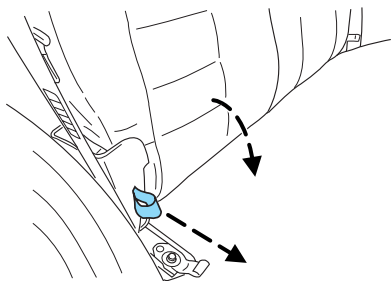

6. Rotate seatback down into load floor position.

WARNING: Make sure seat belt buckle heads are not trapped underneath the seatback and that the seat belt buckle heads are fully extended towards the front of the vehicle. Seat belt buckle heads may break if they are trapped underneath the seatback as the seatback is rotated down.

NOTE:Make sure the floor is clear of all objects before folding the seatback.

Returning the rear seats to upright position

1. Pull seatback up and into upright position making sure seatback locks into place.
2. Rotate seat cushion down into the seating position making sure that the seat cushion is locked into place and that the seat belt buckles are exposed.

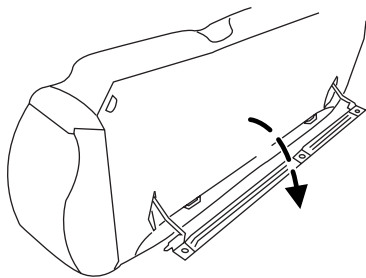

3. Remove the head restraints stored under the front passenger seat and return them to the original position on the seat backs.

WARNING: Make sure that the seat is firmly locked into position and that the safety belt buckles are exposed.

Seating and Safety Restraints

To remove the rear cushion

1. Pull the Yellow tab
2. Pull the cushion so that the rods remove from the locking tabs.

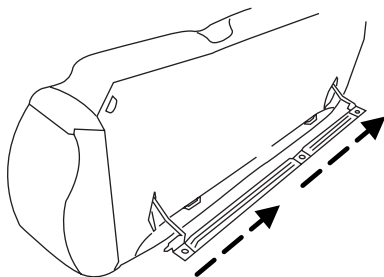

To install the rear cushion

1. Push the cushion so that the rods fit into the locking tabs.
2. Make sure that the hinges are locked into place.

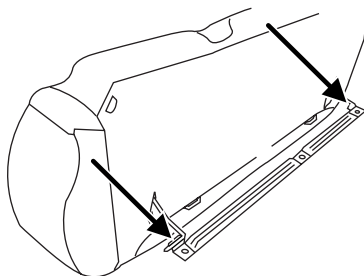

SAFETY RESTRAINTS

Safety restraints precautions

WARNING: Always drive and ride with your seatback upright and the lap belt snug and low across the hips.

WARNING: To reduce the risk of injury, make sure children sit where they can be properly restrained.

WARNING: Never let a passenger hold a child on his or her lap while the vehicle is moving. The passenger cannot protect the child from injury in a collision.

Seating and Safety Restraints

WARNING: All occupants of the vehicle, including the driver, should always properly wear their safety belts, even when an air bag (SRS) is provided.

WARNING: It is extremely dangerous to ride in a cargo area, inside or outside of a vehicle. In a collision, people riding in these areas are more likely to be seriously injured or killed. Do not allow people to ride in any area of your vehicle that is not equipped with seats and safety belts. Be sure everyone in your vehicle is in a seat and using a safety belt properly.

WARNING: In a rollover crash, an unbelted person is significantly more likely to die or be seriously injured than a person wearing a seat belt.

WARNING: Each seating position in your vehicle has a specific safety belt assembly which is made up of one buckle and one tongue that are designed to be used as a pair. 1) Use the shoulder belt on the outside shoulder only. Never wear the shoulder belt under the arm. 2) Never swing the safety belt around your neck over the inside shoulder. 3) Never use a single belt for more than one person.

WARNING: Placing a child, 12 years or younger, in the front seat is dangerous. The child could be hit by a deploying air bag and be seriously injured or even killed. A sleeping child is more likely to lean against the door and be hit by the side air bag (if equipped) in a moderate collision. Whenever possible, always secure a child, 12 years or younger, in the rear seat, with an appropriate child restraint system for the child's age and size. Never use a rear-facing child restraint system in the front seat with an air bag that could deploy.

Energy Management Feature

- This vehicle has a safety belt system with an energy management feature at the front seating positions to help further reduce the risk of injury in the event of a head-on collision.

Seating and Safety Restraints

- This safety belt system has a retractor assembly that is designed to pay out webbing in a controlled manner. This feature is designed to help reduce the belt force acting on the occupant's chest.

WARNING: All safety belts should be checked for proper function. Additionally, if the front air bags have deployed, the front pretensioners have also deployed and both front restraints must be replaced. After any vehicle collision, the safety belt system at all outboard seating positions (except driver, which has no “automatic locking retractor” feature) must be checked by a qualified technician to verify that the “automatic locking retractor” feature for child seats is still functioning properly.

WARNING: BELT AND RETRACTOR ASSEMBLY MUST BE REPLACED if the safety belt assembly “automatic locking retractor” feature or any other safety belt function is not operating properly when checked according to the procedures in Workshop Manual.

WARNING: Failure to replace the Belt and Retractor assembly could increase the risk of injury in collisions.

Combination lap and shoulder belts

1. Insert the belt tongue into the proper buckle (the buckle closest to the direction the tongue is coming from) until you hear a snap and feel it latch. Make sure the tongue is securely fastened in the buckle.

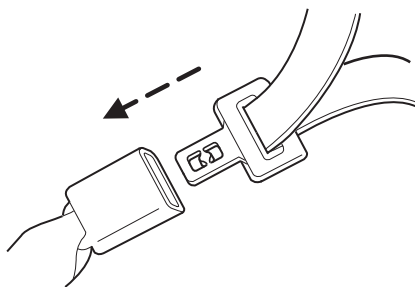

Seating and Safety Restraints

2. To unfasten, push the release button and remove the tongue from the buckle.

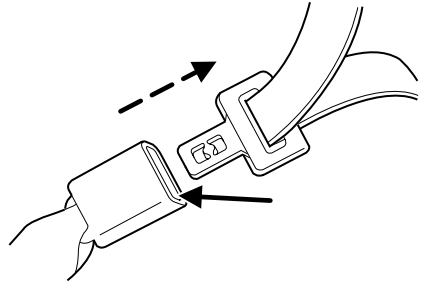

The front outboard and rear outboard safety restraints in the vehicle are combination lap and shoulder belts. The front outboard passenger and rear seat outboard safety belts have two types of locking modes described below:

Vehicle sensitive mode

This is the normal retractor mode, which allows free shoulder belt length adjustment to your movements and locking in response to vehicle movement. For example, if the driver brakes suddenly or turns a corner sharply, or the vehicle receives an impact of approximately 8 km/h (5 mph) or more, the combination safety belts will lock to help reduce forward movement of the driver and passengers.

Automatic locking mode (outboard front passenger seating position only) for use with child safety seats

The automatic locking mode is not available on the driver safety belt.

When to use the automatic locking mode

In this mode, the shoulder belt is automatically pre-locked. The belt will still retract to remove any slack in the shoulder belt. The automatic locking mode is not available on the driver safety belt.

This mode should be used **any time** a child safety seat is installed in a passenger front or outboard rear seating position (if equipped). Children 12 years old and under should be properly restrained in the rear seat whenever possible. Refer to *Safety restraints for children* or *Safety seats for children* later in this chapter.

Seating and Safety Restraints

How to use the automatic locking mode (Outboard front passenger seating position only) for use with child safety seats

- Buckle the combination lap and shoulder belt.

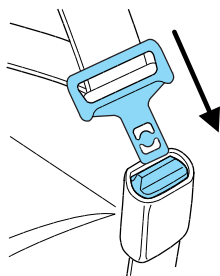

- Grasp the shoulder portion and pull downward until the entire belt is pulled out.



- Allow the belt to retract. As the belt retracts, you will hear a clicking sound. This indicates the safety belt is now in the automatic locking mode.

How to disengage the automatic locking mode

Disconnect the combination lap/shoulder belt and allow it to retract completely to disengage the automatic locking mode and activate the vehicle sensitive (emergency) locking mode.

WARNING: After any vehicle collision, the front passenger outboard seat belt system must be checked by an authorized Mazda dealership to verify that the “automatic locking retractor” feature for child seats is still functioning properly. In addition, all seat belts should be checked for proper function. Additionally, if the front air bags have deployed, the front pretensioners have also deployed and both front restraints must be replaced.

Seating and Safety Restraints

WARNING: BELT AND RETRACTOR ASSEMBLY MUST BE REPLACED if the seat belt assembly “automatic locking retractor” feature or any other seat belt function is not operating properly when checked according to the procedures in Workshop Manual.

WARNING: Failure to replace the Belt and Retractor assembly could increase the risk of injury in collisions.

Front safety belt height adjustment

Adjust the height of the shoulder belt so the belt rests across the middle of your shoulder.

To adjust the shoulder belt height, push the button and slide the height adjuster up or down. Release the button and pull down on the height adjuster to make sure it is locked in place.

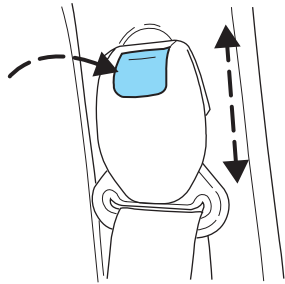

WARNING: Position the safety belt height adjusters so that the belt rests across the middle of your shoulder. Failure to adjust the safety belt properly could reduce the effectiveness of the seat belt and increase the risk of injury in a collision.

Safety belt pretensioner

Your vehicle is equipped with safety belt pretensioners at the driver and front passenger seating positions.

The safety belt pretensioners are designed to activate during certain frontal or near-frontal collisions with sufficient longitudinal deceleration. A safety belt pretensioner is a device which tightens the webbing of the lap and shoulder belts in such a way that they fit more snugly against the body.

Seating and Safety Restraints

The driver and front outboard passenger safety belt systems (including retractors, buckles and height adjusters) must be replaced if the vehicle is involved in a collision that results in the activation of the safety belt pretensioners. Refer to the *Safety belt maintenance* section in this chapter.

WARNING: Failure to replace both front restraints under the above conditions could result in severe personal injuries in the event of a collision. The seat belt pretensioners will only function once. After they are deployed, they will not work again and must be replaced immediately, even if there was no front seat occupant seated at the time.

WARNING: Modifying the components or wiring of the pretensioner system, including the use of electronic testing devices is dangerous. You could accidentally activate it or make it inoperable which would prevent it from activating in an accident. Front occupants could be seriously injured. Never modify the components or wiring, or use electronic testing devices on the pretensioner system.

WARNING: Improper disposal of the pretensioner system or a vehicle with non-deactivated pretensioners is dangerous. Unless all safety procedures are followed, injury could result. Ask an authorized Mazda Dealer how to safely dispose of the pretensioner system or how to scrap a front pretensioner-equipped vehicle.

Safety belt extension assembly

If the safety belt assembly is too short for you, even when fully extended, 20 cm (8 inches) can be added to the safety belt assembly by adding a safety belt extension assembly. Safety belt extension assemblies can be obtained from your authorized Mazda dealership.

Use only extensions manufactured by the same supplier as the safety belt. Manufacturer identification is located at the end of the webbing on the label. Also, use the safety belt extension only if the safety belt is too short for you when fully extended.

NOTE: Do not use extensions to change the fit of the shoulder belt across the torso.

Seating and Safety Restraints

Rear seat lap belts

Adjusting the center lap belt

The lap belt does not adjust automatically.

WARNING: The lap belts should fit snugly and as low as possible around the hips, not around the waist. Failure to position the lap belt correctly may cause serious injury in an accident.

Insert the tongue into the correct buckle (the buckle closest to the direction the tongue is coming from). To lengthen the belt, turn the tongue at a right angle to the belt and pull across your lap until it reaches the buckle.

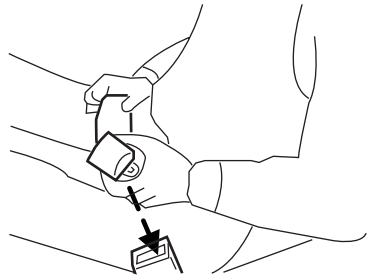

To tighten the belt, pull the loose end of the belt through the tongue until it fits snugly across the hips.

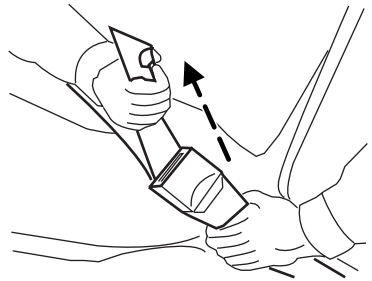

Shorten and fasten the belt when not in use to keep the belt away from door openings and available after unfolding the seats.

Safety belt warning light and indicator chime

The safety belt warning light illuminates in the instrument cluster and a chime sounds to remind the occupants to fasten their safety belts.

Seating and Safety Restraints

Conditions of operation

If...	Then...
The driver's safety belt is not buckled before the ignition switch is turned to the ON position...	The safety belt warning light illuminates 1-2 minutes and the warning chime sounds 4-8 seconds.
The driver's safety belt is buckled while the indicator light is illuminated and the warning chime is sounding...	The safety belt warning light and warning chime turn off.
The driver's safety belt is buckled before the ignition switch is turned to the ON position...	The safety belt warning light and indicator chime remain off.

The following are reasons most often given for not wearing safety belts: (All statistics based on U.S. data)

Reasons given...	Consider...
"Crashes are rare events"	36,700 crashes occur every day. The more we drive, the more we are exposed to "rare" events, even for good drivers. <i>1 in 4 of us will be seriously injured in a crash during our lifetime.</i>
"I'm not going far"	3 of 4 fatal crashes occur within 25 miles of home.
"Belts are uncomfortable"	Safety belts are designed to enhance comfort. If you are uncomfortable - try different positions for the safety belt upper anchorage and seatback which should be as upright as possible; this can improve comfort.
"I was in a hurry"	Prime time for an accident. Safety Belt Warning Chime reminds us to take a few seconds to buckle up.

Seating and Safety Restraints

Reasons given...	Consider...
"Seat belts don't work"	Safety belts , when used properly, reduce risk of death to front seat occupants by 45% in cars , and by 60% in light trucks .
"Traffic is light"	Nearly 1 of 2 deaths occur in single-vehicle crashes , many when no other vehicles are around.
"Belts wrinkle my clothes"	Possibly, but a serious crash can do much more than wrinkle your clothes, particularly if you are unbelted.
"The people I'm with don't wear belts"	Set the example, teen deaths occur 4 times more often in vehicles with TWO or MORE people. Children and younger brothers/sisters imitate behavior they see.
"I have an air bag"	Air bags offer greater protection when used with safety belts. Frontal airbags are not designed to inflate in rear and side crashes or rollovers.
"I'd rather be thrown clear"	Not a good idea. People who are ejected are 40 times more likely to DIE . Safety belts help prevent ejection, WE CAN'T "PICK OUR CRASH".

WARNING: Always wear the safety belt. Do not be tempted to sit on top of the belt to fool police or to defeat the warning system. The safety belt and safety belt warning system are there to protect your life.

Safety belt maintenance

Inspect the safety belt systems periodically to make sure they work properly and are not damaged.

NOTE: If unsure about the proper procedures, bring your vehicle to an authorized Mazda dealership for inspection. Inspect the safety belts to make sure there are no nicks, tears or cuts, replacing if necessary. Check

Seating and Safety Restraints

all automatic locking retractors on all outboard seating positions as well as the automatic locking mode for child safety seats on the passenger front belt. All safety belt assemblies, including retractors, buckles, front seat belt buckle assemblies, buckle support assemblies (slide bar-if equipped), shoulder belt height adjusters (if equipped), shoulder belt guide on seatback (if equipped), child safety seat tether bracket assemblies (if equipped), LATCH child seat tether anchors and lower anchors (if equipped), and attaching hardware, should be inspected after a collision. Mazda recommends that all safety belt assemblies used in vehicles involved in a collision be replaced. However, if the collision was minor and an authorized Mazda technician finds that the belts do not show damage and continue to operate properly, they do not need to be replaced. Safety belt assemblies not in use during a collision should also be inspected and replaced if either damage or improper operation is noted.

The energy absorbing functions may have been activated in a collision so the restraints should be examined; if the front air bags have deployed, the pretensioners have also deployed and must be replaced — regardless of whether there was an occupant in the passenger seat or not. The optional side air bags are not connected to the pretensioners.

WARNING: Failure to inspect and if necessary replace the safety belt assembly under the above conditions could result in severe personal injuries in the event of a collision.

Refer to *Interior* in the *Cleaning* chapter.

AIR BAG SUPPLEMENTAL RESTRAINT SYSTEM (SRS)

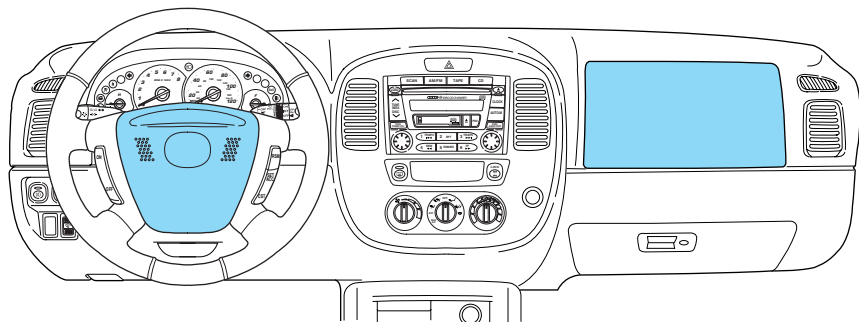

Seating and Safety Restraints

Important supplemental restraint system (SRS) precautions

The supplemental restraint system is designed to work with the safety belt to help protect the driver and right front passenger from certain upper body injuries.

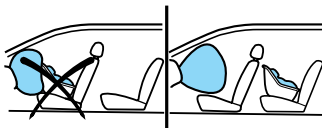

WARNING: Air bags DO NOT inflate slowly or gently and the risk of injury from a deploying air bag is greatest close to the trim covering the air bag module.

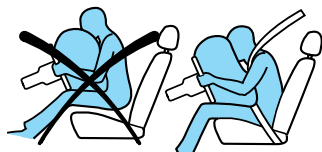

WARNING: All occupants of the vehicle, including the driver, should always properly wear their safety belts, even when an air bag (SRS) is provided.

WARNING: Always transport children 12 years old and under in the back seat and always properly use appropriate child restraint systems.

WARNING: National Highway Traffic Safety Administration (NHTSA) recommends a minimum distance of at least 25 cm (10 inches) between an occupant's chest and the driver air bag module.

WARNING: The driver should always hold onto only the rim of the steering wheel. Never place your arm over the air bag module as a deploying air bag can result in serious arm fractures or other injuries.

Steps you can take to properly position yourself away from the air bag:

- Move your seat to the rear as far as you can while still reaching the pedals comfortably.
- Recline the seat slightly (one or two degrees) from the upright position.

Seating and Safety Restraints

WARNING: Do not put anything on or over the air bag module including hands or feet. Placing objects on or over the air bag inflation area may cause those objects to be propelled by the air bag into your face and torso causing serious injury.

WARNING: Do not attempt to service, repair, or modify the Air Bag Supplemental Restraint Systems or its fuses. See your authorized Mazda dealership.

WARNING: Modifications to the front end of the vehicle, including frame, bumper, front end body structure, tow hooks, and snow plows may affect the performance of the air bag sensors increasing the risk of injury. Do not modify the front end of the vehicle.

WARNING: Additional equipment may effect the performance of the air bag sensors increasing the risk of injury. Consult your authorized Mazda dealership before installation of additional equipment.

Children and air bags

For additional important safety information, read all information on safety restraints in this guide.

WARNING: Children must always be properly restrained. Accident statistics suggest that children are safer when properly restrained in the rear seating positions than in the front seating position. Failure to follow these instructions may increase the risk of injury in a collision.

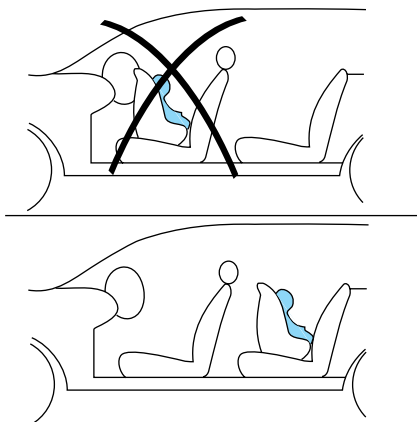

Seating and Safety Restraints

WARNING: Air bags can kill or injure a child in a child seat NEVER place a rear-facing child seat in front of an active air bag. If you must use a forward-facing child seat in the front seat, move the seat all the way back. Secure the seat and the child in it properly.

How does the air bag supplemental restraint system work?

The air bag SRS is designed to activate when the vehicle sustains longitudinal deceleration sufficient to cause the sensors to close an electrical circuit that initiates air bag inflation.

The fact that the air bags did not inflate in a collision does not mean that something is wrong with the system. Rather, it means the forces were not of the type sufficient to cause activation.

Air bags are designed to inflate in frontal and near-frontal collisions, not rollover, side-impact, or rear-impacts unless the collision causes sufficient longitudinal deceleration.

The air bags inflate and deflate rapidly upon activation. After air bag deployment, it is normal to notice a smoke-like, powdery residue or smell the burnt propellant. This may consist of cornstarch, talcum powder (to lubricate the bag) or sodium compounds (e.g., baking soda) that result from the combustion process that inflates the air bag. Small amounts of sodium hydroxide may be present which may irritate the skin and eyes, but none of the residue is toxic.

While the system is designed to help reduce serious injuries, contact with a deploying air bag may also cause abrasions, swelling or temporary

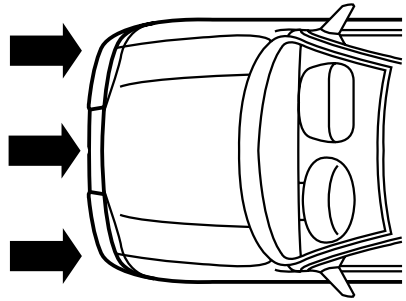

Seating and Safety Restraints

hearing loss. Because air bags must inflate rapidly and with considerable force, there is the risk of death or serious injuries such as fractures, facial and eye injuries or internal injuries, particularly to occupants who are not properly restrained or are otherwise out of position at the time of air bag deployment. Thus, it is extremely important that occupants be properly restrained as far away from the air bag module as possible while maintaining vehicle control.

WARNING: Several air bag system components get hot after inflation. Do not touch them after inflation or you may be burned.

WARNING: If the air bag and safety belt pretensioners have deployed, the air bag and safety belt pretensioners will not function again and must be replaced immediately. If the air bag and safety belt pretensioners are not replaced, the unrepaired area will increase the risk of injury in a collision.

The SRS consists of:

- driver and passenger air bag modules (which include the inflators and air bags),
- one or more impact and safing sensors,
- a readiness light and tone
- diagnostic module
- and the electrical wiring which connects the components.

The diagnostic module monitors its own internal circuits and the supplemental air bag electrical system wiring (including the impact sensors), the system wiring, the air bag system readiness light, the air bag back up power and the air bag ignitors.

Determining if the system is operational

The SRS uses a readiness light in the instrument cluster or a tone to indicate the condition of the system. Refer to the *Air bag readiness* section in the *Instrumentation* chapter. Routine maintenance of the air bag is not required.

Seating and Safety Restraints

A difficulty with the system is indicated by one or more of the following:

- The readiness light will either flash or stay lit.
- The readiness light will not illuminate immediately after ignition is turned on.
- A series of five beep sounds will be heard. The tone pattern will repeat periodically until the problem and/or light are repaired.



If any of these things happen, even intermittently, have the SRS serviced at your authorized Mazda dealership immediately.

WARNING: Unless serviced, the system may not function properly in the event of a collision.

Disposal of air bags and air bag equipped vehicles

For disposal of safety belt pretensioners, air bags, or air bag equipped vehicles, see your authorized Mazda dealership. Air bags **MUST BE** disposed of by qualified personnel.

WARNING: Disposing of an air bag can be dangerous. Unless all safety procedures are followed, injury can result. Ask an Authorized Mazda Dealer how to safely dispose of an air bag or how to scrap an air bag equipped vehicle.

Side air bag system (if equipped)

WARNING: Do not place objects or mount equipment on or near the air bag cover on the side of the seatbacks of the front seats or in front seat areas that may come into contact with a deploying air bag. This is dangerous. In an accident, the object could interfere with the air bag inflation and injure the occupants.

Seating and Safety Restraints

WARNING: Side Air Bag Storage Areas:

Attaching things to the seat in such a way as to cover the outboard side of the seat in any way is dangerous. In an accident the object could interfere with the side air bag, which inflates from the outboard side of the front seats, impeding the added protection of the side air bag system or redirecting the air bag in a way that is dangerous. Furthermore, the bag could be cut open spewing exhaust. Do not hang net bags, map pouches or back pads with side straps on the front seats. Always keep the side air bag storage areas in your front seats free to deploy in the event of a side collision.

WARNING: Using Seat Covers:

Using a seat cover on the front seats could be dangerous. In a severe side collision, the seat covers could interfere with the side air bag inflation and serious injuries could result. Never use seat covers on the front seats.

To prevent damage to the side air bag wiring, don't place luggage or other objects under the front seats.

WARNING: Seating Position with Side Air Bags:

Sitting too close to the side air bag storage compartments or placing hands on them is extremely dangerous. A side air bag inflates with great force and speed directly out of the outboard shoulder of the front seat and expands along the front door on the side the car is hit. Serious injury could occur if someone is sitting too close to the door or leaning against a window in the front seats or if rear seat occupants grab the sides of the front seatbacks. Furthermore, sleeping up against the door or hanging out the driver's-side window while driving could block the side air bag and eliminate the advantages of supplemental protection. Give the side air bags room to work by sitting in the center of the front seats while the vehicle is moving with seat belts worn properly.

Seating and Safety Restraints

WARNING: Modification of the Supplemental Restraint System: Modifying the components or wiring of the supplemental restraint system is dangerous. You could accidentally activate it or make it inoperable. Don't make any modifications to the supplemental restraint system. This includes installing trim, badges, or anything else over the air bag storage areas. It also includes installing extra electric equipment on or near system components or wiring.

An Authorized Mazda Dealer can provide the special care needed in the removal and installation of front seats. It is important to protect the side air bag wiring and connections to assure that the bags do not accidentally deploy and that the seats retain an undamaged air bag connection.

WARNING: Disposing of an air bag can be dangerous. Unless all safety procedures are followed, injury can result. Ask an Authorized Mazda Dealer how to safely dispose of an air bag or how to scrap an air bag equipped vehicle.

WARNING: Do not attempt to service, repair, or modify the air bag Supplemental Restraint System, its fuses or the seat cover on a seat containing an air bag. See your authorized Mazda dealer.

WARNING: All occupants of the vehicle including the driver should always wear their safety belts even when an air bag SRS is provided.

Seating and Safety Restraints

How does the side air bag system work?

The side air bag system (if equipped) consists of the following:

- An inflatable nylon bag (air bag) with a gas generator concealed behind the outboard bolster of the driver and front passenger seatbacks.
- A special seat cover designed to allow airbag deployment.
- The same warning light, electronic control and diagnostic unit as used for the front air bags.
- The two side sensors are located on the lower portion of the b-pillar.

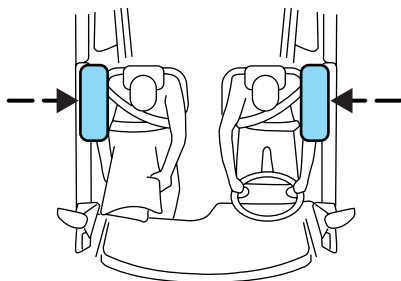

NOTE: A side air bag, in combination with seat belts, can help reduce the risk of severe injuries in the event of a significant side impact collision.

The side air bags are fitted on the outboard side of the seatbacks of the front seats. In certain lateral collisions, the air bag on the side affected by the collision will be inflated, even if the respective seat is not occupied. The air bag was designed to inflate between the door panel and occupant to further enhance the protection provided occupants in side impact collisions.

The air bag SRS is designed to activate when the vehicle sustains lateral deceleration sufficient to cause the sensors to close an electrical circuit that initiates air bag inflation.

The fact that the air bags did not inflate in a collision does not mean that something is wrong with the system. Rather, it means the forces were not of the type sufficient to cause activation. Side air bags are designed to inflate in side-impact collisions, not roll-over, rear-impact, frontal, near-frontal or opposite side collisions, unless the collision causes sufficient lateral deceleration.

WARNING: Several air bag system components get hot after inflation. Do not touch them after inflation.

Seating and Safety Restraints

WARNING: If the side air bag has deployed, the air bag will not function again. The side air bag system (including the seat) must be inspected and serviced by a qualified technician in accordance with the vehicle service manual. If the air bag is not replaced, the unrepaired area will increase the risk of injury in a collision.

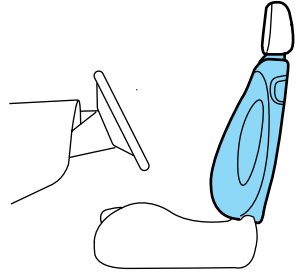

Determining if the system is operational

The SRS uses a readiness light in the instrument cluster or a tone to indicate the condition of the system. Refer to the *Air bag readiness* section in the *Instrumentation* chapter. Routine maintenance of the air bag is not required.

A difficulty with the system is indicated by one or more of the following:

- The readiness light (same light as for front air bag system) will either flash or stay lit.
- The readiness light will not illuminate immediately after ignition is turned on.
- A series of five beep sounds will be heard. The tone pattern will repeat periodically until the problem and light are repaired.

If any of these things happen, even intermittently, have the SRS serviced at your authorized Mazda dealership immediately. Unless serviced, the system may not function properly in the event of a collision.

Disposal of air bags and air bag equipped vehicles

For disposal of safety belt pretensioners, air bags, or air bag equipped vehicles, see your authorized Mazda dealership. Air bags **MUST BE** disposed of by qualified personnel.

WARNING: Disposing of an air bag can be dangerous. Unless all safety procedures are followed, injury can result. Ask an Authorized Mazda Dealer how to safely dispose of an air bag or how to scrap an air bag equipped vehicle.

Seating and Safety Restraints

SAFETY RESTRAINTS FOR CHILDREN

See the following sections for directions on how to properly use safety restraints for children. Also see *Air bag supplemental restraint system (SRS)* in this chapter for special instructions about using air bags.

Important child restraint precautions

NOTE: You are required to use safety restraints for children in the U.S. and Canada. Check your local and state or provincial laws for specific requirements regarding the safety of children in your vehicle.

WARNING: Never let a passenger hold a child on his or her lap while the vehicle is moving. The passenger cannot protect the child from injury in a collision.

NOTE: Always follow the instructions and warnings that come with any infant or child restraint you might use.

WARNING: When possible, always place children under age 12 in the rear seat of your vehicle. Accident statistics suggest that children are safer when properly restrained in the rear seating positions than in the front seating position.

Children and safety belts

If the child is the proper size, restrain the child in a safety seat.

Children who are too large for child safety seats (as specified by your child safety seat manufacturer) should always wear safety belts.

Follow all the important safety restraint and air bag precautions that apply to adult passengers in your vehicle.

If the shoulder belt portion of a combination lap and shoulder belt can be positioned so it does not cross or rest in front of the child's face or neck, the child should wear the lap and shoulder belt. Moving the child closer to the center of the vehicle may help provide a good shoulder belt fit.

WARNING: Do not leave children, unreliable adults, or pets unattended in your vehicle.

Seating and Safety Restraints

WARNING: Placing a child, 12 years or younger, in the front seat is dangerous. The child could be hit by a deploying air bag and be seriously injured or even killed. A sleeping child is more likely to lean against the door and be hit by the side air bag in a moderate collision. Whenever possible, always secure a child, 12 years or younger, in the rear seat, with an appropriate child restraint system for the child's age and size. Never use a rear-facing child restraint system in the front seat with an air bag that could deploy.

Child booster seats

Children outgrow a typical convertible or toddler seat when they weigh 40 pounds and are around 4 years of age. Although the lap/shoulder belt will provide some protection, these children are still too small for lap/shoulder belts to fit properly, which could increase the risk of serious injury.

To improve the fit of both the lap and shoulder belt on children who have outgrown child safety seats, Mazda recommends use of a belt-positioning booster seat.

Booster seats position a child so that safety belts fit better. They lift the child up so that the lap belt rests low across the hips and the knees bend comfortably. Booster seats also make the shoulder belt fit better and more comfortably for growing children.

When children should use booster seats

Children need to use booster seats from the time they outgrow the toddler seat until they are big enough for the vehicle seat and lap/shoulder belt to fit properly. Generally this is when they weigh about 80 lbs (about 8 to 12 years old).

Booster seats should be used until you can answer YES to ALL of these questions:

- Can the child sit all the way back against the vehicle seat back with knees bent comfortably at the edge of the seat without slouching?

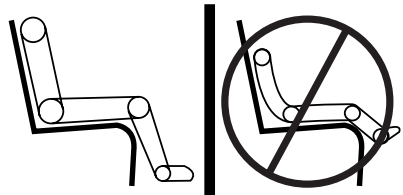

- Does the lap belt rest low across the hips?

Seating and Safety Restraints

- Is the shoulder belt centered on the shoulder and chest?
- Can the child stay seated like this for the whole trip?

WARNING: Booster seats must be installed only in seating positions equipped with a combination lap/shoulder belt.

Types of booster seats

There are two types of belt-positioning booster seats:

- Those that are backless.

If your backless booster seat has a removable shield, remove the shield and use the lap/shoulder belt. If a seating position has a low seat back and no head restraint, a backless booster seat may place your child's head (top of ear level) above the top of the seat. In this case, use a high-backed booster seat.



- Those with a high back.

If, with a backless booster seat, you cannot find a seating position that adequately supports your child's head, a high back booster seat would be a better choice.



Both can be used in any vehicle in a seating position equipped with lap/shoulder belts if your child is over 40 lbs.

The shoulder belt should cross the chest, resting snugly on the center of the shoulder. The lap belt should rest low and snug across the hips, never up high across the stomach.

If the booster seat slides on the vehicle seat, placing a rubberized mesh sold as shelf or carpet liner under the booster seat may improve this condition.

Seating and Safety Restraints

The importance of shoulder belts

Using a booster without a shoulder belt increases the risk of a child's head hitting a hard surface in a collision. For this reason, you should never use a booster seat with a lap belt only. It is best to use a booster seat with lap/shoulder belts in the back seat- the safest place for children to ride.

WARNING: Follow all instructions provided by the manufacturer of the booster seat.

WARNING: Never put the shoulder belt under a child's arm or behind the back because it eliminates the protection for the upper part of the body and may increase the risk of injury or death in a collision.

WARNING: Never use pillows, books, or towels to boost a child. They can slide around and increase the likelihood of injury or death in a collision.

SAFETY SEATS FOR CHILDREN

Child and infant or child safety seats

Use a safety seat that is recommended for the size and weight of the child. Carefully follow all of the manufacturer's instructions with the safety seat you put in your vehicle. If you do not install and use the safety seat properly, the child may be injured in a sudden stop or collision.

When installing a child safety seat:

- Review and follow the information presented in the *Air Bag Supplemental Restraint System* section in this chapter.
- Use the correct safety belt buckle for that seating position (the buckle closest to the direction the tongue is coming from).
- Insert the belt tongue into the proper buckle until you hear a snap and feel it latch. Make sure the tongue is securely fastened in the buckle.

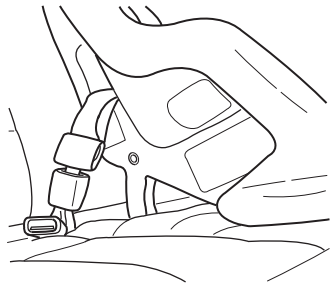

Seating and Safety Restraints

- Keep the buckle release button pointing up and away from the safety seat, with the tongue between the child seat and the release button, to prevent accidental unbuckling.
- Place seat back in upright position.
- Put the safety belt in the automatic locking mode. Refer to *Automatic locking mode* (passenger side front seat).

Mazda recommends the use of a child safety seat having a top tether strap. Install the child safety seat in a seating position which is capable of providing a tether anchorage. For more information on top tether straps, refer to *Attaching child safety seats with tether straps*.

WARNING: Carefully follow all of the manufacturer's instructions included with the safety seat you put in your vehicle. If you do not install and use the safety seat properly, the child may be injured in a sudden stop or collision.

The rear seat head restraints must be removed when using a child seat.

WARNING: Air bags can kill or injure a child in a child seat. NEVER place a rear-facing child seat in front of an active air bag. If you must use a forward-facing child seat in the front seat, move the seat all the way back.

1. Position the child safety seat in a seat with a combination lap and shoulder belt.

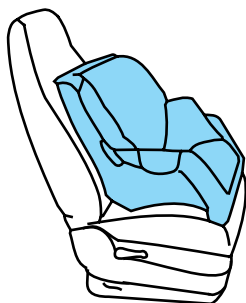

WARNING: Children 12 and under should be properly restrained in the rear seat whenever possible, the back seat environment is generally safer.

Seating and Safety Restraints

2. Pull down on the shoulder belt and then grasp the shoulder belt and lap belt together.

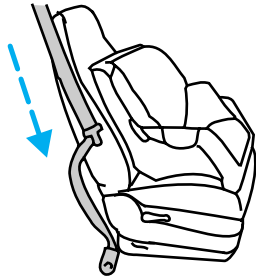

3. While holding the shoulder and lap belt portions together, route the tongue through the child seat according to the child seat manufacturer's instructions. Be sure the belt webbing is not twisted.

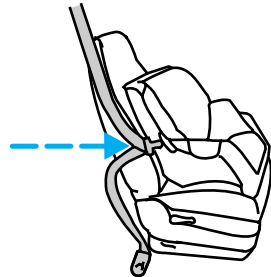

4. Insert the belt tongue into the proper buckle (the buckle closest to the direction the tongue is coming from) for that seating position until you hear a snap and feel the latch engage. Make sure the tongue is latched securely by pulling on it.

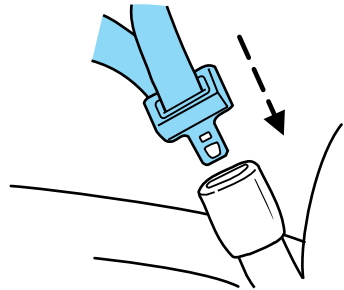

Seating and Safety Restraints

- To put the retractor in the automatic locking mode, grasp the shoulder portion of the belt and pull downward until all of the belt is extracted and a click is heard.

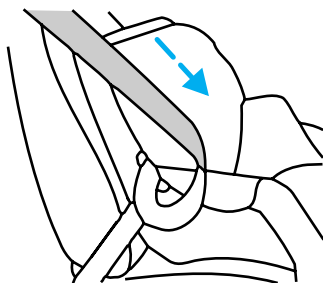

- Allow the belt to retract. The belt will click as it retracts to indicate it is in the automatic locking mode.
- Pull the lap belt portion across the child seat toward the buckle and pull up on the shoulder belt while pushing down with your knee on the child seat.

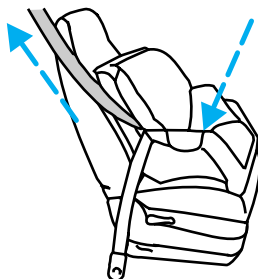

- Allow the safety belt to retract to remove any slack in the belt.
- Before placing the child in the seat, forcibly tilt the seat forward and back to make sure the seat is securely held in place. To check this, grab the seat at the belt path and attempt to move it side to side and forward and back. There should be no more than one inch of movement for proper installation.

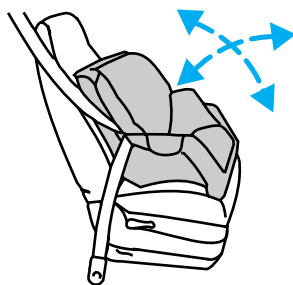

- Try to pull the belt out of the retractor to make sure the retractor is in the automatic locking mode (you should not be able to pull more belt out). If the retractor is not locked, unbuckle the belt and repeat steps two through nine.
- See *Attaching child safety seats with tether straps* in this chapter.

Seating and Safety Restraints

Check to make sure the child seat is properly secured before each use.

Attaching child safety seats with tether straps

Most new forward-facing child safety seats include a tether strap which goes over the back of the seat and hooks to an anchoring point. Tether straps are available as an accessory for many older safety seats. Contact the manufacturer of your child seat for information about ordering a tether strap.

The rear seating positions of your vehicle are equipped with built-in tether strap anchors located behind the seats as described below.

The tether anchors in your vehicle are located on the roof panel in the cargo area.

The tether strap anchors in your vehicle are in the following positions:

WARNING: Attach the tether strap only to the appropriate tether anchor as shown. The tether strap may not work properly if attached somewhere other than the correct tether anchor.

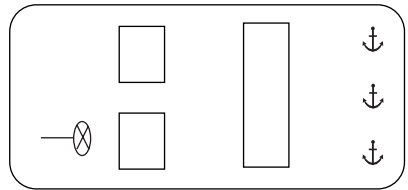

1. Position the child safety seat on the passenger seat cushion.
2. Route the child safety seat tether strap over the back of the seat.

NOTE: For vehicles with adjustable head restraints, route the tether strap under the head restraint and between the head restraint posts, otherwise route the tether strap over the top of the seatback.

NOTE: For vehicles with adjustable head restraints, route the tether strap over the top of the seatback.

Seating and Safety Restraints

3. Locate the correct anchor for for the selected seating position.

NOTE: There are three tether anchors located on the headliner at the rear of the vehicle.

WARNING: If the tether strap is clipped incorrectly, the child safety seat may not be retained properly in the event of a collision. If the safety seat is not anchored properly, the risk of a child being injured in a collision greatly increases.

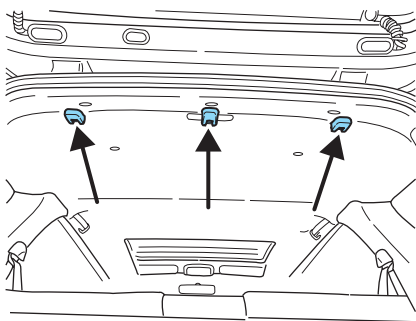

4. Clip the tether strap to the anchor as shown.

The arrow in the above graphic points toward the front of the vehicle.

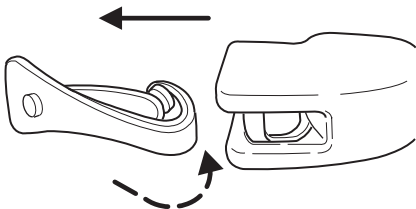

5. Refer to the *Installing child safety seats in combination lap and shoulder belt seating positions* section of this chapter for further instructions to secure the child safety seat.
6. Tighten the child safety seat tether strap according to the manufacturer's instructions.

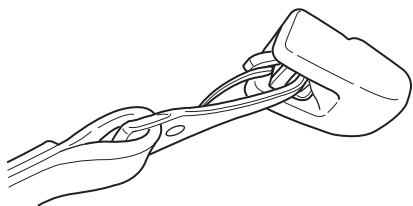

Seating and Safety Restraints

Attaching safety seats with LATCH (Lower Anchors and Tethers for Children) attachments for child seat anchors

Some child safety seats have two rigid or webbing mounted attachments that connect to two anchors at certain seating positions in your vehicle. When properly installed, this type of seat eliminates the need to use seat belts to attach the child seat. For forward-facing child seats, the tether strap must also be attached to the proper tether anchor. See *Attaching safety seats with tether straps* in this chapter.

Your vehicle has LATCH anchors for child seat installation as shown in the illustration. There are none in the front passenger seat.

The anchors closest to the center rear seat are provided primarily for child seats at the outboard seating positions. These anchors are farther apart than the pairs of lower anchors for child seat installation at the outboard seats.

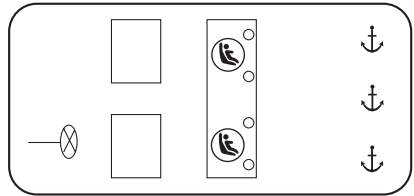

While the anchors closest to the center seat may also be usable, special precautions must be followed. First, if those anchors are already in use by a LATCH equipped child seat on either outboard seat, **you must not attach two LATCH seats to the same anchor point** — it will overload the anchor point. Either spread the two LATCH equipped seats to the outboard positions or use the regular lap belt on the center one (If the seat has a tether, be sure to also attach it to the center tether anchor).

Secondly, those LATCH equipped child seats **with rigid LATCH attachments** will not latch in the center rear position because those two middle anchors are too far apart. You can only attach the rigid LATCH equipped child seats to the outboard seat LATCH anchors that have the proper spacing for that type of child seat. If your child seat has flexible LATCH attachments, be sure that the manufacturer's instructions say that it can reach to anchors spaced at least 500 mm (19 in) apart.

WARNING: Never attach two LATCH child safety seats to the same anchor. In a crash, one anchor may not be strong enough to hold two child safety seat attachments and may break, causing serious injury or death.

Seating and Safety Restraints

The lower anchors for child seat installation are located at the rear section of the rear seat between the cushion and seat back.

The LATCH anchors are below the locator symbols on the seatback.

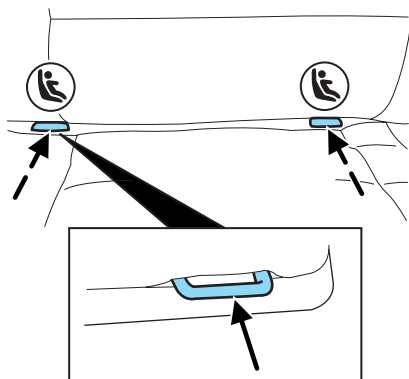

Follow the child seat manufacturer's instructions to properly install a child seat with LATCH attachments.

WARNING: Attach LATCH lower attachments of the child seat only to the anchors shown.

If you install a child seat with rigid LATCH attachments, do not tighten the tether strap enough to lift the child seat off the vehicle seat cushion when the child is seated in it. Keep the tether strap just snug without lifting the front of the child seat. Keeping the child seat just touching the vehicle seat gives the best protection in a severe crash.

Each time you use the safety seat, check that the seat is properly attached to the lower anchors and tether anchor. Try to tilt the child seat from side to side. Also try to tug the seat forward. Check to see if the anchors hold the seat in place.

WARNING: If the safety seat is not anchored properly, the risk of a child being injured in a crash greatly increases.

STARTING

Positions of the ignition

1. LOCK, locks the gearshift lever and allows key removal.
2. ACCESSORY, allows the electrical accessories such as the radio to operate while the engine is not running.
3. ON, all electrical circuits operational. Warning lights illuminated. Key position when driving.
4. START, cranks the engine. Release the key as soon as the engine starts.

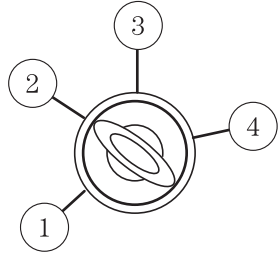

Preparing to start your vehicle

Engine starting is controlled by the powertrain control system.

Note: This system meets all Canadian Interference-Causing Equipment standard requirements regulating the impulse electrical field strength of radio noise.

When starting a fuel-injected engine, avoid pressing the accelerator before or during starting. Only use the accelerator when you have difficulty starting the engine. For more information on starting the vehicle, refer to *Starting the engine* in this chapter.

WARNING: Extended idling at high engine speeds can produce very high temperatures in the engine and exhaust system, creating the risk of fire or other damage.

WARNING: Do not park, idle, or drive your vehicle in dry grass or other dry ground cover. The emission system heats up the engine compartment and exhaust system, which can start a fire.

WARNING: Do not start your vehicle in a closed garage or in other enclosed areas. Exhaust fumes can be toxic. Always open the garage door before you start the engine. See *Guarding against exhaust fumes* in this chapter for more instructions.

Driving

WARNING: If you smell exhaust fumes inside your vehicle, have your authorized Mazda dealer inspect your vehicle immediately. Do not drive if you smell exhaust fumes.

Important safety precautions

A computer system controls the engine's idle revolutions per minute (RPM). When the engine starts, the idle RPM runs higher than normal in order to warm the engine. If the engine idle speed does not slow down automatically, have the vehicle checked by your authorized Mazda dealership.

Before starting the vehicle:

1. Make sure all vehicle occupants have buckled their safety belts. For more information on safety belts and their proper usage, refer to the *Seating and Safety Restraints* chapter.
2. Make sure the headlamps and vehicle accessories are off.

If starting a vehicle with an automatic transmission:

- Make sure the parking brake is set.
- Make sure the gearshift is in P (Park).

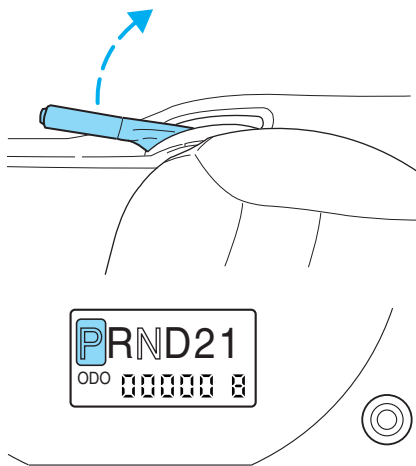

If starting a vehicle with a manual transmission:

- Make sure the parking brake is set.
- Push the clutch pedal to the floor.

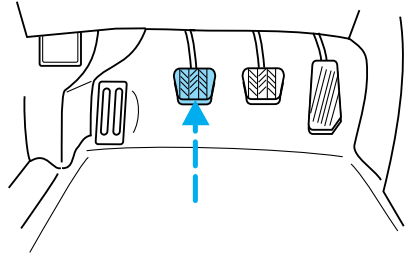

3. Turn the key to 3 (ON) without turning the key to 4 (START).

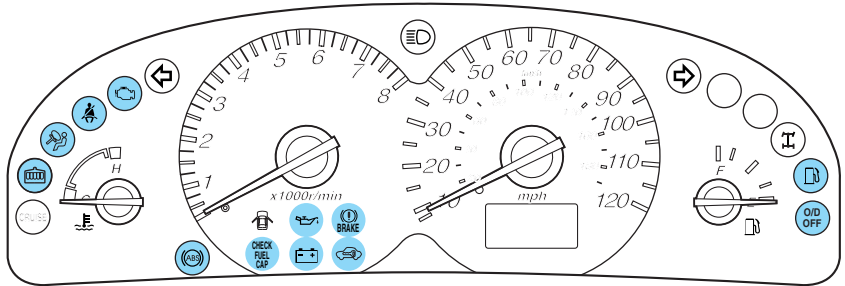
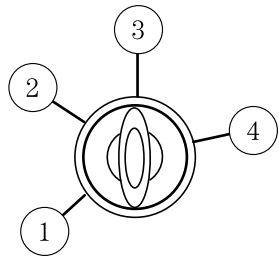

Make sure the corresponding lights illuminate or illuminate briefly. If a light fails to illuminate, have the vehicle serviced.

Note: If the driver's safety belt is fastened, the  light may not illuminate.

Starting the engine

Note: Whenever you start your vehicle, release the key as soon as the engine starts. Excessive cranking could damage the starter.

Driving

1. Turn the key to 4 (START) without pressing the accelerator pedal and release as soon as the engine starts. The key will return to 3 (ON).
2. When the engine starts, release the key, then release the accelerator pedal gradually as the engine speeds up.
3. After idling for a few seconds, apply the brake, shift into gear and drive.

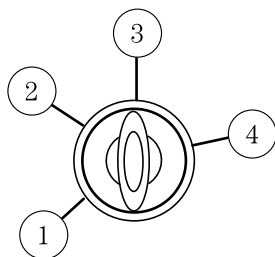

Note: If the engine does not start within five seconds on the first try, turn the key to OFF, wait 10 seconds and try again. If the engine still fails to start, press the accelerator to the floor and try again; this will allow the engine to crank with the fuel shut off in case the engine is flooded with fuel.

Using the engine block heater (if equipped)

An engine block heater warms the engine coolant, which improves starting, warms up the engine faster and allows the heater-defroster system to respond quickly. Use of an engine block heater is strongly recommended if you live in a region where temperatures reach -23°C (-10°F) or below.

For best results, plug the heater in at least three hours before starting the vehicle. Using the heater for longer than three hours will not harm the engine, so the heater can be plugged in the night before starting the vehicle.

WARNING: To reduce the risk of electrical shock, do not use your heater with ungrounded electrical systems or two-pronged (cheater) adapters.

Guarding against exhaust fumes

Although odorless and colorless, carbon monoxide is present in exhaust fumes. Take precautions to avoid its dangerous effects.

WARNING: If you ever smell exhaust fumes of any kind inside your vehicle, have your authorized Mazda dealer inspect and fix your vehicle immediately. Do not drive if you smell exhaust fumes. These fumes are harmful and result in accident or death.

Have the exhaust and body ventilation systems checked whenever:

- the vehicle is raised for service.
- the sound of the exhaust system changes.
- the vehicle has been damaged in a collision.

WARNING: Engine exhaust, some of its constituents, and certain vehicle components contain or emit chemicals known to the State of California to cause cancer and birth defects or other reproductive harm. In addition, certain fluids contained in vehicles and certain products of component wear contain or emit chemicals known to the State of California to cause cancer and birth defects or other reproductive harm.

Important ventilating information

If the engine is idling while the vehicle is stopped in an open area for long periods of time, open the windows at least 2.5 cm (one inch). Adjust the heating or air conditioning (if equipped) to bring in fresh air.

Note: Improve vehicle ventilation by keeping all air inlet vents clear of snow, leaves and other debris.

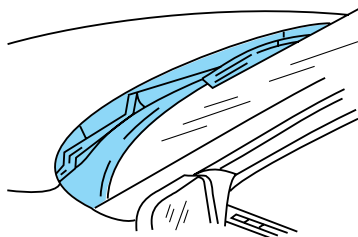

BRAKES

Your service brakes are self-adjusting. Refer to the service maintenance section for scheduled maintenance.

Occasional brake noise is normal and often does not indicate a performance concern with the vehicle's brake system. In normal operation, automotive brake systems may emit occasional or intermittent squeal or groan noises when the brakes are applied. Such noises are usually heard during the first few brake applications in the morning; however, they may be heard at any time while braking and can be aggravated by environmental conditions such as cold, heat, moisture, road dust, salt or mud. If a "metal-to-metal," "continuous grinding" or "continuous squeal" sound is present while braking, the brake linings may be worn-out and should be inspected by an authorized Mazda dealership.

Driving

Four-wheel anti-lock brake system (ABS) (if equipped)

If the vehicle is equipped with an anti-lock braking system (ABS), a noise from the hydraulic pump motor and pulsation in the pedal may be observed during ABS braking events. Pedal pulsation coupled with noise while braking under panic conditions or on loose gravel, bumps, wet or snowy roads is normal and indicates proper functioning of the vehicle's anti-lock brake system.

NOTE: The ABS performs a self-check after you start the engine and begin to drive away.

A brief mechanical noise may be heard during this test. This is normal. If a malfunction is found, the ABS warning light will come on. If the vehicle has continuous vibration or shudder in the steering wheel while braking, the vehicle should be inspected by an authorized Mazda dealership.

The ABS operates by detecting the onset of wheel lockup during brake applications and compensates for this tendency. The wheels are prevented from locking even when the brakes are firmly applied. The accompanying illustration depicts the advantage of an ABS equipped vehicle (on bottom) to a non-ABS equipped vehicle (on top) during hard braking with loss of front braking traction.

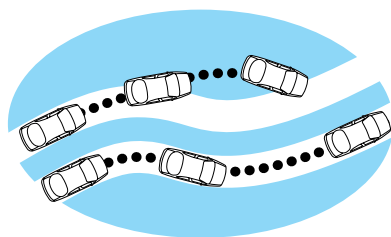

WARNING: The Anti-Lock system does not decrease the time necessary to apply the brakes or always reduce stopping distance. Always leave enough room between your vehicle and the vehicle in front of you to stop.

ABS warning lamp (if equipped)

The  warning lamp in the instrument cluster momentarily illuminates when the ignition is turned on. If the light does not illuminate momentarily at start up, remains on or continues to flash, the ABS needs to be serviced.

With the ABS light on, the anti-lock brake system is disabled and normal braking is still effective unless the brake warning light also remains illuminated with parking brake

released. (If your brake warning lamp illuminates, have your vehicle serviced immediately by an authorized Mazda dealership.)



Using four wheel ABS (if equipped)

- In an emergency or when maximum efficiency from the ABS is required, apply continuous force on the brake. The ABS will be activated immediately, thus allowing you to retain full steering control of your vehicle and, providing there is sufficient space, will enable you to avoid obstacles and bring the vehicle to a controlled stop.

WARNING: The Anti-Lock system does not decrease the time necessary to apply the brakes or always reduce stopping distance. Always leave enough room between your vehicle and the vehicle in front of you to stop.

NOTE: We recommend that you familiarize yourself with this braking technique. However, avoid taking any unnecessary risks.

Parking brake (ⓘ)

Apply the parking brake whenever the vehicle is parked. To set the parking brake, apply the brake pedal and pull the parking brake handle up as far as possible.

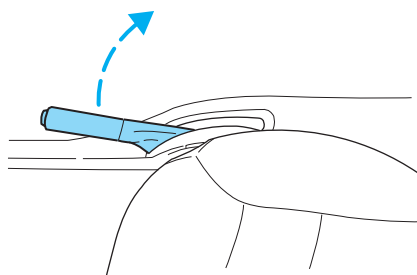

The BRAKE warning lamp in the instrument cluster illuminates and remains illuminated (when the ignition is turned ON) until the parking brake is released.



Driving

WARNING: Always set the parking brake fully and make sure that the gearshift is securely latched in P (Park) (automatic transmission) or in 1 (First Gear) (manual transmission).

NOTE: The parking brake is not recommended to stop a moving vehicle. However, if the normal brakes fail, the parking brake can be used to stop your vehicle in an emergency. Since the parking brake applies only the rear brakes, the vehicle's stopping distance will increase greatly and the handling of your vehicle will be adversely affected.

To release the parking brake, the brake handle may need to be pulled up slightly to release pressure before pushing in the button.

Push the button on the end of the parking brake handle and push the handle down as far as possible. Driving with the parking brake applied will cause the brakes to wear out quickly and reduce fuel economy.

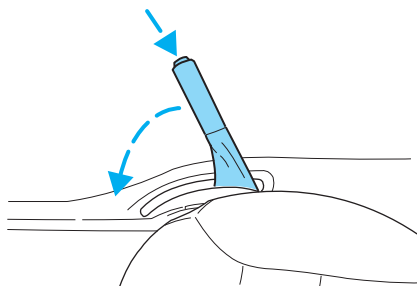

STEERING

To prevent damage to the power steering system:

- Never hold the steering wheel at its furthest turning points (until it stops) for more than a few seconds when the engine is running.
- Do not operate the vehicle with a low power steering pump fluid level (below the MIN mark on the reservoir).

If the power steering system breaks down (or if the engine is turned off), you can steer the vehicle manually, but it takes more effort.

If the steering wanders or pulls, check for:

- an improperly inflated tire
- uneven tire wear
- loose or worn suspension components
- loose or worn steering components
- improper steering alignment

A high crown in the road or high crosswinds may also make the steering seem to wander/pull.

PREPARING TO DRIVE YOUR VEHICLE

Your vehicle has special design and equipment features to make it capable of performing in a wide variety of circumstances. These special design features, such as larger tires and increased ground clearance, give the vehicle a higher center of gravity than a passenger car.

WARNING: Utility vehicles have a significantly higher rollover rate than other types of vehicles. Vehicles with a higher center of gravity such as utility and four-wheel drive vehicles handle differently than vehicles with a lower center of gravity. Utility and four-wheel drive vehicles are not designed for cornering at speeds as high as passenger cars any more than low-slung sports cars are designed to perform satisfactorily under off-road conditions. Avoid sharp turns, excessive speed and abrupt maneuvers in these vehicles. Failure to drive cautiously could result in an increased risk of loss of vehicle control, vehicle rollover, personal injury and death.

WARNING: In a rollover crash, an unbelted person is significantly more likely to die than a person wearing a seat belt.

WARNING: Loaded vehicles, with a higher center of gravity, may handle differently than unloaded vehicles. Extra precautions, such as slower speeds and increased stopping distance, should be taken when driving a heavily loaded vehicle.

Your vehicle has the capability to haul more cargo and people than most passenger cars. Depending upon the type and placement of the load, hauling people and cargo may raise the center of gravity of the vehicle. Use extra caution while becoming familiar with your vehicle. Know the capabilities and limitations of both you as a driver and your vehicle. With a higher center of gravity, the weight and tongue loading warnings and instructions in the towing section are also more important; please consider them carefully. Refer to the *Vehicle Loading* section in this chapter.

AUTOMATIC TRANSMISSION OPERATION (IF EQUIPPED)

Brake-shift interlock

This vehicle is equipped with a brake-shift interlock feature that prevents the gearshift lever from being moved from P (Park) when the ignition is in the ON position unless brake pedal is depressed.

Driving

If you cannot move the gearshift lever out of P (Park) with ignition in the ON position and the brake pedal depressed:

1. Apply the parking brake, turn ignition key to LOCK, then remove the key.
2. Locate the access cover plate to the brake-shift interlock override. It is located on the top of the steering column.

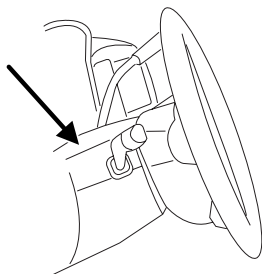

3. Insert a tool (or a screwdriver) into the right-hand side of the brake-shift interlock access cover and remove the cover.

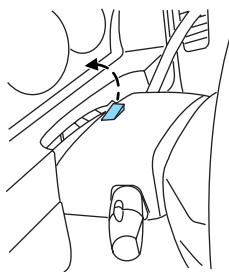

4. Insert a tool (or screw driver) into the access hole to override the brake-shift interlock. Apply the brake and shift into Neutral while holding down the override tab.

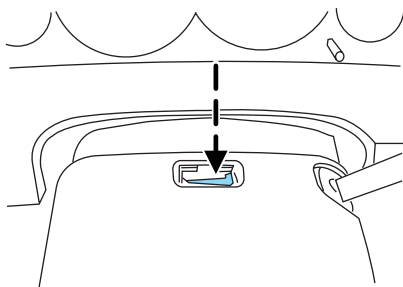

If it is necessary to use the above procedure to move the gearshift lever, it is possible that a fuse has blown or the vehicle's brakelamps are not operating properly. Refer to *Fuses and relays* in the *Roadside emergencies* chapter.

WARNING: Do not drive your vehicle until you verify that the brakelamps are working. Failure to check the brakelights and subsequent use of the brakes may result in a rear-end collision.

WARNING: Always set the parking brake fully and make sure the gearshift is latched in P (Park). Turn the ignition to the LOCK position and remove the key whenever you leave your vehicle.

WARNING: If the parking brake is fully released, but the brake warning lamp remains illuminated, the brakes may not be working properly. See your authorized Mazda dealership.

Driving with an automatic overdrive transaxle

Your automatic transaxle electronically controls the shift feel by using an adaptive learning strategy. This feature is designed to optimize shift smoothness. **NOTE:** It is normal for your transaxle to shift firmly during the first few hundred kilometers (miles) of operation until the adaptive strategy has been learned. The adaptive learning strategy is maintained by power from the battery. When the battery is disconnected or a new battery is installed, the transaxle must relearn its adaptive strategy. Optimal shifting will resume within a few hundred kilometers (miles) of operation.

Your automatic overdrive transaxle provides fully automatic operation in either D (Overdrive) or with the O/D OFF switch depressed. Driving with the gearshift lever in D (Overdrive) gives the best fuel economy for normal driving conditions.

For manual control, start in 1 (First) and then shift manually.

To put your vehicle in gear, start the engine, depress the brake pedal, then move gearshift lever out of P (Park).

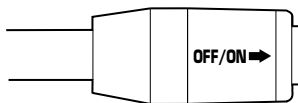

Driving

Understanding gearshift positions

P (Park)

Always come to a complete stop before shifting into P (Park). Make sure the gearshift lever is securely latched in P (Park). This locks the transaxle and prevents the front wheels from rotating.



WARNING: Always set the parking brake fully and make sure the gearshift is latched in P (Park). Turn the ignition to the LOCK position and remove the key whenever you leave your vehicle.

R (Reverse)

With the gearshift lever in R (Reverse), the vehicle will move backward. You should always come to a complete stop before shifting into and out of R (Reverse).



WARNING: Make sure the rearward path of the vehicle is unobstructed before moving the vehicle in reverse.

N (Neutral)

With the gearshift lever in the N (Neutral) position, the vehicle can be started and is free to roll. Hold the brake pedal down while in this position.



Overdrive — column mounted gearshift with O/D off switch

The Overdrive position with the O/D OFF switch **not** depressed is the normal driving position for this automatic overdrive transaxle. When your vehicle cruises at a constant speed for any length of time, this fourth gear will increase your fuel economy.

Overdrive may not be appropriate for certain terrains. If the transaxle shifts back and forth between third and fourth gears while you are driving hilly roads or if your vehicle requires additional power for climbing hills, press the O/D OFF switch. Each time the vehicle is started, the transaxle will automatically return to normal overdrive mode.

If the O/D OFF indicator light is flashing on and off repeatedly when the vehicle is started or does not come on when the O/D OFF control is pressed, there may be a transaxle electronic system malfunction. You should contact your authorized Mazda dealer as soon as possible or damage to the transaxle could occur.

When to use D (Drive) or press the O/D OFF switch

You will notice that there is only one drive position on your gearshift indicator (instead of Drive and Overdrive). However, you will find a control labeled OVERDRIVE located on the gearshift lever. Push in the switch and the O/D OFF light in the instrument cluster will illuminate. With the O/D OFF light illuminated, the transaxle will operate in first, second and third gears and will not shift into fourth gear. Operating in D (O/D OFF) provides more engine braking than Overdrive for descending hills or city driving.

To return the transaxle to the normal Overdrive operation, press the O/D OFF control again. Use this control to select between Overdrive or D (O/D OFF) whenever you drive your vehicle.

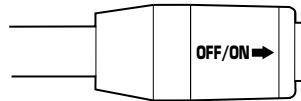
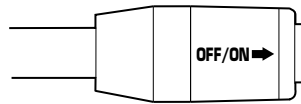

Driving

If the O/D OFF indicator light is flashing on and off repeatedly when the vehicle is started or does not come on when the O/D OFF control is pressed, there may be a transaxle electronic system malfunction. You should contact your authorized Mazda dealer as soon as possible or damage to the transaxle could occur.

2 (Second)

Use 2 (Second) for start-up on slippery roads or to give you more engine braking to slow your vehicle on downgrades.

To avoid damage to the engine and/or transaxle do not go faster than 108 km/h (68 mph) when in this gear. You can upshift from 2 (Second) to overdrive at any time.



1 (First)

Use 1 (First) for when added engine braking is desired when descending steep hills.

The automatic transaxle will shift to the proper gear to ascend any grade without any need to shift to 1 (First).

To avoid damage to the engine and/or transaxle do not go faster than 56 km/h (35 mph) when in this gear. You can upshift from 1 (First) to overdrive at any time.



WARNING: When parking, do not use the gearshift in place of the parking brake. Always set the parking brake fully and make sure that the gearshift is securely latched in Park (P). Turn off the ignition whenever you leave your vehicle. Never leave your vehicle unattended while it is running. Never leave children in an unattended vehicle. If you do not take these precautions, your vehicle may move unexpectedly and injure someone.

If your vehicle gets stuck in mud or snow

If your vehicle gets stuck in mud or snow, it may be rocked out by shifting from forward and reverse gears, stopping between shifts in a steady pattern. Press lightly on the accelerator in each gear.

Do not rock the vehicle if the engine is not at normal operating temperature or damage to the transmission may occur.

Do not rock the vehicle for more than a minute or damage to the transmission and tires may occur, or the engine may overheat.

MANUAL TRANSAXLE OPERATION (IF EQUIPPED)

Using the clutch

Vehicles equipped with a manual transaxle have a starter interrupt interlock that prevents cranking of the engine unless the clutch pedal is depressed.

When starting a vehicle with a manual transaxle, you must:

1. Put the gearshift lever in the neutral position.

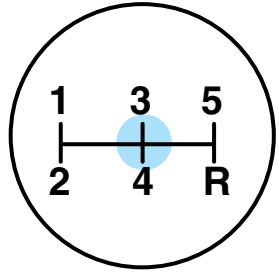

2. Hold down the brake pedal.
3. Depress the clutch pedal.

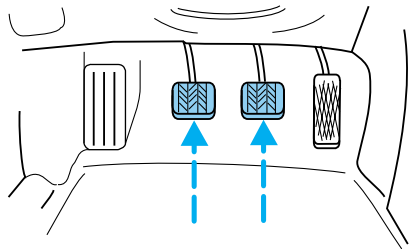

Driving

- Without depressing the accelerator pedal, turn the ignition to position 4 (START), release the ignition as soon as the engine starts.
- Let the engine idle for a few seconds.
- Release the brake pedal, then slowly release the clutch pedal while pressing down slowly on the accelerator pedal.

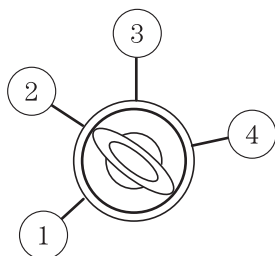

Do not drive with your foot resting on the clutch pedal and do not use the clutch pedal to hold your vehicle at a standstill while waiting on a hill. These actions will seriously reduce clutch life.

Recommended shift speeds

Upshift according to the following charts for best fuel economy:

Upshifts when accelerating (recommended for best fuel economy)	
1-2	22 km/h (14 mph)
2-3	40 km/h (25 mph)
3-4	55 km/h (34 mph)
4-5	70 km/h (44 mph)

Upshifts when cruising (recommended for best fuel economy)	
1-2	19 km/h (12 mph)
2-3	31 km/h (19 mph)
3-4	46 km/h (29 mph)
4-5	61 km/h (38 mph)

Reverse

Make sure that your vehicle is at a complete stop before you shift into R (Reverse). Failure to do so may damage the transaxle.

Put the gearshift lever into the neutral position and wait at least three seconds before shifting into R (Reverse).

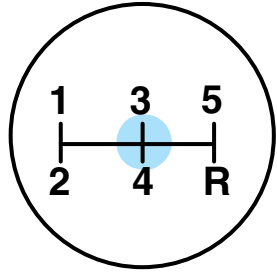

NOTE: You can shift into R (Reverse) only by moving the gearshift lever from left of 3 (Third) and 4 (Fourth) gears before you shift into R (Reverse). This is a special lockout feature which prevents you from shifting into R (Reverse) when you downshift from 5 (Fifth).

Parking your vehicle

1. Apply the brake and shift into the neutral position.

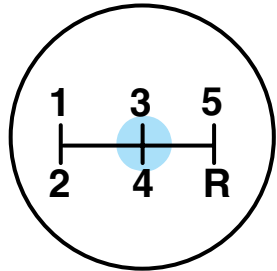

2. Set the parking brake.

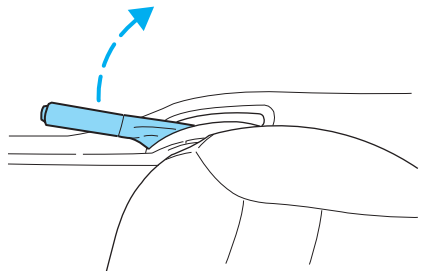

Driving

- Shift into 1 (First).

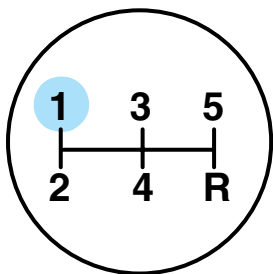

- Turn the ignition to position 1 (LOCK) to shut the engine off and remove the ignition key.

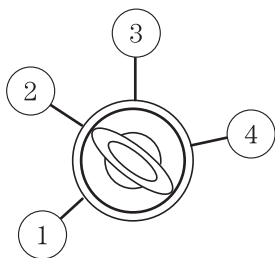

WARNING: Do not park your vehicle in Neutral, it may move unexpectedly and injure someone. Use 1 (First) gear and set the parking brake fully.

FOUR WHEEL DRIVE (4X4) SYSTEM (IF EQUIPPED)

4x4 system general information

WARNING: For important information regarding safe operation of this type of vehicle, see Preparing to drive your vehicle in this chapter.

Your vehicle is equipped with a 4x4 system. This 4x4 system can use all four wheels to power the vehicle. This helps increase traction, enabling you to drive your vehicle over terrain and road conditions not normally traveled by two-wheel drive vehicles.

Power is always supplied to the front wheels and to the rear wheels through the transaxle and Rotary Blade Coupling (RBC) unit that allows you to select a four-wheel drive mode best suited for your current driving conditions.

For the lubricant specification and refill capacity of the Power Take-Off Unit and rear axle refer to the *Maintenance and specifications* chapter.

Operating modes of the 4x4 system

The 4x4 system functions in two modes:

- The 4x4 AUTO mode provides four-wheel drive with full power delivered to the front axle at all times, and to the rear axle as required for increased traction. This is appropriate for normal on-road operating conditions, such as dry road surfaces, wet pavement, snow and gravel.
- The 4x4 ON mode provides four-wheel drive with full power to both axles at all times. It is only intended for severe or off-road driving conditions, such as deep snow and ice (where no dry or wet pavement remains uncovered) and shallow sand or mud.
- **The vehicle should not be operated in the 4x4 ON mode on dry or merely wet pavement. Doing so will produce excessive noise, increase tire wear and may damage driveline components. The 4x4 ON mode is intended for use only on consistently slippery or loose surfaces.**
- **If your vehicle is equipped with this 4x4 system, a spare tire of a different diameter than the road tires should never be used. Such a tire could result in damage to driveline components and make the vehicle difficult to control.**

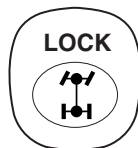
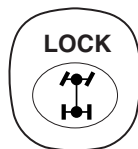

WARNING: Utility and four-wheel drive vehicles are not designed for cornering at speeds as high as passenger cars any more than low-slung sports cars are designed to perform satisfactorily under off-road conditions. Avoid sharp turns or abrupt maneuvers in these vehicles.

4x4 system indicator lights

The 4x4 mode indicator light illuminates only under the following conditions. If the indicator light illuminates when driving in the 4x4 AUTO mode, contact your Mazda dealer as soon as possible.

Driving

The indicator light illuminates when the 4x4 ON mode is engaged.

Shifting between 4x4 Auto and ON modes

Press the four-wheel drive control to apply power to both axles. When you activate the control, the indicator light will illuminate in the instrument cluster.

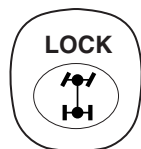

When you press the control again, 4x4 AUTO is activated and, the indicator light will turn off.

Either shift can be done at a stop or while driving at any speed.

Driving off-road with truck and utility vehicles

4x4 vehicles are specially equipped for driving on sand, snow, mud and rough terrain and have operating characteristics that are somewhat different from conventional vehicles, both on and off the road.

How your vehicle differs from other vehicles

Truck and utility vehicles can differ from some other vehicles. Your vehicle may be higher to allow it to travel over rough terrain without getting hung up or damaging underbody components.

The differences that make your vehicle so versatile also make it handle differently than an ordinary passenger car.

Maintain steering wheel control at all times, especially in rough terrain. Since sudden changes in terrain can result in abrupt steering wheel motion, make sure you grip the steering wheel from the outside. Do not grip the spokes.

Drive cautiously to avoid vehicle damage from concealed objects such as rocks and stumps.

You should either know the terrain or examine maps of the area before driving. Map out your route before driving in the area. To maintain steering and braking control of your vehicle, you must have all four wheels on the ground and they must be rolling, not sliding or spinning.

Basic operating principles

- Drive slower in strong crosswinds which can affect the normal steering characteristics of your vehicle.
- Be extremely careful when driving on pavement made slippery by loose sand, water, gravel, snow or ice.

If your vehicle goes off the edge of the pavement

- If your vehicle goes off the edge of the pavement, slow down, but avoid severe brake application, ease the vehicle back onto the

pavement only after reducing your speed. Do not turn the steering wheel too sharply while returning to the road surface.

- It may be safer to stay on the apron or shoulder of the road and slow down gradually before returning to the pavement. You may lose control if you do not slow down or if you turn the steering wheel too sharply or abruptly.
- It often may be less risky to strike small objects, such as highway reflectors, with minor damage to your vehicle rather than attempt a sudden return to the pavement which could cause the vehicle to slide sideways out of control or rollover. Remember, your safety and the safety of others should be your primary concern.

WARNING: Vehicles with a higher center of gravity such as utility and four-wheel drive vehicles handle differently than vehicles with a lower center of gravity. Utility and four-wheel drive vehicles are not designed for cornering at speeds as high as passenger cars any more than low-slung sports cars are designed to perform satisfactorily under off-road conditions. Avoid sharp turns, excessive speed and abrupt maneuvers in these vehicles. Failure to drive cautiously could result in an increased risk of loss of vehicle control, vehicle rollover, personal injury and death.

If your vehicle gets stuck

If your vehicle gets stuck in mud or snow it may be rocked out by shifting between forward and reverse gears, stopping between shifts, in a steady pattern. Press lightly on the accelerator in each gear.

Do not rock the vehicle if the engine is not at normal operating temperature or damage to the transmission may occur.

Do not rock the vehicle for more than a few minutes or damage to the transmission and tires may occur or the engine may overheat.

WARNING: Always set the parking brake fully and make sure the gearshift is latched in 1st gear or R (Reverse) (manual transaxles) or P (Park) (automatic transaxles). Turn the ignition to the LOCK position and remove the key whenever you leave your vehicle.

Driving

WARNING: If the parking brake is fully released, but the brake warning lamp remains illuminated, the brakes may not be working properly. See your authorized Mazda dealership.

Do not rock the vehicle if the engine is not at normal operating temperature or damage to the transaxle may occur.

WARNING: Do not spin the wheels at over 56 km/h (35 mph). The tires may fail and injure a passenger or bystander.

Emergency maneuvers

- In an unavoidable emergency situation where a sudden sharp turn must be made, remember to avoid “over-driving” your vehicle, i.e., turn the steering wheel only as rapidly and as far as required to avoid the emergency. Excessive steering will result in less vehicle control, not more. Additionally, smooth variations of the accelerator and/or brake pedal pressure should be utilized if changes in vehicle speed are called for. Avoid abrupt steering, acceleration or braking which could result in an increased risk of loss of vehicle control, vehicle rollover and/or personal injury. Use all available road surface to return the vehicle to a safe direction of travel.
- In the event of an emergency stop, avoid skidding the tires and do not attempt any sharp steering wheel movements.

WARNING: Vehicles with a higher center of gravity such as utility and four-wheel drive vehicles handle differently than vehicles with a lower center of gravity. Utility and four-wheel drive vehicles are not designed for cornering at speeds as high as passenger cars any more than low-slung sports cars are designed to perform satisfactorily under off-road conditions. Avoid sharp turns, excessive speed and abrupt maneuvers in these vehicles. Failure to drive cautiously could result in an increased risk of loss of vehicle control, vehicle rollover, personal injury and death.

- If the vehicle goes from one type of surface to another (i.e., from concrete to gravel) there will be a change in the way the vehicle responds to a maneuver (steering, acceleration or braking). Again, avoid these abrupt inputs.

Sand

When driving over sand, try to keep all four wheels on the most solid area of the trail. Avoid reducing the tire pressures but shift to a lower gear and drive steadily through the terrain. Apply the accelerator slowly and avoid spinning the wheels.

If you must reduce the tire pressure for whatever reason in sand, make sure you re-inflate the tires as soon as possible.

Avoid excessive speed because vehicle momentum can work against you and cause the vehicle to become stuck to the point that assistance may be required from another vehicle. Remember, you may be able to back out the way you came if you proceed with caution.

Mud and water

NOTE:

- If you must drive through high water, drive slowly. Traction or brake capability may be limited.
- When driving through water, determine the depth; avoid water higher than the bottom of the hubs (if possible) and proceed slowly. If the ignition system gets wet, the vehicle may stall.
- Once through water, always try the brakes. Wet brakes do not stop the vehicle as effectively as dry brakes. Drying can be improved by moving your vehicle slowly while applying light pressure on the brake pedal.

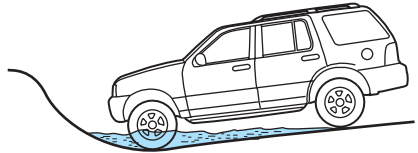

Be cautious of sudden changes in vehicle speed or direction when you are driving in mud. Even 4x4 vehicles can lose traction in slick mud. As when you are driving over sand, apply the accelerator slowly and avoid spinning your wheels. If the vehicle does slide, steer in the direction of the slide until you regain control of the vehicle.

After driving through mud, clean off residue stuck to rotating driveshafts, halfshafts and tires. Excess mud on tires and rotating driveshafts causes an imbalance that could damage drive components.

NOTE:

If the transaxle Power Take Off unit or rear axle are submerged in water, their fluids should be checked and changed, if necessary.

Driving through deep water may damage the transmission.

If the rear axle is submerged in water, the axle lubricant should be checked and changed, if necessary. The rear axle is filled with a lubricant

Driving

that does not normally require a lubricant change for the life of the vehicle. Rear axle lubricant quantities should not need to be checked unless a leak is suspected.

“Tread Lightly” is an educational program designed to increase public awareness of land-use regulations and responsibilities in our nations wilderness areas. Mazda Motor



Corporation joins the U.S. Forest Service and the Bureau of Land Management in encouraging you to help preserve our national forest and other public and private lands by “treading lightly.”

Driving on hilly or sloping terrain

Although natural obstacles may make it necessary to travel diagonally up or down a hill or steep incline, you should always try to drive straight up or straight down. **Avoid driving crosswise or turning on steep slopes or hills.** A danger lies in losing traction, slipping sideways and possibly rolling over. Whenever driving on a hill, determine beforehand the route you will use. Do not drive over the crest of a hill without seeing what conditions are on the other side. Do not drive in reverse over a hill without the aid of an observer.

When climbing a steep slope or hill, start in a lower gear rather than downshifting to a lower gear from a higher gear once the ascent has started. This reduces strain on the engine and the possibility of stalling.

If you do stall out, Do not try to turnaround because you might roll over. It is better to back down to a safe location.

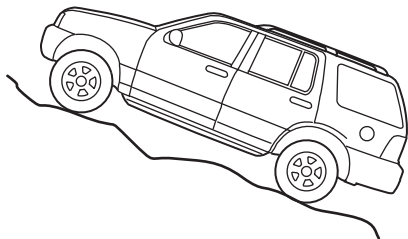

Apply just enough power to the wheels to climb the hill. Too much power will cause the tires to slip, spin or lose traction, resulting in loss of vehicle control.

Descend a hill in the same gear you would use to climb up the hill to avoid excessive brake application and brake overheating. Do not descend in neutral; instead, disengage overdrive or manually shift to a lower gear. When descending a steep hill, avoid sudden hard braking as you could lose control. When you brake hard, the front wheels can't turn and if they aren't turning, you won't be able to steer. The front wheels have to be turning in order to steer the vehicle. Rapid pumping of the brake pedal will help you slow the vehicle and still maintain steering control.

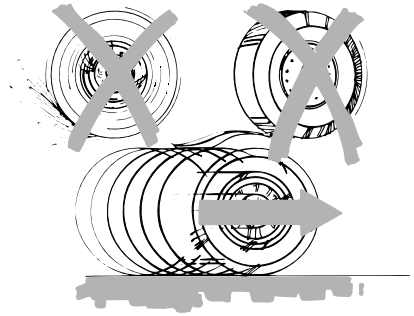

If your vehicle has anti-lock brakes, apply the brakes steadily. Do not “pump” the brakes.

Driving on snow and ice

- 4x4 vehicles have advantages over 2WD vehicles in snow and ice but can skid like any other vehicle.
- Should you start to slide while driving on snowy or icy roads, turn the steering wheel in the direction of the slide until you regain control.
- Avoid sudden applications of power and quick changes of direction on snow and ice. Apply the accelerator slowly and steadily when starting from a full stop.
- Avoid sudden braking as well. Although a 4x4 vehicle may accelerate better than a two-wheel drive vehicle in snow and ice, it won't stop any faster, because as in other vehicles, braking occurs at all four wheels. Do not become overconfident as to road conditions.
- Make sure you allow sufficient distance between you and other vehicles for stopping. Drive slower than usual and consider using one of the lower gears. In emergency stopping situations, avoid locking of the wheels. Use a “squeeze” technique, push on the brake pedal with a steadily increasing force which allows the wheels to brake yet continue to roll so that you may steer in the direction you want to travel. If you lock the wheels, release the brake pedal and repeat the squeeze technique. If your vehicle is equipped with a Four Wheel Anti-Lock Brake System (ABS), apply the brake steadily. Do not “pump” the brakes. Refer to the *Brakes* section of this chapter for additional information on the operation of the anti-lock brake system.

Driving

- Never drive with chains on the front tires of 4x4 vehicles without also putting them on the rear tires. This could cause the rear to slide and swing around during braking.

Tires, Replacement Requirements

Do not use a size and type of tire and wheel other than that originally provided by Mazda Motor Corporation because it can affect the safety and performance of your vehicle, which could lead to loss of vehicle control or rollover and serious injury. Make sure all tires and wheels on the vehicle are of the same size, type, tread design, brand and load-carrying capacity. If you have questions regarding tire replacement, see an authorized Mazda dealer.

If you nevertheless decide to equip your 4x4 for off-road use with tires larger than what Mazda Motor Corporation recommends, you should not use these tires for highway driving.

If you use any tire/wheel combination not recommended by Mazda Motor Corporation, it may adversely affect vehicle handling and could cause steering, suspension, axle or transfer case failure as well as the increased risk of loss of vehicle control.

Do not use “aftermarket lift kits” or other suspension modifications, whether or not they are used with larger tires and wheels.

These “aftermarket lift kits” could adversely affect the vehicle’s handling characteristics, which could lead to loss of vehicle control or rollover and serious injury.

Tires can be damaged during off-road use. For your safety, tires that are damaged should not be used for highway driving because they are more likely to blow out or fail.

You should carefully observe the recommended tire inflation pressure found on the safety compliance certification label attached to the left front door lock facing or door latch post pillar. Failure to follow tire pressure recommendations can adversely affect the way your vehicle handles. Do not exceed the Mazda Motor Corporation recommended pressure even if it is less than the maximum pressure allowed for the tire.

Each day before you drive, check your tires. If one looks lower than the others, use a tire gauge to check pressure of all tires, and adjust if required. Check tire pressure with a tire gauge every few weeks (including spare). Safe vehicle operation requires your tires to be set at the proper pressure and your vehicle not be overloaded.

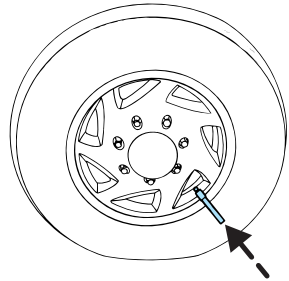

Periodically inspect the tire treads and remove stones, nails, glass or other objects that may be wedged in the tread grooves. Check for holes or cuts that may permit air leakage from the tire and make necessary repairs.

Inspect the tire sidewalls for cuts, bruises and other damage. If internal damage to the tire is suspected, have the tire demounted and inspected in case it needs to be repaired or replaced.

Maintenance and Modifications

The suspension and steering systems on your vehicle have been designed and tested to provide predictable performance whether loaded or empty and durable load carrying capability. For this reason, Mazda Motor Corporation strongly recommends that you do not make modifications such as adding or removing parts (such as lift kits or stabilizer bars) or by using replacement parts not equivalent to the original factory equipment.

Any modifications to a vehicle that raise the center of gravity can make it more likely the vehicle will roll over as a result of a loss of control. Mazda Motor Corporation recommends that caution be used with any vehicle equipped with a high load or device (such as ladder racks or pickup box cover).

Failure to maintain your vehicle properly may void the warranty, increase your repair cost, reduce vehicle performance and operational capabilities and adversely affect driver and passenger safety. Frequent inspection of vehicle chassis components is recommended if the vehicle is subjected to heavy off-road usage.

DRIVING THROUGH WATER

Do not drive quickly through standing water, especially if the depth is unknown. Traction or brake capability may be limited

Driving

and if the ignition system gets wet, your engine may stall. Water may also enter your engine's air intake and severely damage your engine.

If driving through deep or standing water is unavoidable, proceed very slowly. Never drive through water that is higher than the bottom of the hubs (for trucks) or the bottom of the wheel rims (for cars).

Once through the water, always try the brakes. Wet brakes do not stop the vehicle as effectively as dry brakes. Drying can be improved by moving your vehicle slowly while applying light pressure on the brake pedal.

Driving through deep water where the transmission vent tube is submerged may allow water into the transmission and cause internal transmission damage. Have the fluid checked and, if water is found, replace the fluid.

VEHICLE LOADING – WITH AND WITHOUT A TRAILER

This section will guide you in the proper loading of your vehicle and/or trailer, to keep your loaded vehicle weight within its design rating capability, with or without a trailer. Properly loading your vehicle will provide maximum return of vehicle design performance. Before loading your vehicle, familiarize yourself with the following terms for determining your vehicle's weight ratings, with or without a trailer, from the vehicle's Safety Certification Label and Tire and Load Information Label:

Base Curb Weight – is the weight of the vehicle including a full tank of fuel and all standard equipment. It does not include passengers, cargo, or optional equipment.

Vehicle Curb Weight – is the weight of your new vehicle when you picked it up from your dealer plus any aftermarket equipment.



+

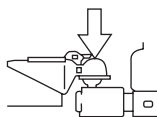

=

CARGO

Cargo Weight – includes all weight added to the Base Curb Weight, including cargo and optional equipment. When towing, trailer tongue load or king pin weight is also part of cargo weight.

GAW (Gross Axle Weight) – is the total weight placed on each axle (front and rear) – including vehicle curb weight and all payload.

GAWR (Gross Axle Weight Rating) – is the maximum allowable weight that can be carried by a single axle (front or rear). **These numbers are shown on the Safety Compliance Certification Label located on the driver’s door or door pillar. The total load on each axle must never exceed its GAWR.**

WARNING: Exceeding the Safety Certification Label axle weight rating limits could result in substandard vehicle handling, performance, engine, transmission and/or structural damage, serious damage to the vehicle, loss of control and personal injury.

Note: For trailer towing information refer to *Trailer Towing* found in this chapter or the RV and Trailer Towing Guide provided by your dealership.

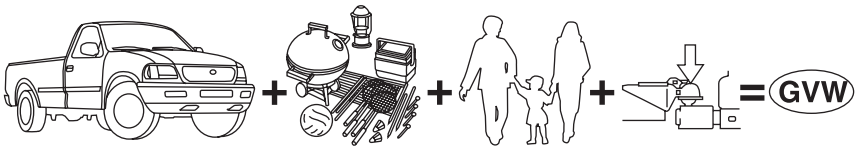

GVW (Gross Vehicle Weight) – is the Vehicle Curb Weight + cargo + passengers.

GVWR (Gross Vehicle Weight Rating) – is the maximum allowable weight of the fully loaded vehicle (including all options, equipment, passengers and cargo). **The GVWR is shown on the Safety Compliance Certification Label located on the driver’s door or door pillar. The GVW must never exceed the GVWR.**

Sample Truck Safety Compliance Certification Label
(Refer to actual label on your vehicle)

Front GAWR	GVWR	Rear GAWR					
MFD. BY FORD MOTOR CO. IN U.S.A.							
DATE: 06/95	GVWR: 6250 LB/2834 KG						
FRONT GAWR: 3450 LB	WITH REAR GAWR: 3777 LB						
1564KG	1713KG	WITH					
P285/75R15SL	TIRES P285/75R15SL	TIRES					
15X7.5J	RIMS 15X7.5J	RIMS					
AT 30 PSI COLD	AT 30 PSI COLD						
THIS VEHICLE CONFORMS TO ALL APPLICABLE FEDERAL MOTOR VEHICLE SAFETY STANDARDS IN EFFECT ON THE DATE OF MANUFACTURE SHOWN ABOVE.							
XXXXXXXXXXXXXX							
VIN: 1FTETX14H 0 SKB 00000		F0018					
TYPE: XXXXXXXXXXXXXXXX		TC183					
EXT PNT: XXXXXX XXXXXX							
WD	TYPE-GVW	BODY	TRANS	AXLE	TAPE	DSO:	SPRINGS
155		REM	E	H8B			M4

Driving

WARNING: Exceeding the Safety Certification Label axle weight rating limits could result in substandard vehicle handling, performance, engine, transmission and/or structural damage, serious damage to the vehicle, loss of control and personal injury.

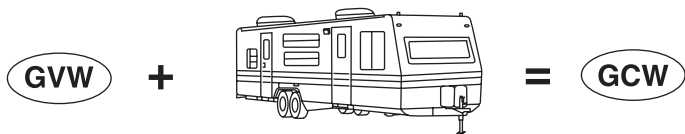

GCW (Gross Combined Weight) – is the weight of the loaded vehicle (GVW) plus the weight of the fully loaded trailer.

GCWR (Gross Combined Weight Rating) – is the maximum allowable weight of the vehicle and the loaded trailer – including all cargo and passengers – that the vehicle can handle without risking damage.

(Important: The towing vehicle's braking system is rated for operation at GVWR, not at GCWR. Separate functional brakes should be used for safe control of towed vehicles and for trailers weighing more than 680 kg [1,500 lbs]). **The GCW must never exceed the GCWR.**

Maximum Loaded Trailer Weight – is the highest possible weight of a fully loaded trailer the vehicle can tow. It assumes a vehicle with only mandatory options, no cargo (internal or external), a tongue load of 10–15% (conventional trailer) or king pin weight of 15–25% (fifth wheel trailer), and driver only (68 kg [150 lbs]). **Consult your dealership (or the RV and Trailer Towing Guide provided by your dealership) for more detailed information.**

Tongue Load or Fifth Wheel King Pin Weight – refers to the amount of the weight that a trailer pushes down on a trailer hitch.

Examples: For a 2268 kg (5000 lbs.) conventional trailer, multiply 5000 by 0.10 and 0.15 to obtain a proper tongue load range of 227 to 340 kg (500 to 750 lbs.). For an 5216 kg (11,500 lbs.) fifth wheel trailer, multiply by 0.15 and 0.25 to obtain a proper king pin load range of 782 to 1304 kg (1,725 to 2,875 lbs.)

WARNING: Do not exceed the GVWR or the GAWR specified on the certification label.

WARNING: Do not use replacement tires with lower load carrying capacities than the originals because they may lower the vehicle's GVWR and GAWR limitations. Replacement tires with a higher limit than the originals do not increase the GVWR and GAWR limitations.

WARNING: Exceeding any vehicle weight rating limitation could result in serious damage to the vehicle and/or personal injury.

Special loading instructions for owners of pickup trucks and utility-type vehicles

WARNING: For important information regarding safe operation of this type of vehicle, see the Preparing to drive your vehicle section in this chapter.

WARNING: Loaded vehicles may handle differently than unloaded vehicles. Extra precautions, such as slower speeds and increased stopping distance, should be taken when driving a heavily loaded vehicle.

Your vehicle can haul more cargo and people than most passenger cars. Depending upon the type and placement of the load, hauling cargo and people may raise the center of gravity of the vehicle.

Calculating the load your vehicle can carry/tow

1. Use the appropriate maximum GCWR chart (in the *Trailer Towing* section in this chapter) for your type of engine and rear axle ratio.
2. Weigh your vehicle without cargo. To obtain correct weights, take your vehicle to a shipping company or an inspection station for trucks.
3. Subtract your loaded weight from the maximum GCWR in the chart. This is the maximum trailer weight your vehicle can tow. It must be below the maximum trailer weight shown in the chart.

TRAILER TOWING

Trailer towing with your vehicle may require the use of a trailer tow option package.

Driving

Trailer towing puts additional loads on your vehicle's engine, transaxle, axle, brakes, tires, and suspension. For your safety and to maximize vehicle performance, be sure to use the proper equipment while towing.

Follow these guidelines to ensure safe towing procedure:

- Be sure to locate all the warnings supplied by the trailer rental or sales company and study the unique requirements of each trailer you intend to tow.
- Stay within your vehicle's load limits.
- Thoroughly prepare your vehicle for towing. Refer to *Preparing to tow* in this chapter.
- Use extra caution when driving while trailer towing. Refer to *Driving while you tow* in this chapter.
- Service your vehicle more frequently if you tow a trailer. Refer to the "Scheduled Maintenance" section of this manual.
- Do not tow a trailer until your vehicle has been driven at least 800 km (500 miles).
- Refer to the instructions included with towing accessories for the proper installation and adjustment specifications.

Do not exceed the maximum loads listed on the Certification label. For load specification terms found on the label, refer to *Vehicle loading* in this chapter. Remember to figure in the tongue load of your loaded vehicle when figuring the total weight.

4x2			
GCWR (Gross Combined Weight Rating)/Trailer Weights			
Engine	Maximum GCWR - kg (lbs.)	Trailer Weight Range - kg (lbs.)	Maximum frontal area of trailer - m ² (ft) ²
2.0L w/manual transmission	1,878 (4,140)	453 (1,000)	2.2 (24)
3.0L w/automatic transmission	2,404 (5,300)	907 (2,000)	2.2 (24)
3.0L w/automatic transmission and towing package	3,103 (6,840)	1,587 (3,500)	2.8 (30)

4x4

GCWR (Gross Combined Weight Rating)/Trailer Weights

Engine	Maximum GCWR - kg (lbs.)	Trailer Weight Range - kg (lbs.)	Maximum frontal area of trailer - m ² (ft) ²
2.0L w/manual transmission	1,932 (4,260)	453 (1,000)	2.2 (24)
3.0L w/automatic transmission	2,477 (5,460)	907 (2,000)	2.2 (24)
3.0L w/automatic transmission and towing package	3,175 (7,000)	1, 587 (3,500)	2.8 (30)

Notes: For high altitude operation, reduce GCW by 2% per 100 meters (300 ft.) elevation. For definitions of terms and instructions on calculating your vehicle's load, refer to *Vehicle Loading* in this chapter. Maximum trailer weights shown. The combined weight of the completed towing vehicle and the loaded trailer must not exceed the GCWR.

WARNING: Do not exceed the GVWR or the GAWR specified on the certification label.

Towing trailers beyond the maximum recommended gross trailer weight exceeds the limit of the vehicle and could result in:

- engine damage
- transmission damage
- structural damage
- loss of control
- personal injury

Preparing to tow

Use the proper equipment for towing a trailer and make sure it is properly attached to your vehicle. See your authorized Mazda dealer.

Driving

Hitches

Do not use hitches that clamp onto the vehicle bumper. Use a load carrying hitch. You must distribute the load in your trailer so that 10–15% of the total weight of the trailer is on the tongue.

Safety chains

Always connect the trailer's safety chains to the frame or hook retainers of the vehicle hitch. To connect the trailer's safety chains, cross the chains under the trailer tongue and allow slack for turning corners.

If you use a rental trailer, follow the instructions that the rental agency gives to you.

Do not attach safety chains to the bumper.

Trailer brakes

Electric brakes and manual, automatic or surge-type trailer brakes are safe if installed properly and adjusted to the manufacturer's specifications. The trailer brakes must meet local and Federal regulations.

WARNING: Do not connect a trailer's hydraulic brake system directly to your vehicle's brake system. Your vehicle may not have enough braking power and your chances of having a collision greatly increase.

The braking system of the tow vehicle is rated for operation at the GVWR not GCWR.

Trailer lamps

Trailer lamps are required on most towed vehicles. Make sure all running lights, brake lights, turn signals and hazard lights are working. See your authorized Mazda dealer for proper instructions and equipment for hooking up trailer lamps.

Driving while you tow

When towing a trailer:

- Turn off the speed control. The speed control may shut off automatically when you are towing on long, steep grades.
- Consult your local motor vehicle speed regulations for towing a trailer.
- To eliminate excessive shifting, use a lower gear. This will also assist in transmission cooling.

- Anticipate stops and brake gradually.
- Do not exceed the GCWR rating or transmission damage may occur.

Servicing after towing

If you tow a trailer for long distances, your vehicle will require more frequent service intervals. Refer to the “Scheduled Maintenance” section for more information.

Trailer towing tips

- Practice turning, stopping and backing up before starting on a trip to get the feel of the vehicle trailer combination. When turning, make wider turns so the trailer wheels will clear curbs and other obstacles.
- Allow more distance for stopping with a trailer attached.
- The trailer tongue weight should be 10–15% of the loaded trailer weight.
- After you have traveled 80 km (50 miles), thoroughly check your hitch, electrical connections and trailer wheel lug nuts.
- To aid in engine/transmission cooling and A/C efficiency during hot weather while stopped in traffic, place the gearshift lever in P (Park) (automatic transmission) or N (Neutral) (manual transmissions).
- Vehicles with trailers should not be parked on a grade. If you must park on a grade, place wheel chocks under the trailer’s wheels.

Launching or retrieving a boat

When backing down a ramp during boat launching or retrieval,

- Do not allow the static water level to rise above the bottom edge of the rear bumper.
- Do not allow waves to break higher than 15 cm (6 inches) above the bottom edge of the rear bumper.

Exceeding these limits may allow water to enter critical vehicle components, adversely affecting driveability, emissions, reliability and causing internal transmission damage.

Replace the rear axle lubricant any time the axle has been submerged in water. Rear axle lubricant quantities are not to be checked or changed unless a leak is suspected or repair required.

Disconnect the wiring to the trailer before backing the trailer into the water. Reconnect the wiring to the trailer after the trailer is removed from the water. Water entering these areas, while connected, could short-circuit the system.

Driving

RECREATIONAL TOWING

An example of “recreational towing” is towing your vehicle behind a motorhome.

If your vehicle is automatic transmission equipped, with a 4x2 (front-wheel drive only) configured powertrain, “recreational towing” is permitted by trailering the vehicle with its front wheels on a dolly. This protects the transmission’s internal mechanical components from potential lack of lubrication damage.

If your vehicle is manual transaxle equipped and 2WD or 4WD, shifting the transaxle into neutral permits “flat-towing” (all wheels on the ground) for pulling behind a motorhome. Your vehicle, with well designed towing equipment, may be towed up to a speed of 120 km/h (75 mph) but you should always obey local speed limits.

If your vehicle is automatic transaxle equipped and 4WD (all-wheel drive), “recreational towing” is permitted only if the vehicle is trailered with all four (4) wheels off the ground. Otherwise, no “recreational towing” is permitted.

For other towing requirements, refer to *Wrecker Towing* in the *Roadside emergencies* chapter.

Roadside Emergencies

HAZARD FLASHER CONTROL

The hazard flasher is located on the instrument panel by the radio. The hazard flashers will operate when the ignition is off.



Push in the flasher control and all front and rear direction signals will flash. Press the flasher control again to turn them off. Use it when your vehicle is disabled and is creating a safety hazard for other motorists.

Note: With extended use, the flasher may run down your battery.

FUEL PUMP SHUT-OFF SWITCH FUEL RESET

This device stops the electric fuel pump from sending fuel to the engine when your vehicle has had a substantial jolt.

After an accident, if the engine cranks but does not start, this switch may have been activated.

This switch is located in the front passenger's footwell, by the kick panel access cover.

To reset the switch:

1. Turn the ignition OFF.
2. Check the fuel system for leaks.
3. Remove the kick panel access cover, located in the front passenger's footwell.
4. If no leaks are apparent, reset the switch by pushing in on the reset button.
5. Turn the ignition ON.
6. Wait a few seconds and return the key to OFF.
7. Make another check of leaks.

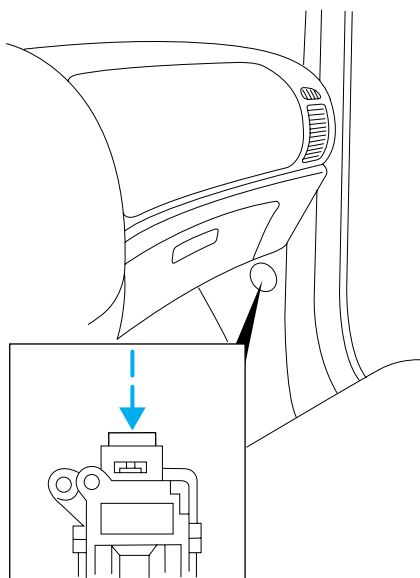

Roadside Emergencies

FUSES AND RELAYS

Fuses

If electrical components in the vehicle are not working, a fuse may have blown. Blown fuses are identified by a broken wire within the fuse. Check the appropriate fuses before replacing any electrical components.

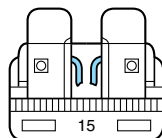

Note: Always replace a fuse with one that has the specified amperage rating. Using a fuse with a higher amperage rating can cause severe wire damage and could start a fire.

Standard fuse amperage rating and color

COLOR					
Fuse rating	Mini fuses	Standard fuses	Maxi fuses	Cartridge maxi fuses	Fuse link cartridge
2A	Grey	Grey	—	—	—
3A	Violet	Violet	—	—	—
4A	Pink	Pink	—	—	—
5A	Tan	Tan	—	—	—
7.5A	Brown	Brown	—	—	—
10A	Red	Red	—	—	—
15A	Blue	Blue	—	—	—
20A	Yellow	Yellow	Yellow	Blue	Blue
25A	Natural	Natural	—	—	—
30A	Green	Green	Green	Pink	Pink
40A	—	—	Orange	Green	Green
50A	—	—	Red	Red	Red
60A	—	—	Blue	—	Yellow
70A	—	—	Tan	—	Brown
80A	—	—	Natural	—	Black

Passenger compartment fuse panel

The fuse panel is located below and to the left of the steering wheel by the brake pedal. Remove the panel cover to access the fuses.

Roadside Emergencies

To remove a fuse use the fuse puller tool provided on the fuse panel cover.

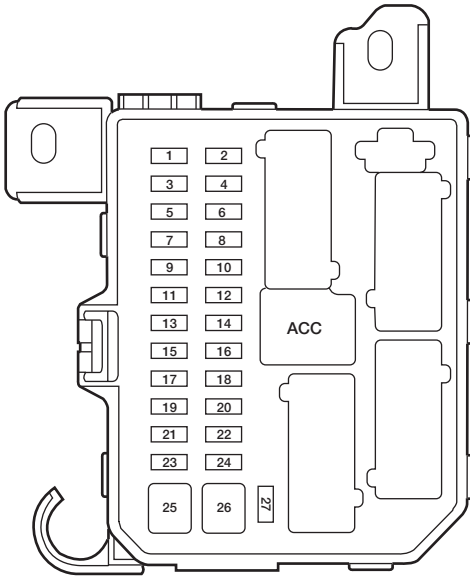

The fuses are coded as follows:

Fuse/Relay Location	Fuse Amp Rating	Passenger Compartment Fuse Panel Description
1	5A	Canister vent control solenoid
2	5A	Blower relay (coil), Pressure switch to PCM
3	10A	Rear wiper motor, Rear washer motor, Rear wiper relay (coil)
4	10A	Four-wheel drive control module, Cluster (restraints control warning)

Roadside Emergencies

Fuse/Relay Location	Fuse Amp Rating	Passenger Compartment Fuse Panel Description
5	5A	ABS unit (EVAC & FILL), ASC unit, Restraints Control Module (RCM), ASC main SW to ASC unit, Clock spring switch
6	10A	Flasher unit, Reversing lamps, Park Aid Module (PAM)
7	10A	Passive Anti-theft Transceiver (PATS), RCM, EEC fuse
8	10A	Cluster, Shift lock relay (coil), O/D signal to PCM, GEM, E/C autolamp mirror
9	3A	PCM relay (coil), Fan relay 1, 2, 3 (coil), A/C relay (coil)
10	20A	Front wiper motor, Front washer motor
11	10A	ACC relay (coil), Key interlock solenoid, GEM
12	5A	Radio
13	—	Not used
14	20A	Cigar lighter
15	15A	Park lamp relay, Front position lamps, License lamps, Tail lamps, Park lamp relay (coil), Trailer fuse, Illumination fuse
16	10A	Cluster, Power mirror, GEM, Heated seats
17	15A	Sun roof motor
18	5A	Illumination for: Cluster, Heater unit, Radio, Hazard switch, Rear defrost switch, 4WD switch, Front fog switch
19	10A	Subwoofer amp

Roadside Emergencies

Fuse/Relay Location	Fuse Amp Rating	Passenger Compartment Fuse Panel Description
20	15A	Turn Indicators, Front Side Turn Lamps, Front turn lamps, Rear turn lamps, Trailer turn, Flasher unit
21	10A	Trailer position lamps
22	15A	Not used
23	20A	Horn relay
24	15A	Stoplamps, High mounted stoplamp, Trailer stoplamp, ABS unit, ASC unit (Brake Pedal Position Switch), PCM, Shift solenoid
25	30A	Power window motors
26	30A	Power door lock motors, GEM (door lock relay coil), Power seat, 4WD relay
27	10A	GEM, Audio, Cluster, Interior lamp, Map lamp, Cargo lamp, Datalink connector
ACC	—	Accessory relay

Power distribution box

The power distribution box is located in the engine compartment. The power distribution box contains high-current fuses that protect your vehicle's main electrical systems from overloads.

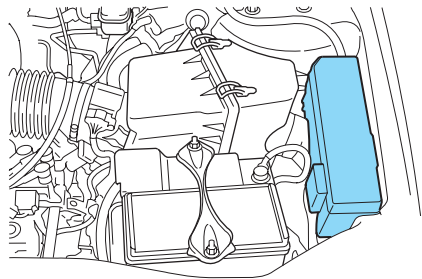

WARNING: Always disconnect the battery before servicing high current fuses.

Roadside Emergencies

WARNING: To reduce risk of electrical shock, always replace the cover to the Power Distribution Box before reconnecting the battery or refilling fluid reservoirs.

If the battery has been disconnected and reconnected, refer to the *Battery* section of the *Maintenance and specifications* chapter.

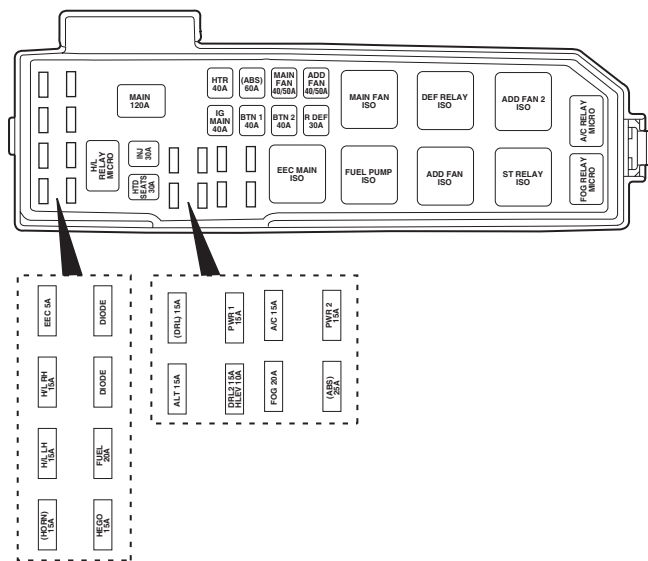

The high-current fuses are coded as follows.

Fuse/Relay Location	Fuse Amp Rating	Power Distribution Box Description
Horn	15A	Horn
H/L LH	15A*	Headlamp (high/low left, High beams)
H/L RH	15A*	Headlamp (high/low right, High beams)
EEC	5A*	EEC (KPWR)
HEGO	15A*	HEGO 1,2, CMS 1,2, VMV

Roadside Emergencies

Fuse/Relay Location	Fuse Amp Rating	Power Distribution Box Description
FUEL	20A*	Fuel pump, EEC (FPM)
DIODE	—	—
DIODE	—	—
H/L RELAY MICRO	—	Headlamp (high/low, right/left relay)
HTD SEATS	30A	Heated seats (if equipped)
INJ	30A**	EEC (VPWR), EVR, MAF, IAC, Bulkhead, HEGO fuse
MAIN	120A	Main
ALT	15A*	Alternator/ Regulator
(DRL)	15A*	Daytime Running Lamps (DRL) unit (feed), DRL relay
(DRL2) (HLEV)	15A*(DRL2) 10A(HLEV)	DRL module, HLEV
PWR 1	15A*	Auxiliary power point
FOG	20A*	Fog lamps, Foglamp indicator
A/C	15A*	A/C clutch
(ABS)	25A*	Anti-Lock Brake System (ABS) SOL, EVAC & FILL
PWR 2	15A*	Auxiliary power point
IG MAIN	40A**	Starter
HTR	40A**	Blower motor, Blower motor relay
BTN 1	40A**	JB - Accessory relay, Radio, TNS relay, Cigar lighter, Cluster, Power mirror, GEM, Accessory delay relay, Power windows, Power moonroof
(ABS)	60A**	ABS motor, EVAC & FILL
BTN 2	40A**	JB - Radio, CD changer, Cluster, Dome lamps, Map lamps, Cargo lamps, Horn relay, GEM, Power locks, Speed control

Roadside Emergencies

Fuse/Relay Location	Fuse Amp Rating	Power Distribution Box Description
MAIN FAN	40A** (2.0 L) 50A(3.0 L)	Main fan
R DEF	30A**	Rear defroster
ADD FAN	40A**(2.0 L) 50A(3.0 L)	Add fan
EEC MAIN ISO	—	EEC relay
FUEL PUMP ISO	—	Fuel pump relay
MAIN FAN ISO	—	Low-speed fan control relay (2.0L engine) High-speed fan control relay 1 (3.0L engine)
ADD FAN ISO	—	High-speed fan control relay 1 (2.0L engine) Low-speed fan control relay (3.0L engine)
DEF RELAY ISO	—	Rear defroster relay
ST RELAY ISO	—	Starter relay
ADD FAN 2 ISO	—	High-speed fan control relay 2 (3.0L engine) Medium-speed fan control relay (2.0L engine)
FOG RELAY MICRO	—	Foglamp relay
A/C RELAY MICRO	—	A/C clutch relay

OVERHEATING

If the temperature gauge indicates overheating and you experience power loss, you hear a loud knocking or pinging noise, the engine is probably too hot.

If this happens:

1. Drive safely to the side of the road and park off the right-of-way.
2. Shift the automatic transmission into P (Park) or the manual transmission into the neutral position, and apply the parking brake.

Roadside Emergencies

3. Turn off the air conditioner.

WARNING: Steam from an overheated engine is dangerous. The escaping steam could seriously burn you. Open the hood ONLY after steam is no longer escaping from the engine.

4. Check whether coolant or steam is escaping from under the hood or from the engine compartment.
 - **If steam is coming from the engine compartment:** do not go near the front of the vehicle. Stop the engine, then turn the ignition switch to the ON position without starting the engine. The radiator cooling fans will start to cool the engine.
 - **If neither coolant nor steam is escaping:** open the hood and idle the engine until it cools. If this does not lower the temperature, stop the engine and let it cool.
5. Check the coolant level. If it is low, look for leaks in the radiator hoses and connections, heater hoses and connections, radiator and water pump.

If you find a leak or other damage, or if coolant is still leaking, stop the engine and call an Authorized Mazda dealer.

See *Adding coolant* in the *Maintenance and specifications* section. If you find no problems, the engine is cool and no leaks are obvious, carefully add coolant as required.

WARNING: When the engine and radiator are hot, scalding coolant and steam may shoot out under pressure and cause serious injury. Do not remove the cooling system cap when the engine and radiator are hot.

Note: If the engine continues to overheat or frequently overheats, have the cooling system inspected. The engine could be seriously damaged unless repairs are made.

TEMPORARY SPARE TIRE INFORMATION

Your vehicle may have a temporary or conventional spare tire. The temporary spare tire for your vehicle is labeled as such. It is smaller than a regular tire and is designed for emergency use only. Replace this tire with a full-size tire as soon as possible.

It is not recommended that the vehicle be operated in 4WD modes with a temporary spare. If 4WD operation is necessary, do not operate above speeds of 16 km/h (10 mph) or for distances above 80 km (50 miles).

Roadside Emergencies

WARNING: If you use the temporary spare tire continuously or do not follow these precautions, the tire could fail, causing you to lose control of the vehicle, possibly injuring yourself or others.

When driving with the temporary spare tire **do not:**

- use more than one temporary spare tire at a time
- exceed 80 km/h (50 mph) or drive further than 3,200 km (2,000 miles) total under any circumstances
- load the vehicle beyond maximum vehicle load rating listed on the Safety Compliance Label
- tow a trailer
- use tire chains
- try to repair the temporary spare tire or remove it from its wheel
- use the wheel for any other type of vehicle

Use of a temporary spare tire at any one wheel location can lead to impairment of the following:

- handling, stability and braking performance
- comfort and noise
- ground clearance and parking at curbs
- Winter driving capability

Tire change procedure

WARNING: When one of the front wheels is off the ground, the transmission alone will not prevent the vehicle from moving or slipping off the jack, even if the vehicle is in P (Park) (automatic transaxle) or R (Reverse) (manual transaxle).

WARNING: To prevent the vehicle from moving when you change a tire, be sure the parking brake is set, then block both sides of the wheel that is diagonally opposite (other side and end of the vehicle) to the tire being changed.

Roadside Emergencies

WARNING: Changing a tire is dangerous if not done properly. The vehicle can slip off the jack and seriously injure you or someone. Be sure to follow the directions for changing a tire, and never get under a vehicle that is supported only by a jack.

1. Park on a level surface, activate hazard flashers and place gearshift lever in P (Park) (automatic transmission) or R (Reverse) (manual transmission).
2. Set the parking brake and turn engine OFF.
3. Block the diagonally opposite wheel.
4. Lift the cargo cover and remove the tool bag with jack handle, lug nut wrench and long spare tire rod and spare tire from the wheel well.

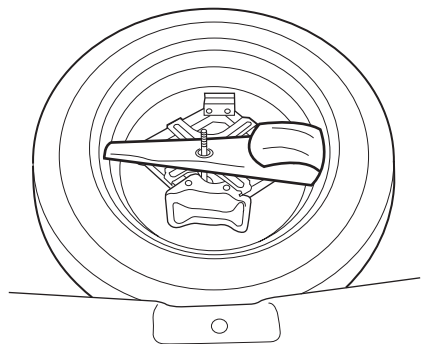
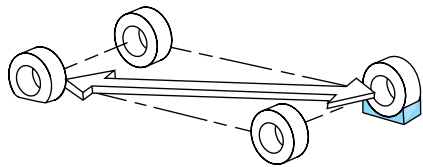
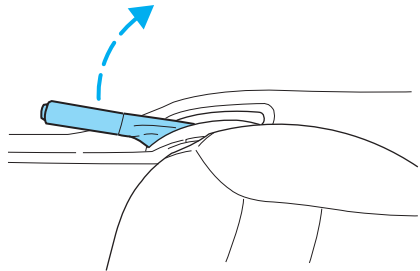

Roadside Emergencies

- Loosen each wheel lug nut one-half turn counterclockwise but do not remove them until the wheel is raised off the ground.

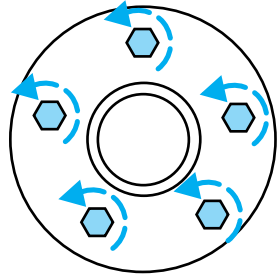

STOP Before placing the jack under the vehicle, NOTE the jack locations:

- Front** jacking notches are located **under the front suspension arm.**

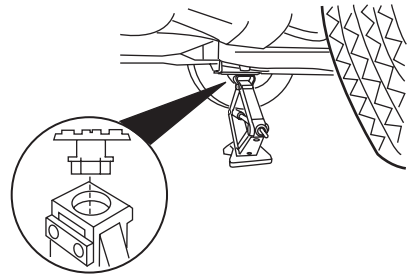

- Rear** jacking notches are located **under the rear trailing arm.**

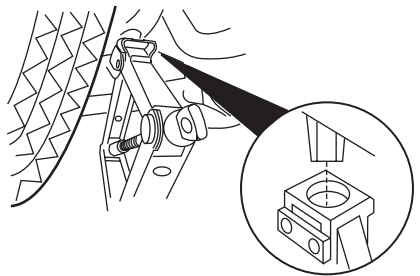

Roadside Emergencies

6. Position the jack according to the following guides and turn the jack handle clockwise until the tire is a maximum of 25 mm (1 inch) off the ground.

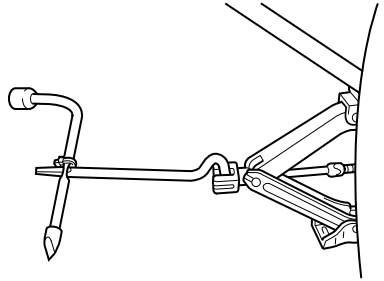

Never use the differentials as a jacking point. It is too easy for the vehicle to tilt or fall and you can be injured.

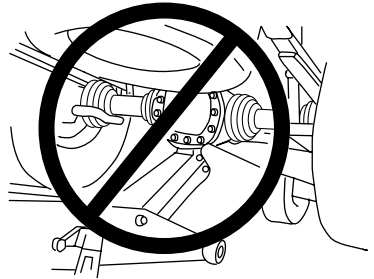

WARNING: To lessen the risk of personal injury, do not put any part of your body under the vehicle while changing a tire. Do not start the engine when your vehicle is on the jack. The jack is only meant for changing the tire.

7. Remove the lug nuts with the lug nut wrench.
8. Replace the flat tire with the spare tire, making sure the valve stem is facing outward. Reinstall lug nuts until the wheel is snug against the hub. Do not fully tighten the lug nuts until the wheel has been lowered.
9. Lower the wheel by turning the jack handle counterclockwise.

Roadside Emergencies

10. Remove the jack and fully tighten the lug nuts in the order shown.

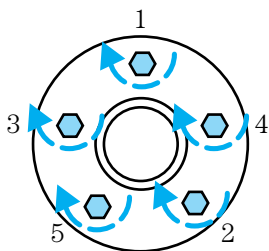

NOTE: To stow the full size flat tire in the cargo floor, the long spare tire rod in the tool bag needs to be installed.

11. Using the lug wrench, remove the spare tire rod from the cargo floor and install the longer spare tire rod.
12. Put flat tire and tool bag with jack handle, lug nut wrench and spare tire rod away. Make sure jack is fastened so it does not rattle when you drive.

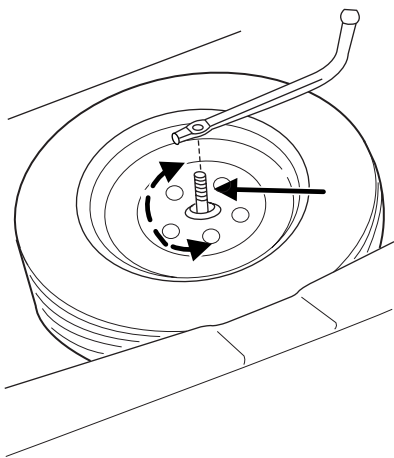

NOTE: The cargo cover can not be reattached to the back seat clips when a full size tire is stowed.

13. Install cargo cover over the flat tire and secure with the plastic nut.
14. Unblock the wheels.

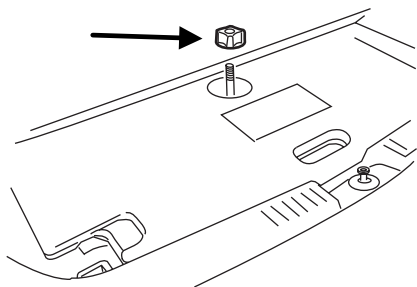

Roadside Emergencies

Wheel lug nut torque specifications

Retighten the lug nuts to the specified torque at 800 km (500 miles) after any wheel disturbance (tire rotation, changing a flat tire, wheel removal, etc.).

Bolt size	Wheel lug nut torque*	
	Nm	Lb-ft
M12 x 1.5	113-153	84-114

* Torque specifications are for nut and bolt threads free of dirt and rust. Use only Mazda recommended replacement fasteners.

WARNING: When a wheel is installed, always remove any corrosion, dirt or foreign materials present on the mounting surfaces of the wheel or the surface of the front disc brake hub and rotor that contacts the wheel. Installing wheels without correct metal-to-metal contact at the wheel mounting surfaces can cause the wheel nuts to loosen and the wheel to come off while the vehicle is in motion, resulting in loss of control.

JUMP STARTING YOUR VEHICLE

WARNING: The gases around the battery can explode if exposed to flames, sparks, or lit cigarettes. An explosion could result in injury or vehicle damage.

Do not push start your vehicle. You could damage the catalytic converter.

WARNING: Batteries contain sulfuric acid which can burn skin, eyes and clothing, if contacted.

Do not attempt to push start your vehicle. Automatic transmissions do not have push-start capability.

Roadside Emergencies

Preparing your vehicle

When the battery is disconnected or a new battery is installed, the transmission must relearn its shift strategy. As a result, the transmission may have firm and/or soft shifts. This operation is considered normal and will not affect function or durability of the transmission. Over time, the adaptive learning process will fully update transmission operation.

- **Use only a 12-volt supply to start your vehicle.**
- Do not disconnect the battery of the disabled vehicle as this could damage the vehicle's electrical system.
- Park the booster vehicle close to the hood of the disabled vehicle making sure the two vehicles **do not** touch. Set the parking brake on both vehicles and stay clear of the engine cooling fan and other moving parts.
- Check all battery terminals and remove any excessive corrosion before you attach the battery cables. Ensure the vent caps are tight and level.
- Turn the heater fan on in both vehicles to protect any electrical surges. Turn all other accessories off.

Connecting the jumper cables

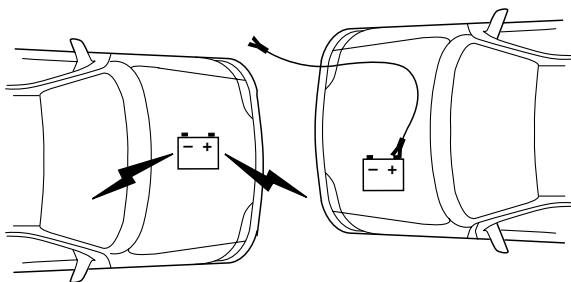

1. Connect the positive (+) jumper cable to the positive (+) terminal of the discharged battery.

Note: In the illustrations, *lightning bolts* are used to designate the assisting (boosting) battery.

Roadside Emergencies

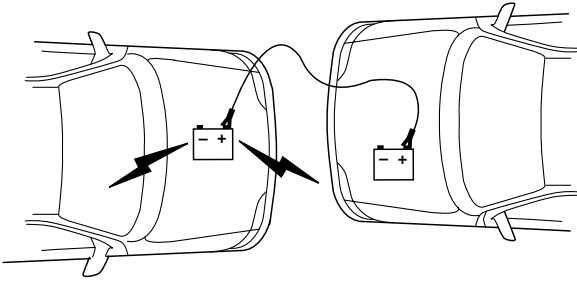

2. Connect the other end of the positive (+) cable to the positive (+) terminal of the assisting battery.

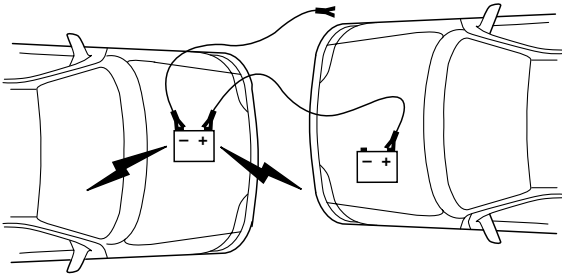

3. Connect the negative (-) cable to the negative (-) terminal of the assisting battery.

Roadside Emergencies

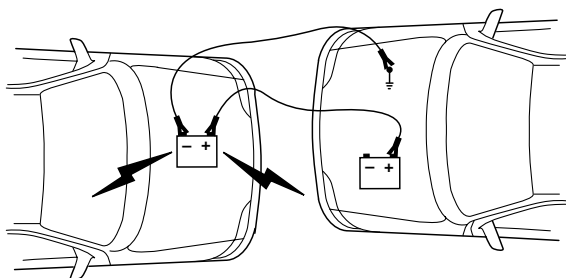

4. Make the final connection of the negative (-) cable to an exposed metal part of the disabled vehicle's engine, away from the battery and the fuel injection system. **NOTE: Do not** use fuel lines, engine rocker covers or the intake manifold as *grounding* points.

WARNING: Do not connect the end of the second cable to the negative (-) terminal of the battery to be jumped. A spark may cause an explosion of the gases that surround the battery.

5. Ensure that the cables are clear of fan blades, belts, moving parts of both engines, or any fuel delivery system parts.

Jump starting

1. Start the engine of the booster vehicle and run the engine at moderately increased speed.
2. Start the engine of the disabled vehicle.
3. Once the disabled vehicle has been started, run both engines for an additional three minutes before disconnecting the jumper cables.

Removing the jumper cables

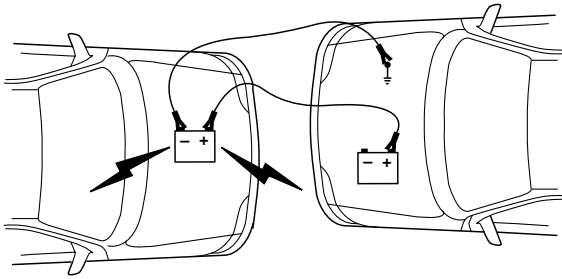

Remove the jumper cables in the reverse order that they were connected.

1. Remove the jumper cable from the *ground* metal surface.

Note: In the illustrations, *lightning bolts* are used to designate the assisting (boosting) battery.

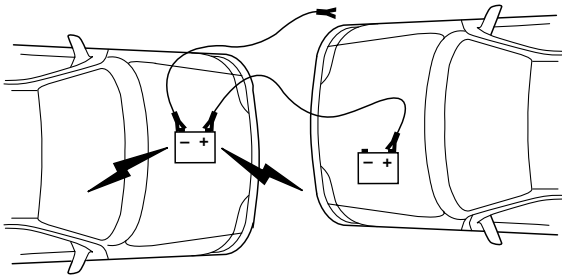

2. Remove the jumper cable on the negative (-) connection of the booster vehicle's battery.

Roadside Emergencies

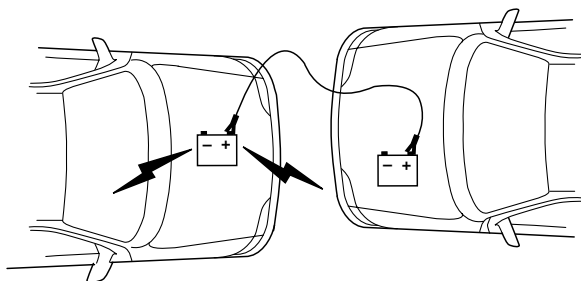

3. Remove the jumper cable from the positive (+) terminal of the booster vehicle's battery.

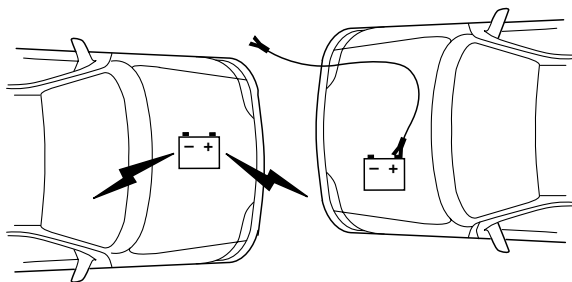

4. Remove the jumper cable from the positive (+) terminal of the disabled vehicle's battery.

After the disabled vehicle has been started and the jumper cables removed, allow it to idle for several minutes so the engine computer can *relearn* its idle conditions.

Roadside Emergencies

WRECKER TOWING

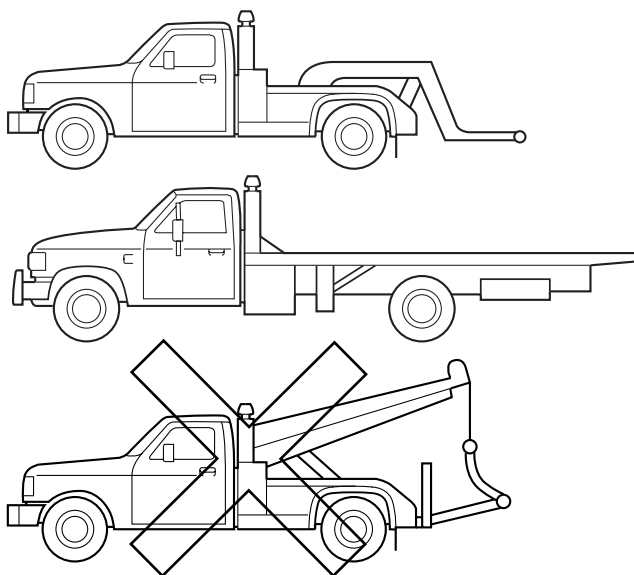

If you need to have your vehicle towed, contact a professional towing service or, if you are a member of a roadside assistance program, your roadside assistance service provider.

It is recommended that your vehicle be towed with a wheel lift and dollies or flatbed equipment. Do not tow with a slingbelt. Mazda has not approved a slingbelt towing procedure.

If your vehicle is to be towed from the rear using wheel lift equipment, it is recommended that the front wheels (drive wheels) be placed on a dolly to prevent damage to the transaxle.

On 4x4 vehicles, it is **required** that your vehicle be towed with a wheel lift and dollies or flatbed equipment with all the wheels off the ground.

If the vehicle is towed by other means or incorrectly, vehicle damage may occur.

Roadside Emergencies

In case of a roadside emergency with a disabled vehicle (without access to wheel dollies, car hauling trailer or flatbed transport vehicle) your vehicle (regardless of powertrain configuration) can be flat towed (all wheels on the ground) under the following conditions:

- Place the transmission in N (Neutral).
- Maximum speed is 56 km/h (35 mph).
- Maximum distance is 80 km (50 miles).

CUSTOMER ASSISTANCE (U.S.A.)

Your complete and permanent satisfaction is our business. We are here to serve you. All Authorized Mazda Dealers have the knowledge and the tools to keep your Mazda vehicle in top condition.

If you have any questions or recommendations for improvement regarding the service of your Mazda vehicle or servicing by Mazda Dealer personnel, we recommend that you take the following steps:

STEP 1: Contact Your Mazda Dealer

Discuss the matter with an Authorized Mazda Dealer. This is the quickest and best way to address the issue. If your concern has not been resolved by the CUSTOMER RELATIONS, SALES, SERVICE, or PARTS MANAGER, then please contact the GENERAL MANAGER of the dealership or the OWNER.

STEP 2: Contact Mazda North American Operations

If for any reason you feel the need for further assistance after contacting your dealership management, you can reach Mazda North American Operations by one of the following ways.

Log on at: www.mazdausa.com

Answers to many questions, including how to locate or contact a local Mazda Dealership in the U.S., can be found here.

By phone at: 1 (800) 222-5500

By letter at:

Attn: Customer Assistance
Mazda North American Operations
7755 Irvine Center Drive
Irvine, CA 92618-2922
P.O. Box 19734
Irvine, CA 92623-9734

Whatever way you contact us, please help us to serve you more efficiently and effectively by providing the following information:

1. Your name, address, and telephone number
2. Year and model of vehicle
3. Vehicle Identification Number (17 digits, noted on your registration or title or located on the upper driver's side corner of the dash)
4. Purchase date and current mileage
5. Your dealer's name and location
6. Your question(s)

Customer Assistance

If you live outside the U.S.A., please contact your nearest Mazda Distributor.

CUSTOMER ASSISTANCE (CANADA)

Your complete and permanent satisfaction is our business. We are here to serve you. All Authorized Mazda Dealers have the knowledge and the tools to keep your Mazda vehicle in top condition.

In our experience, any questions, problems or complaints regarding the operation of your Mazda or any other general service transactions are most effectively resolved by your dealer. If the cause of your dissatisfaction cannot adequately be addressed by normal dealership procedures, we recommend that you take the following steps:

STEP 1: Contact Your Mazda Dealer

Discuss the matter with a member of dealership management. If the Service Manager has already reviewed your concerns, contact the owner of the dealership or its General Manager

STEP 2: Call the Mazda Regional Office

If you feel that you still require assistance, ask the dealer Service Manager to arrange for you to meet the local Mazda Service Representative. If more expedient, contact Mazda Canada Inc. Regional Office nearest you for such arrangements.

STEP 3: Contact the Mazda Customer Relations Department

If still not substantially satisfied, contact the Customer Relations Department, Mazda Canada Inc., 305 Milner Avenue, Suite 400 Scarborough, Ontario M1B 3V4 Canada TEL: 1 (800) 263-4680.

Provide the Department with the following information:

1. Your name, address, and telephone number
2. Year and model of vehicle
3. Vehicle Identification Number (VIN). Refer to the "Vehicle Identification Labels" page of section 10 of this manual for the location of the VIN.
4. Purchase date.
5. Present odometer reading.
6. Your dealer's name and location
7. The nature of your problem and/or cause of dissatisfaction.

The Department, in cooperation with the local Mazda Service Representative, will review the case to determine if everything possible has been done to ensure your satisfaction.

Customer Assistance

Please recognize that the resolution of service problems in most cases requires the use of your Mazda dealer's service facilities, personnel and equipment. We urge you to follow the above three steps in sequence therefore for most effective results.

MEDIATION/ARBITRATION PROGRAM

Occasionally a customer concern cannot be resolved through Mazda's Customer Satisfaction Program. If after exhausting procedures in this manual, your concern is still not resolved, you have another option.

Mazda Canada Inc. participates in an arbitration program administered by the Canadian Motor Vehicle Arbitration Plan (CAMVAP). CAMVAP will advise you about how your concern may be reviewed and resolved by an independent third party through binding arbitration.

Your complete satisfaction is the goal of Mazda Canada Inc. and our dealers. Mazda's participation in CAMVAP makes a valuable contribution to our achieving that goal. There is no charge for using CAMVAP. CAMVAP results are fast, fair and final as the award is binding on both you and Mazda Canada Inc.

CANADIAN MOTOR VEHICLE ARBITRATION PLAN (CAMVAP)

If a specific item of concern arises, where a solution cannot be reached between an owner, Mazda, and/or one of its dealers (that all parties cannot agree upon), the owner may wish to use the services offered by the Canadian Motor Vehicle Arbitration Plan (CAMVAP).

CAMVAP uses the services of Provincial Administrators to assist consumers in scheduling and preparing for their arbitration hearings. However, before you can proceed with CAMVAP you must follow your Mazda dispute resolution process as outlined previously.

CAMVAP is fully implemented in all provinces and territories. Consumers wishing to obtain further information about the Program can obtain an information booklet from their dealer, the Provincial Administrator of the Canadian Motor Vehicle Arbitration Plan Office at the following address or telephone number.

Canadian Motor Vehicle Arbitration Office
235 Yorkland Boulevard, Suite 300
North York, Ontario
M2J 4Y8
1 (800) 207-0685

Customer Assistance

Provincial Administrators may be reached locally as listed below:

Province/Territory	CAMVAP Number
British Columbia & Yukon Territories	(604) 681-0312
Alberta & Northwest Territories	(403) 426-0650
Saskatchewan	(306) 352-9259
Manitoba	(204) 942-7166
Ontario	(416) 596-8824
Atlantic Canada	(902) 422-5413
Quebec	(418) 649-1330

REGIONAL OFFICES

Regional Offices	Areas Covered
<p>Mazda Canada Inc. Western Region 8171 Ackroyd Road Suite 2000 Richmond, B.C. V6X 3K1 (604) 303-5670</p>	<p>Alberta, British Columbia, Manitoba, Saskatchewan, Yukon</p>
<p>Mazda Canada Inc. Central/Atlantic Region 305 Milner Avenue Suite 400 Scarborough, Ontario. M1B 3V4 1 (800) 263-4680</p>	<p>Ontario, New Brunswick, Nova Scotia, Prince Edward Island, Newfoundland</p>
<p>Mazda Canada Inc. Quebec Region 6111 Route Trans Canadienne Pointe Claire, Quebec H9R 5A5 (514) 694-6390</p>	<p>Quebec</p>

Customer Assistance

CUSTOMER ASSISTANCE (PUERTO RICO)

Your complete and permanent satisfaction is our business. That is why all Authorized Mazda Dealers have the knowledge and the tools to keep your Mazda vehicle in top condition.

If you have any questions or recommendations for improvement regarding the service of your Mazda vehicle or servicing by Mazda Dealer personnel, we recommend that you take the following steps:

STEP 1

Discuss the matter with an Authorized Mazda Dealer. This is the quickest and best way to address the issue. If your concern has not been resolved by the CUSTOMER RELATIONS, SALES, SERVICE, or PARTS MANAGER, then please contact the GENERAL MANAGER of the dealership or the OWNER.

STEP 2

If, after following STEP 1, you feel the need for further assistance, please contact your area's Mazda representative (Indicated on the next page).

Please help us by providing the following information:

1. Your name, address, and telephone number
2. Year and model of vehicle
3. Vehicle Identification Number (17 digits, noted on your registration or title or located on the upper driver's side corner of the dash)
4. Purchase date and current mileage
5. Your dealer's name and location
6. Your question(s)

If you would like to write a letter, please address it to the following,
Attn: Customer Assistance

Plaza Motors Corp.

Mazda de Puerto Rico

P.O. Box 362722

San Juan, Puerto Rico

00936-2722

Tel: (787) 788-9300

This way, we can be sure to respond to you as efficiently as possible.
That is our goal.

If you live outside the U.S.A., please contact your nearest Mazda Distributor.

Customer Assistance

MAZDA IMPORTERS/DISTRIBUTORS

U.S.A (Importer/Distributor)

Mazda North American Operations

7755 Irvine Center Drive

Irvine, CA 92618-2922

P.O. Box 19734

Irvine, CA 92623-9734

TEL: 1 (800) 222-5500 (in U.S.A.)

(949) 727-1990 (outside U.S.A.)

(Distributor in each area)

CANADA

Mazda Canada, Inc.

305 Milner Avenue, Suite 400

Scarborough, Ontario M1B 3V4 Canada

TEL: 1 (800) 263-4680 (in Canada)

(416) 609-9909 (outside Canada)

PUERTO RICO

Plaza Motors Corp. (Mazda de Puerto Rico)

P.O. Box 362722, San Juan, Puerto Rico 00936-2722

TEL: (787) 788-9300

GUAM

(d.b.a. Triple J. Enterprises, Inc.)

P.O. Box 6066 Tamuning, Guam

TEL: (671) 646-9216

SAIPAN

Pacific International Marianas, Inc.

(d.b.a. Midway Motors)

P.O. Box 887 Saipan, MP 96950

TEL: (670) 234-7524

Triple J Saipan, Inc.

(d.b.a. Triple J Motors)

Beach Road

Chalan LauLau

Saipan, MP 96950

TEL: (670) 235-4868

AMERICAN SAMOA

Polynesia Motors, Inc.

P.O. Box 1120, Pago Pago, American Samoa 96799

TEL: (684) 699-1854

ADD-ON NON-GENUINE PARTS AND ACCESSORIES

Non-genuine parts and accessories for Mazda vehicles can be found in stores. These may fit your vehicle, but they are not approved by the manufacturer for use with Mazda vehicles. When you install non-genuine parts or accessories, they could affect your vehicle's performance or safety system; the manufacturer's warranty doesn't cover this. Before you install any non-genuine parts or accessories, consult an Authorized Mazda Dealer.

WARNING: Installation of Non-Genuine Parts or Accessories: Installation of non-genuine parts or accessories could be dangerous. Improperly designed parts or accessories could seriously affect your vehicle's performance or safety system. This could cause you to have an accident or increase your chances of injuries in an accident. Always consult an Authorized Mazda Dealer before you install non-genuine parts or accessories.

WARNING: Add-On Electrical and Electronic Equipment: Incorrectly choosing or installing improper add-on equipment or choosing an improper installer could be dangerous. Essential systems could be damaged, causing engine stalling, air-bag (SRS) activation, ABS inactivation, or a fire in the vehicle. Be very careful in choosing and installing add-on electrical equipment, such as mobile telephones, two-way radios, stereo systems, and car alarm systems.

Mazda assumes no responsibility for death, injury, or expenses that may result from the installation of add-on non-genuine parts or accessories.

WARRANTIES FOR YOUR MAZDA

- New Vehicle Limited Warranty
- Safety Restraint System Limited Warranty
- Anti-perforation Limited Warranty
- Federal Emission Control Warranty
 - Emission Defect Warranty
 - Emission Performance Warranty

Customer Assistance

- California Emission Control Warranty (if applicable)
- Replacement Parts and Accessories Limited Warranty
- Tire Warranty

NOTE: Detailed warranty information is provided with your Mazda portfolio.

OUTSIDE THE UNITED STATES

Government regulations in the United States require that automobiles meet specific emission regulations and safety standards. Therefore, vehicles built for use in the United States, may differ from those sold in other countries.

The differences may make it difficult or even impossible for your vehicle to receive satisfactory servicing in other countries. We strongly recommend that you NOT take your Mazda outside the United States. However, in the event that you are moving to Canada permanently, Mazda vehicles built for use in the United States could be eligible for exportation to Canada with specific vehicle modifications to comply with the Canadian Motor Vehicle Safety requirements.

Special Note: The above is applicable for permanent import/export situations and not related to travelers on vacation.

You may have the following problems if you do take your vehicle outside of the United States:

- Recommended fuel may be unavailable. Any kind of leaded fuel or low-octane fuel will affect vehicle performance and damage the emission controls and engine.
- Proper repair facilities, tools, testing equipment, and replacement parts may not be available.

Please refer to your manufacturer's warranty booklet for more information.

OUTSIDE CANADA

Government regulations in Canada require that automobiles meet specific emission regulations and safety standards. Therefore, vehicles built for use in Canada, may differ from those sold in other countries.

The differences may make it difficult or even impossible for your vehicle to receive satisfactory servicing in other countries. We strongly recommend that you NOT take your Mazda outside Canada. However, in the event that you are moving to the United States permanently, Mazda

vehicles built for use in Canada could be eligible for exportation to the United States with specific vehicle modifications to comply with the United States Federal Motor Vehicle Safety requirements.

Special Note: The above is applicable for permanent import/export situations and not related to travelers on vacation.

You may have the following problems if you do take your vehicle outside of Canada:

- Recommended fuel may be unavailable. Any kind of leaded fuel or low-octane fuel will affect vehicle performance and damage the emission controls and engine.
- Proper repair facilities, tools, testing equipment, and replacement parts may not be available.

Please refer to your manufacturers warranty booklet for more information.

REPORTING SAFETY DEFECTS

If you believe that your vehicle has a defect which could cause a crash or could cause injury or death, you should immediately inform the National Highway Traffic Safety Administration (NHTSA) in addition to notifying your Mazda importer/distributor.

If NHTSA receives similar complaints, it may open an investigation, and if it finds that a safety defect exists in a group of vehicles, it may order a recall and remedy campaign. However NHTSA cannot become involved in individual problems between you, your dealer, or your Mazda importer/distributor).

To contact NHTSA, you may either call the Auto Safety Hotline toll-free at 1 (800) 424-9393 (or 366-0123 in Washington, D.C. area) or write to: NHTSA, U.S. Department of Transportation, Washington, D.C. 20590. You can also obtain other information about motor vehicle safety from the Hotline.

(Note)

If you live in the U.S.A., all correspondence to:

Mazda North American Operations
7755, Irvine Center Drive
Irvine, California 92618-2922
P.O. Box 19734
Irvine, CA 92623-9734
Customer Assistance Center
or toll free at 1 (800) 222-5500

Customer Assistance

If you live outside of the U.S.A., please contact the nearest Mazda Distributor. (See the *Mazda Importers/Distributors* section of this manual).

SERVICE PUBLICATIONS

Factory-authorized Mazda service publications are available for owners who wish to do some of their own maintenance and repair.

When requesting any of our publications through an Authorized Mazda Dealer, refer to the chart below.

If they don't have what you need in stock, they can order it for you.

PUBLICATION ORDER NUMBER	PUBLICATION DESCRIPTION
9999 95 062B 04	WORKSHOP MANUAL
9999 95 038G 04	WIRING DIAGRAM
9999 95 014C 04	OWNER'S MANUAL

WORKSHOP MANUAL:

Covers recommended maintenance and repair procedures of the drive train, body and chassis.

WIRING DIAGRAM:

Provides electrical schematics as well as component location for the entire electrical system.

OWNER'S MANUAL:

This booklet contains information regarding the proper care and operation of your vehicle. This is not a technician's manual.

Please note that your Authorized Mazda Dealership has trained personnel and special service tools to correctly and safely maintain Mazda vehicles.

IN CALIFORNIA (U.S. ONLY)

California Civil Code Section 1793.2(d) requires that, if a manufacturer or its representative is unable to repair a motor vehicle to conform to the vehicle's applicable express warranty after a reasonable number of attempts, the manufacturer shall be required to either replace the vehicle with one substantially identical or repurchase the vehicle and reimburse the buyer in an amount equal to the actual price paid or payable by the consumer (less a reasonable allowance for consumer use). The consumer has the right to choose whether to receive a refund or replacement vehicle.

Customer Assistance

California Civil Code Section 1793.22(b) presumes that the manufacturer has had a reasonable number of attempts to conform the vehicle to its applicable express warranties if, within the first 18 months of ownership of a new vehicle or the first 29 000 km (18 000 miles), whichever occurs first:

1. Two or more repair attempts are made on the same nonconformity likely to cause death or serious bodily injury OR
2. Four or more repair attempts are made on the same nonconformity (a defect or condition that substantially impairs the use, value or safety of the vehicle) OR
3. The vehicle is out of service for repair of nonconformities for a total of more than 30 calendar days (not necessarily all at one time)

In the case of 1 or 2 above, the consumer must also notify the manufacturer of the need for the repair of the nonconformity at the following address:

Mazda North American Operations
7755, Irvine Center Drive
Irvine, CA 92618-2922

REPORTING SAFETY DEFECTS (U.S. ONLY)

If you believe that your vehicle has a defect that could cause a crash, or could cause injury or death, you should immediately inform the National Highway Traffic Safety Administration (NHTSA) in addition to notifying Mazda Corporation.

If NHTSA receives similar complaints, it may open an investigation, and if it finds that a safety defect exists in a group of vehicles, it may order a recall and remedy campaign. However, NHTSA cannot become involved in individual problems between you, your dealer or Mazda Corporation.

To contact NHTSA, you may either call the Auto Safety Hotline toll-free at 1-800-424-9393 (202-366-0123 in the Washington D.C. area) or write to:

NHTSA
U.S. Department of Transportation
400 Seventh Street
Washington D.C. 20590

You can also obtain other information about motor vehicle safety from the Hotline.

Cleaning

WASHING THE EXTERIOR

Wash your vehicle regularly with cool or lukewarm water and a neutral Ph shampoo, such as an approved shampoo available from your Mazda dealer.

- Never use strong household detergents or soap, such as dish washing or laundry liquid. These products can discolor and spot painted surfaces.
- Never wash a vehicle that is “hot to the touch” or during exposure to strong, direct sunlight.
- Always use a clean sponge or carwash mitt with plenty of water for best results.
- Dry the vehicle with a chamois or soft terry cloth towel in order to eliminate water spotting.
- It is especially important to wash the vehicle regularly during the winter months, as dirt and road salt are difficult to remove and cause damage to the vehicle.
- Immediately remove items such as gasoline, diesel fuel, bird droppings and insect deposits because they can cause damage to the vehicle’s paintwork and trim over time.
- Remove any exterior accessories, such as antennas, before entering a car wash.
- **Suntan lotions and insect repellents can damage any painted surface; if these substances come in contact with your vehicle, wash off as soon as possible.**

WAXING

Applying a polymer paint sealant to your vehicle every six months will assist in reducing minor scratches and paint damage.

- Wash the vehicle first.
- Do not use waxes that contain abrasives.
- Do not allow paint sealant to come in contact with any non-body (low-gloss black) colored trim, such as grained door handles, roof racks, bumpers, side moldings, mirror housings or the windshield cowl area. The paint sealant will “gray” or stain the parts over time.

PAINT CHIPS

Your dealer has touch-up paint to match your vehicle's color. Touch-up paint can be used to repair minor scratches to painted surfaces.

- Remove particles such as bird droppings, tree sap, insect deposits, tar spots, road salt and industrial fallout before repairing paint chips.
- Always read the instructions before using the products.

ALUMINUM WHEELS AND COVERS

Aluminum wheel rims or covers are coated with a clearcoat paint finish. In order to maintain their shine:

- Clean with One Step Wash and Wax Concentrate, which is available from your authorized Mazda dealer.
- Never apply any cleaning chemical to hot or warm wheel rims or covers.
- Some automatic car washes may cause damage to the finish on your wheel rims or covers. Chemical-strength cleaners, or cleaning chemicals, in combination with brush agitation to remove brake dust and dirt, could wear away the clearcoat finish over time.
- Do not use hydrofluoric acid-based or high caustic-based wheel cleaners, steel wool, fuels or strong household detergent.
- To remove tar and grease, use Extra Strength Tar and Road Oil Removal, available from your authorized Mazda dealer.

ENGINE

Engines are more efficient when they are clean because grease and dirt buildup keep the engine warmer than normal. When washing:

- Take care when using a power washer to clean the engine. The high-pressure fluid could penetrate the sealed parts and cause damage.
- Never spray the engine or other engine components with water. Water will damage the engine or other engine components.
- Spray Engine Shampoo and Degreaser, available at your authorized Mazda dealer, on all parts that require cleaning and pressure rinse clean.
- Cover the highlighted areas to prevent water damage when cleaning the engine.

Cleaning

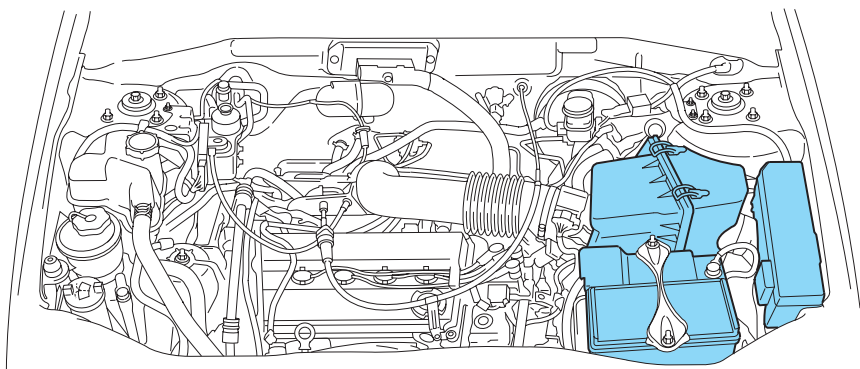

- **2.0L DOHC I4 — Zetec Engine**

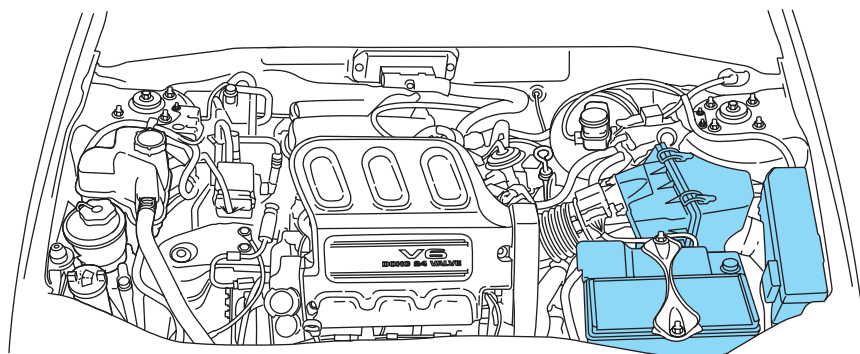

- **3.0L DOHC V6 — Duratec Engine**

- Never wash or rinse the engine while it is running; water in the running engine may cause internal damage.

PLASTIC (NON-PAINTED) EXTERIOR PARTS

Use only approved products to clean plastic parts. These products are available from your dealer.

- For routine cleaning, use One Step Wash and Wax Concentrate, available at your authorized Mazda dealer.
- If tar or grease spots are present, use Extra Strength Tar and Road Oil Removal, available at your authorized Mazda dealer.

WINDOWS AND WIPER BLADES

The windshield, rear window and wiper blades should be cleaned regularly. If the wiper does not wipe properly, substances on the windshield, rear window or the wiper blades may be the cause. These may include hot wax treatments used by commercial car washes, tree sap, or other organic contamination. To clean these items, please follow these tips:

- The windshield or rear window may be cleaned with a non-abrasive cleaner such as Ultra Clear Spray Glass Cleaner, available from your authorized Mazda dealer.
- Do not use abrasives, as they may cause scratches.
- Do not use fuel, kerosene, or paint thinner to clean any parts.
- Wiper blades can be cleaned with isopropyl (rubbing) alcohol or windshield washer solution. Be sure to replace wiper blades when they appear worn or do not function properly.

INSTRUMENT PANEL AND CLUSTER LENS

Clean the instrument panel with a damp cloth, then dry with a dry cloth.

- Avoid cleaners or polish that increase the gloss of the upper portion of the instrument panel. The dull finish in this area helps protect the driver from undesirable windshield reflection.

WARNING: Do not use chemical solvents or strong detergents when cleaning the steering wheel or instrument panel to avoid contamination of the air bag system.

- Be certain to wash or wipe your hands clean if you have been in contact with certain products such as insect repellent and suntan lotion in order to avoid possible damage to the interior painted surfaces.

INTERIOR TRIM

- Clean the interior trim areas with a damp cloth, then dry by wiping with a dry, soft, clean cloth.
- Do not use household or glass cleaners as these may damage the finish.

Cleaning

INTERIOR

For fabric, carpets, cloth seats, safety belts and seats equipped with side air bags (if equipped):

- Remove dust and loose dirt with a vacuum cleaner.
- Remove light stains and soil with Extra Strength Upholstery Cleaner, available at your authorized Mazda dealer.
- If grease or tar is present on the material, spot-clean the area first with Spot and Stain Remover, available at your authorized Mazda dealer.
- Never saturate the seat covers with cleaning solution.
- Do not use household cleaning products or glass cleaners, which can stain and discolor the fabric and affect the flame retardant abilities of the seat materials.

WARNING: Do not use chemical solvents or strong detergents when cleaning the seat where the side air bag (if equipped) is mounted. Such products may contaminate the side air bag system (if equipped) and affect performance of the side air bag (if equipped) in a collision. The air bag may not function correctly and not provide any injury reduction benefits.

LEATHER SEATS (IF EQUIPPED)

Your leather seating surfaces have a clear, protective coating over the leather.

- To clean, use a soft cloth with Deluxe Leather and Vinyl Cleaner. Dry the area with a soft cloth.
- To help maintain its resiliency and color, use the Deluxe Leather Care Kit, available at your authorized Mazda dealer.
- Do not use household cleaning products, alcohol solutions, solvents or cleaners intended for rubber, vinyl and plastics, or oil/petroleum-based leather conditioners. These products may cause premature wearing of the clear, protective coating.

UNDERBODY

Flush the complete underside of your vehicle frequently. Keep body and door drain holes free from packed dirt.

MAZDA CAR CARE PRODUCTS

Your Mazda dealer has many quality products available to clean your vehicle and protect its finishes. These quality products have been specifically engineered to fulfill your automotive needs; they are custom designed to complement the style and appearance of your vehicle. Each product is made from high quality materials that meet or exceed rigid specifications. For best results, use these products or products of equivalent quality. These products are available at your authorized Mazda dealer.

Maintenance and Specifications

INTRODUCTION

Be extremely careful to prevent injury to yourself and others and damage to your vehicle when using this manual for inspection and maintenance.

If you're unsure about any procedure, we strongly urge you to have a reliable and qualified service shop perform the work, preferably an Authorized Mazda Dealer.

Factory-trained Mazda technicians and genuine Mazda parts are best for your vehicle. Without this expertise and the parts that have been designed and made especially for your Mazda, inadequate, incomplete, and insufficient servicing may result in problems. This could lead to vehicle damage or an accident and injuries.

For expert advice and quality service, consult an Authorized Mazda Dealer.

The owner should retain evidence that proper maintenance has been performed as prescribed.

Claims against the warranty resulting from lack of maintenance, as opposed to defective materials or authorized Mazda workmanship, will not be honored.

Any auto repair shop using parts equivalent to your Mazda's original equipment may perform maintenance. **But we recommend that it always be done by an Authorized Mazda Dealer using genuine Mazda parts.**

SCHEDULED MAINTENANCE

Follow Schedule 1 if the vehicle is operated mainly where none of the following conditions apply.

If any do apply, follow Schedule 2 (Canada and Puerto Rico residents follow Schedule 2).

- Repeated short-distance driving
- Driving with an extended use of brakes
- Driving in areas where salt or other corrosive materials are being used
- Driving on rough or muddy roads
- Extended periods of idling or low-speed operation
- Driving for long periods in cold temperatures or extremely humid climates
- Towing a trailer or using a car-top carrier

NOTE:After the described period, continue to follow the described maintenance at the recommended intervals.

Maintenance and Specifications

SCHEDULE 1

I: Inspect and repair, clean, adjust, or replace if necessary
(Oil-permeated air filter cannot be cleaned using the air-blow method)

R: Replace

L: Lubricate

Maintenance Item	Maintenance Interval (Number of months or km (miles), whichever comes first)												
	Months	6	12	18	24	30	36	42	48	54	60	66	72
	x 1000 Km	12	24	36	48	60	72	84	96	108	120	132	144
	(x 1000 Miles)	(7.5)	(15)	(22.5)	(30)	(37.5)	(45)	(52.5)	(60)	(67.5)	(75)	(82.5)	(90)
ENGINE													
Engine valve clearance (for 2.0L engine)									I				
Engine timing belt (for 2.0L engine)	Replace every 144,000 km (90,000 miles)												
Engine oil	R	R	R	R	R	R	R	R	R	R	R	R	R
Oil filter	R	R	R	R	R	R	R	R	R	R	R	R	R
Drive belts				I					I				I
PCV valve (for 2.0L engine) *1	Replace every 96,000 km (60,000 miles)												
PCV valve (for 3.0L engine) *1	Replace every 160,000 km (100,000 miles)												
Hoses and tubes for emission *1									I				
IGNITION SYSTEM													
Spark plugs (PLATINUM-TIPPED type)	Replace every 160,000 km (100,000 miles)												
FUEL SYSTEM													
Air cleaner filter					R				R				R
Fuel filter *1					R				R				R
Fuel lines and hoses *1					I				I				I
COOLING SYSTEM													
Cooling system					I				I				I
Engine coolant (green)	Replace at first 72,000 km (45,000 miles) or 36 months; after that, every 48,000 km (30,000 miles) or 24 months												
Engine coolant (yellow)	Replace at first 160,000 km (100,000 miles) or 60 months; after that, every 80,000 km (50,000 miles) or 36 months												

Maintenance and Specifications

Maintenance Item	Maintenance Interval (Number of months or km (miles), whichever comes first)												
	Months	6	12	18	24	30	36	42	48	54	60	66	72
	x 1000 Km	12	24	36	48	60	72	84	96	108	120	132	144
	(x 1000 Miles)	(7.5)	(15)	(22.5)	(30)	(37.5)	(45)	(52.5)	(60)	(67.5)	(75)	(82.5)	(90)
CHASSIS and BODY													
Brake lines, hoses and connections					I				I				I
Disc brakes					I				I				I
Drum brakes					I				I				I
Steering operation and linkages					I				I				I
Rear differential oil (for 4WD) *2	Replace every 160,000 km (100,000 miles)												
Front and rear suspension ball joints					I				I				I
Driveshaft dust boots					I				I				I
Bolts and nuts on chassis and body					I				I				I
Exhaust system heat shields					I				I				I
All locks and hinges	L	L	L	L	L	L	L	L	L	L	L	L	L
AIR CONDITIONER SYSTEM (if equipped)													
Refrigerant amount		I			I				I				I
Compressor operation		I			I				I				I

*1 According to state and federal regulations, failure to perform maintenance on these items will not void your emissions warranties. However, Mazda recommends that all maintenance services be performed at the recommended time or mileage (kilometrage) period to ensure long-term reliability.

*2 If this component has been submerged in water, the oil should be changed.

Maintenance and Specifications

SCHEDULE 2

I: Inspect and repair, clean, adjust, or replace if necessary
(Oil-permeated air filter cannot be cleaned using the air-blow method)

R: Replace

L: Lubricate

Maintenance Item	Maintenance Interval (Number of months or km (miles), whichever comes first)												
	Months	4	8	12	16	20	24	28	32	36	40	44	48
	x 1000 Km	8	16	24	32	40	48	56	64	72	80	88	96
	(x 1000 Miles)	(5)	(10)	(15)	(20)	(25)	(30)	(35)	(40)	(45)	(50)	(55)	(60)
ENGINE													
Engine valve clearance (for 2.0L engine)													I
Engine timing belt (for 2.0L engine)	Replace every 144,000 km (90,000 miles)												
Engine oil	R	R	R	R	R	R	R	R	R	R	R	R	R
Engine oil (for Puerto Rico)	Replace every 4,800 km (3,000 miles) (or 3 months)												
Oil filter	R	R	R	R	R	R	R	R	R	R	R	R	R
Drive belts							I						I
PCV valve (for 2.0L engine)	*1	Replace every 96,000 km (60,000 miles)											
PCV valve (for 3.0L engine)	*1	Replace every 160,000 km (100,000 miles)											
Hoses and tubes for emission	*1												I
IGNITION SYSTEM													
Spark plugs (PLATINUM TIPPED type)	Replace every 160,000 km (100,000 miles)												
FUEL SYSTEM													
Air cleaner filter			I				R			I			R
Fuel filter	*1						R						R
Fuel lines & hoses	*1						I						I
COOLING SYSTEM													
Cooling system							I						I
Engine coolant (green)	Replace at first 72,000 km (45,000 miles) or 36 months; after that, every 48,000 km (30,000 miles) or 24 months												

Maintenance and Specifications

Maintenance Item	Maintenance Interval (Number of months or km (miles), whichever comes first)												
	Months	4	8	12	16	20	24	28	32	36	40	44	48
	x 1000 Km	8	16	24	32	40	48	56	64	72	80	88	96
	(x 1000 Miles)	(5)	(10)	(15)	(20)	(25)	(30)	(35)	(40)	(45)	(50)	(55)	(60)
Engine coolant (yellow)	Replace at first 160,000 km (100,000 miles) or 60 months; after that, every 80,000 km (50,000 miles) or 36 months												
Engine coolant level	I	I	I	I	I	I	I	I	I	I	I	I	I
ELECTRICAL SYSTEM													
Function of all lights	I	I	I	I	I	I	I	I	I	I	I	I	I
CHASSIS and BODY													
Brake lines, hoses and connections							I						I
Brake fluid level	I	I	I	I	I	I	I	I	I	I	I	I	I
Disc brakes			I				I			I			I
Drum brakes							I						I
Tire inflation pressure and tire wear	I	I	I	I	I	I	I	I	I	I	I	I	I
Steering operation and linkages							I						I
Power steering fluid level	I	I	I	I	I	I	I	I	I	I	I	I	I
Manual transaxle oil	Replace every 48,000 km (30,000 miles)												
Automatic transaxle fluid	Replace every 48,000 km (30,000 miles)												
Rear differential oil (for 4WD) *2	Replace every 160,000 km (100,000 miles)												
Transfer oil (for 4WD) *2	Replace every 48,000 km (30,000 miles)												
Front and rear suspension ball joints							I						I
Driveshaft dust boots							I						I
Bolts and nuts on chassis and body			I				I			I			I
Exhaust system heat shields							I						I
All locks and hinges	L	L	L	L	L	L	L	L	L	L	L	L	L
Washer fluid level	I	I	I	I	I	I	I	I	I	I	I	I	I
AIR CONDITIONER SYSTEM (if equipped)													
Refrigerant amount			I				I			I			I
Compressor operation			I				I			I			I

*1 According to state and federal regulations, failure to perform maintenance on these items will not void your emissions warranties. However, Mazda recommends that all maintenance services be performed

Maintenance and Specifications

at the recommended time or mileage (kilometrage) period to ensure long-term reliability.

*2 If this component has been submerged in water, the oil should be changed.

OWNER MAINTENANCE SCHEDULE

The owner or a qualified service technician should make these vehicle inspections at the indicated intervals to ensure safe and dependable operation.

Bring any problem to the attention of an Authorized Mazda Dealer or qualified service technician as soon as possible.

When Refueling

- Brake and clutch fluid level
- Engine coolant level
- Engine oil level
- Washer fluid level

At Least Monthly

- Tire inflation pressures

At Least Twice a Year (For Example, Every Spring and Fall)

- Automatic transaxle fluid level
- Power steering fluid level

SERVICE RECOMMENDATIONS

To help you service your vehicle:

- We highlight do-it-yourself items in the engine compartment for easy location.
- We provide a Scheduled Maintenance section which makes tracking routine service easy.

If your vehicle requires professional service, your dealership can provide necessary parts and service. Check your “Warranty Information” to find out which parts and services are covered.

Use only recommended fuels, lubricants, fluids and service parts conforming to specifications. Genuine Mazda parts are designed and built to provide the best performance in your vehicle.

Maintenance and Specifications

PRECAUTIONS WHEN SERVICING YOUR VEHICLE

WARNING: A hot engine is dangerous. If the engine has been running, parts of the engine compartment can become very hot. You could be burned. Don't inspect the coolant system or add coolant when the engine is hot.

- Do not work on a hot engine.
- Make sure that nothing gets caught in moving parts.
- Do not work on a vehicle with the engine running in an enclosed space, unless you are sure you have enough ventilation.
- Keep all open flames and other lit material away from the battery and all fuel related parts.

Working with the engine off

- Automatic transmission:
 1. Set the parking brake and shift to P (Park).
 2. Turn off the engine and remove the key.
 3. Block the wheels.
- Manual transmission:
 1. Set the parking brake, depress the clutch and place the gearshift in 1 (First).
 2. Turn off the engine and remove the key.
 3. Block the wheels.

Working with the engine on

- Automatic transmission:
 1. Set the parking brake and shift to P (Park).
 2. Block the wheels.
- Manual transmission:
 1. Set the parking brake, depress the clutch and place the gearshift in N (Neutral).
 2. Block the wheels.

Note: Do not start your engine with the air cleaner removed and do not remove it while the engine is running.

Maintenance and Specifications

OPENING THE HOOD

1. Inside the vehicle, pull the hood release handle located under the bottom of the instrument panel.

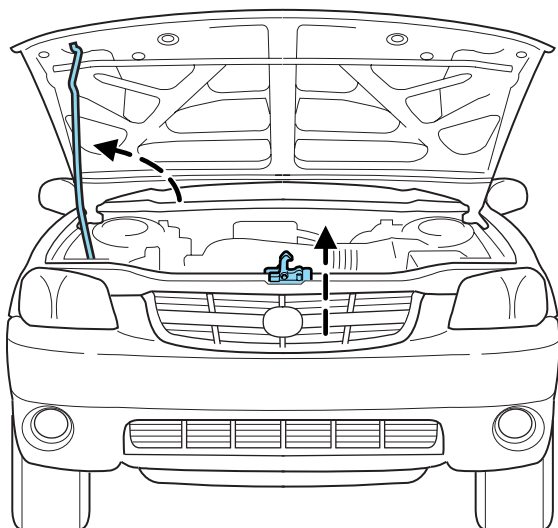
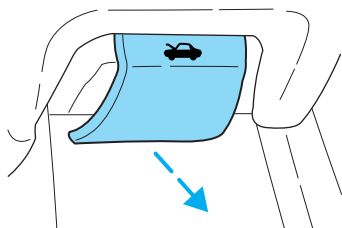

2. At the front of the vehicle, lift up on the auxiliary latch handle located in the center between the hood and the grille.
3. Lift the hood open and secure it with the prop rod.

Maintenance and Specifications

IDENTIFYING COMPONENTS IN THE ENGINE COMPARTMENT

2.0L DOHC I4 Zetec engine

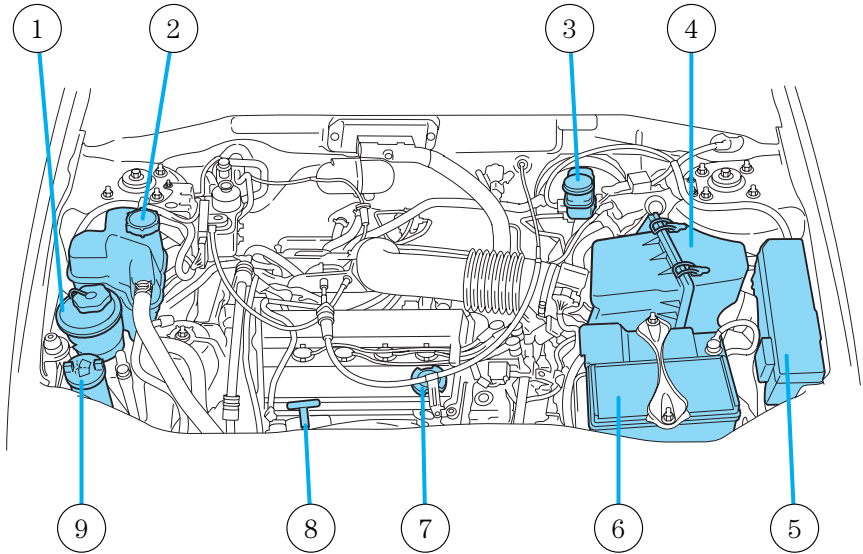

1. Power steering fluid reservoir
2. Engine coolant reservoir
3. Brake/Clutch fluid reservoir
4. Air filter assembly
5. Power distribution box
6. Battery
7. Engine oil filler cap
8. Engine oil dipstick
9. Windshield washer fluid reservoir

Maintenance and Specifications

3.0L DOHC V6 Duratec engine

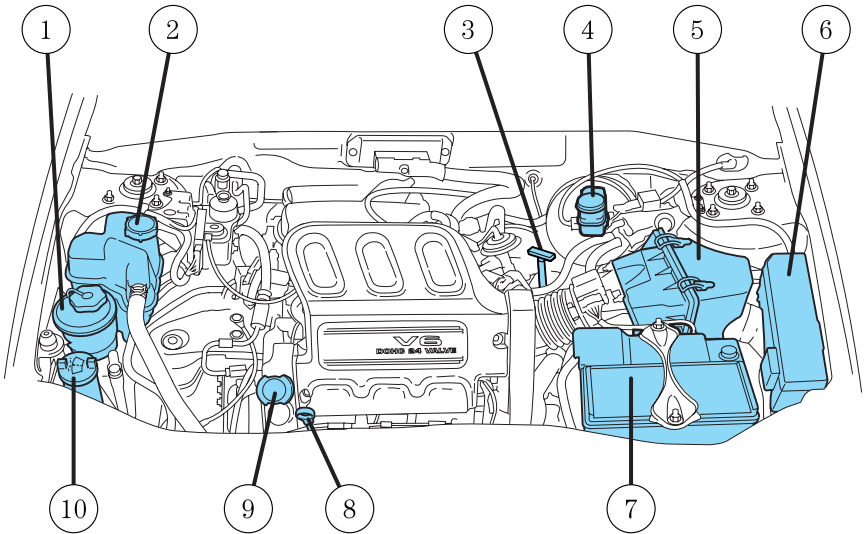

1. Power steering fluid reservoir
2. Engine coolant reservoir
3. Automatic transmission fluid dipstick
4. Brake fluid reservoir
5. Air filter assembly
6. Power distribution box
7. Battery
8. Engine oil dipstick
9. Engine oil filler cap
10. Windshield washer fluid reservoir

Maintenance and Specifications

WINDSHIELD WASHER FLUID

Check the washer fluid whenever you stop for fuel. The reservoir is highlighted with a  symbol.

Add fluid to fill the reservoir if the level is low. In very cold weather, do not fill the reservoir completely.

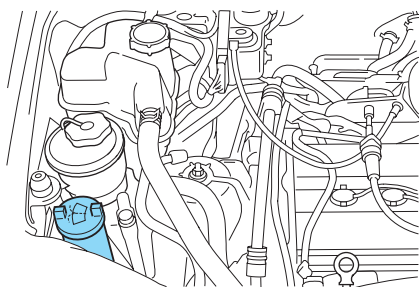

Only use a washer fluid that meets Mazda specifications. Refer to *Refill capacities* in this chapter.

WARNING: If you operate your vehicle in temperatures below 4.5° C (40° F), use washer fluid with antifreeze protection. Failure to use washer fluid with antifreeze protection in cold weather could result in impaired windshield vision and increase the risk of injury or accident.

NOTE: State or local regulations on volatile organic compounds may restrict the use of methanol, a common windshield washer antifreeze additive. Washer fluids containing non-methanol antifreeze agents should be used only if they provide cold weather protection without damaging the vehicle's paint finish, wiper blades or washer system.

Note: Do not put washer fluid in the engine coolant reservoir. Washer fluid placed in the cooling system may harm engine and cooling system components.

Checking and adding washer fluid for the liftgate

Washer fluid for the liftgate is supplied by the same reservoir as the windshield.

ENGINE OIL

Checking the engine oil

Refer to the service maintenance section for the appropriate intervals for checking the engine oil.

1. Make sure the vehicle is on level ground.
2. Turn the engine off and wait a few minutes for the oil to drain into the oil pan.

Maintenance and Specifications

3. Set the parking brake and ensure the gearshift is securely latched in P (Park) (automatic transmissions) or 1 (First) (manual transmissions).
4. Open the hood. Protect yourself from engine heat.
5. Locate and carefully remove the engine oil level indicator (dipstick).

- 2.0L DOHC I4 Zetec engine

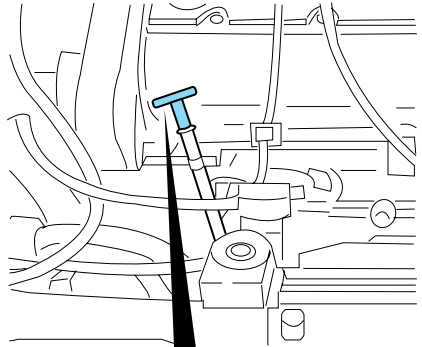

- 3.0L DOHC V6 Duratec engine

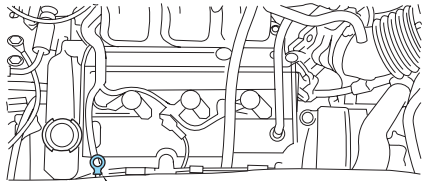

Maintenance and Specifications

- Wipe the indicator clean. Insert the indicator fully, then remove it again.
- If the oil level is **between the MIN-MAX or ADD-FULL marks**, the oil level is acceptable. **DO NOT ADD OIL.**
- If the oil level is below the MIN or ADD mark, add enough oil to raise the level within the MIN-MAX or ADD-FULL range.
- 2.0L DOHC I4 Zetec engine

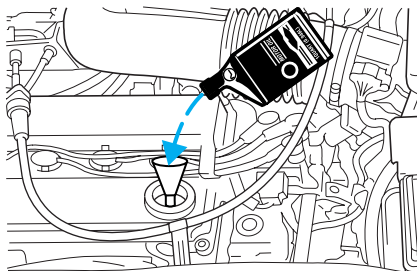

- 3.0L DOHC V6 Duratec engine

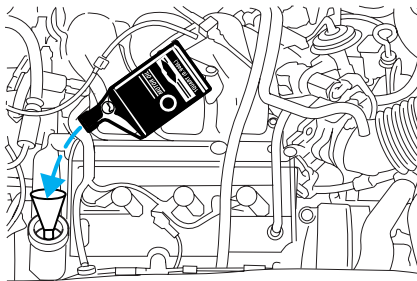

- Oil levels above the MAX or FULL mark may cause engine damage. Some oil must be removed from the engine by a service technician.
- Put the indicator back in and ensure it is fully seated.

Adding engine oil

- Check the engine oil. For instructions, refer to *Checking the engine oil* in this chapter.
- If the engine oil level is not within the normal range, add only certified engine oil of the recommended viscosity. Remove the engine oil filler cap and use a funnel to pour the engine oil into the opening.
- Recheck the engine oil level. Make sure the oil level is not above the MAX or FULL mark on the engine oil level indicator (dipstick).
- Install the indicator and ensure it is fully seated.

Maintenance and Specifications

5. Fully install the engine oil filler cap by turning the filler cap clockwise 1/4 of a turn until it is seated.

To avoid possible oil loss, DO NOT operate the vehicle with the engine oil level indicator and/or the engine oil filler cap removed.

Engine oil and filter recommendations

SAE 5W-20 engine oil is recommended

Look for this certification trademark.



Use SAE 5W-20 motor oil certified for gasoline engines by the American Petroleum Institute (API).

Motor oil displaying the API certification trademark will meet all requirements for your vehicle's engine.

Do not use supplemental engine oil additives, oil treatments or engine treatments. They are unnecessary and could, under certain conditions, lead to engine damage which is not covered by your warranty.

Change your engine oil and filter according to the appropriate schedule listed in the service maintenance section.

Mazda production and replacement oil filters are designed for added engine protection and long life. If a replacement oil filter is used that does not meet Mazda material and design specifications, start-up engine noises or knock may be experienced.

It is recommended you use the appropriate Genuine Mazda oil filter (or another brand meeting Mazda specifications) for your engine application.

Maintenance and Specifications

BATTERY

Your vehicle is equipped with a Mazda maintenance-free battery which normally does not require additional water during its life of service.

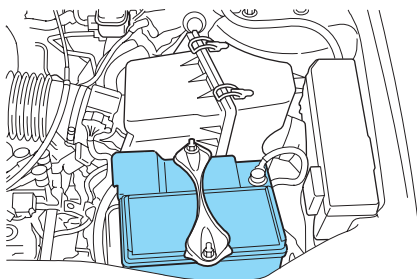

However, for severe usage or in high temperature climates, check the battery electrolyte level. Refer to the service maintenance section for the service interval schedules.

Keep the electrolyte level in each cell up to the “level indicator”. Do not overfill the battery cells.

If the electrolyte level in the battery is low, you can add plain tap water to the battery, as long as you do not use hard water (water with a high mineral or alkali content). If possible, however, try to only fill the battery cells with distilled water. If the battery needs water often, have the charging system checked.

If your battery has a cover/shield, make sure it is reinstalled after the battery has been cleaned or replaced.

For longer, trouble-free operation, keep the top of the battery clean and dry. Also, make certain the battery cables are always tightly fastened to the battery terminals.

If you see any corrosion on the battery or terminals, remove the cables from the terminals and clean with a wire brush. You can neutralize the acid with a solution of baking soda and water.

WARNING: Batteries normally produce explosive gases which can cause personal injury. Therefore, do not allow flames, sparks or lighted substances to come near the battery. When working near the battery, always shield your face and protect your eyes. Always provide proper ventilation.

Maintenance and Specifications

WARNING: When lifting a plastic-cased battery, excessive pressure on the end walls could cause acid to flow through the vent caps, resulting in personal injury and/or damage to the vehicle or battery. Lift the battery with a battery carrier or with your hands on opposite corners.

WARNING: Keep batteries out of reach of children. Batteries contain sulfuric acid. Avoid contact with skin, eyes or clothing. Shield your eyes when working near the battery to protect against possible splashing of acid solution. In case of acid contact with skin or eyes, flush immediately with water for a minimum of 15 minutes and get prompt medical attention. If acid is swallowed, call a physician immediately.

WARNING: Battery posts, terminals and related accessories contain lead and lead compounds. Wash hands after handling.

Because your vehicle's engine is electronically controlled by a computer, some control conditions are maintained by power from the battery. When the battery is disconnected or a new battery is installed, the engine must relearn its idle and fuel trim strategy for optimum driveability and performance. To begin this process:

1. With the vehicle at a complete stop, set the parking brake.
2. Put the gearshift in P (Park) (automatic transmission) or the neutral position (manual transmission), turn off all accessories and start the engine.
3. Run the engine until it reaches normal operating temperature.
4. Allow the engine to idle for at least one minute.
5. Turn the A/C on and allow the engine to idle for at least one minute.
6. Drive the vehicle to complete the relearning process.

NOTE:

- The vehicle may need to be driven to relearn the idle and fuel trim strategy.
- **If you do not allow the engine to relearn its idle trim, the idle quality of your vehicle may be adversely affected until the idle trim is eventually relearned.**

When the battery is disconnected or a new battery installed, the transmission must relearn its adaptive strategy. As a result of this, the

Maintenance and Specifications

transmission may shift firmly. This operation is considered normal and will not affect function or durability of the transmission. Over time the adaptive learning process will fully update transmission operation to its optimum shift feel.

If the battery has been disconnected or a new battery has been installed, the clock and the preset radio stations must be reset once the battery is reconnected.

- Always dispose of automotive batteries in a responsible manner. Follow your local authorized standards for disposal. Call your local authorized recycling center to find out more about recycling automotive batteries.

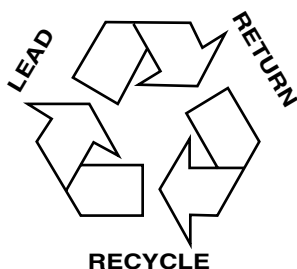

ENGINE COOLANT

Checking engine coolant

The concentration and level of engine coolant should be checked at the mileage intervals listed in the service maintenance section. The coolant concentration should be maintained at 50/50 coolant and water, which equates to a freeze point of -36°C (-34°F). Coolant concentration testing is possible with a hydrometer or antifreeze tester (such as the Rotunda Battery and Antifreeze Tester, 014-R1060). The level of coolant should be maintained at the “cold full” or “cold fill range” level in the coolant reservoir. If the level falls below, add coolant per the instructions in the *Adding Engine Coolant* section.

Your vehicle was factory-filled with a 50/50 engine coolant and water concentration. If the concentration of coolant falls below 40% or above 60%, the engine parts could become damaged or not work properly. **A 50–50 mixture of coolant and water provides the following:**

- **freeze protection down to -36°C (-34°F).**
- **boiling protection up to 129°C (265°F).**
- **protection against rust and other forms of corrosion.**
- **an accurate temperature readout from the engine coolant gauge.**

Maintenance and Specifications

When the engine is cold, check the level of the engine coolant in the reservoir.

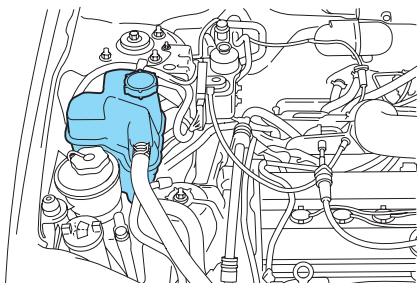

- The engine coolant should be at the “cold fill level” or within the “cold fill range” as listed on the engine coolant reservoir (depending upon application).
- Refer to the Scheduled Maintenance section for service interval schedules.
- Be sure to read and understand *Precautions when servicing your vehicle* in this chapter.

If the engine coolant has not been checked at the recommended interval, the engine coolant reservoir may become low or empty. If the reservoir is low or empty, add engine coolant to the reservoir. Refer to *Adding engine coolant* in this chapter.

WARNING: Automotive fluids are not interchangeable; do not use engine coolant, antifreeze or windshield washer fluid outside of its specified function and vehicle location.

Adding engine coolant

When adding coolant, make sure it is a 50/50 mixture of engine coolant and distilled water. Add the mixture to the coolant reservoir, **when the engine is cool**, until the appropriate fill level is obtained.

WARNING: Do not add engine coolant when the engine is hot. Steam and scalding liquids released from a hot cooling system can burn you badly. Also, you can be burned if you spill coolant on hot engine parts.

WARNING: Do not put engine coolant in the windshield washer fluid container. If sprayed on the windshield, engine coolant could make it difficult to see through the windshield.

Maintenance and Specifications

The cooling system in your vehicle is filled with yellow-colored Mazda Premium Engine Coolant meeting Mazda Specifications.

To maintain the integrity of the coolant and the cooling system and maintain the warranty on the cooling system:

- **Add Mazda Premium Engine Coolant.**
- **Do not mix** different colors or types of coolant. Verify the type of coolant in your vehicle. Make sure the correct coolant is used.
- **Do not add/mix an orange-colored, extended life coolant such as Mazda Speciality Orange Engine Coolant, meeting Mazda specifications with the factory-filled coolant.** Mixing Mazda Speciality Orange Engine Coolant or any orange-colored extended life product with your factory filled coolant can result in degraded corrosion protection.
- A large amount of water without engine coolant may be added, in case of emergency, to reach a vehicle service location. In this instance, the cooling system must be drained and refilled with a 50/50 mixture of engine coolant and distilled water as soon as possible. Water alone (without engine coolant) can cause engine damage from corrosion, overheating or freezing.
- **Do not use alcohol, methanol or brine or any engine coolants mixed with alcohol or methanol antifreeze (coolant).** Alcohol and other liquids can cause engine damage from overheating or freezing.
- **Do not add extra inhibitors or additives to the coolant.** These can be harmful and compromise the corrosion protection of the engine coolant.

For vehicles with overflow coolant systems with a non-pressurized cap on the coolant recovery system, add coolant to the coolant recovery reservoir when the engine is cool. Add the proper mixture of coolant and water to the “cold full” level. For all other vehicles, which have a coolant degas system with a pressurized cap, or if it is necessary to remove the coolant pressure relief cap on the radiator of a vehicle with an overflow system, follow these steps to add engine coolant.

WARNING: To reduce the risk of personal injury, make sure the engine is cool before unscrewing the coolant pressure relief cap. The cooling system is under pressure; steam and hot liquid can come out forcefully when the cap is loosened slightly.

1. Before you begin, turn the engine off and let it cool.

Maintenance and Specifications

2. When the engine is cool, wrap a thick cloth around the coolant pressure relief cap on the coolant reservoir (an opaque plastic bottle). Slowly turn cap counterclockwise (left) until pressure begins to release.
3. Step back while the pressure releases.
4. When you are sure that all the pressure has been released, use the cloth to turn it counterclockwise and remove the cap.
5. Fill the coolant reservoir slowly with the proper coolant mixture (see above), to within the “cold fill range” or the “cold full” level on the reservoir. If you removed the radiator cap in an overflow system, fill the radiator until the coolant is visible and radiator is almost full.
6. Replace the cap. Turn until tightly installed. (Cap must be tightly installed to prevent coolant loss.)

After any coolant has been added, run the engine for a few minutes to mix the coolant. Check the coolant concentration. Make sure the engine is off and cool before removing the coolant pressure relief cap (see preceding steps on cap removal). Check the concentration per the *Checking Engine Coolant* section. If the concentration is not 50/50 (protection to $-34^{\circ}\text{F}/-36^{\circ}\text{C}$), drain some coolant and adjust the concentration. It may take several drains and additions to obtain a 50/50 coolant concentration.

Whenever coolant has been added, the coolant level in the coolant reservoir should be checked the next few times you drive the vehicle. If necessary, add enough 50/50 concentration of engine coolant and distilled water to bring the liquid level to the proper level.

If you have to add more than 1.0 liter (1.0 quart) of engine coolant per month, have your dealer check the engine cooling system. Your cooling system may have a leak. Operating an engine with a low level of coolant can result in engine overheating and possible engine damage).

Recycled engine coolant

Not all coolant recycling processes produce coolant which meets Mazda recommend coolants. Use of a recycled engine coolant which does not meet the Mazda recommended coolant, may harm engine and cooling system components.

 Always dispose of used automotive fluids in a responsible manner. Follow your community's regulations and standards for recycling and disposing of automotive fluids.

Maintenance and Specifications

Coolant refill capacity

To find out how much fluid your vehicle's cooling system can hold, refer to *Refill capacities* in this chapter.

Fill your engine coolant reservoir as outlined in *Adding engine coolant* in this chapter.

Severe climates

If you drive in extremely cold climates (less than -36°C [-34°F):

- **It may be necessary to increase the coolant concentration above 50%.**
- **NEVER increase the coolant concentration above 60%.**
- **Increased engine coolant concentrations above 60% will decrease the overheat protection characteristics of the engine coolant and may cause engine damage.**
- **Refer to the chart on the coolant container to ensure the coolant concentration in your vehicle will provide adequate freeze protection at the temperatures in which you drive in the winter months.**

If you drive in extremely hot climates:

- **It is still necessary to maintain the coolant concentration above 40%.**
- **NEVER decrease the coolant concentration below 40%.**
- **Decreased engine coolant concentrations below 40% will decrease the corrosion protection characteristics of the engine coolant and may cause engine damage.**
- **Decreased engine coolant concentrations below 40% will decrease the freeze protection characteristics of the engine coolant and may cause engine damage.**
- **Refer to the chart on the coolant container to ensure the coolant concentration in your vehicle will provide adequate protection at the temperatures in which you drive.**

Vehicles driven year-round in non-extreme climates should use a 50/50 mixture of engine coolant and distilled water for optimum cooling system and engine protection.

Maintenance and Specifications

WHAT YOU SHOULD KNOW ABOUT AUTOMOTIVE FUELS

Important safety precautions

WARNING: Do not overfill the fuel tank. The pressure in an overfilled tank may cause leakage and lead to fuel spray and fire.

WARNING: The fuel system may be under pressure. If the fuel filler cap is venting vapor or if you hear a hissing sound, wait until it stops before completely removing the fuel filler cap. Otherwise, fuel may spray out and injure you or others.

WARNING: If you do not use the proper fuel filler cap, excessive pressure or vacuum in the fuel tank may damage the fuel system or cause the fuel cap to disengage in a collision, which may result in possible personal injury.

WARNING: Automotive fuels can cause serious injury or death if misused or mishandled.

WARNING: Gasoline may contain benzene, which is a cancer-causing agent.

Observe the following guidelines when handling automotive fuel:



Maintenance and Specifications

WARNING: Automotive fuels can be harmful or fatal if swallowed. Fuel such as gasoline is highly toxic and if swallowed can cause death or permanent injury. If fuel is swallowed, call a physician immediately, even if no symptoms are immediately apparent. The toxic effects of fuel may not be visible for hours.

- Extinguish all smoking materials and any open flames before fueling your vehicle.
- Always turn off the vehicle before fueling.
- Avoid inhaling fuel vapors. Inhaling too much fuel vapor of any kind can lead to eye and respiratory tract irritation. In severe cases, excessive or prolonged breathing of fuel vapor can cause serious illness and permanent injury.
- Avoid getting fuel liquid in your eyes. If fuel is splashed in the eyes, remove contact lenses (if worn), flush with water for 15 minutes and seek medical attention. Failure to seek proper medical attention could lead to permanent injury.
- Fuels can also be harmful if absorbed through the skin. If fuel is splashed on the skin and/or clothing, promptly remove contaminated clothing and wash skin thoroughly with soap and water. Repeated or prolonged skin contact with fuel liquid or vapor causes skin irritation.
- Be particularly careful if you are taking “Antabuse” or other forms of disulfiram for the treatment of alcoholism. Breathing gasoline vapors, or skin contact could cause an adverse reaction. In sensitive individuals, serious personal injury or sickness may result. If fuel is splashed on the skin, promptly wash skin thoroughly with soap and water. Consult a physician immediately if you experience an adverse reaction.
- The Gasoline Distributors, who have converted many stations to self-service pumps are suggesting an increase of fires caused by static during refueling, particularly with women. They suggest you not climb back into your car during refuel as there is a chance you will build up a new electrical charge and not discharge it by touching anything metal before you grab the filler nozzle.

Maintenance and Specifications

WARNING: When refueling always shut the engine off and never allow sparks or open flames near the filler neck. Never smoke while refueling. Fuel vapor is extremely hazardous under certain conditions. Care should be taken to avoid inhaling excess fumes.

WARNING: The flow of fuel through a fuel pump nozzle can produce static electricity, which can cause a fire if fuel is pumped into an ungrounded fuel container. Be very careful to put the container on the ground before adding fuel to it.

Use the following guidelines to avoid static build-up when filling an ungrounded fuel container:

- Place approved fuel container on the ground.
- DO NOT fill a fuel container while it is in the vehicle (including the cargo area).
- Keep the fuel pump nozzle in contact with the fuel container while filling.
- DO NOT use a device that would hold the fuel pump handle in the fill position.

Choosing the right fuel

- **Use only UNLEADED FUEL. The use of leaded fuel is prohibited by law and could damage your vehicle.**
- **Do not use fuel containing methanol. It can damage critical fuel system components.**
- **Your vehicle was not designed to use fuel or fuel additives with metallic compounds, including manganese-based additives.**
- **Repairs to correct the effects of using a fuel for which your vehicle was not designed may not be covered by your warranty.**

Octane recommendations

Your vehicle is designed to use “Regular” unleaded gasoline with pump (R+M)/2 octane rating of 87. We do not recommend the use of gasolines labeled as “Regular” that are sold with octane ratings of 86 or lower in high altitude areas.



Maintenance and Specifications

NOTE: Do not be concerned if your engine sometimes knocks lightly. However, if it knocks heavily under most driving conditions while you are using fuel with the recommended octane rating, see your authorized Mazda dealer to prevent any engine damage.

Fuel quality

NOTE: If you are experiencing starting, rough idle or hesitation driveability problems during a cold start, try a different brand of “Regular” unleaded gasoline. “Premium” unleaded gasoline is not recommended (particularly in the United States) because it may cause these problems to become more pronounced. If the problems persist, see your authorized Mazda dealer.

It should not be necessary to add any aftermarket products to your fuel tank if you continue to use high quality fuel of the recommended octane rating.

Aftermarket products could cause damage to the fuel system. Repairs to correct the effects of using an aftermarket product in your fuel may not be covered by your warranty.

Many of the world’s automakers approved the World-wide Fuel Charter that recommends gasoline specifications to provide improved performance and emission control system protection for your vehicle. Gasolines that meet the World-wide Fuel Charter should be used when available. Ask your fuel supplier about gasolines that meet the World-wide Fuel Charter.

Cleaner air

Mazda endorses the use of reformulated “cleaner-burning” gasolines to improve air quality.

Running out of fuel

Avoid running out of fuel because this situation may have an adverse affect on powertrain components.

If you have run out of fuel:

- You may need to cycle the ignition from OFF to ON several times after refueling, to allow the fuel system to pump the fuel from the tank to the engine.
- The  indicator may come on. For more information on the “Check Engine” indicator, refer to the *Instrument Cluster* chapter.

Fuel Filler Cap

Your fuel tank filler cap has an indexed design with a 1/8 turn on/off feature.

Maintenance and Specifications

When fueling your vehicle:

1. Turn the engine off.
2. Pull the fuel filler door release handle to open the fuel filler door.
3. Carefully turn the filler cap counterclockwise 1/8 of a turn until it stops.
4. Pull to remove the cap from the fuel filler pipe.
5. To install the cap, align the tabs on the cap with the notches on the filler pipe.
6. Turn the filler cap clockwise 1/8 of a turn until it stops.

After refueling, if the “CHECK FUEL CAP” indicator comes on and stays on when you start the engine, the fuel filler cap may not be properly installed. Turn off the engine, remove the fuel filler cap, align the cap properly and reinstall it securely. The indicator should turn off after three driving cycles with the fuel filler cap properly installed. A driving cycle consists of a cold engine start-up followed by mixed city/highway driving.

If you must replace the fuel filler cap, replace it with a fuel filler cap that is designed for your vehicle. The customer warranty may be void for any damage to the fuel tank or fuel system if the correct genuine Mazda fuel filler cap is not used.

WARNING: The fuel system may be under pressure. If the fuel filler cap is venting vapor or if you hear a hissing sound, wait until it stops before completely removing the fuel filler cap. Otherwise, fuel may spray out and injure you or others.

WARNING: If you do not use the proper fuel filler cap, excessive pressure or vacuum in the fuel tank may damage the fuel system or cause the fuel cap to disengage in a collision, which may result in possible personal injury.

Fuel Filter

For fuel filter replacement, see your authorized Mazda dealership. Refer to the service maintenance section for the appropriate intervals for changing the fuel filter.

Replace the fuel filter with an authorized Mazda part. The customer warranty may be void for any damage to the fuel system if an authorized Mazda fuel filter is not used.

Maintenance and Specifications

ESSENTIALS OF GOOD FUEL ECONOMY

Measuring techniques

Your best source of information about actual fuel economy is you, the driver. You must gather information as accurately and consistently as possible. Fuel expense, frequency of fillups or fuel gauge readings are NOT accurate as a measure of fuel economy. We do not recommend taking fuel economy measurements during the first 1,600 km (1,000 miles) of driving (engine break-in period). You will get a more accurate measurement after 3,000 km–5,000 km (2,000 miles–3,000 miles).

Filling the tank

The advertised fuel capacity of the fuel tank on your vehicle is equal to the rated refill capacity of the fuel tank as listed in the *Refill capacities* section of this chapter.

The advertised capacity is the amount of the indicated capacity and the empty reserve combined. Indicated capacity is the difference in the amount of fuel in a full tank and a tank when the fuel gauge indicates empty. Empty reserve is the small amount of fuel remaining in the fuel tank after the fuel gauge indicates empty.

The amount of usable fuel in the empty reserve varies and should not be relied upon to increase driving range. When refueling your vehicle after the fuel gauge indicates empty, you might not be able to refuel the full amount of the advertised capacity of the fuel tank due to the empty reserve still present in the tank.

For consistent results when filling the fuel tank:

- Turn the engine/ignition switch to the off position prior to refueling, an error in the reading will result if the engine is left running.
- Use the same filling rate setting (low — medium — high) each time the tank is filled.
- Allow no more than 2 automatic click-offs when filling.
- Always use fuel with the recommended octane rating.
- Use a known quality gasoline, preferably a national brand.
- Use the same side of the same pump and have the vehicle facing the same direction each time you fill up.
- Have the vehicle loading and distribution the same every time.

Your results will be most accurate if your filling method is consistent.

Calculating fuel economy

1. Fill the fuel tank completely and record the initial odometer reading (in kilometers or miles).

Maintenance and Specifications

2. Each time you fill the tank, record the amount of fuel added (in liters or gallons).
3. After at least three to five tank fill-ups, fill the fuel tank and record the current odometer reading.
4. Subtract your initial odometer reading from the current odometer reading.
5. Follow one of the simple calculations in order to determine fuel economy:

Calculation 1: **Multiply liters used by 100, then divide by total kilometers traveled.**

Calculation 2: **Divide total miles traveled by total gallons used.**

Keep a record for at least one month and record the type of driving (city or highway). This will provide an accurate estimate of the vehicle's fuel economy under current driving conditions. Additionally, keeping records during summer and winter will show how temperature impacts fuel economy. In general, lower temperatures give lower fuel economy.

Driving style — good driving and fuel economy habits

Give consideration to the lists that follow and you may be able to change a number of variables and improve your fuel economy.

Habits

- Smooth, moderate operation can yield up to 10% savings in fuel.
- Steady speeds without stopping will usually give the best fuel economy.
- Idling for long periods of time (greater than one minute) may waste fuel.
- Anticipate stopping; slowing down may eliminate the need to stop.
- Sudden or hard accelerations may reduce fuel economy.
- Slow down gradually.
- Driving at reasonable speeds (traveling at 88 km/h [55 mph] uses 15% less fuel than traveling at 105 km/h [65 mph]).
- Revving the engine before turning it off may reduce fuel economy.
- Using the air conditioner or defroster may reduce fuel economy.
- You may want to turn off the speed control in hilly terrain if unnecessary shifting between third and fourth gear occurs. Unnecessary shifting of this type could result in reduced fuel economy.

Maintenance and Specifications

- Warming up a vehicle on cold mornings is not required and may reduce fuel economy.
- Resting your foot on the brake pedal while driving may reduce fuel economy.
- Combine errands and minimize stop-and-go driving.

Maintenance

- Keep tires properly inflated and use only recommended size.
- Operating a vehicle with the wheels out of alignment will reduce fuel economy.
- Use recommended engine oil. Refer to *Lubricant specifications* in this chapter.
- Perform all regularly scheduled maintenance items. Follow the recommended maintenance schedule and owner maintenance checks found in your vehicle service maintenance section.

Conditions

- Heavily loading a vehicle or towing a trailer may reduce fuel economy at any speed.
- Carrying unnecessary weight may reduce fuel economy (approximately 0.4 km/L [1 mpg] is lost for every 180 kg [400 lb] of weight carried).
- Adding certain accessories to your vehicle (for example bug deflectors, rollbars/light bars, running boards, ski/luggage racks) may reduce fuel economy.
- Using fuel blended with alcohol may lower fuel economy.
- Fuel economy may decrease with lower temperatures during the first 12–16 km (8–10 miles) of driving.
- Driving on flat terrain offers improved fuel economy as compared to driving on hilly terrain.
- Transmissions give their best fuel economy when operated in the top cruise gear and with steady pressure on the gas pedal.
- Close windows for high speed driving.

EPA window sticker

Every new vehicle should have the EPA window sticker. Contact your dealer if the window sticker is not supplied with your vehicle. The EPA window sticker should be your guide for the fuel economy comparisons with other vehicles.

Maintenance and Specifications

It is important to note the box in the lower left corner of the window sticker. These numbers represent the Range of L/100 km (MPG) expected on the vehicle under optimum conditions. Your fuel economy may vary depending upon the method of operation and conditions.

EMISSION CONTROL SYSTEM

Your vehicle is equipped with various emission control components and a catalytic converter which will enable your vehicle to comply with applicable exhaust emission standards. To make sure that the catalytic converter and other emission control components continue to work properly:

- Use only the specified fuel listed.
- Avoid running out of fuel.
- Do not turn off the ignition while your vehicle is moving, especially at high speeds.
- Have the items listed in your service maintenance section performed according to the specified schedule.

The scheduled maintenance items listed in the scheduled maintenance section are essential to the life and performance of your vehicle and to its emissions system.

If other than Mazda authorized parts are used for maintenance replacements or for service of components affecting emission control, such non-Mazda parts should be equivalent to genuine Mazda parts in performance and durability.

WARNING: Do not park, idle, or drive your vehicle in dry grass or other dry ground cover. The emission system heats up the engine compartment and exhaust system, which can start a fire.

Illumination of the  indicator, charging system warning light or the temperature warning light, fluid leaks, strange odors, smoke or loss of engine power, could indicate that the emission control system is not working properly.



WARNING: Exhaust leaks may result in entry of harmful and potentially lethal fumes into the passenger compartment.

Maintenance and Specifications

Do not make any unauthorized changes to your vehicle or engine. By law, vehicle owners and anyone who manufactures, repairs, services, sells, leases, trades vehicles, or supervises a fleet of vehicles are not permitted to intentionally remove an emission control device or prevent it from working. Information about your vehicle's emission system is on the Vehicle Emission Control Information Decal located on or near the engine. This decal identifies engine displacement and gives some tune up specifications.

Please consult your "Warranty Information" for complete emission warranty information.

Readiness for Inspection/Maintenance (I/M) testing

In some localities, it may be a legal requirement to pass an I/M test of the on-board diagnostics system. If your  indicator is on, refer to the description in the *Warning lights and chimes* section of the *Instrument Cluster* chapter. Your vehicle may not pass the I/M test with the  indicator on.

If the vehicle's powertrain system or its battery has just been serviced, the on-board diagnostics system is reset to a "not ready for I/M test" condition. To ready the on-board diagnostics system for I/M testing, a minimum of 30 minutes of city and highway driving is necessary as described below:

- First, at least 10 minutes of driving on an expressway or highway.
- Next, at least 20 minutes driving in stop-and-go, city-type traffic with at least four idle periods.

Allow the vehicle to sit for at least eight hours without starting the engine. Then, start the engine and complete the above driving cycle. The engine must warm up to its normal operating temperature. Once started, do not turn off the engine until the above driving cycle is complete.

Maintenance and Specifications

CHECKING AND ADDING POWER STEERING FLUID

Check the power steering fluid. Refer to the service maintenance section for the service interval schedules. **If adding fluid is necessary, use only MERCON® ATF.**

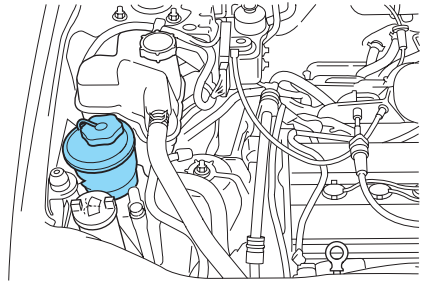

1. Start the engine and let it run until it reaches normal operating temperature (the engine coolant temperature gauge indicator will be near the center of the normal area between H and C).
2. While the engine idles, turn the steering wheel left and right several times.
3. Turn the engine off.
4. Check the fluid level in the reservoir. It should be between the MIN and MAX lines. Do not add fluid if the level is in this range.

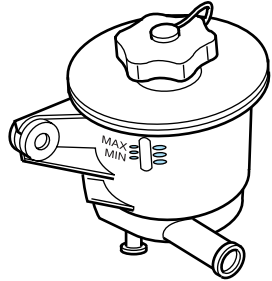

5. If the fluid is low, add fluid in small amounts, continuously checking the level until it reaches the range between the MIN and MAX lines. Be sure to put the cap back on the reservoir.

BRAKE/CLUTCH (IF EQUIPPED) FLUID RESERVOIR

Brake and clutch systems are supplied from the same reservoir.

Maintenance and Specifications

The fluid level will drop slowly as the brakes wear, and will rise when the brake components are replaced. Fluid levels between the “MIN” and “MAX” lines are within the normal operating range, there is no need to add fluid. If the fluid levels are outside of the normal operating range, the performance of your brake/clutch (if equipped) system could be compromised, seek service from an authorized Mazda dealer immediately.

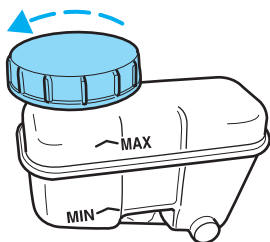

TRANSMISSION FLUID

Checking automatic transmission fluid

Refer to your scheduled maintenance section for scheduled intervals for fluid checks and changes. Your transaxle does not consume fluid. However, the fluid level should be checked if the transaxle is not working properly, i.e., if the transaxle slips or shifts slowly or if you notice some sign of fluid leakage.

Automatic transmission fluid expands when warmed. To obtain an accurate fluid check, drive the vehicle until it is warmed up (approximately 30 km [20 miles]). If your vehicle has been operated for an extended period at high speeds, in city traffic during hot weather or pulling a trailer, the vehicle should be turned off for about 30 minutes to allow fluid to cool before checking.

1. Drive the vehicle 30 km (20 miles) or until it reaches normal operating temperature.
2. Park the vehicle on a level surface and engage the parking brake.
3. With the parking brake engaged and your foot on the brake pedal, start the engine and move the gearshift lever through all of the gear ranges. Allow sufficient time for each gear to engage.
4. Latch the gearshift lever in P (Park) and leave the engine running.
5. Remove the dipstick, wiping it clean with a clean, dry lint free rag. If necessary, refer to *Identifying components in the engine compartment* in this chapter for the location of the dipstick.
6. Install the dipstick making sure it is fully seated in the filler tube.
7. Remove the dipstick and inspect the fluid level. The fluid should be in the crosshatch zone for normal operating temperature.

Maintenance and Specifications

Low fluid level

Do not drive the vehicle if the fluid level is at the bottom of the dipstick and the outside temperatures are above 10°C (50°F).

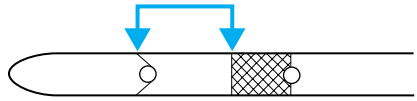

Correct fluid level

The transmission fluid should be checked at normal operating temperatures 66°C-77°C (150°F-170°F) on a level surface. The normal operating temperature can be reached after approximately 30 km (20 miles) of driving.

The transmission fluid should be in the crosshatch zone if at normal operating temperature (66°C-77°C [150°F-170°F]).

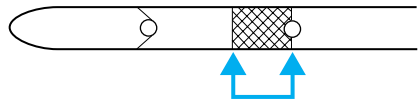

High fluid level

Fluid levels above the crosshatch zone may result in transaxle failure. An overfill condition of transmission fluid may cause shift and/or engagement concerns and/or possible damage.

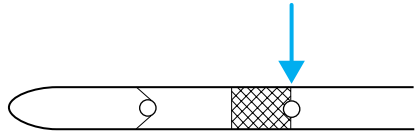

High fluid levels can be caused by an overheating condition.

Adjusting automatic transmission fluid levels

Before adding any fluid, make sure the correct type is used. The type of fluid used is normally indicated on the dipstick and also in the *Lubricant specifications* section in this chapter.

Use of a non-approved automatic transmission fluid may cause internal transaxle component damage.

If necessary, add fluid in 250 mL (1/2 pint) increments through the filler tube until the level is correct.

If an overfill occurs, excess fluid should be removed by a qualified technician.

An overfill condition of transmission fluid may cause shift and/or engagement concerns and/or possible damage.

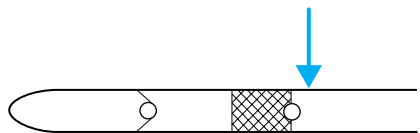

Maintenance and Specifications

Do not use supplemental transmission fluid additives, treatments or cleaning agents. The use of these materials may affect transmission operation and result in damage to internal transmission components.

Checking and adding manual transmission fluid

1. Clean the filler plug.
2. Remove the filler plug and inspect the fluid level.
3. Fluid level should be at bottom of the opening.

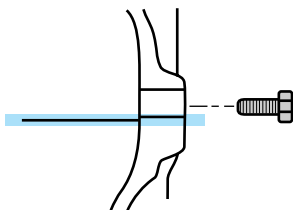

4. Add enough fluid through the filler opening so that the fluid level is at the bottom of the opening.
5. Install and tighten the fill plug securely.

Use only fluid that meets Mazda specifications. Refer to the *Refill capacities* in this chapter.

CLUTCH FLUID (MANUAL TRANSAXLE)

The clutch master cylinder and brake master cylinder are part of the same system; both are refillable through the brake master cylinder with brake fluid. For more information on brake fluid maintenance, refer to *Brake fluid* in this chapter.

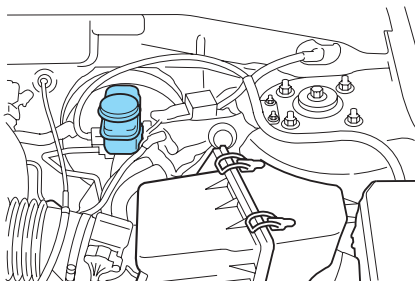

WARNING: Brake fluid is toxic. If brake fluid contacts the eyes, flush eyes with running water for 15 minutes. Seek medical attention if irritation persists. If taken internally, drink water and induce vomiting. Seek medical attention immediately.

Maintenance and Specifications

AIR FILTER MAINTENANCE

Refer to the service maintenance section for the appropriate intervals for changing the air filter element.

When changing the air filter element, only use a Genuine Mazda air filter element.

WARNING: Don't drive without an air filter. This could result in excessive engine wear.

Changing the air filter element

1. Loosen the clamp that secures the air inlet tube to the engine air filter cover and disconnect the tube from the cover.
2. Release the clamps that secure the air filter housing cover.
3. Carefully separate the two halves of the air filter housing.
4. Remove the air filter element from the air filter housing.
5. Wipe the air filter housing and cover clean to remove any dirt or debris and to ensure good sealing.
6. Install a new air filter element.

Be careful not to crimp the filter element edges between the air filter housing and cover. This could cause filter damage and allow unfiltered air to enter the engine if not properly seated.

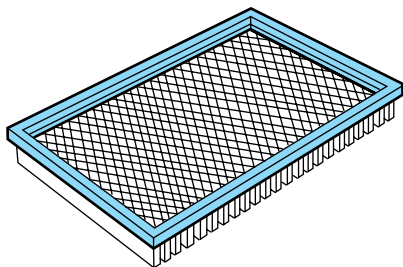

7. Replace the air filter housing cover and secure the clamps.
8. Replace the air inlet tube and secure the clamp.

Note: Failure to use the correct air filter element may result in severe engine damage. The customer warranty may be voided for any damage to the engine if the correct air filter element is not used.

Maintenance and Specifications

INFORMATION ABOUT UNIFORM TIRE QUALITY GRADING

New vehicles are fitted with tires that have a rating on them called Tire Quality Grades. The Quality grades can be found where applicable on the tire sidewall between tread shoulder and maximum section width. For example:

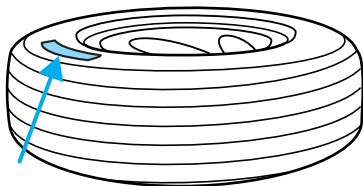

- **Treadwear 200 Traction AA Temperature A**

These Tire Quality Grades are determined by standards that the United States Department of Transportation has set.

Tire Quality Grades apply to new pneumatic tires for use on passenger cars. They do not apply to deep tread, winter-type snow tires, space-saver or temporary use spare tires, tires with nominal rim diameters of 10 to 12 inches or limited production tires as defined in Title 49 Code of Federal Regulations Part 575.104(c)(2).

U.S. Department of Transportation-Tire quality grades: The U.S. Department of Transportation requires Mazda to give you the following information about tire grades exactly as the government has written it.

Treadwear

The treadwear grade is a comparative rating based on the wear rate of the tire when tested under controlled conditions on a specified government test course. For example, a tire graded 150 would wear one and one-half (1 1/2) times as well on the government course as a tire graded 100. The relative performance of tires depends upon the actual conditions of their use, however, and may depart significantly from the norm due to variations in driving habits, service practices, and differences in road characteristics and climate.

Traction AA A B C

The traction grades, from highest to lowest are AA, A, B, and C. The grades represent the tire's ability to stop on wet pavement as measured under controlled conditions on specified government test surfaces of asphalt and concrete. A tire marked C may have poor traction performance.

NOTE: The traction grade assigned to this tire is based on straight-ahead braking traction tests, and does not include acceleration, cornering, hydroplaning or peak traction characteristics.

Maintenance and Specifications

Temperature A B C

The temperature grades are A (the highest), B, and C, representing the tire's resistance to the generation of heat and its ability to dissipate heat when tested under controlled conditions on a specified indoor laboratory test wheel. Sustained high temperature can cause the material of the tire to degenerate and reduce tire life, and excessive temperature can lead to sudden tire failure. The grade C corresponds to a level of performance which all passenger car tires must meet under the Federal Motor Vehicle Safety Standard No. 109. Grades B and A represent higher levels of performance on the laboratory test wheel than the minimum required by law.

WARNING: The temperature grade for this tire is established for a tire that is properly inflated and not overloaded. Excessive speed, underinflation, or excessive loading, either separately or in combination, can cause heat buildup and possible tire failure.

TIRES

Tires are designed to give many thousands of miles of service, but they must be maintained in order to get the maximum benefit from them.

Glossary of tire terminology

- **Tire label:** A label showing the OE (Original Equipment) tire sizes, recommended inflation pressure and the maximum weight the vehicle can carry.
- **Tire Identification Number (TIN):** A number on the sidewall of each tire providing information about the tire brand and manufacturing plant, tire size and date of manufacturer.
- **Inflation pressure:** A measure of the amount of air in a tire.
- **Standard load:** A class of P-metric or Metric tires designed to carry a maximum load at 35 psi [37 psi (2.5 bar) for Metric tires]. Increasing the inflation pressure beyond this pressure will not increase the tires load carrying capability.
- **Extra load:** A class of P-metric or Metric tires designed to carry a heavier maximum load at 41 psi [43 psi (2.9 bar) for Metric tires]. Increasing the inflation pressure beyond this pressure will not increase the tires load carrying capability.
- **kPa:** Kilopascal, a metric unit of air pressure.

Maintenance and Specifications

- **PSI:** Pounds per square inch, a standard unit of air pressure.
- **B-pillar:** The structural member at the side of the vehicle behind the front door.
- **Bead area of the tire:** Area of the tire next to the rim.
- **Sidewall of the tire:** Area between the bead area and the tread.
- **Tread area of the tire:** Area of the perimeter of the tire that contacts the road when mounted on the vehicle.
- **Rim:** The metal support (wheel) for a tire or a tire and tube assembly upon which the tire beads are seated.

INFORMATION CONTAINED ON THE TIRE SIDEWALL

Federal law requires tire manufacturers to place standardized information on the sidewall of all tires. This information identifies and describes the fundamental characteristics of the tire and also provides a U.S. DOT Tire Identification Number for safety standard certification and in case of a recall.

Information on “P” type tires

P215/65R15 95H is an example of a tire size, load index and speed rating. The definitions of these items are listed below. (Note that the tire size, load index and speed rating for your vehicle may be different than this example.)

1. **P:** Indicates a tire, designated by the Tire and Rim Association (T&RA), that may be used for service on cars, SUVs, minivans and light trucks.

Note: If your tire size does not begin with a letter this may mean it is designated by either ETRTO (European Tire and Rim Technical Organization) or JATMA (Japan Tire Manufacturing Association).

2. **215:** Indicates the nominal width of the tire in millimeters from sidewall edge to sidewall edge. In general, the larger the number, the wider the tire.
3. **65:** Indicates the aspect ratio which gives the tire's ratio of height to width.

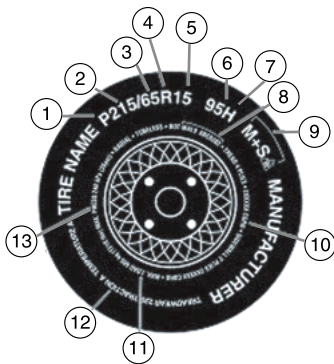

Maintenance and Specifications

- R:** Indicates a “radial” type tire.
- 15:** Indicates the wheel or rim diameter in inches. If you change your wheel size, you will have to purchase new tires to match the new wheel diameter.
- 95:** Indicates the tire’s load index. It is an index that relates to how much weight a tire can carry. You may find this information in your owner’s guide. If not, contact a local tire dealer.

Note: You may not find this information on all tires because it is not required by federal law.

- H:** Indicates the tire’s speed rating. The speed rating denotes the speed at which a tire is designed to be driven for extended periods of time under a standard condition of load and inflation pressure. The tires on your vehicle may operate at different conditions for load and inflation pressure. These speed ratings may need to be adjusted for the difference in conditions. The ratings range from 159 km/h (99 mph) to 299 km/h (186 mph). These ratings are listed in the following chart.

Note: You may not find this information on all tires because it is not required by federal law.

Letter rating	Speed rating - km/h (mph)
Q	159 km/h (99 mph)
R	171 km/h (106 mph)
S	180 km/h (112 mph)
T	190 km/h (118 mph)
U	200 km/h (124 mph)
H	210 km/h (130 mph)
V	240 km/h (149 mph)
W	270 km/h (168 mph)
Y	299 km/h (186 mph)

Note: For tires with a maximum speed capability over 240 km/h (149 mph), tire manufacturers sometimes use the letters ZR. For those with a maximum speed capability over 299 km/h (186 mph), tire manufacturers always use the letters ZR.

- U.S. DOT Tire Identification Number (TIN):** This begins with the letters “DOT” and indicates that the tire meets all federal standards. The next two numbers or letters are the plant code where it was manufactured, the next two are the tire size code and the last

Maintenance and Specifications

four numbers represent the week and year the tire was built. For example, the numbers 317 mean the 31st week of 1997. After 2000 the numbers go to four digits. For example, 2501 means the 25th week of 2001. The numbers in between are marketing codes used at the manufacturer's discretion. This information is used to contact customers if a tire defect requires a recall.

9. **M+S or M/S:** Mud and Snow. or
AT: All Terrain. or
AS: All Season.
10. **Tire Ply Composition and Material Used:** Indicates the number of plies or the number of layers of rubber-coated fabric in the tire tread and sidewall. Tire manufacturers also must indicate the ply materials in the tire and the sidewall, which include steel, nylon, polyester, and others.
11. **Maximum Load:** Indicates the maximum load in kilograms and pounds that can be carried by the tire. Refer to the tire label or the safety certification label, located on the B-Pillar or the driver's door, for the correct tire pressure for your vehicle
12. **Treadwear, Traction and Temperature Grades**
 - **Treadwear:** The treadwear grade is a comparative rating based on the wear rate of the tire when tested under controlled conditions on a specified government test course. For example, a tire graded 150 would wear one and one-half (1½) times as well on the government course as a tire graded 100.
 - **Traction:** The traction grades, from highest to lowest are AA, A, B, and C. The grades represent the tire's ability to stop on wet pavement as measured under controlled conditions on specified government test surfaces of asphalt and concrete. A tire marked C may have poor traction performance.
 - **Temperature:** The temperature grades are A (the highest), B and C, representing the tire's resistance to the generation of heat and its ability to dissipate heat when tested under controlled conditions on a specified indoor laboratory test wheel.
13. **Maximum Permissible Inflation Pressure:** Tire manufactures maximum permissible pressure and/or the pressure at which the maximum load can be carried by the tire. This pressure is normally higher than the manufacturer's recommended cold inflation pressure which can be found on either the tire label or certification label which is located on the structure by the trailing edge of the driver's door or the edge of the driver's door. The cold inflation pressure should never be set lower than the recommended pressure on the label.

Maintenance and Specifications

Note: You may not find this information on all tires because it is not required by federal law.

The tire suppliers may have additional markings, notes or warnings such as standard load, radial tubeless, etc.

Additional information contained on the tire sidewall for “LT” type tires

“LT” type tires have some additional information than those of “P” type tires; these differences are described below:

1. **LT:** Indicates a tire, designated by the Tire and Rim Association (T&RA), that is intended for service on light trucks.
2. **Load Range/Load Inflation Limits:** Indicates the tires load-carrying capabilities and its inflation limits.
3. **Maximum Load Dual kg (lbs.) at kPa (psi) cold:** Indicates the maximum load and tire pressure when the tire is used as a dual; a dual is defined as when four tires are put on the rear axle (a total of six or more tires on the vehicle).
4. **Maximum Load Single kg (lbs.) at kPa (psi) cold:** Indicates the maximum load and tire pressure when the tire is used as a single; a single is defined as when two tires (total) are put on the rear axle.

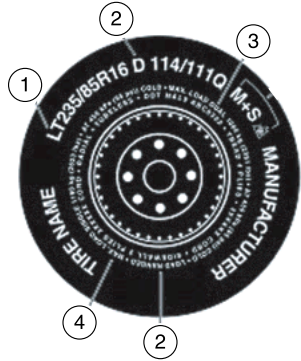

Maintenance and Specifications

Information on “T” type tires

T145/80D16 is an example of a tire size.

Note: The temporary tire size for your vehicle may be different than this example.

1. **T:** Indicates a type of tire, designated by the Tire and Rim Association (T&RA), that is intended for temporary service on cars, SUVs, minivans and light trucks.
2. **145:** Indicates the nominal width of the tire in millimeters from sidewall edge to sidewall edge. In general, the larger the number, the wider the tire.
3. **80:** Indicates the aspect ratio which gives the tires ratio of height to width. Numbers of 70 or lower indicate a short sidewall.
4. **D:** Indicates a “diagonal” type tire.
R: Indicates a “radial” type tire.
5. **16:** Indicates the wheel or rim diameter in inches. If you change your wheel size, you will have to purchase new tires to match the new wheel diameter.

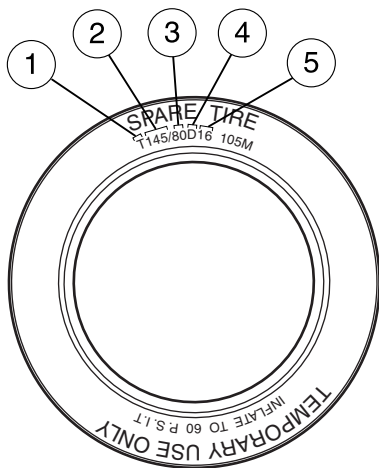

Location of the tire label

You will find a tire label containing tire inflation pressure by tire size and other important information located on the B-Pillar or the driver's door.

TIRE CARE

Improper or inadequate vehicle maintenance can also cause tires to wear abnormally. Here are some of the important maintenance items

Tire inflation pressure

Use a tire gauge to check the tire inflation pressure, including the spare, at least monthly and before long trips. You are strongly urged to buy a reliable tire pressure gauge, as automatic service station gauges may be inaccurate. Mazda recommends the use of a digital or dial type tire pressure gauge rather than a stick type tire pressure gauge.

Maintenance and Specifications

Use the recommended cold inflation pressure for optimum tire performance and wear. Under-inflation or over-inflation may cause uneven treadwear patterns.

NOTE: If you are driving the vehicle at its maximum weight load, make sure the tire inflation pressure is correct for the weight load on the tires.

WARNING: Under-inflation is the most common cause of tire failures and may result in severe tire cracking, tread separation or "blowout", with unexpected loss of vehicle control and increased risk of injury. Under-inflation increases sidewall flexing and rolling resistance, resulting in heat buildup and internal damage to the tire. It also may result in unnecessary tire stress, irregular wear, loss of vehicle control and accidents. A tire can lose up to half of its air pressure and not appear to be flat!

When weather temperature changes occur, tire inflation pressures also change. A 10 degree temperature change causes a corresponding drop of 7 kPa (1 psi) in inflation pressure. Check your tire pressures frequently and adjust them to the proper pressure which can be found on the tire label or certification label.

If checking tire pressure when the tire is hot, (i.e. driven more than 1.6 km [1mile]), never "bleed" or reduce air pressure. The tires are hot from driving and it is normal for pressures to increase above recommended cold pressures. A hot tire at or below recommended cold inflation pressure could be significantly under-inflated.

To check the pressure in your tire(s):

1. Make sure the tires are cool, meaning they are not hot from driving even a mile.

Note: If you have to drive a distance to get air for your tire(s), check and record the tire pressure first and add the appropriate air pressure when you get to the pump. It is normal for tires to heat up and the air pressure inside to go up as you drive. Never "bleed" or reduce air pressure when tires are hot.

2. Remove the cap from the valve on one tire, then firmly press the tire gauge onto the valve.
3. Add air to reach the recommended air pressure

Note: If you overfill the tire, release air by pushing on the metal stem in the center of the valve. Then recheck the pressure with your tire gauge.

Maintenance and Specifications

4. Replace the valve cap.
5. Repeat this procedure for each tire, including the spare.

Note: Some spare tires require higher inflation pressure than the other tires.

6. Visually inspect the tires to make sure there are no nails or other objects embedded that could poke a hole in the tire and cause an air leak.
7. Check the sidewalls to make sure there are no gouges, cuts, bulges or other irregularities.

Tire and wheel alignment

A bad jolt from hitting a curb or pothole can cause the front end of your vehicle to become misaligned or damage to your tires. If your vehicle seems to pull to one side, vibrate or shake when you're driving, the wheels may be out of alignment. Have a qualified technician at a Mazda dealer check the wheel alignment periodically.

Wheel misalignment in the front or the rear can cause uneven and rapid treadwear of your tires and should be corrected by a qualified technician at a Mazda dealer. Front wheel drive (FWD) vehicles, and those with independent front suspension require alignment of all four wheels.

The tire should also be balanced periodically. An unbalanced tire and wheel assembly may result in irregular tire wear.

NOTE: When it is time to replace front tires with new ones, this is an ideal time to perform an alignment. New tires should be balanced at the time they are installed.

Tire rotation

Rotating your tires at the recommended interval (as indicated in the *Scheduled maintenance* section of the *Maintenance and Specifications* chapter) will help your tires wear more evenly providing better tire performance and longer tire life. Unless otherwise specified, rotate the tires approximately every 8,000 km (5,000 miles).

Maintenance and Specifications

- Front Wheel Drive (FWD) vehicles (front tires at top of diagram)

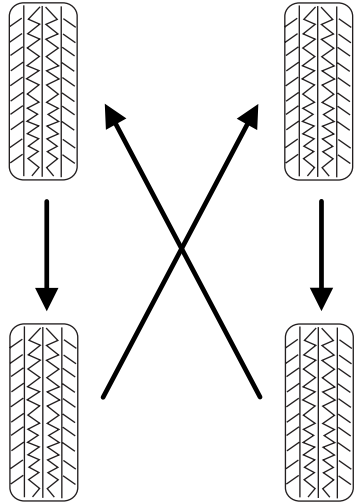

- Rear Wheel Drive (RWD) vehicles/Four Wheel Drive (4WD) vehicles (front tires at top of diagram)

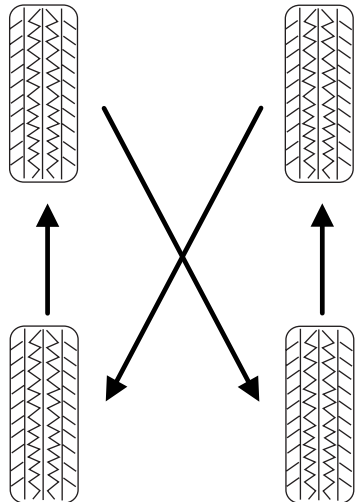

Maintenance and Specifications

Sometimes irregular tire wear can be corrected by rotating the tires.

Note: If your tires show uneven wear ask a qualified technician at a Mazda dealership to check for and correct any wheel misalignment, tire imbalance or mechanical problem involved before tire rotation.

Note: After having your tires rotated, inflation pressure must be checked and adjusted to the vehicle requirements.

Tire wear

Measure and inspect the tire tread on all your tires periodically. Advanced and unusual tire wear can reduce the ability of tread to grip the road in adverse (wet, snowy, etc.) conditions. Visually check your tires for uneven wear, looking for high and low areas or unusually smooth areas. Also check for signs of tire damage.

When the tread is worn down to 4 mm (1/16th of an inch), tires must be replaced to prevent your vehicle from skidding and hydroplaning.

Built-in treadwear indicators, or “wear bars”, which look like narrow strips of smooth rubber across the tread will appear on the tire when the tread is worn down to 4mm (1/16th of an inch). When you see these

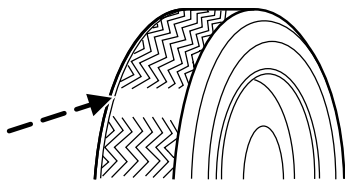

“wear bars”, the tire is worn out and should be replaced.

Inspect your tires frequently for any of the following conditions and replace them if one or more of the following conditions exist:

- Fabric showing through the tire rubber
- Bulges in the tread or sidewalls
- Cracks or cuts on the sidewalls
- Cracks in the tread groove
- Impact damage resulting from use
- Separation in the tread
- Separation in the sidewall
- Severe abrasion on the sidewall

If your vehicle has a leak in the exhaust system, a road tire or the spare tire may be exposed to hot exhaust temperatures requiring the tire to be replaced.

Maintenance and Specifications

Safety practices

Driving habits have a great deal to do with your tire mileage and safety.

- Observe posted speed limits
- Avoid fast starts, stops and turns
- Avoid potholes and objects on the road
- Do not run over curbs or hit the tire against a curb when parking

If your vehicle is stuck in snow, mud, sand, etc., **do not** rapidly spin the tires; spinning the tires can tear the tire and cause an explosion. A tire can explode in as little as three to five seconds.

WARNING: Tire explosions can cause death, personal injury or property damage. Do not allow anyone to stand near, or directly ahead or behind the spinning tire.

WARNING: Never spin the tires in excess of the 55 km/h (35 mph) point indicated on the speedometer.

Highway hazards

No matter how carefully you drive there's always the possibility that you may eventually have a flat tire on the highway. Drive slowly to the closest safe area out of traffic. This may further damage the flat tire, but your safety is more important.

If you feel a sudden vibration or ride disturbance while driving or you suspect your tire or vehicle has been damaged, immediately reduce your speed. Drive with caution until you can safely pull off the road. Stop and inspect the tire for damage. If the tire is under-inflated or damaged, deflate it, remove wheel and replace it with your spare tire and wheel. If you cannot detect a cause, have the vehicle towed to the nearest repair facility or tire dealer to have the vehicle inspected.

USING SNOW TIRES AND TRACTION DEVICES

NOTE: Snow tires must be the same size and grade as the tires you currently have on your vehicle.

The tires on your vehicle have all-weather treads to provide traction in rain and snow. However, in some climates, using snow tires and traction devices may be necessary. If you need to use snow tires and chains, it is recommended that steel wheels are used of the same size and specification as those originally installed.

Maintenance and Specifications

Follow these guidelines when using snow tires and traction devices:

- SAE class “S” cables should be used on front axle for P235/70R16 tires. With P215/70R16 tires, SAE class “S” cables can be used on both the front and rear wheels.
- Do not use tire chains on aluminum wheels. Chains may chip the wheels.
- Install cables or chains securely, verifying that the chains do not touch any wiring, brake lines or fuel lines.

Drive cautiously. If you hear the cables or chains rub or bang against the vehicle, stop and retighten them. If this does not work, remove the cables or chains to prevent vehicle damage.

- Avoid overloading your vehicle.
- Remove the cables or tire chains when they are no longer needed.
- Do not use cables or chains on dry roads.
- The suspension insulation and bumpers will help prevent vehicle damage. Do not remove these components from the vehicle when using snow tires and traction devices.
- Do not exceed 48 km/h (30 mph) with tire chains on your vehicle.

REFILL CAPACITIES

Fluid	Classification	Application	Capacity
Brake fluid	High Performance DOT 3 Motor Vehicle Brake Fluid	All	Fill to line on reservoir
Engine oil (including filter change)	SAE 5W-20	2.0L I4 Zetec engine	4.25L (4.5 quarts)
		3.0L V6 Duratec engine	5.2L (5.5 quarts)
Fuel tank	N/A	2.0L I4 Zetec engine	61L (16 gallons)
		3.0L V6 Duratec engine	61L (16 gallons)
Power steering fluid	MERCON®	All	Fill to line on reservoir

Maintenance and Specifications

Fluid	Classification	Application	Capacity
Transmission fluid ¹	API service GL-4, SAE 75W-90	Manual transaxle (2WD)	2.7L (2.85 quarts) ²
		Manual transaxle (4X4)	2.2L (2.32 quarts) ²
	MERCON® ATF	3.0L engine with Automatic transaxle and oil cooler	12.7L (13.4 quarts) ³
Transfer Case	SAE 75W-140 Synthetic Lubricant	4X4 (Automatic)	0.35L (12 ounces)
	API service GL-5, SAE 80W-90	4X4 (Manual)	0.35L (12 ounces)
Engine coolant ⁴	Mazda yellow-colored Premium Engine Coolant	2.0L I4 Zetec engine with manual transaxle	5.0L (5.3 quarts)
		3.0L V6 Duratec engine with automatic transaxle	10.0L (10.6 quarts)
Rear axle lubricant	API service GL-5, SAE 80W-90 Premium Rear Axle Lubricant	4X4	1.4L (2.96 pints) ⁵
Windshield washer fluid	n/a	All	2.6L (2.7 quarts)

¹Ensure the correct automatic transmission fluid is used. Transmission fluid requirements are indicated on the dipstick or on the dipstick handle. MERCON® and MERCON® V are not interchangeable. DO NOT mix MERCON® and MERCON® V. Refer to your scheduled maintenance section to determine the correct service interval.

²Service refill capacity is determined by filling the transmission to the bottom of the filler hole with the vehicle on a level surface.

Maintenance and Specifications

³Indicates only approximate dry-fill capacity. Some applications may vary based on cooler size and if equipped with an in-tank cooler. The amount of transmission fluid and fluid level should be set by the indication on the dipstick's normal operating range.

⁴Add the coolant type originally equipped in your vehicle. DO NOT MIX different colors or types of coolant. DO NOT USE Extended Life Engine Coolant (orange in color). Refer to *Adding engine coolant* in this chapter.

⁵Fill to 6 mm to 14 mm (1/4 inch to 9/16 inch) below bottom of fill hole.

For further information on your lubrication specifications, see your authorized Mazda dealer.

WHEEL AND TIRE SIZES

Vehicle Grade	Wheel	Tire	Spare Wheel	Spare Tire
DX	6.5JJx16	215/70R16	17x4T	135/90R17
LX-V6/ES-V6 DX-V6 -(Puerto Rico only)	7.0JJx16	235/70R16	17x4T	145/90R17

ENGINE SPECIFICATIONS

Engine	2.0L DOHC I4 Zetec engine	3.0L DOHC V6 Duratec engine
Cubic inches	121	181
Required fuel	87 octane	87 octane
Firing order	1-3-4-2	1-4-2-5-3-6
Spark plug gap	1.22-1.32 mm (0.048-0.052 inch)	1.32-1.42 mm (0.052-0.056 inch)
Ignition system	DIS	Coil on plug
Compression ratio	9.6:1	10.0:1

Maintenance and Specifications

VEHICLE DIMENSIONS

Dimensions	4 Door mm (in.)
(1) Vehicle height/ Maximum height*	1,681 (66.2)/1,744 (68.7)*
(2) Front track / rear	1,550 (61.0)/1,530 (60.2)
(3) Overall width (body)	1,783 (70.2)
(4) Wheelbase	2,620 (103.1)
(5) Overall length	4,394 (173.0)

* Denotes a 4x4 vehicle with optional 16" tires

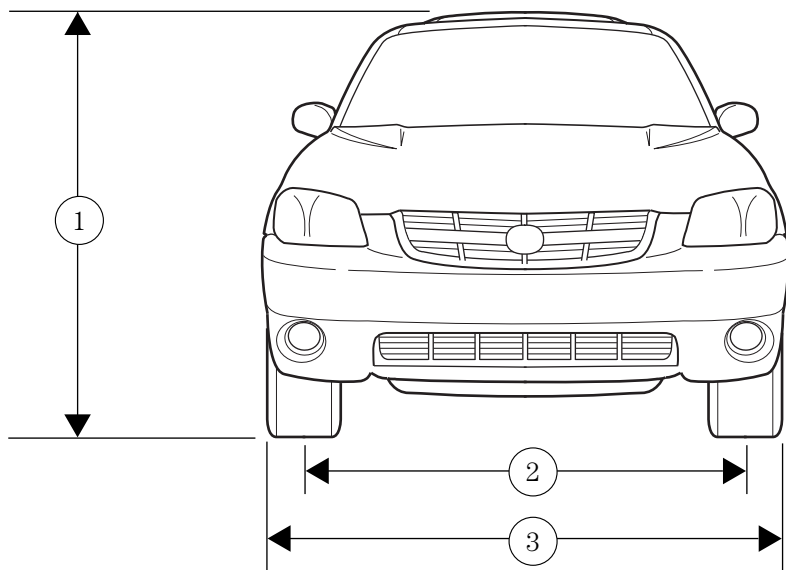

Maintenance and Specifications

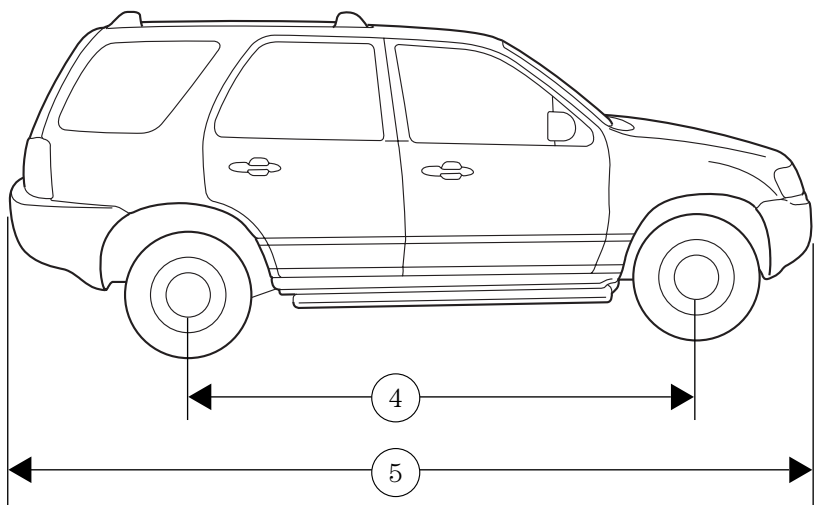

IDENTIFYING YOUR VEHICLE

Certification label

The National Highway Traffic Safety Administration Regulations require that a Certification Label be affixed to a vehicle and prescribe where the Certification Label may be located. The Certification Label is located on the front door latch pillar on the driver's side.

Maintenance and Specifications

Vehicle identification number (VIN)

The vehicle identification number is attached to a metal tag and is located on the driver side instrument panel. (Please note that in the graphic XXXX is representative of your vehicle identification number.)

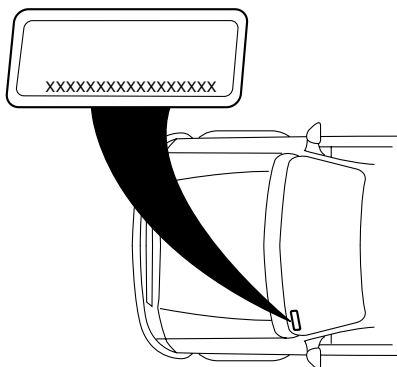

Engine number

The engine number (the last eight numbers of the vehicle identification number) is stamped on the engine block, transmission, frame and transfer case (if equipped).

Accessories

CELL PHONES

Use of cell phones and other devices by driver:

WARNING: Use of any electrical devices such as cell phones, computers, portable radios, vehicle navigation or other devices by the driver while the vehicle is moving is dangerous. Dialing a number on a cell phone while driving also ties-up the driver's hands. Use of these devices will cause the driver to be distracted and could lead to a serious accident. If a passenger is unable to use the device, pull off the right-of-way to a safe area before use. If use of a cell phone is necessary despite this warning, use a hands-free system to at least allow the hands free to drive the vehicle. Never use a cell phone or other electrical device while the vehicle is moving and, instead, concentrate on the full-time job of driving. In addition, the gasoline distributors are warning against using cell phones during refueling procedures, due to their increased concern about static electricity fires in the self-service pump environment.

- A**
- ABS (see Brakes)126
 - Accessory delay62
 - Air bag supplemental restraint system100–101, 105
 - and child safety seats102
 - description101, 105
 - disposal105, 109
 - driver air bag103, 108
 - indicator light104, 109
 - operation103, 108
 - passenger air bag103, 108
 - side air bag105
 - Air cleaner filter231
 - Air conditioning
 - manual heating and air conditioning system44
 - All Wheel Drive (AWD), driving off road138
 - Ambulance packages5
 - Antifreeze (see Engine coolant)212
 - Anti-lock brake system (see Brakes)126–127
 - Anti-theft system78
 - arming the system78
 - disarming a triggered system ..79
 - Audio system (see Radio) ...17, 27
 - Automatic transaxle
 - driving with132
 - fluid, adding228
 - fluid, checking228
 - Automatic transmission129
 - fluid, refill capacities244
 - Auxiliary power point60
- Axle**
- refill capacities244
- B**
- Battery210
 - acid, treating emergencies210
 - jumping a disabled battery171
 - maintenance-free210
 - servicing210
 - Brakes125
 - anti-lock126–127
 - anti-lock brake system (ABS)
 - warning light126
 - fluid, checking and adding227
 - fluid, refill capacities244
 - fluid, specifications246
 - lubricant specifications246
 - parking127
 - shift interlock129
 - Break-in period4
 - Bulbs51
- C**
- Calculating load151
 - Capacities for refilling fluids244
 - Cargo area shade68
 - CD-single17
 - Cell phone warning250
 - Certification Label248
 - Child safety restraints110
 - child safety belts110
 - Child safety seats113
 - attaching with tether straps ..117
 - Cigar lighter
 - Power Point60–61

Index

Cleaning your vehicle	
engine compartment	191
instrument panel	193
interior	194
interior trim	193
Mazda car care products	195
plastic parts	192
washing	190
waxing	190
wheels	191
wiper blades	193
Climate control (see Air conditioning or Heating)	44
Clock	26, 39
Clutch	
fluid	227, 230
operation while driving	135
recommended shift speeds	136
Console	67
overhead	58–59
Controls	
power seat	82
Coolant	
checking and adding	212
refill capacities	216, 244
specifications	246
Cruise control (see Speed control)	63
Customer Assistance	179–180, 183

D

Daytime running lamps (see Lamps)	48
Defrost	
rear window	47

Dipstick	
automatic transmission	
fluid	228
engine oil	206
Door locks	70
Driving under special conditions	134, 141, 144
sand	143
snow and ice	145
through water	143, 147

E

Emergencies, roadside	
jump-starting	171
Emission control system	225
Engine	247
cleaning	191
coolant	212
idle speed control	210
lubrication specifications	246
refill capacities	244
service points	204–205
Engine block heater	124
Engine oil	206
checking and adding	206
dipstick	206
filter, specifications	209
recommendations	209
refill capacities	244
specifications	246
Exhaust fumes	124

F

Fluid capacities	244
Foglamps	48
Four-Wheel Drive vehicles	
description	139

- driving off road140
- indicator light139
- preparing to drive your vehicle129
- Fuel217
 - calculating fuel economy222
 - cap220
 - capacity244
 - choosing the right fuel219
 - comparisons with EPA fuel economy estimates224
 - detergent in fuel220
 - filling your vehicle with fuel217, 220, 222
 - filter, specifications221
 - fuel filler door release66
 - improving fuel economy222
 - octane rating219, 247
 - quality220
 - running out of fuel220
 - safety information relating to automotive fuels217
- Fuses158
- G**
- Garage door opener59
- Gas cap (see Fuel cap)220
- Gas mileage (see Fuel economy)222
- Gauges15
 - engine coolant temperature gauge17
 - fuel gauge17
 - odometer17
 - tachometer17
 - trip odometer17
- GAWR (Gross Axle Weight Rating)
 - calculating151
- GVWR (Gross Vehicle Weight Rating)
 - calculating151
- H**
- Hazard flashers157
- Head restraints81, 83
- Headlamps48
 - aiming50
 - bulb specifications51
 - daytime running lights48
 - flash to pass49
 - high beam49
 - replacing bulbs52
 - turning on and off48
- Heating
 - heating and air conditioning system44
- Hood203
- I**
- Ignition121, 247
- Infant seats (see Safety seats)113
- Inspection/maintenance (I/M) testing226
- Instrument panel
 - cleaning193
 - cluster10
 - lighting up panel and interior49
 - location of components10
- J**
- Jump-starting your vehicle171

Index

- K**
- Keys
positions of the ignition121
- L**
- Lamps
bulb replacement
specifications chart51
cargo lamps49
daytime running light48
fog lamps48
headlamps48
headlamps, flash to pass49
instrument panel, dimming49
interior lamps50–51
replacing bulbs51–52, 54–55
- Lane change indicator
(see Turn signal)50
- Liftgate68
- Lights, warning and indicator10
anti-lock brakes (ABS)126
- Load limits148
- Loading instructions151
- Locks
childproof71
doors70
- Lubricant specifications246
- Luggage rack69
- Lumbar support, seats81–82
- M**
- Manual transaxle135
fluid, checking and adding230
reverse136
- Manual transmission
fluid capacities244
- Mirrors60, 62
fold away63
heated63
side view mirrors (power)62
- Moon roof67
- Motorcraft parts221
- O**
- Octane rating219
- Oil (see Engine oil)206
- Overdrive131
- Overheating164
- P**
- Parking137
- Parking brake127
- Passive anti-theft system
(PATS)75
- Power distribution box
(see Fuses)161
- Power door locks70
- Power Point
Cigar lighter60–61
- Power Seats82
- Power steering128
fluid, checking and adding227
fluid, refill capacity244
fluid, specifications246
- Power Windows61
- Preparing to drive your
vehicle129
- R**
- Radio17, 27

Radio reception42–43
 Rear window defroster47
 Relays158
 Remote entry system
 arming and disarming the
 anti-theft system73
 illuminated entry74
 locking/unlocking doors70
 replacing the batteries73
 Roof rack69

S

Safety Belt Maintenance99
 Safety belts
 (see Safety restraints)90–95
 Safety defects, reporting189
 Safety restraints90–95
 extension assembly96
 for adults91–94
 for children110
 lap belt97
 safety belt maintenance99
 warning light and chime97–98
 Safety seats for children113
 Seat belts
 (see Safety restraints)90
 Seats80
 child safety seats113
 heated83
 SecuriLock passive anti-theft
 system75
 Servicing your vehicle201
 Spare tire
 (see Changing the Tire)165
 Spark plugs, specifications247

Special notice
 ambulance conversions5
 Specification chart,
 lubricants246
 Speed control63
 Starting your vehicle121–123
 jump starting171
 Steering wheel
 tilting58

T

Tilt steering wheel58
 Tires232–233
 alignment240
 care238
 changing165–166, 171
 checking the pressure238
 label238
 rotating240
 safety practices243
 sidewall information234
 snow tires and chains243
 spare tire165
 terminology233
 tire grades233
 treadwear232, 242
 Towing151
 recreational towing156
 trailer towing151
 wrecker177
 Transaxle
 fluid, checking and adding
 (manual)230
 manual operation135
 Transmission
 automatic operation129
 brake-shift interlock (BSI)129
 fluid, checking and adding
 (automatic)228

Index

- fluid, refill capacities244
- Turn signal50
- V**
- Vehicle dimensions247
- Vehicle Identification Number (VIN)249
- Vehicle loading148
- Ventilating your vehicle125
- W**
- Warning lights (see Lights)10
- Washer fluid206
- Water, Driving through147
- Windows
 - power61
 - rear wiper/washer57
- Windshield washer fluid and wipers
 - checking and adding fluid206
 - checking and cleaning57
 - liftgate reservoir206
 - operation56
 - replacing wiper blades58
- Wrecker towing177