

DRIVER ASSURANCE

Mazda Drivers Assurance Plan
Check out www.mymazda.com, the website dedicated to you.

Manage your maintenance records, receive valuable offers, see the latest accessories, and much more!

Mazda Roadside Assistance
Exhilaration, liberation and inspiration, are great reasons to drive a Mazda car, truck, SUV or minivan. In addition to all the other great standard features, you also get peace of mind, our Emergency Roadside Assistance Plan, it's just a phone call away, 24 hours a day, 365 days a year, call **1-800-866-1998**.

Mazda "bumper-to-bumper" Limited Warranty
We design and build every Mazda to give you driving pleasure now and far down the road. We're so confident in our quality that we cover the entire vehicle against defects in materials and workmanship

for 48 months or 50,000 miles, whichever comes first.

Mazda Service Transportation Solution
Being without your Mazda may put a crimp in your day, if you do ever have to take your Mazda in for repairs don't worry, you're covered. With the Mazda Transportation Solution, you will be given a loaner car at no charge when your Mazda vehicle is in for warranty repairs. For all the details, see your Mazda Dealer.

This Quick Tips® guide is provided by Mazda North American Operations to make your Mazda ownership experience more convenient. It is not intended to replace your Owner's Manual.

If you have any questions about your vehicle, you are invited to contact your local dealer. Or if you need additional help, feel free to call our

Customer Assistance Center at 1-800-222-5500
Monday through Friday,
9 a.m.-4:45 p.m., Pacific
9 a.m.-5:45 p.m., Eastern/Central

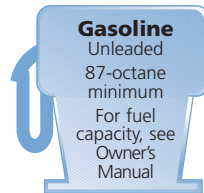

©2004 Calcar, Quick Tips® is a trademark of Calcar, made in USA 5/04 23.229 DOT Mazda North American Operations reserves the right to change product specifications at any time without incurring obligations. 9999-95-023C-05QT 5L5J-19A285-AA

MAZDA B-SERIES TRUCK

Quick Tips®

Reference
Guide for
Controls and
Functions

2005

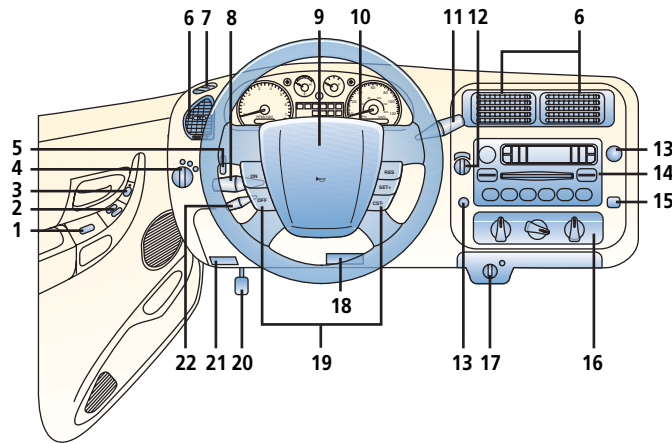

DRIVER'S VIEW

**Getting Started**

B-Series Truck Quick Tips® are designed to quickly familiarize you with some important features of your B-Series Truck

This Driver's View tab is your index to the Quick Tips®, locate the item you would like to learn more about and then turn to the listed tab

Be sure to see the tab called Getting Started, this section contains important operating tips about your B-Series Truck

Items identified in blue text call out important information

1. **Power door locks***, see Locks
2. **Power window switches***, see Switches/Interior Lights
3. **Dual power mirrors***, see Switches/Interior Lights
4. **Lighting switch**
 ☰ Tail, parking and dashboard lights on:
 ⌘ Tail, parking, dashboard and headlights on: Rotate knob to second notch
5. **Instrument panel lighting**
 To brighten/dim: Rotate thumb-wheel up/down
6. **Air vents**
 To open/close: Move thumb-wheel left/right
 To direct air flow: Move tab in center of vent
7. **Side window defroster**
8. **Turn signals/headlight high beams/wiper/washer lever**, see Getting Started
9. **Horn/Air bag**
 Press to sound horn
10. **Hazard warning switch**
 Press on/off
11. **Gearshift lever (A/T)***, see Transmission
12. **4x4 control***, see Transmission
13. **12V socket**
 Use for optional electrical accessories
14. **Audio system**, see Audio Systems
15. **Fog light switch***
 Press on/off; on with low-beams/parking lights only
16. **Climate control panel**, see Climate Control
17. **Passenger's front air bag deactivation switch/light**, see Getting Started
18. **Hood release handle**
 Pull to unlatch hood, see Under Hood
19. **Cruise control***, see Getting Started
20. **Parking brake pedal**
21. **Parking brake release lever**
22. **Tilt steering-wheel lever***
 To change position: Pull lever, tilt wheel up or down, release to lock

*Denotes optional equipment

Always check the Owner's Manual for more operating information and safety features

Driver's
View

GETTING STARTED

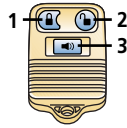

Keyless remote entry system*

Functions only with ignition in OFF position

To lock doors: Press button (1); pressing again within 5 seconds causes doors to relock, horn to beep once if all doors are closed, twice if any door is ajar
To unlock doors: Press (2) to open driver's door; press again within 5 seconds to open other door

Panic alarm: Press (3); horn sounds, parking lights flash and interior lights illuminate; press (3) again to stop or insert key and turn ignition to ON or ACC position



Cruise control*

Operates above 30 mph
Press and release ON (4)

To set speed: Press and release SET+ (6) at desired speed; hold (6) to accelerate

To decelerate: Press and hold CST- (7), release at desired speed; or tap brake pedal, press and release (6) at desired speed
Incremental deceleration: Press and release (7), each tap = minus 1 mph

Incremental acceleration: Press and release (6), each tap = plus 1 mph

To cancel: Tap brake/clutch pedal or push OFF button (8)
Return to preset speed (after braking): Press and release RES (resume) button (5)

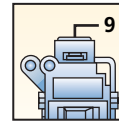

Fuel pump shutoff

Disables fuel pump after a substantial jolt or collision; located in front passenger's footwell, by kick panel access cover

To reset: Press down top of exposed red reset button (9)

WARNING: Do not reset shutoff switch if you see or smell fuel

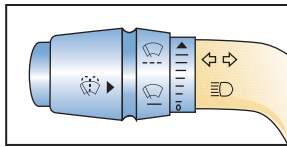

Turn signals/headlight high beams/wiper/washer lever

High beams on/off: Push forward to detent/pull back
To flash high beams: Pull rearward and release

To turn on wipers: Rotate knob forward; first 7 detents are progressively faster intervals, 8th detent is low speed, 9th is high

To activate washers: Push in end of knob; will also operate wipers

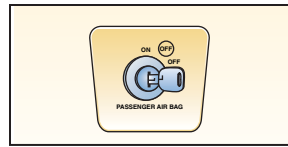

Passenger's front air bag deactivation switch

Deactivate passenger's front air bag when using a child-safety seat
To deactivate/activate: Insert ignition key in switch, rotate to OFF/ON, remove key
Amber OFF light illuminates when deactivated and ignition is on

Tip: Turn ignition off when disabling passenger front air bag

WARNINGS: When using a rear-facing infant-safety seat or a front-facing child seat, always set the passenger seat air bag deactivation switch to

OFF position, an infant or child is in serious danger of being injured or killed if front passenger air bag is deployed

If you install a front-facing child-seat, put it in the outboard seat and slide it all the way rearward, set passenger air bag deactivation switch to OFF position

For Cab-Plus vehicles, do not put child restraints in the center facing jump seats, for complete details see Owner's Manual

*Denotes optional equipment

Always check the Owner's Manual for more operating information and safety features

Instrument Cluster

INSTRUMENT CLUSTER

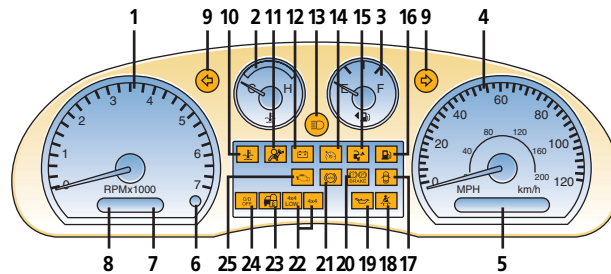

GAUGES

- | | | |
|--|--|--|
| <p>1. Tachometer</p> <p>2. Engine coolant temperature gauge
If above normal range, stop truck and turn off engine; check coolant level when safe</p> | <p>3. Fuel gauge
Fuel tank capacity varies by model; see Owner's Manual</p> <p>4. Speedometer</p> <p>5. Gearshift indicator* (AT)</p> | <p>6. Trip odometer reset button
Push to reset</p> <p>7. Odometer</p> <p>8. Trip odometer</p> |
|--|--|--|

WARNING LIGHTS

- | | | |
|---|--|---|
| <p>9. Turn signals/hazard warning on</p> <p>10. Engine coolant temperature
High engine coolant temperature; stop truck and turn off engine; check coolant level when safe</p> <p>11. Air bag readiness
Air bag malfunction; dealer inspection required</p> <p>12. Charging system warning light
Dealer inspection required</p> <p>13. High beams on</p> <p>14. Cruise control on*</p> | <p>15. Check fuel cap
Fuel cap not securely tightened</p> <p>16. Low fuel</p> <p>17. Door ajar
Door not completely shut</p> <p>18. Always fasten safety belts
Light and chimes</p> <p>19. Engine oil pressure
Immediately stop truck and turn off engine; check oil level</p> <p>20. Brake system
Indicates parking brake on or low brake fluid level, if brake fluid level is low, have vehicle inspected by nearest Mazda Dealer</p> | <p>21. Anti-lock Brake System (ABS)
ABS malfunction, normal brakes only, dealer inspection required</p> <p>22. 4x4 /LOW 4X4 HIGH/ 4X4 LOW Indicator*,
see Transmission</p> <p>23. Anti-theft on*</p> <p>24. Overdrive off indicator* (A/T)
When lit, transmission does not shift into overdrive</p> <p>25. Check engine
Dealer inspection required</p> |
|---|--|---|

*Denotes optional equipment

Always check the Owner's Manual for more operating information and safety features

Instrument Cluster

Locks

LOCKS

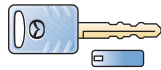

Key/number plate
Operates ignition and all locks

Tip: Use key number plate to purchase new key; store in safe place



Keyless remote entry system*, see Getting Started

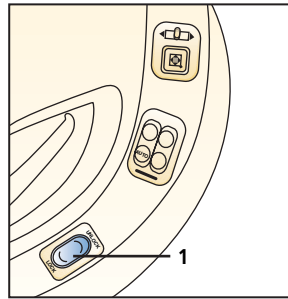

Power door locks*

Front door lock switches

To lock/unlock both doors: Press bottom/top on either door switch (1)

To lock doors without key, exit the vehicle, press lock on either door, close the door

To unlock: Use key to unlock either front door, open door and press top of switch to unlock other door

Manual door locks will override power locks

Power Door Unlock Disable feature, see Owner's Manual

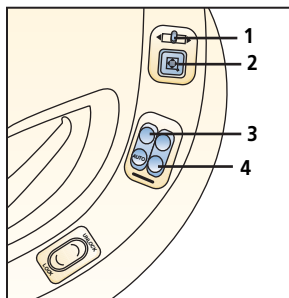

Dual power mirrors*

To adjust left/right mirror: Press control switch (1) left/right, tilt knob (2) in direction of desired mirror movement

Tip: To lock mirrors in place, move control switch (1) to center position

Power window switches*

Operate only with ignition in ACC or ON position

Both windows may be controlled from driver's door; passenger door has separate switch

Driver's window (3): One touch-down; press and release, window goes all the way down; tap front of switch to stop

Press and hold top of switch to close

Passenger window switch (4): Press bottom/top of switch to open/close

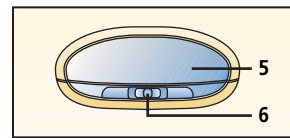

Interior lights

5. Interior light

6. Interior light switch

ON = light always on

DOOR = light on when door open

OFF = light always off

Tip: Battery saver shuts off interior lamps after 45 minutes with ignition off

*Denotes optional equipment

Always check the Owner's Manual for more operating information and safety features

Switches/
Interior Lights

Seats

SEATS

Seats

1. Fore/aft adjustment

Raise lever and hold, slide seat, release lever

2. Seatback angle

To adjust: Lift and hold lever, lean forward or backward to tilt seat, release lever

⚠️ WARNINGS: Do not adjust seats while driving

Safety belts must always be worn when vehicle is in motion

All air bags are supplemental and do not replace safety belt usage

Always wear your safety belt and properly secure children

Shoulder belt height adjustment

To raise belt: Slide adjuster up
To lower belt: Push release button (3) and slide down

⚠️ WARNING: Make sure adjuster locks in one of its positions

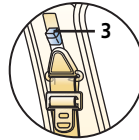

Safety belt emergency locking mode

Belts lock only on hard acceleration, braking, cornering or impacts of about 5 mph or more

Automatic locking mode (front passenger safety belt only)

Must be used when installing child-safety seat

To activate: Pull webbing fully out of retractor until click is heard; belt will only tighten

To disengage: Unbuckle belt and allow webbing to retract fully

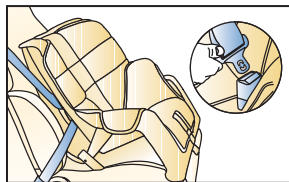

Child-safety seat

To install, use dual-locking mode retractor safety belts; see Owner's Manual for proper installation and child seat tether and LATCH system instructions

⚠️ WARNING: Use age appropriate child restraints, see Owner's Manual and state or province laws

⚠️ WARNINGS: When using a rear-facing infant-safety seat or a front-facing child seat, always set the passenger seat air bag deactivation switch to OFF position, an infant or child is in serious danger of being injured or killed if front passenger air bag is deployed

If you install a front-facing child-seat, put it in the outboard seat and slide it all the way rearward, set passenger air bag deactivation switch to OFF position

For Cab-Plus vehicles, do not put child restraints in the center facing jump seats, for complete details see Owner's Manual

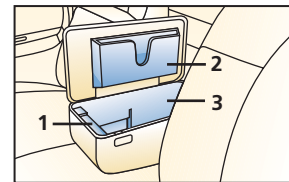

Console (Split bench)

- 1. Coin tray**
- 2. Map storage**
- 3. Storage compartment**

*Denotes optional equipment

Always check the Owner's Manual for more operating information and safety features

Seats/
Console

Audio
Systems

AM/FM STEREO/COMPACT DISC

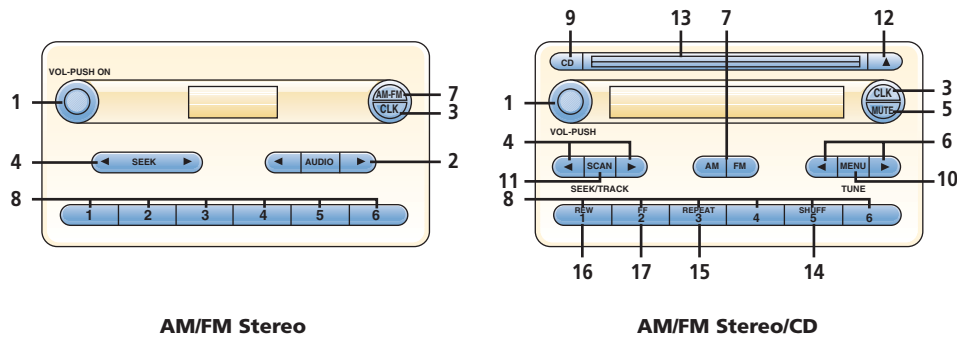
**1. Power/Volume**

Press to turn on/off; turn clockwise/counterclockwise to increase/decrease volume

2. AUDIO

Press to select Bass, Treble, or Balance; then press ◀ AUDIO ▶ to adjust

3. Clock

Press Clock to set time; adjust hour up/down by pressing ◀ / ▶ (2), (6); press Clock again to select minutes, adjust minutes up/down by pressing ◀ / ▶ (2), (6); press Clock again to exit

4. SEEK/TRACK

Radio: Press and release ◀ / ▶ for next strong station down/up; press and hold to skip stations
CD: Press and release ◀ / ▶ to select previous/next track

5. MUTE

Press to mute playing media; press again for normal volume

6. Tune

Press ◀ / ▶ to change frequency down/up
Press and hold to move down/up quickly

7. AM/FM

Press to select AM/FM1/FM2 frequency bands

8. Memory preset buttons

To set: Tune to station, press and hold until sound returns

9. CD

Press to select CD

10. MENU

Press MENU to toggle through following modes; Autoset, Bass, Treble, Balance, and Fade; press ◀ / ▶ to adjust

Autoset

Press ◀ / ▶ to set 6 strongest stations into AM, FM1, or FM2 memory buttons; press again to return to normal stations

11. SCAN

Press to briefly sample next listenable selections, press again to cancel; functions in all modes

12. Eject

Press to eject CD; radio resumes playing

13. CD slot**14. Shuffle**

Press to play CD changer* single disc tracks in random order

15. REPEAT

Press to repeat current CD track

16. REW

Reverse in CD track

17. FF

Advance in CD track

*Denotes optional equipment

Always check the Owner's Manual for more operating information and safety features

Audio
Systems

Audio
Systems

AM/FM STEREO/COMPACT DISC

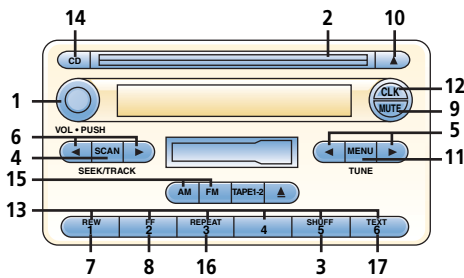

Premium AM/FM Stereo Cassette/CD/MP3*

1. Volume Push On

Press to turn on/off; turn clockwise/counterclockwise to increase/decrease volume

2. CD slot

Tip: Insert CD with label side up

7. REW

Press and hold to play previous disc tracks

8. FF

Press and hold to play next disc tracks

9. MUTE

Press to mute playing media; press again for normal volume

12. Clock

Press Clock to set time; adjust hour up/down by pressing ◀/▶ (5); press Clock again to select minutes, adjust minutes up/down by pressing ◀/▶ (5); press Clock again to exit

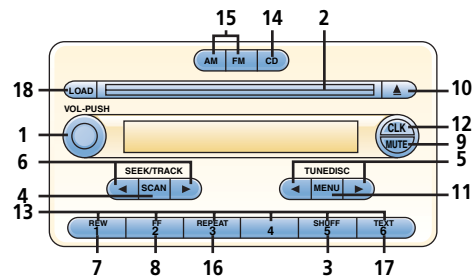

Premium AM/FM Stereo/CD6/MP3*

3. Shuffle

Press to select SHUFFLE which plays random tracks from CD/MP3 discs

4. Scan

Radio: Press to briefly sample listenable stations

CD/MP3: Press to briefly sample tracks

Press again to stop

5. TUNE/DISC

Radio: Press ◀/▶ to change frequency down/up

CD: Press ◀/▶ to select previous/next disc

Hold for rapid movement

MP3: Access previous/next directory

6. SEEK/TRACK

Radio: Press ◀/▶ for next listenable station down/up

CD: Press ◀/▶ to select previous/next track

10. Eject

Press once to eject current CD

Press and hold to eject all stored discs one at a time

Press once, then press desired number 1-6 (13) to eject a CD

11. MENU

Press MENU to toggle through following modes; Autoset, Bass, Treble, Balance, and Fade; press ◀/▶ to adjust

Autoset

Press ◀/▶ to set 6 strongest stations into AM, FM1, or FM2 memory buttons; press again to return to normal stations

Next/previous directory

Previous or next MP3 directory; Press ◀/▶

Flat file/directory mode

To select; press ◀/▶

Track number/normal music name/file name: Press ◀/▶

13. Memory preset buttons 1-6

To set: Tune to station, press and hold until sound returns

14. CD

Press to select CD mode or play CD

15. AM/FM

Press to select radio and alternate among AM/ FM1/ FM2 bands

16. REPEAT

Press to repeat CD/MP3 track

17. TEXT

Press to view next 12 characters in MP3 music name/file name of current MP3 track and directory

18. LOAD

Press to load one CD or auto load up to six discs

*Denotes optional equipment

Always check the Owner's Manual for more operating information and safety features

Audio
Systems

Transmission

TRANSMISSION

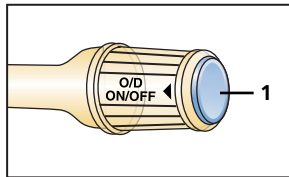
**Automatic transmission***

Gearshift must be in Park or Neutral to start engine; it must be in Park to remove ignition key

P = Park

To move gearshift from Park: You **MUST** press firmly on the brake pedal and the ignition must be in the ON position. Never put moving vehicle in Park.

Always apply parking brake when exiting the vehicle.

R = Reverse

Do not engage Reverse when vehicle is moving forward.

N = Neutral

No gear is engaged; vehicle can roll freely, even on a slight incline, unless the brakes are applied.

D (Overdrive)

For normal driving: Shifts through all forward gears automatically for more relaxed highway driving and optimum fuel economy.

Tip: Torque converter lock-up improves fuel economy and can feel like an additional gear.

D (Overdrive Off)

Press (1) to disengage overdrive; an indicator light on the instrument cluster will illuminate.

Driving without overdrive provides a lower gear for climbing hills and engine braking when descending hills; you can depress (1) at any speed.

To re-engage overdrive, press (1) again and the instrument cluster light will go out.

Tip: A flashing Overdrive Off light indicates a system malfunction; dealer inspection required.

2 = Second

Place the gearshift lever in second when accelerating on slippery roads or to provide additional engine braking on downgrades.

1 = Low

Low provides maximum engine braking on steep downgrades.

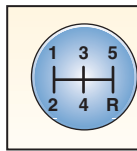
**Manual transmission**

Depress clutch pedal completely to start engine and change gears; stop

truck completely before shifting into reverse.

Tip: Extended use of other than manufacturer's specified tires on a limited-slip rear axle* may result in damage, this may not affect normal driving and may not be noticeable by the driver.

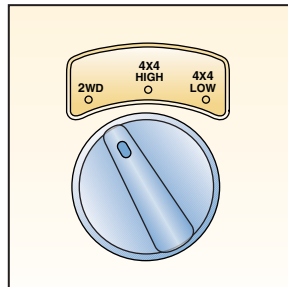
**4-wheel drive system***

2WD = Two-wheel drive
Power to rear axle only, 4x4 indicator lights off.

4x4 HIGH = Four-wheel drive

Power to front and rear axles at normal speed, 4x4 light on.

4x4 LOW = Four-wheel drive (low range)

Power to front and rear axles at reduced speed, 4x4 LOW light on.

To shift from 2WD to 4x4 HIGH: Rotate switch from 2WD to 4x4 HIGH.

To shift from 4x4 HIGH to 2WD: Rotate switch from 4x4 HIGH to 2WD.

Tip: You do not need to shift into reverse to disengage front hubs.

To shift into/out of 4x4 LOW: Stop vehicle, depress brake, place automatic transmission in neutral (with manual transmission, depress clutch pedal); rotate switch to desired setting.

Tip: Pulsation may occur during cornering in 4x4 mode.

*Denotes optional equipment

Always check the Owner's Manual for more operating information and safety features

Transmission

Climate
Control

CLIMATE CONTROL

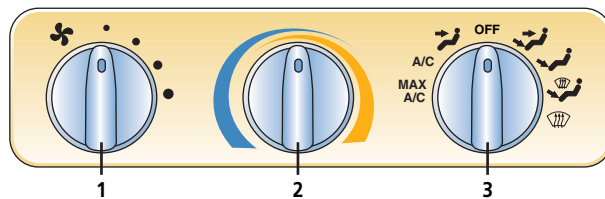
**1. Fan control**

To increase speed and flow:
Rotate knob clockwise

2. Temperature selection

Cooler/warmer = rotate
knob counterclockwise/
clockwise

3. Air flow selections

= air to dash vents,
A/C compressor* off

OFF = system off, no air flow

= air to dash/floor vents,
A/C compressor* on

= air to floor,
A/C compressor* off

= air to floor and windshield,
A/C compressor* on

= defrost, air to windshield,
A/C compressor* on

Air conditioning system*

MAX A/C = cooling with inside air,
air to dash only

A/C = cooling with outside air,
air to dash only

**Control positions for
maximum defrost**

Fan to maximum, temperature
to maximum hot, air flow
selector knob to

**Tips: To prevent moisture
buildup, never drive with
system off**

**When , or selected,
air is dried when temperature
is above 50° F**

**A/C compressor* is on in
defrost position**

*Denotes optional equipment

Always check the Owner's Manual for more operating information and safety features

Climate
Control

Under Hood

UNDER HOOD

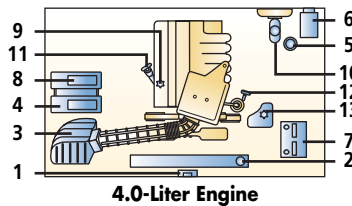
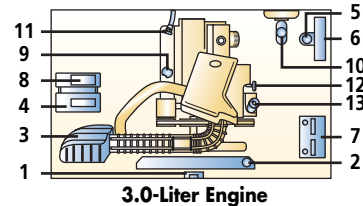
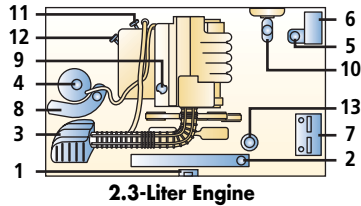
**1. Hood latch**

Pull inside hood release handle, hood pops up slightly; while applying upward pressure on hood, lift auxiliary latch handle and raise hood

2. Radiator cap

Remove cap only when safe and engine is cool

3. Air filter**4. Engine coolant reservoir**

Level should be at fill line indicator mark; remove cap only when safe and engine is cool

⚠ WARNING: Never remove coolant reserve tank cap while engine is running or hot; you could get burned

5. Clutch fluid reservoir

With cap on, check that fluid level is at ridge in reservoir body, use DOT 3 brake fluid

6. Fuse block**7. Battery****8. Windshield washer reservoir**

Fill with windshield washer fluid, not water; use fluids containing non-methanol antifreeze agents only, they will not damage paint, wiper blades and washer system

9. Engine oil filler cap

Use SAE 5W-20 (2.3L, 3.0L) 5W-30 (4.0L) oil for all temperatures; use only oils displaying American Petroleum Institute Certified for Gasoline Engines

10. Brake fluid reservoir

Clean filler cap before removing; use only DOT 3 fluid from a sealed container

If brake fluid level is low, have vehicle inspected by your closest Mazda Dealer

11. Automatic transmission fluid dipstick*

Check with engine on at normal operating temperature; fluid should be within crosshatched area on dipstick

12. Engine oil dipstick

Check with engine off and at normal temperature; fluid should be within crosshatched area on dipstick; do not fill above MAX/FULL line

13. Power steering fluid reservoir

Check with engine off and at normal temperature; fluid level on dipstick should be between arrows in FULL HOT range

*Denotes optional equipment

Always check the Owner's Manual for more operating information and safety features

Under Hood

Driving Tips

DRIVING TIPS

Break-in period

First 1,000 miles: Avoid heavy repeated brake use; avoid full throttle, rapid acceleration or kick-down of transmission; drive at varying road and engine speeds
Do not tow a trailer for first 500 miles
Do not use special "break-in" oils

 **Tip: Follow the same break-in period procedures with newly overhauled engine or when brakes are replaced**

4-wheel Anti-lock Braking System (ABS)

ABS automatically reduces hydraulic pressure to all four wheels (4-wheel ABS) on the verge of locking up

You may feel a slight pulsing of the brake pedal and hear a clicking noise, this tells you the ABS is functioning properly

 **Tips: Maintain constant pressure on the brake pedal. Do not pump the brakes**

ABS self test

A self-diagnostic test is performed when the engine is started; you may feel some pulsation and hear some noise; this is normal

Tire economy and tips

Check pressure monthly when tires are cold
Check for unusual wear and overall condition, do not exceed weight limit on tires and axles
Maintain correct front-end alignment and tire balance; see Owner's Manual for rotation chart

Tire pressure

Decal on the edge of the driver's door provides tire size and pressure information

Tire chains*†

Tire chains can damage aluminum wheels; use on steel wheels only

 **Tips: Use only SAE class "S" chains, install only on rear tires; install as tightly as possible and retighten periodically. Never exceed 30 mph with tire chains**

	NORMAL	SPECIAL
5,000 miles		G
15,000 miles	A	H
30,000 miles	A B	I J
45,000 miles	A C	
60,000 miles	A B D	K L
75,000 miles	A C	
90,000 miles	A B	
100,000 miles	E F	

Change engine oil/replace filter every 3,000**/5,000 miles; rotate tires every 7,500 miles or sooner
Check lug nut torque every 5,000 miles

Normal operating conditions

- A.** Inspect: Engine cooling system, hoses and clamps, automatic transmission fluid level, steering linkage, suspension, brake system
Inspect/lubricate: 4x2 ball joints
- B.** Replace: Air filter/fuel filter
Inspect: Exhaust system
- C.** Change: Green engine coolant
- D.** Lubricate: 4x2 wheel bearings
Replace: Manual transmission fluid
- E.** Inspect: Accessory drive belt(s)
Replace: Spark plugs
Replace: PCV valve (2.3L/3.0L/4.0L)

Special operating conditions

- Towing, extensive idling, low speed driving, dusty conditions and off-road operation, see Owner's Manual
- F.** Change: Yellow engine coolant
 - G.** Inspect: Brake system
 - H.** Replace: Fuel filter
 - I.** Change: Automatic transmission fluid
 - J.** Lubricate: Front wheel bearings (4x2)
 - K.** Change: Transfer case fluid (4x4)
 - L.** Replace: Spark plugs
- Perform maintenance as required**
Inspect/lubricate: U-joints, clutch fluid level
Replace: Engine air filter
Change: Manual transmission fluid

*Denotes optional equipment
**Special operating conditions
† See Owner's Manual

Always check the Owner's Manual for more operating information and safety features