

DRIVER ASSURANCE

Mazda Driver's Assurance Plan
Check out www.mymazda.com, the website dedicated to you. Manage your maintenance records, receive valuable offers, see the latest accessories, and much more!

Mazda Roadside Assistance
Exhilaration, liberation and inspiration, are great reasons to drive a Mazda car, truck, SUV or minivan. In addition to all the other great standard features, you also get peace of mind, our Emergency Roadside Assistance Plan, it's just a phone call away, 24 hours a day, 365 days a year, call **1-800-866-1998**

Mazda "bumper-to-bumper" Limited Warranty
We design and build every Mazda to give you driving pleasure now and far down the road. We're so confident in our quality that we cover the entire vehicle against defects in materials and workmanship

for 48 months or 50,000 miles, whichever comes first
Mazda Service Transportation Solution
Being without your Mazda may put a crimp in your day. If you do ever have to take your Mazda in for repairs don't worry, you're covered. With the Mazda Transportation Solution, you will be given a loaner car at no charge when your Mazda vehicle is in for warranty repairs. For all the details, see your Mazda Dealer

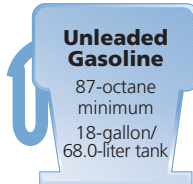

This Quick Tips® guide is provided by Mazda North American Operations to make your Mazda ownership experience more convenient. It is not intended to replace your Owner's Manual. If you have any questions about your vehicle, you are invited to contact your local dealer. Or if you need additional help, feel free to call our **Customer Assistance Center at 1-800-222-5500** Monday through Friday, 9 a.m.-4:45 p.m., Pacific 9 a.m.-5:45 p.m., Eastern/Central



©2004 Calcar, Quick Tips® is a trademark of Calcar, made in USA 6/04 100.174M DOT Mazda North American Operations reserves the right to change product specifications at any time without incurring obligations. 9999-95-078C-05QT 5M81-19G217-AA

2005

MAZDA6 5-DOOR / 4-DOOR/
SPORT WAGON

Quick Tips®

Reference
Guide for
Controls and
Functions

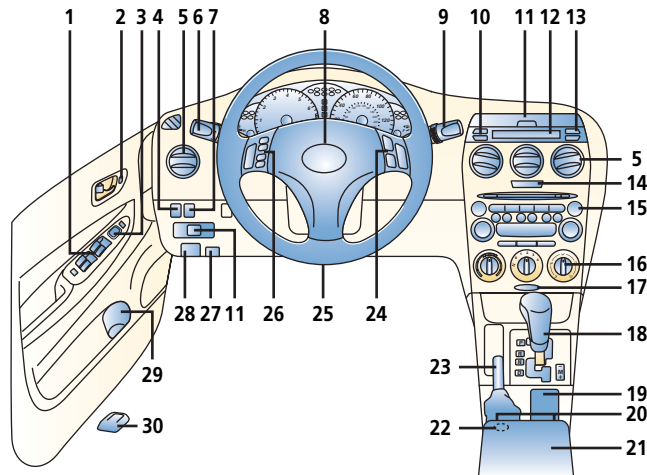

DRIVER'S VIEW

**Getting Started**

Mazda6 Quick Tips® are designed to quickly familiarize you with some important features of your Mazda6

This Driver's View tab is your index to the Quick Tips®, locate the item you would like to learn more about and then turn to the listed tab

Be sure to see the tab called Getting Started, this section contains important operating tips about your Mazda6

Items identified in blue text call out important information

- | | | |
|--|--|---|
| <p>1. Power window switches, see Switches</p> <p>2. Power door locks, see Locks</p> <p>3. Dual power mirrors, see Switches</p> <p>4. ^{TCS OFF} Traction Control System, see Driving Tips</p> <p>5. Air vents</p> <p>6. Turn signal/lighting control lever, see Driver Controls</p> <p>7. Instrument panel lighting, see Getting Started</p> <p>8. Horn/Air bag</p> <p>9. Wiper/washer control lever, see Driver Controls</p> <p>10. Clock/set buttons, see Getting Started</p> <p>11. Storage</p> <p>12. Information display, see Owner's Manual</p> | <p>13. AMB
Ambient temperature display
Push for more than three seconds to change between celsius and fahrenheit</p> <p>14. Hazard warning switch, Press on/off</p> <p>15. Audio system, see Audio Systems</p> <p>16. Climate control panel, see Climate Controls</p> <p>17. Passenger air bag off indicator, see Seats</p> <p>18. Gearshift lever (A/T)*, see Transmission</p> <p>19. Cup holder</p> <p>20. Heated seats*, see Trunk/Console</p> <p>21. Console, see Trunk/Console</p> <p>22. Accessory socket</p> | <p>23. Parking brake lever, see Trunk/Console</p> <p>24. Cruise control, see Getting Started</p> <p>25. Tilt/telescopic steering-wheel lever, see Getting Started</p> <p>26. Audio control switches, see Getting Started</p> <p>27. Remote trunk release (Sedan only)
Push to open trunk; main switch in glove box must be ON, see Getting Started</p> <p>28. Hood release handle</p> <p>29. Bottle holder
⚠ CAUTION: Use plastic bottles with caps, cups may spill when door is closed</p> <p>30. Remote fuel-door release</p> |
|--|--|---|

*Denotes optional equipment

Always check the Owner's Manual for more operating information and safety features

Driver's
View

GETTING STARTED

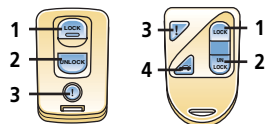

5-Door/ Sport Wagon

Sedan

Remote keyless entry system

Functions only with ignition in LOCK or ACC positions

To lock doors: Press **LOCK** button (1); pressing again within 5 seconds causes doors to relock and horn to beep

To unlock: Press **UNLOCK** (2) for driver's door; press again within 5 seconds to unlock other doors

To open trunk: Press (4)

Panic alarm: Press (3); horn sounds; to stop, press any button on the transmitter or turn ignition to ON position



Instrument panel lighting

To brighten/dim turn thumbwheel up/down

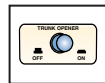

Remote trunk lid release lock-out (Sedan only)

Switch in ON position, remote trunk release functions normal; OFF position disables system; located in glove box

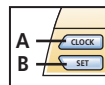

Clock

To set: With ignition in ACC or ON position, press (A) and hold until beep sounds; 12 hr/24hr will be displayed; press (B) to select; press (A) again while selection is flashing: Hr ADJUST displays; press (B) to select hr; press (A) when done, do the same to set minutes

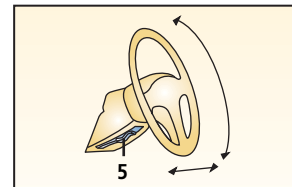

Tilt/telescopic steering-wheel lever

Pull lever (5) down to unlock column, position tilt angle and length of steering column position

WARNING: Do not adjust steering-wheel while driving

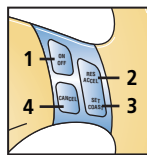

Cruise control

Operates above 25 mph

To activate: Press and release ON/OFF (1)

To set speed: Press and release SET/COAST (3) at desired speed

To accelerate: Press and hold RES/ACCEL (2); incremental acceleration: Press and release (2), each tap = plus 1 mph

To decelerate: Press and hold SET/COAST (3), release at desired speed; or tap brake pedal, press and release (3) at desired speed; incremental deceleration: Press and release (3), each tap = minus 1 mph

To cancel: Tap brake pedal, clutch pedal (manual transaxle) or press CANCEL button (4) or ON/OFF (1)

Return to preset speed after

CANCEL button or braking: Press and release RES/ACCEL button (2)

Tip: Cruise control will not be canceled in Manual Mode during gear changes

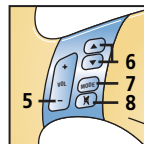

Steering-wheel audio controls

To increase/decrease volume: Press (5)

Radio: Press (6) less than one second to select next preset station, press (6) more than one second to seek next station
Cassette/CD/MD: Press (6) to select next selection/track
Press (7) to select AM, FM 1, FM 2, Tape, CD and MD mode
Press (8) to mute

[†]See Owner's Manual



Rear center position seat belt (Sport Wagon only)[†]

To pull seat belt from ceiling recess (9): Slide tongues with finger while moving downward
Fastening seat belt: Tongue (10) and anchor (11) must be fastened, then slowly pull out lap/shoulder belt (12) and insert tongue (13) into buckle (14) until click is heard
Unfastening seat belt: Depress buckle button to release
Stowing seat belt: Retract belt, put tongues (10) and (13) together, insert securely into recess (9)

Always check the Owner's Manual for more operating information and safety features

Instrument Cluster

INSTRUMENT CLUSTER

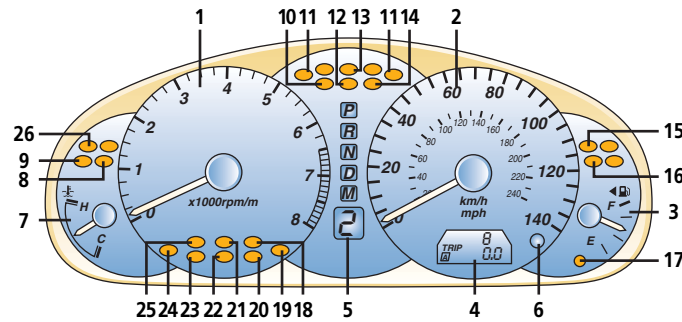

GAUGES

- | | | |
|---|---|--|
| <p>1. Tachometer</p> <p>2. Speedometer</p> <p>3. Fuel gauge</p> <p>4. Odometer/tripmeter</p> <p>5. Gear indicator*
Displays current gear of Sport AT</p> | <p>6. Odometer/tripmeter selector
Press to select among trip A, trip B, and odometer
Press and hold to reset selected trip meter</p> | <p>7. Engine coolant temperature gauge
If above normal range, stop vehicle and turn off engine, check coolant level when safe</p> |
|---|---|--|

WARNING LIGHTS

- | | | |
|--|--|---|
| <p>8. ^{CRUISE} Cruise control, see Getting Started</p> <p>9. ^{CRUISE MAIN} Cruise Control Main Power On, see Getting Started</p> <p>10. ^{ABS} Anti-lock Brake System (ABS)
ABS malfunction, normal brakes only, dealer inspection required</p> <p>11. ^{Turn signals/hazard} Turn signals/hazard warning on</p> <p>12. ^{AT} Automatic transaxle indicator
Dealer inspection required if light remains on</p> <p>13. ^{High beams on} High beams on</p> | <p>14. ^{Traction Control System} Traction Control System, Light flashes when in use; dealer inspection required if light remains on</p> <p>15. ^{Lights on**} Lights on**</p> <p>16. ^{TCS OFF} Traction Control System off, System turned off manually or malfunctioning; dealer inspection required</p> <p>17. Low fuel</p> <p>18. ^{Brake system} Brake system
Parking brake on/low fluid level</p> <p>19. ^{Check engine} Check engine
Dealer inspection required</p> <p>20. ^{Charging system} Charging system warning light
Dealer inspection required</p> | <p>21. ^{Engine oil pressure} Engine oil pressure warning light</p> <p>22. ^{Air bag readiness} Air bag readiness
Front, side and curtain air bag malfunction; warning light constantly flashes or stays on or never comes on with ignition on, dealer inspection required</p> <p>23. ^{Door ajar} Door ajar</p> <p>24. ^{Immobilizer system on} Immobilizer system on, see Locks</p> <p>25. ^{Always fasten} Always fasten safety belts</p> <p>26. ^{Low washer fluid} Low washer fluid level warning light*</p> |
|--|--|---|

*Denotes optional equipment

**If equipped with black-out meter

Always check the Owner's Manual for more operating information and safety features

Instrument Cluster

Driver Controls

DRIVER CONTROLS

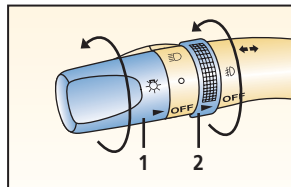

Turn signal/lighting control lever

OFF = Lights off

○ = Tail, parking and dashboard lights on: Rotate knob (1) to first notch

☰ = Tail, parking, dashboard and headlights on: Rotate knob (1) to second notch

High beams on/off: Push lever forward/pull back to detent

To flash high beams: Pull lever back slightly and release

Turn signals right/left: move lever up/down

☰ = Fog lights on: Rotate knob (2); functions only with headlight low beams on

Tip: Headlights switch off automatically within 30 seconds if lights are left on and switch is in lock position or key removed

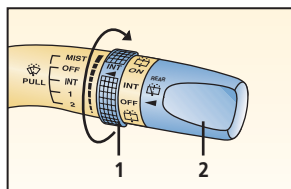

Wiper/washer control lever

Intermittent wiper: One click down

To change interval speed: Rotate inner ring (1)

Normal wiper speed: Two clicks down

Fast wiper speed: Three clicks down

Single wipe: Push stalk up

Washer: Pull stalk back

Rear window wiper/washer (5-Door/Sport Wagon)

To activate rear interval wiper: Rotate knob (2) up to INT

To activate rear normal speed wiper: Rotate knob (2) up to ON

To activate rear washer: Rotate knob (2) up for wiper/washer;

down for washer only;

release to stop

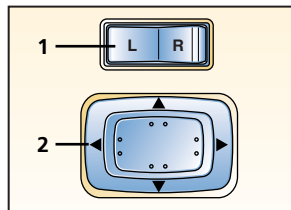

Dual power mirrors

Ignition switch must be in ACC or ON position

Switch is on driver's door

To adjust left/right mirror: Press selector switch (1) left/right, press switch (2) in direction of desired movement

Tip: To lock mirrors in place, move selector switch (1) to center position

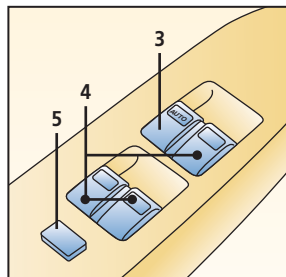

Power window switches

Ignition switch must be in ON position

All windows controlled from the driver's armrest; passenger doors have separate switches

Driver's window

One-touch-down: Push down AUTO switch (3) firmly and release, window goes down all the way; pull switch back briefly to stop; press lightly and hold for normal operation

Passenger window switches

Push switch (4) down and hold to open; pull back and hold to close

Power window lockout switch

Press button (5) down until clicks, only driver's window operates; press again and passenger windows function again

*Denotes optional equipment

Always check the Owner's Manual for more operating information and safety features

Switches

Locks

LOCKS

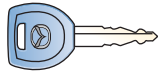

Key
Operates ignition and all locks

Tip: Use key number plate to purchase new key; store in safe place

Immobilizer system
Prevents engine from running unless coded key is used; see Owner's Manual

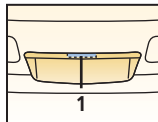

Liftgate is locked/unlocked via power door lock switch or keyless entry transmitter; pull up on handle (1) to open liftgate

Liftgate (Sport Wagon)

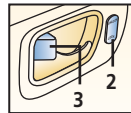

Power door locks Master front door lock switches

To lock/unlock all doors and liftgate: Press bottom/top of switch (2)
To lock doors without key: With door open, press bottom of door lock switch, exit car, close doors
To unlock: Use key to unlock driver's front door, rotate key to counter-clockwise position for more than one second to unlock other doors

Manual door locks Lock button

To lock: Press front of button (3) toward door handle
To unlock: Pull front of button away from door handle

Tip: Doors can be locked with key in ignition (chime sounds to alert you to key in ignition)

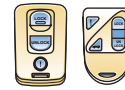

Remote keyless entry system, see Getting Started

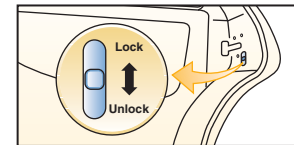

Child-safety locks

Located at the edge of rear doors

To activate: Pull tab up; door opens from outside only

To cancel: Push tab down

WARNING: Since children may access either rear door, child-safety locks for both rear doors should be activated

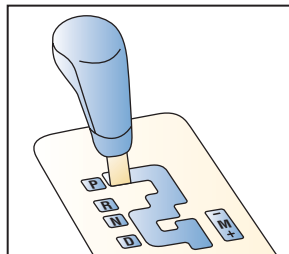

Automatic transmission*

P = Park
To move gearshift from Park: Press firmly on brake pedal
R = Reverse
N = Neutral
No gear engaged
D (Overdrive)
For normal driving: Shifts through all forward gears automatically

Tip: Torque converter lock-up improves fuel economy and can feel like an additional gear change

M (Sport A/T manual shift mode)

Move shifter from D to M to engage manual shift mode, M will be illuminated for manual mode on shift position indicator located in the instrument panel
Manual shifting of transmission is achieved by moving shifter back to upshift and forward to downshift, move shifter from M to D to engage automatic shift mode

Gear indicator (A/T only)*

Illuminated numeral of gear indicator located in the instrument panel displays current gear in Automatic and Manual shift modes

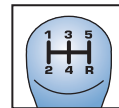

Manual transmission*

Depress clutch pedal to start engine and change gears

WARNING: Do not shift into 1st above 20 mph or clutch failure could occur

Resting your foot on clutch pedal while driving and using the clutch to hold your vehicle at a stand still while waiting on a hill may reduce clutch life

*Denotes optional equipment

Always check the Owner's Manual for more operating information and safety features

Transmission

Seats

SEATS

Shoulder belt height adjustment

To raise: Push adjuster upward
To lower: Pull button (1) and slide downward



⚠️ WARNING: Make sure adjuster locks in one of its positions

Manual controls**1. Fore-aft adjustment**

Lift lever and hold, slide seat, release lever

2. Raise/lower seat

Pull/push lever and release

3. Seatback angle

To adjust: Lift and hold lever, lean forward or backward, release lever

4. Head restraint

To raise/lower: Pull up/push in release button (8) and push down

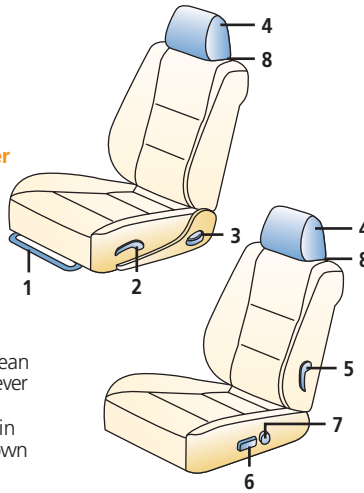
**5. Lumbar adjustment***

Pull lever (5) repeatedly up to 3 times for greater lumbar support

Power driver's seat***6. Raise/lower front of seat cushion**

Pull/push front of switch vertically

Fore/aft adjustment

Slide switch horizontally

Raise/lower rear of seat cushion

Pull/push rear of switch vertically

Raise/lower seat

Pull/push center of switch vertically

💡 Tip: Verify side air bags* by locating "SRS AIRBAG" indicator marks on outboard side of front seatbacks

7. Seatback angle

Press front/rear of switch

Folding rear seatbacks, see Trunk/Liftgate

⚠️ WARNINGS: Do not adjust seats while driving
Safety belts must always be worn when vehicle is in motion
Air bags are supplemental and do not replace safety belt usage

Always wear your safety belt and properly secure children 12 and under in the rear seat

Never place rear-facing infant-safety seat in front of any air bag, an infant is in serious danger of being injured or killed

If you must install a forward-facing child-safety seat in the front seating position, move vehicle seat as far back as possible

Use age appropriate child restraints, see Owner's Manual and state or province laws

Child-safety seat

To install in rear outboard seats: Use dual locking mode retractor seat belts; see Owner's Manual for proper installation and child seat tether and LATCH system instructions

Passenger air bag deactivation indicator light

Front air bag deactivation indicator light provides current status of front passenger air bag and pretensioner system

If total seated weight on front passenger seat is less than approximately 66 lb., front passenger air bag deactivation indicator light illuminates, air bag/pretensioner will not deploy/activate in an accident

If the total seated weight is greater than approximately 93 lb., light does not illuminate, and the air bag/pretensioner will deploy/activate in an appropriate accident,

see Owner's Manual for additional information on this feature and the air bag system

Safety belt emergency locking mode

Belts lock only on hard acceleration, braking, cornering or impacts of about 5 mph or more

Automatic locking mode (front passenger and all rear safety belts only)

Must be used when installing child-safety seat

To activate: Pull webbing fully out of retractor until click is heard; belt will only tighten

To disengage: Unbuckle belt and allow webbing to retract fully

Rear center position seat belt

5-Door: Seat belt stowage located behind left side head rest
Sport Wagon: See Getting Started

*Denotes optional equipment

Always check the Owner's Manual for more operating information and safety features

Seats

Climate Controls

CLIMATE CONTROLS

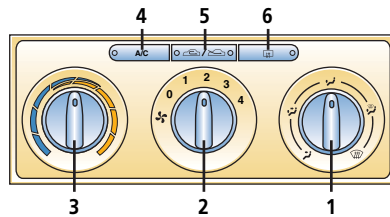

Manual A/C

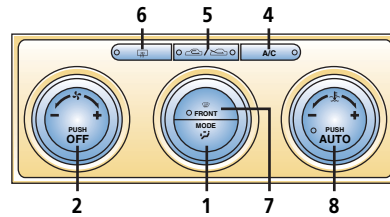

Automatic A/C**

1. Air flow selections

- = air to dash
- = air to dash and floor
- = air to floor
- = air to floor and windshield
- = air to windshield (defrost)
(Manual Climate Control)

5. Air intake control

- = recirculate inside air; use for maximum cooling
- = fresh air

⚠ WARNING: Do not use position in cold weather, windows may fog and hamper vision

7. Windshield defroster switch

Press: Fresh air position is automatically selected, A/C automatically turns ON

Control positions for maximum defrost

Fan to maximum, temperature to maximum hot, selected

☀ Tips: To help prevent windshield fogging in humid weather, select before starting engine

2. Fan control

Rotate knob clockwise/ counterclockwise to increase/ decrease fan speed

3. Temperature control

Cooler/warmer = rotate knob counterclockwise/clockwise

4. A/C = air conditioner

Press to turn on/off

6. Rear window defogger

Press on/off; shuts off with ignition or automatically after 15 minutes of operation; also operates heated side mirrors*

☀ Tip: The word "heated" is imprinted on glass reflector of side mirrors, this indicates they are heated

To prevent moisture buildup, never drive with system off

Objects placed under the front seats may interfere with air flow to the rear

Automatic operation

Press AUTO (8) for automatic operation; rotate outer dial to set temperature, see Owner's Manual

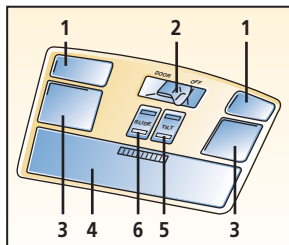

1. Map/reading light switch

Press on/off

2. Interior light switch

DOOR = light on when door open
OFF = light always off

3. Interior map/reading light

4. Sunglass holder

Press concaved lip to open

5. Sunroof tilt switch*

Press rear of switch to tilt rear of sunroof
Press front of switch to close

6. Sunroof slide switch*

Press rear of switch to open sunroof
Press front of switch to close

Illuminated visor mirrors

Mirrors lighted when covers open; off when closed

*Denotes optional equipment

**Standard on all V6 models (all body styles)

Always check the Owner's Manual for more operating information and safety features

Interior Lights

Audio
Systems

AM / FM STEREO / CASSETTE / CD / MD

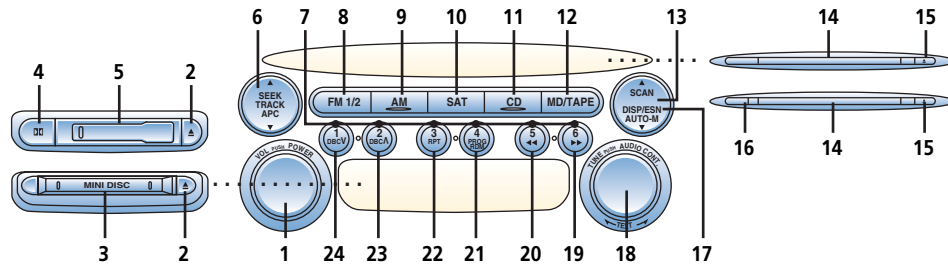

Tips: Always remove antenna before entering a car wash
To remove antenna; rotate counter-clockwise; to install rotate clockwise

1. Power/Volume

Press to turn on/off; rotate to increase/decrease volume

2. Eject button***3. Mini Disc slot*****4. Dolby® Noise Reduction***

Reduces tape noise and hiss; press to activate/deactivate

5. Cassette door***6. SEEK/TRACK/APC**

Radio: Press \wedge / \vee to automatically seek higher/lower frequency

CD: Press \wedge / \vee to select next/previous track

Tape: Press \wedge / \vee to automatically advance tape to beginning of next selection/replay selection; to stop this operation, press button again

7. Memory preset buttons

To set: Tune to station, press and hold until beep sound is heard

*Denotes optional equipment

**Standard audio system only

†For use with cassette tape player, MD player, or CD changer*

††SAT button is standard but requires SIRIUS subscription/additional hardware

8. FM1/2

Press to select between FM1/FM2 station preset buttons (7)

9. AM

Press to select AM frequency band

10. SAT†† Satellite ready capability**11. CD** Press to play CD**12. MD*/Tape***

Press to play Mini-disc Player/cassette tape

18. Tuning/Audio Control

Tune: Rotate counterclockwise/clockwise for lower frequency/higher frequency

Audio control: Press to select BASS/MID**/TREBLE/FADE/BALANCE/ALC (Automatic level control) can be turned on and off; rotate right/left to adjust selected feature

13. Scan/Auto-Memory

Press to briefly sample next listenable selections; functions in all modes

Radio: Press and hold until a beep sound is heard; system automatically scans and temporarily stores six strong stations in each band; press again to cancel

14. CD slot**15. CD eject button****16. LOAD***

To load multiple discs: Press and hold LOAD (16) until beep sound is heard; insert CD when "In" is displayed

To eject disc: Press Eject (15) To eject specific disc: Press and hold Eject (15) until beep sound is heard; within five seconds press the desired tray number 1-6 (7)

17. DISP*

Press: Changes display during MD play

ALC ON = Audio volume decreases/increases with vehicle speed

ALC OFF = Audio volume never changes, stays where set

19. Fast forward $\blacktriangleright\blacktriangleright$

Press to fast forward through a track

20. Reverse $\blacktriangleleft\blacktriangleleft$

Press to reverse through a track

21. Program Random†

Press to enable/cancel random play

22. Repeat

Press to replay current CD/tape selection

23. Disc up \wedge †

Press to skip forward to beginning of next CD

24. Disc down \vee †

Press to skip back to beginning of previous CD

Always check the Owner's Manual for more operating information and safety features

Audio
Systems

HomeLink®

HOMELINK®

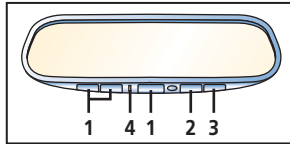
**HomeLink® Wireless Control System***

Located on rear view mirror HomeLink® provides three programmable buttons that will replace three hand-held device transmitters

Tip: It is recommended to park outside of garage when programming HomeLink®

WARNING: When programming a garage door or gate opener, disconnect power to these devices before programming, continuous operation of these devices could damage the motor

To program or reprogram: Press and hold two outer HomeLink® buttons (1) for 20 seconds and no more than 30 seconds, release only after indicator light (4) begins to flash; hold transmitter for the device to be programmed between 1-3 inches to HomeLink®; press transmitter button and desired HomeLink® button (1) simultaneously until HomeLink® indicator light (4) goes from slow to rapid flashing. Verify device operation by pressing HomeLink® button (1) that was just programmed

Tip: You do not need to repeat the first step to program the other two hand-held transmitters for the remaining HomeLink® buttons

Rolling code synchronization procedure

Refer to your garage door opener or device instruction manual to confirm your system is equipped with a rolling code feature

Tip: This procedure is easier to perform with the assistance of another person

To synchronize: Press programming button on garage door opener motor; press/hold for 2 seconds and release the programmed HomeLink® button 2 times within 30 seconds of pressing the garage door opening motor programming button

Some devices may require you to press/hold and release a third time to complete programming procedure. If indicator light stays on, programming is complete

For further information, contact HomeLink® at **1-800-355-3515**, **www.homelink.com** or your authorized Mazda Dealer

To erase all existing programming; press and hold two outer HomeLink® buttons (1) on mirror, continue to hold buttons until indicator light flashes

Auto-dimming rear view mirror

Auto-dimming function changes are based on outside lighting conditions and if bright headlights are visible in rear view mirror

Press on (2), off (3)

Gas cap

After filling vehicle with gasoline, fully reinstall gas cap by turning clockwise until a clicking sound is heard, if gas cap is not fully installed, Check Engine light may come on

For more information on Check Engine light, see Owner's Manual

Anti-lock Braking System (ABS)

ABS automatically reduces hydraulic pressure to any wheel on the verge of locking up. You may feel a slight pulsing of the brake pedal and hear a clicking noise; this tells you the ABS is functioning properly; increase pressure on pedal for maximum braking

Tip: Maintain constant pressure on the brake pedal. Do not pump the brakes

ABS self test

A self-diagnostic test is performed when starting; you may feel some brake pedal pulsation and hear some noise, this is normal

Traction Control System (TCS)

Enhances traction and safety by regulating engine torque. When TCS detects drive wheel slippage it lowers engine torque to prevent loss of traction

*Denotes optional equipment

Always check the Owner's Manual for more operating information and safety features

Driving
Tips

Trunk/
Liftgate

TRUNK / LIFTGATE

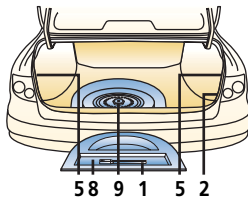

Mazda6 Sedan

1. Lug wrench
2. Jack
Remove cover panel to access
3. Cargo light
4. Cargo securing loops
5. Rear seatback remote handle levers
6. Seatback release buttons
7. Cargo area cover

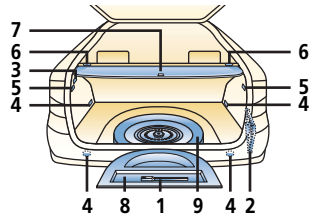

Mazda6 5-Door

- Split rear folding seatback (Sedan)**
Unfasten the lap portion of the rear center seat belt, pull rear seatback remote handle levers (5) To raise seatback: Push seatback firmly until latched, re-attach center belt

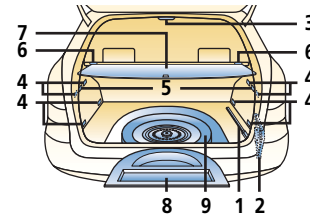

Mazda6 Sport Wagon

- Luggage compartment internal safety release (Sedan)**
 Allows you to escape should you become locked in trunk. Slide illuminated release lever in direction of arrow; lever will glow if it has been exposed to light. Located on interior trunk lid.

8. Sub-compartment cover
Lift carpet, disconnect sub-woofer wire connector, remove cargo sub-compartment cover, remove sub-woofer, remove spare tire (Sedan not equipped with sub-woofer)
9. Temporary spare tire
Stored under panel in trunk

Folding rear seatbacks flat (5-Door/Sport Wagon)

Unfasten rear seat belt, pull handle levers (5) on left/right side or press seatback release buttons (6) support seatback; then fold seatback forward

To raise seatback: Lift seatbacks upward until firmly locked, properly fasten rear seat belts, then check that seat belts are routed properly for passenger use

Tire economy and tips

Check pressure regularly when tires are cold, maintain correct front-end alignment and tire balance; rotate tires every 7,500 miles

Tire pressure

P215/50R17 93V,
P205/60R16 91V (Sedan only)
Front/rear: 32psi cold

 **Tip: Correct tire pressure promotes safe handling and ride comfort**

Tire chains†

Tire chains cannot be used on this vehicle, interference with vehicle body and scratching could occur

*Denotes optional equipment
† See Owner's Manual

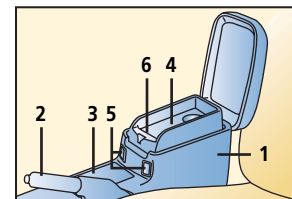

1. Console
2. Parking-brake lever
To engage: Pull up
To release: Pull up slightly while depressing button at front of lever, lower hand brake lever
3. Cup holder
4. Storage
5. Heated seats*
Press on/off switch; indicator light on when activated
6. Accessory socket

Always check the Owner's Manual for more operating information and safety features

Trunk/
Console

Under Hood

UNDER HOOD

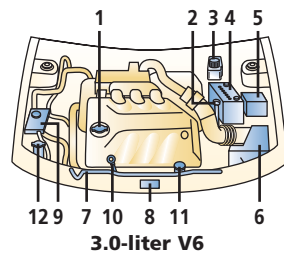
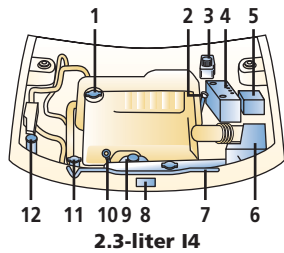

- 1. Engine oil filler cap**
SAE 5W-20
 - 2. Automatic transmission fluid (ATF) dipstick***
See Owner's Manual
 - 3. Brake/Clutch* fluid reservoir**
Fill to MAX mark with DOT 3 fluid; check with cap on
 - 4. Battery**
 - 5. Fuse block**
 - 6. Air filter**
 - 7. Hood support rod**
 - 8. Hood latch**
Push hood latch to the left, open hood
 - 9. Engine coolant reservoir**
Level should be between FULL and LOW markings when cold
 - 10. Engine oil dipstick**
Check with engine off after approximately 5 minutes and at operating temperature; fluid level should be between MAX and MIN markings on dipstick
 - 11. Power steering fluid reservoir**
Check with engine off and at normal temperature; fill to MAX mark
 - 12. Windshield washer reservoir**
Fill with windshield washer fluid
- ⚠ WARNING: Never remove coolant reserve tank cap while engine is running or hot; you could get burned**

Break-in period

First 600 miles:
Drive at varying road and engine speeds; avoid full throttle, rapid acceleration or kick-down of transmission

Unique driving conditions†

Every 5,000 miles change oil/filter, inspect coolant level, lights, brake/clutch fluid, tire pressure/wear, power steering fluid, locks/hinges and washer fluid

NORMAL SERVICE INTERVALS

7,500 miles	A
15,000 miles	A B
22,500 miles	A
30,000 miles	A B C
37,500 miles	A D
45,000 miles	A
52,500 miles	A
60,000 miles	A B C E
67,500 miles	A
75,000 miles	A F
82,500 miles	A
90,000 miles	A
105,000 miles	G

Normal maintenance notes

Rotate tires every 7,500 miles or sooner if needed; replace cabin air filter every 25,000 miles or 24 months

- A.** Change: Engine oil/
replace filter
Lube: Locks and hinges
- B.** Inspect: Disc brakes
- C.** Inspect: Drive belts (3.0 liter), fuel lines and hoses, brake lines, hoses and connections, steering operation and linkages, front suspension ball joints, driveshaft dust boots, inspect exhaust system and heat shields every 45,000 miles and cooling system
- D.** Inspect: Drive belts (2.3 liter)
Replace: Air filter
- E.** Inspect: Hoses and tubes for emission system
- F.** Replace: Spark plugs
Inspect: Engine valve clearance (2.3 liter), adjust if noisy
- G.** Replace: Engine coolant

* Denotes optional equipment
† See Owner's Manual

Always check the Owner's Manual for more operating information and safety features