

## ROADSIDE ASSISTANCE/WARRANTY

### **Mazda Roadside Assistance**

Exhilaration, liberation and inspiration, are great reasons to drive a Mazda car, truck, SUV or minivan. In addition to all the other great standard features, you also get peace of mind with our basic warranty period Emergency Roadside Assistance Plan, it's just a phone call away, 24 hours a day, 365 days a year, call **1-800-866-1998**.

### **Mazda "bumper-to-bumper" Limited Warranty**

We design and build every Mazda to give you driving pleasure now and far down the road. We're so confident in our quality that we cover the entire vehicle against defects in materials and workmanship for 36 months/36,000 miles, whichever comes first, plus we provide a powertrain warranty for 60 months/60,000 miles, whichever comes first.

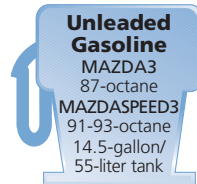

### **Lower Octane Fuel Usage**

If 91 octane fuel is not available, fuel as low as 87 octane can be used temporarily for emergency purposes, use of fuel lower than 91 octane can decrease performance and deteriorate shift quality, refueling vehicle with correct octane fuel a couple of times will restore vehicle performance and shift quality.

This Quick Tips® guide is provided by Mazda North American Operations to make your Mazda ownership experience more convenient. It is not intended to replace your Owner's Manual. If you have any questions about your vehicle, you are invited to contact your local dealer. Or if you need additional help, feel free to call our **Customer Assistance Center at 1-800-222-5500**

Monday through Friday,  
8 a.m.-4:45 p.m., Pacific  
9 a.m.-5:45 p.m., Eastern/Central



©2006 Calcar, Quick Tips® is a trademark of Calcar, made in USA 2/06 102.195M DOT Mazda North American Operations reserves the right to change product specifications at any time without incurring obligations. 9999-95-038C-07QT

2007

## MAZDA3/ MAZDASPEED3

Quick Tips®

Reference  
Guide for  
Controls and  
Functions



## DRIVER'S VIEW

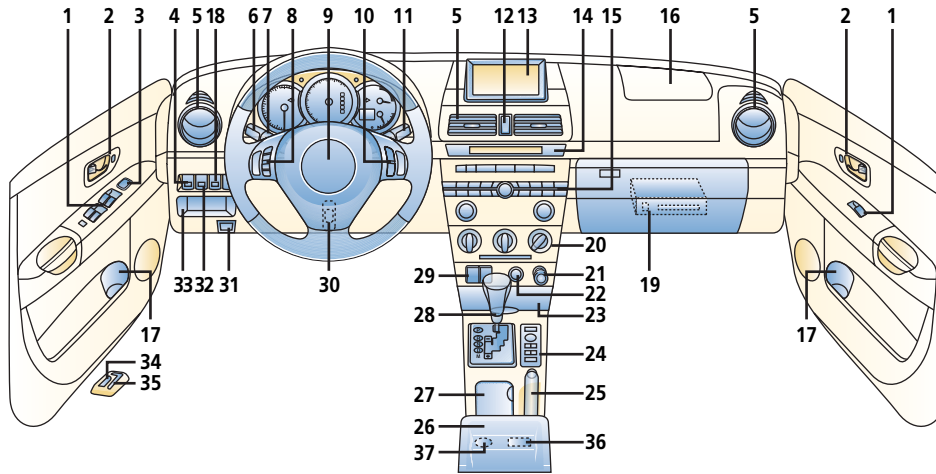

- |  |   |   |
|--|---|---|
| <p><b>1. Power window switches*</b>, see Windows/Mirrors</p> <p><b>2. Door locks*</b>, see Locks</p> <p><b>3. Mirror controls*</b>, see Windows/Mirrors</p> <p><b>4. Xenon headlight leveling switch*</b>, see Getting Started</p> <p><b>5. Air vents</b></p> <p><b>6. Turn signal/lighting control lever</b>, see Getting Started</p> <p><b>7. Fog light switch*</b>, see Getting Started</p> <p><b>8. Audio control switches*</b>, see Getting Started</p> <p><b>9. Horn/Air bag</b>, To beep: Press</p> <p><b>10. Cruise control*</b>, see Getting Started</p> <p><b>11. Wiper/washer control lever</b>, see Getting Started</p> <p><b>12.  Hazard warning switch</b> Push to activate/deactivate</p> <p><b>13. NAVI display*</b>, see Owner's Manual</p> | <p><b>14. Information display/trip computer*</b>, see Information Display</p> <p><b>15. Audio system</b>, see Audio Systems</p> <p><b>16. Passenger air bag</b></p> <p><b>17. Bottle holder</b><br/> <b>CAUTION: Use plastic bottles with caps, cups may spill when door is closed</b></p> <p><b>18.  Traction Control/Dynamic Control System off*</b>, see Driving Tips</p> <p><b>19. NAVI DVD*</b></p> <p><b>20. Climate control panel</b>, see Climate Controls</p> <p><b>21. Cigarette lighter</b></p> <p><b>22. Passenger air bag off indicator</b>, see Getting Started</p> <p><b>23. Ashtray</b></p> <p><b>24. NAVI remote control*</b></p> <p><b>25. Parking-brake lever</b></p> <p><b>26. Center console</b></p> | <p><b>27. Cup holder</b><br/> <b>Tip: Rear cup holders located in rear center armrest</b></p> <p><b>28. Gearshift lever</b>, see Transaxle</p> <p><b>29. Heated seats*</b><br/>Press on/off</p> <p><b>30. Tilt/telescopic steering wheel lever</b>, see Getting Started</p> <p><b>31.  Hood release handle</b><br/>Pull release handle to unlock</p> <p><b>32.  Instrument cluster lighting</b>, see Getting Started</p> <p><b>33. Storage</b></p> <p><b>34.  Fuel-filler lid release</b><br/>To open: Pull lever up</p> <p><b>35.  Remote trunk-lid release (4-Door only)</b><br/>To open: Pull lever up</p> <p><b>36. Auxiliary jack</b></p> <p><b>37. Accessory socket</b><br/>*Denotes optional equipment</p> |
|--|---|---|

Always check the Owner's Manual for more operating information and safety features

Driver's View

## GETTING STARTED

**Getting Started**

**MAZDA3/MAZDASPEED3 Quick Tips®** are designed to quickly familiarize you with some important features of your MAZDA3/MAZDASPEED3

The Driver's View tab is your index to the Quick Tips®, locate the item you would like to learn more about and then turn to the listed tab

This Getting Started section contains important operating tips about your MAZDA3/MAZDASPEED3

Items identified in blue text call out important information

**MAZDASPEED3 Turbocharger tips**

To get maximum performance from your turbocharged engine, take note of the following:

Use 91 octane or above premium unleaded gasoline only, extra fuel additives are NOT recommended

Change engine oil and filter every 7,500 miles, or sooner if needed, see Owner's Manual

Use engine oil with API SL or ILSAC GF-3 service grade or higher, extra oil additives are NOT recommended

After driving at freeway speeds or up a long hill, idle engine at least 30 seconds to cool turbo, avoid shutting engine off abruptly after a hard or long drive, turbocharger damage may result otherwise

Do NOT race or over-rev ANY engine when starting, particularly a turbocharged engine

Do NOT add aftermarket devices to alter the engine's ignition, fuel delivery, or turbo boost pressure, this may lead to serious engine damage and void your warranty

**Tire Pressure Monitoring System (TPMS)**

Warning light illuminates for a few seconds with ignition on. If tire pressure is low, warning light illuminates with audible beep sound, adjust tire pressure to correct specifications, perform tire pressure adjustment before driving, a digital tire pressure gauge is recommended. Flashing warning light may indicate malfunction, dealer inspection required

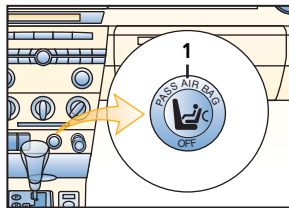
**Passenger air bag deactivation indicator light**

Front air bag deactivation indicator light (1) provides current status of front passenger air bag and pretensioner system

If total seated weight on front passenger seat is less than approximately 66 lb., front passenger air bag deactivation indicator light illuminates, air bag/pretensioner will not deploy/activate in an accident

If the total seated weight is greater than approximately 93 lb., light does not illuminate, and the air bag/pretensioner will deploy/activate in an appropriate accident

See Owner's Manual for additional information on this feature and the air bag system

**Passenger sensing operation**

See Driver's View

Passenger air bag deactivation indicator on dash will illuminate when passenger air bag is deactivated, child-restraint seat with child that weighs a combined total of 66 lbs. or less will deactivate front passenger air bag/pretensioner

See Owner's Manual

**⚠ WARNINGS: Even with a deactivation system, never place rear-facing infant-safety seat in front of any air bag, an infant is in serious danger of being injured or killed**

**If you must install a forward-facing child-safety seat in the front seating position, move vehicle seat as far back as possible**

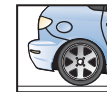
**Fuel filler door**

Located on passenger side

\*Denotes optional equipment

Always check the Owner's Manual for more operating information and safety features

## GETTING STARTED

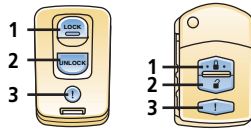
**Remote entry system\***

Functions only with ignition key not inserted

To lock doors: Press LOCK (1); pressing again within 5 seconds causes doors/liftgate to re-lock, horn to beep once and hazard warning lights to flash once if doors/liftgate properly closed

To unlock: Press UNLOCK (2) for driver's door, hazard warning lights will flash twice, press again within 5 seconds for all other doors

Panic alarm: Press ! (3); horn sounds, parking lights flash; press any button on transmitter to stop

After unlocking with the transmitter, all doors or the liftgate will automatically lock if a door or the liftgate is not opened within about 30 seconds

**HID headlights leveling switch\***

Adjusts headlight angle to compensate for weight of passengers and cargo, see Owner's Manual

**Instrument panel lighting**

*With headlights ON:*  
To brighten/dim turn thumbwheel up/down



*Headlights/parking lights ON, ignition key must be ON:* Illumination changes brightness

when dimmer switch (4) is pressed (if equipped with black-out meter)

*With headlights OFF†, key ON:* Press instrument cluster dimmer select button (4) to select between 5 brightness settings for instrument cluster

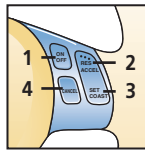
**Cruise control\***

Operates above 19 mph  
Press MAIN (1) to turn system on/off

To set speed: Accelerate to desired speed and press SET/COAST (3)

To accelerate: Press and hold RES/ACCEL (2); release button at desired speed

To decelerate: Press and hold SET/COAST (3); release button at desired speed

Incremental acceleration: Press and release (2); each tap = plus 1 mph

Incremental deceleration: Press and release (3); each tap = minus 1 mph

To cancel: Press CANCEL (4) or MAIN (1); tap brake pedal or depress clutch pedal\*

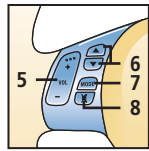
**Steering-wheel audio controls\***

To increase/decrease volume: Press (5)

Radio: Press ▲ / ▼ (6) less than one second to select next/previous preset station, press ▲ / ▼ (6) more than one second until beep sound is heard to seek next/previous station

Cassette\*/CD: Press ▲ (6) to select next selection/track, press ▼ (6) to repeat current selection/track

Press (7) to select FM1, FM2, AM, SAT 1\*, 2\*, 3\*, CD, Cassette\* and other media devices plugged into auxiliary jack (auxiliary jack located in center console, see Driver's View)

Press (8) to mute audio/NAVI system

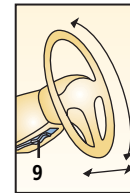
**Tilt/telescopic steering-wheel lever**

Pull lever (9) down to unlock column, position tilt angle and length of steering column position

**Tip:** Telescopic function allows steering wheel to be adjusted closer or farther according to driver's reach

**WARNING:** Do not adjust steering-wheel while driving

\*Denotes optional equipment  
† See Owner's Manual

Always check the Owner's Manual for more operating information and safety features

GETTING STARTED

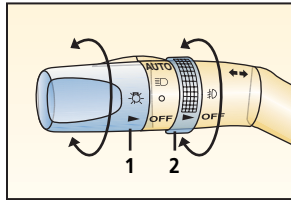

**Turn signal/lighting control lever**

**OFF** = Lights off

○ = Tail, parking and dashboard lights on: Rotate knob (1) to first notch

☐ = Tail, parking, dashboard and headlights on: Rotate knob (1) to second notch

**AUTO\*** = With ignition switch in ON position; headlights and exterior lights automatically turn ON/OFF depending on surrounding darkness/lightness; rotate knob (1) to third notch

High beams on/off: Push forward/pull back to detent  
To flash high beams: Pull back slightly and release  
Turn signals right/left: Move lever up/down  
☐ = Fog lights\* on: Rotate (2); functions only with headlight low beams on

**Tip: Headlights switch off, parking lights remain on, if lights are left on and switch is in lock position or key removed**

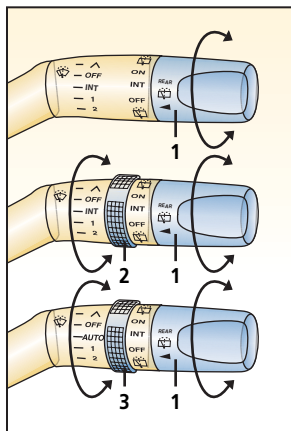

**Wiper/washer control lever**

Single wipe: Push lever up

Washer: Pull back, also operates wipers

Intermittent wiper: One click down

To change interval speed:

Rotate inner ring\* (2)

Normal wiper speed: Two clicks down

High-speed wiper: Three clicks down

Auto\*: One click down

Rain sensor senses rain amount on windshield, then controls wiper automatically

Rain sensor sensitivity is adjusted from high sensitivity (+) to less sensitivity (-) by rotating ring (3)

**Rear window wiper/washer (5-Door only)**

To activate rear interval wiper: Rotate knob (1) up to INT

To activate rear normal speed wiper: Rotate knob (1) up to ON

To activate rear washer: Rotate knob (1) to ☐ and release

\*Denotes optional equipment

Always check the Owner's Manual for more operating information and safety features

## Instrument Cluster

### INSTRUMENT CLUSTER

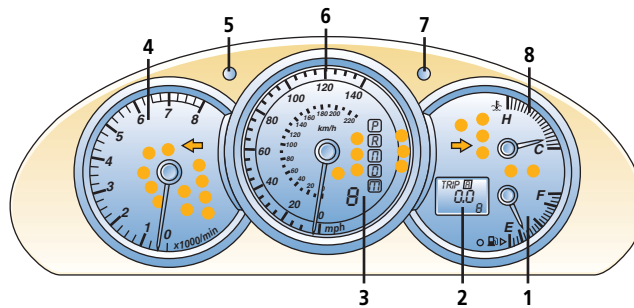

#### GAUGES

- 1. Fuel gauge**  
15-gallon/55-liter tank (2.0L and 2.3L engines)
- 2. Odometer/Trip meter**
- 3. Gear indicator (A/T only)\***  
Displays current gear position
- 4. Tachometer**
- 5. Instrument cluster dimmer select button\*,**  
see Getting Started
- 6. Speedometer**
- 7. Odometer/Trip meter selector**  
Press to view odometer; press again to reset trip odometer A/B settings
- 8. Engine coolant temperature gauge**  
Stop car if above normal range, turn off engine, let vehicle cool; check coolant level when safe

#### WARNING LIGHTS

- **CRUISE Cruise control on\*,**  
Amber light: Cruise control system activated  
Green light: Cruising speed set; see Getting Started
- **(T) Tire Pressure Monitoring System (TPMS)\*,**  
see Getting Started
- **↔ Turn signals/hazard warning on**
- **☰ High beams on**
- **🛑 Engine oil-pressure warning light**  
Stop car when safe and turn off engine; check oil level
- **(P) Brake system**  
Parking brake on/low brake fluid
- **🚗 Always fasten seat belts**
- **🚗 Security indicator light\***
- **☞ Lights on**
- **⚡ Charging system warning light**  
Charging system malfunction; dealer inspection required
- **🚒 Air bag/front seat belt pretensioner system**  
If light flashes or stays on, the air bags/front seat belt pretensioners may not operate in an accident; dealer inspection required
- **🚗 Dynamic Stability Control (DSC)\*,**  
see Driving Tips
- **DSC OFF Traction Control/ Dynamic Control System off\***
- **🚪 Door ajar**
- **⚠️ Power steering malfunction**  
Dealer inspection required if light remains on
- **🔧 Check engine**  
Dealer inspection required
- **⊖ Low fuel**
- **AT Automatic transaxle warning light\***  
Automatic transaxle malfunction; dealer inspection required
- **🛑 Anti-lock Brake System (ABS)\***  
ABS malfunction, normal brakes only; dealer inspection required
- **🚗 Low washer fluid level warning light**

\*Denotes optional equipment

Always check the Owner's Manual for more operating information and safety features

Instrument Cluster

## Locks

### LOCKS

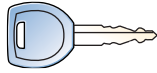

**Key**  
Operates ignition and all locks

 **Tip: Use key number plate to purchase a new key; store in safe place separate from vehicle**

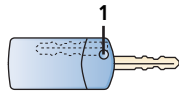

**Retractable key**  
To fold/unfold press release button (1)

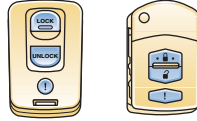

**Remote entry system\***  
See Getting Started

**Immobilizer system**  
Prevents engine from running unless coded key is used, see Owner's Manual

**Illuminated entry system**  
Activates interior lights when dome light switch set to DOOR position; lights off after driver's door is locked or ignition in ON position

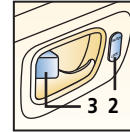

**Power door locks\***  
**Master front door locks switches**

To lock/unlock all doors: Press bottom/top of switch (2)  
To lock doors without key: With door open, press bottom of door lock switch, exit car, close doors  
To unlock: Use key to unlock driver's front door, rotate key to counterclockwise position for more than one second to unlock other doors

**Manual door locks Lock button**  
To lock: Press front of button (3) toward door handle  
To unlock: Pull front of button away from door handle

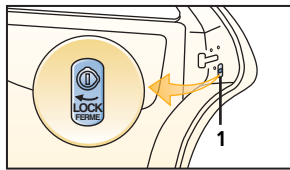

**Child-safety locks**  
Located at the edge of rear doors  
To activate: Rotate childproof lock (1) in direction of arrow using key tip (doors open from outside only); rotate in opposite direction to deactivate

 **WARNINGS: Since children may access either rear door, child-safety locks for both rear doors should be activated. Never leave a child in car with key in the vehicle**

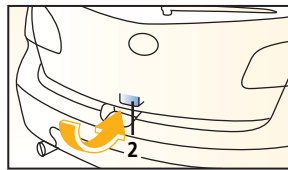

**Liftgate**  
To open: Pull up on handle (2) and raise  
To close: Push liftgate down with both hands until it securely locks; do not slam liftgate



**Luggage compartment internal safety release**

Allows you to escape should you become locked in trunk

Slide illuminated release lever in direction of arrow; lever will glow if it has been exposed to light  
Located on interior trunk lid

\*Denotes optional equipment

Always check the Owner's Manual for more operating information and safety features

Locks



## Windows/ Mirrors

### WINDOWS/MIRRORS

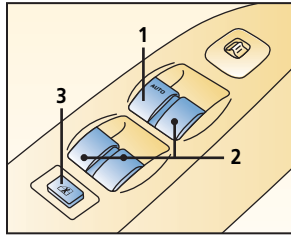

#### Power windows\*

Ignition must be on  
All windows controlled from the driver's armrest; passenger doors have separate switches

**1.** Driver's window: One-touch-down; push down firmly and release, window goes down all the way; pull switch back briefly to stop; press lightly and hold for normal operation

**2.** Passenger window switches: Push down and hold to open, pull back and hold to close

**3.** Power window lockout switch: Press down until it clicks, only driver's window operates; press again and passenger window switches function again

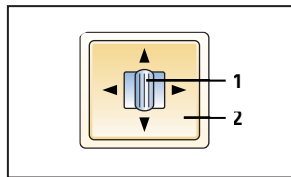

#### Dual power mirrors\*

Ignition must be in ACC or ON  
To adjust left/right mirror: Press control switch (1) left/right, press switch (2) in direction of desired mirror movement

 **Tip: To lock mirrors in place, move control switch to center position**

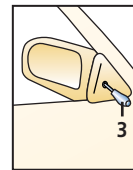

#### Manual mirrors

To adjust: Move knob (3) on door

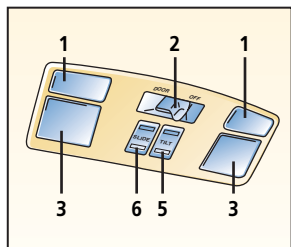

**1. Map/reading light switch\***

Press on/off

**2. Interior light switch**

DOOR = light on when door open

ON = light always on

OFF = light always off

**3. Front interior light**

**4. Rear interior light**

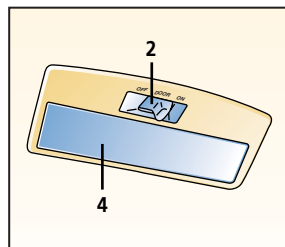

**5. Moonroof tilt switch\***

Press rear of switch to tilt rear of moonroof

Press front of switch to close

**6. Moonroof slide switch\***

Press rear of switch to open moonroof

Press front of switch to close

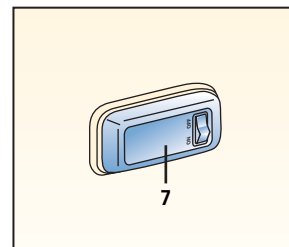

**7. Cargo light\* (5-Door)**

ON = Light always on

OFF = Light always off

**Cargo light\* (4-Door)**

Light on with trunk open

See Trunk/Cargo Area

**Driver/passenger covered visor mirrors**

To access mirror: Lower visor

\*Denotes optional equipment

Always check the Owner's Manual for more operating information and safety features

Interior  
Lights



SEATS

**Shoulder belt height adjustment**

To raise:  
Push adjuster upward

To lower:  
Pull button (1) and slide downward

**⚠ WARNING: Make sure adjuster locks in one of its positions**

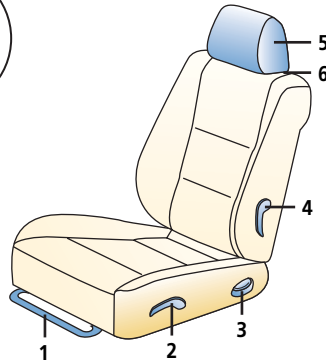
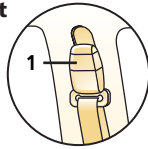

**Seat controls**

**1. Fore-aft adjustment**

Lift lever and hold, slide seat, release lever

**2. Raise/lower seat (Driver's seat only)**

Pull/push lever and release

**3. Seat back angle**

To adjust: Lift and hold lever, lean forward or backward to tilt seat, release lever

**4. Lumbar support adjustment\* (Driver's seat only)**

Pull lever forward

**5. Head restraint**

To raise/lower: Pull up/hold release button (6) and push down

**☀ Tip: Side-impact air bags\* deploy from outboard side of front seatbacks**

**⚠ WARNINGS: Do not adjust seats while driving**

**Safety belts must always be worn when vehicle is in motion**

**Air bags are supplemental and do not replace safety belt usage**

**Always wear your safety belt and properly secure children 12 and under in the rear seat**

**Even with a deactivation system, never place rear-facing infant-safety seat in front of any air bag, an infant is in serious danger of being injured or killed**

**If you must install a forward-facing child-safety seat in the front seating position, move vehicle seat as far back as possible**

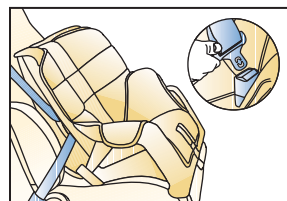

**Child-safety seat**

To install in rear outboard seats: Use dual locking mode retractor seat belts; see Owner's Manual for proper installation and child seat tether and LATCH system instructions

**⚠ WARNING: Use age appropriate child restraints, see Owner's Manual and state or province laws**

**Safety belt emergency locking mode**

Belts lock only on hard acceleration, braking, cornering or impacts of about 5 mph or more

**Automatic locking mode (front passenger and all rear safety belts only)**

Must be used when installing child-safety seat

To activate: Pull belt fully out of retractor, allow belt to retract until click is heard; belt will only tighten

To disengage: Unbuckle belt and allow belt to retract fully

\*Denotes optional equipment

**Always check the Owner's Manual for more operating information and safety features**

## Rear Seats

### REAR SEATS

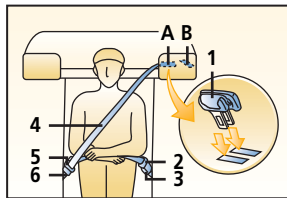

#### Rear center position seat belt†

Pull seat belt (1) from recess located behind head restraint (A) (4-Door) or left side of cargo area (B) (5-Door): Slide tongues with finger while moving upward. Fastening seat belt: Tongue (2) and anchor (3) must be fastened,

then slowly pull out lap/shoulder belt (4) and insert tongue (5) into buckle (6) until click is heard. Unfastening seat belt: Depress buckle button to release. Stowing seat belt: Retract belt, put tongues (2) and (5) together, insert securely into recess (A or B).

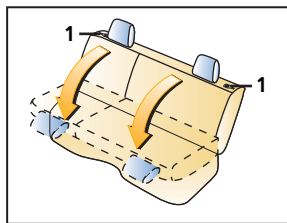

#### Split fold-down rear seatbacks

To fold: Push release knob (1), push seatback down. To return and lock: Push seatback firmly until latched, make sure seatbelts are returned to original positions.

**Tip:** 4-Door has seatback locks as part of trunk security.

**WARNING:** Lower seatback slowly using both hands, seatback is heavy and could cause personal injury.

**Tip:** Rear cup holders located in rear center armrest.

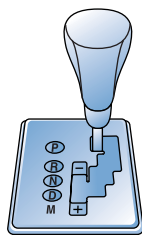

#### Automatic Transaxle\*

Gearshift must be in Park or Neutral to start engine; it must be in Park to remove ignition key.

#### P = Park

To move gearshift from Park: Press firmly on brake pedal then move the shift lever out of P.

#### R = Reverse

**N = Neutral**  
No gear engaged

#### D Drive (Overdrive)

For normal driving: Shifts through all forward gears automatically.



#### M (Sport A/T manual shift mode)

Move shifter from D to M to engage manual shift mode, M will be illuminated for manual mode on

shift position indicator located in the instrument panel.

Manual shifting of transmission is achieved by moving shifter back to upshift and forward to downshift, move shifter from M to D to engage automatic shift mode.



#### Gear indicator (A/T only)\*

Illuminated numeral of gear indicator located in the instrument panel displays current gear in Automatic and Manual shift modes.

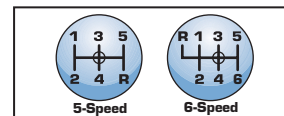

#### Manual transaxle

Depress clutch pedal to start engine and change gears.

**Tip:** Do not shift into 1st above 20 mph or clutch failure could occur.

**6-Speed manual transaxle:** To engage in reverse, push shift lever down and move towards "R" position.

#### Ignition key release button (M/T only)

Press button (1) to remove key from ignition.

\* Denotes optional equipment  
† See Owner's Manual

Always check the Owner's Manual for more operating information and safety features

## Transaxle

## Climate Controls

### CLIMATE CONTROLS

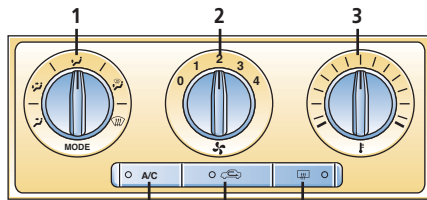

Manual

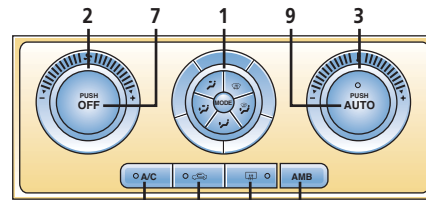

Automatic\* 6

#### 1. Air flow selections

- = air to dash
- = air to dash and floor
- = air to floor
- = air to floor and windshield
- = defrost, air to windshield

#### 2. Fan control

Rotate knob right/left to increase/decrease fan speed

#### 6. Air Conditioning\*

Press to activate/deactivate

**Tip:** With air flow switch in floor position and defrost positions or : A/C turns ON, air intake switches to fresh air

#### 7. OFF

Press (7) to turn system off (Automatic System), rotate knob (2) to 0 (Manual System)

#### Automatic operation

Press AUTO (9) for automatic operation; rotate dial to set temperature, see Owner's Manual

**Tip:** Automatic climate control display viewed via information display, see below

#### 3. Temperature control

Rotate knob to blue for cool, red for warm

#### 4. Rear window defogger

Press to activate/deactivate

#### 5. Air intake control

Press to select recirculated (indicator light on) or outside (indicator light off) air mode

**WARNING:** Do not use recirculated air mode in cold weather; windows will fog and hamper vision

#### 8. AMB\*

Press to display ambient temperature, press again to switch display to temperature set for air conditioner

**Tip:** With audio system ON, temperature display can be switched between Centigrade and Fahrenheit or vice versa by pressing audio POWER button and MEDIA button and holding both for five seconds or more

#### Control positions for maximum defrost

Fan to maximum, temperature to maximum hot, air flow selector knob to

**Tips:** To help prevent windshield fogging in humid weather, select before starting engine. To prevent moisture buildup, never drive with A/C system off. Objects placed under the front seats may interfere with air flow to the rear

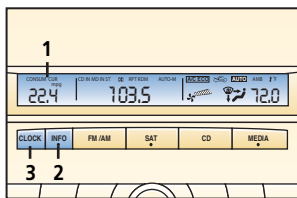

#### Information display

Information display has the following functions: Trip computer\*/clock (1), audio display, automatic climate control display and ambient temperature display\* (AMB)

Trip computer\* can display current fuel economy, average fuel economy, approximate distance you can

travel on available fuel and average vehicle speed

Ignition must be in ON position, press INFO button\* (2) to change trip computer display mode

**Tip:** Press CLOCK button (3) to display clock

See Owner's Manual  
\*Denotes optional equipment

Always check the Owner's Manual for more operating information and safety features

## Information Display

## Audio Systems

### RADIO/COMPACT DISC

#### Audio systems

##### 1. Power/Volume

Press to turn on/off; rotate to increase/decrease volume

##### 2. Program Random†

Press to enable/cancel random play

##### 3. Tune/Auto-Memory/Display

Radio: Press and hold until a beep sound is heard; system automatically scans and temporarily stores up to six strong stations in each band; press again to switch to another preset station  
Tune: Rotate counterclockwise/clockwise for lower frequency/higher frequency

##### 4. Program

Press to change cassette tape-play direction

##### 5. SEEK/TRACK/APC

Radio: Press ▲ / ▼ to automatically seek higher/lower frequency

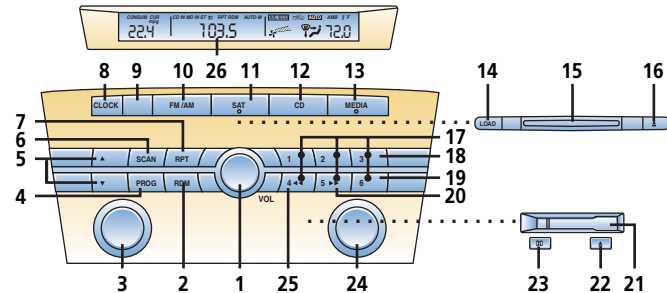

##### 9. SET or INFO\*

Clock setting button, see Clock (8)  
See Information Display

##### 10. FM/AM

Press to turn radio on and select between FM1/FM2/AM station preset buttons (17)

##### 11. SAT\*

Satellite ready capability

##### 18. Disc up ^†

Press to skip forward to beginning of next CD

##### 19. Disc down v†

Press to skip back to beginning of previous CD

##### 20. Fast forward ►►

Press to fast forward through a track

CD: Press ▲ / ▼ to select next/beginning of current track  
Tape: Press ▲ / ▼ to automatically advance tape to beginning of next selection/replay selection; to stop this operation, press button again

##### 6. Scan

Press to briefly sample next listenable selections; functions in all modes

##### 7. RPT

Press to replay current selection

##### 8. Clock

To set: With ignition in ACC or ON position, press (8) and hold until beep sounds; 12 hr/24 hr will be displayed; press (9) to select; press (8) again while selection is flashing: Hr ADJUST displays; press (9) to select hr; press (8) when done, do the same to set minutes

##### 12. CD

Press to play CD

##### 13. MEDIA\*

Press to play cassette tape and to play device plugged into auxiliary jack (auxiliary jack located in center console, see Driver's View)

##### 14. LOAD\*

To load multiple discs: Press and hold LOAD (14) until beep sound is heard; insert CD when "In" is displayed

To eject disc: Press Eject (16)

To eject specific disc: Press and hold Eject (16) until beep sound is heard; within five seconds press the desired tray number 1-6 (17)

##### 15. CD slot

##### 16. CD eject button

##### 17. Memory preset buttons

To set: Tune to station, press and hold until beep sound is heard

##### 21. Cassette door\*

##### 22. Eject button\*

##### 23. Dolby® Noise Reduction\*

Reduces tape noise and hiss; press to activate/deactivate

##### 24. Text/Audio Control

Audio control: Press to select ALC/BASS/TREBLE/FADE/BAL/BEEP ON/ILLM ON  
Rotate right/left to adjust selected feature

**Tip: Automatic Level Control (ALC) automatically adjusts audio volume depending on vehicle speed**

##### 25. Reverse ◀◀

Press to reverse through a track

##### 26. Display, see Information Display

\*Denotes optional equipment

†For use with CD, or CD changer\*

Always check the Owner's Manual for more operating information and safety features

## Audio Systems

Trunk/  
Cargo Area

TRUNK / CARGO AREA

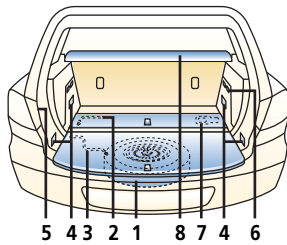

**MAZDA3 5-Door**

**1. Temporary spare tire**

Stored under panel in trunk; to change flat tire: Follow instructions in Owner's Manual

**⚠ WARNING: Do not exceed 50 mph with temporary spare**

**☀ Tip: For instructions and restrictions on use of temporary spare tire, see Owner's Manual**

**2. Lug wrench**

**3. Jack handle**

**4. Cargo securing loops**

**5. Jack**

**6. Cargo light**

**7. Front tiedown eyelet**

**8. Cargo area cover**

5 4 3 2 1 8 7 4 6

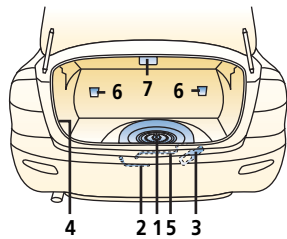

**MAZDA3 4-Door**

**1. Temporary spare tire**

Stored under panel in trunk; to change flat tire: Follow instructions in Owner's Manual

**⚠ WARNING: Do not exceed 50 mph with temporary spare**

**☀ Tip: For instructions and restrictions on use of temporary spare tire, see Owner's Manual**

**2. Lug wrench**

**3. Front tiedown eyelet**

**4. Jack**

**5. Jack handle**

**6. Rear seatback lock (4-Door only)**

Lock or unlock: Move lever

**7. Cargo light**

4 2 1 5 3

**Tire economy and tips**

Check pressure at least monthly when tires are cold

Tires should be of the same make, kind and dimension

Maintain correct front-end alignment and tire balance; rotate tires at 5,000 or 7,500 mile intervals; see Owner's Manual for rotation chart

**Tire pressure**

Decal on driver's door provides tire pressure information

**Tire chains\*†**

Use only SAE Class "S" chains; install on front tires as tightly as possible and re-tighten periodically; do not use chains on dry roads, aluminum wheels, or with tire pressure monitor system, damage may occur, use on steel wheels only

**Anti-lock Braking System (ABS)**

ABS automatically reduces hydraulic pressure to any wheel on the verge of locking up

You may feel a slight pulsing of the brake pedal and hear a clicking noise; this tells you the ABS is functioning properly; increase pressure on pedal for maximum braking

**☀ Tips: Maintain constant pressure on the brake pedal Do not pump the brakes**

**ABS self test**

A self-diagnostic test is performed when starting; you may feel some brake pedal pulsation and hear some noise, this is normal

**Traction Control System (TCS)**

Enhances traction and safety by regulating engine torque

When TCS detects drive wheel slippage it lowers engine torque to prevent loss of traction

**Dynamic Stability Control (DSC)**

DSC light may occasionally flash while driving, this indicates that the DSC was performing a correction to help maintain your best vehicle control, if DSC light remains on, see your Mazda Dealer

**Gas cap**

After filling vehicle with gasoline, fully reinstall gas cap by turning clockwise until a clicking sound is heard, if gas cap is not fully installed, Check Engine light may come on

For more information on Check Engine light, see Owner's Manual

\*Denotes optional equipment  
† See Owner's Manual

Always check the Owner's Manual for more operating information and safety features

Driving Tips

## Under Hood

### UNDER HOOD

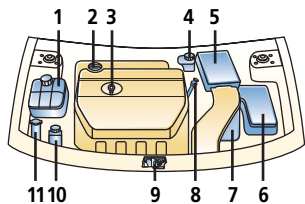

2.0/2.3-liter Engine

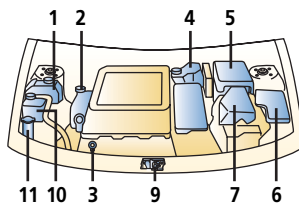

2.3-liter I4 Turbo Engine

#### 1. Engine coolant reservoir

Level should be between COLD FILL RANGE indicator marks

**⚠ WARNING: Never remove coolant reservoir cap while engine is running or hot; remove only when safe**

#### 2. Engine oil filler cap

See Owner's Manual for recommended engine oil viscosity

#### 3. Engine oil dipstick

Fluid should be between F and L on dipstick; do not fill above F

#### 4. Brake/clutch fluid reservoir

Fill to MAX mark with DOT 3 fluid; check with cap on

**☀ Tip: Clutch uses same reservoir as brakes**

#### 5. Battery

#### 6. Fuse panel

Push latch in, lift cover must be between the indicator marks on the dipstick

#### 7. Air filter

#### 8. Automatic transaxle fluid dipstick\*

Check with transaxle in park, engine on and at operating temperature

#### 9. Hood latch

Press right to release hood

#### 10. Power steering fluid reservoir

Level should be between MIN and MAX lines

#### 11. Windshield washer reservoir

Fill with windshield washer fluid

**☀ Tip: Check all fluids with vehicle parked on a level surface and engine off unless otherwise stated**

#### Break-in period

First 600 miles: Avoid heavy braking and acceleration; drive at varying road and engine speeds

**☀ Tip: Follow the same procedures with newly overhauled engine or when brakes are replaced**

#### Maintenance notes:

Rotate tires every 7,500 miles or sooner if needed

Replace cabin air filter every 25,000 miles or 24 months

Replace (FL22)\* engine coolant at 120,000 miles

**⚠ WARNING: Using coolant other than FL22 requires more frequent maintenance intervals**

**☀ Tip: For severe driving conditions, Owner's Manual recommends changing oil and filter at 5,000<sup>†</sup> miles**

**☀ Tip: For additional service intervals and complete details, see Owner's Manual**

#### NORMAL SERVICE INTERVALS

7,500 miles	A		
15,000 miles	A		F
22,500 miles	A		
30,000 miles	A	B	F
37,500 miles	A	C	
45,000 miles	A		F G
52,500 miles	A		
60,000 miles	A	B	D F
67,500 miles	A		
75,000 miles	A	C	E F
82,500 miles	A		
90,000 miles	A	B	F G

**A.** Replace: Engine oil/filter  
Lubricate: All locks and hinges

**B.** Inspect: Cooling system, fuel lines and hoses, brake lines, hoses and connections, steering operation and linkages, front and rear suspension and ball joints, drive-shaft dust boots

**C.** Inspect: Drive belts (tension)  
Replace: Air filter

**D.** Inspect: Hoses and tubes for emission system  
Replace: Engine coolant (Other than FL22)

**E.** Inspect: Engine valve clearance  
Replace: Spark plugs

**F.** Inspect: Disc brakes

**G.** Inspect: Exhaust system and heat shields

\*Denotes optional equipment

<sup>†</sup>See Owner's Manual

Always check the Owner's Manual for more operating information and safety features