

## ROADSIDE ASSISTANCE/WARRANTY

### **Mazda Roadside Assistance**

Exhilaration, liberation and inspiration, are great reasons to drive a Mazda car, truck, SUV or minivan. In addition to all the other great standard features, you also get peace of mind with our basic warranty period Emergency Roadside Assistance Plan, it's just a phone call away, 24 hours a day, 365 days a year, call **1-800-866-1998**.

### **Mazda "bumper-to-bumper" Limited Warranty**

We design and build every Mazda to give you driving pleasure now and far down the road. We're so confident in our quality that we cover the entire vehicle against defects in materials and workmanship for 36 months/36,000 miles, whichever comes first, plus we provide a powertrain warranty for 60 months/60,000 miles, whichever comes first.

This Quick Tips® guide is provided by Mazda North American Operations to make your Mazda ownership experience more convenient. It is not intended to replace your Owner's Manual.

If you have any questions about your vehicle, you are invited to contact your local dealer.

Or if you need additional help, feel free to call our

### **Customer Assistance Center at 1-800-222-5500**

Monday through Friday,  
8 a.m.-4:45 p.m., Pacific  
9 a.m.-5:45 p.m., Eastern/Central

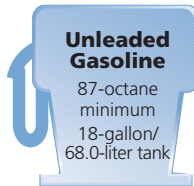

©2006 Calcar, Quick Tips® is a trademark of Calcar, made in USA 4/06 79.871M DOT Mazda North American Operations reserves the right to change product specifications at any time without incurring obligations. 9999-95-078C-07QT 7M81-19G217-AA

2007

# MAZDA6

## Quick Tips®

Reference  
Guide for  
Controls and  
Functions



## DRIVER'S VIEW

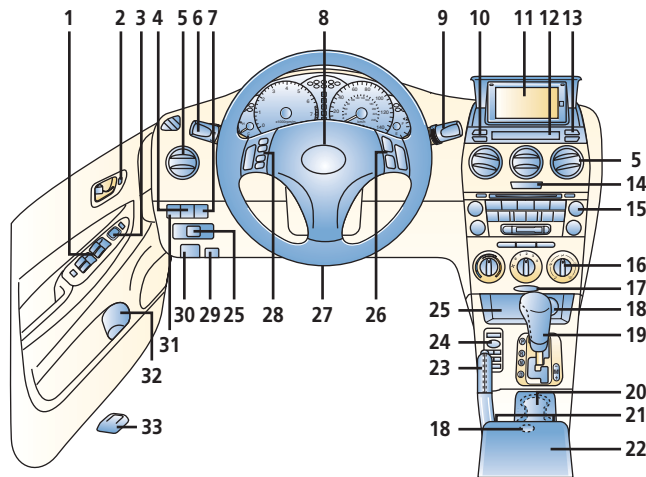

### Getting Started

MAZDA6 Quick Tips® are designed to quickly familiarize you with some important features of your MAZDA6

This Driver's View tab is your index to the Quick Tips®, locate the item you would like to learn more about and then turn to the listed tab

Be sure to see the tab called Getting Started, this section contains important operating tips about your MAZDA6

Items identified in blue text call out important information

- |   |  |  |
|---|--|--|
| <ul style="list-style-type: none"> <li>1. Power window switches, see Switches</li> <li>2. Power door locks, see Locks</li> <li>3. Dual power mirrors, see Switches</li> <li>4. Instrument panel lighting, see Getting Started</li> <li>5. Air vents</li> <li>6. Turn signal/lighting control lever, see Driver Controls</li> <li>7. <sup>TCS</sup><sub>OFF</sub> Traction Control System, see Instrument Cluster</li> <li>8. Horn/Air bag</li> <li>9. Wiper/washer control lever, see Driver Controls</li> <li>10. Clock setting buttons, see Getting Started</li> <li>11. NAVI Display*, see Owner's Manual</li> </ul> | <ul style="list-style-type: none"> <li>12. Information display, see Information Display</li> <li>13. AMB<br/>Ambient temperature display, see Information Display</li> <li>14.  Hazard warning switch, Press on/off</li> <li>15. Audio system, see Audio Systems</li> <li>16. Climate control panel, see Climate Controls</li> <li>17. Passenger air bag off indicator, see Seats</li> <li>18. Accessory socket</li> <li>19. Gearshift lever (A/T), see Transmission</li> <li>20. Cup holder</li> <li>21. Heated seats, see Trunk/Console</li> <li>22. Console, see Trunk/Console</li> <li>23. Parking brake lever, see Trunk/Console</li> <li>24. NAVI Remote control*</li> </ul> | <ul style="list-style-type: none"> <li>25. Storage</li> <li>26. Cruise control, see Getting Started</li> <li>27. Tilt/telescopic steering-wheel lever, see Getting Started</li> <li>28. Audio control switches, see Getting Started</li> <li>29.  Remote trunk release (Sedan only)<br/>Push to open trunk</li> <li>30.  Hood release handle</li> <li>31. Headlight leveling switch, see Getting Started</li> <li>32. Bottle holder<br/> <b>CAUTION:</b> Use plastic bottles with caps, cups may spill when door is closed</li> <li>33.  Remote fuel-door release</li> </ul> |
|---|--|--|

\*Denotes optional equipment

Always check the Owner's Manual for more operating information and safety features

Driver's  
View

## GETTING STARTED

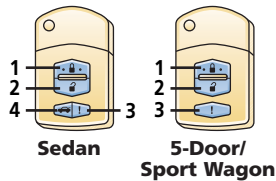
**Remote keyless entry system**

Functions only with key removed from ignition switch

To lock doors: Press button (1); press again within 5 seconds, doors relock and horn beeps

To unlock: Press (2) for driver's door; press again within 5 seconds to unlock other doors, press and hold for 3 seconds to lower front windows

To open trunk: Press (4)

Panic alarm: Press (3); horn sounds; to stop, press any button on the transmitter or turn ignition to ON position

**Remote window operation**

Remote keyless entry: Press unlock button (2) and hold, doors/liftgate unlock and windows fully open

Key: Insert key in driver's door lock; turn toward front/rear of vehicle and hold it, after doors/liftgate are unlocked/locked windows will open/close

**Clock**

To set: With ignition in ACC or ON position, press (A) and hold until beep sounds; 12 hr/24hr will be displayed; press (B) to select; press (A) again while selection is flashing: Hr ADJUST displays; press (B) to select hr; press (A) when done, do the same to set minutes

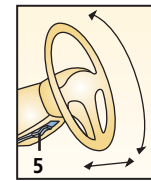
**Tilt/telescopic steering-wheel lever**

Pull lever (5) down to unlock column, adjust tilt angle and length of steering column

**WARNING:** Do not adjust steering-wheel while driving

**Instrument panel lighting**

To brighten/dim turn thumbwheel up/down

**HID headlights leveling switch**

Set position at 0 unless vehicle is loaded heavily, leveling switch adjusts

headlight angle to compensate for weight of passengers and cargo, see Owner's Manual

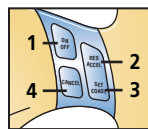
**Cruise control**

Operates above 19 mph

To activate:

Press and release ON/OFF (1)

To set speed: Press and release SET/COAST (3) at desired speed

To accelerate: Press and hold RES/ACCEL (2); incremental acceleration: Press and release (2), each tap = plus 1 mph

To decelerate: Press and hold SET/COAST (3), release at desired speed; or tap brake pedal, press and release (3) at desired speed; incremental deceleration: Press and release (3), each tap = minus 1 mph

To cancel: Tap brake pedal, clutch pedal (manual transaxle) or press CANCEL button (4) or ON/OFF (1)

Return to preset speed after

CANCEL button or braking: Press and release RES/ACCEL button (2)  
**Tip:** Cruise control will not be canceled in Manual Mode during gear changes

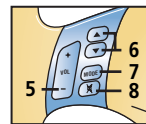
**Steering-wheel audio controls**

To increase/decrease volume: Press (5)

Radio: Press / (6) less than one second to select next/previous preset station, press / (6) more than one second until beep sound is heard to seek next/previous station

Cassette/CD: Press (6) to select next selection/track, press (6) to repeat current selection/track

Press (7) to select AM, FM 1, FM 2, Cassette\* and CD mode

Press (8) to mute Audio/NAVI system\*

\*Denotes optional equipment

† See Owner's Manual

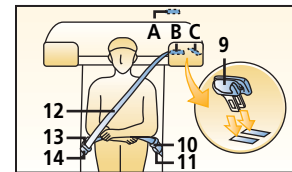
**Rear center position seat belt†**

Pull seat belt (9) from recess located in ceiling (A) (Sport Wagon), behind head restraint (B) (Sedan) or left side of cargo area (C) (5-Door):

Slide tongues with finger while pulling

Fastening seat belt: Tongue (10) and anchor (11) must be fastened, then slowly pull out lap/shoulder belt (12) and insert tongue (13) into buckle (14) until click is heard

Unfastening seat belt: Depress buckle button to release

Stowing seat belt: Retract belt, put tongues (10) and (13) together, insert securely into recess (A, B or C)

Always check the Owner's Manual for more operating information and safety features

## Instrument Cluster

### INSTRUMENT CLUSTER

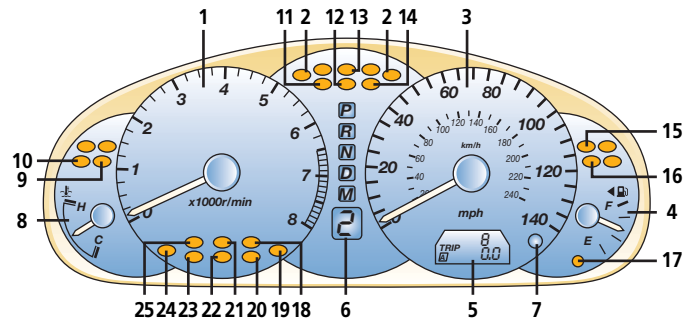

#### GAUGES

- 1. Tachometer**
- 2. ↔ Turn signals/hazard warning on**
- 3. Speedometer**
- 4. Fuel gauge**
- 5. Odometer/tripmeter**
- 6. Gear indicator**  
Displays current gear of Sport AT
- 7. Odometer/tripmeter selector**  
Press to select among trip A, trip B, and odometer  
Press and hold to reset selected trip meter
- 8. Engine coolant temperature gauge**  
If above normal range, stop vehicle and turn off engine, check coolant level when safe

\*If equipped with black-out meter

#### WARNING LIGHTS

- 9. CRUISE Cruise control**, see Getting Started
- 10. CRUISE MAIN Cruise Control Main Power On**, see Getting Started
- 11. Anti-lock Brake System (ABS)**  
ABS malfunction, normal brakes only, dealer inspection required  
ABS automatically reduces hydraulic pressure to any wheel on the verge of locking up  
You may feel a slight pulsing of the brake pedal and hear a clicking noise; this tells you the ABS is functioning properly; increase pressure on pedal for maximum braking
- 12. AT Automatic transaxle indicator**  
Dealer inspection required if light remains on
- 13. High beams on**
- 14. Traction Control System (TCS)**  
Light flashes when in use; dealer inspection required if light remains on  
Enhances traction and safety by regulating engine torque  
When TCS detects drive wheel slippage it lowers engine torque to prevent loss of traction
- 15. Lights on\***
- 16. TCS OFF Traction Control System off**  
System turned off manually or malfunctioning; dealer inspection required
- 17. Low fuel**
- 18. Brake system**  
Parking brake on/low fluid level
- 19. Check engine**  
Dealer inspection required
- 20. Charging system warning light**  
Dealer inspection required
- 21. Engine oil pressure warning light**
- 22. Air bag readiness**  
Front, side and/or curtain air bag malfunction; warning light constantly flashes or stays on or never comes on with ignition on, dealer inspection required
- 23. Door ajar**
- 24. Immobilizer system on**, see Locks
- 25. Always fasten safety belts**

Always check the Owner's Manual for more operating information and safety features

## Instrument Cluster

## Driver Controls

### DRIVER CONTROLS

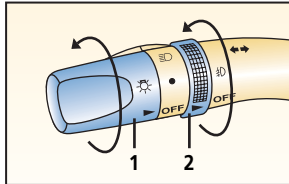

#### Turn signal/lighting control lever

**OFF** = Lights off

○ = Tail, parking and dashboard lights on: Rotate knob (1) to first notch

☰ = Tail, parking, dashboard and headlights on: Rotate knob (1) to second notch

High beams on/off: Push lever forward/pull back to detent

To flash high beams: Pull lever back slightly and release

Turn signals right/left: Move lever up/down

☼ = Fog lights on: Rotate knob (2); functions only with headlight low beams on

☀ **Tip: Headlights switch off automatically within 30 seconds if lights are left on and switch is in lock position or key removed**

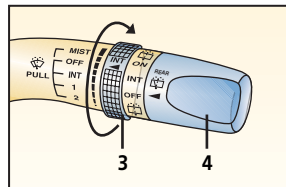

#### Wiper/washer control lever

Intermittent wiper: One click down

To change interval speed: Rotate inner ring (3)

Normal wiper speed: Two clicks down

Fast wiper speed: Three clicks down

Single wipe: Push stalk up

Washer: Pull stalk back

#### Rear window wiper/washer (5-Door/Sport Wagon)

To activate rear interval wiper:

Rotate knob (4) up to INT

To activate rear normal speed wiper: Rotate knob (4) up to ON

To activate rear washer with wipers operating: Rotate knob (4) up to ☼; hold knob (4) to continue washing; release knob and wipers will continue to operate

To operate stand alone wipe/wash function: Rotate knob (4) down and hold, release to stop

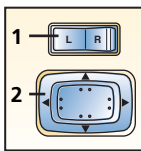

#### Dual power mirrors

Ignition switch must be in ACC or ON position  
Switch is on driver's door

To adjust left/right mirror: Press selector switch (1) left/right, press switch (2) in direction of desired movement

☀ **Tip: To lock mirrors in place, move selector switch (1) to center position**

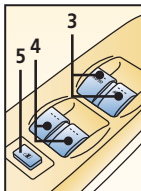

#### Power window switches

With ignition ON

All windows controlled from driver's armrest; passenger doors have separate switches

#### Front window switches

One-touch down/up: Press/pull AUTO switch (3) firmly and release, window goes down/up all the way, press/pull briefly to stop, press/pull lightly and hold for normal operation

☀ **Tip: During closing window operation, window will stop and open partway if object blocks window operation**

#### Rear window switches

Push/pull (4) to open/close

#### Power window lockout switch

Press button (5), only driver's window operates; press again for normal operation

#### Power window initialization procedure

If battery is disconnected or power window fuse is replaced, the auto open/close and anti-pinch features will not function

Resetting procedure:

1. Turn ignition switch to "ON" position
2. Make sure that power window lock switch located on driver's door is not depressed
3. Press switch and fully open power window
4. Pull up switch to fully close power window and continue holding switch for about 2 seconds after window fully closes
5. Repeat steps 3-4 for front passenger power window while seated in front passenger seat
6. Make sure power windows operate correctly using door switches

Always check the Owner's Manual for more operating information and safety features

## Switches

## Locks

### LOCKS

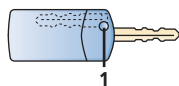

#### Key

Operates ignition and all locks

**Tip:** Use key number plate to purchase a new key; store in safe place separate from vehicle

#### Retractable key

To fold/unfold press release button (1)

#### Immobilizer system

Prevents engine from running unless coded key is used; see Owner's Manual

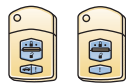

#### Remote keyless entry system, see Getting Started

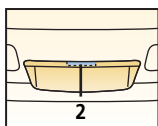

#### Liftgate (Sport Wagon)

Liftgate is locked/unlocked via power door lock switch or keyless entry transmitter; pull up on handle (2) to open liftgate

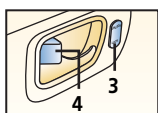

#### Power door locks Master front door lock switches

To lock/unlock all doors and liftgate: Press bottom/top of switch (3)  
To lock doors without key: With door open, press bottom of door lock switch, exit car, close doors  
To unlock: Use key to unlock driver's front door, rotate key to counter-clockwise position for more than one second to unlock other doors, hold for 3 seconds to lower front windows

#### Manual door locks Lock button

To lock: Press front of button (4) toward door handle  
To unlock: Pull front of button away from door handle

**Tip:** Doors can be locked with key in ignition (chime sounds to alert you to key in ignition)

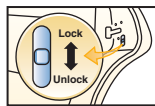

#### Child-safety locks

Located at the edge of rear doors

To activate: Pull tab up; door opens from outside only  
To cancel: Push tab down

**WARNINGS:** Since children may access either rear door, child-safety locks for both rear doors should be activated. Never leave a child in car with key in the vehicle

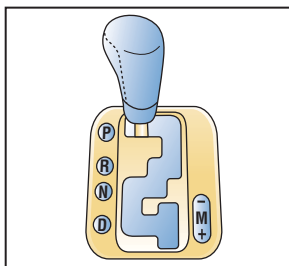

#### Automatic transmission

##### P = Park

To move gearshift from Park: Press firmly on brake pedal

##### R = Reverse

##### N = Neutral

No gear engaged

##### D (Overdrive)

For normal driving: Shifts through all forward gears automatically



#### M (Sport A/T manual shift mode)

Move shifter from D to M to engage manual shift mode, M will be illuminated for manual mode on

shift position indicator located in the instrument panel

Manual shifting of transmission is achieved by moving shifter back to upshift and forward to downshift, move shifter from M to D to engage automatic shift mode

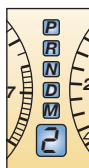

#### Gear indicator (A/T only)

Illuminated numeral of gear indicator located in the instrument panel displays current gear in Automatic and Manual shift modes

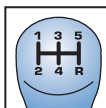

#### Manual transmission

Depress clutch pedal to start engine and change gears

**WARNINGS:** Do not shift into 1st above 20 mph or clutch failure could occur. Resting your foot on clutch pedal while driving and using the clutch to hold your vehicle at a stand still while waiting on a hill may reduce clutch life

Always check the Owner's Manual for more operating information and safety features

## Transmission



## Seats

### SEATS

#### Shoulder belt height adjustment

To raise: Push adjuster upward  
To lower: Pull button (1) and slide downward



**⚠️ WARNING: Make sure adjuster locks in one of its positions**

#### Manual controls

##### 1. Fore-aft adjustment

Lift lever and hold, slide seat, release lever

##### 2. Raise/lower seat

Pull/push lever repeatedly to desired height and release

##### 3. Seatback angle

To adjust: Lift and hold lever, lean forward or backward, release lever

##### 4. Head restraint

To raise/lower: Pull up/push in release button (8) and push down

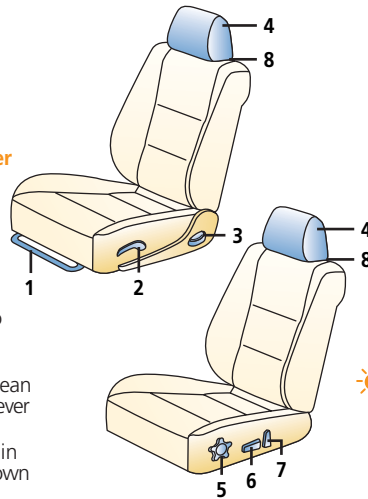

##### 5. Lumbar adjustment

Rotate knob to increase/decrease firmness

##### Power driver's seat

##### 6. Raise/lower front of seat cushion

Pull/push front of switch vertically

##### Fore/aft adjustment

Slide switch horizontally

##### Raise/lower rear of seat cushion

Pull/push rear of switch vertically

##### Raise/lower seat

Pull/push center of switch vertically

##### 7. Seatback angle

Press front/rear of switch

**☀️ Tip: Verify side air bags by locating "SRS AIRBAG" indicator tags on outboard side of front seatbacks**

**Folding rear seatbacks,** see Trunk/Liftgate

**⚠️ WARNINGS: Do not adjust seats while driving**  
**Safety belts must always be worn when vehicle is in motion**  
**Air bags are supplemental and do not replace safety belt usage**

**Always wear your safety belt and properly secure children 12 and under in the rear seat**

**Even with a deactivation system, never place rear-facing infant-safety seat in front of any air bag, an infant is in serious danger of being injured or killed**

**If you must install a forward-facing child-safety seat in the front seating position, move vehicle seat as far back as possible**

**Use age appropriate child restraints, see Owner's Manual and state or province laws**

#### Child-safety seat

To install in rear outboard seats: Use dual locking mode retractor seat belts; see Owner's Manual for proper installation and child seat tether and LATCH system instructions

#### Passenger air bag deactivation indicator light

Front air bag deactivation indicator light provides current status of front passenger air bag and pretensioner system

If total seated weight on front passenger seat is less than approximately 66 lb., front passenger air bag deactivation indicator light illuminates, air bag/pretensioner will not deploy/activate in an accident

If the total seated weight is greater than approximately 93 lb., light does not illuminate, and the air bag/pretensioner will deploy/activate in an appropriate accident,

see Owner's Manual for additional information on this feature and the air bag system

#### Safety belt emergency locking mode

Belts lock only on hard acceleration, braking, cornering or impacts of about 5 mph or more

#### Automatic locking mode (front passenger and all rear safety belts only)

Must be used when installing child-safety seat

To activate: Pull belt fully out of retractor, allow belt to retract until click is heard; belt will only tighten

To disengage: Unbuckle belt and allow belt to retract fully

#### Rear center position seat belt

5-Door: Seat belt stowage located behind left side head rest  
Sport Wagon: See Getting Started

\*Denotes optional equipment

Always check the Owner's Manual for more operating information and safety features

## Seats

## Climate Controls

### CLIMATE CONTROLS

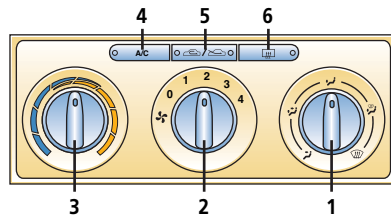

Manual A/C

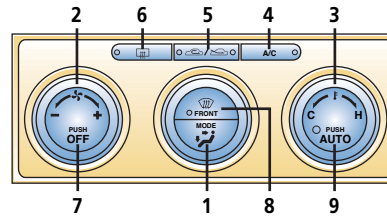

Automatic A/C

#### 1. Air flow selections

- = air to dash
- = air to dash and floor
- = air to floor
- = air to floor and windshield
- = air to windshield (defrost)  
(Manual Climate Control)

#### 5. Air intake control

- = recirculate inside air; use for maximum cooling
- = fresh air

**⚠ WARNING: Do not use position in cold weather, windows may fog and hamper vision**

#### 8. Windshield defroster switch

Press: Fresh air position is automatically selected, A/C automatically turns ON

#### Automatic operation

Press AUTO (9) for automatic operation; rotate outer dial to set temperature, see Owner's Manual

**☀ Tip: Automatic climate control display viewed via information display, see below**

#### 2. Fan control

Rotate knob clockwise/ counterclockwise to increase/ decrease fan speed

#### 3. Temperature control

Cooler/warmer = rotate knob counterclockwise/clockwise

#### 4. A/C = air conditioner

Press to turn on/off

#### 6. Rear window defogger

Press on/off; shuts off with ignition or automatically after 15 minutes of operation; also operates heated side mirrors

**☀ Tip: The word "heated" is imprinted on glass reflector of side mirrors, this indicates they are heated**

#### 7. OFF

#### Control positions for maximum defrost

Fan to maximum, temperature to maximum hot, selected

**☀ Tips: To help prevent windshield fogging in humid weather, select**

**To prevent fogging, never drive with system off  
Objects placed under the front seats may interfere with air flow to the rear**

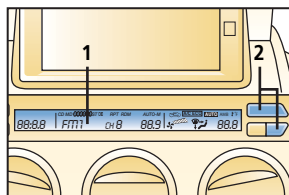

#### Information display

Information display (1) has the following functions: Clock, audio display, automatic climate control display and ambient/cabin temperature display (AMB)

#### AMB

Press AMB button (2) to display ambient temperature, press again to switch display to temperature set for air conditioner

**☀ Tip: To change from Fahrenheit to Centigrade or vice versa: Press AMB button (2) for 2 seconds or more**

Always check the Owner's Manual for more operating information and safety features

Information Display



AM / FM STEREO / CASSETTE / CD CHANGER

**1. Power/Volume**

Press to turn on/off; rotate to increase/decrease volume

**2. SEEK/TRACK/APC**

Radio: Press  $\wedge$  /  $\vee$  to automatically seek higher/lower frequency

CD: Press  $\wedge$  /  $\vee$  to select next/previous track

Cassette\*: Press  $\wedge$  /  $\vee$  to automatically advance tape to beginning of next selection/replay selection; to stop this operation, press button again

**3. LOAD\***

To load multiple discs: Press and hold LOAD (3) until beep sound is heard; insert CD when "In" is displayed

To eject disc: Press Eject (11)

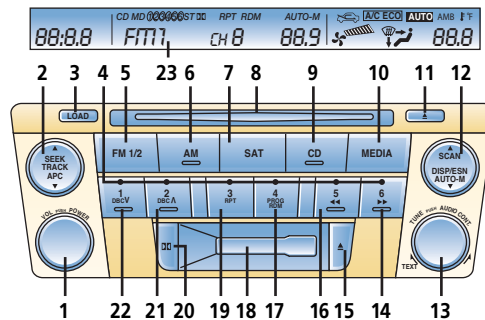

**Tips:** Always remove antenna before entering a car wash  
To remove antenna; rotate counter-clockwise, to install rotate clockwise

To eject specific disc: Press and hold Eject (11) until beep sound is heard; within five seconds press the desired tray number 1-6 (4)

**4. Memory preset buttons**

To set: Tune to station, press and hold until beep sound is heard

**5. FM1/2**

Press to select between FM1/FM2 station preset buttons (4)

**6. AM**

Press to select AM frequency band

**7. SAT†**, Satellite ready capability

**8. CD slot**

Press to play CD

**10. MEDIA**

Press to play cassette tape

**11. CD eject button**

\*Denotes optional equipment  
†SAT button is standard but requires SIRIUS subscription/additional hardware

**12. Scan/Auto-Memory**

Press to briefly sample next listenable selections; functions in all modes

Radio: Press and hold until a beep sound is heard; system automatically scans and temporarily stores six strong stations in each band; press again to cancel

**13. Tuning/Audio Control**

Tune: Rotate counterclockwise/clockwise for lower frequency/higher frequency

Audio control: Press to select ALC/BASS/TREB/FADE/BAL/BEEP (Automatic level control) can be turned on and off; rotate right/left to adjust selected feature

ALC ON = Audio volume decreases/increases with vehicle speed  
ALC OFF = Audio volume does not decrease/increase with changes in vehicle speed

**14. Fast forward ►►**

Press to fast forward through a track

**15. Cassette eject button\***

**16. Reverse ◀◀**

Press to reverse through a track

**17. Program Random**

Press for random play

**18. Cassette door\***

**19. Repeat**

Press to replay current CD/tape selection

**20. Dolby® Noise Reduction\***

Reduces tape noise and hiss; press to activate/deactivate

**21. Disc up ^\***

Press to skip forward to beginning of next CD

**22. Disc down v\***

Press to skip back to beginning of previous CD

**23. Display**, see Information Display

Always check the Owner's Manual for more operating information and safety features

HOMELINK®

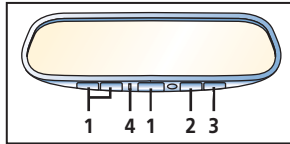

**HomeLink® Wireless Control System\***

Located on rear view mirror HomeLink® provides three programmable buttons that will replace three hand-held device transmitters

**Tip:** It is recommended to park outside of garage when programming HomeLink®

**WARNING:** When programming a garage door or gate opener, disconnect power to these devices before programming, continuous operation of these devices could damage the motor

To program or reprogram: Press and hold two outer HomeLink® buttons (1) for 20 seconds and no more than 30 seconds, release only after indicator light (4) begins to flash; hold transmitter for the device to be programmed between 1-3 inches to HomeLink®; press transmitter button and desired HomeLink® button (1) simultaneously until HomeLink® indicator light (4) goes from slow to rapid flashing. Verify device operation by pressing HomeLink® button (1) that was just programmed

**Tip:** You do not need to repeat the first step to program the other two hand-held transmitters for the remaining HomeLink® buttons

**Rolling code synchronization procedure**

Refer to your garage door opener or device instruction manual to confirm your system is equipped with a rolling code feature

**Tip:** This procedure is easier to perform with the assistance of another person

To synchronize: Press programming button on garage door opener motor; press/hold for 2 seconds and release the programmed HomeLink® button 2 times within 30 seconds of pressing the garage door opening motor programming button

Some devices may require you to press/hold and release a third time to complete programming procedure. If indicator light stays on, programming is complete

For further information, contact HomeLink® at 1-800-355-3515, [www.homelink.com](http://www.homelink.com) or your authorized Mazda Dealer

To erase all existing programming; press and hold two outer HomeLink® buttons (1) on mirror, continue to hold buttons until indicator light flashes

**Auto-dimming rear view mirror\***

Auto-dimming function changes are based on outside lighting conditions and if bright headlights are visible in rear view mirror

Press on (2), off (3)

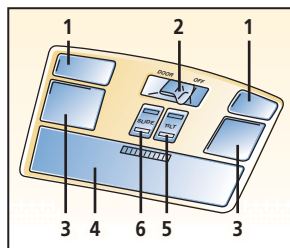

**1. Map/reading light switch**  
Press on/off

**2. Interior light switch**  
DOOR = light on when door open  
OFF = light always off

**3. Interior map/reading light**

**4. Sunglass holder**  
Press concaved lip to open

**5. Moonroof tilt switch**

Press rear of switch to tilt rear of moonroof  
Press front of switch to close

**6. Moonroof slide switch**

Press rear of switch to open moonroof  
Press front of switch to close

**Illuminated visor mirrors**

Mirrors lighted when covers open; off when closed

\*Denotes optional equipment

Always check the Owner's Manual for more operating information and safety features

Trunk/  
Liftgate

TRUNK / LIFTGATE

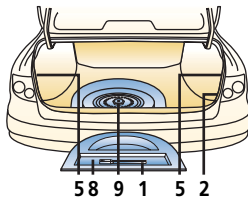

MAZDA6 Sedan

1. Lug wrench
2. Jack  
Remove cover panel to access
3. Cargo light
4. Cargo securing loops
5. Rear seatback remote handle levers
6. Seatback release buttons
7. Cargo area cover

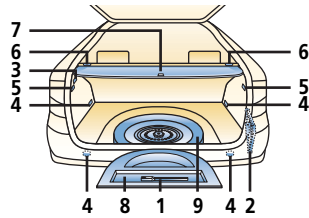

MAZDA6 5-Door

- Split rear folding seatback (Sedan)**  
Unfasten the lap portion of the rear center seat belt, pull rear seatback remote handle levers (5) To raise seatback: Push seatback firmly until latched, re-attach center belt

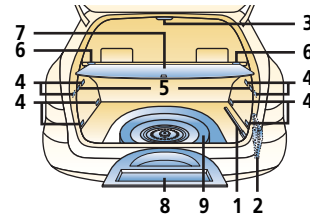

MAZDA6 Sport Wagon

- Luggage compartment internal safety release (Sedan)**  
Allows you to escape should you become locked in trunk  
Slide illuminated release lever in direction of arrow; lever will glow if it has been exposed to light  
Located on interior trunk lid

8. Sub-compartment cover  
Lift carpet, disconnect sub-woofer wire connector, remove cargo sub-compartment cover, remove sub-woofer, remove spare tire (Sedan not equipped with sub-woofer)
9. Temporary spare tire  
Stored under panel in trunk

**Folding rear seatbacks flat (5-Door/Sport Wagon)**

Unfasten rear seat belt, pull handle levers (5) on left/right side or press seatback release buttons (6) support seatback; then fold seatback forward

To raise seatback: Lift seatbacks upward until firmly latched, properly fasten rear seat belts, then check that seat belts are routed properly for passenger use

**Tire economy and tips**

Check pressure regularly when tires are cold, maintain correct front-end alignment and tire balance; rotate tires at 5,000 or 7,500 mile intervals; see Owner's Manual for rotation chart

**Tire pressure**

P215/45R18 93W  
**Front/rear: 35psi cold**  
P215/50R17 93V  
P205/60R16 91V (Sedan only)  
**Front/rear: 32psi cold**

**Tip: Correct tire pressure promotes safe handling and ride comfort**

**Tire chains†**

Tire chains cannot be used on this vehicle, interference with vehicle body and scratching could occur

\*Denotes optional equipment  
† See Owner's Manual

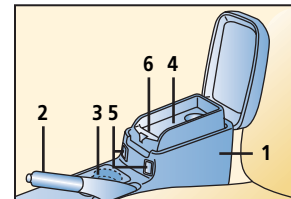

1. Console
2. Parking-brake lever  
To engage: Pull up  
To release: Pull up slightly while depressing button at front of lever, lower hand brake lever
3. Cup holder
4. Storage
5. Heated seats  
Press on/off switch; indicator light on when activated
6. Accessory socket

Always check the Owner's Manual for more operating information and safety features

Trunk/  
Console

## Under Hood

### UNDER HOOD

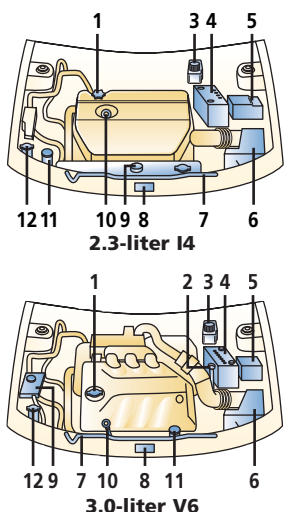

- 1. Engine oil filler cap**  
SAE 5W-20
  - 2. Automatic transmission fluid (ATF) dipstick**  
See Owner's Manual
  - 3. Brake/Clutch\* fluid reservoir**  
Fill to MAX mark with DOT 3 fluid; check with cap on
  - 4. Battery**
  - 5. Fuse block**
  - 6. Air filter**
  - 7. Hood support rod**
  - 8. Hood latch**  
Push hood latch to the right, open hood
  - 9. Engine coolant reservoir**  
Level should be between FULL and LOW markings when cold
  - 10. Engine oil dipstick**  
Check with engine off after approximately 5 minutes and at operating temperature; fluid level should be between MAX and MIN markings on dipstick
  - 11. Power steering fluid reservoir**  
Check with engine off and at normal temperature; fill to MAX mark
  - 12. Windshield washer reservoir**  
Fill with windshield washer fluid
- Gas cap**  
After filling vehicle with gasoline, fully reinstall gas cap by turning clockwise until a clicking sound is heard, if gas cap is not fully installed, Check Engine light may come on. For more information on Check Engine light, see Owner's Manual
- ⚠️ WARNING: Never remove coolant reserve tank cap while engine is running or hot; you could get burned**

#### Break-in period

First 600 miles: Drive at varying road and engine speeds; avoid full throttle, rapid acceleration or kick-down of transmission

#### Unique driving conditions†

Every 5,000 miles change oil/filter, inspect coolant level, lights, brake/clutch fluid, tire pressure/wear, power steering fluid, locks/hinges and washer fluid

#### Normal maintenance notes

Rotate tires every 7,500 miles or sooner if needed

Replace cabin air filter every 25,000 miles or 24 months

Inspect exhaust system and heat shields every 45,000 miles

Replace (FL22) engine coolant every 120,000 miles or 10 years

**⚠️ WARNING: Using coolant other than FL22 requires more frequent maintenance intervals**

#### NORMAL SERVICE INTERVALS

7,500 miles	A
15,000 miles	A B
22,500 miles	A
30,000 miles	A B C
37,500 miles	A D
45,000 miles	A B
52,500 miles	A
60,000 miles	A B C E
67,500 miles	A
75,000 miles	A F
82,500 miles	A
90,000 miles	A
105,000 miles	G

- A.** Change: Engine oil/  
replace filter  
Lube: Locks and hinges
- B.** Inspect: Disc brakes
- C.** Inspect: Drive belts (3.0 liter), fuel lines and hoses, brake lines, hoses and connections, steering operation and linkages, front and rear suspension ball joints, driveshaft dust boots, cooling system
- D.** Inspect: Drive belts (2.3 liter)  
Replace: Air filter
- E.** Inspect: Hoses and tubes for emission system
- F.** Replace: Spark plugs  
Inspect: Engine valve clearance (2.3 liter), adjust if noisy
- G.** Replace: Engine coolant (Other than FL22)

\*Denotes optional equipment  
†See Owner's Manual

**Always check the Owner's Manual for more operating information and safety features**