

MAZDA B-SERIES TRUCK

Quick Tips®

Reference
Guide for
Controls and
Functions

2008



mazda®

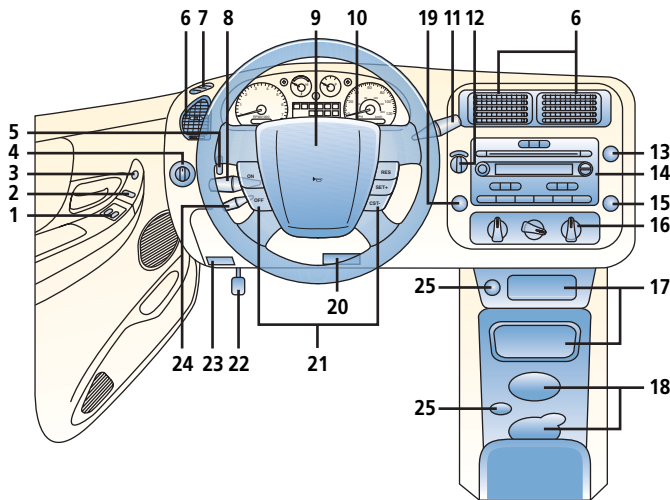

Getting Started

B-Series Truck Quick Tips® are designed to quickly familiarize you with some important features of your B-Series Truck.

This Driver's View tab is your index to the Quick Tips®, locate the item you would like to learn more about and then turn to the listed tab.

Be sure to see the tab called Getting Started, this section contains important operating tips about your B-Series Truck.

Items identified in blue text call out important information.

- 1. Power window switches***, see Switches/Lights
- 2. Power door locks***, see Locks
- 3. Dual power mirrors***, see Switches/Lights
- 4. Headlamp control**, see Switches/Lights
- 5. Instrument panel lighting**
To brighten/dim: Rotate thumb-wheel up/down.
- 6. Air vents**
To open/close: Move thumb-wheel left/right.
To direct air flow: Move tab in center of vent.
- 7. Side window defroster**
- 8. Turn signals/headlight high beams/wiper/washer lever**, see Getting Started
- 9. Horn/Air bag**
Press to sound horn.
- 10. Hazard warning switch**
Press on/off.
- 11. Gearshift lever (A/T)***, see Transmission
- 12. 4x4 control***, see Transmission
- 13. Passenger's front air bag deactivation light**, see Getting Started
- 14. Audio system**, see Audio Systems
- 15. 12V socket***
Use for optional electrical accessories.
- 16. Climate control panel**, see Climate Control
- 17. Storage***
- 18. Cupholders***
- 19. Cigarette lighter***
- 20. Hood release handle**
Pull to unlatch hood, see Under Hood.
- 21. Cruise control***, see Getting Started
- 22. Parking brake pedal**
- 23. Parking brake release lever**
- 24. Tilt steering-wheel lever***
To change position: Pull lever, tilt wheel up or down, release to lock.
- 25. Auxiliary input jack***
Connect portable music device to in-vehicle audio system.

*Denotes optional equipment

Always check the Owner's Manual for more operating information and safety features

GETTING STARTED

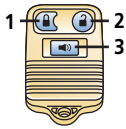

Keyless remote entry system*

Functions only with ignition in OFF position.

To lock doors: Press **1**, pressing **1** again within 3 seconds causes doors to relock, horn to beep once if all doors are closed, twice if any door is ajar.

To unlock driver's door: Press **2**, press again within 3 seconds to unlock passenger's door.

Panic alarm: Press **3**; horn sounds, parking lights flash and interior lights illuminate; press **3** again to stop or insert key and turn ignition to ON or ACC position.

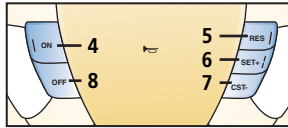

Cruise control*

Operates above 25 mph. Press and release ON **(4)**.

To set speed: Press and release SET+ **(6)** at desired speed, cruise control indicator on instrument cluster illuminates, hold **(6)** to accelerate.

To decelerate: Press and hold CST- **(7)**, release at desired speed; or tap brake pedal, press and release **(6)** at desired speed.

Incremental deceleration: Press and release **(7)**, each tap = minus 1 mph.

Incremental acceleration: Press and release **(6)**, each tap = plus 1 mph.

To cancel: Tap brake/clutch pedal or push OFF button **(8)**.

Return to preset speed (after braking): Press and release RES (resume) button **(5)**.

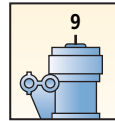

Fuel pump shutoff

Disables fuel pump after a substantial jolt or collision; located under right-

hand side of glove box, just above carpet.

To reset: Press down top of exposed red reset button **(9)**.

⚠ WARNING: Do not reset shutoff switch if you see or smell fuel.

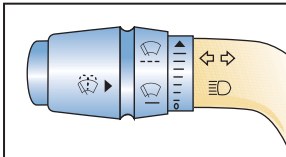

Turn signals/headlight high beams/wiper/washer lever

High beams on/off: Push forward to detent/pull back.

To flash high beams: Pull rearward and release.

To turn on wipers: Rotate knob forward; first 7 detents are progressively faster intervals, 8th detent is low speed, 9th is high.

To activate washers: Push in end of knob; will also operate wipers.

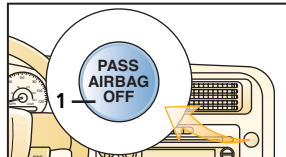

Passenger Air Bag Off indicator

Front passenger sensing system is designed to turn off passenger frontal air bag when a low weight is detected, a person of adult size that is sitting properly in the passenger front seat will enable passenger frontal air bag. The front passenger air bag will also be deactivated if the sensor detects an empty seat.

PASS AIR BAG OFF indicator **(1)** will be illuminated to remind you the passenger air bag is deactivated.

See Owner's Manual for complete details and warnings.

⚠ WARNING: If PASS AIR BAG OFF light goes on or off unexpectedly, please see Owner's Manual for various ways this system may indicate a false reading.

Tire Pressure Monitoring System (TPMS)

Warning light illuminates on instrument cluster for a few seconds with ignition on.

If tire pressure is low, warning light illuminates, adjust tire pressure to correct specifications, perform tire pressure adjustment before driving, a digital tire pressure gauge is recommended. Flashing warning light may indicate malfunction, dealer inspection required.

*Denotes optional equipment

Always check the Owner's Manual for more operating information and safety features

INSTRUMENT CLUSTER

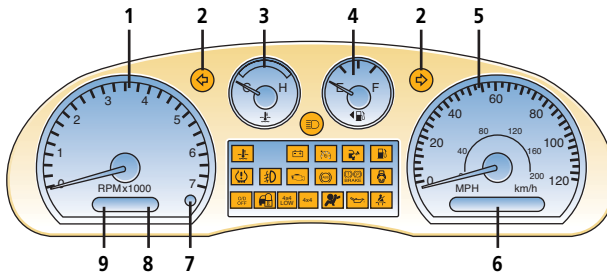

GAUGES

- 1. Tachometer**
- 2. Turn signals/hazard warning on**
- 3. Engine coolant temperature gauge**
If above normal range, stop truck and turn off engine; check coolant level when safe.
- 4. Fuel gauge**
Regular Cab:
17-gallon/64.4-liter tank
CabPlus4:
19.5-gallon/73.8-liter tank
- 5. Speedometer**
- 6. Gearshift indicator* (A/T)**
- 7. Trip odometer reset button**
Push to reset.
- 8. Odometer**
- 9. Trip odometer**

WARNING LIGHTS

- **High beams on**
- **Engine coolant temperature**
High engine coolant temperature; stop truck and turn off engine; check coolant level when safe
- **Charging system warning light**
Dealer inspection required
- **Cruise control***
Illuminates when cruise control is engaged, see Getting Started
- **Check fuel cap**
Fuel cap not securely tightened
- **Low fuel**
- **Tire Pressure Monitoring System (TPMS)**, see Getting Started
- **Fog lamps* on**
- **Check engine**
Dealer inspection required
- **Anti-lock Brake System (ABS)**
ABS malfunction, normal brakes only, dealer inspection required
- **Brake system**
Indicates parking brake on or low brake fluid level, if brake fluid level is low, have vehicle inspected by nearest Mazda Dealer
- **Door ajar**
Door not completely shut
- **Overdrive off indicator* (A/T)**
When lit, transmission does not shift into overdrive
- **Anti-theft on***
- **4x4 / Low 4x4 4X4 HIGH/ 4X4 LOW Indicator***, see Transmission
- **Air bag readiness**
Air bag malfunction; dealer inspection required
- **Engine oil pressure**
Immediately stop truck and turn off engine; check oil level
- **Always fasten seat belts**
Light and chimes

*Denotes optional equipment

Always check the Owner's Manual for more operating information and safety features

LOCKS

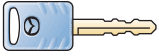

Key

Operates ignition and all locks.

SecuriLock™ passive anti-theft key*

Prevents engine from running unless coded key is used; see Owner's Manual.

Tip: If coded key is lost or stolen, new coded key will need to be programmed at an authorized dealer.



Keyless remote entry system*, see Getting Started

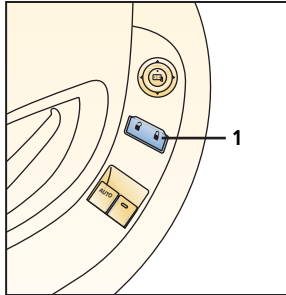

Power door locks*

Front door lock switches

To lock/unlock both doors: Press / on either door switch (1).

To lock doors without key, exit the vehicle, press on either door, close the door.

To unlock: Use key to unlock either front door, open door and press to unlock other door. Manual door locks will override power locks.

WARNING: Never leave a child in car with key in the vehicle.

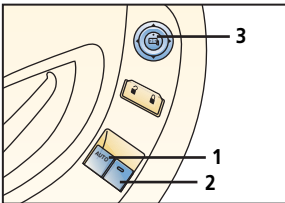

Dual power mirrors*

To adjust left/right mirror: Rotate control switch (3) left/right, tilt in direction of desired mirror movement.

Tip: To lock mirrors in place, move control switch (3) to center position.



Courtesy/reading lamps*

Courtesy lamp illuminates when any door is opened, instrument panel dimmer switch is rotated upward past detent or remote entry is used with ignition off.

Tip: Battery saver shuts off dome lamp after 5 minutes with ignition off.

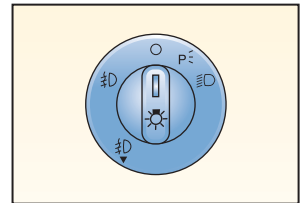

Headlamp control

○ = Headlights off

P = Tail, parking and dashboard lights on: Rotate knob to first notch

⊘ = Tail, parking, dashboard and headlights on: Rotate knob to second notch

⊘ = Foglamps* on: Pull lighting switch towards you; indicator light will illuminate

*Denotes optional equipment

Power window switches*

Operate only with ignition in ACC or ON position.

Both windows may be controlled from driver's door; passenger door has separate switch.

Driver's window (1): One touch-down; press and release, window goes all the way down; tap switch to stop; pull up on switch and hold to close.

Passenger window switch (2): Press/pull switch to open/close.

Always check the Owner's Manual for more operating information and safety features

SEATS

Shoulder belt height adjustment

To raise belt:
Slide adjuster up.
To lower belt:
Push release button (1) and slide down.

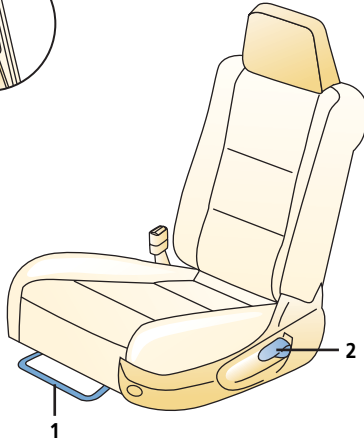
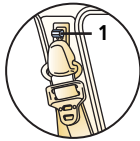

⚠ WARNING: Make sure adjuster locks in one of its positions.

Seats

1. Fore/aft adjustment

Raise lever and hold, slide seat, release lever.

2. Seatback angle

To adjust: Lift and hold lever, lean forward or backward to tilt seat, release lever.

⚠ WARNINGS: Do not adjust seats while driving.

Seat belts must always be worn when vehicle is in motion. All air bags are supplemental and do not replace seat belt usage.

Always wear your seat belt and properly secure children in age appropriate child restraints.

Seat belt emergency locking mode

Belts lock only on hard acceleration, braking, cornering or impacts of about 5 mph or more.

Automatic locking mode (front passenger seat belt only)

Must be used when installing child-safety seat.

To activate: Pull webbing fully out of retractor, allow belt to retract until click is heard; belt will only tighten.

To disengage: Unbuckle belt and allow webbing to retract fully.

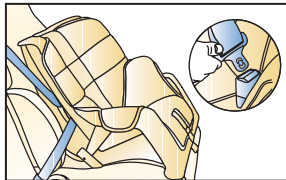

Child-safety seat

To install, use dual-locking mode retractor seat belts; see Owner's Manual for proper installation and child seat tether and LATCH system instructions.

⚠ WARNINGS: Use age appropriate child restraints, see Owner's Manual and state or province laws.

If you must install a front-facing child-seat, put it in the outboard seat and slide it all the way rearward and ensure that the PASSENGER AIR BAG OFF indicator is illuminated, this signifies that the passenger air bag has been deactivated.

For CabPlus4 vehicles, do not put child restraints in the center facing jump seats, for complete details see Owner's Manual.

Always check the Owner's Manual for more operating information and safety features

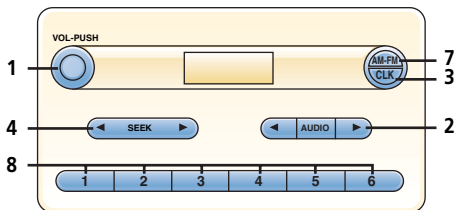

AM/FM Stereo

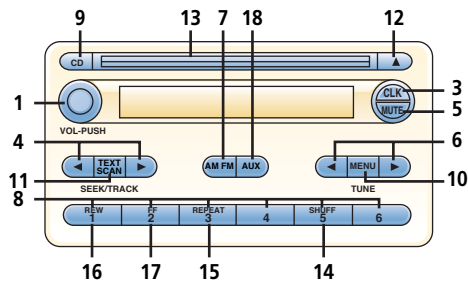

AM/FM Stereo/CD*

1. Power/Volume

Press to turn on/off; turn clockwise/counterclockwise to increase/decrease volume.

2. AUDIO

Press to select Bass, Treble, or Balance; then press ◀AUDIO ▶ to adjust.

3. Clock

Press CLK to set time; adjust hour up/down by pressing ◀/▶ (2), (6); press CLK again to select minutes, adjust minutes up/down by pressing ◀/▶ (2), (6); press CLK to switch display between clock and frequency.

4. SEEK/TRACK

Radio: Press and release ◀/▶ for next strong station down/up; press and hold to skip stations. CD: Press and release ◀/▶ to select previous/next track.

5. MUTE

Press to mute playing media; press again for normal volume.

6. Tune

Press ◀/▶ to change frequency down/up. Press and hold to move down/up quickly.

7. AM/FM

Press to select AM/FM1/FM2 frequency bands.

8. Memory preset buttons

To set: Tune to station, press and hold until sound returns.

9. CD

Press to select CD.

13. CD slot

Press to play CD changer* single disc tracks in random order.

15. REPEAT

Press to repeat current CD track.

10. MENU

Press MENU to toggle through following modes; Autotset, Bass, Treble, Balance, and Fade; press ◀/▶ to adjust.

Autotset

Press ◀/▶ to set 6 strongest stations into AM, FM1, or FM2 memory buttons; press again to return to normal stations.

11. TEXT

Press to view next 12 characters in MP3 music name/file name of current MP3 track and directory.

SCAN

Press to briefly sample next listenable selections, press again to cancel; functions in all modes.

12. Eject

Press to eject CD; radio resumes playing.

16. REW

Reverse in CD track.

17. FF

Advance in CD track.

18. AUX

Press to access AUX modes; NO AUX AUDIO will be displayed if no auxiliary devices are available.

Satellite Radio* equipped:

Press AUX to cycle through SAT1, SAT 2 and SAT 3. Satellite radio is available only in the continental United States with a valid SIRIUS subscription, see Owner's Manual.

*Denotes optional equipment

Always check the Owner's Manual for more operating information and safety features

AM/FM STEREO/COMPACT DISC

1. Volume Push On

Press to turn on/off; turn clockwise/counterclockwise to increase/decrease volume.

2. LOAD

Press to load one CD or auto load up to six discs.

3. AM/FM

Press to select radio and alternate among AM/ FM1/ FM2 bands.

4. CD

Press to select CD mode or play CD.

5. AUX

Press to access AUX modes; NO AUX AUDIO will be displayed if no auxiliary devices are available.

6. CD slot

7. Eject

Press once to eject current CD. Press and hold to eject all stored discs one at a time. Press once, then press desired number 1-6 (17) to eject a CD.

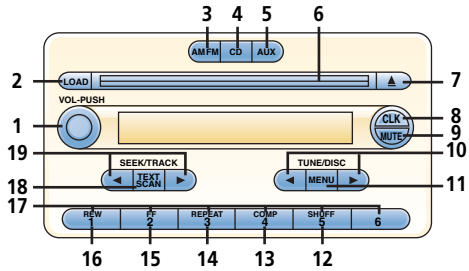

Premium AM/FM Stereo/CD6/MP3*

11. MENU

Press MENU to toggle through following modes; Autoset, Bass, Treble, Balance, and Fade; press **◀/▶** to adjust.

Autoset

Press **◀/▶** to set 6 strongest stations into AM, FM1, or FM2 memory buttons; press again to return to normal stations.

17. Memory preset buttons 1-6

To set: Tune to station, press and hold until sound returns.

18. TEXT

Press to view next 12 characters in MP3 music name/file name of current MP3 track and directory.

8. Clock

Press CLK to set time; adjust hour up/down by pressing **◀/▶** (10); press CLK again to select minutes, adjust minutes up/down by pressing **◀/▶** (10); press CLK to display time with ignition off.

9. MUTE

Press to mute playing media; press again for normal volume.

10. TUNE/DISC

Radio: Press **◀/▶** to change frequency down/up.

CD: Press **◀/▶** to select previous/next disc.

Hold for rapid movement.

MP3: Access previous/next directory.

Next/previous directory

Previous or next MP3 directory: Press **◀/▶**.

Flat file/directory mode: To select; press **◀/▶**.

Track number/normal music name/file name: Press **◀/▶**.

12. Shuffle

Press to select SHUFFLE which plays random tracks from CD/MP3 discs.

13. COMP

Press to combine loud and soft passages.

14. REPEAT

Press to repeat CD/MP3 track.

15. FF

Press and hold to play next disc tracks.

16. REW

Press and hold to play previous disc tracks.

Scan

Radio: Press to briefly sample listenable stations.

CD/MP3: Press to briefly sample tracks.

Press again to stop.

19. SEEK/TRACK

Radio: Press **◀/▶** for next listenable station down/up.

CD: Press **◀/▶** to select previous/next track.

Satellite Radio* equipped:

Press AUX to cycle through SAT1, SAT 2 and SAT 3.

Satellite radio is available only in the continental United States with a valid SIRIUS subscription, see Owner's Manual.

*Denotes optional equipment

Always check the Owner's Manual for more operating information and safety features

TRANSMISSION

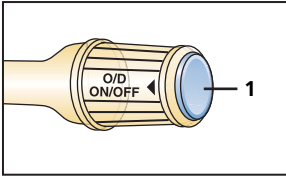
**Automatic transmission***

Gearshift must be in Park or Neutral to start engine; it must be in Park to remove ignition key.

P = Park

To move gearshift from Park: You MUST press firmly on the brake pedal and the ignition must be in the ON position.

Never put moving vehicle in Park.

Always apply parking brake when exiting the vehicle.

R = Reverse

Do not engage Reverse when vehicle is moving forward.

N = Neutral

No gear is engaged; vehicle can roll freely, even on a slight incline, unless the brakes are applied.

D (Overdrive)

For normal driving: Shifts through all forward gears automatically for more relaxed highway driving and optimum fuel economy.

 **Tip: Torque converter lock-up improves fuel economy and can feel like an additional gear.**

D (Overdrive Off)

Press **(1)** to disengage overdrive; an indicator light on the instrument cluster will illuminate.

Driving without overdrive provides a lower gear for climbing hills and engine braking when descending hills; you can depress **(1)** at any speed.

To re-engage overdrive, press **(1)** again and the instrument cluster light will go out.

 **Tip: A flashing Overdrive Off light indicates a system malfunction; dealer inspection required.**

2 = Second

To aid in accelerating on slippery roads, place vehicle in second and vehicle will start from a standstill in second gear, second will also provide additional engine braking at low speed on downgrades.

1 = Low

Low provides maximum engine braking at low speed on steep downgrades.

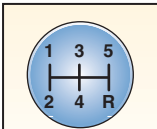
**Manual transmission**

Depress clutch pedal completely to start engine and change gears; stop

truck completely before shifting into reverse.

 **Tip: Extended use of other than manufacturer's specified tires on a limited-slip rear axle* may result in damage, this may not affect normal driving and may not be noticeable by the driver.**

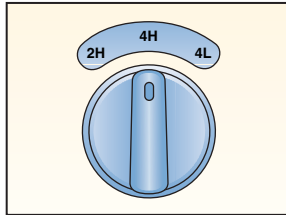
**4-wheel drive system***

2H (2WD) = Two-wheel drive
Power to rear axle only, 4X4 indicator lights off.

4H (4x4 HIGH) = Four-wheel drive
Power to front and rear axles at normal speed, 4X4 light on.

4L (4x4 LOW) = Four-wheel drive (low range)

Power to front and rear axles at reduced speed, 4X4 LOW light on.

To shift from 2WD to 4X4 HIGH: Rotate switch from 2WD to 4x4 HIGH.

To shift from 4X4 HIGH to 2WD: Rotate switch from 4x4 HIGH to 2WD.

 **Tip: You do not need to shift into reverse to disengage front hubs.**

To shift into/out of 4X4 LOW: Stop vehicle, depress brake, place automatic transmission in neutral (with manual transmission, depress clutch pedal); rotate switch to desired setting.

 **Tip: Pulsation may occur during cornering in 4X4 mode.**

*Denotes optional equipment

Always check the Owner's Manual for more operating information and safety features

CLIMATE CONTROL

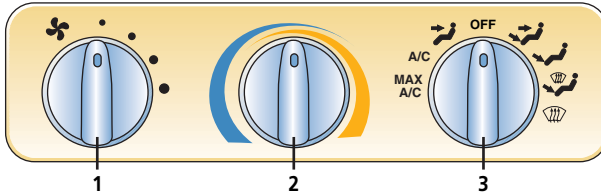
**1. Fan control**

To increase speed and flow:
Rotate knob clockwise.

2. Temperature selection

Cooler/warmer = rotate
knob counterclockwise/
clockwise.

3. Air flow selections

- = air to dash vents,
A/C compressor* off
- OFF = system off, no air flow
- = air to dash/floor vents,
A/C compressor* on
- = air to floor,
A/C compressor* off
- = air to floor and
windshield,
A/C compressor* on
- = defrost, air to
windshield,
A/C compressor* on

**Air conditioning
system***

MAX A/C = cooling with
inside air, air to dash only
A/C = cooling with
outside air, air to dash only

**Control positions for
maximum defrost**

Fan to maximum, temperature
to maximum hot, air flow
selector knob to .

**Tips: To prevent moisture
buildup, never drive with
system off.**

When , or selected,
air is dried when temperature
is above 50° F.

**A/C compressor* is on in
defrost position.**

*Denotes optional equipment

Always check the Owner's Manual for more operating information and safety features

UNDER HOOD

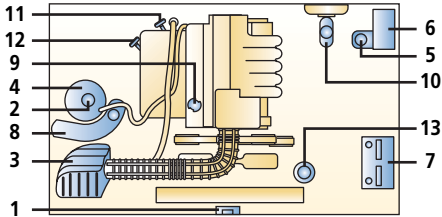

2.3-Liter Engine

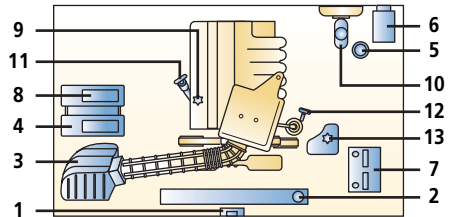

4.0-Liter Engine

1. Hood latch

Pull inside hood release handle, hood pops up slightly; while applying upward pressure on hood, lift auxiliary latch handle and raise hood.

2. Radiator or reservoir cap

Remove cap only when safe and engine is cool.

3. Air filter**4. Engine coolant reservoir**

Level should be at fill line indicator mark; remove cap only when safe and engine is cool.

⚠️ WARNING: Never remove coolant reserve tank cap while engine is running or hot; remove only when system is cool.

5. Clutch fluid reservoir

With cap on, check that fluid level is at ridge in reservoir body, use DOT 3 brake fluid.

6. Fuse block**7. Battery****8. Windshield washer reservoir**

Fill with windshield washer fluid, not water; use fluids containing non-methanol antifreeze agents only, they will not damage paint, wiper blades and washer system.

9. Engine oil filler cap

Use SAE 5W-20 (2.3L), 5W-30 (4.0L) oil for all temperatures; use only oils displaying American Petroleum Institute Certified for Gasoline Engines.

10. Brake fluid reservoir

Clean filler cap before removing; use only DOT 3 fluid from a sealed container.

If brake fluid level is low, have vehicle inspected by your closest Mazda Dealer.

11. Automatic transmission fluid dipstick*

Check with engine on at normal operating temperature; fluid should be within crosshatched area on dipstick.

12. Engine oil dipstick

Check with engine off and at normal temperature; fluid should be within crosshatched area on dipstick; do not fill above MAX line.

13. Power steering fluid reservoir

Check with engine off and at normal temperature; fluid level on dipstick should be between arrows in FULL HOT range.

*Denotes optional equipment

Always check the Owner's Manual for more operating information and safety features

DRIVING TIPS

Break-in period

First 1,000 miles: Avoid heavy repeated brake use; avoid full throttle, rapid acceleration or kick-down of transmission; drive at varying road and engine speeds.

Do not tow a trailer for first 500 miles.

Do not use special "break-in" oils.

 **Tip: Follow the same break-in period procedures with newly overhauled engine or when brakes are replaced.**

4-wheel Anti-lock Braking System (ABS)

ABS automatically reduces hydraulic pressure to all four wheels (4-wheel ABS) on the verge of locking up.

You may feel a slight pulsing of the brake pedal and hear a clicking noise, this tells you the ABS is functioning properly.

 **Tips: Maintain constant pressure on the brake pedal. Do not pump the brakes.**

ABS self test

A self-diagnostic test is performed when the engine is started; you may feel some pulsation and hear some noise; this is normal.

Tire economy and tips

Check pressure monthly when tires are cold.

Check for unusual wear and overall condition, do not exceed weight limit on tires and axles.

Maintain correct front-end alignment and tire balance; see Owner's Manual for rotation chart.

Tire pressure

Decal on the edge of the driver's door provides tire size and pressure information.

Tire chains**†

Tire chains can damage aluminum wheels; use on steel wheels only.

 **Tips: Use only SAE class "S" chains, install only on rear tires; install as tightly as possible and retighten periodically. Never exceed 30 mph with tire chains.**

	NORMAL	SPECIAL
5,000 miles		E
15,000 miles	A	F
30,000 miles	A B	G H
45,000 miles	A	
60,000 miles	A B C	I J
75,000 miles	A	
90,000 miles	A B	
100,000 miles	D	

Change engine oil/replace filter every 3,000**/5,000 miles.

Check lug nut torque every 5,000 miles, for tire rotation intervals, see Owner's Manual.

Normal operating conditions

A. Inspect: Engine cooling system, hoses and clamps, steering linkage, suspension, brake system, parking brake system
Inspect/lubricate: 4x2 ball joints, caliper slide rails

B. Replace: Air filter/fuel filter
Inspect: Exhaust system, automatic transmission fluid level

C. Lubricate: 4x2 wheel bearings

D. Inspect: Accessory drive belt(s)
Replace: Manual transmission fluid
Replace: Spark plugs
Replace: PCV valve†
(2.3L/4.0L)
Change: Yellow engine coolant

Special operating conditions

Towing, extensive idling, low speed driving, dusty conditions and off-road operation, see Owner's Manual.

E. Inspect: Brake system

F. Replace: Fuel filter

G. Change: Automatic transmission fluid

H. Lubricate: Front wheel bearings (4x2)

I. Change: Transfer case fluid (4x4)

J. Replace: Spark plugs

Perform maintenance as required

Inspect/lubricate: U-joints, clutch fluid level

Replace: Engine air filter

Change: Manual transmission fluid

*Denotes optional equipment

**Special operating conditions

†See Owner's Manual

ROADSIDE ASSISTANCE/WARRANTY

Mazda Roadside Assistance

Exhilaration, liberation and inspiration, are great reasons to drive a Mazda car, truck or SUV. In addition to all the other great standard features, you also get peace of mind with our basic warranty period Emergency Roadside Assistance Plan, it's just a phone call away, 24 hours a day, 365 days a year, call **1-800-866-1998**.

Mazda "bumper-to-bumper" Limited Warranty and Powertrain Warranty

Engineers design and build every Mazda to give you driving pleasure now and far down the road. We're so confident in our quality that we cover the entire vehicle against defects in materials and workmanship for 36 months/36,000 miles, whichever comes first, plus we provide a powertrain warranty for 60 months/60,000 miles, whichever comes first.

This Quick Tips® guide is provided by Mazda North American Operations to make your Mazda ownership experience more convenient. For complete details and operating instructions, see your Owner's Manual.

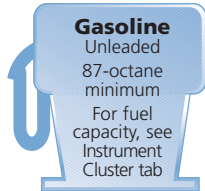

If you have any questions about your vehicle, you are invited to contact your local dealer.

Or if you need additional help, feel free to call our

Customer Assistance Center at 1-800-222-5500

Monday through Friday,
8 a.m.-4:45 p.m., Pacific

9 a.m.-5:45 p.m., Eastern/Central



www.mazdausa.com

©2007 Calcar, Quick Tips® is a trademark of Calcar, made in USA 4/07 11.024M DOT Mazda North American Operations reserves the right to change product specifications at any time without incurring obligations.

9999-95-023C-08QT

8L5J-19A285-AA