

'08

MAZDA **CX-7**

Quick Tips®

Reference

Guide for





Controls and

Functions

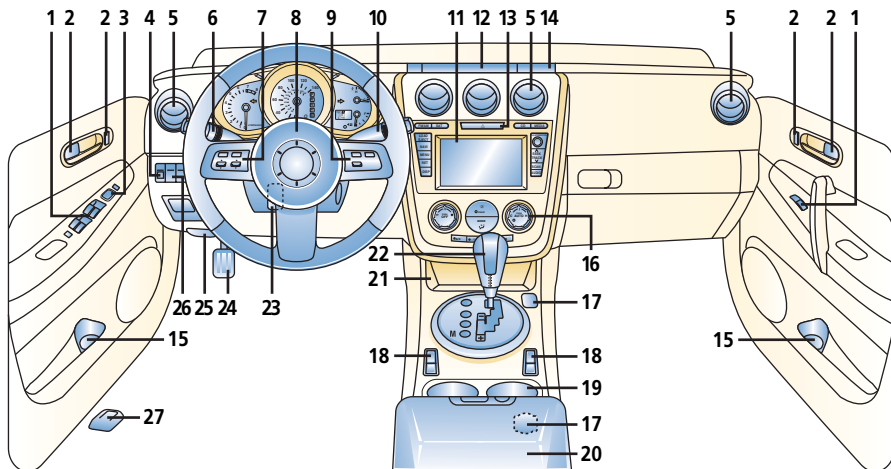

mazda®



- 1. Power window switches,**
see Mirrors/Windows
- 2. Door locks,**
see Locks
- 3. Mirror controls,**
see Mirrors/Windows
- 4. Headlight leveling switch*,**
see Getting Started
- 5. Air vents**
- 6. Turn signal/lighting control lever,**
see Getting Started
- 7. Audio control switches,**
see Getting Started
- 8. Horn/Air bag**
To beep: Press
- 9. Cruise control,**
see Getting Started
- 10. Wiper/washer control lever,**
see Getting Started
- 11. NAVI display*,**
see Owner's Manual
Audio system,
see Audio Systems
- 12. Information display,**
see Information Display
- 13.  Hazard warning switch/light**
Push to activate/deactivate.
- 14. Passenger air bag off indicator,**
see Getting Started
- 15. Bottle holder**
 **Tip: Use plastic bottles with caps, cups may spill when door is closed.**
- 16. Climate control panel,**
see Climate Controls
- 17. Accessory socket**
- 18. Seat warmer***
Press: On/off.
- 19. Cup holder**
- 20. Center console**
- 21. Storage**
- 22. Gearshift lever,**
see Transaxle
- 23. Tilt steering-wheel release lever,**
see Getting Started
- 24. Parking-brake**
To engage: Push down.
To release: Push down slightly, then release.
- 25.  Hood release handle**
Pull release handle to unlock.
- 26. Traction Control System,**
see Driving Tips
- 27.  Fuel-filler lid release**
To open: Pull lever upward and release.

*Denotes optional equipment

Always check the Owner's Manual for more operating information and safety features

GETTING STARTED

Getting Started

Mazda CX-7 Quick Tips® are designed to quickly familiarize you with some important features of your Mazda CX-7.

The Driver's View tab is your index to the Quick Tips®, locate the item you would like to learn more about and then turn to the listed tab.

This Getting Started section contains important operating tips about your Mazda CX-7.

Items identified in blue text call out unique features.

Turbocharger tips

To get maximum performance from your turbocharged engine, take note of the following:

Use 91 octane or above premium unleaded gasoline only, extra fuel additives are NOT recommended.

Change engine oil and filter every 7,500 miles, or sooner if needed, see Owner's Manual.

Use engine oil with API SL or ILSAC GF-3 service grade or higher, extra oil additives are NOT recommended.

After driving at freeway speeds or up a long hill, idle engine at least 30 seconds to cool turbo, avoid shutting engine off abruptly after a hard or long drive, turbocharger damage may result otherwise.

Do NOT race or over-rev ANY engine when starting, particularly a turbocharged engine.

Do NOT add aftermarket devices to alter the engine's ignition, fuel delivery, or turbo boost pressure, this may lead to serious engine damage and void your warranty.

(U) Tire Pressure Monitoring System (TPMS)

Warning light illuminates for a few seconds after ignition is on.

If tire pressure is too low in one or more tires, warning light will illuminate and beeper will sound.

Flashing warning light indicates possible malfunction; dealer inspection required.

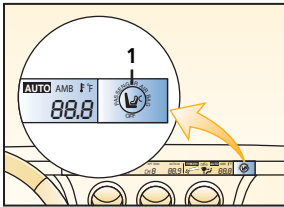
**Passenger air bag deactivation indicator light**

Front air bag deactivation indicator light (1) provides current status of front passenger air bag and pretensioner system.

If total seated weight on front passenger seat is less than approximately 66 lb., front passenger air bag deactivation indicator light illuminates, front passenger and side air

bags/pretensioner will not deploy/activate in an accident.

If the total seated weight is greater than approximately 93 lb., light does not illuminate, and the front passenger and side air bags/pretensioner will deploy/activate in an appropriate accident. See Owner's Manual for additional information on this feature and the air bag system.

Passenger sensing operation

See Driver's View

Passenger air bag deactivation indicator on dash will illuminate when passenger air bag is deactivated, child-restraint seat with child that weighs a combined total of 66 lbs. or less will deactivate front passenger and side air bags/pretensioner, see Owner's Manual.

⚠ WARNINGS: Even with a deactivation system, never place rear-facing infant-safety seat in front of any air bag, an infant is in serious danger of being injured or killed.

If you must install a forward-facing child-safety seat in the front seating position, move vehicle seat as far back as possible.

**HID headlights leveling switch***

Set position at 0 unless vehicle is loaded heavily, leveling switch adjusts headlight angle to compensate for weight of passengers and cargo, see Owner's Manual.

*Denotes optional equipment

Always check the Owner's Manual for more operating information and safety features

GETTING STARTED

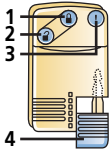

Advanced keyless entry/start system*

Advanced key must be carried by driver to operate properly.

Refer to Owner's Manual for additional instructions.

Tip: Do not use advanced key with activated cell phone in the same hand, advanced key functions may become disabled.

Advanced keyless system customization

Your authorized Mazda Dealer can customize your system if desired with features such as auto-lock, which can be programmed to automatically lock vehicle after driving and exiting vehicle.

For additional information, see Owner's Manual.

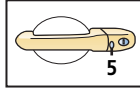

Locking doors

Driver's/passenger's door request switch: Press (5) once on either door to lock other doors.

Press and hold driver's request switch (5) to close windows and moonroof, release to stop.

Advanced key transmitter: Press button (1); pressing again within a few seconds causes doors to unlock and horn to beep.

Unlocking doors/opening liftgate

Driver's door request switch: Press (5) to unlock driver's door; press again within 3 seconds to unlock other doors and liftgate.

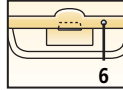

Passenger's door request switch: Press (5) on passenger's door; all doors and liftgate unlock simultaneously.

Liftgate request switch: Press (6) on liftgate, doors and liftgate will lock/unlock.

Advanced key transmitter: Press button (2) for driver's door; press again within 1 1/2 seconds to unlock other doors and liftgate, hold to lower front windows and open moonroof, release to stop.

Activating panic alarm

Panic alarm: Press and hold button (3) for more than 1 second; horn sounds, hazard warning lights flash; to stop, press any remote button.

*Denotes optional equipment

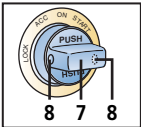

Starting engine

Press start knob (7) to START position to start engine.

cluster; turn start knob (7) to START position to start engine.

Auxiliary key operation

If advanced key cannot be used due to a malfunction or dead advanced key battery, use auxiliary key (4) to lock/unlock doors and to start vehicle.

To start vehicle: Remove start knob cover (7) by pressing both side release buttons (8) while pulling; insert auxiliary key into key cylinder and turn to start engine.

Tip: Do not place advanced key on or around dashboard, storage compartments such as glove box or in open liftgate/cargo

area, engine may not start or warnings may activate.

Turning off engine

Turn start knob to ACC position to turn engine off, push in and turn start knob to LOCK position.

Tip: Vehicle battery may be discharged and vehicle security compromised if start knob is left in ACC position.

Always put vehicle in Park (P), set parking brake and turn start knob to LOCK position when exiting vehicle.

System operation warnings

KEY indicator light flashes (green) indicates advanced key transmitter battery power is low.

KEY indicator light illuminated continuously (red) indicates system malfunction, and auxiliary key should be used, have vehicle inspected at an Authorized Mazda Dealer as soon as possible.

Tip: When using advanced keyless system, unless reprogrammed by dealer, system will beep as confirmation of lock/unlock requests, system will also beep if start knob is left in ACC position, advanced key has been left in vehicle or if advanced key is removed from vehicle while vehicle is running.

For additional system operation warnings, see Owner's Manual.

Replacing battery

See Owner's Manual

Cautions on use

To avoid damage to advanced key, do not allow any severe impacts or contact with liquids, do not place heavy objects on advanced key and do not leave advanced key exposed to direct sunlight or high temperatures, See Owner's Manual for all cautions and warnings.

Always check the Owner's Manual for more operating information and safety features

GETTING STARTED

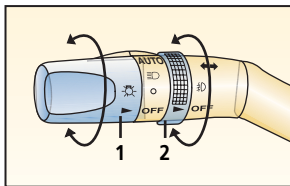

Turn signal/lighting control lever

OFF = Lights off

○ = Tail, parking and dashboard lights on: Rotate knob (1) to first notch

⊞ = Tail, parking, dashboard and headlights on: Rotate knob (1) to second notch
High beams on/off: Push forward/pull back to detent.

To flash high beams: Pull back slightly and release.

AUTO* = With ignition switch in ON position; headlights and exterior lights automatically turn ON/OFF depending on surrounding darkness/lightness; rotate knob (1) to third notch

⊞ = Fog lights* on: Rotate (2); functions only with low beams on

Turn signals right/left: move lever up/down.

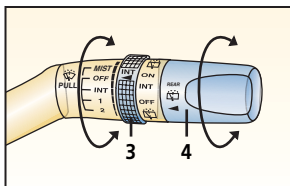

Wiper/washer control lever

Single wipe: Push lever up.

Washer: Pull back, also operates wipers.

Intermittent wiper: One click down. To change interval speed: Rotate inner ring (3).

Normal wiper speed: Two clicks down.

High-speed wiper: Three clicks down.

Rear window wiper/washer

To activate rear interval wiper: Rotate knob (4) up to INT.

To activate rear normal speed wiper: Rotate knob (4) up to ON.

To activate rear washer: Rotate knob (4) to  and release.

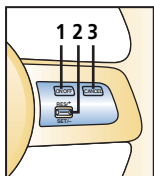

Cruise control

Operates above 19 mph.

Press ON/OFF switch (1) to enable/disable.

To set speed: Press switch (2) down and release.

To increase set speed: Push switch (2) up and release at desired speed.

To decrease set speed: Press switch (2) down and release at desired speed.

To cancel: Tap brake or press CANCEL switch (3).

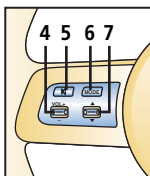

Steering-wheel audio controls

To increase/decrease volume: Press (4).

Press (5) to either mute standard Audio system or activate Navigation Voice Command*.

Press (6) to select AM, FM 1, FM 2 and CD mode.

Radio: Press ▲/▼ (7) less than one second to select next/previous preset station, press ▲/▼ (7) more than one second until beep sound is heard to seek next/previous station.

CD: Press ▲ (7) to select next track, press ▼ (7) to repeat current track.

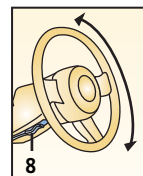

Tilt steering-wheel release lever

Pull lever (8) down to unlock column and pull up to lock column.

⚠ WARNING: Do not adjust steering-wheel while driving because you may lose control of the vehicle.

*Denotes optional equipment

Always check the Owner's Manual for more operating information and safety features

INSTRUMENT CLUSTER

GAUGES

- 1. Tachometer**
- 2. Speedometer**
- 3. Instrument cluster dimmer select button***

Pressing this button will toggle between Navigation screen DAY or NIGHT modes; rotating knob will adjust brightness.





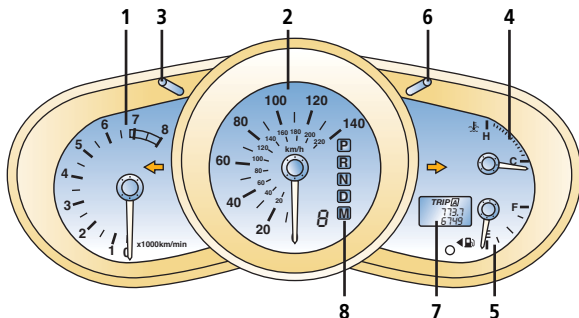















 **Tip: Instrument cluster brightness can be adjusted with headlight switch in any position (black-out meter mode).**

- 4. Engine coolant temperature gauge**
Stop car if above normal range, turn off engine, let vehicle cool; check coolant level when safe.



- 5. Fuel gauge**
18.2-gallon/69-liter tank
- 6. Odometer/Trip meter selector**
Press to view odometer; press again to reset trip odometer A/B settings.
- 7. Odometer/Trip meter**
- 8. Gear indicator**
Displays current gear position or manual mode.

WARNING LIGHTS

-  **Cruise control on**
Amber light: Cruise control system activated
Green light: Cruising speed set; see Getting Started
-  **Tire Pressure Monitoring System (TPMS)**, see Getting Started
-  **High beams on**
-  **Engine oil-pressure warning light**
Stop car when safe and turn off engine; check oil level
-  **Brake system**
Parking brake on/low brake fluid
-  **Always fasten seat belts**
-  **Security indicator light***
-  **Low fuel**
-  **Door ajar**
-  **Charging system warning light**
Charging system malfunction; dealer inspection required
-  **Air bag/front seat belt pretensioner system**
If light flashes or stays on, the air bags/front seat belt pretensioners may not operate in an accident; dealer inspection required
-  **Check engine**
Dealer inspection required if light remains on, see Owner's Manual
-  **AT Automatic transaxle warning light***
Automatic transaxle malfunction; dealer inspection required
-  **Anti-lock Brake System (ABS)**
ABS malfunction, normal brakes only; dealer inspection required
-  **Turn signals/hazard warning on**
-  **KEY***, see Getting Started
-  **TCS OFF**
Traction Control System is deactivated
-  **Lights ON indicator light***
-  **Traction Control System (TCS)/Dynamic Stability Control (DSC)**
Light flashes when in use; dealer inspection required if light remains on
-  **4WD AWD warning light***
Flashing lamp indicates high temperature differential oil, illuminated lamp indicates an abnormality with AWD system; dealer inspection required

*Denotes optional equipment

Always check the Owner's Manual for more operating information and safety features

LOCKS

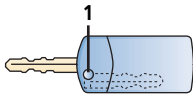
**Key**

Operates ignition and all locks.

Tip: Use key number plate to purchase a new key; store in safe place separate from vehicle.

Retractable type key

To fold/unfold press release button (1).

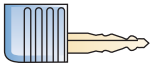
**Auxiliary key***

See Getting Started

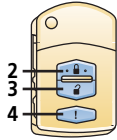
**Keyless entry system**

Functions only with ignition in OFF position.

To lock doors: Press button (2);

pressing again within a few seconds causes doors to relock and horn to beep.

To unlock: Press button (3) for driver's door; press again within 3 seconds to unlock other doors and liftgate, press and hold to lower driver's and passenger windows and open moonroof, release to stop.

Panic alarm: Press and hold button (4) for more than 1 second; horn sounds, hazard warning lights flash; to stop, press any remote button.

**Advanced keyless entry/start system/auxiliary key***

See Getting Started

Illuminated entry system

Activates interior lights when dome light switch set to DOOR position; lights off after driver's door is locked or ignition in ON position.

Immobilizer system

Prevents engine from running unless coded key is used, see Owner's Manual.

WARNING: Never leave a child alone in vehicle and never leave any key where a child can find it, particularly advanced keys which give easier access to a curious child.

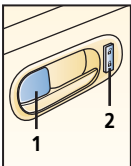
**Manual door locks**

To lock: Press front of button (1) toward door handle.

To unlock: Pull front of button away from door handle.

Power door locks

To lock/unlock all doors and liftgate from inside vehicle: Press bottom/top of switch (2).

Using mechanical key to unlock driver's front door: Rotate key to counterclockwise position for more than one second to unlock other doors and liftgate, continue to hold key in unlock position to roll front windows down and open moonroof. Using key to lock all doors: Rotate key to clockwise position, continue to hold key in lock position to roll front windows up and close moonroof, release to stop.

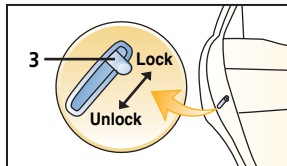
**Child-safety locks**

Located at edge of rear doors.

To activate: Pull tab (3) up; door opens from outside only.

To cancel: Push tab (3) down.

WARNING: Since children may access either rear door, child-safety locks for both rear doors should be activated.

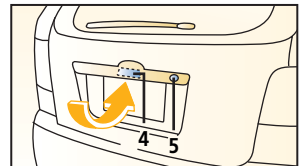
**Liftgate**

To open: Pull up on handle (4) and raise.

To close: Push liftgate down with both hands until it securely locks; do not slam liftgate.

Liftgate request switch* (5) operation, see Getting Started.

*Denotes optional equipment

Always check the Owner's Manual for more operating information and safety features

MIRRORS / WINDOWS

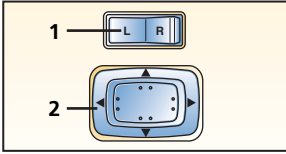

Dual power mirrors

Ignition switch must be in ACC or ON position.
Switch is on driver's door.

To adjust left/right mirror:
Press selector switch (1) left/right, press switch (2) in direction of desired movement.

Tip: To lock mirrors in place, move selector switch (1) to center position.

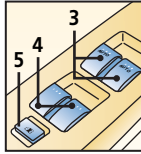

Power window switches

With ignition ON.

All windows controlled from driver's armrest; passenger doors have separate switches.

Front window switches

One-touch down/up: Press/pull AUTO switch (3) firmly and release, window goes down/up all the way, press/pull briefly to stop, press/pull lightly and hold for normal operation.

Tip: During closing window operation, window will stop and open partway if object blocks window operation.

Power window lockout switch

Press button (5), only driver's window operates; press again for normal operation.

Rear window switches

Push/pull (4) to open/close.

Power window initialization procedure

If battery is disconnected or power window fuse is replaced, the auto open/close and anti-pinch features will not function.

Resetting procedure:

1. Turn ignition switch to "ON" position.
2. Press power window switch down to fully open window, then pull switch up to close window completely, continue holding switch up for at least 3 seconds, then release switch.
3. Move to front passenger door and repeat Step 2 for front passenger window.
4. After windows have been initialized turn ignition to "LOCK", then back to "ON."

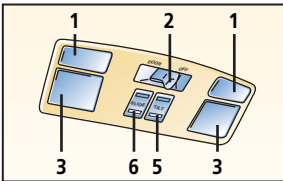

1. Map/reading light switch

Press on/off.

2. Interior light switch

DOOR = Light on when door open
ON = Light always on
OFF = Light always off

3. Front interior light

4. Rear interior light

5. Moonroof tilt switch*

Press rear of switch to tilt rear of Moonroof.
Press front of switch to close.

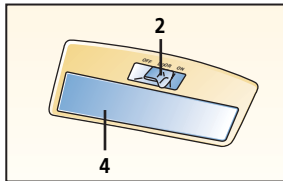

6. Moonroof slide switch*

Press rear of switch to open moonroof.
Press front of switch to close.

Tip: With all doors closed, moonroof and front windows can be opened via Keyless entry by pressing and holding unlock button, or opened/closed by turning and holding driver's door key toward front/rear of vehicle.

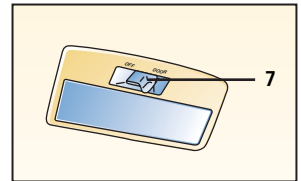

7. Cargo light

DOOR = Light on with liftgate open
OFF = Light always off

Driver/passenger covered visor mirrors

To access mirror: Lower visor.

*Denotes optional equipment

Always check the Owner's Manual for more operating information and safety features

SEATS

Shoulder belt height adjustment

To raise:
Push adjuster up.

To lower:
Pull button (1), slide down; release button.



⚠ WARNING: Make sure adjuster locks in one of its positions.

Manual controls**1. Fore-aft adjustment**

Lift lever and hold, slide seat, release lever.

2. Raise/lower seat (Driver's seat only)

Pull/push lever and release.

3. Seat back angle

To adjust: Lift and hold lever, lean forward or backward to tilt seat, release lever.

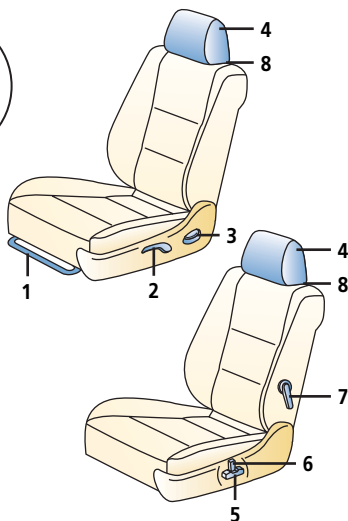
**4. Head restraint**

To raise/lower: Pull up/hold release button (8) and push down.

Power driver's seat*

5. Raise/lower front of seat
Pull/push front of switch vertically.

Fore/aft adjustment
Slide switch horizontally.

Raise/lower rear of seat
Pull/push rear of switch vertically.

Raise/lower seat
Pull/push center of switch vertically.

6. Seatback angle
Press front/rear of switch to change angle.

7. Lumbar support adjustment*
Pull lever forward repeatedly for more support.

⚠ WARNINGS: Do not adjust seats while driving.

Seat belts must always be worn when vehicle is in motion.

Air bags are supplemental and do not replace seat belt usage.

Always wear your seat belt and properly secure children 12 and under in the rear seat.

Even with a deactivation system, never place rear-facing infant-safety seat in front of any air bag, an infant is in serious danger of being injured or killed.

If you must install a forward-facing child-safety seat in the front seating position, move vehicle seat as far back as possible.

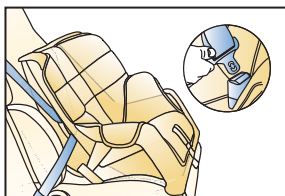
**Child-safety seat**

To install in rear outboard seats: Use dual locking mode retractor seat belts; see Owner's Manual for proper installation and child seat tether and LATCH system instructions.

⚠ WARNING: Use age appropriate child restraints, see Owner's Manual and state or province laws.

Seat belt emergency locking mode

Belts lock only on hard acceleration, braking, cornering or impacts of about 5 mph or more.

Automatic locking mode (all seat belts except driver's seat belt)

Must be used when installing child-safety seat.

To activate: Pull webbing fully out of retractor, allow belt to retract until click is heard; belt will only tighten.

To disengage: Unbuckle belt and allow webbing to retract fully.

*Denotes optional equipment

Always check the Owner's Manual for more operating information and safety features

REAR SEATS

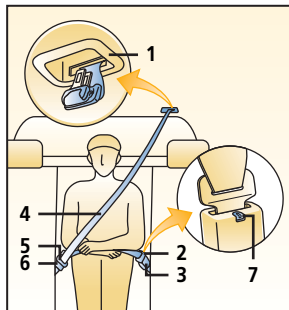
**Rear center position seat belt***

Connecting seat belt: Pull seat belt from ceiling recess (1) and connect tongue (2) to anchor (3).

Wearing seat belt: Slowly pull out lap/shoulder belt (4) and insert tongue (5) into buckle (6) until click is heard.

Unfastening seat belt: Depress buckle button (6) to release.

Tip: Leave center-rear lap portion of seat belt fastened at all times except when folding rear seat.

Stowing seat belt: Insert key or small object in anchor buckle slot (7) to release entire belt, let it fully retract, then put tongues (2) and (5) together, insert securely into recess (1).

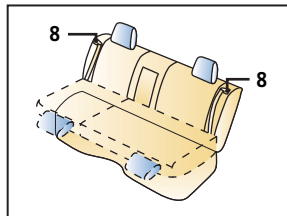
**Folding second-row seats**

Unfasten lap portion of center-rear seat belt; push knob (8) down and carefully lower seatback downward.

See Cargo Area tab for location of rear cargo area remote handle levers.

Returning seatbacks to original positions

Raise seatback to upward position. Make sure seatback is locked into position.

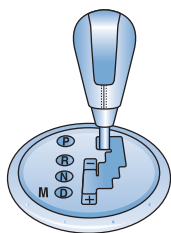
**Automatic Transaxle**

Gearshift must be in Park or Neutral to start engine; it must be in Park to remove ignition key.

P = Park

To move gearshift from Park: Press firmly on brake pedal then move the shift lever out of P.

R = Reverse**N = Neutral**

No gear engaged.

D Drive (Overdrive)

For normal driving: Shifts through all forward gears automatically.

**M (Sport A/T manual shift mode)**

Move shifter from D to M to engage manual shift mode, M will be illuminated for manual mode on

shift position indicator located in the instrument panel.

Manual shifting of transmission is achieved by moving shifter back to upshift and forward to downshift, move shifter from M to D to engage automatic shift mode.

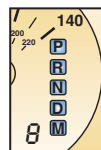
**Gear Indicator**

Illuminated numeral of gear indicator located in the instrument panel

displays current gear in Automatic and Manual shift modes.

Tip: Back-up camera* automatically operates when gearshift lever is placed into reverse and is viewable via navigation display screen.

When using back-up camera, objects may be closer than they appear, please check your surroundings.

*Back-up camera feature is only available with optional Technology Package
† See Owner's Manual

Always check the Owner's Manual for more operating information and safety features

CLIMATE CONTROLS

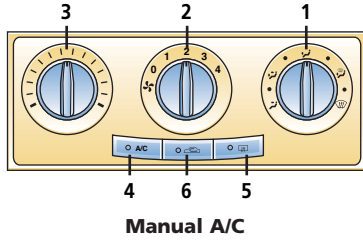

Manual A/C

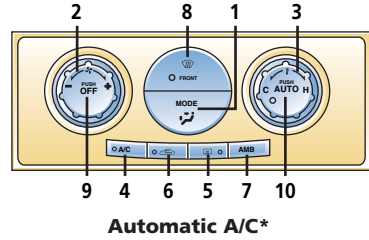

Automatic A/C*

1. Air flow selections

- = air to dash
- = air to dash and floor
- = air to floor
- = air to floor and windshield
- = air to windshield (defrost)
(Manual Climate Control)

6. Air intake control

Press switch to alternate between recirculated (Indicator light on) or outside (Indicator light off) air mode.

= recirculate inside air; use for maximum cooling

⚠️ WARNING: Do not use position in cold weather, windows may fog and hamper vision.

Automatic operation

Press AUTO (10) for automatic operation; rotate outer dial to set temperature, refer to information display for air flow selection, see Owner's Manual.

☀️ Tip: Automatic climate control display viewed via information display, see below.

2. Fan control

Rotate knob clockwise/ counterclockwise to increase/ decrease fan speed.

3. Temperature control

Cooler/warmer = rotate knob counterclockwise/clockwise

4. A/C = air conditioner

Press to turn on/off

5. Rear window defogger

Press on/off; shuts off with ignition or automatically after 15 minutes of operation; also operates heated outside mirrors*.

7. AMB*

Press AMB button (7) to display ambient temperature, press again to switch display to temperature set for air conditioner.

☀️ Tip: To change from Fahrenheit to Centigrade or vice versa: Press AMB button (7) for 3 seconds or more.

8. Windshield defroster switch

Press: Fresh air position is automatically selected, A/C automatically turns ON.

9. OFF

Press to turn system OFF.

Control positions for maximum defrost

Fan to maximum, temperature to maximum hot, selected.

☀️ Tip: To help prevent windshield fogging in humid weather, select before starting engine.

To prevent moisture buildup, never drive with system off. Objects placed under the front seats may interfere with air flow to the rear.

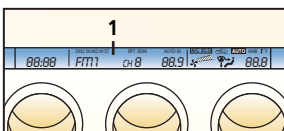

Information Display

Information display (1) has the following functions: Clock, audio display, automatic climate control display* and ambient/cabin temperature display* (AMB).

☀️ Tip: Manual climate control not viewable via information display.

*Denotes optional equipment

Always check the Owner's Manual for more operating information and safety features

Information Display

AM / FM STEREO / CD / CD CHANGER

1. Power/Volume

Press to turn on/off; rotate to increase/decrease volume.

2. Random

Press to play CD selections in random order, press again to cancel.

3. Program*

4. Auto-Memory

Press and hold until a beep sound is heard; system automatically scans and temporarily stores six strong stations in each band; press again to switch to another preset station.

DISP

CD: Press repeatedly to scroll through displays.

Text*: Rotate right/left to display titles longer than 12 characters.

5. Tune

Radio: Rotate counterclockwise/clockwise for lower/higher frequency.

6. SEEK/TRACK

Radio: Press ▲ / ▼ to automatically seek higher/lower frequency.

CD: Press ▲ / ▼ to select next track/beginning of current track.

7. LOAD*

To load multiple discs: Press and hold LOAD (7) until beep sound is heard; insert CD when "IN" is indicated on information display (20).

To eject disc: Press Eject (15).

To eject specific disc: Press and hold Eject (15) until beep sound is heard; within five seconds press the desired tray number 1-6 (16).

*Denotes optional equipment

** See Navigation Owner's Manual for clock setting procedure if equipped with Navigation System

† Not functional in U.S. market

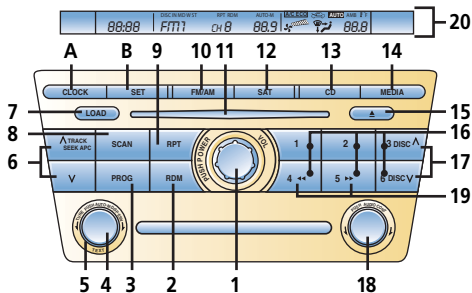

8. Scan

Radio: Press to sample strong stations, press again to stop at current station.

CD: Press to play first few seconds of each selection, press again to stop at current selection.

9. RPT

Press to replay current CD selection.

19. Reverse ◀/Fast forward ▶▶

Press to reverse/fast forward through a track.

20. Display,

see Information Display

10. FM/AM

Press to turn radio on and select between FM1/FM2/AM station preset buttons (16).

11. CD slot

12. SAT*, Satellite ready capability.

13. CD, Press to play CD.

14. Media†

15. CD eject button

16. Memory preset buttons
To set: Tune to station, press and hold until beep sound is heard.

17. Disc ^ / v *

Press to skip to next/previous CD.

18. Audio control

Audio: Press to select ALC/BASS/TREB/FADE/BAL/BEEP/Surround* OFF/1/2/3, rotate right/left to adjust selected feature.

Tip: Automatic Level Control (ALC) automatically adjusts audio volume depending on vehicle speed.

Clock**

To set: With ignition in ACC or ON position, press (A) and hold until beep sounds; 12hr/24hr will appear on display (20); press (B) to select; press (A) again while selection is flashing: Hr ADJUST displays; press (B) to select hour; press (A) when done, do the same to set minutes.

Navigation/Audio System*

AudioPilot* (BOSE system) Automatically adjusts audio volume in accordance with level of noise entering vehicle; press on-screen button to turn ON/OFF.

Centerpoint* (BOSE system) Delivers multi-channel surround sound while listening to CDs.

See Owner's Manual for complete details.

Always check the Owner's Manual for more operating information and safety features

CARGO AREA

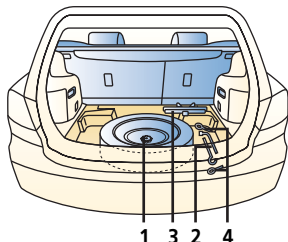

Spare tire

1. Temporary spare tire

Stored under panel in liftgate; to change flat tire: Follow instructions in Owner's Manual.

⚠️ WARNING: Do not exceed 50 mph with temporary spare.

☀️ Tip: For instructions and restrictions on use of temporary spare tire, see Owner's Manual.

2. Lug wrench and jack lever

3. Jack

4. Tiedown eyelet

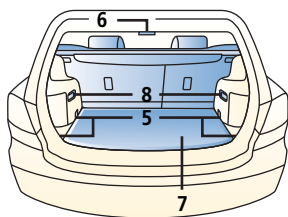

Cargo area

5. Cargo securing loops

6. Cargo light

See Interior Lights for operation.

7. Reversible lower cargo floor (carpet or plastic)

Split-folding rear seatback

Remote handle levers: Pull lever (8) to release seatback.

Gas cap

After filling vehicle with gasoline, fully reinstall gas cap by turning clockwise until a clicking sound is heard, if gas cap is not fully installed, Check Engine light may come on.

For more information on Check Engine light, see Owner's Manual.

Tire economy and tips

Check tire pressure monthly when tires are cold, use a digital tire pressure gauge for accurate tire pressure measurement.

Tires should be of the same type and size.

Maintain correct front-end alignment and tire balance; rotate tires at 5,000 or 7,500 mile intervals; see Owner's Manual for rotation chart.

Tire pressure

Decal on Driver's B-pillar provides tire pressure information.

Anti-lock Braking System (ABS)

ABS automatically reduces hydraulic pressure to any wheel on the verge of locking up.

You may feel a slight pulsing of the brake pedal and hear a clicking noise; this tells you the ABS is functioning properly; increase pressure on pedal for maximum braking.

☀️ Tips: Maintain constant pressure on the brake pedal. Do not pump the brakes.

ABS self test

A self-diagnostic test is performed when starting; you may feel some brake pedal pulsation and hear some noise, this is normal.

Traction Control System (TCS)

Enhances traction and safety by regulating engine torque.

When TCS detects drive wheel slippage it lowers engine torque to prevent loss of traction.

Dynamic Stability Control (DSC)

Controls braking and engine torque in conjunction with ABS and TCS to help control side slip on slippery surfaces or during sudden or evasive maneuvering.

Always check the Owner's Manual for more operating information and safety features

UNDER HOOD

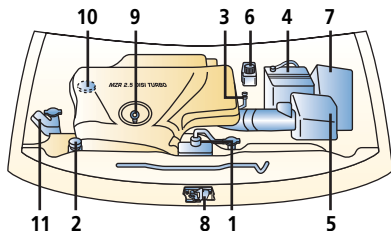

2.3-liter Engine

1. Engine coolant reservoir

Level should be between COLD FILL RANGE indicator marks.

⚠ WARNING: Never remove coolant reservoir cap while engine is running or hot; remove only when system is cool.

2. Power steering fluid reservoir

Level should be between MIN and MAX lines.

3. Automatic transaxle fluid level dipstick Fluid Hot scale A

Fluid above 150°F, level must be between full and low.

Fluid Hot scale B

Cold fluid below 70°F should be close to, but not above bottom notch on dipstick.

4. Battery**5. Air filter****6. Brake fluid reservoir**

Fill to MAX mark with DOT 3 fluid; check with cap on.

7. Fuse block panel

Push latch in; lift cover.

8. Hood latch

Pull up to release hood.

9. Engine oil dipstick

Fluid should be between max. and min. on dipstick; do not fill above max.

10. Engine oil filler cap

SAE 5W-30

11. Windshield washer fluid reservoir

Fill with windshield washer fluid.

☀ Tip: Check all fluids with vehicle parked on a level surface and engine off unless otherwise stated.

Break-in period

First 600 miles: Avoid heavy braking and acceleration; drive at varying road and engine speeds.

☀ Tip: Follow similar procedures with newly overhauled engine or when brakes are replaced.

Maintenance notes:

Rotate tires every 7,500 miles or sooner if needed.

Replace cabin air filter every 25,000 miles or 24 months.

Replace (FL22) engine coolant at 120,000 miles or 10 years.

⚠ WARNING: Using coolant other than FL22 requires more frequent maintenance intervals.

☀ Tip: For severe driving conditions, Owner's Manual recommends changing oil and filter at 5,000[†] miles.

☀ Tip: For additional service intervals and complete details, see Owner's Manual.

NORMAL SERVICE INTERVALS

7,500 miles	A	
15,000 miles	A	F
22,500 miles	A	
30,000 miles	A B	F
37,500 miles	A	C
45,000 miles	A	F G
52,500 miles	A	
60,000 miles	A B	D F
67,500 miles	A	
75,000 miles	A	C E F
82,500 miles	A	
90,000 miles	A B	F G

A. Replace: Engine oil and filter[†]

Lubricate: All locks and hinges

B. Inspect: Fuel lines and hoses, brake lines, hoses and connections, steering operation and linkages, front and rear suspension and ball joints, drive-shaft dust boots

C. Inspect: Drive belts (tension)
Replace: Air filter

D. Inspect: Hoses and tubes for emission system
Replace: Engine coolant (Other than FL22)

E. Inspect: Engine valve clearance
Replace: Spark plugs

F. Inspect: Disc brakes

G. Inspect: Exhaust system and heat shields

[†] See Owner's Manual

Mazda Roadside Assistance

Exhilaration, liberation and inspiration, are great reasons to drive a Mazda car, truck or SUV. In addition to all the other great standard features, you also get peace of mind with our basic warranty period Emergency Roadside Assistance Plan, it's just a phone call away, 24 hours a day, 365 days a year, call **1-800-866-1998**.

Mazda "bumper-to-bumper" Limited Warranty and Powertrain Warranty

Engineers design and build every Mazda to give you driving pleasure now and far down the road. We're so confident in our quality that we cover the entire vehicle against defects in materials and workmanship for 36 months/36,000 miles, whichever comes first, plus we provide a powertrain warranty for 60 months/60,000 miles, whichever comes first.

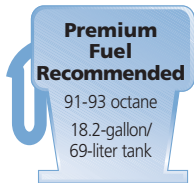
**Lower Octane Fuel Usage**

If 91 octane fuel is not available, fuel as low as 87 octane can be used. Use of lower octane fuel can decrease performance, refueling vehicle with correct octane fuel a couple of times will restore vehicle performance and shift quality.

This Quick Tips® guide is provided by Mazda North American Operations to make your Mazda ownership experience more convenient.

For complete details and operating instructions, see your Owner's Manual.

If you have any questions about your vehicle, you are invited to contact your local dealer. Or if you need additional help, feel free to call our

Customer Assistance Center at 1-800-222-5500

Monday through Friday,

8 a.m.-4:45 p.m., Pacific

9 a.m.-5:45 p.m., Eastern/Central



mazda®

www.mazdausa.com

©2007 Calcar, Quick Tips® is a trademark of Calcar, made in USA 5/07 68.892M DOT Mazda North American Operations reserves the right to change product specifications at any time without incurring obligations. 9999-95-080C-08QT