

'08

# MAZDA **MX-5**

Quick Tips®

Reference  
Guide for  
Controls and  
Functions



# DRIVER'S VIEW

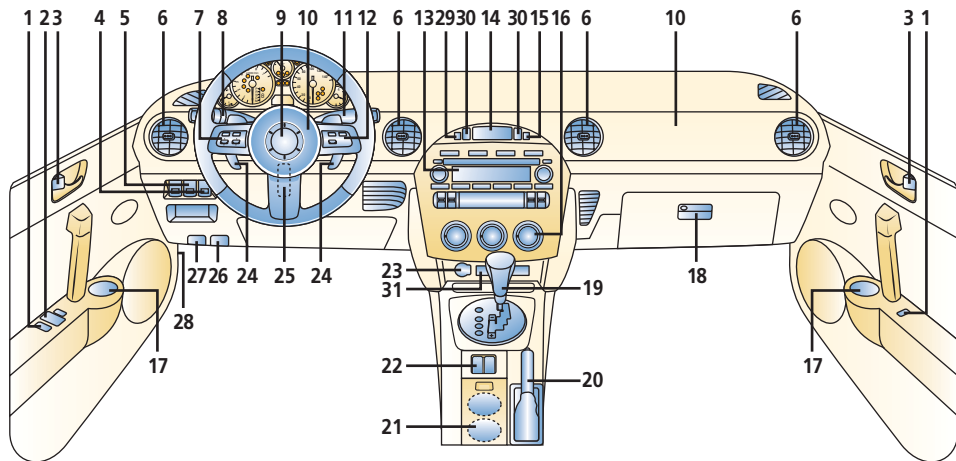

1. **Power door locks\***, see Locks
2. **Power outside mirror switch**, see Switches/Interior Lights
3. **Manual door locks**, see Locks
4. **Passenger air bag deactivation switch**, see Getting Started
5. **DSC Traction Control System\***, see Instrument Cluster
6. **Air vents**  
Move vents to direct airflow.
7. **Audio control switches\***, see Getting Started
8. **Turn signal/lighting control lever**, see Getting Started
9. **Horn**
10. **Air bag**
11. **Wiper/washer lever**, see Getting Started
12. **Cruise control\***, see Getting Started
13. **Audio system**, see Audio Systems
14. **▲ Hazard warning switch**  
Press on/off
15. **Passenger air bag off indicator**, see Getting Started
16. **Climate control system**, see Climate Controls
17. **Bottle holder**  
▲ **CAUTION: Use plastic bottles with caps, cups may spill when door is closed.**
18. **Glove compartment**
19. **Gearshift lever**, see Transmission
20. **Parking brake lever**
21. **Cup holders**
22. **Power window switches**, see Switches/Interior Lights
23. **Accessory socket**
24. **Steering shift switches (A/T only)\***, see Transmission
25. **Tilt steering-wheel lever**, see Getting Started
26. **🚗 Hood release handle**  
Pull to open partially.
27. **🚗 Remote trunk-lid release**  
Press button to open trunk.
28. **Fuse panel**
29. **Power retractable hardtop operation indicator\***, see Convertible
30. **Power retractable hardtop switches\***, see Convertible
31. **Seat warmer\***  
Press on/off.

\*Denotes optional equipment

*Always check the Owner's Manual for more operating information and safety features*

Driver's  
View

## GETTING STARTED

**Getting Started**

Mazda MX-5 Miata Quick Tips® are designed to quickly familiarize you with some important features of your Mazda MX-5 Miata.

The Driver's View tab is your index to the Quick Tips®, locate the item you would like to learn more about and then turn to the listed tab.

This Getting Started section contains important operating tips about your Mazda MX-5 Miata.

Items identified in blue text call out unique features.

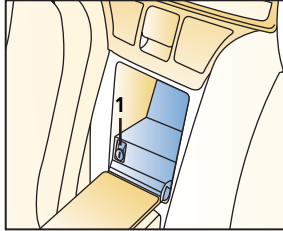
**Remote fuel filler release lever**

Located in rear compartment between seats.

Pull remote fuel-filler lid release lever (1) to open fuel-filler lid.

**Behind seat storage (Soft top only)**

Move seatbacks forward to access additional storage compartments, see Seats.

**Tire Pressure Monitoring System (TPMS)**

Warning light illuminates on instrument cluster for a few seconds with ignition on.

If tire pressure is low, warning light illuminates with audible beep sound, adjust tire pressure to correct specifications, perform tire pressure adjustment before driving, a digital tire pressure gauge is recommended.

Flashing warning light may indicate malfunction, dealer inspection required.

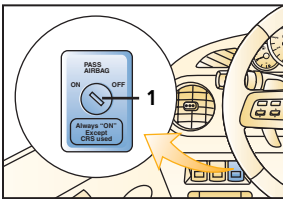
**Passenger's seat air bag deactivation switch†**

Deactivate passenger's seat air bag when using a child-safety seat.

To deactivate/activate: Insert ignition key or auxiliary key (Advanced keyless entry\*) in switch (1), rotate to OFF/ON, remove key.

Passenger air bag off indicator illuminates when air bag is deactivated and ignition is on.

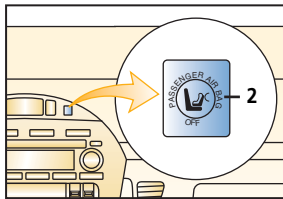
**Passenger air bag deactivation indicator light**

Front air bag deactivation indicator light (2) provides current status of front passenger air bag and pretensioner system.

If total seated weight on front passenger seat is less than approximately 66 lb., front passenger air bag deactivation indicator light illuminates, air bag/pretensioner will not deploy/activate in an accident.

If the total seated weight is greater than approximately 93 lb., light does not illuminate, and the air bag/pretensioner will deploy/activate in an appropriate accident, see Owner's Manual.

**⚠ WARNINGS: Even with advanced air bags, when using a rear-facing infant-safety seat always set the passenger seat air bag deactivation switch to OFF position.**

**An infant is in serious danger of being injured or killed if front passenger air bag is deployed. If you must install a forward-facing child-safety seat in the front seating position, move vehicle seat as far back as possible and set air bag deactivation switch to OFF position.**

\* Denotes optional equipment

† For other rare circumstances when passenger air bag can be shut off, refer to NHTSA guidelines

**Always check the Owner's Manual for more operating information and safety features**

## GETTING STARTED

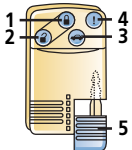

### Advanced keyless entry/start system\*

Advanced key must be carried by driver to operate properly.

### Advanced keyless system customization

Your authorized Mazda Dealer can customize your system if desired with features such as auto-lock, which can be programmed to automatically lock vehicle after driving and exiting vehicle.

For additional information, see Owner's Manual.

**⚠️ WARNING: Never leave a child alone in vehicle and never leave any key where a child can find it, particularly advanced keys which give easier access to a curious child.**

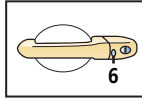

### Locking doors

Driver's/passenger's door request switch: Press (6) once on either door to lock both doors.

Advanced key transmitter: Press button (1); pressing again within a few seconds causes doors to relock and horn to beep.

### Unlocking doors/opening trunk

Driver's door request switch: Press (6) to unlock driver's door; press again within 3 seconds to unlock both doors.

Passenger's door request switch: Press (6) on passenger's door; both doors unlock simultaneously.

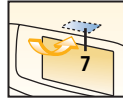

Trunk request switch: Press (7) on trunk lid, only trunk will open, doors do not lock/unlock.

**☀️ Tip: Trunk will not open if power retractable hardtop\* latch is released or top is not in complete raised/lowered position.**

Advanced key transmitter: Press button (2) for driver's door; press again within a 3 seconds to unlock passenger's door, press and hold to lower driver's and passenger windows. **Press and hold button (3) for more than 1 second to open trunk.**

**Activating panic alarm**  
Panic alarm: Press and hold button (4) for more than 1 second; horn sounds, hazard warning lights flash; to stop, press any remote button.

\*Denotes optional equipment

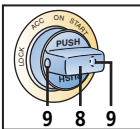

### Starting engine

Press start knob (8); when KEY indicator (green) illuminates on instrument

cluster; turn start knob (8) to START position to start engine.

### Auxiliary key operation

If advanced key cannot be used due to a malfunction or dead advanced key battery, use auxiliary key (5) to lock/unlock doors, trunk and to start vehicle.

To start vehicle: Remove start knob cover (8) by pressing both side release buttons (9) while pulling; insert auxiliary key into key cylinder and turn to start engine.

**☀️ Tip: Do not place advanced key on or around dashboard, storage compartments such as glove box or in open trunk, engine**

**may not start or warnings may activate.**

### Turning off engine

Turn start knob to ACC position to turn engine off, push in and turn start knob to LOCK position.

**☀️ Tip: Vehicle battery may be discharged and vehicle security compromised if start knob is left in ACC position.**

Always put vehicle in Park (P), set parking brake and turn start knob to LOCK position when exiting vehicle.

### System operation warnings

KEY indicator light flashes (green) indicates advanced key transmitter battery power is low.

KEY indicator light illuminated continuously (red) with warning beep indicates system malfunction, and auxiliary key should be used, have vehicle inspected at an Authorized Mazda Dealer as soon as possible.

**☀️ Tip: When using advanced keyless system, unless reprogrammed by dealer, system will beep as confirmation of lock/unlock requests, system will also beep if start knob is left in ACC position, advanced key has been left in vehicle or if advanced key is removed from vehicle while vehicle is running.** For additional system operation warnings, see Owner's Manual.

### Replacing battery

See Owner's Manual

### Cautions on use

To avoid damage to advanced key, do not allow any severe impacts or contact with liquids, do not place heavy objects on advanced key and do not leave advanced key exposed to direct sunlight or high temperatures, see Owner's Manual for all cautions and warnings.

**Always check the Owner's Manual for more operating information and safety features**

# GETTING STARTED

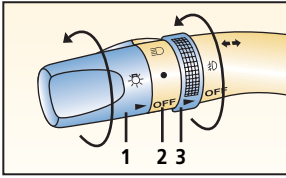

## Turn signal/lighting control lever

**OFF** = Lights off

- = Tail, parking and dashboard lights on: Rotate knob (1) to first notch
- ☰ = Tail, parking, dashboard and headlights on; rotate knob (1) to second notch

High beams on/off: Push lever (2) forward/pull lever back to original position.

To flash high beams: Pull back lever (2) slightly and release.

☼ = Fog lights\* on: Rotate (3); functions only with headlight low beams on

Turn signals right/left: move lever up/down.

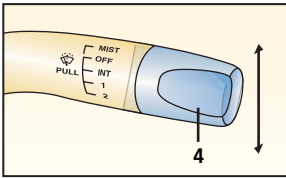

## Windshield wiper/washer lever

Intermittent wiper: One click down.

Normal wiper speed: Two clicks down.

Fast wiper speed: Three clicks down.

Single wipe: Push lever up.

Wash and wipe: Pull lever (4) toward you and hold; washer and wipers will be activated until lever is released.

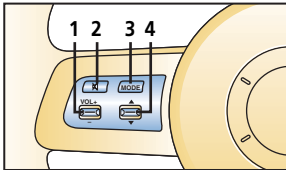

## Steering-wheel audio controls\*

To increase/decrease volume: Push up/press down switch (1).

Press (2) to mute.

Press (3) to select AM, FM1, FM2, CD, SIRIUS\* radio mode.

Push up/press down (4) to seek next/previous preset radio station/CD track.

Press and hold up/down (4) to seek radio stations in AM, FM1, FM2.

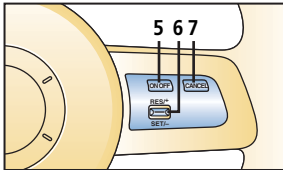

## Cruise control\*

Operates above 19 mph.

Press ON/OFF switch (5) to enable/disable.

To set speed: Press switch (6) down and release.

To increase set speed: Push switch (6) up and release at desired speed.

To decrease set speed: Press switch (6) down and release at desired speed.

To cancel: Tap brake or clutch pedal (manual transmission) or press CANCEL switch (7).

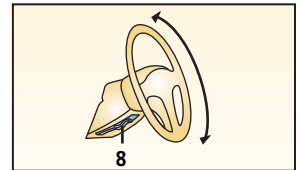

## Tilt steering-wheel lever

Pull lever (8) down to unlock column, adjust angle of column.

**⚠ WARNING: Do not adjust steering-wheel while driving.**

\*Denotes optional equipment

Always check the Owner's Manual for more operating information and safety features

## INSTRUMENT CLUSTER

## GAUGES AND CONTROLS

**1. Dashboard illumination control**, Rotate to dim/brighten.

**2. Tachometer**  
Avoid red zone.

**3.  Turn signal/hazard warning on**

**4. Engine oil pressure gauge**  
If outside normal range, stop vehicle safely and turn off engine, check oil level. See Owner's Manual for scheduled maintenance.

 **Tip: Needle fluctuates with engine RPM, this is normal.**

**5. Speedometer**

**6. Odometer/trip odometer selector**

Press to select odometer or trip odometer A/B; press and hold to reset selected trip odometer.

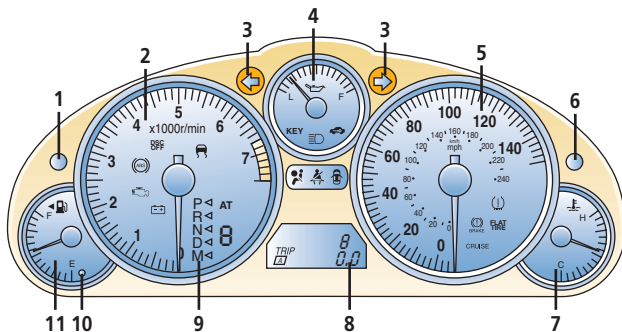

**7. Coolant temperature gauge**

If above normal range, stop vehicle safely and turn off engine; check coolant level when safe.

**8. Coolant temperature gauge**







**9. Odometer/trip odometer display**

**10. Shift/gear position indicators\***

**11. Low fuel indicator**

12.7-gallon/48-liter tank

## WARNING LIGHTS

-  **Cruise control\*** on  
Amber light: Cruise control system activated  
Green light: Cruising speed set; see Getting Started
-  **High beams on**, see Getting Started
-  **Immobilizer system on**, see Locks
-  **Check engine**  
Dealer inspection required
-  **Air bag readiness**  
If light flashes or stays on, the air bags may not operate in an accident; dealer inspection required
-  **Brake system**  
Parking brake on/low brake fluid

•  **AT Automatic transmission warning light\***

•  **Charging system**  
Possible alternator or charging system malfunction, dealer inspection required

•  **Anti-lock Brake System (ABS)**  
Indicates ABS malfunction, dealer inspection required

•  **Door ajar**

•  **DSC OFF Dynamic Stability Control\* off**

•  **Tire pressure monitoring system**, see Getting Started

•  **Always fasten seat belts**

•  **Flat tire warning light**  
Flat tire or system malfunction, dealer inspection required

• **KEY\***, see Getting Started

•  **TCS/DSC indicator light\***  
Flashes when traction control or stability control is functioning, steady light indicates malfunction  
Enhances traction and safety by regulating engine and brake torque

TCS/DSC light may occasionally flash while driving, this indicates that the TCS/DSC was performing a correction to help maintain your best vehicle control, if TCS/DSC light remains on, see your Mazda Dealer

\*Denotes optional equipment

Always check the Owner's Manual for more operating information and safety features

LOCKS

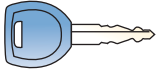

**Key**

Operates ignition and all locks.

**Tip:** Use key number plate to purchase a new key; store in a safe place separate from vehicle.

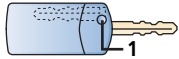

**Retractable key\***

To fold/unfold: Press release button (1).

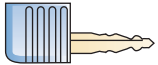

**Auxiliary key\***

See Getting Started

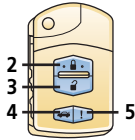

**Remote keyless entry system\***

Functions only with ignition in OFF position.

To lock doors: Press button (2);

pressing again within a few seconds causes doors to relock and horn to beep.

To unlock: Press button (3) for driver's door; press again within 3 seconds to unlock passenger's door. Press and hold button (4) for more than 1 second to open trunk.

**Tip:** Trunk will not open if power retractable hardtop\* latch is released or top is not in complete raised/lowered position.

Panic alarm: Press and hold button (5) for more than 1 second; horn sounds, hazard warning lights flash; to stop, press any remote button.

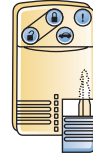

**Advanced keyless entry/start system/auxiliary key\***

See Getting Started

**Immobilizer system**

Prevents engine from running unless coded key is used, see Owner's Manual.

**WARNING:** Never leave a child alone in vehicle and never leave any key where a child can find it, particularly advanced keys which give easier access to a curious child.

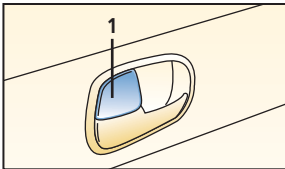

**Manual door locks**

To lock/unlock: Push button (1) into handle/pull toward you.

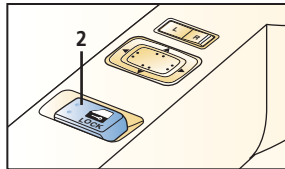

**Power door locks\***

Both doors can be locked/unlocked using power door lock switch (2) or by using key in driver's door.

To unlock driver's door: Turn key toward the front of vehicle.

To unlock both doors: Turn key and hold in unlock position for more than 1 second.

To lock both doors: Turn key toward the back of vehicle.

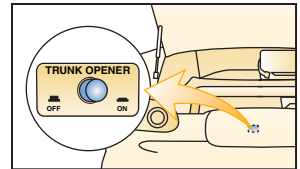

**Remote trunk-lid release lock-out**

Switch in ON position, remote trunk release functions normal; OFF position disables system; switch located in trunk, see Trunk.

\*Denotes optional equipment

Always check the Owner's Manual for more operating information and safety features

## SWITCHES/INTERIOR LIGHTS

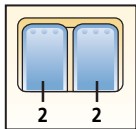
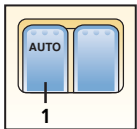

### Power windows

Operate only with ignition on.  
To open/close: Push down/pull up front of switch.

Auto down function is available on driver's window only, identified by AUTO on switch (1) or both driver and passenger windows, switches are blank (2) depending on model.  
Auto down function: Press desired switch down completely and release.

 **Tip: On models with auto down function on both windows, windows can be opened using keyless entry transmitter by pressing and holding unlock button.**

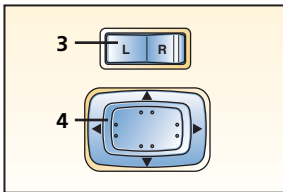

### Dual power mirrors

Operates in accessory mode or with ignition on.

To adjust left/ right mirror: Push selector switch (3) left/right, press switch (4) in direction of desired movement.

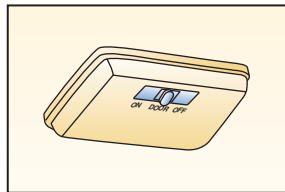

### Dome light

ON = Light always on  
OFF = Light always off  
DOOR = Light on when a door is open

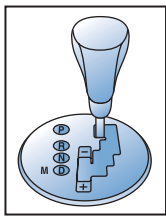

### Automatic transmission\* P = Park

To move gearshift from Park: Press firmly on brake pedal, then move gearshift to gear selection.

**R = Reverse**

**N = Neutral** No gear engaged.

**D (Overdrive)**

For normal driving: Shifts through all forward gears automatically.



### Gear indicator (A/T only)\*

Illuminated numeral of gear indicator located in the instrument panel displays current gear in Automatic and Manual shift modes.

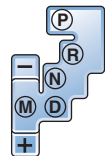

### M (Sport A/T manual shift mode)\*

Move shifter from D to M to engage manual shift mode, M will be illuminated on shift position

indicator located in the instrument panel.

Manual shifting of transmission is achieved by moving shifter back to upshift and forward to downshift, move shifter from M to D to engage automatic shift mode.

 **Tip: You can also shift using steering shift switches.**

**To upshift:** Tap either up switch toward you.

**To downshift:** Tap either down switch away from you.

\*Denotes optional equipment

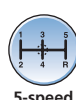

5-speed



6-speed\*

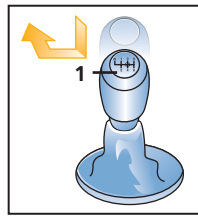

### Manual transmission

Depress clutch pedal to start engine and change gears.

5-Speed: Put shifter in neutral before selecting reverse.

6-Speed: Push shifter (1) downward and over to select reverse gear.

 **Tip: With power retractable hardtop\*, if beep sounds when vehicle is placed into gear, verify hardtop latch is closed, if power top does not operate when in the open position, verify vehicle is not in gear or trunk is not open.**

Always check the Owner's Manual for more operating information and safety features



## SEATS

**Manual controls****1. Fore-aft adjustment**

Lift lever and hold, slide seat, release lever.

**2. Seat belt buckle****3. Seatback angle**

To adjust: Lift and hold lever, lean forward or backward, release lever.

**4. Height adjustment\* (Driver's seat only)**

Pull/push lever and release.

 **Tip: Move seatbacks forward to access additional storage compartments (Soft top only).**

**Seat warmer\***

Located below climate controls, see Driver's View.

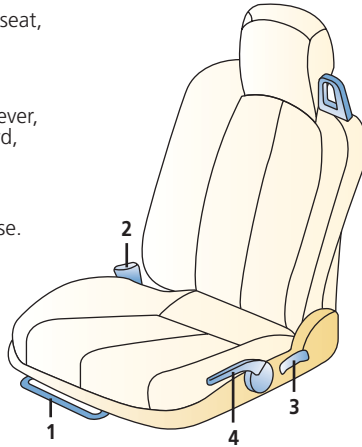

 **Tip: Side-impact air bags deploy from outboard side of driver and front passenger seatbacks.**

 **WARNINGS: Do not adjust seats while driving.**

**Seat belts must always be worn when vehicle is in motion.**

**All air bags are supplemental and do not replace seat belt usage.**

**Properly secure children and even with advanced air bags, set passenger side air bag deactivation switch to OFF position.**

**Seat belt emergency locking mode**

Belts lock only on hard acceleration, braking, cornering or impacts of about 5 mph or more.

**Automatic locking mode (front passenger seat belt only)**

Must be used when installing child-safety seat.

To activate: Pull belt fully out of retractor, connect buckle and allow belt to retract until click is heard; belt will only tighten.

To disengage: Unbuckle belt and allow belt to retract fully.

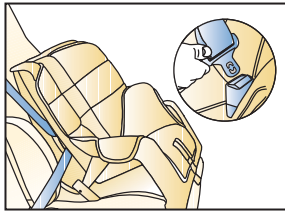
**Child-safety seat**

To install in passenger seat: Use key to disable passenger air bag, then move seat as far back as possible; use dual locking mode retractor seat belt; see Owner's Manual for proper installation of child seat and LATCH system instructions.

 **WARNING: Use age appropriate child restraints, see Owner's Manual and state or province laws.**

 **WARNINGS: Even with advanced air bags, when using a rear-facing infant-safety seat always set the passenger seat air bag deactivation switch to OFF position.**

**An infant is in serious danger of being injured or killed if front passenger air bag is deployed.**

**If you must install a forward-facing child-safety seat in the front seating position, move vehicle seat as far back as possible and set air bag deactivation switch to OFF position.**

\*Denotes optional equipment

**Always check the Owner's Manual for more operating information and safety features**

AM / FM STEREO / CD / MP3

**1. Power/Volume**

Press to turn on/off; rotate to increase/decrease volume.

**2. LOAD**

CD: When LOAD button is pressed, CD will load and play even if CD eject button has been previously pressed.

CD changer\*: To load multiple discs: Press and hold LOAD (2) until beep sound is heard; insert CD when "In" is displayed.

To eject disc: Press Eject (8).

To eject specific disc: Press and hold Eject (8) until beep sound is heard; within five seconds press the desired tray number 1-6 (10).

**3. FM/AM**

Press to turn radio on and select between FM1/FM2/AM station preset buttons (10).

**4. CD slot**

**5. SAT\***, Satellite ready capability.

**6. CD**

Press to play CD.

**7. Display**

**8. CD eject button**

**9. Tune/Audio/Text Control**

Radio: Rotate counter-clockwise/clockwise for lower/higher frequency.

Audio: Press to select ALC or AudioPLT\*/BASS/TREB/FADE/BAL/BEEP.

Rotate right/left to adjust selected feature.

Text\*(MP3): Rotate right/left to display titles.

 **Tip: Automatic Level Control (ALC) automatically adjusts audio volume depending on vehicle speed.**

**10. Memory preset buttons**

To set: Tune to station, press and hold until beep sound is heard.

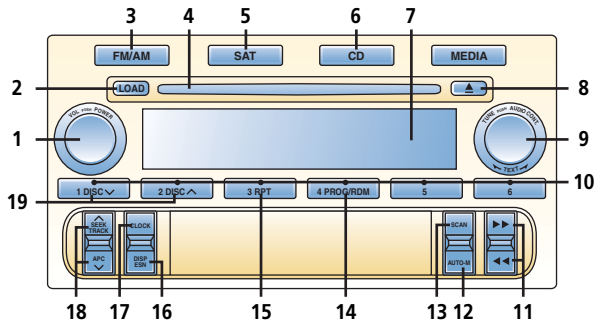

 **Tip: Insert single CD into slot, auto-loading function will set CD and begin play without pressing LOAD button.**

**11. Reverse◀◀ /Fast forward ▶▶**

Press to reverse/fast forward through a track.

**12. Auto-Memory**

Press and hold until a beep sound is heard; system automatically scans and temporarily stores six strong stations in each band; press again to switch to another preset station.

**13. Scan**

Radio: Press to sample strong stations, press again to stop at current station.

CD/MP3: Press to play first few seconds of each selection, press again to stop at current selection.

**14. Random\***

Press to play CD/MP3 selections in random order.

**15. RPT**

Press to replay current CD/MP3 selection.

**16. DISP**

CD/MP3: Press repeatedly to scroll through displays.

**17. Clock**

To set: With ignition in ACC or ON position, press top of switch (17) until beeper sounds and time flashes; press top of switch (18) to set hour, press bottom of switch (18) to set minutes, press top of switch (17) to start clock.

**18. SEEK/TRACK/APC**

Radio: Press ▲ / ▼ to automatically seek higher/lower frequency.

CD/MP3: Press ▲ / ▼ to select next track/beginning of current track.

**19. Disc ▲ / ▼ \***

Press to skip to next/previous CD.

\*Denotes optional equipment

Always check the Owner's Manual for more operating information and safety features

# CLIMATE CONTROLS

## 1. Airflow selector

= air to dash/waist, open mode

= air to dash/waist/floor, open mode

= air to waist/floor, open mode

= air to dash

= air to floor

= air to windshield and floor  
A/C compressor is on

= defrost, air to windshield  
A/C compressor is on

**Tip: Select OPEN MODE position when lowering convertible top for best comfort.**

**WARNING: When using position always set temperature control to hot or warm to prevent glass fogging.**

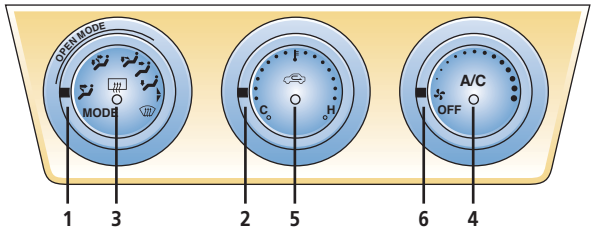

## 4. A/C Air conditioning\*

Press to turn on/off.

**Tip: Use A/C to dehumidify air.**

## 5. Air intake control

Press to select fresh air (indicator light off)/recirculated air (indicator light on).

**WARNING: Do not use recirculated air mode in cold or wet weather; windows could fog and hamper vision.**

## Control positions for maximum defrost

Fan to maximum, temperature to maximum hot, airflow selector knob to .

**Tip: When selected, air is dried by A/C compressor operation when outside temperature is above 39°F.**

## 2. Temperature control

Rotate knob counterclockwise/clockwise for cooler/warmer.

## 3. Rear window defogger

Press to activate/deactivate.

## 6. Fan control

Rotate knob counterclockwise/clockwise to decrease/increase fan speed, turn to OFF to shut system off.

**Tips: To help prevent windshield fogging in humid weather, select .**

**To prevent moisture buildup, never drive with system off with convertible top up.**

## Tire economy and tips

Check pressure at least monthly when tires are cold.

Maintain correct 4-wheel alignment and tire balance.

Rotate tires at 5,000 or 7,500 mile intervals; see Owner's Manual for rotation chart.

## Tire pressure

Decal on the edge of the driver's door jamb provides tire pressure information.

## Tire chains\*†

Tire chains can damage aluminum wheels; use on steel wheels only.

**Tip: Never exceed 30 mph with tire chains.**

**Tip: Use only genuine Mazda tire chains; install only on rear tires; install as tightly as possible and retighten periodically.**

## Anti-lock Brake System (ABS)

ABS automatically reduces hydraulic pressure to any wheel on the verge of locking up.

You may feel a slight pulsing of the brake pedal and hear a clicking noise; this tells you the ABS is functioning properly; increase pressure on pedal for maximum braking.

**Tips: Maintain constant pressure on the brake pedal. Do not pump the brakes.**

## ABS self test

A self-diagnostic test is performed when vehicle starts to move; you may feel some brake pedal pulsation and hear some noise, this is normal.

## Gas cap

After filling vehicle with gasoline, fully reinstall gas cap by turning clockwise until a clicking sound is heard, if gas cap is not fully installed, Check Engine light may come on.

For more information on Check Engine light, see Owner's Manual.

\* Denotes optional equipment

† See Owner's Manual

Always check the Owner's Manual for more operating information and safety features

## CONVERTIBLE

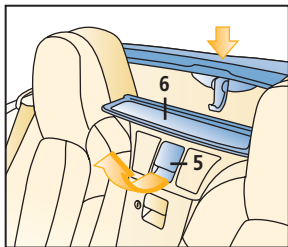
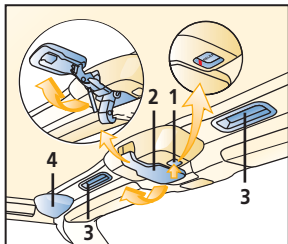

**Tip:** Always stop vehicle in a safe place and park on a level surface; set parking brake; lower side windows; remove items from rear storage area before operating the top.

**Manual convertible top**

**To lower:** Push unlock button (1) while pulling top latch (2) rearward, continue to pull top latch back completely; pull front of top rearward to release from windshield header.

If lowering top from inside vehicle, use either handle (3) to lower.

If lowering top from outside vehicle, grasp side of top, near windshield header (4) to lower.

Fold back top and press firmly on front of top to securely lock in lowered position.

Raise wind blocker (6) if desired.

**Tip:** If manual soft top is hard to lower; raise top slightly; then slowly lower it while pressing upper part of rear glass with your hand.

**To raise:** Lower wind blocker (6); pull unlock lever (5) to release top from lowered position.

If raising top from inside vehicle, grasp either handle (3) to raise.

If raising top from outside vehicle, grasp side of top near windshield header (4) to raise.

Push lever on top latch up until lock button (1) clicks and top latch is securely locked.

**WARNING:** If red indicator is visible on unlock button (1), top is not securely latched.

**Detachable hardtop\***

**To remove:** Push unlock button (1) while pulling top latch (2) rearward, continue to pull top latch back completely; pull front of top rearward to release from windshield header.

Remove seat belts from belt guides; slide seats/fold seatbacks forward; release side latches (8) and disconnect rear window defroster coupler (7); slide top rearward while pressing down on rear deck latches (9); lift hardtop straight off body.

**To install:** Align rear deck latches (9) with rear deck studs (10); slide hard top forward while pressing down on rear deck latches (9); securely lock top latch (2) and side latches (8); reconnect rear window defroster coupler (7).

For complete details, see Owner's Manual.

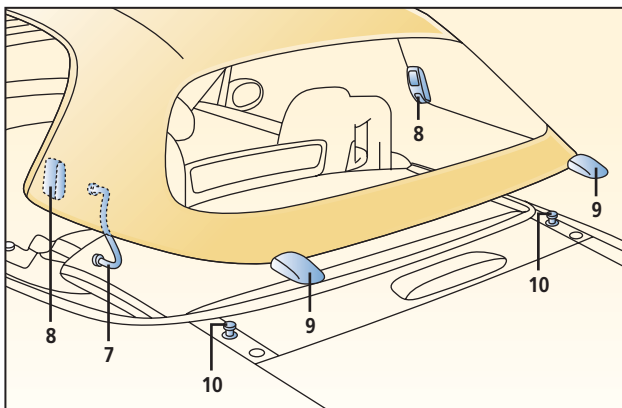

**Tip:** Hardtop should be stored in a dry area and covered with a soft blanket for added protection.

**Tip:** Detachable hardtop removal/installation is easier with two people.

\*Denotes optional equipment

Always check the Owner's Manual for more operating information and safety features

CONVERTIBLE

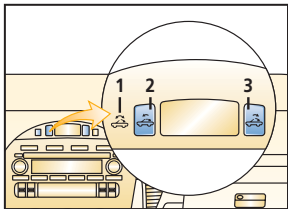

**Power retractable hardtop\***

Will only operate when manual transmission is in Neutral, or when automatic transmission is either in Park or Neutral, ensure vehicle is stopped and set parking brake before operating the top.

**To lower:** Push unlock button (5) while pulling latch (4) rearward; then press and hold open button (3) until beep is heard and top is fully lowered.

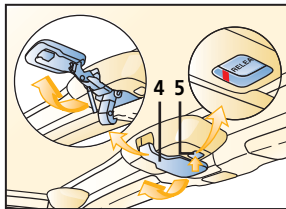

When lowering top: Windows automatically lower if closed or partially opened; deck raises; top lowers; deck lowers; beep sounds to confirm operation is complete.

**To raise:** Press and hold close button (2) until top is fully raised, beep sounds to confirm operation is complete, secure latch (4), if top latch is not securely latched, indicator (1) will remain illuminated and beep sounds when vehicle is placed into gear.

**Tips:** If open/close button is released during lowering/raising operation, a beep will sound.

If trunk is open, a beep sounds when pressing open/close buttons and top will not lower/raise until trunk is closed.

In case of a power loss the tools for manually operating the power retractable hardtop are located in the glove compartment, see Owner's Manual for manual operating instructions.

If beep sounds when vehicle is placed into gear, verify that power retractable hardtop latch is closed, if power top does not operate when in the open position, verify that vehicle is not in gear or trunk is not open.

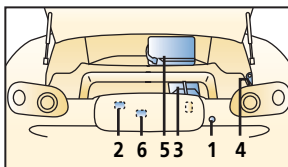

**Trunk**

**1. Lock**

To lock/unlock: Insert key and turn counterclockwise/clockwise.

**2. Trunk light**

**3. Tool bag**

Contains lug wrench, tow hooks and jack handle.

**4. Jack**

To remove: Turn knob counterclockwise, open cover, turn wing bolt counterclockwise, remove jack.

**5. Instant Mobility System emergency flat tire repair kit (IMS)\***

Your Mazda MX-5 Miata is not equipped with a spare tire, if tire repair is required, have vehicle transported via a flatbed towing service to a tire repair center, if tire repair service is not available, repair tire with emergency flat tire repair kit, see Owner's Manual for instructions.

**Tip:** Check expiration date annually on tire sealant container located in flat tire repair kit, replace if necessary.

If equipped with optional run-flat tire, see Owner's Manual.

**Tip:** Run-flat tire is indicated by "RFT" on tire.

**6. Remote trunk-lid release lock-out,** see Locks

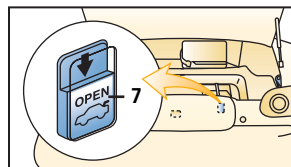

**7. Trunk release lever**

Allows you to escape should you become locked in trunk.

To open: Slide lever in direction of arrow, lever will glow if it has been exposed to light.

**Tip:** Trunk can be opened using remote keyless entry system.

\*Denotes optional equipment

Always check the Owner's Manual for more operating information and safety features

## UNDER HOOD

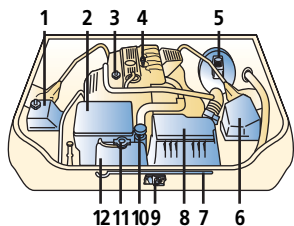
**2.0-liter 4-cylinder**

**Tip:** Check all fluids with vehicle parked on a level surface.

- 1. Windshield washer fluid reservoir**  
Refill with windshield washer fluid.
- 2. Battery**
- 3. Engine oil filler cap,**  
SAE 5W-20
- 4. Engine oil dipstick**  
Check with engine off and at operating temperature. Engine oil should be between FULL and LOW marks on dipstick.
- 5. Brake/clutch\* fluid reservoir**  
If brake/clutch\* fluid level is low, have your vehicle inspected by your nearest Mazda dealer.
- 6. Fuse block**
- 7. Hood support rod**
- 8. Air filter**
- 9. Hood latch**  
Push to right to release hood.
- 10. Power steering fluid reservoir**  
Check with engine off and at operating temperature. Level should be between MIN and MAX.
- 11. Cooling system cap**  
Do not remove if engine is running or hot.
- 12. Engine coolant reservoir**  
Check when engine is cold; fluid level should be between the FULL and LOW marks on reservoir.

**WARNING:** Never remove coolant reservoir cap while engine is running or hot; remove only when system is cool.

**Maintenance notes:**

Rotate tires every 7,500 miles or sooner if needed.

Clean air filter every 15,000 miles.

Inspect engine valve clearance every 75,000 miles.

Replace spark plugs every 75,000 miles.

Replace (FL22)\* engine coolant at 120,000 miles.

**WARNING:** Using coolant other than FL22 requires more frequent maintenance intervals.

**Tip:** For severe driving conditions, Owner's Manual recommends changing oil and filter at 5,000<sup>†</sup> miles.

**NORMAL SERVICE INTERVALS**

7,500 miles	A		
15,000 miles	A		F
22,500 miles	A		
30,000 miles	A B		F
37,500 miles	A	C	
45,000 miles	A		E F
52,500 miles	A		
60,000 miles	A B	D	F
67,500 miles	A		
75,000 miles	A	C	F
82,500 miles	A		
90,000 miles	A B		E F

**Break-in period**

First 600 miles: Avoid heavy braking and acceleration; drive at varying road and engine speeds.

- A.** Change: Engine oil/replace filter  
Lubricate: Locks and hinges
- B.** Inspect: Fuel lines and hoses, brake lines and hoses, steering operation and linkages, front suspension ball joints, driveshaft dust boots, chassis and body bolts
- C.** Inspect: Drive belts (tension)  
Replace: Air filter
- D.** Inspect: Hoses and tubes for emission system  
Replace: Engine coolant (other than FL22), manual transmission oil, rear differential oil
- E.** Inspect: Exhaust system and heat shields
- F.** Inspect: Disc brakes

\*Denotes optional equipment

<sup>†</sup>See Owner's Manual

## Mazda Roadside Assistance

Exhilaration, liberation and inspiration, are great reasons to drive a Mazda car, truck or SUV. In addition to all the other great standard features, you also get peace of mind with our basic warranty period Emergency Roadside Assistance Plan, it's just a phone call away, 24 hours a day, 365 days a year, call **1-800-866-1998**.

## Mazda "bumper-to-bumper" Limited Warranty and Powertrain Warranty

Engineers design and build every Mazda to give you driving pleasure now and far down the road. We're so confident in our quality that we cover the entire vehicle against defects in materials and workmanship for 36 months/36,000 miles, whichever comes first, plus we provide a powertrain warranty for 60 months/60,000 miles, whichever comes first.

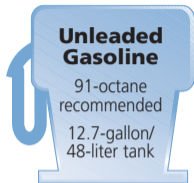

## Lower Octane Fuel Usage

If 91 octane fuel is not available, fuel as low as 87 octane can be used temporarily for emergency purposes. Use of fuel lower than 91 octane can decrease performance and deteriorate shift quality. Refueling vehicle with correct octane fuel a couple of times will restore vehicle performance and shift quality.

This Quick Tips® guide is provided by Mazda North American Operations to make your Mazda ownership experience more convenient. For complete details and operating instructions, see your Owner's Manual. If you have any questions about your vehicle, you are invited to contact your local dealer. Or if you need additional help, feel free to call our **Customer Assistance Center at 1-800-222-5500**

Monday through Friday,  
8 a.m.-4:45 p.m., Pacific  
9 a.m.-5:45 p.m., Eastern/Central



[www.mazdausa.com](http://www.mazdausa.com)

©2007 Calcar, Quick Tips® is a trademark of Calcar, made in USA 5/07 25.471M DOT Mazda North American Operations reserves the right to change product specifications at any time without incurring obligations. 9999-95-031C-08QT