

2014 MAZDA CX-5
SMART START GUIDE



mazda



KEYLESS ENTRY SYSTEM

- This system allows you to lock and unlock the doors by pushing the desired buttons.

Lock

- Push once to lock all doors and liftgate.
- Push twice (within five seconds) for horn sound verification that all doors are locked.



Unlock

- Push once to unlock driver's door or all the doors (depending on personalization setting).
- Push twice (within three seconds) to unlock all doors and liftgate.

Panic Alarm

- Push for one second or more to activate alarm.
- Push Lock, Unlock, or Panic Alarm to turn alarm off.

CAUTION:

- Make sure vehicle is OFF and take the keyless entry system key with you when leaving the vehicle.
- There is no warning beep if the IGN or ACC is ON and the key is taken out of the vehicle, OR if the key is locked inside the vehicle.

CAUTION: RED -- Key Indicator Light may illuminate if either advance key or keyless entry key is placed in the cup holder. The key can sometimes not be detected in the cup holder.

NOTE: Refer to your Owner's Manual for additional details about "Personalization Features".

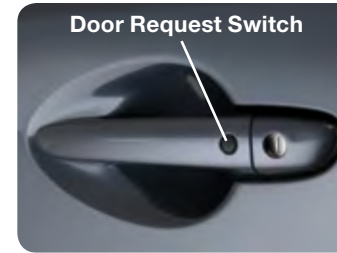

Door Request Switch

Advanced Key

Lock

Unlock



Panic Alarm

Electric Liftgate Opener



Liftgate Request Switch

ADVANCED KEYLESS ENTRY SYSTEM

- This system allows you to lock and unlock the doors without taking the key out.

While Carrying the Advanced Key...

- **Unlock the driver's door** by pushing the driver's door request switch once.
- **Unlock all doors (and liftgate)** by pushing the driver's door request switch once or twice (depending on personalization setting, page 8) OR by pushing the passenger's door request switch once.
- **Lock all doors (and liftgate)** by pushing any request switch once.
- **Open the liftgate** by pushing the electric liftgate opener when ignition is OFF. With ignition ON, vehicle must be in Park (A/T) or have parking brake set (M/T).

NOTE: When the liftgate opener switch is pushed, the liftgate will open slightly. If the liftgate is not opened within 1.5 seconds, the liftgate latch locks (you will hear it lock) and the liftgate cannot be opened or closed from this slightly raised position. To open/close the liftgate, push the liftgate opener switch, open the liftgate within 1.5 seconds, then close it. The door/liftgate ajar warning light will be on if the liftgate is not fully closed.

NOTE: Vehicles equipped with the Advanced Keyless Entry System and the Keyless Entry System both use the same type of keyless entry transmitter. However, only vehicles equipped with the Advanced Keyless Entry System allow you to lock and unlock the doors/liftgate with the door/liftgate request switches (without taking the key out of your purse or pocket).

Vehicles equipped with the Keyless Entry System do not have request switches on the doors/liftgate. To lock and unlock the doors/liftgate, the corresponding transmitter button must be pushed.



ACCELERATED WARM-UP SYSTEM (AWS)

Vehicle Starting:

Your vehicle is equipped with SKYACTIV combustion technology. This technology includes **AWS** (Accelerated Warm-up System) for optimal emission performance during cold starting conditions.

Cold Start (e.g., First start of the day on cold mornings):

Depress the brake (Automatic Trans.) or clutch (Manual Trans.), when the key indicator light turns green → push the **START/STOP** button.

What you will notice: On start-up, the engine speed and sound are higher (1500 RPM) for 30 seconds to 1 minute to quickly bring the catalyst to efficient operating temperature. The RPM will reduce to idle once the temperature is achieved. This is normal engine operation under cold start conditions.

NOTE: You can drive the vehicle during AWS activation, no need to wait.

Normal Start (Emission components within optimal temperature range):

Depress the brake (Automatic Trans.) or clutch (Manual Trans.), when the key indicator light turns green → push the **START/STOP** button.

STARTING THE ENGINE

While Carrying the Key...

- **Start the engine** by pushing the START/STOP button, while pushing the clutch pedal (manual transmission) or the brake pedal (automatic transmission).
- **Shut the engine OFF** by placing the vehicle in Park, then push the START/STOP button.
- **Activate Accessories (ACC)** by pushing the START/STOP button once without pushing the clutch or brake pedal.
- **To turn the ignition to the ON position**, push the START/STOP button twice without pushing the clutch or brake pedal.

The key indicator light → in the instrument cluster will show **GREEN** (engine ready to start) when the key is detected and the clutch pedal (M/T) or the brake pedal (A/T) is pushed. If the KEY warning light illuminates **RED**, or the START/STOP button indicator light flashes **AMBER**, this could indicate a problem with the engine starting system and the inability to start the engine or switch the ignition to ACC or ON. Have your vehicle inspected at an Authorized Mazda Dealer as soon as possible.

Emergency Engine Stop:

Pushing and holding the START/STOP button or repeatedly pushing the button while the engine is running will turn the engine OFF. Use only in case of an emergency.

Emergency Vehicle Entry:

If the key cannot be used due to a malfunction or dead key battery, use the auxiliary key (below) to lock or unlock the doors.



Key (Rear)

Auxiliary Key

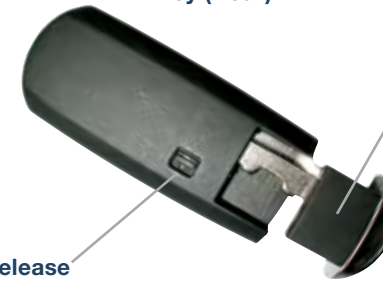

Auxiliary Key Release

Emergency Engine Start

If the engine cannot be started due to a dead key battery:

- 1 Push the brake pedal (A/T) or the clutch pedal (M/T).
- 2 While the indicator light flashes **GREEN**, touch the START/STOP button using the back side of the transmitter (as shown).
- 3 After the **GREEN** indicator light illuminates constantly, push the START/STOP button with your finger to start the engine.

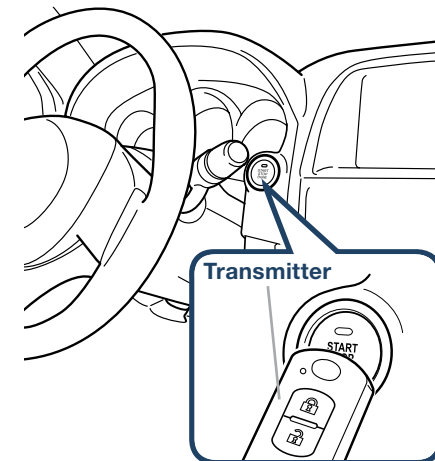



ELECTRONICALLY OPERATED DRIVER SEAT CONTROLS (if equipped)

Lumbar Support Adjustment

To **increase firmness**, push and hold the front part of the switch. Release at desired firmness.

To **decrease firmness**, push and hold the rear part of the switch.

Recline Switch

Push forward or backward to adjust seatback angle.



Slide/Tilt Switch

Seat can be moved back and forth, raised, lowered, or tilted with this control.

NOTE: 8-way power seat shown above. 6-way power seat also available.

MANUAL SEAT CONTROLS

Height Adjustment Lever

Raise or lower seat height by repeatedly pulling up or pushing down on the lever.

Recline Lever

Pull up to adjust seatback angle.



Slide Release Lever

Pull lever up to move seat backward or forward.

FRONT SEAT WARMER

The driver and front passenger seats can be warmed by pushing the applicable seat warmer button while the ignition is ON.

Seat temperature increases with the number of illuminated indicator lights (0-OFF, 1-Low, 2-Mid, 3-High).



FOLDING SECOND-ROW SEATS

- 1 Support the seatback with your hand.
- 2 Push the rear seatback knob down (red indicator is visible when seat is in the **unlocked** position).
- 3 Bring the seatback forward.

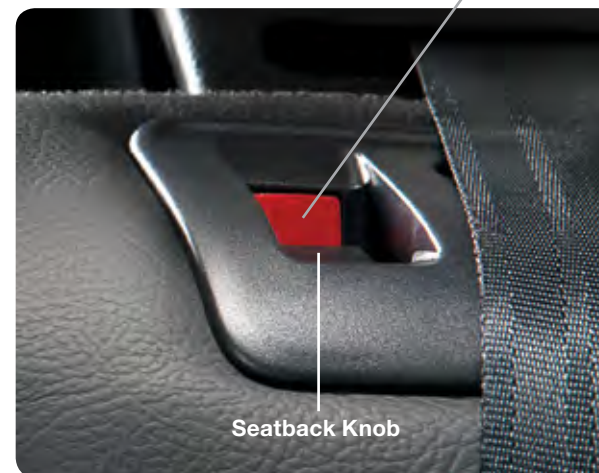



Folding Rear Seatbacks Down



NOTE: 4:2:4 type rear seats shown.

Using remote handle:

- 1 Check that rear seats are clear of objects.
- 2 Open the liftgate and pull the left and right side remote handle levers.



OR

Folding Only Center Seat Down



Using remote handle:

- 1 Store center seat head restraint.
- 2 Check that rear seats are clear.
- 3 Open the liftgate and pull only the smaller of the left side remote handle levers.



Returning rear seats to upright position

- 1 Raise seatbacks until they lock into position (red indicator is not visible when seat is in the locked position).
- 2 Pull on the top of the seatbacks from inside the vehicle to make sure they are locked.
- 3 Check that all seat belts are routed properly for passenger use.

PERSONALIZATION FEATURES



Customize the following vehicle functions using the audio SETUP button:

- Door Locks
- Lighting Control
- Wiper Control

OUTSIDE TEMPERATURE DISPLAY UNIT CHANGE

The outside temperature unit can be switched between Celsius and Fahrenheit using the following procedure:

- 1 With the ignition switched OFF, push and hold the INFO button on the steering wheel. Continue holding the INFO button for 5 seconds or longer while switching the ignition ON.
- 2 Release the INFO button when the outside temperature display flashes.
- 3 Push the up ▲ or down ▼ part of the INFO switch to change the outside temperature unit to Celsius or Fahrenheit.
- 4 Push and hold the INFO button until the outside temperature display stops flashing.



SETTING YOUR CLOCK

- Push the **H** button to set the hour.
- Push the **M** button to set the minutes.

Push the **:00** button to reset clock to nearest hour.





**LIGHTING/
TURN SIGNALS**
(PP. 13-14)

**BLUETOOTH
HANDS-FREE/
AUDIO**
(PP. 29-30, 35-36)

**CRUISE
CONTROL**

**ILLUMINATION
DIMMER**
(Instrument Cluster)
(PP. 11-12)

**INFORMATION
DISPLAY**
(P. 24)

**WIPER/
WASHER**
(P. 14)

CLOCK
(P. 8)

**HAZARD
WARNING**

**NAVIGATION/AUDIO
(WITH 5.8" LCD)**
(PP. 29-34)

**TPMS
SET**
(P. 20)

AFS
(P. 19)

**TCS
OFF**

BSM
(P. 22)

**AUDIO
(WITHOUT 5.8" LCD)**
(PP. 27-28)

**NAVIGATION
SYSTEM
SD CARD**
(P. 33)

**START/STOP
BUTTON**
(P. 4)

**HOOD
RELEASE**

**TILT/TELESCOPING
STEERING WHEEL
LEVER**

CLIMATE CONTROL
(PP. 25-26)

SEAT WARMERS
(P. 6)

**ACCESSORY
SOCKET**

**PASSENGER AIRBAG
OFF INDICATOR¹**

¹ **PASS AIRBAG OFF** This indicator light illuminates to remind you that the front passenger's front/side airbags and seat belt pretensioner will not deploy during a collision. The reason for this is that the weight in the seat is less than approximately 66 lbs. Always wear your seat belt and secure children in the rear seats in appropriate child restraints. See the Owner's Manual for important information on this safety feature.

NOTE: Indicator light turns off when conditions have been met for necessary airbag deployment. See Owner's Manual for further information.

IMPORTANT: When your display setting is set on "AUTO", the instrument cluster and display may become dimmer when the headlights are on. If the display and instrument cluster become too dim or too bright when the headlights are on, simply rotate the dimmer knob located on your instrument cluster to adjust the brightness.

Type B cluster is shown. Type A cluster is similar, but with warning lights in different locations.



See page 8 or the Owner's Manual for further information.



SHIFT POSITION INDICATOR LIGHT TACHOMETER SPEEDOMETER

AMBIENT TEMPERATURE ODOMETER/TRIP METER FUEL GAUGE INFORMATION DISPLAY DASHBOARD ILLUMINATION/DIMMER/TRIP METER²

GLOSSARY OF WARNING AND INDICATOR LIGHTS

NOTE: See Owner's Manual for more details and explanations.

-  **Traction Control System (TCS) Off Indicator Light**
-  **Low Engine Oil Pressure**
-  **Traction Control System (TCS)/Dynamic Stability Control (DSC)**
On: TCS/DSC malfunction
Flashing: TCS/DSC operating
-  **Shift Position Indicator Light**
-  **KEY Warning Light RED** (pp. 1, 3)
-  **KEY Indicator Light GREEN** (pp. 3-4)
-  **Power Steering Malfunction**
-  **Air Bag/Front Seat Belt Pretensioner System Malfunction**
-  **Turn Signals/Hazard Warning Indicator Lights**
-  **4WD Warning Light**
On:
Flashing: Stop vehicle/tow to Mazda dealer.
-  **Check Engine Light**
-  **Master Warning Light**
-  **Tire Pressure Monitoring System (TPMS) Warning Light** (p. 20)
On/Warning Beep: Low tire pressure in one or more tires.
Flashing: TPMS Malfunction
-  **Security Indicator Light**
-  **Cruise Main Indicator Light On (AMBER)/Cruise Set Indicator Light On (GREEN)**
-  **Automatic Transaxle Warning Light**
-  **Lights On (Exterior)** (p. 13)
-  **BSM OFF (Blind Spot Monitoring)** (p. 22)
-  **Seat Belt Unbuckled/Malfunction**
-  **Headlight High Beams On** (p. 13)

-  **Brake Warning Light**
Parking brake on/low brake fluid/malfunction
-  **Adaptive Front Lighting System (AFS) OFF** (p. 19)
-  **Charging System Malfunction**
-  **Door/Liftgate Ajar**
-  **Low Washer Fluid Level Warning Light**
-  **ABS (Antilock Brake System) Malfunction**
-  **Low Fuel Level**
-  **Check Fuel Cap** (p. 17)
-  **Perform Maintenance**

ENGINE COOLANT TEMP LIGHTS

Since this vehicle does not use an engine coolant temperature gauge, red and blue engine coolant temperature lights are used to indicate high and low coolant temperature.

 **Red Coolant Temp Light**
Flashing: Engine is starting to run hot. Drive slowly to reduce engine load.
On: Engine is overheating. Safely pull over to the side of the road and turn the engine off. Refer to the Owner's Manual for more information.

 **Blue Coolant Temp Light**
On: Engine coolant is cold and no warm air is available for heater/defroster.
Off: Engine coolant is warm and warm air is available for heater/defroster. The light may stay on for a few minutes after start-up when the engine is cold, but the vehicle can be driven with the light on or off.

- ¹ Rotate the knob to adjust the brightness of the instrument cluster and other dashboard illuminations.
- ² Push to toggle between trip meter (A & B).
- When a trip meter is selected, push and hold to reset to zero.

TPMS NOTE: Low ambient temperature and/or high altitude causes tire pressures to drop and may turn the TPMS warning light on. If the warning light comes on, check the tire pressure and fill the tires as soon as possible, preferably before moving the vehicle and warming up the tires. Tire pressure should be checked when the tires are cold.

LIGHTING CONTROL/TURN SIGNAL LEVER



Turns tail, parking, and dashboard lights on.

AUTO: The light sensor automatically determines when to turn the headlights on or off.

#0: Turns fog lights on only when headlights are on.

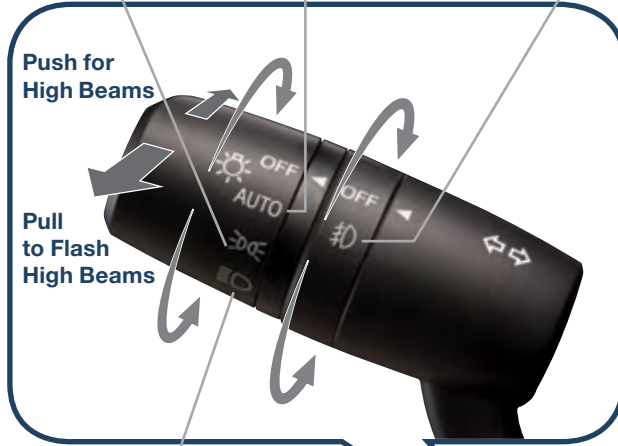

LED: Turns tail, parking, dashboard, and headlights on.

Smart Turn: To signal a lane change, push the turn signal lever up or down halfway and release. The turn signal indicator will flash three times.

(Refer to Owner's Manual for "Personalization Features")

(cont'd on pg. 19)

NOTE: The DRL (Daytime Running Lights) automatically turn on when the ignition is switched ON. To disable/enable this feature see your Authorized Mazda Dealer.

NOTE:

- You can adjust the timing of the Auto Headlights OFF and the sensitivity of the Auto Light Control.

WINDSHIELD/REAR WINDOW WIPER/WASHER CONTROL LEVER

AUTO: The rain sensor senses the amount of rainfall and turns the wipers on or off. Rotate inner ring away from you (clockwise) for more sensitivity (requires less rain to turn wipers on) and toward you (counterclockwise) for less sensitivity (requires more rain to turn wipers on).

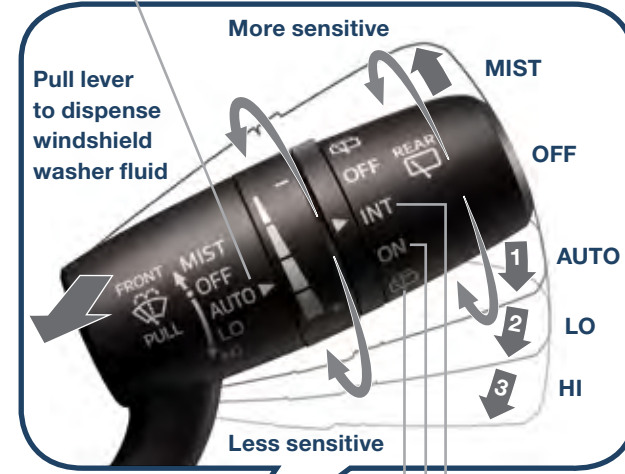

Rear Window Wiper/Washer (Hatchback)

INT: Intermittent

ON: Normal speed

Washer/wiper (hold as desired)



NOTE: Vehicles not equipped with AUTO wipers will have INT wipers. Set the lever to INT and choose an interval timing by rotating the ring between fast and slow.

CAUTION: If the ignition is ON, turn the AUTO wipers OFF when going through a car wash, or while cleaning or touching the windshield.

MANUAL SHIFT MODE

The Manual Shift Mode gives you the feel of driving a manual transmission by allowing you to manually shift to control engine rpm and torque when more control is desired.

To Use

Manual Shift Mode:

- Shift the lever from D to M.

To Shift Up

To A Higher Gear:

- Tap the shift lever back (+) once.

To Shift Down

To A Lower Gear:

- Tap the shift lever forward (-) once.

NOTE: Changing to manual mode can be done while driving the vehicle.

AUTOMATIC TRANSMISSION (Type A)

Various Lockouts:

- ⇒ Indicates that you must depress the brake pedal and hold in the lock-release button to shift (The ignition must be switched ON).
- ⇨ Indicates the shift lever can be shifted freely into any position.
- ➔ Indicates that you must hold in the lock-release button to shift.

Lock-Release Button

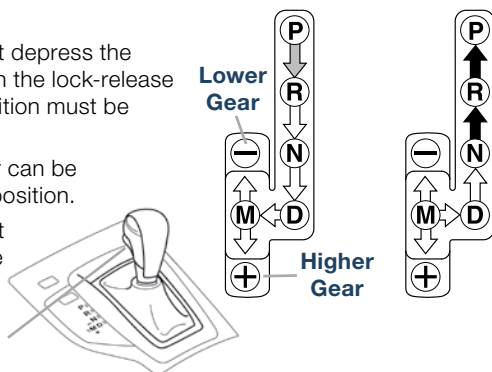

AUTOMATIC TRANSMISSION (Type B)

Various Lockouts:

- ⇨ Indicates the shift lever can be shifted freely into any position.
- ➔ Indicates that you must depress the brake pedal to shift (The ignition must be switched to ON).

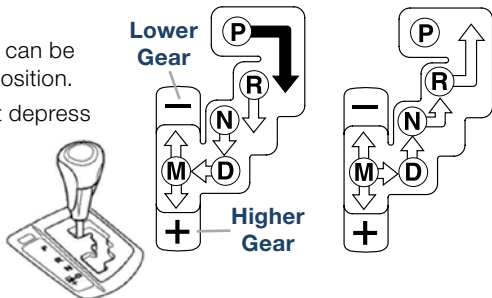

ACTIVE ADAPTIVE SHIFT (AAS) CONTROL

AAS will automatically adjust how and when the transmission shifts gears based on road conditions and your driving style.

The transmission may stay in a lower gear longer than usual when going up or down hills or driving around corners. This feature gives you better control and a more connected driving experience.

6-SPEED MANUAL TRANSMISSION

- Push the clutch pedal completely down to start the engine and to shift gears.
- To place the transmission in Reverse, place shifter in the neutral position, push the shifter knob down, move to the left and push forward.



ACCELERATOR PEDAL KICKDOWN SWITCH*

The accelerator pedal is equipped with a kickdown switch to give the driver more control and to improve fuel economy.

When you depress the accelerator 95% of the way, you will feel an increase in resistance. Push harder, and you will feel a click as you activate the kickdown switch. The transmission will usually downshift (depending on engine speed) and the engine will switch to maximum power mode. This kickdown switch function is the same in both Manual mode and in "D".

*Available on vehicles with automatic transmission only.

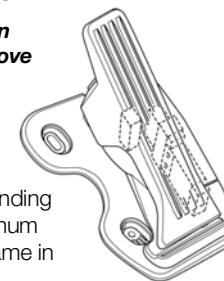

HILL LAUNCH ASSIST (HLA)

HLA helps assist you when accelerating the vehicle from a stop while on a hill or slope.

When the brake pedal is released and the accelerator pedal is pushed, HLA prevents the vehicle from rolling forward or backward. It operates on a downward slope when the shift lever is in the reverse (R) position, and on an upward slope when the shift lever is in a position other than the reverse (R) position.

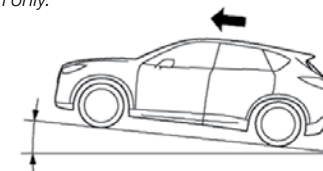

NOTE: The HLA system will hold the vehicle for a maximum of 2.0 seconds while the driver is changing from the brake pedal to the accelerator pedal.

FUEL DOOR RELEASE

(located on floor in front of driver's seat)

To open, pull the fuel door release.

Fuel

Regular Unleaded Fuel –
87 Octane

Fuel Tank Capacity

- 2WD – 14.8 gallons
- AWD – 15.3 gallons

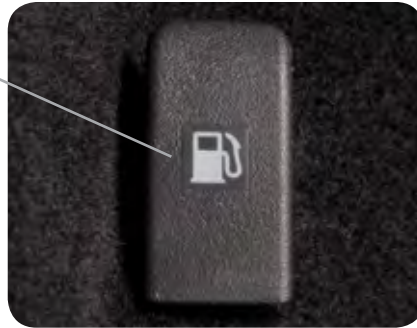

FUEL DOOR

To avoid scratching the paint during refueling, secure the fuel filler cap as shown.



FUEL ECONOMY

To achieve the best fuel economy:



- **Drive sensibly.** Speeding, rapid acceleration and excessive braking will lower fuel economy.
- **Observe the speed limit.** Fuel economy can decrease rapidly at speeds above 60 mph.
- **Keep tires properly inflated.** Under-inflated tires will lower fuel economy.
- **Use the recommended grade of oil specified in the owner's manual and keep the engine properly maintained. Visit your Authorized Mazda Dealer who specializes in the servicing of Mazda engines.**
- **Monitor the Current Fuel Economy in the Information Display.** The current fuel economy is calculated every 2 seconds.

Additional items that also help increase fuel economy:

- Remove excess weight. Heavy items in the vehicle will lower fuel economy.
- Avoid excessive idling. Idling for long periods will waste gas.
- Use cruise control. Using cruise control on the highway helps to maintain a constant speed and saves gas.
- Use overdrive gears. Using overdrive gearing reduces the vehicle's engine speed, which saves gas and reduces engine wear.
- Use a quality gasoline with the recommended octane. Use of higher octane gasoline will not improve your fuel economy.

Visit www.ecodrivingusa.com or www.fueleconomy.gov for more information.

FUEL ECONOMY:

To achieve the best fuel economy, visit www.fueleconomy.gov for more information.



ADAPTIVE FRONT-LIGHTING SYSTEM (AFS) (if equipped)

The adaptive front-lighting system (AFS) automatically turns the headlight beam to the right or left in conjunction with the direction of the steering wheel.

The AFS improves the direction of headlight illumination while cornering, and only works when the vehicle is moving.

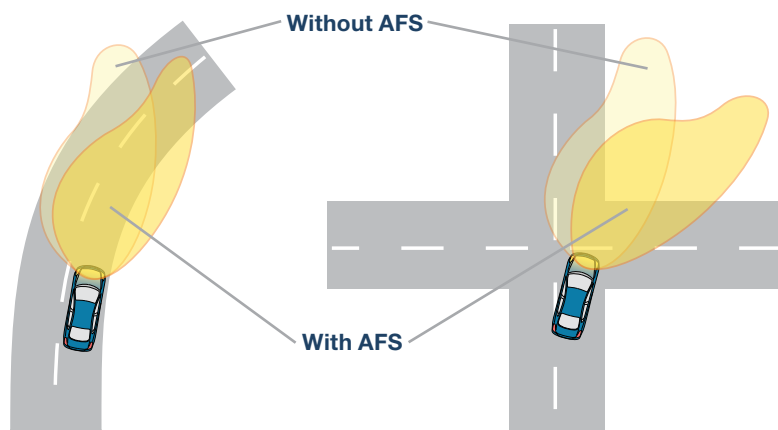

NOTE:

- With AFS, it is normal to see the headlights move and hear the sound of the headlight leveling motors at the front of the vehicle when the ignition is ON.
- The system will need to be reset if the vehicle battery has been disconnected or the system fuse has been replaced. Please refer to your Owner's Manual for easy to follow resetting instructions.



Push AFS OFF to turn system off or on. When off, AFS OFF illuminates in the instrument panel.

TIRE PRESSURE MONITORING SYSTEM (TPMS)

Your vehicle is equipped with a Tire Pressure Monitoring System (TPMS) that detects low tire pressure in one or more tires. In the following cases, the TPMS must be "initialized" so the system can operate normally.

- The tire pressure is adjusted (up or down) in one or more tires.
- A tire rotation is performed.
- Any tire or wheel is replaced.
- The vehicle's battery is disconnected, replaced or completely dead.

Initialization Process (TPMS Warning Light (T) is Illuminated):

- 1 Park the vehicle in a safe place and firmly apply the parking brake.
- 2 Let the tires cool, then adjust the tire pressure to the specified pressure (See tire label located on the driver's side B-pillar or edge of driver's door frame for specification) on all four (4) tires.
- 3 Switch the ignition ON, but leave the vehicle parked.
- 4 Push and hold the TPMS "Set Switch" (left side of dash) until the TPMS warning light (T) in the instrument cluster flashes twice and a beep sound is heard once.



NOTE: See Page 9 for TPMS switch location.

CAUTION: If the TPMS "Set Switch" is pushed without adjusting the tire pressure, the system cannot detect the normal tire pressure. The TPMS warning light may not illuminate, even if the tire pressure is low, or it may illuminate if the tire pressure is normal.



ALUMINUM WHEEL CARE

Your aluminum wheels have a protective coating on them. Only use a mild soap or neutral detergent with a sponge or soft cloth to clean them.

CAUTION: Using a wire brush, polishing compound, solvent, or any type of abrasive cleaner may damage the protective coating.

AUTO-DIMMING MIRROR AND HOMELINK®

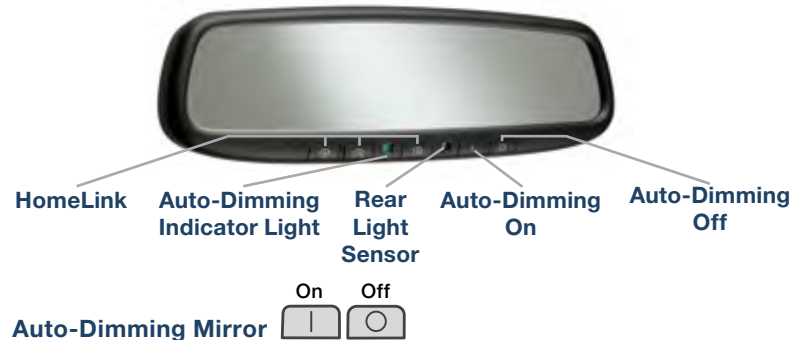

Auto-Dimming Mirror

- Auto-dimming will automatically darken your rearview mirror to reduce headlight glare from vehicles behind you.
- Auto-dimming is activated every time the engine is started.

NOTE: In addition to the auto-dimming mirror's rear light sensor, there is also a front light sensor (not shown). Do not place or hang any objects over the front or rear mirror light sensors; otherwise, the auto-dimming mirror will not operate properly.

HomeLink®



- This feature provides a convenient way to replace up to three transmitters such as garage door openers, home lighting remotes and other radio frequency devices.
- Refer to your Owner's Manual for complete programming details.

NOTE: Genuine Mazda Accessory Auto-Dimming Mirror with Compass and Homelink is available at your Authorized Mazda Dealer.

REAR VIEW MONITOR (if equipped)

Placing the gearshift lever into Reverse automatically operates the Rear View Parking Camera and is viewable via the 5.8" LCD screen.



NOTE: When using the Rear View Parking Camera, please check your surroundings as objects may be closer than they appear.

BLIND SPOT MONITORING (BSM) SYSTEM

The Blind Spot Monitoring (BSM) system is designed to assist the driver by monitoring the blind spots to the rear of the vehicle on both sides.

- If your vehicle speed is 20 mph (32 km/h) or more, the BSM will warn you of vehicles in the detection area by illuminating the BSM warning lights located on the left and right door mirrors.
- If you operate a turn signal in the direction of an illuminated BSM warning light, the system will also warn you with a beep and warning light flash.
- BSM sensors are located under the left and right rear bumper areas. The BSM system may not operate properly if the rear bumper gets too dirty, so keep the rear bumper area clean.

Please refer to your Owner's Manual for complete details.

Turning BSM System Off



Turning the BSM system off will turn off both the light and sound indicators. To manually turn the BSM system off, push the BSM OFF switch on the dash. The BSM OFF indicator will illuminate in the instrument cluster when the BSM system is off. The BSM system will automatically turn on the next time the vehicle is started.

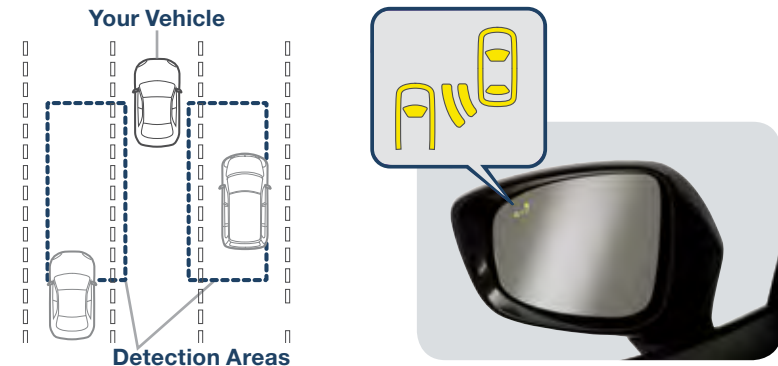

NOTE: Do not rely completely on the BSM system and be sure to look over your shoulder before changing lanes:

- The BSM system can assist the driver in confirming the safety of the surroundings, but is not a complete substitute.
- The driver is responsible for ensuring safe lane changes and other maneuvers.
- Always pay attention to the direction in which the vehicle is traveling and the vehicle's surroundings.
- The BSM system does not operate when the vehicle speed is lower than about 20 mph (32 km/h).

SMART CITY BRAKE SUPPORT (SCBS) SYSTEM (if equipped)

The Smart City Brake Support (SCBS) system is designed to reduce damage in the event of a collision by operating the brake control (SCBS) when the system's laser sensor detects a vehicle ahead:

- When your vehicle speed is 2 to 18 mph (4 to 30 km/h).
- The system determines that a collision with a vehicle ahead is unavoidable.
- It may be possible to avoid a collision if the relative speed between your vehicle and the vehicle ahead is less than 9.3 mph (15 km/h).
- When the driver depresses the brake pedal while the system is in the operation range at about 2 to 18 mph (4 to 30 km/h), the brakes are applied firmly and quickly to assist. (SCBS Automatic Brake is displayed in the Multi-information Display)
- SCBS automatic brake is released approximately 2 seconds after the vehicle comes to a stop.

Refer to your Owner's Manual for complete details.

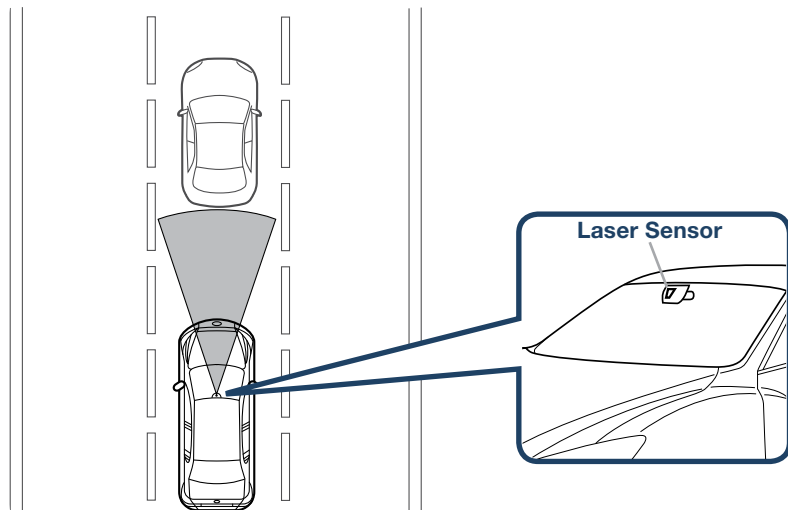

SCBS system can be turned off using DSC Off button.



INFO (Type B Instrument Cluster)

Refer to Owners Manual for Type A instrument cluster.

Push INFO button on steering wheel to display the following (actual displayed information will vary on your vehicle):

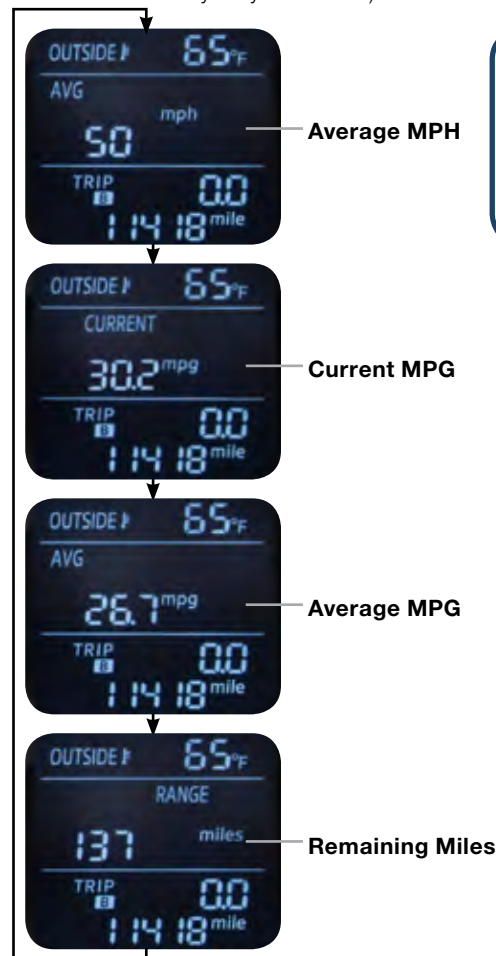

NOTE: To clear Average MPH or Average MPG, push and hold INFO button when selected screen is displayed.

Manual Climate Control

Automatic Climate Control



Temperature Control Dial

Rotate the dial for temperature control.

NOTE: When set to MAX A/C with dashboard vents or dashboard and floor vents, the A/C will turn on, and recirculated air will be selected for maximum cooling.



Fan Control Dial

Rotate the dial to set desired fan speed (1-4).

- Push to recirculate cabin air to reduce outside odors and improve cooling.
- Push for fresh air circulation.
- A/C** Push to manually turn air conditioning on or off.
- Push to defrost the rear window.

Mode Selector Dial

Rotate the dial to select airflow mode.

- Dashboard vents
- Dashboard and floor vents
- Floor vents
- Defroster and floor vents
- Windshield defroster

Best Cooling Settings



Best Heating Settings



NOTE:

- When selecting either defroster mode (or) the air conditioner and fresh air mode are automatically turned on by the system. This helps defrost the windows more efficiently by dehumidifying the air. Manually set the fan control and temperature control dials as desired.
- In either defroster mode (or) air will blow from the side dashboard vents. To defrost the side windows faster, point the vents toward the side windows.

Driver Temperature Control Dial

AUTO ON: Push dial to turn Automatic Air Conditioning system on (indicator light on). Rotate dial to select your desired set temperature (shown above). The airflow mode and the amount of airflow will be automatically controlled in accordance with the set temperature.

NOTE: Automatic climate control will allow you to maintain individual preset cabin temperatures for the driver and passenger when DUAL mode is selected.

- Push to recirculate cabin air to reduce outside odors and improve cooling.
- Push for fresh air circulation.

Fan Control Dial

- Rotate the dial to select the desired fan speed.
- Push OFF to turn climate control system off.



Push to select the following airflow mode:

- Dashboard vents
- Dashboard and floor vents
- Floor vents
- Defroster and floor vents

NOTE: Automatic temperature control always works even if the AUTO indicator turns off by changing the fan speed or the airflow mode.

Passenger Temperature Control Dial

Push to turn DUAL mode ON/OFF.

- With DUAL mode ON (indicator on), rotate the dial to set passenger side temperature separate from the driver's side (shown above).
- With DUAL mode OFF (indicator off), driver controls the temperature setting on both sides.

- Push to defrost the windshield.
- Push to defrost the rear window.

A/C Push to manually turn air conditioning on or off.



FOLDER SEARCH (during MP3/WMA/AAC CD or USB playback)

- To change to the previous folder, push the folder down button ▼, or push the folder up button ▲ to advance to the next folder.

iPOD PLAYER

- Select CATEGORY:** Push pre-set button 5 (down) or 6 (up) to select Playlist/Artist/Album/Song/Podcast/Genre/Composer/Audiobook.
- Select a desired list:** Push FOLDER Up/Down to select a desired list from the list menu.
- Track Up/Down:** To change to the previous track, push SEEK ◀◀ or turn the FILE dial to the left. To change to the next track, push SEEK ▶▶ or turn the FILE dial to the right.

LOADING A CD

- Insert the CD into the slot, label-side up. The auto loading mechanism will load the CD and begin to play it.

POWER ON

Push the Volume/Power dial to turn the audio system on.

MEDIA SELECTION

FM/AM: Push FM/AM button to select the FM1, FM2, or AM band. The selected band will be indicated in the display.

CD: Push CD button to select the CD player when inserting a CD.

USB/iPod: Push USB/AUX button to select the USB or iPod player when connecting USB or iPod.

AUX: Push USB/AUX button to switch to AUX jack input.

TUNING

The radio has the following tuning controls:

Manual: Turn the TUNE dial to manually change the frequency.

Seek: Push the SEEK ▶▶◀◀ tuning buttons to automatically seek a higher or lower frequency with a station.

Scan: Push the SCAN button to automatically sample strong stations for seconds each. Push again to cancel.

Preset Channel: Push 1/2/3/4/5/6 button to select a station stored in memory. To store a station, push and hold 1/2/3/4/5/6 until station is displayed.

Auto Memory Tuning: Push and hold the AUTO-M button to store an additional 6 stations on each FM and AM band without disturbing the previously stored stations. To return to the previously stored stations, push FM or AM button. Refer to the Owner's Manual for complete details.

TEXT: For files with a file name and other information that have been input. The display switches between display of the file name and other information each time the text button (TEXT) is pushed during playback.

PLAYING BLUETOOTH® (BT) AUDIO

- 1 Make sure BT audio device is paired to your vehicle.
- 2 Turn on BT audio device.
- 3 Touch the Bluetooth® on-screen tab.
- 4 Select the BT-Audio option.

GRACENOTE

The Gracenote media database is used to improve voice recognition of artist and album names with the Mazda Hands Free system. To make best use of the voice recognition, install the most recent database.

- 1 Load the Gracenote update on a memory stick from www.MazdaUSA.com/USB. Insert memory stick into the USB port.
- 2 Push the PHONE button.
- 3 Select Setup and scroll down to Gracenote Update.



INSERTING THE CD

Insert CD, label-side up.

BLUETOOTH® AUDIO

Bluetooth® enabled phones and audio players provide an opportunity to play music through the audio system with no wires attached.

Some phone models do not support all features. Go to www.MazdaUSA.com/bluetooth or contact (800) 430-0153 for further assistance or to report a phone/MP3 device concern.

POWER ON

Push the Power/Volume dial to turn the audio system on.

MEDIA SELECTION

Push the AUDIO button to select the appropriate on-screen button:

Radio: Select FM/AM button for FM1, FM2, or AM band.

CD: Select for CD player.

Bluetooth®: Select for BT Audio.

Pandora: Select to play Pandora from Bluetooth device (with Pandora app).

USB: Select to play iPod/iPhone® through USB port.

AUX: Select to switch to AUX input.

SIRIUS: Select for SiriusXM Satellite Radio®. If your vehicle is equipped with SiriusXM Satellite Radio® (satellite radio antenna on roof), your new Mazda includes a **free** introductory subscription with a limited term trial offer. Call 888-539-7474 to activate. See the Owner's Manual and/or dealer for details, or contact your dealer about adding SiriusXM Satellite Radio®.

See your Owner's Manual for further information on:

- Pandora audio application
- Audio menu voice-command

TUNING

Manual: Turn the TUNE/FILE dial to manually change the frequency.

Seek: Push the SEEK >>><<< button or touch and hold the >>><<< on-screen button, to automatically seek a higher or lower frequency or track, depending on media selected.

NOTE: If you continue to push and hold the button, the frequency will continue changing without stopping.

Scan: Touch the SCAN on-screen button to automatically sample strong stations for seconds each. Touch again to cancel.

Auto Memory Tuning:

- 1 Touch the **(Auto Memory)** on-screen button. The auto memory preset list is displayed and the previously tuned frequency is received.
- 2 Touch the **(Update List)** on-screen button to display the frequencies of up to ten radio stations on the auto memory preset list.
- 3 Touch the desired frequency. Refer to the Owner's Manual for complete details.

Preset Channel: Can be used to store 6 AM or 12 FM stations.

HD RADIO

HD radio has a special receiver which allows it to receive digital broadcasts (where available) in addition to the analog broadcasts it already receives. Digital broadcasts have better sound quality than analog broadcasts as digital broadcasts provide free, crystal clear audio.

When the HD radio button is ON (illuminated), there could be a noticeable difference in sound quality and volume when a change from digital to analog signals occurs. If the sound quality and volume becomes noticeably diminished or cuts off, touch the HD button to turn OFF HD radio (not illuminated).

- 1 To set a channel, first select AM, FM1 or FM2.
- 2 Tune to the desired station.
- 3 Long-push any of the preset on-screen buttons. The reception frequency is programmed and displayed on the preset button.

- 4 Repeat this operation for the other stations and bands you want to store. When receiving a programmed frequency, select AM, FM1, or FM2 and touch the preset on-screen button. The station frequency will be displayed.

AUDIO OPERATION USING VOICE

Audio operation and media selection can be done using voice. Push the "Talk" button, wait for a beep, then say a command in a clear, natural voice (not too fast or too slow). A list of available commands will be displayed on the screen, and if you do not say anything, the system will read the commands. Commands will only work when in the correct mode (Radio, CD, BT, USB, or Pandora). To change modes, push the "Talk" button and say "Change mode." Some commands are:

Radio: Seek up/down, Preset #

CD: Play track #

BT: Next/Previous folder

CD, USB, BT: Play, Repeat, Shuffle

CD, USB, BT, Pandora: Pause, Resume

Pandora: Skip song, Thumbs up/down

PORTABLE AUDIO PLAYER INTEGRATION USING THE AUX JACK

Your vehicle is equipped with an AUX or auxiliary jack that will allow you to play your portable audio player through the vehicle's audio system. Learn the system when parked and do not let it distract you while driving.



NOTE: You will need an audio cable with an 1/8 inch (3.5 mm) mini stereo plug (available as a Genuine Mazda accessory) to connect your portable audio player into the AUX jack.

Refer to the Owner's Manual for additional information.

- 1 Locate the AUX jack inside the center console.
- 2 Plug 1/8 inch mini stereo plug into the portable audio player and into the AUX jack. Turn portable audio player on.
- 3 Turn the vehicle audio system on.
- 4 • **Audio Controls (without 5.8" LCD screen):** Push the USB/AUX button on the audio unit to switch to the AUX mode.
 - **Audio Controls (with 5.8" LCD screen):** Push AUDIO button on audio system, then touch AUX on-screen button.
- 5 Use the portable audio player controls to play music.



IMPORTANT: Set the volume level on your portable audio player to the highest level before distortion starts, then use the vehicle's audio system to adjust the volume.

PORTABLE AUDIO PLAYER INTEGRATION USING THE USB PORT

Your vehicle is equipped with a USB port that will allow you to play your USB device or portable audio player through the vehicle's audio system. Learn the system when parked and do not let it distract you while driving.



Refer to the Owner's Manual for additional information.

- 1 Locate the USB port inside the center console.
- 2 Connect the device plug into the portable audio player and into the USB port.
- 3 Turn the vehicle audio system on.
- 4 • **Audio Controls (without 5.8" LCD screen):** Push the USB/AUX button on the audio unit to switch to the USB mode and start playback.
 - **Audio Controls (with 5.8" LCD screen):** Push AUDIO button on audio system, then touch the USB on-screen button and start playback.

NOTE: When the iPod® is connected to the USB port, the USB on-screen tab changes to the iPod on-screen tab. Do not remove the iPod while in the iPod mode. Otherwise, the data could be damaged.

- 5 Use the vehicle's audio system or steering wheel controls to control the USB device connected.

NOTE: The iPod functions on the iPod cannot be operated while it is connected to the vehicle's audio system because it controls the iPod functions.

TO REMOVE OR INSERT THE MAP SD CARD:

- 1 Turn the vehicle ignition OFF.
- 2 Locate the sliding door on the lower left side of the dash and slide it open (right).
 - Remove card: Push the card once, then pull it out.
 - Insert card: Push the card in (label-side up), then slide door closed (left).

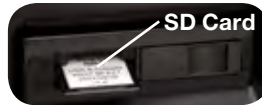

NOTE:

- Visit www.mazdausa.com/navigation within 60 days of vehicle delivery and download the most recent map available for your device for free. In order to download or upgrade your map, the TomTom Home software must be downloaded. Please refer to the Navigation System Owners Manual section of www.mazdausa.com/navigation for additional information.
- Only use your MAP SD card for operating and updating your navigation system. Do not insert the MAP SD card into another vehicle or into any other device such as a camera.
- If your vehicle is not equipped with a factory navigation system, your audio system can be upgraded to include navigation. Contact your Authorized Mazda Dealer for more details.

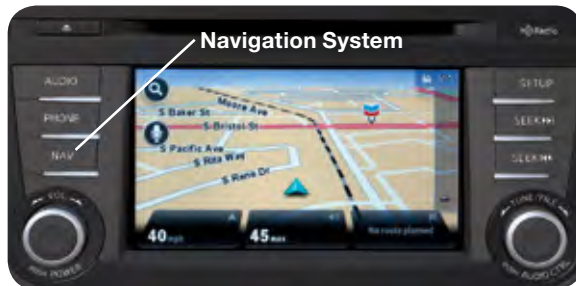

PLANNING A ROUTE USING THE TOUCH-SCREEN

IMPORTANT: In the interest of safety and to reduce distractions while you are driving, you should always plan a route before you start driving.

To plan a route on your Navigation system, do the following:

- 1 Push the NAV button to access the Navigation System.
- 2 Tap the screen (above) to open the **MAIN MENU** (below).
- 3 Touch **Navigate to**.
- 4 Touch **Address**.

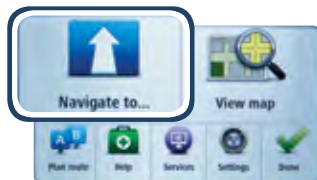

NOTE: Factory Navigation System is available if the vehicle is equipped with the 5.8" LCD screen. Contact your Authorized Mazda Dealer for more details.

NOTE: You can change the country or state setting by touching the flag before you select a city.

- 5 Enter the town or city name.
- 6 Enter the street name.
- 7 Enter the house number, then touch **Done**.
- 8 The location is shown on the map. Touch **Select** to continue or **Back** to enter another address.
- 9 When the new route is shown, touch **Done**.
For more information about the route, touch **Details**.

PLANNING A ROUTE USING YOUR VOICE

You can navigate to any of the following places using your voice:

- An address, **including home**.
- **Favorites**.
- Cities and towns.
- POI (Point of Interest) categories.
- POIs for named brands of, for example, restaurants, gas stations, car rental and gyms.
- A recent destination.

NOTE: POI in a city searches the system in your present location.

To plan a route to an address using your voice, do the following:

NOTE: Planning a route using your voice can be done while driving the vehicle.

- 1 Touch the voice control button  in the Driving view.
- 2 When you hear the tone, you can say, for example "Drive to an address".
- 3 Say the full address (without zip code) for your destination. For example "123 Main St., Los Angeles, California". The system does not recognize zip codes.

NOTE: For best results, say the full address without pausing between words.

- 4 Say "Yes" if the address is correct. If shown a list of addresses, say the list number for the correct address or say "none of these".

NAVIGATION SYSTEM FEATURES:

- While driving your vehicle, you can enter a destination address using your voice, but you cannot enter a destination address using the keyboard.
- While driving your vehicle, the vehicle speed and the maximum speed limit (for most roads) can be seen on the bottom left tabs of the Navigation screen.

NOTE:

- Voice guidance can be skipped by pushing the talk button.
- Refer to the Navigation System Owners Manual for additional navigation system details or visit www.mazdausa.com/navigation

PAIRING YOUR BLUETOOTH® PHONE OR AUDIO DEVICE

NOTE:

- For safety reasons, you cannot pair a phone while driving.
- Before pairing your cell phone or audio device, you must manually turn on the Bluetooth® function on the device. Refer to your device's Bluetooth® for steps to turn on Bluetooth®.
- **For customer service and device compatibility:**
Toll-free call: 800-430-0153
Website: www.MazdaUSA.com/bluetooth
- **IMPORTANT:** Set the volume level on your cell phone or audio device to the highest level before distortion starts, then adjust the volume on the vehicle's audio system.
- When in range of another Wi-Fi device, the Bluetooth connection between your phone and the system may disconnect for a short time if you have Wi-Fi enabled. Turn off Wi-Fi on your phone if needed.

Touch Screen Pairing

- 1 Manually turn Bluetooth on your phone or audio device.
- 2 Push Phone button.
- 3 Touch the **Setup** on-screen button.
- 4 Touch the **Bluetooth Setup** on-screen button. The list of all paired devices is displayed.
- 5 Touch the **Add New Device** on-screen button to display the message and switch to the device operation.
- 6 Using the device, perform a search for the Bluetooth® device (Peripheral device).
- 7 Select "Mazda" from the device list searched by the device.
- 8 Your phone will pair using one of the two ways:
 - a. Input the displayed 4-digit pairing code into the device.
 - b. Verify the displayed 6-digit code on the audio unit, which is also displayed on the device, and touch the **Yes** on-screen button.
- 9 **Call History**
Incoming/Outgoing history for the device is downloaded automatically.

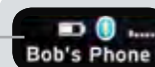
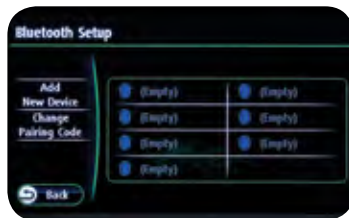

NOTE: For connection issues, please confirm the Bluetooth connection status by pushing the PHONE button and looking in the top left corner for the Bluetooth icon and your phone's name. Some phones will turn off the Bluetooth signal after connecting the USB cable to the vehicle or after downloading an update

- If not displayed, check your phone and make sure Bluetooth is turned on (or discoverable) in the Settings menu. Detailed instructions for some phones are available online.
- If there is still no connection, delete the pairing data on the system and your phone and try again after confirming your cell phone is compatible at www.MazdaUSA.com/bluetooth.

TO MAKE OR RECEIVE A HANDS-FREE CALL

Basic Operation:

- PHONE button:** To receive/swap a call.
- PHONE button:** To skip voice guidance (for speeding up operation).
- PHONE button:** To end/reject a call.

NOTE: On engine start, the last connected device will automatically be re-connected after several seconds.



BLUETOOTH® FEATURES

See your Owner's Manual for more information. Push the PHONE button, then select the "Setup" tab.

SMS TEXT AUDIO DELIVERY/VOICE REPLY: Play (read) text from a Bluetooth connected phone and respond back.

NOTE: If "Message" is grayed out, your phone does not support this feature. See your Owner's Manual for more information.

NOTE: For a list of phones with MAP profile, visit www.MazdaUSA.com/bluetooth.

DON'T DISTURB ME: You will not receive phone calls and messages.
DOWNLOAD PHONEBOOK: Use this feature and "All Contacts" to download and update your phonebook in the vehicle. Some PHONEBOOKS may not automatically update if changes are made on your phone.
AUTOMATIC 911 CALL: Calls 911 after certain moderate to severe collisions. This can be turned ON and OFF.

NOTE: Phone must be paired and connected.

- Some phone models do not support all features. Go to www.MazdaUSA.com/bluetooth or contact (800) 430-0153 for further assistance or to report a phone/MP3 device concern.
- See your Owner's Manual for more information.

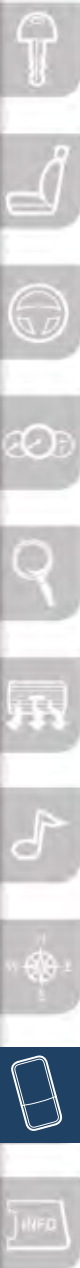

Customer Delivery Checklist



VEHICLE PRESENTATION:

Refer to the Smart Start Guide during presentation

- Keyless Entry**1-2
 - Advanced Keyless Entry*
 - Door/Liftgate Request Switch*
 - Liftgate Opener Switch
- Starting the Engine**..... 3-4
 - Start/Stop Button
 - Accelerated Warm-Up System (AWS)
 - Emergency Vehicle Entry/ Engine Start/Stop
- Seats**5-7
 - Adjustments and Operation (Front and Rear).
- Set Clock** 8

H M :00
- Driver's View** 9-10
 - Location of Switches and Controls
- Instrument Cluster** 11-12
 - Review of Warning and Indicator Light Function and Location
- Lights** 13, 19
- Wiper/Washer**.....14
- Transmission**..... 15-16
- Fuel Door**17
 - Fuel Door Release and Fuel Spec
- Adaptive Front Lighting System (AFS)*** 19
- Tire Pressure Monitoring System (TPMS)**.....20
 - Initialize TPMS before delivery

- Rear View Monitor***.....21
- Blind Spot Monitoring***22
- Smart City Brake Support***23
- Information Display**24
- Climate Control**.....25-26
 - Manual
 - Automatic*



- Audio Controls** 27-30
 - Bluetooth Audio*
- USB & AUX Input**.....31-32
- Navigation System***33-34
 - SD Card
 - Planning a Route
- Bluetooth®***35-36
 - Pair Phone
 - Toll-Free Customer Service
 - Make/Receive a Call
 - 800-430-0153**

SCHEDULED MAINTENANCE

When replacing or topping off engine oil, use Mazda Genuine oil. For optimal engine performance, use SAE 0W-20 engine oil. Please consult an Authorized Mazda Dealer for additional information.

**if equipped*

All items in the Customer Delivery Checklist have been reviewed with the customer and the first maintenance appointment has been scheduled:

SALES CONSULTANT	DATE	CUSTOMER	DATE

Signed copy must be placed in dealer jacket

Customer Delivery Checklist

DEALERSHIP	DATE
SALES CONSULTANT	CUSTOMER'S NAME
VIN	E-MAIL

PRESENTATION OF OWNER'S MATERIALS:

Review the following items with the customer

- Smart Start Guide**
 - Remove this checklist from Smart Start Guide
 - Personalization Features (refer to your Owner's Manual)
- Warranty Information**

Warranty Start Date: _____

Customer Initial: _____

 - Basic Vehicle – 36 months/36,000 miles
 - Roadside assistance program
- www.MyMazda.com**
 - Offer to register customer on www.MyMazda.com
- Owner's Manual**
- Maintenance Passport**
- Floor Mats**
 - Ensure floor mats are properly hooked after cleaning
 - Do not install two floor mats, one on top of the other, on the driver side
 - Accessory rubber floor mats should be cleaned with mild soap and water only
- Tire Pressure Monitoring System**
 - System overview
 - Demonstrate how to reset the TPMS
 - Push and hold the "SET switch" until the TPMS warning light flashes twice and one beep is heard
 - Review the system Caution

SERVICE DEPARTMENT

- Introduce Service Manager; provide business cards
- Review Service and Parts Department hours of operation
- Explain free Full Circle Service Inspection
- Schedule first maintenance service



GENUINE MAZDA SERVICE

Because you and your Mazda deserve the best

Your new Mazda deserves nothing less than the very best. To keep it running like new for years to come, trust the experts at your local Authorized Mazda Dealer. Simply bring your vehicle in for your scheduled maintenance and any needed repairs.*

At participating Mazda Full Circle Service Centers,** our technicians will automatically perform a complimentary Full Circle inspection on your vehicle and issue a detailed report card at every visit. This is designed to help you keep track of your Mazda's critical operating condition. Our factory-trained technicians know your vehicle inside out and use Genuine Mazda Parts, giving your vehicle the optimum care and maintenance it requires to run with flawless precision.

Remember, to further enhance your driving experience, visit your local Mazda Service Center for your scheduled maintenance. It's also the place where you can find a wide variety of tires, parts, and accessories that are just right for your vehicle.

*** See vehicle's scheduled-maintenance program for details.**

**** Visit the Mazda Owners website at www.MyMazda.com/fullcircle to find a participating Mazda Full Circle Service Dealer.**

Customer Experience Center: 1-800-222-5500

Roadside Assistance Contact: 1-800-866-1998

Mazda
FULL CIRCLE
SERVICE

**FREE FULL CIRCLE
SERVICE INSPECTION**

***We're committed to providing
expert Mazda service.***

You love to drive your Mazda, and we love to service your Mazda. With our Full Circle Service, we'll give your vehicle a COMPLIMENTARY MULTI-POINT INSPECTION. Your Mazda will receive a thorough review of its most crucial components.

This easy-to-use Smart Start Guide is intended to help you more fully appreciate some of the unique features and functions of your new vehicle. However, it is not intended to replace your Owner's Manual. The Owner's Manual contains more detailed information to help you better understand the important safety warnings, features, operation, and maintenance of your vehicle. All information, specifications, photographs and illustrations in this publication are those in effect at the time of printing. Mazda reserves the right to change specifications or design without obligation.

© Mazda North American Operations
Printed in U.S.A. 08/15
Print 5
9999 95 050C 14SS



www.MazdaUSA.com