

Mazda CX-9

SMART START GUIDE

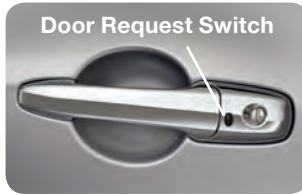

mazda



Door Request Switch

Advanced Key

Lock

Unlock



Liftgate
Panic Alarm



Liftgate Request Switch

ADVANCED KEYLESS ENTRY SYSTEM

- This system allows you to lock and unlock the doors, open the liftgate and even start the engine without taking the key out of your pocket or purse.

While Carrying the Advanced Key

- **Unlock the driver's door** by pushing the driver's door request switch once.
- **Unlock all doors and the liftgate** by pushing the driver's door request switch twice or by pushing the passenger's door request switch or the liftgate request switch.
- **Lock all doors and the liftgate** by pushing the driver's door or passenger door request switch or liftgate request switch once.
- **Open the front windows and moon roof** by pushing the unlock button on the advanced key and then quickly pushing again and holding; release to stop.
- **Close front windows and moon roof** by pushing and holding the driver's door request switch; release to stop.

KEYLESS ENTRY SYSTEM

This system remotely locks and unlocks the doors and the liftgate, and opens the power windows and moon roof.

Release Button

- Push to extend key.
- Push & fold to retract key.

Unlock

- Push once to unlock driver's doors.
- Push twice (within three seconds) to unlock all doors and liftgate.
- Push twice and hold to open front windows and moon roof.



Retractable Key

Lock

- Push once to lock all doors and liftgate.
- Push twice (within five seconds) for horn sound verification that all doors are locked.

Panic Alarm

- Push for one second or more to activate alarm.
- Push Lock, Unlock, or Panic Alarm to turn alarm off.

STARTING THE ENGINE

While Carrying the Advanced Key...

- **Start the engine** by pushing the start knob in and turning it (like a normal key) while depressing the brake pedal.
 - **Shut the engine OFF** by turning the start knob to the ACC position and then pushing in and turning to the OFF position.
- The indicator light will show green when the advanced key is detected. If the indicator light flashes green, the advanced key transmitter battery power is low.

NOTE: The RED Key Indicator Light may illuminate if either advance key or keyless entry key is placed in the cup holder. The cup holder is a dead zone for transmitter reception.

With the Auxiliary Key...

- 1 To start engine, remove the Start knob cover by squeezing both release buttons and pulling the cover off.
- 2 Push the key release to remove the auxiliary key.
- 3 Insert the auxiliary key into the key cylinder and turn it to start the engine.



Release Buttons

Key (Rear)



Auxiliary Key

Auxiliary Key Release





ELECTRONICALLY OPERATED SEAT WITH MEMORY

Recline Switch

Push forward or backward to adjust seatback angle.

Slide/Tilt Switch

Seat can be moved back and forth, raised, lowered, or tilted with this control.



Lumbar Switch

Push forward or backward to increase or decrease lumbar support.



Memory Seat Switch

To Program the Driver's Seat Position and Outside Mirror Angle

- 1 Park the vehicle.
- 2 Adjust the seat to the desired position using the slide/tilt and recline switches.
- 3 Adjust the outside mirror angles.
- 4 Push the memory seat **SET** button followed by one of the programming buttons (1-3) until a beep is heard. Programming is now complete. Program the remaining two buttons as desired.

To Program the Driver's Seat Position and Outside Mirror Angle with Advanced key/Retractable type key

- 1 Adjust the seat and outside mirror angle to the desired positions.
- 2 Switch the ignition off.
- 3 Push the **SET** button next to the programming buttons and then the unlock button on the advanced key/retractable type key you want to program within about 5 seconds. A beep sound is heard when the operation is completed.

NOTE: When the driver's door is unlocked using a programmed advanced key/retractable type key, the seat and outside mirror angles will move to their programmed positions if the driver's door is opened within about 40 seconds. A beep sound is heard after the adjustment to the programmed positions is completed.

To Move the Seat and Outside Mirrors to a Programmed Position

- 1 Shift the selector lever to the P position.
- 2 Push the programming button (1-3) that you selected when programming your seat position.

SECOND ROW SEATBACK RECLINE

To recline the seatback, lean forward slightly while folding lever. Then lean back to the desired position and release the lever.

FOLDING THE SECOND-ROW SEATS

- 1 Unfasten the lap portion of the center-rear seat belt.
- 2 Slide seat all the way back toward rear of vehicle.
- 3 Lower head restraints.
- 4 Pull the seatback folding lever and fold the seatback forward.

SPLIT FOLDING THIRD-ROW SEAT

To create a flat luggage compartment space, fold the seatbacks forward.

- 1 Open liftgate.
- 2 Lower head restraints.
- 3 Pull each strap on the rear of the seat while pushing the left and right seat forward to lay flat.

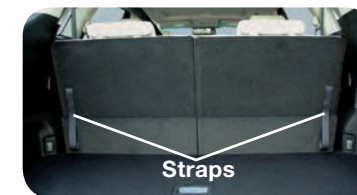

To Return to the Original Position

Pull the strap to return the seatback to the original position.

THIRD-ROW SEAT ACCESS

- Pull the third-row seat access lever on the side of the second-row seatback to fold and slide the seat forward to access third-row seating.
- Return the second-row seatback to the normal upright position by pulling up on the seatback until it locks into place.
- Slide the second-row seat forward or back for proper legroom using the lever under the front of the seat.

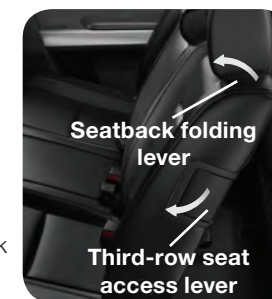

NOTE: The third row seats are equipped with foldable head restraints. To fold the head restraint, pull the strap on the back of the head restraint and fold the head restraint downward. To return the head restraint to its upright position, lift it upward.





PASS AIRBAG OFF This indicator light illuminates to remind you that the front passenger's front/side airbags and seat belt pretensioner will not deploy during a collision. The reason for this is that the weight in the seat is less than approximately 66 lbs. Always wear your seat belt and secure children in the rear seats in appropriate child restraints. See the Owner's Manual for important information on this safety feature.

The instrument cluster has a dimmer function that can be cancelled to make the illumination brighter during the day when the headlights are on. If the illumination is too dim during the day, press the knob, or if the illumination does not dim when turning on the headlights at night, press the knob. When dimmed, rotate the knob to adjust the brightness of the illumination.

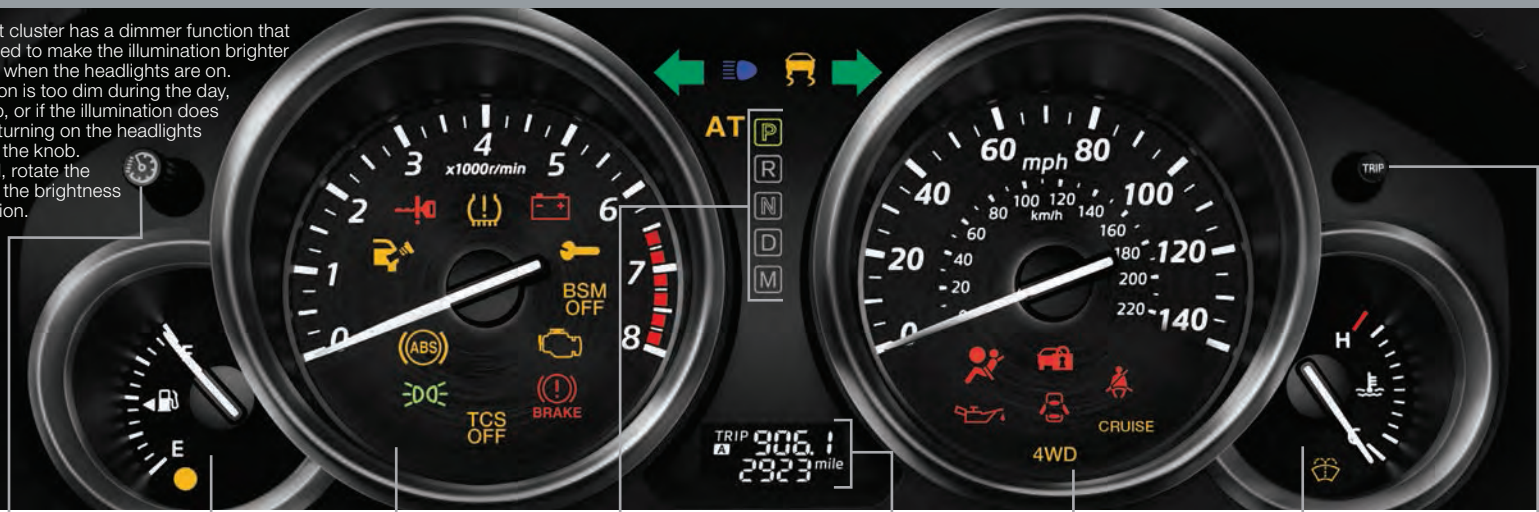

INSTRUMENT CLUSTER DIMMER¹

FUEL GAUGE

TACHOMETER

SHIFT LEVER POSITION INDICATOR

ODOMETER/TRIP METER

SPEEDOMETER

ENGINE COOLANT TEMPERATURE GAUGE

TRIP METER SELECTOR²

GLOSSARY OF WARNING AND INDICATOR LIGHTS

NOTE: See Owner's Manual for more details and explanations.

- Low Fuel Level**
- KEY Warning Light (RED)** (p. 2)
Advanced key not detected or transmitter battery is dead.
- KEY Indicator Light (GREEN)**
On: Advanced key detected; engine is ready to start.
Flashing: Advanced key battery is low.
- Check Fuel Cap**
- ABS (Antilock Brake System) Malfunction**
- Lights On (Exterior)**
- Tire Pressure Monitoring System (TPMS) Warning Light**
On/Warning BEEP: Low tire pressure in one or more tires.
Flashing: TPMS Malfunction
- TCS OFF (Traction Control System)**
- Charging System Malfunction**
- Powertrain Malfunction/Reduced Power**
- BSM OFF (Blind Spot Monitoring)** (p. 13)
- Check Engine Light**

TPMS NOTE: Low ambient temperature and/or high altitude causes tire pressures to drop and may turn the TPMS warning light on. If the warning light comes on, check the tire pressure and fill the tires as soon as possible, preferably before moving the vehicle and warming up the tires. Tire pressure should be checked when the tires are cold.

- Brake Warning Light**
Parking brake on/low brake fluid/malfunction
- Low Engine Oil Pressure**
- Security Indicator Light**
- Door/Liftgate Ajar**
- 4WD 4WD**
On: System is not normal; dealer inspection required.
Flashing: Differential oil temperature is high; dealer inspection required.
- Seat Belt Unbuckled/Malfunction**
- 4WD 4WD**
On: System is not normal; dealer inspection required.
Flashing: Differential oil temperature is high; dealer inspection required.
- Cruise Main Indicator Light On (AMBER)/Cruise Set Indicator Light On (GREEN)**
- Air Bag/Front Seat Belt Pretensioner System Malfunction**
- Low Washer Fluid Level**
- Turn Signals/Hazard Warning Indicator Lights**
- Automatic Transmission Malfunction**
- Shift Position Indicator Light**
- Headlight High Beams On** (p. 9)
- Traction Control System (TCS)/Dynamic Stability Control (DSC)/Roll Stability Control (RSC)**
On: TCS/DSC malfunction
Flashing: TCS/DSC operating

¹ If the instrument cluster and other dashboard illuminations do not dim when turning on the headlights, push the Instrument Cluster Dimmer knob.
² • Push to toggle between trip meter A & B.
 • When a trip meter is selected, push and hold to reset to zero.

LIGHTING CONTROL/TURN SIGNAL LEVER

: Turns tail, parking, and dashboard lights on.

AUTO: The light sensor automatically determines when to turn the headlights on or off.

: Turns fog lights on only when headlights are on.

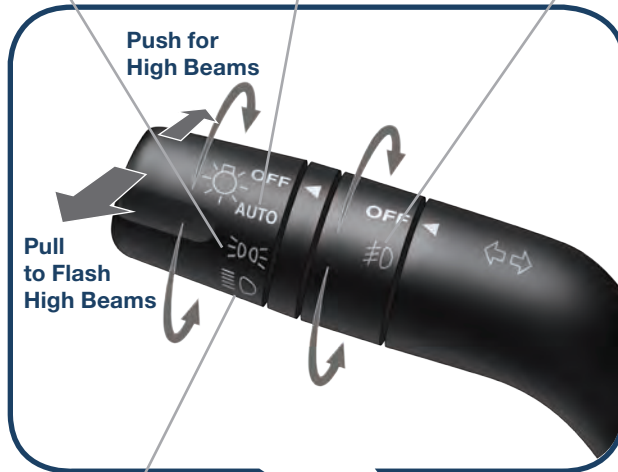

Push for High Beams

Pull to Flash High Beams

: Turns tail, parking, dashboard, and headlights on.

HEADLIGHT LEVELING

Adjust headlight angle with headlight leveling switch depending on vehicle passengers & load (example: Driver only = 0, Driver + Passengers = 1 or 2, etc.). Refer to your Owner's Manual for complete details.



WINDSHIELD/REAR WINDOW WIPER/WASHER CONTROL LEVER

AUTO: The rain sensor senses the amount of rainfall and turns the wipers on or off. Rotate inner ring away from you (clockwise) for more (+) sensitivity (requires less rain to turn wipers on) and toward you (counterclockwise) for less (-) sensitivity (requires more rain to turn wipers on).

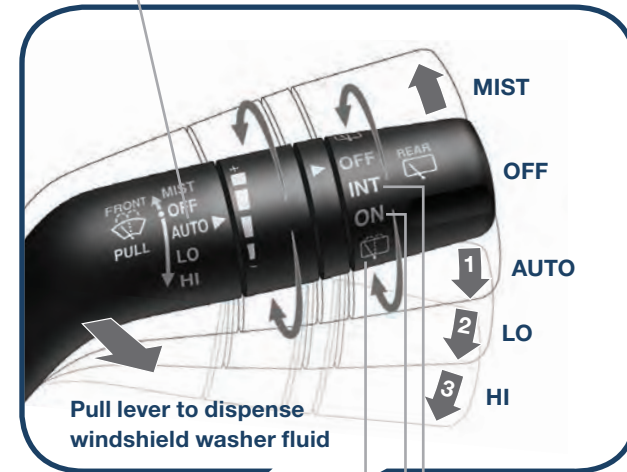

MIST

OFF

1 AUTO

2 LO

3 HI

Pull lever to dispense windshield washer fluid

Rear Window Wiper/Washer

INT: Intermittent

ON: Normal speed

: Washer/wiper (hold as desired)

NOTE: Vehicles not equipped with AUTO wipers will have INT wipers. Set the lever to INT and choose an interval timing by rotating the ring between fast and slow.

CAUTION: When the ignition is ON, turn the AUTO wipers OFF when going through a car wash, or while cleaning or touching the windshield.

POWER MIRRORS WITH REVERSE TILT DOWN FUNCTION*

When the ignition is switched ON and the selector lever is shifted to the R position, the outside mirrors tilt downward to facilitate the view of the lower area on each side of the vehicle.

- 1 Switch the left/right power door mirror selector switch to the left or right side.
- 2 Shift the selector lever to the R position while pressing the brake pedal. The outside mirrors tilt downward automatically.



NOTE: If the left/right power outside mirror selector switch is in the center position, or the selector lever is shifted to a position other than the R position, the outside mirrors return to their on-road position automatically. The door mirrors return to their on-road position automatically even when the ignition is switched from ON to OFF.

AUTO-DIMMING MIRROR AND HOMELINK®

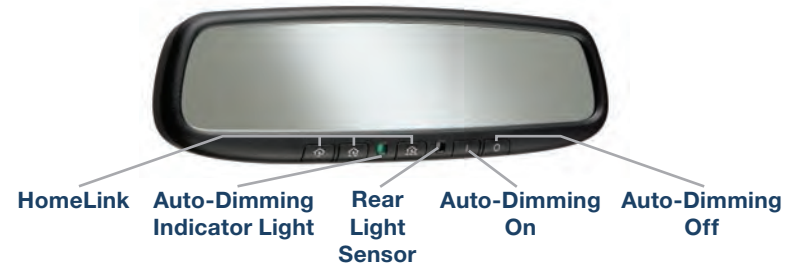

Auto-Dimming Mirror

- Auto-dimming will automatically darken your rearview mirror to reduce headlight glare from vehicles behind you.
- Auto-dimming is activated every time the vehicle is started.

NOTE: In addition to the auto-dimming mirror's rear light sensor, there is also a front light sensor (not shown). Do not place or hang any objects over the front or rear mirror light sensors; otherwise, the auto-dimming mirrors will not operate properly.

HomeLink®



- This feature provides a convenient way to replace up to three transmitters such as garage door openers, home lighting remotes and other radio frequency devices.
- Refer to your Owner's Manual for complete programming details.

NOTE: Genuine Mazda Accessory Auto-Dimming Mirror with Compass and Homelink or Auto-Dimming Mirror with Rearview Camera is available at your Mazda dealer.

BLIND SPOT MONITORING (BSM) SYSTEM (if equipped)

The Blind Spot Monitoring (BSM) system is designed to assist the driver by monitoring the blind spots to the rear of the vehicle on both sides.

- If your vehicle speed is 20 mph (32 km/h) or more, the BSM will warn you of vehicles in the detection area by illuminating the BSM warning lights located on the left and right door mirrors.
- If you operate a turn signal in the direction of an illuminated BSM warning light, the system will also warn you with a beeping sound and warning light flash.
- BSM sensors are located under the left and right rear bumper areas. The BSM system may not operate properly if the rear bumper gets too dirty, so keep the rear bumper area clean.

Please refer to your Owner's Manual for complete details.

Turning BSM System Off

Turning the BSM system off will turn off both the light and sound indicators. To manually turn the BSM system off, push the BSM OFF switch on the dash. The BSM OFF indicator will illuminate in the instrument cluster when the BSM system is off. The BSM system will automatically turn on the next time the vehicle is started.

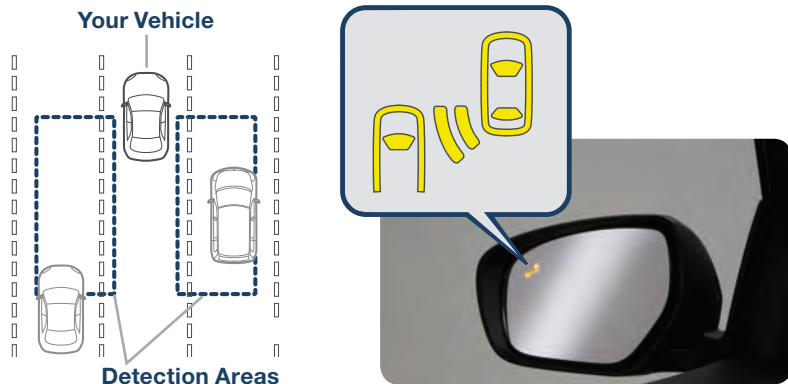

NOTE: Do not rely completely on the BSM system and be sure to look over your shoulder before changing lanes:

- The BSM system can assist the driver in confirming the safety of the surroundings, but is not a complete substitute.
- The driver is responsible for ensuring safe lane changes and other maneuvers.
- Always pay attention to the direction in which the vehicle is traveling and the vehicle's surroundings.
- The BSM system does not operate when the vehicle speed is lower than about 20 mph (32 km/h).

REAR CROSS TRAFFIC ALERT (RCTA) (if equipped)

The RCTA is designed to alert the driver of oncoming traffic when backing out of a parking spot. RCTA is active when your vehicle is in reverse and your vehicle speed is 0 to 8 mph (13 km/h).

When BSM sensors detect an object moving 3 to 18 mph (5 to 30 km/h) (vehicle/motorcycle), RCTA will notify the driver with indicators and sound:

- Rear View Monitor and outside mirror flashing indications.
- Beep sound (same as BSM).

Please refer to your Owner's Manual for complete details.

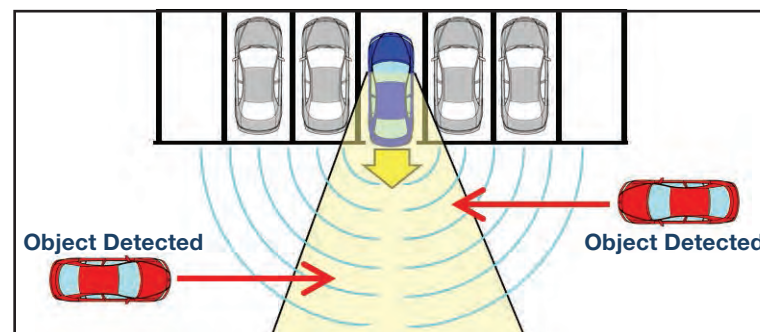

WARNING: RCTA is only a supplementary system to help aid when backing up, however RCTA has limitations. The system does not detect all vehicles. Do not rely solely on the RCTA. Relying solely on the RCTA may cause an unexpected accident resulting in serious injury. Always back up slowly.



REAR VIEW MONITOR (if equipped)

Placing the gearshift lever into Reverse automatically operates the Rear View Parking Camera and is viewable via the 5.8" LCD screen.

NOTE: When using the Rear View Parking Camera, please check your surroundings as objects may be closer than they appear.

PARKING SENSOR SYSTEM (if equipped)

The parking sensor system uses ultrasonic sensors to detect obstructions behind the vehicle with transmission in Reverse and speed below 6 mph (10 km/h). The system notifies the driver of the approximate distance from the vehicle to the obstruction using a beeping sound.

- Push the parking sensor switch on the dash to turn the system on (switch indicator lit) and off.



MANUAL LIFTGATE

- To open, unlock the liftgate, pull up on the handle and raise the liftgate.
- To close, push liftgate down until it securely locks, but do not slam.

POWER LIFTGATE

- To open or close using the advanced keyless transmitter, unlock the liftgate and push and hold the liftgate button for one second or more.
- To open or close from the driver's seat, unlock the liftgate and push and hold the power liftgate switch on the dashboard (see Driver's View) for one second or more.
- To close when the liftgate is open, push and hold the power liftgate switch located on the lower edge of the liftgate panel for one second or more.
- For safety, the power liftgate will open in the event an obstruction is detected while the liftgate is attempting to close.
- If you wish to open the power liftgate while it is in the process of closing, you may push and hold the switch on the dashboard or the switch located on the lower edge of the liftgate panel for one second or more.

Power liftgate will only operate under the following conditions:

- 1 The power liftgate is unlocked.
- 2 The shift lever is in park (P).





INFORMATION DISPLAY

Driver Temperature Control Dial

AUTO ON: Push dial to turn Automatic Air Conditioning system on. Rotate dial to select your desired set temperature (shown in information Display above). The airflow mode and amount of airflow will be automatically controlled in accordance with the set temperature.

MODE Push to select airflow mode.

Fan Control Dial

- Push OFF to turn climate control system off.
- Rotate the dial to select the desired fan speed.

FRONT Push to defrost windshield.

REAR Push to defrost rear window.

Push to recirculate cabin air to reduce outside odors and improve cooling (indicator on) or receive fresh air (indicator off).

A/C Push to manually turn air conditioning ON or OFF.

Passenger Temperature Control Dial

- Push to turn DUAL mode on or off.
- **With DUAL mode ON** (indicator on), rotate the dial to set passenger side temperature separate from the driver's side (shown in the Information Display above).
- **With DUAL mode OFF** (indicator off), driver controls the temperature setting on both sides.

REAR Push to allow control from the rear controls (indicator on).

OUTSIDE TEMP Push to display outside temperature.

FRONT SEAT WARMERS

The driver and front passenger seats can be warmed by pushing the applicable seat warmer button while the ignition is ON.

- Seat temperature increases as the number of indicator lights increases. Two lights equal high, one light equals low.
- When the seat warmers are not needed, push button until indicator lights are off.

REAR CLIMATE CONTROL

Operation from Front Seats

- 1 Turn the front air conditioning on.
- 2 Push the REAR control button on the front control panel (indicator on).
- 3 Selection of the airflow mode, airflow amount and temperature will be automatically controlled to the same setting as the front air conditioner.

Rear Control Panel



Operation from Rear Seats

AUTO ON:

- 1 Turn the front air conditioning on.
- 2 Push AUTO ON button on the rear control panel to turn Rear Automatic Air Conditioning system on. Push Temperature setting button on the rear control panel to select your desired set temperature. The air flow mode and amount of air flow will be automatically controlled in accordance with the set temperature.

NOTE: If the rear AUTO button is pushed while the front A/C button is off, the rear air conditioning operates only to circulate air. Setting the temperature to the maximum high or low will not provide the desired temperature at a faster rate.

NOTE: The automatic temperature control always works, even if the AUTO ON indicator light comes off after rotating the Fan Control Dial or changing vent mode.

NOTE: Automatic climate control will allow you to maintain individual preset cabin temperatures for the driver and passenger when DUAL mode is selected.

PLAYING BLUETOOTH® (BT) AUDIO

- 1 Make sure BT audio device is paired to your vehicle.
- 2 Turn on BT audio device.
- 3 Touch the Bluetooth® on-screen tab.
- 4 Select the BT-Audio option.

GRACENOTE

The Gracenote media database is used to improve voice recognition of artist and album names with the Mazda Hands Free system. To make best use of the voice recognition, install the most recent database.

- 1 Load the Gracenote update on a memory stick from www.MazdaUSA.com/USB. Insert memory stick into the USB port.
- 2 Push the PHONE button.
- 3 Select Setup and scroll down to Gracenote Update.

Eject CD



LOADING A CD

BLUETOOTH® AUDIO

Bluetooth® enabled devices provide an opportunity to play music through the audio system with no wires attached, however, there are some limitations:

Some phone models do not support all features. Go to www.MazdaUSA.com/bluetooth or contact (800) 430-0153 for further assistance or to report a phone /MP3 device concern.

POWER ON

Push the Power/Volume dial to turn the audio system on.

MEDIA SELECTION

Push the AUDIO button to select the appropriate on-screen button:

Radio: Select FM/AM button for FM1, FM2, or AM band.

CD: Select for CD player.

Bluetooth®: Select for BT Audio.

Pandora: Select to play Pandora from Bluetooth device (with Pandora app).

USB: Select to play iPod/iPhone® through USB port.

AUX: Select to switch to AUX input.



New Mazda vehicles equipped with SiriusXM® Satellite Radio will receive an introductory subscription with a limited term trial offer to over 150 channels of SiriusXM Satellite Radio. Enjoy commercial-free music, plus sports, news, entertainment, and every premium channel in your vehicle. Call 877-447-0011 to activate. See the Owner's Manual and/or dealer for details.

See your Owner's Manual for further information on:

- Pandora audio application
- Audio menu voice-command

TUNING

Manual: Turn the TUNE/FILE dial to manually change the frequency.

Seek: Push the SEEK ►►►◄◄◄ button or touch and hold the ►►◄◄ button on-screen button, to automatically seek a higher or lower frequency or track, depending on media selected.

NOTE: If you continue to push and hold the button, the frequency will continue changing without stopping.

Scan: Touch the SCAN on-screen button to automatically sample strong stations for seconds each. Touch again to cancel.

Auto Memory Tuning:

- 1 Touch the **Auto Memory** on-screen button. The auto memory preset list is displayed and the previously tuned frequency is received.
- 2 Touch the **Update List** on-screen button to display the frequencies of up to ten radio stations on the auto memory preset list.

HD RADIO

HD radio has a special receiver which allows it to receive digital broadcasts (where available) in addition to the analog broadcasts it already receives. Digital broadcasts have better sound quality than analog broadcasts as digital broadcasts provide free, crystal clear audio.

When the HD radio button is ON (illuminated), there could be a noticeable difference in sound quality and volume when a change from digital to analog signals occurs. If the sound quality and volume becomes noticeably diminished or cuts off, touch the HD button to turn OFF HD radio (not illuminated).

- 3 Touch the desired frequency. Refer to the Owner's Manual for complete details.

Preset Channel: Can be used to store 6 AM or 12 FM stations.

- 1 To set a channel, first select AM, FM1 or FM2.
- 2 Tune to the desired station.

- 3 Long-push any of the preset on-screen buttons. The reception frequency is programmed and displayed on the preset button.
- 4 Repeat this operation for the other stations and bands you want to store. When receiving a programmed frequency, select AM, FM1, or FM2 and touch the preset on-screen button. The station frequency will be displayed.

AUDIO OPERATION USING VOICE

Audio operation and media selection can be done using voice. Push the "Talk" button, wait for a beep, then say a command in a clear, natural voice (not too fast or too slow). A list of available commands will be displayed on the screen, and if you do not say anything, the system will read the commands. Commands will only work when in the correct mode (Radio, CD, BT, USB, or Pandora). To change modes, push the "Talk" button and say "Change mode." Some commands are:

Radio: Seek up/down, Preset #

CD: Play track #

BT: Next/Previous folder

CD, USB, BT: Play, Repeat, Shuffle

CD, USB, BT, Pandora: Pause, Resume

Pandora: Skip song, Thumbs up/down

PORTABLE AUDIO PLAYER INTEGRATION USING THE USB PORT OR AUX JACK

Your vehicle is equipped with a USB port (some models) and auxiliary AUX jack located in the center console. This will allow you to play your iPod, USB device, or portable audio player through the vehicle's audio system. Learn the system when parked and do not let it distract you while driving.

IMPORTANT:

- Set the volume level on your portable audio player to the highest level before distortion starts, then use the vehicle's audio system to adjust the volume.
- Unplug any device from the USB port and accessory socket before turning off the vehicle. Leaving devices plugged in can drain the battery and cause issues during the Bluetooth pairing process at startup. Wait about 15 seconds after starting the vehicle before plugging anything into the USB port.



Auxiliary Jack

NOTE: You will need an audio cable with an 1/8 inch (3.5 mm) mini stereo plug (available as a Genuine Mazda accessory) to connect your portable audio player into the aux jack.



NOTE: AUX jack is not available on vehicles equipped with Rear Seat Entertainment System (RSES).

Refer to the Owner's Manual for additional information.

- 1 Plug 1/8 inch mini stereo cable into the portable audio player and the AUX jack.
- 2 • **Audio Controls (without navigation):** Push the AUX button on the audio unit to switch to the AUX mode.
 - **Audio Controls (with navigation):** Push AUDIO button on audio system, then touch AUX on-screen button.
- 3 Use the portable audio player controls to play music.

USB Port

Refer to the Owner's Manual for additional information.

- 1 Connect the cable into the portable audio player and the USB port.
- 2 • **Audio Controls (without navigation):** Push the AUX button on the audio unit to switch to the USB mode and start playback.
 - **Audio Controls (with navigation):** Push AUDIO button on audio system, then touch the USB on-screen button.

NOTE: When the iPod® is connected to the USB port, the USB on-screen tab changes to the iPod on-screen tab. Do not remove the iPod while in the iPod mode. Otherwise, the data could be damaged.

- 3 Use the vehicle's audio system or steering wheel controls to control the USB device connected.

NOTE: The iPod functions on the iPod cannot be operated while it is connected to the vehicle's audio system because it controls the iPod functions.

COMMON VOICE RECOGNITION COMMANDS

- **Help:** Informs the user of all available voice commands under the current conditions.
- **Go Back:** Returns to the previous operation.
- **Cancel:** The voice recognition system goes to standby mode.
- **Display On:** The audio unit display is switched on.
- **Display Off:** The audio unit display is switched off.

NOTE: When you push the "Talk" button and do not say a command, a list of available commands will be displayed on the screen. The system will also read the commands.

TO REMOVE OR INSERT THE MAP SD CARD:

- 1 Turn the vehicle ignition OFF.
- 2 Locate the sliding door on the lower left side of the dash (see page 5) and slide it open (right).
 - Remove card: Push the card once, then pull it out.
 - Insert card: Push the card in (label-side up), then slide door closed (left).



NOTE:

- Visit www.mazdausa.com/navigation within 60 days of vehicle delivery and download the most recent map available for your device for free. In order to download or upgrade your map, the TomTom Home software must be downloaded. Please refer to the Navigation System Owners Manual section of www.mazdausa.com/navigation for additional information.
- Only use your MAP SD card for operating and updating your navigation system. Do not insert the MAP SD card into another vehicle or into any other device such as a camera.
- If your vehicle is not equipped with a factory navigation system, your audio system can be upgraded to include navigation. Contact your Authorized Mazda Dealer for more details.



PLANNING A ROUTE USING THE TOUCH-SCREEN

IMPORTANT: In the interest of safety and to reduce distractions while you are driving, you should always plan a route before you start driving.

To plan a route on your Navigation system, do the following:

- 1 Push the NAV button to access the Navigation System.
- 2 Touch the screen (above) to open the Main Menu (below).
- 3 Touch **Navigate to.**
- 4 Touch **Address.**



NOTE: You can change the country or state setting by touching the flag before you select a city.

- 5 Enter the town or city name.

- 6 Enter the street name.
- 7 Enter the house number, then touch **Done**.
- 8 The location is shown on the map. Touch **Select** to continue or **Back** to enter another address.
- 9 When the new route is shown, touch **Done**.
For more information about the route, touch **Details**.

PLANNING A ROUTE USING YOUR VOICE

You can navigate to any of the following places using your voice:

- An address, **including home**.
- **Favorites**.
- Cities and towns.
- POI (Point of Interest) categories.
- POIs for named brands of, for example, restaurants, gas stations, car rental and gyms.
- A recent destination.

NOTE: POI in a city searches the system in your present location.

To plan a route to an address using your voice, do the following:

NOTE: Planning a route using your voice can be done while driving the vehicle.

- 1 Touch the voice control button  in the Driving view.
- 2 When you hear the tone, you can say, for example “Drive to an address”.
- 3 Say the full address (without zip code) for your destination. For example “123 Main St., Los Angeles, California”. The system does not recognize zip codes.

NOTE: For best results, say the full address without pausing between words.

- 4 Say “Yes” if the address is correct. If shown a list of addresses, say the list number for the correct address or say “none of these”.

NAVIGATION SYSTEM FEATURES:

- While driving your vehicle, you can enter a destination address using your voice, but you cannot enter a destination address using the keyboard.
- While driving your vehicle, the vehicle speed and the maximum speed limit (for most roads) can be seen on the bottom left tabs of the Navigation screen.

NOTE:

- Voice guidance can be skipped by pushing the talk button.
- Refer to the Navigation System Owners Manual for additional navigation system details or visit www.mazdausa.com/navigation



PAIRING YOUR BLUETOOTH® PHONE OR AUDIO DEVICE

NOTE:

- For safety reasons, you cannot pair a phone while driving.
- Before pairing your cell phone or audio device, you must manually turn on the Bluetooth® function on the device. Refer to your device's Bluetooth® for steps to turn on Bluetooth®.
- **For customer service and device compatibility:**
Toll-free call: 800-430-0153
Website: www.MazdaUSA.com/bluetooth
- **IMPORTANT:** Set the volume level on your cell phone or audio device to the highest level before distortion starts, then adjust the volume on the vehicle's audio system.
- When in range of another Wi-Fi device, the Bluetooth connection between your phone and the system may disconnect for a short time if you have Wi-Fi enabled. Turn off Wi-Fi on your phone if needed.

Touch Screen Pairing

- 1 Manually turn Bluetooth on your phone or audio device.
- 2 Push Phone button.
- 3 Touch the **Setup** on-screen button.
- 4 Touch the **Bluetooth Setup** on-screen button. The list of all paired devices is displayed.
- 5 Touch the **Add New Device** on-screen button to display the message and switch to the device operation.
- 6 Using the device, perform a search for the Bluetooth® device (Peripheral device).
- 7 Select "Mazda" from the device list searched by the Mazda.
- 8 Your phone will pair using one of the two ways:
 - a. Input the displayed 4-digit pairing code into the device.
 - b. Verify the displayed 6-digit code on the audio unit, which is also displayed on the device, and touch the Yes on-screen button.
- 9 **Call History**
Incoming/Outgoing history for the device is downloaded automatically.

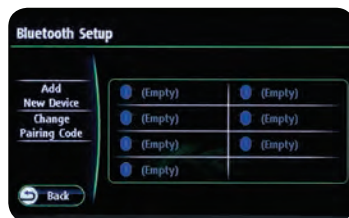

NOTE: Some phone models do not support all features. If your phone or device does not pair, please visit www.MazdaUSA.com/bluetooth or contact (800) 430-0153 for further assistance or to report a phone /audio device concern.

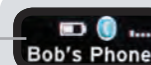

NOTE: For connection issues, please confirm the Bluetooth connection status by pushing the PHONE button and looking in the top left corner for the Bluetooth icon and your phone's name. Some phones will turn off the Bluetooth signal after connecting the USB cable to the vehicle or after downloading an update

- If not displayed, check your phone and make sure Bluetooth is turned on (or discoverable) in the Settings menu. Detailed instructions for some phones are available online.
- If there is still no connection, delete the pairing data on the system and your phone and try again after confirming your cell phone is compatible at www.MazdaUSA.com/bluetooth.

TO MAKE OR RECEIVE A HANDS-FREE CALL

PHONE button: To receive/swap a call.

PHONE button: To make a call (push and say "Phone") or to skip vehicle voice guidance and allow user to speak next voice command.

PHONE button: To end/reject a call.

Automatic Bluetooth Reconnection:

On engine start, the last connected device will automatically be re-connected after several seconds. To switch phones, go to Device Settings and select Bluetooth.

BLUETOOTH FEATURES (WITH NAVIGATION)



See your Owner's Manual for more information. Push the PHONE button, then select the "Setup" tab.

SMS TEXT AUDIO DELIVERY/ VOICE REPLY: Play (read) text from a Bluetooth connected phone and respond back.

NOTE: If "Message" is grayed out, your phone does not support this feature. See your Owner's Manual for more information.

DON'T DISTURB ME: You will not receive phone calls and messages.

DOWNLOAD PHONEBOOK: Use this feature and "All Contacts" to download and update your phonebook in the vehicle. Some PHONEBOOKS may not automatically update if changes are made on your phone.

AUTOMATIC 911 CALL: Calls 911 after certain moderate to severe collisions. This can be turned ON and OFF.

NOTE:

- Phone must be paired and connected.
- Some phone models do not support all features. Go to www.MazdaUSA.com/bluetooth or contact (800) 430-0153 for further assistance or to report a phone/MP3 device concern.
- See your Owner's Manual for more information.

SPORT A/T MANUAL SHIFT MODE

The Sport A/T Manual Shift Mode gives you the feel of driving a manual transmission by allowing you to manually shift to control engine rpm and torque when more control is desired.

To Use Manual Shift Mode:

- Shift the lever from D to M.

To Shift Up To A Higher Gear:

- Tap the shift lever back (+) once.

To Shift Down To A Lower Gear:

- Tap the shift lever forward (-) once.

NOTE: Changing to manual mode can be done while driving the vehicle.

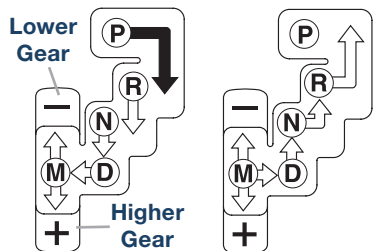

Various Lockouts:

- ⇒ Indicates the shift lever can be shifted freely into any position.
- ➔ Indicates that you must depress the brake pedal to shift (The ignition must be switched to ON).

ACTIVE ADAPTIVE SHIFT (AAS) CONTROL

The transmission will automatically adjust how and when it shifts gears based on road conditions and your driving style. The transmission may stay in a lower gear longer than usual when going up or down hills or driving around corners. This feature gives you better control and a more connected driving experience.

Fuel Door Release

(located on floor in front of driver's seat)

To open, pull the fuel door release.

Fuel

Regular Unleaded Fuel – 87 Octane



Fuel Door

To avoid scratching the paint during refueling, secure the fuel filler cap tether over the hook as shown.



BREAK-IN PERIOD

No special break-in is necessary, but a few precautions in the first 600 miles should be observed.

- Do not race the engine.
- Do not maintain one constant speed, either slow or fast, for a long period of time.
- Avoid full-throttle starts.
- Avoid unnecessary hard stops.
- Do not drive constantly at full-throttle or high engine rpm for extended periods of time.

FUEL ECONOMY:

To achieve the best fuel economy, visit www.fueleconomy.gov for more information.



INFORMATION DISPLAY

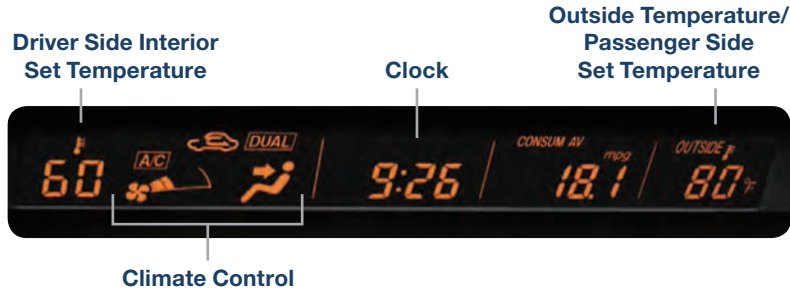

ALUMINUM WHEEL CARE

Your aluminum wheels have a protective coating on them. Only use a mild soap or neutral detergent with a sponge or soft cloth to clean them.

CAUTION: Using a wire brush, polishing compound, solvent, or any type of abrasive cleaner may damage the protective coating.



PERSONALIZE YOUR MAZDA CX-9 WITH GENUINE MAZDA ACCESSORIES

Go to www.MyMazda.com, then select "Accessories" below the MyMazda Home header for a complete listing of available accessories for your Mazda CX-9.



WWW.MYMAZDA.COM—THE OFFICIAL SITE FOR MAZDA OWNERS

Register today on www.MyMazda.com—the ultimate destination for Mazda Owners. Once registered, you'll be able to take advantage of benefits exclusively for Mazda Owners:

- Insider access to exclusive events and promotions
- Personalized maintenance schedules
- Zoom-Zoom Owner Magazine
- Warranty information and on-line Owner's Manuals
- Wallpaper, videos and other fun stuff
- Accessories specifically designed for your vehicle
- Car Care Discount Coupons available from your Authorized Mazda Dealer

Visit and register at www.MyMazda.com today!

MAZDA MOBILE

The following apps are available for iPhone® and Android smartphones:

- **Mazda Assist app** - Provides roadside assistance 24 hours a day, 365 days a year. Toll free number 1-800-866-1998 can also be used for roadside assistance.
- **MyMazda app** - Keep track of your Mazda from the palm of your hand with these features:
 - Maintenance schedule
 - Service coupons
 - Promotional alerts
 - Service history
 - Recall information
 - Parked car locator
 - Scan VIN barcode capability when registering a vehicle
 - Mazda Dealer locator
 - Update owner profile
 - Link to Mazda Assist

The apps can be downloaded, free of charge, from the App store for the iPhone® and Google Play (Android Market) for Android powered devices. After downloading app, customer name, email, smartphone number and VIN are required.



Free Mazda Assist app
iPhone and Android



Free MyMazda app
iPhone and Android

Customer Delivery Checklist

VEHICLE PRESENTATION:

Refer to the Smart Start Guide during presentation

- Keyless Entry**1-2



- Keyless Transmitter
- Advanced Key*
- Door Request Switches*
- Liftgate Request Switch*
- Power Door Locks

- Starting The Engine**.....2



- Start Knob Ignition (Advanced Key*)

- Seats** 3-4

- Adjustment
- Memory Seat Function*

- Rear Seat Access**..... 4

- 2nd and 3rd row seating access

- Driver's View** 5-6

- Location of Switches and Controls

- Set Clock** 6



- Instrument Cluster** 7-8

- Review indicator light function and location

- Lighting Control**.....9

- Wiper/Washer**.....10



- Power Mirrors with Reverse Tilt Down Function*** 11

- Auto-Dimming Mirror***..... 12

- HomeLink®*** 12

- Blind Spot Monitoring***..... 13

- Rear Cross Traffic Alert***..... 14

- Rear View Monitor***..... 15

- Backup Sensor*** 15

- Liftgate**..... 16

- Manual Operation
- Power Liftgate (PLG) Operation*

- Climate Control**.....17-18

- Front Controls
- Rear Controls



- Audio Controls** 19-20

- Sirius® Satellite Radio Operation

- USB/AUX Input**..... 21-22

- Navigation*** 23-24

- SD Card
- Planning a route

- Bluetooth®**25-26

- Tutorial
- Pair Phone
- Make a Call
- Toll-Free Customer Service
800-430-0153

- Sport A/T Manual Shift Mode**..... 27

- Fuel Door** 28

- Fuel-Filler Door Release

**if equipped*

All items in the Customer Delivery Checklist have been reviewed with the customer and the first maintenance appointment has been scheduled:

SALES CONSULTANT	DATE	CUSTOMER	DATE

Signed copy must be placed in dealer jacket

Customer Delivery Checklist

DEALERSHIP	DATE
SALES CONSULTANT	CUSTOMER'S NAME
VIN	E-MAIL

PRESENTATION OF OWNER'S MATERIALS:

Review the following items with the customer

- Smart Start Guide**

- Remove this checklist from Smart Start Guide
- Personalization Features (including all Auto Lock/Unlock function settings, refer to your Owner's Manual)

- www.MyMazda.com**

- Offer to register customer on www.MyMazda.com

- Owner's Manual**

- Maintenance Passport**

- Warranty Information**

Warranty Start Date: _____

Customer Initial: _____

- Basic Vehicle – 36 months/36,000 miles
- Roadside assistance program

- Floor Mats**

- Ensure floor mats are properly hooked after cleaning
- Do not install two floor mats, one on top of the other, on the driver side
- Accessory rubber floor mats should be cleaned with mild soap and water only

SERVICE DEPARTMENT

- Introduce Service Manager; provide business cards
- Review Service and Parts Department hours of operation
- Explain free Full Circle Service Inspection
- Schedule first maintenance service



GENUINE MAZDA SERVICE

Because you and your Mazda deserve the best

Your new Mazda deserves nothing less than the very best. To keep it running like new for years to come, trust the experts at your local Authorized Mazda Dealer. Simply bring your vehicle in for your scheduled maintenance and any needed repairs.*

At participating Mazda Full Circle Service Centers,** our technicians will automatically perform a complimentary Full Circle inspection on your vehicle and issue a detailed report card at every visit. This is designed to help you keep track of your Mazda's critical operating condition. Our factory-trained technicians know your vehicle inside out and use Genuine Mazda Parts, giving your vehicle the optimum care and maintenance it requires to run with flawless precision.

Remember, to further enhance your driving experience, visit your local Mazda Service Center for your scheduled maintenance. It's also the place where you can find a wide variety of tires, parts, and accessories that are just right for your vehicle.

***See vehicle's scheduled-maintenance program for details.**

**** Visit the Mazda Owners website at www.MyMazda.com/fullcircle to find a participating Mazda Full Circle Service Dealer.**

Customer Experience Center: 1-800-222-5500

Roadside Assistance Contact: 1-800-866-1998

Mazda
FULL CIRCLE
SERVICE

**FREE FULL CIRCLE
SERVICE INSPECTION**

***We're committed to providing
expert Mazda service.***

You love to drive your Mazda, and we love to service your Mazda. With our Full Circle Service, we'll give your vehicle a **COMPLIMENTARY MULTI-POINT INSPECTION**. Your Mazda will receive a thorough review of its most crucial components.

This easy-to-use Smart Start Guide is intended to help you more fully appreciate some of the unique features and functions of your new vehicle. However, it is not intended to replace your Owner's Manual. The Owner's Manual contains more detailed information to help you better understand the important safety warnings, features, operation, and maintenance of your vehicle. All information, specifications, photographs and illustrations in this publication are those in effect at the time of printing. Mazda reserves the right to change specifications or design without obligation.

© Mazda North American Operations
Printed in U.S.A. 05/14
Print 1
9999 95 011C 15SS



www.MazdaUSA.com