

## **Zoom-Zoom**

**All children instinctively know it.**

**A few adults still remember it.**

**One unique car company refuses to outgrow it.**

**In grown-up language, it means the exhilaration and**

**liberation that come from experiencing sheer motion.**

**But as usual, children put it much better and simply call it " Go Zoom-Zoom."**

**We practice it every day.**

**It's why we build the kind of cars we do.**

**Zoom-Zoom.**

**Can we re-awaken it in you today?**



# A Word to Mazda Owners

---

Thank you for choosing a Mazda. We at Mazda design and build vehicles with complete customer satisfaction in mind.

To help ensure enjoyable and trouble-free operation of your Mazda, read this manual carefully and follow its recommendations.

An Authorized Mazda Dealer knows your vehicle best. So when maintenance or service is necessary, that's the place to go.

Our nationwide network of Mazda professionals is dedicated to providing you with the best possible service.

We assure you that all of us at Mazda have an ongoing interest in your motoring pleasure and in your full satisfaction with your Mazda product.

**Mazda Motor Corporation**  
**HIROSHIMA, JAPAN**

## **Important Notes About This Manual**

Keep this manual in the glove box as a handy reference for the safe and enjoyable use of your Mazda. Should you resell the vehicle, leave this manual with it for the next owner.

All specifications and descriptions are accurate at the time of printing. Because improvement is a constant goal at Mazda, we reserve the right to make changes in specifications at any time without notice and without obligation.

## **Air Conditioning and the Environment**

Your Mazda's genuine air conditioner is filled with a refrigerant that has been found not to damage the earth's ozone layer. If the air conditioner does not operate properly, consult an Authorized Mazda Dealer.

Perchlorate

Certain components of this vehicle such as [air bag modules, seat belt pretensioners, lithium batteries,...] may contain Perchlorate Material-- Special handling may apply for service or vehicle end of life disposal. See

[www.dtsc.ca.gov/hazardouswaste/perchlorate](http://www.dtsc.ca.gov/hazardouswaste/perchlorate).

**Please be aware that this manual applies to all models, equipment and options. As a result, you may find some explanations for equipment not installed on your vehicle.**

# How to Use This Manual

---

We want to help you get the most driving pleasure from your vehicle. Your owner's manual, when read from cover to cover, can do that in many ways.

Illustrations complement the words of the manual to best explain how to enjoy your Mazda. By reading your manual, you can find out about the features, important safety information, and driving under various road conditions.

The symbol below in this manual means "Do not do this" or "Do not let this happen".

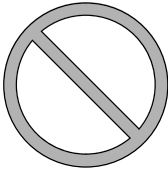

**Index:** A good place to start is the Index, an alphabetical listing of all information in your manual.

You'll find several WARNINGS, CAUTIONS, and NOTES in the manual.

## **WARNING**

*A WARNING indicates a situation in which serious injury or death could result if the warning is ignored.*

## **CAUTION**

*A CAUTION indicates a situation in which bodily injury or damage to your vehicle, or both, could result if the caution is ignored.*

## **NOTE**

*A NOTE provides information and sometimes suggests how to make better use of your vehicle.*

The symbol below, located on some parts of the vehicle, indicates that this manual contains information related to the part. Please refer to the manual for a detailed explanation.



# Table of Contents

---

## **Pictorial Index**

Interior, exterior views and part identification of your Mazda.

**1**

---

## **Essential Safety Equipment**

Important information about safety equipment, including seats, seat belt system, child-restraint systems and SRS air bags.

**2**

---

## **Before Driving**

Use of various features, including keys, doors, mirrors and windows.

**3**

---

## **When Driving**

Information concerning safe driving and stopping.

**4**

---

## **Interior Features**

Use of various features for ride comfort, including air-conditioning and audio system.

**5**

---

## **Maintenance and Care**

How to keep your Mazda in top condition.

**6**

---

## **If Trouble Arises**

Helpful information on what to do if a problem arises with the vehicle.

**7**

---

## **Customer Information and Reporting Safety Defects**

Important consumer information including warranties and add-on equipment.

**8**

---

## **Specifications**

Technical information about your Mazda.

**9**

---

## **Index**

**10**



# 1

## Pictorial Index

Interior, exterior views and part identification of your Mazda.

<b>Interior Overview</b> .....	<b>1-2</b>
Interior Equipment (View A) .....	1-2
Interior Equipment (View B) .....	1-3
Interior Equipment (View C) .....	1-4
<b>Exterior Overview</b> .....	<b>1-5</b>
(4-Door) .....	1-5
(5-Door) .....	1-6

# Interior Overview

## Interior Equipment (View A)

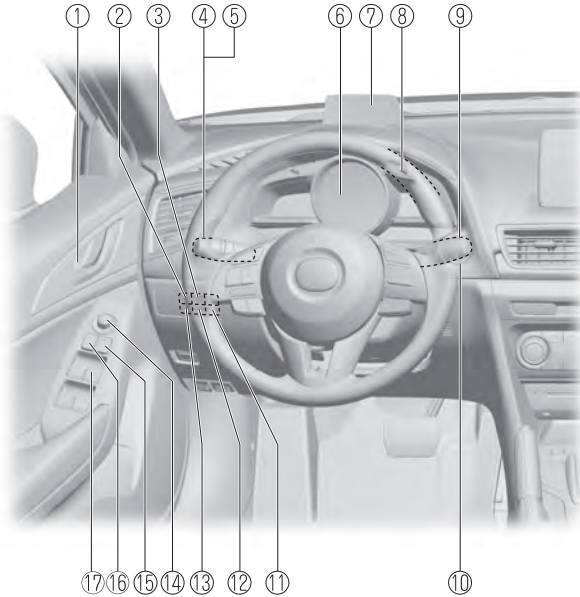

① Door-lock knob .....	page 3-19
② DSC OFF switch .....	page 4-81
③ Tire pressure monitoring system set switch .....	page 4-106
④ Turn and lane-change signal .....	page 4-50
⑤ Lighting control .....	page 4-40
⑥ Instrument cluster .....	page 4-11
⑦ Active driving display .....	page 4-18
⑧ Dashboard illumination knob .....	page 4-15
⑨ Wiper and washer lever .....	page 4-51
⑩ Push button start .....	page 4-4
⑪ LDWS switch .....	page 4-121
⑫ AFS OFF switch .....	page 4-45
⑬ BSM OFF switch .....	page 4-113
⑭ Outside mirror switch .....	page 3-33
⑮ Door-lock switch .....	page 3-16
⑯ Power window lock switch .....	page 3-38
⑰ Power window switches .....	page 3-36



**Interior Equipment (View B)**

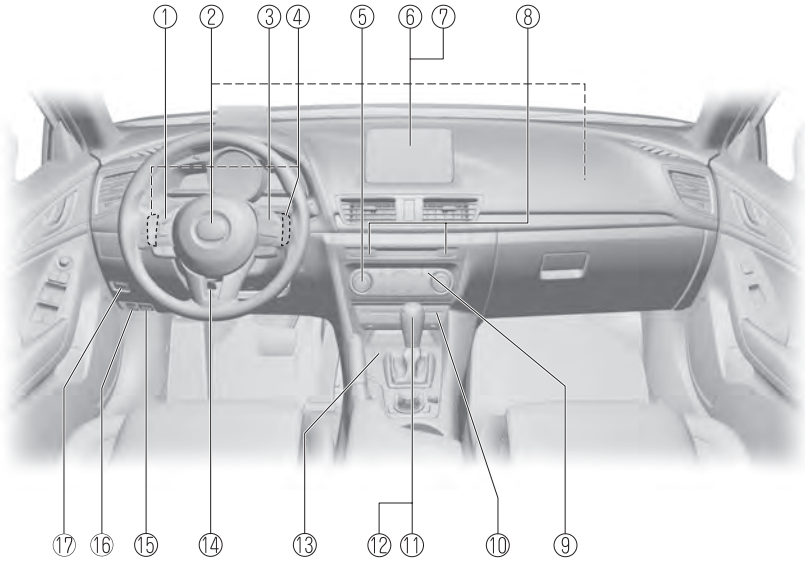

① Audio control switches.....	page 5-57
② SRS air bags.....	page 2-41
③ Cruise control switches.....	page 4-94, 4-99
④ Steering shift switches.....	page 4-32
⑤ Climate control system.....	page 5-2
⑥ Audio system.....	page 5-16
⑦ Navigation system (if equipped).....	Refer to the separate manual
⑧ Seat warmer switches.....	page 2-7
⑨ Rear window defogger switch.....	page 4-56
⑩ CD player.....	page 5-16
⑪ Manual transaxle shift lever.....	page 4-26
⑫ Automatic transaxle selector lever.....	page 4-29
⑬ Drive selection switch.....	page 4-88
⑭ Lock release lever.....	page 3-32
⑮ Hood release handle.....	page 6-24
⑯ Remote fuel-filler lid release.....	page 3-30
⑰ Trunk release button.....	page 3-21

# Interior Overview

## Interior Equipment (View C)

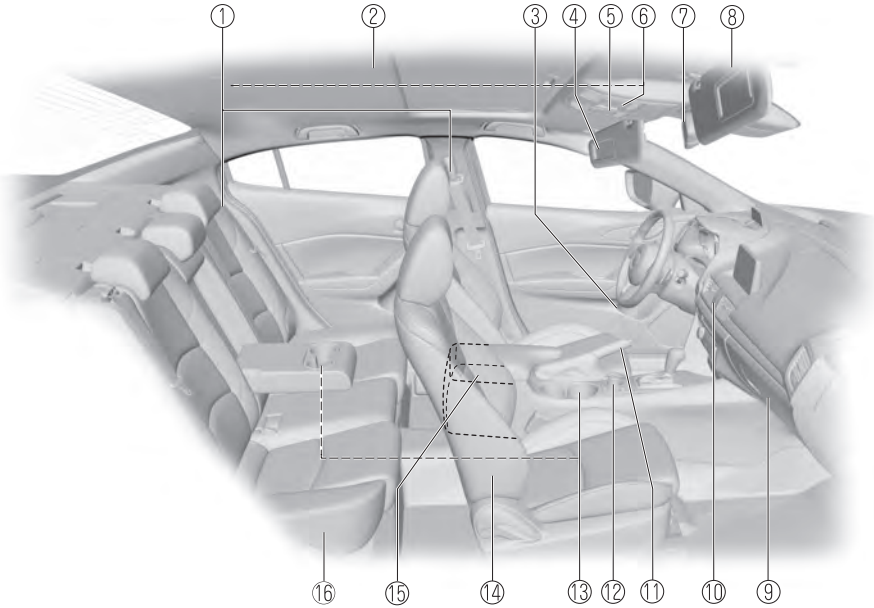

① Seat belts .....	page 2-13
② SRS air bag.....	page 2-41
③ Bottle holder.....	page 5-139
④ Vanity mirror.....	page 5-134
⑤ Moonroof switch.....	page 3-39
⑥ Overhead lights .....	page 5-135
⑦ Rearview mirror .....	page 3-34
⑧ Sunvisor .....	page 5-134
⑨ Glove compartment.....	page 5-140
⑩ Hazard warning flasher switch.....	page 4-58
⑪ Parking brake .....	page 4-68
⑫ Commander switch .....	page 5-38
⑬ Cup holders .....	page 5-138
⑭ Front seat.....	page 2-5
⑮ Center console.....	page 5-141
⑯ Rear seat.....	page 2-8

## (4-Door)

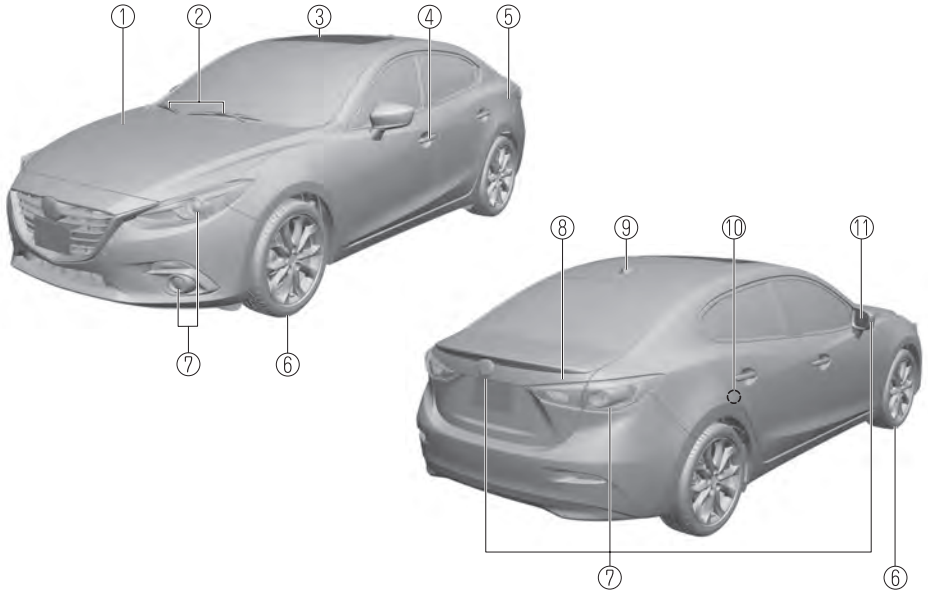

① Hood.....	page 6-24
② Windshield wiper blades.....	page 6-33
③ Moonroof.....	page 3-39
④ Doors and keys.....	page 3-12
⑤ Fuel-filler lid.....	page 3-30
⑥ Wheels and Tires.....	page 6-42
⑦ Exterior lights.....	page 6-46
⑧ Trunk lid.....	page 3-21
⑨ Antenna.....	page 5-16
⑩ Child safety locks.....	page 3-20
⑪ Outside mirror.....	page 3-33

# Exterior Overview

## (5-Door)

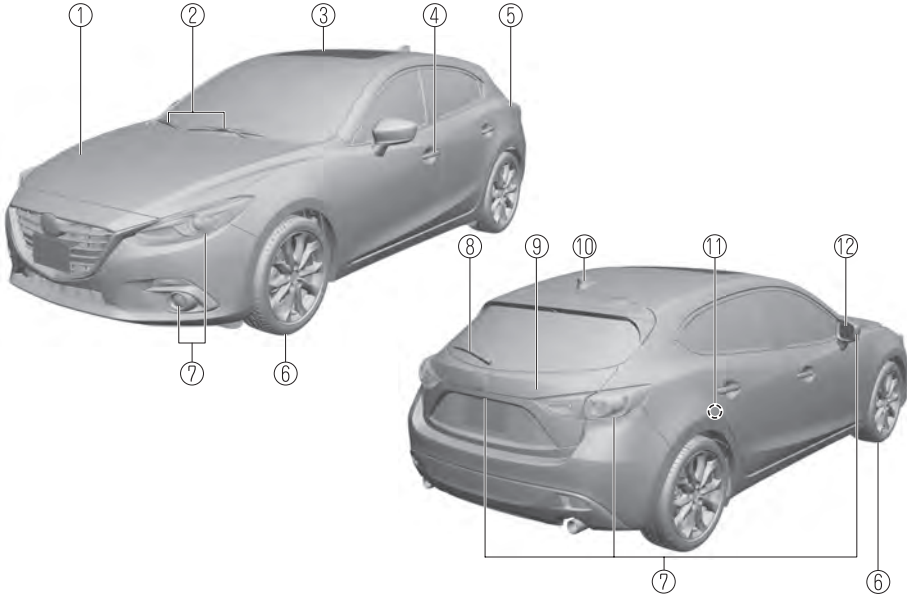

① Hood.....	page 6-24
② Windshield wiper blades.....	page 6-33
③ Moonroof.....	page 3-39
④ Doors and keys.....	page 3-12
⑤ Fuel-filler lid.....	page 3-30
⑥ Wheels and Tires.....	page 6-42
⑦ Exterior lights.....	page 6-46
⑧ Rear window wiper blade.....	page 6-35
⑨ Liftgate.....	page 3-21
⑩ Antenna.....	page 5-16
⑪ Child safety locks.....	page 3-20
⑫ Outside mirror.....	page 3-33

# 2

## Essential Safety Equipment

Important information about safety equipment, including seats, seat belt system, child-restraint systems and SRS air bags.

<b>Seats</b> .....	<b>2-2</b>
Seat Precautions .....	2-2
Front Seat .....	2-5
Rear Seat .....	2-8
Head Restraints .....	2-11
<b>Seat Belt Systems</b> .....	<b>2-13</b>
Seat Belt Precautions .....	2-13
3-Point Type Seat Belt .....	2-16
Seat Belt Warning Systems .....	2-17
Front Seat Belt Pretensioner and Load Limiting Systems .....	2-17
Center-Rear Position 2-Point Type Seat Belt* .....	2-19
Seat Belt Extender.....	2-21
<b>Child-Restraint</b> .....	<b>2-23</b>
Child-Restraint Precautions .....	2-23
Child-Restraint System Installation .....	2-28
Installing Child-Restraint Systems .....	2-29
<b>SRS Air Bags</b> .....	<b>2-41</b>
Supplemental Restraint System (SRS) Precautions .....	2-41
Supplemental Restraint System Components .....	2-48
How the SRS Air Bags Work .....	2-50
SRS Air Bag Deployment Criteria .....	2-54
Limitations to SRS Air Bag .....	2-55
Front Passenger Occupant Classification System* .....	2-57
Constant Monitoring .....	2-62

## Seat Precautions

### **WARNING**

#### **Make sure the adjustable components of a seat are locked in place:**

*Adjustable seats and seatbacks that are not securely locked are dangerous. In a sudden stop or collision, the seat or seatback could move, causing injury. Make sure the adjustable components of the seat are locked in place by attempting to slide the seat forward and backward and rocking the seatback.*

#### **Never allow children to adjust a seat:**

*Allowing children to adjust a seat is dangerous as it could result in serious injury if a child's hands or feet become caught in the seat.*

#### **Do not drive with the seatback unlocked:**

*All of the seatbacks play an important role in your protection in a vehicle. Leaving the seatback unlocked is dangerous as it can allow passengers to be ejected or thrown around and baggage to strike occupants in a sudden stop or collision, resulting in severe injury. After adjusting the seatback at any time, even when there are no other passengers, rock the seatback to make sure it is locked in place.*

#### **Adjust the driver's seat only when the vehicle is stopped:**

*Adjusting the driver's seat while the vehicle is moving is dangerous. The driver could lose control of the vehicle and have an accident.*

#### **Do not modify or replace the front seats:**

*Modifying or replacing the front seats such as replacing the upholstery or loosening any bolts is dangerous. The front seats contain air bag components essential to the supplemental restraint system. Such modifications could damage the supplemental restraint system and result in serious injury. Consult an Authorized Mazda Dealer if there is any need to remove or reinstall the front seats.*

#### **Do not drive with damaged front seats:**

*Driving with damaged front seats is dangerous. A collision, even one not strong enough to inflate the air bags, could damage the front seats which contain essential air bag components. If there was a subsequent collision, an air bag may not deploy which could lead to injuries. Always have an Authorized Mazda Dealer inspect the front seats, front seat belt pretensioners and air bags after a collision.*

#### **Do not drive with either front seats reclined:**

*Sitting in a reclined position while the vehicle is moving is dangerous because you do not get the full protection from seat belts. During sudden braking or a collision, you can slide under the lap belt and suffer serious internal injuries. For maximum protection, sit well back and upright.*

**Do not place an object such as a cushion between the seatback and your back:**

*Putting an object such as a cushion between the seatback and your back is dangerous because you will be unable to maintain a safe driving posture and the seat belt cannot function at its full capacity in a collision, which could result in a serious accident, injury or death.*

**Do not place objects under the seat:**

*The object could get stuck and cause the seat to not be fixed securely, and result in an accident.*

**Do not stack cargo higher than the seatbacks:**

*Stacking luggage or other cargo higher than the seatbacks is dangerous. During sudden braking or a collision, objects can fly around and become projectiles that may hit and injure passengers.*

**Make sure luggage and cargo is secured before driving:**

*Not securing cargo while driving is dangerous as it could move or be crushed during sudden braking or a collision and cause injury.*

**Never allow a passenger to sit or stand on the folded seatback while the vehicle is moving:**

*Driving with a passenger on the folded seatback is dangerous. Allowing a child to sit up on the folded seatback while the vehicle is moving is particularly dangerous. In a sudden stop or even a minor collision, a child not in a proper seat or child-restraint system and seat belt could be thrown forward, back or even out of the vehicle resulting in serious injuries or death. The child in the baggage area could be thrown into other occupants and cause serious injury.*

**Never give the car keys to children and do not allow them to play in the vehicle (4-Door):**

*Playing with the folding rear seats is dangerous. Once the seatbacks are back up, a child in the trunk would not be able to get out the way they had entered. If you have small children, keep the seatbacks locked.*

**Always leave your car locked and keep the car keys safely away from children (4-Door):**

*Leaving your car unlocked or the keys in reach of children is dangerous. Children who find their way into the trunk through an unlocked rear seatback or an open trunk can become accidentally locked in the trunk. This could result in death or brain damage from heat prostration, particularly in the summer. Always lock the doors and the trunk, and as an added measure, keep the rear seatbacks locked, whether you have children in your home or not.*

# Seats

---

 **CAUTION**

- *When operating a seat, be careful not to put your hands or fingers near the moving parts of the seat or on the side trim to prevent injury.*
- *When moving the seats, make sure there is no cargo in the surrounding area. If the cargo gets caught it could damage the cargo.*
- **(Manual Seat)**  
*When returning a rear-reclined seatback of a front seat to its upright position, make sure you hold onto the seatback with your other hand while operating the lever. If the seatback is not supported, it will flip forward suddenly and could cause injury.*
- **(Power Seat)**  
*The seat-bottom power adjustment is operated by motors. Avoid extended operation because excessive use can damage the motors.*
  - *To prevent the battery from running down, avoid using the power adjustment when the engine is stopped. The adjuster uses a large amount of electrical power.*
  - *Do not use the switch to make more than one adjustment at a time.*

**NOTE**

*When returning a rear seat to its original position, place the seat belt in its normal position. Verify that the seat belt pulls out and retracts.*



## Front Seat

### ▼ Seat Operation

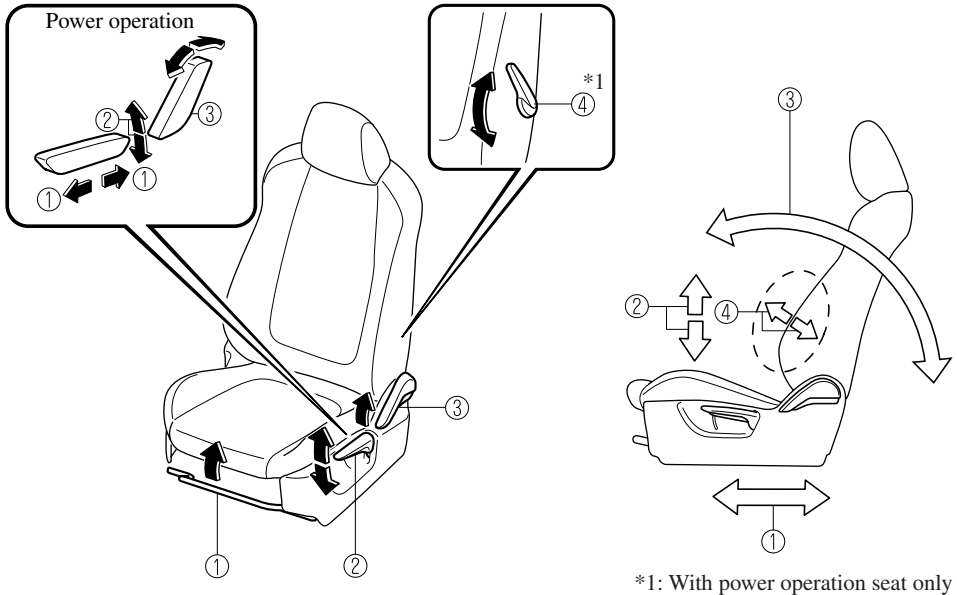

#### ① Seat Slide

(Manual Seat)

To move a seat forward or backward, raise the lever and slide the seat to the desired position and release the lever.

Make sure the lever returns to its original position and the seat is locked in place by attempting to push it forward and backward.

(Power Seat)

To slide the seat, move the slide lifter switch on the outside of the seat to the front or back and hold it. Release the switch at the desired position.

#### ② Height Adjustment (Driver's Seat)

(Manual Seat)

To adjust the seat height, move the lever up or down.

(Power Seat)

To adjust the seat height, move the switch up or down.

# Seats

---

## ③ Seat Recline

(Manual Seat)

To change the seatback angle, lean forward slightly while raising the lever. Then lean back to the desired position and release the lever.

Make sure the lever returns to its original position and the seatback is locked in place by attempting to push it forward and backward.

(Power Seat)

To change the seatback angle, press the front or rear side of the reclining switch. Release the switch at the desired position.

## ④ Lumbar Support Adjustment (Driver's Seat)\*

To increase the seat firmness, move the lever downward. Move the lever upward to decrease firmness.

▼ **Seat Warmer\***

The front seats are electrically heated. The ignition must be switched ON. Press the seat warmer switch to illuminate the indicator light while the ignition is switched ON. The mode changes as follow each time the seat warmer switch is pressed.

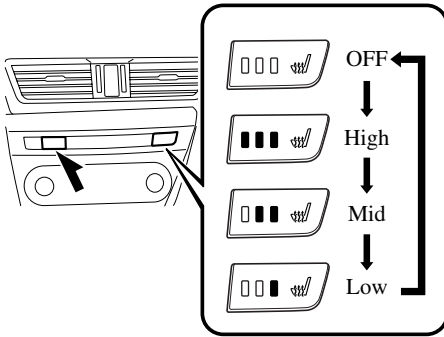

**! WARNING**

**Be careful when using the seat warmer:**

*The heat from the seat warmer may be too hot for some people, as indicated below, and could cause a low-temperature burn.*

- *Infants, small babies, elderly people, and physically challenged people*
- *People with delicate skin*
- *People who are excessively fatigued*
- *People who are intoxicated*
- *People who have taken sleep-inducing medicine such as sleeping pills or cold medicine*

**Do not use the seat warmer with anything having high moisture-retention ability such as a blanket or cushion on the seat:**

*The seat may be heated excessively and cause a low-temperature burn.*

**Do not use the seat warmer even when taking a short nap in the vehicle:**

*The seat may be heated excessively and cause a low-temperature burn.*

**Do not place heavy objects with sharp projections on the seat, or insert needles or pins into it:**

*This could cause the seat to become excessively heated and result in injury from a minor burn.*

**! CAUTION**

*Do not use organic solvents to clean the seat. It may damage the seat surface and the heater.*

**NOTE**

- *If the ignition is switched off while the seat warmer is operating (High, Mid or Low) and then switched ON again, the seat warmer will automatically operate at the temperature set before switching off the ignition.*
- *Use the seat warmer when the engine is running. Leaving the seat warmer on for long periods with the engine not running could cause the battery power to be depleted.*
- *The temperature of the seat warmer cannot be adjusted beyond High, Mid and Low because the seat warmer is controlled by a thermostat.*

\*Some models.

# Seats

## Rear Seat

### ▼ Split/One-piece Folding the Seatback

By lowering the rear seatback(s) the luggage compartment space can be expanded.

### **WARNING**

**Do not drive the vehicle with occupants on folded down seatback(s) or in the luggage compartment.**

*Putting occupants in the luggage compartment is dangerous because seat belts cannot be fastened which could lead to serious injury or death during sudden braking or a collision.*

**Do not allow children to play inside the vehicle with the seatback(s) lowered.**

*Allowing children to play in the vehicle with the seatback(s) folded down is dangerous. If a child enters the luggage compartment and the seatback(s) were raised back up, the child may become trapped in the luggage compartment which could lead to an accident.*

**Tightly secure cargo in the luggage compartment when it is transported with the seatback(s) folded down.**

*Driving without tightly securing cargo and luggage is dangerous as it could move and become an obstruction to driving during emergency braking or a collision resulting in an unexpected accident.*

**When transporting cargo, do not allow the cargo to exceed the height of the seatback(s).**

*Transporting cargo stacked higher than the seatback(s) is dangerous as visibility to the rear and sides of the vehicle is reduced which could interfere with driving operations and lead to an accident.*

### Lowering the seatback(s)

### **CAUTION**

*Check the position of a front seat before folding a rear seatback. Depending on the position of a front seat, it may not be possible to fold a rear seatback all the way down because it may hit the seatback of the front seat which could scratch or damage the front seat or its pocket. Lower or remove the head restraint on the rear outboard seat if necessary.*

**(4-Door)**

**1. (Split-folding type seat)**

Open the trunk lid and pull the lever of the seatback you want to fold down.

**(One-piece folding type seat)**

Open the trunk lid and pull the lever of the seatback.

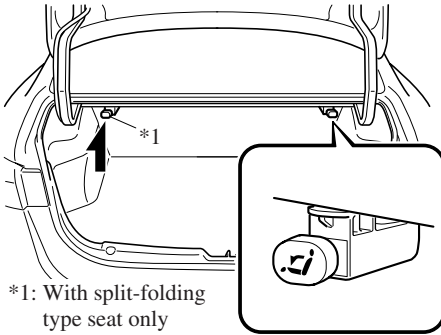

\*1: With split-folding type seat only

2. Open a rear door and fold the rear seat forward.

**(5-Door)**

Press the push knob to fold down the seatback.

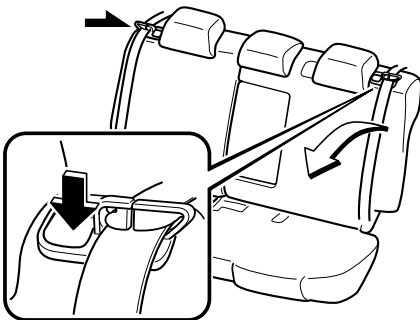

**To return the seatback to its upright position:**

**⚠ WARNING**

***When returning a seatback to its upright position, make sure the 3-point seat belt is not caught in the seatback and the 3-point seat belt is not twisted.***

*If the seat belt is used while it is twisted and caught in the seatback, the seat belt cannot function at its full capacity, which could cause serious injury or death.*

***When returning a seatback to its upright position, make sure that it is firmly locked and the red indication is not visible (5-Door).***

*If the red indication is visible behind the push knob, it means the seatback is not locked. If the vehicle is driven without the seatback locked, it could fold down suddenly and cause an accident.*

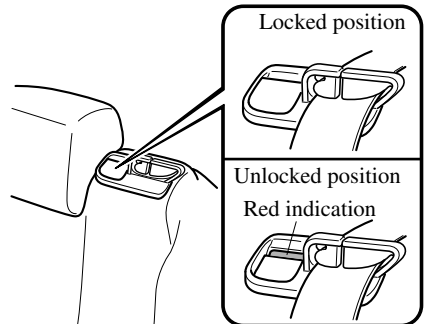

# Seats

1. Make sure that the seat belt passes through the seat belt guide correctly and it is not twisted, then raise the seatback while preventing the seat belt from being caught in the seatback.  
**(4-Door)**

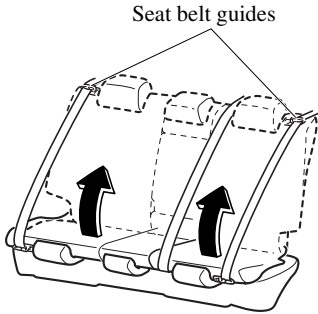

**(5-Door)**

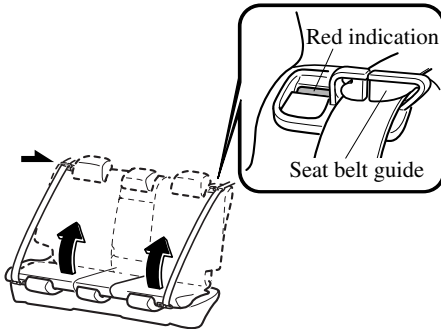

2. Press the seatback rearward and lock it in place. After returning the seatback to its upright position, make sure it is securely locked.

## ▼ Armrest\*

The rear armrest in the center of the rear seatback can be used (no occupant in the center seat) or placed upright.

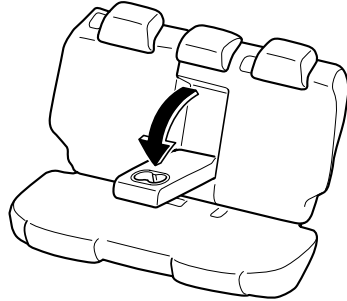

## ⚠ WARNING

**Never put your hands and fingers around the moving parts of the seat and armrest:**

*Putting your hands and fingers around the moving parts of the seat and armrest is dangerous as they could get injured.*

## Head Restraints

Your vehicle is equipped with head restraints on all outboard seats and the rear center seat\*. The head restraints are intended to help protect you and the passengers from neck injury.

### **! WARNING**

***Always drive with the head restraints installed when seats are being used and make sure they are properly adjusted:***

*Driving with the head restraints adjusted too low or removed is dangerous. With no support behind your head, your neck could be seriously injured in a collision.*

### **Height adjustment**

To raise a head restraint, pull it up to the desired position.

To lower the head restraint, press the stop-catch release, then push the head restraint down.

Adjust the head restraint so that the center is even with the top of the passenger's ears.

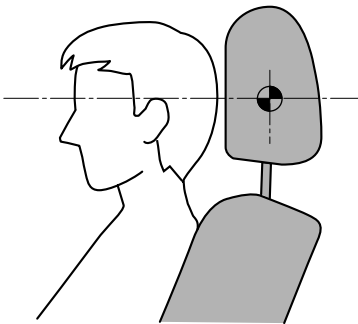

### Front outboard seat

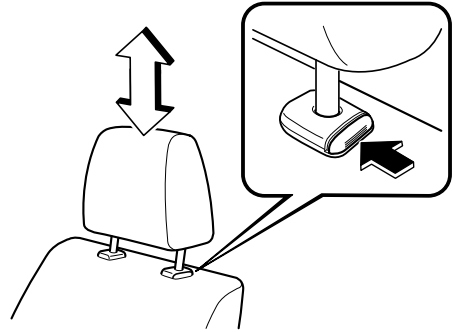

### Rear outboard seat

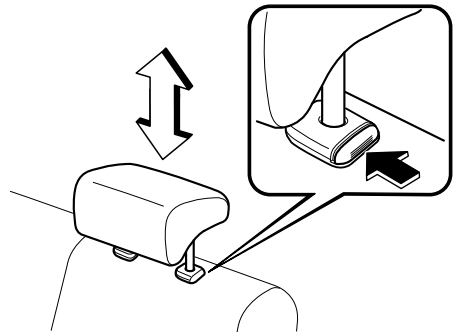

### Rear center seat\*

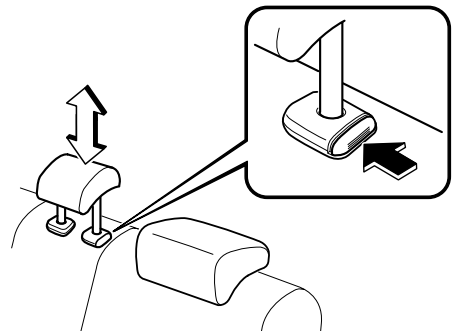

\*Some models.

# Seats

---

## **Removal/Installation**

To remove the head restraint, pull it up while pressing the stop-catch.

To install the head restraint, insert the legs into the holes while pressing the stop-catch.



***Always drive with the head restraints installed when seats are being used and make sure they are properly installed:***

*Driving with the head restraints not installed is dangerous. With no support behind your head, your neck could be seriously injured in a collision.*



## Seat Belt Precautions

Seat belts help to decrease the possibility of severe injury during accidents and sudden stops. Mazda recommends that the driver and all passengers always wear seat belts.

### (U.S.A. and Canada)

All of the seat belt retractors are designed to keep the lap/shoulder belts out of the way when not in use.

The driver's seat belt has no provisions for child-restraint systems and has only an emergency locking mode. The driver may wear it comfortably, and it will lock during a collision.

However, the front passenger's seat and all rear lap/shoulder belt retractors operate in two modes: emergency locking mode, and for child-restraint systems, automatic locking mode. While we recommend you put all children in the rear seats, if you must use the front passenger seat for a child, slide the front passenger seat as far back as possible and make sure any child-restraint system is secured properly.

### (Mexico)

The front seats and rear outboard seats have lap/shoulder belts. These belts have retractors with inertia locks that keep them out of the way when not in use. The locks allow the belts to remain comfortable on users, but they will lock in position during a collision.

The rear center seat has a lap belt with manual adjustment.

## **WARNING**

### **Always wear your seat belt and make sure all occupants are properly restrained:**

*Not wearing a seat belt is extremely dangerous. During a collision, occupants not wearing seat belts could hit someone or things inside the vehicle or even be thrown out of the vehicle. They could be seriously injured or even killed. In the same collision, occupants wearing seat belts would be much safer.*

### **Do not wear twisted seat belts:**

*Twisted seat belts are dangerous. In a collision, the full width of the belt is not available to absorb the impact. This puts more force on the bones beneath the belt, which could cause serious injury or death. So, if your seat belt is twisted, you must straighten the seat belt to remove any twists and to allow the full width of the belt to be used.*

### **Never use one seat belt on more than one person at a time:**

*Using one seat belt for more than one person at a time is dangerous. A seat belt used in this way cannot spread the impact forces properly and the two passengers could be crushed together and seriously injured or even killed. Never use one belt for more than one person at a time and always operate the vehicle with each occupant properly restrained.*

## Seat Belt Systems

---

### **Do not operate a vehicle with a damaged seat belt:**

*Using a damaged seat belt is dangerous. An accident could damage the belt webbing of the seat belt in use. A damaged seat belt cannot provide adequate protection in a collision. Have an Authorized Mazda Dealer inspect all seat belt systems in use during an accident before they are used again.*

### **Have your seat belts changed immediately if the pretensioner or load limiter has been expended:**

*Always have an Authorized Mazda Dealer immediately inspect the front seat belt pretensioners and air bags after any collision. Like the air bags, the front seat belt pretensioners and load limiters will only function once and must be replaced after any collision that caused them to deploy. A seat belt with an expended pretensioner or load limiter is still better than wearing no seat belt at all; however, if the front seat belt pretensioners and load limiters are not replaced, the risk of injury in a collision will increase.*

### **Positioning the Shoulder Portion of the Seat Belt:**

*Improper positioning of the shoulder portion of the seat belt is dangerous. Always make sure the shoulder portion of the seat belt is positioned across your shoulder and near your neck, but never under your arm, on your neck, or on your upper arm.*

### **Positioning the Lap Portion of the Seat Belt:**

*The lap portion of the seat belt worn too high is dangerous. In a collision, this would concentrate the impact force directly on the abdominal area, causing serious injury. Wear the lap portion of the belt snugly and as low as possible.*



*Belt retraction may become difficult if the belts and rings are soiled, so try to keep them clean. For more details about cleaning the seat belts, refer to "Cleaning the Lap/Shoulder Belt Webbing" (page 6-72).*

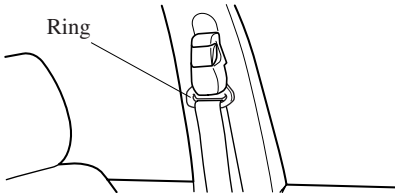

### ▼ Pregnant Women and Persons with Serious Medical Conditions

Pregnant women should always wear seat belts. Ask your doctor for specific recommendations.

The lap belt should be worn **SNUGLY AND AS LOW AS POSSIBLE OVER THE HIPS**.

The shoulder belt should be worn across your shoulder properly, but never across the stomach area.

Persons with serious medical conditions also should wear seat belts. Check with your doctor for any special instructions regarding specific medical conditions.



### ▼ Emergency Locking Mode

When the seat belt is fastened, it will always be in the emergency locking mode.

In the emergency locking mode, the belt remains comfortable on the occupant and the retractor will lock in position during a collision.

If the belt is locked and cannot be pulled out, retract the belt once, and then try pulling it out slowly. If this fails, pull the belt strongly one time and loosen, then pull it out again slowly.

### (Seat Belt with Automatic Locking Mode)

When the seat belt is fastened, it will always be in the emergency locking mode until it is switched to automatic locking mode by pulling it all the way out to its full length. If the belt feels tight and hinders comfortable movement while the vehicle is stopped or in motion, it may be in the automatic locking mode because the belt has been pulled too far out. To return the belt to the more comfortable emergency locking mode, wait until the vehicle has stopped in a safe, level area, retract the belt fully to convert it back to emergency locking mode and then extend it around you again.

### ▼ Automatic Locking Mode\*

Always use the automatic locking mode to keep the child-restraint system from shifting to an unsafe position in the event of an accident. To enable seat belt automatic locking mode, pull it all the way out and connect it as instructed on the child-restraint system. It will retract down to the child-restraint system and stay locked on it. See the section on child restraint (page 2-23).

# Seat Belt Systems

## 3-Point Type Seat Belt

### ▼ Fastening the Seat Belt

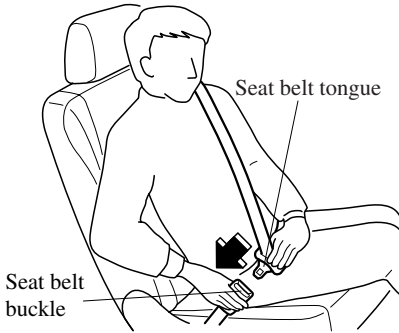

Position the lap belt as low as possible, not on the abdominal area, then adjust the shoulder belt so that it fits snugly against your body.

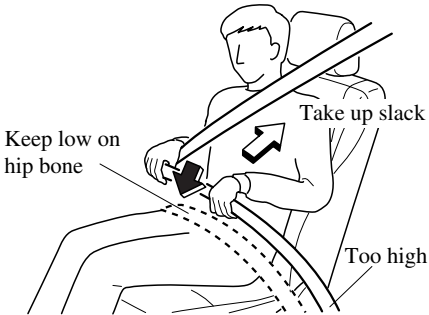

### ▼ Unfastening the Seat Belt

Depress the button on the seat belt buckle. If the belt does not fully retract, pull it out and check for kinks or twists. Then make sure it remains untwisted as it retracts.

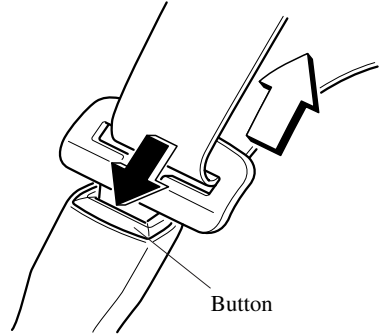

### NOTE

*If a belt does not fully retract, inspect it for kinks and twists. If it is still not retracting properly, have it inspected at an Authorized Mazda Dealer.*

### ▼ Front Shoulder Belt Adjuster

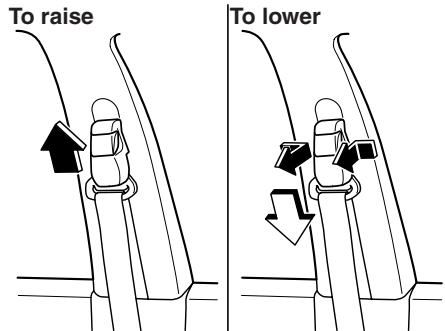

Make sure the adjuster is locked.

## Seat Belt Warning Systems

If it detects that the driver's seat belt is unfastened, the warning light or beep alerts the driver.

Refer to Warning/Indicator Lights on page 4-20.

## Front Seat Belt Pretensioner and Load Limiting Systems

For optimum protection, the driver and front passenger seat belts are equipped with pretensioner and load limiting systems. For both these systems to work properly you must wear the seat belt properly.

### **Pretensioners:**

When a collision is detected, the pretensioners deploy simultaneously with the air bags.

For vehicles with the front passenger occupant classification system, the pretensioners deploy simultaneously with the air bags when a roll-over is also detected.

For deployment details, refer to the SRS Air Bag Deployment Criteria (page 2-54). The front seat belt retractors remove slack quickly as the air bags are expanding. Any time the air bags and seat belt pretensioners have fired they must be replaced.

A system malfunction or operation conditions are indicated by a warning. Refer to Warning/Indicator Lights on page 4-20.

Refer to Air Bag/Front Seat Belt Pretensioner System Warning Beep on page 7-35.

## Seat Belt Systems

---

### (With Front Passenger Occupant Classification System)

In addition, the pretensioner system for the front passenger, like the front and side passenger air bag, is designed to only deploy in accordance with the total seated weight on the front passenger seat. For details, refer to the front passenger seat weight sensors (page 2-57).

### **Load limiter:**

The load limiting system releases belt webbing in a controlled manner to reduce belt force on the occupant's chest. While the most severe load on a seat belt occurs in frontal collisions, the load limiter has an automatic mechanical function and can activate in any accident mode with sufficient occupant movement. Even if the pretensioners have not fired, the load limiting function must be checked by an Authorized Mazda Dealer.



### ***Wear seat belts only as recommended in this owner's manual:***

*Incorrect positioning of the driver and front passenger seat belts is dangerous. Without proper positioning, the pretensioner and load limiting systems cannot provide adequate protection in an accident and this could result in serious injury. For more details about wearing seat belts, refer to "Fastening the seat belts" (page 2-16).*

### ***Have your seat belts changed immediately if the pretensioner or load limiter has been expended:***

*Always have an Authorized Mazda Dealer immediately inspect the front seat belt pretensioners and air bags after any collision. Like the air bags, the front seat belt pretensioners and load limiters will only function once and must be replaced after any collision that caused them to deploy. A seat belt with an expended pretensioner or load limiter is still better than wearing no seat belt at all; however, if the front seat belt pretensioners and load limiters are not replaced, the risk of injury in a collision will increase.*

### ***Do not modify the components or wiring, or use electronic testing devices on the pretensioner system:***

*Modifying the components or wiring of the pretensioner system, including the use of electronic testing devices is dangerous. You could accidentally activate it or make it inoperable which would prevent it from activating in an accident. The occupants or repairers could be seriously injured.*

### ***Properly dispose of the pretensioner system:***

*Improper disposal of the pretensioner system or a vehicle with non-deactivated pretensioners is dangerous. Unless all safety procedures are followed, injury could result. Have an Authorized Mazda Dealer safely dispose of the pretensioner system or scrap a pretensioner system equipped vehicle.*

**NOTE**

- **(With Front Passenger Occupant Classification System)**

*The pretensioner system will not activate in rear impacts.*

- **(Without Front Passenger Occupant Classification System)**

*The pretensioner system will not activate in most roll-overs and rear impacts.*

- *Some smoke (non-toxic gas) will be released when the air bags and pretensioners deploy. This does not indicate a fire. This gas normally has no effect on occupants, however, those with sensitive skin may experience light skin irritation. If residue from the deployment of the air bags or the front pretensioner system gets on the skin or in the eyes, wash it off as soon as possible.*

## Center-Rear Position 2-Point Type Seat Belt\*

### ▼ Fastening the Seat Belt

1. Pull the seat belt tongue to the desired length.
2. Insert it into the seat belt buckle until you hear a click sound.

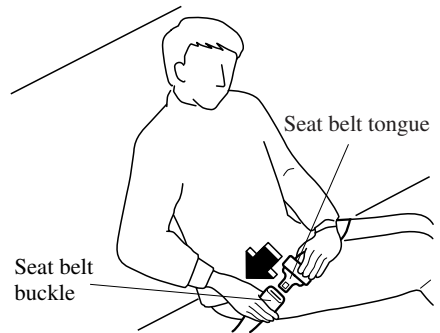

## Seat Belt Systems

3. Adjust the belt length.

To lengthen the belt, hold the seat belt tongue at a right angle to the webbing and pull. To shorten, pull the loose end of the webbing.

### Lengthen

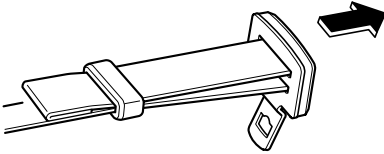

### Shorten

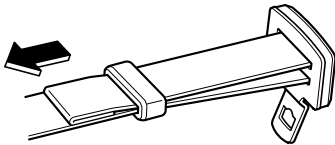

4. Make sure the lap belt is snugly fitted against your body.

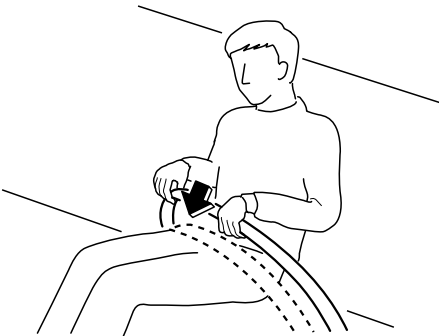

## **⚠ WARNING**

### **Wearing the Lap Belt:**

*A lap belt worn too high is dangerous. In a collision, this would concentrate the impact force directly on the abdominal area, causing serious injury. Wear the lap belt snugly and as low as possible.*

### **▼ Unfastening the Seat Belt**

Depress the button on the seat belt buckle.

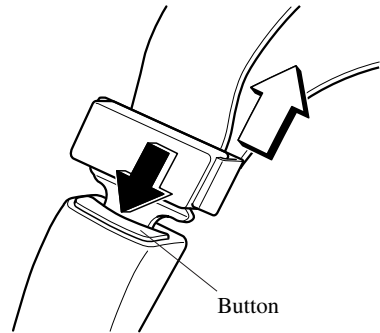



## Seat Belt Extender

If your seat belt is not long enough, even when fully extended, a seat belt extender may be available to you at no charge from your Authorized Mazda Dealer.

This extender will be only for you and for the particular vehicle and seat. Even if it plugs into other seat belts, it may not hold in the critical moment of a crash.

When ordering an extender, only order one that provides the necessary additional length to fasten the seat belt properly.

Please contact your Authorized Mazda Dealer for more information.

### **WARNING**

**Do not use a seat belt extender unless it is necessary:**

*Using a seat belt extender when not necessary is dangerous. The seat belt will be too long and not fit properly. In an accident, the seat belt will not provide adequate protection and you could be seriously injured. Only use the extender when it is required to fasten the seat belt properly.*

**Do not use an improper extender:**

*Using a seat belt extender that is for another person or a different vehicle or seat is dangerous. The seat belt will not provide adequate protection and the user could be seriously injured in an accident. Only use the extender provided for you and for the particular vehicle and seat. NEVER use the extender in a different vehicle or seat. If you sell your Mazda, do not leave your seat belt extender in the vehicle. It could be used accidentally by the new owner of the vehicle. After removing the seat belt extender, discard it. Never use the seat belt extender in any other vehicle you may own in the future.*

**Do not use an extender that is too long:**

*Using an extender that is too long is dangerous. The seat belt will not fit properly. In an accident, the seat belt will not provide adequate protection and you could be seriously injured. Do not use the extender or choose one shorter in length if the distance between the extender's buckle and the center of the user's body is less than 15 cm (6 in).*

## Seat Belt Systems

---

**Do not leave a seat belt extender connected to the buckle:**

*Leaving a seat belt extender connected to the buckle without using the seat belt is dangerous. When the seat belt extender is connected to the driver's seat belt buckle (or front passenger's) seat, the SRS driver's (or front passenger's) air bag system will determine that the driver (or front passenger) is wearing the seat belt even if the driver (or front passenger) is not wearing it. This condition could cause the driver's (or front passenger's) air bag to not activate correctly and result in death or serious injury in the event of collision. Always wear the seat belt with the seat belt extender.*

**Do not use the seat belt extender when installing a child-restraint system on the front or rear passenger seat:**

*Using a seat belt extender to fasten a child-restraint system on any seat is dangerous. Always follow the child-restraint system manufacturer's installation instructions and never use a seat belt extender.*

**NOTE**

*When not in use, remove the seat belt extender and store it in the vehicle. If the seat belt extender is left connected, the seat belt extender might get damaged as it will not retract with the rest of the seat belt and can easily fall out of the door when not in use and be damaged. In addition, the seat belt warning light will not illuminate and function properly.*

## Child-Restraint Precautions

Mazda strongly urges the use of child-restraint systems for children small enough to use them.

You are required by law to use a child-restraint system for children in the U.S. and Canada. Check your local and state or provincial laws for specific requirements regarding the safety of children riding in your vehicle.

Whatever child-restraint system you consider, please pick the appropriate one for the age and size of the child, obey the law and follow the instructions that come with the individual child-restraint system.

A child who has outgrown child-restraint systems should sit in the rear and use seat belts, both lap and shoulder. If the shoulder belt crosses the neck or face, move the child closer to the center of the vehicle in the outboard seats, and towards the buckle on the right if the child is seated on the center seat.

Statistics confirm that the rear seat is the best place for all children up to 12 years of age, and more so with a supplemental restraint system (air bags).

A rear-facing child-restraint system should **NEVER** be used on the front seat with the air bag system activated. The front passenger's seat is also the least preferred seat for other child-restraint systems.

### **(With Front Passenger Occupant Classification System)**

To reduce the chance of injuries caused by deployment of the front passenger air bag, the front passenger seat weight sensors work as a part of the supplemental restraint system. This system deactivates the front passenger front and side air bags and also the front passenger seat belt pretensioner system when the front passenger air bag deactivation indicator light illuminates.

When an infant or small child sits on the front passenger seat, the system shuts off the front passenger front and side air bags and seat belt pretensioner system, so make sure the front passenger air bag deactivation indicator light illuminates.

Even if the front passenger air bag is shut off, Mazda strongly recommends that children be properly restrained and child-restraint systems of all kinds are properly secured on the rear seats which are the best place for children.

For more details, refer to "Front passenger seat weight sensors" (page 2-57).

# Child-Restraint

---

## **! WARNING**

### **Use the correct size child-restraint system:**

*For effective protection in vehicle accidents and sudden stops, a child must be properly restrained using a seat belt or child-restraint system depending on age and size. If not, the child could be seriously injured or even killed in an accident.*

### **Follow the manufacturer's instructions and always keep the child-restraint system buckled down:**

*An unsecured child-restraint system is dangerous. In a sudden stop or a collision it could move causing serious injury or death to the child or other occupants. Make sure any child-restraint system is properly secured in place according to the child-restraint system manufacturer's instructions. When not in use, remove it from the vehicle or fasten it with a seat belt, or latch it down to BOTH LATCH lower anchors for LATCH child-restraint systems and the corresponding tether anchor.*

### **Always secure a child in a proper child-restraint system:**

*Holding a child in your arms while the vehicle is moving is extremely dangerous. No matter how strong the person may be, he or she cannot hold onto a child in a sudden stop or collision and it could result in serious injury or death to the child or other occupants. Even in a moderate accident, the child may be exposed to air bag forces that could result in serious injury or death to the child, or the child may be slammed into an adult, causing injury to both child and adult.*

### **Never use a rear-facing child-restraint system in the front seat with an air bag that could deploy:**

*Rear-facing child-restraint systems on the front seat are particularly dangerous even though you may feel assured that a front passenger air bag will not deploy based on the fact that the front passenger air bag deactivation indicator light illuminates. The child-restraint system can be hit by a deploying air bag and moved violently backward resulting in serious injury or death to the child.*

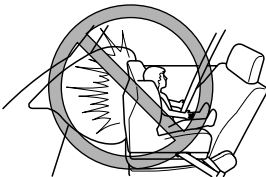

**(U.S.A. and Canada)**

Vehicles with a front passenger air bag have a warning label attached as shown below. The warning label reminds you not to put a rear-facing child-restraint system on the front passenger seat at any time.



**(Mexico)**

NEVER use a rearward facing child restraint on a seat protected by an ACTIVE AIRBAG in front of it, DEATH or SERIOUS INJURY to the CHILD can occur. Vehicles with a front passenger air bag have a warning label attached as shown below. The warning label reminds you not to put a rear-facing child-restraint system on the front passenger seat at any time.



**Do not install a front-facing child-restraint system on the front passenger seat unless it is unavoidable:**

In a collision, the force of a deploying air bag could cause serious injury or death to the child. If installing a front-facing child-restraint system on the front passenger seat is unavoidable, move the front passenger seat as far back as possible.



## Child-Restraint

---

### **Seating a child in a child-restraint system on the front passenger seat is dangerous under certain conditions (With Front Passenger Occupant Classification System):**

Your vehicle is equipped with front passenger seat weight sensors. Even with the front passenger seat weight sensors, if you must use the front passenger seat to seat a child, using a child-restraint system on the front passenger seat under the following conditions increases the danger of the front passenger air bag deploying and could result in serious injury or death to the child.

- The front passenger air bag deactivation indicator light does not illuminate when seating a child in the child-restraint system.
- Luggage or other items are placed on the seat with the child in the child-restraint system.
- A rear passenger or luggage pushing or pulling down on the front passenger seatback.
- A rear passenger puts their feet on the front seat rails.
- Luggage or other items are placed on the seatback or hung on the head restraint.
- Heavy items are placed in the seatback map pocket.
- The seat is washed.
- Liquids are spilled on the seat.
- The front passenger seat is moved backward, pushing into luggage or other items placed behind it.
- The front passenger seatback contacts the rear seat.
- Luggage or other items are placed between the front passenger seat and driver seat.
- Any accessories, which might increase the total seated weight on the front passenger seat, are attached to the front passenger seat.

The designated positions with seat belts on the rear seats are the safest places for children. Always use seat belts and child restraints.

### **Do not allow a child or anyone to lean over or against the side window of a vehicle with side and curtain air bags:**

It is dangerous to allow anyone to lean over or against the side window, the area of the front passenger seat, the front and rear window pillars and the roof edge along both sides from which the side and curtain air bags deploy, even if a child-restraint system is used. The impact of inflation from a side or curtain air bag could cause serious injury or death to an out of position child. Furthermore, leaning over or against the front door could block the side and curtain air bags and eliminate the advantages of supplemental protection. With the front air bag and the additional side air bag that comes out of the front seat, the rear seat is always a better location for children. Take special care not to allow a child to lean over or against the side window, even if the child is seated in a child-restraint system.

**Never use one seat belt on more than one person at a time:**

*Using one seat belt for more than one person at a time is dangerous. A seat belt used in this way cannot spread the impact forces properly and the two passengers could be crushed together and seriously injured or even killed. Never use one belt for more than one person at a time and always operate the vehicle with each occupant properly restrained.*



*A seat belt or child-restraint system can become very hot in a closed vehicle during warm weather. To avoid burning yourself or a child, check them before you or your child touches them.*

**NOTE**

*Your Mazda is equipped with LATCH lower anchors for attachment of specially designed LATCH child-restraint systems in the rear seats. When using these anchors to secure a child-restraint system, refer to "Using LATCH Lower Anchor" (page 2-37).*

# Child-Restraint

## Child-Restraint System Installation

### ▼ Child-Restraint System Types

In this owner's manual, explanation of child-restraint systems is provided for the following three types of popular child-restraint systems: infant seat, child seat, booster seat.

#### **NOTE**

- *Installation position is determined by the type of child-restraint system. Always read the manufacturer's instructions and this owner's manual carefully.*
- *Due to variations in the design of child-restraint systems, vehicle seats and seat belts, all child-restraint systems may not fit all seating positions. Before purchasing a child-restraint system, it should be tested in the specific vehicle seating position (or positions) where it is intended to be used. If a previously purchased child-restraint system does not fit, you may need to purchase a different one that will.*

#### **Infant seat**

An infant seat provides restraint by bracing the infant's head, neck and back against the seating surface.

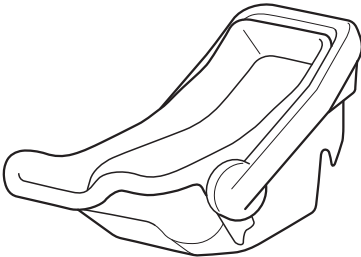

#### **Child seat**

A child seat restrains a child's body using the harness.



#### **Booster seat**

A booster seat is a child restraint accessory designed to improve the fit of the seat belt system around the child's body.





## Installing Child-Restraint Systems

Accident statistics reveal that a child is safer in the rear seat. The front passenger's seat is clearly the worst choice for any child under 12, and with rear-facing child-restraint systems it is clearly unsafe due to air bags.

### **NOTE**

*Even if your vehicle is equipped with front passenger seat weight sensors (page 2-57), which automatically deactivates the front passenger air bag, a rear seat is the safest place for a child of any age or size.*

Some child-restraint systems now come with tethers and therefore must be installed on the seats that take tethers to be effective. In your Mazda, tethered child-restraint systems can only be accommodated in the three positions on the rear seat.

Some child-restraint systems also employ specially designed LATCH attachments; refer to "Using LATCH Lower Anchor" (page 2-37).

## **WARNING**

### **Tethered Child-Restraint Systems Work Only on Tether-Equipped Rear Seats:**

*Installation of a tether equipped child-restraint system in the front passenger's seat defeats the safety design of the system and will result in an increased chance of serious injury if the child-restraint system goes forward without benefit of being tethered. Place tether equipped child-restraint systems where there are tether anchors.*

# Child-Restraint

## ▼ Anchor Bracket

Anchor brackets for securing child-restraint systems are equipped in the vehicle. Locate each anchor position using the illustration.

To install a child-restraint system, always follow the instruction manual accompanying the child-restraint system.

### Anchor bracket location

Use the indicated anchor bracket locations when installing a child-restraint system equipped with a tether.

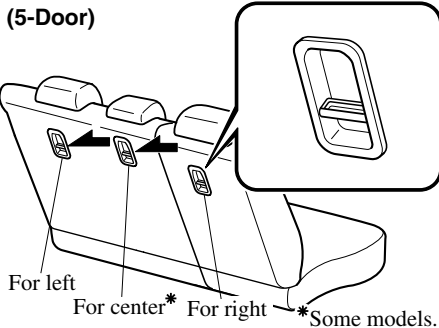
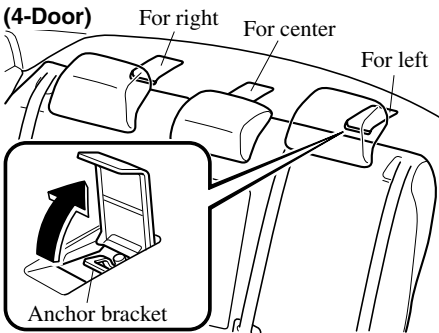

## ⚠ WARNING

**Always attach the tether strap to the correct tether anchor position:**

*Attaching the tether strap to the incorrect tether anchor position is dangerous. In a collision, the tether strap could come off and loosen the child-restraint system. If the child-restraint system moves it could result in death or injury to the child.*

**Always route the tether strap between the head restraint and the seatback:**

*Routing the tether strap on top of the head restraint is dangerous. In a collision the tether strap could slide off the head restraint and loosen the child-restraint system. The child-restraint system could move which may result in death or injury to the child.*

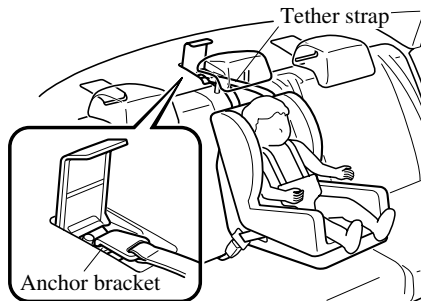
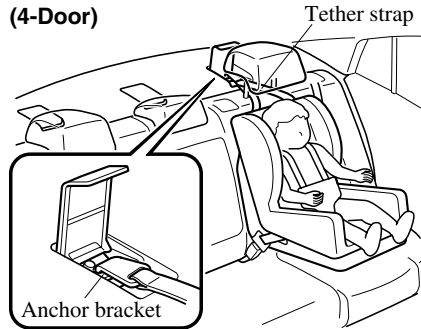

**(5-Door)**

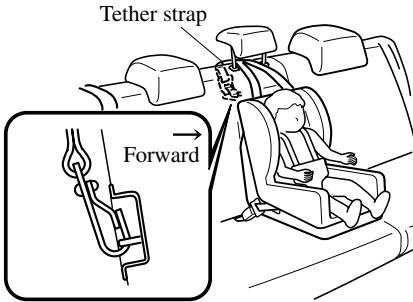
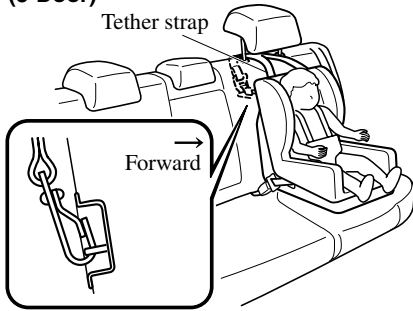

1. Make sure the seatback is securely latched by pushing it back until it is fully locked.
2. Raise the head restraint to the top locked position.  
Refer to Head Restraints on page 2-11.
3. Secure the child-restraint system with the lap portion of the lap/shoulder belt. See the manufacturer's instructions on the child-restraint system for belt routing instructions.
4. To get the retractor into the automatic locking mode, pull the shoulder belt portion of the seat belt until the entire length of the belt is out of the retractor.

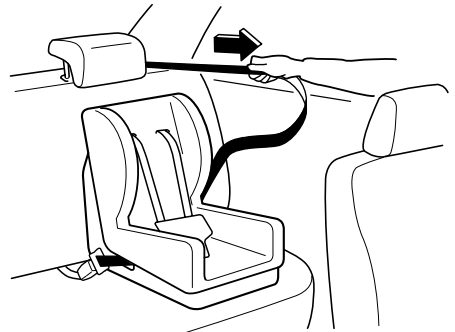

**▼ Using Automatic Locking Mode\***

Follow these instructions when using a child-restraint system, unless you are attaching a LATCH-equipped child-restraint system to the rear LATCH lower anchors. Refer to “Using LATCH Lower Anchor” (page 2-37).

**NOTE**

*Follow the child-restraint system manufacturer's instructions carefully. If you are not sure whether you have a LATCH system or tether, check in the child-restraint system manufacturer's instructions and follow them accordingly. Depending on the type of child-restraint system, it may use LATCH system instead of seat belts or if the belt goes across the child's chest, may recommend against using automatic locking mode.*

\*Some models.

# Child-Restraint

5. Push the child-restraint system firmly into the vehicle seat. Be sure the belt retracts as snugly as possible. A clicking noise from the retractor will be heard during retraction if the system is in the automatic locking mode. If the belt does not lock the seat down tight, repeat this step.



## NOTE

Inspect this function before each use of the child-restraint system. You should not be able to pull the shoulder belt out of the retractor while the system is in the automatic locking mode. When you remove the child-restraint system, be sure the belt fully retracts to return the system to emergency locking mode before occupants use the seat belts.

6. If your child-restraint system requires the use of a tether strap, refer to the manufacturer's instructions to hook and tighten the tether strap.

## ⚠ WARNING

**Use the tether and tether anchor only for a child-restraint system:**

Using the tether or tether anchor to secure anything but a child-restraint system is dangerous. This could weaken or damage the tether or tether anchor and result in injury.

**Always route the tether strap between the head restraint and the seatback:**

Routing the tether strap on top of the head restraint is dangerous. In a collision the tether strap could slide off the head restraint and loosen the child-restraint system. The child-restraint system could move which may result in death or injury to the child.

(4-Door)

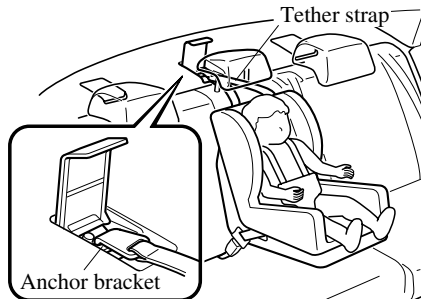
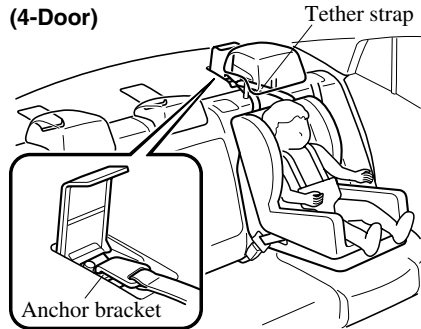

(5-Door)

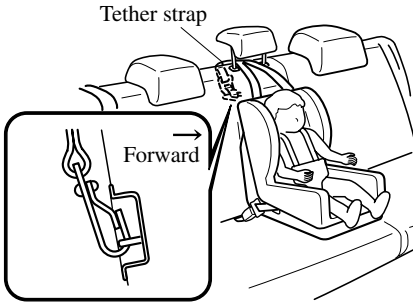
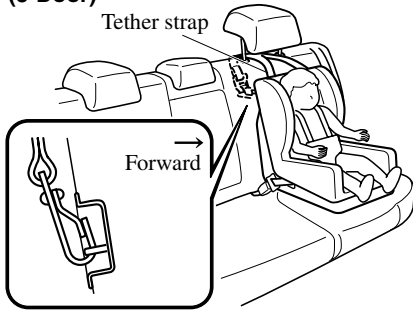

**Always attach the tether strap to the correct tether anchor position:**

Attaching the tether strap to the incorrect tether anchor position is dangerous. In a collision, the tether strap could come off and loosen the child-restraint system. If the child-restraint system moves it could result in death or injury to the child.

**▼ If You Must Use the Front Seat for Children**

If you cannot put all children in the rear seat, at least put the smallest children in the rear and be sure the largest child up front uses the shoulder belt over the shoulder.

NEVER put a rear-facing child-restraint system on the front passenger seat whether your vehicle is equipped with a seat weight sensor or not.

This seat is also not set up for tethered child-restraint systems, put them in one of the rear seat positions set up with tether anchors.

Likewise the LATCH child-restraint system cannot be secured in the front passenger's seat and should be used in the rear seat.

Do not allow anyone to sleep against the side window since your vehicle has side and curtain air bags, it could cause serious injuries to an out of position occupant.

As children more often sleep in cars, it is better to put them in the rear seat. If installing the child-restraint system on the front seat is unavoidable, follow these instructions when using a front-facing child-restraint system in the front passenger's seat.

**NOTE**

- To check if your front seats have side air bags:  
Mazda vehicles equipped with side air bag will have a "SRS AIRBAG" tag on the outboard shoulder of the front seats.
- To check if your vehicle has curtain air bags:  
Mazda vehicles equipped with curtain air bag will have an "SRS AIRBAG" marking on the window pillars along the roof edge.

## Child-Restraint

---

### **WARNING**

**Always move the front passenger seat as far back as possible if installing a front-facing child-restraint system on it is unavoidable:**

*As your vehicle has front air bags and doubly so because your vehicle has side air bags, a front-facing child-restraint system should be put on the front passenger seat only when it is unavoidable.*

*Even if the front passenger air bag deactivation indicator light illuminates, always move the seat as far back as possible, because the force of a deploying air bag could cause serious injury or death to the child.*

**Never use a rear-facing child-restraint system in the front seat with an air bag that could deploy:**

*Rear-facing child-restraint systems on the front seat are particularly dangerous.*

*Even in a moderate collision, the child-restraint system can be hit by a deploying air bag and moved violently backward resulting in serious injury or death to the child.*

*Even though you may feel assured that the front passenger air bag will not deploy based on the fact that the front passenger air bag deactivation indicator light illuminates, you should not use a rear-facing child-restraint system in the front seat.*

**Do not allow a child or anyone to lean over or against the side window of a vehicle with side and curtain air bags:**

*It is dangerous to allow anyone to lean over or against the side window, the area of the front passenger seat, the front and rear window pillars and the roof edge along both sides from which the side and curtain air bags deploy, even if a child-restraint system is used. The impact of inflation from a side or curtain air bag could cause serious injury or death to an out of position child. Furthermore, leaning over or against the front door could block the side and curtain air bags and eliminate the advantages of supplemental protection. With the front air bag and the additional side air bag that comes out of the front seat, the rear seat is always a better location for children. Take special care not to allow a child to lean over or against the side window, even if the child is seated in a child-restraint system.*

**Front Passenger's Seat Child-Restraint System Installation (With Front Passenger Occupant Classification System)**

1. Switch the ignition ON.
2. Slide the seat as far back as possible.

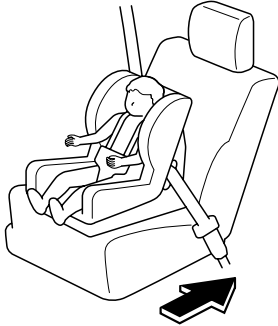

3. Place the child-restraint system on the seat without putting your weight on the seat and fasten the seat belt. See the manufacturer's instructions on the child-restraint system for belt routing instructions.
4. To get the retractor into the automatic locking mode, pull the shoulder belt portion of the seat belt until the entire length of the belt is out of the retractor.
5. Push the child-restraint system firmly into the vehicle seat. Be sure the belt retracts as snugly as possible. A clicking noise from the retractor will be heard during retraction if the system is in automatic locking mode. If the belt does not lock the seat down tight, repeat the previous step and also this one.

**NOTE**

- *Inspect this function before each use of the child-restraint system. You should not be able to pull the shoulder belt out of the retractor while the system is in the automatic locking mode. When you remove the child-restraint system, be sure the belt fully retracts to return the system to emergency locking mode before occupants use the seat belts.*
  - *Follow the child-restraint system manufacturer's instructions carefully. Depending on the type of child-restraint system, it may not employ seat belts which are in automatic locking mode.*
6. Seat your child safely in the child-restraint system and secure the child according to the instructions from the child-restraint system manufacturer.
  7. Make sure the front passenger air bag deactivation indicator light illuminates after installing a child-restraint system on the front passenger seat. If the front passenger air bag deactivation indicator light does not illuminate, remove the child-restraint system, switch the ignition to OFF, and then re-install the child-restraint system (page 2-57).

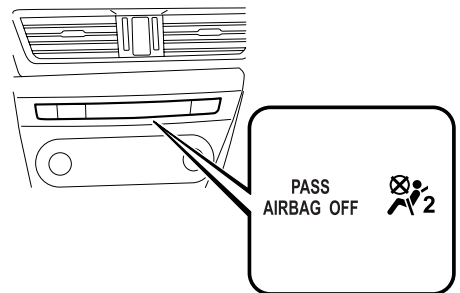

## Child-Restraint

---

### **WARNING**

**Do not seat a child in a child-restraint system on the front passenger seat if the front passenger air bag deactivation indicator light does not illuminate:**

*While it is always better to install any child-restraint system on the rear seat, it is imperative that a child-restraint system **ONLY** be used on the front passenger seat if the deactivation indicator light illuminates when the child is seated in the child-restraint system (page 2-57). Seating a child in a child-restraint system installed on the front passenger seat with the front passenger air bag deactivation indicator light not illuminated is dangerous. If this indicator light does not illuminate, this means that the front passenger front and side air bags, and seat belt pretensioner are ready for deployment. If an accident were to deploy an air bag, a child in a child-restraint system sitting in the front passenger seat could be seriously injured or killed. If the indicator light does not illuminate after seating a child in a child-restraint system on the front passenger seat, seat a child in a child-restraint system on the rear seat and consult an Authorized Mazda Dealer as soon as possible.*



## ▼ Using LATCH Lower Anchor

Your Mazda is equipped with LATCH lower anchors for attachment of specially designed LATCH child-restraint systems in the rear seats. Both anchors must be used, otherwise the seat will bounce around and put the child in danger. Most LATCH child-restraint systems must also be used in conjunction with a tether to be effective. If they have a tether you must use it to better assure your child's safety.

### **WARNING**

#### **Follow the manufacturer's instructions for the use of the child-restraint system:**

*An unsecured child-restraint system is dangerous. In a sudden stop or a collision it could move causing serious injury or death to the child or other occupants. Make sure the child-restraint system is properly secured in place according to the child-restraint system manufacturer's instructions.*

#### **Never attach two child-restraint systems to the same LATCH lower anchor:**

*Attaching two child-restraint systems to the same LATCH lower anchor is dangerous. In a collision, one anchor may not be strong enough to hold two child-restraint system attachments, and it may break, causing serious injury or death. If you use the seat position for another child-restraint system when an outboard LATCH position is occupied, use the center seat belts instead, and the tether if tether-equipped.*

#### **Make sure the child-restraint system is properly secured:**

*An unsecured child-restraint system is dangerous. In a sudden stop or a collision it could move causing serious injury or death to the child or other occupants. Follow the child-restraint system manufacturer's instructions on belt routing to secure the seat just as you would with a child in it so that nobody is tempted to put a child in an improperly secured seat later on. When not in use, remove it from the vehicle or fasten it with a seat belt, or latch it down to BOTH LATCH lower anchors for LATCH child-restraint systems.*

#### **Make sure there are no seat belts or foreign objects near or around the LATCH child-restraint system:**

*Not following the child-restraint system manufacturer's instructions when installing the child-restraint system is dangerous. If seat belts or a foreign object prevent the child-restraint system from being securely attached to the LATCH lower anchors and the child-restraint system is installed improperly, the child-restraint system could move in a sudden stop or collision causing serious injury or death to the child or other occupants. When installing the child-restraint system, make sure there are no seat belts or foreign objects near or around the LATCH lower anchors. Always follow the child-restraint system manufacturer's instructions.*

# Child-Restraint

## Installation on rear outboard seats

1. First, adjust the front seat to allow clearance between the child-restraint system and the front seat (page 2-5).
2. Make sure the seatback is securely latched by pushing it back until it is fully locked.
3. Expand the area between the seat bottom and the seatback slightly to verify the locations of the LATCH lower anchors.

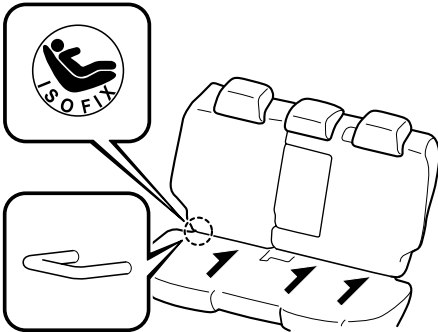

### **NOTE**

*The markings above the LATCH lower anchors indicate the locations of the LATCH lower anchors for the attachment of a child-restraint system.*

4. Raise the head restraint to the top locked position.  
Refer to Head Restraints on page 2-11.
5. Secure the child-restraint system using BOTH LATCH lower anchors, following the child-restraint system manufacturer's instruction. Pull on the child-restraint to be sure both anchors are engaged.

6. If your child-restraint system came equipped with a tether, that means it is very important to properly secure the tether for child safety. Please carefully follow the child-restraint system manufacturer's instructions when installing tethers.

### **WARNING**

**Use the tether and tether anchor only for a child-restraint system:**

*Using the tether or tether anchor to secure anything but a child-restraint system is dangerous. This could weaken or damage the tether or tether anchor and result in injury.*

**Always route the tether strap between the head restraint and the seatback:**

*Routing the tether strap on top of the head restraint is dangerous. In a collision the tether strap could slide off the head restraint and loosen the child-restraint system. The child-restraint system could move which may result in death or injury to the child.*

**(4-Door)**

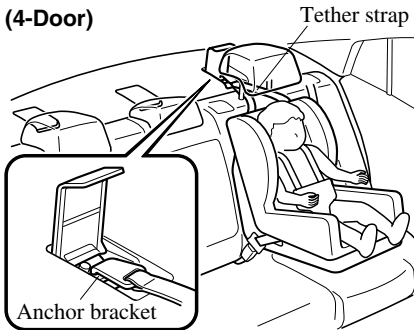

**(5-Door)**

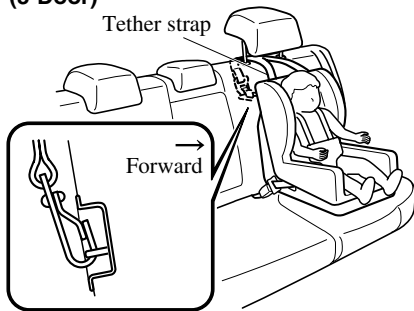

**Always attach the tether strap to the correct tether anchor position:**

*Attaching the tether strap to the incorrect tether anchor position is dangerous. In a collision, the tether strap could come off and loosen the child-restraint system. If the child-restraint system moves it could result in death or injury to the child.*

**Installation on rear center seat**

The LATCH lower anchors at the center of the rear seat are much further apart than the sets of LATCH lower anchors for child-restraint system installation at other seating positions. Child-restraint systems with rigid LATCH attachments cannot be installed on the center seating position. Some LATCH equipped child-restraint systems can be placed in the center position and will reach the nearest LATCH lower anchors which are 443 mm (17.4 in) apart. LATCH compatible child-restraint systems (with attachments on belt webbing) can be used at this seating position only if the child-restraint system manufacturer's instructions state that the child-restraint system can be installed to LATCH lower anchors that are 443 mm (17.4 in) apart. Do not attach two child-restraint systems to the same LATCH lower anchor. If your child-restraint system has a tether, it must also be used for your child's optimum safety.

The procedure for installation on the rear outboards seats is the same.

**LATCH lower anchor location**

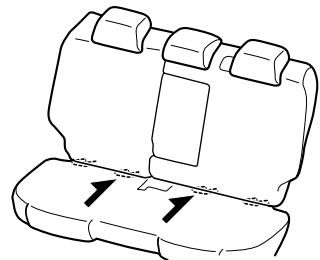

# Child-Restraint

## **! WARNING**

### **Always route the tether strap between the head restraint and the seatback:**

Routing the tether strap on top of the head restraint is dangerous. In a collision the tether strap could slide off the head restraint and loosen the child-restraint system. The child-restraint system could move which may result in death or injury to the child.

#### **(4-Door)**

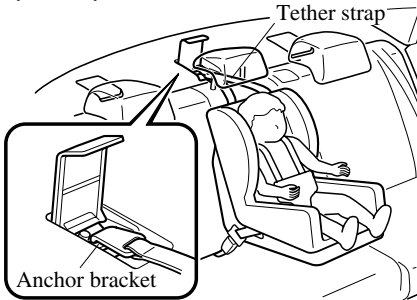

#### **(5-Door)**

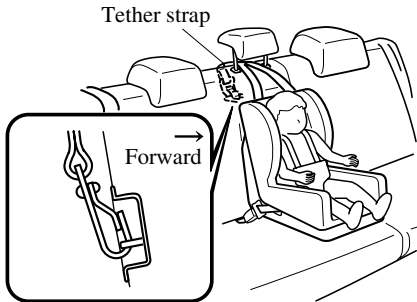

### **Always attach the tether strap to the correct tether anchor position:**

Attaching the tether strap to the incorrect tether anchor position is dangerous. In a collision, the tether strap could come off and loosen the child-restraint system. If the child-restraint system moves it could result in death or injury to the child.

## Supplemental Restraint System (SRS) Precautions

The front and side supplemental restraint systems (SRS) include up to 6 air bags. **Please verify which kinds of air bags are equipped on your vehicle by locating the “SRS AIRBAG” location indicators.** These indicators are visible in the area where the air bags are installed.

The air bags are installed in the following locations:

- The steering wheel hub (driver air bag)
- The front passenger dashboard (front passenger air bag)
- The outboard sides of the front seatbacks (side air bags)\*
- The front and rear window pillars, and the roof edge along both sides (curtain air bags)\*

Vehicles with the Front Passenger Occupant Classification System have a sensor which detects an impending roll-over accident.

The air bag supplemental restraint systems are designed to provide supplemental protection in certain situations so seat belts are always important in the following ways:

Without seat belt usage, the air bags cannot provide adequate protection during an accident. Seat belt usage is necessary to:

- Keep the occupant from being thrown into an inflating air bag.
- Reduce the possibility of injuries during an accident that is not designed for air bag inflation, such as rear impact.
- Reduce the possibility of injuries in frontal, near frontal or side collisions or roll-over accidents that are not severe enough to activate the air bags.
- Reduce the possibility of being thrown from your vehicle.
- Reduce the possibility of injuries to lower body and legs during an accident because the air bags provide no protection to these parts of the body.
- Hold the driver in a position which allows better control of the vehicle.

## SRS Air Bags

---

**If your vehicle is also equipped with a front passenger occupant classification system, refer to the Front Passenger Occupant Classification System (page 2-57) for details.**

If your vehicle is equipped with a front passenger occupant classification system, the front passenger air bag deactivation indicator light illuminates for a specified time after the ignition is switched ON.

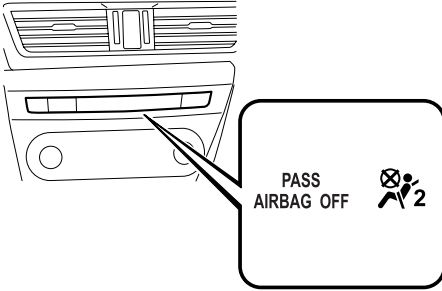

Small children must be protected by a child-restraint system as stipulated by law in every state and province. In certain states and provinces, larger children must use a child-restraint system (page 2-23).

Carefully consider which child-restraint system is necessary for your child and follow the installation directions in this Owner's Manual as well as the child-restraint system manufacturer's instructions.

### **! WARNING**

#### **Seat belts must be worn in air bag equipped vehicles:**

*Depending only on the air bags for protection during an accident is dangerous. Alone, air bags may not prevent serious injuries. The appropriate air bags can be expected to inflate only in the first accident, such as frontal, near frontal or side collisions or roll-over accidents that are at least moderate. Vehicle occupants should always wear seat belts.*

#### **Children should not ride in the front passenger seat:**

*Placing a child, 12 years or under, in the front seat is dangerous. The child could be hit by a deploying air bag and be seriously injured or even killed. A sleeping child is more likely to lean against the door and be hit by the side air bag in moderate collision to the front-passenger side of the vehicle. Whenever possible, always secure a child 12 years and under on the rear seats with an appropriate child-restraint system for the child's age and size.*

**Never use a rear-facing child-restraint system in the front seat with an air bag that could deploy:**

Rear-facing child-restraint systems on the front seat are particularly dangerous even though you may feel assured that a front passenger air bag will not deploy based on the fact that the front passenger air bag deactivation indicator light illuminates. The child-restraint system can be hit by a deploying air bag and moved violently backward resulting in serious injury or death to the child.

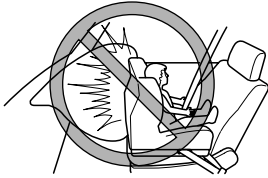

**Do not sit too close to the driver and front passenger air bags:**

Sitting too close to the driver and front passenger air bag modules or placing hands or feet on them is extremely dangerous. The driver and front passenger air bags inflate with great force and speed. Serious injuries could occur if someone is too close. The driver should always hold onto only the rim of the steering wheel. The front seat passenger should keep both feet on the floor. Front seat occupants should adjust their seats as far back as possible and always sit upright against the seatbacks with seat belts worn properly.

**Sit in the center of the seat and wear seat belts properly:**

Sitting too close to the side air bag modules or placing hands on them, or sleeping up against the door or hanging out the windows is extremely dangerous. The side and curtain air bags inflate with great force and speed directly expanding along the door on the side the car is hit. Serious injury could occur if someone is sitting too close to the door or leaning against a window, or if rear seat occupants grab the sides of the front seatbacks. Give the side and curtain air bags room to work by sitting in the center of the seat while the vehicle is moving with seat belts worn properly.

**Do not attach objects on or around the area where driver and front passenger air bags deploy:**

Attaching an object to the driver and front passenger air bag modules or placing something in front of them is dangerous. In an accident, an object could interfere with air bag inflation and injure the occupants.

## SRS Air Bags

---

**Do not attach objects on or around the area where a side air bag deploys:**

*Attaching objects to the front seat in such a way as to cover the outboard side of the seat in any way is dangerous. In an accident the object could interfere with the side air bag, which inflates from the outboard side of the front seats, impeding the added protection of the side air bag system or redirecting the air bag in a way that is dangerous. Furthermore, the bag could be cut open releasing the gas.*

*Do not hang net bags, map pouches or backpacks with side straps on the front seats. Never use seat covers on the front seats. Always keep the side air bag modules in your front seats free to deploy in the event of a side collision.*

**Do not attach objects on or around the area where a curtain air bag deploys:**

*Attaching objects to the areas where the curtain air bag activates such as on the windshield glass, side door glass, front and rear window pillars and along the roof edge and assist grips is dangerous. In an accident the object could interfere with the curtain air bag, which inflates from the front and rear window pillars and along the roof edge, impeding the added protection of the curtain air bag system or redirecting the air bag in a way that is dangerous. Furthermore, the bag could be cut open releasing the gas.*

*Do not place hangers or any other objects on the assist grips. When hanging clothes, hang them on the coat hook directly. Always keep the curtain air bag modules free to deploy in the event of a side collision or roll-over accident.*

**Do not touch the components of the supplemental restraint system after the air bags have inflated:**

*Touching the components of the supplemental restraint system after the air bags have inflated is dangerous. Immediately after inflation, they are very hot. You could get burned.*

**Never install any front-end equipment to your vehicle:**

*Installation of front-end equipment, such as frontal protection bar (kangaroo bar, bull bar, push bar, or other similar devices), snowplow, or winches, is dangerous. The air bag crash sensor system could be affected. This could cause air bags to inflate unexpectedly, or it could prevent the air bags from inflating during an accident. Front occupants could be seriously injured.*

**Do not modify the suspension:**

*Modifying the vehicle suspension is dangerous. If the vehicle's height or the suspension is modified, the vehicle will be unable to accurately detect a collision or roll-over accident resulting in incorrect or unexpected air bag deployment and the possibility of serious injuries.*



**To prevent false detection by the air bag sensor system, heed the following:**

- *Do not use tires or wheels other than those specified for your Mazda:  
Use of any tire or wheel other than those specified for your Mazda (page 9-10) is dangerous. Use of such wheels will prevent the vehicle's accident detections system from accurately detecting a collision or roll-over accident resulting in incorrect or unexpected air bag deployment and the possibility of serious injuries.*
- *Do not overload your vehicle:  
Overloading your vehicle is dangerous as it could prevent the air bag crash sensor system from accurately detecting a collision or roll-over accident resulting in incorrect or unexpected air bag deployment and the possibility of serious injuries. The gross axle weight rating (GAWR) and the gross vehicle weight rating (GVWR) for your vehicle are on the Motor Vehicle Safety Standard Label on the driver's door frame. Do not exceed these ratings.*
- *Do not drive the vehicle off-road:  
Driving your Mazda off-road is dangerous because the vehicle has not been designed to do so. Driving the vehicle off-road could prevent the air bag crash sensor system from accurately detecting a collision or roll-over accident resulting in incorrect or unexpected air bag deployment and the possibility of serious injuries.*

**Do not modify a front door or leave any damage unrepaired. Always have an Authorized Mazda Dealer inspect a damaged front door:**

*Modifying a front door or leaving any damage unrepaired is dangerous. Each front door has a side crash sensor as a component of the supplemental restraint system. If holes are drilled in a front door, a door speaker is left removed, or a damaged door is left unrepaired, the sensor could be adversely affected causing it to not detect the pressure of an impact correctly during a side collision. If a sensor does not detect a side impact correctly, the side and curtain air bags and the front seat belt pretensioner may not operate normally which could result in serious injury to occupants.*

**Do not modify the supplemental restraint system:**

*Modifying the components or wiring of the supplemental restraint system is dangerous. You could accidentally activate it or make it inoperable. Do not make any modifications to the supplemental restraint system. This includes installing trim, badges, or anything else over the air bag modules. It also includes installing extra electrical equipment on or near system components or wiring. An Authorized Mazda Dealer can provide the special care needed in the removal and installation of front seats. It is important to protect the air bag wiring and connections to assure that the bags do not accidentally deploy, the front passenger occupant classification system and that the seats retain an undamaged air bag connection.*

## SRS Air Bags

---

**Do not place luggage or other objects under the front seats:**

*Placing luggage or other objects under the front seats is dangerous. The components essential to the supplemental restraint system could be damaged, and in the event of a side collision, the appropriate air bags may not deploy, which could result in death or serious injury. To prevent damage to the components essential to the supplemental restraint system, do not place luggage or other objects under the front seats.*

**Do not operate a vehicle with damaged air bag/seat belt pretensioner system components:**

*Expended or damaged air bag/seat belt pretensioner system components must be replaced after any collision which caused them to deploy or damage them. Only a trained Authorized Mazda Dealer can fully evaluate these systems to see that they will work in any subsequent accident. Driving with an expended or damaged air bag or pretensioner unit will not afford you the necessary protection in the event of any subsequent accident which could result in serious injury or death.*

**Do not remove interior air bag parts:**

*Removing any components such as the front seats, front dashboard, the steering wheel or parts on the front and rear window pillars and along the roof edge, containing air bag parts or sensors is dangerous. These parts contain essential air bag components. The air bag could accidentally activate and cause serious injuries. Always have an Authorized Mazda Dealer remove these parts.*

**Properly dispose of the air bag system:**

*Improper disposal of an air bag or a vehicle with live air bags in it can be extremely dangerous. Unless all safety procedures are followed, injury could result. Have an Authorized Mazda Dealer safely dispose of the air bag system or scrap an air bag equipped vehicle.*

**NOTE**

- *If it becomes necessary to have the components or wiring system for the supplementary restraint system modified to accommodate a person with certain medical conditions in accordance with a certified physician, contact an Authorized Mazda Dealer, refer to “Customer Assistance (U.S.A.)” (page 8-2).*
- *When an air bag deploys, a loud inflation noise can be heard and some smoke will be released. Neither is likely to cause injury, however, the texture of the air bags may cause light skin injuries on body parts not covered with clothing through friction.*
- *Should you sell your Mazda, we urge you to tell the new owner of its air bag systems and that familiarization with all instructions about them, from the Owner's Manual, is important.*
- *This highly-visible label is displayed which warns against the use of rear-facing child-restraint systems on the front passenger seat.*

*(Except Mexico)*



*(Mexico)*



**Supplemental Restraint System Components**  
**(With Front Passenger Occupant Classification System)**

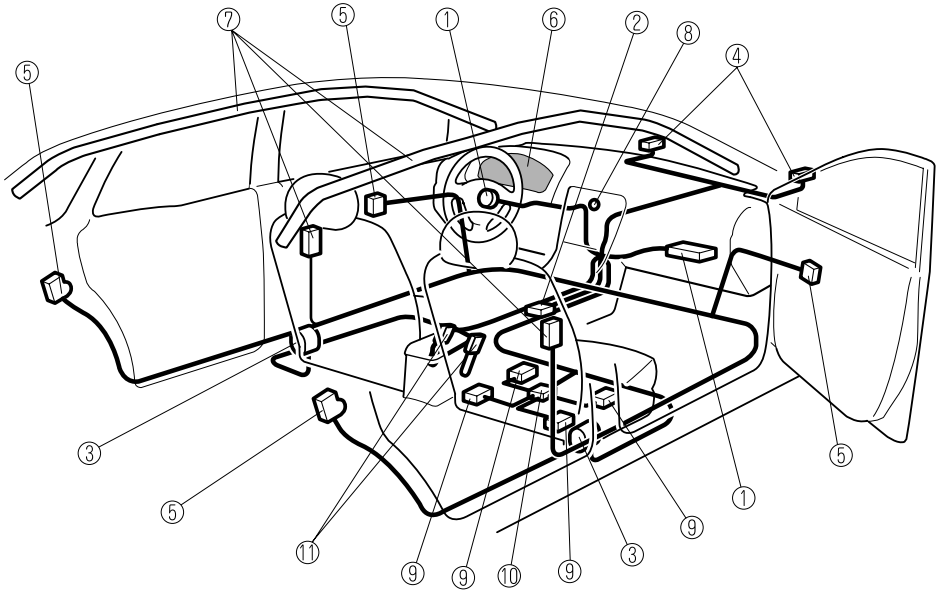

**(Without Front Passenger Occupant Classification System)**

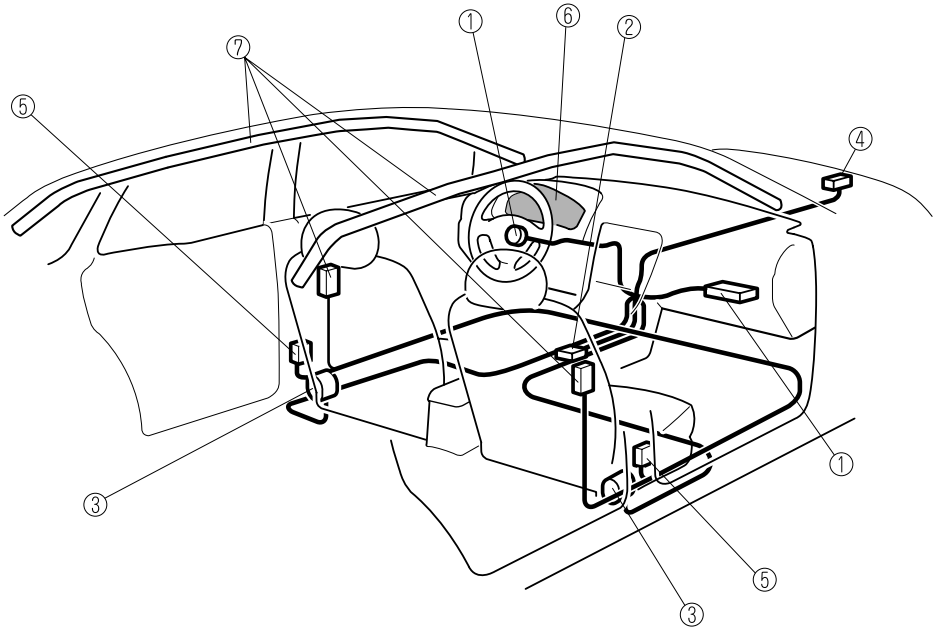

- ① Driver/Front passenger inflators and air bags
- ② Roll-over sensor\*, crash sensors, and diagnostic module (SAS unit)
- ③ Front seat belt pretensioners (page 2-17)
- ④ Front air bag sensors
- ⑤ Side crash sensors\*
- ⑥ Air bag/front seat belt pretensioner system warning light (page 4-20)
- ⑦ Side and curtain inflators and air bags\*
- ⑧ Front passenger air bag deactivation indicator light (page 2-57)
- ⑨ Front passenger seat weight sensors (page 2-57)
- ⑩ Front passenger seat weight sensor control module
- ⑪ Driver and front passenger seat belt buckle switches (page 2-61)

**NOTE**

⑧ -⑪ are equipped only on models with the front passenger occupant classification system.

## How the SRS Air Bags Work

Your Mazda is equipped with the following types of SRS air bags. SRS air bags are designed to work together with the seat belts to help to reduce injuries during an accident. The SRS air bags are designed to provide further protection for passengers in addition to the seat belt functions. Be sure to wear seat belts properly.

### ▼ Front Seat Belt Pretensioners

The front seat belt pretensioners are designed to deploy in moderate or severe frontal, near frontal collisions.

In addition, the pretensioners operate when a side collision (only on the side in which the collision occurs) or a roll-over accident is detected. The pretensioners operate differently depending on what types of air bags are equipped. For details on the seat belt pretensioner operation, refer to the SRS Air Bag Deployment Criteria (page 2-54).

### ▼ Driver Air Bag

The driver's air bag is mounted in the steering wheel.

When air bag crash sensors detect a frontal impact of greater than moderate force, the driver's air bag inflates quickly helping to reduce injury mainly to the driver's head or chest caused by directly hitting the steering wheel.

For more details about air bag deployment, refer to "SRS Air Bag Deployment Criteria" (page 2-54).

### (With Front Passenger Occupant Classification System)

The driver's dual-stage air bag controls air bag inflation in two energy stages. During an impact of moderate severity the driver's air bag deploys with lesser energy, whereas during more severe impacts, it deploys with more energy.

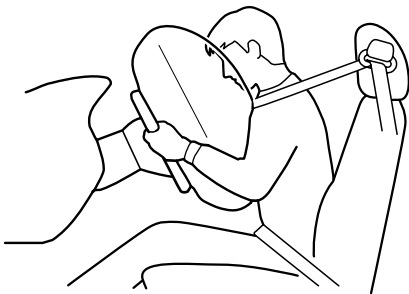

### ▼ Front Passenger Air Bag

The front passenger air bag is mounted in the front passenger dashboard.

The inflation mechanism for the front passenger air bag is the same as the driver's air bag, as mentioned above.

For more details about air bag deployment, refer to "SRS Air Bag Deployment Criteria" (page 2-54).

#### **(With Front Passenger Occupant Classification System)**

In addition, the front passenger air bag is designed to only deploy in accordance with the total seated weight on the front passenger seat. For details, refer to the front passenger occupant classification system (page 2-57).

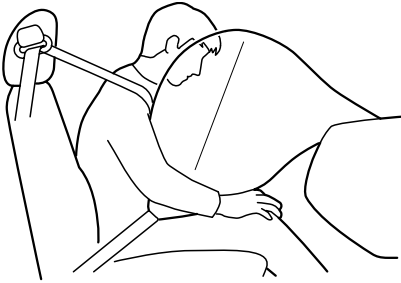

### ▼ Side Air Bags\*

The side air bags are mounted in the outboard sides of the front seatbacks.

When the air bag crash sensors detect a side impact of greater than moderate force, the system inflates the side air bag only on the side in which the vehicle was hit. The side air bag inflates quickly to reduce injury to the driver or front passenger's chest caused by directly hitting interior parts such as a door or window.

For more details about air bag deployment, refer to "SRS Air Bag Deployment Criteria" (page 2-54).

## SRS Air Bags

---

### (With Front Passenger Occupant Classification System)

In addition, the front passenger side air bag is designed to only deploy in accordance with the total seated weight on the front passenger seat. For details, refer to the front passenger occupant classification system (page 2-57).

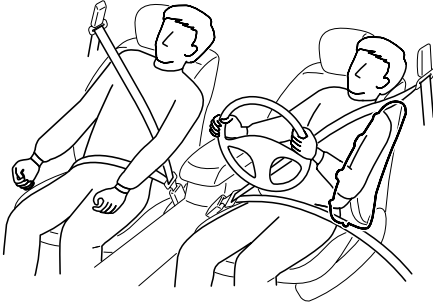

### ▼ Curtain Air Bags\*

The curtain air bags are mounted in the front and rear window pillars, and the roof edge along both sides.

When the air bag crash sensors detect a side impact of greater than moderate force, the curtain air bag inflates quickly and helps to reduce injury mainly to the rear outboard passenger's head caused by directly hitting interior parts such as a door or window. For more details about air bag deployment, refer to "SRS Air Bag Deployment Criteria" (page 2-54).

#### **In a side impact:**

Greater than moderate impact to one side of the vehicle will cause the curtain air bag on that side only to inflate.



Only one side curtain air bag will deploy on the side of the vehicle that receives the force of an impact.



**(With Front Passenger Occupant Classification System)**

**In a roll-over:**

In response to a vehicle roll-over, both curtain air bags inflate.

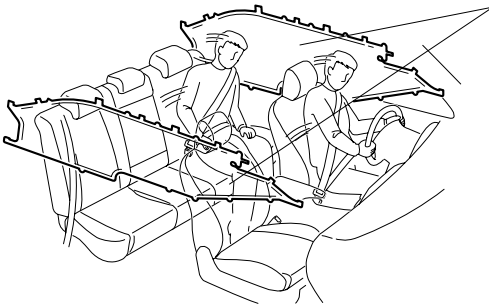

Both curtain air bags will deploy after the roll-over accident is detected.

**(With Front Passenger Occupant Classification System)**

**In an angled collision:**

During a collision, the driver and front passenger's air bags will deploy. Depending on the nature of the impact, the side air bag and the curtain air bag may deploy.



**▼ Warning Light/Beep**

A system malfunction or operation conditions are indicated by a warning.



Refer to Warning/Indicator Lights on page 4-20.

Refer to Warning Sound is Activated on page 7-35.

## SRS Air Bag Deployment Criteria

This chart indicates the applicable SRS equipment that will deploy depending on the type of collision.

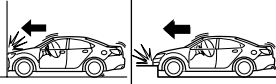
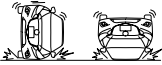
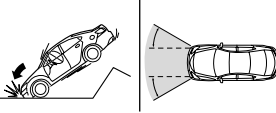
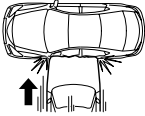
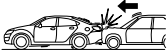
(The illustrations are the representative cases of collisions.)

	Types of collision			
	A severe frontal/near frontal collision	A severe side collision <sup>*4</sup>	A roll-over/near roll-over <sup>*3</sup>	A rear collision
SRS equipment				
				
				
Front seat belt pretensioner	X <sup>*1</sup> (both sides)	X <sup>*1</sup> (impact side only)	X <sup>*1</sup> (both sides)	No air bag and front seat belt pretensioner will be activated in a rear collision.
Driver air bag	X			
Front passenger air bag	X <sup>*1</sup>			
Side air bag <sup>*</sup>	X <sup>*2</sup>	X <sup>*1</sup> (impact side only)		
Curtain air bag <sup>*</sup>	X <sup>*2</sup>	X (impact side only)	X (both sides)	

X: The SRS air bag equipment is designed to deploy in a collision.

**\*1 (With Front Passenger Occupant Classification System)**

The front passenger front and side air bags and the seat belt pretensioner are designed to deploy depending on the condition of the total seated weight on the front passenger seat.

**\*2 (With Front Passenger Occupant Classification System)**

In an angled collision, the side air bag and curtain air bag may deploy.

**\*3 (With Front Passenger Occupant Classification System)**

In a roll-over accident, the seat belt pretensioners and the curtain air bags deploy.

**\*4 (With Side/Curtain Air Bags)**

In a side collision, the seat belt pretensioners and the side/curtain air bags deploy (only on the side in which the collision occurs).

## Limitations to SRS Air Bag

In severe collisions such as those described previously in "SRS Air Bag Deployment Criteria", the applicable SRS air bag equipment will deploy. However, in some accidents, the equipment may not deploy depending on the type of collision and its severity.

### Limitations to front/near front collision detection:

The following illustrations are examples of front/near front collisions that may not be detected as severe enough to deploy the SRS air bag equipment.

Impacts involving trees or poles

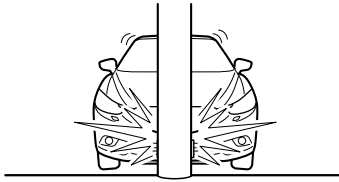

Frontal offset impact to the vehicle

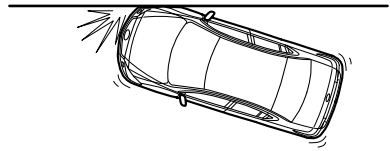

Rear-ending or running under a truck's tail gate

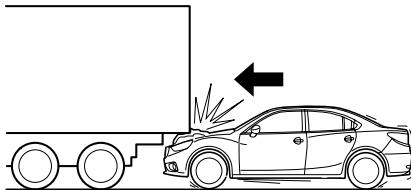

**Limitations to side collision detection:**

The following illustrations are examples of side collisions that may not be detected as severe enough to deploy the SRS air bag equipment.

Side impacts involving trees or poles

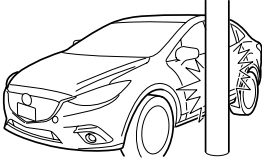

Side impacts with two-wheeled vehicles

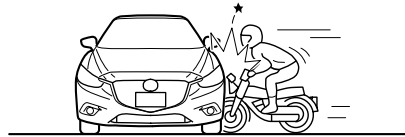

Roll-over (Without Front Passenger Occupant Classification System)



**(With Front Passenger Occupant Classification System)**

**Limitations to roll-over detection:**

The following illustration is an example of an accident that may not be detected as a roll-over accident. Therefore, the front seat belt pretensioners and curtain air bags may not deploy.

Pitch end over end

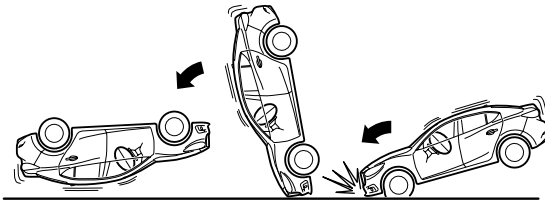

## Front Passenger Occupant Classification System\*

First, please read "Supplemental Restraint System (SRS) Precautions" (page 2-41) carefully.

### ▼ Front Passenger Seat Weight Sensor

Your vehicle is equipped with a front passenger seat weight sensors as a part of the supplemental restraint system. These sensors are located under both of the front passenger seat rails. These sensors determine the total seated weight on the front passenger seat and monitor the seat belt buckle for the front passenger seat. The SAS unit is designed to prevent the front passenger front and side air bags and seat belt pretensioner system from deploying if the front passenger air bag deactivation indicator light illuminates.

To reduce the chance of injuries caused by deployment of the front passenger air bag, the system deactivates the front passenger front and side air bags and also the seat belt pretensioner system when the front passenger air bag deactivation indicator light illuminates. Refer to the following table for the front passenger air bag deactivation indicator light illumination conditions.

This system shuts off the front passenger front and side air bags and seat belt pretensioner system, so make sure the front passenger air bag deactivation indicator light illuminates according to the following table.

The air bag/front seat belt pretensioner system warning light flashes and the front passenger air bag deactivation indicator light illuminates if the sensors have a possible malfunction. If this happens, the front passenger front and side air bags and seat belt pretensioner system will not deploy.

### Front passenger air bag deactivation indicator light

This indicator light illuminates to remind you that the front passenger front and side air bags and seat belt pretensioner will not deploy during a collision.

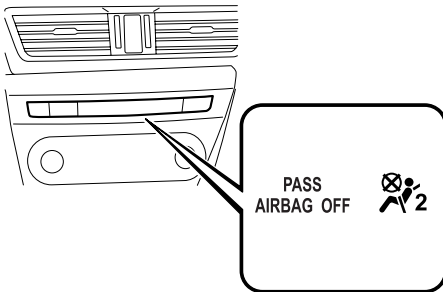

**SRS Air Bags**

If the front passenger weight sensors are normal, the indicator light illuminates when the ignition is switched ON. The light turns off after a few seconds. Then, the indicator light illuminates or is off under the following conditions:

**Front passenger air bag deactivation indicator light on/off condition chart**

Condition detected by the front passenger occupant classification system	Front passenger air bag deactivation indicator light	Front passenger front and side air bags	Front passenger seat belt pretensioner system
Empty (Not occupied)	On	Deactivated	Deactivated
Child or child-restraint system <sup>*1</sup>	On	Deactivated	Deactivated
Adult <sup>*2</sup>	Off	Ready	Ready

\*1 If a larger child sits on the front passenger seat, the sensors might detect the child as being an adult depending on the child's physique.

\*2 If a smaller adult sits on the front passenger seat, the sensors might detect the person as being a child depending on the person's physique.

The curtain air bag is ready for inflating regardless of what the front passenger air bag deactivation indicator light on/off condition chart indicates.

If the front passenger air bag deactivation indicator light does not illuminate when the ignition is switched ON and does not illuminate as indicated in the front passenger air bag deactivation indicator light on/off condition chart, do not allow a child to sit in the front passenger seat and consult an Authorized Mazda Dealer as soon as possible. The system may not work properly in an accident.

**⚠ WARNING**

**Do not decrease the total seated weight on the front passenger seat:**

When an adult or large child sits on the front passenger seat, decreasing the total seated weight on the front passenger seat required for air bag deployment is dangerous. The front passenger seat weight sensors will detect the reduced total seated weight condition and the front passenger front and side air bags and seat belt pretensioner system will not deploy during an accident. The front passenger will not have the supplementary protection of the air bag, which could result in serious injury. Decreasing the total seated weight on the front passenger seat could result in an air bag not deploying under the following conditions, for example:

- A front passenger is seated as shown in the following figure:

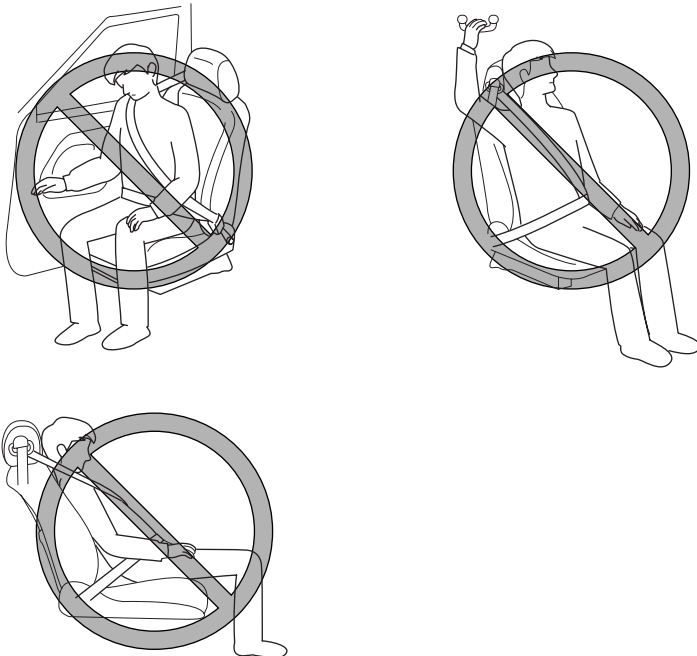

- A rear passenger pushes up on the front passenger seat with their feet.
- Luggage or other items placed under the front passenger seat or between the front passenger seat and driver seat that push up the front passenger seat bottom.
- Any accessories which might decrease the total seated weight on the front passenger seat are attached to the front passenger seat.

The front passenger front and side air bags and seat belt pretensioner systems will deactivate if the front passenger air bag deactivation indicator light illuminates.

## SRS Air Bags

---

### **Do not increase the total seated weight on the front passenger seat:**

*When an infant or small child sits on the front passenger seat, increasing the total seated weight on the front passenger seat is dangerous. The front passenger seat weight sensors will detect the increased total seated weight, which could result in the unexpected deployment of the front passenger front and side air bags and seat belt pretensioner system in an accident and may cause serious injury. Increasing the total seated weight on the front passenger seat could result in the front passenger front and side air bags and seat belt pretensioner system deployment in an accident under the following conditions, for example:*

- *Luggage or other items are placed on the seat with the child in the child-restraint system.*
- *A rear passenger or luggage push or pull down on the front passenger seatback.*
- *A rear passenger steps on the front passenger seat rails with their feet.*
- *Luggage or other items are placed on the seatback or hung on the head restraint.*
- *Heavy items are placed in the seatback map pocket.*
- *The seat is washed.*
- *Liquids are spilled on the seat.*
- *The front passenger seat is moved backward, pushing into luggage or other items placed behind it.*
- *The front passenger seatback contacts the rear seat.*
- *Luggage or other items are placed between the front passenger seat and driver seat.*
- *Any accessories which might increase the total seated weight on the front passenger seat are attached to the front passenger seat.*

### **CAUTION**

- *To assure proper deployment of the front air bag and to prevent damage to the sensors in the front seat bottoms:*
  - *Do not place sharp objects on the front seat bottoms or leave heavy luggage on them.*
  - *Do not spill any liquids on the front seats or under the front seats.*
- *To allow the sensors to function properly, always perform the following:*
  - *Adjust the front seats as far back as possible and always sit upright against the seatbacks with seat belts worn properly.*
  - *If you place your child on the front passenger seat, secure the child-restraint system properly and slide the front passenger seat as far back as possible (page 2-31).*



**NOTE**

- *The system requires about 10 seconds to alternate between turning the front passenger front and side air bags and seat belt pretensioner system on or off.*
- *The front passenger air bag deactivation indicator light may illuminate repeatedly if luggage or other items are put on the front passenger seat, or if the temperature of the vehicle's interior changes suddenly.*
- *The front passenger air bag deactivation indicator light may illuminate for 10 seconds if the total seated weight on the front passenger seat changes.*
- *The air bag/front seat belt pretensioner system warning light might illuminate if the front passenger seat receives a severe impact.*
- *If the front passenger air bag deactivation indicator light does not illuminate after installing a child-restraint system on the front passenger seat, first, re-install your child-restraint system according to the procedure in this owner's manual. Then, if the front passenger air bag deactivation indicator light still does not illuminate, install the child-restraint system on the rear seat and consult an Authorized Mazda Dealer as soon as possible.*
- *If the front passenger air bag deactivation indicator light illuminates when an adult is seated in the front passenger seat, have the passenger re-adjust their posture by sitting with their feet on the floor, and then re-fastening the seat belt. If the front passenger air bag deactivation indicator light still illuminates, move the passenger to the rear seat. If sitting in the rear seat is not possible, slide the front passenger seat as far back as possible. Consult an Authorized Mazda Dealer as soon as possible.*

**▼ Driver and Front Passenger Buckle Switches**

The buckle switches on the front seat belts detect whether or not the front seat belts are securely fastened and further control the deployment of the air bags.

## Constant Monitoring

The following components of the air bag systems are monitored by a diagnostic system:

- Crash sensors, and diagnostic module (SAS unit)
- Front air bag sensors
- Air bag modules
- Side crash sensors
- Air bag/Front seat belt pretensioner system warning light
- Front seat belt pretensioners
- Related wiring

### **(With Front Passenger Occupant Classification System)**

- Front passenger air bag deactivation indicator light
- Front passenger seat weight sensors
- Front passenger seat weight sensor control module
- Front passenger seat belt buckle switches

The diagnostic module continuously monitors the system's readiness. This begins when the ignition is switched ON and continues while the vehicle is being driven.

# 3

## Before Driving

Use of various features, including keys, doors, mirrors and windows.

<b>Keys</b> .....	<b>3-2</b>	<b>Security System</b> .....	<b>3-41</b>
Keys .....	3-2	Modification and Add-On	
Keyless Entry System .....	3-3	Equipment.....	3-41
<b>Advanced Keyless Entry System</b> .....	<b>3-9</b>	Immobilizer System.....	3-41
Advanced Keyless Entry		Theft-Deterrent System*.....	3-43
System*.....	3-9	<b>Driving Tips</b> .....	<b>3-45</b>
Operational Range .....	3-10	Break-In Period.....	3-45
<b>Doors and Locks</b> .....	<b>3-11</b>	Saving Fuel and Protection of the	
Door Locks.....	3-11	Environment.....	3-45
Liftgate/Trunk Lid.....	3-20	Hazardous Driving.....	3-46
Inside Trunk Release Lever		Floor Mat .....	3-46
(4-Door)* .....	3-25	Rocking the Vehicle .....	3-47
<b>Fuel and Emission</b> .....	<b>3-27</b>	Winter Driving.....	3-47
Fuel and Engine Exhaust		Driving In Flooded Area .....	3-49
Precautions.....	3-27	Overloading.....	3-50
Fuel-Filler Lid and Cap.....	3-30	Driving on Uneven Road .....	3-51
<b>Steering Wheel</b> .....	<b>3-32</b>	<b>Towing</b> .....	<b>3-52</b>
Steering Wheel.....	3-32	Trailer Towing.....	3-52
<b>Mirrors</b> .....	<b>3-33</b>	Recreational Towing .....	3-52
Mirrors .....	3-33		
<b>Windows</b> .....	<b>3-36</b>		
Power Windows .....	3-36		
Moonroof * .....	3-39		

# Keys

## Keys

### WARNING

**Do not leave the key in your vehicle with children and keep them in a place where your children will not find or play with them:**

*Leaving children in a vehicle with the key is dangerous. This could result in someone being badly injured or even killed. Children may find these keys to be an interesting toy to play with and could cause the power windows or other controls to operate, or even make the vehicle move.*

### CAUTION

➤ *Because the key (transmitter) uses low-intensity radio waves, it may not function correctly under the following conditions:*

- *The key is carried with communication devices such as cellular phones.*
- *The key contacts or is covered by a metal object.*
- *The key is near electronic devices such as personal computers.*
- *Non-Mazda genuine electronic equipment is installed in the vehicle.*
- *There is equipment which discharges radio waves near the vehicle.*

- *The key (transmitter) may consume battery power excessively if it receives high-intensity radio waves. Do not place the key near electronic devices such as televisions or personal computers.*
- *To avoid damage to the key (transmitter), DO NOT:*
  - *Drop the key.*
  - *Get the key wet.*
  - *Disassemble the key.*
  - *Expose the key to high temperatures on places such as the dashboard or hood, under direct sunlight.*
  - *Expose the key to any kind of magnetic field.*
  - *Place heavy objects on the key.*
  - *Put the key in an ultrasonic cleaner.*
  - *Put any magnetized objects close to the key.*

A code number is stamped on the plate attached to the key set; detach this plate and store it in a safe place (not in the vehicle) for use if you need to make a replacement key (auxiliary key). Also write down the code number and keep it in a separate safe and convenient place, but not in the vehicle.

If your key (auxiliary key) is lost, consult your Authorized Mazda Dealer and have your code number ready.

**NOTE**

The driver must carry the key to ensure the system functions properly.

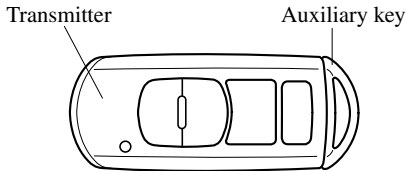

 Key code number plate

To use the auxiliary key, pull it out of the key (transmitter).

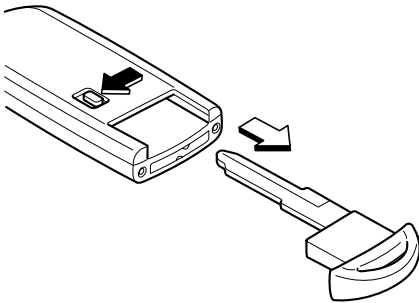
**Keyless Entry System**

This system uses the key buttons to remotely lock and unlock the doors and the liftgate, and opens the trunk lid. The system can start the engine without having to take the key out of your purse or pocket.

It can also help you signal for attention. Operating the theft-deterrent system is also possible on theft-deterrent system-equipped vehicles.

Press the buttons slowly and carefully.

System malfunctions or warnings are indicated by the following warning lights or beeps.

- KEY Warning Light (Red)  
Refer to Warning/Indicator Lights on page 4-20.
- Ignition Not Switched Off (STOP) Warning Beep  
Refer to Ignition Not Switched Off (STOP) Warning Beep on page 7-36.
- Key Removed from Vehicle Warning Beep  
Refer to Key Removed from Vehicle Warning Beep on page 7-36.

If you have a problem with the key, consult an Authorized Mazda Dealer.

If your key is lost or stolen, consult an Authorized Mazda Dealer as soon as possible for a replacement and to make the lost or stolen key inoperative.

**CAUTION**

*Radio equipment like this is governed by laws in the United States.*

*Changes or modifications not expressly approved by the party responsible for compliance could void the user's authority to operate the equipment.*

# Keys

## NOTE

- The keyless entry system operation may vary due to local conditions.
- The keyless entry system is fully operational (door/liftgate lock/unlock) when the push button start is switched off. The system does not operate if the push button start is switched to any position other than off.
- If the key does not operate when pressing a button or the operational range becomes too small, the battery may be dead. To install a new battery, refer to Replace Electrical Battery (page 6-39).
- Battery life is about one year. Replace the battery with a new one if the KEY indicator light (green) flashes in the instrument cluster. Replacing the battery about once a year is recommended because the KEY warning light/indicator light may not illuminate or flash depending on the rate of battery depletion.



- Additional keys can be obtained at an Authorized Mazda Dealer. Up to 6 keys can be used with the keyless functions per vehicle. Bring all keys to an Authorized Mazda Dealer when additional keys are required.

## ▼ Transmitter

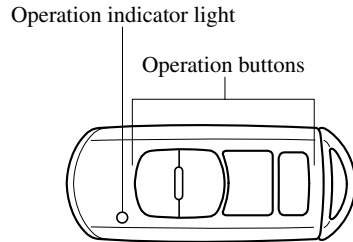

## NOTE

- **(With theft-deterrent system)**  
The hazard warning lights flash when the theft-deterrent system is armed or turned off.  
Refer to Theft-Deterrent System on page 3-43.
- **(With the advanced keyless function)**  
A beep sound can be heard for confirmation when the doors and liftgate are locked/unlocked using the key. If you prefer, the beep sound can be turned off.  
The volume of the beep sound can also be changed.  
Refer to Personalization Features on page 9-12.  
Use the following procedure to change the setting.
  1. Switch the ignition off and close all of the doors and the liftgate/trunk lid.
  2. Open the driver's door.

3. *Within 30 seconds of opening the driver's door, press and hold the LOCK button on the key for 5 seconds or longer. All of the doors and the liftgate lock and the beep sound activates at the currently set volume. (If the beep sound is currently set to not activate, it will not activate.) The setting changes each time the LOCK button on the key is pressed and the beep sound activates at the set volume. (If the beep sound has been set to not activate, it will not activate.)*
4. *The setting change is completed by doing any one of the following:*
  - *Switching the ignition to ACC or ON.*
  - *Closing the driver's door.*
  - *Opening the liftgate/trunk lid.*
  - *Not operating the key for 10 seconds.*
  - *Pressing any button except the LOCK button on the key.*
  - *Pressing a request switch.*

The operation indicator light flashes when the buttons are pressed.

### **Lock button**

To lock the doors and the liftgate, press the lock button and the hazard warning lights will flash once.

#### **(With the advanced keyless function)**

A beep sound will be heard once.

To confirm that all doors and the liftgate have been locked, press the lock button again within 5 seconds. If they are closed and locked, the horn will sound.



### **NOTE**

- *The doors and the liftgate can be locked by pressing the lock button while any other door or the liftgate/trunk lid is open. The hazard warning lights will not flash. When the lock button is pressed while any door is open and then the door is closed, all the doors and the liftgate are locked.*
- *Confirm that all doors and the liftgate are locked visually or audibly by use of the double click.*
- *Make sure all doors and the liftgate are locked after pressing the button.*
- **(With theft-deterrent system)**  
*When the doors are locked by pressing the lock button on the key while the theft-deterrent system is armed, the hazard warning lights will flash once to indicate that the system is armed.*

### **Unlock button**

To unlock the driver's door, press the unlock button and the hazard warning lights will flash twice.

#### **(With the advanced keyless function)**

A beep sound will be heard twice.

To unlock all doors and the liftgate, press the unlock button again within 3 seconds and two more beep sounds will be heard.



# Keys

---

## NOTE

- The system can be set to unlock all doors by performing a single operation. Refer to Personalization Features on page 9-12.

Use the following procedure to change the setting.

1. Switch the ignition off and close all of the doors and the liftgate/trunk lid.
2. Open the driver's door.
3. Within 30 seconds of opening the driver's door, press and hold the UNLOCK button on the key for 5 seconds or longer. The sound of the doors locking/unlocking can be heard.

After this, the system switches the setting each time the UNLOCK button is pressed (the sound of the doors locking/unlocking can be heard).

4. The setting change is completed by doing any one of the following:
  - Switching the ignition to ACC or ON.
  - Closing the driver's door.
  - Opening the liftgate/trunk lid.
  - Not operating the key for 10 seconds.
  - Pressing any button except the UNLOCK button on the key.
  - Pressing a request switch.

- **(Auto re-lock function)**

After unlocking with the key, all doors and the liftgate will automatically lock if any of the following operations are not performed within about 60 seconds. If your vehicle has a theft-deterrent system, the hazard warning lights will flash for confirmation.

The time required for the doors to lock automatically can be changed.

Refer to Personalization Features on page 9-12.

- A door or the liftgate/trunk lid is opened.
- The push button start is switched to any position other than off.

- **(With theft-deterrent system)**

When the doors are unlocked by pressing the unlock button on the key while the theft-deterrent system is turned off, the hazard warning lights will flash twice to indicate that the system is turned off.

### **Trunk button (4-door)**

To open the trunk lid, press and hold the trunk button until the trunk lid opens.

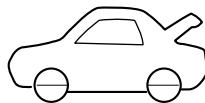

# HOLD



### **Panic button**

If you witness from a distance someone attempting to break into or damage your vehicle, press and hold the panic button to activate the vehicle's alarm.

**! HOLD**

#### **NOTE**

*The panic button will work whether any door or the liftgate/trunk lid is open or closed.*

#### **(Turning on the alarm)**

Pressing the panic button for 1 second or more will trigger the alarm for about 2 minutes and 30 seconds, and the following will occur:

- The horn sounds intermittently.
- The hazard warning lights flash.

#### **(Turning off the alarm)**

The alarm stops by pressing any button on the key.

### **▼ Operational Range**

The system operates only when the driver is in the vehicle or within operational range while the key is being carried.

#### **Starting the Engine**

#### **NOTE**

- *Starting the engine may be possible even if the key is outside of the vehicle and extremely close to a door and window, however, always start the engine from the driver's seat. If the vehicle is started and the key is not in the vehicle, the vehicle will not restart after it is shut off and the push button start is switched to off.*
- *The luggage compartment/trunk is out of the assured operational range, however, if the key (transmitter) is operable the engine will start.*

#### **With the advanced keyless function**

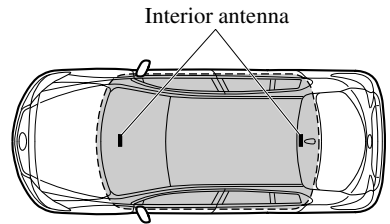



 Operational range

# Keys

---

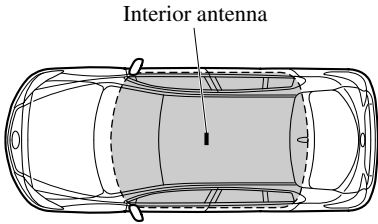
## Without the advanced keyless function



 Operational range

### **NOTE**

*The engine may not start if the key is placed in the following areas:*

- *Around the dashboard*
- *In the storage compartments such as the glove compartment*
- *On the rear parcel shelf (4-door)*

### **▼ Key Suspend Function**

If a key is left in the vehicle, the functions of the key left in the vehicle are temporarily suspended to prevent theft of the vehicle.

To restore the functions, press the unlock button on the functions-suspended key in the vehicle.

## Advanced Keyless Entry System\*

### WARNING

#### **Radio waves from the key may affect medical devices such as pacemakers:**

Before using the key near people who use medical devices, ask the medical device manufacturer or your physician if radio waves from the key will affect the device.

The advanced keyless function allows you to lock/unlock the doors and liftgate, or open the liftgate/trunk lid while carrying the key without using the key.

System malfunctions or warnings are indicated by the following warning beeps.

- Request switch Inoperable Warning Beep  
Refer to Request Switch Inoperable Warning Beep (With the advanced keyless function) on page 7-36.
- Key Left-in-luggage Compartment/Trunk Warning Beep  
Refer to Key Left-in-luggage Compartment Warning Beep (With the advanced keyless function) on page 7-36.
- Key Left-in-vehicle Warning Beep  
Refer to Key Left-in-vehicle Warning Beep (With the advanced keyless function) on page 7-37.

### **NOTE**

*The advanced keyless entry system functions can be deactivated to prevent any possible adverse effect on a user wearing a pacemaker or other medical device. If the system is deactivated, you will be unable to start the engine by carrying the key. Consult an Authorized Mazda Dealer for details. If the advanced keyless entry system has been deactivated, you can start the engine by following the procedure indicated when the key battery goes dead.*

*Refer to Engine Start Function When Key Battery is Dead on page 4-8.*

# Advanced Keyless Entry System

## Operational Range

The system operates only when the driver is in the vehicle or within operational range while the key is being carried.

### NOTE

When the battery power is low, or in places where there are high-intensity radio waves or noise, the operational range may become narrower or the system may not operate. For determining battery replacement, Refer to Keyless Entry System on page 3-3.

## Locking, Unlocking the Doors and the Liftgate

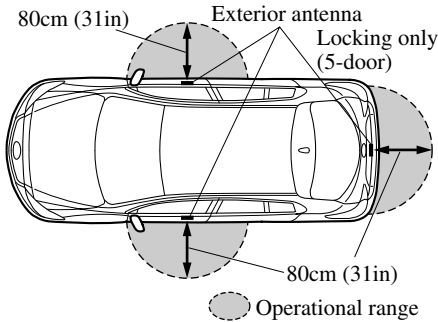

### NOTE

The system may not operate if you are too close to the windows or door handles, or liftgate.

## Opening the Liftgate/Trunk Lid

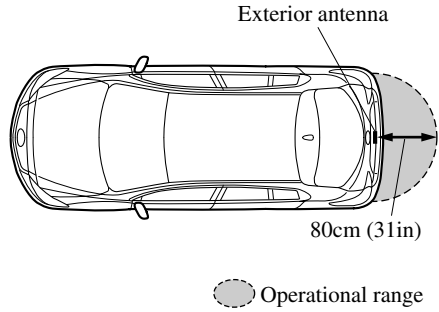

## Door Locks

### **WARNING**

**Always take all children and pets with you or leave a responsible person with them:**

*Leaving a child or a pet unattended in a parked vehicle is dangerous. In hot weather, temperatures inside a vehicle can become high enough to cause brain damage or even death.*

**Do not leave the key in your vehicle with children and keep them in a place where your children will not find or play with them:**

*Leaving children in a vehicle with the key is dangerous. This could result in someone being badly injured or even killed.*

**Keep all doors locked when driving:**

*Unlocked doors in a moving vehicle are dangerous. Passengers can fall out if a door is accidentally opened and can more easily be thrown out in an accident.*

**Always close all the windows and moonroof, lock the doors and take the key with you when leaving your vehicle unattended:**

*Leaving your vehicle unlocked is dangerous as children could lock themselves in a hot vehicle, which could result in death. Also, a vehicle left unlocked becomes an easy target for thieves and intruders.*

**After closing the doors, always verify that they are securely closed:**

*Doors not securely closed are dangerous, if the vehicle is driven with a door not securely closed, the door could open unexpectedly resulting in an accident.*

**Always confirm the safety around the vehicle before opening a door:**

*Suddenly opening a door is dangerous. A passing vehicle or a pedestrian could be hit and cause an accident.*

### **CAUTION**

*Always confirm the conditions around the vehicle before opening/closing the doors and use caution during strong winds or when parked on an incline. Not being aware of the conditions around the vehicle is dangerous because fingers could get caught in the door or a passing pedestrian could be hit, resulting in an unexpected accident or injury.*

## Doors and Locks

### NOTE

- *When the ignition is switched to ACC or ON, the vehicle lock-out prevention feature prevents you from locking yourself out of the vehicle.*

*All doors and the liftgate will automatically unlock if they are locked using the power door locks with any door open.*

*The vehicle lock-out prevention feature does not operate while the ignition is switched off.*

*When any door is opened from the outside while the key is inside the vehicle, the closed doors are locked. All the doors are automatically unlocked by closing the open door.*

#### **(With the advanced keyless function)**

*The beep sound is heard for about 10 seconds to notify the driver that the key has been left in the vehicle.*

#### **(Without the advanced keyless function)**

*The horn sound is heard twice to notify the driver that the key has been left in the vehicle.*

- **(Door unlock (control) system with collision detection)**

*This system automatically unlocks the doors in the event the vehicle is involved in an accident to allow passengers to get out of the vehicle immediately and prevent being trapped inside. While the ignition is switched ON and in the event the vehicle receives an impact strong enough to inflate the air bags, all the doors are automatically unlocked after about 6 seconds have elapsed from the time of the accident.*

*The doors may not unlock depending on how an impact is applied, the force of the impact, and other conditions of the accident.*

*If door-related systems or the battery is malfunctioning, the doors will not unlock.*

### ▼ Locking, Unlocking with Key

All doors and the liftgate lock automatically when the driver's door is locked using the key.

All doors and the liftgate unlock when the driver's door is unlocked and the key is held in the unlock position for one second or longer.

Turn the key toward the front to lock, toward the back to unlock.

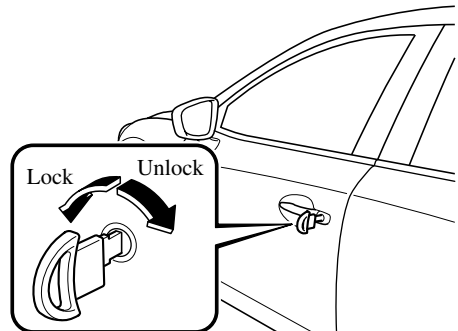

**NOTE**

Holding the key in the unlocked position in the driver's door lock for about a second unlocks all doors and the liftgate. To unlock only the driver's door, insert the key into the driver's door lock and turn the key briefly to the unlock position and then immediately return it to the center position.

### ▼ Locking, Unlocking with Request Switch (With the advanced keyless function)

All doors and the liftgate can be locked/unlocked by pressing the request switch on the front doors while the key is being carried.

**(5-door)**

The request switch on the liftgate can only be used to lock all doors and the liftgate.

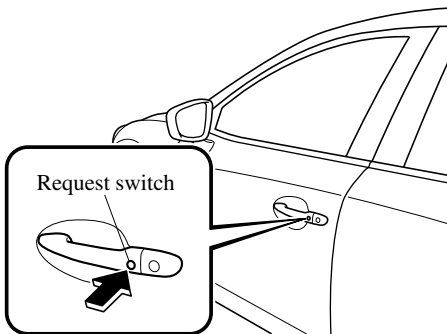
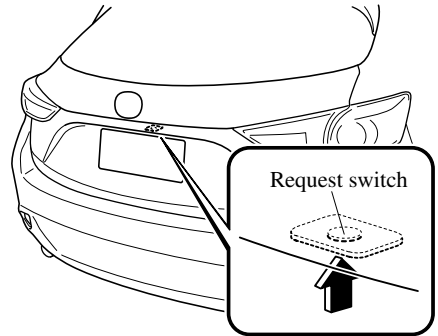
**Front doors****Liftgate (5-door Lock only)****To lock**

To lock the doors and the liftgate, press the request switch and the hazard warning lights will flash once.

A beep sound will be heard once.

**To unlock****Driver's door request switch**

To unlock the driver's door, press the request switch. A beep sound will be heard twice and the hazard warning lights will flash twice.

To unlock all doors and the liftgate, press the request switch again within 3 seconds and two more beep sounds will be heard.

**Front passenger door request switch**

To unlock all doors and the liftgate, press the request switch. A beep sound will be heard twice and the hazard warning lights will flash twice.

## Doors and Locks

---

### NOTE

- The system can be set to unlock all doors by performing a single operation. Refer to Personalization Features on page 9-12.
- Use the following procedure to change the setting.

1. Switch the ignition off and close all of the doors and the liftgate/trunk lid.
2. Open the driver's door.
3. Within 30 seconds of opening the driver's door, press and hold the UNLOCK button on the key for 5 seconds or longer. The sound of the doors locking/unlocking can be heard.

After this, the system switches the setting of pressing the driver's request switch once or twice to unlock all doors and the liftgate each time the UNLOCK button is pressed (the sound of the doors locking/unlocking can be heard).

4. The setting change is completed by doing any one of the following:
  - Switching the ignition to ACC or ON.
  - Closing the driver's door.
  - Opening the liftgate/trunk lid.
  - Not operating the key for 10 seconds.
  - Pressing any button except the UNLOCK button on the key.
  - Pressing a request switch.

- Confirm that all doors and the liftgate are securely locked.

For the liftgate/trunk lid, move it without pressing the electric liftgate/trunk lid opener to verify that the liftgate/trunk lid has not been left ajar.

- All doors and the liftgate cannot be locked when any door or the liftgate is open.
- It may require a few seconds for the doors to unlock after the request switch is pressed.
- A beep sound is heard for confirmation when the doors and the liftgate are locked/unlocked using the request switch. If you prefer, the beep sound can be turned off. The volume of the beep sound can also be changed. Refer to Personalization Features on page 9-12. Use the following procedure to change the setting.

1. Switch the ignition off and close all of the doors and the liftgate/trunk lid.
2. Open the driver's door.
3. Within 30 seconds of opening the driver's door, press and hold the LOCK button on the key for 5 seconds or longer. All of the doors and the liftgate lock and the beep sound activates at the currently set volume. (If the beep sound is currently set to not activate, it will not activate.) The setting changes each time the LOCK button on the key is pressed and the beep sound activates at the set volume. (If the beep sound has been set to not activate, it will not activate.)



4. The setting change is completed by doing any one of the following:

- Switching the ignition to ACC or ON.
- Closing the driver's door.
- Opening the liftgate/trunk lid.
- Not operating the key for 10 seconds.
- Pressing any button except the LOCK button on the key.
- Pressing a request switch.

• **(With theft-deterrent system)**

The hazard warning lights flash when the theft-deterrent system is armed or turned off.

Refer to Theft-Deterrent System on page 3-43.

- The setting can be changed so that the doors and the liftgate are locked automatically without pressing the request switch.

Refer to Personalization Features on page 9-12.

**(Auto-lock function)**

A beep sound is heard when all doors and the liftgate are closed while the advanced key is being carried. All doors and the liftgate are locked automatically after about three seconds when the advanced key is out of the operational range. Also, the hazard warning lights flash once. (Even if the driver is in the operational range, all doors and the liftgate are locked automatically after about 30 seconds.) If you are out of the operational range before the doors and the liftgate/trunk lid are completely closed or another key is left in the vehicle, the auto-lock function will not work. Always make sure that all doors and the liftgate/trunk lid are closed and locked before leaving the vehicle. The auto-lock function does not close the power windows.

• **Auto re-lock function**

After unlocking with the request switch, all doors and the liftgate will automatically lock if any of the following operations are not performed within about 60 seconds. If your vehicle has a theft-deterrent system, the hazard warning lights will flash for confirmation.

The time required for the doors to lock automatically can be changed.

Refer to Personalization Features on page 9-12.

- Opening a door or the liftgate/trunk lid.
- Switching the ignition to any position other than off.

## Doors and Locks

### ▼ Locking, Unlocking with Transmitter

All doors and the liftgate can be locked/unlocked by operating the keyless entry system transmitter, refer to Keyless Entry System (page 3-3).

### ▼ Locking, Unlocking with Door-Lock Switch

All doors and the liftgate lock automatically when the lock side is pressed. They all unlock when the unlock side is pressed.

#### Driver's door

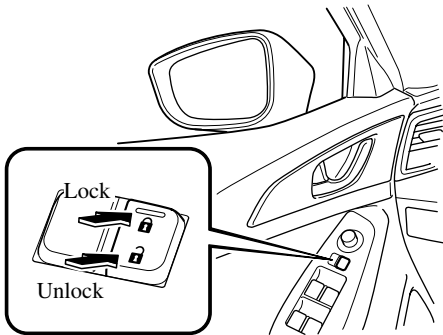

#### Front passenger's door

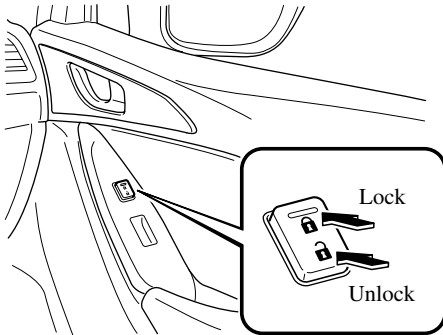

To lock all the doors/liftgate from an open front door, press the lock side of the door lock switch and then close the door.

### NOTE

*When locking the doors this way, be careful not to leave the key inside the vehicle.*

### ▼ Auto Lock/Unlock Function

#### WARNING

**Do not pull the inner handle on a front door:**

*Pulling the inner handle on a front door while the vehicle is moving is dangerous. Passengers can fall out of the vehicle if the door opens accidentally, which could result in death or serious injury.*

- When the vehicle speed exceeds 20 km/h (12 mph), all doors and the liftgate lock automatically.
- When the ignition is switched off, all doors and the liftgate unlock automatically.

These functions can also be disabled so that they do not operate.

### Auto lock/unlock function setting change using door-lock switch

The doors and the liftgate can set to lock or unlock automatically by selecting any one of the functions from the following table and using the driver's door-lock switch on the interior door panel.

## Doors and Locks

### NOTE

- *Function number 3 is the factory setting for your vehicle.*
- *There are only a total of five auto lock/unlock settings available for automatic transaxle vehicles, and three for manual transaxle vehicles. Be sure to press the unlock side of the driver's door-lock switch the correct number of times according to the selected function number. If the switch is mistakenly pressed six times on an automatic transaxle vehicle or four times on a manual transaxle, the procedure will be cancelled. If this occurs, start the procedure from the beginning.*

Function number	Function*1
1	The auto door-lock function is disabled.
2	All the doors and the liftgate lock automatically when the vehicle speed is about 20 km/h (12 mph) or more.
3	All the doors and the liftgate lock automatically when the vehicle speed is about 20 km/h (12 mph) or more. All the doors and the liftgate unlock when the ignition is switched from ON to Off.
4	<b>(Automatic transaxle vehicles only)</b> When the ignition is switched ON and the shift lever is shifted from park (P) to any other gear position, all the doors and the liftgate lock automatically.
5	<b>(Automatic transaxle vehicles only)</b> When the ignition is switched ON and the shift lever is shifted from park (P) to any other gear position, all the doors and the liftgate lock automatically. When the shift lever is shifted to park (P) while the ignition is switched ON, all the doors and the liftgate unlock automatically.

\*1 Other settings for the auto door lock function are available at an Authorized Mazda Dealer. For details consult an Authorized Mazda Dealer. Refer to Personalization Features on page 9-12.

Settings can be changed using the following procedure.

1. Safely park the vehicle. All doors must remain closed.
2. Switch the ignition ON.
3. Press and hold the lock side of the driver's door-lock switch within 20 seconds of switching the ignition ON, and make sure a beep sound is heard about eight seconds afterwards.

# Doors and Locks

4. Refer to the auto lock/unlock function setting table, determine the function number for the desired setting. Press the unlock side of the driver's door-lock switch the same number of times as the selected function number (Ex. If you select function 2, press the unlock side of the switch only 2 times).
5. Three seconds after the function setting has been changed, a beep sound will beep in the amount of the selected function number. (Ex. Function number 3 = 3 beep sounds)

## (Manual transaxle vehicles)

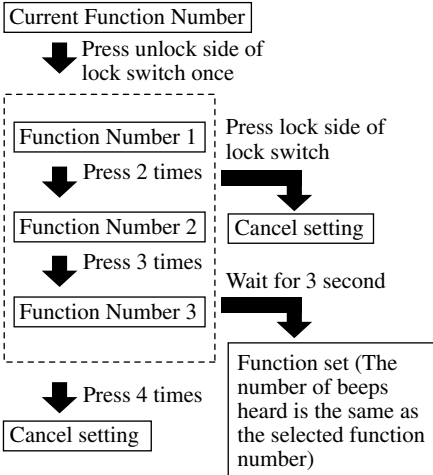

## (Automatic transaxle vehicles)

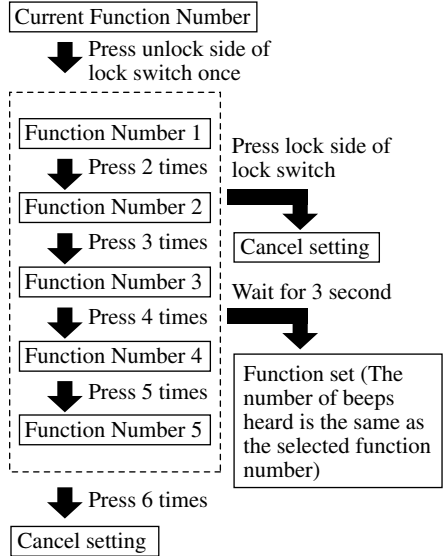

### NOTE

- The doors cannot be locked or unlocked while the setting function is being performed.
- The procedure can be cancelled by pressing the lock side of the driver's door-lock switch.

## ▼ Locking, Unlocking with Door-Lock Knob

### Operation from inside

To lock any door from the inside, press the door-lock knob.

To unlock, pull it outward.

This does not operate the other door locks.

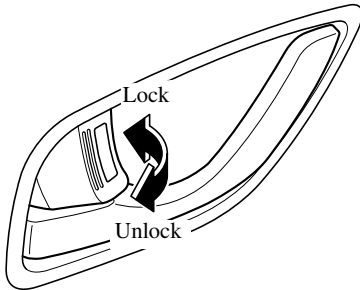

### **NOTE**

*The red indication can be seen when the door-lock knob is unlocked.*

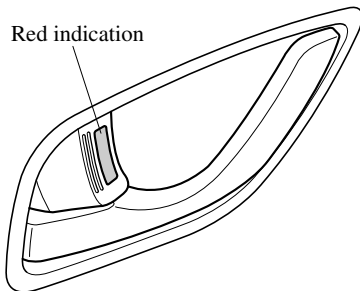

### Operation from outside

To lock the rear and front passenger doors with the door-lock knob from the outside, press the door-lock knob to the lock position and close the door (holding the door handle in the open position is not required).

This does not operate the other door locks.

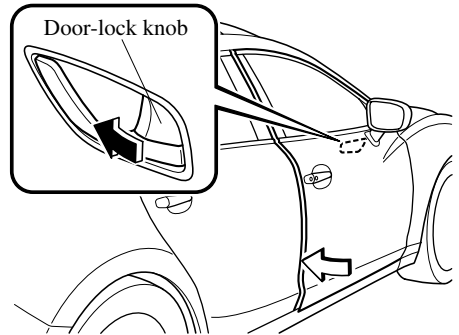

### **NOTE**

*When locking the door this way:*

- *Be careful not to leave the key inside the vehicle.*
- *The driver's door lock knob cannot be used while the driver's door is open.*

## Doors and Locks

### ▼ Rear Door Child Safety Locks

These locks are intended to help prevent children from accidentally opening the rear doors. Use them on both rear doors whenever a child rides in the rear seat of the vehicle.

If you slide the child safety lock to the lock position before closing that door, the door cannot be opened from the inside. The door can only be opened by pulling the outside handle.

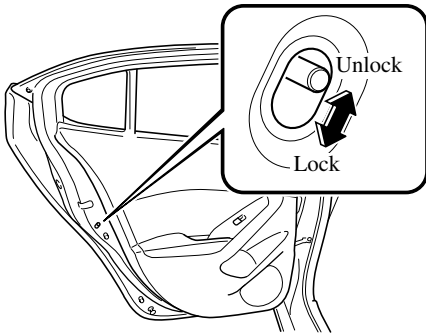

## Liftgate/Trunk Lid

### ⚠ WARNING

#### **Never allow a person to ride in the luggage compartment/trunk:**

*Allowing a person to ride in the luggage compartment/trunk is dangerous. The person in the luggage compartment/trunk could be seriously injured or killed during sudden braking or a collision.*

#### **Do not drive with the liftgate/trunk lid open:**

*Exhaust gas in the cabin of a vehicle is dangerous. An open liftgate/trunk lid in a moving vehicle will cause exhaust gas to be drawn into the cabin. This gas contains CO (carbon monoxide), which is colorless, odorless, and highly poisonous, and it can cause loss of consciousness and death. Moreover, an open liftgate/trunk lid could cause occupants to fall out in an accident.*

#### **Do not stack or leave loaded luggage unsecured in the luggage compartment:**

*Otherwise, the luggage may move or collapse, resulting in injury or an accident. In addition, do not load luggage higher than the seatbacks. It may affect the side or rear field of view.*

## ⚠ CAUTION

- Before opening the liftgate/trunk lid, remove any snow and ice accumulation on it. Otherwise, the liftgate/trunk lid could close under the weight of the snow and ice resulting in injury.
- Be careful when opening/closing the liftgate/trunk lid during strong winds. If a strong gust blows against the liftgate/trunk lid, it could close suddenly resulting in injury.
- Fully open the liftgate/trunk lid and make sure that it stays open. If the liftgate/trunk lid is only opened partially, it could slam shut by vibration or wind gusts resulting in injury.
- When loading or unloading luggage in the luggage compartment/trunk, turn off the engine. Otherwise, you could get burned by the heat of the exhaust gas.
- Be careful not to apply excessive force to the damper stay on the liftgate such as by putting your hand on the stay. Otherwise, the damper stay may bend and affect the liftgate operation.

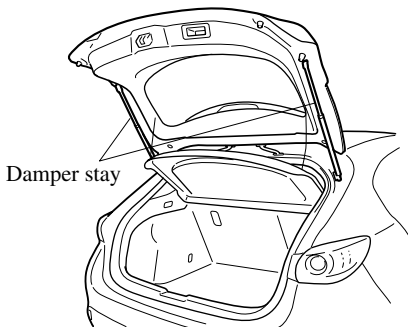

## ▼ Opening and Closing the Liftgate/Trunk Lid

### Opening the liftgate (5-door)

#### Using the electric liftgate opener

Unlock the doors and liftgate, then press the electric liftgate opener on the liftgate and raise it when the latch releases.

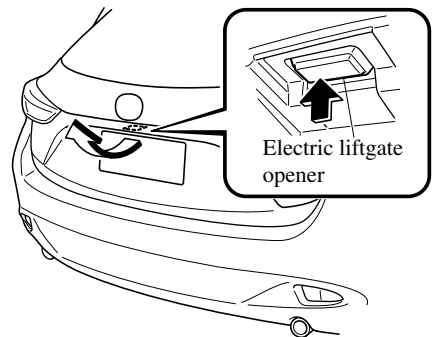

#### NOTE

##### (With the advanced keyless function)

- A locked liftgate can also be opened while the key is being carried.
- When opening the liftgate with the doors and the liftgate locked, it may require a few seconds for the liftgate latch to release after the electric liftgate opener is pressed.
- The liftgate can be closed when the doors are locked with the key left in the vehicle. However, to prevent locking the key in the vehicle, the liftgate can be opened by pressing the electric liftgate opener. If the liftgate cannot be opened despite doing this procedure, press the electric liftgate opener to fully open the liftgate after pushing the liftgate completely closed.

## Doors and Locks

- *When the liftgate latch is released by pressing the electric liftgate opener, the liftgate raises slightly to allow it to be opened. If the liftgate is not operated for a certain period of time after the electric liftgate opener has been pressed, the liftgate cannot be raised any more from its slightly raised position. Press the electric liftgate opener again to fully open the liftgate. To close the liftgate from its slightly raised position, open it first by pressing the electric liftgate opener, then close it after waiting at least 1 second. If the liftgate is not fully closed, the driver is notified by a warning indicated in the instrument cluster.*
- *If the vehicle battery is dead or there is a malfunction in the electrical system and the liftgate cannot be unlocked, the liftgate can be opened by performing the emergency procedure. Refer to When Liftgate/Trunk Lid Cannot be Opened on page 7-39.*

### **Opening the trunk lid (4-door)**

#### **Using the remote release button**

Push the release button.

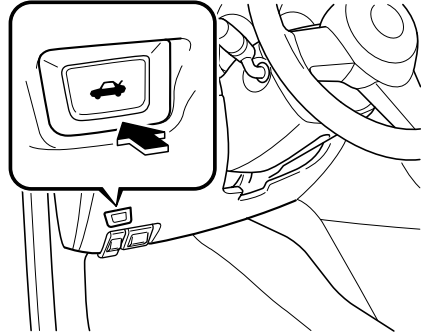

#### **Using the electric trunk lid opener (With the advanced keyless function)**

A trunk lid can also be opened while the key is being carried.

Press the electric trunk lid opener on the trunk lid, then raise the trunk lid when the latch releases.

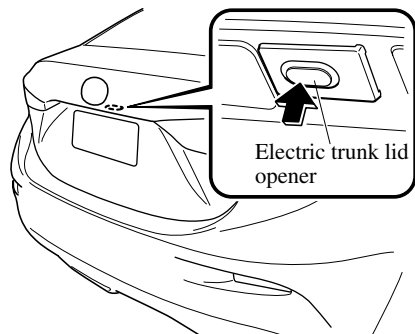



**NOTE**

- When opening the trunk lid with the doors locked, it may require a few seconds for the trunk lid latch to release after the electric trunk lid opener is pressed.
- The trunk lid can be closed when the doors are locked with the key left in the vehicle. However, to prevent locking the key in the vehicle, the trunk lid can be opened by pressing the electric trunk lid opener. If the trunk lid cannot be opened despite doing this procedure, press the electric trunk lid opener to fully open the trunk lid after pushing the trunk lid completely closed.
- If the vehicle battery is dead or there is a malfunction in the electrical system and the trunk lid cannot be unlocked, the trunk lid can be opened by performing the emergency procedure. Refer to *When Liftgate/Trunk Lid Cannot be Opened* on page 7-39.

**Closing the liftgate/trunk lid**

Lower the liftgate/trunk lid slowly using the liftgate/trunk lid grip recess, then push the liftgate/trunk lid closed using both hands.

Do not slam it. Pull up on the liftgate/trunk lid to make sure it is secure.

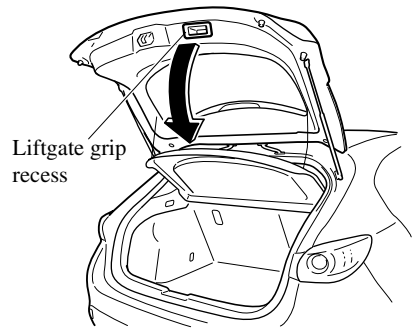
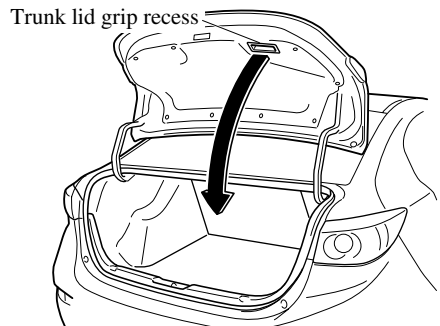
**(5-door)****(4-door)**

# Doors and Locks

## ▼ Luggage Compartment

### Luggage compartment cover (5-door)

#### **! WARNING**

**Do not place anything on top of the cover:**

*Placing luggage or other cargo on top of the luggage compartment cover is dangerous. During sudden braking or a collision, the cargo could become a projectile that could hit and injure someone. The vehicle has a light weight luggage compartment cover to keep the contents of your luggage area out of sight; it will not retain heavy objects that are not tied down in an accident such as a rollover. Tie down all heavy objects, whether luggage or cargo, using the tie down hooks.*

#### **Make sure luggage and cargo are secured before driving:**

*Not securing cargo while driving is dangerous as it could move or be crushed during sudden braking or a collision and cause injury.*

#### **! CAUTION**

*Make sure the luggage compartment cover is firmly secured. If it is not firmly secured, it could unexpectedly disengage resulting in injury.*

The luggage compartment can be accessed by opening the liftgate when the straps are attached to the sides of the liftgate.

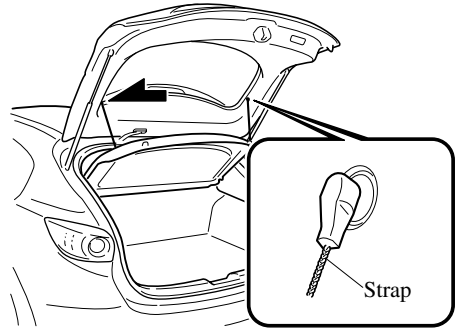

#### **Removing the cover**

This cover can be removed for more room.

1. Remove the straps from the hooks.
2. Lift the end of the luggage compartment cover a little, pull it outward, and remove it from the pins.

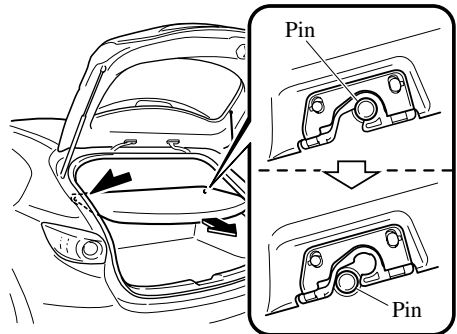

3. Lift the front end of the luggage compartment cover and remove it.

**Loading golf bags (only 4-door vehicle)**

Up to two golf bags can be carried in the trunk.

1. Place the bottom of the first golf bag in the trunk with its bottom pointed to the left and fit it into the front of the trunk.

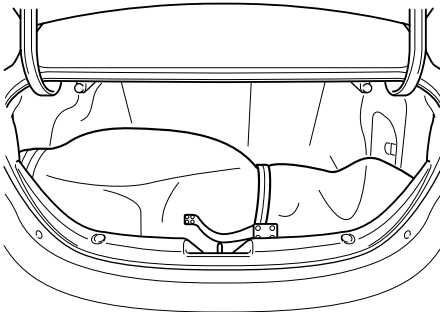

2. Place the second golf bag in the trunk with its bottom pointed to the left and fit it into the back of the trunk.

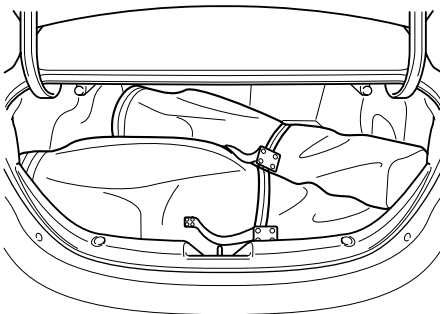
**NOTE**

*Some golf bags cannot fit depending on their size.*

## Inside Trunk Release Lever (4-Door)\*

Your vehicle is equipped with an inside trunk release lever that provides a means of escape for children and adults in the event they become locked inside the trunk.

No matter how careful adults might be with keys and locking their cars, parents should be aware that children may be tempted to play around vehicles and use the trunk as a hiding place.

Adults are advised to familiarize themselves with the operation and location of the inside trunk release lever so that all children can be told about it in an appropriate way, keeping in mind that most vehicles do not have such levers.

### **⚠ WARNING**

**Close the trunk lid, be sure the seat backs are latched and do not allow children to play inside the vehicle:**

*Leaving the trunk lid open or leaving children in the vehicle with the keys is dangerous. Children could open the trunk lid and climb inside resulting in possible injury or death from heat exposure.*

## Doors and Locks

---

**Always keep the car from being a tempting place to play by latching the rear seats, doors and the trunk, and keeping the keys where children can not play with them:**

*Leaving children or animals unattended in a parked vehicle is dangerous. Babies left sleeping and children who lock themselves in cars or trunks can die very quickly from heat prostration. Do not leave your children or pets alone in a car at any time. Do not leave the car, the rear folding seats or the trunk unlocked.*

### ▼ Opening the Trunk Lid from the Inside

Slide the inside trunk release lever in the direction of the arrow. The lever is made of material that will glow for hours in the darkness of the trunk following a brief exposure to ambient light.

The inside trunk release lever is located on the inside of the trunk lid.

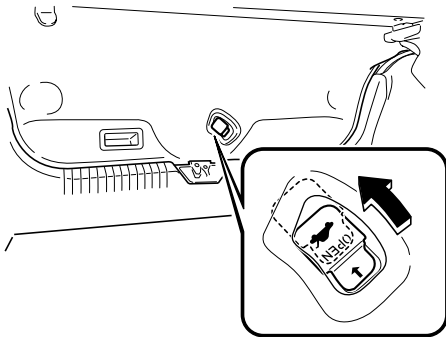

**Fuel and Engine Exhaust Precautions****▼ Fuel Requirements**

Vehicles with catalytic converters or oxygen sensors must use **ONLY UNLEADED FUEL**, which will reduce exhaust emissions and keep spark plug fouling to a minimum.

This vehicle will perform best with fuel listed in the table.

Fuel	Octane Rating* (Anti-knock index)
Regular unleaded fuel	87 [(R+M)/2 method] or above (91 RON or above)

\*U.S. federal law requires that octane ratings be posted on gasoline station pumps.

Fuel with a rating lower than 87 octane (91 RON) could cause the emission control system to lose effectiveness. It could also cause engine knocking and serious engine damage.

**⚠ CAUTION**

- *USE ONLY UNLEADED FUEL.*  
*Leaded fuel is harmful to the catalytic converter and oxygen sensors and will lead to deterioration of the emission control system and or failures.*
- *This vehicle can only use oxygenated fuels containing no more than 10 % ethanol by volume. Damage to the vehicle may occur when ethanol exceeds this recommendation, or if the gasoline contains any methanol. Stop using gasohol of any kind if your vehicle engine is performing poorly.*
- *Never add fuel system additives, otherwise the emission control system could be damaged. Consult an Authorized Mazda Dealer for details.*

Gasoline blended with oxygenates such as alcohol or ether compounds are generally referred to as oxygenated fuels. The common gasoline blend that can be used with your vehicle is ethanol blended at no more than 10 %. Gasoline containing alcohol, such as ethanol or methanol, may be marketed under the name "Gasohol".

Vehicle damage and drivability problems resulting from the use of the following may not be covered by the warranty.

- Gasohol containing more than 10 % ethanol.
- Gasoline or gasohol containing methanol.
- Leaded fuel or leaded gasohol.

## Fuel and Emission

---

### ▼ Emission Control System

This vehicle is equipped with an emission control system (the catalytic converter is part of this system) that enables the vehicle to comply with existing exhaust emissions requirements.

#### **WARNING**

##### **Never park over or near anything flammable:**

*Parking over or near anything flammable, such as dry grass, is dangerous. Even with the engine turned off, the exhaust system remains very hot after normal use and could ignite anything flammable. A resulting fire could cause serious injury or death.*

#### **CAUTION**

*Ignoring the following precautions could cause lead to accumulate on the catalyst inside the converter or cause the converter to get very hot. Either condition will damage the converter and cause poor performance.*

- *USE ONLY UNLEADED FUEL.*
- *Do not drive your Mazda with any sign of engine malfunction.*
- *Do not coast with the ignition switched off.*
- *Do not descend steep grades in gear with the ignition switched off.*
- *Do not operate the engine at high idle for more than 2 minutes.*
- *Do not tamper with the emission control system. All inspections and adjustments must be made by a qualified technician.*
- *Do not push-start or pull-start your vehicle.*

### **NOTE**

- *Under U.S. federal law, any modification to the original-equipment emission control system before the first sale and registration of a vehicle is subject to penalties. In some states, such modification made on a used vehicle is also subject to penalties.*
- *While the engine is off, the sound of a valve opening and closing can be heard at the rear of the right side of the vehicle, however this does not indicate an abnormality. The vehicle has a self-checking device and it operates while the engine is off.*

**▼ Engine Exhaust (Carbon monoxide)**** WARNING****Do not drive your vehicle if you smell exhaust gas inside the vehicle:**

*Engine exhaust gas is dangerous. This gas contains carbon monoxide (CO), which is colorless, odorless, and poisonous. When inhaled, it can cause loss of consciousness and death. If you smell exhaust gas inside the vehicle, keep all windows fully open and contact an Authorized Mazda Dealer immediately.*

**Do not run the engine when inside an enclosed area:**

*Running the engine inside an enclosed area, such as a garage, is dangerous. Exhaust gas, which contains poisonous carbon monoxide, could easily enter the cabin. Loss of consciousness or even death could occur.*

**Open the windows or adjust the heating or cooling system to draw fresh air when idling the engine:**

*Exhaust gas is dangerous. When the vehicle is stopped with the windows closed and the engine running for a long time even in an open area, exhaust gas, which contains poisonous carbon monoxide, could enter the cabin. Loss of consciousness or even death could occur.*

**Clear snow from underneath and around your vehicle, particularly the tail pipe, before starting the engine:**

*Running the engine when a vehicle is stopped in deep snow is dangerous. The exhaust pipe could be blocked by the snow, allowing exhaust gas to enter the cabin. Because exhaust gas contains poisonous carbon monoxide, it could cause loss of consciousness or even death to occupants in the cabin.*

## Fuel and Emission

### Fuel-Filler Lid and Cap

#### **! WARNING**

**When removing the fuel-filler cap, loosen the cap slightly and wait for any hissing to stop, then remove it:**

*Fuel spray is dangerous. Fuel can burn skin and eyes and cause illness if ingested. Fuel spray is released when there is pressure in the fuel tank and the fuel-filler cap is removed too quickly.*

**Before refueling, stop the engine, and always keep sparks and flames away from the filler neck:**

*Fuel vapor is dangerous. It could be ignited by sparks or flames causing serious burns and injuries. Additionally, use of the incorrect fuel-filler cap or not using a fuel-filler cap may result in a fuel leak, which could result in serious burns or death in an accident.*

**Do not continue refueling after the fuel pump nozzle shuts off automatically:**

*Continuing to add fuel after the fuel pump nozzle has shut off automatically is dangerous because overfilling the fuel tank may cause fuel overflow or leakage. Fuel overflow and leakage could damage the vehicle and if the fuel ignites it could cause a fire and explosion resulting in serious injury or death.*

#### **! CAUTION**

*Always use only a genuine Mazda fuel-filler cap or an approved equivalent, available at an Authorized Mazda Dealer. The wrong cap can result in a serious malfunction of the fuel and emission control systems. It may also cause the check engine light in the instrument cluster to illuminate.*

#### ▼ Fuel-Filler Lid

To open, pull the remote fuel-filler lid release.

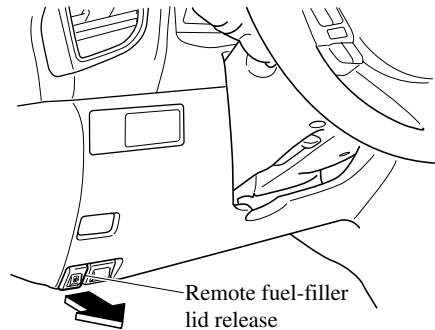



### ▼ Fuel-Filler Cap

To remove the fuel-filler cap, turn it counterclockwise.

Attach the removed cap to the inner side of the fuel lid.

To close the fuel-filler cap, turn it clockwise until a click is heard.

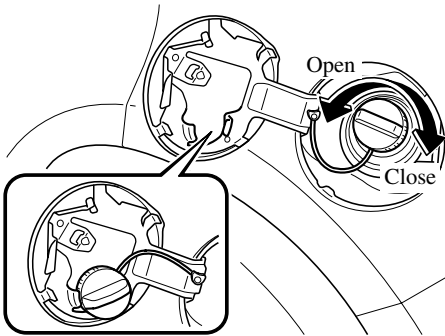

### **⚠ CAUTION**

*If the check fuel cap warning light illuminates, the fuel-filler cap may not be properly installed. If the warning light illuminates, park your vehicle safely off the right-of-way, remove the fuel-filler cap and reinstall it correctly. After the cap has been correctly installed, the fuel cap warning light may continue to illuminate until a number of driving cycles have been completed. A drive cycle consists of starting the engine (after four or more hours with the engine off) and driving the vehicle on city and highway roads. Continuing to drive with the check fuel cap warning light illuminated could cause the check engine light to illuminate as well.*

## Steering Wheel

### **! WARNING**

**Never adjust the steering wheel while the vehicle is moving:**

*Adjusting the steering wheel while the vehicle is moving is dangerous. Moving it can very easily cause the driver to abruptly turn to the left or right. This can lead to loss of control or an accident.*

### ▼ Steering Wheel Adjustment

To change the angle or length of the steering wheel:

1. Stop the vehicle, and then pull down the lock release lever under the steering column.

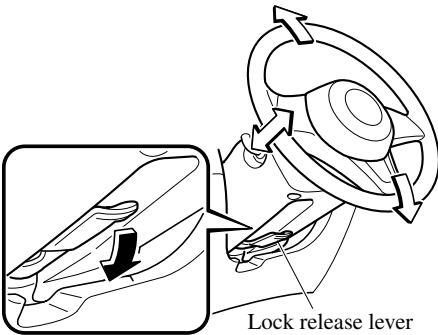

2. Tilt the steering wheel and/or adjust the steering column length to the desired positions, then push the lever up to lock the column.
3. Attempt to push the steering wheel up and down to make sure it's locked before driving.

## Mirrors

Before driving, adjust the inside and outside mirrors.

### ▼ Outside Mirrors

#### **! WARNING**

**Be sure to look over your shoulder before changing lanes:**

*Changing lanes without taking into account the actual distance of the vehicle in the convex mirror is dangerous. You could have a serious accident. What you see in the convex mirror is closer than it appears.*

#### Mirror type

##### **Flat type (driver's side)**

Flat surface mirror.

##### **Convex type (front passenger side)**

The mirror has single curvature on its surface.

#### Power mirror adjustment

The ignition must be switched to ACC or ON position.

To adjust:

1. Rotate the mirror switch to the left (L) or right (R) to choose the left or right side mirror.

2. Press the mirror switch in the appropriate direction.

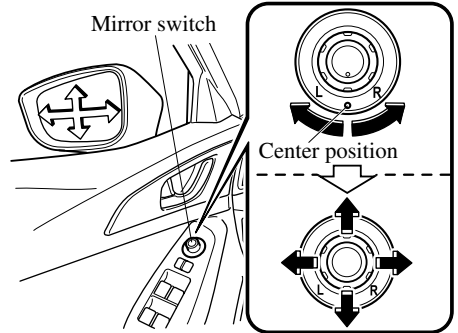

After adjusting the mirror, lock the control by rotating the switch in the center position.

#### Folding mirror

#### **! WARNING**

**Always return the outside mirrors to the driving position before you start driving:**

*Driving with the outside mirrors folded in is dangerous. Your rear view will be restricted, and you could have an accident.*

Fold the outside mirror rearward until it is flush with the vehicle.

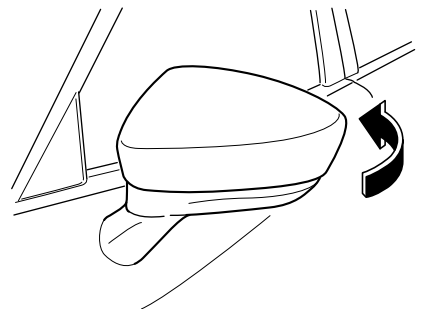

# Mirrors

## ▼ Rearview Mirror

### **⚠ WARNING**

**Do not stack cargo or objects higher than the seatbacks:**

*Cargo stacked higher than the seatbacks is dangerous. It can block your view in the rearview mirror, which might cause you to hit another car when changing lanes.*

### Rearview mirror adjustment

Before driving, adjust the rearview mirror to center on the scene through the rear window.

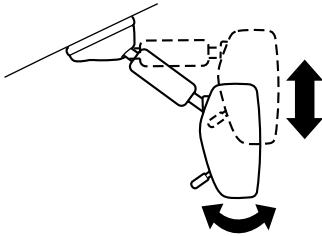

### **NOTE**

*For the manual day/night mirror, perform the adjustment with the day/night lever in the day position.*

## Reducing glare from headlights

### **Manual day/night mirror**

Push the day/night lever forward for day driving. Pull it back to reduce glare of headlights from vehicles at the rear.

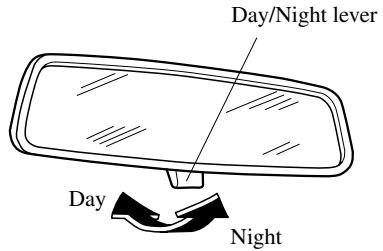

### **Auto-dimming mirror**

The auto-dimming mirror automatically reduces glare of headlights from vehicles at the rear when the ignition is switched ON.

### **(With Homelink wireless control system)**

Press the OFF button (O) to cancel the automatic dimming function. The indicator light will turn off.

To reactivate the automatic dimming function, press the ON button (I). The indicator light will illuminate.

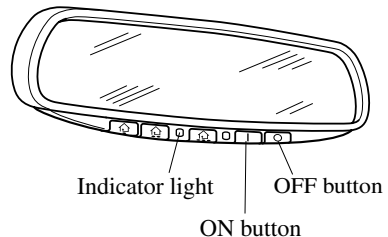

**(Without Homelink wireless control system)**

Press the ON/OFF button  to cancel the automatic dimming function. The indicator light will turn off.

To reactivate the automatic dimming function, press the ON/OFF button . The indicator light will illuminate.

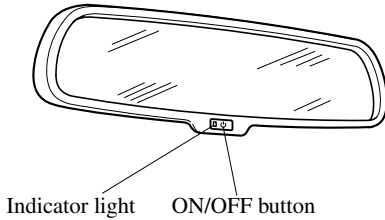

**NOTE**

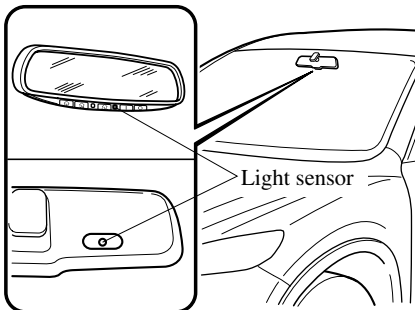

- Do not use glass cleaner or suspend objects on or around the light sensor. Otherwise, light sensor sensitivity will be affected and may not operate normally.  
**(With Homelink wireless control system)**

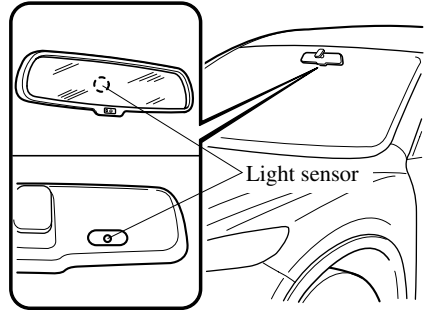

**(Without Homelink wireless control system)**



• **(With Homelink wireless control system)**

For information regarding the 3 buttons (, , ) on the auto-dimming mirror.

Refer to HomeLink Wireless Control System on page 4-58.

- The auto-dimmer function is canceled when the ignition is switched ON and the shift lever is in reverse (R).

## Power Windows

The ignition must be switched ON for the power windows to operate.

### **WARNING**

**Make sure the opening is clear before closing a window:**

*Closing a power window is dangerous. A person's hands, head, or even neck could be caught by the window and result in serious injury or even death. This warning applies especially to children.*

**Never allow children to play with power window switches:**

*Power window switches that are not locked with the power window lock switch would allow children to operate power windows unintentionally, which could result in serious injury if a child's hands, head or neck becomes caught by the window.*

### **CAUTION**

*To prevent burning out the fuse and damaging the power window system, do not open or close more than three windows at once.*

## ▼ Operating the Driver's Power Window

### Normal opening/closing

To open the window to the desired position, lightly hold down the switch. To close the window to the desired position, lightly pull up the switch.

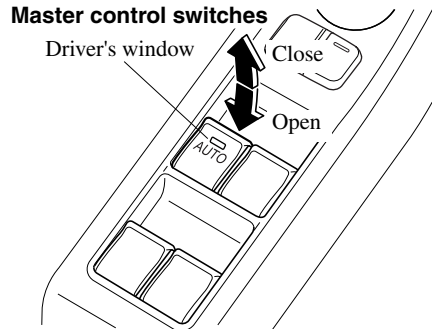

### Auto-opening/closing

To fully open the window automatically, press the switch completely down, then release. The window will fully open automatically.

To fully close the window automatically, pull the switch completely up, then release. The window will fully close automatically.

To stop the window partway, pull or press the switch in the opposite direction and then release it.

### **Power window system initialization procedure**

If the battery was disconnected during vehicle maintenance, or for other reasons (such as a switch continues to be operated after the window is fully open/closed), the window will not fully open and close automatically.

The power window auto function will only resume on a power window that has been reset.

1. Switch the ignition ON.
2. Make sure that the power window lock switch located on the driver's door is not depressed.
3. Press the switch and fully open the window.
4. Pull up the switch to fully close the window and continue holding the switch for about 2 seconds after the window fully closed.

### **Jam-safe window**

If a person's hands, head or an object blocks the window during the auto-closing operation, the window will stop and open halfway.



***Make sure nothing blocks the window just before it reaches the fully closed position or while holding up the power window switch:***

*Blocking the power window just before it reaches the fully closed position or while holding up the power window switch is dangerous.*

*In this case, the jam-safe function cannot prevent the window from closing all the way. If fingers are caught, serious injuries could occur.*

### ***NOTE***

- *Depending on driving conditions, a closing power window could stop and start opening when the window feels a shock that is similar to something blocking it.  
In the event the jam-safe function activates and the power window cannot be closed automatically, pull and hold the switch and the window will close.*
- *The jam-safe window function does not operate until the system has been reset.*

### **Engine-off power window operation**

The power window can be operated for about 40 seconds after the ignition is switched from ON to off with all doors closed. If any door is opened, the power window will stop operating.

### ***NOTE***

*For engine-off operation of the power window, the switch must be held up firmly throughout window closure because the auto-closing function will be inoperable.*

# Windows

## ▼ Operating the Passenger Power Windows

To open the window to the desired position, hold down the switch.

To close the window to the desired position, pull up the switch.

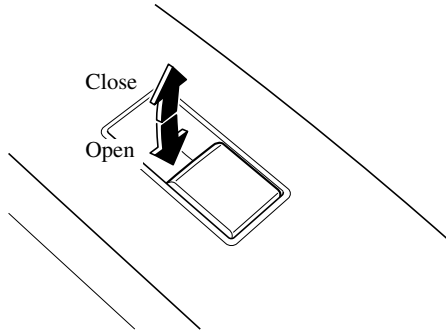

### NOTE

- The power windows may be operated when the power window lock switch on the driver's door is in the unlocked position.
- The passenger windows may be opened or closed using the master control switches on the driver's door.

### Master control switches

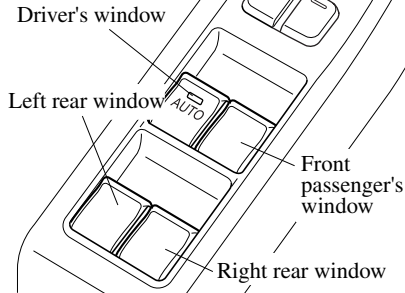

## ▼ Power Window Lock Switch

This feature prevents all power windows from operating, except the driver's power window. Keep this switch in the locked position while children are in the vehicle.

### Locked position (button depressed):

Only the driver's power window can be operated.

### Unlocked position (button not depressed):

All power windows on each door can be operated.

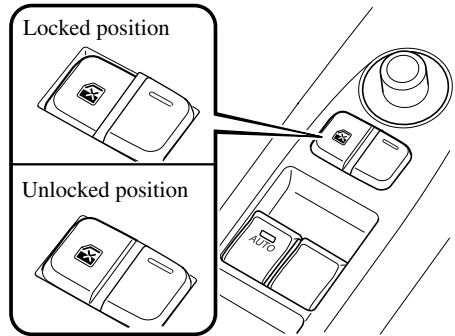



## Moonroof\*

The moonroof can be opened or closed electrically only when the ignition is switched ON.

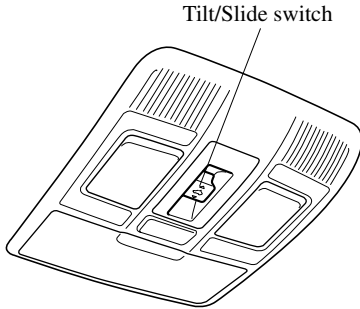

### **! WARNING**

**Do not let passengers stand up or extend part of the body through the open moonroof while the vehicle is moving:**

*Extending the head, arms, or other parts of the body through the moonroof is dangerous. The head or arms could hit something while the vehicle is moving. This could cause serious injury or death.*

**Make sure the opening is clear before closing the moonroof:**

*A closing moonroof is dangerous. The hands, head, or even neck of a person, especially a child, could be caught in it as it closes, causing serious injury or even death.*

### **NOTE**

*Before washing your Mazda, make sure the moonroof is completely closed so that water does not get inside the cabin area. After washing your Mazda or after it rains, wipe the water off the moonroof before operating it to avoid water penetration which could cause rust and water damage to your headliner.*

### **▼ Tilt Operation**

The rear of the moonroof can be tilted open to provide more ventilation.

To fully tilt automatically, momentarily press the tilt/slide switch.

To stop tilting partway, press the tilt/slide switch.

To close to the desired position, press the tilt/slide switch in the forward direction.

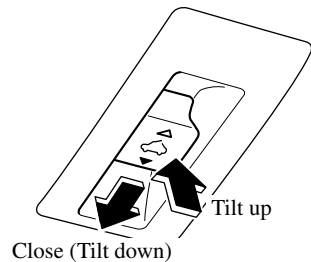

# Windows

## ▼ Slide Operation

To fully open automatically, momentarily press the tilt/slide switch in the backward direction.

To stop sliding partway, press the tilt/slide switch.

To close to the desired position, press the tilt/slide switch in the forward direction.

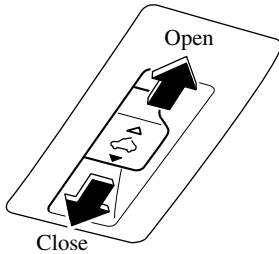

## ▼ Power Moonroof Reset Procedure

If the battery is disconnected, the moonroof will not operate. The moonroof will not operate correctly until it is reset. Carry out the following procedure to reset the moonroof and resume operation:

1. Switch the ignition ON.
2. Press the tilt switch, to partially tilt open the rear of the moonroof.
3. Repeat Step 2. The rear of the moonroof tilts open to the fully open position, then closes a little.

### **NOTE**

*If the reset procedure is performed while the moonroof is in the slide position (partially open) it will close before the rear tilt opens.*

## ▼ Sunshade

The sunshade can be opened and closed by hand.

The sunshade opens automatically when the moonroof is opened, but must be closed by hand.

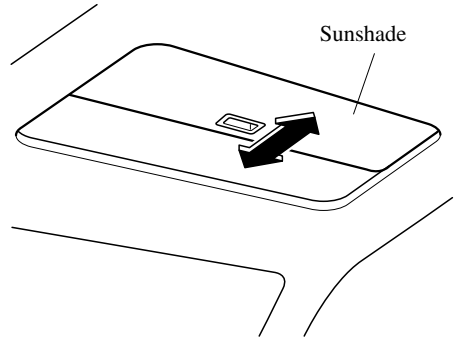

### **CAUTION**

- *The sunshade does not tilt. To avoid damaging the sunshade, do not push up on it.*
- *Do not close the sunshade while the moonroof is opening. Trying to force the sunshade closed could damage it.*

## Modification and Add-On Equipment

Mazda cannot guarantee the immobilizer and the theft-deterrent systems' operation if the system has been modified or if any add-on equipment has been installed.

### CAUTION

*To avoid damage to the vehicle, do not modify the system or install any add-on equipment to the immobilizer and the theft-deterrent systems or the vehicle.*

## Immobilizer System

The immobilizer system allows the engine to start only with a key the system recognizes.

If someone attempts to start the engine with an unrecognized key, the engine will not start, thereby helping to prevent the theft of the vehicle.

If you have a problem with the immobilizer system or the key, consult an Authorized Mazda Dealer.

### CAUTION

- *Radio equipment like this is governed by laws in the United States. Changes or modifications not expressly approved by the party responsible for compliance could void the user's authority to operate the equipment.*
- *To avoid damage to the key, do not:*
  - *Drop the key.*
  - *Get the key wet.*
  - *Expose the key to any kind of magnetic field.*
  - *Expose the key to high temperatures on places such as the dashboard or hood, under direct sunlight.*
- *If the engine does not start with the correct key, and the security indicator light keeps illuminating or flashing, the system may have a malfunction. Consult an Authorized Mazda Dealer.*

# Security System

---

## NOTE

- *The keys carry a unique electronic code. For this reason, and to assure your safety, obtaining a replacement key requires some waiting time. They are only available through an Authorized Mazda Dealer.*
- *Always keep a spare key in case one is lost. If a key is lost, consult an Authorized Mazda Dealer as soon as possible.*
- *If you lose a key, an Authorized Mazda Dealer will reset the electronic codes of your remaining keys and immobilizer system. Bring all the remaining keys to an Authorized Mazda Dealer to reset. Starting the vehicle with a key that has not been reset is not possible.*

## ▼ Operation

### NOTE

- *The engine may not start and security indicator light may illuminate or flash if the key is placed in an area where it is difficult for the system to detect the signal, such as on the dashboard or in the glove compartment. Move the key to a location within the signal range, switch the ignition off, and then restart the engine.*
- *Signals from a TV or radio station, or from a transceiver or mobile telephone could interfere with your immobilizer system. If you are using the proper key and the engine fails to start, check the security indicator light.*

## Arming

The system is armed when the push button start is pressed from ON to off.

The security indicator light in the instrument cluster flashes every 2 seconds until the system is disarmed.



## Disarming

The system is disarmed when the ignition is switched ON with the correct programmed key. The security indicator light illuminates for about 3 seconds and then turns off. If the engine does not start with the correct key, and the security indicator light remains illuminated or flashing, try the following:

Make sure the key is within the operational range for signal transmission. Switch the ignition off, and then restart the engine. If the engine does not start after 3 or more tries, contact an Authorized Mazda Dealer.

### NOTE

- *If the security indicator light flashes continuously while you are driving, do not shut off the engine. Go to an Authorized Mazda Dealer and have it checked. If the engine is shut off while the indicator light is flashing, you will not be able to restart it.*
- *Because the electronic codes are reset when the immobilizer system is repaired, the keys are needed. Make sure to bring all the keys to an Authorized Mazda Dealer so that they can be programmed.*

## Theft-Deterrent System\*

If the theft deterrent system detects an inappropriate entry into the vehicle, which could result in the vehicle or its contents being stolen, the alarm alerts the surrounding area of an abnormality by sounding the horn and flashing the hazard warning lights.

The system will not function unless it's properly armed. So when you leave the vehicle, follow the arming procedure correctly.

### ▼ Operation

#### System triggering conditions

The horn sounds intermittently and the hazard warning lights flash for about 30 seconds when the system is triggered by any one of the following:

- Unlocking a door with the key, door lock switch, or an inside door-lock knob.
- Forcing open a door, the hood or the liftgate/trunk lid.
- Opening the hood by operating the hood release handle.
- Switching the ignition ON without using the push button start.

If the system is triggered again, the lights and horn will activate until the driver's door or the liftgate/trunk lid is unlocked with the transmitter.

#### **(With advanced key)**

The lights and horn can also be deactivated by pressing the request switch on a door.

### NOTE

*If the battery goes dead while the theft-deterrent system is armed, the horn will activate and the hazard warning lights will flash when the battery is charged or replaced.*

### ▼ How to Arm the System

1. Close the windows and the moonroof\* securely.
2. Press the push button start off.
3. Make sure the hood, the doors, and the liftgate/trunk lid are closed.
4. Press the lock button on the transmitter or lock the driver's door from the outside with the auxiliary key. The hazard warning lights will flash once.

The following method will also arm the theft-deterrent system:

Press the door-lock switch “” while any door is open and then close all of the doors.

#### **(With the advanced keyless function)**

Press a request switch.

The security indicator light in the instrument panel flashes twice per second for 20 seconds.



5. After 20 seconds, the system is fully armed.

# Security System

---

## NOTE

- The theft deterrent system can also be armed by activating the auto relock function with all the doors, the liftgate/trunk lid and the hood closed. Refer to Transmitter on page 3-4.
- The system will disarm if one of the following operations takes place within 20 seconds after pressing the lock button:

- Unlocking any door.
- Opening any door or the liftgate/trunk lid.
- Opening the hood.
- Switching the ignition on.
- **(With the advanced keyless function)**  
Pressing the electric liftgate/trunk lid opener while the key is being carried.

To rearm the system, do the arming procedure again.

- When the doors are locked by pressing the lock button on the transmitter or using the auxiliary key while the theft-deterrent system is armed, the hazard warning lights will flash once to indicate that the system is armed.

## ▼ To Turn Off an Armed System

An armed system can be turned off using any one of the following methods:

- Pressing the unlock button on the transmitter.
- Switching the ignition ON.
- **(With the advanced keyless function)**
  - Pressing a request switch on the doors.

The hazard warning lights will flash twice.

## NOTE

When the doors are unlocked by pressing the unlock button on the transmitter while the theft-deterrent system is turned off, the hazard warning lights will flash twice to indicate that the system is turned off.

## ▼ To Stop the Alarm

A triggered alarm can be turned off using any one of the following methods:

- Pressing the unlock button on the transmitter.
- Starting the engine with the push button start.
- **(With the advanced keyless function)**
  - Pressing a request switch on the doors.
  - Pressing the electric liftgate/trunk lid opener while the key is being carried.

The hazard warning lights will flash twice.

## ▼ Theft-Deterrent Labels



A label indicating that your vehicle is equipped with a Theft-Deterrent System is in the glove compartment.

Mazda recommends that you affix it to the lower rear corner of a front door window.

## Break-In Period

No special break-in is necessary, but a few precautions in the first 1,000 km (600 miles) may add to the performance, economy, and life of the vehicle.

- Do not race the engine.
- Do not maintain one constant speed, either slow or fast, for a long period of time.
- Do not drive constantly at full-throttle or high engine rpm for extended periods of time.
- Avoid unnecessary hard stops.
- Avoid full-throttle starts.

## Saving Fuel and Protection of the Environment

How you operate your Mazda determines how far it will travel on a tank of fuel. Use these suggestions to help save fuel and reduce CO<sub>2</sub>.

- Avoid long warm-ups. Once the engine runs smoothly, begin driving.
- Avoid fast starts.
- Drive at lower speeds.
- Anticipate when to apply the brakes (avoid sudden braking).
- Follow the maintenance schedule (page 6-4) and have an Authorized Mazda Dealer perform inspections and servicing.
- Use the air conditioner only when necessary.
- Slow down on rough roads.
- Keep the tires properly inflated.
- Do not carry unnecessary weight.
- Do not rest your foot on the brake pedal while driving.
- Keep the wheels in correct alignment.
- Keep windows closed at high speeds.
- Slow down when driving in crosswinds and headwinds.

### WARNING

**Never stop the engine when going down a hill:**

*Stopping the engine when going down a hill is dangerous. This causes the loss of power steering and power brake control, and may cause damage to the drivetrain. Any loss of steering or braking control could cause an accident.*

## Driving Tips

### Hazardous Driving

#### **! WARNING**

**Be extremely careful if it is necessary to downshift on slippery surfaces:**

*Downshifting into lower gear while driving on slippery surfaces is dangerous. The sudden change in tire speed could cause the tires to skid. This could lead to loss of vehicle control and an accident.*

When driving on ice or in water, snow, mud, sand, or similar hazards:

- Be cautious and allow extra distance for braking.
- Avoid sudden braking and sudden maneuvering.
- Do not pump the brakes. Continue to press down on the brake pedal. Refer to Antilock Brake System (ABS) on page 4-78.
- If you get stuck, select a lower gear and accelerate slowly. Do not spin the front wheels.
- For more traction in starting on slippery surfaces such as ice or packed snow, use sand, rock salt, chains, carpeting, or other nonslip material under the front wheels.

#### **NOTE**

*Use snow chains only on the front wheels.*

### Floor Mat

#### **! WARNING**

**Make sure the floor mats are hooked on the retention pins to prevent them from bunching up under the foot pedals:**

*Using a floor mat that is not secured is dangerous as it will interfere with the accelerator and brake pedal operation, which could result in an accident.*

**Do not install two floor mats, one on top of the other, on the driver's side:**

*Installing two floor mats, one on top of the other, on the driver's side is dangerous as the retention pins can only keep one floor mat from sliding forward.*

*In using a heavy duty floor mat for winter use always remove the original floor mat.*

*Loose floor mat(s) will interfere with the foot pedal and could result in an accident.*

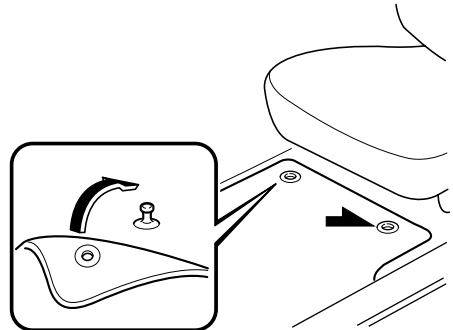

When setting a floor mat, position the floor mat so that its grommets are inserted over the pointed end of the retention posts.



## Rocking the Vehicle

### WARNING

**Do not spin the wheels at more than 56 km/h (35 mph), and do not allow anyone to stand behind a wheel when pushing the vehicle:**

*When the vehicle is stuck, spinning the wheels at high speed is dangerous. The spinning tire could overheat and explode. This could cause serious injuries.*

### CAUTION

*Too much rocking may cause engine overheating, transaxle failure, and tire damage.*

If you must rock the vehicle to free it from snow, sand or mud, depress the accelerator slightly and slowly move the shift lever from 1 (D) to R.

## Winter Driving

Carry emergency gear, including tire chains, window scraper, flares, a small shovel, jumper cables, and a small bag of sand or salt.

Ask an Authorized Mazda Dealer to check the following:

- Have the proper ratio of antifreeze in the radiator.  
Refer to Engine Coolant on page 6-29.
- Inspect the battery and its cables. Cold reduces battery capacity.
- Use an engine oil appropriate for the lowest ambient temperatures that the vehicle will be driven in (page 6-27).
- Inspect the ignition system for damage and loose connections.
- Use washer fluid made with antifreeze—but do not use engine coolant antifreeze for washer fluid (page 6-31).

### NOTE

- *Do not use the parking brake in freezing weather as it may freeze. Instead, shift to P with an automatic transaxle and to 1 or R with a manual transaxle. Block the rear wheels.*
- *Remove snow before driving. Snow left on the windshield is dangerous as it could obstruct vision.*
- *Do not apply excessive force to a window scraper when removing ice or frozen snow on the mirror glass and windshield.*

## Driving Tips

---

- *Never use warm or hot water for removing snow or ice from windows and mirrors as it could result in the glass cracking.*
- *Drive slowly. Braking performance can be adversely affected if snow or ice adheres to the brake components. If this situation occurs, drive the vehicle slowly, releasing the accelerator pedal and lightly applying the brakes several times until the brake performance returns to normal.*

### ▼ Snow Tires

#### **Use snow tires on all four wheels**

Do not go faster than 120 km/h (75 mph) while driving with snow tires. Inflate snow tires 30 kPa (0.3 kgf/cm<sup>2</sup>, 4.3 psi) more than recommended on the tire pressure label (driver's door frame), but never more than the maximum cold-tire pressure shown on the tires.

The vehicle is originally equipped with all season radials designed to be used all year around. In some extreme climates you may find it necessary to replace them with snow tires during the winter months to further improve traction on snow and ice covered roads.

### **! WARNING**

**Use only the same size and type tires (snow, radial, or non-radial) on all four wheels:**

*Using tires different in size or type is dangerous. Your vehicle's handling could be greatly affected and result in an accident.*

### **! CAUTION**

*Check local regulations before using studded tires.*

### ▼ Tire Chains

Check local regulations before using tire chains.

### **! CAUTION**

- *Chains may affect handling.*
- *Do not go faster than 50 km/h (30 mph) or the chain manufacturer's recommended limit, whichever is lower.*
- *Drive carefully and avoid bumps, holes, and sharp turns.*
- *Avoid locked-wheel braking.*
- *Do not use chains on a temporary spare tire; it may result in damage to the vehicle and to the tire.*
- *Do not use chains on roads that are free of snow or ice. The tires and chains could be damaged.*
- *Chains may scratch or chip aluminum wheels.*

### **NOTE**

*The tire pressure monitoring system may not function correctly when using tire chains.*

Install the chains on the front tires only. Do not use chains on the rear tires. Please consult an Authorized Mazda Dealer.

### **Installing the chains**

1. If your vehicle is equipped with wheel covers remove them, otherwise the chain bands will scratch them.
2. Secure the chains on the front tires as tightly as possible.  
Always follow the chain manufacturer's instructions.
3. Retighten the chains after driving 1/2—1 km (1/4—1/2 mile).

### **Driving In Flooded Area**

#### **WARNING**

***Dry off brakes that have become wet by driving slowly, releasing the accelerator pedal and lightly applying the brakes several times until the brake performance returns to normal:***

*Driving with wet brakes is dangerous. Increased stopping distance or the vehicle pulling to one side when braking could result in a serious accident. Light braking will indicate whether the brakes have been affected.*

#### **CAUTION**

*Do not drive the vehicle on flooded roads as it could cause short circuiting of electrical/electronic parts, or engine damage or stalling from water absorption. If the vehicle has been immersed in water, consult an Authorized Mazda Dealer.*

## Overloading

### **WARNING**

**Be careful not to overload your vehicle:**

*The gross axle weight rating (GAWR) and the gross vehicle weight rating (GVWR) of the vehicle are on the Motor Vehicle Safety Standard Label on the driver's door frame. Exceeding these ratings can cause an accident or vehicle damage. You can estimate the weight of the load by weighing the items (or people) before putting them in the vehicle.*

## Driving on Uneven Road

Your vehicle's suspension and underbody can be damaged if driven on rough/uneven roads or over speed bumps at excessive speeds. Use care and reduce speed when traveling on rough/uneven roads or over speed bumps.

Use care not to damage the vehicle's underbody, bumpers or muffler(s) when driving under the following conditions:

- Ascending or descending a slope with a sharp transition angle
- Ascending or descending a driveway or trailer ramp with a sharp transition angle

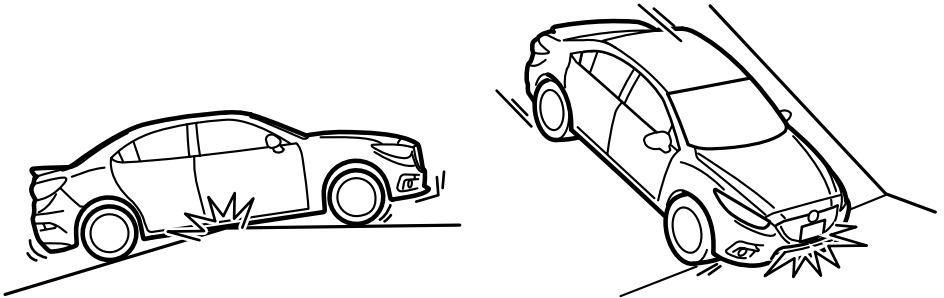

This vehicle is equipped with low profile tires allowing class-leading performance and handling. As a result, the sidewall of the tires are very thin and the tires and wheels can be damaged if driven through potholes or on rough/uneven roads at excessive speeds. Use care and reduce speed when traveling on rough/uneven roads or through potholes.

# Towing

---

## Trailer Towing

Your Mazda is not designed for towing.  
Never tow a trailer with your Mazda.

## Recreational Towing

An example of "recreational towing" is towing your vehicle behind a motorhome. The transaxle is not designed for towing this vehicle on all 4 wheels.

When doing recreational towing refer to "Towing Description" (page 7-21) and "Tiedown Hooks" (page 7-22) and carefully follow the instructions.

# 4

## When Driving

Information concerning safe driving and stopping.

<b>Start/Stop Engine</b> .....	<b>4-4</b>	<b>Radar Sensor</b> .....	<b>4-64</b>
Ignition Switch.....	4-4	Radar Sensor.....	4-64
Starting the Engine.....	4-5	<b>Brake</b> .....	<b>4-67</b>
Turning the Engine Off.....	4-10	Brake System.....	4-67
<b>Instrument Cluster and Display</b> .....	<b>4-11</b>	Hill Launch Assist (HLA).....	4-69
Meters and Gauges.....	4-11	Smart City Brake Support	
Active Driving Display*.....	4-18	(SCBS)*.....	4-71
Warning/Indicator Lights.....	4-20	<b>ABS/TCS/DSC</b> .....	<b>4-78</b>
<b>Transaxle</b> .....	<b>4-26</b>	Antilock Brake System (ABS).....	4-78
Manual Transaxle Operation.....	4-26	Traction Control System (TCS).....	4-79
Automatic Transaxle Controls.....	4-29	Dynamic Stability Control	
<b>Switches and Controls</b> .....	<b>4-40</b>	(DSC).....	4-80
Lighting Control.....	4-40	<b>i-ELOOP</b> .....	<b>4-82</b>
High Beam Control System		i-ELOOP*.....	4-82
(HBC)*.....	4-47	<b>Fuel Economy Monitor</b> .....	<b>4-85</b>
Fog Lights*.....	4-50	Fuel Economy Monitor*.....	4-85
Turn and Lane-Change Signals.....	4-50	<b>Drive Selection</b> .....	<b>4-87</b>
Windshield Wipers and Washer.....	4-51	Drive Selection*.....	4-87
Rear Window Wiper and		<b>Power Steering</b> .....	<b>4-89</b>
Washer*.....	4-55	Power Steering.....	4-89
Rear Window Defogger.....	4-56	<b>Mazda Radar Cruise Control</b>	
Horn.....	4-57	<b>(MRCC)</b> .....	<b>4-90</b>
Hazard Warning Flasher.....	4-58	Mazda Radar Cruise Control	
HomeLink Wireless Control		(MRCC)*.....	4-90
System*.....	4-58		
<b>Forward Sensing Camera</b> .....	<b>4-62</b>		
Forward Sensing Camera*.....	4-62		

---

<b>Cruise Control</b> .....	<b>4-99</b>
Cruise Control* .....	4-99
<b>Tire Pressure Monitoring System</b> .....	<b>4-103</b>
Tire Pressure Monitoring System* .....	4-103
<b>Blind Spot Monitoring (BSM) System</b> .....	<b>4-107</b>
Blind Spot Monitoring (BSM) System* .....	4-107
<b>Forward Obstruction Warning (FOW)</b> .....	<b>4-115</b>
Forward Obstruction Warning (FOW)* .....	4-115
<b>Lane Departure Warning System (LDWS)</b> .....	<b>4-118</b>
Lane Departure Warning System (LDWS)* .....	4-118
<b>Rear View Monitor</b> .....	<b>4-124</b>
Rear View Monitor* .....	4-124



# MEMO

# Start/Stop Engine

## Ignition Switch

### ▼ Push Button Start Positions

The system operates only when the driver is in the vehicle or within operational range while the key is being carried. Each time the push button start is pressed, the ignition switches in the order of off, ACC, and ON. Pressing the push button start again from ON switches the ignition off.

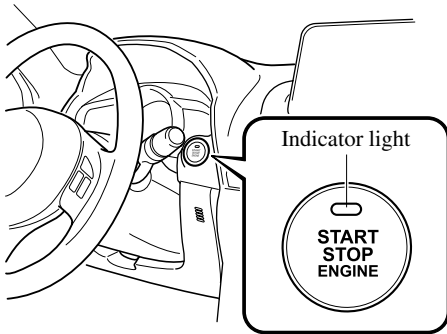

### NOTE

- The engine starts by pressing the push button start while depressing the clutch pedal (manual transaxle) or the brake pedal (automatic transaxle). To switch the ignition position, press the push button start without depressing the pedal.
- Do not leave the ignition switched ON while the engine is not running. Doing so could result in the battery going dead. If the ignition is left in ACC (For automatic transaxle, the selector lever is in the P position, and the ignition is in ACC), the ignition switches off automatically after about 25 minutes.

### Off

The power supply to electrical devices turns off and the push button start indicator light (amber) also turns off. In this position the steering wheel is locked.

### ⚠ WARNING

**Before leaving the driver's seat, always switch the ignition off, set the parking brake, and make sure the selector lever is in P (automatic transaxle) or in 1st gear or R (manual transaxle):**

*Leaving the driver's seat without switching the ignition off, setting the parking brake, and shifting the selector lever to P (automatic transaxle) or to 1st gear or R (manual transaxle) is dangerous. Unexpected vehicle movement could occur which could result in an accident.*

*In addition, if your intention is to leave the vehicle for even a short period, it is important to switch the ignition off, as leaving it in another position will disable some of the vehicle's security systems and run the battery down.*

### ACC (Accessory)

Some electrical accessories will operate and the indicator light (amber) illuminates.

### NOTE

*The keyless entry system does not function while the push button start has been pressed to ACC, and the doors will not lock/unlock even if they have been locked manually.*

**ON**

This is the normal running position after the engine is started. The indicator light (amber) turns off. (The indicator light (amber) illuminates when the ignition is switched ON and the engine is not running.)

Some indicator lights/warning lights should be inspected before the engine is started (page 4-20).

**NOTE**

*When the push button start is pressed to ON, the sound of the fuel pump motor operating near the fuel tank can be heard. This does not indicate an abnormality.*

**Starting the Engine****⚠ WARNING****Radio waves from the key may affect medical devices such as pacemakers:**

*Before using the key near people who use medical devices, ask the medical device manufacturer or your physician if radio waves from the key will affect the device.*

**NOTE**

- *The key must be carried because the key carries an immobilizer chip that must communicate with the engine controls at short range.*
- *The engine can be started when the push button start is pressed from off, ACC, or ON.*
- *The push button start system functions (function which can start the engine by only carrying the key) can be deactivated to prevent any possible adverse effect on a user wearing a pacemaker or other medical device. If the system is deactivated, you will be unable to start the engine by carrying the key. Consult an Authorized Mazda Dealer for details. If the push button start system functions have been deactivated, you can start the engine by following the procedure indicated when the key battery goes dead. Refer to Engine Start Function When Key Battery is Dead on page 4-8.*

# Start/Stop Engine

- After starting a cold engine, the engine speed increases and a whining sound from the engine compartment can be heard.  
*This is for improved exhaust gas purification and does not indicate defect of the parts.*
- Engine-starting is controlled by the spark ignition system.  
*This system meets all Canadian Interference-Causing Equipment Standard requirements regulating the impulse electrical field strength of radio noise.*

1. Make sure you are carrying the key.
2. Occupants should fasten their seat belts.
3. Make sure the parking brake is on.
4. Continue to press the brake pedal firmly until the engine has completely started.
5. **(Manual transaxle)**  
Continue to press the clutch pedal firmly until the engine has completely started.  
**(Automatic transaxle)**  
Put the vehicle in park (P). If you must restart the engine while the vehicle is moving, shift into neutral (N).

## NOTE

### **(Manual transaxle)**

The starter will not operate if the clutch pedal is not depressed sufficiently.

### **(Automatic transaxle)**

The starter will not operate if the selector lever is not in P or N and the brake pedal is not depressed sufficiently.

6. Verify that the KEY indicator light (green) in the instrument cluster and the push button start indicator light (green) illuminate.

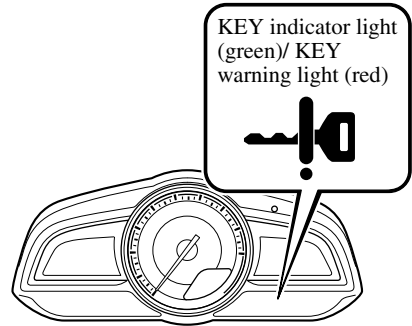
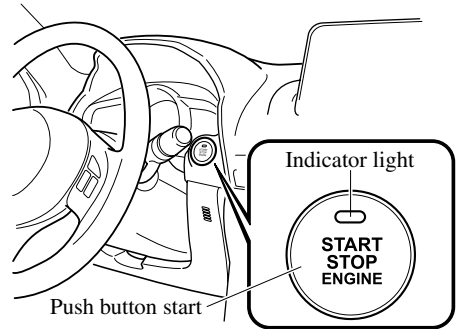

## NOTE

- If the push button start indicator light (green) flashes, make sure that the key is being carried.
- If the push button start indicator light (green) flashes with the key being carried, touch the key to the push button start and start the engine. Refer to Engine Start Function When Key Battery is Dead on page 4-8.

**⚠ CAUTION**

If the KEY warning light (red) illuminates, or the push button start indicator light (amber) flashes, this could indicate a problem with the engine starting system and the inability to start the engine or switch the ignition to ACC or ON. Have your vehicle inspected at an Authorized Mazda Dealer as soon as possible.

**NOTE**

- Under the following conditions, the KEY warning light (red) flashes after the push button start is pressed to inform the driver that the push button start will not switch to ACC even if it is pressed from off.
    - The key battery is dead.
    - The key is out of operational range.
    - The key is placed in areas where it is difficult for the system to detect the signal (page 3-7).
    - A key from another manufacturer similar to the key is in the operational range.
  - **(Forced engine starting method)**  
If the KEY warning light (red) illuminates, or the push button start indicator light (amber) flashes, this could indicate that the engine may not start using the usual starting method. Have your vehicle inspected at an Authorized Mazda Dealer as soon as possible. If this occurs, the engine can be force-started. Press and hold the push button start until the engine starts. Other procedures necessary for starting the engine such as having the key in the cabin, and depressing the clutch pedal (manual transaxle) or the brake pedal (automatic transaxle) are required.
  - When the engine is force-started, the KEY warning light (red) remains illuminated and the push button start indicator light (amber) remains flashing.
  - **(Automatic transaxle)**  
When the selector lever is in the neutral (N) position, the KEY indicator light (green) and the push button start indicator light (green) do not illuminate.
7. Press the push button start after both the KEY indicator light (green) in the instrument cluster and the push button start indicator light (green) illuminate.
- NOTE**
- After starting the engine, the push button start indicator light (amber) turns off and the ignition switches to the ON position.
  - After pressing the push button start and before the engine starts, the operation sound of the fuel pump motor from near the fuel tank can be heard, however, this does not indicate a malfunction.
8. After starting the engine, let it idle for about ten seconds.

## Start/Stop Engine

---

### NOTE

- Whether the engine is cold or warm, it should be started without the use of the accelerator.
- If the engine does not start the first time, refer to *Starting a Flooded Engine under Emergency Starting*. If the engine still does not start, have your vehicle inspected by an Authorized Mazda Dealer (page 7-18).

### ▼ Engine Start Function When Key Battery is Dead

#### CAUTION

When starting the engine by holding the transmitter over the push button start due to a dead key battery or a malfunctioning key, be careful not to allow the following, otherwise the signal from the key will not be received correctly and the engine may not start.

- Metal parts of other keys or metal objects touch the key.



- Spare keys or keys for other vehicles equipped with an immobilizer system touch or come near the key.



- Devices for electronic purchases, or security passage touch or come near the key.

If the engine cannot be started due to a dead key battery, the engine can be started using the following procedure:

1. Depress the brake pedal firmly.
2. **(Manual transaxle)**  
Continue to depress the clutch pedal firmly until the engine has completely started.
3. Verify that the push button start indication light (green) flashes.

### NOTE

The push button start indicator light (green) will flash even if the push button start is pressed before depressing the brake pedal (automatic transaxle) or the clutch pedal (manual transaxle). If the clutch pedal is depressed (manual transaxle) or the brake pedal is depressed (automatic transaxle) under this condition, the engine can be started by resuming the procedure following this.

## Start/Stop Engine

4. Touch the push button start using the backside of the key (as shown) while the push button start indicator light (green) flashes.

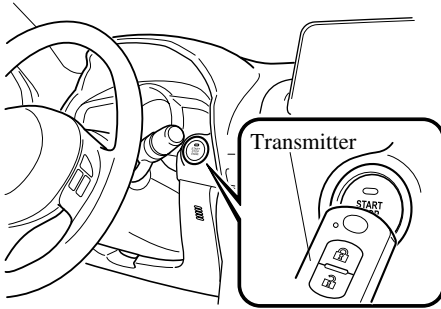

### NOTE

When touching the push button start using the backside of the key as shown in the illustration, touch the push button start with the lock switch side of the key facing up.

5. Verify that the push button start indicator light (green) turns on.
6. Press the push button start to start the engine.

### NOTE

- The engine cannot be started unless the clutch pedal is fully depressed (manual transaxle) or the brake pedal is fully depressed (automatic transaxle).
- If there is a malfunction with the push button start function, the push button start indicator light (amber) flashes. In this case, the engine may start, however, have the vehicle checked at an Authorized Mazda Dealer as soon as possible.

- If the push button start indicator light (green) does not illuminate, perform the operation from the beginning again. If it does not illuminate, have the vehicle checked at an Authorized Mazda Dealer.
- To switch the ignition position without starting the engine, perform the following operations after the push button start indicator light (green) turns on.
  1. Release the clutch pedal (manual transaxle) or brake pedal (automatic transaxle).
  2. Press the push button start to switch the ignition position. The ignition switches in the order of ACC, ON, and off each time the push button start is pressed. To switch the ignition position again, perform the operation from the beginning.

### ▼ Emergency Operation for Starting the Engine

If the KEY warning light (red) illuminates, or the push button start indicator light (amber) flashes, this could indicate that the engine may not start using the usual starting method. Have your vehicle inspected at an Authorized Mazda Dealer as soon as possible. If this occurs, the engine can be force-started. Press and hold the push button start until the engine starts. Other procedures necessary for starting the engine such as having the key in the cabin, and depressing the clutch pedal (manual transaxle) or the brake pedal (automatic transaxle) are required.

# Start/Stop Engine

---

## Turning the Engine Off

### **WARNING**

**Do not stop the engine while the vehicle is moving:**

*Stopping the engine while the vehicle is moving for any reason other than in an emergency is dangerous. Stopping the engine while the vehicle is moving will result in reduced braking ability due to the loss of power braking, which could cause an accident and serious injury.*

1. Stop the vehicle completely.
2. **(Manual transaxle)**  
Shift into neutral and set the parking brake.  
**(Automatic transaxle)**  
Shift the selector lever to the P position and set the parking brake.
3. Press the push button start to turn off the engine. The ignition position is off.

### **CAUTION**

*When leaving the vehicle, make sure the push button start is off.*

### **NOTE**

- *The cooling fan in the engine compartment could turn on for a few minutes after the ignition is switched from ON to OFF, whether or not the A/C is on or off, to cool the engine compartment quickly.*
- *When the push button start is pressed from ON to ACC or OFF, the KEY indicator light (green) may flash for approximately 30 seconds indicating that the remaining battery power of the key is low.  
Replace with a new battery before the key becomes unusable.  
Refer to Battery Replacement on page 6-39.*
- **(Automatic transaxle)**  
*If the engine is turned off while the selector lever is in a position other than P, the ignition switches to ACC.*

### **Emergency Engine Stop**

Continuously pressing the push button start or quickly pressing it any number of times while the engine is running or the vehicle is being driven will turn the engine off immediately. The ignition switches to ACC.



# Instrument Cluster and Display

## Meters and Gauges

### Instrument Cluster

#### Type A

(Digital Speed Meter Type)

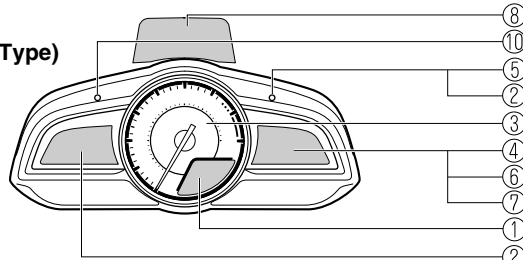

#### Type B

(Analog Speed Meter Type (With Tachometer))

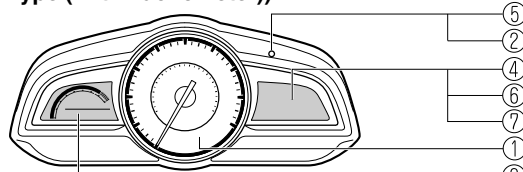

#### Type C

(Analog Speed Meter Type (Without Tachometer))

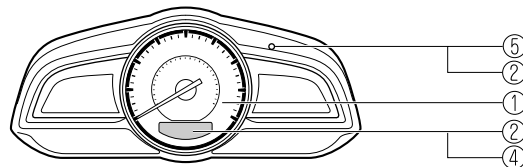

### Steering Switch \*

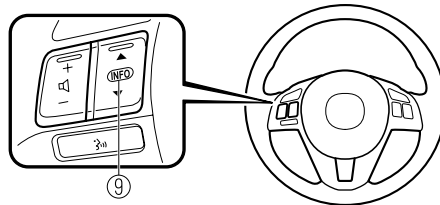

\*Some models.

① Speedometer.....	page 4-12
② Odometer, Trip Meter and Trip Meter Selector .....	page 4-12
③ Tachometer.....	page 4-13
④ Fuel Gauge .....	page 4-14
⑤ Dashboard Illumination.....	page 4-15
⑥ Outside Temperature Display.....	page 4-15
⑦ Cruise Control Set Vehicle Speed Display.....	page 4-16
⑧ Active Driving Display .....	page 4-18

# Instrument Cluster and Display

⑨ Trip Computer and INFO Switch..... page 4-16

⑩ Speed Unit Selector..... page 4-12

## ▼ Speedometer

The speedometer indicates the speed of the vehicle.

## ▼ Speed Unit Selector (Type A Instrument Cluster)

In some countries, you may have to change the speed units between km/h and mph.

Press the speed unit selector for 1.5 seconds or more.

The speed units for the speedometer will change between km/h and mph.

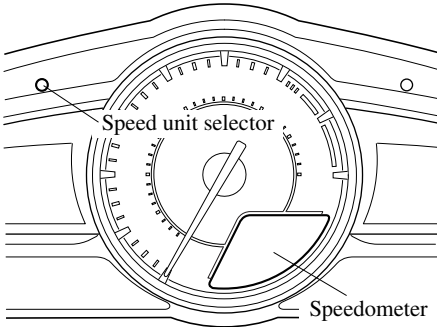

## ▼ Odometer, Trip Meter and Trip Meter Selector

The display mode can be changed from odometer to trip meter A to trip meter B and then back to odometer by pressing the selector while one of them is displayed.

The selected mode will be displayed.

### Type A/Type B

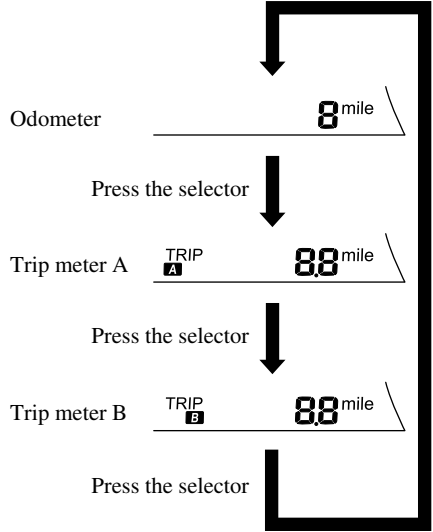

### Type C

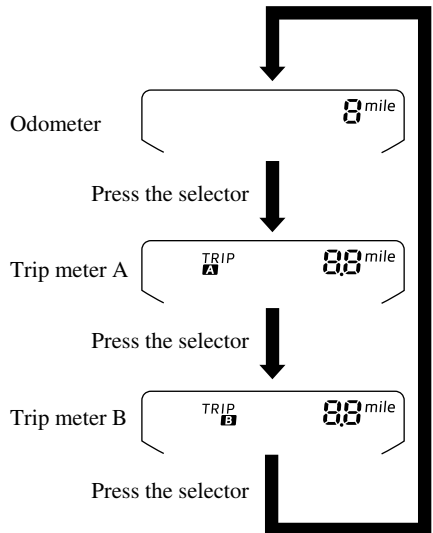

# Instrument Cluster and Display

## NOTE

When the ignition is switched to ACC or off, the odometer or trip meters cannot be displayed, however, pressing the selector can inadvertently switch the trip meters or reset them during an approximate ten-minute period in the following cases:

- After the ignition is switched to off from ON.
- After the driver's door is opened.

## Odometer

The odometer records the total distance the vehicle has been driven.

## Trip meter

The trip meter can record the total distance of two trips. One is recorded in trip meter A, and the other is recorded in trip meter B.

For instance, trip meter A can record the distance from the point of origin, and trip meter B can record the distance from where the fuel tank is filled.

When trip meter A is selected, pressing the selector again within one second will change to trip meter B mode.

When trip meter A is selected, TRIP A will be displayed. When trip meter B is selected, TRIP B will be displayed.

The trip meter records the total distance the vehicle is driven until the meter is again reset. Return it to "0.0" by depressing and holding the selector for one second or more. Use this meter to measure trip distances and to compute fuel consumption.

## NOTE

### • (Vehicles with type B audio)

If the fuel economy data is reset using the fuel economy monitor, or trip A is reset using the trip meter when the function which synchronizes the fuel economy monitor and the trip meter is on, the fuel economy data and trip A are reset simultaneously.

Refer to Fuel Economy Monitor on page 4-85.

- Only the trip meters record tenths of kilometers (miles).
- The trip record will be erased when:
  - The power supply is interrupted (blown fuse or the battery is disconnected).
  - The vehicle is driven over 9999.9 km (mile).

## ▼ Tachometer\*

The tachometer shows engine speed in thousands of revolutions per minute (rpm).



Do not run the engine with the tachometer needle in the RED ZONE. This may cause severe engine damage.

### Type A

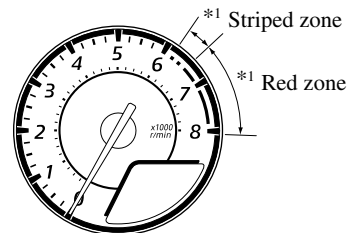

\*1 The range varies depending on the type of gauge.

# Instrument Cluster and Display

## Type B

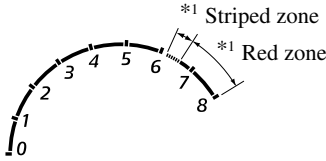

\*1 The range varies depending on the type of gauge.

### NOTE

When the tachometer needle enters the STRIPED ZONE, this indicates to the driver that the gears should be shifted before entering the RED ZONE.

## ▼ Fuel Gauge

The fuel gauge shows approximately how much fuel is remaining in the tank when the ignition is switched ON. We recommend keeping the tank over 1/4 full.

### Type A/Type B

Full



1/4 Full



## Type C

Full



1/4 Full



If the low fuel warning light illuminates or the fuel level is very low, refuel as soon as possible.

Refer to Warning/Indicator Lights on page 4-20.

### NOTE

- After refueling, it may require some time for the indicator to stabilize. In addition, the indicator may deviate while driving on a slope or curve since the fuel moves in the tank.
- The display indicating a quarter or less remaining fuel has more segments to show the remaining fuel level in greater detail.
- The direction of the arrow (←) indicates that the fuel-filler lid is on the left side of the vehicle.

# Instrument Cluster and Display

## ▼ Dashboard Illumination

If the light switch is turned to the ☰ or ☷ position with the ignition switched ON, the brightness of instrument panel illumination is dimmed. If the knob is rotated at this time, the brightness of instrument panel and dashboard illuminations can be adjusted.

- The brightness decreases by rotating the knob to the left. A beep sound will be heard when the knob has been rotated to the maximum dim position.
- The brightness increases by rotating the knob to the right.

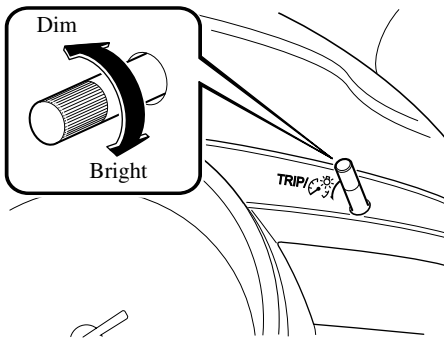

### Function for cancelling illumination dimmer

The illumination dimmer can be cancelled by rotating the knob to the right until a beep sound is heard while the light switch is in the ☰ or ☷ position with the ignition switched ON. If the instrument cluster's visibility is reduced due to glare from surrounding brightness, cancel the illumination dimmer.

## NOTE

- When the illumination dimmer is cancelled, the instrument cluster cannot be dimmed even if the light switch is turned to the ☰ or ☷ position.
- When the illumination dimmer is cancelled, the screen in the center display switches to constant display of the daytime screen.

## ▼ Outside Temperature Display\*

When the ignition is switched ON, the outside temperature is displayed.

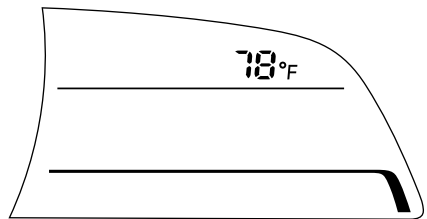

## NOTE

Under the following conditions, the outside temperature display may differ from the actual outside temperature depending on the surroundings and vehicle conditions:

- Significantly cold or hot temperatures.
- Sudden changes in outside temperature.
- The vehicle is parked.
- The vehicle is driven at low speeds.

## Instrument Cluster and Display

The outside temperature unit can be switched between Celsius and Fahrenheit using the following procedure.

1. Press the INFO button with the ignition switched off and continue pressing the INFO button for 5 seconds or longer while switching the ignition ON. The outside temperature display flashes.
2. Press the up ▲ or down ▼ part of the INFO switch to change the outside temperature unit.
3. Press and hold the INFO button for 3 seconds or longer while the outside temperature display is flashing. The outside temperature display illuminates.

### ▼ Cruise Control Set Vehicle Speed Display\*

The vehicle speed preset using the cruise control is displayed.

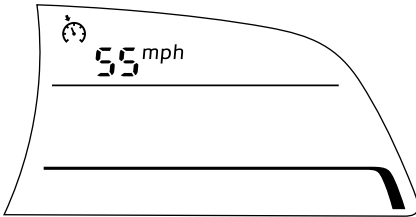

### ▼ Trip Computer and INFO Switch\*

The following information can be selected by pressing the up ▲ or down ▼ part of the INFO switch with the ignition switched ON.

- Approximate distance you can travel on the available fuel
- Average fuel economy
- Current fuel economy
- Average vehicle speed

If you have any problems with your trip computer, consult an Authorized Mazda Dealer.

#### Distance-to-empty mode

This mode displays the approximate distance you can travel on the remaining fuel based on the fuel economy.

The distance-to-empty will be calculated and displayed every second.

RANGE  
100 miles

#### **NOTE**

- *Even though the distance-to-empty display may indicate a sufficient amount of remaining driving distance before refueling is required, refuel as soon as possible if the fuel level is very low or the low fuel warning light illuminates.*
- *The display may not change unless you add more than approximately 9 L (2.3 US gal, 1.9 Imp gal) of fuel.*
- *The distance-to-empty is the approximate remaining distance the vehicle can be driven until all the graduation marks in the fuel gauge (indicating the remaining fuel supply) disappear.*

# Instrument Cluster and Display

## Average fuel economy mode

This mode displays the average fuel economy by calculating the total fuel consumption and the total traveled distance since purchasing the vehicle, re-connecting the battery after disconnection, or resetting the data. The average fuel economy is calculated and displayed every minute.

AVG

22.4 mpg

To clear the data being displayed, press the INFO button for more than 1.5 seconds. After pressing the INFO button, - - - L/100 km (- - - mpg) will be displayed for about 1 minute before the fuel economy is recalculated and displayed.

## Current fuel economy mode

This mode displays the current fuel economy by calculating the amount of fuel consumption and the distance traveled.

Current fuel economy will be calculated and displayed every 2 seconds.

CURRENT

19.7 mpg

When you've slowed to about 5 km/h (3 mph), - - - L/100 km (- - - mpg) will be displayed.

## Average vehicle speed mode

This mode displays the average vehicle speed by calculating the distance and the time traveled since connecting the battery or resetting the data.

Average vehicle speed will be calculated and displayed every 10 seconds.

AVG

25 mph

To clear the data being displayed, press the INFO button for more than 1.5 seconds. After pressing the INFO button, - - - km/h (- - - mph) will be displayed for about 1 minute before the vehicle speed is recalculated and displayed.

# Instrument Cluster and Display

## Active Driving Display\*

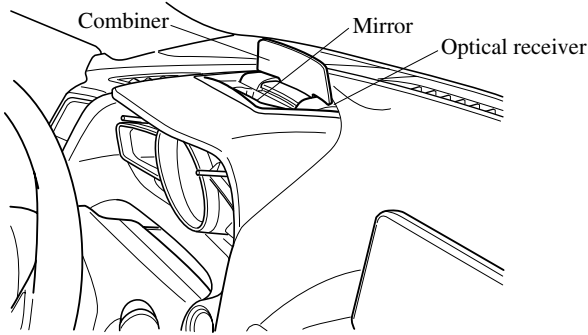

### **! WARNING**

**Adjust the brightness or the display position while paying attention to safe driving:**

*If you do not pay attention to your driving while trying to make the adjustments, it could lead to an unexpected accident.*

### **! CAUTION**

- Do not try to adjust the angle or open/close the active driving display manually. Fingerprints on the display will make it difficult to view and using excessive force when operating it could cause damage.
- Do not place objects in the vicinity of the active driving display. The active driving display may not operate or any interference with its operation could cause damage.
- Do not place beverages near the active driving display. If water or other liquids are splashed on the active driving display, it could cause damage.
- Do not place objects above the active driving display screen or apply stickers to the combiner as they will cause interference.
- A sensor is integrated to control the display's luminosity. If the optical receiver is covered, the display's luminosity will lower making the display difficult to view.
- Do not allow intense light to hit the optical receiver. Otherwise, it could cause damage.

### **NOTE**

- It may be difficult to view the display when wearing sunglasses. Take off your sunglasses or adjust the luminosity.
- If the battery has been removed and re-installed or the battery voltage is low, the adjusted position may deviate.
- The display may be difficult to view or temporarily affected by weather conditions such as rain, snow, light, and temperature.
- If the audio system is removed, the active driving display cannot be operated.



# Instrument Cluster and Display

---

The active driving display indicates the following information:

- Mazda Radar Cruise Control (MRCC) Operation Conditions and Warnings  
Refer to Mazda Radar Cruise Control (MRCC) on page 4-90.
- Lane Departure Warning System (LDWS) Operation Conditions and Warnings  
Refer to Lane Departure Warning System (LDWS) on page 4-118.
- Smart City Brake Support (SCBS) Operation Conditions and Warnings  
Refer to Smart City Brake Support (SCBS) on page 4-71.
- Forward Obstruction Warning (FOW) Operation Conditions and Warnings  
Refer to Forward Obstruction Warning (FOW) on page 4-115.
- Vehicle Speed Setting Using Cruise Control  
Refer to Cruise Control on page 4-99.
- Turn-by-Turn (TBT) (Direction and Distance) and Lane Guidance
- Vehicle Speed

Each setting/adjustment for the active driving display can be performed on the center display (Type B audio).

1. Select the (⊗) icon on the home screen and display the Settings screen.
2. Select the AD-Disp tab.
3. Select the desired item and perform the setting/adjustment.
  - **Height** : Active driving display position
  - **Brightness Control** : Method for adjusting screen brightness (Automatically/Manually)
  - **Calibration** : Brightness initialization setting (when selecting automatic adjustment)
  - **Brightness** : Brightness adjustment (when selecting manual adjustment)
  - **Navigation** : On/Off
  - **Active Driving Display** : On/Off
  - **Reset**

# Instrument Cluster and Display

---

## Warning/Indicator Lights

Instrument Cluster varies depending on model and specifications.

### Instrument Cluster

#### Type A

(Digital Speed Meter Type)

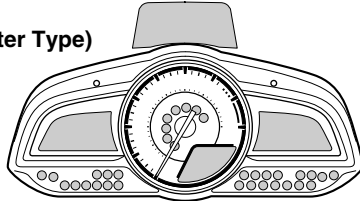

#### Type B

(Analog Speed Meter Type (With Tachometer))

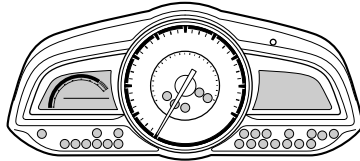

#### Type C

(Analog Speed Meter Type (Without Tachometer))

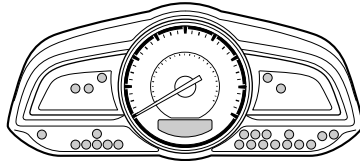

### Center of Dashboard

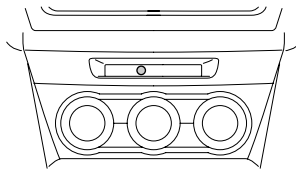









Warning/Indicator lights will appear in any of the highlighted areas









# Instrument Cluster and Display

## ▼ Warning Lights

These lights turn on or flash to notify the user of the system operation status or a system malfunction.

Signal	Warning Lights	Page
	Master Warning Light* <sup>1</sup>	7-24
	Brake System Warning Light* <sup>1,2</sup>	7-24
	ABS Warning Light* <sup>1</sup>	7-24
	Charging System Warning Light* <sup>1</sup>	7-24
	Engine Oil Warning Light* <sup>1</sup>	7-24
	Check Engine Light* <sup>1</sup>	7-24
 (Red)	High Engine Coolant Temperature Warning Light* <sup>1</sup>	7-24
<b>AT</b>	* Automatic Transaxle Warning Light* <sup>1</sup>	7-24
	Power Steering Malfunction Indicator Light* <sup>1</sup>	7-24
	Air Bag/Front Seat Belt Pretensioner System Warning Light* <sup>1</sup>	7-24
	Low Fuel Warning Light	7-24
	Check Fuel Cap Warning Light* <sup>1</sup>	7-24
	Seat Belt Warning Light	7-24
	Door-Ajar Warning Light	7-24

# Instrument Cluster and Display

Signal	Warning Lights	Page
	*Low Washer Fluid Level Warning Light	7-24
	* Tire Pressure Monitoring System Warning Light* <sup>1</sup>	7-24
 (Red)	KEY Warning Light* <sup>1</sup>	7-24
 (Amber)	* Forward Obstruction Warning/Smart City Brake Support (FOW/SCBS) Warning Light* <sup>1</sup>	7-24
 (Amber)	* Lane Departure Warning System (LDWS) Warning Light* <sup>1,3</sup>	7-24
	* Headlight Auto-Leveling Malfunction Indicator Light* <sup>1</sup>	7-24
 (Amber)	* High Beam Control System (HBC) Warning Light* <sup>1</sup>	7-24
 (Amber)	* Mazda Radar Cruise Control (MRCC) Warning Light* <sup>1</sup>	7-24

\*1 The light turns on when the ignition is switched on for an operation check, and turns off a few seconds later or when the engine is started. If the light does not turn on or remains turned on, have the vehicle inspected at an Authorized Mazda Dealer.









\*2 The light turns on continuously when the parking brake is applied.

\*3 The light turns on when the system on stand-by. The light flashes when the system has a malfunction.









# Instrument Cluster and Display

## ▼ Indicator Lights

These lights turn on or flash to notify the user of the system operation status or a system malfunction.

Signal	Indicator Lights	Page
<b>BSM OFF</b>	* BSM OFF Indicator Light	4-113
 (Green)	* Lane Departure Warning System (LDWS) Indicator Light	4-121
 (Green)	KEY Indicator Light	3-9
 (Green)	* High Beam Control System (HBC) Indicator Light	4-49
	Wrench Indicator Light* <sup>1</sup>	4-25
	TCS/DSC Indicator Light* <sup>1</sup>	4-79, 4-80
	DSC OFF Indicator Light* <sup>1</sup>	4-81
<b>AFS OFF</b>	* AFS OFF Indicator Light* <sup>1</sup>	4-45
 (Red)	* Forward Obstruction Warning/Smart City Brake Support (FOW/SCBS) Indicator Light* <sup>1</sup>	4-117, 4-77
	* Forward Obstruction Warning/Smart City Brake Support (FOW/SCBS) OFF Indicator Light* <sup>1</sup>	4-77
<b>i-ELOOP</b>	* i-ELOOP Indicator Light	4-84
 (Blue)	Low Engine Coolant Temperature Indicator Light	4-25

# Instrument Cluster and Display

Signal	Indicator Lights	Page
	* Shift Position Indication	4-30
SPORT	* SPORT Mode Indicator Light	4-88
	Headlight High-Beam Indicator Light	4-44, 4-44
	Turn Signal/Hazard Warning Indicator Lights	4-50, 4-58
	Security Indicator Light* <sup>1</sup>	3-42
 (Green)	* Mazda Radar Cruise Control (MRCC) Indicator Light	4-94
 (Amber)	* Cruise Main Indicator Light	4-100
 (Green)	* Cruise Set Indicator Light	4-100
	Lights-On Indicator Light	4-40

\*1 The light turns on when the ignition is switched on for an operation check, and turns off a few seconds later or when the engine is started. If the light does not turn on or remains turned on, have the vehicle inspected at an Authorized Mazda Dealer.

**▼ Wrench Indicator Light**

When the ignition is switched ON, the wrench indicator light is illuminated and then turns off after a few seconds.

The wrench indicator light is illuminated when the preset maintenance period arrives. Verify the content and perform maintenance.

Refer to Maintenance Monitor on page 6-20.

**▼ Low Engine Coolant Temperature Indicator Light (Blue)**

The light illuminates continuously when the engine coolant temperature is low and turns off after the engine is warm.

If the low engine coolant temperature indicator light remains illuminated after the engine has been sufficiently warmed up, the temperature sensor could have a malfunction. Consult an Authorized Mazda Dealer.

## Manual Transaxle Operation

### ▼ Manual Transaxle Shift Pattern

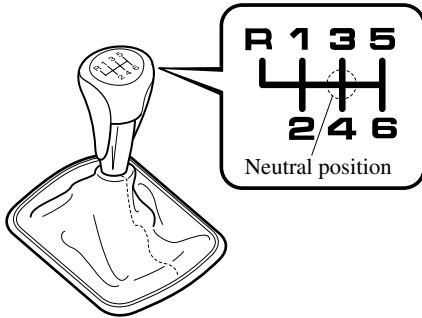

The shift pattern of the transaxle is conventional, as shown.

Depress the clutch pedal all the way down while shifting; then release it slowly.

Your vehicle is equipped with a device to prevent shifting to R (reverse) by mistake. Push the shift lever downward and shift to R.

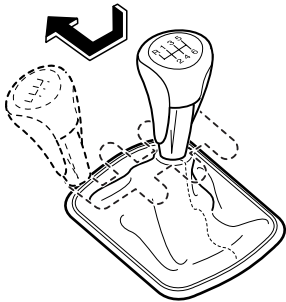

### **⚠ WARNING**

**Do not use sudden engine braking on slippery road surfaces or at high speeds:**

*Shifting down while driving on wet, snowy, or frozen roads, or while driving at high speeds causes sudden engine braking, which is dangerous. The sudden change in tire speed could cause the tires to skid. This could lead to loss of vehicle control and an accident.*

**Always leave the shift lever in 1 or R position and set the parking brake when leaving the vehicle unattended:**

*Otherwise the vehicle could move and cause an accident.*

### **⚠ CAUTION**

- *Keep your foot off the clutch pedal except when shifting gears. Also, do not use the clutch to hold the vehicle on an upgrade. Riding the clutch will cause needless clutch wear and damage.*
- *Do not apply any excessive lateral force to the shift lever when changing from 5th to 4th gear. This could lead to the accidental selection of 2nd gear, which could result in damage to the transaxle.*
- *Make sure the vehicle comes to a complete stop before shifting to R. Shifting to R while the vehicle is still moving may damage the transaxle.*



**NOTE**

- **(For vehicles with type C instrument cluster\*1)**  
If the engine speed is about to exceed the permissible engine speed, the buzzer sounds.  
Refer to Over Rev. Buzzer on page 7-38.  
\*1 To determine which instrument cluster is equipped on your Mazda, Refer to Meters and Gauges on page 4-11.
- If shifting to R is difficult, shift back into neutral, release the clutch pedal, and try again.

**▼ Gear Shift Indicator\***

The gear shift indicator supports you to obtain optimum fuel economy and smooth driving. It displays the selected gear position in the instrument cluster as well as notifies the driver to change to the most suitable gear position corresponding to the actual driving condition.

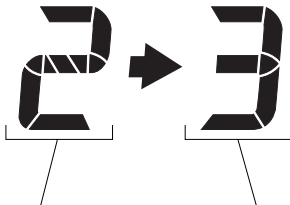

Indication	Condition
Numeral	The selected gear position is displayed.
➡ and numeral	Shift up or down to the indicated gear position is recommended.

**⚠ CAUTION**

Do not rely solely on the shift-up/shift-down recommendations by indications. The actual driving situation might require shift operations different from indication. To avoid the risk of accidents, the road and traffic conditions have to be judged correctly by the driver before shifting.

**NOTE**

- The gear shift indicator turns off when the following operations are performed.
- The vehicle is stopped.
  - The vehicle is put in neutral.
  - The vehicle is driven in reverse.
  - The clutch is not fully engaged when accelerating from a stop.
  - The clutch pedal remains depressed for 2 seconds or longer while driving.

# Transaxle

---

## ▼ Recommendations for Shifting (for Vehicles without Gear Shift Indication)

### Upshifting

For normal acceleration, Mazda recommends these shift points:  
(U.S.A. and Canada)

Gear	Vehicle speed
1 to 2	24 km/h (15 mph)
2 to 3	42 km/h (26 mph)
3 to 4	60 km/h (37 mph)
4 to 5	75 km/h (46 mph)
5 to 6	79 km/h (49 mph)

For cruising, Mazda recommends these shift points:  
(U.S.A. and Canada)

Gear	Vehicle speed
1 to 2	13 km/h (8 mph)
2 to 3	29 km/h (18 mph)
3 to 4	49 km/h (30 mph)
4 to 5	63 km/h (39 mph)
5 to 6	70 km/h (43 mph)



### Downshifting

When you must slow down in heavy traffic or on a steep **upgrade**, downshift before the engine starts to overwork. This reduces the chance of stalling and gives better acceleration when you need more speed. On a steep **downgrade**, downshifting helps maintain safe speed and prolongs brake life.

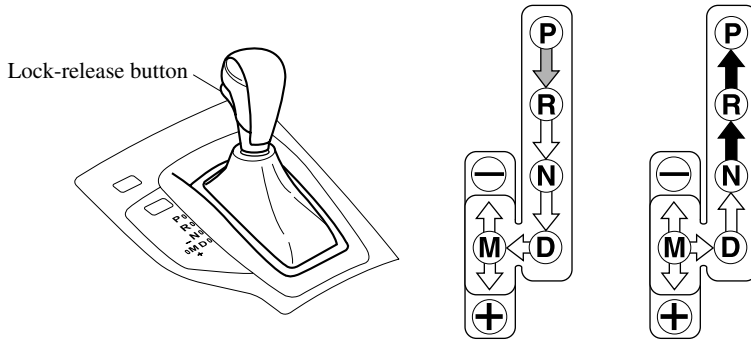
## Automatic Transaxle Controls



### Various Lockouts:

-  Indicates that you must depress the brake pedal and hold in the lock-release button to shift (The ignition must be switched ON).
-  Indicates the shift lever can be shifted freely into any position.
-  Indicates that you must hold in the lock-release button to shift.

### **NOTE**

*The Sport AT has an option that is not included in the traditional automatic transaxle that gives the driver the option of selecting each gear instead of leaving it to the transaxle to shift gears. Even if you intend to use the automatic transaxle functions as a traditional automatic, you should also be aware that you can inadvertently shift into manual shift mode and an inappropriate gear may be retained as the vehicle speed increases. If you notice the engine speed going higher or hear the engine racing, confirm you have not accidentally slipped into manual shift mode (page 4-32).*

# Transaxle

## ▼ Shift Position Indication



The selector position is indicated when the ignition is switched ON.

### Gear position indication

In manual shift mode, the “M” of the shift position indication illuminates and the numeral for the selected gear is displayed.

## ▼ Warning Light

The warning light turns on when the system has a malfunction. Refer to Warning Lights on page 4-21.

## ▼ Transaxle Ranges

- The shift position indicator light in the instrument cluster illuminates. Refer to Warning/Indicator Lights on page 4-20.
- The selector lever must be in P or N to operate the starter.

### P (Park)

P locks the transaxle and prevents the front wheels from rotating.

## WARNING

**Always set the selector lever to P and set the parking brake:**

*Only setting the selector lever to the P position without using the parking brake to hold the vehicle is dangerous. If P fails to hold, the vehicle could move and cause an accident.*

## CAUTION

- *Shifting into P, N or R while the vehicle is moving can damage your transaxle.*
- *Shifting into a driving gear or reverse when the engine is running faster than idle can damage the transaxle.*

### R (Reverse)

In position R, the vehicle moves only backward. You must be at a complete stop before shifting to or from R, except under rare circumstances as explained in Rocking the Vehicle (page 3-47).

### N (Neutral)

In N, the wheels and transaxle are not locked. The vehicle will roll freely even on the slightest incline unless the parking brake or brakes are on.

## WARNING

***If the engine is running faster than idle, do not shift from N or P into a driving gear:***

*It's dangerous to shift from N or P into a driving gear when the engine is running faster than idle. If this is done, the vehicle could move suddenly, causing an accident or serious injury.*

***Do not shift into N when driving the vehicle:***

*Shifting into N while driving is dangerous. Engine braking cannot be applied when decelerating which could lead to an accident or serious injury.*

**⚠ CAUTION**

*Do not shift into N when driving the vehicle. Doing so can cause transaxle damage.*

**NOTE**

*Apply the parking brake or depress the brake pedal before moving the selector lever from N to prevent the vehicle from moving unexpectedly.*

**D (Drive)**

D is the normal driving position. From a stop, the transaxle will automatically shift through a 6-gearsequence.

**M (Manual)**

M is the manual shift mode position. Gears can be shifted up or down by operating the selector lever. Refer to Manual Shift Mode on page 4-32.

**▼ Active Adaptive Shift (AAS)**

Active Adaptive Shift (AAS) automatically controls the transaxle shift points to best suit the road conditions and driver input. This improves driving feel. The transaxle may switch to AAS mode when driving up and down slopes, cornering, driving at high elevations, or depressing the accelerator pedal quickly while the selector lever is in the D position. Depending on the road and driving conditions/vehicle operations, gear shifting could be delayed or not occur, however, this does not indicate a problem because the AAS mode will maintain the optimum gear position.

**▼ Shift-Lock System**

The shift-lock system prevents shifting out of P unless the brake pedal is depressed.

To shift from P:

1. Depress and hold the brake pedal.
2. Start the engine.
3. Press and hold the lock-release button.
4. Move the selector lever.

**NOTE**

- *When the ignition is switched to ACC or the ignition is switched off, the selector lever cannot be shifted from P.*
- *The ignition cannot be switched to OFF if the selector lever is not in P.*

**▼ Shift-Lock Override**

If the selector lever will not move from P using the proper shift procedure, continue to hold down the brake pedal.

1. Remove the shift-lock override cover using a cloth-wrapped flat head screwdriver.
2. Insert a screwdriver and push it down.

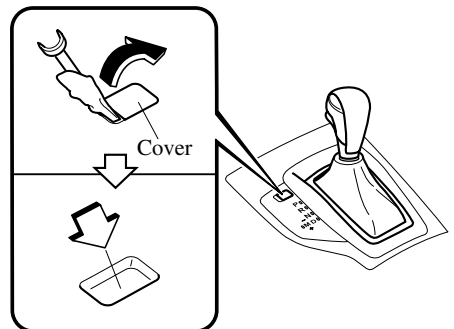

3. Press and hold the lock-release button.
4. Move the selector lever.

# Transaxle

5. Take the vehicle to an Authorized Mazda Dealer to have the system checked.

## ▼ Manual Shift Mode

The manual shift mode gives you the feel of driving a manual transaxle vehicle by allowing you to operate the selector lever manually. This allows you to control engine rpm and torque to the drive wheels much like a manual transaxle when more control is desired.

To change to manual shift mode, shift the lever from D to M.

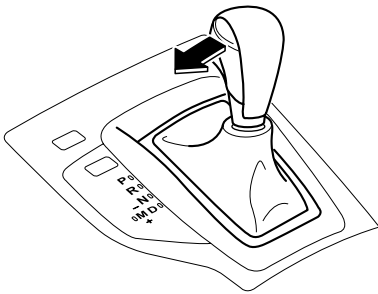

### NOTE

- (For vehicles with type C instrument cluster\*1)

If the engine speed is about to exceed the permissible engine speed, the buzzer sounds.

Refer to Over Rev. Buzzer on page 7-38.

\*1 To determine which instrument cluster is equipped on your Mazda, Refer to Meters and Gauges on page 4-11.

- Changing to manual shift mode while driving will not damage the transaxle.

To return to automatic shift mode, shift the lever from M to D.

### NOTE

- If you change to manual shift mode when the vehicle is stopped, the gear will shift to M1.
- If you change to manual shift mode without depressing the accelerator pedal when driving in D range, 5th gear/6th gear, the gear will shift to M4/M5.

## Indicators

### Manual shift mode indication

In manual shift mode, the “M” of the shift position indication in the instrument panel illuminates.

### Gear position indication

The numeral for the selected gear illuminates.

### Type A

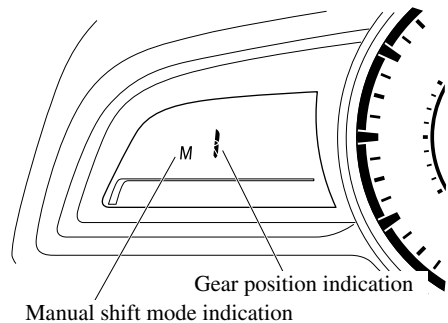

### Type B

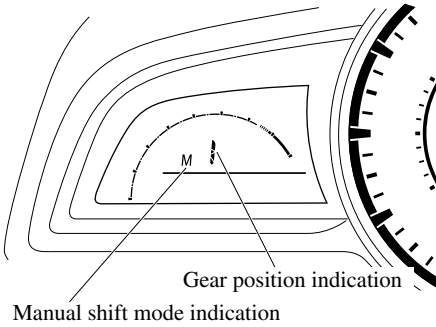

### Type C

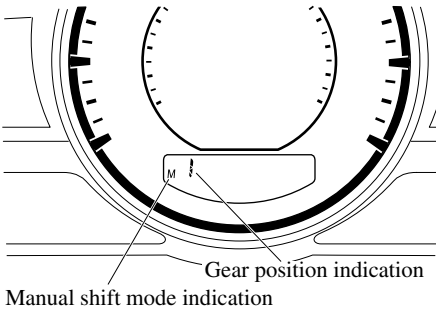

### NOTE

- If the gears cannot be shifted down when driving at higher speeds, the gear position indication will flash twice to signal that the gears cannot be shifted down (to protect the transaxle).
- If the automatic transaxle fluid (ATF) temperature becomes too high, there is the possibility that the transaxle will switch to automatic shift mode and turning off the gear position indication illumination. This is a normal function to protect the automatic transaxle. After the ATF temperature has decreased, the gear position indication illumination turns back on and driving in manual shift mode is restored.

### Shifting

You can shift gears up and down by operating the selector lever or the steering shift switches\*.

### Manually Shifting up

**(M1 → M2 → M3 → M4 → M5 → M6)**

To shift up to a higher gear, move the selector lever back + once.

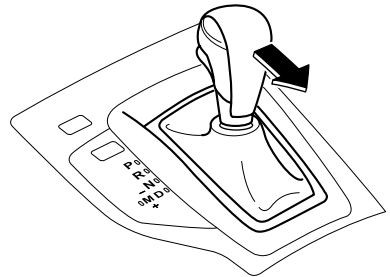

\*Some models.

# Transaxle

To shift up to a higher gear with the steering shift switches, pull the UP switch (+/OFF) toward you once with your fingers.

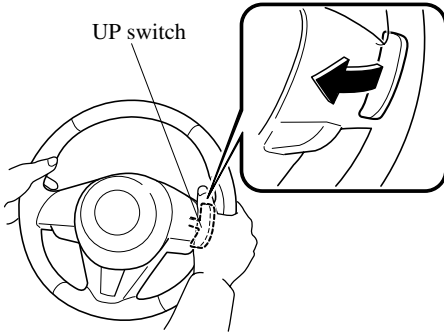

## **WARNING**

**Keep your hands on the steering wheel rim when using fingers on the steering shift switches:**

Putting your hands inside the rim of the steering wheel when using the steering shift switches is dangerous. If the driver's air bag were to deploy in a collision, your hands could be impacted causing injury.

## **NOTE**

- When driving slowly, the gears may not shift up.
- In manual shift mode, do not run the engine with the tachometer needle in the RED ZONE. When the engine rpm is high, a gear may shift up automatically to protect the engine.
- When depressing the accelerator fully, the transaxle will shift to a lower gear, depending on vehicle speed.
- The steering shift switch can be used temporarily even if the selector lever is in the D position while driving. In addition, it returns to automatic shift mode when the UP switch (+/OFF) is pulled rearward for a sufficient amount of time.

## **Manually Shifting down**

**(M6 → M5 → M4 → M3 → M2 → M1)**

To shift down to a lower gear, move the selector lever forward — once.

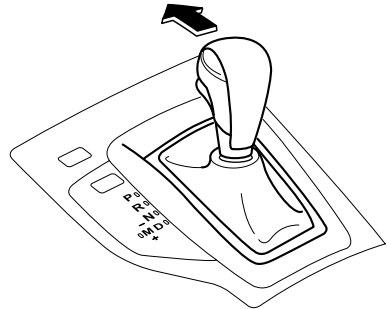



To shift down to a lower gear with the steering shift switches, pull the DOWN switch — toward you once with your fingers.

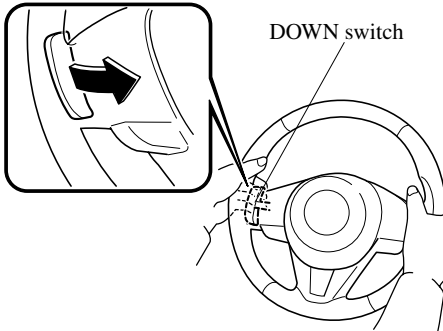

**⚠ WARNING**

***Do not use engine braking on slippery road surfaces or at high speeds:***

*Shifting down while driving on wet, snowy, or frozen roads, or while driving at high speeds causes sudden engine braking, which is dangerous. The sudden change in tire speed could cause the tires to skid. This could lead to loss of vehicle control and an accident.*

***Keep your hands on the steering wheel rim when using fingers on the steering shift switches:***

*Putting your hands inside the rim of the steering wheel when using the steering shift switches is dangerous. If the driver's air bag were to deploy in a collision, your hands could be impacted causing injury.*

**NOTE**

- *When driving at high speeds, the gear may not shift down.*
- *During deceleration, the gear may automatically shift down depending on vehicle speed.*
- *When depressing the accelerator fully, the transaxle will shift to a lower gear, depending on vehicle speed.*

**Second gear fixed mode**

When the selector lever is moved back + while the vehicle speed is about 10 km/h (6.2 mph) or less, the transaxle is set in the second gear fixed mode. The gear is fixed in second while in this mode for easier acceleration from a stop and driving on slippery roads such as snow-covered roads.

If the selector lever is moved back + or forward — while in the second gear fixed mode, the mode will be canceled.

# Transaxle

---

## **Shift gear (shifting) speed limit**

For each gear position while in the manual mode, the speed limit is set as follows: When the selector lever is operated within the range of the speed limit, the gear is shifted.

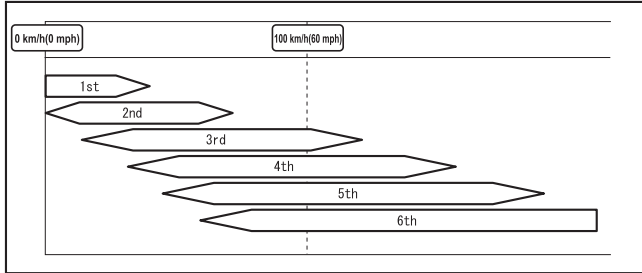

### **Shift up**

The gear does not shift up while the vehicle speed is lower than the speed limit.

### **Shift down**

The gear does not shift down while the vehicle speed exceeds the speed limit. If the vehicle speed exceeds the speed limit and the gear does not shift down, the gear position indication flashes 2 times to notify the driver that the gear cannot be shifted.

### **Kickdown**

When the accelerator pedal is depressed fully while driving, the gear shifts down.

### **NOTE**

*The gear also shifts down using kickdown while in the second gear fixed mode.*

### **Auto-shift down**

The gear shifts down automatically depending on the vehicle speed during deceleration.

### **NOTE**

*If the vehicle comes to a stop while in the second gear fixed mode, the gear remains in second.*

## **Recommendations for shifting**

### **Upshifting**

For normal acceleration and cruising, Mazda recommends these shift points:  
**(U.S.A. and Canada)**

<b>Gear</b>	<b>Vehicle speed*1</b>
M1 to M2	24 km/h (15 mph)
M2 to M3	40 km/h (25 mph)
M3 to M4	65 km/h (40 mph)
M4 to M5	73 km/h (45 mph)
M5 to M6	81 km/h (50 mph)

\*1 Always observe local speed limit regulations.

### **Downshifting**

When you must slow down in heavy traffic or on a steep upgrade, downshift before the engine starts to overwork. This gives better acceleration when you need more speed.

On a steep downgrade, downshifting helps maintain safe speed and prolongs brake life.

# Transaxle

## ▼ Direct Mode\*

Direct mode can be used for temporarily switching gears by operating the steering shift switch while the vehicle is being driven with the selector lever in the D range.

While in direct mode, the D and M indication illuminate and the gear position in use is illuminated.

Direct mode is canceled (released) under the following conditions.

- The UP switch (+/OFF) is pulled rearward for a certain amount of time or longer.
- The vehicle is driven for a certain amount of time or longer (time differs depending on the driving conditions while operating).
- The vehicle is stopped or moving at a slow speed.

### Type A

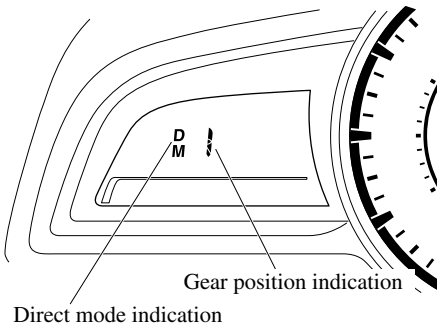

### Type B

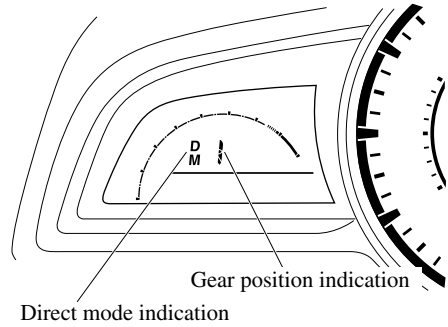

### Type C

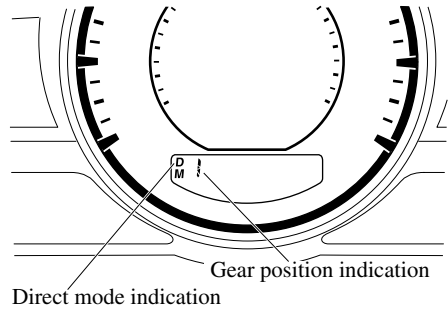

### NOTE

*Shifting up and down while in direct mode may not be possible depending on the vehicle speed. In addition, because direct mode is canceled (released) depending on the rate of acceleration or if the accelerator is fully depressed, use of the manual shift mode is recommended if you need to drive the vehicle in a particular gear for long periods.*

## ▼ Driving Tips

### **WARNING**

**Do not let the vehicle move in a direction opposite to the direction selected by the selector lever:**

*Do not let the vehicle move backward with the selector lever in a forward position, or do not let the vehicle move forward with the selector lever in the reverse position. Otherwise, the engine may stop, causing the loss of the power brake and power steering functions, and make it difficult to control the vehicle which could result in an accident.*

### **Passing**

For extra power when passing another vehicle or climbing steep grades, depress the accelerator fully. The transaxle will shift to a lower gear, depending on vehicle speed.

### **NOTE**

#### ***(Some models)***

*The accelerator pedal may initially feel heavy as it is being depressed, then feel lighter as it is depressed further. This change in pedal force aids the engine control system in determining how much the accelerator pedal has been depressed for performing kickdown, and functions to control whether or not kickdown should be performed.*

### **Climbing steep grades from a stop**

To climb a steep grade from a stopped position:

1. Depress the brake pedal.
2. Shift to D or M1, depending on the load weight and grade steepness.
3. Release the brake pedal while gradually accelerating.

### **Descending steep grades**

When descending a steep grade, shift to lower gears, depending on load weight and grade steepness. Descend slowly, using the brakes only occasionally to prevent them from overheating.

# Switches and Controls

## Lighting Control

### ▼ Headlights

Turn the headlight switch to turn the headlights, other exterior lights and dashboard illumination on or off.

When the lights are turned on, the lights-on indicator light in the instrument cluster turns on.



**NOTE**

- If the light switch is left on, the lights will automatically switch off approximately 30 seconds after switching the ignition off. The time setting can be changed. Refer to Personalization Features on page 9-12.
- To prevent discharging the battery, do not leave the lights on while the engine is off unless safety requires them.

**Without auto-light control**

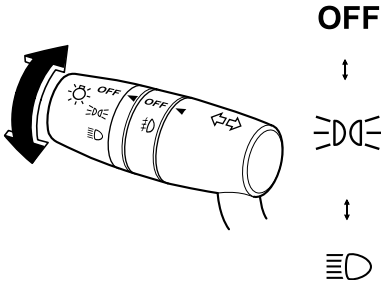

Switch Position	OFF		DRL		ON	
	ON	OFF	ON	OFF	ON	OFF
Ignition Position	ON	OFF	ON	OFF	ON	OFF
Headlights	Off	Off	Off	Off	On	On
Daytime running lights	On	Off	On	Off	Off	Off
Taillights Parking lights License lights Side-marker lights Dashboard illumination	Off	Off	On	On	On	On

# Switches and Controls

## With auto-light control

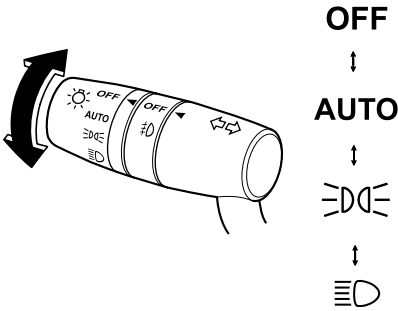

Switch Position	OFF		AUTO		☰☽☰		☰☽	
	ON	OFF	ON	OFF	ON	OFF	ON	OFF
Headlights	Off	Off	Auto* <sup>1</sup>	Off	Off	Off	On	On
Daytime running lights	On	Off	Auto* <sup>1</sup>	Off	On	Off	Off	Off
Taillights								
Parking lights								
License lights	Off	Off	Auto* <sup>1</sup>	Off	On	On	On	On
Side-marker lights								
Dashboard illumination								

\*1 The headlight and other light settings switch automatically depending on the surrounding brightness detected by the sensor.

## Switches and Controls

---

### Auto-light control

When the headlight switch is in the **AUTO** position and the ignition is switched ON, the light sensor senses the surrounding lightness or darkness and automatically turns the headlights, other exterior lights and dashboard illumination on or off (see chart above).

### **CAUTION**

- Do not shade the light sensor by adhering a sticker or a label on the windshield. Otherwise the light sensor will not operate correctly.

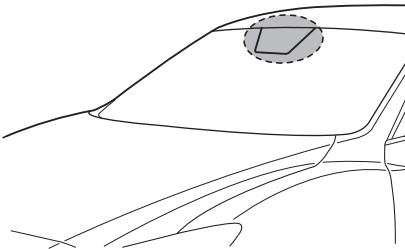

- The light sensor also works as a rain sensor for the auto-wiper control. Keep hands and scrapers clear of the windshield when the wiper lever is in the **AUTO** position and the ignition is switched ON as fingers could be pinched or the wipers and wiper blades could be damaged when the wipers activate automatically. If you are going to clean the windshield, be sure the wipers are turned off completely when it is particularly tempting to leave the engine running. This is particularly important when clearing ice and snow.

### **NOTE**

- The headlights, other exterior lights and dashboard illumination may not turn off immediately even if the surrounding area becomes well-lit because the light sensor determines that it is night time if the surrounding area is continuously dark for several minutes such as inside long tunnels, traffic jams inside tunnels, or in indoor parking lots. In this case, the lights turn off if the light switch is turned to the OFF position.
- **(Without auto headlight off function)**  
When the headlight switch is in the **AUTO** position and the ignition is switched to ACC or the ignition is switched off, the headlights, other exterior lights and dashboard illumination will turn off.
- The dashboard illumination can be adjusted by rotating the knob in the instrument cluster. Also, the day/night mode can be changed by rotating the knob until a beep sound is heard. To adjust the brightness of the dashboard illumination:  
Refer to Dashboard Illumination on page 4-15.
- The sensitivity of the AUTO lights may be changed by an Authorized Mazda Dealer. Refer to Personalization Features on page 9-12.



**Xenon fusion headlight bulbs\***

The low-beam bulbs of the headlights have xenon fusion bulbs that produce a bright white beam over a wide area.



***Do not replace the xenon fusion bulbs yourself:***

*Replacing the xenon fusion bulbs yourself is dangerous, because the xenon fusion bulbs require high voltage. You could receive an electric shock if the bulbs are handled incorrectly. Consult an Authorized Mazda Dealer when replacement is necessary.*

***NOTE***

*If the headlights flicker or the brightness weakens, the bulb-life may be depleted and a replacement is necessary. Consult an Authorized Mazda Dealer.*

# Switches and Controls

## ▼ Headlight High-Low Beam

The headlights switch between high and low beams by moving the lever forward or backward.

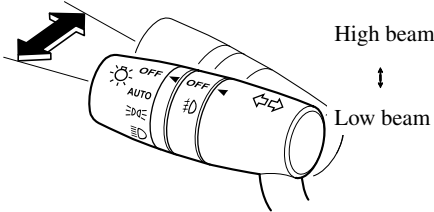

When the headlight high-beams are on, the headlight high-beam indicator light is turned on.



## ▼ Flashing the Headlights

To flash the headlights, pull the lever fully towards you (the headlight switch does not need to be on).

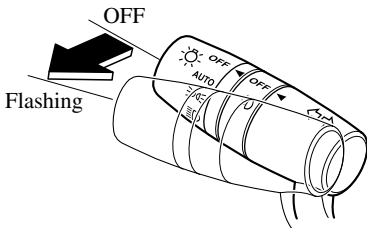

The headlight high-beam indicator light in the instrument cluster illuminates simultaneously. The lever will return to the normal position when released.



## ▼ Headlight Leveling\*

The number of passengers and weight of cargo in the luggage compartment change the angle of the headlights.

### Auto type

The angle of the headlights will be automatically adjusted when turning on the headlights.

The warning/indicator light turns on when the system has a malfunction. Refer to Warning/Indicator Lights on page 4-20.

**Manual type**

The headlight leveling switch is used to adjust the angle of the headlights manually.

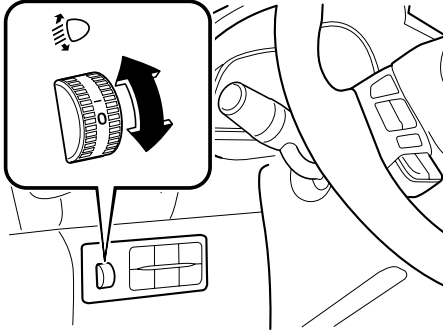

Select the proper headlight angle from the following chart.

Front seat		Rear seat	Load	Switch Position
Driver	Passenger			
×	—	—	—	0
×	×	—	—	0
×	×	×	—	2
×	×	×	×	2.5 (Between 2 and 3)
×	—	—	×	3.5 (Between 3 and 4)

×: Yes  
—: No

**▼ Adaptive Front Lighting System (AFS)\***

The adaptive front lighting system (AFS) automatically adjusts the headlight beams to the left or right in conjunction with the operation of the steering wheel after the headlights have been turned on.

**AFS OFF Indicator Light**

# AFS OFF

**When illuminated**

This indicator light illuminates briefly when the ignition is switched ON, and then turns off. Pressing the AFS OFF switch cancels the AFS function and illuminates the indicator light.

**When flashing**

The indicator light flashes continuously if the system is malfunctioning. Consult an Authorized Mazda Dealer.

**NOTE**

- Even if the AFS is not operating due to some malfunction, the normal headlight function is still operable.
- If there is a malfunction with the headlight auto-leveling function, the indicator light flashes.

## Switches and Controls

---

### **AFS OFF switch**

Pressing the AFS OFF switch turns off the AFS. The AFS OFF indicator light in the instrument cluster illuminates.

Pressing the AFS OFF switch again turns off the switch illumination and turns on the AFS operation. The AFS OFF indicator light turns off.

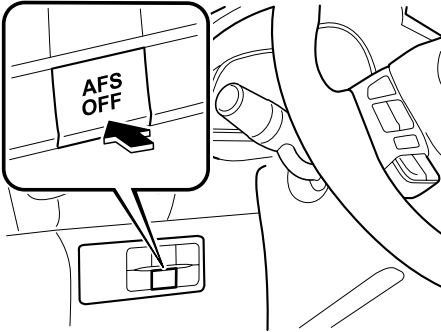

### **▼ Daytime Running Lights**

Some countries require moving vehicles to have their lights on (daytime running lights) during the daytime.

Daytime running lights turn on automatically when the ignition is switched ON.

They turn off when the parking brake is operated or the shift lever is shifted to the P position (automatic transaxle vehicle).

#### ***NOTE***

*(Except Canada)*

*The daytime running lights can be deactivated.*

*Refer to Personalization Features on page 9-12.*

## High Beam Control System (HBC)\*

The High Beam Control System (HBC) determines the conditions in front of the vehicle using the Forward Sensing Camera (FSC) while driving in darkness to automatically switch the headlights between high and low beams.

Refer to Warning/Indicator Lights on page 4-20.

While driving the vehicle at a speed of about 30 km/h (18 mph), the headlights are switched to high beams when there are no vehicles ahead or approaching in the opposite direction.

The system switches the headlights to low beams when one of the following occurs:

- The system detects a vehicle or the headlights/lights of a vehicle approaching in the opposite direction.
- The vehicle is driven on roads lined with streetlamps or on roads in well-lit cities and towns.
- The vehicle is driven at less than about 20 km/h (12 mph).

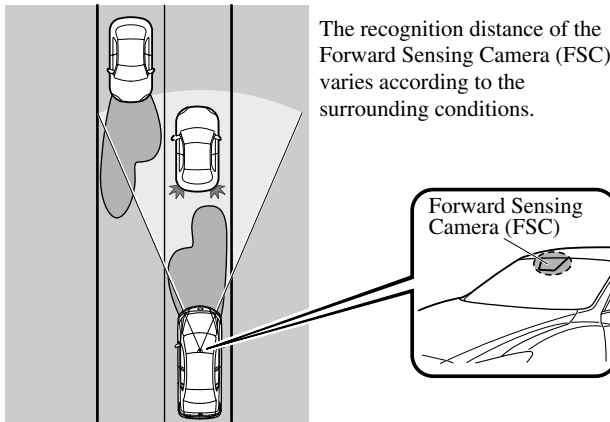

The warning light flashes when the system has a malfunction.

Refer to Warning Lights on page 4-21.

### **CAUTION**

- Do not adjust the vehicle height, modify the headlight units, or remove the camera, otherwise the system will not operate normally.
- Do not rely excessively on the High Beam Control System (HBC) and drive the vehicle while paying sufficient attention to safety. Switch the headlights between the high beams and low beams manually if necessary.

## Switches and Controls

---

### **NOTE**

*The timing in which the system switches the headlights changes under the following conditions. If the system does not switch the headlights appropriately, manually switch between high and low beams according to the visibility as well as road and traffic conditions.*

- *When there are sources of light in the area such as street lamps, illuminated signboards, and traffic signals.*
- *When there are reflective objects in the surrounding area such as reflective plates and signs.*
- *When visibility is reduced under rain, snow and foggy conditions.*
- *When driving on roads with sharp curves or hilly terrain.*
- *When the headlights/rear lamps of vehicles in front of you or in the opposite lane are dim or not illuminated.*
- *When there is sufficient darkness such as at dawn or dusk.*
- *When the luggage compartment is loaded with heavy objects or the rear passenger seats are occupied.*
- *When visibility is reduced due to a vehicle in front of you spraying water from its tires onto your windshield.*

### ▼ To Operate the System

The High Beam Control System (HBC) operates to switch the headlights automatically between high and low beams after the ignition is switched ON and the headlight switch is in the AUTO and high beam position. At the same time, the High Beam Control System (HBC) indicator light (green) in the instrument cluster illuminates.



The High Beam Control System (HBC) determines that it is dark based on the brightness of the surrounding area.

#### **NOTE**

- *When the vehicle speed is 30 km/h (18 mph) or higher, the headlights automatically switch to high beams when there are no vehicles ahead or approaching in the opposite direction. When the vehicle speed is less than about 20 km/h (12 mph), the High Beam Control System (HBC) switches the headlights to low beams.*
- *The low beams may not switch to high beams when cornering.*
- *Operation of the High Beam Control System (HBC) function can be disabled. Refer to Personalization Features on page 9-12.*

### ▼ Manual Switching

#### **Switching to low beams**

Shift the lever to the low beam position. The High Beam Control System (HBC) indicator light (Green) turns off.

#### **Switching to high beams**

Turn the headlight switch to the  position.

The High Beam Control System (HBC) indicator light (Green) turns off and the  is illuminated.

# Switches and Controls

## Fog Lights\*

Use this switch to turn on the fog lights. The fog lights will improve visibility at night and during foggy conditions.

To turn the fog lights on, rotate the fog light switch to the  position.

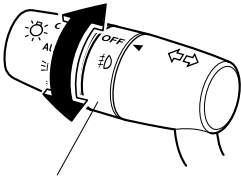

Fog light switch

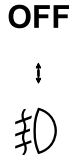

The headlight switch must be in the  position before turning on the fog lights. To turn the fog lights off, do any of the following:

- Rotate the fog light switch to the OFF position.
- Turn the headlight switch to the  or OFF position.

### NOTE

- The fog lights will turn off when the headlights are set at high beams.
- **(With auto-light control)**  
If the fog light switch is in the  position and the headlight switch is in the **AUTO** position, the fog lights will turn on when the headlights, the exterior lights and dashboard illumination turn on.

## Turn and Lane-Change Signals

The ignition must be switched ON to use the turn and lane-change signals.

### ▼ Turn Signals

Move the signal lever down (for a left turn) or up (for a right turn) to the stop position. The signal will self-cancel after the turn is completed.

If the indicator light continues to flash after a turn, manually return the lever to its original position.

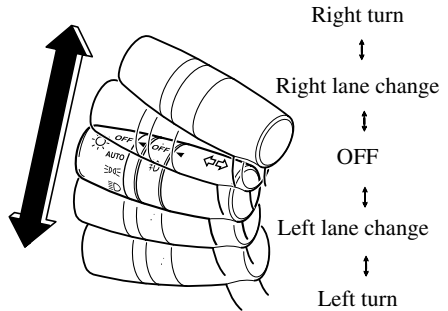

The turn signal indicators (green) in the instrument cluster flash according to the operation of the turn signal lever to show which signal is working.





**NOTE**

- *If an indicator light stays on without flashing or if it flashes abnormally, one of the turn signal bulbs may be burned out.*
- *A personalized function is available to change the turn indicator sound volume. (page 9-12)*

**▼ Lane-Change Signals**

Move the lever halfway toward the direction of the lane change—until the indicator flashes—and hold it there. It will return to the off position when released.

**▼ Three-Flash Turn Signal**

After releasing the turn signal lever, the turn signal indicator flashes three times. The operation can be cancelled by moving the lever in the direction opposite to which it was operated.

**NOTE**

*The three-flash turn signal function can be switched to operable/inoperable using the personalization function.*

*Refer to Personalization Features on page 9-12.*

**Windshield Wipers and Washer**

The ignition must be switched ON to use the wipers.

**⚠ WARNING**

**Use only windshield washer fluid or plain water in the reservoir:**

*Using radiator antifreeze as washer fluid is dangerous. If sprayed on the windshield, it will dirty the windshield, affect your visibility, and could result in an accident.*

**Only use windshield washer fluid mixed with anti-freeze protection in freezing weather conditions:**

*Using windshield washer fluid without anti-freeze protection in freezing weather conditions is dangerous as it could freeze on the windshield and block your vision which could cause an accident. In addition, make sure the windshield is sufficiently warmed using the defroster before spraying the washer fluid.*

# Switches and Controls

**NOTE**

*Because heavy ice and snow can jam the wiper blades, the wiper motor is protected from motor breakdown, overheating and possible fire by a circuit breaker.*

*This mechanism will automatically stop operation of the blades, but only for about 5 minutes.*

*If this happens, turn off the wiper switch and park off the right-of-way, and remove the snow and ice.*

*After 5 minutes, turn on the switch and the blades should operate normally. If they do not resume functioning, consult an Authorized Mazda Dealer as soon as possible. Drive to the side of the road and park off the right-of-way. Wait until the weather clears before trying to drive with the wipers inoperative.*

**▼ Windshield Wipers**

Turn the wipers on by pressing the lever up or down.

**With intermittent wiper**

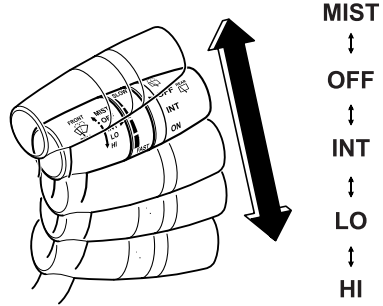

Switch Position	Wiper operation
MIST	Single wipe cycle (mist)
INT	Intermittent
LO	Low speed
HI	High speed

# Switches and Controls

## Variable-speed intermittent wipers

Set the lever to the intermittent position and choose the interval timing by rotating the ring.

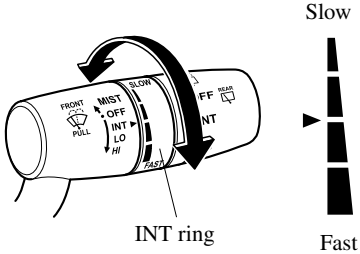

## With auto-wiper control

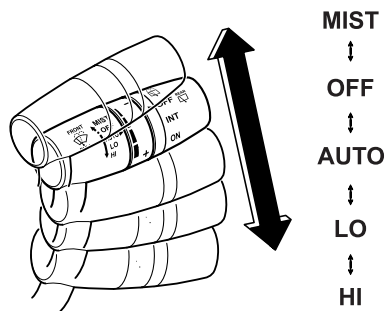

Switch Position	Wiper operation
MIST	Single wipe cycle (mist)
AUTO	Auto control
LO	Low speed
HI	High speed

## Auto-wiper control

When the wiper lever is in the **AUTO** position, the rain sensor senses the amount of rainfall on the windshield and turns the wipers on or off automatically (off—intermittent—low speed—high speed).

The sensitivity of the rain sensor can be adjusted by turning the switch on the wiper lever. From the center position (normal), rotate the switch downward for higher sensitivity (faster response) or rotate it upward for less sensitivity (slower response).

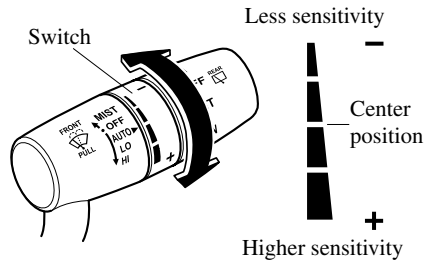

## Switches and Controls

### **CAUTION**

- Do not shade the rain sensor by adhering a sticker or a label on the windshield. Otherwise the rain sensor will not operate correctly.

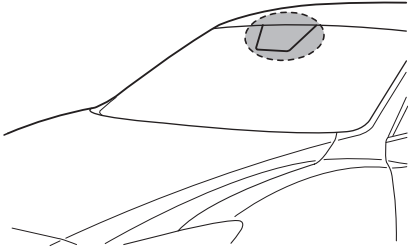

- When the wiper lever is in the **AUTO** position and the ignition is switched ON, the wipers may move automatically in the following cases:
  - If the windshield above the rain sensor is touched or wiped with a cloth.
  - If the windshield is struck with a hand or other object from either outside or inside the vehicle.

Keep hands and scrapers clear of the windshield when the wiper lever is in the **AUTO** position and the ignition is switched ON as fingers could be pinched or the wipers and wiper blades damaged when the wipers activate automatically. If you are going to clean the windshield, be sure the wipers are turned off completely (when it is most likely that the engine is left running) this is particularly important when clearing ice and snow.

### **NOTE**

- Switching the auto-wiper lever from the **OFF** to the **AUTO** position while driving activates the windshield wipers once, after which they operate according to the rainfall amount.
- The auto-wiper control may not operate when the rain sensor temperature is about  $-10^{\circ}\text{C}$  ( $14^{\circ}\text{F}$ ) or lower, or about  $85^{\circ}\text{C}$  ( $185^{\circ}\text{F}$ ) or higher.
- If the windshield is coated with water repellent, the rain sensor may not be able to sense the amount of rainfall correctly and the auto-wiper control may not operate properly.
- If dirt or foreign matter (such as ice or matter containing salt water) adheres to the windshield above the rain sensor, or if the windshield is iced, it could cause the wipers to move automatically. However, if the wipers cannot remove this ice, dirt or foreign matter, the auto-wiper control will stop operation. In this case, set the wiper lever to the low speed position or high speed position for manual operation, or remove the ice, dirt or foreign matter by hand to restore the auto-wiper operation.
- If the auto-wiper lever is left in the **AUTO** position, the wipers could operate automatically from the effect of strong light sources, electromagnetic waves, or infrared light because the rain sensor uses an optical sensor. It is recommended that the auto-wiper lever be switched to the **OFF** position other than when driving the vehicle under rainy conditions.
- The auto-wiper control functions can be turned off. Refer to Personalization Features on page 9-12.

### ▼ Windshield Washer

Pull the lever toward you and hold it to spray washer fluid.

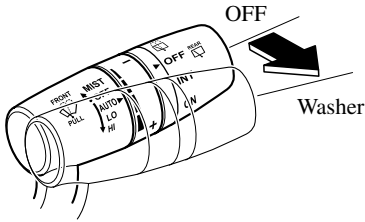

#### NOTE

With the wiper lever in the OFF or intermittent position/AUTO position, the wipers will operate continuously until the lever is released.

If the washer does not work, inspect the fluid level (page 6-31). If the fluid level is normal, consult an Authorized Mazda Dealer.

### Rear Window Wiper and Washer\*

The ignition must be switched ON to use the wiper.

#### ▼ Rear Window Wiper

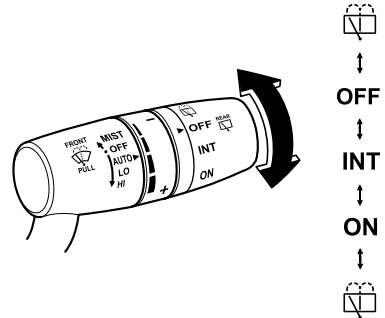

Turn the wiper on by turning the rear wiper/washer switch.

Switch Position	Wiper operation
INT	Intermittent
ON	Normal

#### ▼ Rear Window Washer

To spray washer fluid, turn the rear wiper/washer switch to the  position. After the switch is released, the washer will stop. If the washer does not work, inspect the fluid level (page 6-31). If the fluid level is normal and the washer still does not work, consult an Authorized Mazda Dealer.

# Switches and Controls

## Rear Window Defogger

The rear window defogger clears fog from the rear window.

The ignition must be switched ON to use the defogger.

Press the switch to turn on the rear window defogger. The rear window defogger operates for about 15 minutes and then turns off automatically. The indicator light illuminates when the defogger is operating.

To turn off the rear window defogger before the 15 minutes has elapsed, press the switch again.

### Manual Climate Control

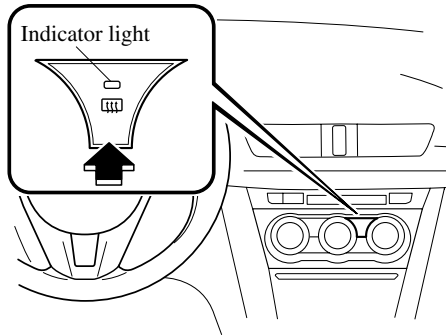

### Automatic Climate Control

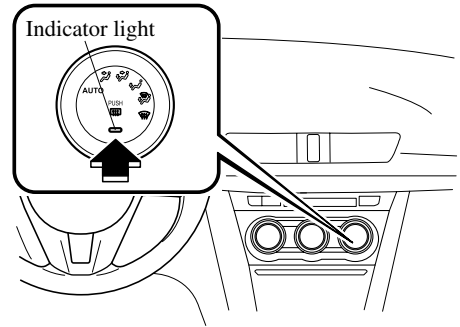

### Dual-Zone Automatic Climate Control

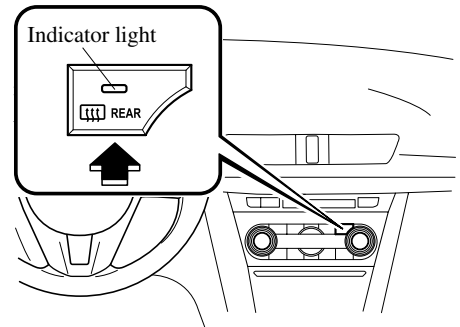

### **CAUTION**

*Do not use sharp instruments or window cleaners with abrasives to clean the inside of the rear window surface. They may damage the defogger grid inside the window.*

### **NOTE**

*This defogger is not designed for melting snow. If there is an accumulation of snow on the rear window, remove it before using the defogger.*

**▼ Mirror Defogger\***

To turn on the mirror defoggers, switch the ignition ON and press the rear window defogger switch (page 4-56).

**Horn**

To sound the horn, press the  mark on the steering wheel.

## Switches and Controls

### Hazard Warning Flasher

The hazard warning lights should always be used when you stop on or near a roadway in an emergency.

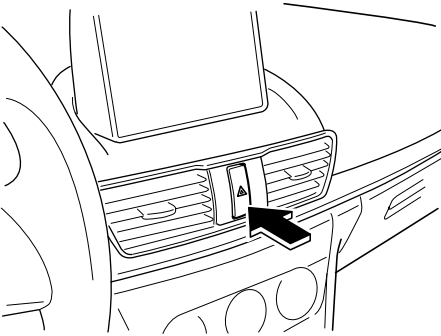

The hazard warning lights warn other drivers that your vehicle is a traffic hazard and that they must take extreme caution when near it.



Depress the hazard warning flasher and all the turn signals will flash. The hazard warning indicator lights in the instrument cluster flash simultaneously.

#### NOTE

- *The turn signals do not work when the hazard warning lights are on.*
- *Check local regulations about the use of hazard warning lights while the vehicle is being towed to verify that it is not in violation of the law.*

### HomeLink Wireless Control System\*

#### NOTE

*HomeLink and HomeLink house are registered trademarks of Johnson Controls.*

The HomeLink system replaces up to 3 hand-held transmitters with a single built-in component in the auto-dimming mirror. Pressing the HomeLink button on the auto-dimming mirror activates garage doors, gates and other devices surrounding your home.

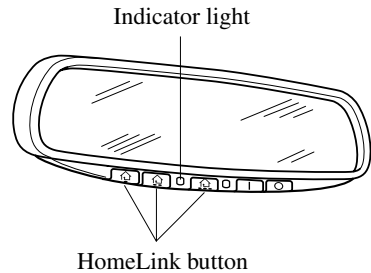



## **WARNING**

**Do not use the HomeLink system with any garage door opener that lacks the safety stop and reverse feature:**

Using the HomeLink system with any garage door opener that lacks the safety stop and reverse feature as required by federal safety standards is dangerous. (This includes garage doors manufactured before April 1, 1982.)

Using these garage door openers can increase the risk of serious injury or death. For further information, contact HomeLink at 1-800-355-3515 or [www.homelink.com](http://www.homelink.com) or an Authorized Mazda Dealer.

**Always check the areas surrounding garage doors and gates for people or obstructions before programming or during operation of the HomeLink system:**

Programming or operating the HomeLink system without verifying the safety of areas surrounding garage doors and gates is dangerous and could result in an unexpected accident and serious injury if someone were to be hit.

### **NOTE**

The programming will not be erased even if the battery is disconnected.

## ▼ **Pre-programming the HomeLink System**

### **NOTE**

It is recommended that a new battery be placed in the hand-held transmitter of the device being programmed to HomeLink for quicker training and accurate transmission of the radio-frequency signal.

- Verify that there is a remote control transmitter available for the device you would like to program.
- Disconnect the power to the device.

## ▼ **Programming the HomeLink System**

### **CAUTION**

When programming a garage door opener or a gate, disconnect the power to these devices before performing programming. Continuous operation of the devices could damage the motor.

The HomeLink system provides 3 buttons which can be individually selected and programmed using the transmitters for current, on-market devices as follows:

1. Disconnect power to the device being programmed.
2. Position the end of your hand-held transmitter 2.5—7.5 cm (1—3 inches) away from the HomeLink button you wish to program while keeping the indicator light in view.
3. Simultaneously press and hold both the chosen HomeLink and hand-held transmitter buttons. **Do not release the buttons until step 3 has been completed.**

## Switches and Controls

---

### NOTE

Some gate operators and garage door openers may require you to replace this Programming Step 2 with procedures noted in the “Gate Operator/Canadian Programming” section.

4. After the HomeLink indicator light changes from a slow to a rapidly blinking light, release both the HomeLink and hand-held transmitter buttons.

### NOTE

If the HomeLink indicator light does not change to a rapidly blinking light, contact HomeLink at [www.homelink.com](http://www.homelink.com) or call 1-800-355-3515 for assistance.

5. Connect power to the device being programmed.
6. Firmly press and hold the programmed HomeLink button for five seconds, and then release it. Perform this operation two times to activate the door or gate. If the door or gate does not activate, press and hold the just-trained HomeLink button and observe the indicator light.

If the indicator light stays on constantly, programming is complete and your device should activate when the HomeLink button is pressed and released.

### NOTE

To program the remaining two HomeLink buttons, begin with “Programming”—**step 1**

If the indicator light blinks **rapidly for two seconds and then turns to a constant light, continue with “Programming” steps 7—9** to complete the programming of a rolling code equipped device (most commonly a garage door opener).

7. At the garage door opener receiver (motor-head unit) in the garage, locate the “learn” or “smart” button. This can usually be found where the hanging antenna wire is attached to the motor-head unit.
8. Firmly press and release the “learn” or “smart” button. (The name and color of the button may vary by manufacturer.)

### NOTE

Complete the programming within 30 seconds.

9. Return to the vehicle and firmly **press, hold for two seconds and release** the programmed HomeLink button. Repeat the “**press/hold/release**” sequence a second time, and, depending on the brand of the garage door opener (or other rolling code equipped device), repeat this sequence a third time to complete the programming process.

HomeLink should now activate your rolling code equipped device.

### NOTE

To program the remaining two HomeLink buttons, begin with “Programming”—**step 1**

For questions or comments, please contact HomeLink at [www.homelink.com](http://www.homelink.com) or 1-800-355-3515.

### ▼ Gate operator/Canadian Programming

Canadian radio-frequency laws require transmitter signals to “time-out” (or quit) after several seconds of transmission — which may not be long enough for HomeLink to pick up the signal during programming. Similar to this Canadian law, some U.S. gate operators are designed to “time-out” in the same manner.

If you live in Canada or you are having difficulties programming a gate operator by using the “Programming” procedures (regardless of where you live), **replace “Programming HomeLink” step 3** with the following:

#### NOTE

*If programming a garage door opener or gate operator, it is advised to unplug the device during the “cycling” process to prevent possible overheating.*

Continue to press and hold the HomeLink button while you **press and release** — **every two seconds** (“cycle”) your hand-held transmitter until the frequency signal has successfully been accepted by HomeLink. (The indicator light will flash slowly and then rapidly.)

Proceed with “Programming” step 4 to complete.

### ▼ Operating the HomeLink System



Press the programmed HomeLink button to operate a programmed device. The code will continue being transmitted for a maximum of 20 seconds.

### ▼ Reprogramming the HomeLink system

To program a device to HomeLink using a HomeLink button previously trained, follow these steps:

1. Press and hold the desired HomeLink button. **DO NOT** release the button.
2. The indicator light will begin to flash after 20 seconds. Without releasing the HomeLink button, proceed with “Programming” - step 1.

### ▼ Erasing Programmed HomeLink Buttons

To erase the existing programming from all three operating channels, press and hold the two outside buttons (, ) on the auto-dimming mirror until the HomeLink indicator light begins to flash after approximately 10 seconds. Verify that the programming has been erased when you resell the vehicle.

## Forward Sensing Camera

---

### Forward Sensing Camera \*

Your vehicle is equipped with a Forward Sensing Camera (FSC). The Forward Sensing Camera (FSC) is positioned near the rearview mirror and used by the following systems.

- High Beam Control System (HBC)
- Lane Departure Warning System (LDWS)

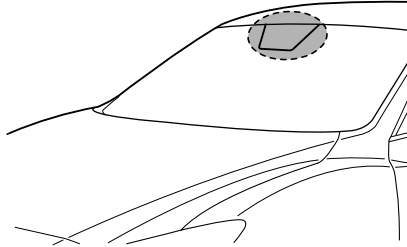

The Forward Sensing Camera (FSC) determines the conditions ahead of the vehicle while traveling at night and detects traffic lanes. The distance in which the Forward Sensing Camera (FSC) can detect objects varies depending on the surrounding conditions.

**⚠ CAUTION**

Heed the following cautions to assure the correct operation of the Forward Sensing Camera (FSC).

- Do not remove the Forward Sensing Camera (FSC) cover.
- Do not place objects on the dashboard which reflect light.
- Do not apply accessories, stickers or film to the windshield near the Forward Sensing Camera (FSC). If there are objects in front of the Forward Sensing Camera (FSC) lens, even a transparent sticker, they will cause the system to not operate correctly.
- Always keep the windshield glass around the camera clean by removing dirt or fogging. Use the windshield defroster to remove fogging on the windshield.
- When cleaning the windshield, do not allow glass cleaners or similar cleaning agent to get on the Forward Sensing Camera (FSC) lens. In addition, do not touch the Forward Sensing Camera (FSC) lens.
- Consult an Authorized Mazda Dealer regarding cleaning the interior side of the windshield around the Forward Sensing Camera (FSC).
- Be careful not to scratch the Forward Sensing Camera (FSC) lens or allow it to get dirty. Also, do not take the camera apart. Otherwise, it could result in damage or malfunction.
- Consult an Authorized Mazda Dealer before performing repairs around the Forward Sensing Camera (FSC).
- The Forward Sensing Camera (FSC) is installed to the windshield. Consult an Authorized Mazda Dealer for windshield repair and replacement.
- When performing repairs around the rearview mirror, consult an Authorized Mazda Dealer.
- Consult an Authorized Mazda Dealer regarding cleaning of the Forward Sensing Camera (FSC) lens.
- Do not hit or apply strong force to the Forward Sensing Camera (FSC) or the area around it. If strong force is applied, stop using the Lane Departure Warning System (LDWS) and the High Beam Control System (HBC), and consult an Authorized Mazda Dealer.
- The direction in which the Forward Sensing Camera (FSC) is pointed has been finely adjusted. Do not change the installation position of the Forward Sensing Camera (FSC) or remove it. Otherwise, it could result in damage or malfunction.

# Radar Sensor

---

## Radar Sensor

Your vehicle is equipped with a radar sensor.

The following systems also use the radar sensor.

- Mazda Radar Cruise Control (MRCC)
- Forward Obstruction Warning (FOW)

The radar sensor functions by detecting the radio waves reflected off a vehicle ahead or an obstruction sent from the radar sensor.

The radar sensor is mounted behind the front emblem.

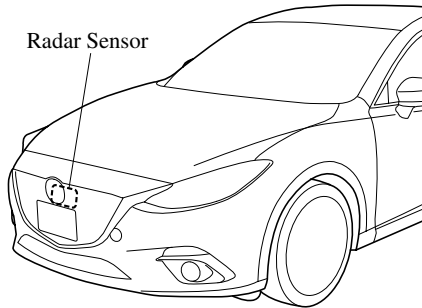

If the Forward Obstruction Warning (FOW) warning light (amber) is illuminated, the area around the radar sensor may be dirty. Refer to “Warning Guidance” in the center display (Type B audio).

Refer to If a Warning Light Turns On or Flashes on page 7-24.

** CAUTION**

*Heed the following precautions to assure correct operation of each system.*

- *Do not adhere stickers (including transparent stickers) to the surface of the radiator grille and front emblem in and around the radar sensor, and do not replace the radiator grille and front emblem with any product that is not a genuine product designed for use with the radar sensor.*
- *The radar sensor includes a function for detecting soiling of the radar sensor's front surface and informing the driver, however, depending on the conditions, it may require time to detect or it may not detect plastic shopping bags, ice or snow. If this occurs, the system may not operate correctly, therefore always keep the radar sensor clean.*
- *Do not install a grille guard.*
- *If the front part of the vehicle has been damaged in a vehicle accident, the position of the radar sensor may have moved. Stop the system immediately and always have the vehicle inspected at an Authorized Mazda Dealer.*
- *Do not use the front bumper to push other vehicles or obstructions such as when pulling out of a parking space. Otherwise, the radar sensor could be hit and its position deviated.*
- *Do not remove, disassemble, or modify the radar sensor.*
- *For repairs, replacement or paint work around the radar sensor, consult an Authorized Mazda Dealer.*
- *Do not modify the suspension. If the suspension are modified, the vehicle's posture could change and the radar sensor may not be able to correctly detect a vehicle ahead or an obstruction.*

## Radar Sensor

---

### **NOTE**

- *In the following cases, the radar sensor may not be able to detect vehicles ahead or obstructions.*
  - *The rear surface of a vehicle ahead does not reflect radio waves effectively, such as an unloaded trailer or an automobile with a loading platform covered by a soft top, vehicles with a hard plastic tailgate, and round-shaped vehicles.*
  - *Vehicles ahead with low vehicle height and thus less area for reflecting radio waves.*
  - *Visibility is reduced due to a vehicle ahead casting off water, snow, or sand from its tires and onto your windshield.*
  - *The trunk/luggage compartment is loaded with heavy objects or the rear passenger seats are occupied.*
  - *Ice, snow, or soiling is on the front surface of the front emblem.*
  - *During inclement weather such as rain, snow, or sand storms.*
  - *When driving near facilities or objects emitting strong radio waves.*
- *In the following cases, the radar sensor may detect vehicles in the opposite lane or surrounding obstructions, or it may not be able to detect vehicles ahead or obstructions.*
  - *The beginning and end of a curve.*
  - *Roads with continuous curves.*
  - *Narrow lane roads due to road construction or lane closures.*
  - *The vehicle ahead enters the radar sensor's blind spot.*
  - *The vehicle ahead is running abnormally due to accident or vehicle damage.*
  - *Roads with repeated up and down slopes*
  - *Driving on poor roads or unpaved roads.*
  - *The distance between your vehicle and the vehicle ahead is extremely short.*
  - *A vehicle suddenly comes close such as by cutting into the lane.*
- *To prevent incorrect operation of the system, use tires of the same specified size, manufacturer, brand, and tread pattern on all four wheels. In addition, do not use tires with significantly different wear patterns or tire pressures on the same vehicle. (Including the temporary spare tire)*
- *If the battery power is weak, the system may not operate correctly.*
- *When driving on roads with little traffic and few vehicles ahead or obstructions for the radar sensor to detect, Forward Obstruction Warning/Smart City Brake Support (FOW/SCBS) warning light (amber) temporarily illuminates, however, this does not indicate a problem.*



## Brake System

### ▼ Foot Brake

This vehicle has power-assisted brakes that adjust automatically through normal use.

Should power-assist fail, you can stop by applying greater force than normal to the brake pedal. But the distance required to stop will be greater than usual.

### **! WARNING**

**Do not coast with the engine stalled or turned off, find a safe place to stop:**

*Coasting with the engine stalled or turned off is dangerous. Braking will require more effort, and the brake's power-assist could be depleted if you pump the brake. This will cause longer stopping distances or even an accident.*

**Shift to a lower gear when going down steep hills:**

*Driving with your foot continuously on the brake pedal or steadily applying the brakes for long distances is dangerous. This causes overheated brakes, resulting in longer stopping distances or even total brake failure. This could cause loss of vehicle control and a serious accident. Avoid continuous application of the brakes.*

**Dry off brakes that have become wet by driving slowly, releasing the accelerator pedal and lightly applying the brakes several times until the brake performance returns to normal:**

*Driving with wet brakes is dangerous. Increased stopping distance or the vehicle pulling to one side when braking could result in a serious accident. Light braking will indicate whether the brakes have been affected.*

### **! CAUTION**

- Do not drive with your foot held on the clutch pedal or brake pedal, or hold the clutch pedal depressed halfway unnecessarily. Doing so could result in the following:
  - The clutch and brake parts will wear out more quickly.
  - The brakes can overheat and adversely affect brake performance.
- Always depress the brake pedal with the right foot. Applying the brakes with the unaccustomed left foot could slow your reaction time to an emergency situation resulting in insufficient braking operation.

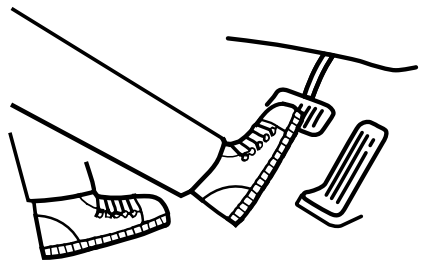

- Wear shoes appropriate for driving in order to avoid your shoe contacting the brake pedal when depressing the accelerator pedal.

# Brake

## ▼ Parking Brake



*Driving with the parking brake on will cause excessive wear of the brake parts.*

### NOTE

*For parking in snow, refer to Winter Driving (page 3-47) regarding parking brake use.*

### Setting the parking brake

Depress the brake pedal and then firmly pull the parking brake lever fully upwards with sufficient force to hold the vehicle in a stationary position.

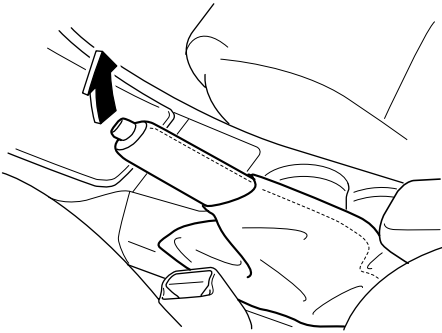

### Releasing the parking brake

Depress the brake pedal and pull the parking brake lever upwards, then press the release button. While holding the button, lower the parking brake lever all the way down to the released position.

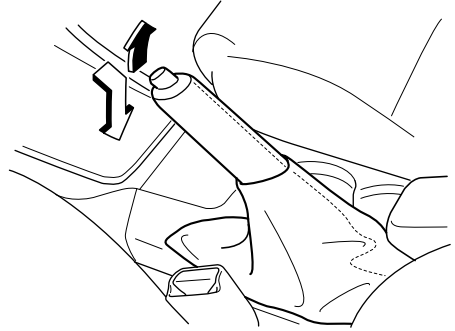

## ▼ Warning Light

The warning light turns on when the system has a malfunction. Refer to Warning Lights on page 4-21.

## ▼ Brake Pad Wear Indicator

When the disc brake pads become worn, the built-in wear indicators contact the disc plates. This causes a screeching noise to warn that the pads should be replaced.

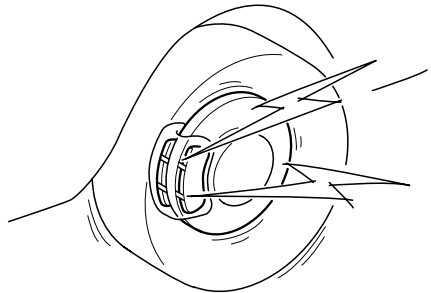

When you hear this noise, consult an Authorized Mazda Dealer as soon as possible.

**⚠ WARNING****Do not drive with worn disc pads:**

*Driving with worn disc pads is dangerous. The brakes could fail and cause a serious accident. As soon as you hear a screeching noise consult an Authorized Mazda Dealer.*

**▼ Brake Assist**

During emergency braking situations when it is necessary to depress the brake pedal with greater force, the brake assist system provides braking assistance, thus enhancing braking performance.

When the brake pedal is depressed hard or depressed more quickly, the brakes apply more firmly.

**NOTE**

- *When the brake pedal is depressed hard or depressed more quickly, the pedal will feel softer but the brakes will apply more firmly. This is a normal effect of the brake assist operation and does not indicate a malfunction.*
- *When the brake pedal is depressed hard or depressed more quickly, a motor/pump operation noise may be heard. This is a normal effect of the brake assist and does not indicate a malfunction.*
- *The brake assist equipment does not supersede the functionality of the vehicle's main braking system.*

**Hill Launch Assist (HLA)**

Hill Launch Assist (HLA) is a function which assists the driver in accelerating from a stop while on a slope. When the driver releases the brake pedal and depresses the accelerator pedal while on a slope, the function prevents the vehicle from rolling. The braking force is maintained automatically after the brake pedal is released on a steep grade.

For vehicles with a manual transaxle, Hill Launch Assist (HLA) operates on a downward slope when the shift lever is in the reverse (R) position, and on an upward slope when the shift lever is in a position other than the reverse (R) position.

For vehicles with an automatic transaxle, Hill Launch Assist (HLA) operates on a downward slope when the shift lever is in the reverse (R) position, and on an upward slope when the shift lever is in a forward gear.

## **WARNING**

### **Do not rely completely on Hill Launch Assist (HLA):**

Hill Launch Assist (HLA) is an auxiliary device for accelerating from a stop on a slope. The system only operates for about two seconds and therefore, relying only on the system, when accelerating from a stop is dangerous because the vehicle may move (roll) unexpectedly and cause an accident. The vehicle could roll depending on the vehicle's load or if it is towing something. In addition, for vehicles with a manual transaxle, the vehicle could still roll depending on how the clutch pedal or the accelerator pedal is operated.

Always confirm the safety around the vehicle before starting to drive the vehicle.

### **NOTE**

- Hill Launch Assist (HLA) does not operate on a gentle slope. In addition, the gradient of the slope on which the system will operate changes depending on the vehicle's load.
- Hill Launch Assist (HLA) does not operate if the parking brake is applied, the vehicle has not stopped completely, or the clutch pedal is released.
- While Hill Launch Assist (HLA) is operating, the brake pedal may feel stiff and vibrate, however, this does not indicate a malfunction.
- Hill Launch Assist (HLA) does not operate while the TCS/DSC indicator light is illuminated. Refer to Warning/Indicator Lights on page 4-20.
- Hill Launch Assist (HLA) does not turn off even if the DSC OFF switch is pressed to turn off the TCS/DSC.

## Smart City Brake Support (SCBS)\*

The Smart City Brake Support (SCBS) system is designed to reduce damage in the event of a collision by operating the brake control (SCBS brake) when the system's laser sensor detects a vehicle ahead and determines that a collision with a vehicle ahead is unavoidable. It may also be possible to avoid a collision if the relative speed between your vehicle and a vehicle ahead is less than about 15 km/h (9.3 mph).

In addition, when the driver depresses the brake pedal while the system is in the operation range at about 4 to 30 km/h (2 to 18 mph), the brakes are applied firmly and quickly to assist. (Brake Assist (SCBS brake assist))

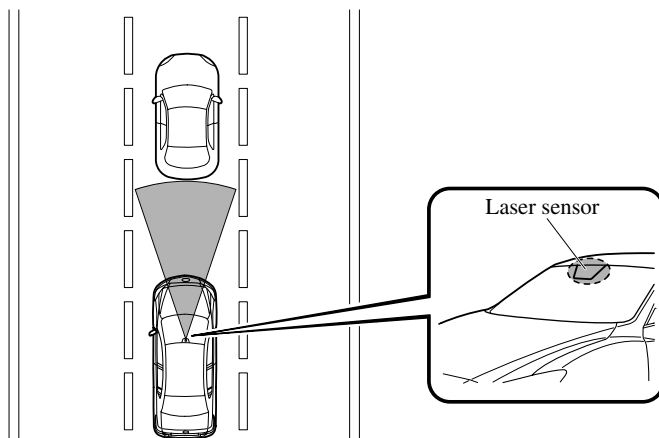

### **! WARNING**

**Do not rely on the Smart City Brake Support System (SCBS) as a substitute for safe driving:**

*The Smart City Brake Support (SCBS) system cannot compensate for unsafe and reckless driving, excessive speed, tailgating (following another vehicle too closely), and driving on slippery roads such as wet, snowy, and icy roads (reduced tire friction and road contact because of water on the road surface). You can still have an accident.*

## **Do not rely completely on the Smart City Brake Support (SCBS) system:**

- *The Smart City Brake Support (SCBS) system is only designed to reduce damage in the event of a collision. Over reliance on the system leading to the accelerator pedal or brake pedal being mistakenly operated could result in an accident.*
- *The Smart City Brake Support (SCBS) is a system which operates in response to a vehicle ahead. The system may not be able to detect or react to 2-wheeled vehicles or pedestrians.*
- *The laser sensor for the Smart City Brake Support (SCBS) system is installed near the rearview mirror. To assure the correct operation of the Smart City Brake Support (SCBS), heed the following cautions.*
  - *Do not apply stickers to the surface of the windshield near the laser sensor (including transparent stickers). Otherwise, the laser sensor may not be able to detect vehicles ahead which could result in an accident.*
  - *Do not apply coating agent to the windshield. Otherwise, the laser sensor may not be able to detect vehicles or obstructions in front which could result in an accident.*
  - *Do not disassemble the laser sensor.*
  - *If cracks or damage caused by flying gravel or debris is visible near the laser sensor, stop using the Smart City Brake Support (SCBS) system immediately and have your vehicle inspected by an Authorized Mazda Dealer. If the vehicle continues to be driven with cracks or scratch marks left on the windshield near the laser sensor, the system may operate unnecessarily and cause an unexpected accident. Refer to Stopping The Smart City Brake Support (SCBS) System Operation on page 4-77.*
  - *When replacing the windshield wipers or windshield, consult an Authorized Mazda Dealer.*

## **Do not modify the suspension:**

*If the vehicle height or inclination is changed, the system will not be able to correctly detect vehicles ahead. This will result in the Smart City Brake Support (SCBS) system not operating normally or mistakenly operating, which could cause a serious accident.*

## **Turn off the Smart City Brake Support (SCBS) when the vehicle is running on a chassis roller or being towed:**

*Turn off the Smart City Brake Support (SCBS) system to prevent mistaken operation when the vehicle is running on a chassis roller or being towed. See the next page on how to turn off the Smart City Brake Support (SCBS).*

*Refer to Stopping The Smart City Brake Support (SCBS) System Operation on page 4-77.*

 **CAUTION**

- *When driving off-road in areas where there is grass or forage, it is recommended that the Smart City Brake Support (SCBS) system be turned off.*
- *Always use tires for all wheels that are of the specified size, and the same manufacturer, brand, and tread pattern. In addition, do not use tires with significantly different wear patterns on the same vehicle as the Smart City Brake Support (SCBS) system may not operate normally.*
- *The laser sensor includes a function for detecting a soiled windshield and informing the driver, however, depending on the conditions, it may not detect plastic shopping bags, ice or snow on the windshield. In such cases, the system cannot accurately determine a vehicle ahead and may not be able to operate normally. Always drive carefully and pay attention to the road ahead.*

**NOTE**

- *The Smart City Brake Support (SCBS) system will not operate if the driver is deliberately performing driving operations (accelerator pedal and steering wheel).*
- *The Smart City Brake Support (SCBS) system will operate under the following conditions.*
  - *The engine is running.*
  - *The Smart City Brake Support (SCBS) warning light (amber) does not illuminate.*
  - *The vehicle speed is between about 4 to 30 km/h (2 to 18 mph).*
  - *The Smart City Brake Support (SCBS) system is not turned off.*
  - *The DSC operation is not turned off using the DSC OFF switch.*
  - *The DSC is not malfunctioning.*
- *The Smart City Brake Support (SCBS) detects a vehicle ahead by emitting a near-infrared laser beam and receiving the beam reflected off the reflector of the vehicle ahead, and then using it for the measurement. Consequently, the Smart City Brake Support (SCBS) may not operate under the following conditions:*
  - *Reflection of the laser is poor due to the shape of the vehicle ahead.*
  - *The vehicle ahead is significantly dirty.*
  - *Under bad weather condition, such as rain, fog and snow.*
  - *The window washer is being used or the windshield wipers are not used when it's raining.*
  - *The windshield is dirty.*
  - *The steering wheel is turned completely left or right, or the vehicle is accelerated rapidly and comes close to the vehicle ahead.*
  - *Trucks with low loading platforms and vehicles with an extremely low or high profile.*
  - *Vehicles with certain shapes such as a vehicle carrier.*

## Brake

---

- *Under the following conditions, the Smart City Brake Support (SCBS) system may not operate normally.*
    - *Heavy luggage is loaded in the luggage compartment or on the rear seat.*
    - *If there is the possibility of partial contact with a vehicle ahead.*
    - *When driving on continuously curving roads, and entering and exiting exits.*
    - *Elongated luggage or cargo is loaded onto installed roof rails and covers the laser sensor.*
    - *Exhaust gas from the vehicle in front, sand, snow, and water vapor rising from manholes and grating, and water splashed into the air.*
    - *When towing a malfunctioning vehicle.*
  - *In the following cases, the laser sensor may inadvertently determine that there is a vehicle ahead and the Smart City Brake Support (SCBS) system may operate.*
    - *Objects on the road at the entrance to a curve.*
    - *Vehicles passing in the opposite lane while making a curve.*
    - *Metal objects, bumps, or protruding objects on the road.*
    - *When passing through a toll gate.*
    - *When passing under a vinyl curtain or flag.*
    - *Plastic objects such as pylons.*
    - *Two-wheeled vehicles, pedestrians, animals or standing trees.*
    - *Vehicle is driven with some of the tires having significant wear.*
  - *When the system operates, the user is notified by the flashing Smart City Brake Support (SCBS) indicator light (red) and the active driving display\*.*
  - *The Smart City Brake Support (SCBS) warning light (amber) turns on when the system has a malfunction.*
- Refer to Warning Lights on page 4-21.*



### ▼ Laser Sensor Handling

The Smart City Brake Support (SCBS) laser sensor is installed at the top of the windshield near the rearview mirror.

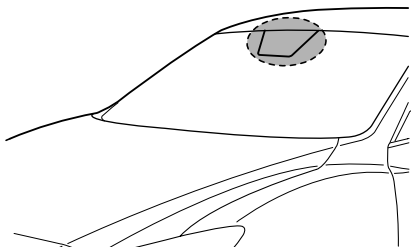

Always keep the surface of the windshield around the laser sensor clean to assure proper operation of the Smart City Brake Support (SCBS) system.

### **⚠ WARNING**

***As there is the possibility of eye damage occurring from the laser, always heed the following precautions:***

- *Never remove the sensor.*
- *A removed sensor will not meet the conditions for a class 1M laser under the IEC 60825-1 specification and therefore eye safety cannot be assured.*
- *Do not peer into the sensor using optical instruments with a magnification function such as magnifying glasses, and microscopic and objective lenses within a distance of 100 mm (3.94 in) from the sensor.*

# Brake

---

Laser classification label:



Laser explanatory label:

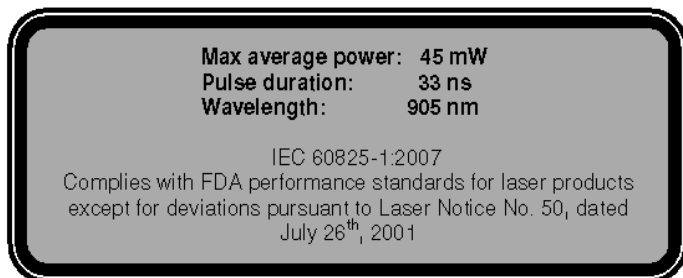

Laser sensor radiation data

Maximum average power: 45 mW

Pulse duration: 33 ns

Wavelength: 905 nm

Divergence angle (horizontal×vertical): 28 degrees×12 degrees

### ▼ Smart City Brake Support (SCBS) Indicator Light (Red)

If the Smart City Brake Support (SCBS) is operating, the indicator light (red) flashes.

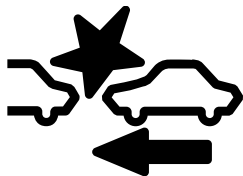

### ▼ Deactivating The Smart City Brake Support (SCBS) System Operation

The Smart City Brake Support (SCBS) system can be temporarily deactivated. Refer to Personalization Features on page 9-12.

When the Smart City Brake Support (SCBS) system is turned off, the Smart City Brake Support (SCBS) OFF indicator light turns on.



When the engine is restarted, the system becomes operational.

#### **NOTE**

*When the DSC OFF switch is pressed to stop the DSC operation, the Smart City Brake Support (SCBS) system operation also stops and the Smart City Brake Support (SCBS) OFF indicator light turns on.*

## **Antilock Brake System (ABS)**

The ABS control unit continuously monitors the speed of each wheel. If one wheel is about to lock up, the ABS responds by automatically releasing and reapplying that wheel's brake.

The driver will feel a slight vibration in the brake pedal and may hear a chattering noise from the brake system. This is normal ABS system operation. Continue to depress the brake pedal without pumping the brakes.

The warning light turns on when the system has a malfunction.  
Refer to Warning Lights on page 4-21.

### **WARNING**

#### **Do not rely on ABS as a substitute for safe driving:**

*The ABS cannot compensate for unsafe and reckless driving, excessive speed, tailgating (following another vehicle too closely), driving on ice and snow, and hydroplaning (reduced tire friction and road contact because of water on the road surface). You can still have an accident.*

#### **NOTE**

- *Braking distances may be longer on loose surfaces (snow or gravel, for example) which usually have a hard foundation. A vehicle with a normal braking system may require less distance to stop under these conditions because the tires will build up a wedge of surface layer when the wheels skid.*
- *The sound of the ABS operating may be heard when starting the engine or immediately after starting the vehicle, however, it does not indicate a malfunction.*

## Traction Control System (TCS)

The Traction Control System (TCS) enhances traction and safety by controlling engine torque and braking. When the TCS detects driving wheel slippage, it lowers engine torque and operates the brakes to prevent loss of traction.

This means that on a slick surface, the engine adjusts automatically to provide optimum power to the drive wheels, limiting wheel spin and loss of traction.

The warning light turns on when the system has a malfunction. Refer to Warning Lights on page 4-21.

### **WARNING**

**Do not rely on the Traction Control System (TCS) as a substitute for safe driving:**

*The Traction Control System (TCS) cannot compensate for unsafe and reckless driving, excessive speed, tailgating (following another vehicle too closely), and hydroplaning (reduced tire friction and road contact because of water on the road surface). You can still have an accident.*

**Use snow tires or tire chains and drive at reduced speeds when roads are covered with ice and/or snow:**

*Driving without proper traction devices on snow and/or ice-covered roads is dangerous. The Traction Control System (TCS) alone cannot provide adequate traction and you could still have an accident.*

### **NOTE**

*To turn off the TCS, press the DSC OFF switch (page 4-81).*

### **▼ TCS/DSC Indicator Light**



This indicator light stays on for a few seconds when the ignition is switched ON. If the TCS or DSC is operating, the indicator light flashes.

If the light stays on, the TCS, DSC or the brake assist system may have a malfunction and they may not operate correctly. Take your vehicle to an Authorized Mazda Dealer.

### **NOTE**

- *In addition to the indicator light flashing, a slight lugging sound will come from the engine. This indicates that the TCS/DSC is operating properly.*
- *On slippery surfaces, such as fresh snow, it will be impossible to achieve high rpm when the TCS is on.*

## Dynamic Stability Control (DSC)

The Dynamic Stability Control (DSC) automatically controls braking and engine torque in conjunction with systems such as ABS and TCS to help control side slip when driving on slippery surfaces, or during sudden or evasive maneuvering, enhancing vehicle safety.

Refer to ABS (page 4-78) and TCS (page 4-79).

DSC operation is possible at speeds greater than 20 km/h (12 mph).

The warning light turns on when the system has a malfunction.

Refer to Warning Lights on page 4-21.

### **WARNING**

#### **Do not rely on the Dynamic Stability Control as a substitute for safe driving:**

*The Dynamic Stability Control (DSC) cannot compensate for unsafe and reckless driving, excessive speed, tailgating (following another vehicle too closely), and hydroplaning (reduced tire friction and road contact because of water on the road surface). You can still have an accident.*

### **CAUTION**

- *The DSC may not operate correctly unless the following are observed:*
  - *Use tires of the correct size specified for your Mazda on all four wheels.*
  - *Use tires of the same manufacturer, brand and tread pattern on all four wheels.*
  - *Do not mix worn tires.*
- *The DSC may not operate correctly when tire chains are used or a temporary spare tire is installed because the tire diameter changes.*

### **TCS/DSC Indicator Light**



This indicator light stays on for a few seconds when the ignition is switched ON. If the TCS or DSC is operating, the indicator light flashes.

If the light stays on, the TCS, DSC or the brake assist system may have a malfunction and they may not operate correctly. Take your vehicle to an Authorized Mazda Dealer.

### ▼ DSC OFF Indicator Light



This indicator light stays on for a few seconds when the ignition is switched ON. It also illuminates when the DSC OFF switch is pressed and TCS/DSC is switched off.

Refer to DSC OFF Switch on page 4-81.

If the light remains illuminated and the TCS/DSC is not switched off, take your vehicle to an Authorized Mazda Dealer. The DSC may have a malfunction.

### ▼ DSC OFF Switch

Press the DSC OFF switch to turn off the TCS/DSC. The DSC OFF indicator light in the instrument cluster will illuminate.

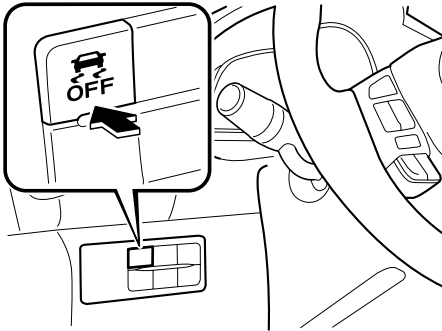

Press the switch again to turn the TCS/DSC back on. The DSC OFF indicator light will turn off.

### NOTE

- When DSC is on and you attempt to free the vehicle when it is stuck, or drive it out of freshly fallen snow, the TCS (part of the DSC system) will activate. Depressing the accelerator will not increase engine power and freeing the vehicle may be difficult. When this happens, turn off the TCS/DSC.
- If the TCS/DSC is off when the engine is turned off, it automatically activates when the ignition is switched ON.
- Leaving the TCS/DSC on will provide the best traction.
- If the DSC OFF switch is pressed and held for 10 seconds or more, the DSC OFF switch malfunction detection function operates and the DSC system activates automatically. The DSC OFF indicator light turns off while the DSC system is operative.

## i-ELOOP\*

On conventional vehicles, the kinetic energy that is generated when the vehicle is decelerated by applying the brakes or during engine braking ends up being discarded as heat. By utilizing this discarded kinetic energy to generate electricity and use it to power the vehicle's electrical devices and accessories such as the A/C and audio, fuel consumption can be reduced. Mazda's system for generating electricity from this kinetic energy is called the Regenerative Braking System (i-ELOOP).

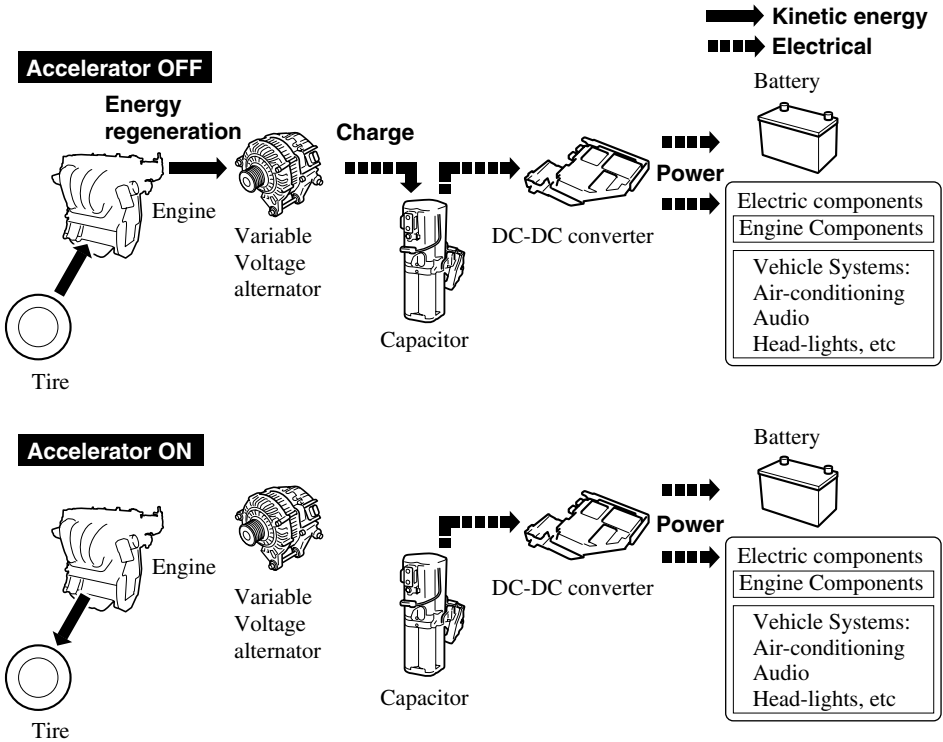



A capacitor is incorporated as the device for storing the generated electricity, which can store and use large amounts of electricity instantly.

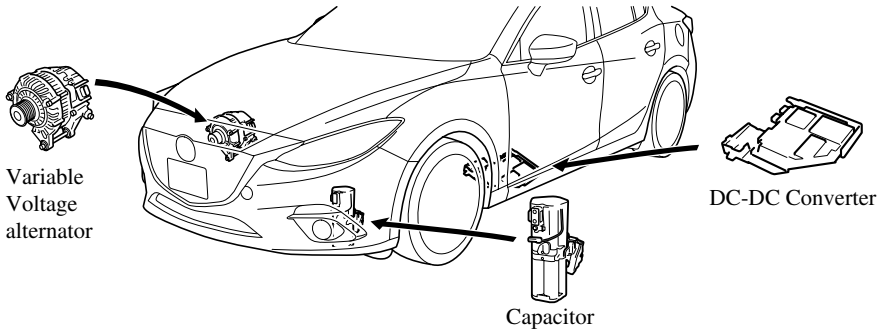

**⚠ CAUTION**

High-current electricity flows through the following areas, therefore do not touch them.

- Variable Voltage alternator
- DC-DC converter
- Capacitor

**NOTE**

- When installing high power consumption devices such high-output speakers, consult an Authorized Mazda Dealer.
- A difference in the fuel economy may occur depending on use conditions such as with the A/C and headlights.
- If the capacitor is to be disposed of, always consult an Authorized Mazda Dealer. For details, go to the following URL.  
<http://www.mazda.com/csr/environment/recycling>

## i-ELOOP

---

### ▼ i-ELOOP Indicator Light/Control Status Display

The driver is notified of the i-ELOOP power generating status and the vehicle conditions by the i-ELOOP indicator light and the control status display.

#### i-ELOOP Indicator Light

# i-ELOOP

#### **Illuminated (vehicle without type B audio)**

The light turns on during power generation.

#### **Flashing**

If the engine is started after the vehicle has not been driven for a long period of time, the i-ELOOP indicator light may flash. Leave the engine idling and wait until the indicator light turns off.

#### **NOTE**

- *The beep will sound if the vehicle is driven while the i-ELOOP indicator light is flashing. In addition, if you turn the steering wheel while the light is flashing, it will feel heavier than normal, but this does not indicate an abnormality. Stop the vehicle in a safe location with the engine running and do not attempt to turn the steering wheel. The steering operation will return to normal after the i-ELOOP indicator light stops flashing.*
- **(Vehicles with type B audio)**  
*A notification is displayed in the center display and the i-ELOOP indicator light flashes at the same time. Refer to Warning Message Indicated on Display on page 7-33.*

#### **Control status display (vehicles with type B audio)**

The i-ELOOP power generating status is displayed in the center display. Refer to Control Status Display on page 4-86.

## Fuel Economy Monitor\*

For vehicles with type B audio, the Control Status and Fuel Consumption are switched and displayed by operating each icon in the display.

In addition, after completing a trip, the total energy efficiency to date is displayed in the ending display when the ending display is turned on.

1. Select the  icon on the home screen to display the applications screen.
2. Select the “Fuel Economy Monitor”.
3. Operate the commander switch or touch the screen and display the menu.

### NOTE

When the menu is displayed by touching the screen, the display is hidden automatically after 6 seconds.

4. Select the icon in the menu and perform the operation. Each icon operates as follows:

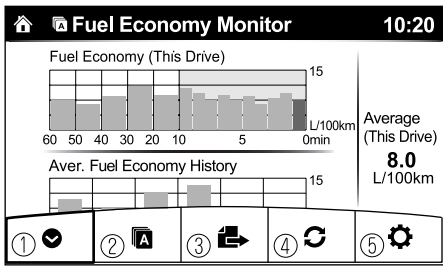
Indication on display	Control status
	① Hides the menu display.
	② Displays the application screen.
	③ Switches the Fuel Economy Monitor in the order of Control Status and Fuel Consumption.
	④ Resets the fuel economy data.
	⑤ Displays the following setting screen. <ul style="list-style-type: none"> <li>•Ending display on/off switching</li> <li>•On/off switching for function which synchronizes reset fuel economy data to trip meter (Trip A)</li> </ul>

## ▼ Fuel Consumption Display

Information regarding the fuel economy is displayed.

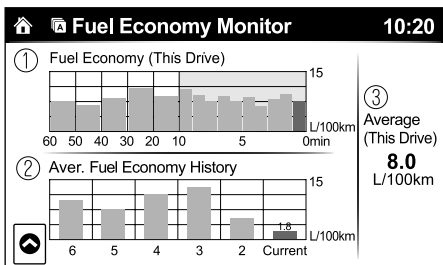
Indication on display	Control status
	① Displays the fuel economy for the past 60 minutes. <ul style="list-style-type: none"> <li>•Displays the fuel economy every minute for the past 1 to 10 minutes.</li> <li>•Displays the fuel economy every 10 minutes for the past 10 to 60 minutes.</li> </ul>
	② Displays the average fuel economy over the past 5 resets and after the current reset.
	③ Calculates the average fuel economy every minute after vehicle travel begins, and displays it.

# Fuel Economy Monitor

## NOTE

- The fuel economy data can be reset by doing the following operation:
  - Press the reset switch from the menu screen.
  - When the function which synchronizes the fuel economy monitor and the trip meter is on, reset trip A of the trip meter.
  - Delete the average fuel economy information displayed in the trip computer.
- After resetting the fuel economy data, "--" is displayed while the average fuel economy is calculated.

## ▼ Control Status Display

The power generating status is displayed

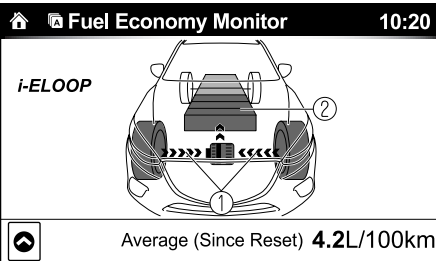
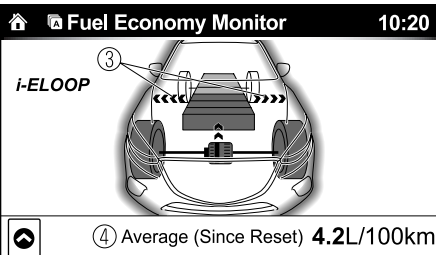
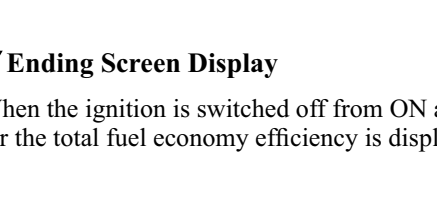
Indication on display	Control status
	<p>① Displays the level of electricity generated by regenerative braking.</p>
	<p>② Displays the amount of the electricity stored in the capacitor.</p>
	<p>③ Displays the status of the electricity stored in the capacitor and being supplied to the electrical devices (whole vehicle in display is illuminated simultaneously).</p> <p>④ Displays the accumulated fuel economy.</p>

## ▼ Ending Screen Display

When the ignition is switched off from ON after completing a trip, the actual performance for the total fuel economy efficiency is displayed for 5 seconds.

## Drive Selection\*

Drive selection is a system to switch the vehicle's drive mode. When the sport mode is selected, vehicle's response against accelerator operation is enhanced. This provides additional quick acceleration which may be needed to safely make maneuvers such as lane changes, merging onto freeways, or passing other vehicles.

### **CAUTION**

*Do not use the sport mode when driving on slippery roads such as wet or snow-covered roads. It may cause tire slipping.*

### **NOTE**

- *When the sport mode is selected, driving at higher engine speeds increases and it may increase fuel consumption. Mazda recommends to cancel the sport mode on normal driving.*
- *Drive mode cannot be switched in the following conditions:*
  - *ABS/TCS/DSC is operating*
  - *Steering wheel is being operated abruptly*

## Drive Selection

### ▼ Drive Selection Switch

The SPORT mode indicator light in the instrument cluster is illuminated while in SPORT mode.

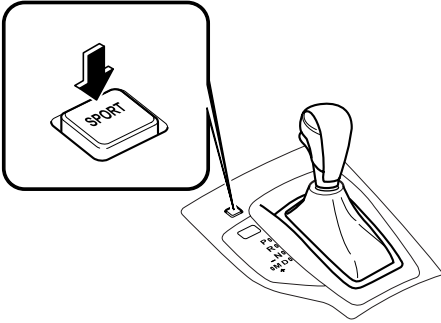

#### NOTE

- If the SET+ / SET - Switch of the Mazda Radar Cruise Control (MRCC) system/ cruise control is pressed while in SPORT mode, SPORT mode is automatically switched off.
- When the ignition is switched off, SPORT mode is also switch off.
- When SPORT mode is selected, the transaxle may automatically shift down or the vehicle speed may accelerate depending on the vehicle speed.

### ▼ SPORT Mode Indicator Light

#### Type A

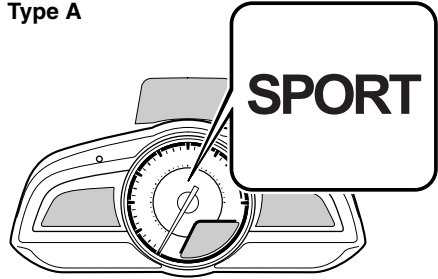

#### Type B

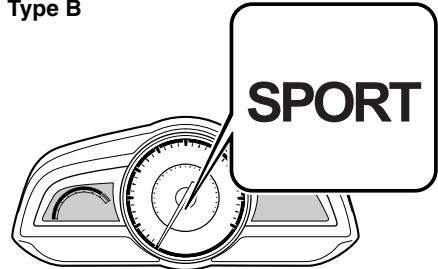

The light is illuminated while in SPORT mode.

#### NOTE

The indicator light flashes a few times to indicate that the mode cannot be switched to SPORT mode even if the drive select switch is pressed under the following conditions:

- ABS/TCS/DSC is operating
- The Mazda Radar Cruise Control (MRCC) system/cruise control is operating.
- The vehicle is making a turn or driving on a curved road.

## Power Steering

- Power steering is only operable when the engine is running. If the engine is off or if the power steering system is inoperable, you can still steer, but it requires more physical effort.

If the steering feels stiffer than usual during normal driving or the steering vibrates, consult an Authorized Mazda Dealer.

- The warning light notifies the driver of system abnormalities and operation conditions.

In addition, the buzzer may also activate depending on the system abnormality or operation condition.

Refer to Warning Lights on page 4-21.

Refer to Power Steering Warning Buzzer on page 7-38.

### CAUTION

*Never hold the steering wheel to the extreme left or right for more than 5 seconds with the engine running. This could damage the power steering system.*

## Mazda Radar Cruise Control (MRCC)

---

### Mazda Radar Cruise Control (MRCC)\*

The Mazda Radar Cruise Control (MRCC) system is designed to maintain headway control\*<sup>1</sup> according to the vehicle speed using a radar sensor to detect the distance to a vehicle ahead, and by presetting the vehicle speed between 30 km/h (19 mph) and 145 km/h (90 mph), the driver is freed from having to constantly use the accelerator or brake pedals.

\*1 Headway Control: Control of the distance between your vehicle and the vehicle ahead detected by the Mazda Radar Cruise Control (MRCC) system.

Additionally, if your vehicle starts closing in on the vehicle ahead because, for example, the vehicle ahead brakes suddenly, a warning sound and a warning indication in the display are activated simultaneously to alert you to maintain a sufficient distance between the vehicles. Use the Mazda Radar Cruise Control (MRCC) system on expressways and other highways which do not require a lot of repeated acceleration and deceleration.

### **WARNING**

**Do not rely completely on the Mazda Radar Cruise Control (MRCC) system and always drive carefully:**

*The Mazda Radar Cruise Control (MRCC) system is designed to reduce load on the driver, and although it maintains a constant vehicle speed, or specifically, it maintains a constant distance between your vehicle and the detected vehicle ahead according to the vehicle speed, the system has detection limitations depending on the type of vehicle ahead and its conditions, the weather conditions, and the road conditions. Additionally, the system may be unable to decelerate sufficiently to avoid hitting the vehicle ahead if the vehicle ahead applies the brakes suddenly or another vehicle cuts into the driving lane, which could result in an accident. Always verify the safety of the surrounding area and depress the brake pedal or accelerator pedal while keeping a safe distance from vehicles ahead or on-coming vehicles.*



# Mazda Radar Cruise Control (MRCC)

---

**Do not use the Mazda Radar Cruise Control (MRCC) system in the following locations. Otherwise, it could lead to an accident:**

- Roads with sharp curves and where vehicle traffic is heavy and there is insufficient space between vehicles. Roads where frequent and repetitive acceleration and deceleration occur (Driving under these conditions using the Mazda Radar Cruise Control (MRCC) system is not possible).
- When entering and exiting interchanges, service areas, and parking areas of highways (If you exit a highway while headway control is in use, the vehicle ahead will no longer be tracked and your vehicle may accelerate to the set speed).
- Slippery roads such as ice or snow-bound roads (The tires could spin causing you to lose vehicle control).
- Long descending slopes (to maintain distance between vehicles, the system automatically and continuously applies the brakes which could result in the loss of brake power).

**For the purposes of safety, switch the Mazda Radar Cruise Control (MRCC) system off when it is not being used.**



If the vehicle is towed or you are towing something, switch the Mazda Radar Cruise Control (MRCC) system off to prevent an incorrect operation.

## NOTE

- The Mazda Radar Cruise Control (MRCC) system operates when all of the following conditions are met.
  - The vehicle speed is about 30 km/h (19 mph) to 145 km/h (90 mph).
  - The Mazda Radar Cruise Control (MRCC) system is turned on.
  - The parking brake is not applied.
  - The Forward Obstruction Warning (FOW) warning light (amber) does not illuminate.
  - The Dynamic Stability Control (DSC) is operating normally.

### **(Manual transaxle)**

- The shift lever is in a position other than reverse (R) or neutral (N).
- The clutch pedal is not depressed.

### **(Automatic transaxle)**

- The selector lever is in the drive (D) position or manual (M) position (manual mode).

## Mazda Radar Cruise Control (MRCC)

---

- *In the following cases, the warnings may not activate even if your vehicle starts closing in on the vehicle ahead.*
  - *You are driving at the same speed as the vehicle ahead.*
  - *Directly after the Mazda Radar Cruise Control (MRCC) system has been set.*
  - *When the accelerator pedal is depressed or directly after the accelerator pedal is released.*
  - *Another vehicle cuts into the driving lane.*
- *The following are not detected as physical objects.*
  - *Vehicles approaching in the opposite direction*
  - *Pedestrians*
  - *Stationary objects (stopped vehicles, obstructions)*
- *If a vehicle ahead is traveling at an extremely low speed, the system may not detect it correctly.*
- *During headway control travel, do not set the system on two-wheeled vehicles such as motorcycles and bicycles.*
- *Do not use the Mazda Radar Cruise Control (MRCC) system under conditions in which the close proximity warnings are frequently activated.*
- *During headway control travel, the system accelerates and decelerates your vehicle in conjunction with the speed of the vehicle ahead. However, if it is necessary to accelerate for a lane change or if the vehicle ahead brakes suddenly causing you to close in on the vehicle rapidly, accelerate using the accelerator pedal or decelerate using the brake pedal depending on the conditions.*
- *While the Mazda Radar Cruise Control (MRCC) system is in use, it does not cancel even if the selector lever (automatic transaxle)/shift lever (manual transaxle) is operated and any intended engine braking will not occur. If deceleration is required, lower the vehicle speed setting or depress the brake pedal.*
- *The brake lights are illuminated while the Mazda Radar Cruise Control (MRCC) automatic braking is operating, however, they may not be illuminated while the vehicle is on a down slope at the set vehicle speed or traveling at a constant speed and following a vehicle ahead.*
- *The Mazda Radar Cruise Control (MRCC) warning light (amber) flashes when the system has a malfunction.*

*Refer to Warning Lights on page 4-21.*

## Mazda Radar Cruise Control (MRCC)

### ▼ Mazda Radar Cruise Control (MRCC) Display Indication

The setting status and operation conditions of the Mazda Radar Cruise Control (MRCC) system are indicated in the active driving display.

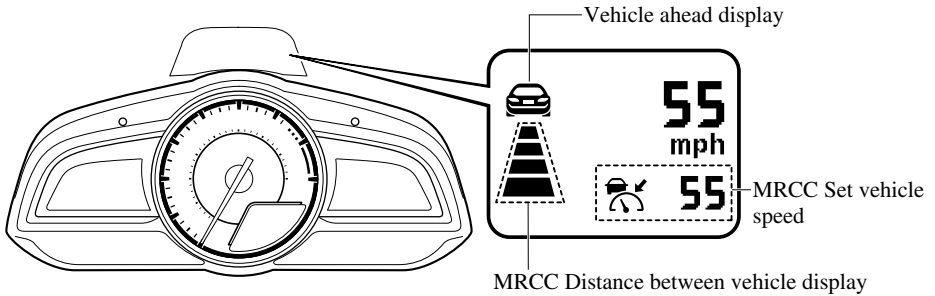

### ▼ Close Proximity Warning

If your vehicle rapidly closes in on the vehicle ahead because the vehicle applies the brakes suddenly while you are traveling in headway control, the warning sound activates and the brake warning is indicated in the display. Always verify the safety of the surrounding area and depress the brake pedal while keeping a safe distance from the vehicle ahead. Additionally, always keep a safe distance from the vehicles behind you.

# BRAKE !

# Mazda Radar Cruise Control (MRCC)

---

## ▼ Setting the System

### To Activate

To activate the system, press the ON switch.

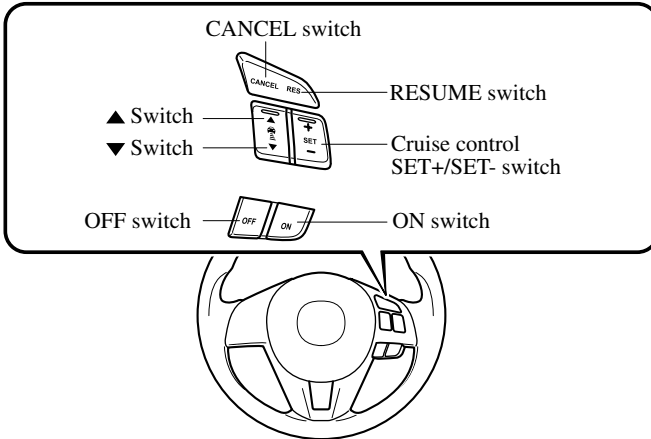

When the system is activated, the vehicle speed and the distance between vehicles while in headway control can be set. The Mazda Radar Cruise Control (MRCC) indication is shown in the active driving display.

### **NOTE**

*When the ignition is switched to ACC or OFF while the Mazda Radar Cruise Control (MRCC) is ON, the Mazda Radar Cruise Control (MRCC) remains ON automatically.*

# Mazda Radar Cruise Control (MRCC)

## How to Set the Speed

1. Adjust the vehicle speed to the desired setting using the accelerator pedal.
2. Headway control begins when the SET+ or SET- switch is pressed. The set speed and the inter-vehicle distance display filled with white lines are displayed. The Mazda Radar Cruise Control (MRCC) indicator light (green) is indicated simultaneously.

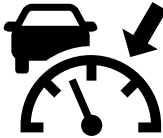

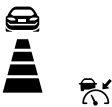
Travel status	Display
During travel at constant speed	 55 mph 55
During travel under headway control	 55 mph 55











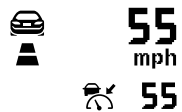

## NOTE

- If a vehicle ahead is detected while traveling at a constant speed, the vehicle-ahead indication is displayed and headway control is performed. Additionally, when a vehicle ahead is no longer detected, the vehicle-ahead indication turns off and the system switches back to travel at constant speed.
- If you are driving the vehicle at a speed faster than the set speed, headway control on the vehicle ahead is not possible. Adjust the system to the desired vehicle speed using the accelerator pedal.

# Mazda Radar Cruise Control (MRCC)

## How to Set the Distance Between Vehicles During Headway Control

The distance between vehicles is set to a shorter distance each time the ▲ switch is pressed. The distance between vehicles is set to a longer distance by pressing the ▼ switch. The distance-between-vehicles can be set to 4 levels; Long, medium, short, and extremely short distance.

Distance-between-vehicles guideline (at 80 km/h (50 mph) vehicle speed)	Indication on display
Long (about 50 m (164 ft))	   <b>55</b> mph <b>55</b>
Medium (about 40 m (131 ft))	   <b>55</b> mph <b>55</b>
Short (about 30 m (98 ft))	   <b>55</b> mph <b>55</b>
Extremely short (about 25 m (82 ft))	   <b>55</b> mph <b>55</b>

### NOTE

- The distance between vehicles differs depending on the vehicle speed, and the slower the vehicle speed, the shorter the distance.
- When the ignition is switched to ACC or OFF and then the engine is started again, the system automatically sets the distance between vehicles to the previous setting.

## Changing the Set Vehicle Speed

### Changing the set vehicle speed using the SET+/SET- switch

Press the SET+ switch to accelerate. Press the SET- switch to decelerate. The set vehicle speed changes as follows each time the SET+/SET- switch is pressed.

Short press	1 km/h (1 mph)
Long press	10 km/h (5 mph)

### NOTE

For example, the set vehicle speed is changed by pressing the SET+/SET- switch four times as follows: The vehicle speed accelerates or decelerates by 4 km/h (4 mph).

### To accelerate using the accelerator pedal

Depress the accelerator pedal and press and release the SET+ or SET- switch at the desired speed. If a switch cannot be operated, the system returns to the set speed when you release your foot from the accelerator pedal.



The warnings and brake control do not operate while the accelerator pedal is depressed.

# Mazda Radar Cruise Control (MRCC)

## **NOTE**

- *When accelerating using the SET+ switch while in headway control, the set vehicle speed can be adjusted but acceleration is not possible. If there is no longer a vehicle ahead, acceleration continues until reaching the set vehicle speed. Check the set vehicle speed by viewing the set vehicle speed display in the active driving display.*
- *When depressing the accelerator pedal, the inter-vehicle distance display in the display in the instrument cluster changes to the white-line display.*
- *The minimum settable speed is 30 km/h (19 mph). If the set vehicle speed reaches 30 km/h (19 mph) using the switch operation, constant speed travel is maintained at about 30 km/h (19 mph) even if the SET- switch is pressed. The Mazda Radar Cruise Control (MRCC) system is not canceled.*

## **To Deactivate**

The Mazda Radar Cruise Control (MRCC) is canceled when the OFF switch is pressed.

## **When the system is temporarily canceled**

In the following cases, the Mazda Radar Cruise Control (MRCC) system is temporarily canceled and the “MRCC Cancelled” indication is displayed in the display in the instrument cluster. The Mazda Radar Cruise Control (MRCC) indicator light (green) turns off simultaneously.

- The CANCEL switch is pressed.
- The brake pedal is depressed.
- The parking brake is applied.
- The selector lever is shifted to park (P), neutral (N) or reverse (R) (automatic transaxle).
- The shift lever is in the reverse (R) position (manual transaxle).
- In the following cases, the “MRCC Cancelled” indication is displayed and the beep sounds one time.
  - The vehicle speed decreases to less than 25 km (16 mph).
  - The DSC has operated.
  - The TCS has operated for a certain period of time.
  - The Smart City Brake Support (SCBS) has operated.
  - When traveling on a down slope for a long period of time.
  - There is a problem with the system.
  - The engine stalls.

## **(Manual transaxle)**

- The shift lever is shifted to neutral (N) for a certain period of time.
- The clutch is depressed for a certain period of time.



# Mazda Radar Cruise Control (MRCC)

## NOTE

- The Mazda Radar Cruise Control (MRCC) system may be canceled during rain, fog, snow or other inclement weather conditions, or the front surface of the radiator grille is dirty.
- If the Mazda Radar Cruise Control (MRCC) system has been temporarily canceled, you can return to the previously set vehicle speed by pressing the RESUME switch after the following conditions have been met.
  - All of the Mazda Radar Cruise Control (MRCC) operation conditions have been met.
  - A certain period of time has elapsed since the system was automatically canceled while driving for a long time on a down slope.
- If the SET +/SET - or RESUME switch is pressed before a certain period of time has elapsed since the system was automatically canceled while driving for a long time on a down slope, "MRCC Not available" is displayed in the display.
- If the OFF switch is pressed to cancel the Mazda Radar Cruise Control (MRCC), the system does not return to the previously set speed even if the RESUME switch is pressed.

## ▼ Shift-up/Shift-down Request Display (Manual Transaxle)

The shift-up or shift-down request display in the display of the instrument cluster may be displayed while the Mazda Radar Cruise Control (MRCC) system is operating. When this occurs, shift gears because the current gear position is not appropriate.

Request	Indication on display
Shift up	
Shift down	

## NOTE

- If the gears are not shifted up even though the shift-up request indication is displayed, load will be applied to the engine and the Mazda Radar Cruise Control (MRCC) system may be automatically canceled or engine damage could occur.
- If the gears are not shifted down even though the shift-down request indication is displayed, the Mazda Radar Cruise Control (MRCC) system may be automatically canceled or engine stalling could occur.

## ▼ Radar Sensor Handling

The Mazda Radar Cruise Control (MRCC) radar sensor is installed on the backside of the radiator grille.

Refer to Radar Sensor on page 4-64.



**Cruise Control\***

With cruise control, you can set and automatically maintain any speed of more than about 25 km/h (16 mph).

**! WARNING****Do not use the cruise control under the following conditions:**

*Using the cruise control under the following conditions is dangerous and could result in loss of vehicle control.*

- *Hilly terrain*
- *Steep inclines*
- *Heavy or unsteady traffic*
- *Slippery or winding roads*
- *Similar restrictions that require inconsistent speed*

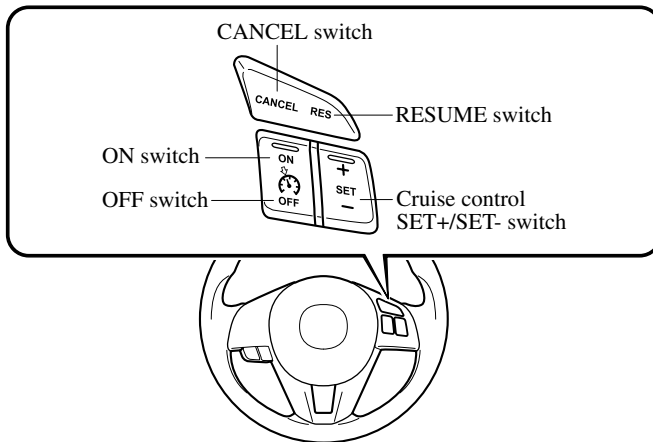
**▼ Cruise Control Switch**

# Cruise Control

---

## ▼ Cruise Main Indicator Light (Amber)/Cruise Set Indicator Light (Green)



The indicator light has two colors.

### Cruise Main Indicator Light (Amber)

The indicator light illuminates amber when the cruise control system is activated.

### Cruise Set Indicator Light (Green)

The indicator light illuminates green when a cruising speed has been set.

## ▼ Activation/Deactivation

To activate the system, press the ON switch. The cruise main indicator light (Amber) illuminates.

To deactivate the system, press the OFF switch.

The cruise main indicator light (Amber) turns off.



### **Always turn off the cruise control system when it is not in use:**

*Leaving the cruise control system in an activation-ready state while the cruise control is not in use is dangerous as the cruise control could unexpectedly activate if the activation button is accidentally pressed, and result in loss of vehicle control and an accident.*

## ▼ To Set Speed

1. Activate the cruise control system by pressing the ON switch. The cruise main indicator light (Amber) illuminates.
2. Accelerate to the desired speed, which must be more than 25 km/h (16 mph).
3. Set the cruise control by pressing the SET + or SET - switch at the desired speed. The cruise control is set at the moment the SET + or SET - switch is pressed. Release the accelerator pedal simultaneously. The cruise set indicator light (Green) illuminates.

### **NOTE**

- *Release the SET + or SET - switch at the desired speed, otherwise the speed will continue increasing while the SET + switch is pressed and held, and continue decreasing while the SET - switch is pressed and held (except when the accelerator pedal is depressed).*
- *On a steep grade, the vehicle may momentarily slow down while ascending, or speed up while descending.*
- *Cruise control will cancel if the vehicle speed decreases below 21 km/h (13 mph) when cruise is activated, such as when climbing a steep grade.*
- *Cruise control may cancel at about 15 km/h (9 mph) below the preset speed, such as when climbing a long, steep grade.*

**▼ To Increase Cruising Speed**

Follow either of these procedures.

**To increase speed using cruise control switch**

Press the SET + switch and hold it. Your vehicle will accelerate. Release the switch at the speed you want.

Press the SET + switch and release it immediately to adjust the preset speed. Multiple operations will increase the preset speed according to the number of times it is operated.

**Increasing speed with a single SET + switch operation**

Meter display for vehicle speed indicated in km/h: 1 km/h (0.6 mph)

Meter display for vehicle speed indicated in mph: 1 mph (1.6 km/h)

**To increase speed using accelerator pedal**

Depress the accelerator pedal to accelerate to the desired speed. Press the SET + or SET – switch and release it immediately.

**NOTE**

*Accelerate if you want to speed up temporarily when the cruise control is on. Greater speed will not interfere with or change the set speed. Take your foot off the accelerator to return to the set speed.*

**▼ To Decrease Cruising Speed**

Press the SET – switch and hold it. The vehicle will gradually slow. Release the switch at the speed you want.

Press the SET – switch and release it immediately to adjust the preset speed. Multiple operations will decrease the preset speed according to the number of times it is operated.

**Decreasing speed with a single SET – switch operation**

Meter display for vehicle speed indicated in km/h: 1 km/h (0.6 mph)

Meter display for vehicle speed indicated in mph: 1 mph (1.6 km/h)

**▼ To Resume Cruising Speed at More Than 25 km/h (16 mph)**

If some other method besides the OFF switch was used to cancel cruising speed (such as applying the brake pedal) and the system is still activated, the most recent set speed will automatically resume when the RESUME switch is pressed.

If vehicle speed is below 25 km/h (16 mph), increase the vehicle speed up to 25 km/h (16 mph) or more and press the RESUME switch.

**▼ To Temporarily Cancel**

To temporarily cancel the system, use one of these methods:

- Slightly depress the brake pedal.
- Depress the clutch pedal (Manual transaxle only).
- Press the CANCEL switch.

If the RESUME switch is pressed when the vehicle speed is 25 km/h (16 mph) or higher, the system reverts to the previously set speed.

## Cruise Control

---

### ▼ To Deactivate

To deactivate the system, press the OFF switch.

# Tire Pressure Monitoring System

## Tire Pressure Monitoring System\*

The Tire Pressure Monitoring System (TPMS) monitors the air pressure of all four tires. If the air pressure of one or more tires is too low, the system warns the driver by indicating the tire pressure monitoring system warning light in the instrument cluster and operating a beep sound. The system monitors the tire pressures indirectly using the data sent from the ABS wheel speed sensors.

To allow the system to operate correctly, the system needs to be initialized with the specified tire pressure (value on the tire pressure label). Follow the procedure and perform the initialization.

Refer to Tire Pressure Monitoring System Initialization on page 4-106.

The warning light flashes when the system has a malfunction.

Refer to Warning Lights on page 4-21.

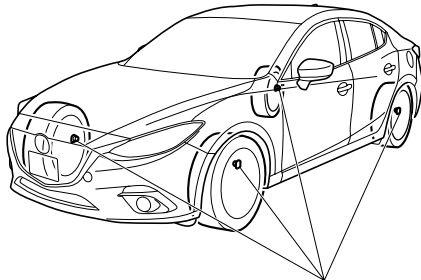

ABS wheel speed sensor

# Tire Pressure Monitoring System

---

## CAUTION

- *Each tire, including the spare (if provided), should be checked monthly when cold and inflated to the inflation pressure recommended by the vehicle manufacturer on the vehicle placard or tire inflation pressure label. (If your vehicle has tires of a different size than the size indicated on the vehicle placard or tire inflation pressure label, you should determine the proper tire inflation pressure for those tires.)*  
*As an added safety feature, your vehicle has been equipped with a tire pressure monitoring system (TPMS) that illuminates a low tire pressure telltale when one or more of your tires is significantly under-inflated. Accordingly, when the low tire pressure telltale illuminates, you should stop and check your tires as soon as possible, and inflate them to the proper pressure. Driving on a significantly under-inflated tire causes the tire to overheat and can lead to tire failure. Under-inflation also reduces fuel efficiency and tire tread life, and may affect the vehicle's handling and stopping ability.*  
*Please note that the TPMS is not a substitute for proper tire maintenance, and it is the driver's responsibility to maintain correct tire pressure, even if under-inflation has not reached the level to trigger illumination of the TPMS low tire pressure telltale.*  
*Your vehicle has also been equipped with a TPMS malfunction indicator to indicate when the system is not operating properly.*  
*The TPMS malfunction indicator is combined with the low tire pressure telltale. When the system detects a malfunction, the telltale will flash for approximately one minute and then remain continuously illuminated. This sequence will continue upon subsequent vehicle start-ups as long as the malfunction exists. When the malfunction indicator is illuminated, the system may not be able to detect or signal low tire pressure as intended. TPMS malfunctions may occur for a variety of reasons, including the installation of replacement or alternate tires or wheels on the vehicle that prevent the TPMS from functioning properly. Always check the TPMS malfunction telltale after replacing one or more tires or wheels on your vehicle to ensure that the replacement or alternate tires and wheels allow the TPMS to continue to function properly.*
- *To avoid false readings, the system samples for a little while before indicating a problem. As a result it will not instantaneously register a rapid tire deflation or blow out.*

# Tire Pressure Monitoring System

---

**NOTE**

*Because this system detects slight changes in tire conditions, the timing of the warning may be faster or slower in the following cases:*

- *The size, manufacturer, or the type of tires is different from the specification.*
- *The size, manufacturer, or the type of a tire is different from the others, or the level of tire wear is excessively different between them.*
- *A run-flat tire, studless tire, snow tire, or tire chains are used.*
- *An emergency tire is used (The tire pressure monitoring system warning light may flash and then continue illuminating).*
- *A tire is repaired using the puncture tire repair kit.*
- *The tire pressure is excessively higher than the specified pressure, or the tire pressure is suddenly lowered for some reason such as a tire burst during driving.*
- *The vehicle speed is lower than about 15 km/h (9.3 mph) (including when the vehicle is stopped), or the drive period is shorter than 5 minutes.*
- *The vehicle is driven on an extremely rough road or a slippery, icy road.*
- *Hard steering and rapid acceleration/deceleration are repeated such as during aggressive driving on a winding road.*
- *Load on the vehicle is applied to a tire such as by loading heavy luggage to one side of the vehicle.*
- *System initialization has not been implemented with the specified tire pressure.*

# Tire Pressure Monitoring System

## ▼ Tire Pressure Monitoring System Initialization

In the following cases, system initialization must be performed so that the system operates normally.

- A tire pressure is adjusted.
- Tire rotation is performed.
- A tire or wheel is replaced.
- The battery is replaced or completely drained.
- The tire pressure monitoring system warning light is illuminated.

### Initialization method

1. Park the car in a safe place and firmly apply the parking brake.
2. Let the tires cool, then adjust the tire pressure of all four (4) tires to the specified pressure indicated on the tire pressure label located on the door jamb of the driver's door (door open).  
Refer to Tires on page 9-10.
3. Switch the ignition ON.
4. While the vehicle is parked, press and hold the tire pressure monitoring system set switch and verify that the tire pressure monitoring system warning light in the instrument cluster flashes twice and a beep sound is heard once.

## ⚠ CAUTION

*If the system initialization is performed without adjusting the tire pressure, the system cannot detect the normal tire pressure and it may not illuminate the tire pressure monitoring system warning light even if a tire pressure is low, or it may illuminate the light even if the pressures are normal.  
The system initialization will not be performed if the switch is pressed while the vehicle is being driven.*

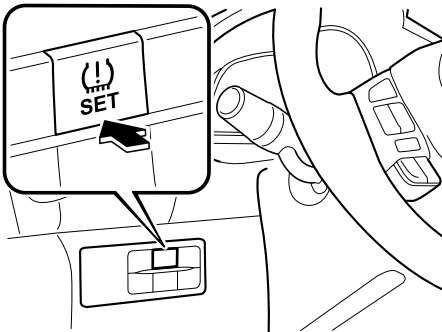



# Blind Spot Monitoring (BSM) System

## Blind Spot Monitoring (BSM) System\*

The Blind Spot Monitoring (BSM) system is designed to assist the driver by monitoring blind spots on both sides of the vehicle to the rear in certain situations such as when changing lanes on roads and freeways or reversing the vehicle from a parking garage.

The Blind Spot Monitoring (BSM) System consists of the Blind Spot Monitoring (BSM) and Rear Cross Traffic Alert (RCTA).

### **WARNING**

**Do not rely completely on the Blind Spot Monitoring (BSM) system. Always look over your shoulder before changing lanes or reversing the vehicle from a parking garage:**

*The Blind Spot Monitoring (BSM) system can assist the driver in confirming the safety of the surroundings but is not a complete substitute. The driver is responsible for assuring lane changes and other maneuvers. Always pay attention to the direction in which the vehicle is traveling and the vehicle's surroundings.*

### **NOTE**

- *The detectability of the radar sensors has its limitations. The Blind Spot Monitoring (BSM) System may not operate properly under the following conditions:*
  - *Ice, snow, or soil adheres to the rear bumper surface around the radar sensors.*
  - *During adverse weather conditions such as rain or snow, or under conditions where water is sprayed.*
  - *The rear bumper area around the radar sensors is blocked by foreign material (such as stickers or a bicycle carrier).*
- *The radar sensors do not detect human, animal, shopping cart, bicycle, or static objects such as fences.*
- *The radar sensors may not detect all types of vehicles around your vehicle, especially the following types of vehicles:*
  - *Motorcycles*
  - *Vehicles with body shapes that radar may not reflect such as a flatbed trailer with no cargo.*
  - *Vehicles with lower body height such as sports cars.*
- *Although the system may detect objects on the road side such as parked vehicles or guardrails and operate the warning light/beep, it does not indicate a malfunction.*
- *If the vehicle is driven on a road with less traffic and few vehicles that the radar sensors can detect, the system may pause (the Blind Spot Monitoring (BSM) OFF indicator light in the instrument cluster flashes). However, it does not indicate a malfunction.*

## Blind Spot Monitoring (BSM) System

---

- *The following conditions may affect the visibility of the Blind Spot Monitoring (BSM) warning lights on the outside mirror, making it difficult to confirm the illumination of the lights:*
  - *Ice or snow adheres to the surface of the outside mirrors.*
  - *The door window glass is tinted.*
- *The radar sensors are equipped inside the rear bumper (page 4-114).*
- *Have the radar sensors inspected at an Authorized Mazda Dealer if any shock is applied to the rear bumper, even in a minor accident. If the vehicle is driven with a damaged radar sensor, the system may not operate properly resulting in an accident.*
- *For repairs or paintwork around the radar sensors, or replacement of the bumper, consult an Authorized Mazda Dealer.*
- *The radar sensors of the Blind Spot Monitoring (BSM) system may be regulated under the radio wave related laws of the country where the vehicle is driven. The sensors in this system are approved for use in the U.S.A. (including territories), Canada, and Mexico. If a vehicle with a Blind Spot Monitoring (BSM) system is driven in a country other than the U.S.A., Canada, or Mexico, the system has to be turned off using the Blind Spot Monitoring (BSM) OFF switch.*

### ▼ Blind Spot Monitoring (BSM)

The Blind Spot Monitoring (BSM) system monitors the detection areas on both sides of the vehicle to the rear and when there are vehicles in the detection area it notifies the driver by illuminating the Blind Spot Monitoring (BSM) warning light while the vehicle speed is about 10 km/h (6.2 mph) or faster and driving forward.

If the turn signal lever is operated to the side the Blind Spot Monitoring (BSM) warning light is illuminated, the Blind Spot Monitoring (BSM) warning light flashes and the system warns the driver of the vehicle in the detection area using a BSM warning beep sound.

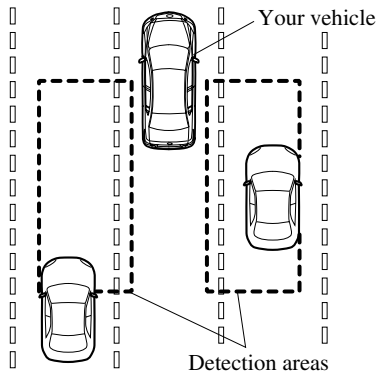

## Blind Spot Monitoring (BSM) System

---

### NOTE

- *The Blind Spot Monitoring (BSM) does not operate when the vehicle speed is lower than about 10 km/h (6.2 mph).*
- *The detection area of the Blind Spot Monitoring (BSM) has been determined based on the lane width of general freeways. Therefore on a road with a narrower lane width, the system may detect vehicles on a lane next to the adjacent lane and operate the warning light/beep. On a road with wider lane width, the system may not detect vehicles on the adjacent lane and may not operate the warning light/beep.*
- *Under the following conditions, the system may be unable to detect vehicles, or detection may be delayed.*
  - *The vehicle accelerates from a standing-start with a vehicle alongside.*
  - *A vehicle moves from a lane two lanes over to the adjacent lane.*
  - *The difference in vehicle speed between your vehicle and another vehicle is larger when passing or being passed, and the vehicle passes the detection area within a short period of time.*
  - *On a steep incline, or when there is a difference in height between lanes.*
  - *Immediately after the system has been activated by pressing the Blind Spot Monitoring (BSM) OFF switch again after it has been turned off (Blind Spot Monitoring (BSM) OFF indicator light in instrument cluster illuminates) by pressing the switch.*
  - **(Automatic transaxle vehicles)**  
*The shift lever is shifted to the R position, or directly after being shifted from the R position.*
- *The system may not operate normally when towing a trailer. Turn off the system by operating the Blind Spot Monitoring (BSM) OFF switch when towing a trailer.*
- *The system switches to the Rear Cross Traffic Alert function when the shift lever (Manual transaxle) or the selector lever (Automatic transaxle) is shifted to the R position.*

# Blind Spot Monitoring (BSM) System

---

## ▼ Rear Cross Traffic Alert (RCTA)

When reversing the vehicle from a parking garage, vehicles approaching both sides of the vehicle are detected to alert the driver of a possible collision by flashing the Blind Spot Monitoring (BSM) warning light and activating the Blind Spot Monitoring (BSM) warning beep sound.

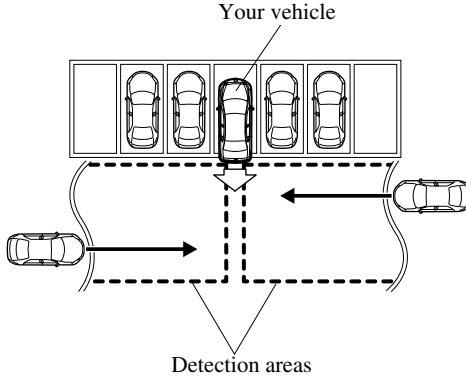

### Rear Cross Traffic Alert (RCTA) system operation

1. The Rear Cross Traffic Alert (RCTA) system operates when the shift lever (manual transaxle) or the selector lever (automatic transaxle) is shifted to the R position.
2. If a vehicle approaches which may hit you, the Blind Spot Monitoring (BSM) system warning light flashes and the Blind Spot Monitoring system (BSM) warning beep sounds at the same time.

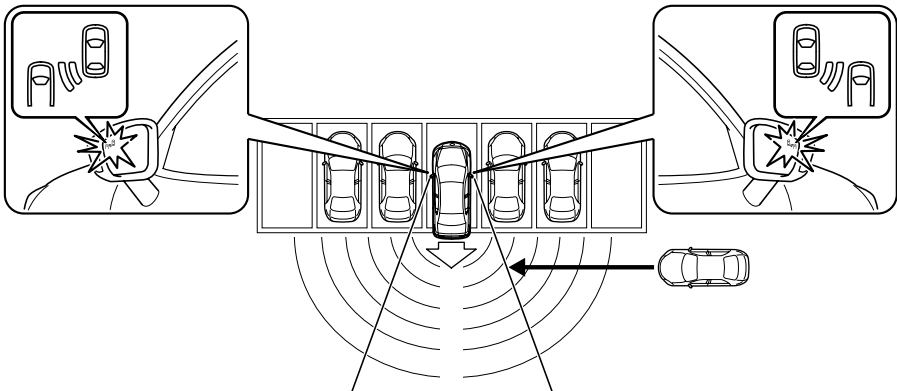

## Blind Spot Monitoring (BSM) System

### NOTE

Under the following conditions, the system may be unable to detect vehicles, or detection may be delayed.

- The vehicle is reversed at a speed of 12 km/h or faster
- The radar is obstructed by objects such as a large vehicle parked adjacently or by a wall. (Reverse vehicle to position in which radar is not obstructed.)

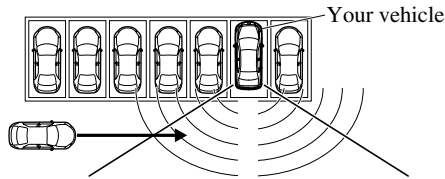

- A vehicle approaches from straight behind

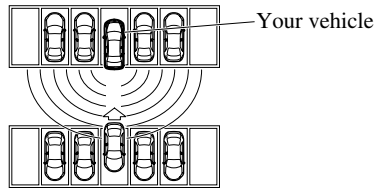

- The vehicle is parked at a highly acute angle

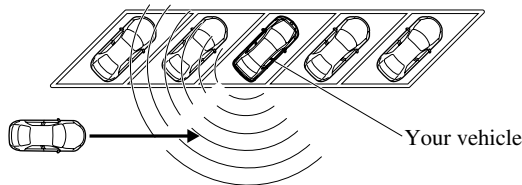

- Immediately after the system has been activated by pressing the Blind Spot Monitoring (BSM) OFF switch again after it has been turned off (Blind Spot Monitoring (BSM) OFF indicator light in instrument cluster illuminates) by pressing the switch.

## Blind Spot Monitoring (BSM) System

---

### ▼ BSM Warning Light

The Blind Spot Monitoring (BSM) system alerts the driver to the presence of another vehicle in an adjacent lane using the Blind Spot Monitoring (BSM) warning lights and the warning beep while the system is operational.

The warning light is equipped on the left and right door mirrors.

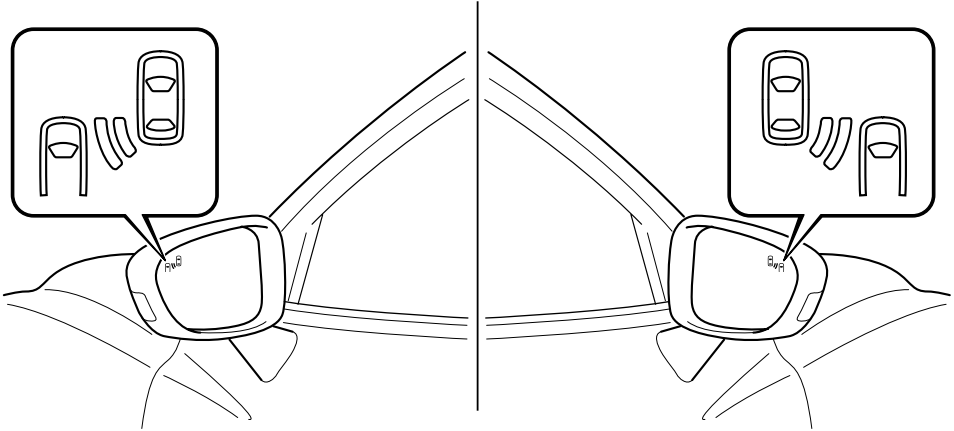

This warning light illuminates for a few seconds when the ignition is switched ON.

### Driving forward

If the Blind Spot Monitoring (BSM) system detects a vehicle in the detection area while the vehicle is driven at a speed of about 10 km/h (6.2mph) or more, the Blind Spot Monitoring (BSM) warning light illuminates on the side of the vehicle where the rear on-coming vehicle is detected. A warning indicator light flashes when the turn signal lever is operated to the side where the Blind Spot Monitoring (BSM) warning lights is illuminated to alert the driver.

### Reversing

If vehicles approach from the rear on the left and right, the Blind Spot Monitoring (BSM) warning lights on both sides flash.

### **NOTE**

- *If ice or snow adhere to the outer mirror surface, the Blind Spot Monitoring (BSM) warning light may not be visible.*
- *If the door window glass is tinted, it may affect the visibility of the Blind Spot Monitoring (BSM) warning light, making it difficult to confirm the illumination of the light.*

# Blind Spot Monitoring (BSM) System

## ▼ BSM OFF Indicator Light

# BSM OFF

This indicator light illuminates for a few seconds when the ignition is switched ON.

The BSM OFF indicator light illuminates when the BSM system is turned off by pressing the BSM OFF switch. The indicator light flashes if the BSM system has a malfunction. Consult an Authorized Mazda Dealer.

### NOTE

*If the vehicle is driven on a road with less traffic and few vehicles that the radar sensors can detect, the system may pause (The BSM OFF indicator light in the instrument cluster flashes). However, it does not indicate a malfunction.*

## ▼ BSM OFF Switch

When the BSM OFF switch is pressed, the BSM system turns off and the BSM OFF indicator light illuminates.

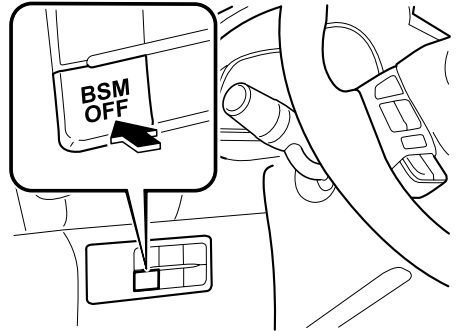

Press the BSM OFF switch again to turn on the BSM system. The BSM OFF indicator light turns off.

### NOTE

*If the ignition is switched off with the BSM system turned off, the system becomes operable automatically when the ignition is switched ON.*

# Blind Spot Monitoring (BSM) System

---

## ▼ Care of Radar Sensors

The radar sensors are equipped inside the rear bumper.

### 4-Door

Radar sensors

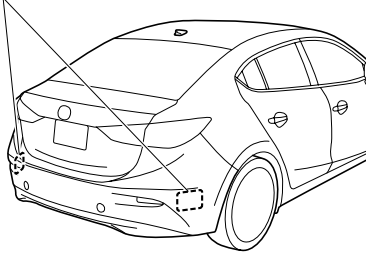

### 5-Door

Radar sensors

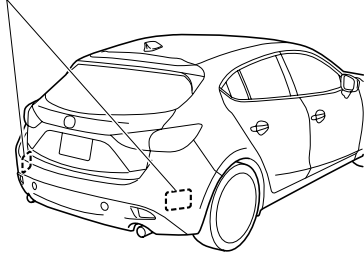

Always keep the bumper surface near the radar sensor area clean so that the BSM system operates normally.

Refer to Exterior Care on page 6-64.

### **NOTE**

- *The BSM OFF indicator light flashes if the radar sensors cannot operate normally. If the light remains flashing after cleaning the bumper surface near the radar sensor area, consult an Authorized Mazda Dealer.*
- *For repairs or paintwork around the radar sensors, or replacement of the bumper, consult an Authorized Mazda Dealer.*



# Forward Obstruction Warning (FOW)

## Forward Obstruction Warning (FOW)\*

Forward Obstruction Warning (FOW) is a system which alerts the driver of a possible collision using an indicator and warning sound in the instrument cluster while the vehicle is being driven at about 15 km/h or faster (10 mph or faster) and the system's radar sensor determines that your vehicle may hit a vehicle or obstruction ahead.

### WARNING

**Do not rely completely on the Forward Obstruction Warning (FOW) system and always drive carefully:**

*Forward Obstruction Warning (FOW) is only designed to reduce damage in the event of a collision. The ability to detect an obstruction is limited depending on the obstruction, weather conditions, or traffic conditions. Therefore, if the accelerator pedal or brake pedal is mistakenly operated it could result in an accident. Always verify the safety of the surrounding area and depress the brake pedal or accelerator pedal while keeping a safe distance from vehicles ahead or on-coming vehicles.*

### NOTE

- *The Forward Obstruction Warning (FOW) system operates when all of the following conditions are met:*
  - *The ignition is switched ON.*
  - *The Forward Obstruction Warning (FOW) system is on.*
  - *The vehicle speed is about 15 km/h (10 mph) or faster.*
  - *The relative speed between your vehicle and the vehicle or obstruction ahead is about 15 km/h (10 mph) — 145 km/h (90 mph).*
- *The Forward Obstruction Warning (FOW) system may not operate under the following conditions:*
  - *If there is the possibility of hitting only a part of a vehicle or obstruction ahead.*
  - *If the vehicle is accelerated rapidly and it comes close to a vehicle ahead.*
  - *The DSC is malfunctioning.*
  - *The vehicle is driven at the same speed as the vehicle ahead.*
  - *The accelerator pedal is depressed.*
  - *The brake pedal is depressed.*
  - *The steering wheel is being operated.*
  - *The selector lever is being operated.*
  - *The turn signal is being used.*

## Forward Obstruction Warning (FOW)

---

- *Although the objects which activate the system are 4-wheeled vehicles, the radar sensor could detect the following objects, determine them to be an obstruction, and operate the Forward Obstruction Warning (FOW) system.*
  - *Objects on the road at the entrance to a curve (including guardrails and snow banks).*
  - *A vehicle appears in the opposite lane while cornering or rounding a curve.*
  - *When crossing a narrow bridge.*
  - *When passing under a low gate or through a tunnel or narrow gate.*
  - *When entering an underground parking area.*
  - *Metal objects, bumps, or protruding objects on the road.*
  - *If you suddenly come close to a vehicle ahead.*
  - *When driving in areas where there is high grass or forage.*
  - *Two-wheeled vehicles such as motorbikes or bicycles.*
  - *Pedestrians or non-metallic objects such as standing trees.*
- *When the system operates, the user is notified by the flashing Forward Obstruction Warning (FOW) indicator light (red) and the active driving display.*
- *The Forward Obstruction Warning (FOW) warning light (amber) turns on when the system has a malfunction.*

*(page 4-21)*

## Forward Obstruction Warning (FOW)

### ▼ Forward Obstruction Warning (FOW) Indicator Light (Red)

If the Forward Obstruction Warning (FOW) is operating, the indicator light (red) flashes.

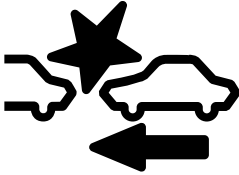

### ▼ Collision Warning

If there is the possibility of a collision with a vehicle or obstruction ahead, the beep sounds continuously and a warning is indicated in the display.

# BRAKE !

### ▼ Stopping The Forward Obstruction Warning (FOW) System Operation

The Forward Obstruction Warning (FOW) system can be deactivated.

Refer to Personalization Features on page 9-12.

When the Forward Obstruction Warning (FOW) system is turned off, the Forward Obstruction Warning (FOW) OFF indicator light turns on.



### ▼ Radar Sensor Handling

The Forward Obstruction Warning (FOW) radar sensor is installed on the backside of the radiator grille.

Refer to Radar Sensor on page 4-64.

# Lane Departure Warning System (LDWS)

## Lane Departure Warning System (LDWS)\*

The LDWS notifies the driver that the vehicle may be deviating from its lane. The system detects the white or yellow lines on the traffic lane using the Forward Sensing Camera (FSC). If it determines that the vehicle may be deviating from its lane, it notifies the driver by flashing the LDWS indicator light (green) and operating the LDWS warning sound.

Refer to Forward Sensing Camera on page 4-62.

Use the LDWS when you drive the vehicle on roads with white or yellow lines.

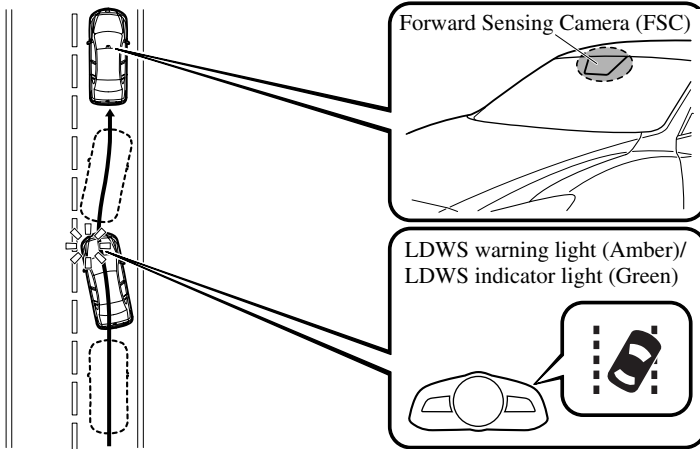

The warning light flashes when the system has a malfunction.

Refer to Warning Lights on page 4-21.

### **! WARNING**

#### **Do not use the LDWS under the following conditions:**

*The system may not operate adequately according to the actual driving conditions, resulting in an accident.*

- > Driving on roads with tight curves.
- > Driving under bad weather conditions (rain, fog, and snow).

#### **The functions of the LDWS have limitations:**

*Always stay on course using the steering wheel and drive with care. The system is not designed to compensate for a driver's lack of caution and if you rely too much on the LDWS it could lead to an accident. The driver is responsible for assuring lane changes and other maneuvers. Always pay attention to the direction in which the vehicle is traveling and the vehicle's surroundings.*

## Lane Departure Warning System (LDWS)

---



*Do not modify the suspension. If the vehicle height or the damping force of the suspensions is changed, the LDWS may not operate correctly.*

### **NOTE**

- *If your vehicle deviates from its traffic lane, the LDWS operates (warning sound and indicator light). Steer the vehicle adequately to drive the vehicle to the center of the lane.*
- *When the turn signal lever is operated for a lane change, the LDWS warning is automatically canceled. The LDWS warning becomes operable when the turn signal lever is returned and the system detects the white or yellow lines.*
- *If the steering wheel, accelerator pedal, or brake pedal is operated abruptly and the vehicle moves close to a white or yellow line, the system determines that the driver is making a lane change and the LDWS warning is automatically canceled.*
- *The LDWS may not operate during the period immediately after the vehicle has deviated from its lane and the LDWS has operated, or the vehicle deviates from its lane repeatedly within a short period of time.*
- *The LDWS does not operate if it does not detect the white or yellow lines of the traffic lane.*

## Lane Departure Warning System (LDWS)

---

- *Under the following conditions, the LDWS may not be able to detect white or yellow lines correctly and the LDWS may not operate correctly.*
  - *If an object placed on the dashboard is reflected in the windshield and picked up by the camera.*
  - *Heavy luggage is loaded in the luggage compartment or on the rear seat and the vehicle is inclined.*
  - *The tire pressures are not adjusted to the specified pressure.*
  - *When the vehicle is driven on the entry and exit to or from the rest area or tollgate of a highway.*
  - *The white or yellow lines are less visible because of dirt or paint flaking.*
  - *The vehicle ahead is running near a white or yellow line and the line is less visible.*
  - *A white or yellow line is less visible because of bad weather (rain, fog, or snow).*
  - *The vehicle is driven on a temporary lane or section with a closed lane due to construction.*
  - *A misleading line is picked up on the road such as a temporary line for construction, or because of shade, lingering snow, or grooves filled with water.*
  - *The surrounding brightness suddenly changes such as when entering or exiting a tunnel.*
  - *The illumination of the headlights is weakened because of dirt or the optical axis is deviated.*
  - *The windshield is dirty or foggy.*
  - *Back-light is reflecting from the road surface.*
  - *The road surface is wet and shiny after rain, or there are puddles on the road.*
  - *The shade of a guardrail parallel to a white or yellow line is on the road.*
  - *The width of a lane is excessively narrow or wide.*
  - *The road is excessively uneven.*
  - *The vehicle is shaken after hitting a road bump.*
  - *There are two or more adjacent white or yellow lines.*
  - *There are various road markings or lane markings of various shapes near an intersection.*

# Lane Departure Warning System (LDWS)

## ▼ When The System Operates

1. Press the LDWS switch. The LDWS goes on stand-by and the LDWS warning light (amber) illuminates. The lane indication (bordered line) is indicated in the active driving display (Type A instrument cluster<sup>\*1</sup>) or the multi information display (Type B instrument cluster<sup>\*1</sup>).

\*1 To determine which instrument cluster is equipped on your Mazda, Refer to Meters and Gauges on page 4-11.

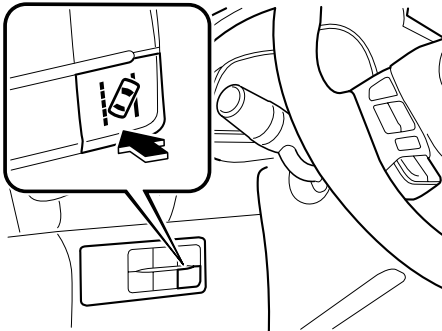

Indication on display

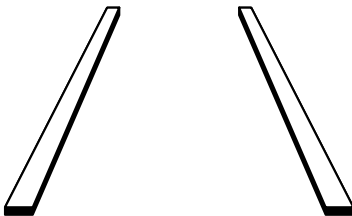

2. Drive the vehicle near the center of the lane and the LDWS indicator light (green) illuminates in the instrument cluster when all of the following conditions are met.
  - The vehicle is driven near the center of the lane with the white or yellow line on the left and right sides, or on either side.
  - The vehicle speed is about 70 km/h (44 mph) or more
  - The vehicle is driven on a straight road or road with gentle curves

The lane indication is indicated in the active driving display (Type A instrument cluster<sup>\*1</sup>) or the multi information display (Type B instrument cluster<sup>\*1</sup>).

- \*1 To determine which instrument cluster is equipped on your Mazda, Refer to Meters and Gauges on page 4-11.

### Indication on display

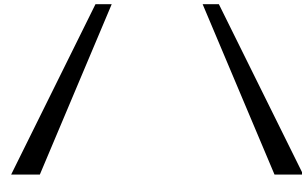

### NOTE

- The LDWS remains on stand-by until it detects white or yellow lines on both the left and right sides, or on either side.
- When the system detects a white or yellow line on one side only, the system will operate the warning only when the vehicle deviates to the side the white or yellow line detected.

## Lane Departure Warning System (LDWS)

---

### **Auto cancel**

Under the following conditions, the LDWS is automatically canceled and kept on stand-by, and the LDWS warning light (amber) in the instrument cluster illuminates.

- The system cannot detect white or yellow lines.
- The vehicle speed is less than about 65 km/h (40 mph).
- The vehicle is making a sharp turn.
- The vehicle is making a turn at an inadequate speed.
- The temperature inside the camera is high or low.
- The windshield around the camera is foggy.
- The windshield around the camera is blocked by an obstruction, causing poor forward visibility.

The lane indication (bordered line) is indicated in the active driving display (Type A instrument cluster\*<sup>1</sup>) or the multi information display (Type B instrument cluster\*<sup>1</sup>).

The LDWS is automatically enabled when the condition changes and the system is operable.

\*1 To determine which instrument cluster is equipped on your Mazda, Refer to Meters and Gauges on page 4-11.

### **Auto cancel of warning**

Under the following conditions, the LDWS determines that the driver is making lane changes and the warning is automatically canceled.

The LDWS is automatically enabled after the operation.

- The steering wheel is operated abruptly.
- The brake pedal is depressed abruptly.
- The accelerator pedal is depressed abruptly.
- A turn signal lever is operated (after the turn signal lever is returned, the LDWS warning may not operate for about 3 seconds which is the period of time required to make a lane correction).

### ***NOTE***

- *After about 5 seconds have elapsed with the turn signal lever left operating, the LDWS warning may operate if the vehicle is close to a white or yellow line.*
- *The sensitivity of the warning (sensitivity with which the system determines the driver's intentional lane change) can be changed. Refer to Personalization Features on page 9-12.*

### **▼ Canceling The System**

To cancel the LDWS, press the LDWS switch. The LDWS indicator light (Green/Amber) in the instrument cluster turns off. The lane indication displayed in the active driving display (Type A instrument cluster\*<sup>1</sup>) or the multi information display (Type B instrument cluster\*<sup>1</sup>) turns off.

\*1 To determine which instrument cluster is equipped on your Mazda, Refer to Meters and Gauges on page 4-11.



# Lane Departure Warning System (LDWS)

## ▼ LDWS Warning

If the system determines that the vehicle may be deviating from its lane while the system is operating, the LDWS warning sounds and the LDWS indicator light (green) flashes.

Refer to Lane Departure Warning System (LDWS) Warning Sound on page 7-37.

In the active driving display (Type A instrument cluster\*<sup>1</sup>) or the multi information display (Type B instrument cluster\*<sup>1</sup>), the direction in which the system determined that the vehicle may be deviating from its lane is indicated.

Operate the steering wheel adequately and drive in the center of the lane.

\*1 To determine which instrument cluster is equipped on your Mazda, Refer to Meters and Gauges on page 4-11.

### Indication on display



### NOTE

- If the LDWS warning sound is set to rumble, the sound will be heard from the vehicle speaker on the side which the system determined the vehicle may be deviating from its lane.
- The LDWS warning sound may not be heard depending on the surrounding conditions such as outside noise.
- The warning timing with which the system determines the vehicle may be deviating from its lane can be changed. Refer to Personalization Features on page 9-12.

## Rear View Monitor

---

### Rear View Monitor\*

The rear view monitor provides visual images of the rear of the vehicle when reversing.

#### **WARNING**

**Always drive carefully confirming the safety of the rear and the surrounding conditions by looking directly with your eyes:**

*Reversing the vehicle by only looking at the screen is dangerous as it may cause an accident or a collision with an object. The rear view monitor is only a visual assist device when reversing the vehicle. The images on the screen may be different from the actual conditions.*

#### **CAUTION**

- Do not use the rear view monitor under the following conditions: Using the rear view monitor under the following conditions is dangerous and could result in injury or vehicle damage or both.
  - Icy or snow-covered roads.
  - Tire chains or a temporary spare tire is installed.
  - The trunk lid/liftgate is not fully closed.
  - The vehicle is on a road incline.
- When the display is cold, images may course across the monitor or the screen and may be dimmer than usual, which could cause difficulty in confirming the surrounding conditions of the vehicle. Always drive carefully confirming the safety of the rear and the surrounding conditions by looking directly with your eyes.
- Do not apply excessive force to the camera. The camera position and angle may deviate.
- Do not disassemble, modify, or remove it as it may no longer be waterproof.
- The camera cover is made of plastic. Do not apply degreasing agents, organic solvents, wax, or glass coating agents to the camera cover. If any are spilled on the cover, wipe off with a soft cloth immediately.
- Do not rub the cover excessively, or polish it using an abrasive compound or a hard brush. The cover may be damaged affecting the image.

#### **NOTE**

- If water, snow, or mud is stuck on the camera lens, wipe it off using a soft cloth. If it cannot be wiped off, use a mild detergent.
- If the camera temperature changes rapidly (Hot to cold, cold to hot), the rear view monitor may not operate correctly.
- When replacing the tires, consult an Authorized Mazda Dealer. Replacing the tires could result in deviation of the guide lines which appear on the display.
- If the vehicle's front, side, or rear has been involved in a collision, the alignment of the rear view parking camera (location, installation angle) may have deviated. Always consult an Authorized Mazda Dealer to have the vehicle inspected.

▼ **Rear View Parking Camera Location**

**4-Door**

**5-Door**  
Rear View Parking Camera

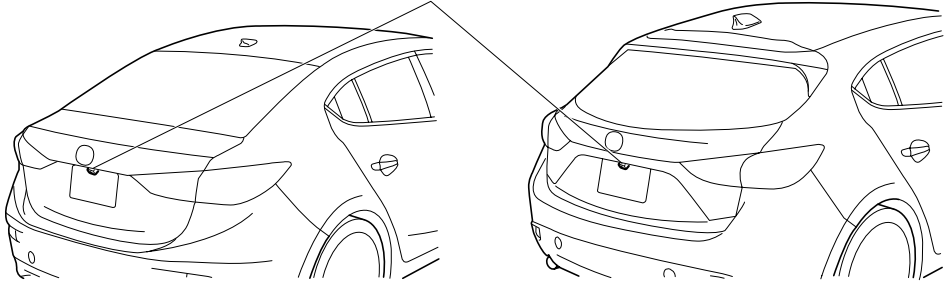

▼ **Switching to the Rear View Monitor Display**

Shift the shift lever to R with the ignition switched ON to switch the display to the rear view monitor display.

**NOTE**

*When the shift lever is shifted from R to another shift lever position, the screen returns to the previous display.*

# Rear View Monitor

## ▼ Displayable Range on the Screen

The images on the screen may be different from the actual conditions.

### (Screen display)

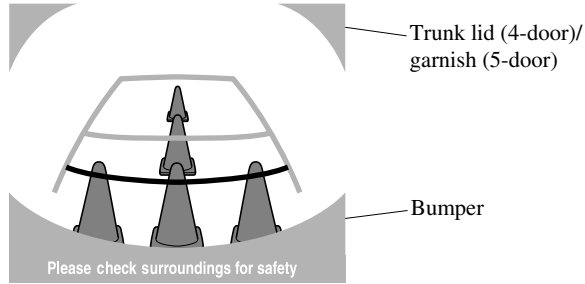

### (Actual view)

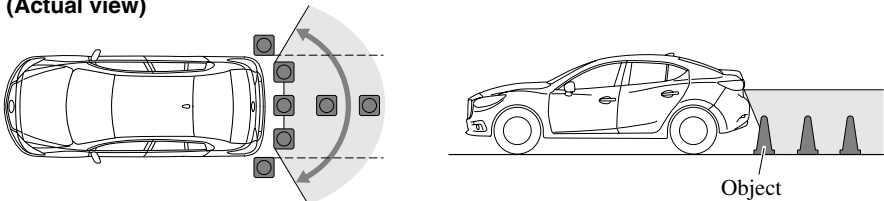

### NOTE

- The displayable range varies depending on the vehicle and road conditions.
- The displayable range is limited. Objects under the bumper or around the bumper ends cannot be displayed.
- The distance appearing in the displayed image is different from the actual distance because the rear view parking camera is equipped with a specific lens.
- Some optionally installed vehicle accessories may be picked up by the camera. Do not install any optional parts that can interfere with the camera view, such as illuminating parts or parts made of reflective material.
- It may be difficult to see the display under the following conditions, however, it does not indicate a malfunction.
  - In darkened areas.
  - When the temperature around the lens is high/low.
  - When the camera is wet such as on a rainy day or during periods of high humidity.
  - When foreign material such as mud is stuck around the camera.
  - When the camera lens reflects sunlight or headlight beams.
- Image display may be delayed if the temperature around the camera is low.

### ▼ Viewing the Display

Guide lines which indicate the width of the vehicle (yellow) are displayed on the screen as a reference to the approximate width of the vehicle in comparison to the width of the parking space you are about to back into.

Use this display view for parking your vehicle in a parking space or garage.

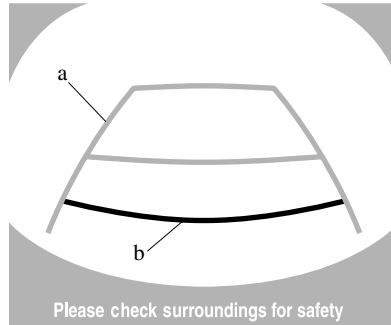

a) Vehicle width guide lines (yellow)

These guide lines serve as a reference to the approximate width of the vehicle.

b) Distance guide lines.

These guide lines indicate the approximate distance to a point measured from the vehicle's rear (from the end of the bumper).

The red and yellow lines indicate the points about 50 cm (19 in) for the red line and 100 cm (39.3 in) for the yellow lines from the rear bumper (at the center point of each of the lines).

### CAUTION

*The guide lines on the screen are fixed lines. They are not synced to the driver's turning of the steering wheel. Always be careful and check the area to the vehicle's rear and the surrounding area directly with your eyes while backing up.*

# Rear View Monitor

---

## ▼Rear View Monitor Operation

The operation of the rear view monitor when reversing the vehicle varies depending on the traffic, road, and vehicle conditions. The amount of steering and the timing also varies depending on conditions, so confirm the surrounding conditions directly with your eyes and steer the vehicle in accordance with the conditions.

Be well aware of the above cautions prior to using the rear view monitor.

### NOTE

*Images displayed on the monitor from the rear view parking camera are reversed images (mirror images).*

1. Shift the shift lever to R to switch the display to the rear view monitor display.
2. Confirming the surrounding conditions, reverse the vehicle.

(Display condition)



(Vehicle condition)

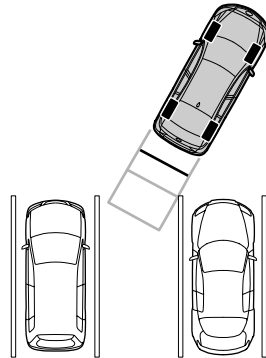

3. After your vehicle begins entering the parking space, continue backing up slowly so that the distance between the vehicle width lines and the sides of the parking space on the left and right are roughly equal.
4. Continue to adjust the steering wheel until the vehicle width guide lines are parallel to the left and right sides of the parking space.

5. Once they are parallel, straighten the wheels and back your vehicle slowly into the parking space. Continue checking the vehicle's surroundings and then stop the vehicle in the best possible position. (If the parking space has division lines, check whether the vehicle width guide lines are parallel to them.)

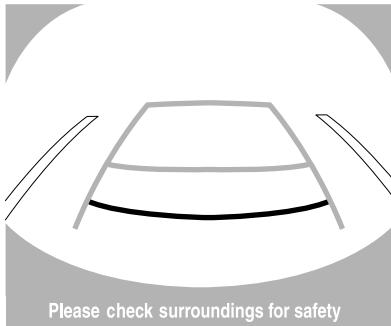
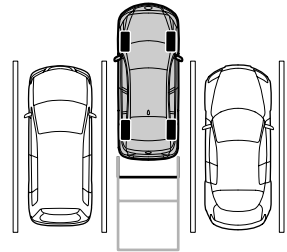
**(Display condition)****(Vehicle condition)**

6. When the shift lever is shifted from R to another shift lever position, the screen returns to the previous display.

**NOTE**

*Because there may be a difference between the displayed image, such as indicated below, and the actual conditions when parking, always verify the safety at the rear of the vehicle and the surrounding area directly with your eyes.*

- *In the image of the parking space (or garage) displayed below, even though the back end and distance guide lines appear parallel in the monitor, they may not actually be parallel on the ground.*
- *When parking in a space with a division line on only one side of the parking space, the division line and the vehicle width guide line may appear parallel on the monitor, but they may not actually be parallel on the ground.*

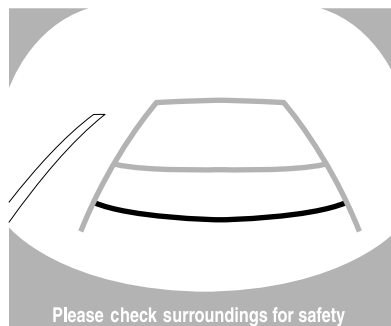

# Rear View Monitor

---

## ▼ Variance Between Actual Road Conditions and Displayed Image

Some variance occurs between the actual road and the displayed road. Such variance in distance perspective could lead to an accident. Note the following conditions that may cause a variance in distance perspective.

### When the vehicle is tilted due to the weight of passengers and load

When the vehicle rear is lowered, the object displayed on the screen appears farther than the actual distance.

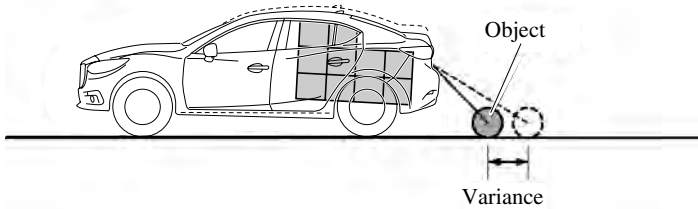

### When there is a steep grade behind the vehicle

When there is a steep upgrade (downgrade) behind the vehicle, the object displayed on the screen appears farther (downgrade: closer) than the actual distance.

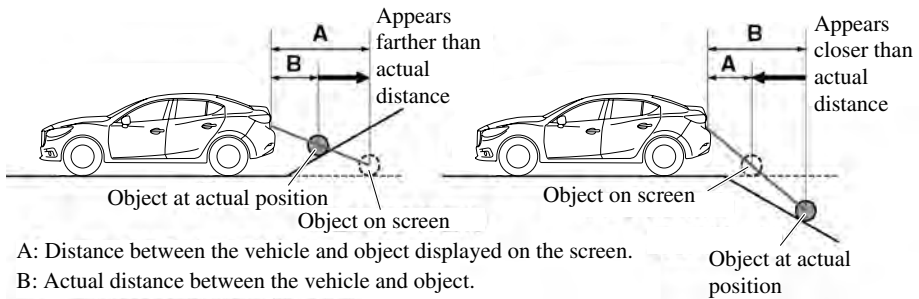



### Three-dimensional object on vehicle rear

Because the distance guide lines are displayed based on a flat surface, the distance to the three-dimensional object displayed on the screen is different from the actual distance.

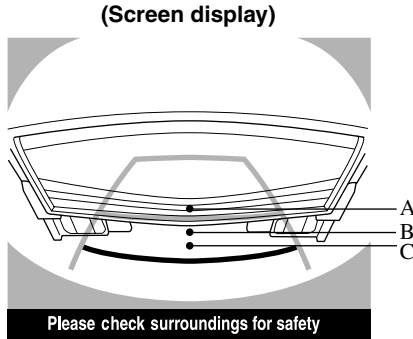

Sensed distance on screen  $A > B > C$

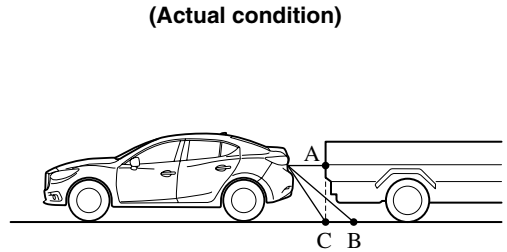

(Actual distance)  $B > C = A$

### ▼ Picture Quality Adjustment

#### **! WARNING**

**Always adjust the picture quality of the rear view monitor while the vehicle is stopped:**

*Do not adjust the picture quality of the rear view monitor while driving the vehicle.*

*Adjusting the picture quality of the rear view monitor such as brightness, contrast, color, and tint while driving the vehicle is dangerous as it could distract your attention from the vehicle operation which could lead to an accident.*

Picture quality adjustment can be done while the shift lever is in reverse (R).

There are four settings which can be adjusted including, brightness, contrast, tint, and color. When adjusting, pay sufficient attention to the vehicle surroundings.

1. Select the ☞ icon on the screen to display the tabs.
2. Select the desired tab item.
3. Adjust the brightness, contrast, tint, and color using the slider.  
If you need to reset, press the reset button.
4. Select the ☞ icon on the screen to close the tab.

# MEMO

Use of various features for ride comfort, including air-conditioning and audio system.

<b>Climate Control System</b> .....	<b>5-2</b>
Operating Tips.....	5-2
Vent Operation .....	5-3
Manual Climate Control .....	5-5
Automatic Climate Control.....	5-9
Dual-Zone Automatic Climate Control.....	5-12
 <b>Audio System</b> .....	 <b>5-16</b>
Antenna .....	5-16
Operating Tips for Audio System .....	5-17
Audio Set (Type A) .....	5-26
Audio Set (Type B) .....	5-38
Audio Control Switch Operation* .....	5-57
AUX/USB/iPod mode.....	5-59
 <b>Bluetooth</b> <sup>®</sup> .....	 <b>5-77</b>
Bluetooth <sup>®</sup> * .....	5-77
Bluetooth <sup>®</sup> Hands-Free (Type A)* .....	5-99
Bluetooth <sup>®</sup> Hands-Free (Type B)* .....	5-105
Bluetooth <sup>®</sup> Audio (Type A)* .....	5-115
Bluetooth <sup>®</sup> Audio (Type B)* .....	5-117
Troubleshooting* .....	5-131
 <b>Interior Equipment</b> .....	 <b>5-134</b>
Sunvisors.....	5-134
Interior Lights .....	5-135
Accessory Sockets .....	5-137
Cup Holder.....	5-138
Bottle Holder.....	5-139
Storage Compartments.....	5-140

# Climate Control System

## Operating Tips

- Operate the climate control system with the engine running.
- To prevent the battery from being discharged, do not leave the fan control dial on for a long period of time with the ignition switched ON when the engine is not running.
- Clear all obstructions such as leaves, snow and ice from the hood and the air inlet in the cowl grille to improve the system efficiency.
- Use the climate control system to defog the windows and dehumidify the air.
- The recirculate mode should be used when driving through tunnels or while in a traffic jam, or when you would like to shut off outside air for quick cooling of the interior.
- Use the outside air mode for ventilation or windshield defrosting.
- If the vehicle has been parked in direct sunlight during hot weather, open the windows to let warm air escape, then run the climate control system.
- Run the air conditioner about 10 minutes at least once a month to keep internal parts lubricated.

- Have the air conditioner checked before the weather gets hot. Lack of refrigerant may make the air conditioner less efficient.

The refrigerant specifications are indicated on a label attached to the inside of the engine compartment. Check the label before refilling the refrigerant. If the wrong type of refrigerant is used, it could result in a serious malfunction of the air conditioner.

For details, consult an Authorized Mazda Dealer.

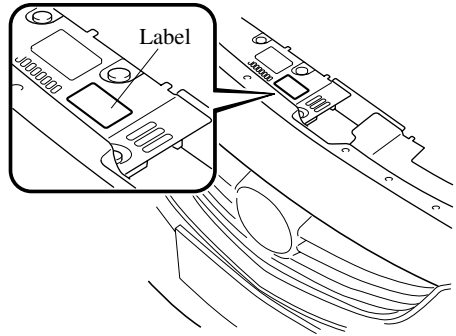

## Vent Operation

### ▼ Adjusting the Vents

#### Directing airflow

To adjust the direction of airflow, move the adjustment knob.

#### **NOTE**

- *When using the air conditioner under humid ambient temperature conditions, the system may blow fog from the vents. This is not a sign of trouble but a result of humid air being suddenly cooled.*
- *The air vents can be fully opened and closed by operating the dial.*

#### Side Vents

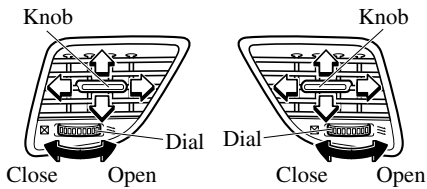

#### Center Vents

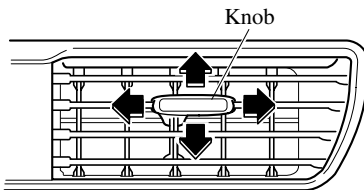

# Climate Control System

---

## ▼ Selecting the Airflow Mode

### Dashboard Vents

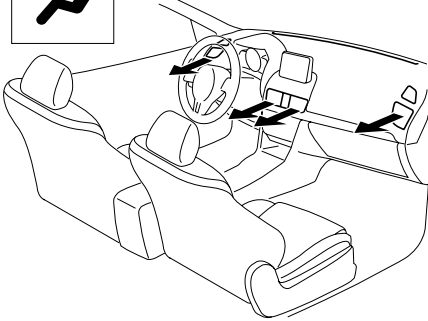

### Defroster and Floor Vents

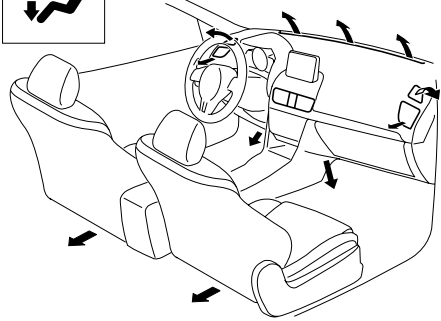

### Dashboard and Floor Vents

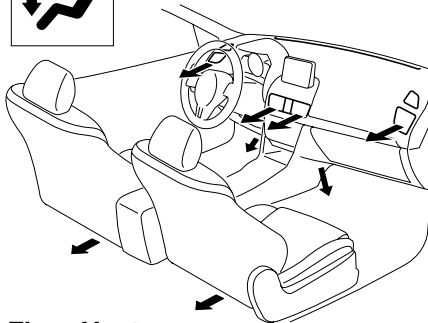

### Defroster Vents

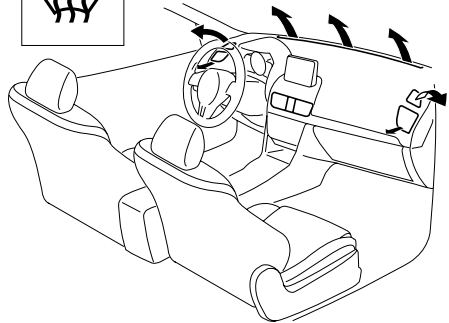
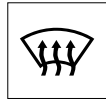

### Floor Vents

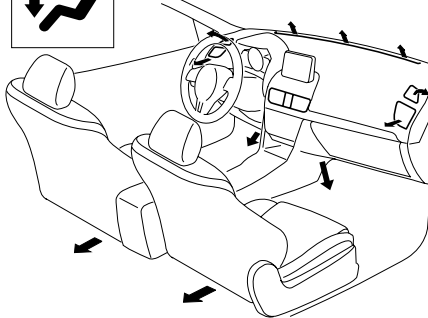

## Manual Climate Control

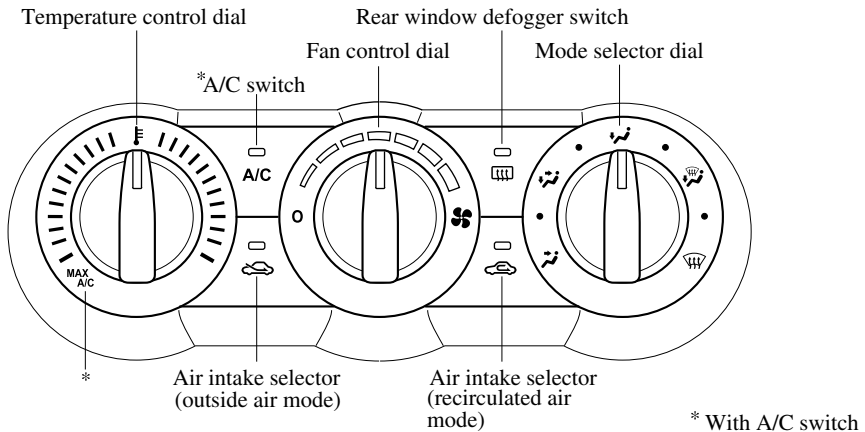



### ▼ Control Switches

#### Temperature control dial

This dial controls temperature. Turn it clockwise for hot and counterclockwise for cold.

#### **NOTE**

When the mode is set to  or  with the fan control dial in a position other than 0 and the temperature control dial in the maximum cold position, the air intake selector switches to the recirculated air mode and the A/C turns on automatically. If A/C is not desired, press the A/C switch to turn it off.



#### Fan control dial

This dial allows variable fan speeds. The fan has seven speeds.

#### Mode selector dial

Turn the mode selector dial to select airflow mode (page 5-4).

#### **NOTE**

- The mode selector dial can be set at the intermediate positions (●) between each mode. Set the dial to an intermediate position if you want to split the airflow between the two modes.
- For example, when the mode selector dial is at the ● position between the  and  positions, airflow from the floor vent is less than that of the  position.

#### A/C switch\*

Press the A/C switch to turn the air conditioner on. The indicator light on the switch will illuminate when the fan control dial is in any position except OFF.

Press the switch once again to turn the air conditioner off.

#### **NOTE**

The air conditioner may not function when the outside temperature approaches 0 °C (32 °F).

# Climate Control System

## Air intake selector

This switch controls the source of air entering the vehicle.

Press the air intake selector switch to alternate between the outside air and recirculated air modes.

## **Recirculated air mode** (↻)

Outside air is shut off. Air within the vehicle is recirculated.

## **Outside air mode** (↻)

Outside air is allowed to enter the cabin. Use this mode for ventilation or windshield defrosting.









### **Do not use the recirculated air mode in cold or rainy weather:**

*Using the recirculated air mode in cold or rainy weather is dangerous as it will cause the windows to fog up. Your vision will be hampered, which could lead to a serious accident.*

## ▼ **Heating**

1. Set the mode selector dial to the  position.
2. Set the air intake selector to the outside air mode.
3. Set the temperature control dial to the hot position.
4. Set the fan control dial to the desired speed.
5. If dehumidified heating is desired, turn on the air conditioner.

## **NOTE**

- If the windshield fogs up easily, set the mode selector dial to the  position.
- If cooler air is desired at face level, set the mode selector dial at the  position and adjust the temperature control dial to maintain maximum comfort.
- The air to the floor is warmer than air to the face (except when the temperature control dial is set at the extreme hot or cold position).
- In the  or  position, the air conditioner is automatically turned on and the outside air mode is automatically selected to defrost the windshield. In the  or  position, the outside air mode cannot be changed to the recirculated air mode.

## ▼ **Cooling (With air conditioner)**

1. Set the mode selector dial to the  position.
2. Set the temperature control dial to the cold position.
3. Set the fan control dial to the desired speed.
4. Turn on the air conditioner by pressing the A/C switch.
5. After cooling begins, adjust the fan control dial and temperature control dial as needed to maintain maximum comfort.



### CAUTION

*If the air conditioner is used while driving up long hills or in heavy traffic, monitor the engine coolant temperature warning light to see if it is illuminated or flashing (page 4-20). The air conditioner may cause engine overheating. If the warning light is illuminated or flashing, turn the air conditioning off (page 7-19).*

#### NOTE

- *When maximum cooling is desired, set the temperature control dial to the extreme cold position and set the air intake selector to the recirculated air mode, then turn the fan control dial fully clockwise.*
- *If warmer air is desired at floor level, set the mode selector dial at the  position and adjust the temperature control dial to maintain maximum comfort.*
- *The air to the floor is warmer than air to the face (except when the temperature control dial is set at the extreme hot or cold position).*

#### ▼ Ventilation



1. Set the mode selector dial to the  position.
2. Set the air intake selector to the outside air mode.
3. Set the temperature control dial to the desired position.
4. Set the fan control dial to the desired speed.

#### ▼ Windshield Defrosting and Defogging





1. Set the mode selector dial to the  position.
2. Set the temperature control dial to the desired position.
3. Set the fan control dial to the desired speed.
4. If dehumidified heating is desired, turn on the air conditioner.

### WARNING

**Do not defog the windshield using the  position with the temperature control set to the cold position:**

*Using the  position with the temperature control set to the cold position is dangerous as it will cause the outside of the windshield to fog up. Your vision will be hampered, which could lead to a serious accident. Set the temperature control to the hot or warm position when using the  position.*

#### NOTE

- *For maximum defrosting, turn on the air conditioner, set the temperature control dial to the extreme hot position, and turn the fan control dial fully clockwise.*
- *If warm air is desired at the floor, set the mode selector dial to the  position.*
- *In the  or  position, the air conditioner is automatically turned on and the outside air mode is automatically selected to defrost the windshield. In the  or  position, the outside air mode cannot be changed to the recirculated air mode.*

## Climate Control System

---

### ▼ Dehumidifying (With air conditioner)

Operate the air conditioner in cool or cold weather to help defog the windshield and side windows.

1. Set the mode selector dial to the desired position.
2. Set the air intake selector to the outside air mode.
3. Set the temperature control dial to the desired position.
4. Set the fan control dial to the desired speed.
5. Turn on the air conditioner by pressing the A/C switch.

#### **NOTE**

*One of the functions of the air conditioner is dehumidifying the air and, to use this function, the temperature does not have to be set to cold. Therefore, set the temperature control dial to the desired position (hot or cold) and turn on the air conditioner when you want to dehumidify the cabin air.*

## Automatic Climate Control

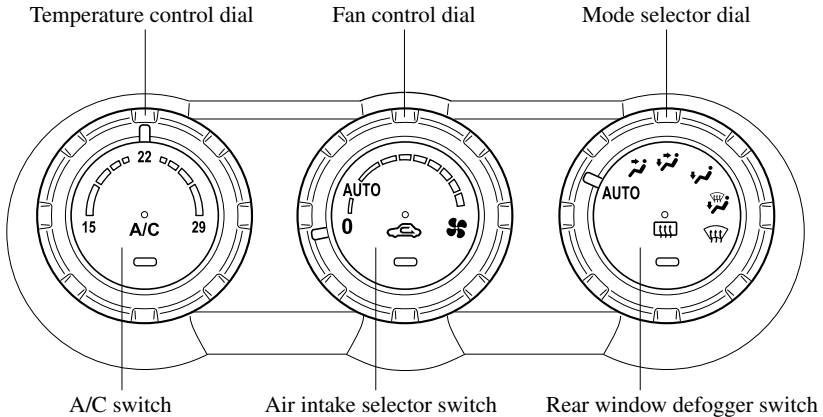

### ▼ Control Switches

#### Temperature control dial

This dial controls temperature. Turn it clockwise for hot and counterclockwise for cold.

#### Fan control dial

The fan has seven speeds.

#### **AUTO position**

The amount of airflow will be automatically controlled in accordance with the set temperature.

#### **Except AUTO position**

The airflow amount can be adjusted to the desired level by turning the dial.

#### **0 position**

To turn off the system, set the dial to 0 position.

#### Mode selector dial

Turn the mode selector dial to select airflow mode (page 5-4).





#### **AUTO position**

The airflow mode automatically adjusts to the selected temperature.

#### **Except AUTO position**

The desired airflow position can be selected by turning the dial.

#### **NOTE**

- With the airflow mode set to the  position and the temperature control dial set at a medium temperature, heated air is directed to the feet and air at a comparably lower temperature will flow through the central, left and right vents.
- When the fan control dial is ON, and the mode selector dial is in the  or  position, the air conditioner is automatically turned on and the outside air mode is automatically selected to defrost the windshield. In the  or  position, the outside air mode cannot be changed to the recirculated air mode.

# Climate Control System

---

## A/C switch

Pressing the A/C switch while the AUTO switch is turned on will turn off the air conditioning (cooling/dehumidifying functions).

The air conditioning can be turned on and off by pressing the A/C switch while the fan control dial is on.

### **NOTE**

*The air conditioner may not function when the outside temperature approaches 0 °C (32 °F).*

## Air intake selector

Outside or recirculated air positions can be selected. Press the switch to select outside/recirculated air positions.

### **Recirculated air position (indicator light illuminated)**

Outside air is shut off. Use this position when going through tunnels, driving in congested traffic (high engine exhaust areas) or when quick cooling is desired.

### **Outside air position (indicator light turned off)**

Outside air is allowed to enter the cabin. Use this mode for ventilation or windshield defrosting.



**Do not use the  position in cold or rainy weather:**

*Using the  position in cold or rainy weather is dangerous as it will cause the windows to fog up. Your vision will be hampered, which could lead to a serious accident.*

## ▼ **Operation of Automatic Air Conditioning**

1. Set the mode selector dial to the AUTO position.
2. Set the air intake selector to the outside air position (indicator light turned off).
3. Set the temperature control dial to the desired position.
4. Set the fan control dial to the AUTO position.
5. Turn on the air conditioner.

To turn off the system, set the fan control dial to OFF.

### **NOTE**

- *Setting the temperature to maximum high or low will not provide the desired temperature at a faster rate.*
- *When selecting heat, the system will restrict airflow until it has warmed to prevent cold air from blowing out of the vents.*

# Climate Control System

## ▼ Windshield Defrosting and Defogging

Set the mode selector dial to the  position and turn the fan control dial to the desired speed.

In this position, the outside air position is automatically selected, and when the fan control dial is ON, the air conditioner automatically turns on. The air conditioner will directly dehumidify the air to the front windshield and side windows (page 5-4). Airflow amount will be increased.

### WARNING

**Set the temperature control to the hot or warm position when defogging ( position):**

*Using the  position with the temperature control set to the cold position is dangerous as it will cause the outside of the windshield to fog up. Your vision will be hampered, which could lead to a serious accident.*

### NOTE

*Use the temperature control dial to increase the air flow temperature and defog the windshield more quickly.*

## ▼ Sunlight/Temperature Sensor

The climate control system measures inside and outside temperatures, and sunlight. It then sets temperatures inside the passenger compartment accordingly.

### CAUTION

*Do not obstruct either sensor, otherwise the climate control system will not operate properly.*

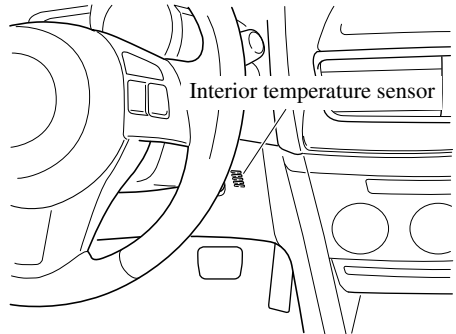
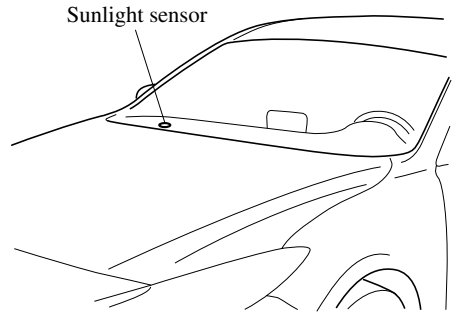

# Climate Control System

## Dual-Zone Automatic Climate Control

Climate control information is displayed on the display.

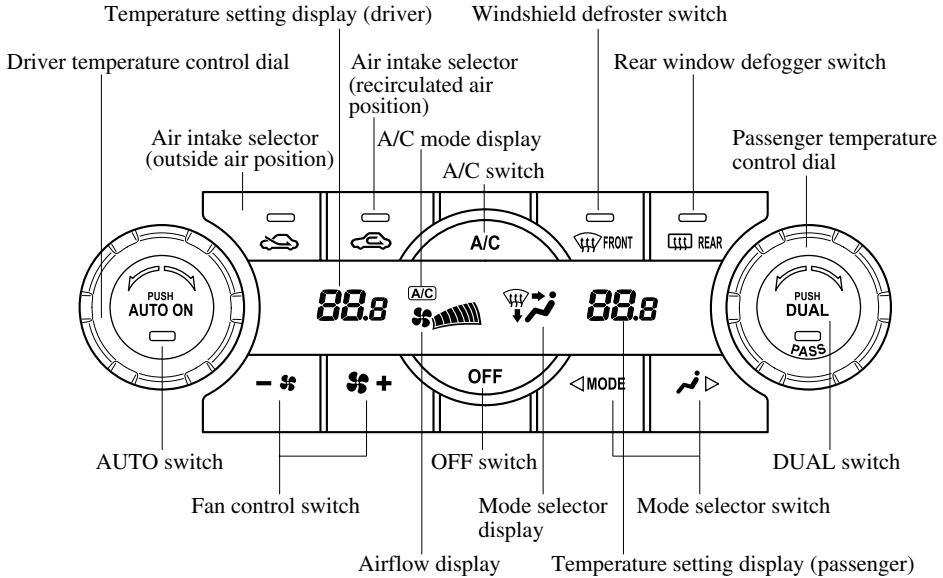

### ▼ Control Switches

#### AUTO switch

By pressing the AUTO switch the following functions will be automatically controlled in accordance with the selected set temperature:

- Airflow temperature
- Amount of airflow
- Selection of airflow mode
- Outside/Recirculated air selection
- Air conditioner operation

#### **NOTE**

##### *AUTO switch indicator light*

- When on, it indicates auto operation, and the system will function automatically.
- If any of the following switches are operated while in auto control, the AUTO switch indicator turns off.

- Mode selector switch
  - Fan control switch
  - Windshield defroster switch
- The functions for switches other than those operated in the above continue to operate in auto control.

#### OFF switch

Pressing the OFF switch shuts off the climate control system.

# Climate Control System

## Temperature control dial

This dial controls temperature. Turn it clockwise for hot and counterclockwise for cold.

- When the DUAL switch is off:  
Turn the driver temperature control dial to control the temperature throughout the entire cabin.
- When the DUAL switch is on:  
Turn the driver or front passenger temperature control dial to independently control the temperature on each side of the cabin.

### **NOTE**

- *The climate control system changes to the individual operation mode (DUAL switch indicator light illuminated) by turning the front passenger temperature control dial even when the DUAL switch is off, which allows individual control of the set temperature for the driver and front passenger.*
- *The temperature units for the temperature setting display can be changed in conjunction with the temperature units for the outside temperature display. Refer to Outside Temperature Display on page 4-15.*







## Fan control switch

The fan has seven speeds. The selected speed will be displayed.

## Mode selector switch

The desired airflow mode can be selected (page 5-4).

### **NOTE**

- *With the airflow mode set to the  position and the temperature control dial set at a medium temperature, heated air is directed to the feet and air at a comparably lower temperature will flow through the central, left and right vents.*
- *To set the air vent to , press the windshield defroster switch.*
- *In the  or  position, the air conditioner is automatically turned on and the outside air mode is automatically selected to defrost the windshield. In the  or  position, the outside air mode cannot be changed to the recirculated air mode.*

## A/C switch

Pressing the A/C switch while the AUTO switch is turned on will turn off the air conditioning (cooling/dehumidifying functions).

The air conditioning can be turned on and off by pressing the A/C switch while the fan control switch is on.

### **NOTE**

- *The air conditioning operates when the A/C switch is pressed even if the fan is off.*
- *The air conditioner may not function when the outside temperature approaches 0 °C (32 °F).*

# Climate Control System

---

## Air intake selector

Outside or recirculated air positions can be selected. Press the switch to select outside/recirculated air positions.

### **Recirculated air position** (↻)

Outside air is shut off. Use this position when going through tunnels, driving in congested traffic (high engine exhaust areas) or when quick cooling is desired.

### **Outside air position** (↻)

Outside air is allowed to enter the cabin. Use this mode for ventilation or windshield defrosting.



**Do not use the ↻ position in cold or rainy weather:**

*Using the ↻ position in cold or rainy weather is dangerous as it will cause the windows to fog up. Your vision will be hampered, which could lead to a serious accident.*

## DUAL switch

Use the DUAL switch to change the mode between the individual operation (driver and passenger) and interconnection (simultaneous) modes.

### **Individual operation mode (indicator light illuminated)**

The set temperature can be controlled individually for the driver and front passenger.

### **Interconnection mode (indicator light turned off)**

The set temperature for the driver and front passenger is controlled simultaneously.

## Windshield defroster switch

Press the switch to defrost the windshield and front door windows.

### **▼ Operation of Automatic Air Conditioning**

1. Press the AUTO switch. Selection of the airflow mode, air intake selector and amount of airflow will be automatically controlled.
2. Use the temperature control dial to select a desired temperature. Press the DUAL switch or turn the front passenger temperature control dial to control the set temperature individually for the driver and front passenger.

To turn off the system, press the OFF switch.

### **NOTE**

- *Setting the temperature to maximum high or low will not provide the desired temperature at a faster rate.*
- *When selecting heat, the system will restrict airflow until it has warmed to prevent cold air from blowing out of the vents.*



# Climate Control System

## ▼ Windshield Defrosting and Defogging

Press the windshield defroster switch. In this position, the outside air position is automatically selected, and the air conditioner automatically turns on. The air conditioner will directly dehumidify the air to the front windshield and side windows (on Page 5-4). Airflow amount will be increased.

### ⚠ WARNING

**Set the temperature control to the hot or warm position when defogging (☀ position):**

*Using the ☀ position with the temperature control set to the cold position is dangerous as it will cause the outside of the windshield to fog up. Your vision will be hampered, which could lead to a serious accident.*

### NOTE

*Use the temperature control dial to increase the air flow temperature and defog the windshield more quickly.*

## ▼ Sunlight/Temperature Sensor

The climate control system measures inside and outside temperatures, and sunlight. It then sets temperatures inside the passenger compartment accordingly.

### ⚠ CAUTION

*Do not obstruct either sensor, otherwise the climate control system will not operate properly.*

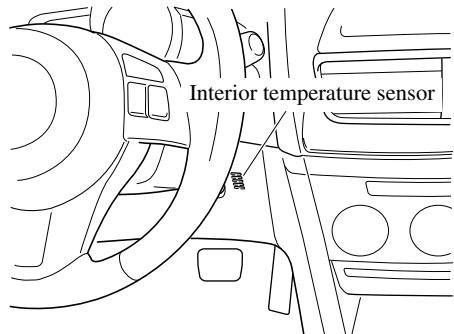
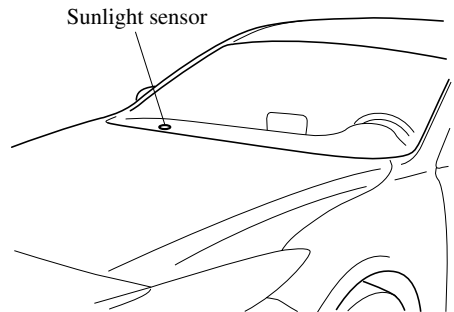

# Audio System

## Antenna

### ▼ Antenna (4-Door)

#### AM/FM Radio Antenna

The AM/FM radio antenna receives both AM and FM signals.  
The antenna is embedded into the window glass.



*When washing the inside of the window which has an antenna, use a soft cloth dampened in lukewarm water, gently wiping the antenna lines. Use of glass cleaning products could damage the antenna.*

#### Satellite Radio Antenna\*

The satellite radio antenna receives SiriusXM signals.

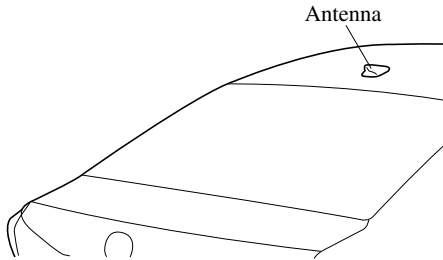

### ▼ Antenna (5-Door)

#### AM/FM Radio Antenna\*

The AM/FM radio antenna receives both AM and FM signals.

#### (Type A)

To remove the antenna, turn it counterclockwise.  
To install the antenna, turn it clockwise.  
Make sure the antenna is securely installed.

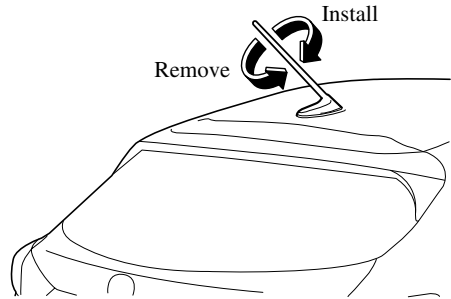

- *To prevent damage to the antenna, remove it before entering a car wash facility or passing beneath a low overhead clearance.*
- *Be careful around the antenna when removing snow from the roof. Otherwise the antenna could be damaged.*

#### **NOTE**

*When leaving your vehicle unattended, we recommend that you remove the antenna and store it inside the vehicle.*

(Type B)

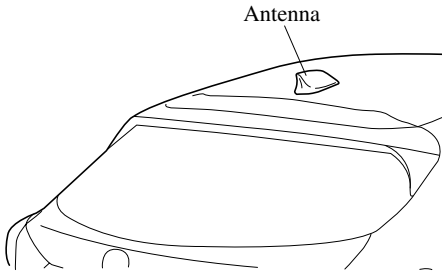

### Antenna for AM/FM and Satellite Radio Antenna\*

The antenna for AM/FM and satellite radio antenna receives both AM and FM signals and SiriusXM signals.

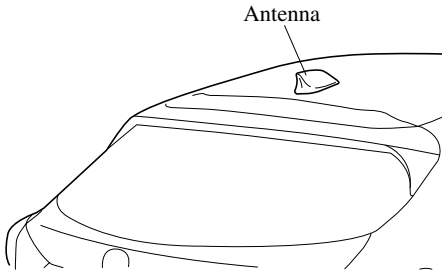

## Operating Tips for Audio System

### **! WARNING**

**Always adjust the audio while the vehicle is stopped:**

*Do not adjust the audio control switches while driving the vehicle. Adjusting the audio while driving the vehicle is dangerous as it could distract your attention from the vehicle operation which could lead to a serious accident.*

*Even if the audio control switches are equipped on the steering wheel, learn to use the switches without looking down at them so that you can keep your maximum attention on the road while driving the vehicle.*

### **! CAUTION**

*For the purposes of safe driving, adjust the audio volume to a level that allows you to hear sounds outside of the vehicle including car horns and particularly emergency vehicle sirens.*

### **NOTE**

- To prevent the battery from being discharged, do not leave the audio system on for a long period of time when the engine is not running.*
- If a cellular phone or CB radio is used in or near the vehicle, it could cause noise to occur from the audio system, however, this does not indicate that the system has been damaged.*

# Audio System

Do not spill any liquid on the audio system.

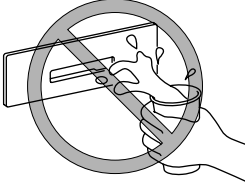

Do not insert any objects, other than CDs, into the slot.

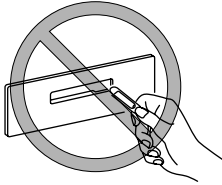

## ▼ Radio Reception

### AM characteristics

AM signals bend around such things as buildings or mountains and bounce off the ionosphere.

Therefore, they can reach longer distances than FM signals.

Because of this, two stations may sometimes be picked up on the same frequency at the same time.

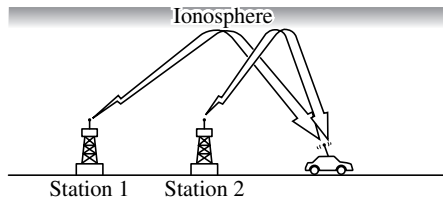

### FM characteristics

An FM broadcast range is usually about 40—50 km (25—30 miles) from the source. Because of extra coding needed to break the sound into two channels, stereo FM has even less range than monaural (non-stereo) FM.

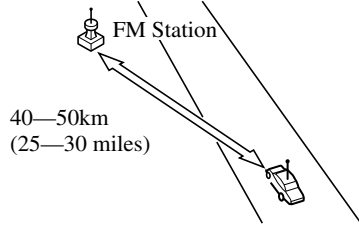

Signals from an FM transmitter are similar to beams of light because they do not bend around corners, but they do reflect. Unlike AM signals, FM signals cannot travel beyond the horizon. Therefore, FM stations cannot be received at the great distances possible with AM reception.

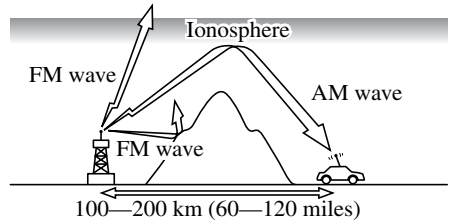

Atmospheric conditions can also affect FM reception. High humidity will cause poor reception. However, cloudy days may provide better reception than clear days.

### Multipath noise

Since FM signals can be reflected by obstructions, it is possible to receive both the direct signal and the reflected signal at the same time. This causes a slight delay in reception and may be heard as a broken sound or a distortion. This problem may also be encountered when in close proximity to the transmitter.

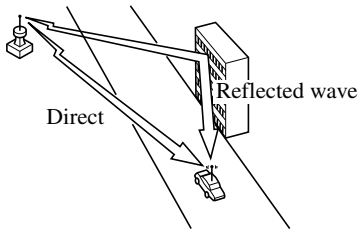

### Flutter/Skip noise

Signals from an FM transmitter move in straight lines and become weak in valleys between tall buildings, mountains, and other obstacles. When a vehicle passes through such an area, the reception conditions may change suddenly, resulting in annoying noise.

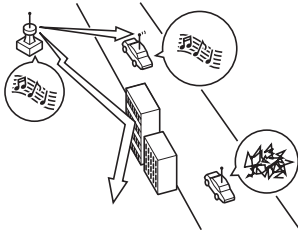

### Weak signal noise

In suburban areas, broadcast signals become weak because of distance from the transmitter. Reception in such fringe areas is characterized by sound breakup.

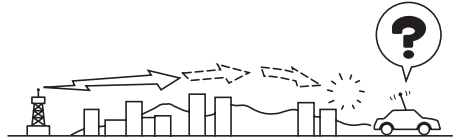

### Strong signal noise

This occurs very close to a transmitter tower. The broadcast signals are extremely strong, so the result is noise and sound breakup at the radio receiver.

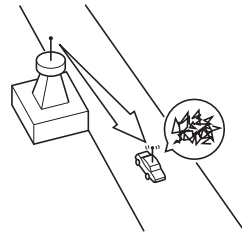

### Station drift noise

When a vehicle reaches the area of two strong stations broadcasting at similar frequencies, the original station may be temporarily lost and the second station picked up. At this time there will be some noise from this disturbance.

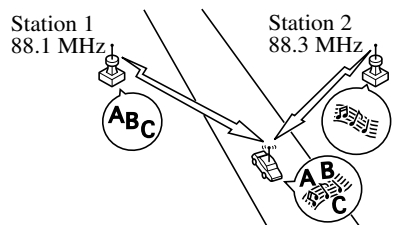

# Audio System

## ▼ Operating Tips for CD Player

### Condensation phenomenon

Immediately after turning on the heater when the vehicle is cold, the CD or optical components (prism and lens) in the CD player may become clouded with condensation. At this time, the CD will eject immediately when placed in the unit. A clouded CD can be corrected simply by wiping it with a soft cloth. Clouded optical components will clear naturally in about an hour. Wait for normal operation to return before attempting to use the unit.

### Handling the CD player

The following precautions should be observed.

- The CD revolves at high speed within the unit. Defective (cracked or badly bent) CDs should never be used.

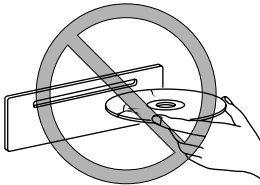

- Do not use non-conventional discs such as heart-shaped, octagonal discs, etc. The disc may not eject resulting in a malfunction.

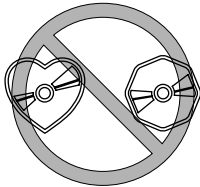

- If the memory portion of the CD is transparent or translucent, do not use the disc.

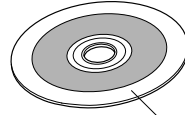

Transparent

- A new CD may have rough edges on its inner and outer perimeters. If a disc with rough edges is used, proper setting will not be possible and the CD player will not play the CD. In addition, the disc may not eject resulting in a malfunction. Remove the rough edges in advance by using a ball-point pen or pencil as shown below. To remove the rough edges, rub the side of the pen or pencil against the inner and outer perimeter of the CD.

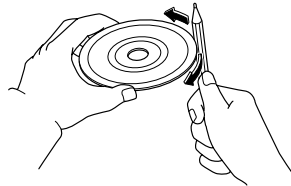

- When driving over uneven surfaces, the sound may jump.

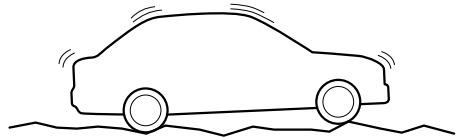

- The CD player has been designed to play CDs bearing the identification logo as shown below. No other discs can be played.



- Use discs that have been legitimately produced. If illegally-copied discs such as pirated discs are used, the system may not operate properly.
- Be sure never to touch the signal surface when handling the CDs. Pick up a CD by grasping the outer edge or the edge of the hole and the outer edge.

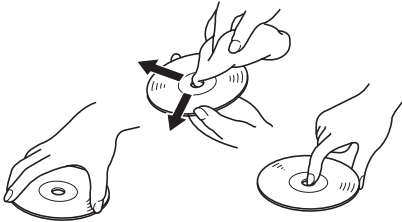

- Do not stick paper or tape on the CD. Avoid scratching the reverse side (the side without a label). The disc may not eject resulting in a malfunction.
- Dust, finger smudges, and dirt can decrease the amount of light reflected from the signal surface, thus affecting sound quality. If the CD should become soiled, gently wipe it with a soft cloth from the center of the CD to the edge.
- Do not use record sprays, antistatic agents, or household spray cleaners. Volatile chemicals such as benzine and thinner can also damage the surface of the CD and must not be used. Anything that can damage, warp, or fog plastic should never be used to clean CDs.

- The CD player ejects the CD if the CD is inserted upside down. Also dirty and/or defective CDs may be ejected.
- Do not insert cleaning discs in the CD player.
- Do not insert any disc with a peel-off seal affixed to it.
- This unit may not be able to play certain CD-R/CD-RWs made using a computer or music CD recorder due to disc characteristics, scratches, smudges, dirt, etc., or due to dust or condensation on the lens inside the unit.
- Storing CDs in the vehicle exposed to direct sunlight or high temperature may damage the CD-R/CD-RWs, and make them unplayable.
- CD-R/CD-RW exceeding 700 MB cannot be played.
- This unit may not be able to play certain discs made using a computer due to the application (writing software) setting used. (For details, consult the store where the application was purchased.)
- It is possible that certain text data, such as titles, recorded on a CD-R/CD-RW may not be displayed when musical data (CD-DA) is playing.
- The period from when a CD-RW is inserted to when it begins playing is longer than a normal CD or CD-R.
- Completely read the instruction manual and cautions for CD-R/CD-RWs.
- Do not use discs with cellophane tape adhering, partially peeled off labels, or adhesive material exuding from the edges of the CD label. Also, do not use discs with a commercially-available CD-R label affixed. The disc may not eject resulting in a malfunction.

# Audio System

---

## ▼ Operating Tips for MP3

### NOTE

*Supply of this product only conveys a license for private, non-commercial use and does not convey a license nor imply any right to use this product in any commercial (i.e. revenue-generating) real time broadcasting (terrestrial, satellite, cable and/or any other media), broadcasting/streaming via the Internet, intranets and/or other networks or in other electronic content distribution systems, such as pay-audio or audio-on-demand applications. An independent license for such use is required. For details, please visit <http://www.mp3licensing.com>.*

- This audio system handles MP3 files that have been recorded on CD-R/CD-RW/CD-ROMs.
- When naming an MP3 file, be sure to add an MP3 file extension (.mp3) after the file name.
- The number of characters which can be displayed is restricted.

### CAUTION

*This unit can only play MP3 files that have an MP3 file extension (.mp3) attached. Do not attach an MP3 file extension to any other type file as it could cause noise to be emitted or a malfunction in the unit.*

## Specialized glossary

### MP3

Abbreviation for “MPEG Audio Layer 3”. A technical standard for audio compression as decided by the ISO<sup>\*1</sup> MPEG working group. Use of MP3 allows for audio data to be compressed to approximately a tenth of the source data size.

\*1 International Organization for Standardization

## ▼ Operating Tips for WMA

WMA is short for Windows Media Audio and is the audio compression format used by Microsoft.

Audio data can be created and stored at a higher compression ratio than MP3.

\*Microsoft and Windows Media are registered trademarks of Microsoft Corporation U.S. in the United States and other countries.

### CAUTION

*This unit plays files with the (.wma) file extension as a WMA file. Do not use the WMA file extension for files other than WMA files. Otherwise, it could result in noise or a malfunction.*

- WMA files written under specifications other than the indicated specification may not play normally or files or folder names may not display correctly.
- The file extension may not be provided depending on the computer operating system, version, software, or settings. In this case, add the file extension “.wma” to the end of the file name, and then write it to the disc.



**▼ Operating Tips for AAC**

AAC stands for Advanced Audio Coding, which is standardized voice compression established by the ISO\*1 working group (MPEG). Audio data can be created and stored at a higher compression ratio than MP3.

This unit plays files with the extensions (.aac/.m4a/.wav\*2) as the AAC files.

\*1 International Organization for Standardization

\*2 Type B

**⚠ CAUTION**

*Do not use an audio file extension on files other than audio files. In addition, do not change the audio file extension. Otherwise, the unit will not recognize the file correctly resulting in noise or a malfunction.*

- AAC files written under specifications other than the indicated specification may not play normally or files or folder names may not display correctly.
- The file extension may not be provided depending on the computer operating system, version, software, or settings. In this case, add the file extension “.aac”, “.m4a”, or “.wav\*2” to the end of the file name, and then write it to the memory.

\*2 Type B

**▼ Operating Tips for OGG**

OGG is the audio compression format for Xiph. Org Foundation.

Audio data can be created and stored at a higher compression ratio than MP3.

**⚠ CAUTION**

*This unit plays files with the (.ogg) file extension as a OGG file. Do not use the OGG file extension for files other than OGG files. Otherwise, it could result in noise or a malfunction.*

- OGG files written under specifications other than the indicated specification may not play normally or files or folder names may not display correctly.
- The file extension may not be provided depending on the computer operating system, version, software, or settings. In this case, add the file extension “.ogg” to the end of the file name, and then write it to the disc.

# Audio System

## ▼ Operating Tips for USB device

This unit plays audio files as follows:

Extension	Playback with this unit
.mp3	MP3
.wma	WMA
.aac	AAC
.m4a	
.wav*1	
.ogg*1	OGG

\*1 Type B

### CAUTION

Do not use an audio file extension on files other than audio files. In addition, do not change the audio file extension. Otherwise, the unit will not recognize the file correctly resulting in noise or a malfunction.

## NOTE

- Playback may not be possible depending on the type and condition of the USB flash memory even if the audio file complies with the standard above.
- A copyright protected WMA/AAC file cannot be played in this unit.
- The order of the music data stored in the device may differ from the playback order.
- To prevent loss or damage of stored data, we recommend that you always back up your data.
- If a device exceeds the maximum electric current value of 1,000 mA, it may not operate or recharge when connected.
- Do not pull out the USB device while in the USB mode (only pull it out while in FM/AM radio or CD mode).
- The device will not operate if the data is password protected.
- MP3/WMA/AAC/OGG\*1 files written under specifications other than the indicated specification may not play normally or files/folder names may not display correctly.

\*1 Type B

### ▼ Operating Tips for iPod

This unit supports playback of music files recorded to an iPod.

- iPod is a trademark of Apple Inc., registered in the U.S. and other countries.

The iPod may not be compatible depending on the model or OS version. In this case, an error message is displayed.

#### **CAUTION**

- *Remove the iPod when it is not in use. Because the iPod is not designed to withstand excessive changes in temperature inside the cabin, it could be damaged or the battery may deteriorate due to the excessive temperature or humidity inside the cabin if it is left in the vehicle.*
- *If data in the iPod is lost while it is connected to the unit, Mazda cannot guarantee recovery of any lost data.*
- *If the iPod battery is deteriorated, the iPod may not recharge and playback may not be possible when it is connected to the unit. Replace the iPod battery immediately.*
- *Be careful not to pinch the iPod connecting cable when opening/closing the center console.*
- *For details on using the iPod, refer to the iPod instruction manual.*
- *When connecting the iPod to a USB port, all commands are made from the audio unit. iPod control is not possible.*

#### **NOTE**

*The audio unit cannot display images or videos stored in an iPod.*

# Audio System

## Audio Set (Type A)

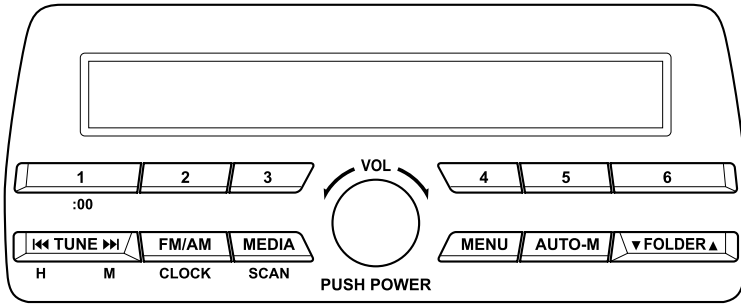

① Power/Volume/Sound Controls.....	page 5-28
② Clock .....	page 5-30
③ Operating the Radio .....	page 5-32
④ Operating the Compact Disc (CD) Player.....	page 5-34
⑤ How to use Auxiliary jack/USB port .....	page 5-37
⑥ Error Indications .....	page 5-37

# MEMO

# Audio System

## ▼ Power/Volume/Sound Controls

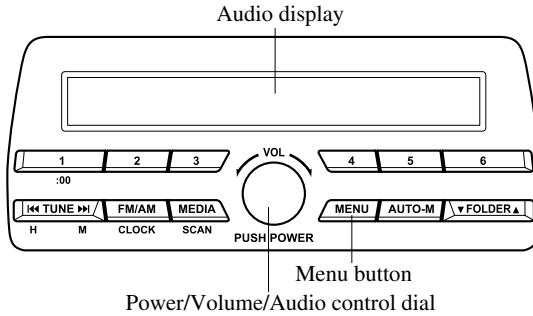

### Power ON/OFF

Switch the ignition to ACC or ON. Press the power/volume dial to turn the audio system on. Press the power/volume dial again to turn the audio system off.

### Volume adjustment

To adjust the volume, turn the power/volume dial. Turn the power/volume dial clockwise to increase volume, counterclockwise to decrease it.

### Audio sound adjustment

1. Press the menu button (**MENU**) to select the function. The selected function will be indicated.

2. Turn the audio control dial to adjust the selected functions as follows:

Indication	Setting value	
	Turn Counterclockwise	Turn Clockwise
ALC (Automatic volume adjustment)	Level decrease	Level increase
BASS (Low pitch sound)	Decrease bass	Increase bass
TREB (Treble sound)	Decrease treble	Increase treble
FADE (Front/back volume balance)	Shift the sound to the front	Shift the sound to the rear
BAL (Left/right volume balance)	Shift the sound to the left	Shift the sound to the right
BEEP (Audio operation sound)	Off	On
BT SETUP*	Select mode	
12Hr <> 24Hr	12Hr (Flashing)	24Hr (Flashing)

\*Depending on the model, this function may not be available.

**NOTE**

*If not operated for several seconds, the display returns to the previous display. To reset bass, treble, fade, and balance, press the menu button (MENU) for 2 seconds. The unit will beep and "CLEAR" will be displayed.*

**Automatic Level Control (ALC)**

The automatic level control (ALC) changes the audio volume automatically according to the vehicle speed. The faster the vehicle speed, the higher the volume increases. ALC has ALC OFF and ALC LEVEL 1 to 7 modes. At ALC LEVEL 7, the amount that the volume can increase is at the maximum. Select the mode according to the driving conditions.

**BT SETUP mode\***

Music and other audio such as voice data recorded on portable audio devices and mobile phones available on the market which are equipped with the Bluetooth® transmission function can be listened to via wireless transmission over the vehicle's speakers. Using the BT SETUP mode, these devices can be programmed to the Bluetooth® unit or changed (page 5-80).

**Time adjustment**

Rotating the audio control dial switches the display between 12 and 24-hour clock time (page 5-30).

# Audio System

## ▼ Clock

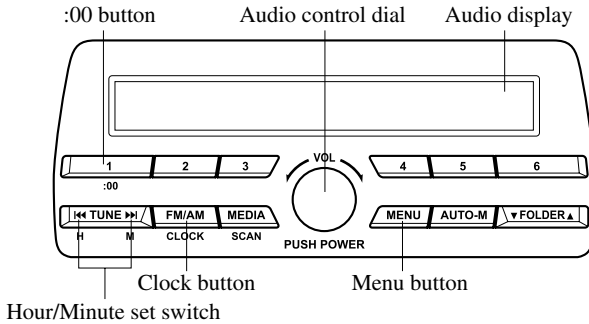

### Setting the time

The clock can be set at any time when the ignition is switched to ACC or ON.

- To adjust the time, press the clock button (FM/AM) for about 2 seconds until a beep is heard.
- The clock's current time will flash.

#### **Time adjustment**

- To adjust the time, press the hour/minute set button (▶▶, ◀◀) while the clock's current time is flashing.
  - The hours advance while the hour set button (◀◀) is pressed. The minutes advance while the minute set button (▶▶) is pressed.
- Press the clock button (FM/AM) again to start the clock.

### Time resetting

- Press the clock button (FM/AM) for about 2 seconds until a beep is heard.
- Press the :00 button (1).
- When the button is pressed, the time will be reset as follows:  
(Example)  
12:01—12:29→12:00  
12:30—12:59→1:00

### **NOTE**

- When the :00 button (1) is pressed, the seconds will start at "00".
- Switching between 12 and 24-hour clock time:  
Press the menu button (MENU) several times until 12 and 24-hour clock time are displayed. Turn the audio control dial in either direction, select the desired clock setting while the preferred clock time is flashing.



# MEMO

# Audio System

## ▼ Operating the Radio

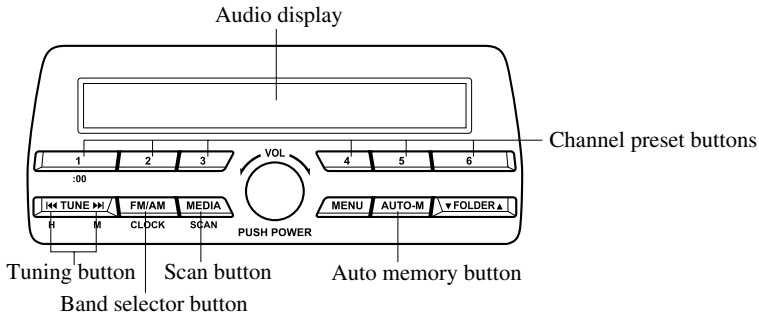

### **Radio ON**

Press a band selector button (**FM/AM**) to turn the radio on.

### **Band selection**

Successively pressing the band selector button (**FM/AM**) switches the bands as follows: FM1→FM2→AM.

The selected mode will be indicated.

### **NOTE**

*If the FM broadcast signal becomes weak, reception automatically changes from STEREO to MONO for reduced noise.*

### **Tuning**

The radio has the following tuning methods: Manual, Seek, Scan, Preset channel, and Auto memory tuning. The easiest way to tune stations is to set them on preset channels.

### **Manual tuning**

Select the station by pressing the tuning button (▶▶, ◀◀) lightly.

### **Seek tuning**

Automatic search for radio stations starts when the tuning button (▶▶, ◀◀) is pressed until a beep sound is heard. The search stops when a station is found.

### **NOTE**

*If you continue to press and hold the button, the frequency will continue changing without stopping.*

### **Scan tuning**

Press and hold the scan button (**MEDIA**) to automatically sample strong stations. Scanning stops at each station for about 5 seconds. To hold a station, press and hold the scan button (**MEDIA**) again during this interval.

### **Preset channel tuning**

The 6 preset channels can be used to store 6 AM and 12 FM stations.

1. To set a channel first select AM, FM1, or FM2. Tune to the desired station.
2. Press a channel preset button for about 2 seconds until a beep is heard. The preset channel number or station frequency will be displayed. The station is now held in the memory.

3. Repeat this operation for the other stations and bands you want to store. To tune one in the memory, select AM, FM1, or FM2 and then press its channel preset button. The station frequency or the channel number will be displayed.

### **Auto memory tuning**

This is especially useful when driving in an area where the local stations are not known.

Press and hold the auto memory button (**AUTO-M**) for about 2 seconds until a beep is heard; the system will automatically scan and temporarily store up to 6 stations with the strongest frequencies in each selected band in that area.

After scanning is completed, the station with the strongest frequency will be tuned and its frequency displayed. Press and release the auto memory button (**AUTO-M**) to recall stations from the auto-stored stations. One stored station will be selected each time and its frequency and channel number will be displayed.

### **NOTE**

*If no stations can be tuned after scanning operations, "A" will be displayed.*

# Audio System

## ▼ Operating the Compact Disc (CD) Player\*

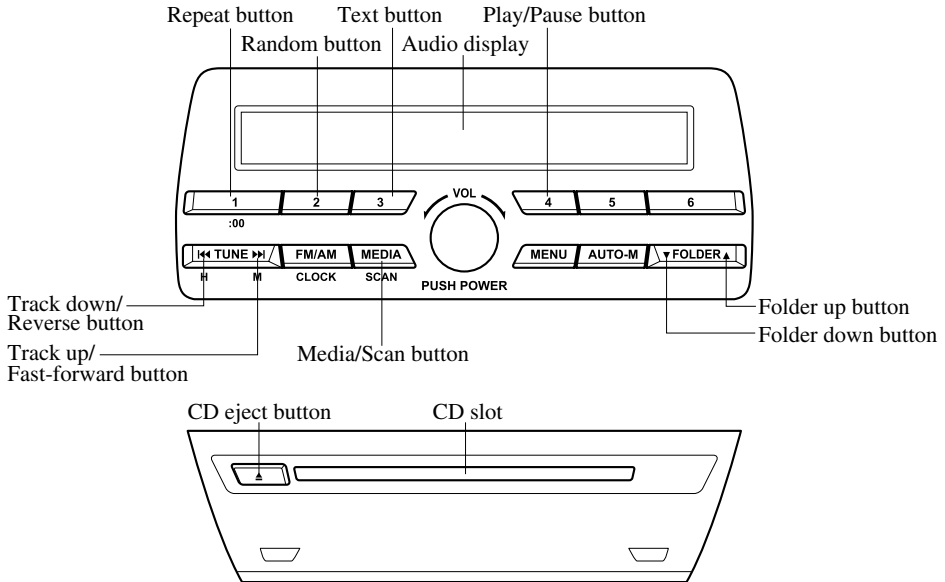

Type	Playable data
Music/MP3/WMA/AAC CD player	*Music data (CD-DA) *MP3/WMA/AAC file

### NOTE

If a disc has both music data (CD-DA) and MP3/WMA/AAC files, playback of the two or three file types differs depending on how the disc was recorded.

### Inserting the CD

Insert the CD into the slot, label-side up. The auto-loading mechanism will set the CD and begin play.

### NOTE

There will be a short lapse before play begins while the player reads the digital signals on the CD.

### Ejecting the CD

Press the CD eject button (▲) to eject the CD.

### Playback

Press the media button (MEDIA) to switch to CD mode and start playback.

### NOTE

The CD mode cannot be selected if a CD has not been inserted.

### Pause

To stop playback, press the Play/Pause button (4). Press the button again to resume playback.

### Fast-forward/Reverse

Press and hold the fast-forward button (▶▶) to advance through a track at high speed. Press and hold the reverse button (◀◀) to reverse through a track at high speed.

**Track search**

Press the track up button (▶▶) once to skip forward to the beginning of the next track. Press the track down button (◀◀) within a few seconds after playback begins to track down to the beginning of the previous track.

Press the track down button (◀◀) after a few seconds have elapsed to start playback from the beginning of the current track.

**Folder search (during MP3/WMA/AAC CD playback)**

To change to the previous folder, press the folder down button (▼), or press the folder up button (▲) to advance to the next folder.

**Music scan****During music CD playback**

This function scans the titles on a CD and plays 10 seconds of each song to aid you in finding a song you want to listen to. Press and hold the scan button (MEDIA) during playback to start the scan play operation (the track number will flash). Press and hold the scan button (MEDIA) again to cancel scan playback.

**During MP3/WMA/AAC CD playback**

This function scans the titles in a folder currently being played and plays 10 seconds of each song to aid you in finding a song you want to listen to. Press and hold the scan button (MEDIA) during playback to start the scan play operation (the track number will flash). Press and hold the scan button (MEDIA) again to cancel scan playback.

**NOTE**

*If the unit is left in scan, normal playback will resume where scan was selected.*

**Repeat playback****During music CD playback**

1. Press the repeat button (1) during playback to play the current track repeatedly. "TRACK RPT" is displayed.
2. Press the button again to cancel the repeat playback.

**During MP3/WMA/AAC CD playback****(Track repeat)**

1. Press the repeat button (1) during playback to play the current track repeatedly. "TRACK RPT" is displayed.
2. To cancel the repeat playback, press the button again after 3 seconds.

**(Folder repeat)**

1. Press the repeat button (1) during playback, and then press the button again within 3 seconds to play the tracks in the current folder repeatedly. "FOLDER RPT" is displayed.
2. Press the button again to cancel the repeat playback.

**Random playback**

Tracks are randomly selected and played.

**During music CD playback**

1. Press the random button (2) during playback to play the tracks on the CD randomly. "DISC RDM" is displayed.
2. Press the button again to cancel the random playback.

# Audio System

## During MP3/WMA/AAC CD playback

### (Folder random)

1. Press the random button (2) during playback to play the tracks in the folder randomly. "FOLDER RDM" is displayed.
2. To cancel the random playback, press the button again after 3 seconds.

### (CD random)

1. Press the random button (2) during playback, and then press the button again within 3 seconds to play the tracks on the CD randomly. "DISC RDM" is displayed.
2. Press the button again to cancel the random playback.

### Switching the display

For files with a file name and other information that have been input, the display switches between display of the file name and other information each time the text button (3) is pressed during playback.

### Music CD

Track number/Elapsed time

Track number

Track name\*

Album name\*

Artist name\*

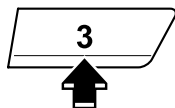

\* Depending on the CD, this information may not be available.

## MP3/WMA/AAC CD

File number/Elapsed time

Folder number/File number

File name

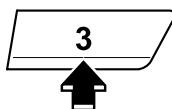

Folder name

Album name

Song name

Artist name

### **NOTE**

- The information viewable in the display is only CD information (such as artist name, song title) which has been recorded to the CD.
- This unit cannot display some characters. Characters which cannot be displayed are indicated by an asterisk (\*).

### **Display scroll**

Only 13 characters can be displayed at one time. To display the rest of the characters of a long title, press and hold the text button (3). The display scrolls the next 13 characters. Press and hold the text button (3) again after the last 13 characters have been displayed to return to the beginning of the title.

**NOTE**

*The number of characters which can be displayed is restricted.*

**Message display**

If “CHECK CD” is displayed, it means that there is some CD malfunction. Check the CD for damage, dirt, or smudges, and then properly reinsert it. If the message appears again, insert another known good CD. If the message continues to appear, take the unit to an Authorized Mazda Dealer for service.

**▼ How to use Auxiliary jack/USB port**

Audio can be heard from the vehicle's speakers by connecting a commercially-available portable audio unit to the auxiliary jack.

Use a commercially-available, non-impedance (3.5 $\phi$ ) stereo mini plug cable. Contact an Authorized Mazda Dealer for details.

In addition, audio can be played from the vehicle audio device by connecting a USB device or an iPod to the USB port. Refer to AUX/USB/iPod mode on page 5-59.

**▼ Error Indications**

If you see an error indication on the audio display, find the cause in the chart. If you cannot clear the error indication, take the vehicle to an Authorized Mazda Dealer.

Indication	Cause	Solution
CHECK CD	CD is inserted upside down	Insert the CD properly. If the error indication continues to display, consult an Authorized Mazda Dealer.
	CD is defective	Insert another CD properly. If the error indication continues to display, consult an Authorized Mazda Dealer.

# Audio System

## Audio Set (Type B)

### NOTE

*The explanation of functions described in this manual may differ from the actual operation, and the shapes of screens and buttons and the letters and characters displayed may also differ from the actual appearance. Additionally, depending on future software updates, the content may successively change without notice.*

Audio Set (Type B) has three different human interfaces.

- Commander switch
- Touch panel
- Voice recognition with steering switch and microphone

### Commander switch operation

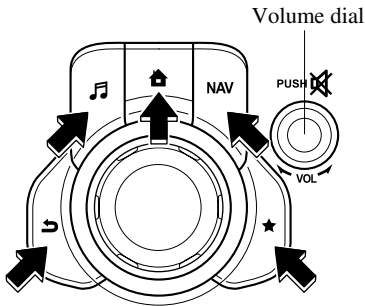

### NOTE

*For safety reasons, some operations are disabled while the vehicle is being driven.*

### Volume dial operation

Press the volume dial to switch the audio MUTE on and off.

Turn the volume dial to adjust the volume. The volume increases by turning the dial clockwise, and decreases by turning it counterclockwise.

### Switches around commander knob

🏠 : Displays the home screen.

🎵 : Displays the Entertainment screen.

NAV : Displays the Navigation screen. (Only navigation-equipped vehicles)

★ : Displays the Favorites screen. Long-press to store particular items in Favorites. (AM/FM radio, phonebook and destination of the navigation system can be programmed.)

➡ : Returns to previous screen.



## Commander knob operation

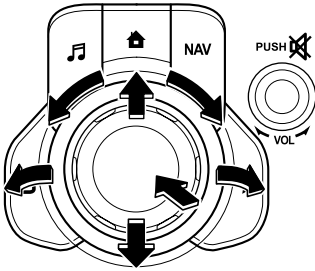

### (Selection of icons on screen)

1. Tilt or turn the commander knob and move the cursor to the desired icon.
2. Press the commander knob and select the icon.

### **NOTE**

*Long-press operation of the commander knob is also possible for some functions.*

## Touch panel operation



*Do not press the screen strongly or press it with a sharp-pointed object. Otherwise, the screen could be damaged.*

### **NOTE**

*For safety reasons, touch panel operation is disabled while the vehicle is moving.*

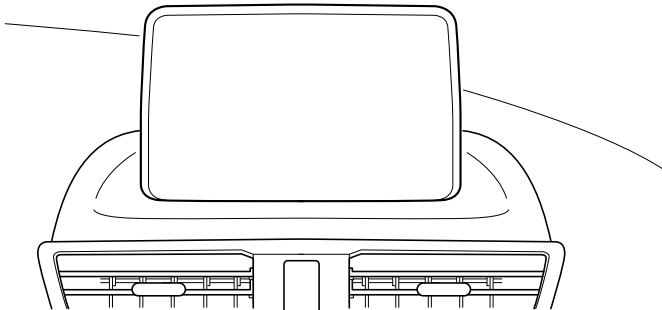

# Audio System

---

## ▼ Basic Operation Method

### TOUCH & TAP

1. Touch the item indicated in the center display.
2. The operation is launched and the next item is displayed.

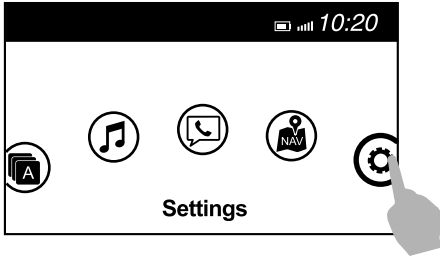

### SLIDE

1. Touch the setting item displaying a slider bar.
2. Slide your finger in the desired direction.

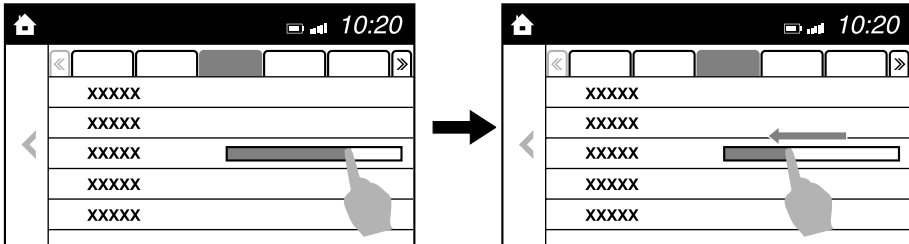

### SWIPE

1. Touch the item displaying a slider bar.
2. Swipe your finger in the desired direction.









### Return to previous screen

1. Touch the .

### Displaying the home screen

1. Touch the .

### ▼ Home screen

Icon	Function
	<p><b>Applications</b> Information such as average fuel economy, maintenance, and warnings can be verified. Depending on the grade and specification, the screen display may differ.</p>
	<p><b>Entertainment</b> Operates audio such as the radio and CDs. The audio source most recently used is displayed. An audio source which cannot be used at that time is skipped and the previous audio source is displayed. To change the audio source, select the  icon again.</p>
	<p><b>Communication</b> Bluetooth® related functions are available.</p>
	<p><b>Navigation</b> Navigation screen is displayed (vehicles with navigation system). If the SD card for the navigation system is not inserted, the compass indicating the direction in which the vehicle is moving is displayed. The compass may not indicate the correct bearing when the vehicle is stopped or traveling at a slow speed.</p>
	<p><b>Settings</b> Overall setting menu (Such as display, sound, Bluetooth® and Language). Depending on the grade and specification, the screen display may differ.</p>

# Audio System

## ▼ Volume/Display/Sound Controls

### Commander switch

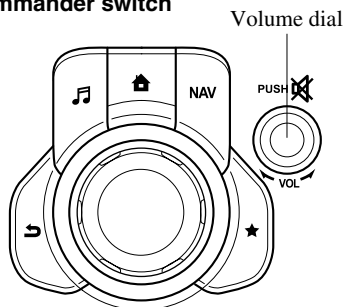

### Audio control switch

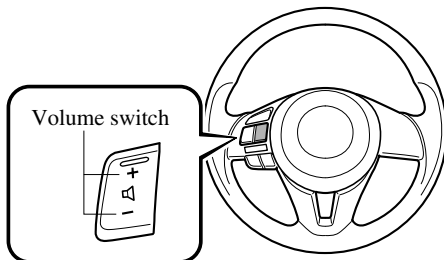

### Volume adjustment

Turn the commander switch volume dial. The volume switch on the steering switch can also be pressed.

### Display setting

Select the  icon on the home screen and display the Settings screen. Select the **Display** tab to select the item you would like to change.

### **Display OFF/Clock**

The center display can be turned off. Select **Turn Display Off** to turn the display off. When **Turn Display Off and Show Clock** is selected the center display turns off and the clock is displayed. The center display can be turned back on as follows:

- Touch the center display.
- Operate the commander switch.

### **Daytime/nighttime screen setting**

The daytime or nighttime screen can be selected.

**Auto**: Switches screen automatically according to headlight illumination condition\*1

**Day**: Daytime screen setting

**Night**: Nighttime screen setting

\*1 The display is constantly on daytime screen when the illumination dimmer is cancelled.

### **Brightness adjustment**

Adjust the center display brightness using the slider.

### **Contrast adjustment**

Adjust the center display contrast using the slider.

### **Display setting reset**

All of the screen setting values can be reset to their initial settings.

1. Select **Restore Factory settings**.
2. Select **Yes**.

### Audio sound adjustment

Select the  icon on the home screen and display the Settings screen.

Select the **Sound** tab to select the item you would like to change.

Indication	Setting value
Bass (Low pitch sound)	+ Side: Low pitch enhancement - Side: Low pitch reduction
Treble (Treble sound)	+ Side: Treble enhancement - Side: Treble reduction
Fade (Front/Rear volume balance)	Rear: Front speaker volume reduction Front: Rear speaker volume reduction
Balance (Left/right volume balance)	Right: Left side volume reduction Left: Right side volume reduction
ALC* <sup>1</sup> (Automatic volume adjustment)	Off—Adjustment at seven levels
Centerpoint®* <sup>2</sup> (Automatic surround level adjustment)	On/Off
AudioPilot®* <sup>2</sup> (Automatic volume adjustment)	On/Off
Beep (Audio operation sound)	On/Off

\*1 Standard audio

\*2 Bose® Sound System

### Automatic Level Control (ALC)

The automatic level control is a feature that automatically adjusts audio volume and sound quality according to the vehicle speed. The volume increases in accordance with the increase in vehicle speed, and decreases as vehicle speed decreases.

### Centerpoint®\*<sup>3</sup>

Centerpoint® lets vehicle owners enjoy a Bose® surround sound experience from their existing CDs, MP3s and satellite radio.

Specifically engineered to meet the unique demands of reproducing surround sound in a vehicle.

Converts stereo signals to multiple channels allowing greater precision when reproducing the sound.

An enhanced algorithm to simultaneously create a wider, more spacious sound field.

\*3 Centerpoint® is a registered trademark of Bose Corporation.

### AudioPilot®\*<sup>4</sup>

When driving, background noise can interfere with enjoying music.

AudioPilot® noise compensation technology continuously adjusts the music to compensate for background noise and vehicle speed.

It reacts only to sustained noise sources and not intermittent ones, such as speed bumps.

An enhanced DSP algorithm allows faster and more effective compensation for unusual situations, such as driving on a very rough road or at high speeds.

\*4 AudioPilot® is a registered trademark of Bose Corporation.















# Audio System

## ▼ Operating the Radio

### Radio ON

Select the  icon on the home screen and display the Entertainment screen. When selecting the desired radio, the following icons are indicated in the lower part of the center display.

#### AM/FM Radio

Icon	Function
	Displays the Entertainment menu. Use to switch to a different audio source.
	Displays the station list. Select <b>Update Station List</b> to display the frequencies of up to ten radio stations on the auto memory preset list. Select the desired frequency.
	Displays the Favorites list. Long-press to store radio station currently being aired.
	Switches the <b>HD Radio</b> on and off. Displays the multi-cast channel list of the HD Radio.
	You can search for receivable radio stations. Scanning stops at each station for about five seconds. Select again to continue receiving the radio station.
	Manual radio station selection. Select the tuner and rotate the commander knob or drag the display, or touch the radio frequency. Press  or  to change the radio frequency one step at a time. When  or  is long-pressed, the radio frequency changes continually. It stops when you remove your hand from the icon or the commander knob.
	Launches the iTunes Tagging function (for Apple devices with USB use only). Can be used when the <b>HD Radio</b> is on.
	Automatic radio station selection.
	When long-pressed, the radio frequency changes continually. It stops when you remove your hand from the icon or the commander knob.
	Displays sound settings to adjust audio quality level. Refer to Volume/Display/Sound Controls on page 5-42.

## **Favorites Radio**

Selected stations can be registered for convenient operation. Up to 50 stations can be registered. The Favorites list is common to AM, FM, and satellite radio.

### **Registering to Favorites**

Long-press the ★ icon to register the current radio station. The registration can also be performed using the following procedure.

1. Select the ★ icon to display the Favorites list.
2. Select **Add/Edit Radio Favorites**.
3. Select **Add <active station>**.
4. The station is added to the bottom of the Favorites list.

### **NOTE**

*If the battery is disconnected, your Favorites list will be not deleted.*

### **Selecting radio station from Favorites**

1. Select the ★ icon to display the Favorites list.
2. Select the radio station name or radio frequency to tune in the radio station.

### **Deleting from Favorites**

1. Select the ★ icon to display the Favorites list.
2. Select **Add/Edit Radio Favorites**.
3. Select **Delete**.
4. Select the radio station or radio frequency you want to delete.
5. Select **Delete**.

### **Changing Favorites list order**

1. Select the ★ icon to display the Favorites list.
2. Select **Add/Edit Radio Favorites**.
3. Select **Move**.

4. Select a radio station or radio frequency. The selected radio station can be moved.
5. Move the radio station then select **OK**.

## **Radio Broadcast Data System (RBDS)\***

### **Radio text information display**

Radio text information sent from a broadcasting station is displayed in the center display.

### **NOTE**

*Radio text information is a function of FM radio. Text information is not displayed in the following:*

- *During HD Radio reception*
- *Not an RBDS broadcast*
- *RBDS broadcast, but radio text is not transmitted from the radio station*

### **Genre Seek**

Some FM stations transmit Genre codes (Program type like a Rock, News, and so on). This code enables alternative stations transmitting the same Genre code to be found quickly.

### **(To scan for Genre Seek:)**

1. Select the  icon while in the FM mode.
2. Select **Genre Seek** to open the genre list.
3. Select the genre type you want to select.
4. Select the **⏮, ⏭** icon.

### **NOTE**

*To change the desired genre, select the  icon.*

## Audio System

---

Ex.)

89.3 is currently being received. With Rock selected as the Genre, the radio stations broadcasting Rock are at the following frequencies.

98.3\*1, 98.7, 104.3\*1, 107.1

\*1 Radio stations with good reception

The frequency changes as follows each time **Genre Seek** is pressed.

89.3→98.3→104.3→98.3

### NOTE

- Only one Genre can be selected.
- It may not be possible to receive any station even if the Genre Seek function is used.
- If a program in the selected genre is not broadcast to a region, reception is not possible even if the Genre Seek function is used.
- The Genre Seek function searches for genre code (program type) which FM analog broadcasts transmit. HD Radio specialty programs (HD2-HD8) cannot be searched because they are not FM analog broadcasts.
- If radio stations which are selected by scanning using the Genre Seek function are HD Radio broadcasting stations, they are changed from analog broadcasts to HD Radio broadcasts after a few seconds if the reception conditions are good. The genre is displayed after the switch, however, the genre for FM analog broadcasts may differ.

### HD Radio

#### **What is HD Radio™ Technology and how does it work?**

HD Radio™ Technology is the digital evolution of analog AM/FM radio. Your radio product has a special receiver which allows it to receive digital broadcasts (where available) in addition to the analog broadcasts it already receives. Digital broadcasts have better sound quality than analog broadcasts as digital broadcasts provide free, crystal clear audio. For more information, and a guide to available radio stations and programming, please visit [www.hdradio.com](http://www.hdradio.com).

#### **Benefits of HD Radio™ Technology (Information)**



The song title, artist name, album name and genre will appear on the screen when available by the radio station.

#### **(Multicast)**

On the FM radio frequency most digital stations have “multiple” or supplemental programs on each FM station.

#### **Listening to HD Radio™ Technology**

If  icon turns on by selecting a radio station which is an HD Radio broadcasting station, the analog broadcast is switched to an HD Radio broadcast automatically after a few seconds and then received.





If the HD Radio broadcast is stopped and changed to an analog broadcast, press down  to turn off .

#### **Multicast channel selection (FM)**

If multi-cast channels are available for an HD Radio broadcast currently being received, the multi-cast channel list is displayed. Select the desired radio station.



**NOTE**

- *If an analog broadcast is received once and HD Radio is received while HD1 is selected, the audio unit switches to the HD Radio station automatically.*
- *When the  icon is illuminated, there could be a noticeable difference in sound quality and volume when a change from digital to analog signals occurs. If the sound quality and volume become noticeably diminished or cut off, select the  icon to turn off HD Radio ( icon is not illuminated).*
- *Once an analog broadcast is received when HD1 is selected from the Favorite channels, it is switched to HD Radio automatically. If the radio reception conditions are poor, or HD is off, switching to HD Radio broadcasts is not possible.*
- *When an HD specialty channel (HD2 to HD8) is selected from the Favorite channels, “Signal Lost” is displayed and no audio is output until HD Radio is received. If the radio reception conditions are poor, “Signal Lost” continues to be displayed.*
- *If the  icon is not illuminated, information such as song titles of the HD Radio station are received, however, the audio output is analog.*

**iTunes Tagging (for Apple devices with USB use only)**

By tagging a song currently being aired, the song can be easily purchased from the iTunes Store. Up to 100 tags can be stored.

1. Select the  icon. The tag is stored in the audio unit.
2. Connect the device via USB. The tag is sent to the connected device automatically.

3. Synchronize the device with iTunes. The tagged song can now be purchased from the iTunes Store.

**NOTE**

- *Both AM and FM HD Radio can be used.*
- *Because iTunes Tagging only supports purchasing from the iTunes Store, direct downloading from the equipped vehicle audio is not possible.*
- *If the available memory for the connected device is insufficient, the tag is not sent.*
- *If an error occurs while the tag is being sent, reconnect the device.*

**▼ Operating the Satellite Radio\*****What is satellite radio?**

With over 130 channels, SiriusXM Satellite Radio brings you more of what you love. Get channels and channels of commercial-free music, plus sports, news, talk, entertainment and more.

**Commercial-free music from nearly every genre** —rock to pop, hip-hop to country, jazz, classical and more. Plus live performances and artist-dedicated channels.

**Live sports Play-by-Play & Expert Talk** —every NFL game, every NASCAR® race, 24/7 sports talk, college sports and more.

**Exclusive entertainment, comedy and talk** —The biggest names, compelling talk, hilarious comedy.

**World-class news plus local traffic and weather.**

Sign up for SiriusXM Satellite Radio today!

## Audio System

---

### **NOTE**

- *To listen to SiriusXM, a prior subscription (fee-based) is required.*
- *The channels which you can receive depend on the package you subscribe to.*
- *Satellite radio is broadcast as Sirius, XM, and SiriusXM in the U.S.A., and Sirius and XM in Canada. In this owner's manual, only the name SiriusXM is used.*
- *For traffic and weather channels, map information is not displayed and only audio broadcasts can be received.*
- *Call 888-539-7474 to activate. For more information, visit [www.siriusxm.com](http://www.siriusxm.com). Satellite radio is only available in regions providing satellite radio service (some areas of the United States and Canada). Contact Authorized Mazda Dealer for details.*

### **How to Activate Satellite Radio**

You must call SiriusXM to activate your service. Activation is free and takes only a few minutes.

SiriusXM service uses an ID code to identify your radio. This code is needed to activate SiriusXM service, and report any problems.

Please have the following information ready:



- Radio ID (8-digit electronic serial no - See below for how to find your ESN)
- Valid credit card information (may not be required at initial sign-up)









Be sure you are parked outside with a clear view of open sky, you will be instructed to turn on your radio (in SiriusXM mode and tuned to channel 184 (Sirius)/1 (XM and SiriusXM)). Activation typically takes only 2—5 minutes.

### **Displaying the Radio ID (ESN)**

When channel 0 is selected, the radio ID is displayed. Use the PREVIOUS or NEXT channel buttons to select channel 0.

**SiriusXM operation**

Select the  icon on the home screen to display the Entertainment screen. When  is selected, the following icons are indicated in the bottom part of the center display.

Icon	Function
	Displays the Entertainment menu. Use to switch to a different audio source.
	Displays the channel list of the current category.
	Displays the favorites list. Long-press to store the channel currently being aired. Refer to Operating the Radio on page 5-44.
	Indicates that the parental lock function is in use. Switching of Lock/Unlock and PIN code setting changes can be performed.
	Plays each channel in the current channel list for 5 seconds. Select again to continue receiving the channel.
	Plays the previous channel.
	Plays the next channel.
	Displays sound settings to adjust audio quality level. Refer to Volume/Display/Sound Controls on page 5-42.

## Audio System

---

### Selection from channel list

Receivable channels can be displayed on the channel list screen. You can easily select the channel you want to listen from the list. Each category can be also displayed.

1. Select the  icon to display the channel list.
2. Select a desired channel.

### (Select from category list)

1. Select the  icon to display the channel list.
2. Select **[Category:]** to display the category list.
3. Select a desired category.

### Parental lock

If a channel is locked, the channel is muted.

To use the parental lock function, the PIN code must be initialized first.

By using the session lock, the parental lock can be enabled or disabled during the current drive cycle (from when the ignition is switched on to switched off). When the session lock is on, the parental lock is available. When the session lock is off, the parental lock is temporarily cancelled.

When canceling the parental lock or session lock, or when changing the PIN code, PIN code input is required.

### PIN code reset

If the registered code has been forgotten, reset the code to the default [0000] code.

1. Select the  icon.
2. If the selected channel is locked, input the PIN code to cancel the parental lock temporarily.
3. Select **[Reset PIN Code]**.

4. Input the default code [0000] using the number buttons.
5. Select **[OK]**.
6. Input the new PIN code using the number buttons.
7. Select **[OK]**.

# MEMO

# Audio System

## ▼ Operating the Compact Disc (CD) Player\*

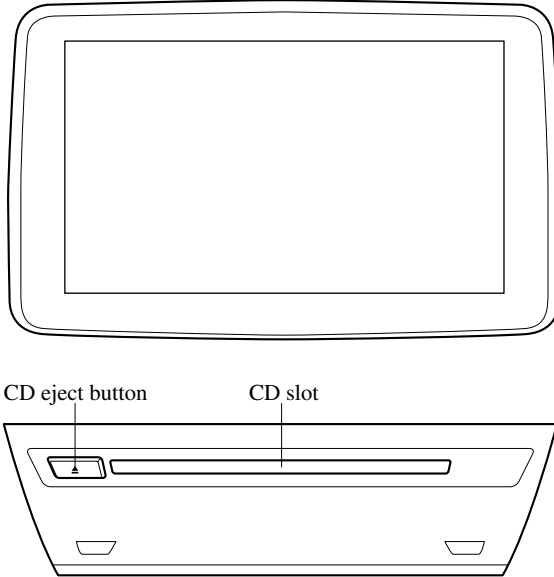

Type	Playable data
Music/MP3/WMA/AAC CD player	<ul style="list-style-type: none"> <li>*Music data (CD-DA)</li> <li>*MP3/WMA/AAC file</li> </ul>

### **NOTE**

*If a disc has both music data (CD-DA) and MP3/WMA/AAC files, playback of the two or three file types differs depending on how the disc was recorded.*

### **Inserting the CD**

Insert the CD into the slot, label-side up. The auto-loading mechanism will set the CD and begin play.



### **NOTE**

*There will be a short lapse before play begins while the player reads the digital signals on the CD.*

### **Ejecting the CD**



Press the CD eject button (▲) to eject the CD.

## **Playback**

Select the  icon on the home screen with a CD inserted and display the Entertainment screen. When  is selected, the following icons are indicated in the lower part of the center display.

Icon	Function
	Displays the Entertainment menu. Use to switch to a different audio source.
	<b>(Music CD)</b> Displays the track list of the CD. Select the track you want to play. <b>(MP3/WMA/AAC CD)</b> Displays the top level folder/file list. Select the folder you want to select. The files in the selected folder are displayed. Select the file you want to play.
	<b>(MP3/WMA/AAC CDs only)</b> Displays the file list of the folder currently being played. Select the song you want to listen to.
	<b>(Music CD)</b> Replays the song currently being played repeatedly. Select it again to cancel. <b>(MP3/WMA/AAC CD)</b> Replays the song currently being played repeatedly. When selected again, the songs in the folder are played repeatedly. Select it again to cancel.
	<b>(Music CD)</b> Plays songs on the CD in random order. Select it again to cancel. <b>(MP3/WMA/AAC CD)</b> Plays songs in the folder in random order. When selected again, the songs on the CD are played in random order. Select it again to cancel.
	<b>(Music CD)</b> The beginning of each track on a CD is played to aid in searching for a desired track. When selected again, the operation is canceled and the song currently being played continues. <b>(MP3/WMA/AAC CD)</b> The beginning of each track in a folder is played to aid in searching for a desired track. When selected again, the operation is canceled and the song currently being played continues.  If the audio is operated during scan-play, the track being scan-played is played normally. Then, the audio operation is performed.
	If selected within a few seconds of a song which has started to play, the previous song is selected. If more than a few seconds have elapsed after a song has begun to play, the song currently being played is replayed from the beginning. Long-press to fast reverse. It stops when you remove your hand from the icon or the commander knob.

# Audio System

Icon	Function
	Plays a CD. When selected again, playback is temporarily stopped.
	Advances to the beginning of the next song. Long-press to fast forward. It stops when you remove your hand from the icon or the commander knob.
	Displays sound settings to adjust audio quality level. Refer to Volume/Display/Sound Controls on page 5-42.

## Example of use (When searching for a song from the top level of an MP3/WMA/AAC CD)

1. Select the  icon and display the folder/file list at the top level.

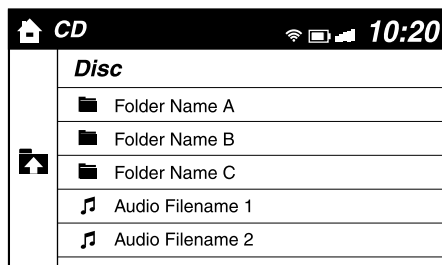

2. When the folder is selected, folders/file lists in the folder are displayed.
3. Select the desired song.

### NOTE

- Select  to move to a folder one level higher.
- The appearance of the repeat and shuffle icons changes depending on the type of operation in which the function is used.

## ▼ How to use Auxiliary jack/USB port

Audio can be heard from the vehicle's speakers by connecting a commercially-available portable audio unit to the auxiliary jack.

Use a commercially-available, non-impedance (3.5 $\phi$ ) stereo mini plug cable. In addition, audio can be played from the vehicle audio device by connecting a USB device or an iPod to the USB port. Refer to AUX/USB/iPod mode on page 5-59.



## ▼ Settings

### NOTE

*Depending on the grade and specification, the screen display may differ.*

Select the  icon on the home screen and display the Settings screen.

Switch the tab and select the setting item you want to change.

You can customize settings in the setup display as follows:

Tab	Item	Function
AD-Disp	Height Brightness Control Other	Refer to Active Driving Display on page 4-18.
Display	Refer to Volume/Display/Sound Controls on page 5-42.	
Safety	Smart City Brake Support Blind Spot Monitoring Volume Other	Refer to Personalization Features on page 9-12.
Sound	Refer to Volume/Display/Sound Controls on page 5-42.	
Clock	Adjust Time	Displays the currently set time is displayed. Press <b>+</b> to advance the hour/minute, and select <b>-</b> to move the hour/minute back. AM/PM can only be selected with the 12-hour clock display.
	GPS Sync	When ON is selected, “Adjust Time” is disabled.
	Time Format	Changes the display between 12 and 24-hour clock time.
	Time Zone Select	Selects the time zone.
	Daylight Savings Time	Turns the daylight saving time setting on/off. When ON, the time advances 1 hour. When OFF, it returns to normal time.
Vehicle	Rain Sensing Wiper Door Locks Other	Refer to Personalization Features on page 9-12.
Devices	Bluetooth®	Refer to Bluetooth® Preparation (Type B) on page 5-94.

# Audio System

---

Tab	Item	Function
System	Tool Tips	Turns button explanations ON/OFF.
	Language	Changes the language.
	Temperature	Changes the setting between Fahrenheit and Celsius.
	Distance	Changes the setting between miles and kilometers.
	Music Database Update	Used to update Gracenote®. Gracenote is used with USB Audio, and provides: 1. Supplemental music information (Such as song name, artist name) 2. Voice recognition assistance for Play Artist and Play Album Gracenote can be downloaded from the Mazda Handsfree Website. Refer to Gracenote Database (Type B) on page 5-75.
	Restore All Factory Settings	Memory and settings are initialized to the factory settings. The initialization launches by selecting the <input type="button" value="Yes"/> button.
	About	Agreements and Disclaimers
Version Information		Can verify the current audio unit OS version and Gracenote Database version.

**▼ Applications****NOTE**

Depending on the grade and specification, the screen display may differ.

Select the  icon on the home screen to display the Applications screen. The following information can be verified.

Top screen	Item	Function
HD Radio™ Traffic Map*	—	—
Fuel Economy Monitor	Fuel Consumption Control Status (Vehicles with i-ELOOP) Settings	Refer to Fuel Economy Monitor on page 4-85.
Maintenance	Scheduled Maintenance Tire Rotation Oil Change	Refer to Maintenance Monitor (Type B audio) on page 6-20.
Warning Guidance	Warnings currently active can be verified.	Refer to If a Warning Light Turns On or Flashes on page 7-24.

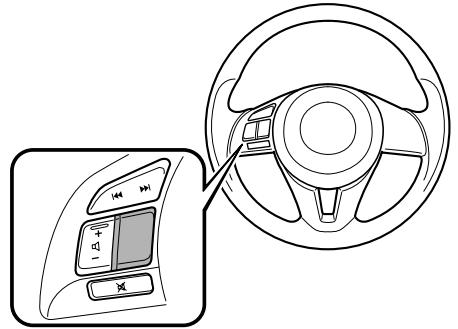
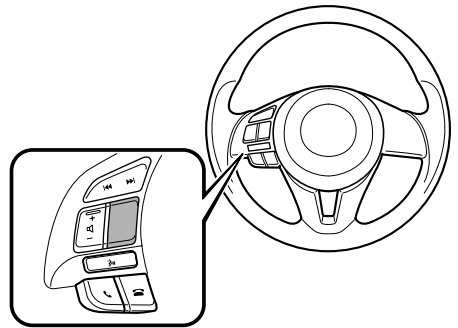
**Audio Control Switch Operation\*****Without Bluetooth® Hands-Free****With Bluetooth® Hands-Free**

# Audio System

## ▼ Adjusting the Volume

To increase the volume, press up the volume switch (+).

To decrease the volume, press down the volume switch (-).



## ▼ Seek Switch

### AM/FM radio

Press the seek switch (◀◀, ▶▶). The radio switches to the next/previous stored station in the order that it was stored.

Press and hold the seek switch (◀◀, ▶▶) to seek all usable stations at a higher or lower frequency whether programmed or not.

Radio stations which have been previously stored in the auto memory tuning (Type A)/favorite radio (Type B) can be called up by pressing the seek switch (◀◀, ▶▶) while any radio station stored in the auto memory tuning (Type A)/favorite radio (Type B) is being received. Radio stations can be called up in the order they were stored with each press of the switch (◀◀, ▶▶).

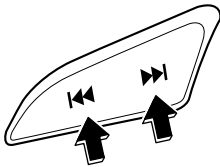

## USB Audio/Bluetooth® Audio /CD

Press the seek switch (▶▶) to skip forward to the beginning of the next track.

Press the seek switch (◀◀) within a few seconds after playback begins to track down to the beginning of the previous track.

Press the seek switch (◀◀) after a few seconds have elapsed to start playback from the beginning of the current track.

Press and hold the seek switch (◀◀, ▶▶) to continuously switch the tracks up or down.

## Pandora®/Aha™/Stitcher™ Radio (Type B)

Press the seek switch (▶▶) to skip forward to the beginning of the next track.

Press and hold the seek switch (▶▶) to evaluate the playback of the current song as “Like”.

Press and hold the seek switch (◀◀) to evaluate the playback of the current song as “Dislike”.

## ▼ Mute Switch\*

Press the mute switch (⊗) once to mute audio, press it again to resume audio output.

### **NOTE**

*If the ignition is switched off with the audio muted, the mute will be canceled. Therefore, when the engine is restarted, the audio is not muted. To mute the audio again, press the mute switch (⊗).*

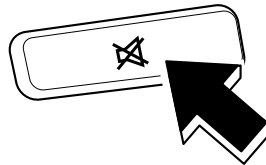

## AUX/USB/iPod mode

Audio can be heard from the vehicle's speakers by connecting a commercially-available portable audio unit to the auxiliary jack.

A commercially-available, non-impedance (3.5 $\phi$ ) stereo mini plug cable is required.

Contact an Authorized Mazda Dealer for details.

In addition, audio can be played from the vehicle audio device by connecting a USB device or an iPod to the USB port.

### NOTE

#### (Type B)

The SD card slot is for the navigation system. For vehicles with the navigation system, the SD card (Mazda genuine) with stored map data is inserted into the SD card slot and used.

### Type A (Without CD player)

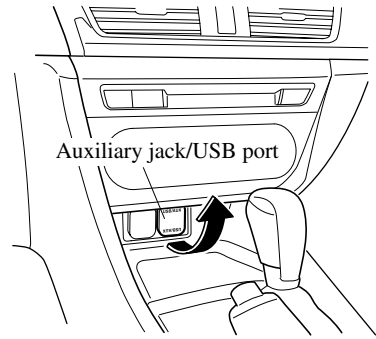

### Type A (With CD player)

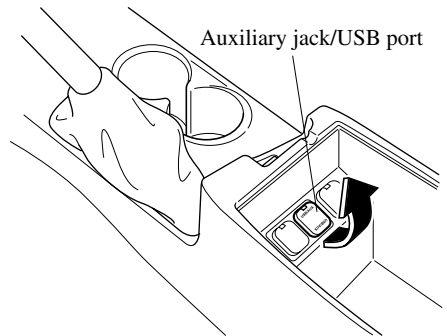

### Type B (Without CD player)

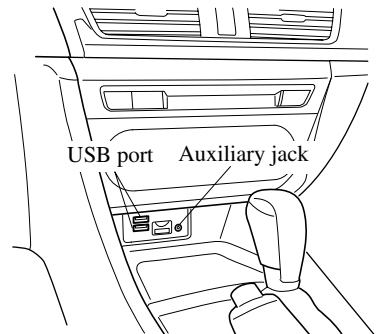

# Audio System

## Type B (With CD player)

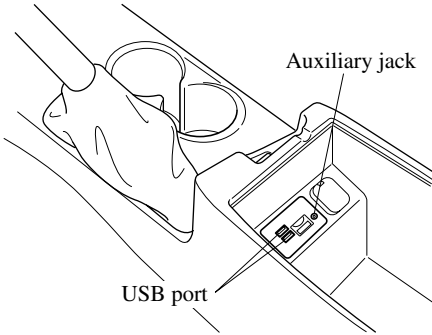

- ① How to use AUX mode (Type A) ..... page 5-62
- ② How to use USB mode (Type A) ..... page 5-64
- ③ How to use iPod mode (Type A) ..... page 5-68
- ④ How to use AUX mode (Type B) ..... page 5-71
- ⑤ How to use USB mode (Type B) ..... page 5-71

### **! WARNING**

**Do not adjust the portable audio unit or a similar product while driving the vehicle:**

Adjusting the portable audio unit or a similar product while driving the vehicle is dangerous as it could distract your attention from the vehicle operation which could lead to a serious accident. Always adjust the portable audio unit or a similar product while the vehicle is stopped.

### **! CAUTION**

- Always close the auxiliary jack/USB port lid when it is not in use. If foreign matter or liquid penetrates the auxiliary jack/USB port, it may cause a malfunction.
- Depending on the portable audio device, noise may occur when the device is connected to the vehicle accessory socket. (If noise occurs, do not use the accessory socket.)

### **NOTE**

- This mode may not be usable depending on the portable audio device to be connected.
- Before using the auxiliary jack/USB port, refer to the instruction manual for the portable audio device.
- Use a commercially-available, non-impedance (3.5Φ) stereo mini plug for connecting the portable audio unit to the auxiliary jack. Before using the auxiliary jack, read the manufacturer's instructions for connecting a portable audio unit to the auxiliary jack.
- To prevent discharging of the battery, do not use the auxiliary input for long periods with the engine off or idling.
- When connecting a device to the auxiliary jack or USB port, noise may occur depending on the connected device. If the device is connected to the vehicle's accessory socket, the noise can be reduced by unplugging it from the accessory socket.

### ▼ How to connect USB port/ Auxiliary jack

#### Type A (Without CD player)

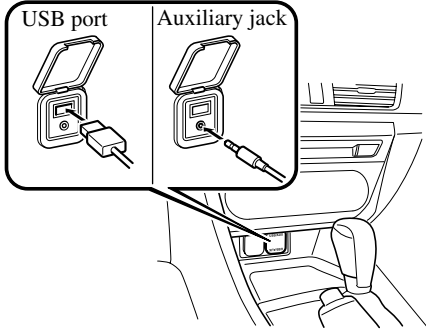

#### Type A (With CD player)

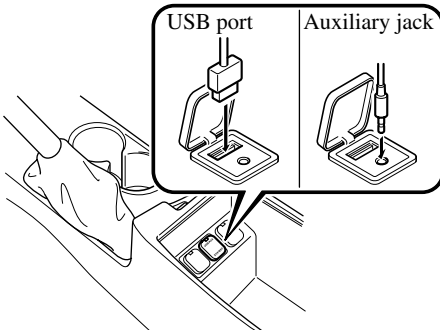

#### Type B (Without CD player)

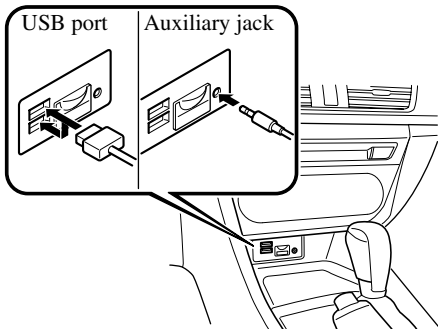

#### Type B (With CD player)

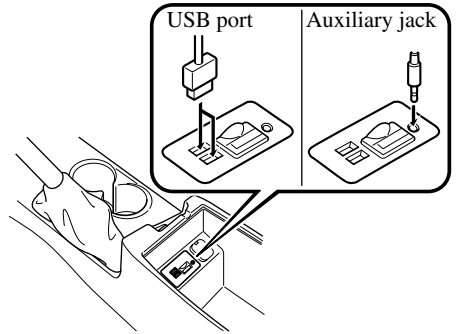

#### Connecting a device

1. Open the console lid (with CD player).
2. If there is a cover on the AUX jack or USB port, remove the cover.
3. Connect the connector on the device to the USB port.

#### Connecting with a connector cable

1. Open the console lid (with CD player).
2. If there is a cover on the AUX jack or USB port, remove the cover.
3. Connect the device plug/connector cable to the auxiliary jack/USB port.  
For vehicles with a CD player, pass the device plug/connector cable through the notch in the console and connect.

### **⚠ WARNING**

**Do not allow the connection plug cord to get tangled with the parking brake or the shift lever:**

*Allowing the plug cord to become tangled with the parking brake or the shift lever is dangerous as it could interfere with driving, resulting in an accident.*

## Audio System

---

### CAUTION

*Do not place objects or apply force to the auxiliary jack/USB port with the plug connected.*

### NOTE

- *Insert the plug into the auxiliary jack/USB port securely.*
- *Insert or pull out the plug with the plug perpendicular to the auxiliary jack/USB port hole.*
- *Insert or remove the plug by holding its base.*

### ▼ How to use AUX mode (Type A)



1. Switch the ignition to ACC or ON.
2. Press the power/volume dial to turn the audio system on.
3. Press the media button (**MEDIA**) of the audio unit to change to the AUX mode.

### NOTE

- *When the device is not connected to the auxiliary jack, the mode does not switch to the AUX mode.*
- *Set the volume of the portable audio unit to the maximum within the range that the sound does not become distorted, then adjust the volume using the power/volume dial of the audio unit or the up/down switch of the audio control switch.*
- *Audio adjustments other than audio volume can only be done using the portable audio device.*
- *If the connection plug is pulled out from the auxiliary jack while in AUX mode, noise may occur.*



# MEMO

# Audio System

## ▼ How to use USB mode (Type A)

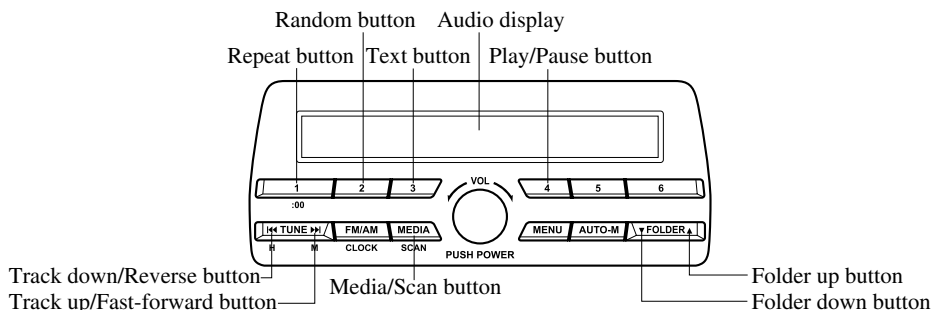

Type	Playable data
USB mode	MP3/WMA/AAC file

This unit does not support a USB 3.0 device. In addition, other devices may not be supported depending on the model or OS version.

### Playback

1. Switch the ignition to ACC or ON.
2. Press the power/volume dial to turn the audio system on.
3. Press the media button (**MEDIA**) to switch to the USB mode and start playback.

### **NOTE**

- Some devices such as smart phones may require a setting change to allow USB operation.
- When the USB device is not connected, the mode does not switch to USB mode.
- When there is no playable data in the USB device, "NO CONTENTS" is flashed.

- Playback of the USB device is in the order of the folder numbers. Folders which have no MP3/WMA/AAC files are skipped.
- Do not remove the USB device while in the USB mode. The data may be damaged.

### Pause

To stop playback, press the play/pause button (4). Press the button again to resume playback.

### Fast-forward/Reverse

Press and hold the fast-forward button (▶▶) to advance through a track at high speed. Press and hold the reverse button (◀◀) to reverse through a track at high speed.

### Track search

Press the track up button (▶▶) once to skip forward to the beginning of the next track. Press the track down button (◀◀) within a few seconds after playback begins to track down to the beginning of the previous track.

Press the track down button (◀◀) after a few seconds have elapsed to start playback from the beginning of the current track.

**Folder search**

To change to the previous folder, press the folder down button (▼), or press the folder up button (▲) to advance to the next folder.

**Music Scan**

This function scans the titles in a folder currently being played and plays ten seconds of each song to aid you in finding a song you want to listen to.

Press and hold the scan button (MEDIA) during playback to start the scan play operation (the track number will flash). Press and hold the scan button (MEDIA) again to cancel scan playback.

**NOTE**

*If the unit is left in scan, normal playback will resume where scan was selected.*

**Repeat playback****Track repeat**

1. Press the repeat button (1) during playback to play the current track repeatedly. "TRACK RPT" is displayed.
2. To cancel the repeat playback, press the button again after 3 seconds.

**Folder repeat**

1. Press the repeat button (1) during playback, and then press the button again within 3 seconds to play the tracks in the current folder repeatedly. "FOLDER RPT" is displayed.
2. Press the button again to cancel the repeat playback.

**Random playback**

Tracks are randomly selected and played.

**Folder random**

1. Press the random button (2) during playback to play the tracks in the folder randomly. "FOLDER RDM" is displayed.
2. To cancel the random playback, press the button again after 3 seconds.

**All random**

1. Press the random button (2) during playback, and then press the button again within 3 seconds to play the tracks in the USB device randomly. "ALL RDM" is displayed.
2. Press the button again to cancel the random playback.

**Switching the display**

For files with a file name and other information that have been input, the display switches between display of the file name and other information each time the text button (3) is pressed during playback.

File number/Elapsed time display

Folder number/File number

File name

Folder name

Album name

Song name

Artist name

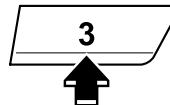

## Audio System

---

### **NOTE**

- *The information (artist name, music name) is displayed only when the USB device information in the USB device has information which can be displayed on the screen.*
- *This unit cannot display some characters. Characters which cannot be displayed are indicated by an asterisk (\*).*

### **Display scroll**

Only 13 characters can be displayed at one time. To display the rest of the characters of a long title, press and hold the text button (3). The display scrolls the next 13 characters. Press and hold the text button (3) again after the last 13 characters have been displayed to return to the beginning of the title.

### **NOTE**

*The number of characters which can be displayed is restricted.*

### **Error Messages**

When the message “CHECK USB” is displayed, it indicates that there is some error in the USB device. Verify that the content recorded in the USB device has MP3/WMA/AAC files and re-connect correctly. If the message reappears, have the unit checked by an Authorized Mazda Dealer.

# MEMO

# Audio System

## ▼ How to use iPod mode (Type A)

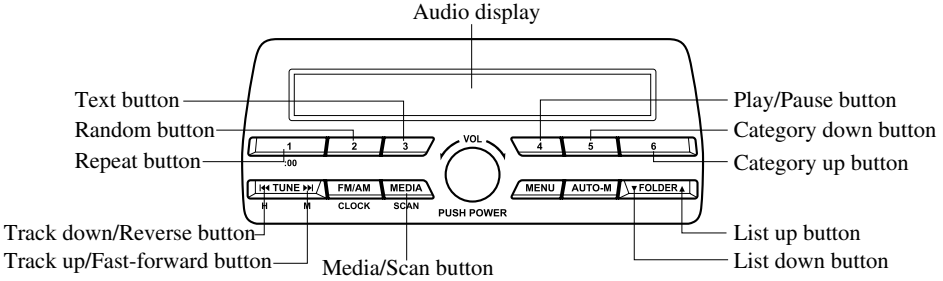

An iPod may not be compatible depending on the model or OS version. In this case, an error message is displayed.

### NOTE

*The iPod functions on the iPod cannot be operated while it is connected to the unit because the unit controls the iPod functions.*

### Playback

1. Switch the ignition to ACC or ON.
2. Press the power/volume dial to turn the audio system on.
3. Press the media button (**MEDIA**) to switch to the iPod mode and start playback.

### NOTE

- When an iPod is not connected, the mode does not switch to the iPod mode.
- When there is no playable data in the iPod, "NO CONTENTS" is flashed.
- Do not remove the iPod while in the iPod mode. Otherwise, the data could be damaged.

### Pause

To stop playback, press the play/pause button (4).  
Press the button again to resume playback.

### Fast-forward/Reverse

Press and hold the fast-forward button (▶▶) to advance through a track at high speed. Press and hold the reverse button (◀◀) to reverse through a track at high speed.

### Track search

Press the track up button (▶▶) once to skip forward to the beginning of the next track. Press the track down button (◀◀) within a few seconds (depends on iPod software version) after playback begins to track down to the beginning of the previous track.

Press the track down button (◀◀) after a few seconds (depends on iPod software version) have elapsed to start playback from the beginning of the current track.

### Category search

Press the category down button (5) to select the previous category and press the category up button (6) to select the next category.

### NOTE

*The types of categories include Playlist, Artist, Album, Song, Podcast, Genre, Composer, and Audio book.*

**List search**

Press the list down button (▼) to select the previous list and press the list up button (▲) to select the next list.

**NOTE**

*When the selected category is Song or Audio book, there is no list.*

**Music Scan**

This function scans the titles in a list currently being played and plays 10 seconds of each song to aid you in finding a song you want to listen to.

Press and hold the scan button (MEDIA) during playback to start the scan play operation (the track number will flash). Press and hold the scan button (MEDIA) again to cancel scan playback.

**NOTE**

*If the unit is left in scan, normal playback will resume where scan was selected.*

**Repeat playback**

1. Press the repeat button (1) during playback to play the current track repeatedly. "TRACK RPT" is displayed.
2. Press the button again to cancel the repeat playback.

**Random playback**

Tracks are randomly selected and played.

**Song random**

1. Press the random button (2) during playback to play the tracks in the list randomly. "SONG RDM" is displayed.
2. To cancel the random playback, press the button again after 3 seconds.

**Album random**

1. Press the random button (2) during playback, and then press the button again within 3 seconds to play the tracks in the iPod randomly. "ALBUM RDM" is displayed.
2. Press the button again to cancel the random playback.

**NOTE**

*The track number being played randomly is in the order of the iPod shuffle table.*

**Switching the display**

For files with a file name and other information that have been input, the display switches between display of the file name and other information each time the text button (3) is pressed during playback.

File number/Elapsed time

Category (Playlist title/Genre title /Composer title/Podcast title)

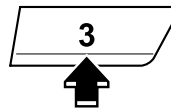

Artist name

Album name

Song name

## Audio System

### NOTE

- *The information (artist name, music name) is displayed only when the iPod has information which can be displayed.*
- *This unit cannot display some characters. Characters which cannot be displayed are indicated by an asterisk (\*).*

### Display scroll

13 characters can be displayed at one time. To display the rest of the characters of a long title, press and hold the text button (3). The display scrolls the next 13 characters. Press and hold the text button (3) again after the last 13 characters have been displayed to return to the beginning of the title.

### NOTE

*The number of characters which can be displayed is restricted.*

### Error Messages

If the message “CHECK iPod” is displayed, it indicates that there is a malfunction in the iPod. Verify that the content recorded in the iPod has playable files and connect correctly. If the message reappears, have the unit checked by an Authorized Mazda Dealer.

### ▼ Error Indications (Type A)



If you see an error indication on the display, find the cause in the chart. If you cannot clear the error indication, take the vehicle to an Authorized Mazda Dealer.

Indication	Cause	Solution
CHECK USB	USB device malfunction	Verify that the content recorded in the USB device has MP3/WMA/AAC files and re-connect correctly. If the error indication continues to display, consult an Authorized Mazda Dealer.
CHECK iPod	iPod malfunction	Verify that the content recorded in the iPod has playable files and re-connect correctly. If the error indication continues to display, consult an Authorized Mazda Dealer.



**▼ How to use AUX mode (Type B)**

1. Select the  icon on the home screen and display the Entertainment screen.
2. Select **AUX** to switch to the AUX mode. The following icons are displayed in the lower part of the center display.

Icon	Function
	Displays the Entertainment menu. Use to switch to a different audio source.
	Displays sound settings to adjust audio quality level. Refer to Volume/Display/Sound Controls on page 5-42.

**NOTE**

- *If a device is not connected to the auxiliary jack, the mode does not switch to the AUX mode.*
- *Set the volume of the portable audio unit to the maximum within the range that the sound does not become distorted, then adjust the volume using the volume dial of the commander switch or the up/down switch of the audio control switch.*
- *Audio adjustments can also be made using the portable audio device's volume setting.*
- *If the connection plug is pulled out from the auxiliary jack while in AUX mode, noise may occur.*

**▼ How to use USB mode (Type B)**

Type	Playable data
USB mode	MP3/WMA/AAC/OGG file











This unit does not support a USB 3.0 device. In addition, other devices may not be supported depending on the model or OS version.

USB devices formatted to FAT32 are supported (USB devices formatted to other formats such as NTFS are not supported).

# Audio System

## Playback

1. Select the  icon on the home screen and display the Entertainment screen.
2. Select [USB 1] or [USB 2] to switch the USB mode. The following icons are displayed in the lower part of the center display.

Icon	Function
	Displays the Entertainment menu. Use to switch to a different audio source.
	Category list is displayed.
	Current track list is displayed. Select a desired track to play it.
	Plays the current track repeatedly. Select it again to play the tracks in the current track list repeatedly. When selected again, the function is canceled.
	Tracks in the current track list are played randomly. Select it again to cancel.
	Starts playing a track similar to the current track using Gracenote's More Like This™. Select the desired song from the category list to cancel More Like This™.
	If selected within a few seconds from the beginning of a song which has started to play, the previous song is selected. If more than a few seconds have elapsed, the song currently being played is replayed from the beginning. Long-press to fast reverse. It stops when you remove your hand from the icon or the commander knob.
	Track is played. When selected again, playback is temporarily stopped.
	Advances to the beginning of the next song. Long-press to fast forward.
	Displays sound settings to adjust audio quality level. Refer to Volume/Display/Sound Controls on page 5-42.

## NOTE

- To move to the desired location on the track, move the slider indicating the playback time.
- The appearance of the repeat and shuffle icons changes depending on the type of operation in which the function is used.

**Category list**

Select the  icon and display the following category list.

Select a desired category and item.

Category	Function
Playlist	Displays playlists on the device.
Artist	Displays the artist name list. All the tracks or tracks for each album of the selected artist can be played.
Album	Displays the album name list.
Song	All the tracks in the device are displayed.
Genre	Displays the genre list. All the tracks or tracks per album or artist in the selected genre can be played.
Audiobook	Displays the audiobook list. Chapters can be selected and played.
Podcast	Displays the podcast list. Episode can be selected and played. (Special service for some Apple devices.)
Folder	Displays the folder/file list.

# Audio System

---

## Example of use (to play all tracks in USB device)

### (Method 1)

1. Select  to display the category list.
2. Select **Song**.  
All the tracks in the USB device are displayed.
3. Select a desired track.  
The selected track is played. All the tracks in the USB device can be played by continuing playback.

### NOTE

*Only the tracks in the desired category selected in Step 2 are played.*

### (Method 2)\*1

1. Select  to display the category list.
2. Select **Folder**.  
All the folders in the USB device are displayed.
3. Select **All Songs**.  
All the tracks in the USB device are displayed.
4. Select a desired track.  
The selected track is played. All the tracks in the USB device can be played by continuing playback.

\*1 Can be operated using an Android™ device or USB flash memory.

### NOTE

*Only the tracks in the desired folder selected in Step 3 are played.*

### ▼ Gracenote Database (Type B)

When a USB device is connected to this unit and the audio is played, the album name, artist name, genre and title information are automatically displayed if there is a match in the vehicle's database compilation to the music being played. The information stored in this device uses database information in the Gracenote music recognition service.



*For information related to the most recent Gracenote database which can be used and how to install it, go to the Mazda Hands Free Website:  
<http://www.mazdahandsfree.com>*

### Introduction

Music recognition technology and related data are provided by Gracenote®. Gracenote is the industry standard in music recognition technology and related content delivery. For more information visit [www.gracenote.com](http://www.gracenote.com).

CD and music-related data from Gracenote, Inc., copyright © 2000 to present Gracenote. Gracenote Software, copyright © 2000 to present Gracenote. One or more patents owned by Gracenote apply to this product and service. See the Gracenote website for a non-exhaustive list of applicable Gracenote patents. Gracenote, CDDDB, MusicID, MediaVOCS, the Gracenote logo and logotype, and the “Powered by Gracenote” logo are either registered trademarks or trademarks of Gracenote in the United States and/or other countries.



### Gracenote® End User License Agreement

This application or device contains software from Gracenote, Inc. of Emeryville, California (“Gracenote”). The software from Gracenote (the “Gracenote Software” enables this application to perform disc and/or file identification and obtain music-related information, including name, artist, track, and title information (“Gracenote Data” from online servers or embedded databases (collectively, “Gracenote Servers” and to perform other functions. You may use Gracenote Data only by means of the intended End-User functions of this application or device.

You agree that you will use Gracenote Data, the Gracenote Software, and Gracenote Servers for your own personal non-commercial use only. You agree not to assign, copy, transfer or transmit the Gracenote Software or any Gracenote Data to any third party. **YOU AGREE NOT TO USE OR EXPLOIT GRACENOTE DATA, THE GRACENOTE SOFTWARE, OR GRACENOTE SERVERS, EXCEPT AS EXPRESSLY PERMITTED HEREIN.**

## Audio System

---

You agree that your non-exclusive license to use the Gracenote Data, the Gracenote Software, and Gracenote Servers will terminate if you violate these restrictions. If your license terminates, you agree to cease any and all use of the Gracenote Data, the Gracenote Software, and Gracenote Servers. Gracenote reserves all rights in Gracenote Data, the Gracenote Software, and the Gracenote Servers, including all ownership rights. Under no circumstances will Gracenote become liable for any payment to you for any information that you provide. You agree that Gracenote, Inc. may enforce its rights under this Agreement against you directly in its own name.

The Gracenote service uses a unique identifier to track queries for statistical purposes. The purpose of a randomly assigned numeric identifier is to allow the Gracenote service to count queries without knowing anything about who you are. For more information, see the web page for the Gracenote Privacy Policy for the Gracenote service.

The Gracenote Software and each item of Gracenote Data are licensed to you “AS IS.” Gracenote makes no representations or warranties, express or implied, regarding the accuracy of any Gracenote Data from in the Gracenote Servers. Gracenote reserves the right to delete data from the Gracenote Servers or to change data categories for any cause that Gracenote deems sufficient. No warranty is made that the Gracenote Software or Gracenote Servers are error-free or that functioning of Gracenote Software or Gracenote Servers will be uninterrupted. Gracenote is not obligated to provide you with new enhanced or additional data types or categories that Gracenote may provide in the future and is free to discontinue its services at any time.

GRACENOTE DISCLAIMS ALL WARRANTIES EXPRESS OR IMPLIED, INCLUDING, BUT NOT LIMITED TO, IMPLIED WARRANTIES OF MERCHANTABILITY, FITNESS FOR A PARTICULAR PURPOSE, TITLE, AND NON-INFRINGEMENT. GRACENOTE DOES NOT WARRANT THE RESULTS THAT WILL BE OBTAINED BY YOUR USE OF THE GRACENOTE SOFTWARE OR ANY GRACENOTE SERVER. IN NO CASE WILL GRACENOTE BE LIABLE FOR ANY CONSEQUENTIAL OR INCIDENTAL DAMAGES OR FOR ANY LOST PROFITS OR LOST REVENUES.

© 2000 to present. Gracenote, Inc.

### **Updating the database**

The Gracenote media database can be updated using USB device.

1. Connect a USB device containing the software for updating Gracenote.
2. Select the  icon on the home screen and display the Settings screen.
3. Select the **System** tab and select **Music Database Update**.
4. Select **Search**. The list of the update package stored in the USB device and the version are displayed.
5. Select the package to use the update.
6. Select **Install**.

### **NOTE**

*Gracenote can be downloaded from the Mazda Hands-free Website.*

## Bluetooth®\*

### **Bluetooth® Hands-Free outline**

When a Bluetooth® device (mobile phone) is connected to the vehicle's Bluetooth® unit via radio wave transmission, a call can be made or received by pressing the talk button, pick-up button, or hang-up button on the audio remote control switch, or by operating the center display. For example, even if a device (mobile phone) is in your coat pocket, a call can be made without taking the device (mobile phone) out and operating it directly.

### **Bluetooth® audio outline**

When a portable audio unit equipped with the Bluetooth® communication function is paired to the vehicle, you can listen to music stored on the paired portable audio device from the vehicle's speakers. It is not necessary to connect the portable audio device to the vehicle's external input terminal. After programming, operate the vehicle audio control panel to play/stop the audio.

### ***NOTE***

- *For your safety, a device can be paired only when the vehicle is parked. If the vehicle starts to move, the pairing procedure will end. Park the vehicle in a safe place before pairing.*
- *The communication range of a Bluetooth® equipped device is about 10 meters (32 ft) or less.*
- *Basic audio operation is available using voice commands even if Bluetooth® is not connected.*

# Bluetooth®

## **CAUTION**

Some Bluetooth® mobile devices are not compatible with the vehicle. Consult an Authorized Mazda Dealer, Mazda's call center or Web support center for information regarding Bluetooth® mobile device compatibility:

- U.S.A.  
Phone: 800-430-0153  
Web: [www.MazdaUSA.com/bluetooth](http://www.MazdaUSA.com/bluetooth)
- Canada  
Phone: 800-430-0153  
Web: [www.mazdahandsfree.ca](http://www.mazdahandsfree.ca)
- Mexico  
Center of Attention to Client (CAC)  
Phone: 01-800-01-MAZDA  
Web:  
[www.mazdamexico.com.mx](http://www.mazdamexico.com.mx)

### Applicable Bluetooth® specification (Recommended)

Type A: Ver. 2.0

Type B: Ver. 1.1/1.2/2.0 + EDR/2.1 + EDR/3.0 (conformity)

### ▼ Component Parts

#### Audio unit

Type A

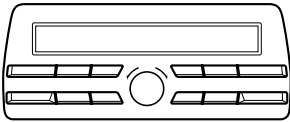

Type B

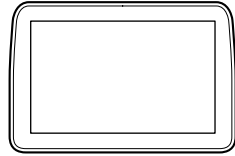

#### Talk button, Pick-up button and Hang-up button

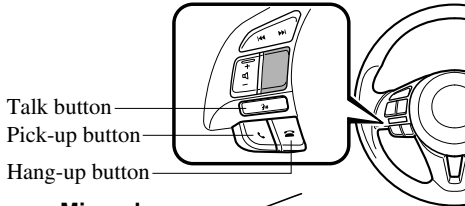

#### Microphone

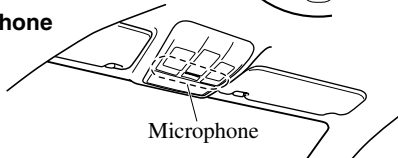



### **Microphone (hands-free)**

The microphone is used for speaking voice commands or when making a Hands-free call.

### **Talk button, Pick-Up button and Hang-Up button (hands-free)**

The basic functions of Bluetooth® Hands-Free can be used for such things as making calls or hanging up using the talk, pick-up and hang-up buttons on the steering wheel.

### **Commander switch (Type B)**

The commander switch is used for volume adjustment and display operation. Tilt or turn the commander knob to move the cursor. Press the commander knob to select the icon.

### **Volume adjustment**

The power/volume dial of the audio unit\*1 or the volume dial of the commander switch\*2 is used to adjust the volume. Turn the dial to the right to increase volume, to the left to decrease it.

The volume can also be adjusted using the volume button on the steering wheel.

\*1 Type A

\*2 Type B

### ***NOTE***

*If the volume is lower compared to other audio modes, increase the volume from the device side.*

### **(Type B)**

Conversation volume and the volume of the voice guidance and ringtone can each be set in advance.

1. Select the  icon on the home screen and display the Communication screen.
2. Select **Settings**.
3. Adjust the **Phone Volume** and the **VR and Ringtone** using the slider.

**Bluetooth®****▼ Bluetooth® Preparation (Type A)****Bluetooth® Hands-Free Preparation****Pairing code setting**

The 4-digit pairing code setting for registration of your cell phone (pairing) can be set beforehand.

**NOTE**

*The initial setting value is “0000”.*

1. Press the pick-up button or talk button with a short press.
2. **Say:** [Beep] “Setup”
3. **Prompt:** “Select one of the following: Pairing options, confirmation prompts, language, passcode, select phone or select music player.”
4. **Say:** [Beep] “Pairing options”
5. **Prompt:** “Select one of the following: Pair, Edit, Delete, List, or Set Pairing Code.”
6. **Say:** [Beep] “Set pairing code”
7. **Prompt:** “Your current pairing code is XXXX. Do you want to change it to a different pairing code?”
8. **Say:** [Beep] “Yes”
9. **Prompt:** “Please say a 4-digit pairing code.”
10. **Say:** [Beep] “YYYY”
11. **Prompt:** “YYYY is this correct?”
12. **Say:** [Beep] “Yes” or “No”
13. If “Yes”, go to Step 14. If “No”, the procedure returns to Step 9.
14. **Prompt:** “Your new pairing code is YYYY. Use this pairing code when pairing devices to the Hands free system. Do you want to pair a device now?”
15. **Say:** [Beep] “Yes” or “No”
16. If “Yes”, the system switches to the device registration mode. If “No”, the system returns to standby status.

**Device pairing**

To use Bluetooth® Hands-Free, the device equipped with Bluetooth® has to be paired to the hands-free unit using the following procedure.

A maximum of seven devices including hands-free mobile phones and Bluetooth® audio devices can be paired to one vehicle.

**NOTE**

*If a Bluetooth® device has already been paired to the vehicle as a Bluetooth® audio device, it does not need to be paired again when using the device as a hands-free mobile phone. Conversely, it does not need to be paired again as a Bluetooth® audio device if it has already been paired as a hands-free mobile phone.*

1. Activate the Bluetooth® application of the device.

**NOTE**

*For the operation of the device, refer to its instruction manual.*

2. Press the pick-up button or talk button with a short press.
3. **Say:** [Beep] “Setup”
4. **Prompt:** “Select one of the following: Pairing options, confirmation prompts, language, passcode, select phone or select music player.”
5. **Say:** [Beep] “Pairing options”
6. **Prompt:** “Select one of the following: Pair, Edit, Delete, List, or Set Pairing Code.”
7. **Say:** [Beep] “Pair”
8. **Prompt:** “Start the pairing process on your Bluetooth® device. Your pairing code is 0000 (XXXX). Input this on your Bluetooth® device when prompted on the device. See device manual for instructions.”

- Using the device, perform a search for the Bluetooth® device (Peripheral device).

**NOTE**

*For the operation of the device, refer to its instruction manual.*

- Select “Mazda” from the device list searched by the device.
- Input the 4-digit pairing code to the device.
- Prompt:** “Please say the name of the device after the beep.”
- Say:** [Beep] “XXXX - - -” (Say a “device tag”, an arbitrary name for the device.) Example: “Stan's device.”

**NOTE**



*Say a paired “device tag” within 10 seconds.*

*If more than two devices are to be paired, they cannot be paired with the same or similar “device tag”.*

- Prompt:** “XXXXXX - - - (Ex. “Stan's device”) (Device tag). Is this correct?”
- Say:** [Beep] “Yes”
- Prompt:** “Pairing complete”

After a device is registered, the system automatically identifies the device. By activating Bluetooth® Hands-Free again, or by activating Bluetooth® Hands-Free first after switching the ignition from OFF to ACC, the system reads out a voice guidance, “XXXXXX - - - (Ex. “Stan's device”) (Device tag) is connected”.

**NOTE**

- When the pairing is completed, the  symbol is displayed.*
- Some Bluetooth® audio devices need a certain amount of time before the  symbol is displayed.*
- Device registration can also be done by operating the audio unit.*
- Depending on the device, the registration status may be lost after a certain period of time. If this occurs, repeat the entire process from Step 1.*

**Registered device read-out**

Bluetooth® Hands-Free can read-out the devices registered to its system.

**NOTE**

*Do this function only when parked. It is too distracting to attempt while driving and you may make too many errors to be effective.*

- Press the pick-up button or talk button with a short press.
- Say:** [Beep] “Setup”
- Prompt:** “Select one of the following: Pairing options, confirmation prompts, language, passcode, select phone or select music player.”
- Say:** [Beep] “Pairing options”
- Prompt:** “Select one of the following: Pair, Edit, Delete, List, or Set Pairing Code”
- Say:** [Beep] “List”

**Bluetooth®**

7. **Prompt:** “XXXXX..., XXXXX..., XXXXX... (Ex. Device A, device B, device C)” (The voice guidance reads out the device tags registered to the hands-free system.)

Press the talk button with a short press during the read-out at the desired device, and then say one of the following voice commands to execute it.

- “Select phone”: Selects device (Mobile phone) when the talk button is short-pressed.
  - “Select music player”: Selects device (Music player) when the talk button is short-pressed.
  - “Edit”: Edits device when the talk button is short-pressed.
  - “Continue”: Continues the list readout.
  - “Delete”: Deletes the registered device when the talk button is short-pressed.
  - “Previous”: Returns to the previous device in read-out when the talk button is short-pressed.
8. **Prompt:** “End of list, would you like to start from the beginning?”
9. **Say:** [Beep] “No”
10. **Prompt:** “Returning to main menu.”

**Device selection**

If several devices have been paired, the Bluetooth® unit links the device last paired. If you would like to link a different paired device, it is necessary to change the link. The order of device priority after the link has been changed is maintained even when the ignition is switched off.

**(Hands-free phone)**

1. Press the pick-up button or talk button with a short press.
2. **Say:** [Beep] “Setup”





3. **Prompt:** “Select one of the following: Pairing options, confirmation prompts, language, passcode, select phone or select music player.”
4. **Say:** [Beep] “Select phone”
5. **Prompt:** “Please say the name of the device you would like to select. Available devices are XXXXX... (Ex. device A), XXXXX... (Ex. device B), XXXXX... (Ex. device C). Which device please?”
6. **Say:** [Beep] “XXXXX... (Ex. Device B)”
7. **Prompt:** “XXXXX... (Ex. Device B). Is this correct?”
8. **Say:** [Beep] “Yes” or “No”
9. If “Yes”, go to Step 10. If “No”, the procedure returns to Step 5.
10. **Prompt:** “XXXXX... (Ex. Device B) selected.”

**(Music player)**

1. Press the pick-up button or talk button with a short press.
2. **Say:** [Beep] “Setup”
3. **Prompt:** “Select one of the following: Pairing options, confirmation prompts, language, passcode, select phone or select music player.”
4. **Say:** [Beep] “Select music player”
5. **Prompt:** “Please say the name of the device you would like to select. Available devices are XXXXX... (Ex. device A), XXXXX... (Ex. device B), XXXXX... (Ex. device C). Which device please?”
6. **Say:** [Beep] “XXXXX... (Ex. Device B)”
7. **Prompt:** “XXXXX... (Ex. Device B). Is this correct?”
8. **Say:** [Beep] “Yes” or “No”
9. If “Yes”, go to Step 10. If “No”, the procedure returns to Step 5.

10. **Prompt:** “XXXXX... (Ex. Device B) selected.”

**NOTE**

- *When the selected device connection is completed, the  or  symbol is displayed.*
- *Some Bluetooth® audio devices need a certain amount of time before the  or  symbol is displayed.*
- *Device (Music player) selection can also be done by operating the panel button.*

**Deleting a device**

Registered devices (Mobile phone) can be deleted individually or collectively.

**NOTE**

*Do this function only when parked. It is too distracting to attempt while driving and you may make too many errors to be effective.*

1. Press the pick-up button or talk button with a short press.
2. **Say:** [Beep] “Setup”
3. **Prompt:** “Select one of the following: Pairing options, confirmation prompts, language, passcode, select phone or select music player.”
4. **Say:** [Beep] “Pairing options”
5. **Prompt:** “Select one of the following: Pair, Edit, Delete, List, or Set Pairing Code.”

**NOTE**

*A registered device (Mobile phone) can be deleted using the registration list.*

6. **Say:** [Beep] “Delete”

7. **Prompt:** “Please say the name of the device you would like to delete. Available devices are XXXXX... (Ex. device A), XXXXX... (Ex. device B), XXXXX... (Ex. device C), or all. Which device please?”
8. **Say:** [Beep] “X” (Say the number of the device to be deleted.)

**NOTE**

*Say “All” to delete all devices (Mobile phone).*

9. **Prompt:** “Deleting XXXXX... (Ex. device B...) (Registered device tag). Is this correct?”
10. **Say:** [Beep] “Yes”
11. **Prompt:** “Deleted”

**Registered device editing**

1. Press the pick-up button or talk button with a short press.
2. **Say:** [Beep] “Setup”
3. **Prompt:** “Select one of the following: Pairing options, confirmation prompts, language, passcode, select phone or select music player.”
4. **Say:** [Beep] “Pairing options”
5. **Prompt:** “Select one of the following: Pair, Edit, Delete, List, or Set Pairing Code.”
6. **Say:** [Beep] “Edit”
7. **Prompt:** “Please say the name of the device you would like to edit. Available devices are XXXXX... (Ex. device A), XXXXX... (Ex. device B), XXXXX... (Ex. device C). Which device please?”
8. **Say:** [Beep] “X” (Say the number of the device to be edited.)
9. **Prompt:** “New name please?”
10. **Say:** [Beep] “XXXXX... (Ex. Device C)” (Speak a “device tag” an arbitrary name for the device.)
11. **Prompt:** “XXXXX... (Ex. device C) (Device tag), is this correct?”

# Bluetooth®

12. Say: [Beep] “Yes”

13. Prompt: “New name saved.”

## Bluetooth® Audio Preparation

### Bluetooth® audio device set-up

Bluetooth® audio pairing, changes, deletions, and display of paired device information can be performed.

1. The mode changes as follows each time the menu button (**MENU**) is pressed. Select “BT SETUP”.

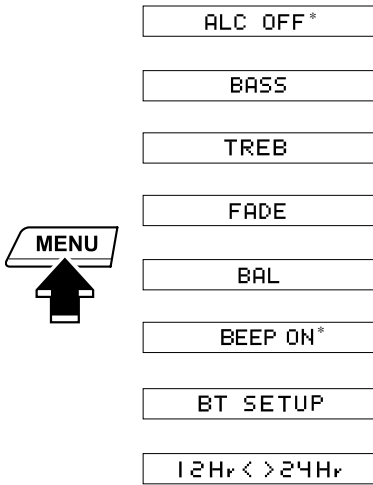

\* Depending on the mode selected, the indication changes.

2. Turn the audio control dial and select a desired mode.

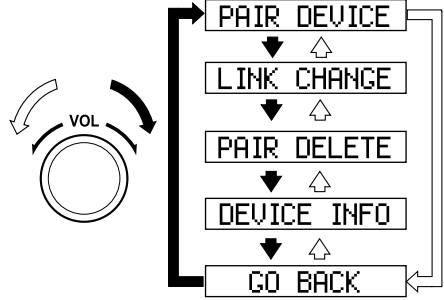

Display	Mode	Function
PAIR DEVICE	Pairing mode	Bluetooth® audio device pairing
LINK CHANGE	Link change mode	Changing link to Bluetooth® audio device
PAIR DELETE	Pairing deletion mode	Deleting link to Bluetooth® audio device
DEVICE INFO	Device information display mode	Displaying vehicle's Bluetooth® unit information

3. Press the audio control dial to determine the mode.

### Bluetooth® audio device pairing

Any Bluetooth® audio device must be paired to the vehicle's Bluetooth® unit before it can be listened to over the vehicle's speakers.

A maximum of seven devices including Bluetooth® audio devices and hands-free mobile phones can be paired to one vehicle.

**NOTE**

- *If a Bluetooth® device has already been paired to the vehicle as a hands-free mobile phone, it does not need to be paired again when using the device as a Bluetooth® audio device. Conversely, it does not need to be paired again as a hands-free mobile phone if it has already been paired as a Bluetooth® audio device.*
- *Device registration can also be done using voice recognition.*

Concerning the operation of a Bluetooth® audio device itself, refer to its instruction manual.

Some Bluetooth® audio devices have PIN codes (four digits). Refer to the audio device's instruction manual because the pairing procedure differs depending on whether it has a PIN code or not.

**Pairing a Bluetooth® audio device which has a four-digit PIN code**

1. Using the audio control dial, select the pairing mode “PAIR DEVICE” in the “BT SETUP” mode. (Refer to “Bluetooth® audio device set-up” for details.)
2. Press the audio control dial to determine the mode. After “ENTER PIN” is displayed on the audio display for three seconds, “PIN 0000” is displayed and the PIN code can be input.
3. Input the PIN code of your Bluetooth® audio device by pressing channel preset buttons 1 to 4 while “PIN 0000” is displayed.  
Press channel preset button 1 to input the first digit, 2 for the second, 3 for the third, and 4 for the fourth. For example, if the PIN code were “4213” press channel preset button 1 four times (1, 2, 3, 4), button 2 twice (1, 2), button 3 once (1), and button 4 three times (1, 2, 3). If the “PIN 0000” display disappears before finishing the PIN code input, repeat the procedure from Step 1.

**NOTE**

*Some devices accept only a particular pairing code (Usually, “0000” or “1234”).*

*If pairing cannot be completed, refer to the owner's manual of your mobile device, and try those numbers if necessary.*

4. Press the audio control dial while the input PIN code is displayed. “PAIRING” flashes on the audio display.
5. Operate the Bluetooth® audio device and set it to the pairing mode while “PAIRING” is flashing.
6. When the pairing is completed, 🎵 and “PAIR SUCCESS” are displayed after about 10-30 seconds, after which “PAIR SUCCESS” continues to be displayed for three seconds, and then the unit returns to the normal display.

## Bluetooth®

### NOTE

- Some Bluetooth® audio devices need a certain amount of time before the 🎵 symbol is displayed.
- If the pairing failed, “Err” flashes for three seconds.
- Pairing cannot be performed while the vehicle is moving. If you attempt to perform pairing while the vehicle is moving, “PAIR DISABLE” is displayed.
- If seven Bluetooth® audio devices have already been paired to the vehicle, pairing cannot be performed and “MEMORY FULL” is displayed. Delete one paired device to pair another one.

### Pairing a Bluetooth® audio device which does not have a four-digit PIN code

1. Using the audio control dial, select the pairing mode “PAIR DEVICE” in the “BT SETUP” mode. (Refer to “Bluetooth® audio set up” for details.)
2. Press the audio control dial to determine the mode. After “ENTER PIN” is displayed on the audio display for three seconds, “PIN 0000” is displayed and the PIN code can be input.
3. Press the audio control dial while “PIN 0000” is displayed. “PAIRING” flashes on the audio display.
4. Operate the Bluetooth® audio device and set it to the pairing mode while “PAIRING” is flashing.
5. As the Bluetooth® audio device requires a PIN code, input “0000”.
6. When the pairing is completed, 🎵 and “PAIR SUCCESS” are displayed after about 10-30 seconds, after which “PAIR SUCCESS” continues to be displayed for three seconds, and then the unit returns to the normal display.

### NOTE

- If pairing cannot be completed, try “1234” instead. Refer to the owner's manual of your mobile device for the right PIN code.
- Some Bluetooth® audio devices need a certain amount of time before the 🎵 symbol is displayed.
- If the pairing failed, “Err” flashes for three seconds.
- Pairing cannot be performed while the vehicle is moving. If you attempt to perform pairing while the vehicle is moving, “PAIR DISABLE” is displayed.
- If seven Bluetooth® audio devices have already been paired to the vehicle, pairing cannot be performed and “MEMORY FULL” is displayed. Delete one paired device to pair another one.

### Device selection

If several devices have been paired, the Bluetooth® unit links the device last paired. If you would like to link a different paired device, it is necessary to change the link. The order of device priority after the link has been changed is maintained even when the ignition is switched off.

1. Using the audio control dial, select the link change mode “LINK CHANGE” in the “BT SETUP” mode. (Refer to “Bluetooth® audio device set-up” for details.)
2. Press the audio control dial to determine the mode.
3. The name of the currently linked Bluetooth® audio device is displayed. If no Bluetooth® audio device is currently linked, the name of the first device among the paired devices is displayed.



- Turn the audio control dial to select the name of the device you would like to link.

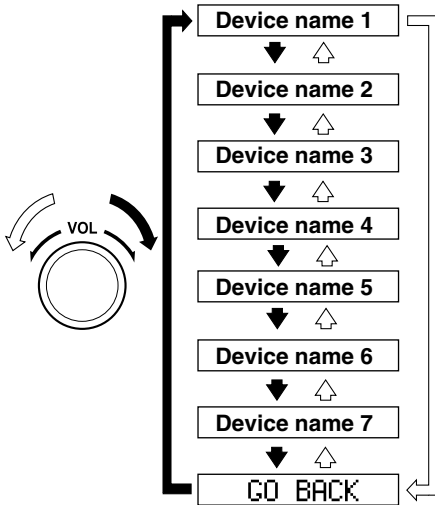

- Press the audio control dial to select the device you would like to link. The 🎵 symbol disappears, and “PAIRING” flashes in the audio display.

**NOTE**

*When “GO BACK” is selected and the audio control dial is pressed, the display returns to “LINK CHANGE”.*

- If the link to the desired device is successful, the 🎵 symbol is displayed again, together with “LINK CHANGED”. “LINK CHANGED” is displayed for three seconds, then it returns to the normal display.

**NOTE**

- Some Bluetooth® audio devices need a certain amount of time before the 🎵 symbol is displayed.*
- If a hands-free type mobile phone has been the most recently paired device, the Bluetooth® unit links this device. If you would like to use a Bluetooth® audio type device which has been previously paired to the Bluetooth® unit, the link must be changed to this device.*
- If an error occurs while trying to link a device, “Err” flashes in the audio display for three seconds, and the display returns to “LINK CHANGE”. If this occurs, check the pairing status of the Bluetooth® audio device and the location of the device in the vehicle (not in the trunk or a metal-type box), and then try the link operation again.*
- Device selection can also be done using voice recognition.*

**How to confirm the device currently linked**

Switch to the link-change mode. (Refer to “Changing the link to a Bluetooth® audio device”)

The device name displayed first is the device which is currently linked.

**Deleting a device**

- Using the audio control dial, select the pairing delete mode “PAIR DELETE” in the “BT SETUP” mode. (Refer to “Bluetooth® audio device set-up” for details.)
- Press the audio control dial to determine the mode.
- The name of the first device among the paired devices is displayed.

- Rotate the audio control dial and select the name of the paired device you would like to delete.

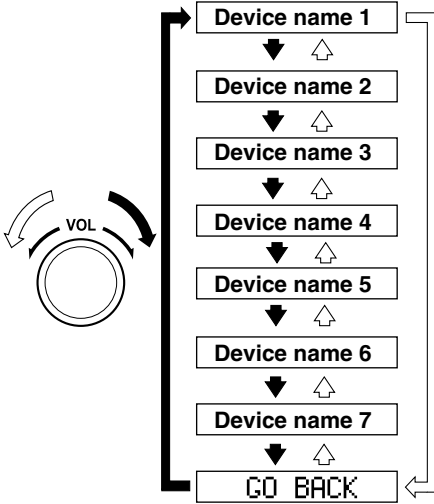

**NOTE**

Only the names of paired devices can be displayed. If only one device is paired, only the name for this device is displayed.

- If a selection other than “GO BACK” is made and the audio control dial is pressed, “SURE ? NO” is displayed.
- Rotate the audio control dial clockwise and switch the display to “SURE ? YES”.

**NOTE**

The display changes as follows depending on whether the audio control dial is rotated clockwise or counterclockwise.

- Clockwise: “SURE ? YES” displayed
- Counterclockwise: “SURE ? NO” displayed

- Press the audio control dial to delete the selected device.

**NOTE**

Select “GO BACK” and press the audio control dial to return to the “PAIR DELETE” display.

- “PAIR DELETED” is displayed for three seconds after the deletion is completed, and then it returns to the normal display.

**NOTE**

If an error occurs while trying to delete the paired device, “Err” flashes in the display for three seconds and the display returns to “LINK DELETE”.

**Bluetooth® audio device information display**

- Using the audio control dial, select the pair device information display mode “DEVICE INFO” in the “BT SETUP” mode. (Refer to “Bluetooth® audio device set-up” for details.)
- Press the audio control dial to determine the mode.
- The name of the Bluetooth® unit device is displayed.
- Rotate the audio control dial to select the information for the Bluetooth® unit which you would like to view.

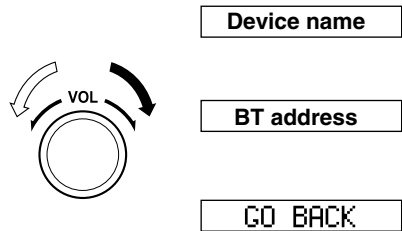

**NOTE**

When “GO BACK” is selected and the audio control dial is pressed, the display returns to “DEVICE INFO”.

### ▼ Available Language (Type A)

The available languages are English, Spanish, and Canadian French. If the language setting is changed, all of the voice guidance and voice input commands are done in the selected language.

#### NOTE

- *If the language setting is changed, device registration is maintained.*
- *Phonebook records are not cleared, but each language has a separate phonebook. Therefore, entries created in one language will need to be re-entered in the phonebook of the new language.*
- *Do these steps before you start driving. These less used functions are too distracting to undertake while driving until you are fully familiar with the system.*

#### (Method 1)

1. Press the pick-up button or talk button with a short press.
2. **Say:** [Beep] “Setup”
3. **Prompt:** “Select one of the following: Pairing options, confirmation prompts, language, passcode, select phone or select music player.”
4. **Say:** [Beep] “Language”
5. **Prompt:** “Select a language: English, French, or Spanish.”
6. **Say:** [Beep] “French” (Speak the desired language: “English”, “French” or “Spanish”)

#### NOTE

*Other language settings can also be made while in the current setting by saying the name of the language in the native pronunciation.*

7. **Prompt:** “French (Desired language) selected. Is this correct?”

8. **Say:** [Beep] “Yes”
9. **Prompt:** “French (Desired language) selected” (Spoken in the newly selected language).

#### (Method 2)

1. Press the pick-up button or talk button with a short press.
2. **Say:** [Beep] “French” (Say the desired language: “English”, “French” or “Spanish”). (Change the desired language by saying the language name.)

#### NOTE

*Other language settings can also be made while in the current setting by saying the name of the language in the native pronunciation.*

3. **Prompt:** “Would you like to change the language to French (Desired language)?”
4. **Say:** [Beep] “Yes”
5. **Prompt:** “Please wait. Switching to French phonebook. French selected” (Spoken in the newly selected language).

### ▼ Voice Recognition (Type A)

In this section, the basic operation of the voice recognition is explained.

#### Activating Voice Recognition

To Activate the Main Menu: Press the pick-up button or talk button with a short press.

#### Ending Voice Recognition

Use one of the following methods:

- Press and hold the talk-button.
- Press the hang-up button.

## Bluetooth®

---

### **Skipping Voice Guidance (for faster operation)**

Press and release the talk-button.

#### **NOTE**

- *The Bluetooth® Hands-Free system is operable several seconds after the ignition is switched to ACC or ON (requires less than 15 seconds).*
- *When operating the audio unit or the A/C while using Bluetooth® Hands-Free, the beep sounds or voice guidance (audio unit)/cannot be heard.*

### **Tutorial**

The tutorial explains how to use Bluetooth® Hands-Free.

To activate the tutorial, do the following:

1. Press the pick-up button or talk button with a short press.
2. **Say:** [Beep] “Tutorial”
3. Follow the prompts to receive the appropriate voice guidance instructions.

### **Commands useable anytime during voice recognition**

“Help” or “Go Back” are commands which can be used at anytime during voice recognition.

### **Help function use**

The help function informs the user of all the available voice commands under the current conditions.

1. **Say:** [Beep] “Help”
2. Follow the prompts to receive the appropriate voice guidance instructions.

### **Returning to previous operation**

This command is for returning to the previous operation while in the voice recognition mode.

**Say:** [Beep] “Go Back”

### **To prevent a deterioration in the voice recognition rate and voice quality, the following points should be observed:**

- **The voice recognition cannot be performed while voice guidance or the beep sound is operating. Wait until the voice guidance or the beep sound is finished before saying your commands.**
- Dialects or different wording other than hands-free prompts cannot be recognized by voice recognition. Speak in the wording specified by the voice commands.
- It is not necessary to face the microphone or approach it. Speak the voice commands while maintaining a safe driving position.
- Do not speak too slow or too loud.
- Speak clearly, without pausing between words or numbers.
- Close the windows and/or the moonroof to reduce loud noises from outside the vehicle, or turn down the airflow of the air-conditioning system while Bluetooth® Hands-Free is being used.
- Make sure the vents are not directing air up towards the microphone.

**NOTE**

*If the voice recognition performance is not satisfactory.*

*Refer to Voice Recognition Learning Function (Speaker Enrollment) (Type A) on page 5-92.*

*Refer to Troubleshooting on page 5-131.*

▼ **Security Setting (Type A)**

If a passcode is set, the system cannot be activated unless the passcode is input.

**NOTE**

*Do this function only when parked. It is too distracting to attempt while driving and you may make too many errors to be effective.*

**Passcode setting**

1. Press the pick-up button or talk button with a short press.
2. **Say:** [Beep] “Setup”
3. **Prompt:** “Select one of the following: Pairing options, confirmation prompts, language, passcode, select phone or select music player.”
4. **Say:** [Beep] “Passcode”
5. **Prompt:** “Passcode is disabled. Would you like to enable it?”
6. **Say:** [Beep] “Yes”
7. **Prompt:** “Please say a 4-digit passcode. Remember this passcode. It will be required to use this system.”
8. **Say:** [Beep] “XXXX” (Say a desired 4-digit passcode, “PCode”.)
9. **Prompt:** “Passcode XXXX (Passcode, PCode). Is this correct?”
10. **Say:** [Beep] “Yes”
11. **Prompt:** “Passcode is enabled.”

**Using Bluetooth® Hands-Free with a passcode**

1. Press the pick-up button or talk button with a short press.
2. **Prompt:** “Hands-Free system is locked. State the passcode to continue.”
3. **Say:** [Beep] “XXXX” (Say the set passcode “PCode”.)
4. If the correct passcode is input, voice guidance “XXXXXX... (Ex. “Mary’s device”) (Device tag) is connected” is announced.  
If the passcode is incorrect, voice guidance “XXXX (4-digit passcode, Pcode) incorrect passcode, please try again” is announced.

**Canceling the passcode**

**NOTE**

*Do this function only when parked. It is too distracting to attempt while driving and you may make too many errors to be effective.*

1. Press the pick-up button or talk button with a short press.
2. **Say:** [Beep] “Setup”
3. **Prompt:** “Select one of the following: Pairing options, confirmation prompts, language, passcode, select phone or select music player.”
4. **Say:** [Beep] “Passcode”
5. **Prompt:** “Passcode is enabled. Would you like to disable it?”
6. **Say:** [Beep] “Yes”
7. **Prompt:** “Passcode is disabled.”

**Confirmation Prompts**

The confirmation prompt confirms the command content to the user before advancing to the operation requested by the user. When this function is turned on, the system reads out the voice input command previously received and confirms whether the command is correct before advancing to the command execution.

When the confirmation prompt function is turned on:

(Ex. “Calling John's device. Is this correct?”)

When the confirmation prompt function is turned off:

(Ex. “Calling John's device.”)

**NOTE**

*If the confirmation prompt function is turned off when making an emergency call, the system reads out and confirms the command before executing it.*

1. Press the pick-up button or talk button with a short press.
2. **Say:** [Beep] “Setup”
3. **Prompt:** “Select one of the following: Pairing options, confirmation prompts, language, passcode, select phone or select music player.”
4. **Say:** [Beep] “Confirmation prompts”
5. **Prompt:** “Confirmation prompts are on/off. Would you like to turn confirmation prompts off/on?”
6. **Say:** [Beep] “Yes”
7. **Prompt:** “Confirmation prompts are off/on.”

**▼ Voice Recognition Learning Function (Speaker Enrollment) (Type A)**

The voice recognition learning function enables voice recognition appropriate to the characteristics of the user's voice. If the recognition of the voice input commands to the system is not adequate, this function can largely improve the system's voice recognition of the user. If your voice can be recognized sufficiently without using this function, you may not realize the added benefit of the function. To register your voice, the voice input command list must be read out. Read out the list when the vehicle is parked. Perform the registration in as quiet a place as possible 5-89. The registration must be performed completely. The required time is a few minutes. The user needs to be seated in the driver's seat with the voice input command list for voice recognition learning open to the page indicated below.

**When voice recognition learning is done for the first time**

1. Press the pick-up button or talk button with a short press.
2. **Say:** [Beep] “Voice training”
3. **Prompt:** “This operation must be performed in a quiet environment while the vehicle is stopped. See the owner's manual for the list of required training phrases. Press and release the talk button when you are ready to begin. Press the hang-up button to cancel at any time.”
4. Press the talk button with a short press.
5. The voice guidance reads out the voice input command number (refer to the voice input command list for voice recognition learning). (Ex. “Please read phrase 1”)

6. **Say:** [Beep] “0123456789” (Say the voice input command for voice recognition learning (1 to 8) according to the voice guidance.)
7. **Prompt:** “Speaker enrollment is complete.”

**NOTE**

*If an error occurred in the voice recognition learning, re-learning can be done by pressing the talk button with a short press.*

**Voice recognition re-learning**

If voice recognition learning has already been done.

1. Press the pick-up button or talk button with a short press.
2. **Say:** [Beep] “Voice training”
3. **Prompt:** “Enrollment is enabled/disabled. Would you like to disable/enable or retrain?”
4. **Say:** [Beep] “Retrain”
5. **Prompt:** “This operation must be performed in a quiet environment while the vehicle is stopped. See the owner's manual for the list of required training phrases. Press and release the talk button when you are ready to begin. Press the hang-up button to cancel at any time.”
6. Press the talk button with a short press.
7. The voice guidance reads out the voice input command number (refer to the voice input command list for voice recognition learning). (Ex. “Please read phrase 1”)
8. **Say:** [Beep] “0123456789” (Say the voice input command for voice recognition learning (1 to 8) according to the voice guidance.)
9. **Prompt:** “Speaker enrollment is complete.”

**NOTE**

*If an error occurred in the voice recognition learning, re-learning can be done by pressing the talk button with a short press.*

**Voice input command list for voice recognition learning**

When reading out, the following points must be observed:

- Read out the numbers one at a time correctly and naturally.  
(For example, “1234” must be read out “one, two, three, four” not “twelve, thirty four”.)
- Do not read out parentheses. “(” and hyphens “-” are used for separating numbers in a phone number.

Ex.

“(888) 555-1212” must be spoken “Eight, eight, eight, five, five, five, one, two, one, two.”

Phrase	Command
1	0123456789
2	(888) 555-1212
3	Call
4	Dial
5	Setup
6	Cancel
7	Continue
8	Help

**NOTE**

- *The applicable phrase appears in the audio display.*
- *After user voice registration is completed, voice guidance “Speaker enrollment is complete” is announced.*

# Bluetooth®

## Voice recognition learning on/off

1. Press the pick-up button or talk button with a short press.
2. **Say:** [Beep] “Voice training”
3. **Prompt:** “Enrollment is enabled/disabled. Would you like to disable/enable or retrain?”
4. **Say:** [Beep] “Disable” or “Enable”
5. When “Disable” is spoken, the voice recognition learning is turned off. When “Enable” is spoken, the voice recognition learning is turned on.
6. **Prompt:** “Speaker Enrollment is disabled/enabled.”

## ▼ Bluetooth® Preparation (Type B)

### Device pairing

To use Bluetooth® audio and Hands-Free, the device equipped with Bluetooth® has to be paired to the unit using the following procedure. A maximum of seven devices including Bluetooth® audio devices and hands-free mobile phones can be paired.

#### **NOTE**

*The Bluetooth® system may not operate for 1 or 2 minutes after the ignition is switched to ACC or ON. However, this does not indicate a problem. If the Bluetooth® system does not connect automatically after 1 or 2 minutes have elapsed, make sure that the Bluetooth® setting on the device is normal and attempt to reconnect the Bluetooth® device from the vehicle side.*

### **Pairing Procedure**

1. Select the  icon on the home screen and display the Settings screen.
2. Select the **Devices** tab.
3. Select **Bluetooth**.
4. Turn the Bluetooth® setting on.

5. Select **Add New Device** to display the message and switch to the device operation.
6. Using your device, perform a search for the Bluetooth® device (Peripheral device).
7. Select “Mazda” from the device list searched by the device.
8. **(Device with Bluetooth® version 2.0)** Input the displayed 4-digit pairing code into the device.

#### **(Device with Bluetooth® version 2.1 or higher)**

Make sure the displayed 6-digit code on the audio is also displayed on the device, and touch the **Yes**.

Connection permission and phonebook access permission for your mobile device may be required depending on the mobile device.

9. If pairing is successful, the functions of the device connected to Bluetooth® are displayed.
10. **(Devices compatible with Mazda Email / SMS function)**  
SMS (Short Message Service) messages, and E-mail for the device are downloaded automatically. A download permission operation for your device may be required depending on the device.

#### **NOTE**

*When Call history and messages are downloaded automatically, each automatic download setting must be on. Refer to Communication Settings on page 5-114.*



After a device is registered, the system automatically identifies the device. By activating Bluetooth® Hands-Free again, or by activating Bluetooth® Hands-Free first after switching the ignition from OFF to ACC, the device connection condition is indicated in the center display.

**IMPORTANT note about pairing and automatic reconnection:**

- **If pairing is redone on the same mobile phone device, first clear “Mazda” displayed on the Bluetooth® setting screen of the mobile device.**
- When the OS of the device is updated, the pairing information may be deleted. If this happens, reprogram the pairing information to the Bluetooth® unit.
- Before you pair your device, make sure that Bluetooth® is “ON”, both on your phone and on the vehicle.

**Device selection**

If several devices have been paired, the Bluetooth® unit links the device last paired. If you would like to link a different paired device, it is necessary to change the link. The order of device priority after the link has been changed is maintained even when the ignition is switched off.

**Connecting other devices**

1. Select the  icon on the home screen and display the Settings screen.
2. Select the **Devices** tab.
3. Select **Bluetooth**.
4. Turn the Bluetooth® setting on.
5. Select the name of the device you would like to connect.

6. **Phone and Audio** selection  
 Connects both devices as hands-free and Bluetooth® audio.  
**Phone Only** selection  
 Connects as a hands-free device.  
**Audio Only** selection  
 Connects as Bluetooth® audio.

**NOTE**

*The following functions can be used for the Hands-free or audio.*

- *Hands-free: Phone calls and E-mail/SMS*
- *Audio: Bluetooth® audio, Pandora®, Aha™, Stitcher™ radio*

**Disconnecting a device**

1. Select the  icon on the home screen and display the Settings screen.
2. Select the **Devices** tab.
3. Select **Bluetooth**.
4. Turn the Bluetooth® setting on.
5. Select the device name which is currently connected.
6. Select **Disconnect**.

**Deleting a device**

**Selecting and deleting devices**



1. Select the  icon on the home screen and display the Settings screen.
2. Select the **Devices** tab.
3. Select **Bluetooth**.
4. Turn the Bluetooth® setting on.
5. Select the device name which you would like to delete.
6. Select **Unpair This Device**.
7. Select **Yes**.

**Bluetooth®****Deleting all devices**

1. Select the  icon on the home screen and display the Settings screen.
2. Select the **Devices** tab.
3. Select **Bluetooth**.
4. Select **Custom Settings**.
5. Select **Unpair All Paired Devices**.
6. Select **Yes**.

**Changing PIN code**

PIN code (4 digits) can be changed.

1. Select the  icon on the home screen and display the Settings screen.
2. Select the **Devices** tab.
3. Select **Bluetooth**.
4. Select **Custom Settings**.
5. Select **Change Pairing Code**.
6. Input the new PIN code to be set.
7. Select .

**▼ Available Language (Type B)**

The Bluetooth® Hands-Free System applies to the following languages:

- English
- Spanish
- French

Refer to Settings on page 5-55.

**▼ Voice Recognition (Type B)**

In this section, the basic operation of the voice recognition is explained.

**Activating Voice Recognition**

Press the talk button.

**Ending Voice Recognition**

Use one of the following methods:

- Press the hang-up button.
- Say, “Cancel”.
- Operate the commander switch or the center display (only when vehicle is stopped).

**Skipping Voice Guidance (for faster operation)**

Press and release the talk button.

**Troubleshooting for Voice Recognition**

If you do not understand an operation method while in the voice recognition mode, say “Tutorial” or “Help”.

**Commands useable anytime during voice recognition**

“Go Back” and “Cancel” are commands which can be used at anytime during voice recognition.

**Returning to previous operation**

To return to the previous operation, say, “Go Back” while in voice recognition mode.

**Cancel**

To put the Bluetooth® Hands-Free system in standby mode, say, “Cancel” while in voice recognition mode.

**To prevent a deterioration in the voice recognition rate and voice quality, the following points should be observed:**

- **The voice recognition cannot be performed while voice guidance or the beep sound is operating. Wait until the voice guidance or the beep sound is finished before saying your commands.**
- Phone related commands are available only when your phone is connected via Bluetooth®. Make sure your phone is connected via Bluetooth® before you operate phone related voice commands.
- Music play commands, such as Play Artist and Play Album can be used only in USB audio mode.
- Do not speak too slowly or loudly (no loud voice).
- Speak clearly, without pausing between words or numbers.
- Dialects or different wording other than hands-free prompts cannot be recognized by voice recognition. Speak in the wording specified by the voice commands.
- It is not necessary to face the microphone or approach it. Speak the voice commands while maintaining a safe driving position.
- Close the windows and/or the moonroof to reduce loud noises from outside the vehicle, or turn down the airflow of the air-conditioning system while Bluetooth® Hands-Free is being used.
- Make sure the vents are not directing air up towards the microphone.

**NOTE**

*If the voice recognition performance is not satisfactory.*

*Refer to Troubleshooting on page 5-131.*

**▼ Audio Operation Using Voice Recognition (Type B)****Main audio operation**

The below commands are examples of the available commands.

When the talk button is pressed and the following command is spoken out, the audio can be operated. The commands in the ( ) can be omitted. The specified name and number are put into the {}.

<b>Voice command</b>	<b>Function</b>	<b>Corresponding audio source</b>
(Go to/Play) AM (Radio)	Switches the audio source to AM radio.	All
(Go to/Play) FM (Radio)	Switches the audio source to FM radio.	All
(Go to/Play) Bluetooth (Audio)	Switches the audio source to BT audio.	All
(Go to/Play) Pandora	Switches the audio source to Pandora®	All
(Go to/Play) Aha (Radio)	Switches the audio source to Aha™ Radio.	All
(Go to/Play) Stitcher	Switches the audio source to Stitcher™ Radio.	All
(Go to/Play) USB 1	Switches the audio source to USB 1.	All
(Go to/Play) USB 2	Switches the audio source to USB 2.	All
Play Playlist {Playlist name}	Plays the selected playlist.	USB
Play Artist {Artist name}	Plays the selected artist.	USB
Play Album {Album name}	Plays the selected album.	USB
Play Genre {Genre name}	Plays the selected genre.	USB
Play Folder {Folder name}	Plays the selected folder.	USB

**NOTE**

- *Some commands cannot be used depending on devices and use conditions.*
- *If the Bluetooth® device, USB, or AUX is not connected, the related commands cannot be used.*

## Bluetooth® Hands-Free (Type A)\*

### ▼ Making a Call

#### Phonebook Usage

Telephone calls can be made by saying the name of a person (voice tag) whose phone number has been registered in Bluetooth® Hands-Free in advance. Refer to Phonebook registration.

1. Press the pick-up button or talk button with a short press.
2. **Say:** [Beep] “Call”
3. **Prompt:** “Name please.”
4. **Say:** [Beep] “XXXXX...” (Ex. “John’s phone”)” (Say a voice tag registered in the phonebook.)
5. **Prompt:** “Calling XXXXX... (Ex. “John’s phone”) XXXX (Ex. “at home”). Is this correct?” (Voice tag and phone number location registered in phonebook).
6. **Say:** [Beep] “Yes”
7. **Prompt:** “Dialing”

#### **NOTE**

The “Call” command and the voice tag can be combined.

Ex. In Step 2, say, “Call John’s phone”, then, Steps 3 and 4 can be skipped.

#### **Phonebook registration**

Phone numbers can be registered to the Bluetooth® Hands-Free phonebook.

#### **NOTE**

Do this function only when parked. It is too distracting to attempt while driving and you may make too many errors to be effective.

1. Press the pick-up button or talk button with a short press.
2. **Say:** [Beep] “Phonebook”
3. **Prompt:** “Select one of the following: New entry, edit, list names, delete, erase all or import contact.”
4. **Say:** [Beep] “New entry”
5. **Prompt:** “Name please.”
6. **Say:** [Beep] “XXXXX...” (Ex. “Mary’s phone”)” (Say a voice tag for the name registered.)
7. **Prompt:** “Adding XXXXX... (Ex. “Mary’s phone”) (Registered voice tag). Is this correct?”
8. **Say:** [Beep] “Yes”
9. **Prompt:** “Home, Work, Mobile, or Other?”
10. **Say:** [Beep] “Mobile” (Say “Home”, “Work”, “Mobile”, or “Other”, for the desired location to be registered.)
11. **Prompt:** “Mobile (Location to be registered). Is this correct?”
12. **Say:** [Beep] “Yes”
13. **Prompt:** “Number, please.”
14. **Say:** [Beep] “XXXXXXXXXXXX” (Say the phone number to be registered.)
15. **Prompt:** “XXXXXXXXXXXX (Phone number registration). After the beep, continue to add numbers, or say Go-Back to re-enter the last entered numbers, or press the Pick-Up button to save the number.”

**Bluetooth®****16. (Registration)**

Press the pick-up button or say “Enter”, then go to Step 17.

**(Adding/inputting telephone number)**

Say, “XXXX” (desired telephone number), then go to Step 15.

**(Telephone number correction)**

Say, “Go Back”. The prompt replies, “Go Back. The last entered numbers have been removed.”. Then go back to Step 13.

**17. Prompt:** “Number saved. Would you like to add another number for this entry?”

**18. Say:** [Beep] “Yes” or “No”.

**19. If “Yes”,** an additional phone number registration can be made for the same entry.

If “No”, the system returns to standby status.

**(Import contact)**

Phonebook data from your device (Mobile phone) can be sent and registered to your Bluetooth® Hands-Free phonebook using Bluetooth®.

1. Press the pick-up button or talk button with a short press.
2. **Say:** [Beep] “Phonebook”
3. **Prompt:** “Select one of the following: New entry, edit, list names, delete, erase all or import contact.”
4. **Say:** [Beep] “Import contact”
5. **Prompt:** “The hands free System is ready to receive a contact from a phone. Only a home, a work, and a mobile number can be imported, This process requires operation of a mobile phone. refer to the phone's manual for more information”

6. Device (Mobile phone) operation:

Select one entry from the phonebook and send it using Bluetooth®.

7. **Prompt:** “X (Number of locations which include data) numbers have been imported. What name would you like to use for these numbers?”
8. **Say:** [Beep] “XXXXX... (Ex. “Mary's phone”)” (Say a voice tag for the name registered.)
9. **Prompt:** “Adding XXXXX... (Ex. “Mary's phone”) (Voice tag). Is this correct?”
10. **Say:** [Beep] “Yes”
11. **Prompt:** “Number saved. Would you like to import another contact?”
12. **Say:** [Beep] “Yes” or “No”
13. If “Yes”, the procedure proceeds to Step 5.  
If “No”, the procedure proceeds to Step 14.

**Editing phonebook**

The data registered to the Bluetooth® Hands-Free phonebook can be edited.

**NOTE**

*Do this function only when parked. It is too distracting to attempt while driving and you may make too many errors to be effective.*

1. Press the pick-up button or talk button with a short press.
2. **Say:** [Beep] “Phonebook”
3. **Prompt:** “Select one of the following: New entry, edit, list names, delete, erase all or import contact.”
4. **Say:** [Beep] “Edit”
5. **Prompt:** “Please say the name of the entry you would like to edit or say, “List names”.”

6. **Say:** [Beep] “XXXXX... (Ex. “Mary’s phone”)” (Say the voice tag for the registered name to be edited in the phonebook.)
7. **Prompt:** “Home, Work, Mobile, or Other?”
8. **Say:** [Beep] “Home” (Say the registered location to be edited: “Home”, “Work”, “Mobile”, or “Other”).
9. **Prompt:** “XXXXX... (Ex. “Mary’s phone”) (Registered voice tag) XXXX (Ex. “Home”) (Registered location). Is this correct?”
10. **Say:** [Beep] “Yes”
11. **Prompt:** “The current number is XXXXXXXXXXXX (Ex. “555-1234”) (Currently registered number). New number, please.”

**NOTE**

*If there was no previous phone number registered to a location (Ex. “Work”), the prompt will only read out “Number, please”*

12. **Say:** [Beep] “XXXXXXXXXXXX (Ex. “555-5678”)” (Say the new phone number to be registered.)
13. **Prompt:** “XXXXXXXX (Telephone number) After the beep, continue to add numbers, or say Go-Back to re-enter the last entered numbers, or press the Pick-Up button to save the number.”

**14.(Number Change)**

Press the pick-up button, then go to Step 15.

**(Adding/inputting telephone number)**

Say, “XXXX” (desired telephone number), then go to Step 13.

**(Telephone number correction)**

Say, “Go Back”. The prompt replies, “Go Back. The last entered numbers have been removed. Number, please.”. Then go back to Step 12.

15. **Prompt:** “Number changed.”

**Phonebook data deletion**

**(Erasing individual phonebook data)**

Individual data registered to the Bluetooth® Hands-Free phonebook can be cleared.

**NOTE**

*Do this function only when parked. It is too distracting to attempt while driving and you may make too many errors to be effective.*

1. Press the pick-up button or talk button with a short press.
2. **Say:** [Beep] “Phonebook”
3. **Prompt:** “Select one of the following: New entry, edit, list names, delete, erase all or import contact.”
4. **Say:** [Beep] “Delete”
5. **Prompt:** “Please say the name of the entry you would like to delete or say, “List names”. ”
6. **Say:** [Beep] “XXXXX... (Ex. “John’s phone”) ” (Say the registered voice tag to be deleted from the phonebook.)
7. **Prompt:** “Deleting XXXXX... (Ex. “John’s phone”) (Registered voice tag) Home (Registered location). Is this correct?”
8. **Say:** [Beep] “Yes”

## Bluetooth®

- Prompt:** “XXXXX... (Ex. “John's phone”) (Registered voice tag) Home (Registered location) deleted.”

### (Complete deletion of the phonebook data)

All data registered to the Bluetooth® Hands-Free phonebook can be erased.

#### NOTE

*Do this function only when parked. It is too distracting to attempt while driving and you may make too many errors to be effective.*

- Press the pick-up button or talk button with a short press.
- Say:** [Beep] “Phonebook”
- Prompt:** “Select one of the following: New entry, edit, list names, delete, erase all or import contact.”
- Say:** [Beep] “Erase all”
- Prompt:** “Are you sure you want to erase everything from your Hands Free system phonebook?”
- Say:** [Beep] “Yes”
- Prompt:** “You are about to delete everything from your Hands Free system phonebook. Do you want to continue?”
- Say:** [Beep] “Yes”
- Prompt:** “Please wait, erasing the Hands Free system phonebook.”
- Prompt:** “Hands-Free system phonebook erased.”

### Read-out of names registered to the Bluetooth® Hands-Free phonebook

Bluetooth® Hands-Free can read out the list of names registered to its phonebook.

- Press the pick-up button or talk button with a short press.
- Say:** [Beep] “Phonebook”

- Prompt:** “Select one of the following: New entry, edit, list names, delete, erase all or import contact.”
- Say:** [Beep] “List names”
- Prompt:** “XXXXX..., XXXXX..., XXXXX... (Ex. “John's phone”, Mary's phone, Bill's phone)” (Voice guidance reads out the voice tags registered to the phonebook.)  
Press the talk button with a short press during the read-out at the desired name, and then say one of the following voice commands to execute it.
  - “Continue”: Continues the list readout.
  - “Call”: Calls the registered phonebook data when the talk button is short-pressed.
  - “Edit”: Edits the registered phonebook data when the talk button is short-pressed.
  - “Delete”: Deletes the registered phonebook data when the talk button is short-pressed.
  - “Previous”: Returns to the previous phonebook data in read-out when the talk button is short-pressed.
- Prompt:** “End of list, would you like to start from the beginning?”
- Say:** [Beep] “No”
- The procedure returns to Step 3.

### Redial Function

Redialing the number of the person previously dialed using the phone is possible.

- Press the pick-up button or talk button with a short press.
- Say:** [Beep] “Redial”
- Prompt:** “Dialing”



## Telephone Number Input

### **NOTE**

*Practice this while parked until you are confident you can do it while driving in a non-taxing road situation. If you are not completely comfortable, make all calls from a safe parking position, and only start driving when you can devote your full attention to driving.*

1. Press the pick-up button or talk button with a short press.
2. **Say:** [Beep] “Dial”
3. **Prompt:** “Number, please”
4. **Say:** [Beep] “XXXXXXXXXXXXX (Telephone number)”
5. **Prompt:** “XXXXXXXXXXXXX. (Telephone number) After the beep, continue to add numbers, or say Go-Back to re-enter the last entered numbers, or press the Pick-Up button to execute dialing.”
6. **(Dialing)**  
Press the pick-up button or say “Dial”, then go to Step 7.  
**(Adding/inputting telephone number)**  
Say, “XXXX” (desired telephone number), then go to Step 5.  
**(Telephone number correction)**  
Say, “Go Back”. The prompt replies, “Go Back. The last entered numbers have been removed.”. Then go back to Step 3.
7. **Prompt:** “Dialing”

### **NOTE**

*The “Dial” command and a telephone number can be combined.  
 Ex. In Step 2, say, “Dial 123-4567” then, Steps 3 and 4 can be skipped.*

## Emergency calls

A call can be made to the emergency phone number (911: U.S.A./Canada, 066: Mexico) using the voice input command. It may not function properly in some areas in Mexico.

1. Press the pick-up button or talk button with a short press.
2. **Say:** [Beep] “Emergency”
3. - **U.S.A./Canada vehicles - Prompt:** “Dialing “911”, is this correct?”  
 - **Mexico vehicles - Prompt:** “Dialing “066”, is this correct?”
4. **Say:** [Beep] “Yes”
5. **Prompt:** “Dialing”

## ▼ **Receiving an Incoming Call**

1. **Prompt:** “Incoming call, press the pick-up button to answer”
2. To accept the call, press the pick-up button.  
To reject the call, press the hang-up button.

## ▼ **Hanging Up a Call**

Press the hang-up button during the call. A beep sound will confirm that call is ended.

## ▼ **Mute**

The microphone can be muted during a call.

1. Press the talk button with a short press.
2. **Say:** [Beep] “Mute”
3. **Prompt:** “Microphone muted”

## Canceling mute

1. Press the talk button with a short press.
2. **Say:** [Beep] “Mute off”
3. **Prompt:** “Microphone unmuted”

**▼ Transferring a Call from Hands-Free to a Device (Mobile Phone)**

Communication between the hands-free unit and a device (Mobile phone) is canceled, and the line can be switched to a standard call using a device (Mobile phone).

1. Press the talk button with a short press.
2. **Say:** [Beep] “Transfer call”
3. **Prompt:** “Transferred call to phone”

**▼ Transferring a Call from a Device (Mobile Phone) to Hands-Free**

Communication between devices (Mobile phone) can be switched to Bluetooth® Hands-Free.

1. Press the talk button with a short press.
2. **Say:** [Beep] “Transfer call”
3. **Prompt:** “Transferred call to Hands Free system”

**▼ Call interrupt**

A call can be interrupted to receive an incoming call from a third party. Switch to a new incoming call using the following methods.

**Method 1**

1. Press the pick-up button.
2. **Prompt:** “Swapping calls.”

**Method 2**

1. Press the talk button with a short press.
2. **Say:** [Beep] “Swap calls”
3. **Prompt:** “Swapping calls.”

**NOTE**

- *To refuse an incoming call, press the hang-up button.*
- *After receiving a new incoming call, the previous call is placed on hold.*

**Switching calls**

Switching back to the previous call can also be done.

**Method 1**

1. Press the pick-up button.
2. **Prompt:** “Swapping calls.”

**Method 2**

1. Press the talk button with a short press.
2. **Say:** [Beep] “Swap calls”
3. **Prompt:** “Swapping calls.”

**Three-way call function**

1. Press the talk button with a short press.
2. **Say:** [Beep] “Join calls”
3. **Prompt:** “Joining calls”

**Making a call using a telephone number**

1. Press the talk button with a short press.
2. **Say:** [Beep] “Dial”
3. **Prompt:** “Number, please”
4. **Say:** [Beep] “XXXXXXXXXXXXX (Telephone number)”
5. **Prompt:** “XXXXXXXXXXXXX. (Telephone number) After the beep, continue to add numbers, or say Go-Back to re-enter the last entered numbers, or press the Pick-Up button to execute dialing.”
6. **(Dialing)**  
Press the pick-up button or say “Dial”, then go to Step 7.  
**(Adding/inputting telephone number)**  
Say, “XXXX” (desired telephone number), then go to Step 5.  
**(Telephone number correction)**  
Say, “Go Back”. The prompt replies, “Go Back. The last entered numbers have been removed.”. Then go back to Step 3.
7. **Prompt:** “Dialing”

### **Making calls using the phonebook**

1. Press the talk button with a short press.
2. **Say:** [Beep] “Call”
3. **Prompt:** “Name please.”
4. **Say:** [Beep] “XXXXX... (Ex. “John’s phone”)” (Say a voice tag registered in the phonebook.)
5. **Prompt:** “Calling XXXXX... (Ex. “John’s phone”) XXXX (Ex. “at home”). Is this correct?” (Voice tag and phone number location registered in phonebook).
6. **Say:** [Beep] “Yes”
7. **Prompt:** “Dialing”

### **Redialing function**

1. Press the talk button with a short press.
2. **Say:** [Beep] “Redial”
3. **Prompt:** “Dialing”

### **Ending the current call**

Press the hang-up button during the call.

### **▼DTMF (Dual Tone Multi-Frequency Signal) Transmission**

This function is used when transmitting DTMF via the user’s voice. The receiver of a DTMF transmission is generally a home telephone answering machine or a company’s automated guidance call center (When you send tone signals back according to the voice guidance recording).

1. Press the talk button with a short press.
2. **Say:** [Beep] “XXXX... send” (Say DTMF code)
3. **Prompt:** “Sending XXXX... (DTMF code)”

## **Bluetooth® Hands-Free (Type B)\***

### **▼ Making a Call**

#### **Phonebook Usage**

Telephone calls can be made by saying the contact name in the downloaded phonebook or the name of a person whose phone number has been registered in the Bluetooth® Hands-Free. Refer to Import contact (Download Phonebook).

1. Press the talk button.
2. Wait for the beep sound.
3. **Say:** “Call XXXXX... (Ex. “John”) Mobile”.
4. Follow the voice guidance to place the call.

#### **Screen operation**

1. Select the  icon on the home screen and display the Communication screen.
2. Select **[Contacts]** to display the contact list.
3. Select the contact you would like to call to display the details for the contact.
4. Select the desired phone number to make the call.

#### **Import contact (Download Phonebook)**

Phonebook data from your device (Mobile phone) can be sent and registered to your Bluetooth® Hands-Free phonebook using Bluetooth®.

**(Automatic downloading)**

The “Auto Download Contacts” setting must be on. When hands-free is connected to the device, the phonebook is downloaded automatically. Refer to Communication Settings on page 5-114.

**(Manually downloading)**

If the “Auto Download Contacts” setting is off, download the phonebook using the following procedure.

1. Select the  icon on the home screen and display the Communication screen.
2. Select **Contacts** to display the contact list.
3. Select **Edit Contacts**.
4. Select **Import All Contacts** or **Import Selected Contact** to switch to the device operation.
5. If **Import All Contacts** is selected, select **Download**.
6. Download will be started from the mobile phone.

**NOTE**

- If the phonebook has been already registered to the hands-free unit, the current phonebook is overwritten during “Import All Contacts”.
- A maximum of 1000 contacts can be registered to the phonebook.
- Phonebook, incoming/outgoing call record, and favorite memories are exclusive to each mobile phone to protect privacy.

**Favorites Contacts**

A maximum of 50 contacts can be registered. It will take less time to make a call after registering the telephone number. In addition, you do not have to look for the person you want to call in the phonebook.

**Registering to your favorites**

1. Select the  icon on the home screen and display the Communication screen.
2. Select **Favorites** to display the favorites list.
3. Select **Add/Edit Communication Favorites**.
4. Select **Add New Contact** or **Add New Contact Details**.
5. Select from the displayed list.

**NOTE**

When “Add New Contact” is selected, information such as the selected person’s name is also registered. In addition, when “Add New Contact Details” is selected, only the telephone number of the selected person is registered.

**Making a call from your favorites**

1. Select the  icon on the home screen and display the Communication screen.
2. Select **Favorites** to display the favorites list.
3. **(Only one phone number is registered to contact)**  
Select the contact information you would like to call. Go to Step 5.  
**(Multiple phone numbers are registered to contact)**  
Select the contact you would like to call to display the screen indicating the details for the contact. Go to Step 4.

4. Select the phone number you would like to call.
5. Select **Yes**.

### Deleting from your favorites

1. Select the  icon on the home screen and display the Communication screen.
2. Select **Favorites** to display the favorites list.
3. Select **Add/Edit Communication Favorites**.
4. Select **Delete**.
5. Select the contact information which you would like to delete.
6. Select **Delete**.

### Changing the display order of your favorites list

1. Select the  icon on the home screen and display the Communication screen.
2. Select **Favorites** to display the favorites list.
3. Select **Add/Edit Communication Favorites**.
4. Select **Move**.
5. The contact can be moved after it is selected.
6. Move the contact and select **OK**.

### Changing contact name of your favorites

1. Select the  icon on the home screen and display the Communication screen.
2. Select **Favorites** to display the favorites list.
3. Select **Add/Edit Communication Favorites**.
4. Select **Rename**.
5. Select the contact to display the keyboard screen.
6. If a new name is input and **OK** is selected, the contact name is stored.



### **NOTE**

*If the contact is long-pressed when the favorites list is displayed, the contact information can be edited (deleted, moved).*

### **Telephone Number Input**

### **NOTE**

*Practice this while parked until you are confident you can do it while driving in a non-taxing road situation. If you are not completely comfortable, make all calls from a safe parking position, and only start driving when you can devote your full attention to driving.*

1. Select the  icon on the home screen and display the Communication screen.
2. When **Dial Phone** is pressed, the dial pad is displayed.
3. Input the telephone number using the dial pad.
4. Select  to make the call.

### **Numeral or symbol entry**

Use the dial pad.

Long-press the **0 +** to input +.

Select  to delete the currently input value.

Long-press  to delete all input values.

### **Redial Function**

Makes a call to the last person called (latest person on outgoing call record) from the mobile phone/vehicle.

1. Press the talk button.
2. Wait for the beep sound.
3. **Say:** "Redial"

# Bluetooth®

---

## **Call back Function**

Makes a call to the last person who called your (latest person on incoming call record) mobile phone/vehicle.

1. Press the talk button.
2. Wait for the beep sound.
3. **Say:** “Call back”

## **Mobile 911 (U.S.A./Canada only)**

If the vehicle is involved in a moderate to severe collision, a call is made automatically to 911 from the connected device. The “Emergency Assistance Call” setting must be on.

Refer to Communication Settings on page 5-114.



*Though the system can be set to not call 911, doing so will defeat the purpose of the system. Mazda recommends that the Mobile 911 system remain activated.*

## **NOTE**

- **Mobile 911 is a secondary function of the audio entertainment system. Therefore, the mobile 911 function does not assure that the call is always made to 911 after an accident occurs.**
- *A Hands-free device must be paired and connected. The 911 operator can verify the vehicle's position information using the Hands-free device GPS if equipped. The 911 operator can verify the vehicle's position information.*

1. If the vehicle is involved in a moderate to severe collision, notification of the call to 911 is made via audio and screen display. To cancel the call, press **Cancel Emergency Assistance Call** or hang-up button within 10 seconds.
2. If **Cancel Emergency Assistance Call** or hang-up button is not pressed within 10 seconds, the call is made to 911 automatically.

## ▼ Receiving an Incoming Call









When an incoming call is received, the incoming call notification screen is displayed. The “Incoming Call Notifications” setting must be on.

Refer to Communication Settings on page 5-114.

To accept the call, press the pick-up button on the audio control switch or select **Answer** on the screen.

To reject the call, press the hang-up button on the audio control switch or select **Ignore** on the screen.

The following icons are displayed on the screen during a call. Icons which can be used differ depending on use conditions.

Icon	Function
	Displays the Communication menu.
	Ends the call.
	<b>Transferring a call from hands-free to a mobile phone</b> Communication between the hands-free unit and a device (Mobile phone) is canceled, and the line can be switched to the device (Mobile phone) as a standard call.
	<b>Transferring a call from a device (mobile phone) to hands-free</b> Communication between devices (mobile phone) can be switched to Bluetooth® Hands-Free.
	<b>Mute</b> The microphone can be muted during a call. When selected again, the mute is canceled.
	A call is made to other person during a call and a 3-way call can be made. Select the contact from the following to make a call. <b>Call History</b> : Call History is displayed. <b>Contacts</b> : The phonebook is displayed. <b>Dial</b> : The dial pad is displayed. Input the phone number. The device may be unusable depending on the contractual content.
	The call on hold is made to make a 3-way call. The device may be unusable depending on the contractual content.
	Switches the call on hold.
	<b>DTMF (Dual Tone Multi-Frequency Signal) Transmission</b> This function is used when transmitting DTMF via the dial pad. The receiver of a DTMF transmission is generally a home telephone answering machine or a company's automated guidance call center. Input the number using a dial pad.

## **NOTE**

- *If the ignition is switched off during a hands-free call, the line is transferred to the device (Mobile phone) automatically.*
- *If the DTMF code has two or more digits or symbols, each one must be transmitted individually.*

## **▼ Call Interrupt**

A call can be interrupted to receive an incoming call from a third party.

When **Hold + Answer** is selected or the pick-up button on the steering wheel is pressed, the current call is held and the system switches to the new incoming call.

When **End + Answer** is selected, the current call is ended and the system switches to the new incoming call (GSM network only).

When **Ignore** is selected or the hang-up button on the steering wheel is pressed, an incoming call is refused.

## **NOTE**

- *The function may not be available depending on the contractual content of the mobile device.*
- *The function may not be operable depending on the type of the telephone network and the mobile device.*



## ▼ Receiving and Replying to Messages (available only with Email/SMS compatible phones)

SMS (Short Message Service) messages, and E-mail received by connected devices can be downloaded, displayed, and played (read by the system).

Additionally, replies can also be made to calls and messages in the received messages.

### **Downloading messages**

Up to 20 new messages can be downloaded and displayed from a connected device.

#### **NOTE**

*For e-mail, 20 messages for each account can be downloaded.*

### **(Automatic downloading)**

The “Auto Download Email” (E-mail) or “Auto Download Text Message” (SMS) setting must be on. A message is downloaded automatically when the Bluetooth® unit is connected to the device. Refer to Communication Settings on page 5-114.

### **(Manually downloading)**

When the “Auto Download Email” (E-mail) or “Auto Download Text Message” (SMS) setting is off, the message is downloaded using the following procedure.

1. Select the  icon on the home screen and display the Communication screen.
2. Select **Email** or **Text Messages** to display the Inbox.
3. Select **Update Inbox**.
4. Download will be started from the mobile phone.

#### **NOTE**

- *Attached data is not downloaded.*
- *Messages up to 1 kilobyte (e-mail)/140-bytes (SMS) can be downloaded.*
- *A message list is created for each device.*
- *If the connected device does not correspond to MAP 1.0, the AT command is used to download. The downloaded message indicates that it is already read.*
- *Downloading using the AT command may not function depending on the connected device.*

### **Receiving messages**

#### **(Method 1)**

When a device receives a message, a message received notification is displayed. The “Email Notifications” (E-mail) or “Text Notifications” (SMS) setting must be on.









Refer to Communication Settings on page 5-114.

Select **Read** and display the message.

#### **(Method 2)**

1. Select the  icon on the home screen and display the Communication screen.
2. Select **Notifications** and display the new message list for e-mail and SMS.
3. Select the message you would like to display.

The following icons are displayed in the lower part of the details on the message. Icons which can be used differ depending on use conditions.

Icon	Function
	Displays the Communication menu.
	Displays the inbox.
	Plays back a message. When selected again, playback is temporarily stopped.
	Displays the previous message.
	Displays the next message.
	Only replies to the sender of the currently displayed message. Select the sentence on the displayed reply screen and select the sentence for sending from the preset message. Select <b>Send</b> .
	<b>(Only E-mail)</b> Replies to all members including CC. Select the sentence on the displayed reply screen and select the sentence for sending from the preset message. Select <b>Send</b> .
	Makes a call to a person who sent a message. For E-mail, this function may not work depending on the device.
	Deletes a message. The messages stored in a device is also deleted.

**NOTE**

*Up to three preset messages can be selected.*

### Example of use (verify unread E-mail)

1. Select the  icon on the home screen and display the Communication screen.
2. Select **Email** to display the inbox.





3. Select the unread message displayed in bold.
4. The details of the message are displayed and replying to the message, making a call, or playback can be performed.



### Changing account for displaying (E-mail only)

1. Select **Inbox**.
2. Select the account which you would like to display. Only the messages for the selected account are displayed in the inbox.

### Editing preset messages

1. Select the  icon on the home screen and display the Communication screen.
2. Select **Settings**.
3. Select **Edit Preset Messages**.
4. Select the preset message which you would like to edit. The keyboard screen is displayed.
5. When the message is input and  is selected, the message is stored as a preset message.

### NOTE

- Select the  icon to change the language.
- Select the  icon to switch between capitalized and lower-case characters.
- Select the  icon to return to the previous screen without storing the edit.

**▼ Communication Settings**

Select the  icon on the home screen and display the Communication screen.  
Select **Settings** to change the setting.

Item	Setting	Function
Bluetooth®	—	Go to Bluetooth® setting menu. Refer to Bluetooth® Preparation (Type B) on page 5-94.
Incoming Call Notifications	On/Off	Notifies when an incoming call is received.
Auto Download Text Message	On/Off	Downloads SMS automatically when the Bluetooth® unit is connected to the device.
Text Notifications	On/Off	Notifies when a new SMS is received.
Auto Download Email* <sup>1</sup>	On/Off	Downloads E-mail automatically when the Bluetooth® unit is connected to the device.
Email Notifications	On/Off	Notifies when a new Email is received.
Auto Download Call History	On/Off	Downloads Call History automatically when the Bluetooth® unit is connected to the device.
Auto Download Contacts* <sup>1</sup>	On/Off	Downloads the phonebook automatically when the Bluetooth® unit is connected to the device.
Ringtone	Car/Phone/Off	Changes the ringtone setting.
Phone Volume	Adjusts using the slider.	Adjusts the conversation volume.
VR and Ringtone	Adjusts using the slider.	Adjusts the voice guidance and ringtone volume.
Contacts Display Order	First Name, Last Name	Displays the contact information in alphabetical order of the first name.
	Last Name, First Name	Displays the contact information in alphabetical order of the last name.
Edit Preset Messages	—	Edits the preset message. Refer to Receiving and Replying to Messages (available only with E-mail/SMS compatible phones) on page 5-111.
Emergency Assistance Call	On/Off	Mobile Utilizes the Mobile 911 function.
Restore Factory settings	—	Initializes all Communication Settings.

\*1 Depending on the device, it may be necessary to acquire download permission on the device side.

## Bluetooth® Audio (Type A)\*

### Applicable Bluetooth® specification (Recommended)

Ver. 2.0

### Response profile

- A2DP (Advanced Audio Distribution Profile) Ver. 1.0/1.2
- AVRCP (Audio/Video Remote Control Profile) Ver. 1.0/1.3

A2DP is a profile which transmits only audio to the Bluetooth® unit. If your Bluetooth® audio device corresponds only to A2DP, but not AVRCP, you cannot operate it using the control panel of the vehicle's audio system. In this case, only the operations on the mobile device are available the same as when a portable audio device for a non-compliant Bluetooth® device is connected to the AUX terminal.

Function	A2DP	AVRCP	
		Ver. 1.0	Ver. 1.3
Playback	—	X	X
Pause	—	X	X
File (Track) up/down	—	X	X
Reverse	—	—	X
Fast-forward	—	—	X
Text display	—	—	X

X: Available

—: Not available

### NOTE

- The battery consumption of Bluetooth® audio devices increases while Bluetooth® is connected.
- If a general mobile phone device is USB connected during music playback over the Bluetooth® connection, the Bluetooth® connection is disconnected. For this reason, you cannot have music playback over a Bluetooth® connection and music playback using a USB connection at the same time.
- The system may not operate normally depending on the Bluetooth® audio device.

### ▼ How to Use the Bluetooth® Audio System

#### Switching to Bluetooth® audio mode

To listen to music or voice audio recorded to a Bluetooth® audio device, switch to the Bluetooth® audio mode to operate the audio device using the audio system control panel. Any Bluetooth® audio device must be paired to the vehicle's Bluetooth® unit before it can be used. Refer to Bluetooth® Preparation (Type A) on page 5-80.

1. Turn on the Bluetooth® audio device's power.
2. Switch the ignition to ACC or ON. Make sure that the “♪” symbol is displayed in the audio display. The symbol is not displayed if an un-paired Bluetooth® audio device is being used or the vehicle's Bluetooth® unit has a malfunction.

### NOTE

Some Bluetooth® audio devices need a certain amount of time before the “♪” symbol is displayed.

# Bluetooth®

- Press the media button (**MEDIA**) to switch to the Bluetooth® audio mode and start playback.

**If the current device version is lower than AVRCP Ver. 1.3:** “BT Audio” is displayed.

**If the current device is AVRCP Ver. 1.3:** The playback time is displayed.

### NOTE

- If the Bluetooth® audio device does not begin playback, press the Play/Pause button (4).
- If a call is received on a hands-free mobile phone during playback from the Bluetooth® audio device, the playback is stopped. Playback from the Bluetooth® audio device resumes after the call ends.

### Playback

- To listen to a Bluetooth® audio device over the vehicle's speaker system, switch the mode to Bluetooth® audio mode. (Refer to “Switching to Bluetooth® audio mode”)
- To stop playback, press the Play/Pause button (4).
- Press the button again to resume playback.

### Selecting a file (track)

#### Selects the next file (track)

Short-press the track up button (▶▶).

#### Selects the beginning of the current file (track)

Short-press the track down button (◀◀).

### Fast-forward/Reverse (AVRCP Ver. 1.3)

#### Fast-forward

Press and hold the fast-forward button (▶▶).

#### Reverse

Press and hold the reverse down button (◀◀).

### Switching the display (only AVRCP Ver. 1.3)

For files with a song title and other information that have been input, the display switches between display of the song title and other information each time the text button (3) is pressed during playback.

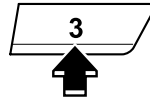

Playback time



Album title



Song title



Artist name

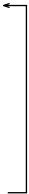

### NOTE

- If title information is not available, “NO TITLE” is displayed.
- This unit cannot display some characters. Characters which cannot be displayed are indicated by an asterisk (\*).

**Display scroll**

Only 13 characters can be displayed at one time. To display the rest of the characters of a long title, press and hold the text button (3). The display scrolls the next 13 characters. Press and hold the text button (3) again after the last 13 characters have been displayed to return to the beginning of the title.

**▼ Bluetooth® Audio Device Information Display**

If a Bluetooth® audio device is connected, the following information is displayed in the audio display.

	AVRCP Ver. lower than 1.3	AVRCP Ver. 1.3
Device name	X	X
Title	—	X
Artist name	—	X
Album name	—	X
File number	—	X
Playback time	—	X
Folder number	—	—

X: Available  
 —: Not available

**NOTE**

*Some information may not display depending on the device, and if the information cannot be displayed, “NO TITLE” is indicated.*

**Bluetooth® Audio (Type B)\***

**Applicable Bluetooth® specification (Recommended)**

Ver. 1.1/1.2/2.0 + EDR/2.1 + EDR/3.0 (conformity)

**Response profile**

- A2DP (Advanced Audio Distribution Profile) Ver. 1.0/1.2
- AVRCP (Audio/Video Remote Control Profile) Ver. 1.0/1.3/1.4

**Bluetooth®**

A2DP is a profile which transmits only audio to the Bluetooth® unit. If your Bluetooth® audio device corresponds only to A2DP, but not AVRCP, you cannot operate it using the control panel of the vehicle's audio system. In this case, only the operations on the mobile device are available the same as when a portable audio device for a non-compliant Bluetooth® device is connected to the AUX terminal.

Function	A2DP	AVRCP		
		Ver. 1.0	Ver. 1.3	Ver. 1.4
Playback	X	X	X	X
Pause	X	X	X	X
File (Track) up/down	—	X	X	X
Reverse	—	—	X	X
Fast-forward	—	—	X	X
Text display	—	—	X	X
Repeat	—	—	Depends on device	Depends on device
Shuffle	—	—	Depends on device	Depends on device
Scan	—	—	Depends on device	Depends on device
Folder up/down	—	—	—	Depends on device

X: Available

—: Not available

**NOTE**

- *The battery consumption of Bluetooth® audio devices increases while Bluetooth® is connected.*
- *If a general mobile phone device is USB connected during music playback over the Bluetooth® connection, the Bluetooth® connection is disconnected. For this reason, you cannot have music playback over a Bluetooth® connection and music playback using a USB connection at the same time.*
- *The system may not operate normally depending on the Bluetooth® audio device.*



## ▼ How to Use the Bluetooth® Audio System

### Switching to Bluetooth® audio mode

To listen to music or voice audio recorded to a Bluetooth® audio device, switch to the Bluetooth® audio mode to operate the audio device using the audio system control panel. Any Bluetooth® audio device must be paired to the vehicle's Bluetooth® unit before it can be used.

Refer to Bluetooth® Preparation (Type B) on page 5-94.

1. Turn on the Bluetooth® audio device's power.
2. Switch the ignition to ACC or ON.
3. Select the  icon on the home screen and display the Entertainment screen.
4. When Bluetooth® is selected, switches to the Bluetooth® audio mode to begin playback.





### **NOTE**





- If Bluetooth® audio is used after using Pandora®, Aha™ or Stitcher™ radio, the application on the mobile device has to be closed first.
- If the Bluetooth® audio device does not begin playback, select the  icon.
- If the mode is switched from Bluetooth® audio mode to another mode (radio mode), audio playback from the Bluetooth® audio device stops.

### Playback

To listen to a Bluetooth® audio device over the vehicle's speaker system, switch the mode to Bluetooth® audio mode. (Refer to “Switching to Bluetooth® audio mode”)

After switching to the Bluetooth® audio mode, the following icons are displayed in the lower part of the display. Icons which can be used differ depending on the version of the Bluetooth® audio device which you are currently using.

Icon	Function
	Displays the Entertainment menu. Use to switch to a different audio source.
	<b>(AVRCP Ver. 1.4 only)</b> Displays the top level folder/file list. Select the folder which you want to select. The files in the selected folder are displayed. Select the file you want to play.
	<b>(AVRCP Ver. 1.3 or higher)</b> Replays the song currently being played repeatedly. When selected again, the songs in the folder are played repeatedly. Select it again to cancel. Icons change when the song is repeated or the folder is repeated.
	<b>(AVRCP Ver. 1.3 or higher)</b> Plays songs in the folder in random order. When selected again, the songs on the device are played in random order. Select it again to cancel. Icons change during folder shuffle or device shuffle.

Icon	Function
	<p>Scans the titles in a folder and plays the beginning of each song to aid in finding a desired song.</p> <p>When selected again, the beginning of each song on the device is played.</p> <p>When selected again, the operation is canceled and the song currently being played continues.</p>
	<p>Returns to the beginning of the previous song.</p> <p>Long-press to fast reverse. It stops when you remove your hand from the icon or the commander knob.</p>
	<p>Plays the Bluetooth® audio. When selected again, playback is temporarily stopped.</p>
	<p>Advances to the beginning of the next song.</p> <p>Long-press to fast forward. It stops when you remove your hand from the icon or the commander knob.</p>
	<p>Displays sound settings to adjust audio quality level.</p> <p>Refer to Volume/Display/Sound Controls on page 5-42.</p>

**Example of use (When searching for a song from the top level of a device)**

1. Select the  icon and display the folder/file list at the top level.

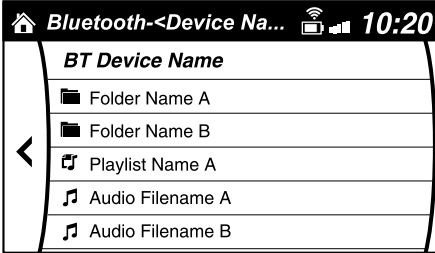

2. When the folder is selected, folders/file lists in the folder are displayed. When the playlist is selected, the file list is displayed.
3. Select the desired song.

**NOTE**

Select  to move to a folder one level higher.

**▼ Bluetooth® Audio Device Information Display**

If a Bluetooth® audio device is connected, the following information is displayed in the center display.

	AVRCP Ver. lower than 1.3	AVRCP Ver. 1.3	AVRCP Ver. 1.4 or higher
Device name	X	X	X
Remaining battery charge of device	X	X	X
Song name	—	X	X
Artist name	—	X	X
Album name	—	X	X
Playback time	—	X	X
Genre name	—	X	X
Album art image	—	—	—

X: Available  
 —: Not available

**NOTE**

Some information may not display depending on the device, and if the information cannot be displayed, "Unknown - - -" is indicated.

**Bluetooth®****▼ How to Use Pandora®\*****What is Pandora®?**

Pandora® is free personalized Internet radio. Simply enter a favorite artist, track, genre, and Pandora® will create a personalized station that plays their music and more like it. Rate songs by giving thumbs-up and thumbs-down feedback to further refine your station, discover new music and help Pandora® play only music you like.

\* Pandora®, the Pandora® logo, and the Pandora® trade dress are trademarks or registered trademarks of Pandora Media, Inc., used with permission.









**NOTE**

To operate Pandora® from your Bluetooth® device, perform the following in advance:

- Create Pandora® account on the Web.
- Create Pandora® station using Pandora® application.
- Install Pandora® application on your device.

**Playback**

Select the  icon on the home screen and display the Entertainment screen. When Pandora is selected, the following icons are indicated in the bottom part of the center display.

Icon	Function
	Displays the Entertainment menu. Use to switch to a different audio source.
	Displays the station list. Use to switch to other stations.
	<b>Thumbs-Down</b> Press the  icon to tell Pandora® not to play this track.
	<b>Thumbs-Up</b> Press the  icon to tell Pandora® “you like this track” and it helps to bring in more tracks like it to your station.
	<b>Bookmarking</b> Bookmarks the song or artist currently being played.
	Plays the track. When selected again, playback is temporarily stopped.
	Goes to the next song.

Icon	Function
	Displays sound settings to adjust audio quality level. Refer to Volume/Display/Sound Controls on page 5-42.

**NOTE**

- The skip function may not be available depending on the device.
- The number of skips is limited by Pandora®.
- If the  icon is selected when the skip song function is running, the next song is skipped.

**Selection from station list**

Selection can be made from a programmed radio station list.

1. Select the  icon.
2. Select the desired radio station.

**NOTE**

When **Shuffle** is selected, songs randomly selected from the radio station list are played.

**Selecting the sort method**

The displayed order of the station list can be changed.

1. Select the  icon.
2. Select **Sort By:**.
3. Select **Date** to display in the order starting from the newly created station.
4. Select **A-Z** to display in alphabetical order.

**NOTE**

The displayed order of **Shuffle** cannot be changed.

**Bookmarking**

You can bookmark song or artist to check out later on the Web.

1. Select the  icon.
2. Select **Bookmark Song** to bookmark the song.
3. Select **Bookmark Artist** to bookmark the artist.

**Bluetooth®****▼ How to Use Aha™\***

Aha is an application which can be used to enjoy various Internet content such as Internet radio and podcasts.

Stay connected to your friends activities by getting updates from Facebook and Twitter.

Using the location-based service, nearby services and destinations can be searched or real-time local information can be obtained.



For details on Aha, refer to “<http://www.aharadio.com/>”.

\* Aha, the Aha logo, and the Aha trade dress are trademarks or registered trademarks of Harman International Industries, Inc., used with permission.





**NOTE**









- *The service content provided by Aha varies depending on the country in which the user resides. In addition, the service is not available in some countries.*
- *To operate Aha from your Bluetooth® device, perform the following in advance:*
  - *Install the Aha application to your device.*
  - *Create an Aha account for your device.*
  - *Log onto Aha using your device.*
  - *Select the preset station on your device.*

**Playback**

Select the  icon on the home screen and display the Entertainment screen. When  is selected, the following icons are displayed at the bottom of the center display. The displayed icon differs depending on the selected station.

In addition, icons other than the following icons may be displayed.

Icon	Function
	Displays the Entertainment menu. Use to switch to a different audio source.
	Displays the main menu. Use to switch to other stations.
	Displays the content list. Use to switch to other desired content on the station.
	<b>Shout</b> Records voice. Records voice and posts it as playable audio to Facebook and other social stations.
	<b>Like<sup>1</sup></b> Evaluates the current content as “Like”.

Icon	Function
	<b>Dislike*</b> <sup>1</sup> Evaluates the current content as “Dislike”.
	Reverses for 15 seconds.
	<b>Map (vehicles with navigation system)</b> Displays the destination searched by the location based services on the navigation system.
	<b>Call</b> A call can be made to the telephone number of a shop searched using the Location Based Services. Available when a device is connected as a Hands-Free.
	Returns to the previous content.
	Pauses playback of the content. When selected again, playback resumes.
	Goes to the next content.
	Fast-forwards for 30 seconds.
	Displays sound settings to adjust audio quality level. Refer to Volume/Display/Sound Controls on page 5-42.

\*1 Some stations may use alternate variations of Like and Dislike, based on station type or provider.

## Main menu

Select the  icon.

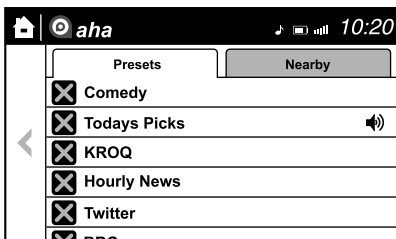

**Bluetooth®**

---

Switch the tab and select the station category.

<b>Tab</b>	<b>Function</b>
Presets	Displays the preset station list set on the device. Select the preset station name to play the station content.
Nearby	Select the desired station. Guidance is provided to the searched destination near the vehicle's position. You can designate desired categories previously set using the filter setting on your device.

**NOTE**

*The available Location Based Services may differ because the services depend on the content provided by Aha™.*



**Example of use (Location Based Services)**

1. Select the desired station from the Nearby tab on the main menu.  
 The destination name or address playback starts in the order of the destination name list.



2. When the 📍 icon is selected, the currently displayed destination is displayed on the navigation system (vehicles with navigation system).
3. When the ☎ icon is selected, a phone call is placed to the currently displayed destination.
4. Select the 📁 icon and display the content list.  
 Selection of other destinations from the list can be made.

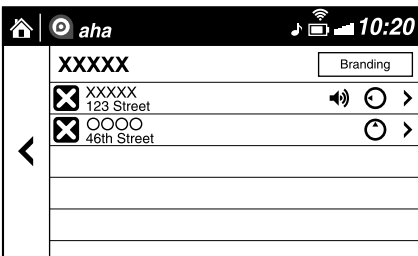

**Shout**

Some social stations, such as Facebook or Karaoke, support the ability to record and share voice messages using the “Shout” function.

1. Select the 🗣 icon and start the countdown (3, 2, 1, 0). Recording starts when the countdown reaches zero.
2. Records voice.
3. Select **Save** and store/post the recording.

**NOTE**

- Recordable time varies depending on the station (Max. 30 seconds).
- Recording stops automatically when the recordable time has elapsed. You can then post or delete the recording.

**▼ How to Use Stitcher™ Radio****What is Stitcher™ Radio?**

Stitcher™ Radio is an application for streaming Internet radio or podcasts on demand. Recommended content is automatically selected by registering content which you put into your favorites, or by pressing the Like or Dislike button.

For details on Stitcher™ Radio, refer to “<http://stitcher.com/>”.



\*Stitcher™, the Stitcher™ logo, and the Stitcher™ trade dress are trademarks or registered trademarks of Stitcher, Inc., used with permission.







**NOTE**



To operate Stitcher™ Radio from your Bluetooth® device, perform the following in advance:

- Install the Stitcher™ Radio application to your device.
- Create a Stitcher™ Radio account for your device.
- Log onto Stitcher™ Radio using your device.

**Playback**

Select the Entertainment screen and display the  icon on the home screen. When  is selected, the following icons are indicated in the bottom part of the center display.

Icon	Function
	Displays the Entertainment menu. Use to switch to a different audio source.
	Displays the station list. Use to switch to other stations.
	<b>Dislike</b> Evaluates the current program as “Dislike”.
	<b>Like</b> Evaluates the current program as “Like”.
	Adds the current station to your favorites or deletes the current station from your favorites.
	Reverses for 30 seconds.
	Plays the station. Select it again to pause playback.

Icon	Function
	Goes to the next station.
	Displays sound settings to adjust audio quality level. Refer to Volume/Display/Sound Controls on page 5-42.

### Station list

- Select the  icon and display the station list.
  - Favorites station name: Select to display the program registered to your favorites.
  - Category name: A recommended category selected from your favorites by Stitcher™ is displayed.  
 Select it to display the category program.

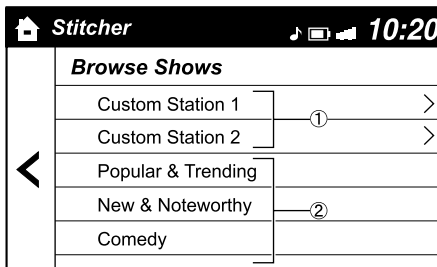

- Select the program name to play it.

## Add to your favorites

If the current program has not been registered to your favorites, it can be registered to your favorites.

1. Select the ★ icon to display the favorites station which the registration can be added.
2. Select the station name which you want to register.
3. Select **[OK]** to add the program to the selected favorites station.

## NOTE

- *Multiple favorites stations can be selected and registered.*
- *Favorites stations registered by oneself as well those set by default are displayed.*

## Delete from your favorites

If the current program has already been registered to your favorites, the program can be deleted from your favorites.

1. Select the ★ icon.
2. The program is automatically deleted from the favorites station.

## Troubleshooting\*

### **Mazda Bluetooth® Hands-Free Customer Service**

If you have any problems with Bluetooth®, contact our toll-free customer service center.

- **U.S.A.**  
Phone: 800-430-0153 (Toll-free)  
Web: [www.MazdaUSA.com/bluetooth](http://www.MazdaUSA.com/bluetooth)
- **Canada**  
Phone: 800-430-0153 (Toll-free)  
Web: [www.mazdahandsfree.ca](http://www.mazdahandsfree.ca)
- **Mexico**  
Center of Attention to Client (CAC)  
Phone: 01-800-01-MAZDA (Toll-free)  
Web: [www.mazdamexico.com.mx](http://www.mazdamexico.com.mx)

### **Bluetooth® Device pairing, connection problems**

Symptom	Cause	Solution method
Unable to perform pairing	—	First make sure the device is compatible with the Bluetooth® unit, and then check whether the Bluetooth® function and the Find Mode/Visible setting*1 on the device are turned on. If pairing is still not possible after this, contact an Authorized Mazda Dealer or Mazda Bluetooth® Hands-Free Customer Service.
Pairing cannot be performed again	The pairing information paired to the Bluetooth® unit or device is not recognized correctly.	Perform pairing using the following procedure. *Clear “Mazda” stored in the device. *Perform pairing again.
Unable to perform pairing	The Bluetooth® function and the Find Mode/Visible setting*1 on the device may turn off automatically after a period of time has elapsed depending on the device.	Check whether the Bluetooth® function and the Find Mode/Visible setting*1 on the device are turned on and pairing or reconnect.
Does not connect automatically when starting the engine		
Automatically connects, but then disconnects suddenly		
Disconnects intermittently	The device is in a location in which radio wave interference can occur easily, such as inside a bag in a rear seat, in a rear pocket of a pair of pants.	Move the device to a location in which radio wave interference is less likely to occur.
Does not connect automatically when starting the engine	The pairing information is updated when the device OS is updated.	Perform pairing again.

\*1 Setting which detects the existence of a device external to the Bluetooth® unit

**NOTE**

- When you update the operating system of your mobile device the pairing information may be invalidated. Therefore, the device may need to be re-paired to the hands-free unit.
- If you pair your phone which has already been paired to your vehicle more than once in the past, you need to delete “Mazda” on your mobile device. Then, execute the Bluetooth® search on your mobile device once again, and pair to a newly detected “Mazda”.
- Before you pair your device, make sure that Bluetooth® is “ON”, both on your phone and on the vehicle.

**Voice recognition related problems**

Symptom	Cause	Solution method
Poor voice recognition	<ul style="list-style-type: none"> <li>•Excessive, slow speech.</li> <li>•Excessive, forceful speech (shouting).</li> <li>•Speaking before the beep sound has ended.</li> <li>•Loud noise (speaking or noise from outside/inside vehicle).</li> <li>•Airflow from A/C is blowing against the microphone.</li> <li>•Speaking in off-standard expressions (dialect).</li> </ul>	Regarding the causes indicated on the left, be careful with how you speak. In addition, when numbers are spoken in a sequence, recognition ability will improve if no stop is placed between the numbers.
False recognition of numbers		
Poor voice recognition	There is a malfunction in the microphone.	A poor connection or malfunction with the microphone may have occurred. Consult an Authorized Mazda Dealer.
Phone-related voice recognition is disabled	There is a problem with the connection between the Bluetooth® unit and the device.	If there is any malfunction after checking the pairing situation, check for device pairing or connection problems.
Names in the phonebook are not easily recognized	The Bluetooth® system is under a condition in which recognition is difficult.	By carrying out the following measures, the rate of recognition will improve. <ul style="list-style-type: none"> <li>•Clear memory from the phonebook which is not used very often.</li> <li>•Avoid shortened names, use full names. (Recognition improves the longer the name is. By not using names such as “Mom”, “Dad”, recognition will improve.)</li> </ul>
When operating the audio, a song name is not recognized	Song names cannot be recognized by voice.	—
You want to skip guidance	—	Guidance can be skipped by quickly pressing and releasing the Talk button.

**Regarding problems with calls**

Symptom	Cause	Solution method
When starting a call, vehicle noise from the other party can be heard	For about three seconds after starting a call, the Bluetooth® unit's Noise Suppression function requires time to adapt to the call environment.	This does not indicate a problem with the device.
The other party cannot be heard or the speaker's voice is quiet	The volume is set at zero or low.	Increase the volume.

**Other problems**

Symptom	Cause	Solution method
The indication for the remaining battery is different between the vehicle and the device	The indication method is different between the vehicle and the device.	—
When a call is made from the vehicle, the telephone number is updated in the incoming/outgoing call record but the name does not appear	The number has not been registered into the phonebook.	If the number has been registered into the phonebook, the incoming/outgoing call record is updated by the name in the phonebook when the engine is restarted.
The cell phone does not synchronize with the vehicle regarding the incoming/outgoing call record	Some types of cell phones do not synchronize automatically.	Operate the cell phone for synchronization.
It takes a long time to complete the function for changing the language	A maximum of 60 seconds is required.	—

# Interior Equipment

## Sunvisors

When you need a sunvisor, lower it for use in front or swing it to the side.

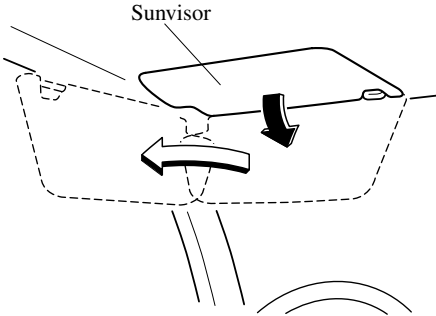

### ▼ Side Extension Sunvisors\*

The visor extender extends the sunvisor's range of sun shading.

To use, pull it out.

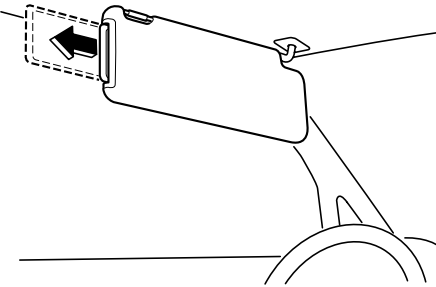

### **CAUTION**

*When moving the sunvisor, retract the visor extender to its original position. Otherwise, the visor extender could hit the rearview mirror.*

### ▼ Vanity Mirrors

To use the vanity mirror, lower the sunvisor.

If your vehicle is equipped with a vanity mirror light, it will illuminate when you open the cover.

To prevent the battery from being discharged, the vanity mirror will only illuminate in the tilt range shown below.

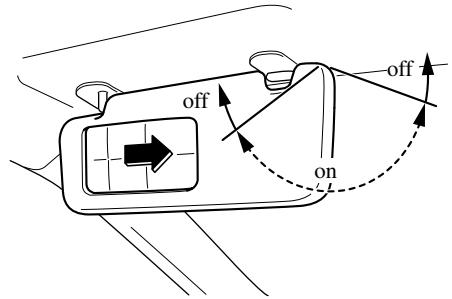



## Interior Lights

### Overhead Lights

Switch Position	Overhead Lights
OFF	Light off
DOOR	<ul style="list-style-type: none"> <li>•Light is on when any door is open</li> <li>•Light is on or off when the illuminated entry system is on</li> </ul>
ON	Light on

### With Map Lights

Front

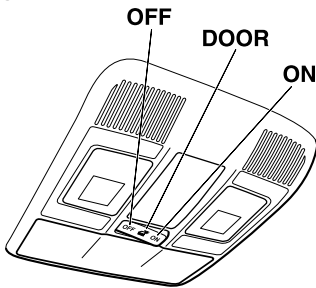

Rear

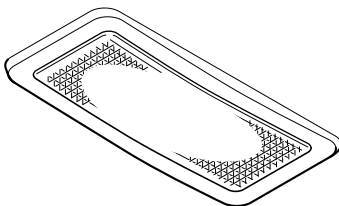

### Without Map Lights

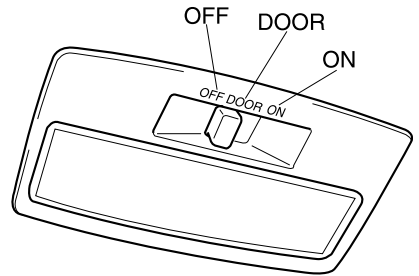

### NOTE

#### (With map lights)

The map lights and rear overhead light also turn on and off when the front overhead light switch is operated.

### Map Lights\*

When the overhead light switch is in the door or off position, press the lens to illuminate the map lights, and then press the lens again to turn them off.

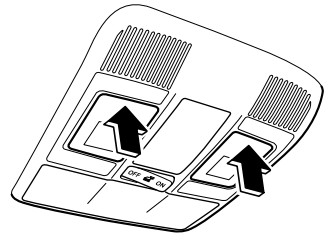

### NOTE

The map lights will not turn off even if the lens is pressed in the following cases:

- The overhead light switch is in the ON position.
- The overhead light switch is in the door position with the door open.
- The illuminated entry system is on.

# Interior Equipment

## Luggage Compartment Lights (5-door)

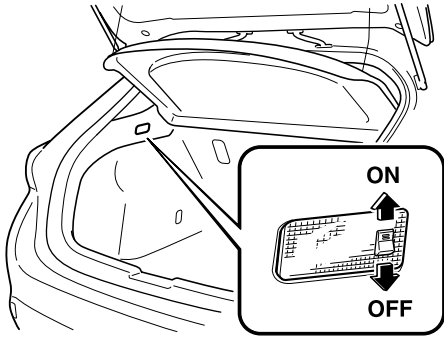

Switch Position	Luggage Compartment Light
OFF	Light off
ON	Light on when the liftgate is open

## Trunk Light (4-door)

The trunk light is on when the lid is open and off when it's closed.

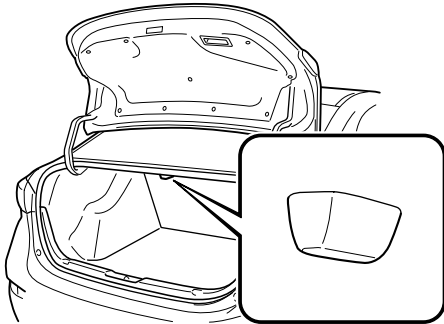

### **NOTE**

To prevent the battery from being discharged, do not leave the trunk open for a long period when the engine is not running.

## ▼ Illuminated Entry System

When the illuminated entry system operates, the overhead light (switch is in the DOOR position) turn on for:

- About 30 seconds after the driver's door is unlocked and the ignition is switched off.
- About 15 seconds after all doors are closed and the ignition is switched off.
- About 5 seconds after all doors are closed and the ignition is switched off when the key is out of the vehicle.
- Illuminates for about 15 seconds when the ignition is returned from ACC to OFF.

The light also turns off when:

- The ignition is switched on and all doors are closed.
- The driver's door is locked.

### **NOTE**

#### • **Battery saver**

*If any door is left open with the overhead light switch in the DOOR position, or the liftgate/trunk lid is left open, the overhead light or luggage compartment light/trunk light turns off after about 30 minutes to prevent battery depletion.*

- *The operation of the illuminated entry system can be changed.*

*Refer to Personalization Features on page 9-12.*

## Accessory Sockets

Only use genuine Mazda accessories or the equivalent requiring no greater than 120 W (DC 12 V, 10 A).

### Type A

The accessory sockets can be used regardless of whether the ignition is on or off.

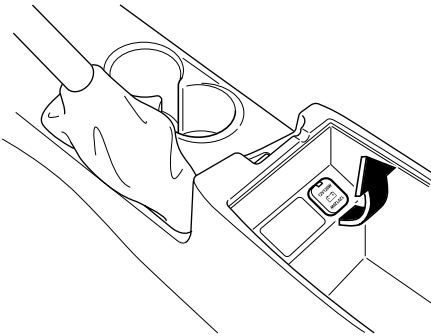

### Type B\*

The ignition must be switched to ACC or ON.

### With CD Player

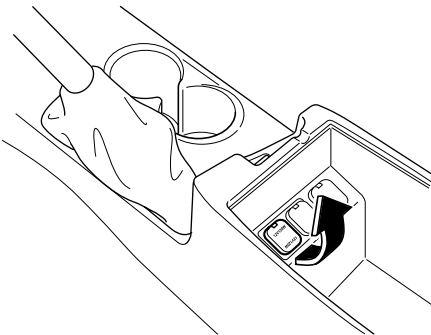

### Without CD Player

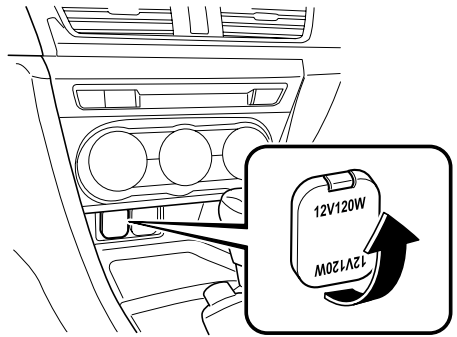

### ⚠ CAUTION

- To prevent accessory socket damage or electrical failure, pay attention to the following:
  - Do not use accessories that require more than 120 W (DC 12 V, 10 A).
  - Do not use accessories that are not genuine Mazda accessories or the equivalent.
  - Close the cover when the accessory socket is not in use to prevent foreign objects and liquids from getting into the accessory socket.
  - Correctly insert the plug into the accessory socket.
  - Do not insert the cigarette lighter into the accessory socket.

## Interior Equipment

- Noise may occur on the audio playback depending on the device connected to the accessory socket.
- Depending on the device connected to the accessory socket, the vehicle's electrical system may be affected, which could cause the warning light to illuminate. Disconnect the connected device and make sure that the problem is resolved. If the problem is resolved, disconnect the device from the socket and switch the ignition off. If the problem is not resolved, consult an Authorized Mazda Dealer.

### NOTE

To prevent discharging of the battery, do not use the socket for long periods with the engine off or idling.

### Connecting the accessory socket

1. Open the lid.
2. Pass the connection plug cord through the cutout of the console and insert the plug into the accessory socket.

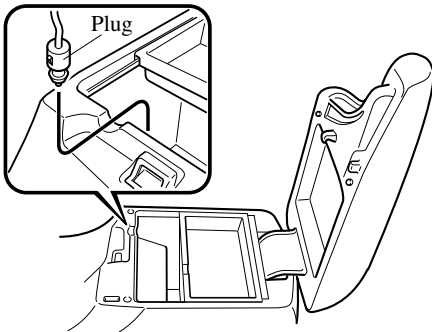

## Cup Holder

### **⚠ WARNING**

**Never use a cup holder to hold hot liquids while the vehicle is moving:**

Using a cup holder to hold hot liquids while the vehicle is moving is dangerous. If the contents spill, you could be scalded.

**Do not put anything other than cups or drink cans in cup holders:**

Putting objects other than cups or drink cans in a cup holder is dangerous.

During sudden braking or maneuvering, occupants could be hit and injured, or objects could be thrown around the vehicle, causing interference with the driver and the possibility of an accident. Only use a cup holder for cups or drink cans.

### ▼ Front

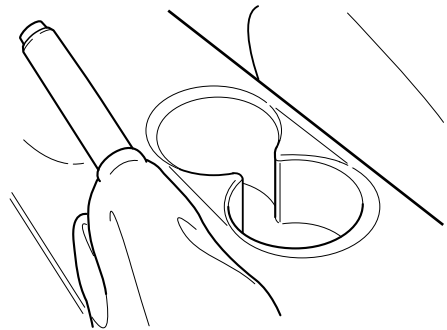

**▼ Rear\***

The rear cup holder is on the rear center armrest.

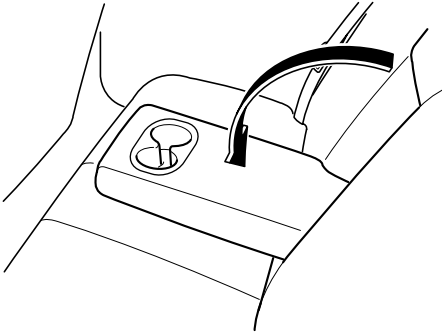
**Bottle Holder**

Bottle holders are on the inside of the doors.

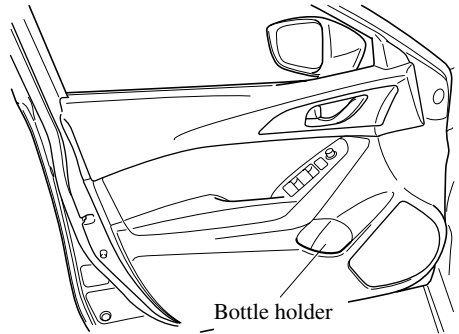
**⚠ CAUTION**

*Do not use the bottle holders for containers without caps. The contents may spill when the door is opened or closed.*

# Interior Equipment

## Storage Compartments

### **! WARNING**

**Keep storage boxes closed when driving:**

*Driving with the storage boxes open is dangerous. To reduce the possibility of injury in an accident or a sudden stop, keep the storage boxes closed when driving.*

**Do not put articles in storage spaces with no lid:**

*Putting articles in storage spaces with no lid is dangerous as they could be thrown around the cabin if the vehicle is suddenly accelerated and cause injury depending on how the article is stored.*

### **! CAUTION**

*Do not leave lighters or eyeglasses in the storage boxes while parked under the sun. A lighter could explode or the plastic material in eyeglasses could deform and crack from high temperature.*

### ▼ Overhead Console\*

This console box is designed to store eyeglasses or other accessories. Push and release to open.

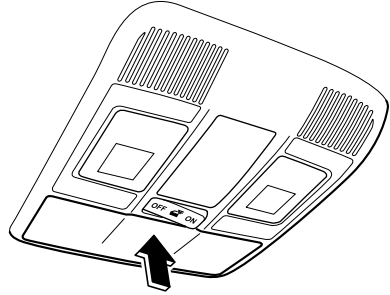

### ▼ Glove Compartment

To open the glove compartment, pull the latch toward you.

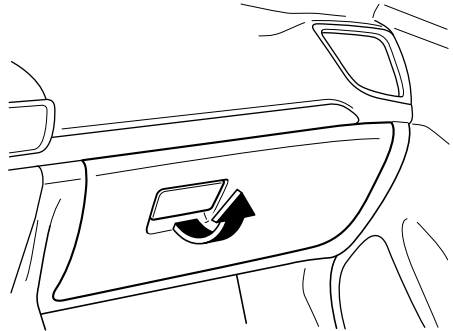

To close the glove compartment, firmly press in the center of the glove compartment lid.

## ▼ Center Console

To open, pull the release latch.

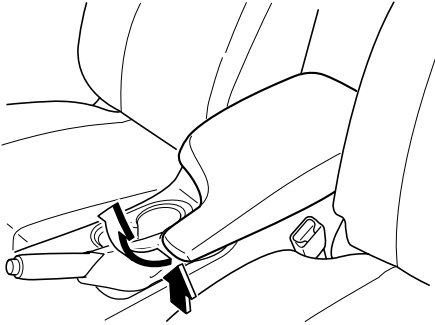

## Storage tray

The storage tray can be removed.

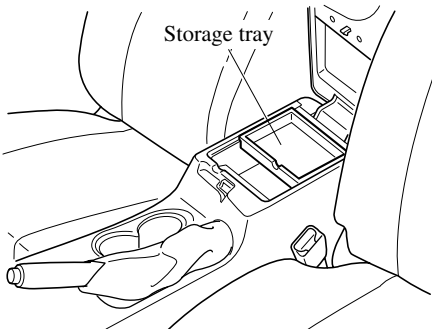

## ▼ Rear Coat Hooks

### **! WARNING**

**Never hang heavy or sharp objects on the assist grips and coat hooks:**

*Hanging heavy or sharp-ended objects such as a coat hanger from the assist grips or coat hooks is dangerous as they can fly off and hit an occupant in the cabin if a curtain air bag was to deploy, which could result in serious injury or death.*

Always hang clothes on the coat hooks and the assist grips without hangers.

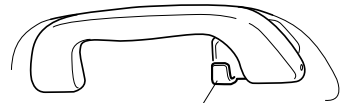

Coat hook

# MEMO



# 6

## Maintenance and Care

How to keep your Mazda in top condition.

<b>Essential Information .....</b>	<b>6-2</b>
Introduction .....	6-2
<b>Scheduled Maintenance.....</b>	<b>6-4</b>
Scheduled Maintenance (U.S.A., Canada, and Puerto Rico).....	6-4
Scheduled Maintenance (Mexico) .....	6-13
Maintenance Monitor.....	6-20
<b>Owner Maintenance.....</b>	<b>6-22</b>
Owner Maintenance Precautions .....	6-22
Hood.....	6-24
Engine Compartment Overview .....	6-26
Engine Oil .....	6-27
Engine Coolant.....	6-29
Brake/Clutch Fluid.....	6-31
Washer Fluid .....	6-31
Body Lubrication .....	6-32
Wiper Blades .....	6-33
Battery.....	6-37
Battery Replacement.....	6-39
Tires.....	6-42
Light Bulbs.....	6-46
Fuses .....	6-59
<b>Appearance Care.....</b>	<b>6-64</b>
Exterior Care .....	6-64
Interior Care .....	6-70

## Essential Information

---

### Introduction

Be extremely careful and prevent injury to yourself and others or damage to your vehicle when using this manual for inspection and maintenance.

If you are unsure about any procedure it describes, we strongly urge you to have a reliable and qualified service shop perform the work, preferably an Authorized Mazda Dealer.

Factory-trained Mazda technicians and genuine Mazda parts are best for your vehicle. Without this expertise and the parts that have been designed and made especially for your Mazda, inadequate, incomplete, and insufficient servicing may result in problems. This could lead to vehicle damage or an accident and injuries.

For expert advice and quality service, consult an Authorized Mazda Dealer.

To continue warranty eligibility and to protect your investment, it is your responsibility to properly maintain your vehicle according to factory recommended schedules outlined in this manual. As part of this you must keep your maintenance records, receipts, repair orders and any other documents as evidence this maintenance was performed. You must present these documents, should any warranty coverage disagreement occur. Failure to do so can result in your warranty being voided either in whole or in part.

This evidence may consist of the following:

- The Mazda Scheduled Maintenance Record, refer to the Warranty Booklet, must be completely filled out showing mileage, repair order number, date for each service, and signed by a qualified automotive service technician who service vehicles.
- Original copies of repair orders or other receipts that include the mileage and date the vehicle was serviced. Each receipt should be signed by a qualified automotive service technician.
- For self maintenance, a statement that you completed the maintenance yourself, displaying mileage and the date the work was performed. Also, receipts for the replacement parts (fluid, filters, etc.) indicating the date and mileage must accompany this statement.

#### **NOTE**

*If you elect to perform maintenance yourself or have your vehicle serviced at a location other than an Authorized Mazda Dealer, Mazda requires that all fluids, parts and materials must meet Mazda standards for durability and performance as described in this manual.*

Claims against the warranty resulting from lack of maintenance, as opposed to defective materials or authorized Mazda workmanship, will not be honored.

Any auto repair shop using parts equivalent to your Mazda's original equipment may perform maintenance. **But we recommend that it always be done by an Authorized Mazda Dealer using genuine Mazda parts.**

Selecting "Maintenance Monitor" enables the system to notify you of your vehicle's approaching inspection/servicing period (page 6-20).

## Scheduled Maintenance

---

### Scheduled Maintenance (U.S.A., Canada, and Puerto Rico)

Follow Schedule 1 if the vehicle is operated mainly where none of the following conditions (severe driving conditions) apply.

- Repeated short-distance driving
- Driving in dusty conditions
- Driving with extended use of brakes
- Driving in areas where salt or other corrosive materials are used
- Driving on rough or muddy roads
- Extended periods of idling or low-speed operation
- Driving for long periods in cold temperatures or extremely humid climates
- Driving in extremely hot conditions
- Driving in mountainous conditions continually

If any do apply, follow Schedule 2. (Canada and Puerto Rico residents follow Schedule 2.)

#### **Vehicles using Engine Oil Flexible Maintenance**

Engine Oil Flexible Maintenance is available for U.S.A. and Puerto Rico residents whose vehicle is operated mainly where none of the following conditions apply:

- Extended periods of idling or low-speed operation such as police car, taxi or driving school car
- Driving in dusty conditions

If any do apply, follow Schedule 2 with engine oil fixed maintenance.

Once engine oil flexible maintenance is selected, the vehicle calculates the remaining oil life based on engine operating conditions. The vehicle lets you know when an oil change is due by illuminating the wrench indicator light in the instrument cluster. Change the oil as soon as possible within the next 500 km (250 miles) or 15 days. Refer page 6-20 for the details. Mazda Genuine 0W-20 Oil and Castrol® 0W-20 Oil are required to achieve optimum performance.

#### **NOTE**

- *Please ensure that the Flexible Oil Maintenance Setting is reset after each Oil and Filter replacement.*
- *For maintenance guidelines beyond the miles/months listed, follow the maintenance intervals provided in the Scheduled Maintenance Tables.*

# Scheduled Maintenance

## ▼ Schedule 1

### U.S.A. residents - Engine oil flexible maintenance interval

Use when the maintenance monitor for “Oil Change” is set to “Flexible”. For details, see maintenance monitor. (page 6-20)

Maintenance Interval	Number of months or kilometers (miles), whichever comes first.								
	Months	12	24	36	48	60	72	84	96
	×1000 km	16	32	48	64	80	96	112	128
	×1000 miles	10	20	30	40	50	60	70	80
<b>ENGINE</b>									
Drive belts			I				I		
Engine oil & filter* <sup>1</sup>	Replace when wrench indicator light is ON. (Max interval: 12 months/16,000km (10,000 miles))								
<b>COOLING SYSTEM</b>									
Engine coolant	FL22 type* <sup>2</sup>	Replace at first 192,000 km (120,000 miles) or 10 years; after that, every 96,000 km (60,000 miles) or 5 years.							
	Others	Replace at first 96,000 km (60,000 miles) or 4 years; after that, every 2 years.							
<b>FUEL SYSTEM</b>									
Air filter	Replace when any equivalent timing of replacing engine oil. (Max interval:36 months/60,000km (37,500 miles))								
Fuel lines and hoses* <sup>3</sup>		I		I		I		I	
Hoses and tubes for emission* <sup>3</sup>				I					I
<b>IGNITION SYSTEM</b>									
Spark plugs	Replace every 120,000 km (75,000 miles).								
<b>CHASSIS and BODY</b>									
Brake lines, hoses and connections		I		I		I		I	
Disc brakes	I	I	I	I	I	I	I	I	I
Tire (Rotation)	Rotate every 8,000 km (5,000 miles).								
Steering operation and linkages		I		I		I		I	
Front and rear suspension, ball joints and wheel bearing axial play		I		I		I		I	
Driveshaft dust boots		I		I		I		I	
Bolts and nuts on chassis and body		T		T		T		T	
Exhaust system and heat shields				I					I
<b>AIR CONDITIONER SYSTEM</b>									
Cabin air filter	Replace when any equivalent timing of replacing engine oil. (Max interval:24 months/48,000km (30,000 miles))								

## Scheduled Maintenance

---

### **Chart symbols:**

**I:** Inspect: Inspect and clean, repair, adjust, fill up, or replace if necessary.

**T:** Tighten

### **Remarks:**

- \*1 The engine oil and filter must be changed at least once a year or within 16,000km (10,000 miles) since last engine oil and filter change. The system must be reset whenever replacing the engine oil regardless of the message/wrench indicator light display.
- \*2 Use FL22 type coolant in vehicles with the inscription “FL22” on the radiator cap itself or the surrounding area. Use FL22 when replacing the coolant.
- \*3 According to state/provincial and federal regulations, failure to perform maintenance on these items will not void your emissions warranties. However, Mazda recommends that all maintenance services be performed at the recommended time or mileage/kilometer period to ensure long-term reliability.

# Scheduled Maintenance

## U.S.A. residents - Fixed maintenance interval

Use when the maintenance monitor for “Oil Change” is set to “Fixed”. For details, see maintenance monitor. (page 6-20)

Maintenance Interval	Number of months or kilometers (miles), whichever comes first.								
	Months	6	12	18	24	30	36	42	48
	×1000 km	12	24	36	48	60	72	84	96
	×1000 miles	7.5	15	22.5	30	37.5	45	52.5	60
<b>ENGINE</b>									
Drive belts						I			
Engine oil & filter	R	R	R	R	R	R	R	R	R
<b>COOLING SYSTEM</b>									
Engine coolant	FL22 type* <sup>1</sup>	Replace at first 192,000 km (120,000 miles) or 10 years; after that, every 96,000 km (60,000 miles) or 5 years.							
	Others	Replace at first 96,000 km (60,000 miles) or 4 years; after that, every 2 years.							
<b>FUEL SYSTEM</b>									
Air filter						R			
Fuel lines and hoses* <sup>2</sup>					I				I
Hoses and tubes for emission* <sup>2</sup>									I
<b>IGNITION SYSTEM</b>									
Spark plugs	Replace every 120,000 km (75,000 miles).								
<b>CHASSIS and BODY</b>									
Brake lines, hoses and connections					I				I
Disc brakes		I			I		I		I
Tire (Rotation)* <sup>3</sup>	Rotate every 12,000 km (7,500 miles).								
Steering operation and linkages					I				I
Front and rear suspension, ball joints and wheel bearing axial play					I				I
Driveshaft dust boots					I				I
Bolts and nuts on chassis and body					T				T
Exhaust system and heat shields	Inspect every 72,000 km (45,000 miles) or 5 years.								
<b>AIR CONDITIONER SYSTEM</b>									
Cabin air filter					R				R

### Chart symbols:

**I:** Inspect: Inspect and clean, repair, adjust, fill up, or replace if necessary.

**R:** Replace

**L:** Lubricate

**T:** Tighten

## Scheduled Maintenance

---

### Remarks:

- \*1 Use FL22 type coolant in vehicles with the inscription “FL22” on the radiator cap itself or the surrounding area. Use FL22 when replacing the coolant.
- \*2 According to state/provincial and federal regulations, failure to perform maintenance on these items will not void your emissions warranties. However, Mazda recommends that all maintenance services be performed at the recommended time or mileage/kilometer period to ensure long-term reliability.
- \*3 To equalize tread wear for maintaining good performance in handling and braking, rotate the tires every 12,000 km (7,500 miles). However Mazda recommends to rotate every 8,000km (5,000 miles) to help increase tire life and distribute wear more evenly.



# Scheduled Maintenance

## ▼ Schedule 2

### U.S.A. (severe driving conditions) and Puerto Rico residents

Maintenance Interval	Number of months or kilometers (miles), whichever comes first.												
	Months	4	8	12	16	20	24	28	32	36	40	44	48
	×1000 km	8	16	24	32	40	48	56	64	72	80	88	96
	×1000 miles	5	10	15	20	25	30	35	40	45	50	55	60
<b>ENGINE</b>													
Drive belts								I					
Engine oil & filter	Flexible* <sup>1</sup>	Replace when wrench indicator light is ON. (Max interval:12 months/16,000km (10,000 miles))											
	Fixed	R	R	R	R	R	R	R	R	R	R	R	R
<b>COOLING SYSTEM</b>													
Engine coolant	FL22 type* <sup>2</sup>	Replace at first 192,000 km (120,000 miles) or 10 years; after that, every 96,000 km (60,000 miles) or 5 years.											
	Others	Replace at first 96,000 km (60,000 miles) or 4 years; after that, every 2 years.											
Engine coolant level		I	I	I	I	I	I	I	I	I	I	I	I
<b>FUEL SYSTEM</b>													
Air filter	U.S.A. (severe driving conditions)							R					
	Puerto Rico						R						R
Fuel lines and hoses* <sup>3</sup>							I						I
Hoses and tubes for emission* <sup>3</sup>													I
<b>IGNITION SYSTEM</b>													
Spark plugs	Replace every 120,000 km (75,000 miles).												
<b>ELECTRICAL SYSTEM</b>													
Function of all lights		I	I	I	I	I	I	I	I	I	I	I	I
<b>CHASSIS and BODY</b>													
Brake lines, hoses and connections							I						I
Brake and clutch fluid level		I	I	I	I	I	I	I	I	I	I	I	I
Disc brakes			I				I			I			I
Tire (Rotation)	Rotate every 8,000 km (5,000 miles).												
Tire inflation pressure and tire wear		I	I	I	I	I	I	I	I	I	I	I	I
Steering operation and linkages							I						I
Front and rear suspension, ball joints and wheel bearing axial play							I						I
Driveshaft dust boots							I						I
Bolts and nuts on chassis and body							T						T

# Scheduled Maintenance

Maintenance Interval	Number of months or kilometers (miles), whichever comes first.												
	Months	4	8	12	16	20	24	28	32	36	40	44	48
	×1000 km	8	16	24	32	40	48	56	64	72	80	88	96
	×1000 miles	5	10	15	20	25	30	35	40	45	50	55	60
Exhaust system and heat shields	Inspect every 72,000 km (45,000 miles) or 5 years.												
All locks and hinges	L	L	L	L	L	L	L	L	L	L	L	L	L
Washer fluid level	I	I	I	I	I	I	I	I	I	I	I	I	I
<b>AIR CONDITIONER SYSTEM</b>													
Cabin air filter	Replace every 40,000 km (25,000 miles) or 2 years.												

### Chart symbols:

**I:** Inspect: Inspect and clean, repair, adjust, fill up, or replace if necessary.

**R:** Replace

**L:** Lubricate

**T:** Tighten

### Remarks:

\*1 Engine oil flexible maintenance is available for U.S.A. and Puerto Rico residents whose vehicle is operated mainly where none of the following conditions apply.

- Extended periods of idling or low-speed operation such as police car, taxi or driving school car
- Driving in dusty conditions

If any do apply, follow fixed maintenance.

The engine oil and filter must be changed at least once a year or within 16,000 km (10,000 miles) since last engine oil and filter change. The system must be reset whenever replacing the engine oil regardless of the message/wrench indicator light display.

- \*2 Use FL22 type coolant in vehicles with the inscription “FL22” on the radiator cap itself or the surrounding area. Use FL22 when replacing the coolant.
- \*3 According to state/provincial and federal regulations, failure to perform maintenance on these items will not void your emissions warranties. However, Mazda recommends that all maintenance services be performed at the recommended time or mileage/kilometer period to ensure long-term reliability.

# Scheduled Maintenance

## Canada residents

Maintenance Interval	Number of months or kilometers (miles), whichever comes first.												
	Months	4	8	12	16	20	24	28	32	36	40	44	48
	×1000 km	8	16	24	32	40	48	56	64	72	80	88	96
	×1000 miles	5	10	15	20	25	30	35	40	45	50	55	60
<b>ENGINE</b>													
Drive belts								I					
Engine oil & filter	R	R	R	R	R	R	R	R	R	R	R	R	R
<b>COOLING SYSTEM</b>													
Engine coolant	FL22 type*1	Replace at first 192,000 km (120,000 miles) or 10 years; after that, every 96,000 km (60,000 miles) or 5 years.											
	Others	Replace at first 96,000 km (60,000 miles) or 4 years; after that, every 2 years.											
Engine coolant level	I	I	I	I	I	I	I	I	I	I	I	I	I
<b>FUEL SYSTEM</b>													
Air filter								R					
Fuel lines and hoses*2							I						I
Hoses and tubes for emission*2													I
<b>IGNITION SYSTEM</b>													
Spark plugs	Replace every 120,000 km (75,000 miles).												
<b>ELECTRICAL SYSTEM</b>													
Function of all lights	I	I	I	I	I	I	I	I	I	I	I	I	I
<b>CHASSIS and BODY</b>													
Brake lines, hoses and connections							I						I
Brake and clutch fluid level	I	I	I	I	I	I	I	I	I	I	I	I	I
Disc brakes			I				I			I			I
Tire (Rotation)	Rotate every 8,000 km (5,000 miles).												
Tire inflation pressure and tire wear	I	I	I	I	I	I	I	I	I	I	I	I	I
Steering operation and linkages							I						I
Front and rear suspension, ball joints and wheel bearing axial play							I						I
Driveshaft dust boots							I						I
Bolts and nuts on chassis and body							T						T
Body condition (for rust, corrosion and perforation)			I				I			I			I
Exhaust system and heat shields	Inspect every 72,000 km (45,000 miles) or 5 years.												
All locks and hinges	L	L	L	L	L	L	L	L	L	L	L	L	L
Washer fluid level	I	I	I	I	I	I	I	I	I	I	I	I	I
<b>AIR CONDITIONER SYSTEM</b>													
Cabin air filter	Replace every 40,000 km (25,000 miles) or 2 years.												

## Scheduled Maintenance

---

### Chart symbols:

**I:** Inspect: Inspect and clean, repair, adjust, fill up, or replace if necessary.

**R:** Replace

**L:** Lubricate

**T:** Tighten

### Remarks:

\*1 Use FL22 type coolant in vehicles with the inscription "FL22" on the radiator cap itself or the surrounding area. Use FL22 when replacing the coolant.

\*2 According to state/provincial and federal regulations, failure to perform maintenance on these items will not void your emissions warranties. However, Mazda recommends that all maintenance services be performed at the recommended time or mileage/kilometer period to ensure long-term reliability.

## Scheduled Maintenance (Mexico)

Follow Schedule 1 if the vehicle is operated mainly where none of the following conditions (severe driving conditions) apply.

- Repeated short-distance driving
- Driving in dusty conditions
- Driving with extended use of brakes
- Driving in areas where salt or other corrosive materials are used
- Driving on rough or muddy roads
- Extended periods of idling or low-speed operation
- Driving for long periods in cold temperatures or extremely humid climates
- Driving in extremely hot conditions
- Driving in mountainous conditions continually

If any do apply, follow Schedule 2.

### **NOTE**

*For maintenance guidelines beyond the kilometers/months listed, follow the maintenance intervals provided in the Scheduled Maintenance Tables.*

# Scheduled Maintenance

## ▼ Schedule 1

Maintenance Interval	Number of months or kilometers, whichever comes first												
	Months	6	12	18	24	30	36	42	48	54	60	66	72
	×1000 km	10	20	30	40	50	60	70	80	90	100	110	120
<b>ENGINE</b>													
Drive belts				I					I				I
Engine oil	R	R	R	R	R	R	R	R	R	R	R	R	R
Engine oil filter	R	R	R	R	R	R	R	R	R	R	R	R	R
<b>COOLING SYSTEM</b>													
Cooling system				I					I				I
Engine coolant	FL22 type*1	Replace at first 200,000 km or 10 years; after that, every 100,000 km or 5 years											
	Others	Replace every 2 years											
<b>FUEL SYSTEM</b>													
Air filter		R		R		R		R		R		R	
Fuel lines and hoses				I <sup>2</sup>					I <sup>2</sup>				I
Hoses and tubes for emission				I <sup>2</sup>					I <sup>2</sup>				I
Fuel filter	Replace every 60,000 km												
<b>IGNITION SYSTEM</b>													
Spark plugs	Replace every 120,000 km												
<b>CHASSIS and BODY</b>													
Brake lines, hoses and connections		I		I		I		I		I		I	
Brake and clutch fluid level	I	I	I			I	I	I		I	I	I	
Brake fluid				R					R				R
Disc brakes	I	I	I	I	I	I	I	I	I	I	I	I	I
Tire (Rotation)	Rotate every 10,000 km												
Tire inflation pressure and tire wear	I	I	I	I	I	I	I	I	I	I	I	I	I
Steering operation and linkages	I	I	I	I	I	I	I	I	I	I	I	I	I
Front and rear suspension, ball joints and wheel bearing axial play		I		I		I		I		I		I	
Driveshaft dust boots		I		I		I		I		I		I	
Bolts and nuts on chassis and body		T		T		T		T		T		T	
Exhaust system and heat shields		I		I		I		I		I		I	
All locks and hinges	L	L	L	L	L	L	L	L	L	L	L	L	L
Washer fluid level	I	I	I	I	I	I	I	I	I	I	I	I	I
<b>AIR CONDITIONER SYSTEM</b>													
Cabin air filter				R					R				R

# Scheduled Maintenance

---

**Chart symbols:**

**I:** Inspect: Inspect and clean, repair, adjust, fill up, or replace if necessary.

**R:** Replace

**L:** Lubricate

**T:** Tighten

**Remarks:**

- \*1 Use FL22 type coolant in vehicles with the inscription “FL22” on the radiator cap itself or the surrounding area. Use FL22 when replacing the coolant.
- \*2 According to state/provincial and federal regulations, failure to perform maintenance on these items will not void your emissions warranties. However, Mazda recommends that all maintenance services be performed at the recommended time or kilometer period to ensure long-term reliability.

# Scheduled Maintenance

## ▼ Schedule 2

Maintenance Interval	Number of months or kilometers, whichever comes first												
	Months	3	6	9	12	15	18	21	24	27	30	33	36
	×1000 km	5	10	15	20	25	30	35	40	45	50	55	60
<b>ENGINE</b>													
Drive belts									I				
Engine oil	R	R	R	R	R	R	R	R	R	R	R	R	R
Engine oil filter	R	R	R	R	R	R	R	R	R	R	R	R	R
<b>COOLING SYSTEM</b>													
Cooling system									I				
Engine coolant	FL22 type*1	Replace at first 200,000 km or 10 years; after that, every 100,000 km or 5 years											
	Others	Replace every 2 years											
Engine coolant level	I	I	I	I	I	I	I	I	I	I	I	I	I
<b>FUEL SYSTEM</b>													
Air filter		C		R		C		R		C		R	
Fuel lines and hoses								I <sup>2</sup>					
Hoses and tubes for emission								I <sup>2</sup>					
Fuel filter	Replace every 60,000 km												
<b>IGNITION SYSTEM</b>													
Spark plugs	Replace every 120,000 km												
<b>ELECTRICAL SYSTEM</b>													
Function of all lights	I	I	I	I	I	I	I	I	I	I	I	I	I
<b>CHASSIS and BODY</b>													
Brake lines, hoses and connections				I				I					I
Brake and clutch fluid level		I		I		I				I			I
Brake fluid								R					
Disc brakes		I		I		I		I		I			I
Tire (Rotation)	Rotate every 10,000 km												
Tire inflation pressure and tire wear		I		I		I		I		I			I
Steering operation and linkages		I		I		I		I		I			I
Front and rear suspension, ball joints and wheel bearing axial play				I				I					I
Driveshaft dust boots				I				I					I
Bolts and nuts on chassis and body				T				T					T
Exhaust system and heat shields				I				I					I
All locks and hinges		L		L		L		L		L			L
Washer fluid level		I		I		I		I		I			I



# Scheduled Maintenance

Maintenance Interval	Number of months or kilometers, whichever comes first												
	Months	3	6	9	12	15	18	21	24	27	30	33	36
	×1000 km	5	10	15	20	25	30	35	40	45	50	55	60
<b>AIR CONDITIONER SYSTEM</b>													
Cabin air filter					R				R				R

**Chart symbols:**

**I:** Inspect: Inspect and clean, repair, adjust, fill up, or replace if necessary.

**R:** Replace

**L:** Lubricate

**C:** Clean

**T:** Tighten

**Remarks:**

- \*1 Use FL22 type coolant in vehicles with the inscription “FL22” on the radiator cap itself or the surrounding area. Use FL22 when replacing the coolant.
- \*2 According to state/provincial and federal regulations, failure to perform maintenance on these items will not void your emissions warranties. However, Mazda recommends that all maintenance services be performed at the recommended time or kilometer period to ensure long-term reliability.

# Scheduled Maintenance

(Cont.)

Maintenance Interval	Number of months or kilometers, whichever comes first												
	Months	39	42	45	48	51	54	57	60	63	66	69	72
	×1000 km	65	70	75	80	85	90	95	100	105	110	115	120
<b>ENGINE</b>													
Drive belts				I									I
Engine oil	R	R	R	R	R	R	R	R	R	R	R	R	R
Engine oil filter	R	R	R	R	R	R	R	R	R	R	R	R	R
<b>COOLING SYSTEM</b>													
Cooling system				I									I
Engine coolant	FL22 type*1	Replace at first 200,000 km or 10 years; after that, every 100,000 km or 5 years											
	Others	Replace every 2 years											
Engine coolant level	I	I	I	I	I	I	I	I	I	I	I	I	I
<b>FUEL SYSTEM</b>													
Air filter		C		R		C		R		C			R
Fuel lines and hoses				I <sup>2</sup>									I
Hoses and tubes for emission				I <sup>2</sup>									I
Fuel filter	Replace every 60,000 km												
<b>IGNITION SYSTEM</b>													
Spark plugs	Replace every 120,000 km												
<b>ELECTRICAL SYSTEM</b>													
Function of all lights	I	I	I	I	I	I	I	I	I	I	I	I	I
<b>CHASSIS and BODY</b>													
Brake lines, hoses and connections				I				I					I
Brake and clutch fluid level		I					I		I		I		
Brake fluid				R									R
Disc brakes		I		I		I		I		I			I
Tire (Rotation)	Rotate every 10,000 km												
Tire inflation pressure and tire wear		I		I		I		I		I			I
Steering operation and linkages		I		I		I		I		I			I
Front and rear suspension, ball joints and wheel bearing axial play				I				I					I
Driveshaft dust boots				I				I					I
Bolts and nuts on chassis and body				T				T					T
Exhaust system and heat shields				I				I					I
All locks and hinges		L		L		L		L		L			L
Washer fluid level		I		I		I		I		I			I

# Scheduled Maintenance

Maintenance Interval	Number of months or kilometers, whichever comes first												
	Months	39	42	45	48	51	54	57	60	63	66	69	72
	×1000 km	65	70	75	80	85	90	95	100	105	110	115	120
<b>AIR CONDITIONER SYSTEM</b>													
Cabin air filter					R				R				R

### Chart symbols:

**I:** Inspect: Inspect and clean, repair, adjust, fill up, or replace if necessary.

**R:** Replace

**L:** Lubricate

**C:** Clean

**T:** Tighten

### Remarks:

- \*1 Use FL22 type coolant in vehicles with the inscription "FL22" on the radiator cap itself or the surrounding area. Use FL22 when replacing the coolant.
- \*2 According to state/provincial and federal regulations, failure to perform maintenance on these items will not void your emissions warranties. However, Mazda recommends that all maintenance services be performed at the recommended time or kilometer period to ensure long-term reliability.

## Scheduled Maintenance

### Maintenance Monitor

#### ▼ Maintenance Monitor (Type A audio)

“Oil Change” with a flexible setting\*<sup>1</sup> is available. Consult your Authorized Mazda Dealer when you want to change the setting\*<sup>2</sup>. Once the system turns on, the wrench indicator light in the instrument cluster will be illuminated when remaining oil life becomes less than 500 km (300 mile), or remaining days are less than 15 (whichever comes first).

#### Reset method

Press and hold the TRIP button with the ignition switched off, then switch it on. Keep pressing the TRIP button for more than 5 seconds. The master warning light will flash for a few seconds when the reset is completed.

- \*1 The flexible setting is available in the United States and Puerto Rico. Based on the engine operating conditions, the onboard computer in your vehicle calculates the remaining oil life. Mazda Genuine 0W-20 oil and Castrol® 0W-20 oil are required to achieve optimum calculation performance.
- \*2 Once the Flexible Oil Maintenance Setting is selected, the system must be reset whenever replacing the engine oil.

#### ▼ Maintenance Monitor (Type B audio)

1. Select the  icon on the home screen to display the “Applications” screen.
2. Select the “Maintenance” to display the maintenance list screen.
3. Switch the tab and select the setting item you want to change.

You can customize settings in the setup display as follows:

Tab	Item	Explanation
Maintenance	Setting	Notification can be switched on/off.
	Time (months)	Displays the time or distance until maintenance is due. Select this item to set the maintenance period.
	Distance (mile or km)	“Scheduled Due!” is displayed in red and the wrench indicator light in the instrument cluster will be illuminated when the remaining distance is less than 500 km or 250 mile, or the remaining number of days is less than 15 (whichever comes first).
	Reset	Resets the time and distance to the initial values. Once the system turns on, it needs to be reset whenever carrying out maintenance.

## Scheduled Maintenance

Tab	Item	Explanation
Tire Rotation	Setting	Notification can be switched on/off.
	Distance (mile or km)	Displays the distance until tire rotation is due. Select this item to set the tire rotation distance. "Tire Rotation Due!" is displayed in red and the wrench indicator light in the instrument cluster will be illuminated when the remaining distance is less than 500 km or 250 mile.
	Reset	Resets the remaining distance to the initial value. Once the system turns on, it needs to be reset whenever rotating the tires.
Oil Change	Setting	Oil replacement period can be selected from the flexible setting or fixed setting, or it can be set to non-display. The flexible setting is available only in the United States and Puerto Rico. Once engine oil flexible maintenance is selected, the vehicle calculates the remaining oil life based on the engine operating conditions. The vehicle lets you know when an oil change is due by illuminating the wrench indicator light in the instrument cluster. Mazda Genuine 0W-20 oil and Castrol® 0W-20 oil are required to achieve optimum performance.
	Distance (mile or km) (Displays only in fixed setting)	Displays the distance until the oil replacement is due. Select this item to set the oil replacement distance. "Oil Change Due!" is displayed in red and the wrench indicator light in the instrument cluster will be illuminated when the remaining distance is less than 500 km or 250 mile.
	Oil life (%) (Displays only in flexible setting)	Displays the engine oil life until the oil replacement is due. "Oil Change Due!" is displayed in red and the wrench indicator light in the instrument cluster will be illuminated when the remaining oil life distance is less than 500 km (300 mile), or remaining days are less than 15 (whichever comes first).
	Reset	In flexible setting: Resets the remaining oil life to 100 %. In fixed setting: Resets the remaining distance to the initial value. Once the Flexible Oil Maintenance Setting is selected, the system must be reset whenever replacing the engine oil.

## Owner Maintenance

---

### Owner Maintenance Precautions

The owner or a qualified service technician should make these vehicle inspections at the indicated intervals to ensure safe and dependable operation.

Bring any problem to the attention of an Authorized Mazda Dealer or qualified service technician as soon as possible.

#### **When Refueling**

- Brake and clutch fluid level (page 6-31)
- Engine coolant level (page 6-29)
- Engine oil level (page 6-28)
- Washer fluid level (page 6-31)

#### **At Least Monthly**

- Tire inflation pressures (page 6-42)

#### **At Least Twice a Year (For Example, Every Spring and Fall)**

You can do the following scheduled maintenance items if you have some mechanical ability and a few basic tools and if you closely follow the directions in this manual.

- Engine coolant (page 6-29)
- Engine oil (page 6-27)

Improper or incomplete service may result in problems. This section gives instructions only for items that are easy to perform.

As explained in the Introduction (page 6-2), several procedures can be done only by a qualified service technician with special tools.

Improper owner maintenance during the warranty period may affect warranty coverage. Refer to Introduction (page 6-2) for owner's responsibility in protecting your investment. For details, read the separate Mazda Warranty statement provided with the vehicle. If you are unsure about any servicing or maintenance procedure, have it done by an Authorized Mazda Dealer.

There are strict environmental laws regarding the disposal of waste oil and fluids. Please dispose of your waste properly and with due regard to the environment.

We recommend that you entrust the oil and fluid changes of your vehicle to an Authorized Mazda Dealer.

** WARNING**

**Do not perform maintenance work if you lack sufficient knowledge and experience or the proper tools and equipment to do the work. Have maintenance work done by a qualified technician:**

*Performing maintenance work on a vehicle is dangerous if not done properly. You can be seriously injured while performing some maintenance procedures.*

**If you must run the engine while working under the hood, make certain that you remove all jewelry (especially rings, bracelets, watches, and necklaces) and all neckties, scarves, and similar loose clothing before getting near the engine or cooling fan which may turn on unexpectedly:**

*Working under the hood with the engine running is dangerous. It becomes even more dangerous when you wear jewelry or loose clothing.*

*Either can become entangled in moving parts and result in injury.*



**Switch the ignition to off and make sure the fan is not running before attempting to work near the cooling fan:**

*Working near the cooling fan when it is running is dangerous. The fan could continue running indefinitely even if the engine has stopped and the engine compartment temperature is high. You could be hit by the fan and seriously injured.*

**Do not leave items in the engine compartment:**

*After you have finished checking or doing servicing in the engine compartment, do not forget and leave items such as tools or rags in the engine compartment.*

*Tools or other items left in the engine compartment could cause engine damage or a fire leading to an unexpected accident.*

# Owner Maintenance

## Hood

### **⚠ WARNING**

**Always check that the hood is closed and securely locked:**

*A hood that is not closed and securely locked is dangerous as it could fly open while the vehicle is moving and block the driver's vision which could result in a serious accident.*

### ▼ Opening the Hood

1. With the vehicle parked, pull the release handle to unlock the hood.

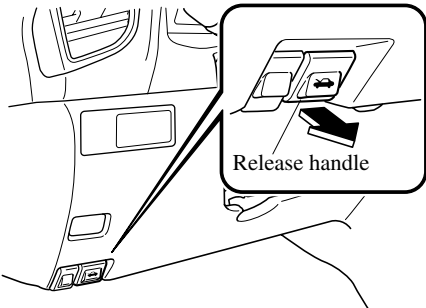

2. Insert your hand into the hood opening, slide the latch lever to the right, and lift up the hood.

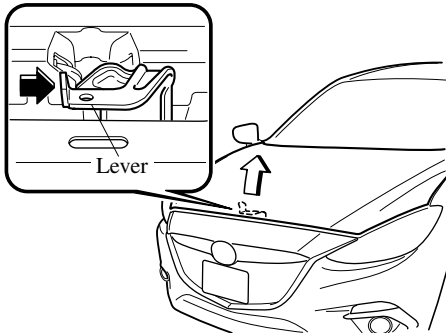

### **NOTE**

*The lever is located a little to the left of center when facing the vehicle.*

3. Grasp the support rod in the padded area and secure it in the support rod hole indicated by the arrow to hold the hood open.

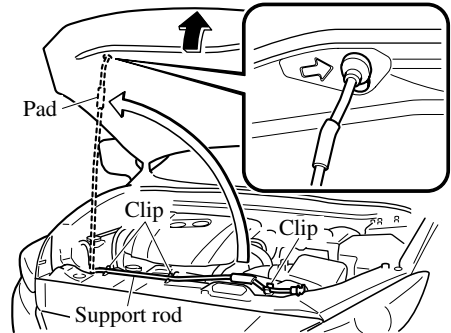



**▼ Closing the Hood**

1. Check under the hood area to make certain all filler caps are in place and all loose items (e.g. tools, oil containers, etc.) have been removed.
2. Lift the hood, grasp the padded area on the support rod, and secure the support rod in the clip. Verify that the support rod is secured in the clip before closing the hood.

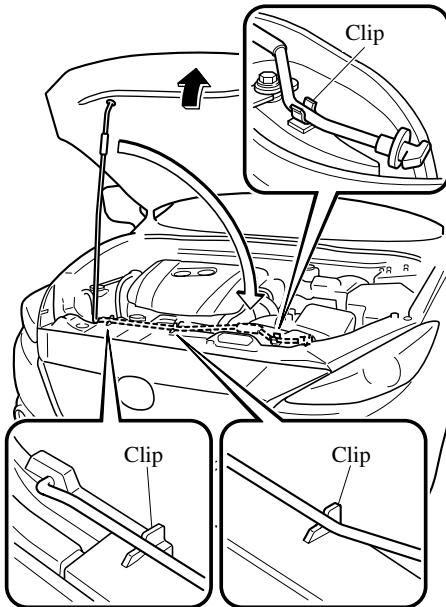

3. Lower the hood slowly to a height of about 20 cm (7.9 in) above its closed position and then let it drop.

**⚠ CAUTION**

*When closing the hood, do not push it excessively such as by applying your weight. Otherwise, the hood could be deformed.*

## Engine Compartment Overview

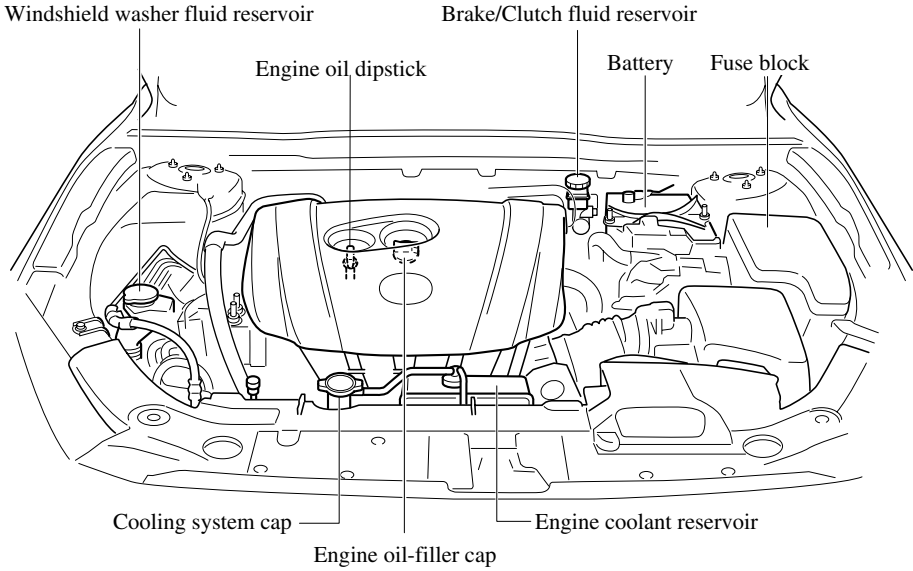

## Engine Oil

### NOTE

*Changing the engine oil should be performed by an Authorized Mazda Dealer.*

*Refer to Introduction (page 6-2) for owner's responsibility in protecting your investment.*

### ▼ Recommended Oil

#### U.S.A., Canada, and Puerto Rico

**Use SAE 0W-20 engine oil.**

Mazda Genuine Oil is used in your Mazda vehicle. Mazda Genuine 0W-20 Oil is required to achieve optimum fuel economy.

For maintenance service, Mazda recommends Mazda Genuine Parts and Castrol® (U.S.A. only).



(ILSAC)

Only use SAE 0W-20 oil “Certified For Gasoline Engines” by the American Petroleum Institute (API).

Oil with this trademark symbol conforms to the current engine and emission system protection standards and fuel economy requirements of the International Lubricant Standardization and Approval Committee (ILSAC), comprised of U.S. and Japanese automobile manufacturers.

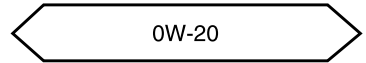
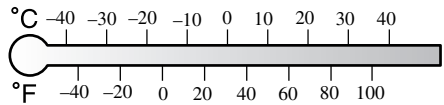

# Owner Maintenance

## Except U.S.A., Canada, and Puerto Rico

### Use SAE 5W-30 engine oil.

Oil container labels provide important information.

A chief contribution this type of oil makes to fuel economy is reducing the amount of fuel necessary to overcome engine friction.

For maintenance service, Mazda recommends Mazda Genuine Parts and Castrol® (Mexico only).



(ILSAC)

## (Mexico)

Use SAE 5W-30 engine oil. If SAE 5W-30 engine oil is not available, use SAE 5W-20 engine oil.

The quality designation SM, or ILSAC must be on the label.

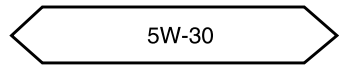
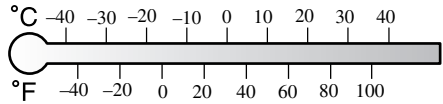

## ▼ Inspecting Engine Oil Level

1. Be sure the vehicle is on a level surface.
2. Warm up the engine to normal operating temperature.
3. Turn it off and wait at least 5 minutes for the oil to return to the oil pan.
4. Pull out the dipstick, wipe it clean, and reinsert it fully.

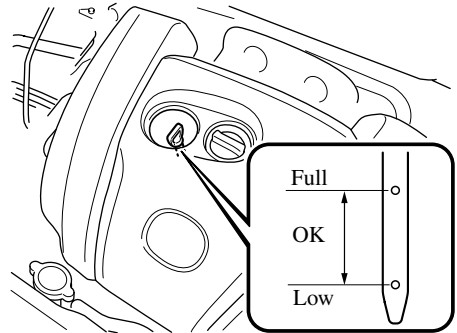

5. Pull it out again and examine the level. The level is normal if it is between Low and Full. If it is near or below Low, add enough oil to bring the level to Full.

 **CAUTION**

*Do not add engine oil over Full. This may cause engine damage.*

6. Make sure the O-ring on the dipstick is positioned properly before reinserting the dipstick.
7. Reinsert the dipstick fully.

## Engine Coolant

### ▼ Inspecting Coolant Level

 **WARNING**

**Do not use a match or live flame in the engine compartment. DO NOT ADD COOLANT WHEN THE ENGINE IS HOT:**

*A hot engine is dangerous. If the engine has been running, parts of the engine compartment can become very hot. You could be burned. Carefully inspect the engine coolant in the coolant reservoir, but do not open it.*



**Switch the ignition to off and make sure the fan is not running before attempting to work near the cooling fan:**

*Working near the cooling fan when it is running is dangerous. The fan could continue running indefinitely even if the engine has stopped and the engine compartment temperature is high. You could be hit by the fan and seriously injured.*



**Do not remove either cooling system cap when the engine and radiator are hot:**

*When the engine and radiator are hot, scalding coolant and steam may shoot out under pressure and cause serious injury.*

### NOTE

*Changing the coolant should be done by an Authorized Mazda Dealer.*

## Owner Maintenance

Inspect the antifreeze protection and coolant level in the coolant reservoir at least once a year—at the beginning of the winter season—and before traveling where temperatures may drop below freezing.

Inspect the condition and connections of all cooling system and heater hoses. Replace any that are swollen or deteriorated.

The coolant should be at full in the radiator and between the F and L marks on the coolant reservoir when the engine is cool.

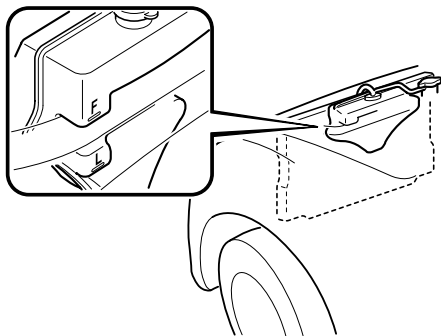

If it is at or near L, add enough coolant to the coolant reservoir to provide freezing and corrosion protection and to bring the level to F.

Securely tighten the coolant reservoir tank cap after adding coolant.

### **CAUTION**

- *Radiator coolant will damage paint. Rinse it off quickly if spilled.*
- *Use only soft (demineralized) water in the coolant mixture. Water that contains minerals will cut down on the coolant's effectiveness.*
- *Do not add only water. Always add a proper coolant mixture.*
- *The engine has aluminum parts and must be protected by an ethylene-glycol-based coolant to prevent corrosion and freezing.*
- *DO NOT USE coolants Containing Alcohol, methanol, Borate or Silicate. These coolants could damage the cooling system.*
- *DO NOT MIX alcohol or methanol with the coolant. This could damage the cooling system.*
- *Do not use a solution that contains more than 60% antifreeze. This would reduce effectiveness.*

### **NOTE**

*If the "FL22" mark is shown on or near the cooling system cap, it is recommended to use Mazda Genuine FL22 engine coolant.*

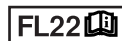

If the coolant reservoir is empty or new coolant is required frequently, consult an Authorized Mazda Dealer.

## Brake/Clutch Fluid

### ▼ Inspecting Brake/Clutch Fluid Level

#### **! WARNING**

**If the brake/clutch fluid level is low, have the brakes inspected:**

*A low brake/clutch fluid level is dangerous.*

*A low level could indicate brake lining wear or a brake system leak which could cause the brakes to fail and lead to an accident.*

The brakes and clutch draw fluid from the same reservoir.

Inspect the fluid level in the reservoir regularly. It should be kept between the MAX and MIN lines.

The level normally drops with accumulated distance, a condition associated with wear of brake and clutch linings. If it is excessively low, have the brake/clutch system inspected by an Authorized Mazda Dealer.

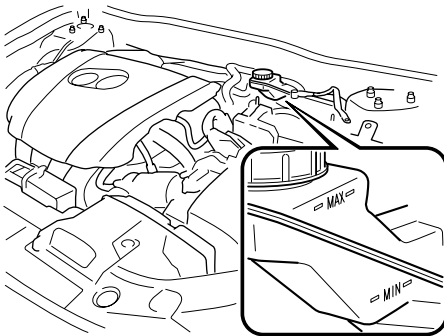

## Washer Fluid

### ▼ Inspecting Washer Fluid Level

#### **! WARNING**

**Use only windshield washer fluid or plain water in the reservoir:**

*Using radiator antifreeze as washer fluid is dangerous. If sprayed on the windshield, it will dirty the windshield, affect your visibility, and could result in an accident.*

**Using Washer Fluid Without Anti-freeze Protection in Cold Weather:**

*Operating your vehicle in temperatures below 4 degrees C (40 degrees F) using washer fluid without anti-freeze protection is dangerous as it could cause impaired windshield vision and result in an accident. In cold weather, always use washer fluid with anti-freeze protection.*

#### **NOTE**

*State or local regulations may restrict the use of volatile organic compounds (VOCs), which are commonly used as anti-freeze agents in washer fluid. A washer fluid with limited VOC content should be used only if it provides adequate freeze resistance for all regions and climates in which the vehicle will be operated.*

## Owner Maintenance

---

Inspect fluid level in the washer fluid reservoir; add fluid if necessary.

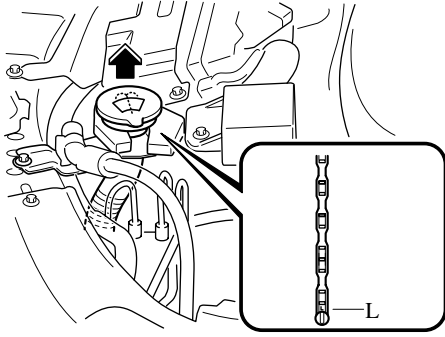

Use plain water if washer fluid is unavailable.  
But use only washer fluid in cold weather to prevent it from freezing.

### **NOTE**

*Front and rear washer fluid is supplied from the same reservoir.*

## Body Lubrication

All moving points of the body, such as door and hood hinges and locks, should be lubricated each time the engine oil is changed. Use a nonfreezing lubricant on locks during cold weather.

Make sure the hood's secondary latch keeps the hood from opening when the primary latch is released.



## Wiper Blades

### ⚠ CAUTION

- *Hot waxes applied by automatic car washers have been known to affect the wiper's ability to clean windows.*
- *To prevent damage to the wiper blades, do not use gasoline, kerosene, paint thinner, or other solvents on or near them.*
- *When the wiper lever is in the AUTO position and the ignition is switched ON, the wipers may move automatically in the following cases:*
  - *If the windshield above the rain sensor is touched.*
  - *If the windshield above the rain sensor is wiped with a cloth.*
  - *If the windshield is struck with a hand or other object.*
  - *If the rain sensor is struck with a hand or other object from inside the vehicle.*

*Be careful not to pinch hands or fingers as it may cause injury, or damage the wipers. When washing or servicing the vehicle, make sure the wiper lever is in the OFF position.*

Contamination of either the windshield or the blades with foreign matter can reduce wiper effectiveness. Common sources are insects, tree sap, and hot wax treatments used by some commercial car washes.

If the blades are not wiping properly, clean the window and blades with a good cleaner or mild detergent; then rinse thoroughly with clean water. Repeat if necessary.

### ▼ Replacing Windshield Wiper Blades

When the wipers no longer clean well, the blades are probably worn or cracked. Replace them.

### ⚠ CAUTION

*To prevent damage to the wiper arms and other components, do not try to sweep the wiper arm by hand.*

### NOTE

*To prevent damage to the wiper arm blades when raising both the driver and passenger side wiper arms, raise the driver side wiper arm first. Conversely, when setting down the wiper arms, set the passenger side wiper arm down first.*

1. Raise the wiper arm.
2. Open the clip and slide the blade assembly in the direction of the arrow.

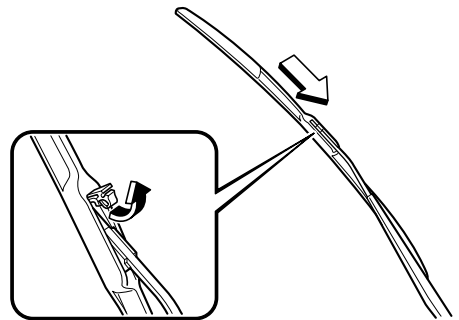

# Owner Maintenance

3. Tilt the blade assembly and remove it from the arm.

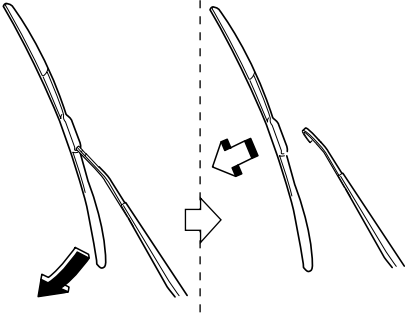

## CAUTION

*To prevent damage to the windshield let the wiper arm down easily, do not let it slap down on the windshield.*

4. Pull down the blade rubber and slide it out of blade holder.

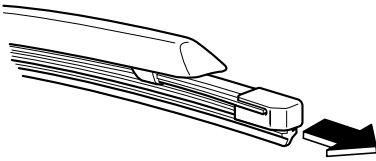

5. Remove the metal stiffeners from each blade rubber and install them in the new blade.

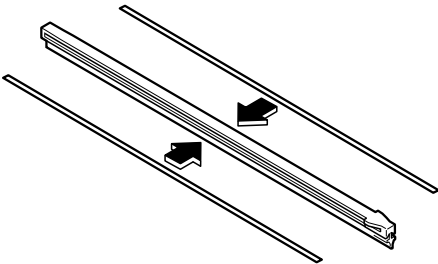

## CAUTION

- Do not bend or discard the stiffeners. You need to use them again.
- If the metal stiffeners are switched, the blade's wiping efficiency could be reduced.  
So do not use the driver's side metal stiffeners on the passenger's side, or vice versa.
- Be sure to reinstall the metal stiffeners in the new blade rubber so that the curve is the same as it was in the old blade rubber.

6. Carefully insert the new blade rubber. Then install the blade assembly in the reverse order of removal.

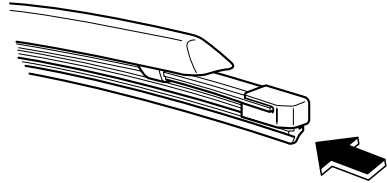

### ▼ Replacing Rear Window Wiper Blade (5-Door)

When the wiper no longer cleans well, the blade is probably worn or cracked. Replace it.

Replace it.

#### **⚠ CAUTION**

*To prevent damage to the wiper arm and other components, do not move the wiper by hand.*

1. Remove the cover.

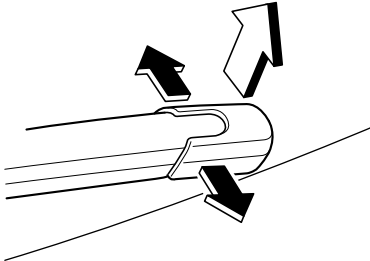

2. **(With stopper type)**  
Remove the stopper and raise the wiper arm.

**(Without stopper type)**

Raise the wiper arm.

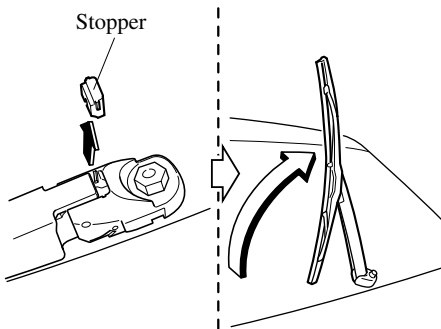

3. Firmly rotate the wiper blade to the right until it unlocks, then remove the blade.

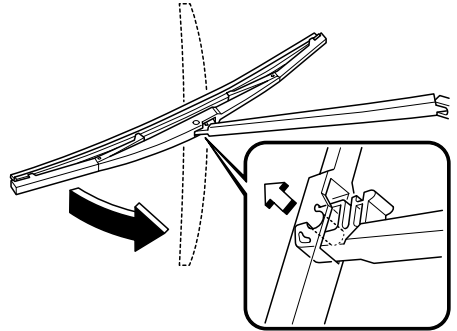

#### **⚠ CAUTION**

*To prevent damage to the rear window, do not let the wiper arm fall on it.*

4. Pull down the blade rubber and slide it out of the blade holder.

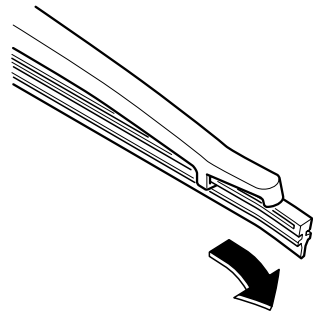

## Owner Maintenance

---

5. Remove the metal stiffeners from the blade rubber and install them in the new blade.

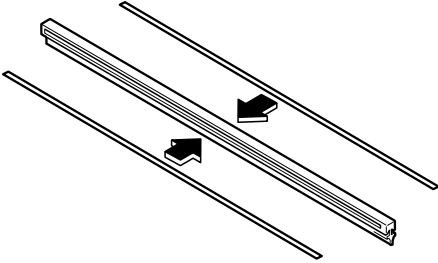

### CAUTION

*Do not bend or discard the stiffeners.  
You need to use them again.*

6. Carefully insert the new blade rubber. Then install the blade assembly in the reverse order of removal.

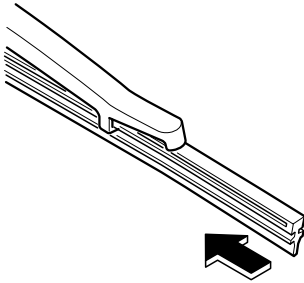

## Battery

### **WARNING**

#### **Wash hands after handling the battery and related accessories:**

Battery posts, terminals and related accessories contain lead and lead compounds, chemicals known to the State of California to cause cancer and reproductive harm.



**Read the following precautions carefully before using the battery or inspecting to ensure safe and correct handling:**



#### **Always wear eye protection when working near the battery:**

Working without eye protection is dangerous. Battery fluid contains SULFURIC ACID which could cause blindness if splashed into your eyes. Also, hydrogen gas produced during normal battery operation, could ignite and cause the battery to explode.



#### **Wear eye protection and protective gloves to prevent contact with battery fluid:**

Spilled battery fluid is dangerous.

Battery fluid contains SULFURIC ACID which could cause serious injuries if it gets in eyes, or on the skin or clothing. If this happens, immediately flush your eyes with water for 15 minutes or wash your skin thoroughly and get medical attention.



#### **Always keep batteries out of the reach of children:**

Allowing children to play near batteries is dangerous. Battery fluid could cause serious injuries if it gets in the eyes or on the skin.



**Keep flames and sparks away from open battery cells and do not allow metal tools to contact the positive (+) or negative (-) terminal of the battery when working near a battery. Do not allow the positive (+) terminal to contact the vehicle body:**

Flames and sparks near open battery cells are dangerous. Hydrogen gas, produced during normal battery operation, could ignite and cause the battery to explode. An exploding battery can cause serious burns and injuries. Keep all flames including cigarettes and sparks away from open battery cells.

## Owner Maintenance

---



**Keep all flames, including cigarettes, and sparks away from open battery cells:**

Flames and sparks near open battery cells are dangerous. Hydrogen gas, produced during normal battery operation, could ignite and cause the battery to explode. An exploding battery can cause serious burns and injuries.

### **NOTE**

Before performing battery maintenance, remove the battery cover by pulling the tab.

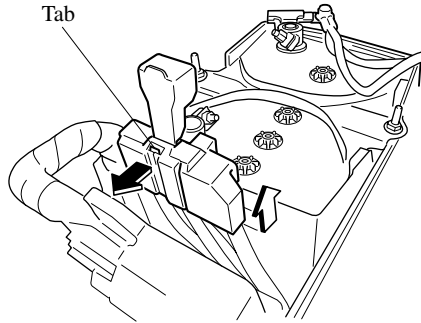

## ▼ Battery Maintenance

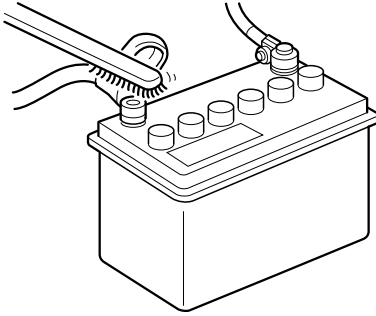

To get the best service from a battery:

- Keep it securely mounted.
- Keep the top clean and dry.
- Keep terminals and connections clean, tight, and coated with petroleum jelly or terminal grease.
- Rinse off spilled electrolyte immediately with a solution of water and baking soda.
- If the vehicle will not be used for an extended time, disconnect the battery cables and charge the battery every six weeks.

## ▼ Battery Replacement

Contact an Authorized Mazda Dealer for a battery replacement purchase.

## Battery Replacement

If the buttons on the transmitter are inoperable and the operation indicator light does not flash, the battery may be dead.

Replace with a new battery before the transmitter becomes unusable.

### **⚠ CAUTION**

- *Make sure the battery is installed correctly. Battery leakage could occur if it is not installed correctly.*
- *When replacing the battery, be careful not to touch any of the internal circuitry and electrical terminals, bend the electrical terminals, or get dirt in the transmitter as the transmitter could be damaged.*
- *There is the danger of explosion if the battery is not correctly replaced.*
- *Dispose of used batteries according to the following instructions.*
  - *Insulate the plus and minus terminals of the battery using cellophane or equivalent tape.*
  - *Never disassemble.*
  - *Never throw the battery into fire or water.*
  - *Never deform or crush.*
- *Replace only with the same type battery (CR2025 or equivalent).*

## Owner Maintenance

---

The following conditions indicate that the battery power is low:

- The KEY indicator light (green) flashes in the instrument cluster for about 30 seconds after the engine is turned off.
- The system does not operate and the operation indicator light on the transmitter does not flash when the buttons are pressed.
- The system's operational range is reduced.

Replacing the battery at an Authorized Mazda Dealer is recommended to prevent damage to the key. If replacing the battery by yourself, follow the instruction below.

### Replacing the key battery

1. Pull out the auxiliary key.

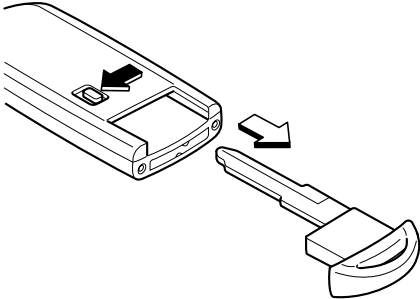

2. Insert a small, flathead screwdriver into the groove shown in the figure and rotate the screwdriver to open the cover slightly.

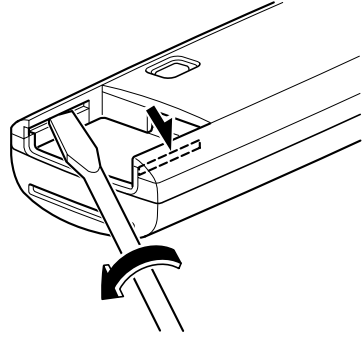

3. Insert the small, flathead screwdriver into the gap between the cover and the transmitter, and then rotate the screwdriver to detach the cover.

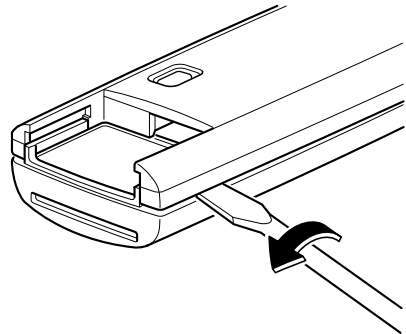



4. Remove the battery cap, then remove the battery.

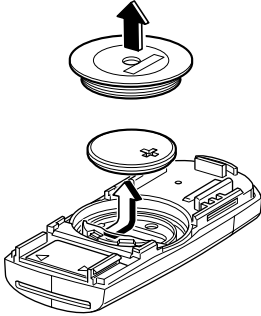

5. Insert a new battery with the positive pole facing up, and then cover the battery with the battery cap.

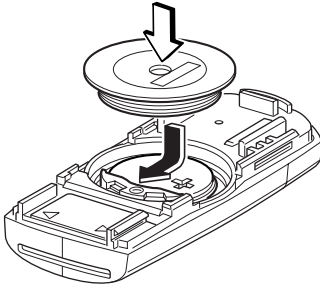

6. Close the cover.

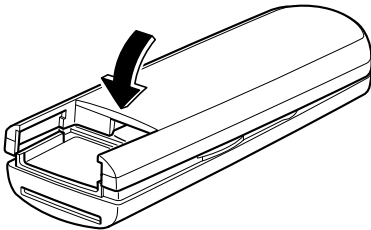

7. Reinsert the auxiliary key.

**CAUTION**

- > Be careful not to allow the rubber ring shown in the figure to be scratched or damaged.
- > If the rubber ring detaches, reattach it before inserting a new battery.

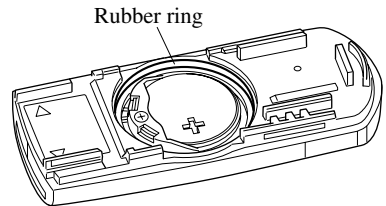

## Owner Maintenance

---

### Tires

For reasons of proper performance, safety, and better fuel economy, always maintain recommended tire inflation pressures and stay within the recommended load limits and weight distribution.

#### **WARNING**

##### **Using Different Tire Types:**

*Driving your vehicle with different types of tires is dangerous. It could cause poor handling and poor braking; leading to loss of control.*

*Except for the limited use of the temporary spare tire, use only the same type tires (radial, bias-belted, bias-type) on all four wheels.*

##### **Using Wrong-Sized Tires:**

*Using any other tire size than what is specified for the vehicle (page 9-10) is dangerous. It could seriously affect ride, handling, ground clearance, tire clearance, and speedometer calibration. This could cause you to have an accident. Use only tires that are the correct size specified for the vehicle.*

### ▼ Tire Inflation Pressure

#### **WARNING**

##### **Always inflate the tires to the correct pressure:**

*Overinflation or underinflation of tires is dangerous. Adverse handling or unexpected tire failure could result in a serious accident.*

*Refer to Tires on page 9-10.*

##### **Use only a Mazda-genuine tire valve cap:**

*Use of a non-genuine part is dangerous as the correct tire air pressure cannot be maintained if the tire valve becomes damaged. If the vehicle is driven under this condition, the tire air pressure will decrease which could result in a serious accident. Do not use any part for the tire valve cap that is not a Mazda-genuine part.*

Inspect all tire pressures monthly (including the spare) when the tires are cold. Maintain recommended pressures for the best ride, handling, and minimum tire wear.

Refer to the specification charts (page 9-10).

After adjusting the tire pressure, initialization of the tire pressure monitoring system is necessary to make the system operate normally.

Refer to Tire Pressure Monitoring System Initialization on page 4-106.

**NOTE**

- *Always check tire pressure when tires are cold.*
- *Warm tires normally exceed recommended pressures. Do not release air from warm tires to adjust the pressure.*
- *Underinflation can cause reduced fuel economy, uneven and accelerated tire wear, and poor sealing of the tire bead, which will deform the wheel and cause separation of tire from rim.*
- *Overinflation can produce a harsh ride, uneven and accelerated tire wear, and a greater possibility of damage from road hazards.*  
*Keep your tire pressure at the correct levels. If one frequently needs inflating, have it inspected.*

**▼ Tire Rotation****⚠ WARNING****Rotate tires periodically:**

*Irregular tire wear is dangerous. To equalize tread wear for maintaining good performance in handling and braking, rotate the tires every 12,000 km (7,500 miles). However Mazda recommends to rotate every 8,000 km (5,000 miles) to help increase tire life and distribute wear more evenly. Refer to Scheduled Maintenance on page 6-4.*

During rotation, inspect them for correct balance.

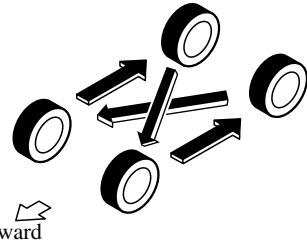

Do not include (TEMPORARY USE ONLY) spare tire in rotation.

Also, inspect them for uneven wear and damage. Abnormal wear is usually caused by one or a combination of the following:

- Incorrect tire pressure
- Improper wheel alignment
- Out-of-balance wheel
- Severe braking

After rotation, inflate all tire pressures to specification (page 9-10) and inspect the lug nuts for tightness.

After adjusting the tire pressure, initialization of the tire pressure monitoring system is necessary to make the system operates normally. Refer to Tire Pressure Monitoring System Initialization on page 4-106.

**⚠ CAUTION**

*Rotate unidirectional tires and radial tires that have an asymmetrical tread pattern or studs only from front to rear, not from side to side. Tire performance will be reduced if rotated from side to side.*

## Owner Maintenance

### ▼ Replacing a Tire



**Always use tires that are in good condition:**

*Driving with worn tires is dangerous. Reduced braking, steering, and traction could result in an accident.*

**Replace all four tires at the same time:**

*Replacing just one tire is dangerous. It could cause poor handling and poor braking resulting in loss of vehicle control. Mazda strongly recommends that you replace all four tires at the same time.*

If a tire wears evenly, a wear indicator will appear as a solid band across the tread. Replace the tire when this happens.

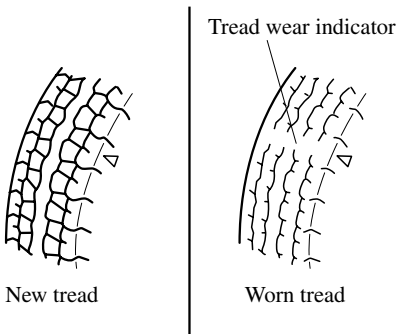

You should replace the tire before the band crosses the entire tread.

After adjusting the tire pressure, initialization of the tire pressure monitoring system is necessary to make the system operate normally. Refer to Tire Pressure Monitoring System Initialization on page 4-106.

### **NOTE**

*Tires degrade over time, even when they are not being used on the road. It is recommended that tires generally be replaced when they are 6 years or older. Heat caused by hot climates or frequent high loading conditions can accelerate the aging process. You should replace the spare tire when you replace the other road tires due to the aging of the spare tire. The period in which the tire was manufactured (both week and year) is indicated by a 4-digit number. Refer to Tire Labeling on page 8-24.*

### ▼ Temporary Spare Tire

Inspect the temporary spare tire at least monthly to make sure it is properly inflated and stored.

### **NOTE**

*The temporary spare tire condition gradually deteriorates even if it has not been used.*

The temporary spare tire is easier to handle because of its construction which is lighter and smaller than a conventional tire. This tire should be used only for an emergency and only for a short distance.

Use the temporary spare tire only until the conventional tire is repaired, which should be as soon as possible.

Refer to Tires on page 9-10.

### CAUTION

- Do not use your temporary spare tire rim with a snow tire or a conventional tire. Neither will properly fit and could damage both tire and rim.
- The temporary spare tire has a tread life of less than 5,000 km (3,000 miles). The tread life may be shorter depending on driving conditions.
- The temporary spare tire is for limited use, however, if the tread wear solid-band indicator appears, replace the tire with the same type of temporary spare (page 6-45).

### NOTE

Tires degrade over time, even when they are not being used on the road. It is recommended that tires generally be replaced when they are 6 years or older. Heat caused by hot climates or frequent high loading conditions can accelerate the aging process. You should replace the spare tire when you replace the other road tires due to the aging of the spare tire. The period in which the tire was manufactured (both week and year) is indicated by a 4-digit number.

Refer to Tire Labeling on page 8-24.

### ▼ Replacing a Wheel

### WARNING

**Always use wheels of the correct size on your vehicle:**

*Using a wrong-sized wheel is dangerous. Braking and handling could be affected, leading to loss of control and an accident.*

### CAUTION

A wrong-sized wheel may adversely affect:

- Tire fit
- Wheel and bearing life
- Ground clearance
- Snow-chain clearance
- Speedometer calibration
- Headlight aim
- Bumper height
- Tire Pressure Monitoring System\*

When replacing a wheel, make sure the new one is the same as the original factory wheel in diameter, rim width, and offset (inset/outset).

Proper tire balancing provides the best riding comfort and helps reduce tread wear. Out-of-balance tires can cause vibration and uneven wear, such as cupping and flat spots.

# Owner Maintenance

## Light Bulbs

### With Xenon Fusion Headlights

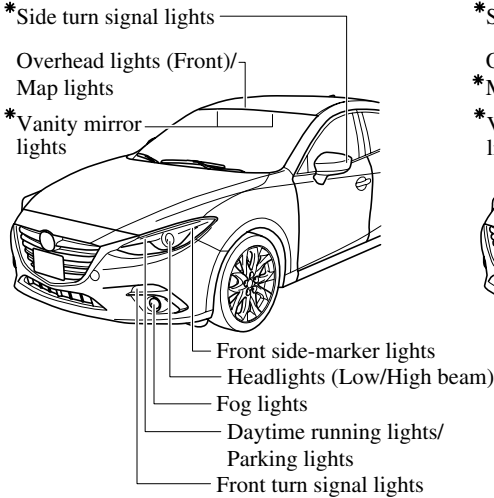

### With Halogen Headlights

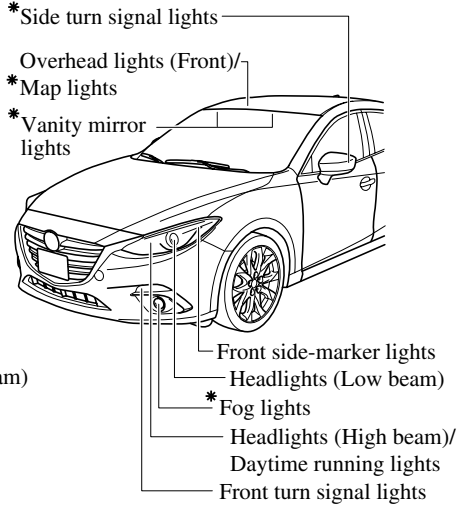

### 4-Door

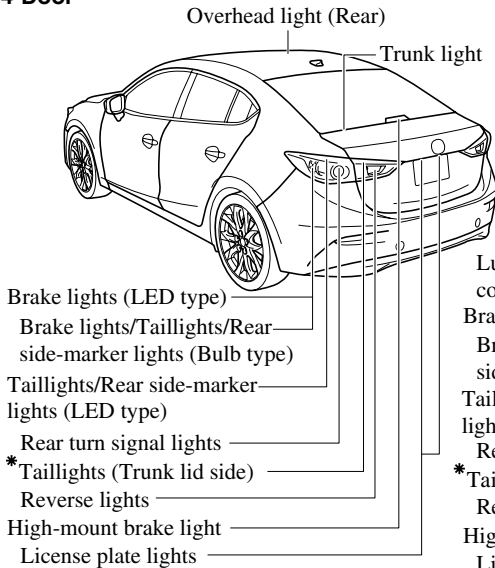

### 5-Door

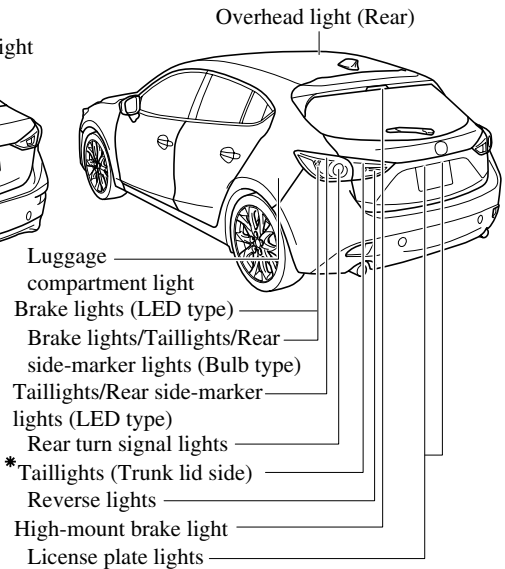

\*Some models.

## **⚠ WARNING**

**Do not replace the xenon fusion bulbs yourself:**

Replacing the xenon fusion bulbs yourself is dangerous. Because the xenon fusion bulbs require high voltage, you could receive an electric shock if the bulbs are handled incorrectly. Consult an Authorized Mazda Dealer when the replacement is necessary.

**Never touch the glass portion of a halogen bulb with your bare hands and always wear eye protection when handling or working around the bulbs:**

When a halogen bulb breaks, it is dangerous. These bulbs contain pressurized gas. If one is broken, it will explode and serious injuries could be caused by the flying glass.

If the glass portion is touched with bare hands, body oil could cause the bulb to overheat and explode when lit.

**Always keep halogen bulbs out of the reach of children:**

Playing with a halogen bulb is dangerous. Serious injuries could be caused by dropping a halogen bulb or breaking it some other way.

### NOTE

- To replace the bulb, contact an Authorized Mazda Dealer.
- If the halogen bulb is accidentally touched, it should be cleaned with rubbing alcohol before being used.
- Use the protective cover and carton for the replacement bulb to dispose of the old bulb promptly and out of the reach of children.

## ▼ Replacing Exterior Light Bulbs

### Headlights (With xenon fusion headlights)

#### Low/High beam bulbs

You cannot replace the low/high beam bulbs by yourself. The bulbs must be replaced at an Authorized Mazda Dealer.

### Headlights (With halogen headlights)

#### Low-beam bulbs

1. If you are changing the right bulb, start the engine, turn the steering wheel all the way to the left, and turn off engine. If you are changing the left bulb, turn the steering wheel to the right, and turn off engine.
2. Make sure the headlight switch is off.
3. Pull the center of each plastic retainer and remove the retainers.

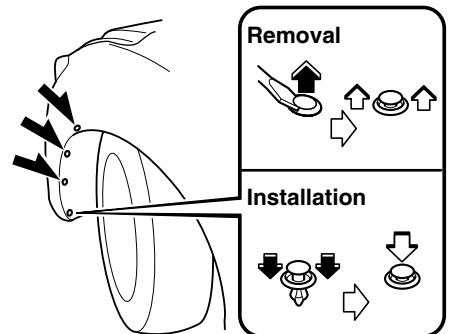

# Owner Maintenance

4. Turn the screw counterclockwise and remove it, and then partially peel back the mudguard.

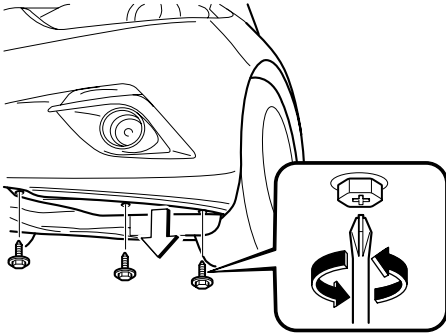

5. Disconnect the connector from the unit by pressing the tab on the connector with your finger and pulling the connector downward.

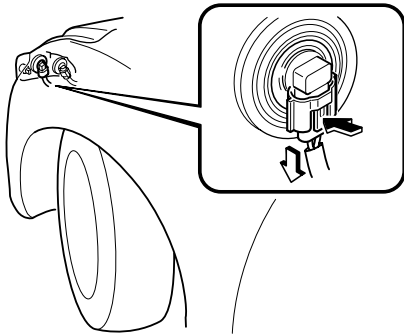

6. Turn the socket and bulb assembly to remove it. Carefully remove the bulb from its socket in the reflector by gently pulling it straight backward out of the socket.

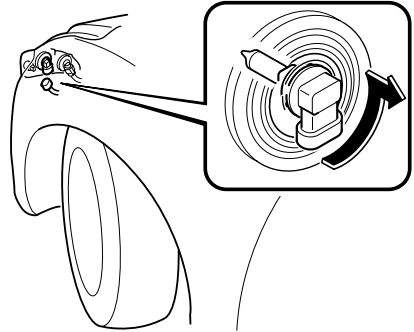

7. Install the new bulb in the reverse order of the removal procedure.

## High-beam bulbs/Daytime running lights

1. Make sure the ignition is switched off, and the headlight switch is off.
2. Lift the hood.
3. Disconnect the connector from the unit by pressing the tab on the connector with your finger and pulling the connector downward.

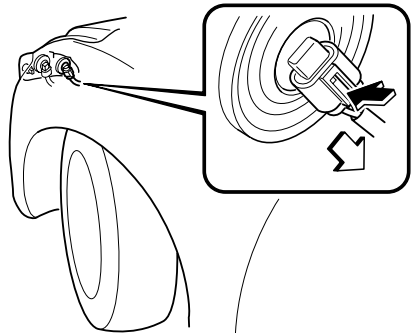



- Turn the socket and bulb assembly to remove it. Carefully remove the bulb from its socket in the reflector by gently pulling it straight backward out of the socket.

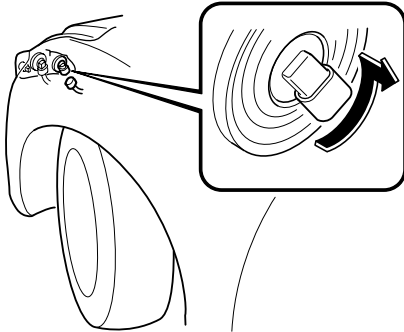

- Install the new bulb in the reverse order of the removal procedure.

### **Daytime running lights/Parking lights (With xenon fusion headlights)**

Due to the complexity and difficulty of the procedure, the LED bulbs must be replaced by an Authorized Mazda Dealer.

#### **NOTE**

*LED bulb replacement is not possible because it is built into the unit. Replace the unit.*

### **Front turn signal lights, Parking lights/ Front side-marker lights (With halogen headlights), Front side-marker lights (With xenon fusion headlights)**

- If you are changing the right bulb, start the engine, turn the steering wheel all the way to the left, and turn off engine. If you are changing the left bulb, turn the steering wheel to the right, and turn off engine.
- Make sure the headlight switch is off.

- Pull the center of each plastic retainer and remove the retainers.

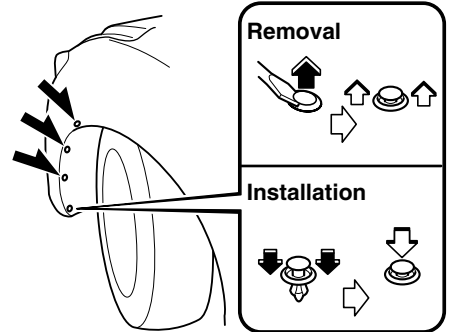

- Turn the screw counterclockwise and remove it, and then partially peel back the mudguard.

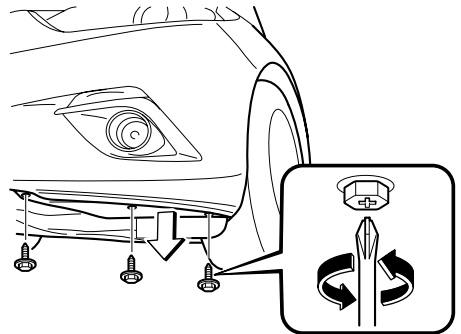

- Turn the socket and bulb assembly counterclockwise and remove it.

# Owner Maintenance

6. Disconnect the bulb from the socket.  
**Front turn signal lights**

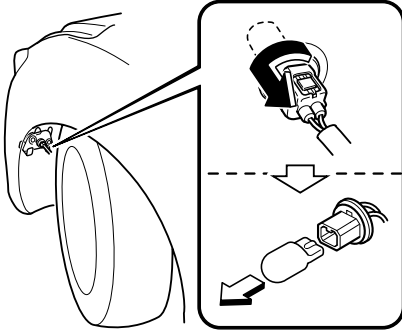

**Parking lights/Front side-marker lights (With halogen headlights),  
Front side-marker lights (With xenon fusion headlights)**

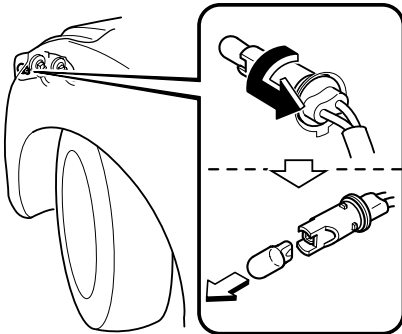

7. Install the new bulb in the reverse order of the removal procedure.

## **Fog lights\***

1. If you are changing the right bulb, start the engine, turn the steering wheel all the way to the left, and turn off engine. If you are changing the left bulb, turn the steering wheel to the right, and turn off engine.
2. Make sure the fog light switch is off.
3. Pull the center of each plastic retainer and remove the retainers.

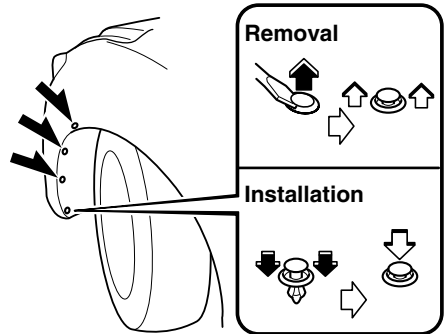

4. Turn the screw counterclockwise and remove it, and then partially peel back the mudguard.

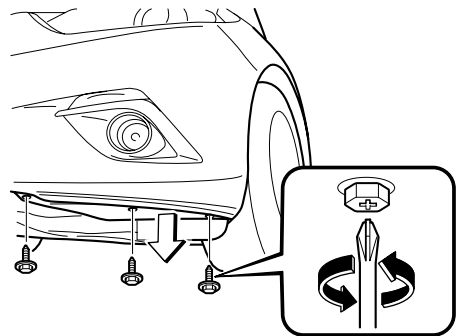

5. Disconnect the connector from the unit by pressing the tab on the connector with your finger and pulling the connector downward.

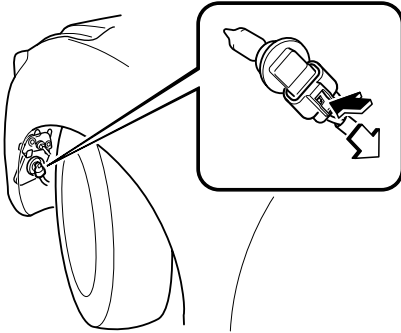

6. Turn the socket and bulb assembly to remove it. Carefully remove the bulb from its socket in the reflector by gently pulling it straight backward out of the socket.

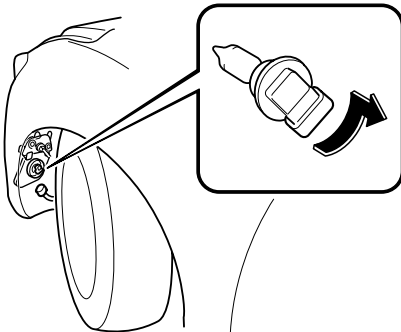

7. Install the new bulb in the reverse order of the removal procedure.

### Side turn signal lights\*, Brake lights (LED type), Taillights/Rear side-marker lights (LED type), Taillights (Trunk lid side/Liftgate side), High-mount brake light

Due to the complexity and difficulty of the procedure, the LED bulbs must be replaced by an Authorized Mazda Dealer.

#### **NOTE**

*LED bulb replacement is not possible because it is built into the unit. Replace the unit.*

### Rear turn signal lights, Brake lights/ Taillights/Rear side-marker lights (Bulb type)

#### **4-Door**

1. Make sure the ignition is switched off, and the headlight switch is off.
2. Pull the center of each plastic retainer and remove the retainers.
3. Remove trunk end trim.

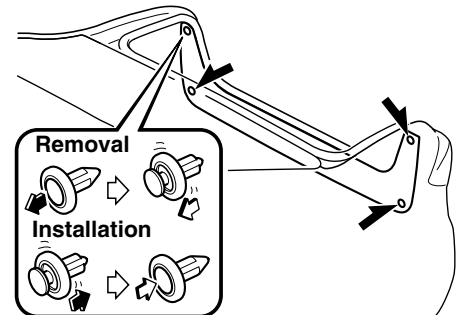

4. Pull the center of each plastic retainer and remove the retainers.

# Owner Maintenance

5. Peel back the trunk side trim.

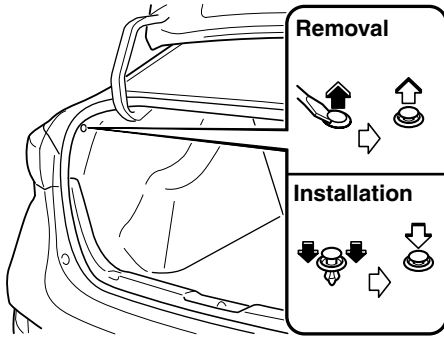

6. Turn the socket and bulb assembly counterclockwise and remove it.
7. Disconnect the bulb from the socket.

## Rear turn signal lights

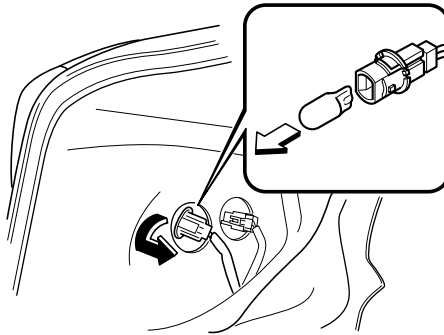

## Brake lights/Taillights/Rear side-marker lights (Bulb type)

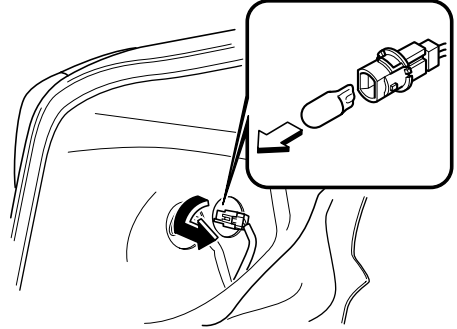

8. Install the new bulb in the reverse order of the removal procedure.

## 5-Door (Left side)

1. Make sure the ignition is switched off, and the headlight switch is off.
2. Remove the cover.

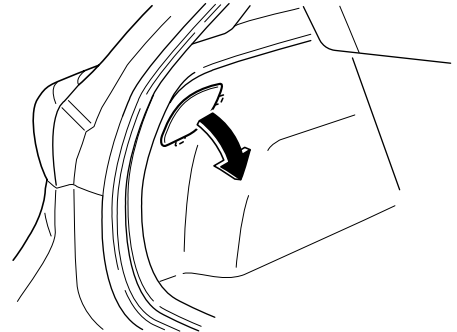

3. Turn the socket and bulb assembly counterclockwise and remove it.

4. Disconnect the bulb from the socket.  
**Rear turn signal lights**

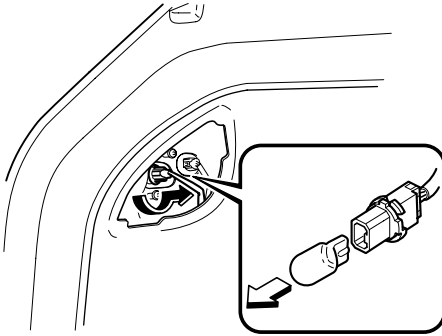

**Brake lights/Taillights/Rear side-marker lights (Bulb type)**

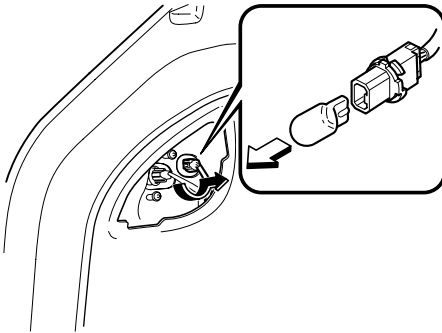

5. Install the new bulb in the reverse order of the removal procedure.

6. Insert the cover tabs and install the cover.

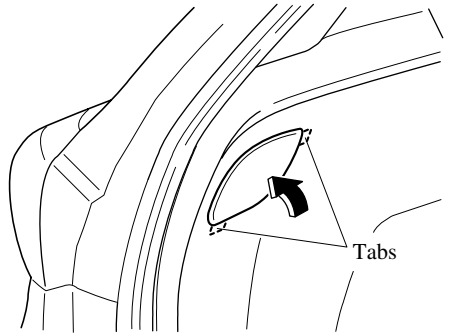

**NOTE**

*Verify that the cover is securely installed.*

**(Right side)**

1. Make sure the ignition is switched off, and the headlight switch is off.
2. Turn the knob and remove the cover.

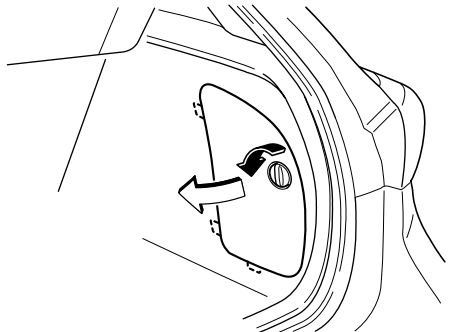

## Owner Maintenance

3. Turn the wing bolt and jack screw counterclockwise.

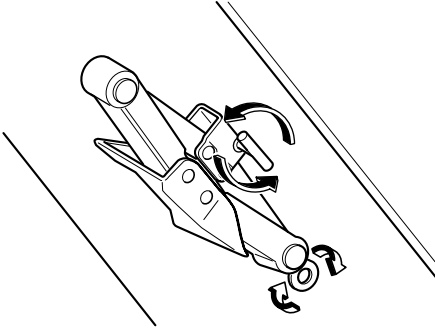

4. Remove the jack
5. Turn the socket and bulb assembly counterclockwise and remove it.
6. Disconnect the bulb from the socket.

### Rear turn signal lights

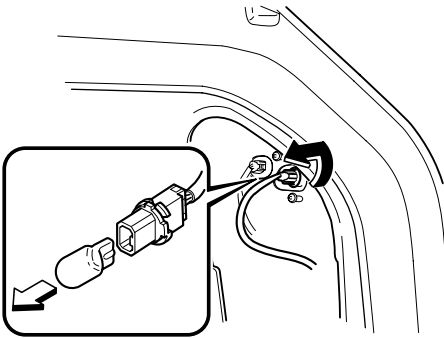

### Brake lights/Taillights/Rear side-marker lights (Bulb type)

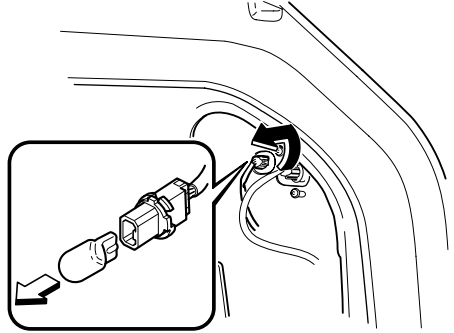

7. Install the new bulb.
8. Insert the wing bolt into the jack with the jack screw pointing to the down and turn the wing bolt clockwise to temporarily tighten it.
9. Turn the jack screw in the direction shown in the figure.

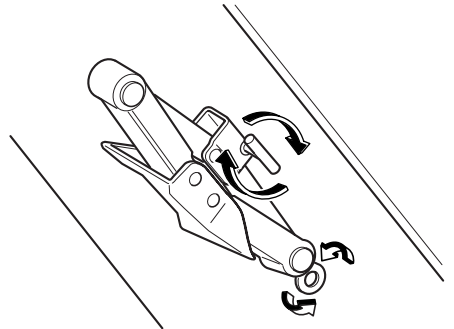

10. Turn the wing bolt completely to secure the jack.

### NOTE

*If the jack is not completely secured, it could rattle while driving. Make sure the jack screw is sufficiently tightened.*

11. Install the cover in the reverse order of the removal procedure.
12. Insert the cover tabs and install the cover.

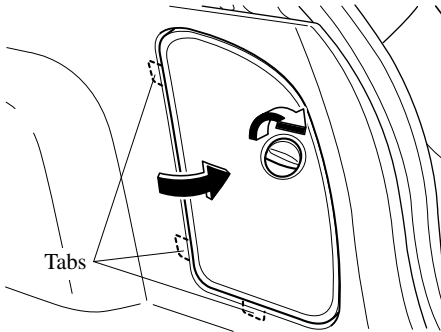
**NOTE**

*Verify that the cover is securely installed.*

**Reverse lights****4-Door**

1. Make sure the ignition is switched off, and the headlight switch is off.
2. Pull the center of each plastic retainer and remove the retainers.
3. Peel back the trunk lid trim.

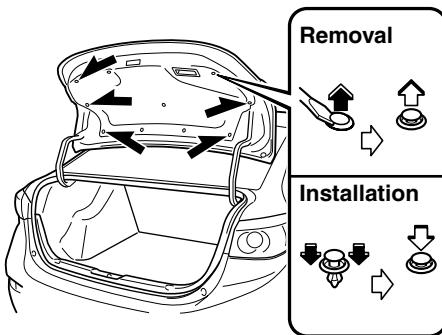

4. Disconnect the electrical connector from the bulb by pressing the tab on the connector with your finger and pulling the connector.

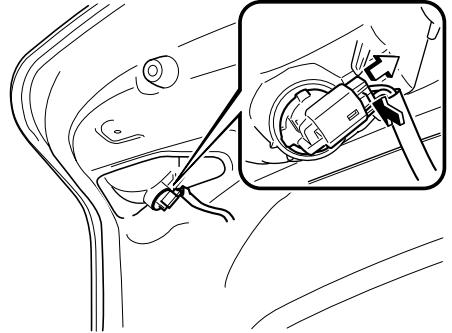

5. Turn the socket and bulb assembly counterclockwise and remove it.
6. Disconnect the bulb from the socket.

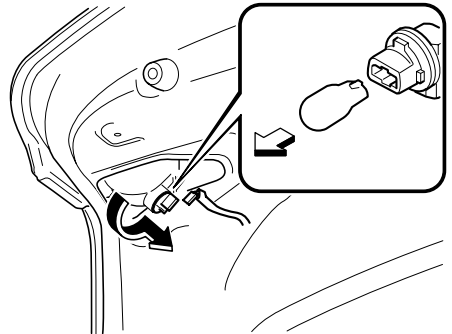

7. Install the new bulb in the reverse order of the removal procedure.

# Owner Maintenance

## 5-Door

1. Make sure the ignition is switched off, and the headlight switch is off.
2. Remove the cover.

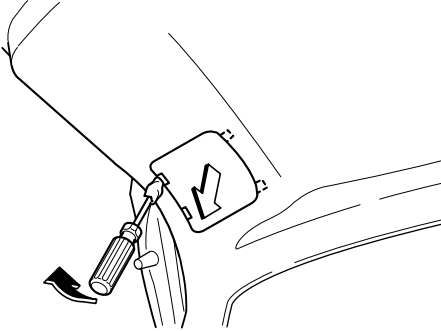

3. Disconnect the electrical connector from the bulb by pressing the tab on the connector with your finger and pulling the connector.

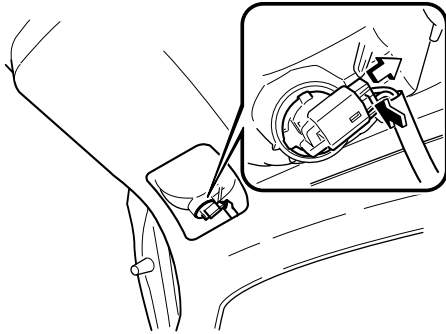

4. Turn the socket and bulb assembly counterclockwise and remove it.

5. Disconnect the bulb from the socket.

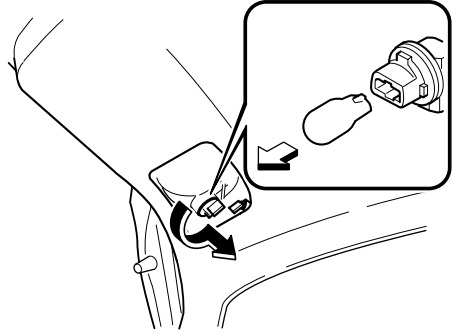

6. Install the new bulb in the reverse order of the removal procedure.

## License plate lights

### 4-Door

1. Make sure the ignition is switched off, and the headlight switch is off.
2. Pull the center of each plastic retainer and remove the retainers.
3. Peel back the trunk lid trim.

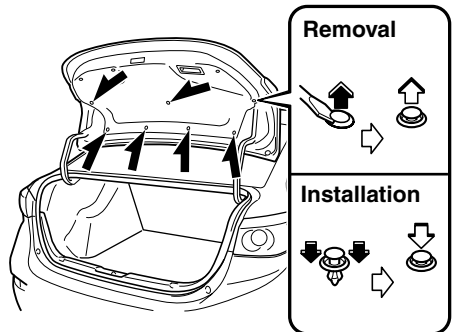

4. Turn the socket and bulb assembly counterclockwise and remove it.



5. Disconnect the bulb from the socket.

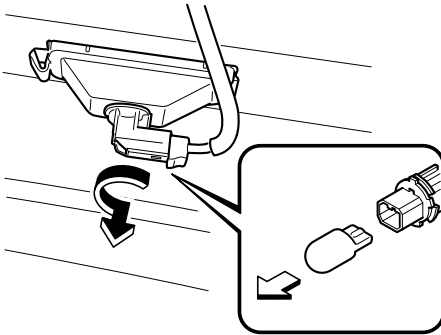

6. Install the new bulb in the reverse order of the removal procedure.

## 5-Door

1. Make sure the ignition is switched off, and the headlight switch is off.
2. Wrap a flathead screwdriver with a soft cloth to prevent damage to the lens, and then remove the lens by carefully prying on the edge of the lens with a flathead screwdriver.
3. Disconnect the bulb by pulling it out.

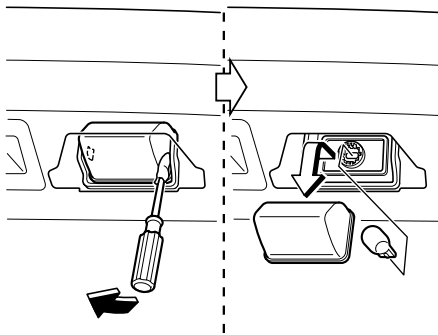

4. Install the new bulb in the reverse order of the removal procedure.

## ▼ Replacing Interior Light Bulbs

### Overhead lights (Front)/Map lights\*, Overhead lights (Front)\*, Overhead lights (Rear)\*, Vanity mirror lights\*

1. Wrap a small flathead screwdriver with a soft cloth to prevent damage to the lens, and then remove the lens by carefully prying on the edge of the lens with the flathead screwdriver.
2. Disconnect the bulb by pulling it out.  
**Overhead lights (Front)/Map lights\***

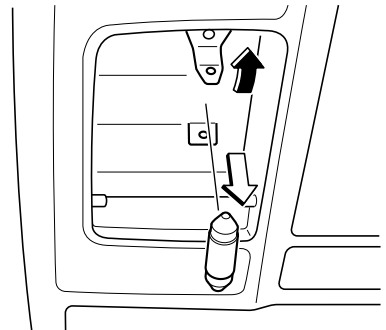
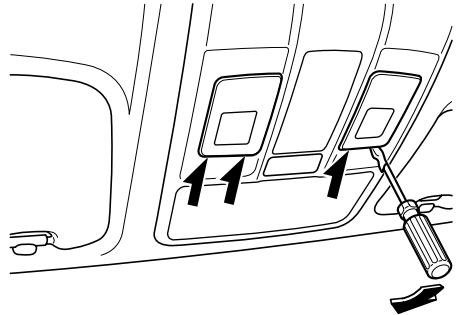

# Owner Maintenance

## Overhead lights (Front)\*

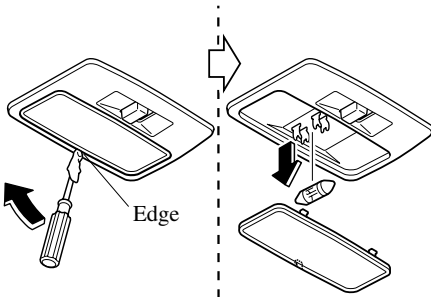

## Overhead lights (Rear)\*

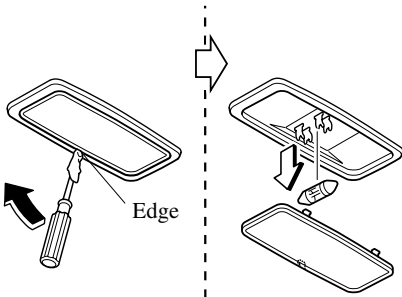

## Vanity mirror lights\*

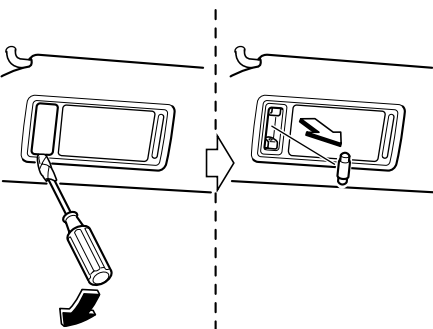

3. Install the new bulb in the reverse order of the removal procedure.

## Trunk light (4-Door)

1. Press both sides of the lens cap to remove it.
2. Disconnect the bulb by pulling it out.

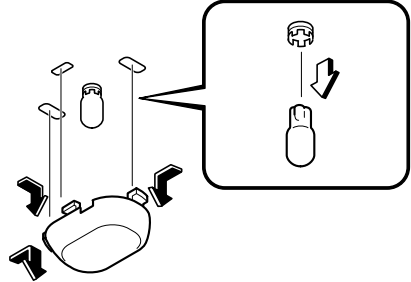

3. Install the new bulb in the reverse order of the removal procedure.

## Luggage compartment light (5-Door)

1. Wrap a small flathead screwdriver with a soft cloth to prevent damage to the lens and remove the lens by carefully prying on the edge of the lens with the flathead screwdriver.
2. Disconnect the bulb by pulling it out.

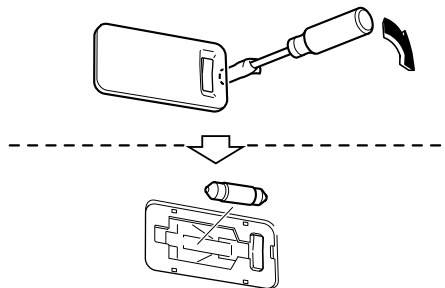

3. Install the new bulb in the reverse order of the removal procedure.

## Fuses

Your vehicle's electrical system is protected by fuses.

If any lights, accessories, or controls do not work, inspect the appropriate circuit protector. If a fuse has blown, the inside element will be melted.

If the same fuse blows again, avoid using that system and consult an Authorized Mazda Dealer as soon as possible.

### ▼ Fuse Replacement

#### Replacing the fuses on the vehicle's left side

If the electrical system does not work, first inspect the fuses on the vehicle's left side.

1. Make sure the ignition is switched off, and other switches are off.
2. Open the fuse panel cover.

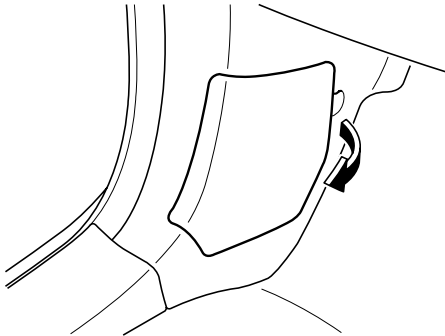

3. Pull the fuse straight out with the fuse puller provided on the fuse block located in the engine compartment.

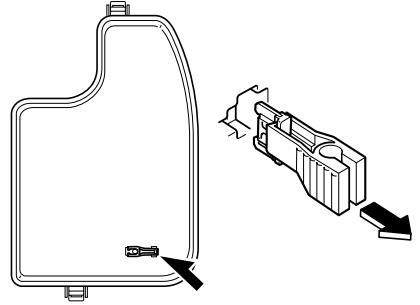

4. Inspect the fuse and replace it if it is blown.

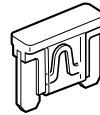

Normal

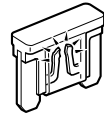

Blown

5. Insert a new fuse of the same amperage rating, and make sure it fits tightly. If it does not fit tightly, have an expert install it. We recommend an Authorized Mazda Dealer.

If you have no spare fuses, borrow one of the same rating from a circuit not essential to vehicle operation, such as the AUDIO or OUTLET circuit.

### **⚠ CAUTION**

*Always replace a fuse with a genuine Mazda fuse or equivalent of the same rating. Otherwise you may damage the electric system.*

## Owner Maintenance

6. Reinstall the cover and make sure that it is securely installed.

### Replacing the fuses under the hood

If the headlights or other electrical components do not work and the fuses in the cabin are normal, inspect the fuse block under the hood. If a fuse is blown, it must be replaced. Follow these steps:

1. Make sure the ignition is switched off, and other switches are off.
2. Remove the fuse block cover.

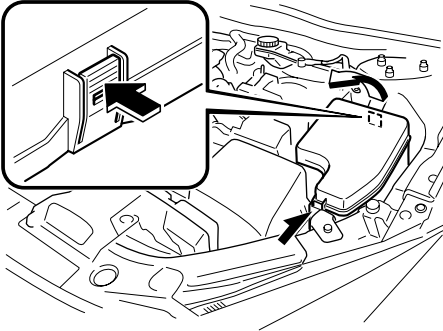

3. If any fuse but the MAIN fuse is blown, replace it with a new one of the same amperage rating.

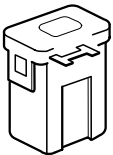

Normal

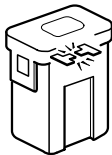

Blown

### **! WARNING**

***Do not replace the main fuse and multiplex slow blow fuse by yourself. Have an Authorized Mazda Dealer perform the replacement:***

*Replacing these fuses by yourself is dangerous because they are high current fuses. Incorrect replacement could cause an electrical shock or a short circuit resulting in a fire.*

4. Reinstall the cover and make sure that it is securely installed.

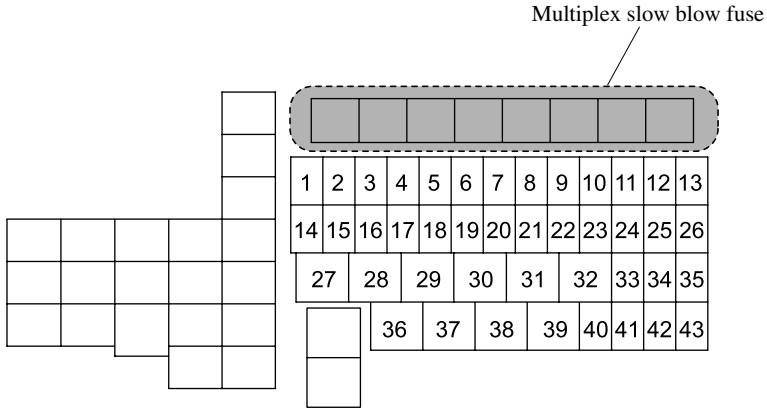
**▼ Fuse Panel Description****Fuse block (Engine compartment)**

DESCRIPTION		FUSE RATING	PROTECTED COMPONENT
1	FOG	15 A	Fog lights*
2	H/L HI	20 A	Headlight high beam*
3	H/CLEAN	20 A	—
4	STOP	10 A	Brake lights
5	ROOM	15 A	Overhead light
6	ENG+B	7.5 A	Engine control system
7	FUEL WARM	—	—
8	HAZARD	25 A	Hazard warning flashers, Turn signal lights
9	ABS/DSCS	30 A	ABS, Dynamic stability control system
10	METER2	—	—
11	AUDIO2	7.5 A	Audio system
12	BOSE	25 A	Bose® Sound System-equipped model*
13	AUDIO1	15 A	Audio system
14	FUEL PUMP	15 A	Fuel system
15	HID R DRL	15 A	Headlight (RH)* <sup>1</sup> , Daytime running lights*
16	AT PUMP	—	—
17	HORN	15 A	Horn
18	TAIL	15 A	Taillights, License plate lights, Parking lights, Front side-marker lights

# Owner Maintenance

DESCRIPTION		FUSE RATING	PROTECTED COMPONENT
19	CNG	15 A	—
20	AT	15 A	Transaxle control system
21	R.WIPER	15 A	Rear window wiper*
22	A/C	7.5 A	Air conditioner
23	ENGINE3	15 A	Engine control system
24	ENGINE2	15 A	Engine control system
25	ENGINE1	15 A	Engine control system
26	GLOW SIG	—	—
27	EVVT	20 A	Engine control system
28	WIPER	20 A	Front window wiper and washer
29	DCDC REG	—	—
30	FUEL PUMP2	30 A	—
31	ADD FAN DE	—	—
32	P.WINDOW1	30 A	Power windows
33	H/L LOW R	15 A	Headlight low beam (RH)*2
34	H/L LOW L HID L	15 A	Headlight (LH)*1, Headlight low beam (LH)*2
35	METER1	10 A	Instrument cluster
36	IG2	30 A	For protection of various circuits
37	LPG	30 A	—
38	FAN DE	—	—
39	DCDC DE	—	—
40	SRS1	7.5 A	Air bag
41	ENGINE. IG1	15 A	Engine control system
42	C/U IG1	15 A	For protection of various circuits
43	—	—	—

\*1 With xenon fusion headlights

\*2 With halogen headlights

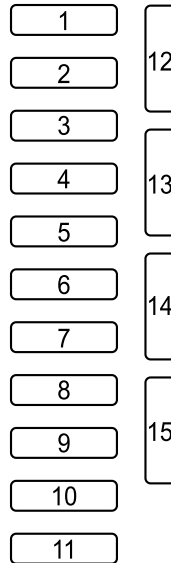
**Fuse block (Left side)**

DESCRIPTION		FUSE RATING	PROTECTED COMPONENT
1	P.WINDOW3 P.SEAT D	30 A	Power seat*
2	D.LOCK	25 A	Power door locks
3	P.WINDOW2	25 A	Power windows
4	SEAT WARM	20 A	Seat warmer*
5	R.OUTLET3	15 A	Accessory sockets
6	SRS2/ESCL	15 A	Seat weight sensor*
7	SUNROOF	10 A	Moonroof*
8	M.DEF	7.5 A	Mirror defogger*
9	R.OUTLET1	15 A	—
10	MIRROR	7.5 A	Power control mirror
11	F.OUTLET	15 A	Accessory sockets
12	ABS IG AT IND	7.5 A	AT shift indicator*
13	SRS1	7.5 A	—
14	METER1	10 A	—
15	C/U IG1	15 A	—

## Appearance Care

---

### Exterior Care

The paintwork on your Mazda represents the latest technical developments in composition and methods of application.

Environmental hazards, however, can harm the paint's protective properties, if proper care is not taken.

Here are some examples of possible damage, with tips on how to prevent them.

#### Etching Caused by Acid Rain or Industrial Fallout

##### Occurrence

Industrial pollutants and vehicle emissions drift into the air and mix with rain or dew to form acids. These acids can settle on a vehicle's finish. As the water evaporates, the acid becomes concentrated and can damage the finish.

And the longer the acid remains on the surface, the greater the chance is for damage.

##### Prevention

It is necessary to wash and wax your vehicle to preserve its finish according to the instructions in this section. These steps should be taken immediately after you suspect that acid rain has settled on your vehicle's finish.

#### Damage Caused by Bird Dropping, Insects, or Tree Sap

##### Occurrence

Bird droppings contain acids. If these are not removed they can eat away the clear and color base coat of the vehicle's paintwork.

When insects stick to the paint surface and decompose, corrosive compounds form. These can erode the clear and color base coat of the vehicle's paintwork if they are not removed.

Tree sap will harden and adhere permanently to the paint finish. If you scratch the sap off while it is hard, some vehicle paint could come off with it.

##### Prevention

It is necessary to have your Mazda washed and waxed to preserve its finish according to the instructions in this section. This should be done as soon as possible.

Bird droppings can be removed with a soft sponge and water. If you are traveling and these are not available, a moistened tissue may also take care of the problem. The cleaned area should be waxed according to the instructions in this section.

Insects and tree sap are best removed with a soft sponge and water or a commercially available chemical cleaner.

Another method is to cover the affected area with dampened newspaper for one to two hours. After removing the newspaper, rinse off the loosened debris with water.



### **Water Marks**

#### **Occurrence**

Rain, fog, dew, and even tap water can contain harmful minerals such as salt and lime. If moisture containing these minerals settles on the vehicle and evaporates, the minerals will concentrate and harden to form white rings. The rings can damage your vehicle's finish.

#### **Prevention**

It is necessary to wash and wax your vehicle to preserve its finish according to the instructions in this section. These steps should be taken immediately after you find water marks on your vehicle's finish.

### **Paint Chipping**

#### **Occurrence**

Paint chipping occurs when gravel thrown in the air by another vehicle's tires hits your vehicle.

#### **How to avoid paint chipping**

Keeping a safe distance between you and the vehicle ahead reduces the chances of having your paint chipped by flying gravel.

### **NOTE**

- *The paint chipping zone varies with the speed of the vehicle. For example, when traveling at 90 km/h (56 mph), the paint chipping zone is 50 m (164 ft).*
- *In low temperatures a vehicle's finish hardens. This increases the chance of paint chipping.*
- *Chipped paint can lead to rust forming on your Mazda. Before this happens, repair the damage by using Mazda touch-up paint according to the instructions in this section. Failure to repair the affected area could lead to serious rusting and expensive repairs.*

Follow **all** label and container directions when using a chemical cleaner or polish. Read all warnings and cautions.

## Appearance Care

### ▼ Maintaining the Finish

#### Washing



➤ *When the wiper lever is in the AUTO position and the ignition is switched ON, the wipers may move automatically in the following cases:*

- *If the windshield above the rain sensor is touched or wiped with a cloth.*
- *If the windshield is struck with a hand or other object from either outside or inside the vehicle.*

*Keep hands and scrapers clear of the windshield when the wiper lever is in the AUTO position and the ignition is switched ON as fingers could be pinched or the wipers and wiper blades damaged when the wipers activate automatically. If you are going to clean the windshield, be sure the wipers are turned off completely (when it is most likely that the engine is left running) this is particularly important when clearing ice and snow.*

- *Do not spray water in the engine compartment. Otherwise, it could result in engine-starting problems or damage to electrical parts.*
- *When washing and waxing the vehicle, be careful not to apply excessive force to any single area of the vehicle roof or the antenna. Otherwise, you could dent the vehicle or damage the antenna.*

To help protect the finish from rust and deterioration, wash your Mazda thoroughly and frequently, at least once a month, with lukewarm or cold water.

If the vehicle is washed improperly, the paint surface could be scratched. Here are some examples of how scratching could occur.

Scratches occur on the paint surface when:

- The vehicle is washed without first rinsing off dirt and other foreign matter.
- The vehicle is washed with a rough, dry, or dirty cloth.
- The vehicle is washed at a car wash that uses brushes that are dirty or too stiff.
- Cleansers or wax containing abrasives are used.

#### NOTE

- *Mazda is not responsible for scratches caused by automatic car washes or improper washing.*
- *Scratches are more noticeable on vehicles with darker paint finishes.*

To minimize scratches on the vehicle's paint finish:

- Rinse off any dirt or other foreign matter using lukewarm or cold water before washing.
- Use plenty of lukewarm or cold water and a soft cloth when washing the vehicle. Do not use a nylon cloth.
- Rub gently when washing or drying the vehicle.
- Take your vehicle only to a car wash that keeps its brushes well maintained.
- Do not use abrasive cleansers or wax that contain abrasives.

## CAUTION

*Do not use steel wool, abrasive cleaners, or strong detergents containing highly alkaline or caustic agents on chrome-plated or anodized aluminum parts. This may damage the protective coating; also, cleaners and detergents may discolor or deteriorate the paint.*

Pay special attention to removing salt, dirt, mud, and other foreign material from the underside of the fenders, and make sure the drain holes in the lower edges of the doors and rocker panels are clean.

Insects, tar, tree sap, bird droppings, industrial fallout, and similar deposits can damage the finish if not removed immediately. When prompt washing with plain water is ineffective, use a mild soap made for use on vehicles.

Thoroughly rinse off all soap with lukewarm or cold water. Do not allow soap to dry on the finish.

After washing the vehicle, dry it with a clean chamois to prevent water spots from forming.

## WARNING

***Dry off brakes that have become wet by driving slowly, releasing the accelerator pedal and lightly applying the brakes several times until the brake performance returns to normal:***

*Driving with wet brakes is dangerous. Increased stopping distance or the vehicle pulling to one side when braking could result in a serious accident. Light braking will indicate whether the brakes have been affected.*

### When using an automatic car wash

- Retract the door mirrors.
- The automatic car wash brushes could reduce the paint lustre or hasten paint deterioration.

### When using a high water pressure car wash

High water temperature and high water pressure car washers are available depending on the type of car wash machine. If the car washer nozzle is put too close to the vehicle, the force of the spray could damage or deform the molding, affect the sealability of parts, and allow water to penetrate the interior. Keep a sufficient space (30 cm (12 in) or more) between the nozzle and the vehicle. In addition, do not spend too much time spraying the same area of the vehicle, and be very careful when spraying between gaps in doors and around windows.

### Waxing

Your vehicle needs to be waxed when water no longer beads on the finish. Always wash and dry the vehicle before waxing it. In addition to the vehicle body, wax the metal trim to maintain its luster.

1. Use wax which contains no abrasives. Waxes containing abrasive will remove paint and could damage bright metal parts.
2. Use a good grade of natural wax for metallic, mica, and solid colors.
3. When waxing, coat evenly with the sponge supplied or a soft cloth.
4. Wipe off the wax with a soft cloth.

## Appearance Care

---

### NOTE

*A spot remover to remove oil, tar, and similar materials will usually also take off the wax. Rewax these areas even if the rest of the vehicle does not need it.*

### ▼ Repairing Damage to the Finish

Deep scratches or chips on the finish should be repaired promptly. Exposed metal quickly rusts and can lead to major repairs.

#### CAUTION

*If your Mazda is damaged and needs metal parts repaired or replaced, make sure the body shop applies anti-corrosion materials to all parts, both repaired and new. This will prevent them from rusting.*

### ▼ Bright-Metal Maintenance

- Use tar remover to remove road tar and insects. Never do this with a knife or similar tool.
- To prevent corrosion on bright-metal surfaces, apply wax or chrome preservative and rub it to a high luster.
- During cold weather or in coastal areas, cover bright-metal parts with a coating of wax or preservative heavier than usual. It would also help to coat them with noncorrosive petroleum jelly or some other protective compound.

#### CAUTION

*Do not use steel wool, abrasive cleaners, or strong detergents containing highly alkaline or caustic agents on chrome-plated or anodized aluminum parts. This may result in damage to the protective coating and cause discoloration or paint deterioration.*

### ▼ Underbody Maintenance

Road chemicals and salt used for ice and snow removal and solvents used for dust control may collect on the underbody. If not removed, they will speed up rusting and deterioration of such underbody parts as fuel lines, frame, floor pan, and exhaust system, even though these parts may be coated with anti-corrosive material.

Thoroughly flush the underbody and wheel housings with lukewarm or cold water at the end of each winter. Try also to do this every month.

Pay special attention to these areas because they easily hide mud and dirt.

**It will do more harm than good to wet down the road grime without removing it.**

The lower edges of doors, rocker panels, and frame members have drain holes that should not be clogged. Water trapped there will cause rusting.

## **WARNING**

**Dry off brakes that have become wet by driving slowly, releasing the accelerator pedal and lightly applying the brakes several times until the brake performance returns to normal:**

*Driving with wet brakes is dangerous. Increased stopping distance or the vehicle pulling to one side when braking could result in a serious accident. Light braking will indicate whether the brakes have been affected.*

## ▼ **Aluminum Wheel Maintenance\***

A protective coating is provided over the aluminum wheels. Special care is needed to protect this coating.

## **CAUTION**

*Do not use any detergent other than mild detergent. Before using any detergent, verify the ingredients. Otherwise, the product could discolor or stain the aluminum wheels.*

### **NOTE**

- *Do not use a wire brush or any abrasive cleaner, polishing compound, or solvent on aluminum wheels. They may damage the coating.*
- *Always use a sponge or soft cloth to clean the wheels. Rinse the wheels thoroughly with lukewarm or cold water. Also, be sure to clean the wheels after driving on dusty or salted roads to help prevent corrosion.*
- *Avoid washing your vehicle in an automatic car wash that uses high-speed or hard brushes.*

## ▼ **Plastic Part Maintenance**

- When cleaning the plastic lenses of the lights, do not use gasoline, kerosene, rectified spirit, paint, thinner, highly acidic detergents, or strongly alkaline detergents. Otherwise, these chemical agents can discolor or damage the surfaces resulting in a significant loss in functionality. If plastic parts become inadvertently exposed to any of these chemical agents, flush with water immediately.
- If plastic parts such as the bumpers become inadvertently exposed to chemical agents or fluids such as gasoline, oil, engine coolant, or battery fluid, it could cause discoloration, staining, or paint peeling. Wipe off any such chemical agents or fluids using a soft cloth immediately.
- High water temperature and high water pressure car washers are available depending on the type of high pressure car washer device. If the car washer nozzle is put too close to the vehicle or aimed at one area for an extended period of time, it could deform plastic parts or damage the paint.
- Do not use wax containing compounds (polish). Otherwise, it could result in paint damage.
- In addition, do not use an electrical or air tool to apply wax. Otherwise, the frictional heat generated could result in deformation of plastic parts or paint damage.

## Appearance Care

---

### Interior Care

#### **WARNING**

##### **Do not spray water in the cabin:**

*Splashing water on electrical parts such as the audio unit and switches is dangerous as it could cause a malfunction or a fire.*

#### **▼ Dashboard Precautions**

Prevent caustic solutions such as perfume and cosmetic oils from contacting the dashboard. They will damage and discolor the dashboard. If these solutions get on the dashboard, wipe them off immediately.

#### **CAUTION**

*Do not use glazing agents. Glazing agents contain ingredients which may cause discoloration, wrinkling, cracks and peeling.*

#### **Instrument panel top (soft pad)**

- Extremely soft material is used for the soft pad surface. When cleaning, it is recommended that you use a clean towel dampened in a mild detergent to remove soiling.
- If the soft pad surface is rubbed harshly, it could result in the surface being damaged leaving white scratch marks.

#### **▼ Cleaning the Upholstery and Interior Trim**

##### **Vinyl**

Remove dust and loose dirt from vinyl with a whisk broom or vacuum cleaner. Clean vinyl with a leather-and-vinyl cleaner.

##### **Leather\***

Remove dust and sand first using a vacuum cleaner or other means, then wipe dirt off using a soft cloth with a leather cleaner or a soft cloth soaked in mild soap. Wipe off the remaining cleaner or soap using a cloth soaked in clean water and wrung out well.

Remove moisture with a dry, soft cloth and allow the leather to further dry in a well-ventilated, shaded area. If the leather gets wet such as from rain, also remove moisture and dry it as soon as possible.

##### **NOTE**

- *Because genuine leather is a natural material, its surface is not uniform and it may have natural scars, scratches, and wrinkles.*
- *To maintain the quality for as long as possible, periodical maintenance, about twice a year, is recommended.*
- *Sand and dust on the seat surface may damage the overcoat of the genuine leather surfaces and accelerate wear.*
- *Greasy soiling on genuine leather may cause molding and stains.*
- *Rubbing hard with a stiff brush or cloth may cause damage.*
- *Do not wipe the leather using alcohol, chlorine bleach, or organic solvents such as thinner, benzene, or gasoline. Otherwise, it may cause discoloration or stains.*

- *If the seats get wet, promptly remove moisture with a dry cloth. Remaining moisture on the surface may cause deterioration such as hardening and shrinkage.*
- *Exposure to direct sunlight for long periods may cause deterioration and shrinkage. When parking the car under direct sunlight for long periods, shade the interior using sunshades.*
- *Do not leave vinyl products on the seats for long periods as they may affect the leather quality and coloring. If the cabin temperature becomes hot, the vinyl may deteriorate and adhere to the genuine leather.*

### **Fabric**

Remove dust and loose dirt from fabric with a whisk broom or vacuum cleaner. Clean it with a mild soap solution good for upholstery and carpets. Remove fresh spots immediately with a fabric spot cleaner.

To keep the fabric looking clean and fresh, take care of it. Otherwise its color will be affected, it can be stained easily, and its fire-resistance may be reduced.



*Use only recommended cleaners and procedures. Others may affect appearance and fire-resistance.*

### **Panel**

When the interior panels need to be cleaned, use soft material such as a soft cloth soaked in clean water and wrung out well and lightly wipe off dirt from the surface. If a panel requires further cleaning, use the following procedure.

1. Wipe dirt off using a soft cloth soaked in mild detergent (about 5% solution).
2. Wipe off any remaining detergent using a cloth soaked in clean water and wrung out well.

### **NOTE**

- *Do not wipe leather parts using alcohol, chlorine bleach, or organic solvents such as thinner, benzene, or gasoline. Otherwise, it may cause discoloration or stains.*
- *Scratches or nicks on the panels and metallic trim resulting from the use of a hard brush or cloth may not be repairable.*
- *Be particularly careful when cleaning high lustre panels and metallic trim as they can be easily scratched.*

### **▼ Maintenance of the Active Driving Display**

The combiner and mirror surface have a special coating. When cleaning, do not use a hard or rough-surface cloth, or cleaning detergent. In addition, if a chemical solvent gets on the active driving display, wipe it off immediately. Otherwise, the combiner and mirror could be damaged and the surface coating could be scratched. Use a fine, soft cloth such as those used for cleaning eyeglasses.

## Appearance Care

---

### ▼ Cleaning the Lap/Shoulder Belt Webbing

Clean the webbing with a mild soap solution recommended for upholstery or carpets. Follow instructions. Do not bleach or dye the webbing; this may weaken it.

After cleaning the belts, thoroughly dry the belt webbing and make sure there is no remaining moisture before retracting them.

#### **WARNING**

**Have an Authorized Mazda Dealer replace damaged seat belts immediately:**

*Using damaged seat belts is dangerous. In a collision, damaged belts cannot provide adequate protection.*

### ▼ Cleaning the Window Interiors

If the windows become covered with an oily, greasy, or waxy film, clean them with glass cleaner. Follow the directions on the container.

#### **CAUTION**

- *Do not scrape or scratch the inside of the window glass. It could damage the thermal filaments and the antenna lines.*
- *When washing the inside of the window glass, use a soft cloth dampened in lukewarm water, gently wiping the thermal filaments and the antenna lines. Use of glass cleaning products could damage the thermal filaments and the antenna lines.*

### ▼ Cleaning the Floor Mats

Rubber floor mats should be cleaned with mild soap and water only.

#### **WARNING**

**Do not use rubber cleaners, such as tire cleaner or tire shine, when cleaning rubber floor mats:**

*Cleaning the rubber floor mats with rubber cleaning products makes the floor mats slippery.*

*This may cause an accident when depressing the accelerator, brake, or clutch (Manual transaxle) pedal or when getting in or out of the vehicle.*

After removing the floor mats for cleaning, always reinstall them securely.3-46



## If Trouble Arises

Helpful information on what to do if a problem arises with the vehicle.

<b>Parking in an Emergency</b> .....	<b>7-2</b>
Parking in an Emergency .....	7-2
<b>Flat Tire</b> .....	<b>7-3</b>
Spare Tire and Tool Storage.....	7-3
Changing a Flat Tire.....	7-6
<b>Battery Runs Out</b> .....	<b>7-15</b>
Jump-Starting.....	7-15
<b>Emergency Starting</b> .....	<b>7-18</b>
Starting a Flooded Engine.....	7-18
Push-Starting.....	7-18
<b>Overheating</b> .....	<b>7-19</b>
Overheating.....	7-19
<b>Emergency Towing</b> .....	<b>7-21</b>
Towing Description.....	7-21
Tiedown Hooks* .....	7-22
<b>Warning/Indicator Lights and Warning Sounds</b> .....	<b>7-24</b>
If a Warning Light Turns On or Flashes.....	7-24
Message Indicated on Display* .....	7-33
Warning Sound is Activated.....	7-35
<b>When Liftgate/Trunk Lid Cannot be Opened</b> .....	<b>7-39</b>
When Liftgate/Trunk Lid Cannot be Opened .....	7-39
<b>Active Driving Display Does Not Operate*</b> .....	<b>7-41</b>
If the Active Driving Display Does Not Operate.....	7-41

## Parking in an Emergency

---

### Parking in an Emergency

The hazard warning lights should always be used when you stop on or near a roadway in an emergency.

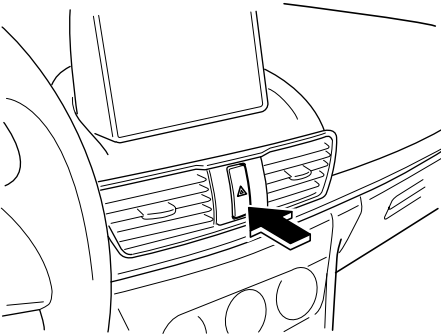

The hazard warning lights warn other drivers that your vehicle is a traffic hazard and that they must take extreme caution when near it.



Depress the hazard warning flasher and all the turn signals will flash. The hazard warning indicator lights in the instrument cluster flash simultaneously.

#### **NOTE**

- *The turn signals do not work when the hazard warning lights are on.*
- *Check local regulations about the use of hazard warning lights while the vehicle is being towed to verify that it is not in violation of the law.*

## Spare Tire and Tool Storage

Spare tire and tools are stored in the locations illustrated in the diagram.

### 4-Door

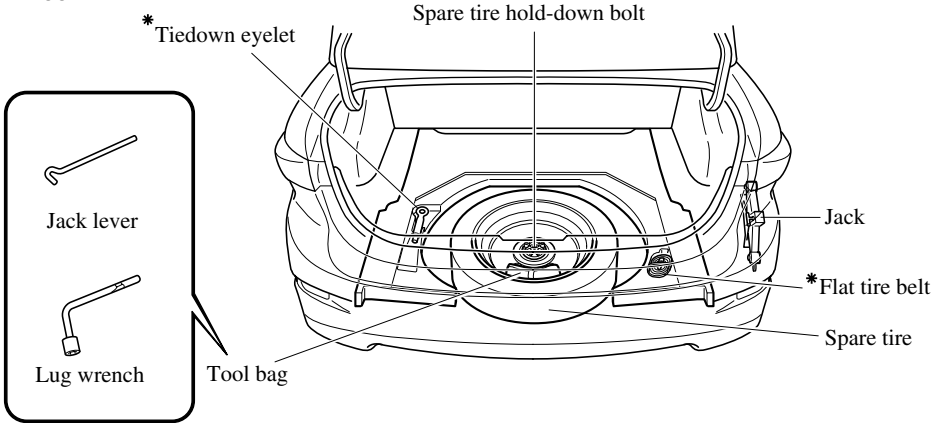

### 5-Door

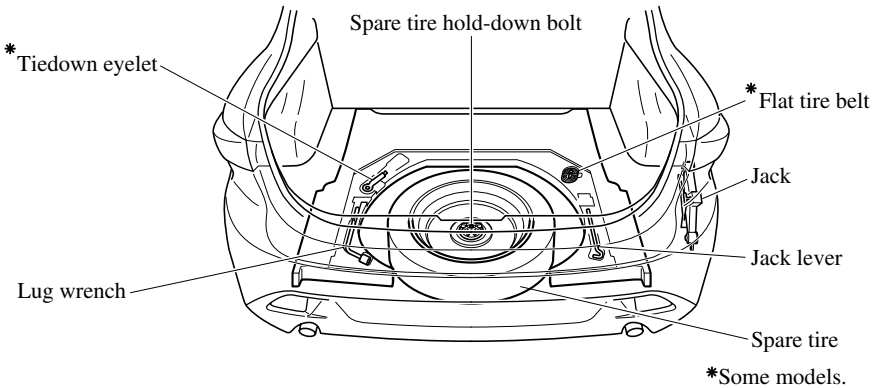

▼ **Jack**

**To remove the jack**

1. **(4-Door)**

Push the tabs and remove the cover.

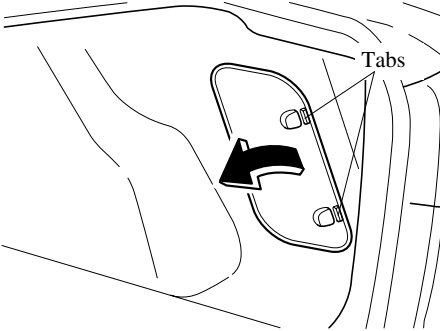

**(5-Door)**

Turn the knob and remove the cover.

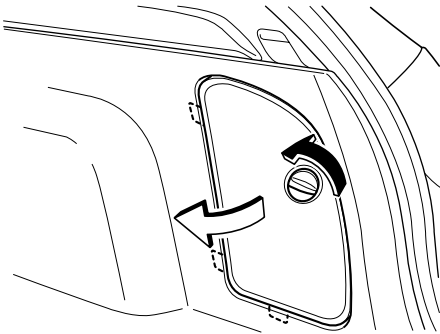

2. Turn the wing bolt and jack screw counterclockwise.

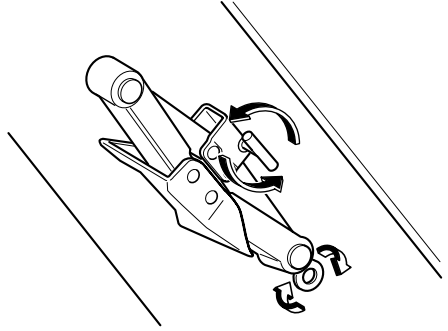

**To secure the jack**

1. Insert the wing bolt into the jack with the jack screw pointing to the down and turn the wing bolt clockwise to temporarily tighten it.  
2. Turn the jack screw in the direction shown in the figure.

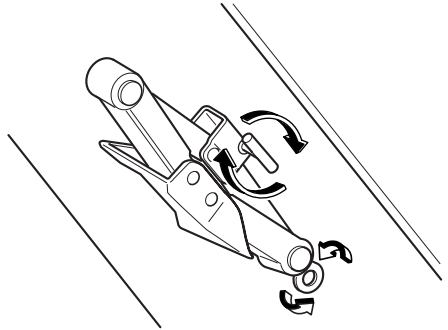

3. Turn the wing bolt completely to secure the jack.

**NOTE**

*If the jack is not completely secured, it could rattle while driving. Make sure the jack screw is sufficiently tightened.*

4. Insert the cover tabs and install the cover.

(4-Door)

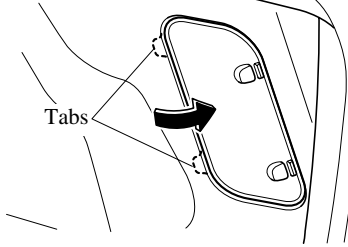

(5-Door)

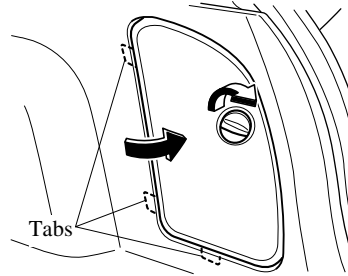

**NOTE**

*Verify that the cover is securely installed.*

**Maintenance**

- Always keep the jack clean.
- Make sure the moving parts are kept free from dirt or rust.
- Make sure the screw thread is adequately lubricated.

**▼ Spare Tire**

Your Mazda has a temporary spare tire. The temporary spare tire is lighter and smaller than a conventional tire, and is designed only for emergency use and should be used only for VERY short periods. Temporary spare tires should NEVER be used for long drives or extended periods.

**⚠ WARNING**

**Do not install the temporary spare tire on the front wheels (driving wheels):**

*Driving with the temporary spare tire on one of the front driving wheels is dangerous. Handling will be affected. You could lose control of the vehicle, especially on ice or snow bound roads, and have an accident. Move a regular tire to the front wheel and install the temporary spare tire to the rear.*

**⚠ CAUTION**

- *When using the temporary spare tire, driving stability may decrease compared to when using only the conventional tire. Drive carefully.*
- *To avoid damage to the temporary spare tire or to the vehicle, observe the following precautions:*
  - *Do not exceed 80 km/h (50 mph).*
  - *Avoid driving over obstacles. Also, do not drive through an automatic car wash. This tire's diameter is smaller than a conventional tire, so the ground clearance is reduced about 10 mm (0.4 in).*
  - *Do not use a tire chain on this tire because it will not fit properly.*
  - *Do not use your temporary spare tire on any other vehicle, it has been designed only for your Mazda.*
  - *Use only one temporary spare tire on your vehicle at the same time.*

# Flat Tire

## To remove the spare tire

1. Lift the trunk/luggage compartment mat.

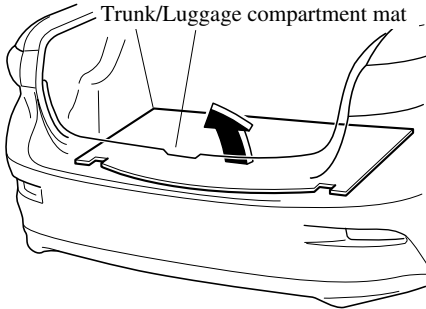

2. Turn the spare tire hold-down bolt counterclockwise.

Spare tire hold-down bolt

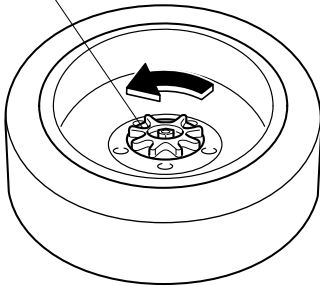

## To secure the spare tire

Store the spare tire in the reverse order of removal. After storing, verify that the spare tire is stored securely.

## Changing a Flat Tire

### **NOTE**

*If the following occurs while driving, it could indicate a flat tire.*

- *Steering becomes difficult.*
- *The vehicle begins to vibrate excessively.*
- *The vehicle pulls in one direction.*

If you have a flat tire, drive slowly to a level spot that is well off the road and out of the way of traffic to change the tire. Stopping in traffic or on the shoulder of a busy road is dangerous.

### **! WARNING**

***Be sure to follow the directions for changing a tire:***

*Changing a tire is dangerous if not done properly. The vehicle can slip off the jack and seriously injure someone. No person should place any portion of their body under a vehicle that is supported by a jack.*

***Never allow anyone inside a vehicle supported by a jack:***

*Allowing someone to remain in a vehicle supported by a jack is dangerous. The occupant could cause the vehicle to fall resulting in serious injury.*

### **NOTE**

*Make sure the jack is well lubricated before using it.*

1. Park on a level surface off the right-of-way and firmly set the parking brake.
2. Put a vehicle with an automatic transaxle in Park (P), a manual transaxle in Reverse (R) or 1, and turn off the engine.
3. Turn on the hazard warning flasher.
4. Have everyone get out of the vehicle and away from the vehicle and traffic.
5. Remove the jack, tool, and spare tire (page 7-3).
6. Block the wheel diagonally opposite the flat tire. When blocking a wheel, place a tire block both in front and behind the tire.

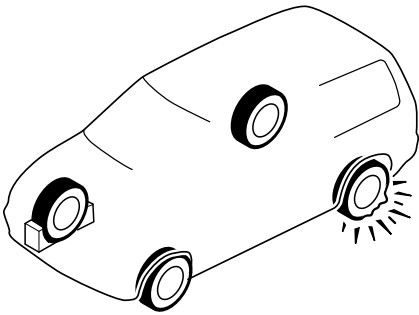

**NOTE**

*When blocking a tire, use rocks or wood blocks of sufficient size if possible to hold the tire in place.*

▼ **Removing a Flat Tire**

1. If your vehicle is equipped with a wheel cover, pry off the wheel cover with the beveled end of the jack lever.

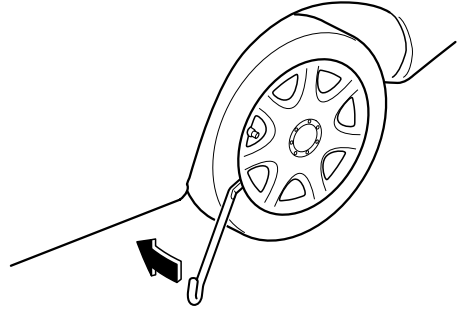

**NOTE**

*Force the end of the jack lever firmly between wheel and cover, or removal will be difficult.*

2. Loosen the lug nuts by turning them counterclockwise one turn each, but do not remove any lug nuts until the tire has been raised off the ground.

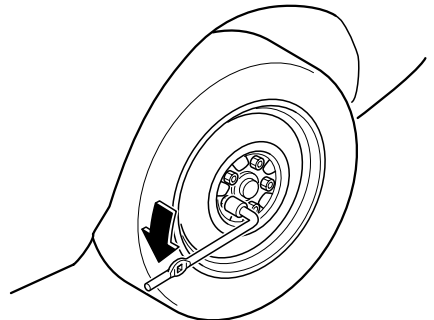

3. Place the jack on the ground.

If Trouble Arises  
**Flat Tire**

---

- Turn the jack screw in the direction shown in the figure and adjust the jack head so that it is close to the jack-up position.

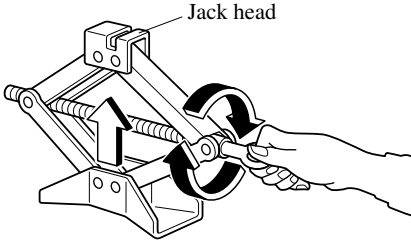

- Place the jack under the jack-up position closest to the tire being changed with the jack head squarely under the jack-up point.

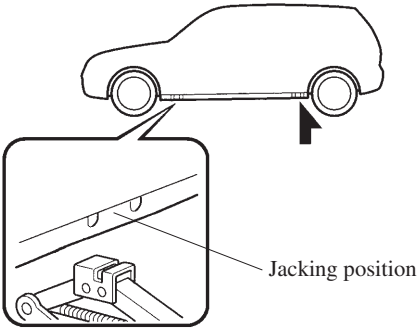

- Continue raising the jack head gradually by rotating the screw with your hand until the jack head is inserted into the jack-up position.

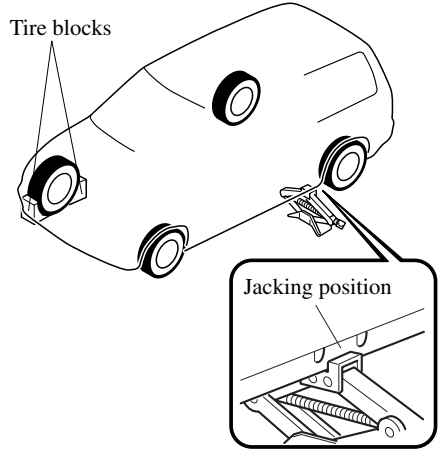



**⚠ WARNING**

**Use only the front and rear jacking positions recommended in this manual:**

Attempting to jack the vehicle in positions other than those recommended in this manual is dangerous. The vehicle could slip off the jack and seriously injure or even kill someone. Use only the front and rear jacking positions recommended in this manual.

**Do not jack up the vehicle in a position other than the designated jack-up position or place any objects on or under the jack:**

Jacking up the vehicle in a position other than the designated jack-up position or placing objects on or under the jack is dangerous as it could deform the vehicle body or the vehicle could fall off the jack resulting in an accident.

**Use only the jack provided with your Mazda:**

Using a jack that is not designed for your Mazda is dangerous. The vehicle could slip off the jack and seriously injure someone.

**Never place objects under the jack:**

Jacking the vehicle with an object under the jack is dangerous. The jack could slip and someone could be seriously injured by the jack or the falling vehicle.

7. Insert the jack lever and attach the lug wrench to tire jack.

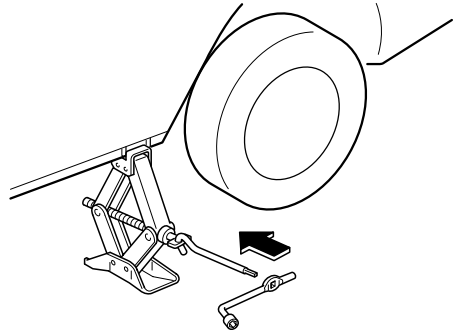

8. Turn the jack handle clockwise and raise the vehicle high enough so that the spare tire can be installed. Before removing the lug nuts, make sure your Mazda is firmly in position and that it cannot slip or move.

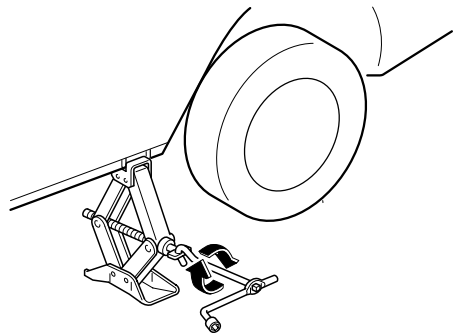

# Flat Tire

## **⚠ WARNING**

**Do not jack up the vehicle higher than is necessary:**

*Jacking up the vehicle higher than is necessary is dangerous as it could destabilize the vehicle resulting in an accident.*

**Do not start the engine or shake the vehicle while it is jacked up:**

*Starting the engine or shaking the vehicle while it is jacked up is dangerous as it could cause the vehicle to fall off the jack resulting in an accident.*

**Never go under the vehicle while it is jacked up:**

*Going under the vehicle while it is jacked up is dangerous as it could result in death or serious injury if the vehicle were to fall off the jack.*

9. Remove the lug nuts by turning them counterclockwise; then remove the wheel and center cap.

## ▼ Locking Lug Nuts\*

If your vehicle has Mazda optional antitheft wheel lug nuts, one on each wheel will lock the tires and you must use a special key to unlock them. This key will attach to the lug wrench and can be stored with the spare tire. Register them with the lock manufacturer by filling out the card provided in the glove compartment and mailing it in the accompanying envelope. If you lose this key, consult an Authorized Mazda Dealer or use the lock manufacturer's order form, which is with the registration card.

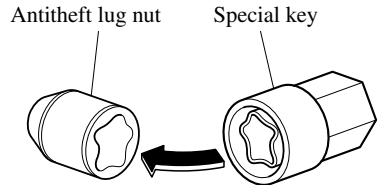

## **To remove an antitheft lug nut**

1. Obtain the special key for the antitheft lug nut.
2. Place the special key on top of the antitheft lug nut, and be sure to hold the key square to it. If you hold the key at an angle, you may damage both key and nut. Do not use a power impact wrench.
3. Place the lug wrench on top of the key and apply pressure. Turn the wrench counterclockwise.

### **To install the antitheft lug nut**

1. Place the special key on top of the nut, and be sure to hold the key square to it. If you hold the key at an angle, you may damage both key and nut. Do not use a power impact wrench.
2. Place the lug wrench on top of the special key, apply pressure, and turn it clockwise.

Nut tightening torque	
N·m (kgf·m, ft·lbf)	108—147 (12—14, 80—108)

### **▼ Mounting the Spare Tire**

1. Remove dirt and grime from the mounting surfaces of the wheel and hub, including the hub bolts, with a cloth.

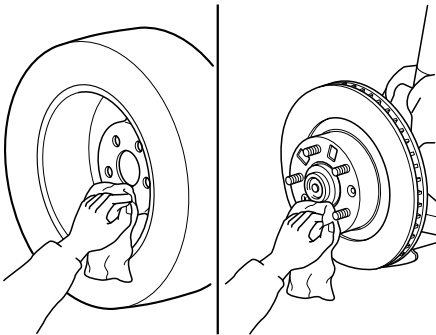

### **⚠ WARNING**

**Make sure the mounting surfaces of the wheel, hub and lug nuts are clean before changing or replacing tires:**

*When changing or replacing a tire, not removing dirt and grime from the mounting surfaces of the wheel, hub and hub bolts is dangerous. The lug nuts could loosen while driving and cause the tire to come off, resulting in an accident.*

2. Mount the spare tire.
3. Install the lug nuts with the beveled edge inward; tighten them by hand.

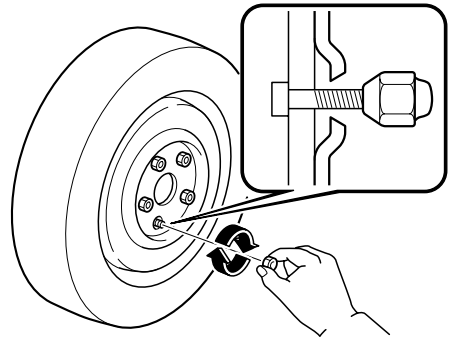

### **⚠ WARNING**

**Do not apply oil or grease to lug nuts and bolts and do not tighten the lug nuts beyond the recommended tightening torque:**

*Applying oil or grease to lug nuts and bolts is dangerous. The lug nuts could loosen while driving and cause the tire to come off, resulting in an accident. In addition, lug nuts and bolts could be damaged if tightened more than necessary.*

# Flat Tire

- Turn the lug wrench counterclockwise and lower the vehicle. Use the lug wrench to tighten the nuts in the order shown.

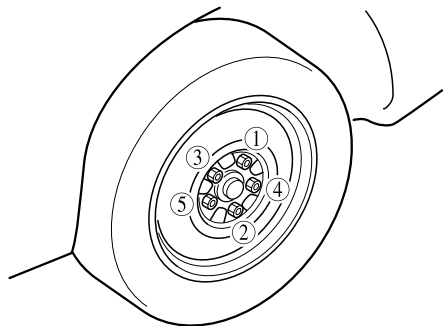

If you are unsure of how tight the nuts should be, have them inspected at an Authorized Mazda Dealer.

Nut tightening torque	
N·m (kgf·m, ft·lbf)	108—147 (12—14, 80—108)

## WARNING

**Always securely and correctly tighten the lug nuts:**

*Improperly or loosely tightened lug nuts are dangerous. The wheel could wobble or come off. This could result in loss of vehicle control and cause a serious accident.*

**Be sure to reinstall the same nuts you removed or replace them with metric nuts of the same configuration:**

*Because the wheel studs and lug nuts on your Mazda have metric threads, using a non-metric nut is dangerous. On a metric stud, it would not secure the wheel and would damage the stud, which could cause the wheel to slip off and cause an accident.*

- Open the trunk/luggage compartment mat.

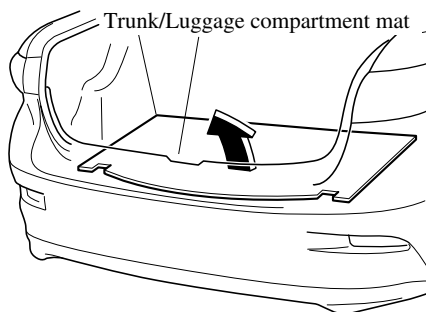

- Remove the belt for securing the flat tire.

7. Put the flat tire into the trunk/luggage compartment on the left and toward the back.

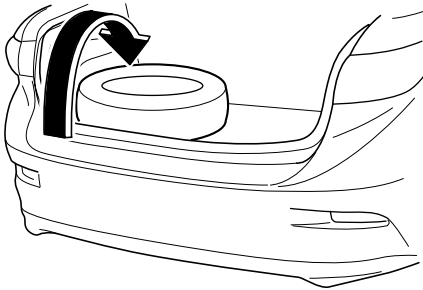

8. (Split-folding type seat)  
Fold the rear seatback forward on the right side of the rear seat.
9. (Split-folding type seat)  
Unlock the rear seatback on the left side and assure a clearance to pass the belt.
- (One-piece folding type seat)  
Unlock the rear seatback and assure a clearance to pass the belt.
10. Pass the belt through the rear seatback as shown in the figure.  
After passing the belt through, return the rear seatback to the original position.  
(Split-folding type seat)

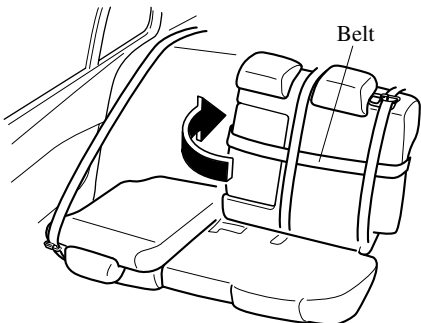

(One-piece folding type seat)

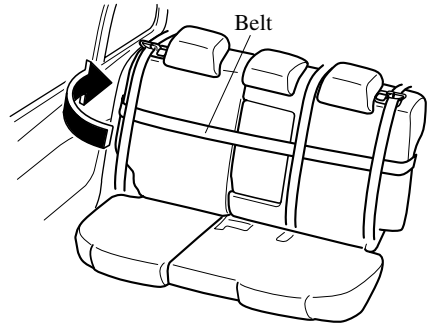

**NOTE**

*Pass the belt underneath the seatbelts.*

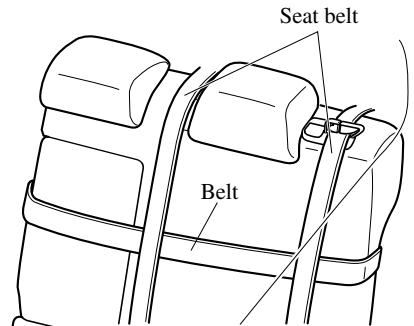

# Flat Tire

11. Pass the buckle through the wheel as shown in the figure and secure it so that the buckle does not contact the wheel.  
(Aluminum wheel)

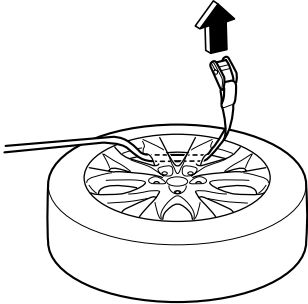

(Steel wheel)

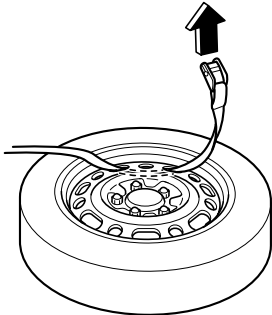

12. Pass the belt through the buckle, then pull the belt end to secure the flat tire.

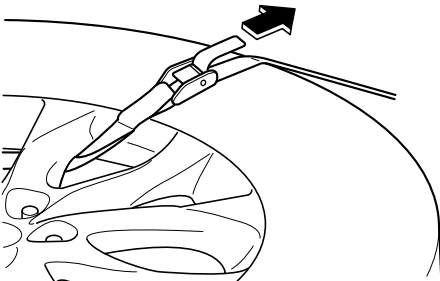

13. (Split-folding tire seat)

Return the rear seatback on the right side of the rear seatback to its original position.

14. Remove the tire blocks and store the tools and jack.

15. Check the inflation pressure. Refer to Tires on page 9-10.

16. Have the flat tire repaired or replaced as soon as possible.

### NOTE

*Do not press the tire pressure monitoring system set switch after installing the spare tire. The switch is only to be pressed after installing the repaired flat tire or installing a replacement tire (page 4-20).*

### **WARNING**

**Do not drive with any tires that have incorrect air pressure:**

*Driving on tires with incorrect air pressure is dangerous. Tires with incorrect pressure could affect handling and result in an accident. When you check the regular tires' air pressure, check the spare tire, too.*

### NOTE

*To prevent the jack and tool from rattling, store them properly.*

## Jump-Starting

Jump-starting is dangerous if done incorrectly. So follow the procedure carefully. If you feel unsure about jump-starting, we strongly recommend that you have a competent service technician do the work.

### **WARNING**



#### **Follow These Precautions Carefully:**

*To ensure safe and correct handling of the battery, read the following precautions carefully before using the battery or inspecting it.*



#### **Do not allow the positive (+) terminal to contact any other metal object that could cause sparks:**

*Flames and sparks near open battery cells are dangerous. Hydrogen gas, produced during normal battery operation, could ignite and cause the battery to explode. An exploding battery can cause serious burns and injuries. When working near a battery, do not allow metal tools to contact the positive (+) or negative (–) terminal of the battery.*



#### **Keep all flames, including cigarettes, and sparks away from open battery cells:**

*Flames and sparks near open battery cells are dangerous. Hydrogen gas, produced during normal battery operation, could ignite and cause the battery to explode. An exploding battery can cause serious burns and injuries.*

#### **Do not jump-start a frozen battery or one with a low fluid level:**

*Jump-starting a frozen battery or one with a low fluid level is dangerous. It may rupture or explode, causing serious injury.*

#### **Connect the negative cable to a good ground point away from the battery:**

*Connecting the end of the second jumper cable to the negative (–) terminal of the discharged battery is dangerous.*

*A spark could cause the gas around the battery to explode and injure someone.*

#### **Route the jumper cables away from parts that will be moving:**

*Connecting a jumper cable near or to moving parts (cooling fans, belts) is dangerous. The cable could get caught when the engine starts and cause serious injury.*

# Battery Runs Out

## **CAUTION**

*Use only a 12 V booster system. You can damage a 12 V starter, ignition system, and other electrical parts beyond repair with a 24 V power supply (two 12 V batteries in series or a 24 V motor generator set).*

Connect cables in numerical order and disconnect in reverse order.

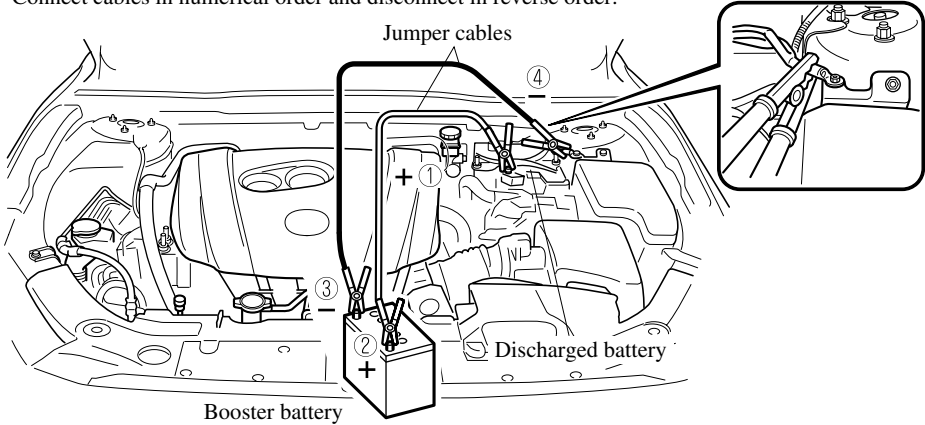



# Battery Runs Out

1. Remove the battery cover.

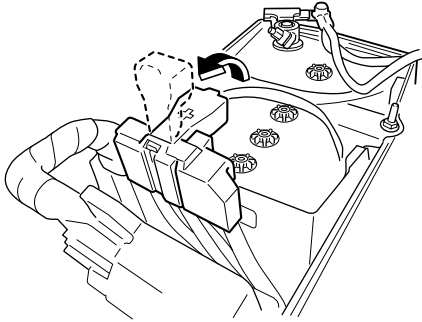

2. Make sure the booster battery is 12 V and that its negative terminal is grounded.
3. If the booster battery is in another vehicle, do not allow both vehicles to touch. Turn off the engine of the vehicle with the booster battery and all unnecessary electrical loads in both vehicles.
4. Connect the jumper cables in the exact sequence as in the illustration.
  - Connect one end of a cable to the positive terminal on the discharged battery (1).
  - Attach the other end to the positive terminal on the booster battery (2).
  - Connect one end of the other cable to the negative terminal of the booster battery (3).
  - Connect the other end to the ground point indicated in the illustration away from the discharged battery (4).
5. Start the engine of the booster vehicle and run it a few minutes. Then start the engine of the other vehicle.

6. **(With i-ELOOP system)**

The i-ELOOP indicator light may flash after the engine is started. The indicator light turns off when the engine is running and the charging is completed. Make sure the i-ELOOP indicator light is turned off before driving.

# i-ELOOP

## NOTE

- If the vehicle is driven with the i-ELOOP indicator light flashing, a beep sound is heard.
  - If the steering wheel is operated with the i-ELOOP indicator light flashing, it may feel heavier than normal, however, this does not indicate a malfunction. The steering operation will return to normal when the i-ELOOP indicator light turns off.
  - Do not remove the jumper cables while the i-ELOOP indicator light is flashing.
7. When finished, carefully disconnect the cables in the reverse order described in the illustration.
  8. If the battery cover has been removed, install it in the reverse order of removal.

## NOTE

Verify that the covers are securely installed.

## Emergency Starting

---

### Starting a Flooded Engine

If the engine fails to start, it may be flooded (excessive fuel in the engine).

Follow this procedure:

1. If the engine does not start within five seconds on the first try, wait ten seconds and try again.
2. Make sure the parking brake is on.
3. Depress the accelerator all the way and hold it there.
4. Depress the clutch pedal (Manual transaxle) or the brake pedal (Automatic transaxle), then press the push button start. If the engine starts, release the accelerator immediately because the engine will suddenly rev up.
5. If the engine fails to start, crank it without depressing the accelerator.

If the engine still does not start using the above procedure, have your vehicle inspected by an Authorized Mazda Dealer.

### Push-Starting

Do not push-start your Mazda.

#### **WARNING**

**Never tow a vehicle to start it:**

*Towing a vehicle to start it is dangerous. The vehicle being towed could surge forward when its engine starts, causing the two vehicles to collide. The occupants could be injured.*

#### **CAUTION**

*Do not push-start a vehicle that has a manual transaxle. It can damage the emission control system.*

**NOTE**

*You cannot start a vehicle with an automatic transaxle by pushing it.*

## Overheating

If the High engine coolant temperature warning light illuminates, the vehicle loses power, or you hear a loud knocking or pinging noise, the engine is probably too hot.

### **WARNING**



**Switch the ignition to off and make sure the fan is not running before attempting to work near the cooling fan:**

*Working near the cooling fan when it is running is dangerous. The fan could continue running indefinitely even if the engine has stopped and the engine compartment temperature is high. You could be hit by the fan and seriously injured.*



**Do not remove either cooling system cap when the engine and radiator are hot:**

*When the engine and radiator are hot, scalding coolant and steam may shoot out under pressure and cause serious injury.*

**Open the hood ONLY after steam is no longer escaping from the engine:**

*Steam from an overheated engine is dangerous. The escaping steam could seriously burn you.*

If the High engine coolant temperature warning light illuminates:

1. Drive safely to the side of the road and park off the right-of-way.
2. Put a vehicle with an automatic transaxle in park (P), a manual transaxle in neutral.
3. Apply the parking brake.
4. Turn off the air conditioner.
5. Check whether coolant or steam is escaping from the engine compartment.

### **If steam is coming from the engine compartment:**

Do not go near the front of the vehicle. Stop the engine. Wait until the steam dissipates, then open the hood and start the engine.

### **If neither coolant nor steam is escaping:**

Open the hood and idle the engine until it cools.

### **CAUTION**

*If the cooling fan does not operate while the engine is running, the engine temperature will increase. Stop the engine and call an Authorized Mazda Dealer.*

6. Make sure the cooling fan is operating, then turn off the engine after the temperature has decreased.
7. When cool, check the coolant level. If it is low, look for coolant leaks from the radiator and hoses.

# Overheating

---

**If you find a leak or other damage, or if coolant is still leaking:**

Stop the engine and call an Authorized Mazda Dealer.

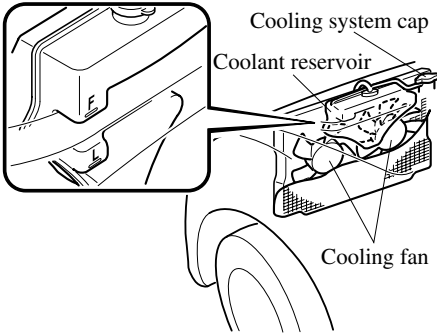

**If you find no problems, the engine is cool, and no leaks are obvious:**

Carefully add coolant as required (page 6-29).

**⚠ CAUTION**

*If the engine continues to overheat or frequently overheats, have the cooling system inspected. The engine could be seriously damaged unless repairs are made. Consult an Authorized Mazda Dealer.*

# Emergency Towing

## Towing Description

We recommend that towing be done only by an Authorized Mazda Dealer or a commercial tow-truck service.

Proper lifting and towing are necessary to prevent damage to the vehicle. Government and local laws must be followed.

A towed vehicle usually should have its drive wheels (front wheels) off the ground. If excessive damage or other conditions prevent this, use wheel dollies.

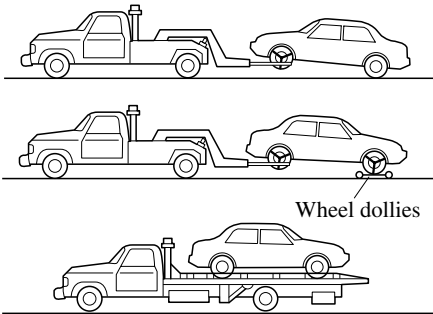

When towing with the rear wheels on the ground, release the parking brake.

## CAUTION

- > Do not tow the vehicle pointed backward with driving wheels on the ground. This may cause internal damage to the transaxle.

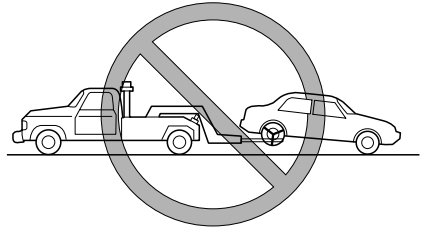

- > Do not tow with sling-type equipment. This could damage your vehicle. Use wheel-lift or flatbed equipment.

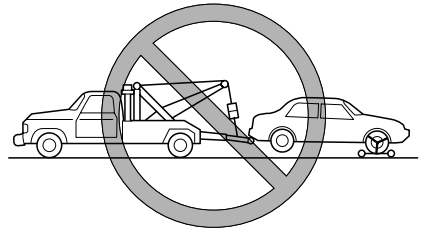

# Emergency Towing

## Tiedown Hooks\*

### CAUTION

Do not use the front and rear tiedown eyelets for towing the vehicle. They have been designed only for securing the vehicle to a transport vessel during shipping. Using the eyelets for any other purpose could result in the vehicle being damaged.

### ▼ Tiedown Hooks

1. Remove the tiedown eyelet and the lug wrench from the luggage compartment (page 7-3).
2. Wrap a flathead screwdriver or similar tool with a soft cloth to prevent damage to a painted bumper, and open the cap located on the front or rear bumper.

#### Front

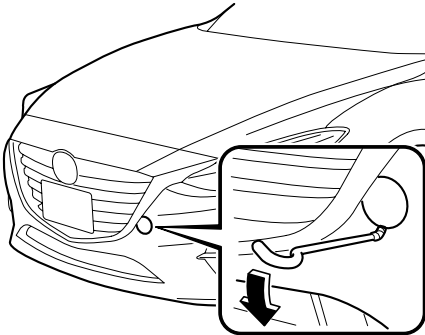

#### Rear

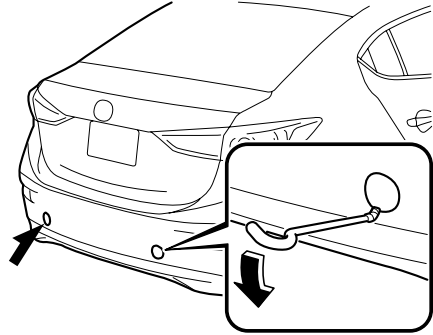

### CAUTION

Do not use excessive force as it may damage the cap or scratch the painted bumper surface.

#### NOTE

Remove the cap completely and store it so as not to lose it.

3. Securely install the tiedown eyelet using the lug wrench.

#### Front

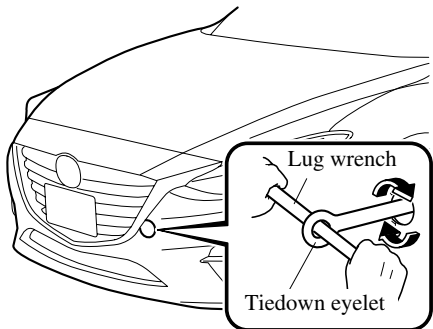

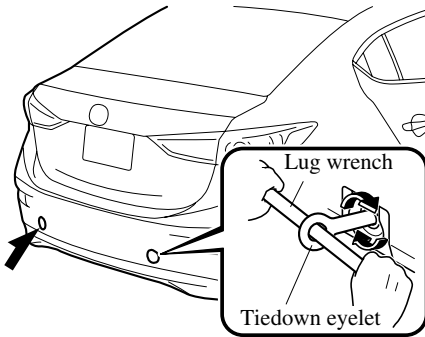
**Rear**

4. Hook the tying rope to the tiedown eyelet.

**⚠ CAUTION**

*If the tiedown eyelet is not securely tightened, it may loosen or disengage from the bumper when tying the vehicle. Make sure that the tiedown eyelet is securely tightened to the bumper.*

# Warning/Indicator Lights and Warning Sounds

## If a Warning Light Turns On or Flashes

If any warning light turns on/flashes, take appropriate action for each light. There is no problem if the light turns off, however if the light does not turn off or turns on/flashes again, consult an Authorized Mazda Dealer.



**(Vehicles with type B audio)**

The warning contents can be verified on the audio.

1. Select the  icon on the home screen to display the applications screen.
2. Select the “Warning Guidance”.







### ▼ Stop Vehicle in Safe Place Immediately

If any of the following warning lights turns on, the system may have a malfunction. Stop the vehicle in a safe place immediately and contact an Authorized Mazda Dealer.



Signal	Warning
 BRAKE Brake System Warning Light	<p>This warning has the following functions:</p> <p><b><u>Parking brake warning/Warning light inspection</u></b>                      The light illuminates when the parking brake is applied with the ignition switched to START or ON. It turns off when the parking brake is fully released.</p> <p><b><u>Low brake fluid level warning</u></b>                      If the brake warning light remains illuminated even though the parking brake is released, the brake fluid may be low or there could be a problem with the brake system. Park the vehicle in a safe place immediately and contact an Authorized Mazda Dealer.</p> <div style="border: 2px solid black; padding: 5px; text-align: center; margin: 10px 0;">  <b>WARNING</b> </div> <p><b><i>Do not drive with the brake system warning light illuminated. Contact an Authorized Mazda Dealer to have the brakes inspected as soon as possible:</i></b>  <i>Driving with the brake system warning light illuminated is dangerous. It indicates that your brakes may not work at all or that they could completely fail at any time. If this light remains illuminated, after checking that the parking brake is fully released, have the brakes inspected immediately.</i></p> <div style="border: 2px solid black; padding: 5px; text-align: center; margin: 10px 0;">  <b>CAUTION</b> </div> <p><i>In addition, the effectiveness of the braking may diminish so you may need to depress the brake pedal more strongly than normal to stop the vehicle.</i></p>



# Warning/Indicator Lights and Warning Sounds

Signal	Warning
 <p data-bbox="113 373 303 437">Electronic Brake Force Distribution System Warning</p>	<p data-bbox="325 231 1053 320">If the electronic brake force distribution control unit determines that some components are operating incorrectly, the control unit may illuminate the brake system warning light and the ABS warning light simultaneously. The problem is likely to be the electronic brake force distribution system.</p> <div data-bbox="325 336 566 384" style="border: 1px solid black; padding: 2px; text-align: center;">  <b>WARNING</b> </div> <p data-bbox="325 392 1053 459"><b>Do not drive with both the ABS warning light and brake warning light illuminated. Have the vehicle towed to an Authorized Mazda Dealer to have the brakes inspected as soon as possible:</b></p> <p data-bbox="370 464 1020 552"><i>Driving when the brake system warning light and ABS warning light are illuminated simultaneously is dangerous. When both lights are illuminated, the rear wheels could lock more quickly in an emergency stop than under normal circumstances.</i></p>
 <p data-bbox="135 660 281 703">Charging System Warning Light</p>	<p data-bbox="325 561 981 608">If the warning light illuminates while driving, it indicates a malfunction of the alternator or of the charging system.</p> <p data-bbox="325 608 1003 651">Drive to the side of the road and park off the right-of-way. Consult an Authorized Mazda Dealer.</p> <div data-bbox="325 667 572 715" style="border: 1px solid black; padding: 2px; text-align: center;">  <b>CAUTION</b> </div> <p data-bbox="370 727 1020 774"><i>Do not continue driving when the charging system warning light is illuminated because the engine could stop unexpectedly.</i></p>
 <p data-bbox="124 1034 292 1077">Engine Oil Warning Light</p>	<p data-bbox="325 785 762 807">This warning light indicates low engine oil pressure.</p> <div data-bbox="325 823 572 871" style="border: 1px solid black; padding: 2px; text-align: center;">  <b>CAUTION</b> </div> <p data-bbox="370 884 1053 930"><i>Do not run the engine if the oil pressure is low. Otherwise, it could result in extensive engine damage.</i></p> <p data-bbox="325 930 953 952">If the light illuminates or the warning indication is displayed while driving:</p> <ol data-bbox="325 967 1048 1058" style="list-style-type: none"> <li>1. Drive to the side of the road and park off the right-of-way on level ground.</li> <li>2. Turn off the engine and wait 5 minutes for the oil to drain back into the oil pan.</li> <li>3. Inspect the engine oil level 6-28. If it's low, add the appropriate amount of engine oil while being careful not to overfill.</li> </ol> <div data-bbox="325 1074 572 1121" style="border: 1px solid black; padding: 2px; text-align: center;">  <b>CAUTION</b> </div> <p data-bbox="370 1134 1025 1181"><i>Do not run the engine if the oil level is low. Otherwise, it could result in extensive engine damage.</i></p> <ol data-bbox="325 1181 712 1203" style="list-style-type: none"> <li>4. Start the engine and check the warning light.</li> </ol> <p data-bbox="325 1225 1042 1291">If the light remains illuminated even though the oil level is normal or after adding oil, stop the engine immediately and have your vehicle towed to an Authorized Mazda Dealer.</p>

# Warning/Indicator Lights and Warning Sounds





Signal	Warning
 <p>(Red) High Engine Coolant Temperature Warning Light</p>	<p>The light flashes when the engine coolant temperature is extremely high, and illuminates when the engine coolant temperature increases further.</p> <p><b>Handling Procedure</b> <b>Flashing light</b> Drive slowly to reduce engine load until you can find a safe place to stop the vehicle and wait for the engine to cool down.</p> <p><b>Illuminated light</b> This indicates the possibility of overheating. Park the vehicle in a safe place immediately and stop the engine. Refer to Overheating 7-19.</p> <div style="border: 1px solid black; padding: 5px; text-align: center;">  <b>CAUTION</b> </div> <p><i>Do not drive the vehicle with the high engine coolant temperature warning light illuminated. Otherwise, it could result in damage to the engine.</i></p>
 <p>Power Steering Malfunction Indicator Light</p>	<p>The light illuminates/flashes if the electric power steering has a malfunction. If the light illuminates/flashes, stop the vehicle in a safe place and do not operate the steering wheel. There is no problem if the light turns off after a while. Contact an Authorized Mazda Dealer if the light illuminates/flashes continuously.</p> <p><b>NOTE</b></p> <ul style="list-style-type: none"> <li>• <i>If the indicator light illuminates/flashes, the power steering will not operate normally. If this happens, the steering wheel can still be operated, however; the operation may feel heavy compared to normal, or the steering wheel could vibrate when turning.</i></li> <li>• <i>Repeatedly jerking the steering wheel left and right while the vehicle is stopped or moving extremely slowly will cause the power steering system to go into protective mode which will make the steering feel heavy, but this does not indicate a problem. If this occurs, park the vehicle safely and wait several minutes for the system to return to normal.</i></li> </ul>

## ▼ Contact Authorized Mazda Dealer and Have Vehicle Inspected







If any of the following warning lights turns on/flashes, the system may have a malfunction. Contact an Authorized Mazda Dealer to have your vehicle inspected.

Signal	Warning
 <p>Master Warning Light</p>	<ul style="list-style-type: none"> <li>• <b>(Vehicles with type B audio)</b> The light turns on when the system has a malfunction. Operate the center display and verify the content. Refer to If a Warning Light Turns On or Flashes on page 7-24.</li> <li>• <b>(Vehicles without type B audio)</b> The light illuminates continuously if any one of the following occurs. Consult an Authorized Mazda Dealer. <ul style="list-style-type: none"> <li>• There is a malfunction in the battery management system.</li> <li>• There is a malfunction in the brake switch.</li> </ul> </li> </ul>



# Warning/Indicator Lights and Warning Sounds

Signal	Warning
 <p>ABS Warning Light</p>	<p>If the ABS warning light stays on while you're driving, the ABS control unit has detected a system malfunction. If this occurs, your brakes will function normally as if the vehicle had no ABS. Should this happen, consult an Authorized Mazda Dealer as soon as possible.</p> <p><b>NOTE</b></p> <ul style="list-style-type: none"> <li>•When the engine is jump-started to charge the battery, uneven rpm occurs and the ABS warning light may illuminate. If this occurs, it is the result of the weak battery and does not indicate an ABS malfunction. Recharge the battery.</li> <li>•The brake assist system does not operate while the ABS warning light is illuminated.</li> </ul>
 <p>Check Engine Light</p>	<p>If this light illuminates while driving, the vehicle may have a problem. It is important to note the driving conditions when the light illuminated and consult an Authorized Mazda Dealer.</p> <p>The check engine light may illuminate in the following cases:</p> <ul style="list-style-type: none"> <li>•The fuel tank level being very low or approaching empty.</li> <li>•The engine's electrical system has a problem.</li> <li>•The emission control system has a problem.</li> <li>•The fuel-filler cap is missing or not tightened securely.</li> </ul> <p>If the check engine light remains on, or it flashes continuously, do not drive at high speeds and consult an Authorized Mazda Dealer as soon as possible.</p>
<p><b>AT</b> Automatic Transaxle Warning Light*</p>	<p>The light/indication illuminates when the transaxle has a problem.</p> <div data-bbox="297 807 535 855" style="border: 1px solid black; padding: 5px; text-align: center;">  <b>CAUTION</b> </div> <p><i>If the automatic transaxle warning light illuminates, the transaxle has an electrical problem. Continuing to drive your Mazda in this condition could cause damage to your transaxle. Consult an Authorized Mazda Dealer as soon as possible.</i></p>
 <p>Air Bag/Seat Belt Pretensioner System Warning Light</p>	<p>A system malfunction is indicated if the warning light constantly flashes, constantly illuminates or does not illuminate at all when the ignition is switched ON. If any of these occur, consult an Authorized Mazda Dealer as soon as possible. The system may not operate in an accident.</p> <div data-bbox="292 1050 529 1098" style="border: 1px solid black; padding: 5px; text-align: center;">  <b>WARNING</b> </div> <p><b>Never tamper with the air bag/pretensioner systems and always have an Authorized Mazda Dealer perform all servicing and repairs:</b></p> <p><i>Self-servicing or tampering with the systems is dangerous. An air bag/pretensioner could accidentally activate or become disabled causing serious injury or death.</i></p>

# Warning/Indicator Lights and Warning Sounds



Signal	Warning
 <p>Tire Pressure Monitoring System Warning Light*</p>	<p>If the tire pressure monitoring system has a malfunction, the tire pressure warning light flashes for about 1 minute when the ignition is switched ON and then continues illuminating. Have your vehicle checked by an Authorized Mazda Dealer as soon as possible.</p> <div style="border: 1px solid black; padding: 5px; margin: 10px 0;">  <b>WARNING</b> </div> <p><b>If the tire pressure monitoring system warning light illuminates or flashes, or the tire pressure warning beep sound is heard, decrease vehicle speed immediately and avoid sudden maneuvering and braking:</b></p> <p><i>If the tire pressure monitoring system warning light illuminates or flashes, or the tire pressure warning beep sound is heard, it is dangerous to drive the vehicle at high speeds, or perform sudden maneuvering or braking. Vehicle drivability could worsen and result in an accident.</i></p> <p><i>To determine if you have a slow leak or a flat, pull over to a safe position where you can check the visual condition of the tire and determine if you have enough air to proceed to a place where air may be added and the system monitored again by an Authorized Mazda Dealer or a tire repair station.</i></p> <p><b>Do not ignore the TPMS Warning Light:</b></p> <p><i>Ignoring the TPMS warning light is dangerous, even if you know why it is illuminated. Have the problem taken care of as soon as possible before it develops into a more serious situation that could lead to tire failure and a dangerous accident.</i></p>
 <p>(Red) (Illuminate) KEY Warning Light</p>	<p>If any malfunction occurs in the keyless entry system, it illuminates continuously.</p> <div style="border: 1px solid black; padding: 5px; margin: 10px 0;">  <b>CAUTION</b> </div> <p><i>If the key warning indicator light illuminates or the push button start indicator light (amber) flashes, the engine may not start. If the engine cannot be started, try starting it using the emergency operation for starting the engine, and have the vehicle inspected at an Authorized Mazda Dealer as soon as possible.</i></p> <p><i>Refer to Emergency Operation for Starting the Engine on page 4-9.</i></p>
 <p>(Amber) (Flashes) Lane Departure Warning System (LDWS) Warning Light*</p>	<p>The warning light flashes when the system has a malfunction. Have your vehicle inspected at an Authorized Mazda Dealer.</p> <p>The LDWS does not operate when the warning light flashes.</p> <div style="border: 1px solid black; padding: 5px; margin: 10px 0;">  <b>CAUTION</b> </div> <ul style="list-style-type: none"> <li>➤ <i>If any of the following cases occurs, the system may have a malfunction. Have the vehicle inspected at an Authorized Mazda Dealer.</i> <ul style="list-style-type: none"> <li>➤ <i>The light flashes while the vehicle is being driven.</i></li> <li>➤ <i>The light does not illuminate when the ignition is switched ON.</i></li> </ul> </li> <li>➤ <i>Always use tires for all wheels that are of the specified size, and the same manufacture, brand, and tread pattern. In addition, do not use tires with significantly different wear patterns on the same vehicle. If such improper tires are used, the LDWS may not operate normally.</i></li> <li>➤ <i>When an emergency spare tire is used, the system may not operate normally.</i></li> </ul>

# Warning/Indicator Lights and Warning Sounds



Signal	Warning
 <p>Headlight Auto-Leveling Malfunction Indicator Light*</p>	<p>This indicator light stays on for a few seconds when the ignition is switched ON. Thereafter, the indicator light will illuminate when the headlight auto-leveling system has a malfunction.</p> <p>If the indicator light illuminates, contact an Authorized Mazda Dealer.</p> <p><b>NOTE</b> <i>Vehicles with the adaptive front lighting system (AFS) are not equipped with the headlight auto-leveling malfunction indicator light. If there is a malfunction with the headlight auto-leveling function, the AFS OFF indicator light flashes.</i></p>
 <p>(Amber) High Beam Control System (HBC) Warning Light*</p>	<p><b>When illuminated</b></p> <p>The warning light illuminates if the area of the windshield in front of the forward sensing camera (FSC) is fogged or obstructed.</p> <p><b>When flashing</b></p> <p>This light flashes if there is a malfunction in the high beam control system (HBC). Have your vehicle inspected by an Authorized Mazda Dealer.</p>
 <p>(Amber) (Flashing) Mazda Radar Cruise Control (MRCC) Warning Light*</p>	<p>The warning light flashes if there is a malfunction in the system while the Mazda Radar Cruise Control (MRCC) system is on. Have your vehicle inspected at an Authorized Mazda Dealer.</p>

## ▼ Taking Action



Take the appropriate action and verify that the warning light turns off.

Signal	Warning	Action to be taken
 <p>Low Fuel Warning Light</p>	<p>The light turns on when the remaining fuel is about 9.0 L (2.3 US gal, 1.9 Imp gal).</p> <p><b>NOTE</b> <i>The light illumination timing may vary because fuel inside the fuel tank moves around according to the driving conditions and the vehicle posture.</i></p>	<p>Add fuel.</p>
 <p>Check Fuel Cap Warning Light</p>	<p>If the check fuel cap warning light illuminates while driving, the fuel-filler cap may not be installed properly.</p>	<p>Stop the engine and reinstall the fuel-filler cap. Refer to Fuel-Filler Cap on page 3-31</p>

# Warning/Indicator Lights and Warning Sounds

Signal	Warning	Action to be taken
 <p>Seat Belt Warning Light</p>	<p>The seat belt warning light illuminates if the driver or front passenger's seat is occupied and the seat belt is not fastened with the ignition switched ON.</p> <p><b>Seat belt reminder</b></p> <p>If the vehicle is driven with the driver or front passenger's seat belt unfastened, the seat belt warning light illuminates and a warning beep sounds.</p> <p><b>NOTE</b></p> <p><i>If the driver or front passenger's seat belt is unfastened (only when the front passenger seat is occupied) and the vehicle is driven at a speed faster than about 20 km/h (12 mph), the warning light will flash and a beep sound will be heard. After a short time, the warning light stops flashing, but remains illuminated, and the beep sound stops.</i></p> <p>Until a seat belt is fastened or a given period of time has elapsed, the beep sound will not stop even if the vehicle speed falls below 20 km/h (12 mph).</p> <p><b>NOTE</b></p> <ul style="list-style-type: none"> <li>• <i>The warning light flashes and a beep sound will be heard for about 6 seconds if the driver's seat belt is not fastened when the ignition is switched ON.</i></li> <li>• <i>If a driver or front passenger's seat belt is unfastened after the beep sound turns off (warning light remains illuminated), and the vehicle speed exceeds 20 km/h (12 mph), the warning light flashes and beep sound activates again.</i></li> <li>• <i>Placing heavy items on the front passenger seat may cause the front passenger seat belt warning function to operate depending on the weight of the item.</i></li> <li>• <i>To allow the front passenger seat weight sensor to function properly, do not place and sit on an additional seat cushion on the front passenger seat. The sensor may not function properly because the additional seat cushion could cause sensor interference.</i></li> <li>• <i>When a small child sits on the front passenger seat, it is possible that the warning light will not operate.</i></li> </ul>	
 <p>Door-Ajar Warning Light</p>	<p>The light turns on if any door is not closed securely.</p>	<p>Close the door securely.</p>
 <p>Low Washer Fluid Level Warning Light*</p>	<p>This warning light indicates that little washer fluid remains.</p>	<p>Add washer fluid (page 6-31).</p>

# Warning/Indicator Lights and Warning Sounds

Signal	Warning	Action to be taken
 <p>Tire Pressure Monitoring System Warning Light*</p>	<p>When the warning light illuminates, and the warning beep sound is heard (about 3 seconds), tire pressure is too low in one or more tires.</p> <p><b>⚠ WARNING</b></p> <p><b>If the tire pressure monitoring system warning light illuminates or flashes, or the tire pressure warning beep sound is heard, decrease vehicle speed immediately and avoid sudden maneuvering and braking:</b></p> <p>If the tire pressure monitoring system warning light illuminates or flashes, or the tire pressure warning beep sound is heard, it is dangerous to drive the vehicle at high speeds, or perform sudden maneuvering or braking. Vehicle drivability could worsen and result in an accident.</p> <p>To determine if you have a slow leak or a flat, pull over to a safe position where you can check the visual condition of the tire and determine if you have enough air to proceed to a place where air may be added and the system monitored again by an Authorized Mazda Dealer or a tire repair station.</p> <p><b>Do not ignore the TPMS Warning Light:</b> Ignoring the TPMS warning light is dangerous, even if you know why it is illuminated. Have the problem taken care of as soon as possible before it develops into a more serious situation that could lead to tire failure and a dangerous accident.</p>	<p>Inspect the tires and adjust to the specified inflation pressure (page 6-42).</p> <p><b>NOTE</b></p> <ul style="list-style-type: none"> <li>• Perform tire pressure adjustment when the tires are cold. Tire pressure will vary according to the tire temperature, therefore let the vehicle stand for 1 hour or only drive it 1.6 km (1 mile) or less before adjusting the tire pressures. When pressure is adjusted on hot tires to the cold inflation pressure, the TPMS warning light/beep may turn on after the tires cool and pressure drops below specification. Also, an illuminated TPMS warning light, resulting from the tire air pressure dropping due to cold ambient temperature will remain illuminated even if the ambient temperature rises. In this case, it will also be necessary to adjust the tire air pressures. If the TPMS warning light illuminates due to a drop in tire air pressure, make sure to check and adjust the tire air pressures.</li> <li>• Tires lose air naturally over time and the TPMS cannot tell if the tires are getting too soft over time or you have a flat. However, when you find one low tire in a set of four—that is an indication of trouble; you should have someone drive the vehicle slowly forward so you can inspect any low tire for cuts and any metal objects sticking through tread or sidewall. Put a few drops of water in the valve stem to see if it bubbles indicating a bad valve. Leaks need to be addressed by more than simply reinflating the tire as leaks are dangerous — take it to an Authorized Mazda Dealer.</li> </ul>
 <p>(Amber) Forward Obstruction Warning/Smart City Brake Support (FOW/SCBS) Warning Light*</p>	<p>The light turns on if the windshield and the radar sensor are dirty or there is a malfunction in the system.</p>	<p>Verify the reason why the warning light is illuminated on the center display (page 7-24). If the reason why the warning light is illuminated is due to a dirty windshield, clean the windshield.</p> <p>If the warning light is illuminated because of a dirty radar sensor, clean the front emblem.</p> <p>For any other reasons, have the vehicle inspected at an Authorized Mazda Dealer.</p>

# Warning/Indicator Lights and Warning Sounds

---

## KEY Warning Light

Take the appropriate action and verify that the warning light turns off.

Signal	Cause	Action to be taken
 (Red) (Flashing)	The advanced key battery is dead.	Replace the battery (page 6-39).
	The advanced key is not within the operation range.	Bring the advanced key into the operation range (page 3-7).
	The advanced key is placed in areas inside the cabin where it is difficult for the key to be detected.	
	A key from another manufacturer similar to the advanced key is in the operation range.	Take the key from another manufacturer similar to the advanced key out of the operation range.
	Without the ignition switched off, the advanced key is taken out of the cabin, and then all the door are closed.	Bring the advanced key back into the cabin.



# Warning/Indicator Lights and Warning Sounds

## Message Indicated on Display\*

If a message is displayed in the center display (Type B audio), take appropriate action (in a calm manner) according to the displayed message.

(Display example)

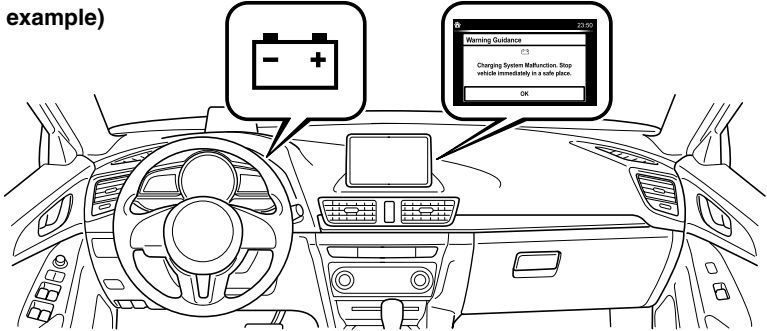

### ▼ Stop Vehicle in Safe Place Immediately

If the following messages are displayed in the center display (Type B audio), a vehicle system may be malfunctioning. Stop the vehicle in a safe place and contact an Authorized Mazda Dealer.

Display	Indicated Condition
	<p>Displays if the engine coolant temperature has increased excessively.</p>
	<p>Displays if the charging system has a malfunction.</p>

\*Some models.

# Warning/Indicator Lights and Warning Sounds

## ▼ Make Sure the Message is No Longer Displayed

Displays in the following cases:

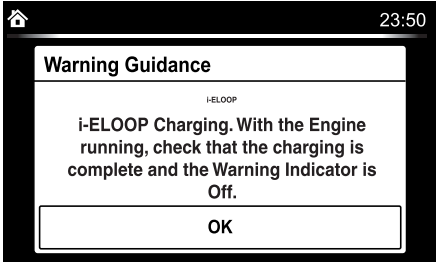
Display	Indicated Condition/Action to be taken
 <p>The screenshot shows a vehicle's infotainment screen with a black background. At the top left is a home icon, and at the top right is the time '23:50'. The main content area is titled 'Warning Guidance' and contains the text: 'i-ELOOP Charging. With the Engine running, check that the charging is complete and the Warning Indicator is Off.' Below this text is a white rectangular button with the text 'OK'.</p>	<p>Displays if i-ELOOP requires charging. Leave the engine idling and wait until the message disappears.</p> <p><b>NOTE</b></p> <ul style="list-style-type: none"> <li>•If the vehicle is driven while the message is displayed, the buzzer will sound.</li> <li>•If you turn the steering wheel while the message is displayed, it will feel heavier than normal, but this does not indicate an abnormality. The steering operation will return to normal after the message has disappeared.</li> </ul>

# Warning/Indicator Lights and Warning Sounds

## Warning Sound is Activated

### ▼ Lights-On Reminder

The lights-on reminder is operable when the time setting\*<sup>1</sup> of the auto headlight off function is off.

If lights are on and the ignition is switched to ACC or the ignition is switched off, a continuous beep sound will be heard when the driver's door is opened.

- \*1 If the light switch is left on, the auto headlight off function automatically turns off the lights about 30 seconds after switching the ignition off. The time setting can be changed. Refer to Personalization Features on page 9-12.

### NOTE

- When the ignition is switched to ACC, the "Ignition Not Switched Off (STOP) Warning Beep" (page 7-36) overrides the lights-on reminder.
- A personalized function is available to change the sound volume for the lights-on reminder. Refer to Personalization Features on page 9-12.

### ▼ Air Bag/Front Seat Belt Pretensioner System Warning Beep

If there is a problem with the air bag/seat belt pretensioner systems and the warning light illumination, a warning beep sound will be heard for about 5 seconds every minute.

The air bag and seat belt pretensioner system warning beep sound will continue to be heard for approximately 35 minutes. Have your vehicle inspected at an Authorized Mazda Dealer as soon as possible.



**Do not drive the vehicle with the air bag/seat belt pretensioner system warning beep sounding:**

*Driving the vehicle with the air bag/seat belt pretensioner system warning beep sounding is dangerous. In a collision, the air bags and the seat belt pretensioner system will not deploy and this could result in death or serious injury. Contact an Authorized Mazda Dealer to have the vehicle inspected as soon as possible.*

## Warning/Indicator Lights and Warning Sounds

---

### ▼ Seat Belt Warning Beep

If the driver's seat belt is not fastened when the ignition is switched ON, a beep sound will be heard for about 6 seconds. If the driver or the front passenger's seat belt is not fastened and the vehicle is driven at a speed faster than about 20 km/h (12 mph), a beep sound will be heard again for a specified period of time.

#### NOTE

- *Placing heavy items on the front passenger seat may cause the front passenger seat belt warning function to operate depending on the weight of the item.*
- *To allow the front passenger seat weight sensor to function properly, do not place and sit on an additional seat cushion on the front passenger seat. The sensor may not function properly because the additional seat cushion could cause sensor interference.*
- *When a small child sits on the front passenger seat, it is possible that the warning beep will not operate.*

### ▼ Ignition Not Switched Off (STOP) Warning Beep

If the driver's door is opened while the ignition is switched to ACC, a continuous beep sound will be heard to notify the driver that the ignition has not been switched off (STOP). Left in this condition, the keyless entry system will not operate, the car cannot be locked, and the battery power will be depleted.

### ▼ Key Removed from Vehicle Warning Beep

A beep sound will be heard 6 times and the KEY warning light (red) will flash continuously if the ignition has not been switched off, all the doors are closed, and the key is removed from the vehicle. This is to notify the driver that the key has been removed from the vehicle and the ignition has not been switched off.

#### NOTE

*Because the key utilizes low-intensity radio waves, the Key Removed From Vehicle Warning may activate if the key is carried together with a metal object or it is placed in a poor signal reception area.*

### ▼ Request Switch Inoperable Warning Beep (With the advanced keyless function)

If the request switch is pressed with a door open or ajar or the ignition has not been switched off while the key is being carried, a beep will be heard for about 2 seconds to indicate that the doors and the liftgate/trunk lid cannot be locked.

### ▼ Key Left-in-luggage Compartment Warning Beep (With the advanced keyless function)

If the key is left in the trunk with all doors locked and the trunk lid closed, a beep sound is heard for about 10 seconds to remind the driver the key has been left in the trunk. If this happens, open the trunk lid by pressing the electric trunk lid opener and remove the key. A key removed from the trunk may not function because its functions may have been temporarily suspended. To restore the key function, perform the applicable procedure (page 3-8).

## Warning/Indicator Lights and Warning Sounds

### ▼ Key Left-in-vehicle Warning Beep (With the advanced keyless function)

If a key is left in the vehicle cabin and all the doors and the trunk are locked using a separate key, a beep sound is heard for about 10 seconds to remind the driver that the key has been left in the vehicle cabin. If this happens, open the door and remove the key. A key removed from the vehicle this way may not function because its functions may have been temporarily suspended. Perform the applicable procedure to restore the functions of the key (page 3-8).

### ▼ i-ELOOP Warning Beep\*

The beep will activate if you attempt to drive the vehicle under the following conditions.

- The i-ELOOP indicator light is flashing green.
- “i-ELOOP Charging” is indicated in the center display (Type B audio).

The beep will stop when the vehicle is stopped. Make sure the indicator light is no longer illuminated and the message is no longer displayed before driving the vehicle.

### ▼ Tire Inflation Pressure Warning Beep\*

The warning beep sound will be heard for about 3 seconds when there is any abnormality in tire inflation pressures (page 4-103).

### ▼ Lane Departure Warning System (LDWS) Warning Sound\*

While the system is operating, if the system determines that the vehicle may depart from the lane, it sounds a warning sound.

#### NOTE

- *The volume of the LDWS warning sound can be changed.*  
Refer to Personalization Features on page 9-12.
- *The type of the LDWS warning sound can be changed.*  
Refer to Personalization Features on page 9-12.

### ▼ Blind Spot Monitoring (BSM) System Warning Beep\*

#### Driving forward

The warning beep operates when the turn signal lever is operated to the side where the Blind Spot Monitoring (BSM) warning light is illuminated.

#### NOTE

*A personalized function is available to change the Blind Spot Monitoring (BSM) warning beep sound volume.*  
Refer to Personalization Features on page 9-12.

#### Reversing

If a moving object such as a vehicle or two-wheeled vehicle approaches on the left or right from behind your vehicle, the Blind Spot Monitoring (BSM) warning sound is activated.

## Warning/Indicator Lights and Warning Sounds

### ▼ Mazda Radar Cruise Control (MRCC) System Warnings\*

The Mazda Radar Cruise Control (MRCC) system warnings notify the driver of system malfunctions and cautions on use when required.

Check based on the beep sound.

Cautions	What to check
The beep sounds 1 time while the Mazda Radar Cruise Control (MRCC) is operating	The vehicle speed is slower than 25 km/h (16 mph) and the Mazda Radar Cruise Control (MRCC) system has been canceled.
The beep sounds continuously while driving	The distance between your vehicle and the vehicle ahead is too close. Verify the safety of the surrounding area and reduce vehicle speed.
When the Mazda Radar Cruise Control (MRCC) is operating, the beep sounds and the Mazda Radar Cruise Control (MRCC) warning light (amber) in the instrument cluster flashes.	A malfunction in the system may be indicated. Have your vehicle inspected at an Authorized Mazda Dealer.

### ▼ Collision warning\*

If there is the possibility of a collision with a vehicle ahead, the beep sounds continuously and a warning is indicated in the display.

### ▼ Power Steering Warning Buzzer

If the power steering system has a malfunction, the power steering malfunction light turns on or flashes and the buzzer operates at the same time. Refer to Warning/Indicator Lights on page 4-20.

### ▼ Over Rev. Buzzer\*

The buzzer sounds to notify the driver if the engine speed is about to exceed the permissible engine speed.



*Operate the accelerator and shift gears according to the driving conditions so that the buzzer does not sound. If the engine speed exceeds the permissible engine speed, the engine could be damaged.*

# When Liftgate/Trunk Lid Cannot be Opened

## When Liftgate/Trunk Lid Cannot be Opened

If the vehicle battery is dead or there is a malfunction in the electrical system and the liftgate/trunk lid can not be opened, perform the following procedure as an emergency measure to Open it:

### (5-door)

1. Remove the cap on the interior surface of the liftgate with a flathead screwdriver.

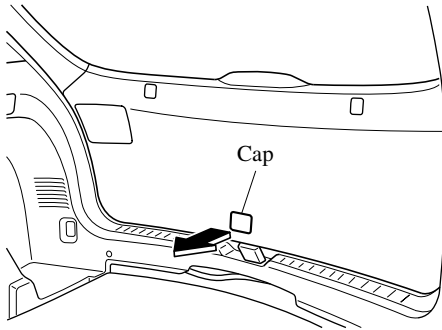

2. Turn the lever to the right to unlock the liftgate.

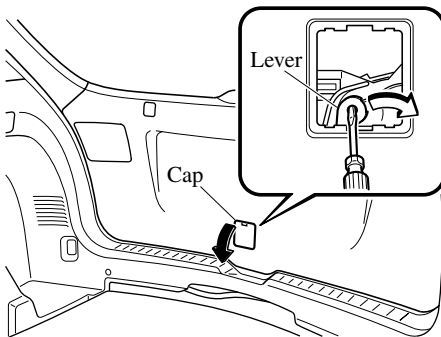

### (4-door)

1. Open the cover.
2. Open the cap.

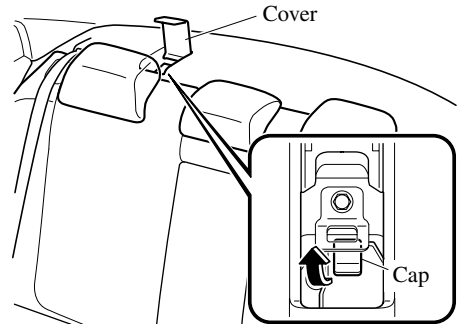

3. Turn the screw counterclockwise and remove it, and then remove the inner cover.

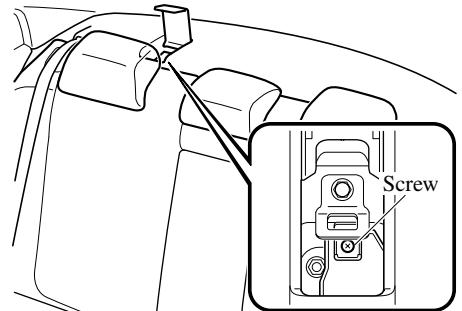

# When Liftgate/Trunk Lid Cannot be Opened

4. Move the lever to the left to fold the seatback.

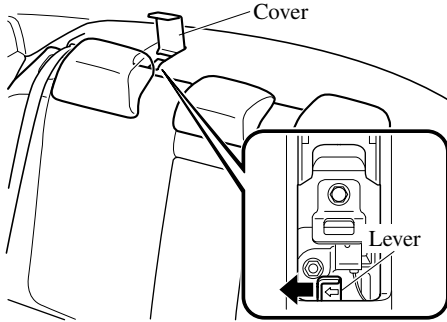

5. Move the lever to the left to open the trunk lid.

**(Type A)**

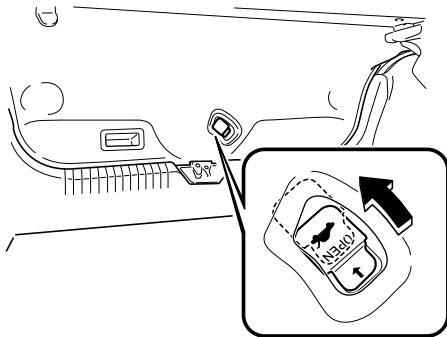

**(Type B)**

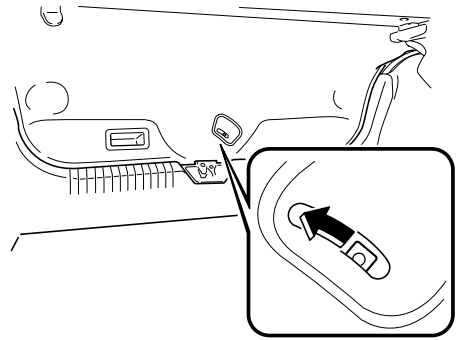

After performing this emergency measure, have the vehicle inspected at an Authorized Mazda Dealer as soon as possible.



## Active Driving Display Does Not Operate\*

---

### If the Active Driving Display Does Not Operate

If the active driving display does not operate, switch the ignition off and then restart the engine. If the active driving display does not operate even with the engine restarted, have the vehicle inspected at an Authorized Mazda Dealer.

# MEMO

Important consumer information including warranties and add-on equipment.

<b>Customer Assistance .....</b>	<b>8-2</b>	<b>Recording of Vehicle Data .....</b>	<b>8-21</b>
Customer Assistance (U.S.A.) .....	8-2	Recording of Vehicle Data .....	8-21
Customer Assistance (Canada) .....	8-6	<b>Uniform Tire Quality Grading System</b>	
Customer Assistance		<b>(UTQGS) .....</b>	<b>8-22</b>
(Puerto Rico) .....	8-9	Uniform Tire Quality Grading System	
Customer Assistance (Mexico) .....	8-10	(UTQGS) .....	8-22
<b>Mazda Importer/Distributors .....</b>	<b>8-12</b>	<b>Tire Information (U.S.A.) .....</b>	<b>8-24</b>
Importer/Distributor .....	8-12	Tire Labeling .....	8-24
<b>Reporting Safety Defects .....</b>	<b>8-13</b>	Location of the Tire Label	
Reporting Safety Defects		(Placard) .....	8-30
(U.S.A.) .....	8-13	Tire Maintenance .....	8-33
Reporting Safety Defects		Vehicle Loading .....	8-36
(Canada) .....	8-14	Steps for Determining the Correct	
<b>Warranty .....</b>	<b>8-15</b>	Load Limit .....	8-42
Warranties for Your Mazda .....	8-15	<b>Declaration of Conformity .....</b>	<b>8-43</b>
Outside the United States/		Declaration of Conformity .....	8-43
Canada .....	8-16	<b>Service Publications .....</b>	<b>8-50</b>
Registering Your Vehicle in A Foreign		Service Publications .....	8-50
Country (Except United States and			
Canada) .....	8-17		
Add-On Non-Genuine Parts and			
Accessories .....	8-18		
<b>Cell Phones .....</b>	<b>8-19</b>		
Cell Phones Warning .....	8-19		
<b>Event Data Recorder .....</b>	<b>8-20</b>		
Event Data Recorder (U.S.A. and			
Canada) .....	8-20		

## Customer Assistance

---

### Customer Assistance (U.S.A.)

Your complete and permanent satisfaction is our business. We are here to serve you. All Authorized Mazda Dealers have the knowledge and the tools to keep your Mazda vehicle in top condition.

If you have any questions or recommendations for improvement regarding the service of your Mazda vehicle or servicing by Mazda Dealer personnel, we recommend that you take the following steps:

#### **NOTE**

*If it becomes necessary to have the components or wiring system for the supplementary restraint system modified to accommodate a person with certain medical conditions in accordance with a certified physician, contact an Authorized Mazda Dealer.*

#### **▼ STEP 1: Contact Your Mazda Dealer**

Discuss the matter with an Authorized Mazda Dealer. This is the quickest and best way to address the issue.

- If your concern has not been resolved by the CUSTOMER RELATIONS, SALES, SERVICE, or PARTS MANAGER, then please contact the GENERAL MANAGER of the dealership or the OWNER.
- If it becomes necessary to have the components or wiring system for the supplementary restraint system modified to accommodate a person with certain medical conditions in accordance with a certified physician, go to STEP 2.

#### **▼ STEP 2: Contact Mazda North American Operations**

If for any reason you feel the need for further assistance after contacting your dealership management or it becomes necessary to have the components or wiring system for the supplementary restraint system modified to accommodate a person with certain medical conditions in accordance with a certified physician, you can reach Mazda North American Operations by one of the following ways.

Log on: at [www.MazdaUSA.com](http://www.MazdaUSA.com)

Answers to many questions, including how to locate or contact a local Mazda dealership in the U.S., can be found here.

E-mail: click on “Contact Us” located on the “Inside Mazda” tab, or at the bottom of the page at [www.MazdaUSA.com](http://www.MazdaUSA.com)

By phone at: 1 (800) 222-5500

By letter at:

Attn: Customer Assistance  
Mazda North American Operations  
7755 Irvine Center Drive  
Irvine, CA 92618-2922  
P.O. Box 19734  
Irvine, CA 92623-9734

In order to serve you efficiently and effectively, please help us by providing the following information:

1. Your name, address, and telephone number
2. Year and model of vehicle
3. Vehicle Identification Number (17 digits, noted on your registration or title or located on the upper driver's side corner of the dash)
4. Purchase date and current mileage
5. Your dealer's name and location
6. Your question(s)

If you live outside the U.S.A., please contact your nearest Mazda Distributor.

### ▼ **STEP 3: Contact Better Business Bureau (BBB)**

Mazda North American Operations realizes that mutual agreement on some issues may not be possible. As a final step to ensure that your concerns are being fairly considered, Mazda North American Operations has agreed to participate in a dispute settlement program administered by the Better Business Bureau (BBB) system, at no cost to you the consumer.

BBB AUTO LINE works with consumers and the manufacturer in an attempt to reach a mutually acceptable resolution of any warranty related concerns. If the BBB is not able to facilitate a settlement they will provide an informal hearing before an arbitrator.

You are required to resort to BBB AUTO LINE before exercising rights or seeking remedies under the Federal Magnuson-Moss Warranty Act, 15 U.S.C. § 2301 et seq. To the extent permitted by the applicable state “Lemon Law”, you are also required to resort to BBB AUTO LINE before exercising any rights or seeking remedies under the “Lemon Law”. If you choose to seek remedies that are not created by the Magnuson-Moss Warranty Act or the applicable state “Lemon Law”, you are not required to first use BBB AUTO LINE.

The whole process normally takes 40 days or less. The arbitration decision is not binding on you or Mazda unless you accept the decision. For more information about BBB AUTO LINE, including current eligibility standards, please call 1-800-955-5100 or visit the BBB website at [www.lemonlaw.bbb.org](http://www.lemonlaw.bbb.org).

## Customer Assistance

---

Being truly committed to customer satisfaction is more than a phrase with Mazda. We hope to satisfy every customer directly, but if there is ever a question about our decision, Mazda believes in providing a fast, fair and free method such as the BBB AUTO LINE to ensure Mazda delivers on our commitment to do the right thing for our customers!

### ▼ California Customers

1. Mazda North American Operations participates in BBB AUTO LINE, a mediation/arbitration program administered by the Council of Better Business Bureaus [4200 Wilson Boulevard, Arlington, Virginia 22203] through local Better Business Bureaus. BBB AUTO LINE and Mazda have been certified by the Arbitration Certification Program of the California Department of Consumer Affairs.
2. If you have a problem arising under a Mazda written warranty, we encourage you to bring it to our attention. If we are unable to resolve it, you may file a claim with BBB AUTO LINE. Claims must be filed with BBB AUTO LINE within six (6) months after the expiration of the warranty.
3. To file a claim with BBB AUTO LINE, call 1-800-955-5100. There is no charge for the call.
4. In order to file a claim with BBB AUTO LINE, you will have to provide your name and address, the brand name and vehicle identification number (VIN) of your vehicle, and a statement of the nature of your problem or complaint. You will also be asked to provide: the approximate date of your acquisition of the vehicle, the vehicle's current mileage, the approximate date and mileage at the time any problem(s) were first brought to the attention of Mazda or one of our dealers, and a statement of the relief you are seeking.
5. BBB AUTO LINE staff may try to help resolve your dispute through mediation. If mediation is not successful, or if you do not wish to participate in mediation, claims within the program's jurisdiction may be presented to an arbitrator at an informal hearing. The arbitrator's decision should ordinarily be issued within 40 days from the time your complaint is filed; there may be a delay of 7 days if you did not first contact Mazda about your problem, or a delay of up to 30 days if the arbitrator requests an inspection/report by an impartial technical expert or further investigation and report by BBB AUTO LINE.
6. You are required to use BBB AUTO LINE before asserting in court any rights or remedies conferred by California Civil Code Section 1793.22. You are also required to use BBB AUTO LINE before exercising rights or seeking remedies created by Title I of the Magnuson-Moss Warranty Act, 15 U.S.C. sec. 2301 et seq. If you choose to seek redress by pursuing rights and remedies not created by California Civil Code Section 1793.22 or Title I of the Magnuson-Moss Warranty Act, resort to BBB AUTO LINE is not required by those statutes.

7. California Civil Code Section 1793.2 (d) requires that, if Mazda or its representative is unable to repair a new motor vehicle to conform to the vehicle's applicable express warranty after a reasonable number of attempts, Mazda may be required to replace or repurchase the vehicle. California Civil Code Section 1793.22 (b) creates a presumption that Mazda has had a reasonable number of attempts to conform the vehicle to its applicable express warranties if, within 18 months from delivery to the buyer or 18,000 miles on the vehicle's odometer, whichever occurs first, one or more of the following occurs:
- The same nonconformity [a failure to conform to the written warranty that substantially impairs the use, value or safety of the vehicle] results in a condition that is likely to cause death or serious bodily injury if the vehicle is driven **AND** the nonconformity has been subject to repair two or more times by Mazda or its agents **AND** the buyer or lessee has directly notified Mazda of the need for the repair of the nonconformity; OR
  - The same nonconformity has been subject to repair 4 or more times by Mazda or its agents **AND** the buyer has notified Mazda of the need for the repair of the nonconformity; OR
  - The vehicle is out of service by reason of repair of nonconformities by Mazda or its agents for a cumulative total of more than 30 calendar days after delivery of the vehicle to the buyer.

**NOTICE TO Mazda AS REQUIRED ABOVE SHALL BE SENT TO THE FOLLOWING ADDRESS:**

Mazda North American Operations  
7755 Irvine Center Drive  
Irvine, CA 92618  
ATTN: Customer Mediation

8. The following remedies may be sought in BBB AUTO LINE: repairs, reimbursement for money paid to repair a vehicle or other expenses incurred as result of a vehicle nonconformity, repurchase or replacement of your vehicle, and compensation for damages and remedies available under Mazda's written warranty or applicable law.
9. The following remedies may **not** be sought in BBB AUTO LINE: punitive or multiple damages, attorneys' fees, or consequential damages other than as provided in California Civil Code Section 1794 (a) and (b).
10. You may reject the decision issued by a BBB AUTO LINE arbitrator. If you reject the decision, you will be free to pursue further legal action. The arbitrator's decision and any findings will be admissible in a court action.
11. If you accept the arbitrator's decision, Mazda will be bound by the decision, and will comply with the decision within a reasonable time not to exceed 30 days after we receive notice of your acceptance of the decision.
12. Please call BBB AUTO LINE at 1-800-955-5100 for further details about the program.

## Customer Assistance

---

### Customer Assistance (Canada)

#### ▼ Satisfaction Review Process

Your complete and permanent satisfaction is of primary concern to Mazda. All Authorized Mazda Dealers have both the knowledge and tools to keep your Mazda in top condition. In our experience, any questions, problems, or complaints regarding the operation of your Mazda or any other general service transactions are most effectively resolved by your dealer. If the cause of your dissatisfaction cannot adequately be addressed by normal dealership procedures, we recommend that you take the following steps:

#### ▼ STEP 1: Contact the Mazda Dealer

Discuss the matter with a member of dealership management. If the Service Manager has already reviewed your concerns, contact the owner of the dealership or its General Manager.

#### ▼ STEP 2: Contact the Mazda Regional Office

If you feel that you still require assistance, ask the dealer Service Manager to arrange for you to meet the local Mazda Service Representative. If more expedient, contact Mazda Canada Inc. Regional Office nearest you for such arrangements. Regional Office address and phone numbers are shown (page 8-8).

#### ▼ STEP 3: Contact the Mazda Customer Relations Department

If still not substantially satisfied, contact the Customer Relations Department, Mazda Canada Inc., 55 Vogell Road, Richmond Hill, Ontario, L4B 3K5 Canada TEL: 1 (800) 263-4680.

Provide the Department with the following information:

1. Your name, address and telephone number
2. Year and model of vehicle
3. Vehicle Identification Number (VIN). Refer to the "Vehicle Identification Labels" page of section 9 of this manual for the location of the VIN.
4. Purchase date
5. Present odometer reading
6. Your dealer's name and location
7. The nature of your problem and/or cause of dissatisfaction

The Department, in cooperation with the local Mazda Service Representative, will review the case to determine if everything possible has been done to ensure your satisfaction.



Please recognize that the resolution of service problems in most cases requires the use of your Mazda dealer's service facilities, personnel and equipment. We urge you to follow the above three steps in sequence for most effective results.

### ▼ **Mediation/Arbitration Program**

Occasionally a customer concern cannot be resolved through Mazda's Customer Satisfaction Program. If after exhausting the procedures in this manual your concern is still not resolved, you have another option.

Mazda Canada Inc. participates in an arbitration program administered by the Canadian Motor Vehicle Arbitration Plan (CAMVAP). CAMVAP will advise you about how your concern may be reviewed and resolved by an independent third party through binding arbitration.

Your complete satisfaction is the goal of Mazda Canada Inc. and our dealers. Mazda's participation in CAMVAP makes a valuable contribution to our achieving that goal. There is no charge for using CAMVAP. CAMVAP results are fast, fair and final as the award is binding on both you and Mazda Canada Inc.

### ▼ **Canadian Motor Vehicle Arbitration Plan (CAMVAP)**

If a specific item of concern arises, where a solution cannot be reached between an owner, Mazda, and/or one of its dealers (that all parties cannot agree upon), the owner may wish to use the services offered by the Canadian Motor Vehicle Arbitration Plan (CAMVAP).

CAMVAP uses the services of Provincial Administrators to assist consumers in scheduling and preparing for their arbitration hearings. However, before you can proceed with CAMVAP you must follow your Mazda dispute resolution process as outlined previously.

CAMVAP is fully implemented in all provinces and territories.

Consumers wishing to obtain further information about the Program should contact the Provincial Administrator at 1 (800) 207-0685, or by contacting the Canadian Motor Vehicle Arbitration Plan Office at:

Canadian Motor Vehicle Arbitration Plan  
235 Yorkland Boulevard, suite 300  
North York, Ontario  
M2J 4Y8  
<http://camvap.ca>

## Customer Assistance

---

Provincial Administrators may be reached locally as listed below:

Province/Territory	CAMVAP Number
British Columbia & Yukon Territories	1 (800) 207-0685
Alberta & Northwest Territories	1 (800) 207-0685
Saskatchewan	1 (800) 207-0685
Manitoba	1 (800) 207-0685
Ontario	1 (800) 207-0685
Atlantic Canada	1 (800) 207-0685
Quebec	1 (800) 207-0685

### ▼ Regional Offices

REGIONAL OFFICES	COVERING AREAS
MAZDA CANADA INC. WESTERN REGION 5011 275 STREET LANGLEY, BRITISH COLUMBIA V4W 0A8 (778) 369-2100 1 (800) 663-0908	ALBERTA, BRITISH COLUMBIA, MANITOBA, SASKATCHEWAN, YUKON
MAZDA CANADA INC. CENTRAL REGION 55 VOGELL ROAD, RICHMOND HILL, ONTARIO, L4B 3K5 1 (800) 263-4680	ONTARIO, NEW BRUNSWICK, NOVA SCOTIA, PRINCE EDWARD ISLAND, NEWFOUNDLAND
MAZDA CANADA INC. QUEBEC REGION 6111 ROUTE TRANSCANADIENNE POINTE CLAIRE, QUEBEC H9R 5A5 (514) 694-6390	QUEBEC

## Customer Assistance (Puerto Rico)

Your complete and permanent satisfaction is our business. That is why all Authorized Mazda Dealers have the knowledge and the tools to keep your Mazda vehicle in top condition. If you have any questions or recommendations for improvement regarding the service of your Mazda vehicle or servicing by Mazda Dealer personnel, we recommend that you take the following steps:

### ▼STEP 1

Discuss the matter with an Authorized Mazda Dealer. This is the quickest and best way to address the issue. If your concern has not been resolved by the CUSTOMER RELATIONS, SALES, SERVICE, or PARTS MANAGER, then please contact the GENERAL MANAGER of the dealership or the OWNER.

### ▼STEP 2

If, after following STEP 1, you feel the need for further assistance, please contact your area's Mazda representative (Indicated on the next page).

Please help us by providing the following information:

1. Your name, address, and telephone number
2. Year and model of vehicle
3. Vehicle Identification Number (17 digits, noted on your registration or title or located on the upper driver's side corner of the dash)
4. Purchase date and current mileage
5. Your dealer's name and location
6. Your question(s)

## Customer Assistance

---

### Customer Assistance (Mexico)

Your complete and permanent satisfaction is our business. We are here to serve you. All Authorized Mazda Dealers have the knowledge and the tools to keep your Mazda vehicle in top condition.

If you have any questions or recommendations for improvement regarding the service of your Mazda vehicle or servicing by Mazda Dealer personnel, we recommend that you take the following steps:

#### ▼ Contact Your Mazda Dealer

Discuss the matter with an Authorized Mazda Dealer. This is the quickest and best way to address the issue.

- If your concern has not been resolved by the CUSTOMER RELATIONS, SALES, SERVICE, or PARTS MANAGER, then please contact the GENERAL MANAGER of the dealership or the OWNER.
- If it becomes necessary to have the components or wiring system for the supplementary restraint system modified to accommodate a person with certain medical condition in accordance with a certified physician you must contact your dealership in order to avoid the potential loss of the warranty of your vehicle which may occur if some third party is hired by the customer to make any modifications to this system.

Log on: at [www.mazdamexico.com.mx](http://www.mazdamexico.com.mx)

Answers to many questions, including how to locate or contact a local Mazda dealership in Mexico, can be found here.

E-mail: click on “Contactanos” at the top of the page at [www.mazdamexico.com.mx](http://www.mazdamexico.com.mx)

By phone at: 01 800 01 MAZDA (62932)

By letter at:

Attn: Customer Assistance  
Mazda Motor de Mexico  
Mario Pani #150, PB Col. Lomas de Santa Fe  
Mexico, D.F. C.P. 05300  
Del. Cuajimalpa de Morelos  
Tel: Customer Assistance  
01 800 01 MAZDA(62932).

## Customer Assistance

---

In order to serve you efficiently and effectively, please help us by providing the following information:

1. Your name, address, and telephone number
2. Year and model of vehicle
3. Vehicle Identification Number (17 digits, noted on your registration or title or located on the upper driver's side corner of the dash)
4. Purchase date and current mileage
5. Your dealer's name and location
6. Your question(s)

## Mazda Importer/Distributors

---

### Importer/Distributor

#### ▼ U.S.A.

##### **Mazda North American Operations**

7755 Irvine Center Drive  
Irvine, CA 92618-2922 U.S.A.  
P.O. Box 19734

Irvine, CA 92623-9734 U.S.A.  
TEL: 1 (800) 222-5500 (in U.S.A.)  
(949) 727-1990 (outside U.S.A.)

#### ▼ CANADA

##### **Mazda Canada Inc.**

55 Vogell Road, Richmond Hill,  
Ontario, L4B 3K5 Canada  
TEL: 1 (800) 263-4680 (in Canada)  
(905) 787-7000 (outside Canada)

#### ▼ PUERTO RICO/U.S. Virgin Island

##### **International Automotive Distributor Group, LLC. (Mazda de Puerto Rico)**

P.O. Box 191850, San Juan, Puerto Rico  
00919-1850  
TEL: (787) 641-1777

#### ▼ MEXICO

##### **Mazda Motor de Mexico**

Mario Pani # 150, PB Col. Lomas de  
Santa Fe Mexico, D.F. C.P. 05300 Del.  
Cuajimalpa  
TEL: Center of Attention to Clients:  
01 (800) 016 2932. in Mexico

#### ▼ GUAM

##### **Triple J Motors**

157 South Marine Drive, Tamuning,  
GUAM 96911 USA  
P.O. Box 6066 Tamuning, Guam 96931  
TEL: (671) 649-6555

#### ▼ SAIPAN

##### **Pacific International Marianas, Inc. (d.b.a. Midway Motors)**

P.O. Box 887 Saipan, MP 96950  
TEL: (670) 234-7524

##### **Triple J Saipan, Inc.**

**(d.b.a. Triple J Motors)**  
P.O. Box 500487 Saipan, MP 96950-0487  
TEL: (670) 234-7133/3051

#### ▼ AMERICAN SAMOA

##### **Polynesia Motors, Inc.**

P.O. Box 1120, Pago Pago, American  
Samoa 96799  
TEL: (684) 699-9347

## Reporting Safety Defects (U.S.A.)

If you believe that your vehicle has a defect which could cause a crash or could cause injury or death, you should immediately inform the National Highway Traffic Safety Administration (NHTSA) in addition to notifying Mazda Motor Corporation (Your Mazda Importer/Distributor).

If NHTSA receives similar complaints, it may open an investigation, and if it finds that a safety defect exists in a group of vehicles, it may order a recall and remedy campaign. However, NHTSA cannot become involved in individual problems between you, your dealer, or Mazda Motor Corporation (Your Mazda Importer/Distributor).

To contact NHTSA, you may call the Vehicle Safety Hotline toll-free at 1-888-327-4236 (TTY:1-800-424-9153); go to <http://www.safercar.gov>; or write to: Administrator, NHTSA, 1200 New Jersey Avenue, SE., Washington, DC, 20590. You can also obtain other information about motor vehicle safety from <http://www.safercar.gov>.

### **NOTE**

*If you live in the U.S.A., all correspondence to Mazda Motor Corporation should be forwarded to:*

*Mazda North American Operations  
7755 Irvine Center Drive  
Irvine, California 92618-2922*

*or*

*P.O. Box 19734*

*Irvine, CA 92623-9734*

*Customer Experience Center or toll free at 1 (800) 222-5500*

*If you live outside of the U.S.A., please contact the nearest Mazda Distributor shown (page 8-12) in this booklet.*

## Reporting Safety Defects

---

### Reporting Safety Defects (Canada)

Canadian customers who wish to report a safety-related defect to Transport Canada, Defect Investigations and Recalls, may telephone the toll free hotline 1-800-333-0510, or contact Transport Canada by mail at: Transport Canada, ASFAD, Place de Ville Tower C, 330 Sparks Street, Ottawa ON K1A 0N5.

For additional road safety information, please visit the Road Safety website at:  
<http://www.tc.gc.ca/roadsafety/menu.htm>



## Warranties for Your Mazda

- New Vehicle Limited Warranty
- Powertrain Limited Warranty
- Safety Restraint System Limited Warranty
- Anti-perforation Limited Warranty
- Federal Emission Control Warranty/California Emission Control Warranty
  - Emission Defect Warranty
  - Emission Performance Warranty
- Emission Control Warranty
- Replacement Parts and Accessories Limited Warranty
- Tire Warranty

**NOTE**

*Warranty information varies depending on the country. Refer to the Warranty Booklet for detailed warranty information.*

## Warranty

---

### Outside the United States/Canada

Government regulations in the United States/Canada require that automobiles meet specific emission regulations and safety standards. Therefore, vehicles built for use in the United States/Canada may differ from those sold in other countries.

The differences may make it difficult or even impossible for your vehicle to receive satisfactory servicing in other countries. We strongly recommend that you NOT take your Mazda outside the United States/Canada.

#### United States

However, in the event that you are moving to Canada permanently, Mazda vehicles built for use in the United States could be eligible for exportation to Canada with specific vehicle modifications to comply with the Canadian Motor Vehicle Safety Standards (CMVSS).

#### Canada

However, in the event that you are moving to the United States permanently, Mazda vehicles built for use in Canada could be eligible for exportation to the United States with specific vehicle modifications to comply with the United States Federal Motor Vehicle Safety Standards (FMVSS).

#### NOTE

*The above is applicable for a permanent import/export situation and not related to travelers on vacation.*

You may have the following problems if you do take your vehicle outside of the United States/Canada:

- Recommended fuel may be unavailable. Any kind of leaded fuel or low-octane fuel will affect vehicle performance and damage the emission controls and engine.
- Proper repair facilities, tools, testing equipment, and replacement parts may not be available.

Please refer to your Manufacturer's Warranty Booklet for more information.

## **Registering Your Vehicle in A Foreign Country (Except United States and Canada)**

Registering your vehicle in a foreign country may be problematic depending on whether it meets the specific emission and safety standards of the country in which the vehicle will be driven. Consequently, your vehicle may require modifications at personal expense in order to meet the regulations.

In addition, you should be aware of the following issues:

Satisfactory vehicle servicing may be difficult or impossible in another country.

The fuel specified for your vehicle may be unavailable.

Parts, servicing techniques, and tools necessary to maintain and repair your vehicle may be unavailable.

There might not be an Authorized Mazda Dealer in the country you plan to take your vehicle.

The Mazda warranty is valid only in certain countries.

# Warranty

---

## Add-On Non-Genuine Parts and Accessories

Non-genuine parts and accessories for Mazda vehicles can be found in stores. These may fit your vehicle, but they are not approved by Mazda for use with Mazda vehicles. When you install non-genuine parts or accessories, they could affect your vehicle's performance or safety systems; the Mazda warranty doesn't cover this. Before you install any non-genuine parts or accessories, consult an Authorized Mazda Dealer.

### **WARNING**

**Always consult an Authorized Mazda Dealer before you install non-genuine parts or accessories:**

*Improperly designed parts or accessories could seriously affect your vehicle's performance or safety systems. This could cause you to have an accident or increase your chances of injuries in an accident.*

**Be very careful in choosing and installing add-on electrical equipment, such as mobile telephones, two-way radios, stereo systems, and car alarm systems:**

*Incorrectly choosing or installing improper add-on equipment or choosing an improper installer is dangerous. Essential systems could be damaged, causing engine stalling, air-bag (SRS) activation, ABS/TCS/DSC inactivation, or a fire in the vehicle.*

Mazda assumes no responsibility for death, injury, or expenses that may result from the installation of add-on non-genuine parts or accessories.

## Cell Phones Warning

### **WARNING**

**Please comply with the legal regulations concerning the use of communication equipment in vehicles in your country:**

*Use of any electrical devices such as cell phones, computers, portable radios, vehicle navigation or other devices by the driver while the vehicle is moving is dangerous. Dialing a number on a cell phone while driving also ties-up the driver's hands. Use of these devices will cause the driver to be distracted and could lead to a serious accident. If a passenger is unable to use the device, pull off the right-of-way to a safe area before use. If use of a cell phone is necessary despite this warning, use a hands-free system to at least leave the hands free to drive the vehicle. Never use a cell phone or other electrical devices while the vehicle is moving and, instead, concentrate on the full-time job of driving.*

## Event Data Recorder

---

### Event Data Recorder (U.S.A. and Canada)

This vehicle is equipped with an event data recorder (EDR). The main purpose of an EDR is to record, in certain crash or near crash-like situations, such as an air bag deployment or hitting a road obstacle, data that will assist in understanding how a vehicle's systems performed. The EDR is designed to record data related to vehicle dynamics and safety systems for a short period of time, typically 30 seconds or less. The EDR in this vehicle is designed to record such data as:

- How various systems in your vehicle were operating;
- Whether or not the driver and passenger safety belts were buckled/fastened;
- How far (if at all) the driver was depressing the accelerator and/or brake pedal; and,
- How fast the vehicle was traveling.

These data can help provide a better understanding of the circumstances in which crashes and injuries occur.

#### NOTE:

EDR data are recorded by your vehicle only if a non-trivial crash or near crash-like situation occurs; no data are recorded by the EDR under normal driving conditions and no personal data (e.g., name, gender, age, and crash location) are recorded. However, other parties, such as law enforcement, could combine the EDR data with the type of personally identifying data routinely acquired during a crash investigation.

To read data recorded by an EDR, special equipment is required, and access to the vehicle or the EDR is needed. In addition to the vehicle manufacturer, other parties, such as law enforcement, that have the special equipment, can read the information if they have access to the vehicle or the EDR.

Mazda will not disclose any of the data recorded in an EDR to a third party unless:

- A written agreement from the vehicle owner or the lessee is obtained
- Officially requested by the police or other law enforcement authorities
- Used as a defense for Mazda in a law suit, claim, or arbitration
- Ordered by a judge or court

However, if necessary Mazda will:

- Use the data for research on Mazda vehicle performance, including safety.
- Disclose the data or the summarized data to a third party for research purposes without disclosing vehicle or owner identification information.

## Recording of Vehicle Data

This vehicle is equipped with a computer which records the following main vehicle data related to vehicle controls, operation, and other driving conditions.

### **Recorded data**

- Vehicle conditions such as engine speed and vehicle speed
- Driving operation conditions such as accelerator and brake pedals, and information related to the environmental circumstances while the vehicle is driven
- Malfunction diagnosis information from each on-vehicle computer
- Information related to controls of other on-vehicle computers

### ***NOTE***

*The record data may vary depending on the vehicle grade and optional equipment. Voice and images are not recorded.*

### **Data handling**

Mazda and its subcontracting parties may obtain and use the recorded data for vehicle malfunction diagnosis, research and development, and quality improvement.

Mazda will not disclose or provide any of the obtained data to a third party unless:

- An agreement from the vehicle owner (agreements from lessor and lessee for leased vehicle) is obtained
- Officially requested by the police or other law enforcement authorities
- For statistical processing by a research institution after processing the data so that identification of the owner or the vehicle is impossible

## Uniform Tire Quality Grading System (UTQGS)

---

### Uniform Tire Quality Grading System (UTQGS)

This information relates to the tire grading system developed by the U.S. National Highway Traffic Safety Administration for grading tires by tread wear, traction, and temperature performance.

#### ▼ Tread Wear

The tread wear grade is a comparative rating based on the wear rate of the tire when tested under controlled conditions on a specified government test course.

For example, a tire graded 150 would wear one-and-a-half times as well on the government course as a tire graded 100.

The relative performance of tires depends upon the actual conditions of their use, however, and may depart significantly from the norm because of variations in driving habits, service practices and differences in road characteristics and climate.

#### ▼ Traction-AA, A, B, C

The traction grades, from highest to lowest, are AA, A, B, and C. These grades represent the tire's ability to stop on wet pavement as measured under controlled conditions on specified government test surfaces of asphalt and concrete. A tire marked C may have poor traction performance.

#### WARNING

*The traction grade assigned to this tire is based on braking (straight ahead) traction tests and does not include acceleration cornering (turning), hydroplaning, or peak traction characteristics.*

#### ▼ Temperature-A, B, C

The temperature grades A (the highest), B, and C, represent the tire's resistance to the generation of heat and its ability to dissipate heat when tested under controlled conditions on a specified indoor laboratory test wheel.

Sustained high temperature can cause the material of the tire to degenerate and reduce tire life, and excessive temperatures can lead to sudden tire failure.

Grade C corresponds to a level of performance which all passenger vehicle tires must meet under the Federal Motor Vehicle Safety Standard No. 109. Grades B and A represent higher levels of performance on the laboratory test wheel than the minimum required by law.



# Uniform Tire Quality Grading System (UTQGS)

## **⚠ WARNING**

### **Keep your vehicle's tires properly inflated and not overloaded:**

*Driving with improperly inflated or overloaded tires is dangerous. Excessive speed, underinflation, or excessive loading, either separately or in combination, can cause heat buildup and possible tire failure. The temperature grade for this tire is established for a tire that is properly inflated and not overloaded.*

These grades will be added to the sidewalls of passenger vehicle tires over the next several years according to a schedule established by the NHTSA and the tire manufacturers.

The grade of tires available as standard or optional equipment on Mazda vehicles may vary with respect to grade.

ALL PASSENGER VEHICLE TIRES MUST CONFORM TO THESE GRADES AND TO ALL OTHER FEDERAL TIRE-SAFETY REQUIREMENTS.

## **▼ UNIFORM TIRE QUALITY GRADING**

Quality grades can be found where applicable on the tire sidewall between tread shoulder and maximum section width.

For example:

**TREADWEAR 200 TRACTION AA TEMPERATURE A**

**UTQGS MARK (example)**

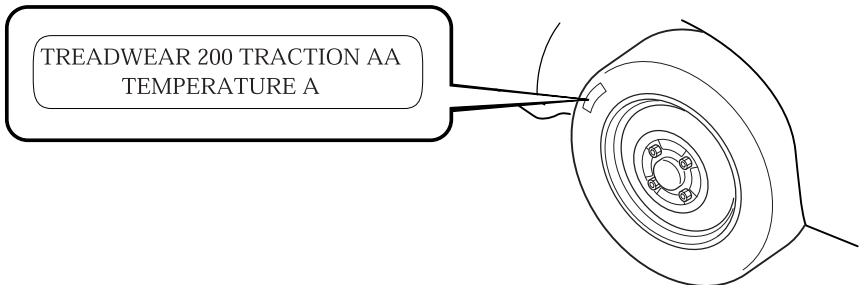

## Tire Information (U.S.A.)

### Tire Labeling

Federal law requires tire manufacturers to place standardized information on the sidewall of all tires. This information identifies and describes the fundamental characteristics of the tire and also provides a tire identification number for safety standard certification and in case of a recall.

#### ▼ Information on Passenger Vehicle Tires

Please refer to the sample below.

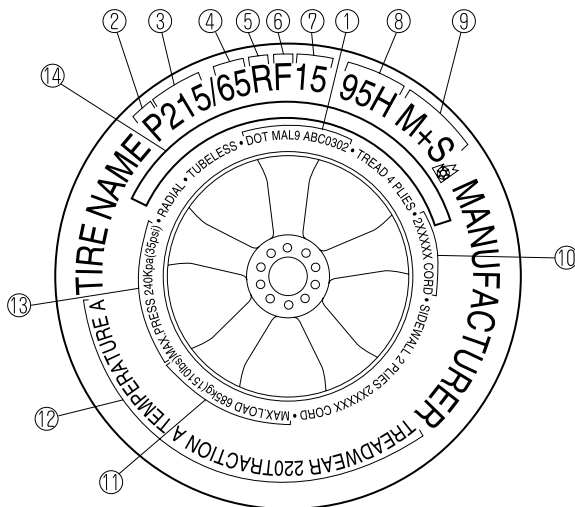

1. TIN: U.S. DOT tire identification number
2. Passenger car tire
3. Nominal width of tire in millimeters
4. Ratio of height to width (aspect ratio)
5. Radial
6. Run-flat tire
7. Rim diameter code
8. Load index & speed symbol
9. Severe snow conditions
10. Tire ply composition and materials used
11. Max. load rating
12. Tread wear, traction and temperature grades

13. Max. permissible inflation pressure

#### 14. SAFETY WARNING

P215/65R15 95H is an example of a tire size and load index rating. Here is an explanation of the various components of that tire size and load index rating. Note that the tire size and load index rating may be different from the example.

#### **P**

Indicates a tire that may be installed on cars, SUVs, minivans and light trucks as designated by the Tire and Rim Association (T&RA).

#### ***NOTE***

*If your tire size does not begin with a letter this may mean it is designated by either ETRTO (European Tire and Rim Technical Organization) or JATMA (Japan Tire Manufacturing Association).*

#### **215**

“215” is the nominal width of the tire in millimeters. This three-digit number gives the width in millimeters of the tire from sidewall edge to sidewall edge. In general, the larger the number, the wider the tire.

#### **65**

“65” is the aspect ratio. This two-digit number indicates the tire's ratio of height to width.

#### **R**

“R” is the tire construction symbol. R indicates “Radial ply construction”.

#### **15**

“15” is the wheel rim diameter in inches.

#### **95**

“95” is the Load Index. This two-or three-digit number indicates how much weight each tire can support.

## Tire Information (U.S.A.)

---

### H

“H” is the speed rating. The speed rating denotes the maximum speed for which the use of the tire is rated.

Letter Rating	Speed Rating
Q	99 mph
R	106 mph
S	112 mph
T	118 mph
U	124 mph
H	130 mph
V	149 mph
W	168* mph
Y	186* mph

\* For tires with a maximum speed capability over 149 mph, tire manufacturers sometimes use the letters ZR. For tires with a maximum speed capability over 186 mph, tire manufacturers always use the letters ZR.

### M+S or M/S: Mud and Snow

AT: All Terrain.

AS: All Season. The “M+S” or “M/S” indicates that the tire has some functional use in mud and snow.

### U.S. DOT Tire Identification Number (TIN)

This begins with the letters “DOT” which indicates the tire meets all federal standards. The next two numbers or letters are the plant code where it was manufactured, and the last four numbers represent the week and year the tire was manufactured. For example, the numbers 457 means the 45th week of 1997. After 2000 the numbers go to four digits. For example, the number 2102 means the 21th week of 2002. The other numbers are marketing codes used at the manufacturer's discretion. This information is used to contact consumers if a tire defect requires a recall.

### Tire Ply Composition and Materials Used

The number of plies indicates the number of layers of rubber-coated fabric in the tire. In general, the greater the number of plies, the more weight a tire can support. Tire manufacturers also must indicate the tire materials, which include steel, nylon, polyester, and other.

### Maximum Load Rating

This number indicates the maximum load in kilograms and pounds that can be carried by the tire.

**Maximum Permissible Inflation Pressure**

This number is the greatest amount of air pressure that should ever be put in the tire under normal driving conditions.

**Tread Wear, Traction and Temperature Grades**

**Tread wear:** The tread wear grade is a comparative rating based on the wear rate of the tire when tested under controlled conditions on a specified government test course. For example, a tire graded 150 would wear one and one-half (1 1/2) times as well on the government course as a tire graded 100.

**Traction:** The traction grades, from highest to lowest are AA, A, B, and C. The grades represent the tire's ability to stop on wet pavement as measured under controlled conditions on specified government test surfaces of asphalt and concrete. A tire marked C may have poor traction performance.

**Temperature:** The temperature grades are A (the highest), B and C, representing the tire's resistance to the generation of heat and its ability to dissipate heat when tested under controlled conditions on a specified indoor laboratory test wheel.

**Snow Tires**

In some heavy snow areas, local governments may require true snow tires, those with very deeply cut tread. These tires should only be used in pairs or placed on all four wheels. Make sure you purchase snow tires that are the same size and construction type as the other tires on your vehicle.

**SAFETY WARNING**

The following safety warning appears on the tire's sidewall.  
SERIOUS INJURY MAY RESULT FROM:

- EXPLOSION OF TIRE/RIM ASSEMBLY DUE TO IMPROPER MOUNTING-MATCH TIRE DIAMETER TO RIM DIAMETER; NEVER EXCEED 40 psi (275 kPa) TO SEAT BEADS-ONLY SPECIALLY TRAINED PERSONS SHOULD MOUNT TIRES.
- TIRE FAILURE DUE TO UNDER-INFLATION/OVERLOADING/DAMAGE-FOLLOW OWNER'S MANUAL AND PLACARD IN VEHICLE-FREQUENTLY CHECK INFLATION PRESSURE AND INSPECT FOR DAMAGE.

## Tire Information (U.S.A.)

---

### ▼ Information on Temporary Tires

Please refer to the sample below.

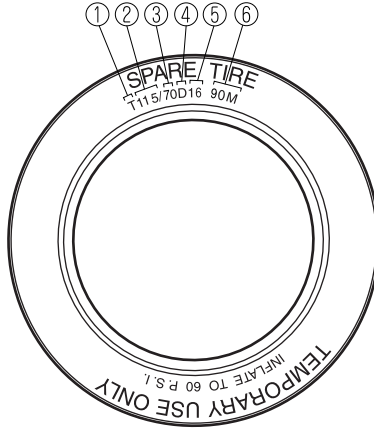

1. Temporary tires
2. Nominal width of tire in millimeters
3. Ratio of height to width (aspect ratio)
4. Diagonal
5. Rim diameter code
6. Load index & speed symbol

T115/70D16 90M is an example of a tire size and load index rating. Here is an explanation of the various components of that tire size and load index rating. Note that the tire size and load index rating may be different from the example.

#### **T**

Indicates a tire that may be installed on cars, SUVs, minivans and light trucks as designated by the Tire and Rim Association (T&RA).

#### **115**

“115” is the nominal width of the tire in millimeters. This three-digit number gives the width in millimeters of the tire from sidewall edge to sidewall edge. In general, the larger the number, the wider the tire.

#### **70**

“70” is the aspect ratio. This two-digit number indicates the tire's ratio of height to width.

#### **D**

“D” is the tire construction symbol. D indicates “diagonal ply construction”.

# Tire Information (U.S.A.)

---

**16**

“16” is the wheel rim diameter in inches.

**90**

“90” is the Load Index. This two-or three-digit number indicates how much weight each tire can support.

**M**

“M” is the speed rating. The speed rating denotes the maximum speed for which the use of the tire is rated.

Letter Rating	Speed Rating
M	81 mph

# Tire Information (U.S.A.)

## Location of the Tire Label (Placard)

You will find the tire label containing tire inflation pressure by tire size and other important information on the driver's side B-pillar or on the edge of the driver's door frame.

### SAMPLE



TIRE AND LOADING INFORMATION			
RENSEIGNEMENTS SUR LES PNEUS ET LE CHARGEMENT			
SEATING CAPACITY NOMBRE DE PLACES	TOTAL 5	FRONT AVANT 2	REAR ARRIÈRE 3
The combined weight of occupants and cargo should never exceed		xxx kg or xxx lbs.*	
Le poids total des occupants et du chargement ne doit jamais dépasser		xxx kg ou xxx lb.*	
TIRE PNEU	SIZE DIMENSIONS	COLD TIRE PRESSURE PRESSION DES PNEUS À FROID	SEE OWNER'S MANUAL FOR ADDITIONAL INFORMATION  VOIR LE MANUEL DE L'USAGER POUR PLUS DE RENSEIGNEMENTS
FRONT AVANT	P195/70R14	200 kPa, 29 psi	
REAR ARRIÈRE	P195/70R14	200 kPa, 29 psi	
SPARE DE SECOURS	T125/70D15	420 kPa, 60 psi	

### ▼ Recommended Tire Inflation Pressure

On the tire label you will find the recommended tire inflation pressure in both kPa and psi for the tires installed as original equipment on the vehicle. It is very important that the inflation pressure of the tires on your vehicle is maintained at the recommended pressure. You should check the tire pressure regularly to insure that the proper inflation pressure is maintained.

Refer to Tires on page 9-10.

#### NOTE

*Tire pressures listed on the vehicle placard or tire information label indicate the recommended cold tire inflation pressure, measured when the tires are cold, after the vehicle has been parked for at least 3 hours. As you drive, the temperature in the tire warms up, increasing the tire pressure.*



 **WARNING**

**Always check the tire inflation pressures on a regular basis according to the recommended tire inflation pressure on the tire label and in conjunction with the information in this owner's manual:**

*Driving your vehicle with under-inflated tires is dangerous.*

*Under-inflation is the most common cause of failures in any kind of tire and may result in severe cracking, tread separation or "blowout", with unexpected loss of vehicle control and increased risk of injury. Under-inflation increases sidewall flexing and rolling resistance, resulting in heat buildup and internal damage to the tire. It results in unnecessary tire stress, irregular wear, loss of control and accidents. A tire can lose up to half of its air pressure and not appear to be flat!*

*It is impossible to determine whether or not tires are properly inflated just by looking at them.*

**▼ Checking Tire Pressure**

1. When you check the air pressure, make sure the tires are cold —meaning they are not hot from driving even a mile.
2. Remove the cap from the valve on one tire.
3. Firmly press a tire gauge onto the valve.
4. Add air to achieve recommended air pressure.
5. If you overfill the tire, release air by pushing on the metal stem in the center of the valve. Then recheck the pressure with your tire gauge.
6. Replace the valve cap.
7. Repeat with each tire, including the spare.

**NOTE**

*Some spare tires require higher inflation pressure.*

8. Visually inspect the tires to make sure there are no nails or other objects embedded that could poke a hole in the tire and cause an air leak.
9. Check the sidewalls to make sure there are no gouges, cuts, bulges, cracks or other irregularities.

## Tire Information (U.S.A.)

---

### ▼ Glossary of Terms

**Tire Placard:** A label indicating the OE tire sizes, recommended inflation pressure, and the maximum weight the vehicle can carry.

**Tire Identification Number (TIN):** A number on the sidewall of each tire providing information about the tire brand and manufacturing plant, tire size, and date of manufacture.

**Inflation Pressure:** A measure of the amount of air in a tire.

**kPa:** Kilopascal, the metric unit for air pressure.

**psi:** Pounds per square inch, the English unit for air pressure.

**B-pillar:** The structural member at the side of the vehicle behind the front door.

**Original Equipment (OE):** Describes components originally equipped on the vehicle.

**Vehicle Load Limit:** The maximum value of the combination weight of occupants and cargo.

**Bead Area of the Tire:** Area of the tire next to the rim.

**Sidewall Area of the Tire:** Area between the bead area and the tread.

**Tread Area of the Tire:** Area on the perimeter of the tire that contacts the road when it's mounted on the vehicle.

**Seating capacity** means the total allowable number of vehicle occupants. Seating capacity is described on the tire label.

**Production options weight** is the combination weight of installed regular production options weighing over 2.3 kilograms in excess of the standard items which they replace, and not previously considered in the curb weight or accessory weight, including heavy duty brakes, ride levelers, roof rack, heavy duty battery, and special trim.

**Rim** is the metal support (wheel) for a tire or a tire and tube assembly upon which the tire beads are seated.

## Tire Maintenance

Improper or inadequate vehicle maintenance can cause tires to wear abnormally. Here are some important maintenance points:

### ▼ Tire Inflation Pressure

Inspect all tire pressure monthly (including the spare) when the tires are cold. Maintain recommended pressures for the best ride, top handling, and minimum tire wear. Use the pressures specified on the vehicle tire information placard or tire label for optimum service.

### ▼ Tire Rotation

To equalize tread wear, rotate the tires every 12,000 km (7,500 miles) at the latest or sooner if irregular wear develops. Mazda recommends to rotate every 8,000 km (5,000 miles) to help increase tire life and distribute wear more evenly.

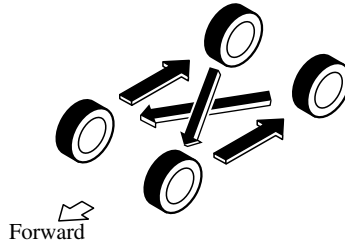

Do not include (TEMPORARY USE ONLY)  
spare tire in rotation.

Inspect the tires for uneven wear and damage. Abnormal wear is usually caused by one or a combination of the following:

- Incorrect tire pressure
- Improper wheel alignment
- Out-of-balance wheel
- Severe braking

After rotation, inflate all tire pressures to specification (page 9-10) and inspect the lug nuts for tightness.

### **⚠ CAUTION**

*Rotate unidirectional tires and radial tires that have an asymmetrical tread pattern or studs only from front to rear, not from side to side. Tire performance will be weakened if rotated from side to side.*

## Tire Information (U.S.A.)

---

### ▼ Replacing a Tire



**Always use tires that are in good condition:**

*Driving with worn tires is dangerous. Reduced braking, steering, and traction could result in an accident.*

If a tire wears evenly, a wear indicator will appear as a solid band across the tread. Replace the tire when this happens.

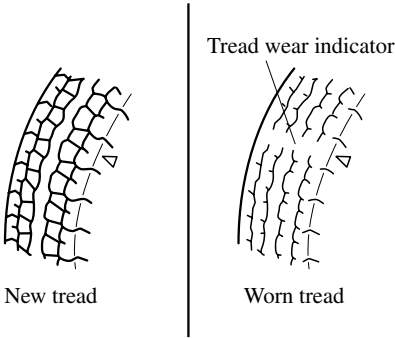

You should replace the tire before the band crosses the entire tread.

**NOTE**

*Tires degrade over time, even when they are not being used on the road. It is recommended that tires generally be replaced when they are 6 years or older. Heat caused by hot climates or frequent high loading conditions can accelerate the aging process. You should replace the spare tire when you replace the other road tires due to the aging of the spare tire. The period in which the tire was manufactured (both week and year) is indicated by a 4-digit number. Refer to Tire Labeling on page 8-24.*

**▼ Safety Practices**

The way you drive has a great deal to do with your tire mileage and safety. So cultivate good driving habits for your own benefit.

- Observe posted speed limits and drive at speeds that are safe for the existing weather conditions
- Avoid fast starts, stops and turns
- Avoid potholes and objects on the road
- Do not run over curbs or hit the tire against the curb when parking

** CAUTION**

*If you feel a sudden vibration or ride disturbance while driving or you suspect your tire or vehicle has been damaged, immediately reduce your speed. Drive with caution until you can safely pull off the road. Stop and inspect the tire for damage. If the tire is under-inflated or damaged, deflate it, remove the tire and rim and replace it with your spare tire. If you cannot detect a cause, have the vehicle towed to the nearest vehicle or tire dealer to have the vehicle inspected.*

## Vehicle Loading

### **WARNING**

**Do not tow a trailer with this vehicle:**

*Towing a trailer with this vehicle is dangerous because it has not been designed to tow a trailer and doing so will affect the drive system which could result in vehicle damage.*

This section will guide you in the proper loading of your vehicle, to keep your loaded vehicle weight within its design rating capability. Properly loading your vehicle will provide maximum return of vehicle design performance. Before loading your vehicle, familiarize yourself with the following terms for determining your vehicle's weight ratings, from the vehicle's Safety Certification Label and Tire and Load Information Label:

### **WARNING**

**Overloaded Vehicle:**

*Overloading a vehicle is dangerous. The results of overloading can have serious consequences in terms of passenger safety. Too much weight on a vehicle's suspension system can cause spring or shock absorber failure, brake failure, handling or steering problems, irregular tire wear, tire failure or other damage.*

*Overloading makes a vehicle harder to drive and control. It also increases the distance required for stopping. In cases of serious overloading, brakes can fail completely, particularly on steep grades. The load a tire will carry safely is a combination of the size of the tire, its load range, and corresponding inflation pressure.*

*Never overload the vehicle and always observe the vehicle's weight ratings from the vehicle's Safety Certification and Tire and Load Information labels.*

## Tire Information (U.S.A.)

---

**Base Curb Weight** is the weight of the vehicle including a full tank of fuel and all standard equipment. It does not include passengers, cargo, or optional equipment.

**Vehicle Curb Weight** is the weight of your new vehicle when you picked it up from your dealer plus any aftermarket equipment.

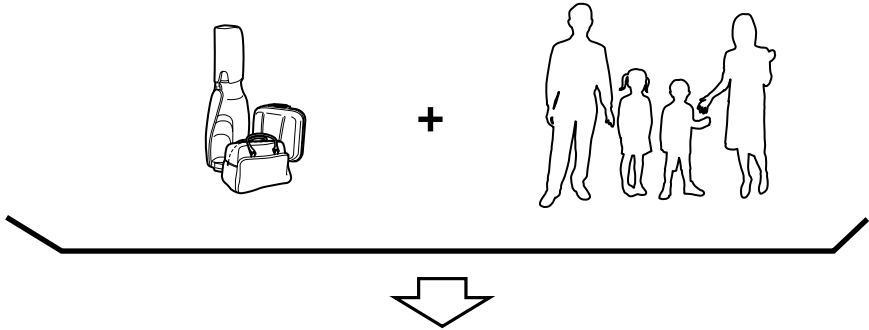

### PAYLOAD

**Payload** is the combination weight of cargo and passengers that the vehicle is designed to carry. The maximum payload for your vehicle can be found on the Tire and Load Information label on the driver's door frame or door pillar. Look for "THE COMBINATION WEIGHT OF OCCUPANTS AND CARGO SHOULD NEVER EXCEED XXX kg or XXX lbs" for your maximum payload. The payload listed on the tire label is the maximum payload for the vehicle as built by the assembly plant. If any aftermarket or dealer installed equipment has been installed on the vehicle, the weight of the equipment must be subtracted from the payload listed on the tire label in order to be accurate.

# Tire Information (U.S.A.)

SAMPLE



**TIRE AND LOADING INFORMATION**  
**RENSEIGNEMENTS SUR LES PNEUS ET LE CHARGEMENT**

SEATING CAPACITY NOMBRE DE PLACES	TOTAL 5	FRONT AVANT 2	REAR ARRIÈRE 3
--------------------------------------	---------	------------------	-------------------

The combined weight of occupants and cargo should never exceed **xxx** kg or **xxx** lbs.\*  
 Le poids total des occupants et du chargement ne doit jamais dépasser **xxx** kg ou **xxx** lb.\*

TIRE PNEU	SIZE DIMENSIONS	COLD TIRE PRESSURE PRESSION DES PNEUS À FROID	SEE OWNER'S MANUAL FOR ADDITIONAL INFORMATION  VOIR LE MANUEL DE L'USAGER POUR PLUS DE RENSEIGNEMENTS
FRONT AVANT	P195/70R14	200 kPa, 29 psi	
REAR ARRIÈRE	P195/70R14	200 kPa, 29 psi	
SPARE DE SECOURS	T125/70D15	420 kPa, 60 psi	





## CARGO

**Cargo Weight** includes all weight added to the Base Curb Weight, including cargo and optional equipment.

The cargo weight limit decreases depending on the number of vehicle occupants. The cargo weight limit can be calculated by subtracting the total weight of the vehicle occupants from the “combination weight of occupants and cargo should never exceed” value on the tire label.



## Tire Information (U.S.A.)

Examples: Based on a single occupant weight of 68 kg (150 lbs), and a value of 385 kg (849 lbs) for the “combination weight of occupants and cargo should never exceed”:

The cargo weight limit with one occupant is  $385 \text{ kg (849 lbs)} - 68 \text{ kg (150 lbs)} = 317 \text{ kg (699 lbs)}$

The cargo weight limit with two occupants is  $385 \text{ kg (849 lbs)} - (68 \times 2) \text{ kg (} (150 \times 2) \text{ lbs)} = 249 \text{ kg (549 lbs)}$

If the weight of the occupant increases, the cargo weight limit decreases by that much.

**GAW (Gross Axle Weight)** is the total weight placed on each axle (front and rear) - including vehicle curb weight and all payload.

**GAWR (Gross Axle Weight Rating)** is the maximum allowable weight that can be carried by a single axle (front or rear). **These numbers are shown on the Safety Compliance Certification Label located on the driver's door frame or door pillar. The total load on each axle must never exceed its GAWR.**

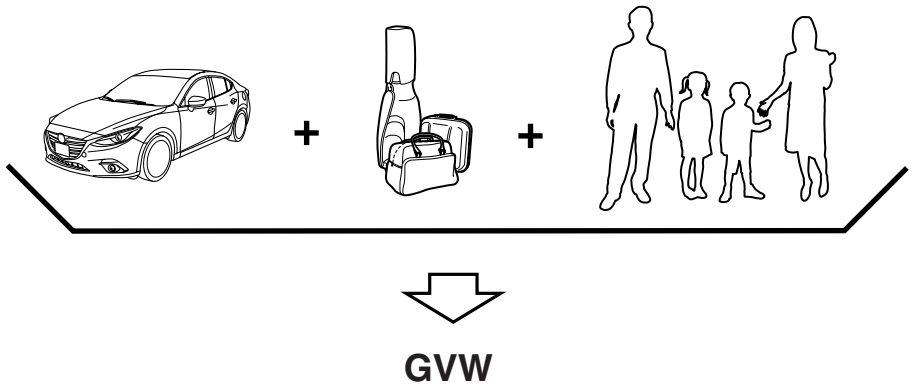

**GVW (Gross Vehicle Weight)** is the Vehicle Curb Weight + cargo + passengers.

**GVWR (Gross Vehicle Weight Rating)** is the maximum allowable weight of the fully loaded vehicle (including all options, equipment, passengers and cargo). **The GVWR is shown on the Safety Compliance Certification Label located on the driver's door frame or door pillar. The GVW must never exceed the GVWR.**



## Tire Information (U.S.A.)

---

**GCW (Gross Combination Weight)** is the weight of the loaded vehicle (GVW).

**GCWR (Gross Combination Weight Rating)** is the maximum allowable weight of the vehicle - including all cargo and passengers - that the vehicle can handle without risking damage. **The GCW must never exceed the GCWR.**

### **WARNING**

**Never Exceed GVWR or GAWR Specifications:**

*Exceeding the GVWR or the GAWR specified on the certification label is dangerous. Exceeding any vehicle rating limitation could result in a serious accident, injury, or damage to the vehicle.*

*Do not use replacement tires with lower load carrying capacities than the originals because they may lower the vehicle's GVWR and GAWR limitations. Replacement tires with a higher limit than the originals do not increase the GVWR and GAWR limitations. Never exceed the GVWR or the GAWR specified on the certification label.*

## Tire Information (U.S.A.)

---

### Steps for Determining the Correct Load Limit

#### Steps for Determining Correct Load Limit-

- (1) Locate the statement “The combined weight of occupants and cargo should never exceed XXX kg or XXX lbs.” on your vehicle's placard.
- (2) Determine the combined weight of the driver and passengers that will be riding in your vehicle.
- (3) Subtract the combined weight of the driver and passengers from XXX kg or XXX lbs.
- (4) The resulting figure equals the available amount of cargo and luggage load capacity. For example, if the “XXX” amount equals 1400 lbs. and there will be five 150 lb passengers in your vehicle, the amount of available cargo and luggage load capacity is 650 lbs.  
( $1400 - 750 (5 \times 150) = 650$  lbs.)
- (5) Determine the combined weight of luggage and cargo being loaded on the vehicle. That weight may not safely exceed the available cargo and luggage load capacity calculated in Step 4.
- (6) If your vehicle will be towing a trailer, load from your trailer will be transferred to your vehicle. Consult this manual to determine how this reduces the available cargo and luggage load capacity of your vehicle.

## Declaration of Conformity

### ▼ Keyless Entry System/Immobilizer System

#### FCC WARNING

Changes or modifications not expressly approved by the party responsible for compliance could void the user's authority to operate the equipment.

#### FCC/IC

This device complies with Part 15 of FCC Rules and Industry Canada licence-exempt RSS standard(s). Operation is subject to the following two conditions: (1) this device may not cause interference, and (2) this device must accept any interference, including interference that may cause undesired operation of this device.

Le présent appareil est conforme aux la Partie 15 des règles de la FCC et CNR d'Industrie Canada applicables aux appareils radio exempts de licence. L'exploitation est autorisée aux deux conditions suivantes: (1) l'appareil ne doit pas produire de brouillage, et (2) l'utilisateur de l'appareil doit accepter tout brouillage radioélectrique subi, même si le brouillage est susceptible d'en compromettre le fonctionnement.

#### (MEXICO)

La operación de este equipo está sujeta a las siguientes dos condiciones: (1) es posible que este equipo o dispositivo no cause interferencia perjudicial y (2) este equipo o dispositivo debe aceptar cualquier interferencia, incluyendo la que pueda causar su operación no deseada.

# Declaration of Conformity

---

## ▼ Blind Spot Monitoring (BSM) System

(U.S.A)

FCC ID : OAYSRR2A

This device complies with part 15 of the FCC Rules. Operation is subject to the following two conditions:

- (1) This device may not cause harmful interference, and
- (2) this device must accept any interference received, including interference that may cause undesired operation.

FCC Warning

Changes or modifications not expressly approved by the party responsible for compliance could void the user's authority to operate the equipment.

(Canada)

Applicable law : Canada 310

This device complies with the radio standards specification RSS-310 of Industry Canada.

Operation is subject to the following two conditions:

- (1) This device may not cause harmful interference.
- (2) This device must accept any interference received, including interference that may cause undesired operation.

Frequency bands : 24.05 - 24.25GHz

Output power : less than 20 milliwatts

Droit applicable : Canada 310

Le présent appareil est conforme aux CNR d'Industrie RSS-310 applicables aux appareils radio exempts de licence. L'exploitation est autorisée aux deux conditions suivantes:

- (1) l'appareil ne doit pas produire de brouillage, et
- (2) l'utilisateur de l'appareil doit accepter tout brouillage radioélectrique subi, même si le brouillage est susceptible d'en compromettre le fonctionnement.

Bandes de fréochquences : 24.05 - 24.25GHz

Puissance éochmise : Moins de 20 milliwatts

(Mexico)

Certificado de homologacion: RCPCOSR11-1177

Continental SRR2-A

Este equipo opera a título secundario, consecuentemente, debe aceptar interferencias perjudiciales incluyendo equipos de la misma clase y puede no causar interferencias a sistemas operando a título primario.

Cofetel notice:

“La operación de este equipo está sujeta a las siguientes dos condiciones:

(1) es posible que este equipo o dispositivo no cause interferencia perjudicial y

(2) este equipo o dispositivo debe aceptar cualquier interferencia, incluyendo la que pueda causar su operación no deseada.”

ATTENTION:

Cofetel requires that their notice is printed on the user manual in Spanish with the exact words above.

If the user manual in Spanish does not contain the notice it will not be accepted by Cofetel and they will not grant NOM-121 certificate.

Moreover, it is important to tell your customer that Cofetel inspectors are checking the user manual in Spanish that is included with the product. If the manual does not contain Cofetel notice as above, they will put a penalty to the importer and distributor.

**NOTE**

*During printing time of this user manual the approvals listed above are granted.*

**⚠ WARNING**

*Change or modifications not expressly approved by the party responsible for compliance could void the use's authority to operate the equipment.*

**▼ HomeLink Wireless Control System**

**⚠ CAUTION**

*HomeLink has been tested and complies with FCC and Industry Canada rules. Changes or modifications not expressly approved by the party responsible for compliance could void the user's authority to operate the device.*

**NOTE**

FCC ID: NZLMOBHL4

CANADA:4112A-MOBHL4

*This device complies with part 15 of the FCC Rules. Operation is subject to the following two conditions:*

*1- This device may not cause harmful interference, and*

*2- This device must accept any interference received, including interference that may cause undesired operation.*

## Declaration of Conformity

---

### ▼ Bluetooth® Hands-Free

#### Type A

#### U.S.A. and Canada

Model: MAZ

Brand: **Johnson Controls Inc.**  
915 E. 32<sup>nd</sup> St., Holland, MI  
49423 Michigan  
United States of America  
MAZ

**CE 0682**

FCC ID: CB2MBLUEC09 IC:279B-MBLUEC09

This device complies with Part 15 of the FCC Rules and with RSS-210 of Industry Canada. Operation is subject to the following two conditions:

- (1) This device may not cause harmful interference, and
- (2) This device must accept any interference received, including interference that may cause undesired operation.

#### **WARNING**

*Changes or modifications not expressly approved by the party responsible for compliance could void the user's authority to operate the equipment.*

The term "IC: " before the radio certification number only signifies that Industry Canada technical specifications were met.

The antenna used for this transmitter must not be co-located or operating in conjunction with any other antenna or transmitter. End-users and installers must be provided with installation instructions and transmitter operating conditions for satisfying RF exposure compliance.

#### **Bluetooth® Hands-Free Customer Service**

- U.S.A.  
Phone: 800-430-0153 (Toll-free)  
Web: [www.MazdaUSA.com/bluetooth](http://www.MazdaUSA.com/bluetooth)
- Canada  
Phone: 800-430-0153 (Toll-free)  
Web: [www.mazdahandsfree.ca](http://www.mazdahandsfree.ca)



# Declaration of Conformity

---

## Mexico

Para cumplimiento de la Cofetel:

La operación de este equipo está sujeta a las siguientes dos condiciones:

(1) es posible que este equipo o dispositivo no cause interferencia perjudicial y  
(2) este equipo o dispositivo debe aceptar cualquier interferencia, incluyendo la que pueda causar su operación no deseada"

- Brief description: Bluetooth module for Hands-free telephone and streaming audio
- Name and address of the importer: Refer to "MEXICO" (page 8-12) in Importer/Distributor section.
- Brand name of the product: Johnson Controls Inc.
- Model name of the product: MAZ
- Names and addresses of where the warranty can be served: Refer to "MEXICO" (page 8-12) in Importer/Distributor section.
- Names and addresses of where to acquire spare parts, consumables and accessories: Refer to "MEXICO" (page 8-12) in Importer/Distributor section.
- Warranty period, items covered by the warranty and its possible limitations or exceptions: Refer to the Warranty Booklet for detailed warranty information.
- Warranty procedure:  
Center of Attention to Client (CAC)  
Phone: 01-800-01-MAZDA  
Web: [www.mazdamexico.com.mx](http://www.mazdamexico.com.mx)
- Electrical specifications:  
Voltage: 9-16V, Frequency: 2.4Ghz, Current: 270mA(Typ)

# Declaration of Conformity

---

## Type B

### U.S.A. and Canada

#### Type B – Model: MAZDA GEN 65 CMU

FCC ID: CB262932 IC: 279B-62932

#### FCC/IC Regulatory Notice

##### **Modification statement**

Johnson Controls Interiors LLC has not approved any changes or modifications to this device by the user. Any changes or modifications could void the user's authority to operate the equipment.

*Johnson Controls Interiors LLC n'approuve aucune modification apportée à l'appareil par l'utilisateur, quelle qu'en soit la nature. Tout changement ou modification peuvent annuler le droit d'utilisation de l'appareil par l'utilisateur.*

##### **Interference statement**

This device complies with Part 15 of the FCC Rules and Industry Canada licence-exempt RSS standard(s). Operation is subject to the following two conditions: (1) this device may not cause interference, and (2) this device must accept any interference, including interference that may cause undesired operation of the device.

*Le présent appareil est conforme aux CNR d'Industrie Canada applicables aux appareils radio exempts de licence. L'exploitation est autorisée aux deux conditions suivantes : (1) l'appareil ne doit pas produire de brouillage, et (2) l'utilisateur de l'appareil doit accepter tout brouillage radioélectrique subi, même si le brouillage est susceptible d'en compromettre le fonctionnement.*

##### **Radiation Exposure Statement**

This device complies with FCC/IC radiation exposure limits set forth for an uncontrolled environment and meets the FCC radio frequency (RF) Exposure Guidelines in Supplement C to OET65 and RSS-102 of the IC radio frequency (RF) Exposure rules. The antenna should be installed and operated with minimum distance of 20 cm between the radiator and your body. This transmitter must not be co-located or operating in conjunction with any other antenna or transmitter.

*Le présent appareil est conforme à l'exposition aux radiations FCC / IC définies pour un environnement non contrôlé et répond aux directives d'exposition de la fréquence de la FCC radiofréquence (RF) dans le Supplément C à OET65 et RSS-102 de la fréquence radio (RF) IC règles d'exposition. L'antenne doit être installée de façon à garder une distance minimale de 20 centimètres entre la source de rayonnements et votre corps. L'émetteur ne doit pas être colocalisé ni fonctionner conjointement avec à autre antenne ou autre émetteur.*

Mexico



▼ **Forward Obstruction Warning (FOW)/Mazda Radar Cruise Control (MRCC)**

FCC ID : HYQ DNMWR006

**FCC WARNING**

Changes or modifications not expressly approved by the party responsible for compliance could void the user's authority to operate the equipment.

**Radiofrequency radiation exposure Information:**

This equipment complies with FCC radiation exposure limits set forth for an uncontrolled environment.

This equipment should be installed and operated with minimum distance of 20 cm between the radiator (antenna) and your body.

This transmitter must not be co-located or operating in conjunction with any other antenna or transmitter.

This device complies with part 15 of the FCC Rules. Operation is subject to the following two conditions : (1) This device may not cause harmful interference, and (2) this device must accept any interference received, including interference that may cause undesired operation.

This device complies with Industry Canada licence-exempt RSS standard(s).

Operation is subject to the following two conditions:

- (1) this device may not cause interference, and
- (2) this device must accept any interference, including interference that may cause undesired operation of the device.

Le présent appareil est conforme aux CNR d'Industrie Canada applicables aux appareils radio exempts de licence. L'exploitation est autorisée aux deux conditions suivantes :

- (1) l'appareil ne doit pas produire de brouillage, et
- (2) l'utilisateur de l'appareil doit accepter tout brouillage radioélectrique subi, même si le brouillage est susceptible d'en compromettre le fonctionnement.

## Service Publications

### Service Publications

Factory-authorized Mazda service publications are available for owners who wish to do some of their own maintenance and repair.

When requesting any of our publications through an Authorized Mazda Dealer, refer to the chart below.

If they do not have what you need in stock, they can order it for you.

PUBLICATION ORDER NUMBER	PUBLICATION DESCRIPTION
9999-95-017B-15	2015 WORKSHOP MANUAL (English)
9999-MX-017B-15	2015 WORKSHOP MANUAL (Spanish)
9999-95-019G-15	2015 WIRING DIAGRAM (English)
9999-MX-019G-15	2015 WIRING DIAGRAM (Spanish)
9999-95-038C-15	2015 OWNER'S MANUAL (English)
9999-EC-038C-15	2015 OWNER'S MANUAL (English and French)
9999-PR-038C-15	2015 OWNER'S MANUAL (Spanish)
9999-95-064F-15	2015 SERVICE HIGHLIGHTS
9999-95-038C-15NAV	2015 NAVIGATION SYSTEM OWNER'S MANUAL (English)
9999-EC-038C-15NAV	2015 NAVIGATION SYSTEM OWNER'S MANUAL (English and French)
9999-PR-038C-15NAV	2015 NAVIGATION SYSTEM OWNER'S MANUAL (Spanish)

#### ▼ WORKSHOP MANUAL:

Covers recommended maintenance and repair procedures of the drive train, body and chassis.

#### ▼ WIRING DIAGRAM:

Provides electrical schematics as well as component location for the entire electrical system.

#### ▼ OWNER'S MANUAL:

This booklet contains information regarding the proper care and operation of your vehicle. This is not a technician's manual.

#### ▼ SERVICE HIGHLIGHTS:

Provides description and operation of the many systems of your Mazda.

**▼ NAVIGATION SYSTEM OWNER'S MANUAL:**

This booklet contains information regarding the proper operation and use of the navigation system. This is not a technician's manual.

# MEMO

# 9

## Specifications

Technical information about your Mazda.

<b>Identification Numbers</b> .....	<b>9-2</b>
Vehicle Information Labels.....	9-2
<b>Specifications</b> .....	<b>9-4</b>
Specifications .....	9-4
<b>Personalization Features</b> .....	<b>9-12</b>
Personalization Features .....	9-12

# Identification Numbers

## Vehicle Information Labels

### ▼ Vehicle Identification Number

The vehicle identification number legally identifies your vehicle. The number is on a plate attached to the cowl panel located on the left corner of the dashboard. This plate can easily be seen through the windshield.

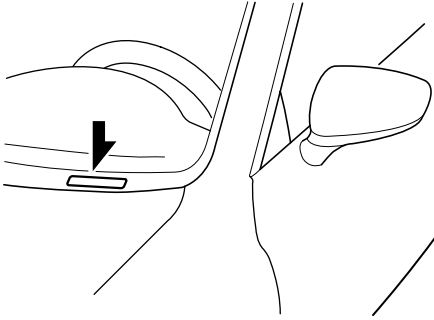

### ▼ Motor Vehicle Safety Standard Label (U.S.A. and Canada)

For vehicle identification number beginning with JMI\*1

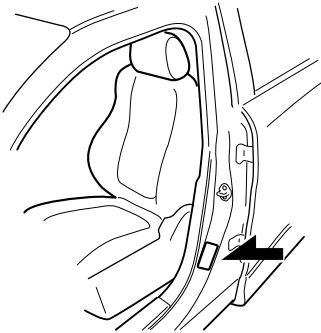

For vehicle identification number beginning with 3MZ\*1

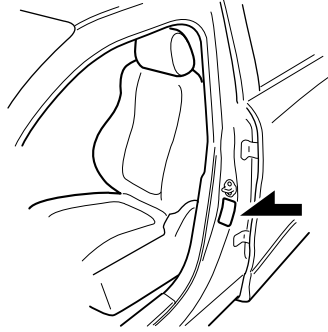

\*1 Check the vehicle identification number on the vehicle identification number plate. Refer to Vehicle Identification Number on page 9-2.

### ▼ Chassis Number

Open the cover shown in the figure to check the chassis number.

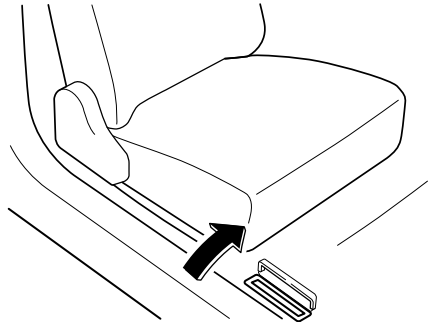



# Identification Numbers

## ▼ Vehicle Emission Control Information Label (U.S.A. and Canada)

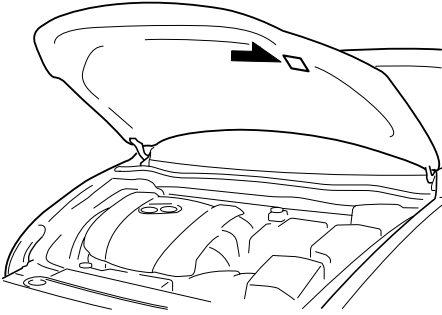

## ▼ Tire Pressure Label

For vehicle identification number beginning with JM1\*1

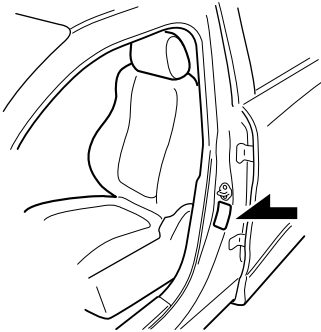

For vehicle identification number beginning with 3MZ\*1

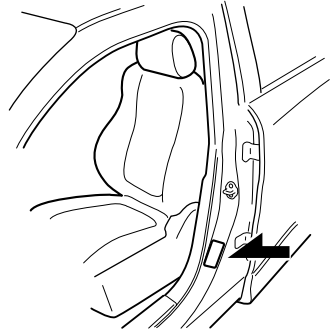

\*1 Check the vehicle identification number on the vehicle identification number plate. Refer to Vehicle Identification Number on page 9-2.

## ▼ Engine Number

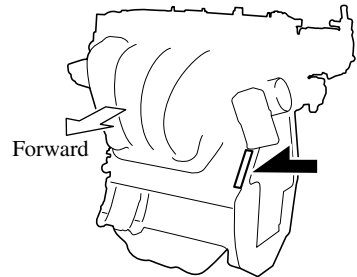

# Specifications

## Specifications

### ▼ Engine

Item	Specification	
	SKYACTIV-G 2.0	SKYACTIV-G 2.5
Type	DOHC-16V in-line, 4-cylinder	
Bore × Stroke	83.5 × 91.2 mm (3.29 × 3.59 in)	89.0 × 100 mm (3.50 × 3.94 in)
Displacement	1,997.6 ml (1,997.6 cc)	2,488.5 ml (2,488.5 cc)
Compression ratio	13.0	

### ▼ Electrical System

Item	Classification	
Battery	Q-85 <sup>*1</sup>	
	12V-60Ah/20HR <sup>*2</sup> or 12V-65Ah/20HR <sup>*2</sup>	
Spark-plug number	Mazda Genuine spark plug <sup>*3</sup>	PE5R-18-110 or PE5S-18-110

\*1 Q-85 is designed for i-ELOOP system. Only Q-85 should be used to ensure correct operation of i-ELOOP system. Consult an Authorized Mazda Dealer for details.

\*2 Not for i-ELOOP system.

\*3 This spark plug provides the SKYACTIV-G engine with optimum performance. Contact an Authorized Mazda Dealer for details.

### CAUTION

*When cleaning the iridium plugs, do not use a wire brush. The fine particulate coating on the iridium alloy and platinum tips could be damaged.*

**▼ Lubricant Quality**

Lubricant	Classification	
Engine oil	Refer to Recommended Oil on page 6-27.	
Manual transaxle oil	API Service	GL-4
	SAE	75W-80
Automatic transaxle fluid	Mazda Genuine ATF FZ	
Brake/Clutch fluid	SAE J1703 or FMVSS116 DOT-3	

**NOTE**

Refer to Introduction on (page 6-2) for owner's responsibility in protecting your investment.

**▼ Capacities****(Approximate Quantities)**

		Item	Capacity	
Engine oil	SKYACTIV-G 2.0	With oil filter replacement	4.2 L (4.4 US qt, 3.7 Imp qt)	
		Without oil filter replacement	4.0 L (4.2 US qt, 3.5 Imp qt)	
	SKYACTIV-G 2.5	With oil filter replacement	4.5 L (4.8 US qt, 4.0 Imp qt)	
		Without oil filter replacement	4.3 L (4.5 US qt, 3.8 Imp qt)	
Coolant	SKYACTIV-G 2.0	For vehicle identification number beginning with JM1*1	Manual transaxle	6.3 L (6.7 US qt, 5.5 Imp qt)
			Automatic transaxle	6.5 L (6.9 US qt, 5.7 Imp qt)
		For vehicle identification number beginning with 3MZ*1	Manual transaxle	6.7 L (7.1 US qt, 5.9 Imp qt)
			Automatic transaxle	6.9 L (7.3 US qt, 6.1 Imp qt)
	SKYACTIV-G 2.5	U.S.A. and Canada	Manual transaxle	6.5 L (6.9 US qt, 5.7 Imp qt)
			Automatic transaxle	6.8 L (7.2 US qt, 6.0 Imp qt)
		Mexico	Manual transaxle	6.5 L (6.9 US qt, 5.7 Imp qt)
			Automatic transaxle	6.7 L (7.1 US qt, 5.9 Imp qt)
Manual transaxle oil			1.70 L (1.80 US qt, 1.50 Imp qt)	
Automatic transaxle fluid			7.8 L (8.2 US qt, 6.9 Imp qt)	
Fuel tank	U.S.A. and Canada		50.0 L (13.2 US gal, 11.0 Imp gal)	
	Mexico		51.0 L (13.5 US gal, 11.2 Imp gal)	

Check oil and fluid levels with dipsticks or reservoir gauges.

\*1 Check the vehicle identification number on the vehicle identification number plate. Refer to Vehicle Identification Number on page 9-2.

# Specifications

---

## ▼ Dimensions

### **4-Door**

#### **(U.S.A. and Canada)**

Item	Vehicle specification
Overall length	4,580 mm (180.3 in)
Overall width	1,795 mm (70.7 in)
Overall height	1,455 mm (57.3 in)
Front tread	1,555 mm (61.2 in)
Rear tread	1,560 mm (61.4 in)
Wheelbase	2,700 mm (106.3 in)

#### **(Mexico)**

Item	Vehicle specification
Overall length	4,580 mm (180.3 in)
Overall width	1,795 mm (70.7 in)
Overall height	1,450 mm (57.1 in)
Front tread	1,555 mm (61.2 in)
Rear tread	1,560 mm (61.4 in)
Wheelbase	2,700 mm (106.3 in)

### **5-Door**

#### **(U.S.A. and Canada)**

Item	Vehicle specification	
Overall length	4,460 mm (175.6 in)	
Overall width	1,795 mm (70.7 in)	
Overall height*1	Type A	1,470 mm (57.9 in)
	Type B	1,455 mm (57.3 in)
Front tread	1,555 mm (61.2 in)	
Rear tread	1,560 mm (61.4 in)	
Wheelbase	2,700 mm (106.3 in)	

**(Mexico)**

Item		Vehicle specification
Overall length		4,460 mm (175.6 in)
Overall width		1,795 mm (70.7 in)
Overall height*1	Type A	1,465 mm (57.7 in)
	Type B	1,450 mm (57.1 in)
Front tread		1,555 mm (61.2 in)
Rear tread		1,560 mm (61.4 in)
Wheelbase		2,700 mm (106.3 in)

\*1 The overall height is categorized according to the antenna type as follows:

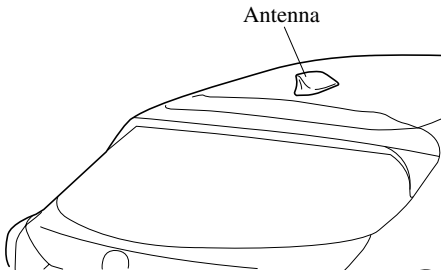
**Type A****Type B**

Except above.

**▼Weights****U.S.A. and Canada****SKYACTIV-G 2.0**

Item		Weight	
		Manual transaxle	Automatic transaxle
GVWR (Gross Vehicle Weight Rating)		1,772 kg (3,907 lbs)	1,815 kg (4,001 lbs)
GAWR (Gross Axle Weight Rating)	Front	925 kg (2,039 lbs)	975 kg (2,149 lbs)
	Rear	855 kg (1,885 lbs)	848 kg (1,870 lbs)

**SKYACTIV-G 2.5**

Item		Weight	
		Manual transaxle	Automatic transaxle
GVWR (Gross Vehicle Weight Rating)		1,815 kg (4,001 lbs)	1,847 kg (4,072 lbs)
GAWR (Gross Axle Weight Rating)	Front	970 kg (2,138 lbs)	997 kg (2,198 lbs)
	Rear	865 kg (1,907 lbs)	854 kg (1,883 lbs)

# Specifications

---

## Mexico

### SKYACTIV-G 2.0

Item		Weight	
		Manual transaxle	Automatic transaxle
GVW (Gross Vehicle Weight)	Total	1,815 kg (4,001 lbs)	1,835 kg (4,045 lbs)
	Front	920 kg (2,028 lbs)	940 kg (2,072 lbs)
	Rear	895 kg (1,973 lbs)	895 kg (1,973 lbs)
GAW (Permissible axle load)	Front	945 kg (2,083 lbs)	965 kg (2,127 lbs)
	Rear	945 kg (2,083 lbs)	945 kg (2,083 lbs)

### SKYACTIV-G 2.5

Item		Weight
GVW (Gross Vehicle Weight)	Total	1,865 kg (4,112 lbs)
	Front	970 kg (2,138 lbs)
	Rear	895 kg (1,973 lbs)
GAW (Permissible axle load)	Front	995 kg (2,194 lbs)
	Rear	945 kg (2,083 lbs)

## ▼ Air Conditioner

The type of refrigerant used is indicated on a label attached to the inside of the engine compartment. Check the label before recharging the refrigerant. Refer to Climate Control System on page 5-2.

Item	Classification
Refrigerant Type	HFC134a (R-134a)

**▼ Light Bulbs****Exterior light**

Light bulb			Category	
			Wattage	UNECE*1 (SAE)
Headlights	Halogen	High beam	65	HB3 (9005)
		Low beam	55	H11 (H11)
	Xenon fusion	High/Low beam	35	D4S (D4S)
Daytime running lights	With halogen bulb headlights		65	HB3 (9005)
	With xenon fusion bulb headlights		LED*2	— (—)
Parking lights (Front side-marker lights)	With halogen bulb headlights		5	WY5W (—)
Front side-marker lights	With xenon fusion bulb headlights		5	W5W (—)
Parking lights	With xenon fusion bulb headlights		LED*2	— (—)
Front turn signal lights			21	WY21W (7443NA)
Fog lights*			55	H11 (H11)
Side turn signal lights*			LED*2	— (—)
High-mount brake light			LED*2	— (—)
Rear turn signal lights			21	WY21W (7443NA)
Brake lights/ Taillights/Rear side-marker lights	LED type		LED*2	— (—)
	Bulb type		21/5	W21/5W (7443)
Taillights (Liftgate side/Trunk lid side)*			LED*2	— (—)
Reverse lights	4-Door		18	W16W (921)
	5-Door		21	W21W (7440)
License plate lights			5	W5W (—)

\*1 UNECE stands for United Nations Economic Commission for Europe.

\*2 LED is the abbreviation for Light Emitting Diode.

# Specifications

---

## Interior light

Light bulb	Category	
	Wattage	UNECE* <sup>1</sup>
Trunk light (4-Door)	3	—
Luggage compartment light (5-Door)	5	—
Overhead lights (Front)/Map lights*	8	—
Overhead light (Front)*	10	—
Overhead light (Rear)*	10	—
Vanity mirror lights*	2	—

\*1 UNECE stands for United Nations Economic Commission for Europe.

## ▼ Tires

### **NOTE**

*The tires have been optimally matched with the chassis of your vehicle.*

*When replacing tires, Mazda recommends that you replace tires of the same type originally fitted to your vehicle. For details, contact an Authorized Mazda Dealer.*

Check the tire pressure label for tire size and inflation pressure.

Refer to Tire Inflation Pressure on page 6-42.

After adjusting the tire pressure, initialization of the tire pressure monitoring system is necessary to make the system operates normally.

Refer to Tire Pressure Monitoring System Initialization on page 4-106.

## Standard tire

### **(U.S.A. and Canada)**

Tire size	Inflation pressure	
	Front	Rear
P205/60R16 91H	250 kPa (36 psi)	250 kPa (36 psi)
215/45R18 89W	250 kPa (36 psi)	250 kPa (36 psi)



**(Mexico)**

Tire size	Inflation pressure	
	Front	Rear
P205/60R16 91H	250 kPa (2.5 bar, 36 psi)	250 kPa (2.5 bar, 36 psi)

Tire size		Inflation pressure	
		Up to 3 persons	—Full load
215/45R18 89W	Front	240 kPa (2.4 bar, 35 psi)	280 kPa (2.8 bar, 41 psi)
	Rear	230 kPa (2.3 bar, 33 psi)	300 kPa (3.0 bar, 44 psi)

1 person's weight: About 75 kg

**Temporary spare tire**

Tire size	Inflation pressure
T125/70D16 96M	420 kPa (60 psi)

**Lug nut tightening torque**

When installing a tire, tighten the lug nut to the following torque.  
 108—147 N•m (12—14 kgf•m, 80—108 ft•lbf)

**▼ Fuses**

Refer to Fuses on page 6-59.

# Personalization Features

## Personalization Features

The following personalization features can be set or changed by an Authorized Mazda Dealer. Consult an Authorized Mazda Dealer for details.

Additionally, some of the personalization features can be changed by the customer depending on the feature.

Personalization features which can be changed differ depending on the market and specification.

- ① Settings can be changed by operating the center display screen.
- ② Settings can be changed by operating the vehicle switches.
- ③ Settings can be changed by an Authorized Mazda Dealer.

Item		Feature	Factory Setting	Available Settings	Settings change method			
					①	②	③	
Safety	Forward Obstruction Warning (FOW) Refer to Forward Obstruction Warning (FOW) on page 4-115.	The system can be changed so that Forward Obstruction Warning (FOW) does not operate.*1	On	On/Off	×	Refer to Settings on page 5-55.	—	—
		The distance at which the collision warning activates can be changed.	Near	Near/Far	×	Refer to Settings on page 5-55.	—	—
		The volume of the collision warning can be changed.	High	High/Low/Off	×	Refer to Settings on page 5-55.	—	—
	Smart City Brake Support (SCBS) Refer to Smart City Brake Support (SCBS) on page 4-71.	The system can be changed so that Smart City Brake Support (SCBS) does not operate.*1	On	On/Off	×	Refer to Settings on page 5-55.	—	—

# Personalization Features

Item		Feature		Factory Setting	Available Settings	Settings change method		
						①	②	③
Safety	Lane Departure Warning System (LDWS) Refer to Lane Departure Warning System (LDWS) on page 4-118.	The warning sound for the Lane Departure Warning System (LDWS) can be changed.* <sup>2</sup>		Beep	Beep/Rumbl.	×	—	×
		Rumbl.	The volume of the warning sound for the Lane Departure Warning System (LDWS) can be changed.	High	High/Mid/Low	×	—	×
				Beep	High	High/Low	×	—
		The sensitivity of the warning for the Lane Departure Warning System (LDWS) can be changed.		Low	High/Low	×	—	×
		The warning timing in which the Lane Departure Warning System (LDWS) determines that the vehicle may be deviating from its lane can be changed.		Before	At/Before	×	—	×
	Blind Spot Monitoring (BSM) system Refer to Blind Spot Monitoring (BSM) System on page 4-107.	The volume of the BSM warning beep can be changed.* <sup>3</sup>		High	High/Low/Off	×	—	×

# Personalization Features

Item		Feature	Factory Setting	Available Settings	Settings change method		
					①	②	③
Vehicle	Power door lock Refer to Auto Lock/Unlock Function on page 3-16.	Changes the auto lock/unlock function setting for all the doors according to the vehicle speed, the vehicle power supply condition, and the selector lever position.	Lock: When Driving Unlock: IGN Off	Lock: Out of Park Unlock: In Park/ Lock: Shifting Out of Park/ Lock: When Driving Unlock: IGN Off/ Lock: When Driving/ Off	× Refer to Settings on page 5-55.	× Refer to Auto Lock/Unlock Function on page 3-16.	×
	Keyless entry system Refer to Keyless Entry System on page 3-3.	The method for unlocking the doors using the transmitter can be changed.	Driver's: Once, All Doors: Twice	All Doors: Once/ Driver's: Once, All Doors: Twice	× Refer to Settings on page 5-55.	× Refer to Transmitter on page 3-4.	×
		The time required for the doors to relock automatically after unlocking with the transmitter can be changed.	60 seconds	90 seconds/ 60 seconds/ 30 seconds	× Refer to Settings on page 5-55.	—	×

# Personalization Features

Item	Feature	Factory Setting	Available Settings	Settings change method			
				①	②	③	
Vehicle	Advanced keyless entry system Refer to Advanced Keyless Entry System on page 3-9.	The volume of the answer-back beep during advanced keyless entry system operation can be changed.	Medium	High/ Medium/ Low/ Off	× Refer to Settings on page 5-55.	× Refer to Locking, Unlocking with Request Switch (With the advanced keyless function) on page 3-13.	×
		The function to automatically lock the doors when leaving the vehicle while carrying the key can be changed.	Off	On/Off	× Refer to Settings on page 5-55.	—	×
		The method for unlocking the doors using the request switch/transmitter can be changed.	Driver's: Once, All Doors: Twice	All Doors: Once/ Driver's: Once, All Doors: Twice	× Refer to Settings on page 5-55.	× Refer to Locking, Unlocking with Request Switch (With the advanced keyless function) on page 3-13. Refer to Transmitter on page 3-4.	×
		The time required for the doors to relock automatically after unlocking with the request switch/transmitter can be changed.	60 seconds	90 seconds/ 60 seconds/ 30 seconds	× Refer to Settings on page 5-55.	—	×
	Illumination entry Refer to Illuminated Entry System on page 5-136.	The time required for the interior lamp to turn off automatically can be changed (prevents battery depletion when a door is open/ ajar).	30 minutes	60 minutes/ 30 minutes/ 10 minutes	× Refer to Settings on page 5-55.	—	×
		The time required for the interior lamp to turn off automatically after all doors are closed can be changed.	15 seconds	60 seconds/ 30 seconds/ 15 seconds/ 7.5 seconds	× Refer to Settings on page 5-55.	—	×

# Personalization Features

Item		Feature	Factory Setting	Available Settings	Settings change method		
					①	②	③
Vehicle	Auto-wiper control Refer to Windshield Wipers and Washer on page 4-51.	The auto-wiper control function can be changed.	On	On/Off*4	✗ Refer to Settings on page 5-55.	—	✗
	Daytime running lights Refer to Daytime Running Lights on page 4-46.	The function of the daytime running lights can be changed.	On	On/Off	—	—	✗
	Auto headlight off*5 Refer to Headlights on page 4-40.	The time required for headlights to turn off after ignition is switched off can be changed.	30 seconds	120 seconds/ 90 seconds/ 60 seconds/ 30 seconds/ Off*6	✗ Refer to Settings on page 5-55.	—	✗
	Auto-light control Refer to Headlights on page 4-40.	The headlight illumination on/off timing based on surrounding lightness/darkness can be changed.	Medium	High/ Med. High/ Medium/ Med. Low/ Low	✗ Refer to Settings on page 5-55.	—	✗
	High Beam Control System (HBC) Refer to High Beam Control System (HBC) on page 4-47.	The High Beam Control System (HBC) function can be changed.*1	On	On/Off	✗ Refer to Settings on page 5-55.	—	✗
	Lights-on reminder*7 Refer to Lights-On Reminder on page 7-35.	The volume of the lights-on reminder warning alarm can be changed.	Off	High/Low/ Off	✗ Refer to Settings on page 5-55.	—	✗

# Personalization Features

Item		Feature	Factory Setting	Available Settings	Settings change method		
					①	②	③
Vehicle	Turn indicator Refer to Turn and Lane-Change Signals on page 4-50.	The turn indicator beep volume level can be changed.	High	High/Low	×	—	×
	Three-flash turn signal Refer to Three-Flash Turn Signal on page 4-51.	The three-time flash function can be changed.	On	On/Off	×	—	×
System	Distance unit	The distance unit can be changed.	mi or km	mi/km	×	—	×
	Language	The display language can be changed.*8	English	English/ French/ Spanish	×	—	×
	Temperature unit	The temperature unit can be changed.	°F or °C	°F/°C	×	—	×
Fuel Economy Monitor Refer to Fuel Economy Monitor on page 4-85.	Ending display	Setting can be changed so that the ending display of the Fuel Economy Monitor is displayed.	Off	On/Off	×	—	×
	Fuel economy resetting procedure	Setting can be changed so that the fuel economy reset is linked with the trip meter reset.	Off	On/Off	×	—	×

# Personalization Features

Item		Feature	Factory Setting	Available Settings	Settings change method		
					①	②	③
Active driving display Refer to Active Driving Display on page 4-18.	Turn-by-Turn (TBT)	Setting can be changed so that the Turn-by-Turn (TBT) of the Active driving display is not displayed.	On	On/Off	× Refer to Active driving display on page 4-18.	—	×

- \*1 Though these systems can be turned Off, doing so will defeat the purpose of the system and Mazda recommends that these systems remain On.
- \*2 For vehicles with an audio system other than the on-screen function type, the warning sound cannot be changed. The warning sound is only a beep.
- \*3 Only the volume of the warning beep during Blind Spot Monitoring (BSM) operation can be changed. The volume of the warning beep during Rear Cross Traffic Alert (RCTA) operation cannot be changed.
- \*4 If the auto-wiper control is set to Off, the wiper lever **AUTO** position is set to intermittent operation.
- \*5 If the setting is changed to Off, the following operation is performed according to the headlight switch position:
  - At **AUTO** position: Headlights turn off immediately after the ignition is switched off.
  - At any position other than **AUTO**: Headlights do not turn off after the ignition is switched off.
- \*6 When set to Off, the lights-on reminder is operable.
- \*7 The setting of the lights-on reminder can be changed with the time setting of auto headlight off function set to Off. Refer to Lights-On Reminder on page 7-35.
- \*8 Available only in display from the center display.



---

# **10** Index

# Index

---

## A

- Accessory Socket ..... 5-137
- Active Driving Display ..... 4-18
- Adaptive Front Lighting System (AFS)..... 4-45
- Add-On Non-Genuine Parts and Accessories ..... 8-18
- Advanced Key
  - Advanced keyless entry system ..... 3-9
  - Operational range ..... 3-10
- Advanced Key removed from vehicle warning beep ..... 7-36
- Air Bag/Front Seat Belt Pretensioner System Warning Beep ..... 7-35
- Air Bag Systems ..... 2-41
- Ambient Temperature Display ..... 4-15
- Antilock Brake System (ABS)..... 4-78
- Audio Control Switch
  - Adjusting the Volume ..... 5-58
  - Mute Switch ..... 5-58
  - Seek Switch ..... 5-58
- Audio System..... 5-16
  - AUX/USB/iPod mode ..... 5-59
  - Antenna ..... 5-16
  - Audio Control Switch ..... 5-57
  - Audio Set (Type A) ..... 5-26
  - Audio Set (Type B) ..... 5-38
  - Operating Tips for Audio System... 5-17
  - Satellite Radio ..... 5-47
- Automatic Transaxle ..... 4-29
  - Active Adaptive Shift (AAS) ..... 4-31
  - Direct Mode ..... 4-38
  - Driving tips..... 4-39
  - Manual shift mode..... 4-32
  - Shift-lock system..... 4-31
  - Shift position indication ..... 4-30
  - Warning light..... 4-30

## B

- Battery..... 6-37
  - Maintenance ..... 6-39
  - Replacement..... 6-39
  - Specifications ..... 9-4
- Battery runs out..... 7-15
  - Jump-Starting ..... 7-15
- Blind Spot Monitoring (BSM) System..... 4-107
  - BSM OFF switch..... 4-113
  - BSM warning light..... 4-112
  - Blind Spot Monitoring (BSM) ... 4-108
  - Care of radar sensors ..... 4-114
- Blind Spot Monitoring (BSM) System warning beep ..... 7-37
- Blind Spot Monitoring (BSM) system
  - Rear Cross Traffic Alert (RCTA) ... 4-110
- Bluetooth® ..... 5-77
  - Bluetooth® Audio (Type A) ..... 5-115
  - Bluetooth® Audio (Type B) ..... 5-117
  - Bluetooth® Hands-Free (Type A) ... 5-99
  - Bluetooth® Hands-Free (Type B) ... 5-105
  - Troubleshooting ..... 5-131
- Body Lubrication ..... 6-32
- Bottle Holder..... 5-139
- Brakes
  - Brakes assist..... 4-69
  - Foot brake..... 4-67
  - Pad wear indicator ..... 4-68
  - Parking brake ..... 4-68
  - Warning light..... 4-68
- Break-In Period ..... 3-45

## C

- Capacities ..... 9-5
- Carbon Monoxide ..... 3-29
- Cell Phones ..... 8-19
- Center Console ..... 5-141

Child Restraint	
Child-restraint precautions .....	2-23
Installing child-restraint systems...	2-29
LATCH child-restraint systems.....	2-37
Child Safety Locks for Rear Doors.....	3-20
Climate Control System.....	5-2
Automatic Climate Control .....	5-9
Dual-Zone Automatic Climate Control.....	5-12
Gas specifications.....	9-8
Manual Climate Control.....	5-5
Operating Tips.....	5-2
Vent Operation .....	5-3
Clock.....	5-30
Collision warning.....	7-38
Control Status Display .....	4-86
Cruise Control.....	4-99
Cruise Control Switch.....	4-99
Cruise Control Set Vehicle Speed Display .....	4-16
Cup Holder.....	5-138
Customer Assistance .....	8-2

## D

Dashboard Illumination .....	4-15
Daytime Running Lights.....	4-46
Defogger	
Mirror.....	4-57
Rear window .....	4-56
Dimensions .....	9-6
Direct Mode	
Automatic transaxle .....	4-38
Door Locks.....	3-11
Drive selection .....	4-87
Driving In Flooded Area .....	3-49

Driving Tips	
Automatic transaxle .....	4-39
Break-in period.....	3-45
Driving in flooded area.....	3-49
Driving on uneven road.....	3-51
Floor mat .....	3-46
Hazardous driving .....	3-46
Overloading.....	3-50
Rocking the vehicle.....	3-47
Winter driving .....	3-47
Driving on Uneven Road .....	3-51
Dynamic Stability Control (DSC).....	4-80
DSC OFF Indicator Light.....	4-81
DSC OFF Switch.....	4-81
TCS/DSC Indicator Light .....	4-80

## E

Emergency Starting	
Push-Starting .....	7-18
Starting a Flooded Engine.....	7-18
Emergency Towing	
Tiedown Hooks .....	7-22
Towing Description.....	7-21
Emission Control System.....	3-28
Ending Screen Display.....	4-86
Engine	
Coolant .....	6-29
Engine Compartment Overview....	6-26
Exhaust gas.....	3-29
Hood release.....	6-24
Oil.....	6-27
Starting .....	4-5
Essential information .....	6-2
Event Data Recorder .....	8-20
Exhaust Gas .....	3-29
Exterior Care.....	6-64
Aluminum Wheel Maintenance ....	6-69
Bright-Metal Maintenance .....	6-68
Maintaining the Finish .....	6-66
Plastic Part Maintenance .....	6-69

# Index

---

## F

- Flasher
  - Hazard warning ..... 4-58
  - Headlights ..... 4-40
- Flat Tire ..... 7-3
  - Mounting the Spare Tire..... 7-11
  - Removing a Flat Tire..... 7-7
- Floor Mat ..... 3-46
- Fluid
  - Brake/Clutch ..... 6-31
  - Washer..... 6-31
- Fluids
  - Classification..... 9-5
- Fog Lights ..... 4-50
- Foot Brake..... 4-67
- Forward Obstruction Warning (FOW)..... 4-115
  - Collision Warning ..... 4-117
  - Forward Obstruction Warning (FOW)  
Indicator Light (Red)..... 4-117
  - Rader Sensor ..... 4-117
- Forward Sensing Camera ..... 4-62
- Front Seat ..... 2-5
- Fuel
  - Filler lid and cap..... 3-30
  - Gauge ..... 4-14
  - Requirements..... 3-27
  - Tank capacity ..... 9-5
- Fuel Consumption Display ..... 4-85
- Fuel Economy Monitor ..... 4-85
  - Control status display ..... 4-86
  - Ending screen display ..... 4-86
  - Fuel consumption display ..... 4-85

## G

- Gauges..... 4-11
- Glove Compartment..... 5-140

## H

- Hazard Warning Flasher..... 4-58
- Hazardous Driving ..... 3-46
- Head Restraint..... 2-11
- Headlights
  - Control..... 4-40
  - Flashing ..... 4-44
  - High-low beam..... 4-44
  - Leveling..... 4-44
- High Beam Control System (HBC) .... 4-47
- Hill Launch Assist (HLA)..... 4-69
- HomeLink Wireless Control System... 4-58
- Hood Release ..... 6-24
- Horn ..... 4-57

## I

- i-ELOOP ..... 4-82
  - Control status display ..... 4-84
  - Display ..... 4-82
  - i-ELOOP indicator light..... 4-84
- i-ELOOP warning beep..... 7-37
- If a Warning Light Turns On or Flashes..... 7-24
- If the Active Driving Display does not operate..... 7-41
- Ignition
  - Switch..... 4-4
- Ignition not switched off (STOP) warning beep ..... 7-36
- Immobilizer System ..... 3-41
- Indicator Lights..... 4-23
  - AFS OFF ..... 4-45
  - BSM OFF ..... 4-113
  - Low engine coolant temperature... 4-25
  - Wrench ..... 4-25
- Inside Trunk Release Lever ..... 3-25
- Inspecting Brake/Clutch Fluid Level... 6-31
- Inspecting Coolant Level ..... 6-29
- Inspecting Engine Oil Level ..... 6-28
- Inspecting Washer Fluid Level..... 6-31

Interior Care .....	6-70
Cleaning the Lap/Shoulder Belt	
Webbing .....	6-72
Cleaning the Upholstery and Interior	
Trim .....	6-70
Cleaning the Window Interiors .....	6-72
Dashboard Precautions.....	6-70
Maintenance of the Active Driving	
Display .....	6-71
Interior Lights .....	5-135
Luggage Compartment Light .....	5-135
Map Lights .....	5-135
Overhead Lights .....	5-135

## J

Jack .....	7-4
Jump-Starting.....	7-15

## K

Key Suspend Function .....	3-8
Key left-in-luggage compartment warning	
beep (With the advanced keyless	
function).....	7-36
Key left-in-vehicle warning beep (With the	
advanced keyless function).....	7-37
Keyless Entry System .....	3-3
Key removed from vehicle warning	
beep .....	7-36
Keys .....	3-2
Key suspend function.....	3-8
Transmitter .....	3-4

## L

Label Information .....	9-2
Lane-Change Signals .....	4-51
Lane Departure Warning System	
(LDWS).....	4-118
Canceling the system.....	4-122
LDWS warning .....	4-123
When the system operates.....	4-121

Lane departure warning system (LDWS)	
warning sound.....	7-37
Liftgate.....	3-20
When liftgate/trunk lid cannot be	
opened .....	7-39
Light Bulbs	
Replacement.....	6-46
Specifications .....	9-9
Lighting Control.....	4-40
Lights-on reminder.....	7-35
Lubricant Quality .....	9-5
Luggage Compartment Light.....	5-135

## M

Maintenance	
Information.....	6-2
Scheduled .....	6-4
Maintenance Monitor.....	6-20
Manual Transaxle Operation.....	4-26
Recommendations for shifting .....	4-28
Map Lights .....	5-135
Mazda Radar Cruise Control (MRCC)...	4-90
Close Proximity Warning .....	4-93
Display Indication .....	4-93
Radar Sensor Handling .....	4-98
Setting the System.....	4-94
Shift-up/Shift-down Request	
Display .....	4-98
Mazda Radar Cruise Control (MRCC)	
System warnings .....	7-38
Meters and Gauges.....	4-11
Mirror Defogger.....	4-57
Mirrors	
Outside mirrors.....	3-33
Rearview mirror .....	3-34
Moonroof .....	3-39
<b>O</b>	
Odometer and Trip Meter.....	4-12
Outside Mirrors.....	3-33
Outside Temperature Display.....	4-15

# Index

---

Over Rev. buzzer..... 7-38  
Overhead Console..... 5-140  
Overhead Lights..... 5-135  
Overheating..... 7-19  
Overloading..... 3-50  
Owner Maintenance  
    Battery replacement ..... 6-39  
    Closing the Hood..... 6-25  
    Engine Compartment Overview.... 6-26  
    Opening the Hood ..... 6-24  
    Owner Maintenance Precautions.. 6-22

## P

Parking Brake..... 4-68  
Personalization Features ..... 9-12  
Power Steering ..... 4-89  
Power Windows ..... 3-36  
Power steering warning buzzer..... 7-38

## R

Radar Sensor ..... 4-64  
Rear Coat Hooks..... 5-141  
Rear Cross Traffic Alert (RCTA) ..... 4-110  
Rear Door Child Safety Locks..... 3-20  
Rear Seat ..... 2-8  
Rear View Monitor..... 4-124  
    Displayable range on the screen... 4-126  
    Picture quality adjustment..... 4-131  
    Rear view monitor operation..... 4-128  
    Rear view parking camera  
    location..... 4-125  
    Switching to the rear view monitor  
    display ..... 4-125  
    Variance between actual aoad  
    conditions and displayed Image... 4-130  
    Viewing the display ..... 4-127  
Rear Window Defogger ..... 4-56  
Rear Window Washer..... 4-55  
Rear Window Wiper..... 4-55  
Rearview Mirror..... 3-34  
Recommended Oil ..... 6-27

Recording of Vehicle Data ..... 8-21  
Recreational Towing ..... 3-52  
Registering Your Vehicle in A Foreign  
Country ..... 8-17  
Replacement  
    Electrical battery ..... 6-39  
    Fuse ..... 6-59  
    Light Bulbs..... 6-46  
    Tires..... 6-44  
    Wheel ..... 6-45  
    Wiper..... 6-33  
Rocking the Vehicle ..... 3-47

## S

SRS Air Bags  
    Front passenger occupant classification  
    system..... 2-57  
    How the SRS air bags work ..... 2-50  
    Limitations to SRS air bag..... 2-55  
    Monitoring..... 2-62  
    SRS air bag deployment criteria ... 2-54  
    Supplemental restraint system  
    components ..... 2-48  
Safety Defects, Reporting ..... 8-13  
Satellite Radio ..... 5-47  
Saving Fuel and Protection of the  
Environment..... 3-45  
Scheduled Maintenance ..... 6-4  
Seat Belt System  
    2-point type ..... 2-19  
    3-point type ..... 2-16  
    Automatic locking..... 2-15  
    Emergency locking..... 2-15  
    Extender ..... 2-21  
    Pregnant women..... 2-15  
Seat belt warning beep ..... 7-36  
Seats  
    Front seat..... 2-5  
    Head restraint ..... 2-11  
    Rear seat ..... 2-8  
    Seat warmer..... 2-7

Security System	
Immobilizer system.....	3-41
Theft-deterrent system .....	3-43
Sensor	
Radar Sensor .....	4-64
Service Publications.....	8-50
Smart City Brake Support (SCBS) .....	4-71
Deactivating the Smart City Brake	
Support (SCBS) System operation ...	4-77
Laser sensor handling.....	4-75
Smart City Brake Support (SCBS)	
Indicator Light (Red).....	4-77
Spare Tire .....	7-5
Specifications .....	9-4
Speed Unit Selector.....	4-12
Speedometer.....	4-12
Starting the Engine.....	4-5
Steering Wheel.....	3-32
Horn.....	4-57
Storage Compartments.....	5-140
Center console.....	5-141
Glove compartment.....	5-140
Overhead console.....	5-140
Rear coat hooks .....	5-141
Sunshade .....	3-40
Sunvisors.....	5-134

## T

Tachometer.....	4-13
Theft-Deterrent System.....	3-43
Tiedown	
Hook.....	7-22
Tire Information .....	8-24
Tire Pressure Monitoring System .....	4-103
Tire inflation pressure warning beep...	7-37

Tires .....	6-42
Flat Tire .....	7-3
Replacing a Tire .....	6-44
Replacing a Wheel .....	6-45
Snow tires.....	3-48
Specifications .....	9-10
Temporary Spare Tire.....	6-44
Tire Inflation Pressure .....	6-42
Tire Rotation .....	6-43
Tire chains .....	3-48
Uniform tire quality grading system	
(UTQGS).....	8-22
Towing	
Recreational towing .....	3-52
Trailer Towing .....	3-52
Towing Description.....	7-21
Traction Control System (TCS) .....	4-79
TCS/DSC Indicator Light .....	4-79
Transmitter .....	3-4
Trip Computer.....	4-16
Trip Meter .....	4-12
Trouble	
Battery runs out.....	7-15
Emergency Starting.....	7-18
Emergency Towing.....	7-21
Flat Tire .....	7-3
Overheating .....	7-19
Parking in an Emergency .....	7-2
When liftgate/trunk lid cannot be	
opened .....	7-39
Trunk Lid .....	3-20
Inside trunk release lever .....	3-25
When liftgate/trunk lid cannot be	
opened .....	7-39
<b>V</b>	
Vanity Mirrors .....	5-134
Vehicle Information Labels.....	9-2

# Index

---

## W

Warning Lights.....	4-21
Warning Message Indicated on Display .....	7-33
Warning Sound is Activated.....	7-35
Advanced Key removed from vehicle warning beep .....	7-36
Air Bag/Front Seat Belt Pretensioner System Warning Beep .....	7-35
Blind Spot Monitoring (BSM) System warning beep .....	7-37
Collision warning .....	7-38
i-ELOOP warning beep .....	7-37
Ignition not switched off (STOP) warning beep .....	7-36
Key left-in-luggage compartment warning beep (With the advanced keyless function) .....	7-36
Key left-in-vehicle warning beep (With the advanced keyless function) .....	7-37
Key removed from vehicle warning beep .....	7-36
Lane departure warning system (LDWS) warning sound .....	7-37
Lights-on reminder .....	7-35
Mazda Radar Cruise Control (MRCC) System warnings .....	7-38
Over Rev. buzzer .....	7-38
Power steering warning buzzer .....	7-38
Seat belt warning beep .....	7-36
Tire inflation pressure warning beep .....	7-37
Warranty .....	8-15
Weights.....	9-7
Windows	
Power windows .....	3-36
Windshield Washer .....	4-55
Windshield Wipers .....	4-52
Winter Driving .....	3-47

## Wiper

Replacing Rear Window Wiper Blade (5-Door).....	6-35
Replacing Windshield Wiper Blades .....	6-33