

*MAZDA5*

**SMART START GUIDE**



**mazda**



## KEYLESS ENTRY SYSTEM

This system remotely locks and unlocks the doors and the liftgate.

### Release Button

- Push to extend key.
- Push and fold to retract key.

### Lock

- Push once to lock all doors and liftgate.
- Push twice (within five seconds) for horn sound verification that all doors are locked.

### Unlock

- Push once to unlock driver's door.
- Push twice (within five seconds) to unlock all doors and liftgate.

### Panic Alarm

- Push for one second or more to activate alarm.
- Push Lock, Unlock, or Panic Alarm to turn alarm off.



Retractable Key

## LIFTGATE

Grasp the lower end of the liftgate and push the electric liftgate opener button on the liftgate, when the latch releases, raise the liftgate.

While the ignition is switched ON, the liftgate can be opened only when the vehicle is stopped with the parking brake applied (manual transaxle), or with the selector lever in the P position (automatic transaxle).

**NOTE:** When the liftgate opener switch is pushed, the liftgate will open slightly. If the liftgate is not opened within 1.5 seconds, the liftgate latch locks (you will hear it lock) and the liftgate cannot be opened or closed from this slightly raised position. To open/close the liftgate, push the liftgate opener switch, open the liftgate within 1.5 seconds, then close it. The door/liftgate ajar warning light will be on if the liftgate is not fully closed.



Electric Liftgate Opener

# Information Display



## INFO

Push INFO button on steering wheel to display the following (actual displayed information will vary on your vehicle):

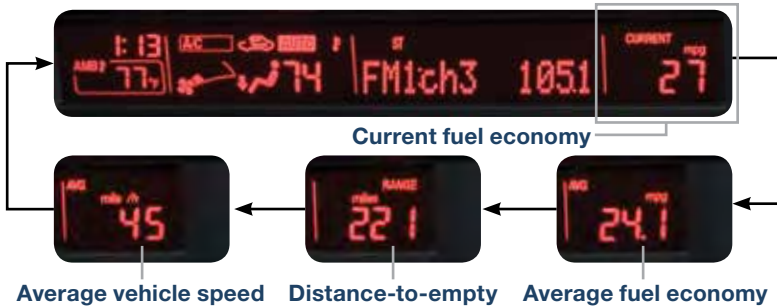

## BREAK-IN PERIOD

No special break-in is necessary, but a few precautions in the first 600 miles should be observed.

- Do not race the engine.
- Do not maintain one constant speed, either slow or fast, for a long period of time.
- Avoid full-throttle starts.
- Avoid unnecessary hard stops.
- Do not drive constantly at full-throttle or high engine rpm for extended periods of time.



# Seat Controls and Storage

## SEAT CONTROLS

### Recline Lever

Pull up to adjust seatback angle.

### Lumbar Adjustment

Lumbar can be changed by pulling the lumbar lever forward to adjust the lumbar support.

### Height Adjustment Lever

Raise or lower seat height by repeatedly pulling up or pushing down on the lever.

### Slide Release Lever

Pull lever up to move seat backward or forward.



### Fuel Door Release

(located on floor in front of driver's seat)

To open, pull the fuel door release.

#### Fuel

Regular Unleaded Fuel – 87 Octane



### Fuel Door

To avoid scratching the paint during refueling, secure the fuel filler cap tether over the hook as shown.



#### FUEL ECONOMY:

To achieve the best fuel economy, visit [www.fueleconomy.gov](http://www.fueleconomy.gov) for more information.





### Split-Folding Third-Row Seatback

- To create a flat luggage compartment space, lower the head restraints all the way down, pull the release strap, then fold the seatbacks forward.
- To return the seatbacks to the original position, pull the release strap.



### Second Row Seat Storage/Flip Out Center Console

- Pull up on the strap on either seat to lift the seat bottom and you'll find convenient space to store small items and a console in the right side seat that flips out.
- When returning the seat bottom into place, make sure it locks into position by attempting to move it up and down.

**NOTE:** The second row seats are equipped with foldable head restraints. To fold the head restraint, pull the strap on the back of the head restraint and fold the head restraint downward. To return the head restraint to its upright position, lift it upward.



### To fold the second row seats flat:

- 1 Slide the seat all the way back.
- 2 Lift up the seat bottom.



- 3 Fold the head restraint downward.
- 4 Fold down the seatback using the recline lever.

# Driver's View

**HEADLIGHT  
LEVELING**  
(P. 9)

**LIGHTING/  
TURN SIGNALS**  
(P. 9)

**BLUETOOTH®  
& AUDIO**

**CRUISE  
CONTROL**



**DSC/TCS  
SWITCH**

**HOOD  
RELEASE**

**PARKING  
SENSOR  
SYSTEM**  
(P. 2)

**TILT/TELESCOPING  
STEERING WHEEL  
LEVER**



**INFORMATION  
DISPLAY**  
(PP. 2, 13, 15-16)

**PASSENGER  
AIRBAG OFF  
INDICATOR<sup>1</sup>**

**HAZARD  
WARNING**

**CLOCK**  
(P. 15)

**AUDIO  
SYSTEM**  
(PP. 15-16)



**WIPER/  
WASHER**  
(P. 10)

**CLIMATE  
CONTROL**  
(PP. 13-14)

**SPORT A/T**  
(P. 11)

**SEAT WARMER**  
(LOCATED ON CENTER CONSOLE)

<sup>1</sup>  This indicator light illuminates to remind you that the front passenger's front/side airbags and seat belt pretensioner will not deploy during a collision. The reason for this is that the weight in the seat is less than approximately 66 lbs. Always wear your seat belt and secure children in the rear seats in appropriate child restraints. See the Owner's Manual for important information on this safety feature.

# Instrument Cluster









INSTRUMENT  
CLUSTER DIMMER<sup>1</sup>

TACHOMETER

FUEL GAUGE

## GLOSSARY OF WARNING AND INDICATOR LIGHTS

**NOTE:** See Owner's Manual for more details and explanations

-  **Check Fuel Cap** (p. 3)
-  **Check Engine Light**
-  **ABS (Antilock Brake System) Malfunction**
-  **Power Steering Malfunction**
-  **Lights On (Exterior)** (p. 9)
-  **Tire Pressure Monitoring System (TPMS) Warning Light**  
**On/Warning Beep:** Low tire pressure in one or more tires.
-  **Low Fuel Level**

### ENGINE COOLANT TEMP LIGHTS

Since this vehicle does not use an engine coolant temperature gauge, red and blue engine coolant temperature lights are used to indicate high and low coolant temperature.

#### **Red Coolant Temp Light**

**Flashing:** Engine is starting to run hot. Drive slowly to reduce engine load.

**On:** Engine is overheating. Safely pull over to the side of the road and turn the engine off. Refer to the Owner's Manual for more information.

#### **Blue Coolant Temp Light**

**On:** Engine coolant is cold and no warm air is available for heater/defroster.

**Off:** Engine coolant is warm and warm air is available for heater/defroster. The light may stay on for a few minutes after start-up when the engine is cold, but the vehicle can be driven with the light on or off.

7

<sup>1</sup> • Rotate the knob to adjust the brightness of the instrument cluster and other dashboard illuminations.





### SHIFT LEVER POSITION INDICATOR

Turn Signals/Hazard Warning Indicator Lights

Traction Control System (TCS)/Dynamic Stability Control (DSC)  
On: TCS/DSC malfunction  
Flashing: TCS/DSC operating

Seat Belt Unbuckled/Malfunction

**AT** Automatic Transmission Malfunction (p. 11)

Door/Liftgate Ajar

**CRUISE** Cruise Main Indicator Light On (**AMBER**)/Cruise Set Indicator Light On (**GREEN**)

### SPEEDOMETER

### TRIP METER SELECTOR<sup>2</sup>

Headlight High Beams On (p. 9)

Airbag/Front Seat Belt Pretensioner System Malfunction

Low Engine Oil Pressure

Charging System Malfunction

Security Indicator Light

**Brake Warning Light**  
Parking brake on/low brake fluid/malfunction

**Dynamic Stability Control (DSC)/Traction Control System (TCS) Off Indicator Light**  
DSC OFF switch pushed and TCS/DSC turned off.

**TPMS NOTE:** Low ambient temperature and/or high altitude causes tire pressures to drop and may turn the TPMS warning light on. If the warning light comes on, check the tire pressure and fill the tires as soon as possible, preferably before moving the vehicle and warming up the tires. Tire pressure should be checked when the tires are cold.

<sup>2</sup> • Push to toggle between trip meter (A & B).  
• When a trip meter is selected, push and hold to reset to zero.

# Lights

## LIGHTING CONTROL/TURN SIGNAL LEVER

: Turns tail, parking, and dashboard lights on.

**AUTO:** The light sensor automatically determines when to turn the headlights on or off.

: Turns fog lights on only when headlights are on.

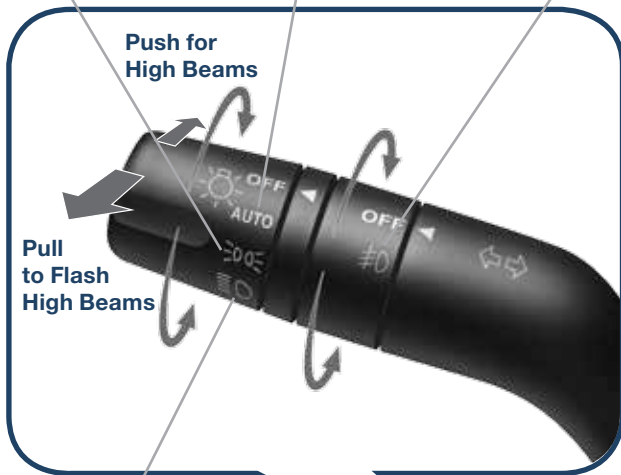

: Turns tail, parking, dashboard, and headlights on.

## HEADLIGHT LEVELING

Adjust headlight angle with headlight leveling switch depending on vehicle passengers & load (example: Driver only = 0, Driver + Passengers = 1 or 2, etc. ). Refer to your Owner's Manual for complete details.



## WINDSHIELD/REAR WINDOW WIPER/WASHER CONTROL LEVER

**AUTO:** The rain sensor senses the amount of rainfall and turns the wipers on or off. Rotate inner ring away from you (clockwise) for more (+) sensitivity (requires less rain to turn wipers on) and toward you (counterclockwise) for less (-) sensitivity (requires more rain to turn wipers on).

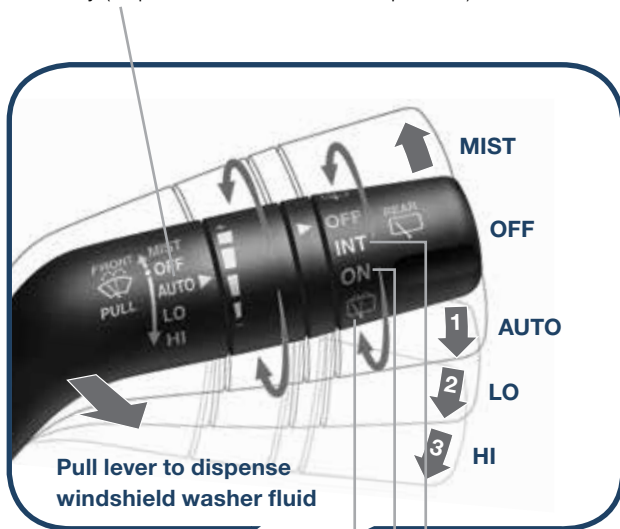

### Rear Window Wiper/Washer

- INT:** Intermittent
- ON:** Normal speed
-  : Washer/wiper (hold as desired)

**NOTE:** Vehicles not equipped with AUTO wipers will have INT wipers. Set the lever to INT and choose an interval timing by rotating the ring between fast and slow.

**CAUTION:** When the ignition is ON, turn the AUTO wipers OFF when going through a car wash, or while cleaning or touching the windshield.

# Transmission

## SPORT A/T MANUAL SHIFT MODE

The Sport A/T Manual Shift Mode gives you the feel of driving a manual transmission by allowing you to manually shift to control engine rpm and torque when more control is desired.

### To Use Manual Shift Mode:

- Shift the lever from D to M.

**NOTE:** Changing to manual mode can be done while driving the vehicle.

### To Shift Up To A Higher Gear:

- Tap shift lever back (+) once.

### To Shift Down To A Lower Gear:

- Tap shift lever forward (-) once.

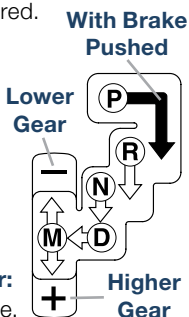

The transmission will automatically adjust how and when it shifts gears based on road conditions and your driving style. The transmission may stay in a lower gear longer than usual when going up or down hills or driving around corners. This feature gives you better control and a more connected driving experience.

## PARKING SENSOR SYSTEM



The parking sensor system uses ultrasonic sensors to detect obstructions behind the vehicle with transmission in Reverse and speed below 6 mph (10 km/h). The system notifies the driver of the approximate distance from the vehicle to the obstruction using a beep sound.

- Push the parking sensor switch on the dash to turn the system on (switch indicator lit) and off.

## ALUMINUM WHEEL CARE



Your aluminum wheels have a protective coating on them. Only use a mild soap or neutral detergent with a sponge or soft cloth to clean them.

**CAUTION:** Using a wire brush, polishing compound, solvent, or any type of abrasive cleaner may damage the protective coating.



## USB PORT/AUXILIARY JACK

Your vehicle is equipped with a USB port and auxiliary AUX jack located below the shifter. Learn the system when parked and do not let it distract you while driving.

### AUX Jack

**NOTE:** Available at your Mazda dealer is the Genuine Mazda Accessory 3.5 mm audio cable which can be used to connect your portable audio player into the aux jack.



- 1 Locate the AUX jack inside the center console.
- 2 Plug 3.5 mm audio cable into the portable audio player and into the AUX jack. Turn portable audio player on.
- 3 Turn the vehicle audio system on.
- 4 Push the AUX/USB button on the audio unit **OR** the MODE button on the steering wheel controls.
- 5 Use the portable audio player controls to play music.

**IMPORTANT:** Set the volume level on your portable audio player to the highest level before distortion starts, then adjust the volume on the audio system.

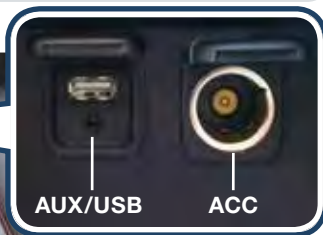

### USB Port

Refer to the Owner's Manual for additional information.

- 1 Connect the cable into the portable audio player and the USB port.
- 2 Push the AUX/USB button on the audio unit to switch to the USB mode and start playback.
- 3 Use the vehicle's audio system or steering wheel controls to control the USB device connected.

**NOTE:** The iPod functions on the iPod cannot be operated while it is connected to the vehicle's audio system because it controls the iPod functions.

# Automatic Climate Control

Outside Temperature  Climate Control  FM1ch3 1051  Interior Set Temperature



## Temperature Control Dial

**AUTO ON:** Push dial to turn Automatic Air Conditioning system on. Rotate dial to select your desired set temperature (shown in Information Display above). The airflow mode and the amount of airflow will be automatically controlled in accordance with the set temperature.

 Push to recirculate cabin air to reduce outside odors and improve cooling (indicator on) or receive fresh air (indicator off).

## Mode Selector

### MODE



Push to select the following airflow mode:

 Dashboard vents

 Dashboard and floor vents

 Floor vents

 Defroster and floor vents

 Windshield defroster

 FRONT Push to defrost the windshield.

 Push to defrost the rear window.

 REAR Push to turn rear vent system on or off.

## Fan Control Dial

- Rotate the dial to select the desired fan speed.

- Push OFF to turn climate control system off.

**A/C** Push to manually turn air conditioning on or off.

**NOTE:** The displayed outside ambient temperature may vary from the actual ambient temperature depending on the surrounding area and vehicle conditions. The best time to read the ambient temperature is when the vehicle is moving at a steady rate of speed and not when moving slow in traffic.



**NOTE:** Automatic climate control will allow you to maintain a preset cabin temperature.

 The heater and defroster work best when the blue coolant temperature light in the instrument cluster is off.

**NOTE:**

- Rotating the fan control dial, or pushing the MODE button, A/C switch, or windshield defroster switch while in AUTO ON mode will cancel auto A/C.
- With any defroster mode, the system turns on the A/C compressor and selects the FRESH AIR mode. This helps defrost the windows more efficiently by dehumidifying the air. The A/C compressor will always be on in defroster mode, but the defroster (and floor) will deliver warm air when the temperature dial is set to a warmer temperature and the engine warms up.

### FRONT VENT SYSTEM AIRFLOW OPERATION



When the “Windshield Defroster” or “Defroster and Floor” or “Floor” mode is selected, air will not only blow from the defroster vents on top of the dash or the floor vents, but also a small amount from the dashboard vents. If air is not desired from the dashboard vents, they can be closed using the dials or vent louvers.



- To defrost the windshield faster, close the dashboard vents.
- To defrost the side windows faster, point the side dashboard vents toward the side windows.
- To warm the passengers' upper bodies faster, point the side and/or center dashboard vents toward the inside of the vehicle.

### REAR VENT SYSTEM OPERATION

- 1 Turn the front air conditioning system on (AUTO or manually).
- 2 Push the rear ventilation control switch  REAR located on the front climate control panel, or push either the low or high rear vent button on the rear console (indicator light will illuminate).



**Low speed cool or cold air only from vents.**

**High speed cool or cold air only from vents.**

**NOTE:** Only cool or cold air (no heat) blows through the rear vents while the front climate control is on. Heat for the rear passengers comes from under the front seats when the front heater is on and set to floor mode. When pushing the rear ventilation control switch on the front control panel (with climate control system on), the rear ventilation system operates at low speed only. To change to high speed, push the HI rear vent button.

# Audio Controls

Clock 1:13 77.1 74 FM

## SETTING YOUR CLOCK

- Push the H button to set the hour.
- Push the M button to set the minutes.

**NOTE:** Push the :00 button to reset clock to nearest hour.



## POWER ON

Push the VOL/POWER dial to turn the audio system on.

## MEDIA SELECTION

**Radio:** Push FM/AM button to select the FM1, FM2, or AM band.



New Mazda vehicles equipped with SiriusXM® Satellite Radio will receive an introductory subscription with a limited term trial offer to over 150 channels of SiriusXM Satellite Radio. Enjoy commercial-free music, plus sports, news, entertainment, and every premium channel in your vehicle. Call 877-447-0011 to activate. See the Owner's Manual and/or dealer for details.

**CD:** Push the CD button to select the CD player which plays CDs, MP3s, and WMA. See the Owner's Manual for complete details.

**AUX/USB:** Push the AUX/USB button to select the auxiliary jack or USB port.

## TUNING

**Manual:** Turn the TUNE dial to manually change the frequency.

**Seek:** Push the SEEK/TRACK tuning buttons ▲▼ to automatically seek a higher or lower frequency with a station.

**Scan:** Push the SCAN button to automatically sample strong stations for a few seconds each. Push again to cancel.

**Preset Channel:** Push the Preset Channel buttons (1-6) to select a station stored in memory. To store a station, push and hold a button (1-6) until a beep is heard.

**Category (Sirius® only):** Push the FOLDER ▲▼ to change to a different category.

**Auto Memory Tuning:** Push and hold the AUTO-M button to store an additional 6 stations on each FM and AM band without disturbing the previously stored stations. To return to the previously stored stations, push FM/AM button. Refer to the Owner's Manual for complete details.



1ch3 105.1 FM -15 Audio



 **MUTE**  
(without  
Bluetooth®)



**NOTE:** Push the MODE button to change between FM1, FM2, AM, CD, SIRIUS 1, 2, 3, and AUX.

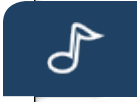

**LOADING A CD**

- Insert CD, label-side up.

**PLAYING A CD**

- Push CD button to play a CD when a CD is in the unit.
- Push SEEK/TRACK tuning buttons ▲▼ to select previous or next track.
- Push FOLDER ▲▼ to select previous or next folder (for MP3s and WMAs).

**PLAYING BLUETOOTH® (BT) AUDIO**

- 1 Make sure BT audio device is paired.
- 2 Turn on BT audio device.
- 3 Push the AUX/USB button until "BT AUDIO" is displayed.

**BLUETOOTH® AUDIO**

Bluetooth® enabled phones and audio players provide an opportunity to play music through the audio system with no wires attached.

Some phone models do not support all features. Go to [www.MazdaUSA.com/bluetooth](http://www.MazdaUSA.com/bluetooth) or contact (800) 430-0153 for further assistance or to report a phone/MP3 device concern.

## PAIRING YOUR BLUETOOTH® PHONE OR AUDIO DEVICE

### NOTE:

- For safety reasons, you cannot pair a phone while driving.
- Before pairing your cell phone or audio device, you must manually turn on the Bluetooth® function on the device. Refer to your device's Bluetooth® for steps to turn on Bluetooth®.
- **For customer service and device compatibility:**  
**Toll-free call: 800-430-0153**  
**Website: [www.MazdaUSA.com/bluetooth](http://www.MazdaUSA.com/bluetooth)**
- **IMPORTANT:** Set the volume level on your cell phone or audio device to the highest level before distortion starts, then adjust the volume on the vehicle's audio system.
- When in range of another Wi-Fi network, the Bluetooth connection between your phone and the system may disconnect for a short time if you have Wi-Fi enabled. Turn off Wi-Fi on your phone if needed.



- 1 Manually turn Bluetooth on your phone or audio device.
- 2 Push and release the  or  button located on the steering wheel and wait for a beep.
- 3 After the beep say, **"Set-up"**.
- 4 After the beep say, **"Pairing options"**.
- 5 After the beep say, **"Pair"**.
- 6 After the beep, say any 4-digit code.
- 7 Place phone or audio device in Discovery mode; if necessary, consult its manual, or go to [www.mazdausa.com/bluetooth](http://www.mazdausa.com/bluetooth) and select model, Bluetooth®, then follow screen prompts.
- 8 Input the 4-digit code you chose earlier.
- 9 After the phone or audio device is recognized, you will be prompted to name the paired device, such as **"Tom's phone or player"**.
- 10 When paired, a symbol will be displayed in the information display - a phone symbol for a phone and a music symbol for an audio device. If the symbol is not displayed, the Bluetooth® device is not paired.



**NOTE:** If your compatible Bluetooth® phone is equipped with a music player and supports the Bluetooth® profile A2DP, your phone will pair for both hands-free calling as well as Bluetooth® audio during the pairing process, and will be considered one unit. Please refer to your Owner's Manual for complete details on how to "pair" up to 7 Bluetooth® phones and audio devices, and how to use the built-in tutorial and other important safety information.

## TO MAKE OR RECEIVE A HANDS-FREE CALL

### Basic Operation:

-  **button:** To receive/swap a call.
-  **button:** To skip voice guidance (for speeding up operation).
-  **button:** To end/reject a call.

**NOTE:** On engine start, the last connected device will automatically be re-connected after several seconds.



## PERSONALIZE YOUR MAZDA5 WITH GENUINE MAZDA ACCESSORIES

Go to [www.MyMazda.com](http://www.MyMazda.com), then select “Accessories” below the MyMazda Home header for a complete listing of available accessories for your Mazda5.

## *WWW.MYMAZDA.COM— THE OFFICIAL SITE FOR MAZDA OWNERS*

Register today on MyMazda.com—the ultimate destination for Mazda Owners. Once registered, you’ll be able to take advantage of benefits exclusively for Mazda Owners:

- Insider access to exclusive events and promotions
- Personalized maintenance schedules
- Zoom-Zoom Owner Magazine
- Warranty information and on-line Owner’s Manuals
- Wallpaper, videos and other fun stuff
- Accessories specifically designed for your vehicle
- Car Care Discount Coupons available from your Authorized Mazda Dealer

Visit and register at [www.MyMazda.com](http://www.MyMazda.com) today!

### MAZDA MOBILE

The following apps are available for iPhone® and Android smartphones:

- **Mazda Assist app** - Provides roadside assistance 24 hours a day, 365 days a year. Toll free number 1-800-866-1998 can also be used for roadside assistance.
- **MyMazda app** - Keep track of your Mazda from the palm of your hand with these features:
  - Maintenance schedule
  - Service coupons
  - Promotional alerts
  - Service history
  - Recall information
  - Parked car locator
  - Scan VIN barcode capability when registering a vehicle
  - Mazda Dealer locator
  - Update owner profile
  - Link to Mazda Assist

The apps can be downloaded, free of charge, from the App store for the iPhone® and Google Play (Android Market) for Android powered devices. After downloading app, customer name, email, smartphone number and VIN are required.



**Free Mazda Assist app**  
iPhone and Android



**Free MyMazda app**  
iPhone and Android

# Customer Delivery Checklist

## VEHICLE PRESENTATION:

Refer to the Smart Start Guide during presentation

**Keyless Entry**..... 1



**Liftgate**..... 1

**Information System**.....2

**Break In Period**..... 2

**Seats** ..... 3

- Adjustment

**Fuel Door**.....3

- Fuel Door Release
- Fuel Specifications
- Fuel Economy

**Rear Seats** ..... 4

- 2nd and 3rd row seating access
- 2nd row seat storage/ center console

**Driver's View**.....5-6

- Location of Switches and Control

**Instrument Cluster** .....7-8

- Review of Warning and Indicator Light Function and Location

**Lights** ..... 9



**Wiper/Washer**.....10



**Sport A/T Manual Shift Mode**.....11

**Parking Sensor System\***.....11

**Aluminum Wheel Care** .....11

**AUX/USB Input** ....12

**Climate Control** ..... 13-14

- Center Vents and Airflow Operation
- Auto Mode



**Set Clock**.....15



**Audio Controls**..... 15-16

- Bluetooth Audio

**Bluetooth® Hands-Free** .....17

- Pair Phone
- Make/Receive Call
- Toll-Free Customer Service 800-430-0153

## SCHEDULED MAINTENANCE:

When replacing or topping off engine oil, use Mazda Genuine oil. For optimal engine performance, use SAE 0W-20 engine oil. Please consult an Authorized Mazda Dealer for additional information.

**All items in the Customer Delivery Checklist have been reviewed with the customer and the first maintenance appointment has been scheduled:**

SALES CONSULTANT	DATE	CUSTOMER	DATE

Signed copy must be placed in dealer jacket.

# Customer Delivery Checklist

DEALERSHIP	DATE
SALES CONSULTANT	CUSTOMER'S NAME
VIN	E-MAIL

## PRESENTATION OF OWNER'S MATERIALS:

*Review the following items with the customer*

### Smart Start Guide

- Remove this checklist from Smart Start Guide
- Personalization Features (refer to your Owner's Manual)

### Warranty Information

**Warranty Start Date:** \_\_\_\_\_

**Customer Initial:** \_\_\_\_\_

- Basic Vehicle – 36 months/36,000 miles
- Roadside assistance program

### [www.MyMazda.com](http://www.MyMazda.com)

- Offer to register customer on [www.MyMazda.com](http://www.MyMazda.com)

## SERVICE DEPARTMENT

- Introduce Service Manager; provide business cards
- Review Service and Parts Department hours of operation
- Explain free Full Circle Service Inspection
- Schedule first maintenance service

### Owner's Manual

### Maintenance Passport

### Floor Mats

- Ensure floor mats are properly hooked after cleaning
- Do not install two floor mats, one on top of the other, on the driver side
- Accessory rubber floor mats should be cleaned with mild soap and water only



## GENUINE MAZDA SERVICE

***Because you and your Mazda deserve the best***

Your new Mazda deserves nothing less than the very best. To keep it running like new for years to come, trust the experts at your local Authorized Mazda Dealer. Simply bring your vehicle in for your scheduled maintenance and any needed repairs.\*

At participating Mazda Full Circle Service Centers,\*\* our technicians will automatically perform a complimentary Full Circle inspection on your vehicle and issue a detailed report card at every visit. This is designed to help you keep track of your Mazda's critical operating condition. Our factory-trained technicians know your vehicle inside out, and use Genuine Mazda Parts, giving your vehicle the optimum care and maintenance it requires to run with flawless precision.

Remember, to further enhance your driving experience, visit your local Mazda Service Center for your scheduled maintenance. It's also the place where you can find a wide variety of tires, parts, and accessories that are just right for your vehicle.

\* See vehicle's scheduled-maintenance program for details.

\*\* Visit the Mazda Owners website at [www.MyMazda.com/fullcircle](http://www.MyMazda.com/fullcircle) to find a participating Mazda Full Circle Service Dealer.

Customer Experience Center: 1-800-222-5500

Roadside Assistance Contact: 1-800-866-1998

*Mazda*  
**FULL CIRCLE**  
*SERVICE*

**FREE FULL CIRCLE  
SERVICE INSPECTION**

***We're committed to providing  
expert Mazda service.***

You love to drive your Mazda, and we love to service your Mazda. With our Full Circle Service, we'll give your vehicle a COMPLIMENTARY MULTI-POINT INSPECTION. Your Mazda will receive a thorough review of its most crucial components.

This easy-to-use Smart Start Guide is intended to help you more fully appreciate some of the unique features and functions of your new vehicle. However, it is not intended to replace your Owner's Manual. The Owner's Manual contains more detailed information to help you better understand the important safety warnings, features, operation, and maintenance of your vehicle. All information, specifications, photographs and illustrations in this publication are those in effect at the time of printing. Mazda reserves the right to change specifications or design without obligation.

© Mazda North American Operations  
Printed in U.S.A. 06/14  
Print 1  
9999 95 005C 15SS



[www.MazdaUSA.com](http://www.MazdaUSA.com)