



SMART START GUIDE

MAZDA **CX-5**



ZOOM-ZOOM

This easy-to-use **SMART START GUIDE** provides important information about some unique features and functions of your new vehicle. Additional features are available at mymazda.com and the **MyMazda app** -> **VEHICLE HOW TO**. Complete information on features and functions is available in your Owner's Manual.



TABLE OF CONTENTS

- 3** Driver's View
- 5** Advanced Keyless Entry
- 6** Starting The Engine
- 7** Tire Pressure Monitoring System
- 8** Multi-Information Display
- 9** Power Liftgate
- 10** Rear Seat
- 11** Seat Warmers
- 12** Heated Steering Wheel
- 13** Mazda Connect Infotainment System
- 17** Bluetooth®
- 19** Navigation System
- 22** Active Driving Display
- 23** Commander Switch
- 24** Voice Control
- 25** Mazda Radar Cruise Control
- 27** Smart City Brake Support
- 28** Smart Brake Support
- 29** Lane-keep Assist / Lane Departure Warning System
- 31** Distance Recognition Support System
- 32** Traffic Sign Recognition
- 33** Blind Spot Monitoring System
- 34** Rear Cross Traffic Alert
- 35** Lighting / Turn Signals
- 36** Wiper / Washer Control
- 37** Adaptive Front-Lighting System
- 38** High Beam Control
- 39** Audio Controls
- 41** Audio USB and AUX Inputs
- 43** Automatic Climate Control
- 45** Instrument Cluster
- 47** Automatic Transmission
- 49** Auto-Dimming Mirror
- 50** HomeLink®
- 51** Electric Parking Brake / AUTOHOLD
- 52** Personalize Your CX-5



DRIVER'S VIEW



PASS
AIRBAG OFF 

¹ This indicator light illuminates to remind you that the front passenger's front/side airbags and seat belt pretensioner will not deploy during a collision. The reason for this is that the weight in the seat is less than approximately 66 lbs. Always wear your seat belt, and if a front-facing child seat must be used, you must deactivate the passenger's airbag. See the Owner's Manual for important information on this safety feature.



A	Power Liftgate Switch	9
B	Traction Control System / Lane-keep Assist / Lane Departure Warning	45
C	Fuel Filler Lid / Hood Release	-

STEERING COLUMN

D	Lighting / Turn Signals	35
E	Bluetooth® Hands-Free / Audio Control / Voice Control	17 24
F	Tilt / Telescoping Steering Wheel Lever	-
G	Instrument Cluster and Indicator Lights	45
H	Cruise Control	25
I	Wiper / Washer Control	36

CENTER CONSOLE

J	Start / Stop Engine	6
K	Mazda Connect Infotainment System	13
L	Hazard Warning	-
M	Passenger's Airbag OFF Indicator ¹	3
N	Front Seat Warmers	11
O	Heated Steering Wheel	12
P	Climate Control	43
Q	Drive Selection	47
R	Electric Parking Brake (EPB) / AUTOHOLD	51
S	Commander Switch	23

ADVANCED KEYLESS ENTRY

(IF EQUIPPED)

ADVANCED KEYLESS ENTRY SYSTEM

This system allows you to lock and unlock the doors without taking the key out of your pocket or purse.

CAUTION:

The RED KEY indicator light may illuminate on the instrument cluster (p. 45) if the advanced key is placed in the cup holder. The key may not be detected in the cup holder.

CAUTION:

Make sure the engine is OFF and take the key with you when leaving the vehicle.

When locking the doors using the inside door switches, be careful not to leave the key inside the vehicle to prevent lock-out.

While Carrying the Advanced Key...

- Unlock the driver's door by pushing the driver's door request switch once.
- Unlock all doors by pushing the driver's door request switch once or twice (depending on personalization setting, p. 15) OR by pushing the passenger's door request switch once.
- Lock all doors (and liftgate) by pushing any request switch once.

NOTE: Only vehicles equipped with the Advanced Keyless Entry System allow you to lock and unlock the doors with the door request switches (without taking the key out of your purse or pocket).

Vehicles equipped with the Keyless Entry System do not have request switches on the doors/liftgate. To lock and unlock the doors, the corresponding transmitter button must be pushed.

Refer to your Owner's Manual for additional details about "Personalization Features".

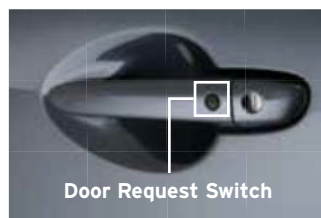

STARTING THE ENGINE

STARTING THE ENGINE WITH ACCELERATED WARM-UP SYSTEM (AWS)

The CX-5 is equipped with SKYACTIV combustion technology. This technology includes AWS (Accelerated Warm-up System) for optimal emission performance during cold starting conditions.

While Carrying the Advanced Key...

- **START THE ENGINE** by pushing the START/STOP ENGINE button while pushing the brake pedal.
- **WHAT WILL YOU NOTICE?** On start-up, the engine speed and sound are elevated (1500 RPM) for less than one minute to quickly bring the catalyst to efficient operating temperature. The RPM will reduce to idle once the temperature is achieved. This is normal engine operation under cold-start conditions.
- **WHAT DOES THIS DO?** This reduces emissions and allows Mazda to improve efficiency.
- **SHUT THE ENGINE OFF** by making sure the vehicle is in Park and setting the electric parking brake, then push the START/STOP ENGINE button.
- **ACTIVATE ACCESSORIES (ACC)** by pushing the START/STOP ENGINE button once without pushing the brake pedal.
- **TURN THE IGNITION TO THE ON POSITION** by pushing the START/STOP ENGINE button twice without pushing the brake pedal.



EMERGENCY ENGINE STOP

Pushing and holding the START/STOP ENGINE button or repeatedly pushing the START/STOP ENGINE button while the engine is running will turn the engine OFF. Use only in case of an emergency.

NOTE: The engine may not start if the key cannot be detected. The key indicator light may flash RED or “Key not detected” may be displayed if the key is placed in the cup holder.

If the START/STOP ENGINE button indicator light flashes AMBER, this could indicate a problem with the engine starting system. You may not be able to start the engine or switch the ignition to ACC or ON. Have your vehicle inspected at an Authorized Mazda Dealer as soon as possible.

TIRE PRESSURE MONITORING SYSTEM

TIRE PRESSURE MONITORING SYSTEM (TPMS)

For your safety, the CX-5 is equipped with TPMS that detects low tire pressure in one or more tires. If the tire pressure starts getting low in one or more tires, the system alerts the driver by turning on a light in the instrument cluster (pp. 45-46) and sounding an alarm.

WHAT TO DO?

Don't ignore the TPMS warning light. Stop and check your tire pressure for all tires (when tires are cold) and inflate the tires to the proper air pressure. Properly inflated tires are safer, last longer, and increase fuel economy.

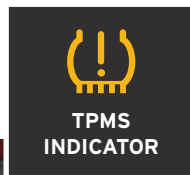

NOTE: Drastic changes in temperature or altitude can affect the air pressure in the tires, and may cause the TPMS warning light to turn on.

MULTI-INFORMATION DISPLAY

(IF EQUIPPED)

MULTI-INFORMATION DISPLAY



Push and hold the INFO button on the steering wheel to reset the currently displayed feature, such as Average MPG.

Toggle the INFO button on the steering wheel up or down to cycle through different types of information.

DISPLAY SCREENS

Current Fuel Economy, Trip Meter A, Average Fuel Economy, Outside Temperature, Odometer, Distance-to-Empty, Fuel Gauge

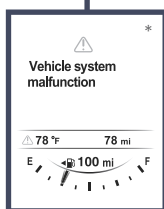
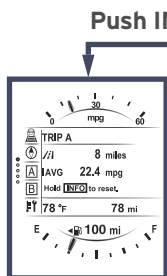

Warning Message, Outside Temperature, Odometer, Distance-to-Empty, Fuel Gauge

*Displayed only when a warning occurs.

Push INFO button

Current Fuel Economy, Trip Meter B, Average Fuel Economy, Outside Temperature, Odometer, Distance-to-Empty, Fuel Gauge

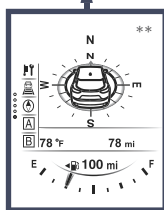
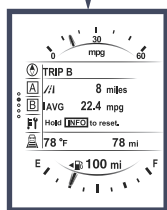

Compass, Outside Temperature, Odometer, Distance-to-Empty, Fuel Gauge

**Displayed only while vehicle is being driven.

Push INFO button

Engine Coolant, Temperature Gauge, Maintenance Monitor, Outside Temperature, Odometer, Distance-to-Empty, Fuel Gauge

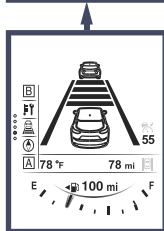
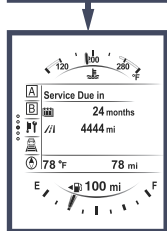

i-ACTIVSENSE, Outside Temperature, Odometer, Distance-to-Empty, Fuel Gauge

NOTE: New screen items are in bold.

Push INFO button

POWER LIFTGATE

(IF EQUIPPED)

POWER LIFTGATE

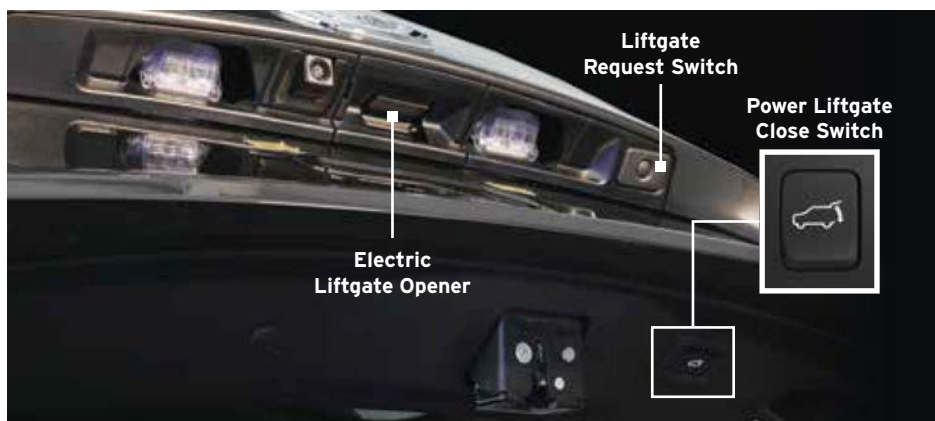

To open or close the liftgate from inside the vehicle:
Push the power liftgate switch on the left side of the dash.

To open the liftgate from outside the vehicle:
Open the power liftgate using the electric liftgate opener or advanced keyless remote.

To close the liftgate from outside the vehicle:
Close the power liftgate by pushing the power liftgate close switch or by using the advanced keyless remote.

Push the liftgate request switch to lock or unlock the vehicle.

The power liftgate can be changed to open to your desired position.

To change how far the liftgate will open:
Stop the liftgate at the desired position. Then push and hold the power liftgate close switch for about three seconds. A beep will sound two times to indicate that the position change has been completed.

NOTE: The power liftgate cannot be set to less than halfway open.

To reset to the original position:
Open the liftgate and push and hold the power liftgate close switch for about seven seconds. A beep will sound three times to indicate that the reset has been completed.



REAR SEAT

SPLIT-FOLDING REAR SEAT

To create a flat luggage compartment space, fold the seatbacks forward.

- 1 Lower the head restraints all the way down.
- 2 Pull the lever on the top of the rear seatback to fold the seatback flat.

NOTE: Use remote handle lever located in the cargo area to lower center seat.



SEAT WARMERS

(IF EQUIPPED)

FRONT SEAT WARMERS

Seat warmers operate with the ignition ON.



REAR SEAT WARMERS

WARNING:

Turn rear seat warmers OFF before folding rear seats down.



To turn seat warmers on:

Push the switch, located in the center armrest, to select your desired heat level (Low, Mid or High).

To turn seat warmers off:

Continually push the switch until no lights are illuminated.

NOTE:

- When the engine is off, the seat warmers automatically turn OFF.
- The seat warmers automatically turn off when they have been operating continuously for 90 minutes.
- To turn the seat warmers back on, push the switch until the desired heat level is selected.

HEATED STEERING WHEEL

(IF EQUIPPED)

HEATED STEERING WHEEL

The areas of the steering wheel (shown below) will heat when the ignition is ON and the heated steering wheel switch is turned on.



To turn heated steering wheel on:

Push the switch and the light will illuminate.

To turn heated steering wheel off:

Push the switch and the light will turn off.

MAZDA CONNECT INFOTAINMENT SYSTEM

MAZDA CONNECT INFOTAINMENT SYSTEM

MAZDA CONNECT is designed to be operated using one of the following three interfaces:

- 1 The commander switch (p. 23).
- 2 Voice control (p. 24).
- 3 The touchscreen (if the vehicle is moving at speeds below 5 mph).

ENTERTAINMENT

This section is for music features. AM, FM, XM, Bluetooth®, Aha, Pandora, Stitcher, USB, AUX are available.



APPLICATIONS

This section is for vehicle maintenance features and driver's information.

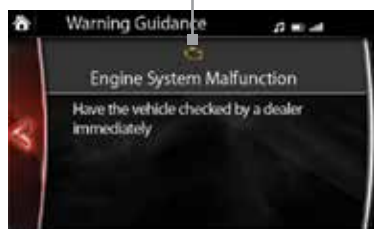
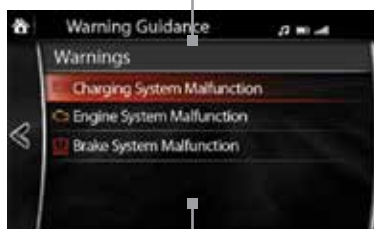

NOTE:

- In the interest of safety, the touchscreen is disabled at speeds over 5 mph. Use the commander switch or voice command to operate the infotainment system.
- You can touch and tap, slide or swipe the touchscreen, but you cannot pinch to zoom or expand.



COMMUNICATION

This section is for phone calls and text messaging (SMS) features. A Mazda Connect compatible Bluetooth® mobile phone needs to be connected.



NAVIGATION

Mazda Navigation requires an SD card. Otherwise, the compass is displayed.



SETTINGS

This section lets you customize your Mazda settings. See pages 15-16 for more information.

To purchase SD cards, please visit the nearest Authorized Mazda Dealer.

For assistance with MAZDA CONNECT, visit www.mazdausa.com/mazdaconnect or call 800-430-0153.

MAZDA CONNECT SETTINGS

(IF EQUIPPED)

MAZDA CONNECT SETTINGS

To view the different setting screens:

- 1 Move the commander switch to the left or right to change tabs.
- 2 Turn the commander switch to scroll down the list.
- 3 When the desired tab is highlighted, push the commander switch.

NOTE: If there is a scroll bar on the right side, there are more items farther down.

ACTIVE DRIVING DISPLAY SETTINGS



SOUND SETTINGS



SAFETY SETTINGS

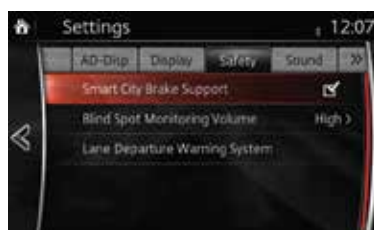

CLOCK SETTINGS

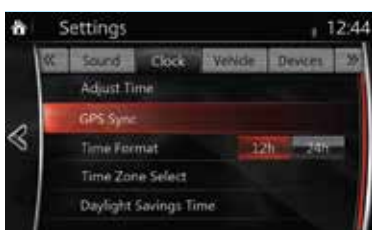

The Clock tab can be used to adjust the time, sync the clock with GPS, and change between 12-hour and 24-hour clock.

DISPLAY SETTINGS

Select **Turn Display Off** to only turn the display off. Touch the screen or use the commander switch to turn the display back on.

Use the **System** tab to change the brightness of the display between Day (bright), Night (dim), and AUTO (switches from Day to Night when headlights are turned ON).

See illumination dimmer (pp. 45-46).



VEHICLE SETTINGS



SYSTEM SETTINGS



BLUETOOTH® DEVICE SETTINGS



BLUETOOTH®

PAIRING YOUR BLUETOOTH® PHONE OR AUDIO DEVICE

Pairing Instructions:

- 1 Manually turn on Bluetooth® on your mobile or audio device.
- 2 Select **Communication** from the Home screen.
- 3 Select **Settings**.
- 4 Turn Bluetooth® ON by selecting **Bluetooth®**.
- 5 Select **Add New Device**, and switch to the operation on your mobile device.
- 6 On your mobile device, select “Mazda”.
- 7 Verify the displayed 6-digit code both on the display and on your mobile device.



IMPORTANT: If your mobile device was once paired to another Mazda vehicle, that “Mazda” must be deleted from the Bluetooth® device list on your mobile device.

For phones compatible with SMS and MMS:

- 8 On your mobile device, hit “Allow” to let Mazda Connect download your phonebook and text messages (SMS).
- 9 For iPhone, go to Settings > Bluetooth®. Select the “i” information icon for the connected device. Switch “Show Notifications” to ON.

NOTE:

- For safety reasons, you cannot pair a phone while driving.
 - For customer service and device compatibility, visit www.mazdausa.com/mazdaconnect or call 800-430-0153.
 - When in range of another Wi-Fi device, the Bluetooth® connection between your phone and the system may disconnect for a short time if you have Wi-Fi enabled.
 - Turn off Wi-Fi on your mobile device if needed.
-

TO MAKE OR RECEIVE A HANDS-FREE CALL

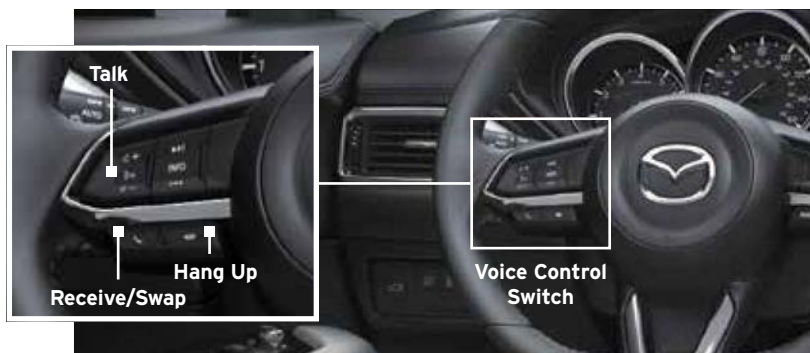

Push  button: To Receive/Swap a call

Push  button: To Activate Voice Recognition

- To start a voice recognition session.
- To skip the voice recognition system voice prompts.

Push  button: To Hang Up

- To end a voice recognition session.

Automatic Bluetooth® Reconnection:

- On engine start, the last connected device will automatically be re-connected after several seconds. If the devices do not automatically reconnect, you may manually reconnect by going to Device Setting and selecting Bluetooth®.
- To switch devices, go to Device Settings and select Bluetooth®.

For a stable Bluetooth® connection:

- Make sure there is no metal object nor any obstacle blocking Bluetooth® signal between the vehicle's display and your mobile device.
- Turn OFF unnecessary applications on your mobile device. When your mobile device is busy, it often drops Bluetooth® connection.
- Turn OFF energy saving mode on your mobile device.

NOTE: Some phone models do not support all features. If your phone or device does not pair, please visit www.mazdausa.com/mazdaconnect or contact (800) 430-0153 for further assistance or to report a phone/audio device concern.

The following icons are displayed on the touchscreen during a call:

 Ends a call.

 Transfers a call from hands-free to the mobile phone.

 Transfers a call from the mobile phone to hands-free.

 Mutes the microphone.

 Switches the call on hold.

 Allows access to the numerical keypad.

NAVIGATION SYSTEM

(IF EQUIPPED)









NAVIGATION SYSTEM

Planning A Route

IMPORTANT:

- In the interest of safety, plan a route before you start driving.
- To adjust the volume of the navigation system voice while driving, turn the VOL knob when voice guidance is being given. To prompt voice guidance, push the NAVI button to repeat the last instruction.
- For assistance with the navigation system, visit www.mazdausa.com/mazdaconnect or call 800-430-0153.



ICON	VOICE CONTROL	PURPOSE
	Hide/Show Menu Bar	To open and close the Menu bar.
	Enter Destination	To enter an address or favorite destination, or select a place of interest or a location on the map.
	Navigation Information	To switch to the navigation information screen on which items such as traffic information and GPS reception conditions are located.
	Cancel	To cancel an existing way point/route.
	Point of Interest	To find places nearby.
	Route Options	To display the route parameters and full length of the route. Perform route-related actions such as edit or cancel, pick route alternatives, avoid parts, or add destination to Favorites.
	View Mode	To change the map mode (2D north up/2D heading up/3D).
	Settings	To adjust the navigation settings.

To plan a route on your navigation system:

- 1 Push the NAV button on the commander switch.
- 2 Select ENTER DESTINATION.
- 3 Select Find Address.

NOTE: By default, the navigation system detects the country and city/town you are in. If needed, you can change the country or state setting by selecting **Country** or a new city/town by selecting **City** or **Zip code**.

- 4 Enter the street name.
- 5 Enter the house number, then select the ✓.
- 6 The system transitions to a screen where the input location can be checked. To transition to the next screen, select ✓ Select, or to transition to the previous screen, select ↶.

NOTE:

- Select Places Nearby for Points Of Interest (POI) around the selected location, or select Add to Favorites to register the selected location to Favorites.
- The route can be edited by selecting other options.

-
- 7 If ✓ Start is selected or if no operation is performed for 10 seconds, the route guidance is started. The set route can be checked by selecting MAP.

(Continued on next page)

NAVIGATION SYSTEM

CONTINUED

PLANNING A ROUTE USING VOICE COMMANDS

To plan a route to an address using your voice:

- 1 Push the TALK  button on the steering wheel.
 - 2 When you hear the tone, say "Address".
 - 3 When on the address screen, say the full address (without zip code) for your destination, for example "123 Main St., Los Angeles, California". The system does not recognize zip codes.
 - 4 Say "Yes" if the address is correct. If shown a list of addresses, say the list number for the correct address or say "None of these".
-

NOTE:

- For best results, say the full address without pausing between words.
 - Voice guidance can be skipped by pushing the TALK  button.
 - When prompt voice guidance is muted, you will need to go into Navigation Settings to turn the volume back on for the NAVI button to repeat the last instructions.
-

To remove or insert the MAP SD card (to update the map database):

- 1 Turn the ignition OFF.
- 2 Locate the SD card slot located in the center console.

Remove card:

Open the cover and push the card once, then pull it out.

Insert card:

Push the card in (label-side up), then close the cover.



NOTE:

- Visit www.mazdausa.com/navigation and download the most recent map available for your device for free for three years from vehicle delivery.
 - For assistance with the navigation system, visit www.mazdausa.com/mazdaconnect or call 800-430-0153.
 - Only use your MAP SD card for operating and updating your navigation system. DO NOT insert the MAP SD card into another vehicle or into any other device such as a camera.
 - DO NOT put other SD cards in this slot.
-

ACTIVE DRIVING DISPLAY

(IF EQUIPPED)

ACTIVE DRIVING DISPLAY

To change the settings/adjustments for the Active Driving Display:

- 1 Select the Settings icon on the Home screen.
- 2 Select the AD-Disp tab.
- 3 Select the desired item to change.

HEIGHT: Adjust the position of the virtual image of the Active Driving Display up or down.

BRIGHTNESS CONTROL: Method for adjusting screen brightness (automatically with instrument cluster illumination or manually).

BRIGHTNESS: Brightness adjustment (when selecting manual adjustment).

ROTATION





NAVIGATION: On/Off.

DISPLAY INFORMATION

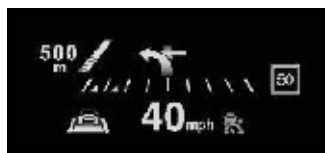
ACTIVE DRIVING DISPLAY



RESET: Reset to default settings.



	Vehicle Speed Setting using cruise control
	Navigation Turn-By-Turn (TBT) direction, distance and lane guidance
	Traffic Sign Recognition (TSR) using navigation
	Speed Limit

NOTE:

- If the display does not operate, switch the ignition off and then switch it back on. If it still does not operate even with the ignition switched ON, have the vehicle inspected at an Authorized Mazda Dealer.
- It may be difficult to view the display when wearing sunglasses. Take off your sunglasses or adjust the luminosity.
- If the battery has been removed and re-installed or the battery voltage is low, the adjusted position may deviate.
- The display may be difficult to view or be temporarily affected by weather conditions such as rain, snow, light, and temperature.

IF EQUIPPED	
	Lane Departure Warning System (LDWS) operation conditions and warnings
	Smart Brake Support (SBS) warnings
	Vehicle Speed Setting using cruise control

COMMANDER SWITCH

COMMANDER SWITCH

The commander switch is the primary means for operating Mazda Connect. It allows you to keep your eyes on the road while providing tactile feedback as you operate Mazda Connect via the commander switch and buttons.

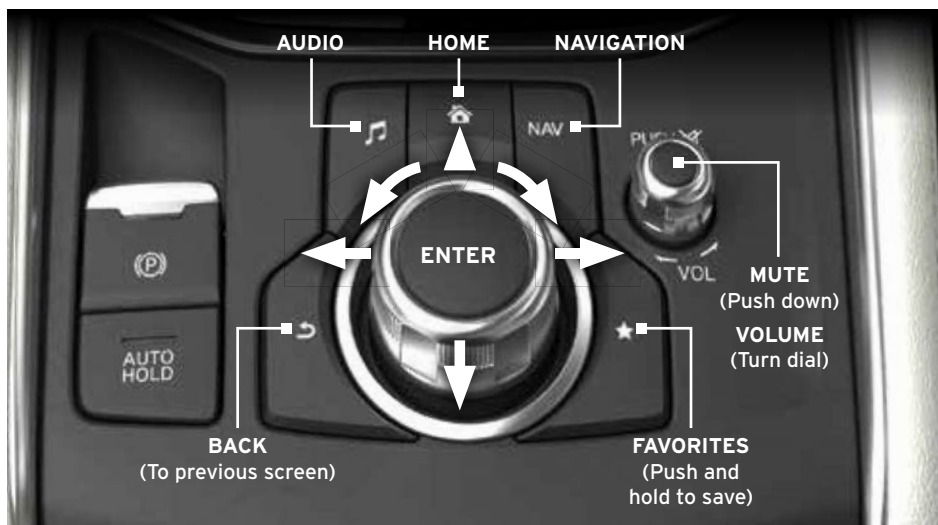

Five buttons are placed naturally beneath the fingers and mirror the on-screen icons for a more intuitive operation. Select a button around the commander switch to operate the desired function.

The following items can be stored as Favorites:

- 50 stations total for AM, FM and XM.
- 50 contacts in the system phonebook.
- 50 points of interest in navigation. (To edit or delete HOME, select HOME and push and hold the commander switch until the Edit/Delete HOME screen appears.)

Select an item on the screen by:

- 1 Moving the switch up or down, left or right, and/or turning the dial to move the cursor to the desired on-screen location.
- 2 Pushing the switch down (ENTER) to select your choice on the screen.

VOICE CONTROL

VOICE CONTROL

Voice control is activated by pushing the TALK  button on the steering wheel and speaking a command. Voice commands usually contain a verb (action word) followed by a noun. Common verbs are "Go to" and "Play".



USEFUL COMMANDS:

"CALL <phonebook contact name>
<mobile/home/work>"

(Example: "Call John Smith mobile")

"DIAL <number>" (Example: "Dial 911")

"REDIAL" - This command makes a call to the last person you called (the top person listed on Outgoing call history).

"CALLBACK" - This command makes a call to the last person who called you (the top person listed on Incoming call history).

"DRIVE HOME" /

"NAVIGATE HOME" / "TAKE ME HOME"

Any of these HOME commands sets the destination to your home address (p. 23).

NOTE: Navigation commands are available only when Navigation map is displayed.



OTHER COMMON VOICE COMMANDS:

"HELP" - This command lets you know the available VR commands per display.

"TUTORIAL" - Mazda Connect overall introduction.

"ADDRESS" - This is a useful command for navigation address entry.

IMPORTANT:

- Make sure to say your command AFTER the beep sound.
 - You can skip the system's prompt anytime by pushing the TALK  button.
 - You can end your voice recognition session either by pushing the Hang-up  button on the steering wheel or by operating the commander switch.
-

MAZDA RADAR CRUISE CONTROL

WITH STOP & GO FUNCTION (IF EQUIPPED)

MAZDA RADAR CRUISE CONTROL (MRCC) WITH STOP & GO FUNCTION

WARNING:

Do not rely completely on the MRCC with Stop & Go function and always drive carefully obeying the speed limit.

WARNING:

Switch the MRCC system off when it is not in use.



DO NOT get out of the vehicle while the stop hold control is operating.

The MRCC with Stop & Go function maintains vehicle speed and following distance using a radar sensor to detect a vehicle ahead. The driver simply presets the vehicle speed between 0 mph and 90 mph and the system will maintain a safe following distance without having to turn the cruise control off or use the accelerator or brake pedals. If the vehicle ahead stops while you are following behind it, your vehicle will stop automatically.

The system operates in two modes:

CONSTANT SPEED MODE: When no vehicle is detected ahead, the driver's set speed is maintained.

HEADWAY CONTROL MODE: When a vehicle is detected ahead, a distance between your vehicle and the vehicle ahead is maintained.

MODE	DISPLAY
Constant Speed	
Headway Control	

Setting the MRCC with Stop & Go function:

When the Mode switch is pushed, the vehicle speed and the distance between vehicles while in headway control can be set. The MRCC with Stop & Go function indication is shown in the multi-information display. The indicator light in the multi-information display will be green and will turn on simultaneously.

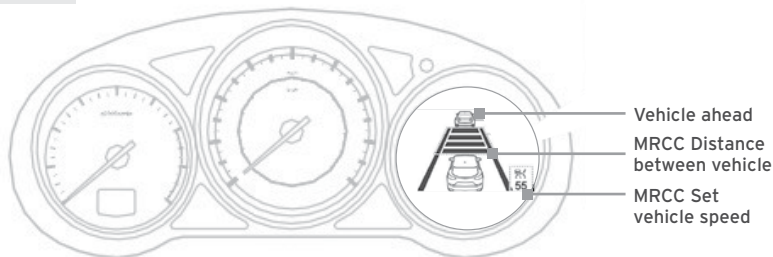

NOTE: The radar for the MRCC with Stop & Go function is located behind the Mazda emblem in the grille. Keep this area clean to ensure the system works properly.

How to set the speed:

- 1 Adjust the vehicle to the desired speed using the accelerator pedal.
- 2 Push the SET + or SET - switch. The set speed and the inter-vehicle distance display filled with white lines are displayed in the multi-information display and the MRCC indicator light (green) turns on simultaneously.
- 3 Push the center of the RESUME switch to resume set speed.



How to set the distance between vehicles:

The distance between vehicles is increased by pushing the ▲ switch and decreased by pushing the ▼ switch. The distance between vehicles can be set to four levels.

Switching to conventional cruise control function:

When the Mode switch is pushed while the MRCC with Stop & Go function system is turned on, the system is switched to conventional cruise control function.

The MRCC with Stop & Go function indicator light (green) in the instrument cluster turns off and "Radar Cruise Control deactivated" message is displayed in the multi-information display at the same time.

CLOSE PROXIMITY WARNING



While traveling in headway control, if your vehicle rapidly closes in on a vehicle ahead because the other driver applied his or her

brakes suddenly, a warning sound activates and the BRAKE! warning is indicated in the display. Always verify the safety of the surrounding area and depress the brake pedal while keeping a safe distance from the vehicle ahead. Additionally, always keep a safe distance from the vehicles behind you.

NOTE: The MRCC with Stop & Go function sometimes will brake your vehicle when encountering a semi truck (tractor trailer). This is normal. Simply push the accelerator pedal to override the system.

DISTANCES BETWEEN VEHICLES (at 50 mph)	DISPLAY
Long (about 164 ft)	
Medium (about 131 ft)	
Short (about 98 ft)	
Extremely Short (about 82 ft)	

SMART CITY BRAKE SUPPORT

(IF EQUIPPED)

WARNING:

SCBS is only a supplementary system to reduce damage in the event of a collision; however, the SCBS has limitations. Do not rely solely on the SCBS. Always keep your eyes on the road.

SMART CITY BRAKE SUPPORT (SCBS) SYSTEM

Between speeds of 2 mph to 18 mph, the Smart City Brake Support attempts to minimize damage if a collision is unavoidable. In some instances, SCBS may be able to stop the vehicle automatically to avoid a collision with the vehicle ahead.

Partial list of operating conditions:

- During vehicle speeds of 2 mph to 18 mph.
- SCBS system has not been turned off.

NOTE: It may be possible to avoid a collision if the relative speed between your vehicle and the vehicle ahead is less than 12 mph.

Refer to your Owner's Manual for a complete list of SCBS operating conditions and system details.

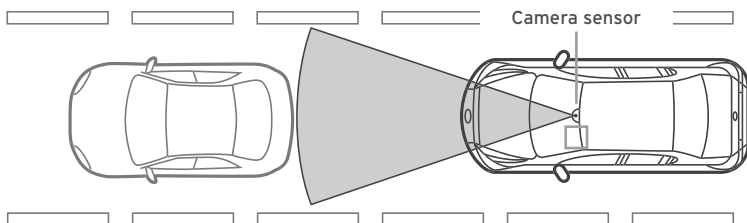

SAFETY SETTINGS

SCBS can be turned off using Safety Settings in MAZDA CONNECT (p. 15).



SMART BRAKE SUPPORT

(IF EQUIPPED)

WARNING:

SBS is only a supplementary system to reduce damage in the event of a collision; however, the SBS has limitations. Do not rely solely on the SBS. Always keep your eyes on the road.

SMART BRAKE SUPPORT (SBS)

At speeds of 10 mph or higher, the Smart Brake Support (SBS) alerts the driver of a possible collision and attempts to reduce the severity of an imminent collision with the vehicle ahead. SBS operates when the vehicle is traveling at speeds higher than the range of the SMART CITY BRAKE SUPPORT (SCBS).

Partial list of operating conditions:

- During vehicle speeds of 10 mph or higher.
- The Smart Brake Support (SBS) system has not been turned off.

SBS system can be turned off using Safety Settings in MAZDA CONNECT (p. 15).

Refer to your Owner's Manual for a complete list of SBS operating conditions and system details.

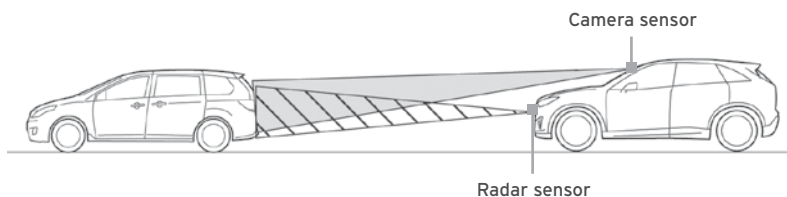

COLLISION WARNING

If there is the possibility of a collision with a vehicle ahead, the beep sounds continuously and a warning is indicated in the multi-information display.



LANE-KEEP ASSIST SYSTEM /

LANE DEPARTURE WARNING SYSTEM (IF EQUIPPED)

LANE-KEEP ASSIST SYSTEM (LAS) and LANE DEPARTURE WARNING SYSTEM (LDWS)

The Lane-keep Assist System and Lane Departure Warning System recognize the painted lane lines using the Forward Sensing Camera (FSC) installed on the windshield.

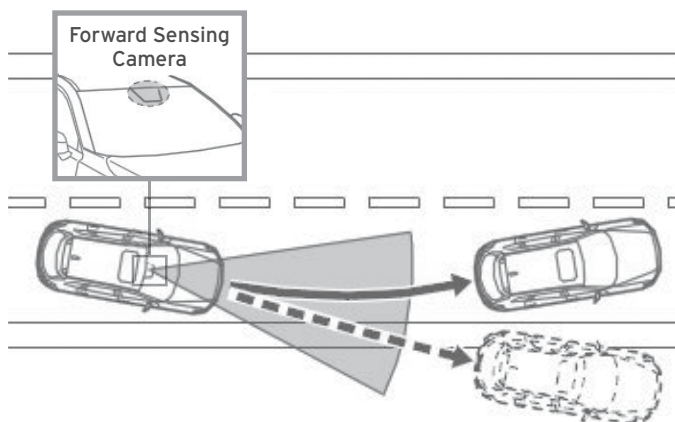

If the vehicle deviates from its lane at speeds above 37 mph, the system alerts the driver to provide steering assistance and uses the following indications to help the driver stay within the lines.

NOTE: The system operates in two modes, steering assistance ON and steering assistance OFF (warning only). Steering assistance ON/OFF can be changed in MAZDA CONNECT (p. 15).

INDICATOR LIGHT*	ACTIVE DRIVING DISPLAY	MULTI-INFORMATION DISPLAY	CONDITION
			The painted road lane lines are not recognized OR one side is recognized OR the vehicle speed is less than 37 mph.
			Both side painted road lane lines are recognized at vehicle speeds of 37 mph or more.
	 1: Warning (Flashes)		Warning is triggered when vehicle deviates from its lane (depending on personalization setting). 1. When equipped with Active Driving Display. 2. When not equipped with Active Driving Display.
	2: No Active Driving Display		
OFF indicator turns on.			LAS and LDWS OFF
* When the steering assistance is off, indicator light is NOT displayed. ** When the steering assistance is off, indicator light is NOT displayed.			

NOTE: Any driver vehicle input (e.g., turn signal, steering or acceleration, hands off, Traction Control System switch off) will cancel warning and steering assist.

The steering operation assist for the Lane-keep Assist System and Lane Departure Warning System can be turned off. Refer to the Owner's Manual for further information.

Use the LAS and LDWS switch to turn the system ON or OFF.



WARNING:

The Lane Departure Warning System (LDWS) is not an automatic driving system.

- The recognition ability of the Lane Departure Warning System (LDWS) is limited.
- Over-reliance on the system could lead to an accident.
- Always stay on course using the steering wheel and drive with care.

DISTANCE RECOGNITION SUPPORT SYSTEM

(IF EQUIPPED)

DISTANCE RECOGNITION SUPPORT SYSTEM (DRSS)

The Distance Recognition Support System (DRSS) measures the distance between your vehicle and the vehicle ahead. DRSS uses a radar sensor (front) while the vehicle speed is 19 mph or faster and indicates a recommended distance to maintain between the vehicles. Furthermore, if your vehicle approaches a vehicle ahead more closely than the appropriate distance to maintain between the vehicles, the vehicle ahead indication in the display is illuminated in white to advise the driver to keep a safe distance from the vehicle ahead.

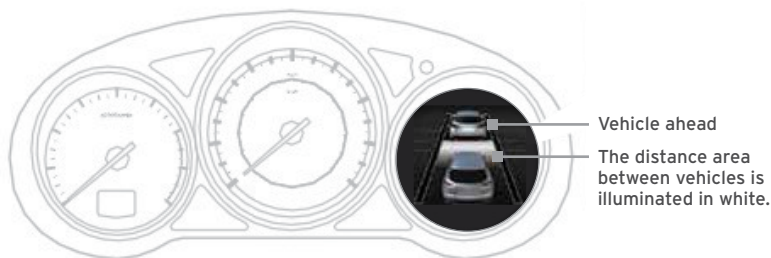

DISPLAY				
DISTANCE BETWEEN VEHICLES (at 25 mph)	About 82 ft	About 66 ft	About 49 ft	About 33 ft
DISTANCE BETWEEN VEHICLES (at 50 mph)	About 164 ft	About 131 ft	About 98 ft	About 65 ft

TRAFFIC SIGN RECOGNITION

(IF EQUIPPED)

TRAFFIC SIGN RECOGNITION (TSR) SYSTEM

The Traffic Sign Recognition (TSR) System helps prevent the driver from overlooking traffic signs and provides support for safe driving by displaying traffic signs on the Active Driving Display. TSR recognizes traffic signs by using the Forward Sensing Camera (FSC) or the navigation system while driving.

When vehicle speed exceeds the speed limit sign displayed in the Active Driving Display, the system notifies the driver with an indication in the Active Driving Display and a warning sound.

ACTIVE DRIVING DISPLAY GUIDE

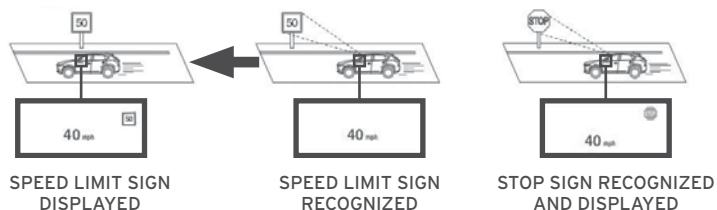

The TSR displays the SPEED LIMIT (including auxiliary signs), DO NOT ENTER , and traffic STOP signs.

NOTE: The Traffic Sign Recognition (TSR) System is not supported in some countries or regions. For more information, consult an Authorized Mazda Dealer. The Traffic Sign Recognition (TSR) System operates only if the navigation system SD card (Mazda Genuine) is inserted in the SD card slot. Consult an Authorized Mazda Dealer for details.

BLIND SPOT MONITORING SYSTEM

BLIND SPOT MONITORING (BSM)

The BSM system is designed to assist the driver by monitoring blind spots on the left and right sides of the vehicle in certain situations, such as lane changes.

WARNING:

BSM is only a supplementary system to help aid in monitoring blind spots; however, BSM has limitations. The system may not detect all vehicles, especially a motorcycle. Do not rely solely on the BSM. Relying solely on the BSM may cause an unexpected accident resulting in death or serious injury. Make sure to look over your shoulder before changing lanes.

- If your vehicle speed is 6 mph or more, the BSM will warn you of vehicles in the detection area by illuminating the BSM warning lights located on the left and right door mirrors.
- If you operate a turn signal in the direction of an illuminated BSM warning light, the system will also warn you with a beep (depending on personalization setting, p. 15) and a warning light will flash.
- BSM sensors are located under the left and right rear bumper areas. The BSM system may not operate properly if the rear bumper is dirty, so keep the rear bumper area clean and free of bumper stickers.



BSM Warning Light

NOTE:

- The BSM can assist the driver in confirming the safety of the surroundings, but is not a complete substitute.
 - The driver is responsible for ensuring safe lane changes and other maneuvers.
 - Always pay attention to the direction in which the vehicle is traveling and the vehicle's surroundings.
- The BSM does not operate when the vehicle speed is lower than about 6 mph.
 - The BSM system volume can be adjusted in personalization settings (p. 15).

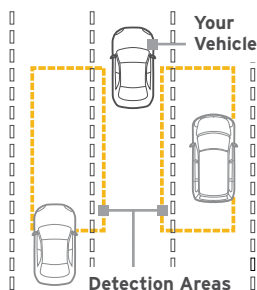

Refer to your Owner's Manual for complete details.

Turning BSM System Off:

Turning the BSM system off will turn off both the light and sound indicators. To turn the BSM System off, refer to the "Personalization Features" in the Owner's Manual.

The BSM OFF indicator in the instrument cluster will turn on to indicate the BSM system is off.

NOTE: Turning the BSM system will also turn off the Rear Cross Traffic Alert System.

REAR CROSS TRAFFIC ALERT

(IF EQUIPPED)

REAR CROSS TRAFFIC ALERT (RCTA)

The RCTA is designed to alert the driver of oncoming traffic when backing out of a parking spot. RCTA is active when your vehicle is in reverse and your vehicle speed is 0 mph to 9 mph.

When the BSM sensors detect a moving object, the RCTA will notify the driver with indicators and sound:

- Rear view monitor and outside mirror flashing indications.

Refer to your Owner's Manual for complete details.

WARNING:

RCTA is only a supplementary system to help aid when backing up; however, RCTA has limitations. The system does not detect all vehicles, especially motorcycles. Do not rely solely on the RCTA. Relying solely on the RCTA may cause an unexpected accident resulting in serious injury. Always back up slowly.

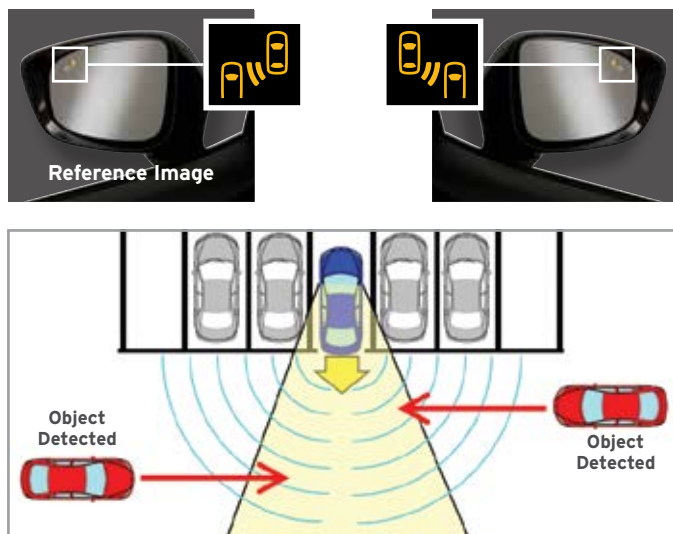

LIGHTING / TURN SIGNALS

LIGHTING CONTROL / TURN SIGNAL LEVER

AUTO (IF EQUIPPED)

The light sensor automatically determines when to turn the headlights on or off.



Turns tail, parking, and dashboard lights on.



Turns fog lights on only when headlights are on.



Turns tail, parking, dashboard, and headlights on.

THREE-FLASH SIGNAL

To signal a lane change, push the turn signal lever up or down halfway and release. The turn signal indicator will only flash three times. See Personalization Features to activate.



NOTE: The Daytime Running Lights (DRL) automatically turn on when the ignition is switched ON. To disable/enable this feature, see your Authorized Mazda Dealer.

NOTE: You can adjust the timing of the Auto Headlights OFF and the sensitivity of the Auto Light Control. See MAZDA CONNECT SETTINGS (p. 15).

WIPER / WASHER CONTROL

WINDSHIELD WIPER / WASHER CONTROL LEVER

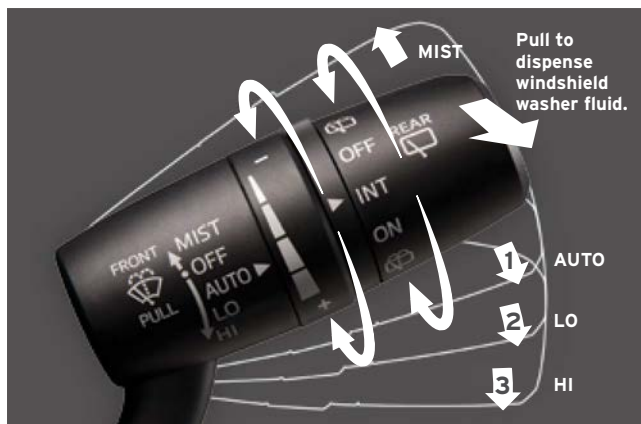

Windshield Wiper/Washer Control Lever

NOTE: Vehicles not equipped with AUTO wipers will have INT wipers. Set the lever to INT and choose an interval timing by rotating the ring between fast and slow.

AUTO (IF EQUIPPED)

The rain sensor senses the amount of rainfall and turns the wipers on or off. Rotating the inner ring clockwise (away from you) creates greater wiper sensitivity and makes the wipers move faster. The + position increases wiper speed. Rotating the inner ring counterclockwise (toward you) makes the wipers move slower. The - position decreases wiper speed.



REAR WINDOW WIPER/WASHER
(hold as desired)

INT

Intermittent

ON

Normal speed

CAUTION:

If the ignition is ON, turn the AUTO wipers OFF when going through a car wash or while cleaning or touching the windshield.

ADAPTIVE FRONT-LIGHTING SYSTEM

(IF EQUIPPED)

ADAPTIVE FRONT-LIGHTING SYSTEM (AFS)

AFS automatically turns the headlight beam to the right or left in conjunction with the direction of the steering wheel.

The AFS improves the direction of headlight illumination while cornering and only works when the vehicle is moving.

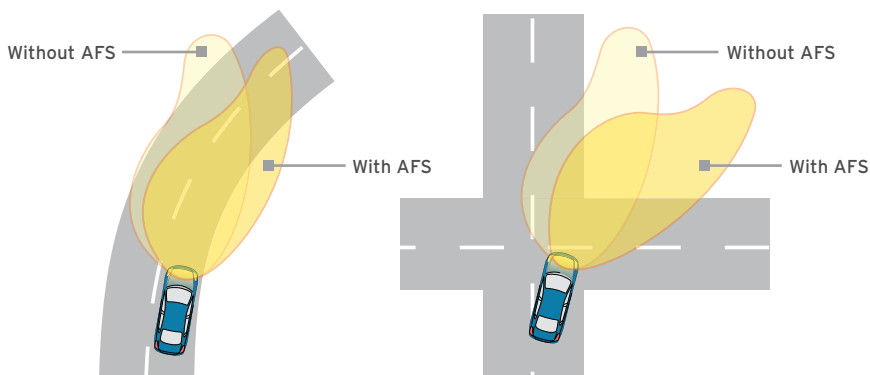

NOTE: With AFS, it is normal to see the headlights move and hear the sound of the headlight leveling motors at the front of the vehicle when the ignition is ON.

The system will need to be reset if the vehicle battery has been disconnected or the system fuse has been replaced. Please refer to your Owner's Manual for easy-to-follow resetting instructions.

VEHICLE SETTINGS

AFS can be turned off using Vehicle Settings in MAZDA CONNECT (p. 15).



HIGH BEAM CONTROL

(IF EQUIPPED)

HIGH BEAM CONTROL (HBC)

With HBC, the headlights are switched to high beams at speeds above 18 mph when there are no vehicles in front of your vehicle or approaching in the opposite direction.



The HBC system switches to low beam when:

- You are approaching a vehicle or a vehicle is approaching in the opposite direction.
- Driving on roads lined with street lights or well-lit cities and towns.
- At speeds lower than 12 mph.

To turn HBC on:

- 1 Turn the headlight switch to the AUTO position.
- 2 Push the headlight lever forward to the High Beam position.











NOTE: When the HBC system is on, the HBC indicator light in the instrument cluster will illuminate (green). The High Beam indicator light will turn on (blue) when the HBC system switches to high beam and will turn off when the HBC system switches to low beam.

AUDIO CONTROLS

(IF EQUIPPED)





AUDIO OPERATION

The following icons are displayed on the screen:

-  **SOURCES:** Displays the Audio menu to change the audio source (AM, FM, XM, Bluetooth®, Aha, Pandora, Stitcher, USB, AUX).
-  **Auto Memory:** Displays a list of the 10 strongest radio stations. Because station strength changes as you drive, select the Update Station List icon to re-scan for strong stations.
-  **Favorites:** Displays a list of your favorite AM, FM, and XM radio stations.
-  **HD Radio:** Switches HD Radio on/off.
-  **Scan:** Scans radio stations or songs (scanning stops at each one for five seconds). Select again to stop.
-  **Tuner:** Displays manual radio tuner.
-  **Tag:** Saves artist and title and sends them to your Apple device (for Apple devices with USB use only).
-  **Seek Previous/Next:** Selects previous or next receivable radio station or song. Push and hold to change the radio station continually.
-  **Settings:** Adjusts the audio quality level (bass, treble, etc.).



The following icons are displayed on the USB and BT music screens only:

-  **TRACK LIST:** Displays the track list.
-  **REPEAT:** Repeats the current song. Select again to stop.
-  **SHUFFLE:** Plays the songs in random order. Select again to stop.
-  **PLAY/PAUSE:** Plays and pauses the song.



New Mazda vehicles equipped with SiriusXM® Satellite Radio will receive an introductory four-month trial subscription that starts on the day the vehicle is sold. Enjoy over 150 channels including commercial-free music, plus sports, comedy, entertainment, news and much more.

To start listening to SiriusXM, select XM from audio sources, then push channel up and down to listen to over 150 channels. If you do not hear audio, please activate service to your radio with a simple refresh process.

- 1 Scroll to XM Radio, go to channel 1 and push "previous" to channel 0 to find your radio ID.
- 2 Go to siriusxm.com/refresh and enter radio ID or call 1-855-MYREFRESH (1-855-697-3373).

HD RADIO

HD radio has a special receiver which allows it to receive digital broadcasts (where available) in addition to the analog broadcasts it already receives. Digital broadcasts have better sound quality than analog broadcasts as digital broadcasts provide free, crystal clear audio.

When the HD radio button is ON (red), there could be a noticeable difference in sound quality and volume when a change from digital to analog signals occurs. If the sound quality and volume become noticeably diminished or cut off, select the HD button to turn HD radio OFF (not red).

AUDIO OPERATION USING VOICE

Audio operation and media selection can be done using voice recognition. Push the TALK  button on the steering wheel, wait for a beep, then say a command in a clear, natural voice (not too fast or too slow). Some common commands are listed below.

Play (and any of the following):

AM, FM, XM, Bluetooth®, Aha, Pandora, Stitcher, USB, AUX

Play or Resume/Pause or Stop/Next or Previous Play (and any of the following when connected to USB port): Song, Playlist <playlist name>, Artist <artist name>, Album <album name>, Genre <genre name>, Folder <folder name>

Tune to Station: <FM or AM then frequency>

Tune to Channel Number (XM)

NOTE: Push the TALK  button and say “Help” at any time to hear a list of available commands.

BLUETOOTH® (BT) AUDIO

Bluetooth®-enabled phones and audio players provide an opportunity to play music through the audio system without wires.

Some phone models do not support all features. Go to www.mazdausa.com/mazdaconnect or contact (800) 430-0153 for further assistance or to report a phone/audio device concern.

NOTE: To use BT audio, make sure the musical icon is displayed by going to  Bluetooth® in Device Settings. Some Bluetooth® audio devices need a certain amount of time before the icon is displayed.

PLAYING BLUETOOTH® AUDIO

- 1 Make sure the BT audio device is paired to your vehicle.
 - 2 Turn on the BT audio device and open the audio app on the device.
 - 3 Select Bluetooth® from Sources. See your Owner's Manual for further information on Pandora, Aha, and Stitcher operations.
-

NOTE: In order to use Aha, Pandora and Stitcher as audio sources, the app must be installed on your phone. These apps stream music using your data plan and listening to them counts toward your monthly cellular data usage.

AUDIO USB and AUX INPUTS

PORTABLE AUDIO PLAYER INTEGRATION USING THE USB PORT OR AUX JACK

Your vehicle is equipped with one or two USB ports (depending on vehicle grade) and an AUX jack in the center console that allow you to play your iPod, USB device, or portable audio player through the vehicle's audio system. Learn the system when parked and do not let it distract you while driving.

Locate the USB port or AUX jack.

- 1 Connect your portable audio player into the USB port or AUX jack.
- 2 Turn the vehicle's audio system on.
- 3 Audio Controls: Select AUX or USB from the Sources menu.
- 4 USB Port: Use the vehicle's audio system or steering wheel controls to control the connected USB device.
- 5 AUX Jack: Use the portable audio player controls to play music.

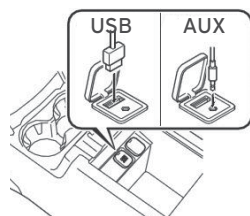

TYPE "A"

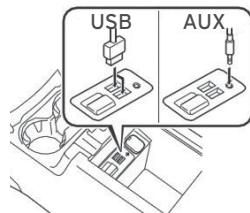

TYPE "B"

IMPORTANT: Set the volume level on your portable audio player to the highest level before distortion starts, then use the vehicle's audio system to adjust the volume.

NOTE: You will need an audio cable with an 1/8 inch (3.5 mm) mini stereo plug (available as a Genuine Mazda accessory) to connect your portable audio player into the AUX jack.



REAR SEAT USB CHARGING PORTS

The rear seat console has two 2.1 amp USB charging ports that charge your USB-powered device so that you can enjoy your portable media in the rear seat. These rear seat USB charging ports cannot be used for audio playback through the Mazda Connect system. Refer to the Owner's Manual for additional information.



REAR SEAT USB PORTS

NOTE: When using a USB memory stick, the system plays the first audio file when restarting the vehicle. It does not start where it left off when turning off the engine.

12 VOLT ACCESSORY SOCKETS

The accessory sockets are on with the ignition in ACC or ON. There is an accessory socket located at the front and rear of the vehicle.



CENTER ACC SOCKET

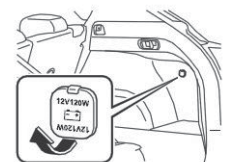

REAR ACC SOCKET

NOTE: When using the accessory socket, make sure to disconnect any device from it when turning off the ignition; otherwise, the vehicle's battery could go dead.

AUTOMATIC CLIMATE CONTROL

(IF EQUIPPED)



DRIVER'S TEMPERATURE CONTROL DIAL

AUTO ON: Push the dial to turn automatic air conditioning system on (AUTO ON and A/C indicator on). The airflow mode, fan speed and air conditioning will be automatically controlled in accordance with the set temperature.

PASSENGER'S TEMPERATURE CONTROL DIAL

Push to turn DUAL mode ON/OFF.

- With DUAL mode ON (indicator on), rotate the dial to set the passenger's side temperature separate from the driver's side.
- With DUAL mode OFF (indicator off), the driver controls the temperature setting on both sides.

NOTE: A/C indicator will illuminate when AUTO ON is active. The air conditioning cycles on/off as necessary to maintain the set temperature. The A/C may operate even while heating is desired - this is to prevent excess humidity and fogging.

Automatic climate control will allow you to maintain individual preset cabin temperatures for the driver and passenger when DUAL is pushed.

Automatic temperature control always works even if the AUTO indicator turns off by changing the fan speed or airflow mode.

 Push the fan (+) and (-) buttons to select the desired fan speed.

A/C Push to manually turn air conditioning on or off.

OFF Push the OFF switch to turn the climate control system off.

 Push to receive fresh air in the cabin.

 Push to recirculate cabin air.

 Push to select the following airflow mode:

 Dashboard vents

 Dashboard and floor vents

 Floor vents

 Defroster and floor vents

 Push to defrost the windshield.

 Push to defrost the rear window.

WINDSHIELD WIPER DE-ICER

The thermal filaments in the windshield heat up to allow the wipers to move freely in icy conditions. The windshield wiper de-icer operates in conjunction with the rear window defogger.



To turn on the windshield wiper de-icer, switch the ignition ON and press the rear window defogger switch.

INSTRUMENT CLUSTER

















Type "A" Instrument Cluster (with LCD multi-information display) shown.

Refer to Owner's Manual for type "B" instrument cluster (without multi-information display) information.

GLOSSARY OF WARNING AND INDICATOR LIGHTS



IMPORTANT: When your Mazda Connect display setting is set on "AUTO", the instrument cluster and display may become dimmer when the headlights are on. If the display and instrument cluster become too dim or too bright when the headlights are on, simply rotate the dimmer knob located on your instrument cluster to adjust the brightness.

- | | |
|---|---|
|  TCS OFF Traction Control System OFF |  Master Warning |
|  Low Engine Oil Pressure |  Smart Brake Support and Smart City Brake Support
Flashing Red: SBS and SCBS are operating. |
|  Traction Control System/Dynamic Stability Control
On: TCS/DSC malfunction
Flashing: TCS/DSC operating |  Smart Brake Support and Smart City Brake Support OFF
Amber: SBS and/or SCBS malfunction. |
| PRNDM Shift Position |  Tire Pressure Monitoring System Warning* (p. 7)
On/Warning Beep: Low tire pressure in one or more tires.
Flashing: TPMS malfunction. |
|  Advanced key detected |  Security |
|  Advanced key not detected (p. 5) |  Cruise Main ON (Amber)/
Cruise Set ON (Green) |
|  Power Steering Malfunction |  AT Automatic Transaxle Warning |
|  Airbag/Front Seat Belt Pretensioner System Malfunction |  Lights ON (Exterior) (p. 35) |
|  Turn Signals/Hazard Warning | |
| 4WD All-Wheel Drive ON
Flashing: Stop vehicle/
tow to Mazda dealer. | |
|  Check Engine | |

ENGINE COOLANT TEMPERATURE LIGHTS

Since this vehicle does not use an engine coolant temperature gauge, red and blue engine coolant temperature lights are used to indicate high and low coolant temperature.



Red Coolant Temperature

FLASHING: Engine is starting to run hot. Drive slowly to reduce engine load.

ON: Engine is overheating. Safely pull over to the side of the road and turn the engine off. Refer to the Owner's Manual for more information.



Blue Coolant Temperature

ON: Engine coolant is cold and no warm air is available for heater/defroster.

OFF: Engine coolant is warm and warm air is available for heater/defroster. The light may stay on for a few minutes after start-up when the engine is cold, but the vehicle can be driven with the light on or off.



TYPE B
Information Display

TPMS NOTE: Low ambient temperature and/or high altitude causes tire pressures to drop and may turn the TPMS warning light on. If the warning light comes on, check the tire pressure and fill the tires as soon as possible, preferably before moving the vehicle and warming up the tires. Tire pressure should be checked when the tires are cold.

- | | | | |
|--|--|--|--|
| | Blind Spot Monitoring OFF
(p. 33) | | Low Washer Fluid Level |
| | Seat Belt Unbuckled/Malfunction | | Anti-lock Brake System Malfunction |
| | Headlight High Beams ON | | Low Fuel Level |
| | Electric Parking Brake | | Check Fuel Cap |
| | Brake Warning
Parking brake on/
low brake fluid/malfunction | | Perform Maintenance |
| | Adaptive Front-lighting System OFF (p. 37) | | High Beam Control ON |
| | Charging System Malfunction | | Mazda Radar Cruise Control ON (White) SET (Green) |
| | Mazda Radar Cruise Control Stop & Go Function and AUTOHOLD | | SPORT Mode ON |
| | Door Ajar | | LED Headlight |
| | Liftgate Ajar | | Brake Pedal Operation Demand |
| | | | Lane-keep Assist System and Lane Departure Warning System |

See your Owner's Manual for more details and explanations.

- 1 Rotate the knob to adjust the brightness of the instrument cluster and other dashboard illuminations.
- 2 Push to toggle between trip meter (A & B). When a trip meter is selected, push and hold to reset to zero.

AUTOMATIC TRANSMISSION

(IF EQUIPPED)

MANUAL SHIFT MODE

Manual Shift Mode gives you the feel of driving a manual transmission by allowing you to manually shift to control engine rpm and torque when more control is desired.

To Use Manual Shift Mode:

Shift the lever from D to M.

To Shift Up To A Higher Gear:

Tap the shift lever back (+) once.

To Shift Down To A Lower Gear:

Tap the shift lever forward (-) once.



DRIVE SELECTION

SPORT mode will choose a lower gear for increased acceleration response. It will also hold a lower gear/delay upshifting when it detects you are braking or cornering because it anticipates that you will want to accelerate out of the turn more quickly.

Push the SPORT button to switch to SPORT mode and the SPORT mode indicator light in the instrument cluster turns on. Push again to turn off.



NOTE: If the SET button of the cruise control is pushed while in SPORT mode, SPORT mode is switched off. SPORT mode cannot be turned on or off when cornering.

- When the ignition is switched OFF, SPORT mode is also switched off.
- Fuel consumption increases slightly when using SPORT mode.

FUEL ECONOMY

To achieve the best fuel economy, visit www.fueleconomy.gov for more information.



ACTIVE ADAPTIVE SHIFT (AAS) CONTROL

AAS will automatically adjust how and when the transmission shifts gears based on road conditions and your driving style. The transmission may stay in a lower gear longer than usual when going up or down hills or driving around corners. This feature gives you better control and a more connected driving experience.

ACCELERATOR PEDAL KICKDOWN SWITCH

The accelerator pedal is equipped with a kickdown switch designed to allow optimal engine performance while accelerating.

When you depress the accelerator 90% of the way, you will feel an increase in resistance. Push harder, and you will feel a click as you activate the kickdown switch. The transmission will usually downshift (depending on engine speed) and the engine will switch to maximum power mode. This kickdown switch function is the same in both Manual Shift Mode and in "D".

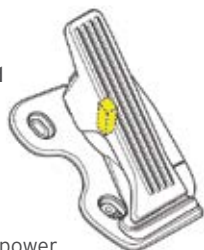

HILL LAUNCH ASSIST (HLA)

HLA helps assist you when accelerating the vehicle from a stop while on a hill or slope.

When the brake pedal is released and the accelerator pedal is pushed, HLA prevents the vehicle from rolling forward or backward. It operates on a downward slope when the shift lever is in the reverse (R) position and on an upward slope when the shift lever is in a position other than the reverse (R) position.

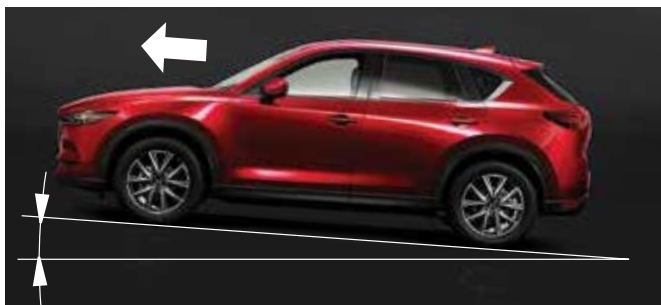

IMPORTANT: The HLA system will hold the vehicle for a maximum of two seconds while the driver is changing from the brake pedal to the accelerator pedal.

AUTO-DIMMING MIRROR

(IF EQUIPPED)

AUTO-DIMMING MIRROR



- Auto-dimming will automatically darken your rearview mirror to reduce headlight glare from vehicles behind you.
- Auto-dimming is activated every time the engine is started.



NOTE: In addition to the auto-dimming mirror's rear light sensor, there is also a front light sensor (not shown). Do not place or hang any objects over the front or rear mirror light sensors; otherwise, the auto-dimming mirror will not operate properly.

HOMELINK®

(IF EQUIPPED)

HOMELINK®



- This feature provides a convenient way to replace up to three transmitters such as garage door openers, home lighting remotes and other radio frequency devices.
- Refer to your Owner's Manual for complete programming details.



NOTE: Genuine Mazda Accessory Auto-Dimming Mirror with Compass and HomeLink® is available at your Authorized Mazda Dealer. Refer to your Owner's Manual for further information.

ELECTRIC PARKING BRAKE / AUTOHOLD

ELECTRIC PARKING BRAKE

Applying the electric parking brake:

The electric parking brake can be applied regardless of the ignition switch position.

- 1 Depress the brake pedal.
- 2 Pull the electric parking brake switch UP to apply the brake.

Releasing the electric parking brake:

The electric parking brake can be released while the ignition is switched to ON or while the engine is running.

- 1 Depress the brake pedal.
- 2 Push the electric parking brake switch DOWN to release the brake.

Electric parking brake automatic release:

The electric parking brake is released automatically when the accelerator pedal is depressed and all of the following conditions are met:

- The engine is running.
- The driver's door is closed.
- The driver's seat belt is fastened.
- Selector lever is in the D, M or R position.

AUTOHOLD

The AUTOHOLD feature holds the vehicle's brakes on, even if you take your foot off the brake pedal. This function can be best used while sitting still in traffic or when waiting for a traffic light to turn green.

- 1 Once completely stopped, push the AUTOHOLD button to turn the system on (the green "HOLD" indicator light will come on).
- 2 Release your foot from the brake pedal.
- 3 Once you push the accelerator pedal again, the brakes will automatically release.

NOTE: For more information about the AUTOHOLD feature, refer to your Owner's Manual.



PERSONALIZE YOUR CX-5

PERSONALIZE YOUR CX-5 WITH GENUINE MAZDA ACCESSORIES

Go to www.MyMazda.com, then select "Accessories" below the MyMazda Home header for a complete listing of available accessories for your CX-5.

WWW.MYMAZDA.COM – THE OFFICIAL SITE FOR MAZDA OWNERS

Register today on www.MyMazda.com—the ultimate destination for Mazda owners. Once registered, you'll be able to take advantage of benefits exclusively for Mazda owners:

- Insider access to exclusive events and promotions
- Personalized maintenance schedules
- Zoom-Zoom Owner Magazine
- Warranty information and online Owner's Manuals
- Wallpaper, videos and other fun stuff
- Accessories specifically designed for your vehicle
- Car Care Discount Coupons available from your Authorized Mazda Dealer



VISIT AND REGISTER AT WWW.MYMAZDA.COM TODAY!

The following apps are available for iPhone® and Android smartphones:

MAZDA ASSIST APP

Provides roadside assistance 24 hours a day, 365 days a year. Toll-free number 1-800-866-1998 can also be used for roadside assistance.

MYMAZDA APP

Keep track of your Mazda from the palm of your hand with these features:

- Maintenance schedule
- Service coupons
- Promotional alerts
- Service history
- Recall information
- Parked car locator
- Scan VIN barcode capability when registering a vehicle
- Mazda Dealer locator
- Update owner profile
- Link to Mazda Assist

The apps can be downloaded, free of charge, from the App store for the iPhone® and Google Play (Android Market) for Android-powered devices. After downloading the app, customer name, email, smartphone number and VIN are required.



Free Mazda Assist app
iPhone® and Android



Free MyMazda app
iPhone® and Android



CUSTOMER DELIVERY CHECKLIST

MyMazda App Overview:

- Download MyMazda App on customer's phone
- Register customer in MyMazda
- Review sections of App ending with "how to" section

Vehicle Presentation:

Exterior

- Door request switch operation
- Power liftgate operation*

Interior

- Show customer how to adjust seats, side mirrors, and steering wheel
- Review controls and switch locations (lights, wipers, climate control, etc.)
- Multi-Information display operation*

MAZDA CONNECT Infotainment System Overview:

Settings

- Review **Display** settings
- Set heads up display height
- Review **Safety** settings
- Set Blind Spot Monitoring System volume
- Set audio **Sound** settings
- Set **Clock**
- Review **Vehicle** settings
- Set door lock settings
- Set turn signal settings
- Set lighting settings
- Review **Devices** settings
- Review system **Settings**

Communications

- Explain tool bar options
- Pair a phone
- Make a call
- Review voice commands for phone

Additional vehicle and owner resources can be found at:
www.mazdausa.com/owners & www.MyMazda.com

* If equipped

Entertainment

- Explain tool bar options
- Save customer's favorite radio stations
- Play Bluetooth audio
- Play Pandora, Stitcher and/or Aha

Navigation*

- Explain tool bar options
- Plan a route using voice recognition

Safety (i-ACTIVSENSE):

- Blind Spot Monitoring System*
- Rear Cross Traffic Alert*
- Mazda Radar Cruise Control*
- Smart City Brake Support*
- Smart Brake Support*
- Distance Recognition Support System*
- Traffic Sign Recognition*
- Lane-keep Assist/Lane Departure Warning*

Presentation of Owner's Materials:

- Owner's Manual
- Warranty Information Booklet
Warranty Start Date: _____
Customer Initial: _____
- Perform Service Introduction
 - Suggested service intervals and set first appointment

SALES CONSULTANT	DATE	CUSTOMER	DATE

DEALERSHIP	DATE
SALES CONSULTANT	CUSTOMER'S NAME
VIN	E-MAIL

SCHEDULED MAINTENANCE RECORD

1	MILEAGE	DEALERSHIP
	REPAIR ORDER NUMBER / DATE	AUTHORIZED SIGNATURE

2	MILEAGE	DEALERSHIP
	REPAIR ORDER NUMBER / DATE	AUTHORIZED SIGNATURE

3	MILEAGE	DEALERSHIP
	REPAIR ORDER NUMBER / DATE	AUTHORIZED SIGNATURE

4	MILEAGE	DEALERSHIP
	REPAIR ORDER NUMBER / DATE	AUTHORIZED SIGNATURE

5	MILEAGE	DEALERSHIP
	REPAIR ORDER NUMBER / DATE	AUTHORIZED SIGNATURE

6	MILEAGE	DEALERSHIP
	REPAIR ORDER NUMBER / DATE	AUTHORIZED SIGNATURE

7	MILEAGE	DEALERSHIP
	REPAIR ORDER NUMBER / DATE	AUTHORIZED SIGNATURE

8	MILEAGE	DEALERSHIP
	REPAIR ORDER NUMBER / DATE	AUTHORIZED SIGNATURE



2017CX5OWNERSMANUAL.MAZDAUSA.COM

GENUINE MAZDA SERVICE

Because you and your Mazda deserve the best

Your new Mazda deserves nothing less than the very best. To keep it running like new for years to come, trust the experts at your local Authorized Mazda Dealer. Simply bring your vehicle in for your scheduled maintenance and any needed repairs.*

At participating Mazda Full Circle Service Centers,** our technicians will automatically perform a complimentary Full Circle inspection on your vehicle and issue a detailed report card at every visit. This is designed to help you keep track of your Mazda's critical operating condition. Our factory-trained technicians know your vehicle inside out and use Genuine Mazda Parts, giving your vehicle the optimum care and maintenance it requires to run with flawless precision.

Remember to further enhance your driving experience, visit your local Mazda Service Center for your scheduled maintenance. It's also the place where you can find a wide variety of tires, parts and accessories that are just right for your vehicle.

* See your vehicle's scheduled-maintenance program for details.

** To learn more about Mazda Full Circle Service, visit www.MazdaUSA.com, click on the "Owners" tab, scroll down and click on "Service & Parts", and scroll down to "Mazda FULL CIRCLE SERVICE".

CUSTOMER EXPERIENCE CENTER: 1.800.222.5500

ROADSIDE ASSISTANCE CONTACT: 1.800.866.1998



COMPLIMENTARY MAZDA FULL CIRCLE SERVICE INSPECTION

We're committed to providing expert Mazda service

You love to drive your Mazda, and we love to service your Mazda. With our Full Circle Service, we'll give your vehicle a COMPLIMENTARY MULTI-POINT INSPECTION.

Your Mazda will receive a thorough review of its most crucial components.



Print 1 • March 2017 • Printed in U.S.A. • 9999 95 050C 17SS

© MAZDA NORTH AMERICAN OPERATIONS

