

Mazda CX-9



Link to CX-9 Digital Owner's Manual:
<http://2016CX9ownersmanual.MazdaUSA.com>

Driver's View



1

¹ To provide a better view of the instrument cluster, adjust the steering wheel up or down/in or out.



**ILLUMINATION
DIMMER/
TRIP METER**
(P. 44)

**MULTI-
INFORMATION
DISPLAY**
(P. 6)

**WIPER/
WASHER**
(P. 34)

**MAZDA CONNECT
INFOTAINMENT SYSTEM**
(PP. 11-14)

CLOCK
(P. 14)

**START/STOP
ENGINE BUTTON**
(P. 4)

**HAZARD
WARNING**

**SEAT
WARMERS**

CLIMATE CONTROL
(PP. 41-42)

**PASSENGER AIRBAG
OFF INDICATOR²**

² **PASS
AIRBAG OFF**

This indicator light turns on to remind you that the front passenger's front/side airbags and seat belt pretensioner will not deploy during a collision. The reason for this is that the sensor has determined that an adult is not sitting in the front passenger seat.

NOTE: If a smaller adult sits on the front passenger seat, the sensors might detect the adult as being a child depending on the person's physique and may deactivate the front passenger's front/side airbags and seat belt pretensioner. Always wear your seat belt and secure children in the rear seats in appropriate child restraints. See the Owner's Manual for important information on this safety feature.







ADVANCED KEYLESS ENTRY SYSTEM (if equipped)

This system allows you to lock and unlock the doors without taking the key out.

While Carrying the Advanced Key...

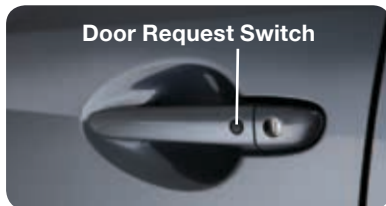
- Unlock the driver's door by pushing the driver's door request switch once.
- Unlock all doors by pushing the driver's door request switch once or twice (depending on personalization setting) OR by pushing the passenger's door request switch once.
- Lock all doors (and liftgate) by pushing any request switch once.



CAUTION: RED KEY indicator light  may illuminate if advanced key is placed in the cup holder. The key may sometimes not be detected in the cup holder.

CAUTION:

- Make sure vehicle is OFF and take the vehicle key with you when leaving the vehicle.
- When locking doors using inside door switches, be careful not to leave the key inside the vehicle.

NOTE: Refer to your Owner's Manual for additional details about "Personalization Features".

NOTE: Vehicles equipped with the Advanced Keyless Entry System and the Keyless Entry System both use the same type of keyless entry transmitter. However, only vehicles equipped with the Advanced Keyless Entry System allow you to lock and unlock the doors with the door request switches (without taking the key out of your purse or pocket). Vehicles equipped with the Keyless Entry System do not have request switches on the doors/liftgate. To lock and unlock the doors, the corresponding transmitter button must be pushed.

Starting the Engine

STARTING THE ENGINE WITH ACCELERATED WARM-UP SYSTEM (AWS)

The CX-9 is equipped with SKYACTIV combustion technology. This technology includes AWS (Accelerated Warm-up System) for optimal emission performance during cold starting conditions.

While Carrying the Key...

- **Start the engine** by pushing the START/STOP ENGINE button while pushing the brake pedal.

What will you notice? On start-up, the engine speed and sound are higher (1500 RPM) for less than one minute to quickly bring the catalyst to efficient operating temperature. The RPM will reduce to idle once the temperature is achieved. This is normal engine operation under cold-start conditions.

What does this do? This heats up the catalytic converter faster to reduce emissions and allows Mazda to use an exhaust header on the engine (to improve efficiency and horsepower).

- **Shut the engine OFF** by making sure the vehicle is in Park and setting the parking brake, then push the START/STOP ENGINE button.
- **Activate Accessories (ACC)** by pushing the START/STOP ENGINE button once without pushing the brake pedal.
- **Turn the ignition to the ON position** by pushing the START/STOP ENGINE button twice without pushing the brake pedal.

NOTE: You can drive the vehicle during AWS activation, there is no need to wait.

Emergency Engine Stop

Pushing and holding the START/STOP ENGINE button or repeatedly pushing the button while the engine is running will turn the engine OFF. Use only in case of an emergency.

NOTE: The engine may not start if the key cannot be detected. The Key Indicator Light may flash **RED** or "Key not detected" may be displayed if the key is placed in the cup holder.

If the START/STOP ENGINE button indicator light flashes **AMBER**, this could indicate a problem with the engine starting system. You may not be able to start the engine or switch the ignition to ACC or ON. Have your vehicle inspected at an Authorized Mazda Dealer as soon as possible.



Tire Pressure Monitor System

TIRE PRESSURE MONITORING SYSTEM (TPMS)

For your safety, the CX-9 is equipped with TPMS that detects low tire pressure in one or more tires. If the tire pressure starts getting low in one or more tires, the system alerts the driver by turning on a light in the instrument cluster (pp. 43-44) and sounding an alarm.

What to do? Don't ignore the TPMS warning light. Stop and check your tire pressure (when tires are cold) and inflate them to the proper pressure. Properly inflated tires are safer, last longer, and increase fuel economy.

In the following cases, the TPMS must be “initialized” so the system can operate normally.

- The tire pressure is adjusted (up or down) in one or more tires.
- A tire rotation is performed.
- Any tire or wheel is replaced.
- The vehicle's battery is disconnected, replaced or completely dead.

Initialization Process (TPMS Warning Light is Illuminated)

- 1 Park the vehicle in a safe place and firmly apply the parking brake.
- 2 Let the tires cool, then adjust the tire pressure to the specified pressure (see tire label located on the driver's side door jamb area) on all four (4) tires.
- 3 Switch the ignition ON, but leave the vehicle parked.
- 4 Push and hold the TPMS “Set Switch” (left side of dash) until the TPMS warning light  in the instrument cluster flashes twice and a beep sound is heard once.



CAUTION: If the TPMS “Set Switch” is pushed without adjusting the tire pressure, the system cannot detect the normal tire pressure. The TPMS warning light may not turn on, even if the tire pressure is low, or it may turn on if the tire pressure is normal.

NOTE: Drastic changes in temperature or altitude can affect the pressure in the tires, causing the TPMS warning light to turn on. Verify the tire pressures when driving through extreme temperature or altitude changes.

Multi-Information Display

MULTI-INFORMATION DISPLAY (if equipped)

Toggle the INFO button on the steering wheel up or down to cycle through different types of information.



Push the center of the INFO button to make selections.



Multi-Information Display

Push and hold the center of the INFO button to reset the currently displayed feature such as Average MPG.

DISPLAY SCREENS

Current Fuel Economy,
Trip Meter A,
Average Fuel Economy,
Outside Temperature,
Odometer,
Distance-to-Empty,
Fuel Gauge

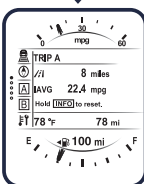

Push INFO button

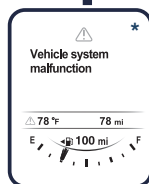

Warning Message,
Outside Temperature,
Odometer,
Distance-to-Empty,
Fuel Gauge
**Displayed only when a warning occurs.*

Push INFO button ↓

Current Fuel Economy,
Trip Meter B,
Average Fuel Economy,
Outside Temperature,
Odometer,
Distance-to-Empty,
Fuel Gauge

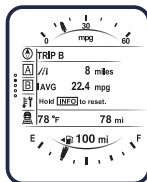

↑ Push INFO button



Compass,
Outside Temperature,
Odometer,
Distance-to-Empty,
Fuel Gauge
***Displayed only while vehicle is being driven.*

Push INFO button ↓

Engine Coolant,
Temperature Gauge,
Maintenance Monitor,
Outside Temperature,
Odometer,
Distance-to-Empty,
Fuel Gauge

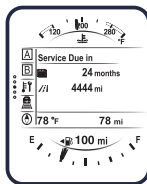

↑ Push INFO button



i-ACTIVSENSE,
Outside Temperature,
Odometer,
Distance-to-Empty,
Fuel Gauge

Push INFO button

NOTE: New screen items are in **bold**

Power Liftgate

POWER LIFTGATE (if equipped)

The power liftgate can be changed to open to your desired position.

To open or close the liftgate from inside the vehicle: Push the power liftgate button on the left side of the dash.



To open the liftgate from outside the vehicle:

Open the power liftgate using the electric liftgate opener or advanced keyless remote.

To close the liftgate from outside the vehicle:

Close the power liftgate by pushing the power liftgate close switch or advanced keyless remote.

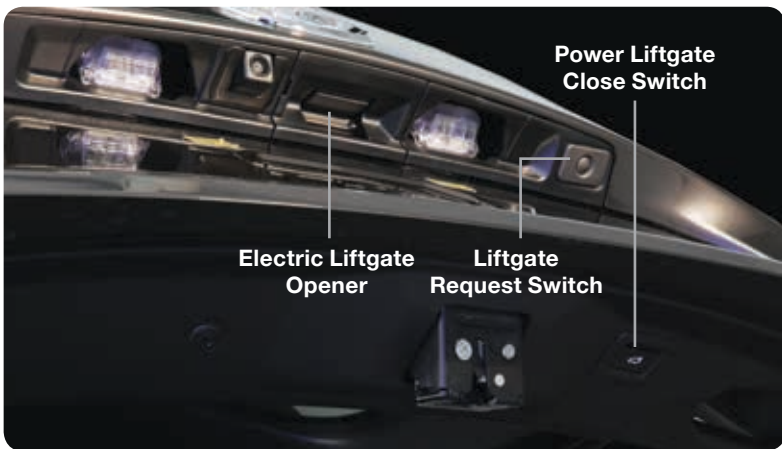

Push the **Liftgate Request Switch** to lock or unlock the vehicle.

To change how far the liftgate will open: Stop the liftgate at the desired position. Then push and hold the power liftgate close switch for about three seconds. A beep will sound two times to indicate that the position change has been completed.

NOTE: The power liftgate cannot be set less than halfway open.

To reset to the original position: Open the liftgate and push and hold the power liftgate close switch for about seven seconds. A beep will sound three times to indicate that the reset has been completed.

Ambient Lights

AMBIENT LIGHTS (if equipped)

Ambient lights can be adjusted in the Personalization Features. The factory setting is medium, but can be made brighter, darker, or turned off. To do so:

- 1 Make sure the parking lights or headlights are turned on.
- 2 Go to "Personalization Features" and select Setting.
- 3 Select Vehicle, and then select Lighting.
- 4 Select Ambient lights and choose between bright, medium, dark and off.

Ambient lights illuminate around the console, the power window switch, and enhance the visibility of the front console.

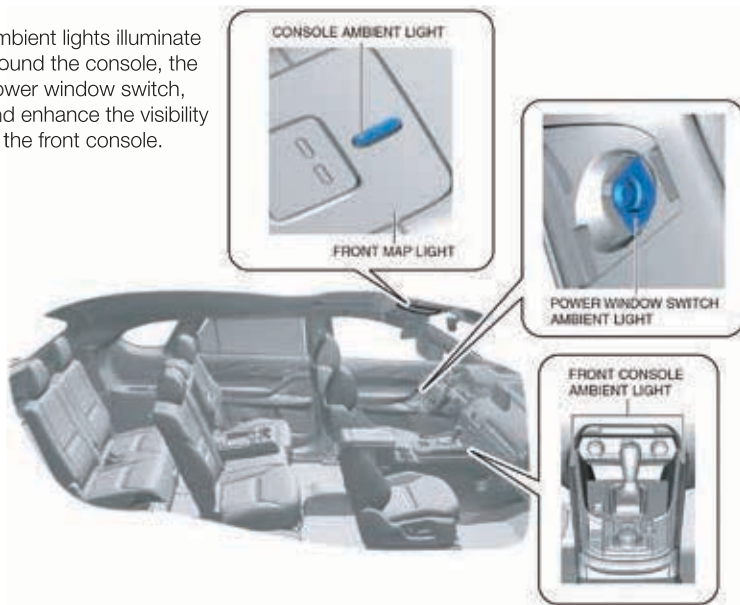

NOTE: When set to OFF, the ambient lights remain turned off regardless of whether or not the parking lights or headlights are on or off.



SECOND ROW SEATS

The second row seats can be folded, tilted, and/or moved forward or backward.

1 Seat slide (forward-backward adjustment)

To move a seat forward or backward, raise the lever and slide the seat to the desired position, then release the lever.

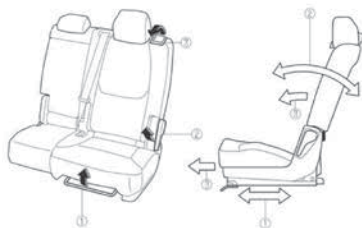

2 Seat recline

To change the seatback angle, lean forward slightly while raising the lever, then lean back to the desired position; release the lever.

3 Third row seat access

To access to the third-row seats, pull the lever up and fold the seatback and slide it forward.

Entering/exiting the third row seat with child-restraint system installed (Right-side seat only)

Access to the third-row seat is possible even when a child-restraint system is installed to the second-row seat.

Pull the lever up to lower the front side of the seat and slide the seat forward.



Split folding the second row seats

To create a flat luggage compartment space, fold the seatbacks forward.

- 1 Lower the head restraints all the way down.
- 2 Raise the lever on the side of the second-row seat to fold the seatback down.

THIRD ROW SEATS

To create a flat luggage compartment space, fold the seatbacks forward.

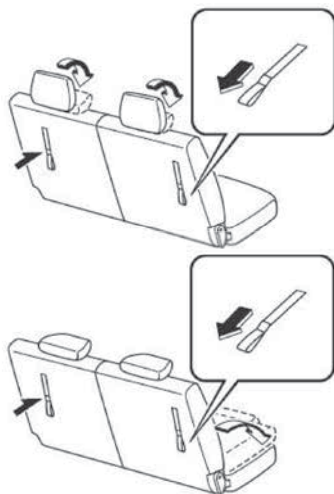
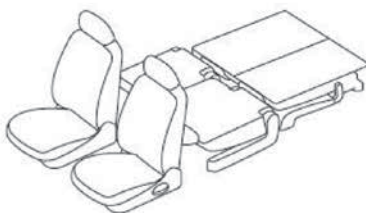

Folding the seatbacks (with strap)

- 1 Slide the second-row seat all the way forward.
- 2 Pull the strap to fold down the head restraint.
- 3 Pull the strap further to fold the third-row seat.

Folding the seatbacks (with lever)

- 1 Slide the second-row seat all the way forward.
- 2 Lower the lever to fold down the head restraint.
- 3 Lower the lever further to fold the third-row seat forward.

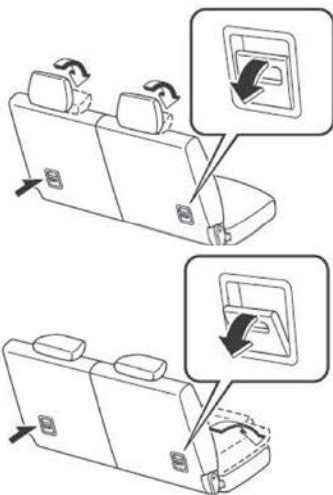

MAZDA CONNECT Infotainment System

MAZDA CONNECT INFOTAINMENT SYSTEM

MAZDA CONNECT is designed to be operated using one of the following **three interfaces**:

- 1 The commander switch (p. 21).
- 2 The touchscreen (if the vehicle is not moving).
- 3 Voice command (p. 22).



Applications

This section is about vehicle maintenance and driver's information.



Entertainment

This section is about music.

FM/AM/XM/
Bluetooth®/USB/
Pandora/Stitcher/
aha/CD/AUX
are available.

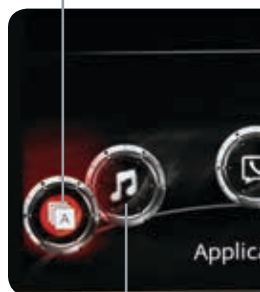



NOTE:

- In the interest of safety and to avoid distracted driving, the touchscreen is disabled at speeds over 5 mph. Use the commander switch or voice command to operate the infotainment system.
- You can touch and tap, slide or swipe the touchscreen, but cannot pinch to zoom or expand.



Communication

This section is about Phone Call and Text Message (SMS). A Mazda Connect compatible Bluetooth mobile phone needs to be connected.



Settings

This section lets you customize many things. See pages 13-14 for more information.



Navigation

Mazda Navigation SD card is required. Compass is displayed otherwise.



To purchase SD card, please visit nearest Mazda Dealer. For issues with MAZDA CONNECT, visit www.mazdausa.com/mazdaconnect or call 800-430-0153.

MAZDA CONNECT Settings

MAZDA CONNECT SETTINGS

To view the different setting screens:

- 1 Move the commander switch to the left or right to change tabs.
- 2 Turn the commander switch to scroll down the list.
- 3 When the desired tab is highlighted, push the commander switch.

NOTE: If there is a scroll bar on the right side, there are more items farther down.

Use this to turn off the display.
Touch the screen or use the commander switch to turn back on.

Use system to change the brightness of the display between Day (bright), Night (dim), and AUTO (switches from Day to Night when headlights are turned ON). See illumination dimmer (p. 44).

Display Settings

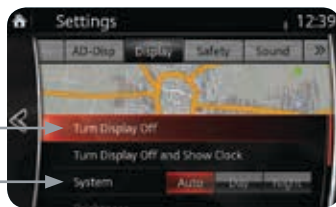

Sound Settings



Bluetooth Device Settings

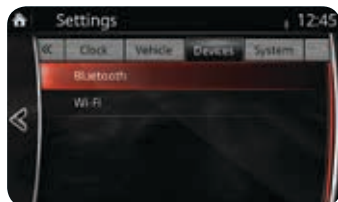

Vehicle Settings



System Settings



Active Driving Display Settings



Clock Settings

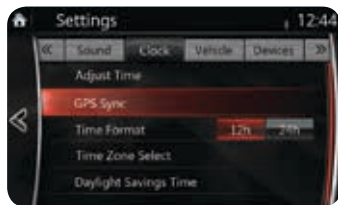

Safety Settings



The Clock tab can be used to adjust the time, sync the clock with GPS, and change between 12 and 24 hr. clock.

PAIRING YOUR BLUETOOTH® PHONE OR AUDIO DEVICE

NOTE:

- For safety reasons, you cannot pair a phone while driving.
- **For customer service and device compatibility, visit www.mazdausa.com/mazdaconnect or call 800-430-0153.**
- When in range of another Wi-Fi device, the Bluetooth connection between your phone and the system may disconnect for a short time if you have Wi-Fi enabled. Turn off Wi-Fi on your phone if needed.



Pairing Instructions:

- 1 Manually turn on Bluetooth on your phone or audio device.
- 2 Select Communication from Home screen.
- 3 Select Settings.
- 4 Select Bluetooth.
- 5 Select Add New Device, and switch to the operation on your mobile device.
- 6 On your mobile device, select "Mazda".
- 7 Verify the displayed 6-digit code both on the display and on your mobile device.

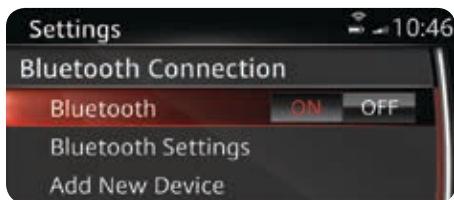

For phones compatible with SMS and MMS:

- 8 On your mobile device, hit "Allow" to let Mazda Connect download your phonebook and text messages (SMS).

IMPORTANT:

- If your mobile device was once paired to any Mazda vehicle in the past, "Mazda" on the Bluetooth device list on your mobile device must be deleted.
- 9 For iPhone, go to Settings>Bluetooth. Select the "i" information icon for the connected device. Switch "Show Notifications" to ON.

TO MAKE OR RECEIVE A HANDS-FREE CALL

Push  button: To receive/ swap a call.

Push  button: To talk

- To start voice recognition session
- To skip system's lady voice guidance

Push  button: To hang up

- To end voice recognition session (this button is also used to hang up call)

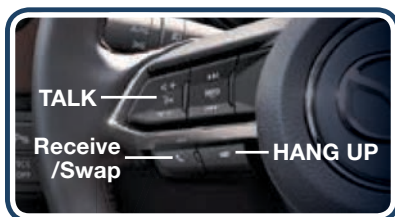

Automatic

Bluetooth Reconnection:







- On engine start, the last connected device will automatically be re-connected after several seconds.
- To switch phones, go to Device Settings and select Bluetooth.

For a stable Bluetooth connection:

- Make sure there is no metal object nor any obstacle blocking Bluetooth signal between vehicle's display and your mobile device.
- Turn OFF unnecessary applications on your mobile device. When your mobile device is busy, it often drops Bluetooth connection.
- Turn OFF energy saving mode on your mobile device.

NOTE: Some phone models do not support all features. If your phone or device does not pair, please visit www.mazdausa.com/mazdaconnect or contact (800) 430-0153 for further assistance or to report a phone/audio device concern.

The following icons are displayed on the touchscreen during a call:

-  Ends a call.
-  Transfers a call from hands-free to the mobile phone.
-  Transfers a call from the mobile phone to hands-free.
-  Mutes the microphone.
-  Switches the call on hold.
-  Allows transmitting DTMF (Dual Tone Multi-Frequency) signal via the numerical keypad (generally to a home telephone answering machine or an automated guidance call center).

Navigation System









NAVIGATION SYSTEM (if equipped)

Planning A Route



IMPORTANT:

- In the interest of safety and to reduce distractions while you are driving, you should always plan a route before you start driving.
- To adjust the volume of the navigation system voice while driving, adjust the volume by turning the VOL knob when voice guidance is being given. To prompt voice guidance, push the NAVI button to repeat the last instruction.
- **For issues with the navigation system, visit www.mazdausa.com/mazdaconnect or call 800-430-0153.**

ICON	Voice Control	Purpose
	Hide/Show Menu Bar	To open and close the Menu bar.
	Enter Destination	To enter an address or favorite destination, or select a place of interest or a location on the map.
	Navigation Information	To switch to the navigation information screen on where items such as traffic information and GPS reception conditions are located.
	Cancel	To cancel an existing way point/route.
	Point of Interest	To find places nearby.
	Route Options	To display the route parameters and full length of route. Perform route-related actions such as edit or cancel, pick route alternatives, avoid parts, or add destination to Favorites.
	View Mode	To change the map mode (2D north up / 2D heading up / 3D).
	Settings	To adjust the navigation settings.



To plan a route on your navigation system:

- 1 Push the **NAV** button on the commander switch.
- 2 Select **ENTER DESTINATION**.
- 3 Select **Find Address**.

NOTE: By default, the navigation system detects the country and city/town you are in. If needed, you can change the country or state setting by selecting **Country** or a new city/town by selecting **City** or **Zip code**.

- 4 Enter the street name.
- 5 Enter the house number, then select the ✓.
- 6 The system transitions to a screen where the input location can be checked. To transition to the next screen, select ✓ **Select**, or to transition to the previous screen, select ↶.

NOTE: Select **Places Nearby** for POIs (Points of Interest) around the selected location, or select **Add to Favorites** to register the selected location to Favorites.

NOTE: The route can be edited by selecting other options.

- 7 If ✓ **Start** is selected or if no operation is performed for 10 seconds, the route guidance is started. The set route can be checked by selecting **MAP**.

Planning A Route Using Voice Commands

You can navigate to any of the following places using your voice:

- An address, including home
- Favorites
- Cities and towns
- POI (Point of Interest) categories
- A recent destination

NOTE: POI searches for points of interest near your present location.

Navigation System (cont'd)

To plan a route to an address using your voice:

- 1 Push the **TALK** button on the steering wheel.
- 2 When you hear the tone, you can say, for example “Address”.
- 3 When on an address screen, say the full address (without zip code) for your destination, for example “123 Main St., Los Angeles, California”. The system does not recognize zip codes.
- 4 Say “Yes” if the address is correct. If shown a list of addresses, say the list number for the correct address or say “None of these”.

NOTE:

- For best results, say the full address without pausing between words.
- Voice guidance can be skipped by pushing the TALK button.
- When prompt voice guidance is muted, you will need to go into Navigation Settings to turn the volume back on for the NAVI button to repeat the last instructions.

To remove or insert the MAP SD card (to update the map database):

- 1 Turn the vehicle ignition OFF.
- 2 Locate the SD card slot located in the center console.
 - **Remove card:** Open the cover and push the card once, then pull it out.
 - **Insert card:** Push the card in (label-side up), then close the cover.

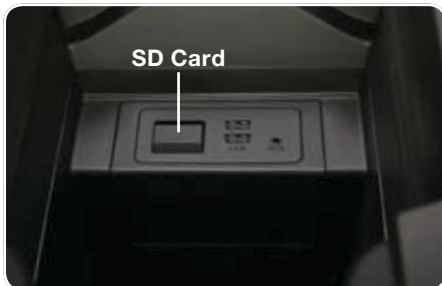

- Visit www.mazdausa.com/navigation and download the most recent map available for your device for free for 3 years from vehicle delivery.
- For issues with the navigation system, visit www.mazdausa.com/mazdaconnect or call **800-430-0153**.
- Only use your MAP SD card for operating and updating your navigation system. Do not insert the MAP SD card into another vehicle or into any other device such as a camera.
- Do not put other SD cards in this slot.

Active Driving Display

ACTIVE DRIVING DISPLAY (if equipped)



CAUTION: Always adjust the display using the Settings screen (AD-Disp tab).

NOTE: Active Driving Display may not show up on lighter colored roads.

To change the settings/adjustments for the Active Driving Display:

- 1 Select the Settings icon on the Home screen.
- 2 Select the AD-Disp tab.
- 3 Select the desired item to change.
 - **Height:** Adjust the position of the virtual image of the Active Driving Display up or down.
 - **Brightness Control:** Method for adjusting screen brightness (automatically with instrument cluster illumination or manually).
 - **Brightness:** Brightness adjustment (when selecting manual adjustment).
 - **Rotation:** Adjust the angle of the active driving display.
 - **Display Information:** Select what items to display.
 - **Active Driving Display:** On/Off.
 - **Reset:** Reset to default settings.

NOTE:

- If the display does not operate, switch the ignition off and then switch it back on. If it still does not operate even with the ignition switched ON, have the vehicle inspected at an Authorized Mazda Dealer.
- It may be difficult to view the display when wearing sunglasses with polarized lenses. Take off your sunglasses or adjust the luminosity.
- If the battery has been removed and re-installed or the battery voltage is low, the adjusted position may deviate.
- The display may be difficult to view or temporarily affected by weather conditions such as rain, snow, light, and temperature.

Commander / Voice Control

COMMANDER SWITCH

The commander switch is the primary means for operating Mazda Connect. It allows you to keep your eyes on the road.

The control places five buttons naturally beneath the five fingers and shows five matching icons on the home screen for touch-only operation. Select a button around the commander switch to operate the desired system.



BACK
(to previous screen)

FAVORITES
The following can be stored in Favorites:

- 50 stations total for AM, FM, and XM.
- 50 contacts in the system phonebook.
- 50 points of interest in navigation. (To edit or delete HOME, select HOME and push and hold the commander knob until the Edit/Delete HOME screen appears.)

MUTE (push down)/
VOLUME (turn dial)

Push and hold the Favorites (Star) button to store your favorites.

Select an item on the screen by:

- 1 Moving the switch up or down, left or right, and/or turning the dial to move the cursor to the desired on-screen location (and get a description of the icon).
- 2 Pushing the switch down (ENTER) to select your choice on the screen.

VOICE CONTROL

Voice control is activated by pushing the TALK button on the steering wheel and speaking a command. Voice commands usually contain a verb (action word) followed by a noun. Common verbs are “Go to” and “Play”.



USEFUL COMMANDS:

- “**Call** <phonebook contact name> <mobile/home/work>” (example: “Call John Smith mobile”)
- “**Redial**” – This command makes a call to the last person you called (the top person listed on Outgoing call history).
- “**Callback**” – This command makes a call to the last person who called you (the top person listed on Incoming call history).
- “**Dial <number>**” (Example: “Dial 911”)
- “**Drive home**” / “**Navigate home**” / “**Take me home**” Any of above commands sets the destination to your home address.

NOTE: Navigation commands are available only when Navigation MAP is displayed.

OTHER COMMON VOICE COMMANDS:

- “**Help**” - This command lets you know the available VR commands operation per display.
- “**Tutorial**” - Mazda Connect overall introduction.
- “**Address**” - This is a useful command for navigation.

IMPORTANT:

- Make sure to say your command **AFTER BEEP SOUND**.
- You can skip system’s prompt anytime by pushing TALK button.
- You can end your voice recognition session either by pushing Hang-up button on the steering wheel or by operating the commander switch.

Mazda Radar Cruise Control

MAZDA RADAR CRUISE CONTROL (MRCC) SYSTEM (if equipped)

The MRCC system maintains vehicle speed and following distance using a radar sensor to detect a vehicle ahead. The driver simply presets the vehicle speed between 19 mph and 90 mph and the system will maintain a safe following distance without having to turn the cruise control off.

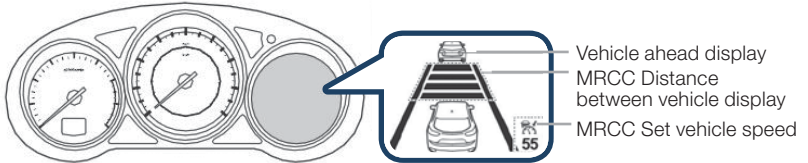

The system operates in two modes, Constant Speed and Headway Control modes:

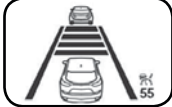
Constant Speed Mode	Headway Control Mode
When no vehicle is detected ahead, the driver's set speed is maintained.	When a vehicle is detected ahead, a distance between your vehicle and the vehicle ahead is maintained.
	

Setting the MRCC

When the Mode switch is pushed, the vehicle speed and the distance between vehicles while in headway control can be set. The MRCC indication is shown in the multi-display. The indicator light in the multi-display and the Active Driving Display will be green and will turn on simultaneously.

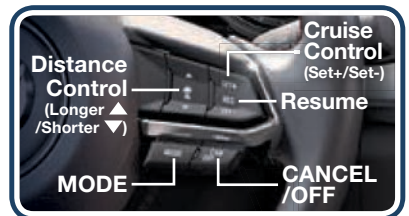

NOTE: The radar for the MRCC is located behind the Mazda emblem in the grill. Keep this area clean to avoid the system not working properly.



MRCC WARNING: MRCC shuts off when it reaches the low mph limit. "BRAKE" is displayed. The vehicle will not brake/stop by itself.





How to set the speed:

- 1 Adjust the vehicle to the desired speed using the accelerator pedal.
- 2 Push the SET + or SET - switch. The set speed and the inter-vehicle distance display filled with white lines is displayed in the Active Driving Display and the MRCC indicator light (green) turns on simultaneously.
- 3 Push the center of RESUME switch to resume set speed.

Travel Status	During travel at constant speed	During travel under headway control
Display		

How to set the distance between vehicles:

The distance between vehicles is set to a shorter distance by pushing the ▼ switch and a longer distance by pushing the ▲ switch. The distance between vehicles can be set to four levels.

Distance between vehicles guideline (at 50mph)	Long (about 164ft)	Medium (about 131ft)	Short (about 98ft)	Extremely Short (about 82ft)
Display				

CAUTION: Do not rely completely on the MRCC system and always drive carefully obeying the speed limit.

NOTE: The MRCC sometimes will brake your vehicle when passing a semi truck (tractor trailer). This is normal. Simply push the accelerator pedal to override the system.

Switching to conventional cruise control function:

When the Mode switch is pushed while the Mazda Radar Cruise Control (MRCC) system is turned on, the system is switched to conventional cruise control function.

The Mazda Radar Cruise Control (MRCC) indicator light (green) in the instrument cluster turns off and "Radar Cruise Control deactivated" message is displayed in the multi-information display at the same time.

CLOSE PROXIMITY WARNING

While traveling in headway control, if your vehicle rapidly closes in on a vehicle ahead because the other driver applied his or her brakes suddenly, a warning sound activates and the **BRAKE!** warning is indicated in the display. Always verify the safety of the surrounding area and depress the brake pedal while keeping a safe distance from the vehicle ahead. Additionally, always keep a safe distance from the vehicles behind you.

BRAKE!

Smart City Brake Support

SMART CITY BRAKE SUPPORT (SCBS) SYSTEM (if equipped)

Between speeds of 2 to 18 mph, the Smart City Brake Support attempts to minimize damage if a collision is unavoidable. In some instances, SCBS may be able to stop the vehicle automatically to avoid a collision with the vehicle ahead.

Partial list of operating conditions:

- During vehicle speeds of 2 to 18 mph.
- The driver does not react quickly enough and may hit the vehicle ahead.
- The Smart City Brake Support (SCBS) system has not been turned off.

NOTE: It may be possible to avoid a collision if the relative speed between your vehicle and the vehicle ahead is less than 12 mph.

Refer to your Owner's Manual for a complete list of SCBS operating conditions and system details.

WARNING: SCBS is only a supplementary system to reduce damage in the event of a collision; however, the SCBS has limitations. Do not rely solely on the SCBS. Always keep your eyes on the road.

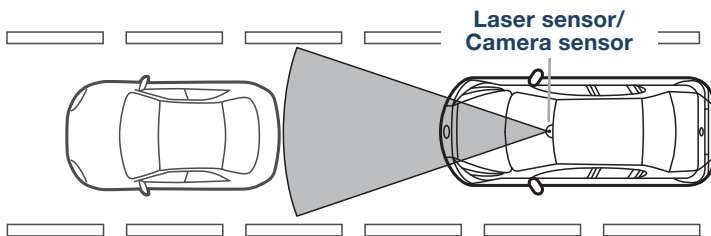

SCBS system can be turned off using Safety Settings in MAZDA CONNECT (p.14).



Smart Brake Support

SMART BRAKE SUPPORT (SBS) (if equipped)

At speeds of 10 mph or higher, the Smart Brake Support alerts the driver of a possible collision and attempts to reduce the severity of an imminent collision with the vehicle ahead. SBS operates when the vehicle is traveling at speeds higher than the range of the SMART CITY BRAKE SUPPORT (SCBS).

Partial list of operating conditions:

- During vehicle speeds of 10 mph or higher.
- If the vehicle is accelerating rapidly and comes close to the vehicle ahead.
- The Smart Brake Support (SBS) system has not been turned off.

Refer to your Owner's Manual for a complete list of SBS operating conditions and system details.

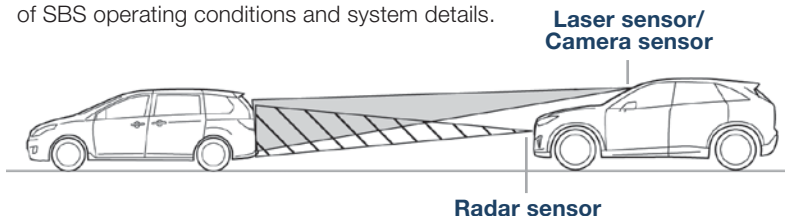

SBS system can be turned off using Safety Settings in MAZDA CONNECT (p.14).

WARNING: SBS is only a supplementary system to reduce damage in the event of a collision; however, the SBS has limitations. Do not rely solely on the SBS. Always keep your eyes on the road.

Collision Warning

If there is the possibility of a collision with a vehicle ahead, the beep sounds continuously and a warning is indicated in the multi-information display.



Lane-keep Assist System and Lane Departure Warning System

LANE-KEEP ASSIST SYSTEM (LAS) and LANE DEPARTURE WARNING SYSTEM (LDWS) (if equipped)

The Lane-keep Assist System (LAS) and Lane Departure Warning System (LDWS) recognize the painted lane lines using the Forward Sensing Camera (FSC) installed on the windshield.

- If the vehicle deviates from its lane at speeds above 37 mph, the system alerts the driver to provide steering assistance and uses the following indications to help the driver stay within the lines.

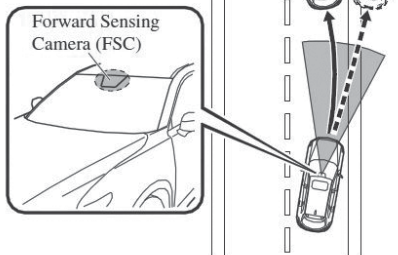

Indicator Light *1	Active Driving Display	Multi-Information Display	Condition
			The painted road lane lines on are not recognized or one side recognition or the vehicle speed is less than 37mph.
	*2		The both side painted road lane lines are recognized at vehicle speeds of 37mph or more.
	① Warning(Flashes)		Warning is triggered when vehicle deviates from its lane.(depending on personalization setting) ①Case Active Driving Display is equipped ②Case Active Driving Display is not equipped
	② No Active Driving Display		
No indicator light			LAS & LDWS OFF

*1. When the steering assistance is off, indicator light is not displayed.
*2. When the steering assistance is off, indicator light is not displayed.

NOTE: The system operates in two modes, steering assistance ON mode and steering assistance OFF mode (warning only). Steering assistance ON/OFF can be changed in MAZDA CONNECT (p. 11)



NOTE: Any driver input (e.g., turn signal, steering or acceleration, hands off, TCS switch off) will cancel warning.

The steering operation assist for the Lane-keep Assist System (LAS) and Lane Departure Warning System (LDWS) can be turned off. Refer to the owner's manual for further information.



Use the LAS and LDWS switch to turn system ON or OFF.

WARNING: Don't rely completely on the Lane-keep Assist System (LAS) and Lane Departure Warning System (LDWS):

- The Lane-keep Assist System (LAS) and Lane Departure Warning System (LDWS) are not an automatic driving system.
- The recognition ability of the Lane-keep Assist System (LAS) and Lane Departure Warning System (LDWS) is limited.
- Over-reliance on the system could lead to an accident.
- Always stay on course using the steering wheel and drive with care.

Distance Recognition Support System

DISTANCE RECOGNITION SUPPORT SYSTEM (DRSS) (if equipped)

The Distance Recognition Support System (DRSS) measures the distance between your vehicle and a vehicle ahead using a radar sensor (front) while the vehicle speed is 19 mph or faster and indicates a recommended distance to maintain between the vehicles. Furthermore, if your vehicle approaches a vehicle ahead more closely than the appropriate distance to maintain between the vehicles, the vehicle ahead indication in the display is illuminated in white to advise the driver to keep a safe distance from the vehicle ahead.

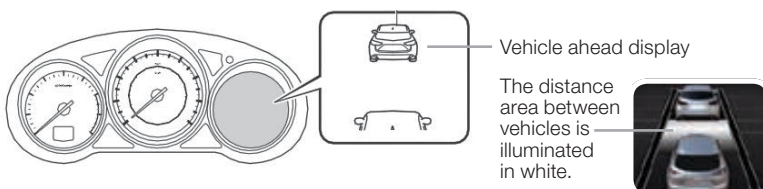

Indication on Display	Distance between vehicles guidelines (During travel at about 25 mph)	Distance between vehicles guidelines (During travel at about 50 mph)
	About 82 ft	About 164 ft
	About 66 ft	About 131 ft
	About 56 ft	About 98 ft
	About 46 ft	About 65 ft

Electric Parking Brake

ELECTRIC PARKING BRAKE

The electric parking brake equipment applies the parking brake using an electric motor.

Applying the electric parking brake:

The electric parking brake can be applied regardless of the ignition switch position.

- 1 Depress the brake pedal.
- 2 Pull the electric parking brake switch **UP** to apply the brake.

Releasing the electric parking brake:

The electric parking brake can be released while the ignition is switched ON or while the engine is running.

- 1 Depress the brake pedal.
- 2 Push the electric parking brake switch **DOWN** to release the brake.



Electric parking brake automatic release:

The parking brake is released automatically when the accelerator pedal is depressed and all of the following conditions are met:

- The engine is running.
- The driver's door is closed.
- The driver's seat belt is fastened.
- Selector lever is in the D, M or R position.

Blind Spot Monitoring System

BLIND SPOT MONITORING (BSM)

The BSM system is designed to assist the driver by monitoring blind spots on the left and right sides of the vehicle in certain situations, such as lane changes.

Turning BSM System Off

Turning the BSM system off will turn off both the light and sound indicators. To manually turn the BSM system off, push the BSM OFF switch on the dash.

The BSM OFF indicator in the instrument cluster will turn on to indicate when the BSM system is off. The BSM system will automatically turn on the next time the vehicle is started.



- If your vehicle speed is 6 mph or more, the BSM will warn you of vehicles in the detection area by illuminating the BSM warning lights located on the left and right door mirrors.
- If you operate a turn signal in the direction of an illuminated BSM warning light, the system will also warn you with a beep (depending on personalization setting) and warning light flash.
- BSM sensors are located under the left and right rear bumper areas. The BSM system may not operate properly if the rear bumper is dirty, so keep the rear bumper area clean and free of bumper stickers.

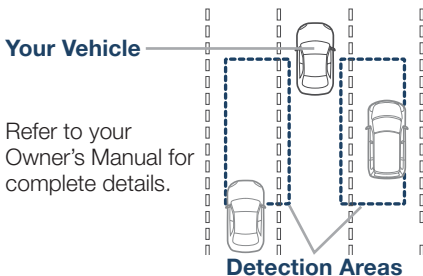

NOTE:

- The BSM can assist the driver in confirming the safety of the surroundings, but is not a complete substitute.
- The driver is responsible for ensuring safe lane changes and other maneuvers.
- Always pay attention to the direction in which the vehicle is traveling and the vehicle's surroundings.
- The BSM does not operate when the vehicle speed is lower than about 6 mph.

WARNING:

BSM is only a supplementary system to help aid in monitoring blind spots; however, BSM has limitations. The system may not detect all vehicles, especially a motorcycle. Do not rely solely on the BSM. Relying solely on the BSM may cause an unexpected accident resulting in death or serious injury. Make sure to look over your shoulder before changing lanes.

Rear Cross Traffic Alert

REAR CROSS TRAFFIC ALERT (RCTA) (if equipped)

The RCTA is designed to alert the driver of oncoming traffic when backing out of a parking spot. RCTA is active when your vehicle is in reverse and your vehicle speed is 0 to 6 mph.

When BSM sensors detect an object moving 3 to 18 mph, RCTA will notify the driver with indicators and sound:

- Rear View Monitor and outside mirror flashing indications.
- Beep sound is customizable (same as BSM).

Refer to your Owner's Manual for complete details.

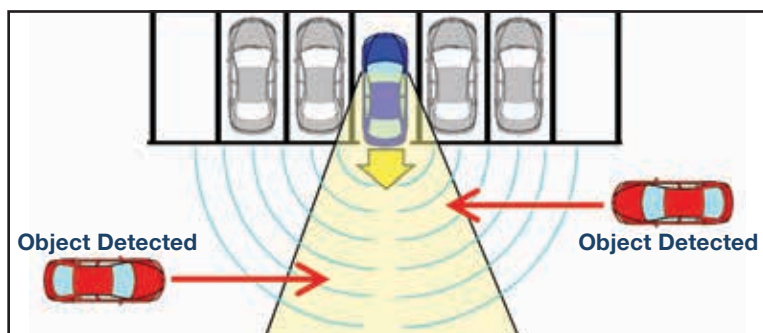

Settings
button for rear
view monitor.

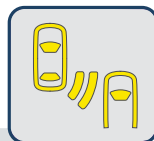

WARNING: RCTA is only a supplementary system to help aid when backing up; however, RCTA has limitations. The system does not detect all vehicles, especially a motorcycle. Do not rely solely on the RCTA. Relying solely on the RCTA may cause an unexpected accident resulting in serious injury. Always back up slowly.

Exterior Lights

LIGHTING CONTROL/TURN SIGNAL LEVER

: Turns tail, parking, and dashboard lights on.

AUTO: The light sensor automatically determines when to turn the headlights on or off.

: Turns fog lights on only when headlights are on.

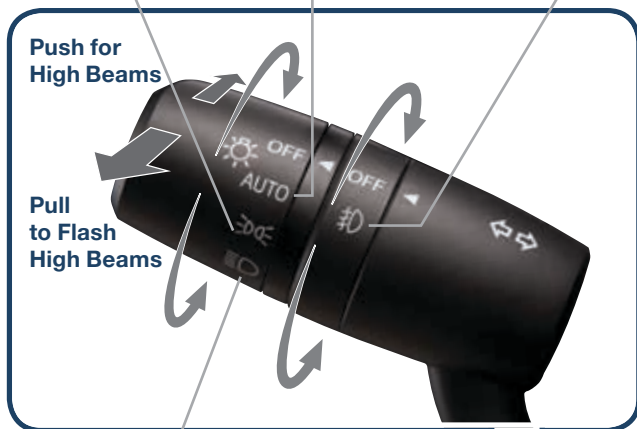

: Turns tail, parking, dashboard, and headlights on.

Three-Flash Turn Signal: To signal a lane change, push the turn signal lever up or down halfway and release. The turn signal indicator will flash three times.



NOTE: The DRL (Daytime Running Lights) automatically turn on when the ignition is switched ON. To disable/enable this feature, see your Authorized Mazda Dealer.

NOTE:

- You can adjust the timing of the Auto Headlights OFF and the sensitivity of the Auto Light Control. (See MAZDA CONNECT SETTINGS on page 14.)

WINDSHIELD WIPER/WASHER CONTROL LEVER

AUTO: The rain sensor senses the amount of rainfall and turns the wipers on or off. Rotating the inner ring clockwise (away from you) creates greater wiper sensitivity and makes the wipers move faster. The **+** position increases wiper speed. Rotating the inner ring counterclockwise (toward you) makes the wipers move slower. The **-** position decreases wiper speed.

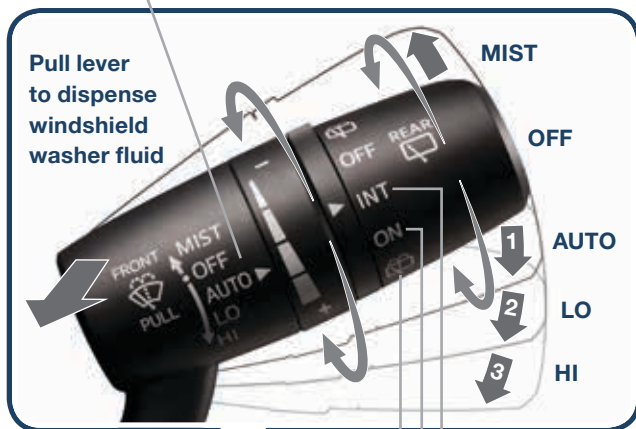

Rear Window Wiper/Washer

INT: Intermittent

ON: Normal speed

 Washer/wiper (hold as desired)

NOTE: Vehicles not equipped with AUTO wipers will have INT wipers. Set the lever to INT and choose an interval timing by rotating the ring between fast and slow.

CAUTION: If the ignition is ON, turn the AUTO wipers OFF when going through a car wash or while cleaning or touching the windshield.

Adaptive Front Lighting System

ADAPTIVE FRONT-LIGHTING SYSTEM (AFS) (if equipped)

The Adaptive Front-Lighting System (AFS) automatically turns the headlight beam to the right or left in conjunction with the direction of the steering wheel.

The AFS improves the direction of headlight illumination while cornering and only works when the vehicle is moving.

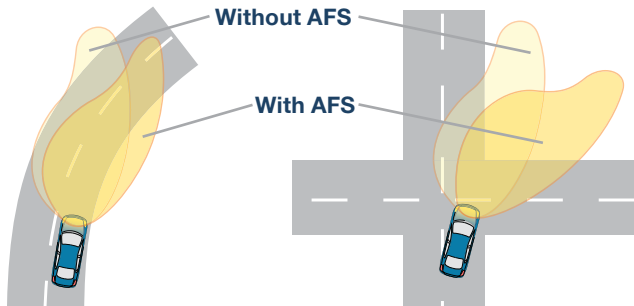

NOTE:

- With AFS, it is normal to see the headlights move and hear the sound of the headlight leveling motors at the front of the vehicle when the ignition is ON.
- The system will need to be reset if the vehicle battery has been disconnected or the system fuse has been replaced. Please refer to your Owner's Manual for easy-to-follow resetting instructions.

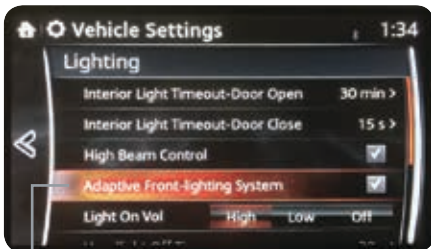

AFS can be turned off using Vehicle Settings in MAZDA CONNECT (p. 14).

High Beam Control

HIGH BEAM CONTROL (HBC) (if equipped)

With HBC, the headlights are switched to high beams at speeds above 18 mph when there are no vehicles in front of your vehicle or approaching in the opposite direction.

The HBC system switches to low beam when:

- You are approaching a vehicle or a vehicle is approaching in the opposite direction.
- Driving on roads lined with street lights or well-lit cities and towns.
- At speeds lower than 12 mph.

To turn HBC on:

- 1 Turn the headlight switch to the AUTO position.
- 2 Push the headlight lever forward to the High Beam position.



When the HBC system is on, the HBC indicator light in the instrument cluster will illuminate (GREEN).

The High Beam indicator light will turn on (BLUE) when the HBC system switches to high beam and will turn off when the HBC system switches to low beam.



Audio Controls

BLUETOOTH® AUDIO

Bluetooth® enabled phones and audio players provide an opportunity to play music through the audio system with no wires attached.

Some phone models do not support all features. Go to www.mazdausa.com/mazdaconnect or contact (800) 430-0153 for further assistance or to report a phone/MP3 device concern.

Playing Bluetooth® (BT) Audio

- 1 Make sure BT audio device is paired to your vehicle.
- 2 Turn on BT audio device and open the audio app on the device.
- 3 Select Bluetooth from Sources. See your Owner's Manual for further information on:
 - Pandora · Aha · Stitcher

  FM Radio



AUDIO OPERATION

The following icons are displayed on the screen:

 **SOURCES:** Displays Audio menu to change audio source (FM / AM / XM / Aha / Pandora / Stitcher / Bluetooth / USB / CD / AUX).

NOTE: In order to use Aha, Pandora and Stitcher as audio sources, the App must be installed on your phone. These Apps stream music using your data plan and listening to them counts toward your monthly cellular data usage.

 **AUTO MEMORY:** Displays a list of 10 strongest radio stations. Because station strength changes as you drive, select Update Station List icon to re-scan for strong stations.

 **FAVORITES:** Displays list of your favorite AM, FM, and XM radio stations.

 **HD RADIO:** Switches HD Radio On/Off.

 **SCAN:** Scans radio stations or songs (scanning stops at each one for 5 seconds). Select again to stop.

 **TUNER:** Displays manual radio tuner.

 **TAG:** Saves artist and title and sends them to your Apple device (for Apple devices with USB use only).

 **SEEK PREVIOUS/NEXT:**

 Selects previous or next receivable radio station or song. Push and hold to change radio station continually.

 **SETTINGS:** Adjusts the audio quality level (bass, treble, etc.).

The following icons are displayed on the CD, USB, and BT music screens only:

 **TRACK LIST:** Displays the track list of the CD.

 **REPEAT:** Repeats the current song. Select again to stop.

 **SHUFFLE:** Plays the songs on the CD in random order. Select again to stop.

 **PLAY/PAUSE:** Plays and pauses the CD.





New Mazda vehicles equipped with SiriusXM® Satellite Radio will receive an introductory 4-month trial subscription that starts on the day the vehicle is sold. Enjoy over 150 channels including commercial-free music, plus sports, comedy, entertainment, news and much more.

To start listening to SiriusXM, select XM from audio sources, then push channel up and down to listen to over 150 channels. If you do not hear audio, please activate service to your radio with a simple refresh process.

- 1 Scroll to XM Radio, go to channel 1 and push "previous" to channel 0 to find your radio ID.
- 2 Go to siriusxm.com/refresh and enter radio ID or call **1-855-MYREFRESH** (1-855-697-3373).

NOTE: To use BT audio, make sure the musical icon is displayed by going to  Bluetooth in Device settings. Some Bluetooth® audio devices need a certain amount of time before the icon is displayed.

HD RADIO

HD radio has a special receiver which allows it to receive digital broadcasts (where available) in addition to the analog broadcasts it already receives. Digital broadcasts have better sound quality than analog broadcasts as digital broadcasts provide free, crystal clear audio.

When the HD radio button is ON (red), there could be a noticeable difference in sound quality and volume when a change from digital to analog signals occurs. If the sound quality and volume become noticeably diminished or cut off, select the HD button to turn OFF HD radio (not red).

AUDIO OPERATION USING VOICE

Audio operation and media selection can be done using voice recognition. Push the TALK button on the steering wheel, wait for a beep, then say a command in a clear, natural voice (not too fast or too slow). Some common commands are listed below.

Play (and any of the following):

AM, FM, XM, CD, Bluetooth, Aha, Pandora, Stitcher, USB, AUX

Play or Resume / Pause or Stop / Next or Previous Play (and any of the following when connected to USB port):

Song, Playlist <playlist name>, Artist <artist name>, Album <album name>, Genre <genre name>, Folder <folder name>

Tune to Station:

<FM or AM then frequency>

Tune to Channel Number (XM)

AUDIO: You cannot access your device when connected to Pandora.

NOTE: Push the TALK button and say "Help" at any time to hear a list of available commands.

Audio USB and AUX Inputs

PORTABLE AUDIO PLAYER INTEGRATION USING THE USB PORT OR AUX JACK

Your vehicle is equipped with a USB port and auxiliary AUX jack in the center console that allow you to play your iPod, USB device, or portable audio player through the vehicle's audio system. Learn the system when parked and do not let it distract you while driving.

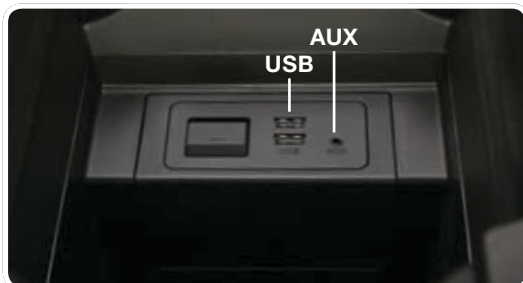

IMPORTANT:

- Set the volume level on your portable audio player to the highest level before distortion starts, then use the vehicle's audio system to adjust the volume.
- Unplug any device from the USB port and accessory socket before turning off the vehicle. Leaving devices plugged in can drain the battery and cause issues during the Bluetooth pairing process at start-up. Wait about 15 seconds after starting the vehicle before plugging anything into the USB port.

NOTE: You will need an audio cable with an 1/8 inch (3.5 mm) mini stereo plug (available as a Genuine Mazda accessory) to connect your portable audio player into the AUX jack.



- 1 Locate the USB port or AUX jack.
- 2 Connect the device plug into the portable audio player and into the USB port or AUX jack.
- 3 Turn the vehicle audio system on.
- 4 **Audio Controls:** Select AUX or USB from the Sources menu.
- 5 **USB Port:** Use the vehicle's audio system or steering wheel controls to control the connected USB device.
AUX Jack: Use the portable audio player controls to play music.

REAR SEAT USB CHARGER

The rear seat console has two 2.1 amp USB chargers which charge your device so that you can play music through the device (iPod, phone, etc.), but not through the vehicle audio system. Refer to the Owner's Manual for additional information.



NOTE: When using a USB memory stick, the system plays the first audio file when restarting the vehicle. It does not start where it left off when turning off the engine.

12 VOLT ACCESSORY SOCKETS

The accessory sockets are on with ignition in ACC or ON. There is an accessory socket located at the front and rear of the vehicle.



Front ACC Socket

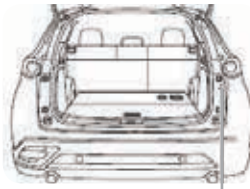

Rear ACC Socket

NOTE: When using the accessory socket, make sure to disconnect any device from it when turning off the ignition; otherwise, the vehicle's battery could go dead.

Automatic Climate Control



DRIVER TEMPERATURE CONTROL DIAL

AUTO ON: Push dial to turn automatic air conditioning system on (AUTO ON and A/C indicator on). The airflow mode, fan speed and air conditioning will be automatically controlled in accordance with the set temperature.

Fan Control

- Push the fan (+) and (-) buttons to select the desired fan speed.
- Push OFF to turn climate control system off.

 Push to recirculate cabin air (light on). When the light is off cabin receives fresh air.

REAR Push the "REAR" switch to operate the rear air conditioning.

NOTE: A/C indicator will illuminate when AUTO ON is active. The air conditioning cycles on/off as necessary to maintain the set temperature. The A/C may operate even while heating is desired - this is to prevent excess humidity and fogging while the system operates.



Push to select the following airflow mode:

-  Dashboard vents and floor vents
-  Dashboard and floor vents
-  Floor vents
-  Defroster and floor vents
-  Push to defrost the windshield.
- A/C** Push to manually turn air conditioning on or off.

PASSENGER TEMPERATURE CONTROL DIAL

Push to turn DUAL mode ON/OFF.

- With DUAL mode ON (indicator on), rotate the dial to set passenger's side temperature separate from the driver's side (shown above).
- With DUAL mode OFF (indicator off), driver controls the temperature setting on both sides.

 Push to defrost the rear window.

NOTE: Automatic temperature control always works even if the AUTO indicator turns off by changing the fan speed or airflow mode.

NOTE: Automatic climate control will allow you to maintain individual preset cabin temperatures for the driver and passenger when DUAL mode is selected.

REAR CLIMATE CONTROL

Operation from Front Seats

- 1 Turn the front air conditioning on.
- 2 Push the REAR control button on the front control panel (indicator on).
- 3 Selection of the airflow mode, airflow amount and temperature will be automatically controlled to the same setting as the front air conditioner.



Operation from Rear Seats

- 1 Push the AUTO button on the rear control panel to turn Rear Automatic Air Conditioning system on.
- 2 Push the Temperature selector button on the rear control panel to select your desired set temperature. The airflow mode and amount of airflow will be automatically controlled in accordance with the set temperature.

NOTE: If the rear AUTO button is pushed while the front A/C button is off, the rear air conditioning operates only to circulate air. Setting the temperature to the maximum high or low will not provide the desired temperature at a faster rate.



Instrument Cluster Type A (with Multi-Information Display)

OUTSIDE TEMPERATURE DISPLAY

The outside temperature unit can be switched between °C and °F using System Settings in the infotainment system.

IMPORTANT: When your Mazda Connect display setting is set on "AUTO", the instrument cluster and display may become dimmer when the headlights are on. If the display and instrument cluster become too dim or too bright when the headlights are on, simply rotate the dimmer knob located on your instrument cluster to adjust the brightness.



GLOSSARY OF WARNING AND INDICATOR LIGHTS

- | | | | |
|--|--|--|--|
| | Lane Departure Warning System (LDWS) and Lane-keep Assist System (LAS) System On (WHITE)/ Lane Detected (GREEN) (pp. 27-28) | | Engine Oil Level |
| | Adaptive Front-Lighting System (AFS) OFF (p. 35) | | LED Headlight |
| | Traction Control System (TCS) OFF | | Brake Pedal Operation Demand |
| | Traction Control System (TCS)/ Dynamic Stability Control (DSC)
On: TCS/DSC malfunction
Flashing: TCS/DSC operating | | Turn Signals/Hazard |
| | Blind Spot Monitoring (BSM) OFF/ Rear Cross Traffic Alert (RCTA) System (pp. 31-32) | | Tire Pressure Monitoring System (TPMS) (p. 5)
On/Warning Bleep: Low tire pressure in one or more tires. Flashing: TPMS Malfunction |
| | SPORT Mode On (p. 45) | | Cruise Main On (WHITE) |
| | Lights On (Exterior) | | Cruise Set On (GREEN) |
| | High Beam Control On | | Mazda Radar Cruise Control On (AMBER), Set (GREEN) (pp. 23-24) |
| | Headlight High Beams On | | Anti-lock Brake System (ABS) Malfunction |
| | Air Bag/Front Seat Belt Pretensioner System Malfunction | | Shift Position |
| | Check Engine | | Security System |
| | Seat Belt Unbuckled/Malfunction | | Smart Brake Support (SBS) and Smart City Brake Support (SCBS)
Flashing Red: SBS and SCBS are operating.
Amber: SBS and/or SCBS malfunction.
SBS and SCBS are turned off. |
| | | | 4-Wheel Drive (4WD) |



TRIP COMPUTER

The following information can be selected by pushing the ▲ or ▼ of the INFO button on the steering wheel.

- Approximate distance you can travel on the available fuel (RANGE)
- Current fuel economy
- To reset, push and hold the INFO button for more than 1.5 seconds.

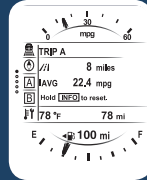

- Door Ajar**
- Liftgate Ajar**
- Electric Parking Brake**
- Brake Warning**
Parking brake on/
low brake fluid/malfunction
- Master Warning**
- Low Fuel Level**
- Low Engine Oil Pressure**
- Power Steering Malfunction**
- Automatic Transaxle**
- Charging System Malfunction**
- Low Washer Fluid Level**
- KEY Warning (RED)**
- KEY Indicator (GREEN)**
- Check Fuel Cap**
- Perform Maintenance**

NOTE: See Owner's Manual for more details and explanations.

- Rotate the knob to adjust the brightness of the instrument cluster and other dashboard illuminations.
- Push to toggle between trip meter (A & B).
- When a trip meter is selected, push and hold to reset to zero.

ENGINE COOLANT TEMP LIGHTS

Since this vehicle does not use an engine coolant temperature gauge, red and blue engine coolant temperature lights are used to indicate high and low coolant temperature.

Red Coolant Temp Light

Flashing: Engine is starting to run hot. Drive slowly to reduce engine load.

On: Engine is overheating. Safely pull over to the side of the road and turn the engine off. Refer to the Owner's Manual for more information.

Blue Coolant Temp Light

On: Engine coolant is cold and no warm air is available for heater/defroster.

Off: Engine coolant is warm and warm air is available for heater/defroster. The light may stay on for a few minutes after start-up when the engine is cold, but the vehicle can be driven with the light on or off.

NOTE: When your Mazda Connect display setting is set on "AUTO", the instrument cluster and display may become dimmer when the headlights are on. If the display and instrument cluster become too dim or too bright when the headlights are on, simply rotate the dimmer knob located on your instrument cluster to adjust the brightness.

Transmission

MANUAL SHIFT MODE

Manual Shift Mode gives you the feel of driving a manual transmission by allowing you to manually shift to control engine rpm and torque when more control is desired.



To Use Manual Shift Mode:

- Shift the lever from D to M.



To Shift Up To A Higher Gear:

- Tap the shift lever back (+) once.

To Shift Down To A Lower Gear:

- Tap the shift lever forward (-) once.

DRIVE SELECTION

SPORT mode will choose a lower gear for increased acceleration response. It will also hold a lower gear/delay upshifting when it detects you are braking or cornering because it anticipates that you will want to accelerate out of the turn more quickly.

Push the SPORT button to switch to SPORT mode and the SPORT mode indicator light in the instrument cluster turns on. Push again to turn off.



NOTE:

- If the SET button of the cruise control is pushed while in SPORT mode, SPORT mode is switched off. SPORT mode cannot be turned on or off when cornering.
- When the ignition is switched off, SPORT mode is also switched off.
- Fuel consumption increases slightly when using SPORT mode.

FUEL ECONOMY:

To achieve the best fuel economy, visit www.fueleconomy.gov for more information.



ACTIVE ADAPTIVE SHIFT (AAS) CONTROL

AAS will automatically adjust how and when the transmission shifts gears based on road conditions and your driving style. The transmission may stay in a lower gear longer than usual when going up or down hills or driving around corners. This feature gives you better control and a more connected driving experience.

ACCELERATOR PEDAL KICKDOWN SWITCH

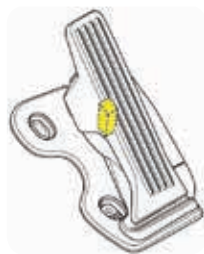

The accelerator pedal is equipped with a kickdown switch designed to allow optimal engine performance while accelerating.

When you depress the accelerator 95% of the way, you will feel an increase in resistance. Push harder, and you will feel a click as you activate the kickdown switch. The transmission will usually downshift (depending on engine speed) and the engine will switch to maximum power mode. This kickdown switch function is the same in both Manual mode and in "D".

HILL LAUNCH ASSIST (HLA)

HLA helps assist you when accelerating the vehicle from a stop while on a hill or slope.



When the brake pedal is released and the accelerator pedal is pushed, HLA prevents the vehicle from rolling forward or backward. It operates on a downward slope when the shift lever is in the reverse (R) position and on an upward slope when the shift lever is in a position other than the reverse (R) position.

IMPORTANT: The HLA system will hold the vehicle for a maximum of 2.0 seconds while the driver is changing from the brake pedal to the accelerator pedal.



Parking Sensor System

PARKING SENSOR SYSTEM (if equipped)

The parking sensor system uses ultrasonic sensors to detect obstructions around the rear of the vehicle while parking, when the selector lever is in reverse (R). The system notifies the driver of surrounding obstructions using beep sounds.

Parking Sensor switch to turn system ON or OFF.

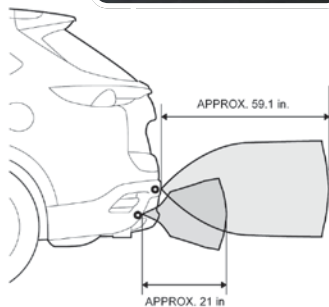
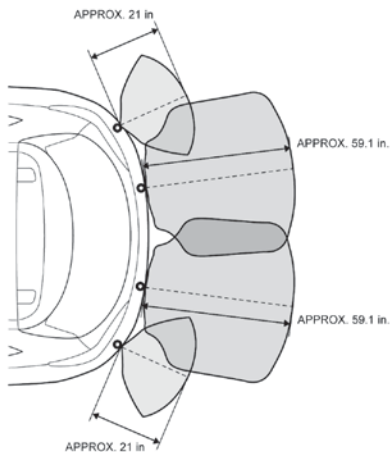
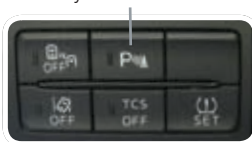

WARNING: The parking sensor system is a device to assist the driver in confirming safety. It is not a substitute for the driver and cannot guarantee 100% safety. Do not rely completely on the parking sensor system and drive while confirming the safety of the surrounding area visually.



AUTO-DIMMING MIRROR AND HOMELINK® (if equipped)

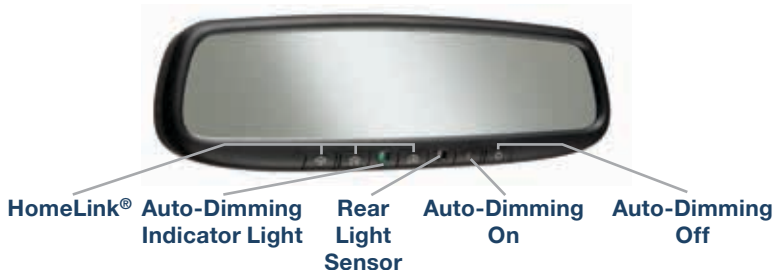

Auto-Dimming Mirror

- Auto-dimming will automatically darken your rearview mirror to reduce headlight glare from vehicles behind you.
- Auto-dimming is activated every time the engine is started.



NOTE: In addition to the auto-dimming mirror's rear light sensor, there is also a front light sensor (not shown). Do not place or hang any objects over the front or rear mirror light sensors; otherwise, the auto-dimming mirror will not operate properly.

HomeLink®

- This feature provides a convenient way to replace up to three transmitters such as garage door openers, home lighting remotes and other radio frequency devices.
- Refer to your Owner's Manual for complete programming details.



NOTE: Genuine Mazda Accessory Auto-Dimming Mirror with Compass and HomeLink® is available at your Authorized Mazda Dealer. Refer to *Owner's Manual* for further information.



REAR DOOR SUNSHADES

The rear door sunshades provide an extra degree of shade to rear seat passengers.

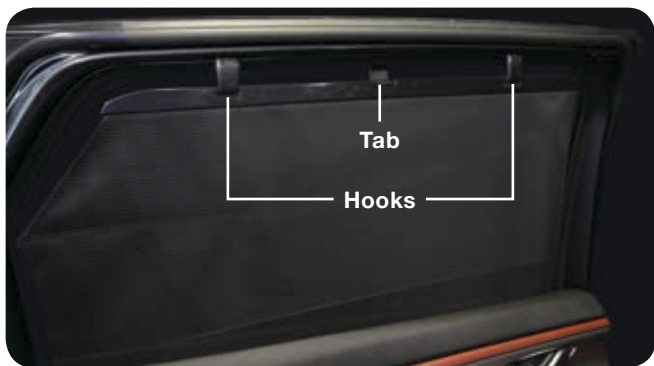

To Use:

- Pull the tab upward and hook the slots.

To Return:

- Unhook the sunshade and retract it slowly.

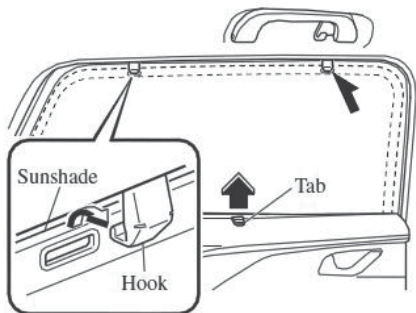



PERSONALIZE YOUR CX-9 WITH GENUINE MAZDA ACCESSORIES

Go to www.MyMazda.com, then select "Accessories" below the MyMazda Home header for a complete listing of available accessories for your CX-9.

WWW.MYMAZDA.COM—THE OFFICIAL SITE FOR MAZDA OWNERS

Register today on www.MyMazda.com—the ultimate destination for Mazda Owners. Once registered, you'll be able to take advantage of benefits exclusively for Mazda Owners:

- Insider access to exclusive events and promotions
- Personalized maintenance schedules
- Zoom-Zoom Owner Magazine
- Warranty information and on-line Owner's Manuals
- Wallpaper, videos and other fun stuff
- Accessories specifically designed for your vehicle
- Car Care Discount Coupons available from your Authorized Mazda Dealer

Visit and register at www.MyMazda.com today!

MAZDA MOBILE

The following apps are available for iPhone® and Android smartphones:

- **Mazda Assist app** - Provides roadside assistance 24 hours a day, 365 days a year. Toll free number 1-800-866-1998 can also be used for roadside assistance.
- **MyMazda app** - Keep track of your Mazda from the palm of your hand with these features:
 - Maintenance schedule
 - Service coupons
 - Promotional alerts
 - Service history
 - Recall information
 - Parked car locator
 - Scan VIN barcode capability when registering a vehicle
 - Mazda Dealer locator
 - Update owner profile
 - Link to Mazda Assist

The apps can be downloaded, free of charge, from the App store for the iPhone® and Google Play (Android Market) for Android powered devices. After downloading app, customer name, email, smartphone number and VIN are required.



Free Mazda Assist app
iPhone and Android



Free MyMazda app
iPhone and Android



CUSTOMER DELIVERY CHECKLIST

MyMazda App Overview:

- Download MyMazda App on customer's phone
- Register customer in MyMazda
- Review sections of App ending with "how to" section

Vehicle Presentation:

Exterior

- Door request switch operation
- Power liftgate operation*

Interior

- Show customer how to adjust seats, side mirrors, and steering wheel
- Review controls and switch locations (lights, wipers, climate control, etc.)
- Multi-Information display operation*

MAZDA CONNECT Infotainment System Overview:

Settings

- Review **Display** settings
- Set heads up display height
- Review **Safety** settings
- Set Blind Spot Monitoring System volume
- Set audio **Sound** settings
- Set **Clock**
- Review **Vehicle** settings
- Set door lock settings
- Set turn signal settings
- Set lighting settings
- Review **Devices** settings
- Review system **Settings**

Communications

- Explain tool bar options
- Pair a phone
- Make a call
- Review voice commands for phone

Additional vehicle and owner resources can be found at:
www.mazdausa.com/owners & www.MyMazda.com

* If equipped

Entertainment

- Explain tool bar options
- Save customer's favorite radio stations
- Play Bluetooth audio
- Play Pandora, Stitcher and/or Aha

Navigation*

- Explain tool bar options
- Plan a route using voice recognition

Safety (i-ACTIVSENSE):

- Blind Spot Monitoring System*
- Rear Cross Traffic Alert*
- Mazda Radar Cruise Control*
- Smart City Brake Support*
- Smart Brake Support*
- Distance Recognition Support System*
- Traffic Sign Recognition*
- Lane-keep Assist/Lane Departure Warning*

Presentation of Owner's Materials:

- Owner's Manual
- Warranty Information Booklet
 Warranty Start Date: _____
 Customer Initial: _____
- Perform Service Introduction
 - Suggested service intervals and set first appointment

SALES CONSULTANT	DATE	CUSTOMER	DATE

DEALERSHIP	DATE
SALES CONSULTANT	CUSTOMER'S NAME
VIN	E-MAIL

Genuine Mazda Service

Because you and your Mazda deserve the best

Your new Mazda deserves nothing less than the very best. To keep it running like new for years to come, trust the experts at your local Authorized Mazda Dealer. Simply bring your vehicle in for your scheduled maintenance and any needed repairs.*

At participating Mazda Full Circle Service Centers,** our technicians will automatically perform a complimentary Full Circle inspection on your vehicle and issue a detailed report card at every visit. This is designed to help you keep track of your Mazda's critical operating condition. Our factory-trained technicians know your vehicle inside out and use Genuine Mazda Parts, giving your vehicle the optimum care and maintenance it requires to run with flawless precision.

Remember to further enhance your driving experience, visit your local Mazda Service Center for your scheduled maintenance. It's also the place where you can find a wide variety of tires, parts and accessories that are just right for your vehicle.

*See vehicle's scheduled-maintenance program for details.

**To learn more about Mazda Full Circle Service, visit www.MazdaUSA.com and click on the "Owners" tab, scroll down and click on "Service & Parts", scroll down to "Mazda FULL CIRCLE SERVICE".

Customer Experience Center: 1-800-222-5500

Roadside Assistance Contact: 1-800-866-1998



COMPLIMENTARY FULL CIRCLE SERVICE INSPECTION

*We're committed to providing
expert Mazda service.*

You love to drive your Mazda, and we love to service your Mazda. With our Full Circle Service, we'll give your vehicle a COMPLIMENTARY MULTI-POINT INSPECTION. Your Mazda will receive a thorough review of its most crucial components.

This easy-to-use Smart Start Guide is intended to help you more fully appreciate some of the unique features and functions of your new vehicle. However, it is not intended to replace your Owner's Manual. The Owner's Manual contains more detailed information to help you better understand the important safety warnings, features, operation, and maintenance of your vehicle. All information, specifications, photographs and illustrations in this publication are those in effect at the time of printing. Mazda reserves the right to change specifications or design without obligation.



© Mazda North America Operations
Printed in U.S.A 011/16
Print 1
9999 95 011C 17SS

www.MazdaUSA.com

ZOOM-ZOOM

THE MAZDA CX-9 | DRIVING MATTERS™

