

A Word to Mazda Owners

Thank you for choosing a Mazda. We at Mazda design and build vehicles with complete customer satisfaction in mind.

To help ensure enjoyable and trouble-free operation of your Mazda, read this manual carefully and follow its recommendations.

An Authorized Mazda Dealer knows your vehicle best. So when maintenance or service is necessary, that's the place to go.

Our nationwide network of Mazda professionals is dedicated to providing you with the best possible service.

We assure you that all of us at Mazda have an ongoing interest in your motoring pleasure and in your full satisfaction with your Mazda product.

Mazda Motor Corporation
HIROSHIMA, JAPAN

Please be aware that this manual applies to all models, equipment and options. As a result, you may find some explanations for equipment not installed on your vehicle.

©2019 Mazda Motor Corporation
September 2019 (Print1)

How to Use This Manual

We want to help you get the most driving pleasure from your vehicle. Your owner's manual, when read from cover to cover, can do that in many ways.

Illustrations complement the words of the manual to best explain how to enjoy your Mazda. By reading your manual, you can find out about the features, important safety information, and driving under various road conditions.

The symbol below in this manual means "Do not do this" or "Do not let this happen".



Index: A good place to start is the Index, an alphabetical listing of all information in your manual.

You'll find several WARNINGS, CAUTIONS, and NOTES in the manual.

WARNING

A WARNING indicates a situation in which serious injury or death could result if the warning is ignored.

CAUTION

A CAUTION indicates a situation in which bodily injury or damage to your vehicle, or both, could result if the caution is ignored.

NOTE

A NOTE provides information and sometimes suggests how to make better use of your vehicle.

Table of Contents

Overview Mazda Connect overview, what Mazda Connect can do for you	1
Features Using vehicle information such as fuel economy and maintenance information	2
Convenience Using Apple CarPlay	3
Trouble Taking action such as when functions cannot be set or other problems arise	4
Index	5

1

Overview

Mazda Connect overview, what Mazda Connect can do for you

What is Mazda Connect ?.....	1-2
What is Mazda Connect ?.....	1-2

Basic Operations.....	1-6
Basic Operations.....	1-6
Commander Switch	
Operation.....	1-7
Audio Remote Control Switch	
Operation.....	1-10
Operation Using Voice	
Recognition Function.....	1-13
Favorites.....	1-17
Appendix.....	1-22

What is Mazda Connect ?

What is Mazda Connect ?

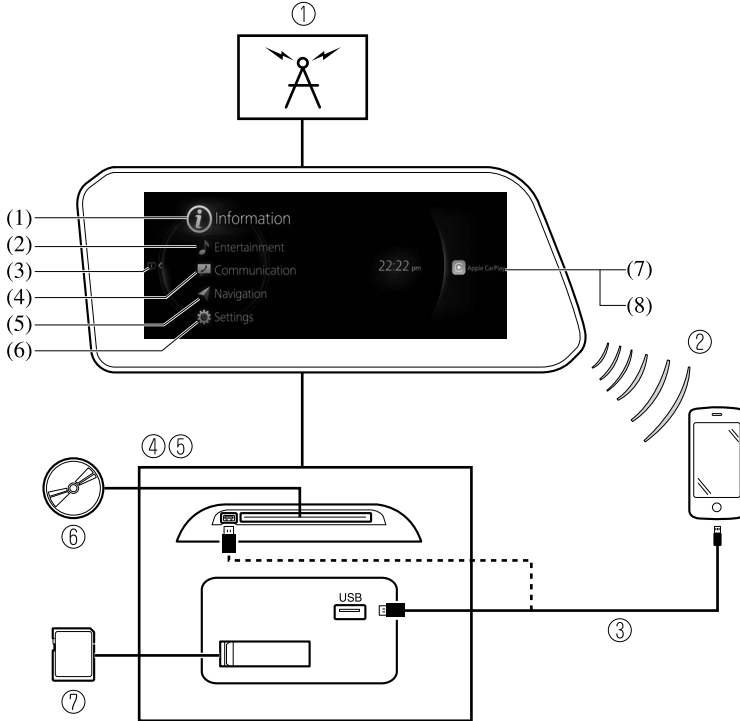

1. Radio
2. Bluetooth® Audio/Hands-Free Call/SMS (Short Message Service)
3. USB Audio/USB Video
4. USB port*1/SD card slot*2
5. CD/DVD player*
6. CD/DVD
7. SD card (Navigation system)*

*1 The location of the USB slot differs depending on the vehicle model.

*2 The SD card slot is for the navigation system only. For vehicles with the navigation system, the SD card (Mazda genuine) with stored map data is inserted into the SD card slot and used.

What is Mazda Connect ?

No.	Menu	Explanation
(1)	Information	<p><u>Fuel Efficiency Monitor:</u> Monitor fuel efficiency in real time and view fuel efficiency history.</p> <p><u>SiriusXM Travel Link:</u> Access traffic information, weather, fuel prices, parking information and sports scores.</p> <p><u>Vehicle Status Monitor:</u> View important vehicle maintenance messages, information, and intervals.</p> <p><u>Owner's Manual:</u> Learn about Mazda features, safety information, maintenance, and more.</p>
(2)	Entertainment	FM AM SiriusXM* DAB* Pandora* Bluetooth USB1 Audio/USB2 Audio USB1 Video*/USB2 Video* Disc*/CD*/DVD*
(3)	Notifications	Displays text messages received by the mobile device paired to Mazda Connect and notifications from the vehicle.
(4)	Communication	By connecting your mobile device, such as a Smartphone, to Mazda Connect via Bluetooth®, you can use the hands-free call and short message functions.
(5)	Navigation	<p>The navigation system (vehicles with navigation system) can be used when the SD card for the navigation system is inserted.</p> <p>If the SD card for the navigation system is not inserted, the compass indicating the direction in which the vehicle is moving is displayed. The compass may not indicate the correct bearing when the vehicle is stopped or traveling at a slow speed.</p> <p>For the navigation system operation, refer to the navigation system manual.</p>

What is Mazda Connect ?

No.	Menu	Explanation
(6)	Settings	<p>You can change the settings for the Mazda Connect screen, sound settings, and the vehicle functions.</p> <p><u>In-Vehicle Displays:</u> Configures settings and content for all in-vehicle displays.</p> <p><u>Sound Settings:</u> Configures the in-vehicle listening experience.</p> <p><u>Safety Settings:</u> Configures safety and driver assistance features.</p> <p><u>Vehicle Settings:</u> Configures vehicle convenience features.</p> <p><u>Connectivity Settings:</u> Configures Bluetooth and other device connectivity settings.</p> <p><u>System Settings:</u> Configures language, time, and other general settings.</p>
(7)	Apple CarPlay	You can use Apple CarPlay™ by connecting an iPhone® compatible with Apple CarPlay™ to the USB slot.
(8)	Android Auto	You can use Android Auto™ by connecting an Android™ Smartphone compatible with Android Auto™ to the USB port.



Always adjust Mazda Connect while the vehicle is stopped:

Do not adjust Mazda Connect with the Commander switch while driving the vehicle. Adjusting Mazda Connect with the Commander switch while driving the vehicle is dangerous as it could distract your attention from the vehicle operation which could lead to a serious accident.

Even if the audio remote control switches are equipped on the steering wheel, learn to use the switches without looking down at them so that you can keep your maximum attention on the road while driving the vehicle.

Do not allow the connection plug cord to get tangled with the shift lever (manual transmission)/selector lever (automatic transmission):

Allowing the plug cord to become tangled with the shift lever (manual transmission)/selector lever (automatic transmission) is dangerous as it could interfere with driving, resulting in an accident.

What is Mazda Connect ?

Do not adjust a mobile device or a similar product while driving the vehicle:

Adjusting a mobile device or a similar product while driving the vehicle is dangerous as it could distract your attention from the vehicle operation which could lead to a serious accident. Always adjust a mobile device or a similar product while the vehicle is stopped.



For the purposes of safe driving, adjust the audio volume to a level that allows you to hear sounds outside of the vehicle including car horns and particularly emergency vehicle sirens.

NOTE

- Do not use Mazda Connect for a long time with the engine stopped. Otherwise, the battery power could be depleted.
- If a mobile phone or CB radio is used in or near the vehicle, it could cause noise to occur from the audio system. However, this does not indicate a problem.

Basic Operations

NOTE

The explanation of functions described in this manual may differ from the actual operation, and the shapes of screens and buttons and the letters and characters displayed may also differ from the actual appearance.

Additionally, depending on future software updates, the content may successively change without notice.

Commander Switch Operation

The commander switch can be used to switch to each function and to operate each function.

Set the palm of your hand on the commander knob so that your fingers can touch each of the switches.



You can switch the screens without having to look down at your hand.

NOTE

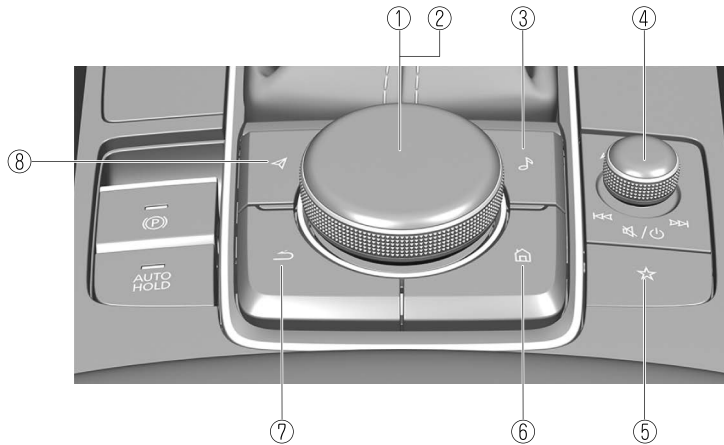



For safety reasons, some operations are disabled while driving the vehicle.



The shape of the switches varies depending on the vehicle model.

No.	Item	Explanation
1		Commander knob (selection): Rotate or slide the commander knob to highlight/select the on-screen functions you want to use.
2		Commander knob (select): Depress the commander knob to select the desired on-screen function you want to use.
3		Entertainment button: The audio source screen last used is displayed. (During Apple CarPlay™ or Android Auto™ music playback) Displays the Apple CarPlay™ or Android Auto™ now playing screen.

No.	Item	Explanation
4		<p>Volume knob:</p> <p>Volume adjustment</p> <p>Adjust the volume by turning the volume knob. If you adjust the volume during voice guidance, the volume of the voice guidance will change. If you adjust the volume during a hands-free call, the conversation volume will change. Press the volume knob to mute/pause the audio. Press the knob again to resume.</p> <p>Power off</p> <p>Press and hold the volume knob to turn the Mazda Connect system off.</p> <p>NOTE</p> <p>If you press the volume knob to mute an audio source which can be paused, such as Apple CarPlay™, USB audio, or Bluetooth® audio, while it is playing, the song playback pauses. Press the volume knob again to cancel the mute and the pause at the same time.</p> <p>Selecting a radio station</p> <p>(FM/AM radio)</p> <p>Radio stations saved to your Favorites can be selected by sliding the volume knob left (SEEK DOWN)/right (SEEK UP) while listening to FM/AM/SiriusXM®*. The station will change each time you slide the volume knob. If you want to manually tune to the next available station before or after the currently selected station, slide and hold the volume knob left (SEEK DOWN) or right (SEEK UP) until you hear a beep and the tuner will select the next available station.</p> <p>(DAB radio)*</p> <p>You can call up radio stations registered to your Favorites by sliding the volume knob left/right while listening to DAB radio. The radio stations change each time you slide the volume knob. In addition, the service switches to the next service when you continue sliding the knob to the right until you hear a beep, and it switches to the previous service when you continue sliding the knob to the left. If there is no next or previous service in the selected Ensemble, Ensemble switches.</p> <p>Playback Control</p> <p>Music and video files can be cued when listening to stored content via USB, Bluetooth®, and SiriusXM®, audio, or video. Slide the volume knob right to skip to the next track or slide it to the left to go back to the previous track. You can also slide and hold the volume knob to fast forward or rewind the track.</p>

No.	Item	Explanation
5		<p><u>Favorites button:</u> Displays the favorites screen. Press and hold to register AM/FM/SiriusXM® stations, contacts, navigation destinations, or any highlighted menu items to create easily accessible shortcuts.</p>
6		<p><u>Home button:</u> Displays the home screen.</p> <p>(While Apple CarPlay™ or Android Auto™ is displayed) Displays the Apple CarPlay™ or Android Auto™ home screen.</p> <p>(While Apple CarPlay™ or Android Auto™ is connected) Press and hold while the Mazda Connect screen is displayed to switch the screen from Mazda Connect to Apple CarPlay™ or Mazda Connect to Android Auto™. In addition, press and hold while the Apple CarPlay™ or Android Auto™ screen is displayed to switch to the Mazda Connect screen.</p>
7		<p><u>Back button:</u> Returns to previous screen.</p>
8		<p><u>Map button:</u> Displays the navigation screen (vehicles with navigation system). In order for the navigation system to function, the SD card for the navigation system is required. If the SD card for the navigation system is not inserted, the compass indicating the direction in which the vehicle is moving is displayed. For the navigation system operation, refer to the navigation system manual.</p> <p>(During Apple CarPlay™ or Android Auto™ route guidance) Displays the Apple CarPlay™ or Android Auto™ map screen.</p> <p>NOTE With an active Mazda Navigation route, pressing the Map button will repeat the navigation voice guidance.</p>

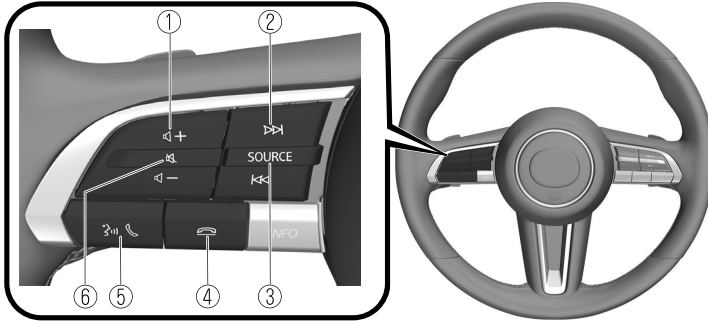

Audio Remote Control Switch Operation

The audio remote control switch is on the left side of the steering wheel. You can operate basic audio functions, pick up/hang up the phone, or activate voice control using the switch.





The shape of the switches may differ depending on the vehicle model.

No.	Item	Explanation
1		<p><u>Volume adjustment button:</u></p> <p>Press the (+) or (-) button to adjust the volume.</p>
		<p>If you adjust the volume during voice guidance, the volume of the voice guidance will change.</p> <p>If you adjust the volume during a hands-free call, the conversation volume will change.</p>

No.	Item	Explanation
2	 (SEEK UP)	<p>Seek Switch:</p>
	 (SEEK DOWN)	<p>Selecting a radio station</p> <p>(FM/AM radio) You can call up radio stations registered to your favorites by pressing the seek switch while listening to FM/AM radio. The radio stations change each time you press the switch. In addition, when the button is pressed and held, the current audio source is muted and the audio source selection screen is displayed.</p> <p>(DAB radio)* You can call up radio stations registered to your Favorites by pressing the seek switch while listening to DAB radio. The radio station changes each time you press the seek switch. In addition, if you press and hold the seek switch until you hear a beep, the service switches to the next or previous service. If there is no next or previous service in the selected Ensemble, Ensemble switches.</p> <p>Playback Control</p> <p>Music and video files can be cued when listening to stored content via USB, Bluetooth®, and SiriusXM®, audio, or video. Slide the volume knob right to skip to the next track or slide it to the left to go back to the previous track. You can also slide and hold the volume knob to fast forward or rewind the track.</p>



Basic Operations

No.	Item	Explanation
3	SOURCE	<p><u>SOURCE button:</u></p> <p>The audio source can be switched each time the button is pressed. In addition, when the button is pressed and held, the audio currently being played is turned off and the audio source selection screen is displayed.</p> <p>(During Apple CarPlay™ or Android Auto™ playback) Press and hold the SOURCE button to mute the current audio source.</p>
4		<p><u>Hang-up button :</u></p> <p>(During a call) Press the button to end the call.</p> <p>(While receiving a call) Press the button to refuse a call.</p>
5		<p><u>Talk/Pick-up button :</u></p> <p>(While receiving a call) Press the button to answer the call.</p>
6		<p><u>Mute button:</u></p> <p>Press the button to mute. Press it again to cancel the mute.</p> <p>NOTE If you press the mute button to mute an audio source which can be paused, such as Apple CarPlay™, USB audio, or Bluetooth® audio, while it is playing, the song playback pauses. Press the mute button again to cancel the mute and the pause at the same time.</p>

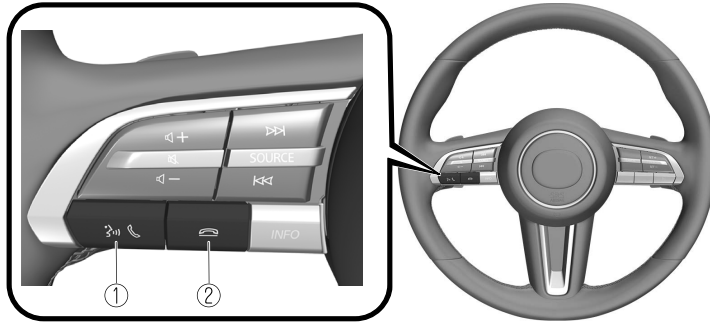
Operation Using Voice Recognition Function

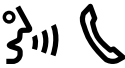

The shape of the switches may differ depending on the vehicle model.

No.	Item	Explanation
1		<p>Talk/Pick-up button :</p> <p>When the button is pressed, the voice recognition top screen is displayed and the voice recognition is activated.</p> <p>(While voice guidance is being announced) Press the button to skip the voice guidance.</p>
2		<p>Hang-up button:</p> <p>Press the button to end the voice recognition.</p>

Voice recognition activation

When the talk/pick-up button on the audio remote control switch is pressed, top screen of the voice recognition will be displayed.

NOTE

When an Apple CarPlay™ or Android Auto™ compatible device is connected, the Mazda Connect voice recognition system is disabled to allow the use of Siri® or Android Auto™ voice recognition at any time with the talk/pick-up button.

Commands usable at any time

“Help” - Can be used to check for usable voice commands.

“Back” - Returns to the previous screen. When a voice command is spoken while on the telephone number input screen, the content that was previously input is deleted.

“Cancel”- The voice recognition is ended.

To learn more on how to operate Mazda Connect

“Owner's Manual” - The operation guide screen is displayed.

Ending voice recognition

Do any one of the following operations:

- Press the hang-up button.
- Press and hold the talk/Pick-up button.
- Say the word, "Cancel".

Convenient operating tips for using the voice recognition function

Examples of effective voice commands in various categories are displayed on top screen of the voice recognition.

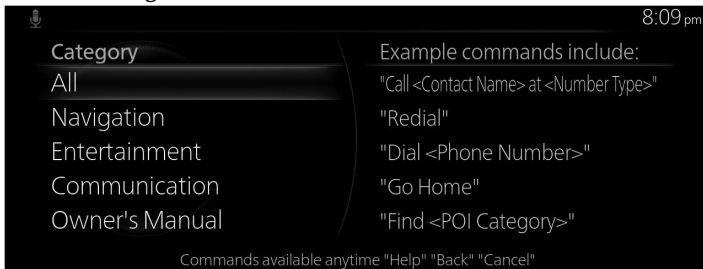

NOTE

- The voice command examples shown in this manual is only a partial list of the available commands. Some voice commands may only be available with selected vehicle models.
- When the Barge-In setting is on, voice commands can be made even while the voice guidance is being announced. For details on Barge-In, refer to System Settings on page 2-136.
- For details on voice commands which can be used on the navigation screen, refer to the navigation system manual.

To prevent misunderstood voice commands, be aware of the following points:

- Connect your mobile phone to Bluetooth® before operating the mobile phone using voice recognition.
- After pressing the talk/pick-up button, wait for the beep before speaking a command.
- Speaking in a slightly louder voice will improve voice recognition, but an excessively loud voice is unnecessary. Try to speak in a slightly louder voice than when talking to other passengers in the vehicle.
- You do not need to speak slowly. Speak at a normal speed.
- When calling a person in the device's phone book, the recognition rate increases the longer the name is. Errors may occur with names that are short such as "Mama", "Home", or "wife".
- Speak clearly, without pausing between words or numbers.
- Voice commands other than those specified, cannot be recognized. Speak in the wording specified by the voice commands.

- It is not necessary to face the microphone or approach it. Speak the voice commands while maintaining a safe driving position.
- Close the windows and the moonroof to reduce loud noises from outside the vehicle and to prevent the airflow of the air-conditioning system from being a disturbance when using Bluetooth® Hands-Free.
- Make sure that the air flow from the air conditioner is not blowing on the microphone.
- If the voice recognition is poor with the guidance volume set to high, set the Barge-In to OFF.

Examples of available voice commands

The specified name and number are put into the {}.

Common

- Back
- Help (You can listen to help guidance at each screen.)
- {Line Number} (You can select the line number on the screen.)
- Next Page
- Previous Page
- Cancel

Menu

- All
- Navigation
- Entertainment
- Communication
- Owner's Manual (the In-vehicle Digital Owner's Manual voice recognition can be displayed.)

Setting

- Voice Recognition Settings
- Owner's Manual (the In-vehicle Digital Owner's Manual voice recognition can be displayed.)
- Display Off

Music

- Play Artist (You can also use "Play Artist {Artist name}".)
- Play Album (You can also use "Play Album {Album Name}".)
- Play Playlist (You can also use "Play Playlist {Playlist Name}".)
- Play Song (You can also use "Play Song {Song Name}".)
- Play Audiobook (You can also use "Play Audiobook {Audiobook Name}".)
- Play Podcast (You can also use "Play Podcast {Podcast Name}".)

Basic Operations

Radio

- Tune to {Frequency} AM
- Tune to {Frequency} FM
- Tune to {Frequency} HD {Sub Channel}
- SiriusXM Channel {Channel Number}
- SiriusXM {Station Name}
- SiriusXM Genre (You can also use "SiriusXM {Genre Name}")
- Tune to DAB {DAB Station Name}

Source

- Change Source (You can also use "Change Source to USB"*1 and "USB"*1.)
- Audio OFF (You can also use "Change Source to Audio OFF".)

Phone

- Dial Phone Number (You can also use "Dial {Phone Number}")
- Call History
- Call a Contact (You can also use "Call {Contact Name}" and "Call {Contact Name} at {Number Type}")
- Redial

*1 : Audio source names other than "USB" can also be used as follows:
Bluetooth/AM/FM/SiriusXM/DAB/Disc/Pandora/USB1 Audio/USB2 Audio/
USB1 Video/USB2 Video

NOTE

- Some commands may not be usable depending on the region and equipment.
- Some commands cannot be used depending on the device connection conditions and the use conditions.

Favorites

Registering to Favorites

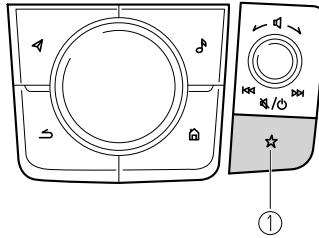

1. Favorites button

The Favorites button provides quick access to contents such as radio stations, contacts, navigation destinations, and other items that are registered to your Favorites.

You can use the following methods to add a new Favorite.

- Press and hold the ★ button on the commander switch while a desired contact, radio station, or a navigation destination is selected.

Selecting contents from Favorites

1. Press the ★ on the commander switch to display the Favorites list.

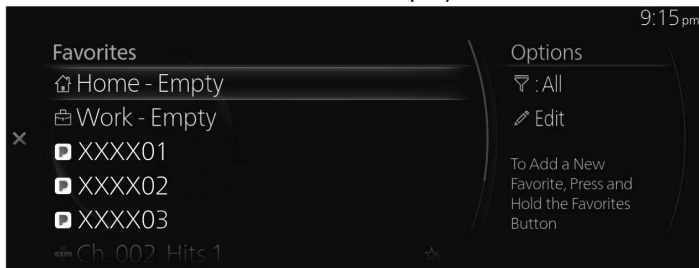

2. Select the desired item you want to play/display from the list to play/display.

Options menu

Options	Explanation
[Currently selected category]	The category name of the filter currently selected is displayed. Select to change the category displayed in the Favorites list.
Edit	Select to edit the Favorites list.

Basic Operations

NOTE

· **(Only vehicles with navigation system)**

You can register your home and workplace by selecting “Home” and “Work”. For details, refer to the Navigation System Owner's Manual.

Editing Favorites list

You can change the names and their display order in your favorites list, and delete contents registered to it.

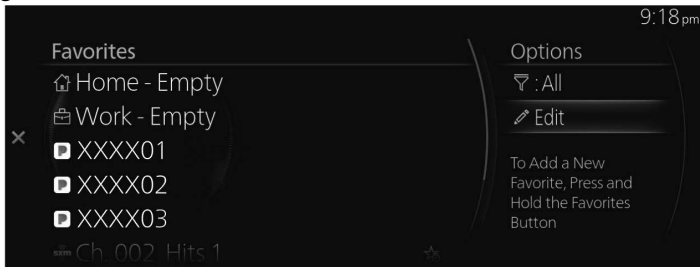

Edit	Explanation
Reorder Favorites	The Favorites list order can be changed.
Rename Favorites	Names in the Favorites list can be changed.
Edit Home	(Only vehicles with navigation system) You can register your home. For details, refer to the Navigation System Owner's Manual.
Edit Work	(Only vehicles with navigation system) You can register your workplace. For details, refer to the Navigation System Owner's Manual.
Delete Favorite(s)	Registered Favorites can be individually selected for deletion.

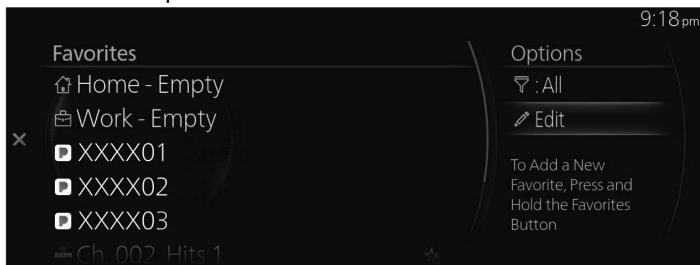

Changing the Favorites list order

1. Select “Edit” from the Options menu.



2. Select "Reorder Favorites" from the Edit menu.



3. Select the item in which you want to change the display order. Rotate the  to move the item and press the  to enter it.



Changing a displayed name in the Favorites list

1. Select "Edit" from the Options menu.

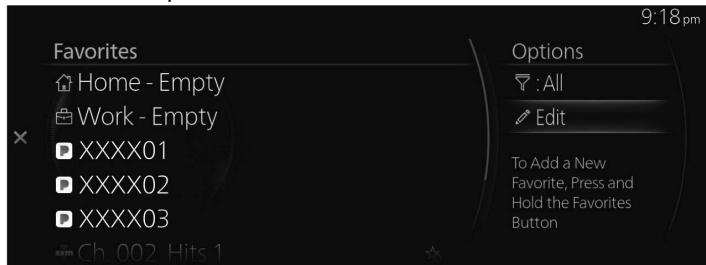

Basic Operations

2. Select "Rename Favorites" from the Edit menu.

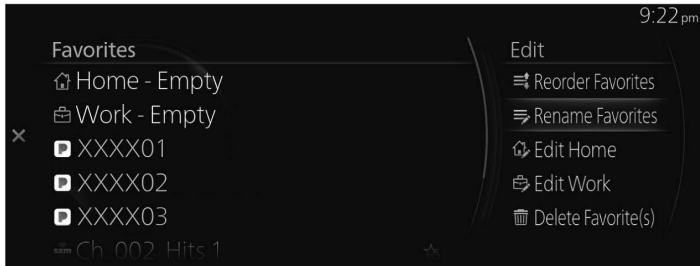

3. Select the item in which you want to change a displayed name, and change the name using the keyboard display.



Deleting contents from the Favorites list

1. Select "Edit" from the Options menu.

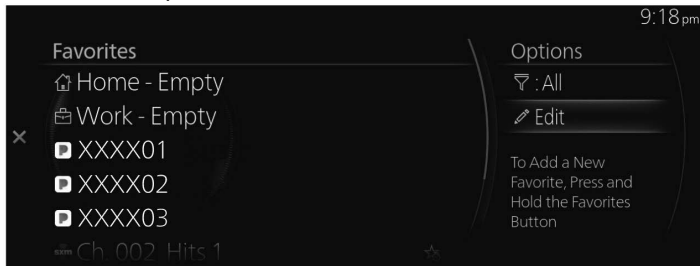

2. Select "Delete Favorite(s)" from the Edit menu.

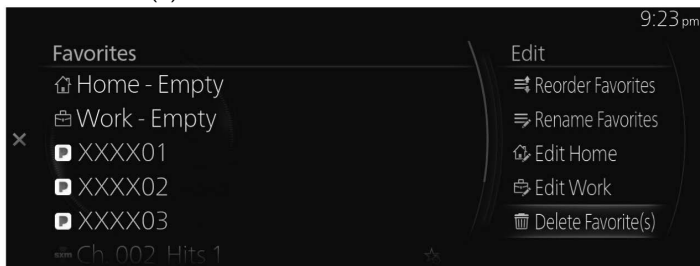

Basic Operations

3. Place a check in the box next to the item you want to delete and select “Delete” to delete the item. You can delete multiple items.

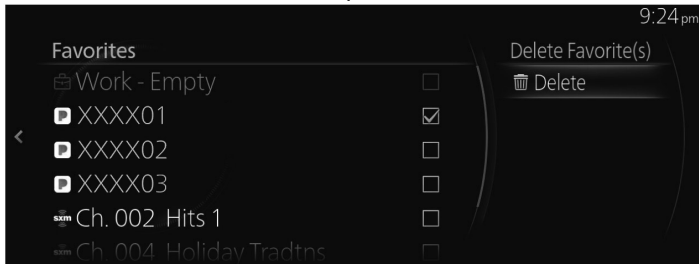

Appendix

Gracenote® Database

When audio CDs are played, the unit searches the database stored in the vehicle for the album name, artist name, genre, title, and album art, and if there is a match in the vehicle's database compilation to the music being played, each type of music information is automatically added (Album art only for MP3/WMA/AAC CDs and when playing USB audio and Bluetooth® audio). The database information stored in this device uses database information in the Gracenote® music recognitions service.

SiriusXM Travel Link®*



ADVISORY ONLY

The weather information is subject to service interruptions and may contain errors or inaccuracies and consequently should not be relied upon exclusively. You are urged to check alternate weather information sources prior to making safety related decisions. You acknowledge and agree that you shall be solely responsible for use of the information and all decisions taken with respect thereto. By using this weather service, you release and waive any claims against Sirius XM Radio Inc. and Mazda Motor Corporation and all of their respective affiliates with regard to this service.

SiriusXM® Satellite Radio*



Products/applications shall display “Call [Appropriate Phone Number] to Enable Services” for any unsubscribed SiriusXM Data Service(s).

This shall be shown on the same screen as the Radio ID and the service subscription status:

Contact your SiriusXM Representative for the appropriate call center phone number.

- U.S.A.: 1-877-447-0011
- Canada: 1-877-438-9677

SiriusXM® All Access Subscription

Hopefully, you're already loving SiriusXM in your new Mazda. But don't stop there — you can also listen on the app and online. All Access is the very best subscription package — with the most channels and the most flexibility. With All Access, you get every channel available on your vehicle, plus you can listen on the app, online, and in your home on a variety of connected devices. — so you can enjoy SiriusXM wherever you are. Here's what's included:

- Over 150 satellite channels to enjoy in your car, coast-to-coast, 24/7.
- All kinds of commercial-free music, plus every major sport, world-class news and the biggest names in talk & entertainment.
- All of our premium programming, including Howard Stern, every NFL, MLB®, and NBA game, NHL® games, every NASCAR® race, 24/7 talk channels dedicated to the biggest leagues, and much more.

All SiriusXM services require a subscription, sold separately or as a package by SiriusXM Radio Inc. (or, in Canada, SiriusXM Canada Inc.), after any trial subscription which may be included with your vehicle purchase or lease. To subscribe after your trial subscription, call 1-877-447-0011 (U.S.A.) or 1-877-438-9677 (Canada).

CAUTION

It is prohibited to copy, decompile, disassemble, reverse engineer, hack, manipulate, or otherwise make available any technology or software incorporated in receivers compatible with the SiriusXM satellite radio service or that support the SiriusXM website, the online service or any of its content. Furthermore, the AMBE® voice compression software included in this product is protected by intellectual property rights including patent rights, copyrights, and trade secrets of Digital Voice Systems, Inc. The SiriusXM Service may include traffic, weather and other content and emergency alert information and data. Such information and data is not for "safety for life", but is merely supplemental and advisory in nature and, therefore, cannot be relied upon as safety critical. Neither SiriusXM nor Mazda is responsible for any errors in accuracies in the SiriusXM data services or its use in applications. The SiriusXM content is subject to change without notice.

NOTE

SiriusXM Satellite Radio Service is available in the 48 contiguous United States and the District of Columbia. The service is not available in Alaska, Hawaii or Puerto Rico.

HD Radio™*

What is HD Radio™ Technology and how does it work?

HD Radio™ Technology is the digital evolution of analog AM/FM radio. Your radio product has a special receiver which allows it to receive digital broadcasts (where available) in addition to the analog broadcasts it already receives.

Digital broadcasts have better sound quality than analog broadcasts as digital broadcasts provide free, crystal clear audio.

For more information, and a guide to available radio stations and programming, please visit www.hdradio.com.

Benefits of HD Radio™ Technology

(Information)

The song title, artist name, album name will appear on the screen when available by the radio station.

(Multicast)

On the FM radio frequency most digital stations have "multiple" or supplemental programs on each FM station.

HD Radio Technology manufactured under license from iBiquity Digital Corporation. U.S. and Foreign Patents.

For patents see <http://dts.com/patents>.

Apple CarPlay™



➤ YOU EXPRESSLY ACKNOWLEDGE AND AGREE THAT USE OF APPLE CARPLAY™ (“THE APPLICATION”) IS AT YOUR SOLE RISK AND THAT THE ENTIRE RISK AS TO SATISFACTORY QUALITY, PERFORMANCE, ACCURACY AND EFFORT IS WITH YOU TO THE MAXIMUM EXTENT PERMITTED BY APPLICABLE LAW, AND THAT THE APPLICATION AND INFORMATION ON THE APPLICATION IS PROVIDED “AS IS” AND “AS AVAILABLE”, WITH ALL FAULTS AND WITHOUT WARRANTY OF ANY KIND, AND MAZDA HEREBY DISCLAIMS ALL WARRANTIES AND CONDITIONS WITH RESPECT TO THE APPLICATION AND INFORMATION ON THE APPLICATION, EITHER EXPRESS, IMPLIED OR STATUTORY, INCLUDING, BUT NOT LIMITED TO, THE IMPLIED WARRANTIES AND/OR CONDITIONS OF MERCHANTABILITY, SATISFACTORY QUALITY, FITNESS FOR A PARTICULAR PURPOSE, ACCURACY, QUIET ENJOYMENT, AND NONINFRINGEMENT OF THIRD PARTY RIGHTS.

AS EXAMPLES, AND WITHOUT LIMITATION, MAZDA DISCLAIMS ANY WARRANTY REGARDING THE ACCURACY OF DATA PROVIDED BY THE APPLICATION, SUCH AS THE ACCURACY OF DIRECTIONS, ESTIMATED TRAVEL TIME, SPEED LIMITS, ROAD CONDITIONS, NEWS, WEATHER, TRAFFIC, OR OTHER CONTENT PROVIDED BY APPLE, ITS AFFILIATES, OR THIRD PARTY PROVIDERS; MAZDA DOES NOT GUARANTEE AGAINST LOSS OF APPLICATION DATA, WHICH MAY BE LOST AT ANY TIME; MAZDA DOES NOT GUARANTEE THAT THE APPLICATION OR ANY SERVICES PROVIDED THROUGH THEM WILL BE PROVIDED AT ALL TIMES OR THAT ANY OR ALL SERVICES WILL BE AVAILABLE AT ANY PARTICULAR TIME OR LOCATION. FOR EXAMPLE, SERVICES MAY BE SUSPENDED OR INTERRUPTED WITHOUT NOTICE FOR REPAIR, MAINTENANCE, SECURITY FIXES, UPDATES, ETC., SERVICES MAY BE UNAVAILABLE IN YOUR AREA OR LOCATION, ETC.

IN ADDITION, YOU UNDERSTAND THAT CHANGES IN THIRD PARTY TECHNOLOGY OR GOVERNMENT REGULATION MAY RENDER THE SERVICES AND/OR APPLICATIONS OBSOLETE AND/OR UNUSABLE. TO THE EXTENT NOT PROHIBITED BY LAW, IN NO EVENT SHALL MAZDA OR ITS AFFILIATES BE LIABLE FOR PERSONAL INJURY, OR ANY INCIDENTAL, SPECIAL, INDIRECT OR CONSEQUENTIAL DAMAGES WHATSOEVER, INCLUDING, WITHOUT LIMITATION, DAMAGES FOR LOSS OF PROFITS, CORRUPTION OR LOSS OF DATA, FAILURE TO TRANSMIT OR RECEIVE ANY DATA, BUSINESS INTERRUPTION OR ANY OTHER COMMERCIAL DAMAGES OR LOSSES, ARISING OUT OF OR RELATED TO THE APPLICATION OR YOUR USE OF OR INABILITY TO USE THE APPLICATION OR INFORMATION ON THE APPLICATION.

- When using Apple CarPlay™, please avoid distraction and use Apple CarPlay™ responsibly. Stay fully aware of driving conditions and always obey applicable laws.

NOTE

- Apple CarPlay™ is provided by Apple® and its use is subject to your agreement to the Apple CarPlay™ terms of use, which are included as part of the Apple iOS terms of use.
- When using Apple CarPlay™, location, speed, and other vehicle data is transferred to your iPhone®. For further details, refer to Apple®'s Privacy Policy.

Android Auto™



- YOU EXPRESSLY ACKNOWLEDGE AND AGREE THAT USE OF ANDROID AUTO™ (“THE APPLICATION”) IS AT YOUR SOLE RISK AND THAT THE ENTIRE RISK AS TO SATISFACTORY QUALITY, PERFORMANCE, ACCURACY AND EFFORT IS WITH YOU TO THE MAXIMUM EXTENT PERMITTED BY APPLICABLE LAW, AND THAT THE APPLICATION AND INFORMATION ON THE APPLICATION IS PROVIDED “AS IS” AND “AS AVAILABLE,” WITH ALL FAULTS AND WITHOUT WARRANTY OF ANY KIND, AND MAZDA HEREBY DISCLAIMS ALL WARRANTIES AND CONDITIONS WITH RESPECT TO THE APPLICATION AND INFORMATION ON THE APPLICATION, EITHER EXPRESS, IMPLIED OR STATUTORY, INCLUDING, BUT NOT LIMITED TO, THE IMPLIED WARRANTIES AND/OR CONDITIONS OF MERCHANTABILITY, SATISFACTORY QUALITY, FITNESS FOR A PARTICULAR PURPOSE, ACCURACY, QUIET ENJOYMENT, AND NONINFRINGEMENT OF THIRD PARTY RIGHTS.

AS EXAMPLES, AND WITHOUT LIMITATION, MAZDA DISCLAIMS ANY WARRANTY REGARDING THE ACCURACY OF DATA PROVIDED BY THE APPLICATION, SUCH AS THE ACCURACY OF DIRECTIONS, ESTIMATED TRAVEL TIME, SPEED LIMITS, ROAD CONDITIONS, NEWS, WEATHER, TRAFFIC, OR OTHER CONTENT PROVIDED BY GOOGLE, ITS AFFILIATES, OR THIRD PARTY PROVIDERS; MAZDA DOES NOT GUARANTEE AGAINST LOSS OF APPLICATION DATA, WHICH MAY BE LOST AT ANY TIME; MAZDA DOES NOT GUARANTEE THAT THE APPLICATION OR ANY SERVICES PROVIDED THROUGH THEM WILL BE PROVIDED AT ALL TIMES OR THAT ANY OR ALL SERVICES WILL BE AVAILABLE AT ANY PARTICULAR TIME OR LOCATION. FOR EXAMPLE, SERVICES MAY BE SUSPENDED OR INTERRUPTED WITHOUT NOTICE FOR REPAIR, MAINTENANCE, SECURITY FIXES, UPDATES, ETC., SERVICES MAY BE UNAVAILABLE IN YOUR AREA OR LOCATION, ETC.

IN ADDITION, YOU UNDERSTAND THAT CHANGES IN THIRD PARTY TECHNOLOGY OR GOVERNMENT REGULATION MAY RENDER THE SERVICES AND/OR APPLICATIONS OBSOLETE AND/OR UNUSABLE. TO THE EXTENT NOT PROHIBITED BY LAW, IN NO EVENT SHALL MAZDA OR ITS AFFILIATES BE LIABLE FOR PERSONAL INJURY, OR ANY INCIDENTAL, SPECIAL, INDIRECT OR CONSEQUENTIAL DAMAGES WHATSOEVER, INCLUDING, WITHOUT LIMITATION, DAMAGES FOR LOSS OF PROFITS, CORRUPTION OR LOSS OF DATA, FAILURE TO TRANSMIT OR RECEIVE ANY DATA, BUSINESS INTERRUPTION OR ANY OTHER COMMERCIAL DAMAGES OR LOSSES, ARISING OUT OF OR RELATED TO THE APPLICATION OR YOUR USE OF OR INABILITY TO USE THE APPLICATION OR INFORMATION ON THE APPLICATION.

- When using Android Auto™, please avoid distraction and use Android Auto™ responsibly. Stay fully aware of driving conditions and always obey applicable laws.

NOTE

- Android Auto™ is provided by Google and its use is subject to your agreement to the Android Auto™ terms of use.
- When using Android Auto™, location, speed, and other vehicle data is transferred to your smart phone. For further details, refer to Google Privacy Policy.

Trademark

- Pandora®, the Pandora® logo, and the Pandora® trade dress are trademarks or registered trademarks of Pandora Media, Inc., used with permission.
- HD Radio™ and the HD, HD Radio, and “Arc” logos are proprietary trademarks of iBiquity Digital Corp.



- Manufactured under license by Dolby Laboratories, Inc.. Dolby and the double-D symbol are trademarks of Dolby Laboratories.
- iPhone, iPod touch, iPod nano, Siri and Apple Music are registered trademarks of Apple Inc.
- Apple CarPlay is trademarks of Apple Inc.
- iOS is a trademark or registered trademark of Cisco in the U.S. and other countries and is used under license.
- “Made for iPhone” and “Made for iPod” mean that an accessory has been designed to connect specifically to iPhone or iPod, and has been certified by the developer to meet Apple performance standards. Apple is not responsible for the operation of this device or its compliance with safety and regulatory standards. Please note that the use of this accessory with iPhone or iPod may affect wireless performance.

Made for
 iPhone 7 Plus
 iPhone 7
 iPhone SE
 iPhone 6s Plus
 iPhone 6s

- iPhone 6 Plus
- iPhone 6
- iPhone 5s
- iPhone 5c
- iPhone 5
- iPhone 4s
- iPod touch (6th generation)
- iPod touch (5th generation)
- iPod nano (7th generation)



- Google, Android, Android Auto and other related marks are trademarks of Google LLC.
- AudioPilot is a registered trademark of Bose Corporation.
- Centerpoint is a registered trademark of Bose Corporation.
- Windows Media and Microsoft are registered trademarks of Microsoft Corporation U.S. in the United States and other countries. This product is protected by certain intellectual property rights of Microsoft Corporation and third parties. Use or distribution of such technology outside of this product is prohibited without a license from Microsoft or an authorized Microsoft subsidiary and third parties.
- The Bluetooth® word mark and logos are registered trademarks owned by Bluetooth SIG, Inc. and any use of such marks by Panasonic Corporation is under license. Other trademarks and trade names are those of their respective owners.



Basic Operations

- SDHC Logo is a trademark of SD-3C, LLC.



- Gracenote, the Gracenote logo and logotype are either a registered trademark or a trademark of Gracenote, Inc. in the United States and/or other countries.



Regarding the license for the audio amplifier (except vehicles with Bose audio)

License for CMSIS-RTOS RTX Implementation

Copyright (c) 1999-2009 KEIL, 2009-2015 ARM Germany GmbH, 2013-2016 ARM Ltd All rights reserved.

Redistribution and use in source and binary forms, with or without modification, are permitted provided that the following conditions are met:

- Redistributions of source code must retain the above copyright notice, this list of conditions and the following disclaimer

- Redistributions in binary form must reproduce the above copyright notice, this list of conditions and the following disclaimer in the documentation and/or other materials provided with the distribution.
- Neither the name of ARM nor the names of its contributors may be used to endorse or promote products derived from this software without specific prior written permission.

THIS SOFTWARE IS PROVIDED BY THE COPYRIGHT HOLDERS AND CONTRIBUTORS "AS IS" AND ANY EXPRESS OR IMPLIED WARRANTIES, INCLUDING, BUT NOT LIMITED TO, THE IMPLIED WARRANTIES OF MERCHANTABILITY AND FITNESS FOR A PARTICULAR PURPOSE ARE DISCLAIMED.

IN NO EVENT SHALL COPYRIGHT HOLDERS AND CONTRIBUTORS BE LIABLE FOR ANY DIRECT, INDIRECT, INCIDENTAL, SPECIAL, EXEMPLARY, OR CONSEQUENTIAL DAMAGES (INCLUDING, BUT NOT LIMITED TO, PROCUREMENT OF SUBSTITUTE GOODS OR SERVICES; LOSS OF USE, DATA, OR PROFITS; OR BUSINESS INTERRUPTION) HOWEVER CAUSED AND ON ANY THEORY OF LIABILITY, WHETHER IN CONTRACT, STRICT LIABILITY, OR TORT (INCLUDING NEGLIGENCE OR OTHERWISE) ARISING IN ANY WAY OUT OF THE USE OF THIS SOFTWARE, EVEN IF ADVISED OF THE POSSIBILITY OF SUCH DAMAGE.

2

Features

Using vehicle information such as fuel economy and maintenance information

Information.....	2-2	Communication.....	2-88
Fuel Efficiency Monitor.....	2-2	Communication.....	2-88
SiriusXM Travel Link®.....	2-9	Bluetooth® Hands-Free.....	2-89
Vehicle Status Monitor.....	2-11	Navigation.....	2-109
Owner's Manual*.....	2-14	Navigation*.....	2-109
Entertainment.....	2-15	Settings.....	2-110
Entertainment.....	2-15	Settings.....	2-110
FM.....	2-30	In-Vehicle Displays.....	2-113
AM.....	2-35	Sound Settings.....	2-115
SiriusXM®.....	2-38	Safety Settings.....	2-117
DAB*.....	2-45	Vehicle Settings.....	2-122
Pandora®.....	2-49	Connectivity Settings.....	2-126
Bluetooth®.....	2-55	System Settings.....	2-136
USB1 Audio/USB2 Audio.....	2-59		
USB1 Video/USB2 Video*.....	2-66		
CD*.....	2-71		
DVD*.....	2-78		

Fuel Efficiency Monitor

The fuel efficiency monitor switches between the fuel efficiency history, energy flow monitor (if equipped) , and settings. They can be displayed by selecting each item on the center display.

1. Select "Information" on the home screen.
2. Select "Fuel Efficiency Monitor".
3. Press the commander switch to display the menu.
4. Select the item in the menu. Each item operates as follows:

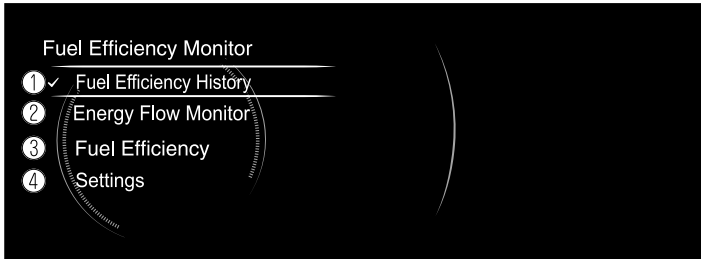

1. Displays the information regarding the fuel efficiency.
2. Displays the system operation status.
3. Displays the actual energy efficiency.*
4. Displays the settings for the fuel efficiency monitor.

Fuel efficiency history

Displays the information regarding the fuel efficiency.

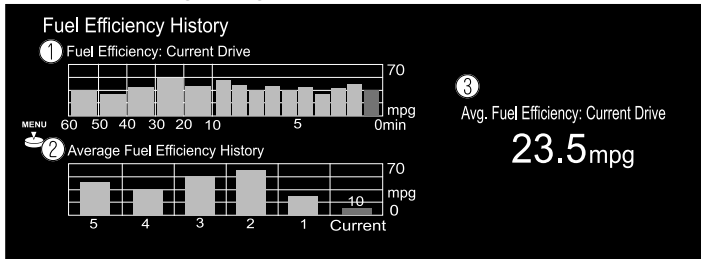

1. Displays the fuel efficiency for the past 60 minutes.
 - Displays the fuel efficiency every minute for the past 1 to 10 minutes.
 - Displays the fuel efficiency every 10 minutes for the past 10 to 60 minutes.
2. Displays the average fuel efficiency over the past 5 resets and after the current reset.
3. Calculates the average fuel efficiency at regular intervals after vehicle travel starts, and displays it.

Energy flow monitor

With M Hybrid (Without SKYACTIV-X 2.0)

Displays the i-stop operation status, operation status of the cylinder deactivation function, and the M Hybrid operation and energy generating status.

Displays the energy flow by the direction of the arrows and movement of the arrows. If there is no energy flow, the arrows are not displayed.

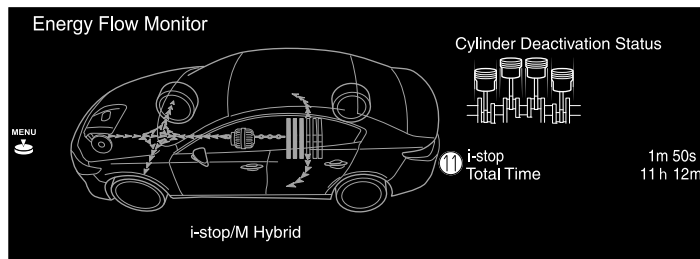
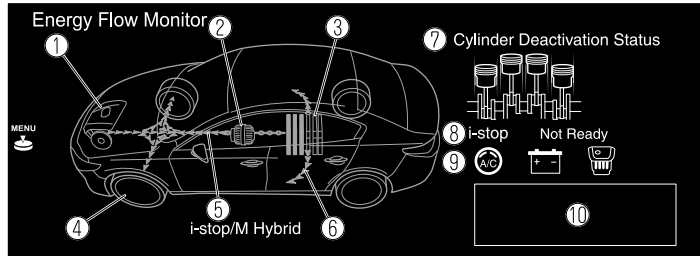

1. Engine
2. Integrated Starter-Generator (ISG)
3. M Hybrid battery
4. Tires
5. Arrows indicating energy flow
6. The arrow moves from the M Hybrid battery towards the electrical devices, and the vehicle indication is illuminated at the same time.
All the arrows are indicated, however the actual indication differs.
(Example)

- When the M Hybrid battery is charging, the arrow moves towards M Hybrid battery.
- While driving, the arrows move towards the tires from the engine (both the engine and ISG, depending on the driving conditions). In addition, the arrow moves from the M Hybrid battery towards the electrical devices, and the vehicle indication is illuminated at the same time.*¹
- The tire indications rotate while driving.

NOTE

- The remaining amount of power in the M Hybrid battery is indicated at 6 levels.
 - Charging of the M Hybrid battery is controlled automatically by M Hybrid. The remaining power in the M Hybrid battery may not reach the maximum even though power is regenerated by the engine power and deceleration regeneration. However, this does not indicate a problem.
7. The condition of each cylinder is displayed by colors. The operating cylinders are displayed in red.*
 8. Displays the readiness status as to whether operation of the i-stop function is available.
 9. Displays the operation readiness status of the i-stop function using icons (engine, battery, and air conditioner). Icons which indicate that a system's operation readiness has been completed are illuminated. Icons which have not been illuminated indicate that the system's operation readiness has not been completed.
 10. Indicates the operations required by the driver to operate the i-stop function while it is not operating.
 11. Displays the current amount of time that the i-stop function has been operating and the accumulated amount of time that it has been operating.
- *1 The indication may differ depending on the driving conditions.

With M Hybrid (With SKYACTIV-X 2.0)

Displays the i-stop operation status, operation status of the combustion status, and the M Hybrid operation and energy generating status.

Displays the energy flow by the direction of the arrows and movement of the arrows. If there is no energy flow, the arrows are not displayed.

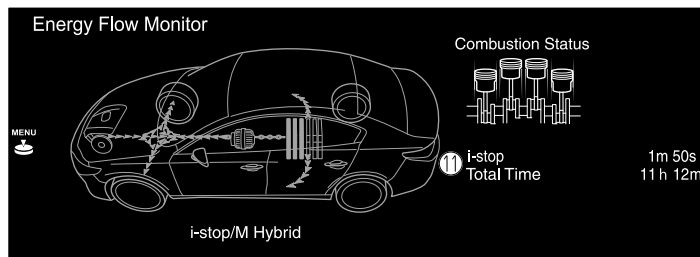
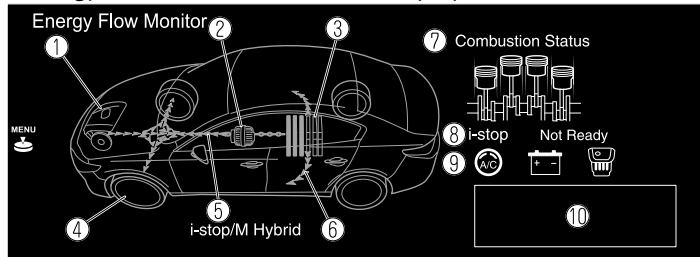

1. Engine
2. Integrated Starter-Generator (ISG)
3. M Hybrid battery
4. Tires
5. Arrows indicating energy flow
6. The arrow moves from the M Hybrid battery towards the electrical devices, and the vehicle indication is illuminated at the same time.

All the arrows are indicated, however the actual indication differs.

(Example)

- When the M Hybrid battery is charging, the arrow moves towards M Hybrid battery.
- While driving, the arrows move towards the tires from the engine (both the engine and ISG, depending on the driving conditions). In addition, the arrow moves from the M Hybrid battery towards the electrical devices, and the vehicle indication is illuminated at the same time.*1
- The tire indications rotate while driving.

NOTE

- The remaining amount of power in the M Hybrid battery is indicated at 6 levels.
 - Charging of the M Hybrid battery is controlled automatically by M Hybrid. The remaining power in the M Hybrid battery may not reach the maximum even though power is regenerated by the engine power and deceleration regeneration. However, this does not indicate a problem.
7. Displays the cylinder indication in white while fuel is not injected to the engine. When fuel is injected to the engine, the color changes to red and then to dark green as fuel is burnt efficiently. In addition, while fuel is burnt efficiently, SPCCI is indicated on the display. (SPCCI = Spark Controlled Compression Ignition)
 8. Displays the readiness status as to whether operation of the i-stop function is available.
 9. Displays the operation readiness status of the i-stop function using icons (engine, battery, and air conditioner). Icons which indicate that a system's operation readiness has been completed are illuminated. Icons which have not been illuminated indicate that the system's operation readiness has not been completed.
 10. Indicates the operations required by the driver to operate the i-stop function while it is not operating.
 11. Displays the current amount of time that the i-stop function has been operating and the accumulated amount of time that it has been operating.
- *1 The indication may differ depending on the driving conditions.

Only vehicles with i-stop function

Displays the i-stop operation status.

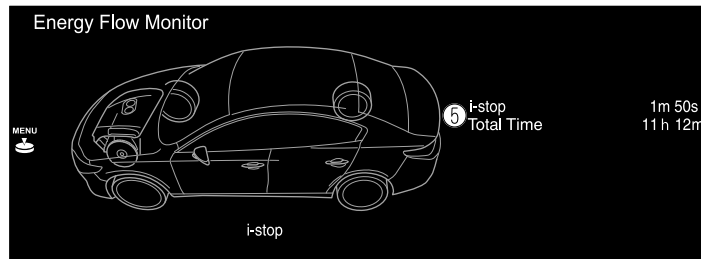
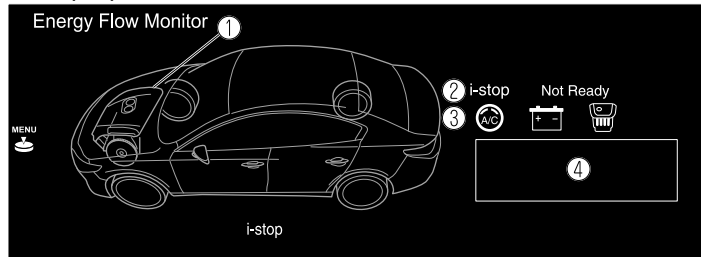

1. Displays the operation status of the i-stop function in the engine area. The engine area is illuminated while the engine idling stop is not operating, and it is not illuminated while the engine idling stop is operating.
2. Displays the readiness status as to whether operation of the i-stop function is available.
3. Displays the operation readiness status of the i-stop function using icons (engine, battery, and air conditioner). Icons which indicate that a system's operation readiness has been completed are illuminated. Icons which have not been illuminated indicate that the system's operation readiness has not been completed.
4. Indicates the operations required by the driver to operate the i-stop function while it is not operating.
5. Displays the current amount of time that the i-stop function has been operating and the accumulated amount of time that it has been operating.

Information

Only vehicles cylinder deactivation function

Displays the cylinder deactivation operation status.

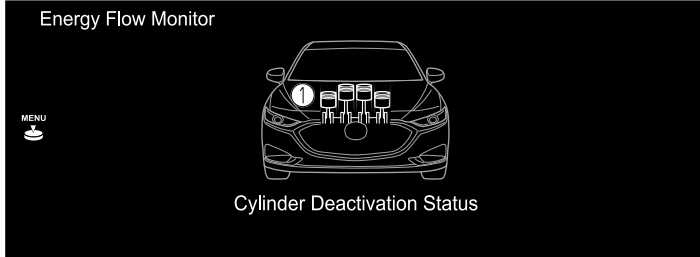

1. The condition of each cylinder is displayed by colors. The operating cylinders are displayed in red.

Fuel Efficiency*

The actual performance of the energy efficiency is displayed.

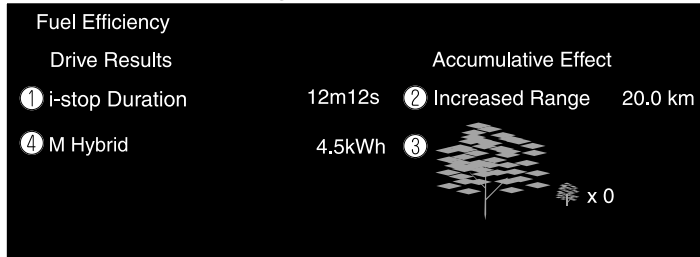

1. Displays the amount of time that the i-stop function has operated.
2. Displays the total driving distance which could be extended by the operation of the i-stop function.
3. The leaf graphic grows according to the amount of CO2 emissions reduced by the system effects. The cumulative total amount of leaf growth is indicated in terms of the number of tree graphics.
4. Displays the system power generation amount.*

Settings

Displays the fuel efficiency monitor settings screen.

The following settings can be changed in the settings screen.

- Fuel efficiency history reset
- Setting to reset or not reset the linked average fuel efficiency indicated in the instrument cluster and the fuel efficiency history (current) on the center display when tripmeter (TRIP A) is reset.

SiriusXM Travel Link®*

Properly equipped Mazda vehicles will also get the following SiriusXM infotainment services : Traffic, Weather, Sports Scores, Fuel Prices, and more. For a list of available features in your vehicle, visit SiriusXM.com/infotainment and get the most out of your driving experience.

1. Select "Information" on the home screen.

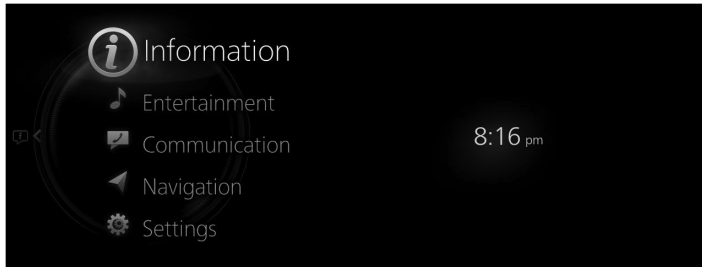

2. Select "SiriusXM Travel Link".

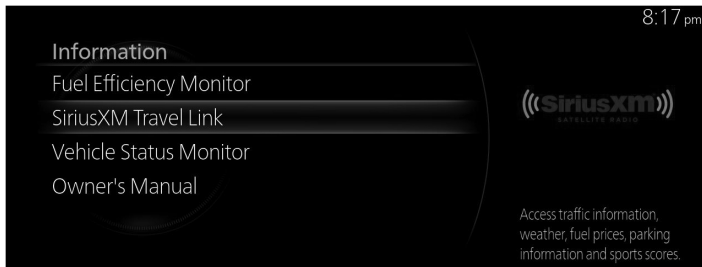

3. Select the menu you want to display.

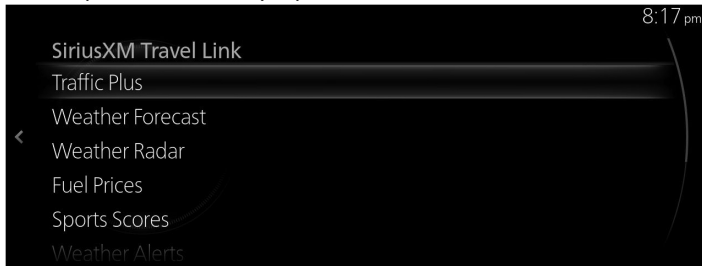

Menu	Explanation
Traffic Plus*1	Displays continuously updated traffic information on the navigation screen in real time.
Weather Forecast	Displays the weather forecast.
Weather Radar*1	Displays items such as weather radar, severe storms, and tropical storm information on the navigation screen.

Information

Menu	Explanation
Fuel Prices ^{*1}	Displays information for gas stations.
Sports Scores	Displays a list of each genre list and the game schedules and match results for teams selected from the list. You can check on the details of a team by registering the team to "My Teams". Up to 50 items can be registered.
Weather Alerts ^{*2}	Displays weather information, warnings, and security alerts. You can also turn the notifications on/off by selecting or deselecting the check box of "Alert Notifications".
Parking Information ^{*1}	Displays information for parking areas.
Subscription Status	You can check the status of each service subscription.

^{*1} With Car navigation system

^{*2} Except Canada

NOTE

- Select a service which you do not currently subscribe to and a message is displayed indicating that the service subscription has expired.
If you want to re-subscribe, select "Call" and you can make a call to the telephone number indicated on the screen. To make the telephone call, you need to establish a Bluetooth® hands-free connection using a Bluetooth® device.
- For safety reasons, detailed information screens for items such as "Sports Scores" and "Weather Alerts" may not be displayed while you are driving the vehicle.

Vehicle Status Monitor

1. Select "Information" on the Home screen to display the vehicle status monitor.
2. Select "Vehicle Status Monitor".

You can customize settings in the setup display as follows:

Item	Explanation
Vehicle Warning Messages	If there is a problem with the vehicle, information about the problem is displayed.
Next Service	<p>The next maintenance period is displayed.</p> <p><u>Date</u> The date manually set by the customer is displayed.</p> <p><u>Distance</u> If "Next Service Date" is set to "Automatic" The "Distance Until Oil Change" content is displayed.</p> <p>If "Next Service Date" is set to "Manual" The traveled distance manually set by the customer is displayed. However, when any of the following conditions is met, the "Distance Until Oil Change" content is displayed.</p> <ul style="list-style-type: none"> • You have not set the traveled distance. • "Distance Until Oil Change" is shorter than the traveled distance set by the customer.

Information

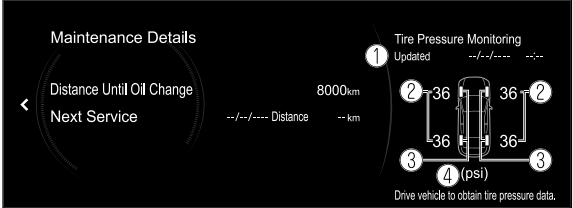
Item		Explanation
Maintenance Details	Engine Oil Level	The engine oil level is displayed.
	Distance Until Oil Change	The traveled distance until engine oil needs to be replaced is displayed.
	Next Service	The next maintenance period manually set by the customer is displayed.
	Tire pressure monitor	<p>The current tire pressure can be checked.</p>  <ol style="list-style-type: none"> 1. When tire pressures were last modified 2. Air pressure of each tire 3. Tire pressure condition of each tire <ul style="list-style-type: none"> · When air pressure is low: Yellow color · When air pressure is correct: Blue color · When air pressure cannot be monitored: Black color 4. Tire pressure units <p>NOTE</p> <ul style="list-style-type: none"> · While the tire pressure monitoring system is learning the tire positions, such as immediately after a tire position has been changed, the tire pressure at the tire position prior to it being changed is displayed until the system completes the learning. For this reason, the tire pressures displayed for the tire positions may be different from the actual tire pressures at the tire positions. · The air pressure displayed on the display may be different from the value measured using an air pressure gauge. · The display units for the tire pressures can be changed. Refer to Settings on page 2-110.

Item		Explanation
Vehicle Maintenance Settings	Next Service Date	The method of setting the next maintenance can be selected from the following. <ul style="list-style-type: none"> • Automatic • Manual
	Set Next Service Date	If "Next Service Date" is set to "Manual", the next maintenance date can be set.
	Set Next Service Distance	If "Next Service Date" is set to "Manual", the traveled distance until the next maintenance period can be set.
	Reset Oil Change Distance	The "Distance Until Oil Change" content can be reset. After replacing the engine oil, perform the reset (engine oil data re-setting) of the recorded value in this item.

Features

Information

Owner's Manual*

Learn about Mazda features, safety information, maintenance, and more.

Entertainment

Do not spill any liquid on the audio system.



Do not insert any objects, other than CDs, into the slot.

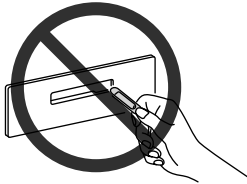

Radio

The radio reception strength varies due to the position of the antenna constantly changing with the movement of the vehicle, and from the effects of objects such as tall buildings and traffic signals, which could make it difficult to maintain optimum reception.

Refer to FM on page 2-30.

Refer to AM on page 2-35.

CD

Usable media and playable data with this unit are as follows.

Discs displaying the following markings can be used.

Commercially available discs		
Recorded discs		
		

Playable data registered to a disc as an MP3/WMA/AAC CD is as follows.

MP3,WMA,AAC

NOTE

- If a disc has both music data (CD-DA) and MP3/WMA/AAC files, playback of the two or three file types differs depending on how the disc was recorded.
- For details on data standards, refer to Playable audio files.
- Copy controlled CDs (copyright protected CDs) that are not in accordance with standards may not be able to playback.
- Do not use non-conventional discs such as heart-shaped or octagonal discs. Otherwise, it could damage the unit.

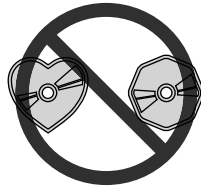

- A new CD may have rough edges on its inner and outer perimeters. If a disc with rough edges is used, proper setting will not be possible and the CD player will not play the CD. In addition, the disc may not eject resulting in a malfunction. Remove the rough edges in advance by using a ball-point pen or pencil as shown in the following figure. To remove the rough edges, rub the side of the pen or pencil against the inner and outer perimeter of the CD.

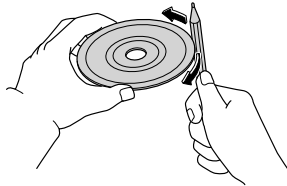



- When driving on rough roads the sound may skip due to intense vibrations.
- The CD may not work properly due to dust on the lens inside the device.
- During cold and rainy weather, condensation (water droplets) in the player may occur and cause it to not operate correctly. In this case, take the CD out and ventilate the cabin or dehumidify it before using it.
- Use discs that have been legitimately produced. If illegally-copied discs such as pirated discs are used, the system may not operate properly.
- The CD signal surface may become dirty if directly touched by hand, which may cause the sound to skip. Hold the CD from the edge and center hole. Store the CD in a case out of direct sunlight. Due to direct sunlight, high temperature and storage conditions in the cabin, the CD may not playback.
- When cleaning the CD, gently wipe off the dirt with a soft cloth from the center of the CD to the edge. Do not use benzene, thinner and anti-static agents. Otherwise, the CD surface may become damaged.
- Do not use CDs that have been written on, or CDs that have labels or stickers applied to them. Otherwise, the disc may not eject resulting in a malfunction.

- Do not use deformed or cracked CDs. Otherwise, the disc may not eject resulting in a malfunction.
- Do not use discs with partially peeled off labels, and cellophane tape or rental CD label's adhesive material exuding from the edges of the CD label. Also, do not use discs with a commercially-available CD-R label applied. Otherwise, the disc may not eject resulting in a malfunction.
- Do not insert cleaning discs in the CD player.
- Do not place fingers or objects in the CD slot. Otherwise, it could cause damage.
- CD-R/CD-RW may not playback depending on the condition of the recorder and disc used for recording.
- CD-R/CD-RW that have not been finalized (process to make it playable on a standard CD player) cannot be played.
- CD-R/CD-RW exceeding 700 MB cannot be played.
- This device may not be able to play certain CD-R/CD-RWs made using a computer or music recorder due to disc characteristics, scratches, or dirt.
- Discs recorded on a computer may not play due to the application (writing software) setting and circumstances. Record with the correct format (for details, consult the store where the application was purchased).
- It is possible that certain text data, such as titles, recorded on a CD-R/CD-RW may not be displayed when musical data (CD-DA) is playing.
- The period from when inserting a CD-RW to when it starts playing is longer than a normal CD or CD-R.
- Completely read the instruction manual and cautions for CD-R/CD-RWs. Refer to CD on page 2-71.

DVD

Usable and playable data with this unit are as follows.
Discs indicating the following markings can be used.

Commercially available discs	
Recorded discs	

NOTE

- This unit is compatible with CPRM (Content Protection for Recordable Media).
- The region code compatible with this unit is "2" or "3". The region codes that can be played are pre-determined depending on the region, and only discs with compatible region codes can be played.
- DVD-Video/DVD-VR files written under specifications other than the indicated specification may not be able to play normally or files or folder names may not be displayed correctly.
- DVD-Video/DVD-VR menus are not displayed for DVD-VR files.
- Do not use non-conventional DVDs such as heart-shaped or octagonal discs. Otherwise, it could damage the unit.

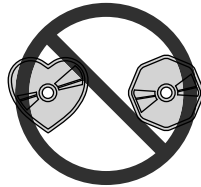

- A new DVD may have rough edges on its inner and outer perimeters. If a disc with rough edges is used, proper setting will not be possible and the DVD player will not play the DVD. In addition, the disc may not eject resulting in a malfunction. Remove the rough edges in advance by using a ball-point pen or pencil as shown below. To remove the rough edges, rub the side of the pen or pencil against the inner and outer perimeter of the DVD.

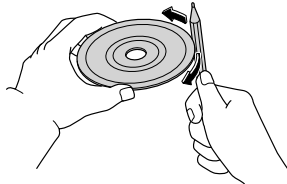









- When driving on rough roads, the sound may skip or images may be distorted due to intense vibrations.
- During cold and rainy weather, condensation (water droplets) in the player may occur and cause it to not operate correctly. In this case, take the DVD out and ventilate the cabin or dehumidify it before using it.
- Use discs that have been legitimately produced. If illegally-copied discs such as pirated discs are used, the system may not operate properly.
- The DVD signal surface may become dirty if directly touched by hand, which may cause the sound to skip and images to be distorted. Hold the DVD from the edge and center hole.
- Keep the DVD in a case out of direct sunlight. Due to direct sunlight, high temperature and storage conditions in the cabin, the CD may not playback.
- When cleaning the DVD, gently wipe off the dirt with a soft cloth from the center of the DVD to the edge. Do not use benzine, thinner and anti-static agents. Otherwise, the DVD surface may become damaged.

- Do not use DVDs that have been written on, or DVDs that have labels or stickers applied to them. Otherwise, the disc may not eject resulting in a malfunction.
- Do not use deformed or cracked DVDs. Otherwise, the disc may not eject resulting in a malfunction.
- Do not use discs with partially peeled off labels, and cellophane tape or rental DVD label's adhesive material exuding from the edges of the DVD label. Otherwise, the disc may not eject resulting in a malfunction.
- Do not insert cleaning discs in the DVD player.
- Do not place fingers or objects in the DVD slot. Otherwise, it could cause damage.
- DVD-R/DVD+R/DVD-RW/DVD+RW may not playback depending on the condition of the recorder and disc used for recording.
- DVD-R/DVD+R/DVD-RW/DVD+RW that have not been finalized (process to make it playable on a standard DVD player) cannot be played.
- This unit may not be able to play certain DVD-R/DVD+R/DVD-RW/DVD+RW made using a computer or DVD recorder due to disc characteristics, scratches, smudges, dirt, etc., or due to dust or condensation on the lens inside the unit.
- Discs recorded on a computer may not play due to the application (writing software) setting and circumstances. Record with the correct format (for details, consult the store where the application was purchased).
- Completely read the instruction manual and cautions for DVD-R/DVD+R/DVD-RW/DVD+RWs.
- The conditions in which a DVD video can be played may be pre-determined depending on the intentions of the disc software creator. Functions may not operate as the user intends because this DVD player operates according to the design intentions of the software creator. Always refer to the instructions accompanying the disc to be played.

Mark indicated on disc

Marks indicated on discs or packages are as follows:

Mark		Meaning	
NTSC	PAL	Indicates a color TV system. (broadcast system depends on market)	
		Indicates the number of audio tracks. The number indicates the number of audio recordings.	
		Indicates the number of subtitled languages. The number indicates the number of recorded languages.	
		Number of angles. The number indicates the number of recorded angles.	
		Indicates the screen modes which can be selected. "16:9" indicates a wide screen and "4:3" indicates a standard screen.	
			Indicates the region code for which a disc can be played. ALL indicates global applicability, and a number indicates applicability based on region.

For the correct use of DVDs (Glossary)

DVD-Video

DVD-Video is a video image storing standard determined by the DVD forum. "MPEG2", a global standard in digital compression technologies, has been adopted which compresses on average about 1/40th of the image data and stores it. In addition, a variable-rate coding technology, which changes the assigned information amount according to the shape of the screen image, has been adopted. Audio information can be stored using Dolby digital instead of PCM and more realistic sounding audio can be enjoyed.

In addition, various, supplementary functions such as multi-angle and multi-language availability are provided for enhanced enjoyment.

DVD-VR

DVD-VR is short for DVD Video Recording Format; video image storing standard determined by the DVD forum.

Multi-angle

One of the DVD player's functions. Because scenes can be recorded in multiple angles (camera position), users can choose a desired angle.

Multi-language

As a function of the DVD player, audio or subtitles for the same video images can be stored in multiple languages and the language can be selected freely.

Region code

DVD players and discs are assigned codes for each market region and only discs manufactured for that specific region can be played.

A disc cannot be played if the region code assigned to the player differs from the disc.

In addition, even if a region code is not indicated on the disc, disc playback may be prohibited depending on the region. In this case, a disc might not be playable in this DVD player.

Refer to DVD on page 2-78.

USB audio device

Playable data files registered to USB memory devices are as follows:

Audio files: MP3, WMA, AAC, MP4, 3GPP, WAV, FLAC, OGG

Video files: MP4, AVI, ASF

Files written under specifications other than the indicated specifications may not play normally or the file or folder names may not display correctly.



Do not use an audio file extension on files other than audio files. In addition, do not change the audio file extension. Otherwise, the unit will not recognize the file correctly resulting in noise or a malfunction.

NOTE

- This function may not be usable depending on the mobile device to be connected.
 - USB memory formatted to FAT16 and FAT32 is supported.
 - **(FAT16)**
 - Maximum file size: 2 GB
 - Maximum volume size: 2 GB
 - **(FAT32)**
 - Maximum file size: 4 GB -1 byte
 - Maximum volume size: 2 TB (when sector size is 512 bytes)
- (USB memory formatted to other formats such as NTFS is not supported.)
- The maximum number of playable files on a single USB device is 9999 files. In addition, the maximum number of playable files for a single folder is 255 files.
 - Devices can be used which comply with the USB 2.0/1.1 standard. Even with USB 3.0 standard products, if the device is compatible with USB 2.0 it can be used as a USB 2.0 device.
 - This unit cannot play copyright protected files.
 - The order of the music data stored in the device may differ from the playback order.
 - The maximum current for a single USB port is 2.5 A. If a device requiring more current than this is connected, the device may not operate normally or it may not be charged.
 - Data protected by a password cannot be played.

Entertainment

- To prevent loss or damage of stored data, we recommend that you always back up your data.
- Playback of music data not compatible to playback by a USB audio device may not be possible on this unit.
- USB video files are playable when stored on a USB audio device that supports the Mass Storage Class protocol.

Refer to USB1 Audio/USB2 Audio on page 2-59.

Refer to USB1 Video/USB2 Video on page 2-66.

Gracenote® music recognition service

NOTE

- The Gracenote® music recognition service cannot guarantee that the content of the data it provides is 100% complete.
- The Gracenote® music database can be updated using USB memory.
Refer to System Settings on page 2-136.
- Gracenote® music recognition service is compatible with USB and Bluetooth® audio files played via Mazda Connect.

Bluetooth® audio

When a mobile device equipped with Bluetooth® is paired to the vehicle's Mazda Connect, you can listen to music from the mobile device through the vehicle's speakers.

Refer to Connectivity Settings on page 2-126.

After programming, operate the vehicle center display to play/stop the audio.

NOTE

- This function may not be usable depending on the Bluetooth® device. Consult an Authorized Mazda Dealer for information concerning the Bluetooth® device.
- Park the vehicle in a safe place and perform pairing.
- The communication range of a Bluetooth® device is about 10 meters or shorter.
- It may be difficult to connect the Bluetooth® device if it is left in a bag.
- This unit supports only SCMS-T for output of digital sound protected contents.
- Playback of music from music distribution service applications such as on Smartphones may not be possible.

Compatible Bluetooth® standard (recommended)

Compatibility with Ver.1.1/1.2/2.0 + EDR/2.1 + EDR/3.0 (conformity) and Bluetooth® Ver. 3.0

Supported profiles

- A2DP (Advanced Audio Distribution Profile) Ver. 1.3
 - AVRCP (Audio/Video Remote Control Profile) Ver. 1.0/1.3/1.4/1.5/1.6
- A2DP is a profile which transmits only audio to the Bluetooth® unit. If your Bluetooth® device corresponds only to A2DP, but not AVRCP, you cannot operate it using the Mazda Connect. Only operation using the Bluetooth® audio device is possible.

Function	AVRCP				
	Ver.1.0	Ver.1.3	Ver.1.4	Ver.1.5	Ver.1.6
Playback	X	X	X	X	X
Pause	X	X	X	X	X
File (track) up	X	X	X	X	X
File (track) down	X	X	X	X	X
Album up	—	X	X	X	X
Album down	—	X	X	X	X
Fast-forward	X	X	X	X	X
Reverse	X	X	X	X	X
Repeat playback	—	X	X	X	X
Shuffle playback	—	X	X	X	X
Playlist display	—	—	X	X	X
Playlist, music information display (such as song name, artist name)	—	X	X	X	X

X: Available

—: Not available

NOTE

- The actual operability of functions may differ from the table depending on the device to be connected.
- The battery consumption of Bluetooth® audio devices increases while Bluetooth® is connected.

Refer to Bluetooth® on page 2-55.

Playable audio files



Do not use an audio file extension on files other than audio files. In addition, do not change the audio file extension. Otherwise, the unit will not recognize the file correctly resulting in noise or a malfunction.

Playable audio files on this unit are as follows:

Compatible format		Compatible bit rate	Compatible sampling rate	CD	DVD	USB
MP3	MPEG-1 Layer 3	32 - 320 kbps	32 kHz / 44.1 kHz / 48 kHz	X	X	X
	MPEG-2 Layer 3	8 - 160 kbps	16 kHz / 22.05 kHz / 24 kHz			
WMA	WMA Ver7	48 - 192 kbps	32 kHz / 44.1 kHz / 48 kHz	X	X	X
	WMA Ver8					
	WMA Ver9					
	WMA Ver9.1					
	WMA Ver9.2					
AAC	MPEG-2 Part 7	8 - 320 kbps	11.025 kHz / 12 kHz / 16 kHz / 22.05 kHz / 24 kHz / 32 kHz / 44.1 kHz / 48 kHz	X	X	X
	MPEG-4 Part 3					
	HE-AAC					
	AACPlus v2 / eAAC+					
MP4	MPEG-2 Part 7					
	MPEG-4 Part 3					
	MPEG-1 Layer 3					
	MPEG-2 Layer 3					
	ALAC					
3GPP	MPEG-4 AAC-LC					
	HE-AAC					
	AACPlus v2 / eAAC+					
WAV	LPCM	—	8 kHz / 11.025 kHz / 12 kHz / 16 kHz / 22.05 kHz / 24 kHz / 32 kHz / 44.1 kHz / 48 kHz / 88.2 kHz / 96 kHz / 176.4 kHz / 192 kHz	—	—	X
FLAC	FLAC	—	—	—	X	

Compatible format		Compatible bit rate	Compatible sampling rate	CD	DVD	USB
OGG	Vorbis	32 - 500 kbps	8 kHz / 11.025 kHz / 16 kHz / 22.05 kHz / 32 kHz / 44.1 kHz / 48 kHz			
	FLAC	—	8 kHz / 11.025 kHz / 12 kHz / 16 kHz / 22.05 kHz / 24 kHz / 32 kHz / 44.1 kHz / 48 kHz / 88.2 kHz / 96 kHz / 176.4 kHz / 192 kHz	—	—	X

X: Available

—: Not available

MP3

MP3 stands for MPEG Audio Layer3, which is standardized voice compression established by the ISO (International Organization for Standardization) working group (MPEG).

The MP3 can compress audio data to approximately a tenth of the source data size. This unit plays files with the extension (.mp3) as MP3 files.

WMA

WMA is short for Windows Media Audio and is the audio compression format used by Microsoft.

Audio data can be created and saved at a higher compression ratio than MP3. This unit plays files with the extension (.wma) as WMA files.

* Microsoft and Windows Media are registered trademarks of Microsoft Corporation U.S. in the United States and other countries.

· WMA files written under specifications other than the indicated specification may not play normally or files or folder names may not display correctly.

AAC

AAC stands for Advanced Audio Coding, which is standardized voice compression established by the ISO (International Organization for Standardization) working group (MPEG).

Audio data can be created and saved at a higher compression ratio than MP3. This unit plays files with the extension (.aac) as AAC files.

· AAC files written under specifications other than the indicated specification may not play, normally or files or folder names may not display correctly.

WAV

WAV stands for RIFF waveform Audio Format, which is standardized voice compression developed by Microsoft and IBM.

This unit plays files with the extension (.wav), registered in PCM format (pulse code modulation) as WAV files.

NOTE

The PCM format is a method of digitalizing analog audio data using adopted formats such as CD.

- WAV files written under specifications other than the indicated specification may not play normally or files or folder names may not display correctly.

OGG

OGG is the voice compression format used by the Xiph.Org Foundation.

Audio data can be created and saved at a higher compression ratio than MP3.

This unit plays files with the extensions (.ogg/.ogx/.oga) as OGG files.

- OGG files written under specifications other than the indicated specification may not play normally or files or folder names may not display correctly.

MP4

MP4 is a container file format standardized by MPEG-4 Part 14.

This unit plays files with the extension (.m4a) as MP4 audio files.

3GPP

3GPP is a file format established by the Third Generation Partnership Project.

This unit plays files with the extension (.3gp) as 3GPP files.

FLAC

FLAC is short for Free Lossless Audio Codec, which is a license-free audio file format.

This unit plays files with the extension (.flac/.fla) as FLAC files.

Playable video files



Do not use a video file extension on files other than video files. In addition, do not change the video file extension. Otherwise, the unit will not recognize the file correctly resulting in noise or a malfunction.

Playable video files are as follows:

Compatible format			Maximum image size	Maximum frame rate	CD	DVD	USB
MP4	Images	MPEG-4 AVC	1920 × 1080	60 i / 30 p	-	-	X
		MPEG4					
	Audio	AAC					
		MP3					
AVI	Images	MPEG-4 AVC					
		MPEG4					
		WMP9					
		Advanced Profile					
	Audio	AAC					
		MP3					
ASF	Images	WMA 9.2 (7, 8, 9.1, 9.2)					
		WMP9					
	Audio	WMP9 Advanced Profile					
		WMA 9.2 (7, 8, 9.1, 9.2)					

X: Available

—: Not available

MP4

MP4 is a container file format standardized by MPEG-4 Part 14. This unit plays files with the extension (.mp4/.m4v) as MP4 video files.

AVI

AVI is short for Audio Video Interleave, which is a container file format developed by Microsoft.

This unit plays files with the extension (.avi) as AVI files.

ASF

ASF is short for Advanced Systems Format, which is a container file format developed by Microsoft.

This unit plays files with the extension (.wmv) as ASF files.

Agreements and disclaimers related to Apple CarPlay™

This unit is compatible with Apple CarPlay™ which can operate an iPhone® using the vehicle's audio device.

Apple CarPlay™ is compatible with iPhone5 models or higher.



For the purposes of safety, do not operate your iPhone® while driving.

Disconnect the iPhone® when it is not in use. If the device is left in the cabin, it could be damaged or the battery may weaken due to the excessive temperature or humidity inside the cabin.

If the iPhone® battery has deteriorated, it may not recharge or play audio even if it is connected to this unit.

NOTE

- An iPhone5 model or higher may not be compatible with Apple CarPlay™ depending on the OS version.
- To prevent loss or damage of stored data, we recommend that you always back up your data.

Refer to Apple CarPlay™ on page 3-2.

Android™

This unit is compatible with Android™ Smartphones using Android™ 5.0 Lollipop or higher.

To use Android Auto™, a Smartphone with the Android Auto™ application downloaded is required.



For the purposes of safety, do not operate your Android™ Smartphone while driving. Disconnect the Android™ Smartphone when it is not in use. If the device is left in the cabin, it could be damaged or the battery may weaken due to the excessive temperature or humidity inside the cabin.

If the Android™ Smartphone battery has deteriorated, it may not recharge or play audio even if it is connected to this unit.

NOTE

- To prevent loss or damage of stored data, we recommend that you always back up your data.

Refer to Android Auto™ on page 3-6.

Entertainment

FM

1. Select "Entertainment" on the home screen.

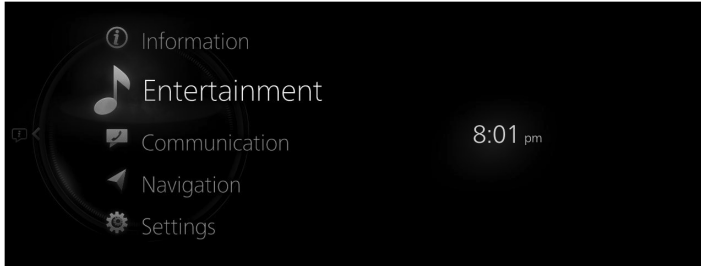

2. Select "FM" on the Source List screen.

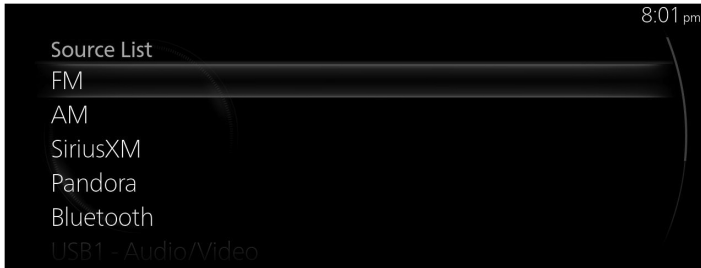



NOTE

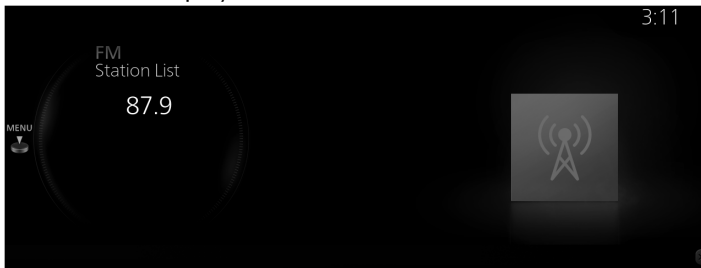

If there is currently playing content, select "Entertainment" to have the contents displayed on the playback screen.

While on the playback screen, press the  on the commander switch to display the Source List screen.

3. The playback screen is displayed.



Rotate the  to display the last list displayed from the Favorites list or Station List for FM.

When the  is displayed, press the  to display the menu.

NOTE

The Station List may not be displayed depending on the region.

FM radio menu



Menu	Explanation
Source List	Displays the Source List screen. The audio source can be switched.
Favorites	Displays the Favorites list for the FM radio. The radio station list registered to your Favorites is displayed where you can select the radio station you want to listen to. If you have no registered Favorites, an empty list is displayed. Refer to Favorites on page 1-17 for the method of registering to Favorites.
Station List	The radio station list is displayed where you can select the radio station you want to listen to. The genre of the radio station displayed in the list can be selected and the list can be updated depending on the region and specifications. (If Option is available and the genre can be selected) A list can be displayed by narrowing down to genres such as News or Rock M. (If Option is available and "Update List" can be selected) The list picks up the 10 stations with the strongest radio waves and they are displayed. When Update List is selected, the Station List can be updated at an arbitrary timing.
Tuner Controls	Displays the control screen (icon) on the playback screen. For details on the operation method for each icon, refer to How to Use the Tuner Controls (icon).
Manual Tuning	Rotate the displayed frequency dial to select the radio station you want to listen to.
Radio Text	If there is textual information during a radio broadcast, it is displayed.



Entertainment

Menu	Explanation
FM Settings*	<p>Sets the FM radio. (With HD Radio) You can enable/disable the "HD Radio Tuner" or the "Live Event Mode". When the Live Event Mode is enabled and a real-time broadcast such as a sports event is being broadcast, it is switched forcibly to an analog broadcast. If you have an HD radio broadcast that you always want to receive, disable the Live Event Mode setting. However, depending on the reception conditions, the audio may jump or repeat. (With Radio Data System (RDS)) You can enable/disable the "Traffic Announcement Settings", "Alternative Frequency Settings", or "Region Lock Settings".</p>
Audio Settings	<p>Adjusts the sound quality. Refer to Sound Settings on page 2-115.</p>

How to Use the Tuner Controls (icon)



Rotate the  to select the icon you want to operate.

Menu	Explanation
	<p>If you select the icon, the next available station is tuned-in automatically. Receivable stations are tuned-in in ascending order every 5 seconds. Once a desired station has been found, select the icon again to turn the feature off.</p>
	<p>Automatically seeks the next available radio station. Radio frequencies are changed one step at a time until a receivable station is found.</p>
	<p>If the icon is selected again while the tuner is seeking the next available radio station, the seek will stop at the current frequency. If the icon is selected and held, the tuner will continue to seek until the command knob is released.</p>

HD Radio*

Listening to HD Radio™ Technology



When tuned to a radio station with an available HD Radio signal, the  icon will illuminate and the analog broadcast will automatically switch over to the HD Radio broadcast.

If you wish to avoid the HD Radio broadcast, or if HD Radio broadcasts are unavailable in your area, you can uncheck the “HD Radio Tuner” option in the “FM Settings” menu to turn the HD Radio tuner off.

Multicast channel selection

If multi-cast channels are available for an HD Radio broadcast currently being received, the multi-cast channel list is displayed.
Select the desired radio station.

NOTE

- If an analog broadcast is being received first and then an HD Radio broadcast is received while HD1 is selected, the unit switches to the HD Radio station automatically.
- When the  icon is illuminated, there could be a noticeable difference in sound quality and volume when a change from digital to analog signals occurs. If the sound quality and volume become noticeably diminished or cut off, uncheck the “HD Radio Tuner” in the “FM Settings”, to turn the HD radio off.
- If an analog broadcast is being received when HD1 is selected from the Favorite channels, the unit is switched to HD Radio automatically.
If the radio reception conditions are poor, or HD is off, switching to HD Radio broadcasts is not possible.
- When an HD multi-cast channel (HD2 to HD8) is selected from Favorites, “Signal Lost” may be displayed and no audio output until the HD Radio broadcast is received.
If HD Radio reception conditions are poor, “Signal Lost” may continue to be displayed.
- If the  icon is not illuminated, song and/or station information may be shown while listening to the analog broadcast.

Radio Data System (RDS)*

Traffic Announcement (TA)

When “Traffic Announcement Settings” is enabled by the FM Settings, traffic information can be received.

When traffic information is received, you can switch to the Traffic Announcement (TA) screen even if an audio source*¹ other than FM is selected.

When playback of the Traffic Announcement (TA) ends, the screen switches to the previous screen automatically, but if you want to stop the playback midstream, select “Cancel” or “TA Off” displayed on the screen.

Cancel : Leave Traffic Announcement Settings enabled as is and return to the previous screen.

TA Off : Disable Traffic Announcement Settings and return to the previous screen.

*¹ FM stations that cannot receive Traffic Announcement (TA) or RDS Traffic Announcement (TA) cannot be received while DAB radio is playing.

NOTE

The "Traffic Announcement Settings" set value and "Traffic Announcement" set value for the DAB Settings are linked.

Alarm

When emergency information is received, it switches to the Alarm screen automatically even if an audio source*1 other than FM is selected.

When the Alarm playback ends, it returns to the previous screen automatically. If you want to stop the playback midstream, select "Cancel" displayed on the screen.

*1 RDS Alarm cannot be received while AM radio or DAB radio is playing.

Alternative frequency (AF)

AF functions on FM stations. Enable "Alternative Frequency Settings" by the FM Settings.

If the radio reception of the current station weakens, the system switches to an alternative station automatically.

Region Lock

Region Lock functions on FM stations. Enable "Region Lock Settings" by the FM Settings.

When traveling to another country, the setting automatically switches to a program the same as the program being listened to, or to a related program.

AM

1. Select "Entertainment" on the home screen.

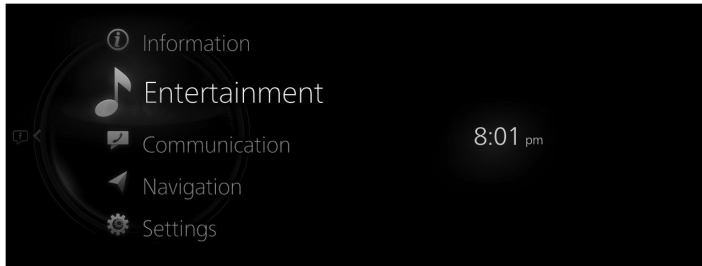

2. Select "AM" on the Source List screen.

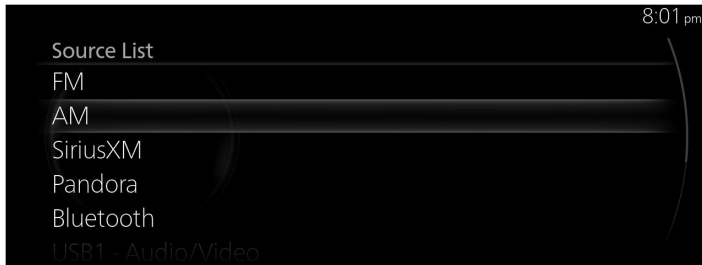

NOTE



If there is currently playing content, select "Entertainment" to have the contents displayed on the playback screen.

While on the playback screen, press the  on the commander switch to display the Source List screen.

3. The playback screen is displayed.



Rotate the  to display the last list displayed from the Favorites list or Station List for the AM.

When the  is displayed, press the  to display the menu.

Entertainment

NOTE

Station List may not be displayed depending on the region.

AM radio menu

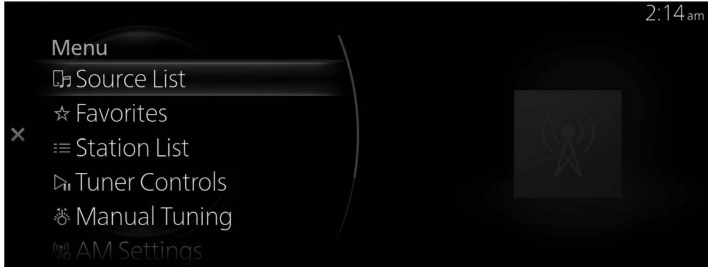



Menu	Explanation
Source List	Displays the Source List screen. The audio source can be switched.
Favorites	Displays the Favorites list of the AM radio. The radio station list registered to your Favorites is displayed where you can select the radio station you want to listen to. If you have no registered Favorites, an empty list is displayed. Refer to Favorites on page 1-17 for the method of registering to Favorites.
Station List	The radio station list is displayed where you can select the radio station you want to listen to. The list can be updated depending on the region and specifications. (If Option is available and "Update List" can be selected) The list picks up the 10 stations with the strongest radio waves and they are displayed. When Update List is selected, the Station List can be updated at an arbitrary timing.
Tuner Controls	Displays the control screen (icon) on the playback screen. For details on the operation method for each icon, refer to How to Use the Tuner Controls (icon).
Manual Tuning	Rotate the displayed frequency dial to select the radio station you want to listen to.
AM Settings*	Sets the AM radio. You can enable/disable the "HD Radio Tuner" or the "Live Event Mode". When the Live Event Mode is enabled and a real-time broadcast such as a sports event is being broadcast, it is switched forcibly to an analog broadcast. If you have an HD radio broadcast that you always want to receive, disable the Live Event Mode setting. However, depending on the reception conditions, the audio may jump or repeat.
Audio Settings	Adjusts the sound quality. Refer to Sound Settings on page 2-115.

How to Use the Tuner Controls (icon)



Rotate the  to select the icon you want to operate.

Menu	Explanation
	If you select the icon, the next available station is tuned-in automatically. Receivable stations are tuned-in in ascending order every 5 seconds. Once a desired station has been found, select the icon again to turn the feature off.
	Automatically seeks the next available radio station. Radio frequencies are changed one step at a time until a receivable station is found.
	If the icon is selected again while the tuner is seeking the next available radio station, the seek will stop at the current frequency. If the icon is selected and held, the tuner will continue to seek until the commander knob is released.

HD Radio*

Listening to HD Radio™ Technology

When tuned to a radio station with an available HD Radio signal, the  icon will illuminate and the analog broadcast will automatically switch over to the HD Radio broadcast.

If you wish to avoid the HD Radio broadcast, or if HD Radio broadcasts are unavailable in your area, you can uncheck the "HD Radio Tuner" option in the "AM Settings" menu to turn the HD Radio tuner off.

Entertainment

SiriusXM®*

Displaying the Radio ID

Select channel 0 from the Channel List to display the radio ID.

How to Use SiriusXM®

1. Select "Entertainment" on the home screen.

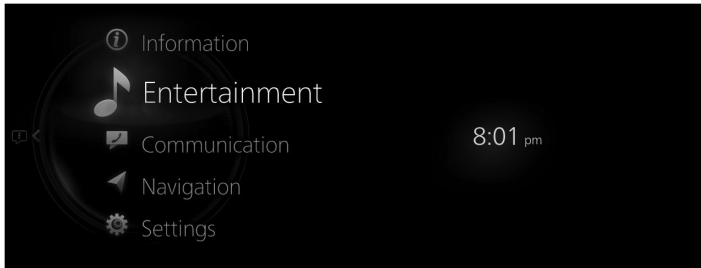

2. Select "SiriusXM" on the Source List screen.

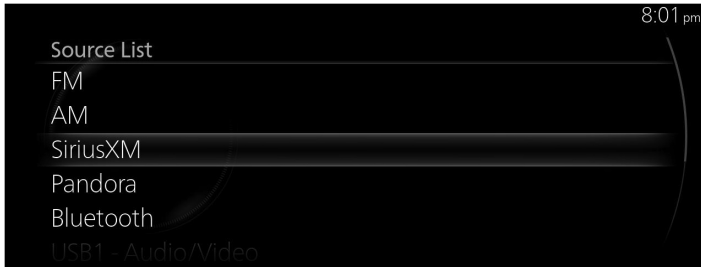

NOTE

If there is currently playing content, select "Entertainment" to have the contents displayed on the playback screen.

While on the playback screen, press the  on the commander switch to display the Source List screen.

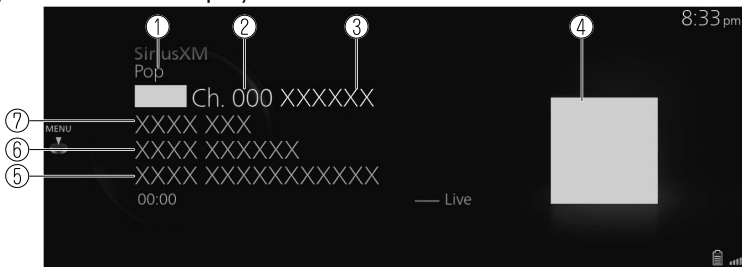

3. The playback screen is displayed.



1. Category name

2. Radio station number
3. Radio station name
4. Album art
5. Album name
6. Artist name
7. Song name

Rotate the  to display the Favorites list for SiriusXM®

When the  is displayed, you can display the menu by pressing the .

SiriusXM® menu

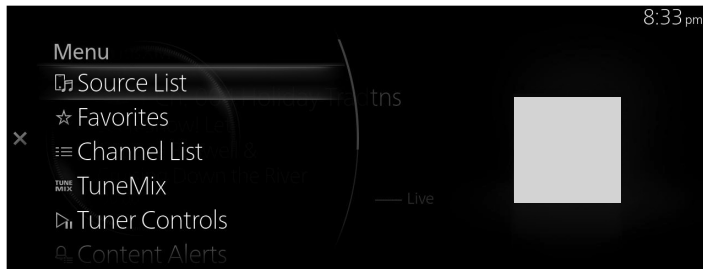

Menu	Explanation
Source List	Displays the Source List screen. You can switch the audio source.
Favorites	Displays the Favorites list for SiriusXM®. The radio station list registered to your Favorites is displayed where you can select the radio station you want to listen to. If you have no registered Favorites, an empty list is displayed. Refer to Favorites on page 1-17 for the method of registering to Favorites.
Channel List	The radio station list is displayed where you can select the radio station you want to listen to. You can narrow down a radio station list to display by selected categories. SiriusXM Featured Displays the recommended radio station list distributed by SiriusXM®. When the list is updated,  is displayed.
TuneMix	Displays the currently created TuneMix list. Select TuneMix Channel to begin playback. In addition, a TuneMix Channel can be created or deleted. For details, refer to TuneMix™.

Entertainment

Menu	Explanation
Tuner Controls	Displays the control screen (icon) on the playback screen. For the operation method for each icon, refer to How to Use the Tuner Controls (icon).
Content Alerts	The record of content alerts received in the past is displayed in a list. You can select the contents you want to listen to from this list.
Save Artist/Song	You can register the artist or song currently playing. After registering, you can receive alerts when the artist or song is broadcast by SiriusXM®.
SiriusXM Settings	Sets SiriusXM®. For the items you can set, refer to SiriusXM Settings.
Audio Settings	Adjusts the sound quality. Refer to Sound Settings on page 2-115.

TuneMix™

TuneMix plays songs in a unique mix from user-selected SiriusXM music channels.

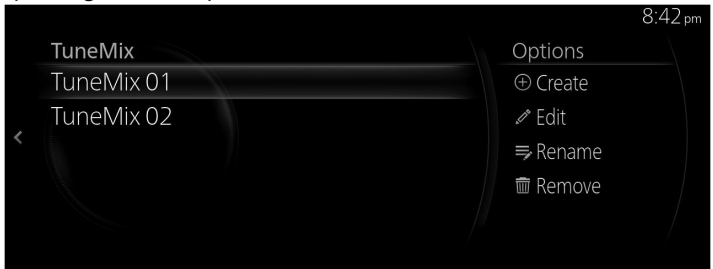

Plays the TuneMix™ Channel selected by pressing the .

You can edit the TuneMix™ Channel selected by sliding the  to the right.

Option	Explanation
Create	Creates a TuneMix™ Channel.
Edit	Changes the radio station registered to the TuneMix™ Channel.
Rename	Changes the TuneMix™ Channel name.
Remove	Deletes the registered TuneMix™ Channel.

Creating TuneMix™ Channel

You can select your desired SiriusXM® music channels and create a TuneMix™ Channel.

1. Select "Create".



2. Select several radio stations you want to register to the TuneMix™ Channel from the SiriusXM® music channel list. A check is placed next to the selected station.



3. Select "Create".

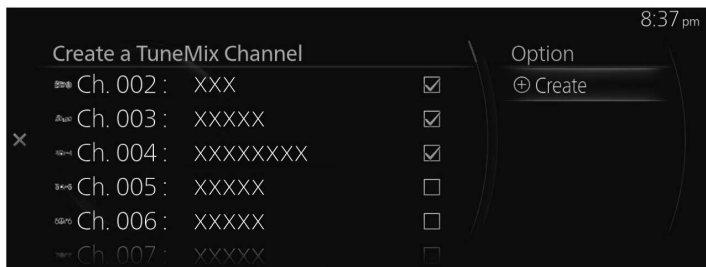

4. Input the title for the TuneMix™ Channel you are creating.
5. Select ✓.



Entertainment

NOTE

Two or more radio stations are required to create a TuneMix™ Channel. In addition, up to 5 radio stations can be registered.



Up to 3 TuneMix™ Channels can be registered.

How to Use the Tuner Controls (icon)

The displayed icon differs depending on the playback status.



Icon	Explanation
	Switches to the next station. (Displayed in only some vehicle models)
	Switches to the previous station. (Displayed in only some vehicle models)
	Cues the next music within the same radio station. If there is no more content, the operation no longer functions. (Other than during scan-play) Press and hold to fast forward.
	Cues the previous music in the same radio station. If there is no previous content, the operation no longer functions. (Other than during scan-play) Press and hold to fast reverse.
	Plays a radio. When selected again, playback is temporarily stopped.
	Plays each channel in the current channel list for 10 seconds. Select again to continue receiving the channel. This icon cannot be selected during playback of TuneMix™, Traffic & Weather Now, or SportsFlash.
	If buffered content is being played, the control switches to real-time playback. It cannot be selected during real time playback and TuneMix™ playback.

Icon	Explanation
	The TuneMix™ broadcast ends when the icon is pressed. Continues playing the selected radio station as it is.
	Plays the Traffic & Weather Now. When it is pressed again, playback is stopped, and playback begins from the previously selected radio station. When there is no playable “Traffic & Weather Now”, the selection cannot be selected.
	(During playback of SportsFlash) Stops playback of SportsFlash and begins playback from the previously selected radio station. When “SportsFlash” is not being played, it cannot be selected.

SiriusXM Settings

Menu	Explanation
Parental Controls	Sets the parental lock and changes the lock code.
Smart Favorites	Selects/changes radio stations registered to Smart Favorites. Up to 10 radio stations can be registered. Smart Favorites Broadcasts of registered stations are buffered. Also, when registering radio stations to Favorites, up to 10 stations are registered to Smart Favorites automatically.
TuneStart	Switches TuneStart on/off. TuneStart Stations registered to Smart Favorites are played from a break point such as the beginning of a song, not in real-time. The break point differs depending on the contents and buffering conditions.
Artist/Song Alerts	You can switch the Artist/Song Alerts on/off and delete registered artists and music. Artist/Song Alerts The function alerts you when an artist or song is played which is registered to “Save Artist/Song”.
SportsFlash	You can switch SportsFlash on/off and register and delete sports teams. Up to 50 teams can be registered. SportsFlash The function notifies you when registered sports team highlights are announced.

Entertainment

Menu	Explanation
Traffic & Weather Now	When you set a city, you can receive notifications regarding traffic and weather for that city.

Parental lock

To use the parental lock function, a lock code must first be set.

The parental lock can be enabled or disabled during the current drive cycle (from when the ignition is switched on to switched off). Parental lock is set when "Enable Channel Lock" is turned on. When it is turned off, the parental lock is canceled.

When a parental lock is set and a locked radio station is selected, the lock code input screen is displayed. If the correct lock code is input, the parental lock is temporarily canceled.

When canceling the parental lock or when changing the Lock code, Lock code input is required.

Lock code reset

If the registered code has been forgotten, reset the code to the default [0000] code.

1. Select "Parental Controls" from the SiriusXM Settings.
2. Select "Edit Lock Code".
3. Input the default code [0000] on the screen with the current input lock code.
4. Input the new code that you want to set.
5. The confirmation screen is displayed and the lock code reset is completed.

Initialization

To initialize the SiriusXM® settings, you need to return all of the Mazda Connect settings to their default settings.

Refer to System Settings on page 2-136.

DAB*

What is DAB radio?

DAB radio is a digital broadcasting system for radio.

DAB radio provides a high-quality radio sound source using an auto frequency switching function in boundary areas.

By displaying the radio text, information such as the song name and artist name can be displayed.

NOTE

This unit is also compatible with DAB+ radio.

1. Select "Entertainment" on the home screen.

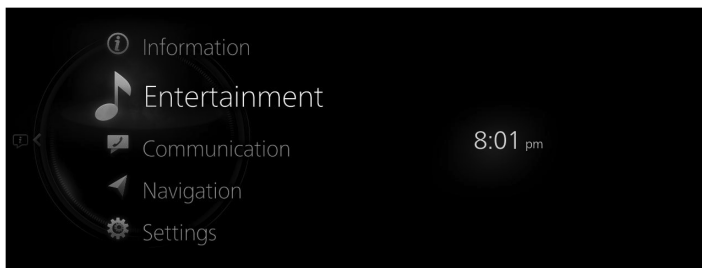

2. Select "DAB" on the Source List screen.

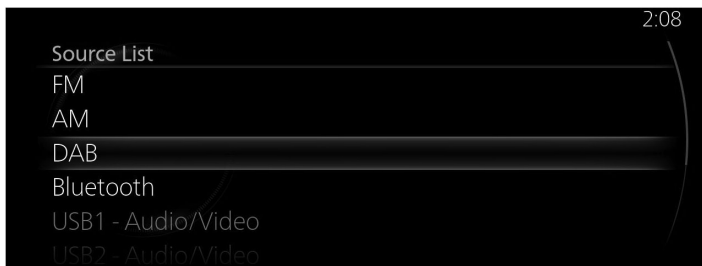

NOTE

If there is currently playing content, select "Entertainment" to have the contents displayed on the playback screen.



While on the playback screen, press the  on the commander switch to display the Source List screen.

Entertainment

3. The playback screen is displayed.



Rotate the  to display the last list displayed from the Favorites list or the Station List for DAB.

When the  is displayed, you can display the menu by pressing the .

DAB menu

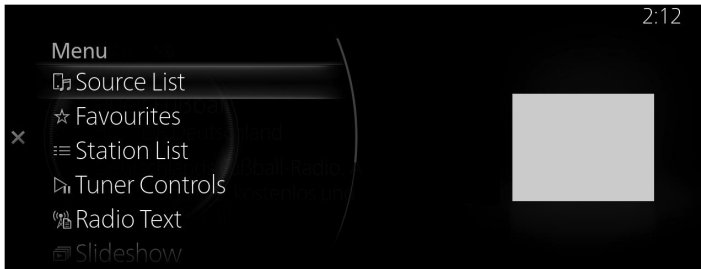



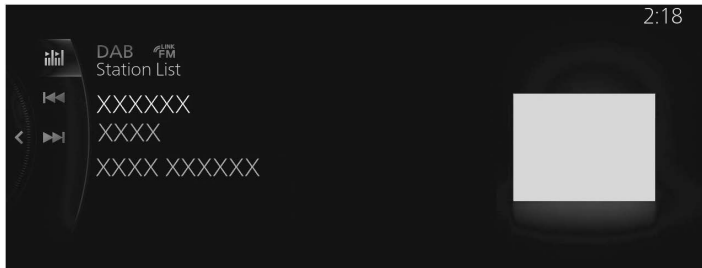

Menu	Explanation
Source List	Displays the Source List screen. You can switch the audio source.
Favorites	Displays the Favorites list for DAB. The radio station list registered to your Favorites is displayed where you can select the contents you want to listen to. If you have no registered Favorites, an empty list is displayed. Refer to Favorites on page 1-17 for the method of registering to Favorites.
Station List	Displays the station list (ensemble and station). You can select the contents you want to listen to from the displayed Station List. You can change the Ensemble by selecting "Select Ensemble".
Tuner Controls	Displays the control screen (icon) on the playback screen. For the operation method for each icon, refer to How to Use the Tuner Controls (icon).
Radio Text	Displays radio text of the radio station being received.
Slideshow	When broadcast stations with a slide show service is received, the slide show is enlarged.

Menu	Explanation
DAB Settings	Sets DAB. For the items you can set, refer to DAB Settings.
Audio Settings	Adjusts the sound quality. Refer to Sound Settings on page 2-115.

How to Use the Tuner Controls (icon)



Icon	Explanation
	(Other than during scan-play) Searches your desired station from the station list. Tunes to each station in the station list for 5 seconds. Select again when your desired station is tuned.
	Stops scan and sets the radio station being received.
	Select to start automatic radio station selection to switch to the next or previous service. If there is no next or previous service in the selected Ensemble, Ensemble switches.
	Press and hold to switch Ensemble. (During scan or automatic radio station selection) Stops scan or automatic radio station selection and sets the radio station being received.

DAB Settings

Menu	Explanation
DAB-DAB Link	Sets enable/disable of DAB-DAB Link. When enabled, if the reception for the currently playing DAB radio worsens, the same program being played by the DAB radio station is searched and automatically switched.
DAB-FM Link	Sets enable/disable of DAB-FM Link. When enabled, if the reception for the currently playing DAB radio worsens, the same program being played by the FM radio station is searched and switches temporarily so that the program can be played continuously. If the DAB radio station finds the same program being played on the FM radio station, it automatically switches to that radio station.
Traffic Announcement	Sets enable/disable of Traffic Announcement. When enabled, the Traffic Announcement screen can be switched when selecting an audio source* ¹ other than DAB.
L Band*	Set enable/disable of L Band. When enabled, the L band frequency band can be received in addition to Band III.

*¹ Except for DAB radio stations which cannot receive Traffic Announcement or while listening to FM radio.

Traffic Announcement

When "Traffic Announcement" is enabled using DAB Settings, traffic information can be received.

When traffic information is received while in TA mode, the Traffic Announcement screen can be switched when selecting an audio source*¹ other than DAB.

When playback of the Traffic Announcement ends, the displayed screen automatically returns to the previous screen, but if you want to stop the playback midstream, select "Cancel" or "TA Off" displayed on the screen.

Cancel: Leave Traffic Announcement enabled and return the displayed screen to the previous screen.

TA Off: Disable Traffic Announcement and return the displayed screen to the previous screen.

*¹ Except for DAB radio stations which cannot receive Traffic Announcement or while listening to FM radio.

NOTE

The "Traffic Announcement" set value and "Traffic Announcement (TA)" set value for the FM Settings are linked.

Pandora®*

What is Pandora®?

Pandora® is free personalized Internet radio. Simply enter a favorite artist, track, genre, and Pandora® will create a personalized station that plays their music and more like it. Rate songs by giving thumbs-up and thumbs-down feedback to further refine your station, discover new music and help Pandora® play only music you like.

* Pandora®, the Pandora® logo, and the Pandora® trade dress are trademarks or registered trademarks of Pandora Media, Inc., used with permission.

NOTE

- Pandora® may not be available outside of the U.S.A..
- To operate Pandora® from your Bluetooth® device, perform the following in advance:
 - Install Pandora® application onto the device.
 - Create Pandora® account.
 - Create Pandora® station.

1. Select “Entertainment” on the home screen.

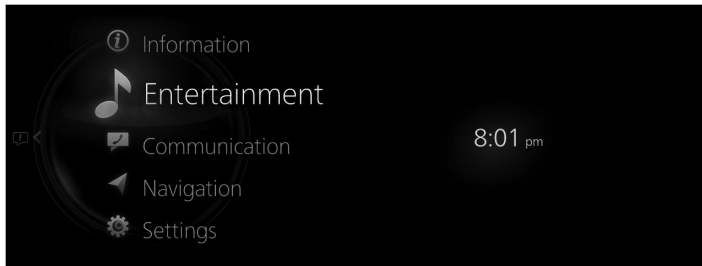

2. Select “Pandora” on the Source List screen.

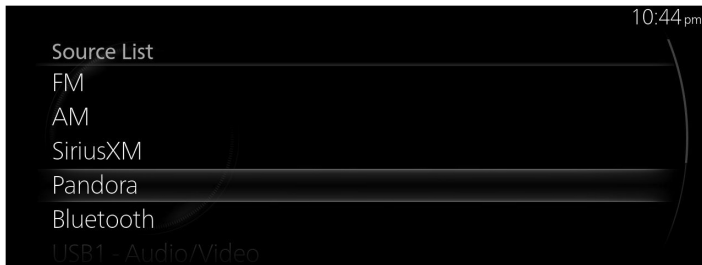

Entertainment

NOTE



If there is currently playing content, select “Entertainment” to have the contents displayed on the playback screen.

While on the playback screen, press the  on the commander switch to display the Source List screen.

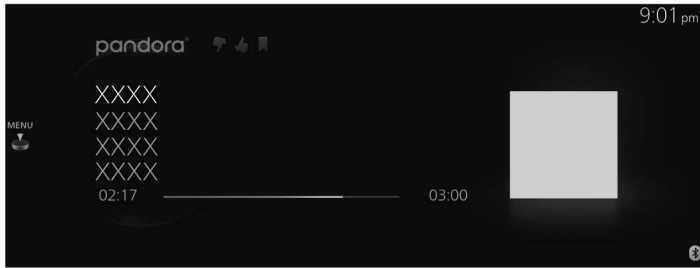
3. The playback screen is displayed.



Rotate the  to display the Favorites list for the Pandora.

When the  is displayed, you can display the menu by pressing the .

Pandora® menu

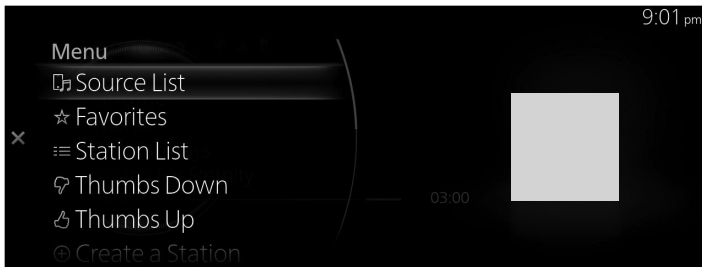

Menu	Explanation
Source List	Displays the Source List screen. You can switch the audio source.
Favorites	Displays the Favorites list for Pandora®. The radio station list registered to your Favorites is displayed where you can select the contents you want to listen to. If you have no registered Favorites, an empty list is displayed. Refer to Favorites on page 1-17 for the method of registering to Favorites.
Station List	Displays the radio station received from the connected Smartphone. You can select the contents you want to listen to from the displayed Station List. You can change the display order of the Station List. For details on how to change the display order, refer to Changes the display order of the Station List.
Thumbs Down	Evaluates the currently playing contents (thumbs down).

Menu	Explanation
Thumbs Up	Evaluates the currently playing contents (thumbs up).
Create a Station	You can create your own special radio station. For details on how to create your radio station, refer to Create a Station.
Bookmark	Bookmarks the currently playing contents or artist. You can bookmark song or artist to check out later on the Web.
Playback Controls	Displays the control screen (icon) on the playback screen. For the operation method for each icon, refer to How to Use the Tuner Controls (icon).
Pandora Settings	Sets Pandora®. For the items you can set, refer to Pandora Settings.
Bluetooth Settings	You can change the Bluetooth® settings. Refer to Connectivity Settings on page 2-126.
Audio Settings	Adjusts the sound quality. Refer to Sound Settings on page 2-115.

NOTE

- The skip function may not be available depending on the device.
- The number of skips is limited by Pandora®.
- If the “Thumbs Down” is selected when the skip song function is running, the next song is skipped.

Changes the display order of the Station List

1. Select “Station List”.

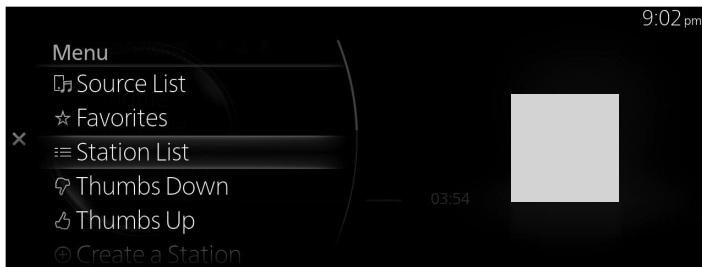

Entertainment

2. Select “ [currently selected sort classification]” from Option.



3. Select the sort classification from the Sort menu to switch the display order of the Station List.



Date Created: Contents are displayed according to the date they were created.
A-Z: Contents are displayed in alphabetic order.

Create a Station

1. Select “Create a Station”.

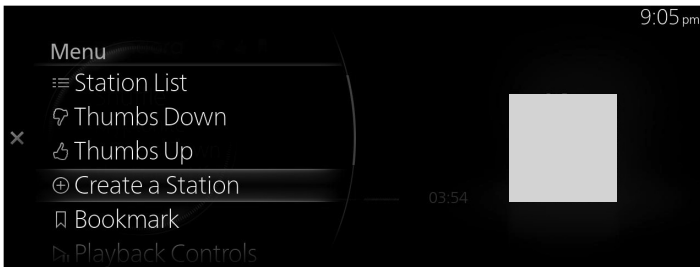



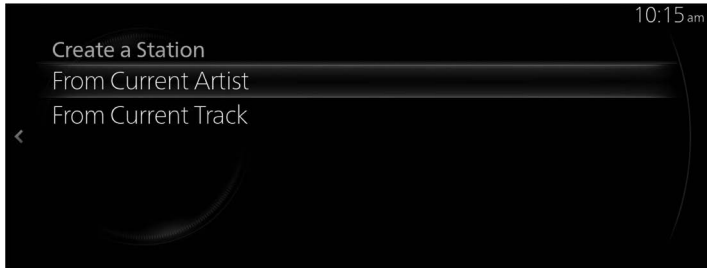

2. Select the menu and create a new radio station.

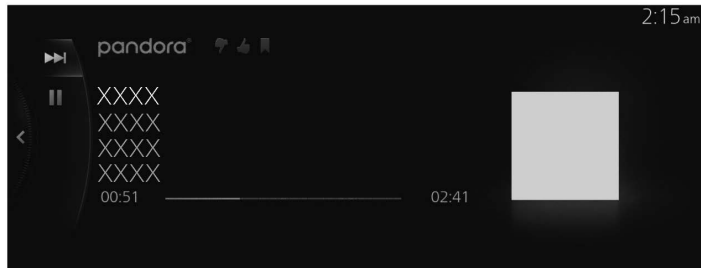

From Current Artist: Creates a radio station from the song or artist being played.
From Current Track: Creates a radio station from the song being played.

How to Use the Tuner Controls (icon)



Icon	Explanation
	Goes to the next song.
	(When selected during pause) Plays the track.
	(When selected during playback) Pauses the track.

Pandora Settings

The Pandora® settings can be changed.

Entertainment

1. Select "Pandora Settings".

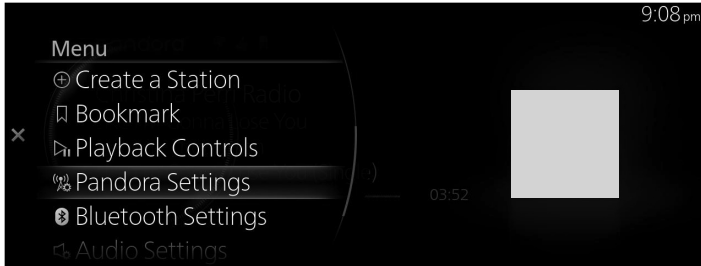

2. Select the menu and change the Pandora® settings.

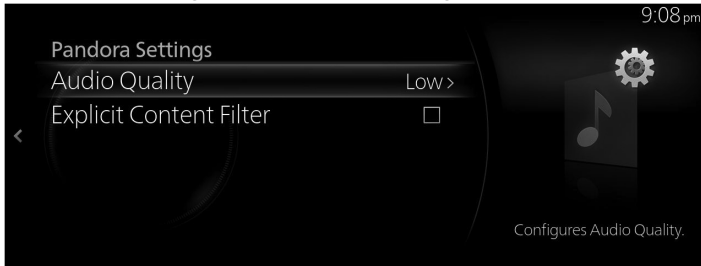

Audio Quality: Switches the sound quality of the contents to "High" or "Low".
Explicit Content Filter : When checked to turn on, playback restrictions of the contents are applied.

Bluetooth®

To play content from a Bluetooth® audio device on Mazda Connect, select the Bluetooth® source. Before using the Bluetooth® audio device, you will need to register it to Mazda Connect.

Refer to Connectivity Settings on page 2-126.

1. Ensure that the audio device is powered on and that the Bluetooth® feature is enabled.
2. Select “Entertainment” on the home screen.

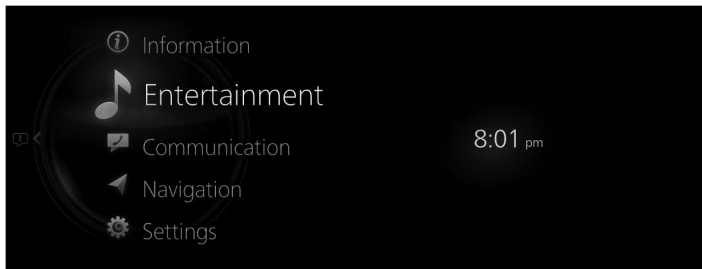

3. Select “Bluetooth” on the Source List screen.

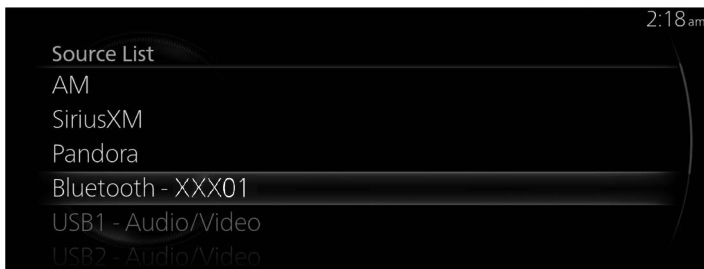

NOTE

If there is currently playing content, select “Entertainment” to have the contents displayed on the playback screen.

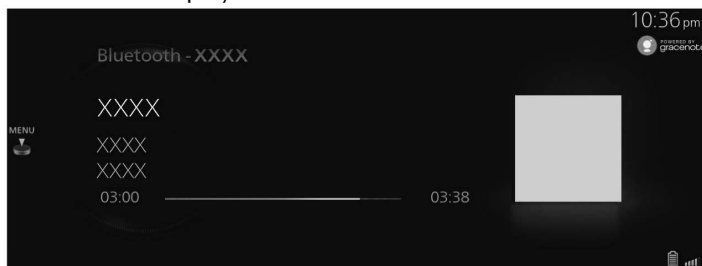

While on the playback screen, press the  on the commander switch to display the Source List screen.

4. The playback screen is displayed.



Entertainment

Rotate the  to display the Now Playing List.

When the  is displayed, you can display the menu by pressing the .

NOTE

- If the Applications screen on the device is not displayed, playback of Bluetooth® Audio on Mazda Connect may not be possible.
- If the Bluetooth® audio device does not begin playback, you need to start the playback manually.
Select “Playback Controls” from the Bluetooth® audio menu, and then select .
- If the mode is switched from Bluetooth® Audio mode to another mode (such as radio mode), playback from the Bluetooth® Audio device stops.

Bluetooth® Audio menu

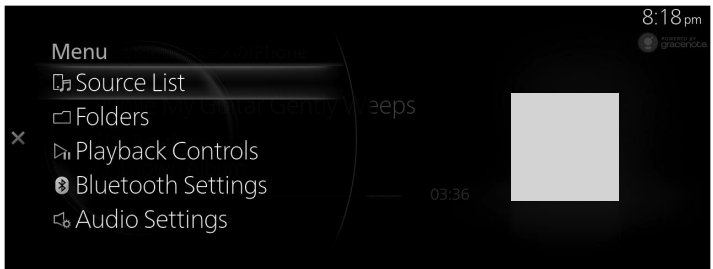





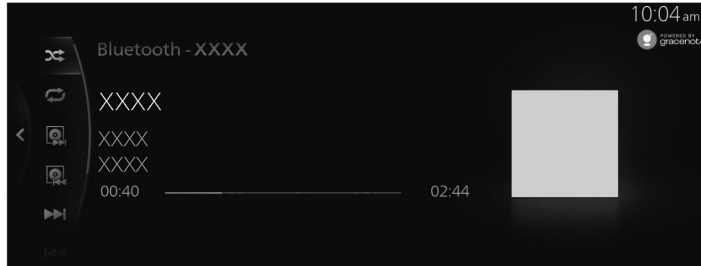









Menu	Explanation
Source List	Displays the Source List screen. You can switch the audio source.
Folders	Displays the top level folder/file. Select the folder to display the files in the folder. After you select the file you want to listen to, it begins playback.
Playback Controls	Displays the control screen (icon) on the playback screen. For the operation method for each icon, refer to How to Use the Tuner Controls (icon).
Bluetooth Settings	You can change the Bluetooth® settings. Refer to Connectivity Settings on page 2-126.
Audio Settings	Adjusts the sound quality. Refer to Sound Settings on page 2-115.

How to Use the Tuner Controls (icon)



Rotate the  to select the icon you want to operate.

Icon		Explanation
		Plays the songs in the folder currently selected in random order.
		Plays all of the songs in random order.
		Cancels the random playback.
		Repeats the playback of the song being played.
		Plays the song in the folder currently selected repeatedly.
		Cancels the repeat playback.
		Advances to the beginning of the next album.
		Returns to the beginning of the previous album.
		Advances to the beginning of the next song. Press and hold to fast forward. Release it to stop.
		Returns to the beginning of the previous song. Press and hold to fast reverse. Release it to stop.
		(When selected during pause) Playback resumes.
		(When selected during playback) Playback is paused.

NOTE

Some of the icons may not be displayed depending on the Bluetooth® audio device to be connected.

Display of Bluetooth® Audio device information

When a Bluetooth® Audio device is connected, the following information is displayed on the screen.

Information		AVRCP Ver. lower than 1.3	AVRCP Ver. 1.3	AVRCP Ver. 1.4 or higher
Playlist information	Song name list	—	—	X
	File name	—	—	X
	Folder type (such as artist, album, genre)	—	—	X
Song playback information	Song name	—	X	X
	Album name	—	X	X
	Artist name	—	X	X
	Playback time	X	X	X

X: Displayed

—: Not displayed

NOTE

Some information may not display depending on the device.

USB1 Audio/USB2 Audio

Audio can be played by connecting a commercially-available memory or music player to the vehicle's USB port.

WARNING

Do not allow the cord connected to the USB port to get tangled in the selector lever/shift lever.

If the cord gets tangled, it could be a distraction to your driving and result in an unexpected accident.

CAUTION

- Do not place items or apply force to the USB port or console box lid with the plug connected.
- Depending on the mobile device to be connected, noise may occur when using the device with it connected to the accessory power socket equipped on the vehicle (if noise occurs, do not use the accessory power socket).
- Do not connect an SD card reader or USB hub to the USB port. Playback of the music written to the card is not supported. The navigation system may also become unusable. In addition, do not connect a mouse or keyboard.
- Do not leave a USB audio device in the cabin. Otherwise, the cabin temperature will increase to a high temperature under direct sunlight which could cause damage.
- The SD card slot is for the navigation system. To use the navigation system, an SD card (Mazda genuine) for the navigation system needs to be inserted. Do not insert an SD card with music files saved on it.

NOTE

- This function may be unusable depending on the mobile device to be connected.
- Before use, read the manufacturer's instruction manual for a commercially-available mobile device.
- Do not use the audio for a long time with the engine stopped. Otherwise, the battery power could be depleted.
- Noise may occur depending on the mobile device to be connected.
- Insert the plug into the USB port securely.
- Devices can be used which comply with the USB 2.0/1.1 standard. Even with USB 3.0 standard products, if the device is compatible with USB 2.0, it can be used as a USB 2.0 device.

Entertainment

Connecting devices

Connect the USB audio device to the vehicle using the USB cable. Insert or pull out the plug with the plug perpendicular to the USB port opening.

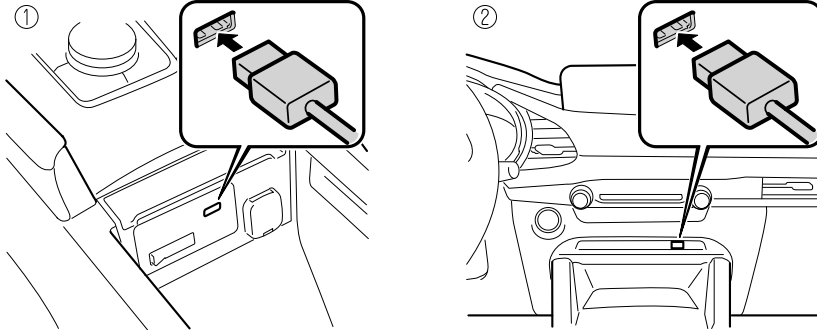

1. Located on center console
2. Located in front console area

The location of the USB port differs depending on the vehicle model.

Playing music

NOTE

- When using USB memory, it may require some time before playback begins depending on the capacity and number of stored files.
- Album art may not be displayable depending on the size of the album art.

1. Select "Entertainment" on the home screen.

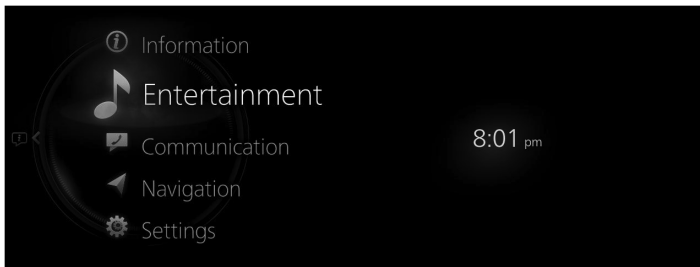

2. Select “USB1 Audio - [device name]” or “USB2 Audio - [device name]”.

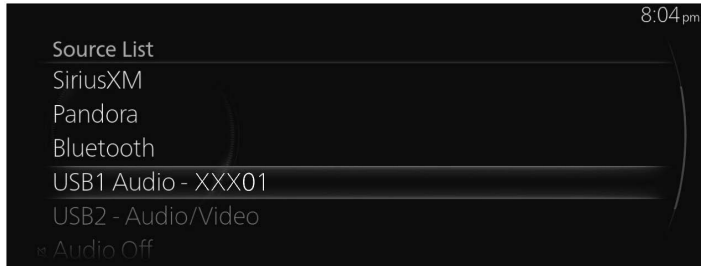



NOTE

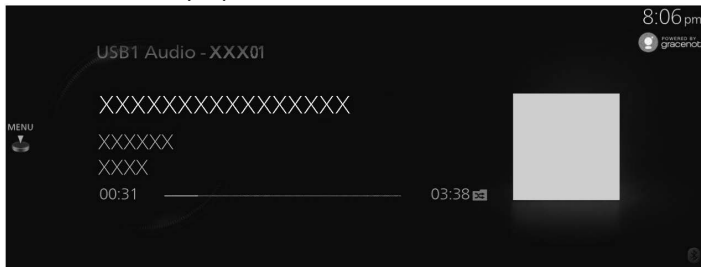

If there is currently playing content, select “Entertainment” to have the contents displayed on the playback screen.

While on the playback screen, press the  on the commander switch to display the Source List screen.

3. The playback screen is displayed.



Rotate the  to display the Track List.

When the  is displayed, you can display the menu by pressing the .

USB audio menu

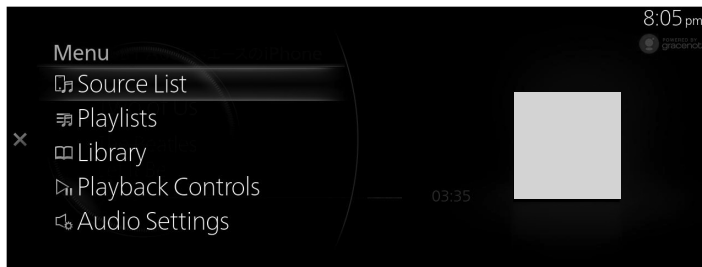

Menu	Explanation
Source List	Displays the Source List screen. You can switch the audio source.

Entertainment

Menu	Explanation
Folders*1	Displays the folder list. You can select the music you want to listen to from the folder.
Playlists*2	Displays the playlist. You can select the music you want to listen to from the playlist.
Library	Displays the Library screen. You can select the category you want to play such as album or artist. For details, refer to Selecting tracks from the Library.
Playback Controls	Displays the control screen (icon) on the playback screen. For the operation method for each icon, refer to How to Use the Tuner Controls (icon).
Audio Settings	Adjusts the sound quality. Refer to Sound Settings on page 2-115.

*1 Displayed when connected to a device other than an Apple device.

*2 Displayed when connected to an Apple device.

Selecting tracks from the Library

1. Select the category from the Library screen.

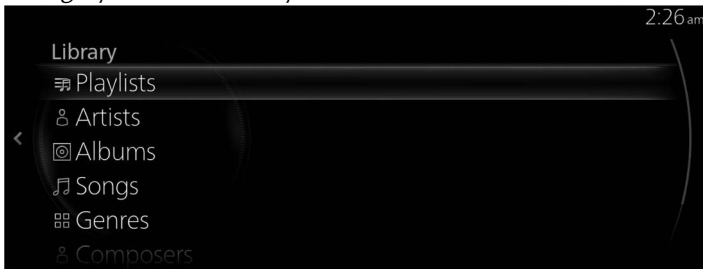

2. Select the playback method for the song from the category list.

Category	Explanation
Playlists*1	Displays the list of playlists and plays the selected playlist as a track list.
Artists	Displays the list of artists and plays the selected artist's album or all the tracks as a track list.
Albums	Displays the list of artists and plays the selected artist's album or all the tracks as a track list.
Songs	Displays the list of all the tracks and plays all the tracks as a track list. In addition, you can search for the track you want to listen to using an alphabetical search.
Genres	Displays the list of the music genres and plays artist-separate or album-separate tracks in the selected genre, or all the tracks as a track list.

Category	Explanation
Composers	A list of composers is displayed where you can select the album for a composer or all of the tracks and play them as a track list.
Podcasts* ²	Displays the Podcast list and plays the selected episode.
Audiobooks* ²	Displays the audio book list and plays the selected chapter.

*1 Displayed when connected to a device other than an Apple device.

*2 Displayed when connected to an Apple device.

Example of use (when playing tracks of a selected artist)

1. Select “Artists”.

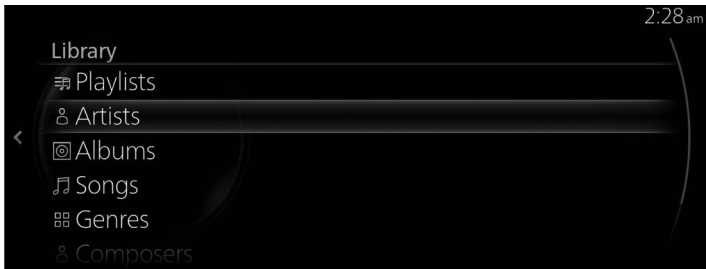

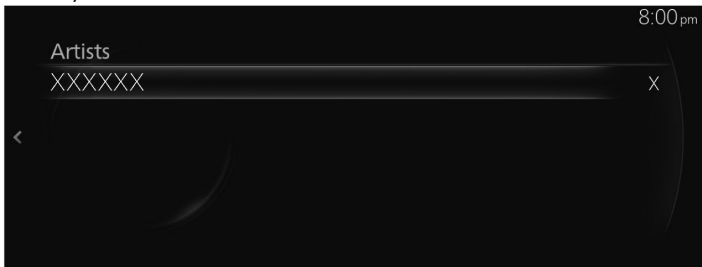

2. Select the artist you want to listen to.





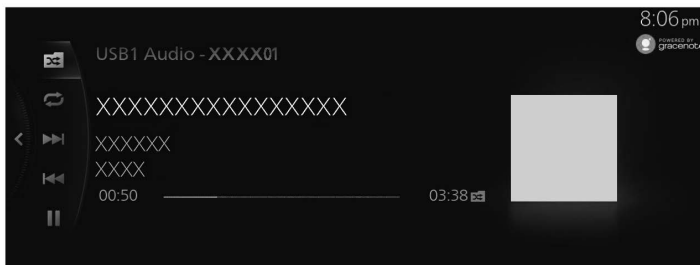









3. Select the track name you want to listen to from the list of displayed track names. The selected track is played.

How to Use the Tuner Controls (icon)



Rotate the  to select the icon you want to operate.

Icon	Explanation
	When USB devices other than Apple products, such as USB memory and audio players are connected
	 Plays the tracks in the folder currently selected in random order.
	 Plays all the tracks randomly.
	 Cancels random playback.
	When an Apple product is connected
	 Shuffles the playback of all of the tracks in the currently selected playlist or album.
	 Repeats the playback of the song being played.
	 Repeats the playback of all of the tracks in the currently selected folder, playlist, or album.
	 Cancels the repeat playback.
	Advances to the beginning of the next song. Press and hold to fast forward. Release it to stop.
	Returns to the beginning of the previous song. Press and hold to fast reverse. Release it to stop.
	(When selected during pause) Plays the track.
	(When selected during playback) Pauses the track.

Album art displayed during USB audio playback

When connecting a USB audio device to this unit and playing audio, the unit searches the database stored in the vehicle for the album art. If there is a match in the vehicle's database compilation to the music being played, the album art is displayed. The database information stored in this device uses database information in the Gracenote® music recognitions service.

NOTE

- Automatically added information may differ from the actual information.
- Album art may not be displayed depending on how the music data is read.

Album art display priority

You can change the album art display priority to either the album art saved in the USB audio device or the Gracenote® database.

Refer to System Settings on page 2-136.

Updating the database

The Gracenote® database can be updated using a USB Audio device.

Select “Gracenote Database Update” from the System Settings screen.

Refer to System Settings on page 2-136.

USB1 Video/USB2 Video*

You can play videos by connecting a commercially-available USB memory to the vehicle's USB port.

WARNING

Do not allow the cord connected to the USB port to get tangled in the selector lever:

If the cord gets tangled, it could be a distraction to your driving and result in an unexpected accident.

CAUTION

- Do not place items or apply force to the USB port or console box lid with the plug connected.
- Depending on the mobile device to be connected, noise may occur when using the device with it connected to the accessory power socket equipped on the vehicle (if noise occurs, do not use the accessory power socket).
- Do not connect an SD card reader or USB hub to the USB port. Playback of the music written to the card is not supported. The navigation system may also become unusable. In addition, do not connect a mouse or keyboard.
- Do not leave a USB audio device in the cabin. Otherwise, the cabin temperature will increase to a high temperature under direct sunlight which could cause damage.
- The SD card slot is for the navigation system. To use the navigation system, an SD card (Mazda genuine) for the navigation system needs to be inserted. Do not insert an SD card with music files saved on it.

NOTE

- This function may be unusable depending on the mobile device to be connected.
- Before use, read the manufacturer's instruction manual for a commercially-available mobile device.
- Do not play video for a long time with the engine stopped. Otherwise, the battery power could be depleted.
- Noise may occur depending on the mobile device to be connected.
- Insert the plug into the USB port securely.
- Devices can be used which comply with the USB 2.0/1.1 standard. Even with USB 3.0 standard products, if the device is compatible with USB 2.0, it can be used as a USB 2.0 device.

Connecting devices

Connect the USB audio device to the vehicle using the USB cable. Insert or pull out the plug with the plug perpendicular to the USB port opening.

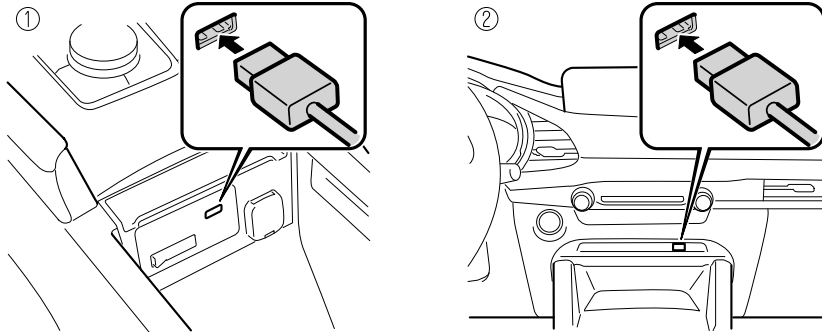

1. Located on center console
2. Located in front console area

The location of the USB port differs depending on the vehicle model.

Playing video

NOTE

- When using USB memory, it may require some time before playback begins depending on the capacity and number of stored files.
- Video playback is compatible with USB memory and USB audio devices other than Apple® products.

1. Select "Entertainment" on the home screen.

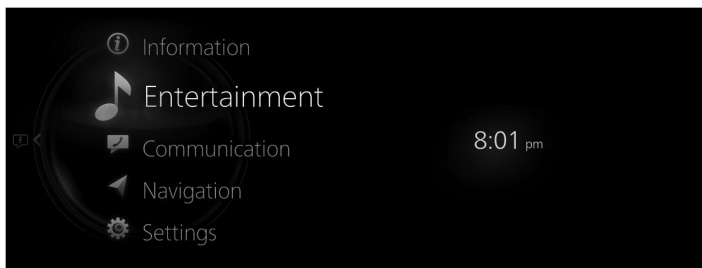

Entertainment

2. Select "USB1 Video - [device name]" or "USB2 Video - [device name]".

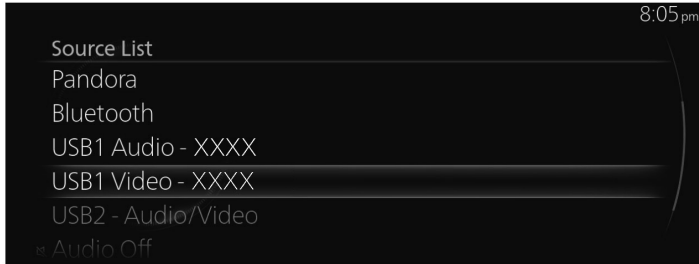

NOTE

If there is currently playing content, select "Entertainment" to have the contents displayed on the playback screen.

While on the playback screen, press the  on the commander switch to display the Source List screen.

3. The playback screen is displayed.



NOTE

For safety reasons, images are not displayed and only the audio is played while driving, and some functions are limited.

Rotate the  to display the Track List.

When the  is displayed, you can display the menu by pressing the .

USB video menu

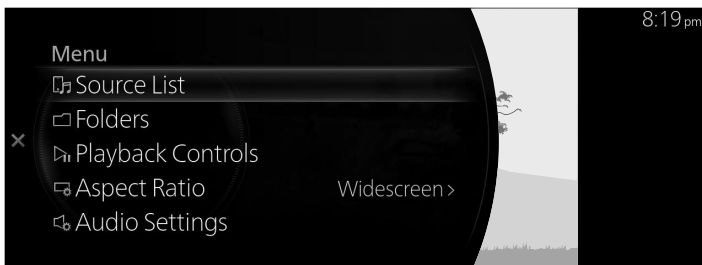

Menu	Explanation
Source List	Displays the Source List screen. You can switch the audio source.
Folders	Displays the Folders screen. Displays the folder list where you can select the video you want to play from the folder. For the selection method, refer to <i>Selecting videos from a folder</i> . If there is no folder, the folder selection screen is omitted and it moves to the file selection screen.
Playback Controls	Displays the control screen (icon) on the playback screen. For the operation method for each icon, refer to <i>How to Use the Tuner Controls (icon)</i> .
Aspect Ratio	The screen size can be switched to "Widescreen"/"Letterbox"/"Pan and Scan".
Audio Settings	Adjusts the sound quality. Refer to <i>Sound Settings</i> on page 2-115.

Selecting videos from a folder

1. Select the folder from the Folders screen.



2. Select the folder to display the file list in the folder.

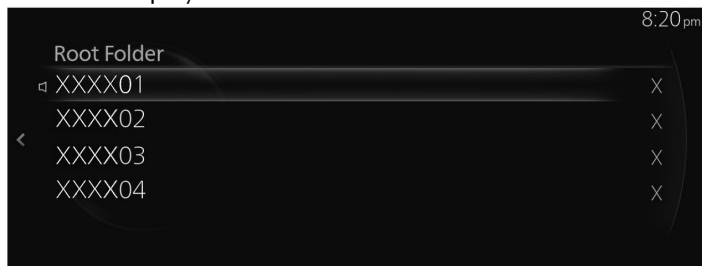







3. Select the video you want to play to begin playback.

How to Use the Tuner Controls (icon)



Rotate the  to select the icon you want to operate.

Icon	Explanation
	Advances to the beginning of the next video. Press and hold to fast forward. Release it to stop.
	Returns to the beginning of the previous video. Press and hold to fast reverse. Release it to stop.
	Plays the video in slow motion playback.
	(When selected during pause) Plays the video. (When selected during slow motion playback) Cancels slow motion playback.
	(When selected during playback) Playback is paused.
	Stops the video.

CD*

Inserting a disc into the unit

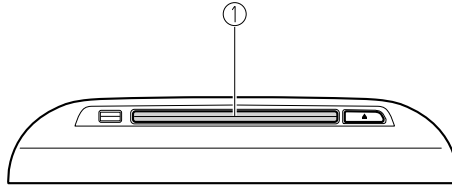

1. CD/DVD slot

The shape of the CD/DVD player differs depending on the vehicle model.

1. Switch the ignition to ACC or ON.
2. Insert the disc into the slot, label side up. The auto-loading mechanism will set the disc and start to play.

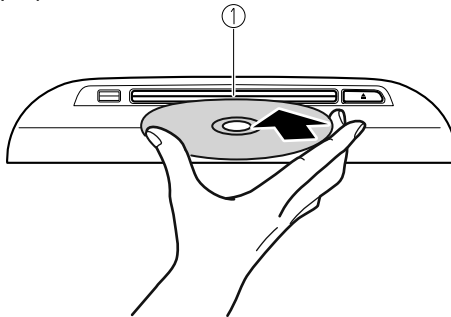

1. CD/DVD slot

NOTE

- Use only 12 cm CDs. This device cannot playback 8 cm CDs (single) even if an adapter is used. If an 8 cm CD adapter is used, the device might be damaged.
- There will be a short lapse before play begins while the player reads the digital signals on the CD.

Entertainment

Changing to the CD playback screen

1. Select "Entertainment" on the home screen.

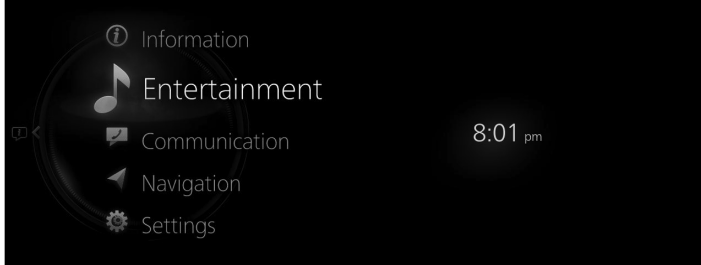

2. Select "CD".

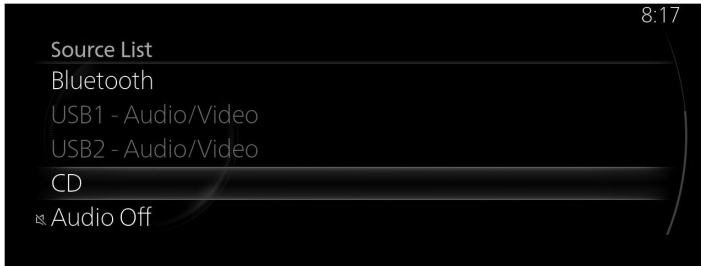

NOTE

- If there is currently playing content, select "Entertainment" to have the contents displayed on the playback screen.

While on the playback screen, press the  on the commander switch to display the Source List screen.

- If a disc is not inserted, "Disc" is displayed, however, it cannot be selected.

3. The playback screen is displayed.

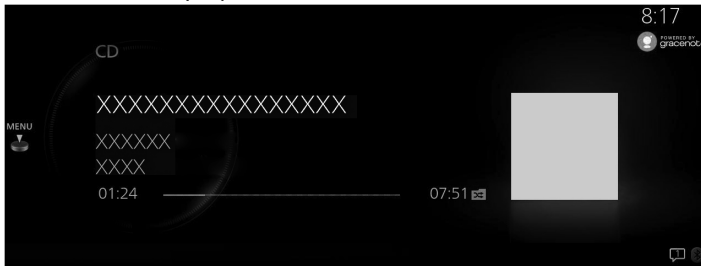

Display the track list using .

When the  is displayed, you can display the menu by pressing the .

NOTE

- This unit is compatible with CD-TEXT. When playing a CD-TEXT-compatible disc, music information such as a song name or artist name is displayed.
- For MP3/WMA/AAC CDs, if music information was embedded when the music file was created, the information is displayed.

CD menu

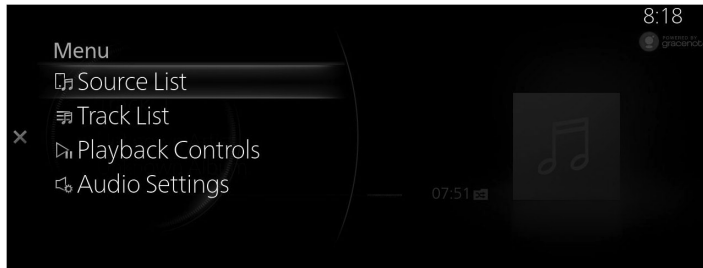

Menu	Explanation
Source List	Displays the Source List. The audio source can be switched.
Track List*	(Music CD) Displays the Track List. You can select the music you want to listen to from the Track List.
Folders*	(MP3/WMA/AAC CD) Displays the folder list. You can select the music you want to listen to from the folder.
Playback Controls	Displays the control screen (icon) on the playback screen. For the operation method of each icon, refer to How to Use the Tuner Controls (icon).
Audio Settings	Adjusts the sound quality. Refer to Sound Settings on page 2-115.

NOTE

(MP3/WMA/AAC CD)

Playback starts in the order from the top of the list. If a folder exists, playback begins with the songs in that folder, and then the next folder/file list. If there are no playable songs in a folder, the next folder/file list is played.

Entertainment

Example of use (When searching for a song from the top level of an MP3/WMA/AAC CD)

1. Select "Folders" and display the folder/file list at the top level.

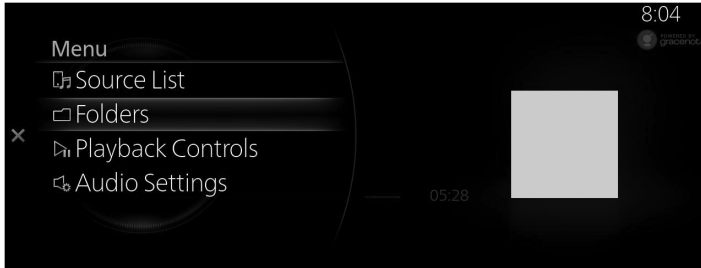

2. When selecting the folder, folders/file lists in the folder are displayed.

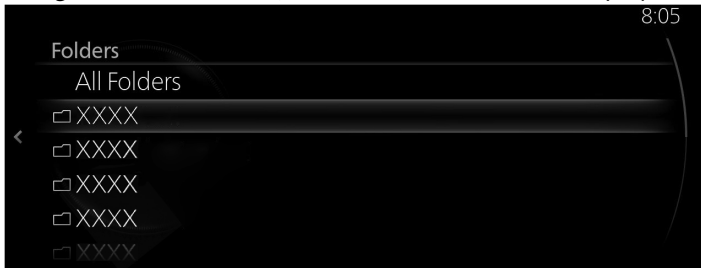

3. Select the file you want to listen to.

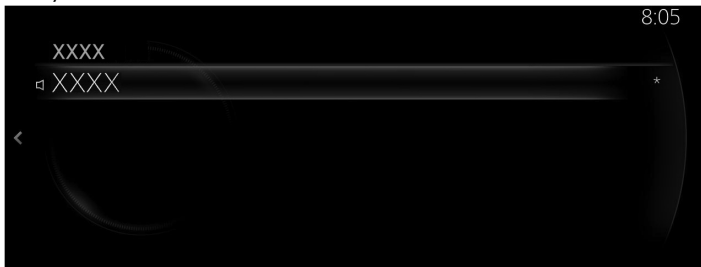







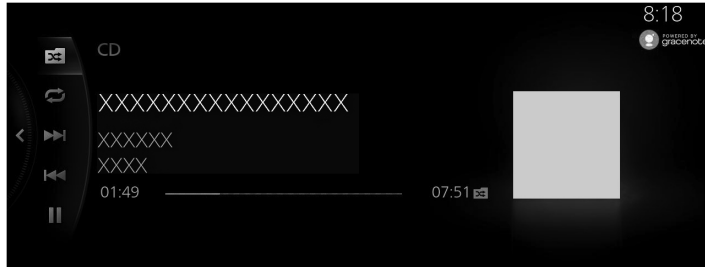





NOTE

- When the  is slid to the left, it moves to a folder one level higher.
- When a CD is ejected, the unit changes to the audio source played before the CD.

How to Use the Tuner Controls (icon)



Rotate the  to select the icon you want to operate.

Icon		Explanation
		Plays the tracks in the currently selected folder or CD in random order.
		(MP3/WMA/AAC CD) Plays all the tracks in the folder in random order.
		Displays that random playback is canceled.
		Repeats the playback of the song being played.
		(MP3/WMA/AAC CD) Plays the song in the folder currently selected repeatedly.
		Displays that repeat playback is canceled.
		Advances to the beginning of the next song. Press and hold to fast forward. Release it to stop.
		Returns to the beginning of the previous song. Press and hold to fast reverse. Release it to stop.
		(When selected during pause) Resume playback.
		(When selected during playback) Playback is paused.

Music information displayed during CD playback

When connecting a CD/DVD player to this unit and the audio is played, the unit searches the database stored in the vehicle for the album name, artist name, genre, title, and album art, and if there is a match in the vehicle's database compilation to the music being played, each type of music information is automatically added (for MP3/WMA/AAC CDs, only album art). The database information stored in this device uses database information in the Gracenote® music recognitions service.

NOTE

- Automatically added information may differ from the actual information.
- If there is music information in a music file even for music not registered to the Gracenote® database, the music information will be displayed.
- Music information may not be displayed depending on how the music data is read.

Updating the database

The Gracenote® database can be updated using a USB Audio device. Select "Gracenote Database Update" from the System Settings screen. Refer to System Settings on page 2-136.

Ejecting a disc

1. Press the ▲ button.

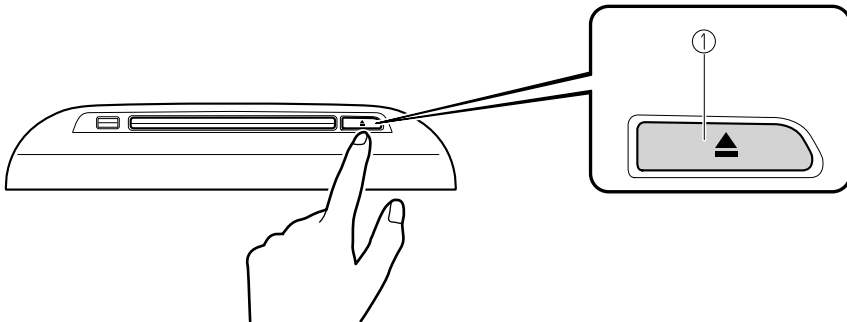

1. CD/DVD eject button

2. Remove the disc by grasping its edge.

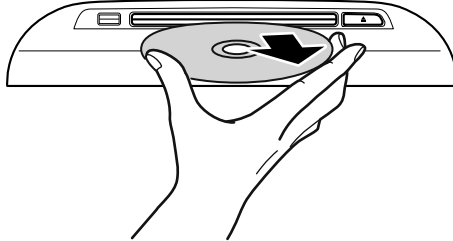

DVD*

Inserting a DVD into the unit

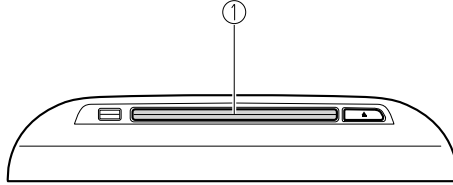

1. CD/DVD slot

The shape of the CD/DVD player differs depending on the vehicle model.

1. Switch the ignition to ACC or ON.
2. Insert the DVD into the slot, label side up. The auto-loading mechanism will set the disc and the DVD playback screen is displayed.

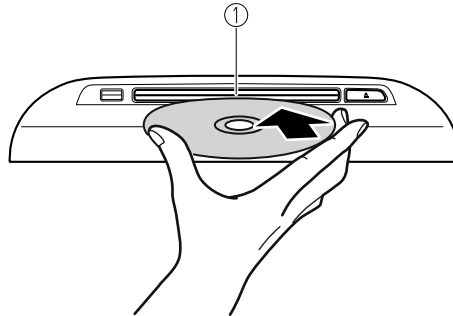

1. CD/DVD slot

NOTE

- Use only 12 cm DVDs. This device cannot playback 8 cm DVDs even if an adapter is used. If an 8 cm DVD adapter is used, the device might be damaged.
- There will be a short lapse before play begins while the player reads the digital signals on the DVD.
- For details on playing music recorded on DVD-R/DVD+R/DVD-RW/DVD+RW, refer to the CD item.
Refer to CD on page 2-71.

Changing to the DVD playback screen

1. Select "Entertainment" on the home screen.

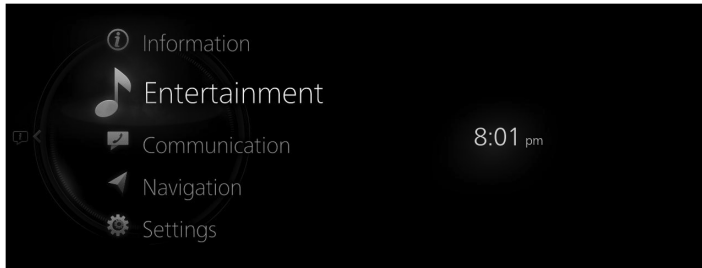

2. Select "DVD".

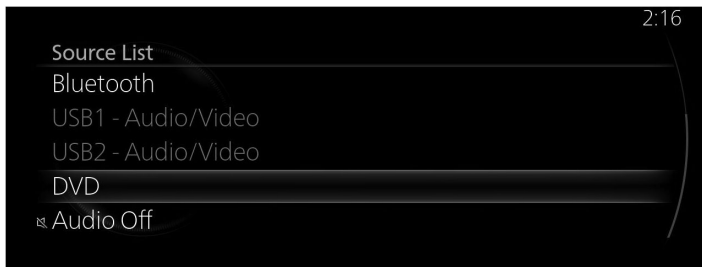

NOTE

- If there is currently playing content, select "Entertainment" to have the contents displayed on the playback screen.
 - While on the playback screen, press the  on the commander switch to display the Source List screen.
 - If a disc is not inserted, "Disc" is displayed, however, it cannot be selected.
3. The playback screen is displayed.





NOTE

- For safety reasons, images are not displayed and only the audio is played while driving, and some functions are limited.

Entertainment

- If the mode is switched to DVD mode once the DVD playback has stopped, the playback restarts without displaying the DVD menu screen.
- If you switch to another type of audio while a DVD is playing, the DVD playback stops temporarily.

Rotate the  to display the Chapter.

When the  is displayed, you can display the menu by pressing the .

DVD menu









Menu	Explanation
Source List	Displays the Source List screen. The audio source can be switched.
Chapter List	Displays the chapter list. Select the video you want to play from the chapter list.
Playback Controls	Displays the control screen (icon) on the playback screen. For the operation method of each icon, refer to How to Use the Tuner Controls (icon).
Cursor*	(DVD Video) Moves on the DVD menu screen for item selection. Move to the desired position using the up/down, left/right arrows and select OK .
Disc Menu*	(DVD Video) Displays the top menu of the DVD.
Title Menu*	(DVD Video) Displays the title menu of the DVD.
Title Number	Specifies the title number of the DVD you want to play and plays it. Input the title number of the DVD and select  .
DVD Settings	Makes settings for the DVD. For details, refer to DVD Settings.
Audio Settings	Adjusts the sound quality. Refer to Sound Settings on page 2-115.

How to Use the Tuner Controls (icon)



Rotate the  to select the icon you want to operate.

Icon	Explanation
	Advances to the beginning of the next video. Press and hold to fast forward. Release it to stop.
	Returns to the beginning of the previous video. Press and hold to fast reverse. Release it to stop.
	(When selected during pause) Plays the video. (When selected during slow motion playback) Cancels slow motion playback.
	(When selected during playback) Playback is paused.
	Plays the video in slow motion playback.
	Stops the video.
	Returns to the title menu.

DVD Settings

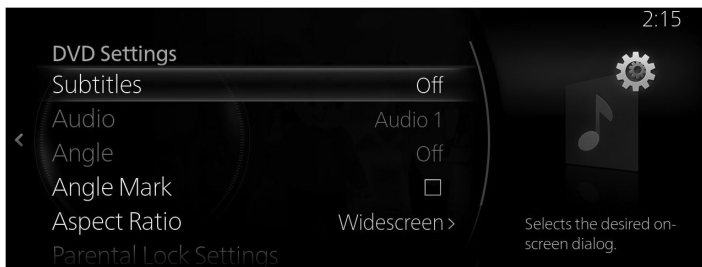

Rotate the  to select the icon you want to operate.

Menu	Explanation
Subtitles	Changes the subtitle settings. You can select the type of subtitles or turn them off.
Audio	Changes the audio settings. You can select the type of audio.
Multi-Audio*	(DVD VR) Switches between Primary Audio/Supplementary Audio.
Angle*	(DVD Video) Changes the camera angle.
Angle Mark*	(DVD Video) Switches the multi-angle mark display between enable/disable.
Aspect Ratio	Changes the screen size. You can select from "Widescreen"/"Letterbox"/"Pan and Scan".
Parental Lock Settings*	(DVD Video) Displays the Parental Lock Settings screen. You can change the parental lock level, and set, change, and reset the PIN code. For the operation method, refer to Parental Lock.

Parental lock

Some DVDs have a parental lock level.

When the DVD parental lock level exceeds the setting level set on this unit, the playback is disabled. You can change the parental lock level, and set, change, and reset the PIN code.

To use the parental lock function, you need to set a PIN code.

Setting the PIN code (4-digit)

1. Select "Change PIN Code".

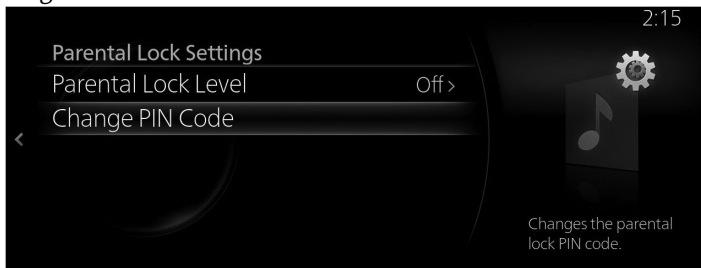

2. Input the new PIN code.



3. Select ✓.

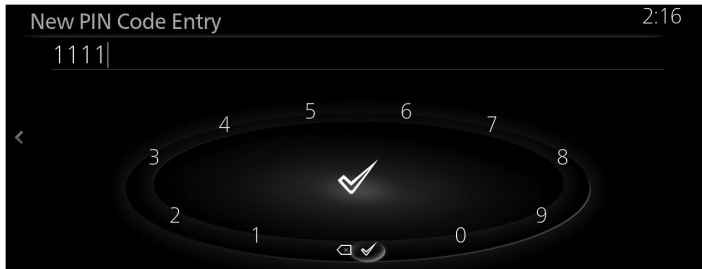

Changing the parental lock level

1. Select "Parental Lock Level".

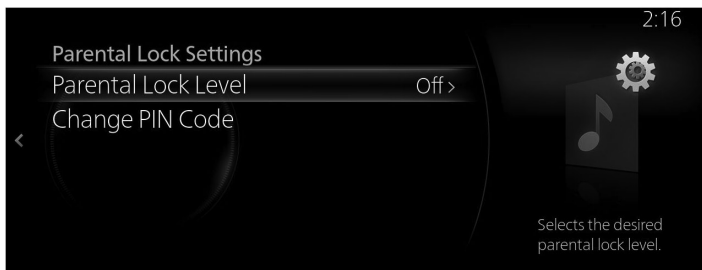

2. Input the PIN code.

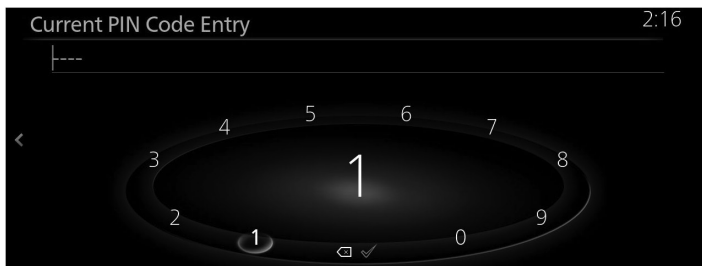

Entertainment

3. Select ✓.

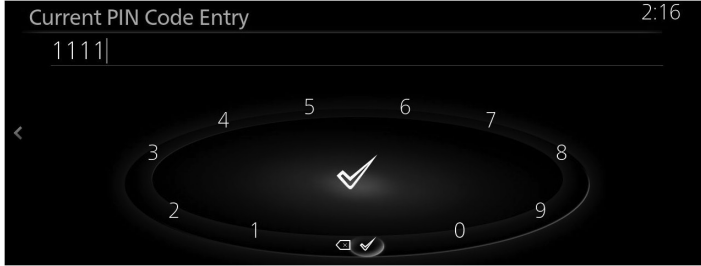

4. Select your desired restriction level from "Off", or from "8 (Restriction level: Low)" to "1 (Restriction level: High)".

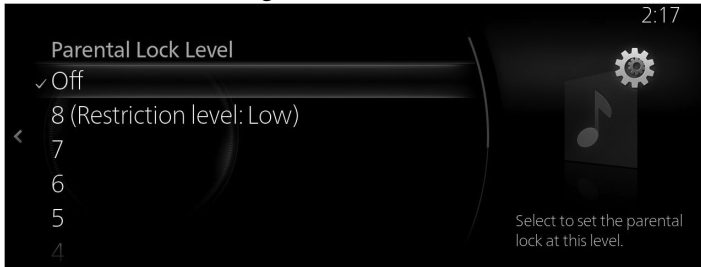

Changing the PIN code

1. Select "Change PIN Code".



2. Input the current PIN code.

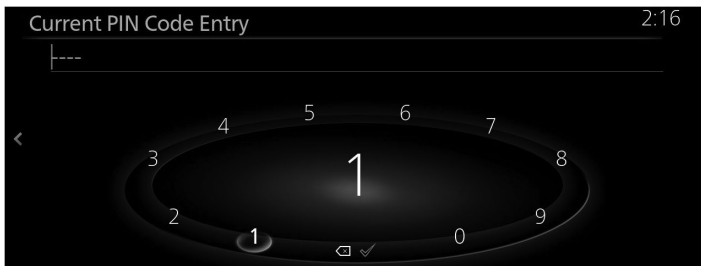

3. Select ✓.

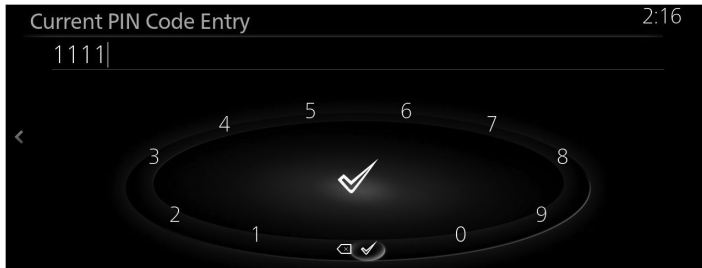

4. Input the new PIN code.



5. Select ✓.

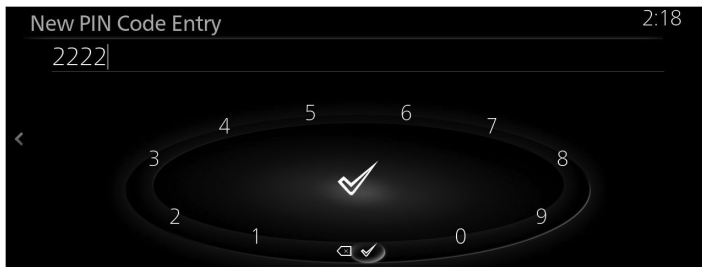



Resetting the PIN code

If you forgot the programmed PIN code, you can reset it using the following procedure.

Entertainment

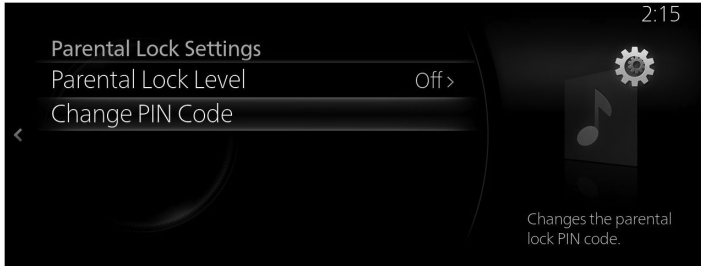
1. Select "Change PIN Code".



2. Select  10 times while nothing is input.

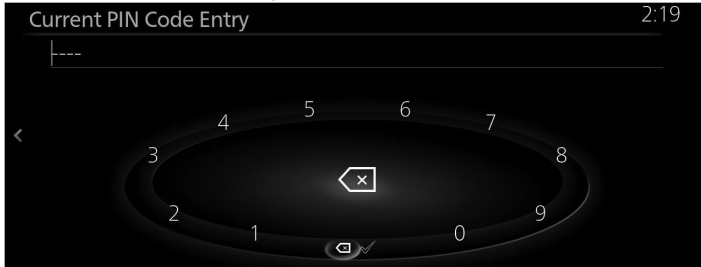

Playing a locked DVD

If you want to play a DVD which has been locked by the parental lock function, it can be unlocked by inputting the PIN code.

1. If you try to play a locked DVD, the PIN code input screen is displayed.

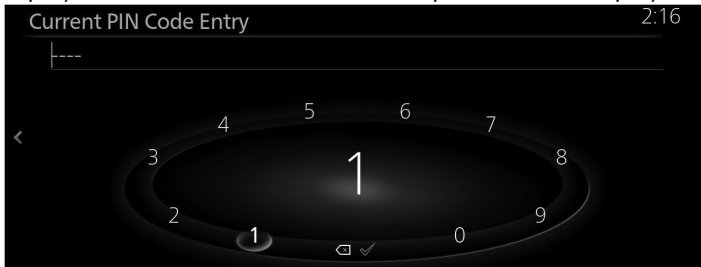

2. Input the current PIN code.

3. Select ✓.

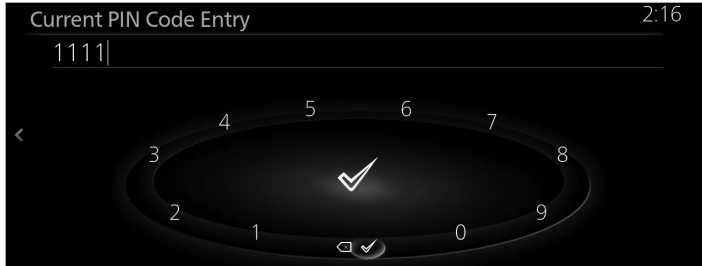

Ejecting a DVD

1. Press the  button.

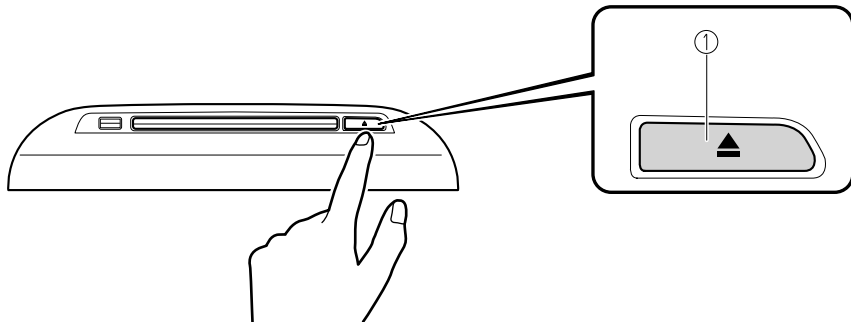

1. CD/DVD eject button

2. Remove the DVD by grasping its edge.

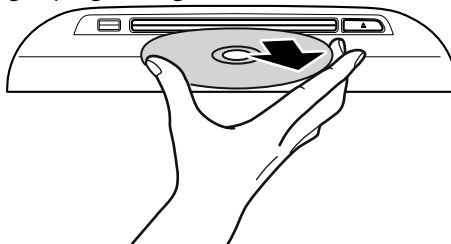

Communication

By connecting your mobile device, such as a Smartphone, to Mazda Connect via Bluetooth®, you can perform hands-free calling and short message functions.

Bluetooth® Hands-Free

When connecting a Bluetooth® device (mobile phone) to the vehicle's Bluetooth® unit via radio wave transmission, calls can be made or received.

NOTE

- Park the vehicle in a safe place and perform pairing.
- The communication range of a Bluetooth® device is about 10 meters or shorter.
- Some Bluetooth® mobile devices are not compatible with the vehicle. Consult an Authorized Mazda Dealer, Mazda's call center or Web support center for information regarding Bluetooth® mobile device compatibility:
 - Website: <https://connect.mazda.com/en/>
 - U.S.A.
Phone: 800-430-0153
 - Canada
Phone: 800-430-0153
 - Mexico
Center of Attention to Client (CAC)
Phone: 01-800-01-MAZDA
 - Australia
 - New Zealand
 - Germany
Phone: 0800 4263 738 (8:00—18:00 Central European Time)
 - Europe (Except Germany)
Phone: 00800 4263 7383 (8:00—18:00 Central European Time)
 - Worldwide
Phone: + 49 (0) 6838 907 287 (8:00—18:00 Central European Time)

Supported Bluetooth® standard (recommended)

Ver. 1.1/1.2/2.0 + EDR/2.1 + EDR/3.0 (conformity)
and devices that are compatible with Bluetooth® Ver 3.0.

Component Parts

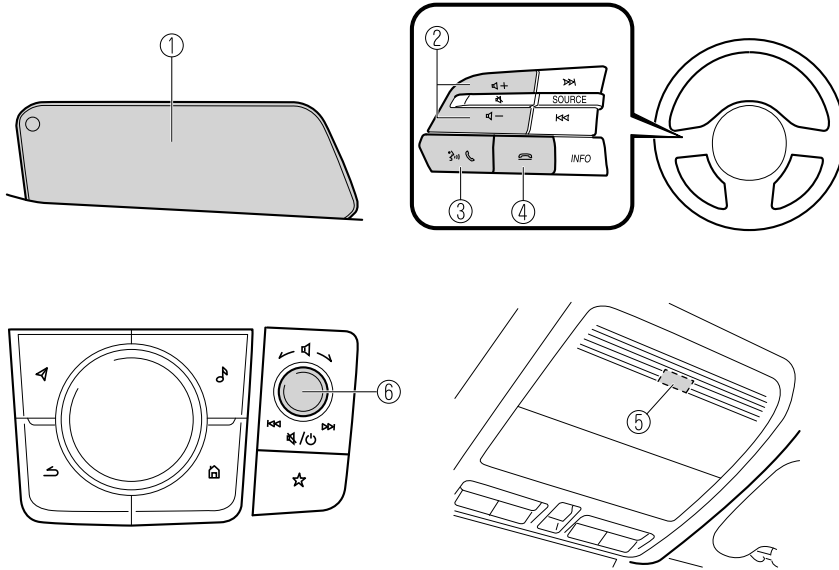

1. Center display
2. Volume adjustment button
3. Talk/pick-up button
4. Hang-up button
5. Microphone
6. Volume knob

The display and the shape of each switch may differ depending on the vehicle model.

Volume adjustment button

Adjusts the voice guidance and conversation volume.

Talk/pick-up button

Activates the voice recognition, skips the voice guidance. In addition, when you press the button while on an incoming call, you can answer the call.

Hang-up button

Ends the call or refuses an incoming call. In addition, it ends the voice recognition operation.

Volume knob

Adjusts the voice guidance and conversation volume the same as the volume adjustment button on the audio remote control switch. The volume increases by turning the dial clockwise, and decreases by turning it counterclockwise.

Microphone (hands-free)

The microphone is used for inputting a voice command using voice recognition or when making a hands-free call.

NOTE

The Bluetooth® Call Volume is independent of the Bluetooth® Audio volume, which is also independent of the AM/FM/USB audio volume. Ensure that the Bluetooth® device volume is set at a reasonable level, and then adjust the call volume using the Mazda Connect volume knob.

▼ Making a Call

For Mazda Connect, making calls is possible using any of the following six methods:

- Favorites
- Call history
- Phonebook downloaded from a Bluetooth® device (mobile phone)
- Dialing a telephone number
- “Redial”– Voice recognition command for making a call to the latest outgoing call history.

Making a call from your Favorites

1. Select “Communication” on the home screen.

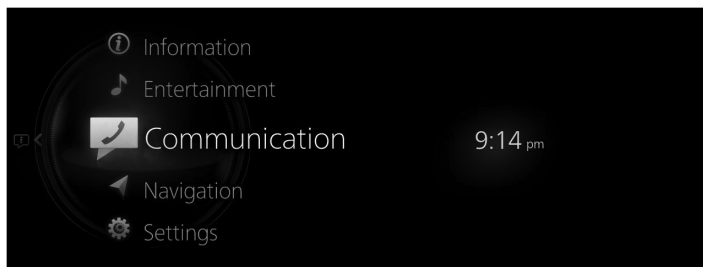

Communication

2. Select "Favorites".



3. Select the contact information you want to make a call from the displayed Favorites list.

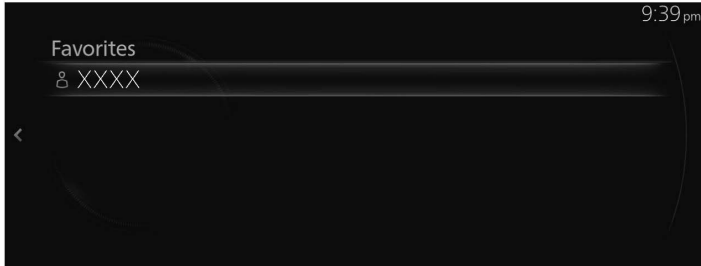

4. Select the telephone number and make the call.

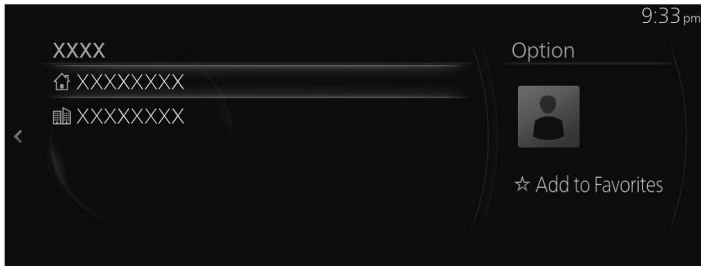

Making a call using the call history (outgoing call history, incoming call history)

Operation using voice

Makes a call to the last person called (latest person on outgoing call history) from the mobile phone/vehicle.

1. Press the  on the audio remote control switch.
2. Say: "Redial"

Center Display Operation

1. Select "Communication" on the home screen.

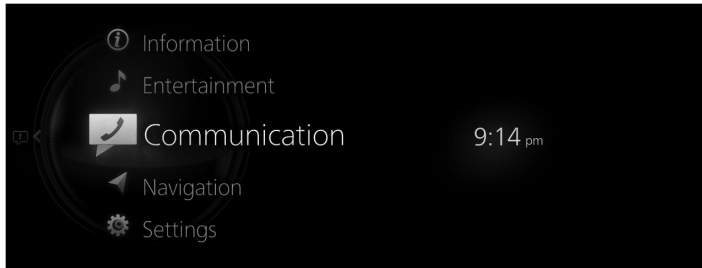

2. Select "Call History".

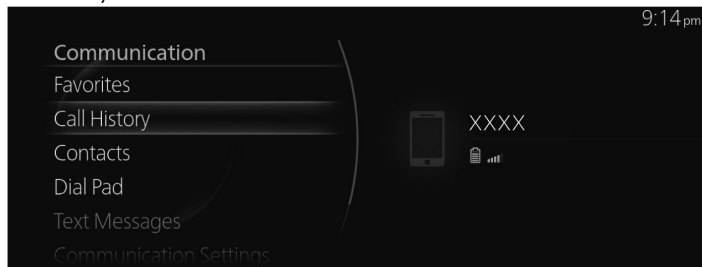

3. Select the contact or telephone number you want to call from the displayed call history to make a call.

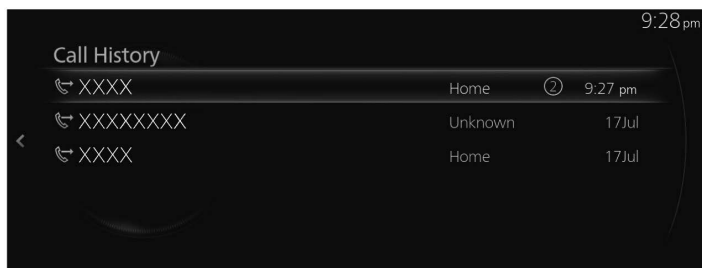

Making a call using the contacts (phonebook)

Operation using voice

Telephone calls can be made by saying the contact name in the downloaded phonebook.

1. Press the  on the audio remote control switch.
2. Say: "Call {Contact Name} at {Number Type}"
For the {Contact Name}, say the name of the person registered in the phonebook. Depending on the registered content in a phonebook, calls can be made from "Home", "Work", "Mobile", or "Other" telephone number types.

Communication

3. Follow the voice guidance to make a call.

NOTE

Make a call using the contact downloaded beforehand.
Refer to Downloading a phonebook on page 2-98.

Center Display Operation

1. Select "Communication" on the home screen.

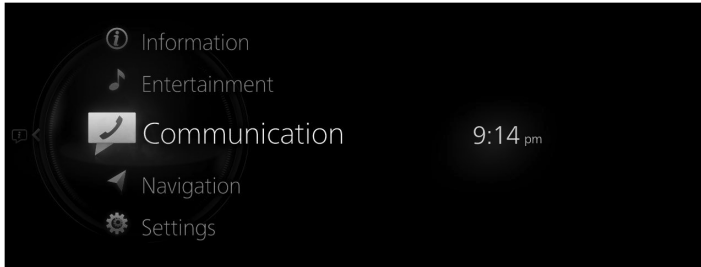

2. Select "Contacts".

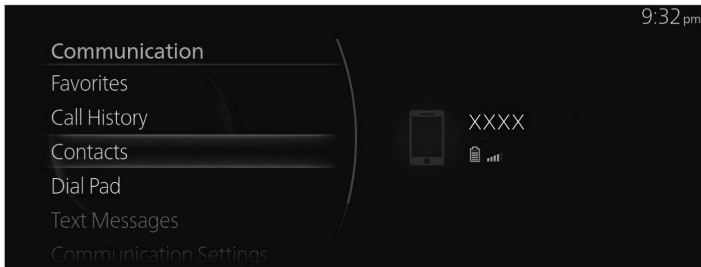

3. Select the contact you want to call from the displayed contact list and make the call.



4. Select the phone number to make the call.

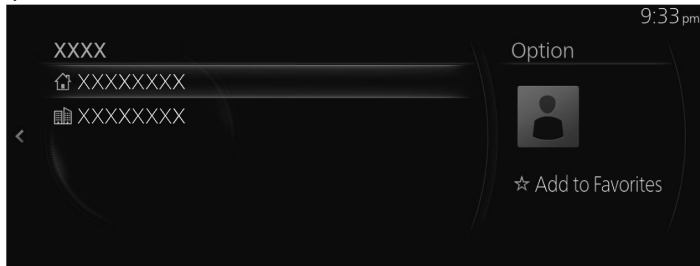

Input the telephone number and make the call

NOTE

Practice this while parked until you are confident you can do it while driving in a non-taxing road situation. If you are not completely comfortable, make all calls from a safe parking position, and only start driving when you can devote your full attention to driving.

Operation using voice

You can make a call by saying the phone number.

1. Press the  on the audio remote control switch.
2. Say: "Dial {Phone Number}"
3. Follow the voice guidance to make a call.

Center Display Operation

1. Select "Communication" on the home screen.

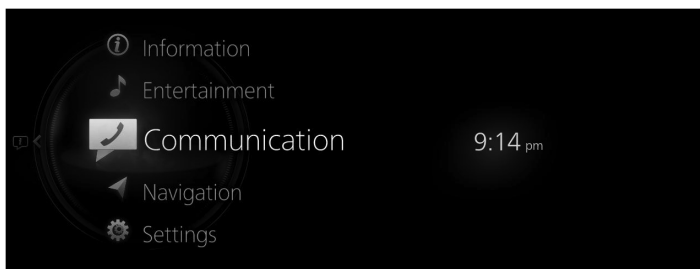

Communication

2. Select "Dial Pad".

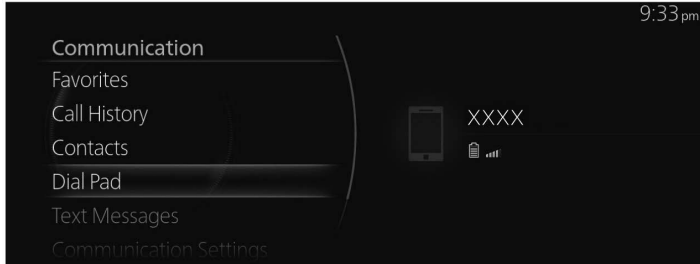

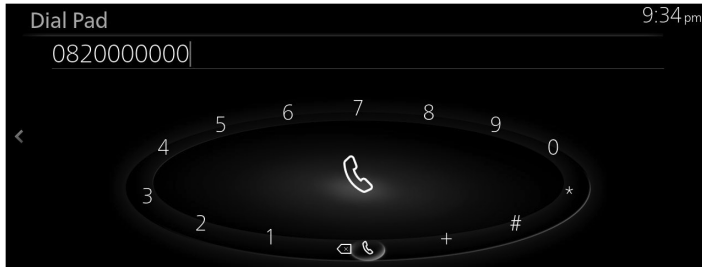

3. Input the telephone number using the dial pad.

4. Select  to make a call.



NOTE

- Select  to delete the previous input number.
- Press and hold  to delete all input numbers.

Automatic 911 dialing (U.S.A./Canada only)

If the vehicle is involved in a moderate to severe collision, a call is made automatically to 911 from the connected device. The "Emergency Assistance Call" setting must be on.

Refer to Communication Settings on page 2-106.



Though the system can be set to not call 911, doing so will defeat the purpose of the system. Mazda recommends that the Automatic 911 dialing system remain activated.

NOTE

- **Automatic 911 dialing is a secondary function of the audio entertainment system. Therefore, the Automatic 911 dialing function does not assure that the call is always made to 911 after an accident occurs.**

- A Hands-free device must be paired and connected. The 911 operator can verify the vehicle's position information using the Hands-free device GPS if equipped.

The 911 operator can verify the vehicle's position information.

1. If the vehicle is involved in a moderate to severe collision, notification of the call to 911 is made via audio and screen display.
To cancel the call, "Cancel" within 10 seconds.
2. If "Cancel" is not pressed within 10 seconds, the call is made to 911 automatically.

▼ Receiving a call

When the Incoming Call Notifications setting is turned on, the incoming call notification screen is displayed when receiving an incoming call. Refer to Communication Settings on page 2-106.

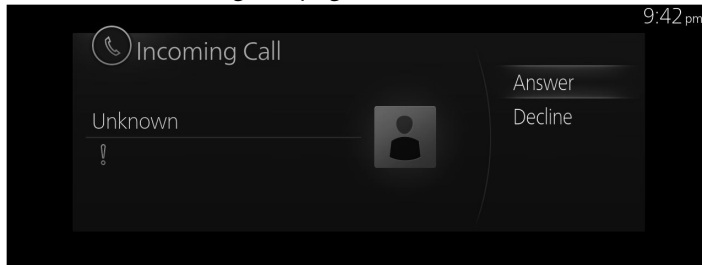

When the conversation begins, press the  on the audio remote control switch on the steering wheel control switch, or select "Answer" on the screen.

To refuse a call, press the  on the audio remote control switch or select "Decline" on the screen.

NOTE

When the Incoming Call Notifications setting is turned off, the incoming call notification screen is not displayed.

▼ Things you can do during a call

The following menu is displayed on the screen during a call. The displayed menu differs depending on the use conditions.

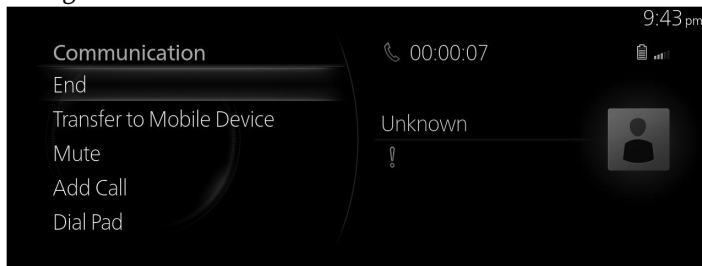

Communication

Menu	Explanation
End	Ends the call.
Transfer to Mobile Device	Transfers a call from hands-free to a mobile phone. Communication between this unit and a Bluetooth® device is canceled, and an incoming call can be received by the device (mobile phone) as a standard call.
Transfer to Vehicle	Transfers a call from a device (mobile phone) to hands-free. Communication between devices (mobile phone) can be switched to Bluetooth® Hands-Free.
Mute	Mutes the microphone during a call.
Unmute	Cancels the mute for the microphone during a call.
Add Call	A call is made to another person during a call, and a 3-way call can be made. Select the contact from the following to make a call. Call History : The call history is displayed. Contacts : The phonebook is displayed. Dial Pad : The dial pad is displayed. Input the phone number. The function may not be available depending on the contractual content of the mobile device.
Dial Pad	DTMF (Dual Tone Multi-Frequency Signal) Transmission This function is used when transmitting DTMF via the dial pad. The receiver of a DTMF transmission is generally a home telephone answering machine or a company's automated guidance call center. Input the number using a dial pad.
Send Stored Tones	(When registering a phone number and DTMF data to a contact with whom you are currently calling.) Sends the DTMF data after the separator character (p or w) following the phone number.

▼ Downloading a phonebook

The phonebook data from the Bluetooth® device can be registered to the contacts on the unit using Bluetooth®.

Automatic downloading

When the Contacts and Call History Sync setting is on, contacts and call history are automatically downloaded when connected to a Bluetooth® device.
Refer to Communication Settings on page 2-106.

Manually downloading

When the Contacts and Call History Sync setting is off, download the phonebook using the following procedure.

1. Select "Communication" on the home screen.

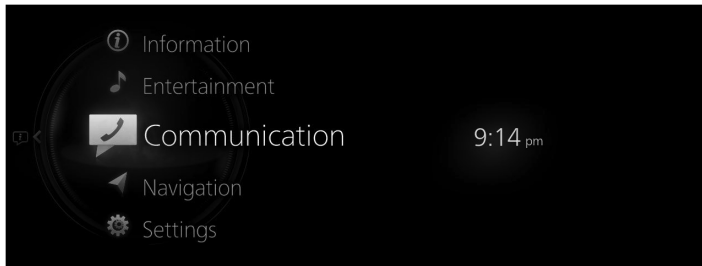

2. Select "Contacts".

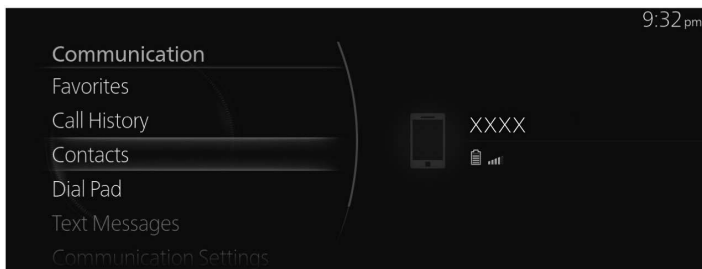

3. Select "Update Contacts".

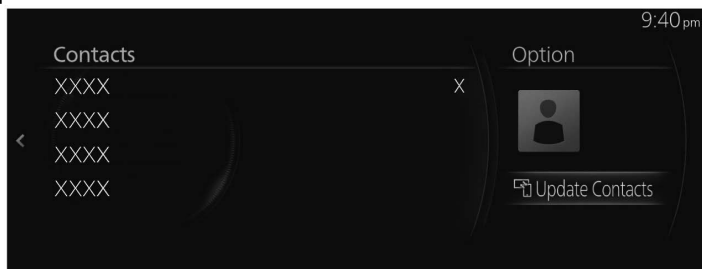

NOTE

- The phonebook download uses the Bluetooth® PBAP profile.
- Up to 5,000 contacts can be registered.
- The phonebook, incoming/outgoing call history, and Favorite memories are exclusive to each paired Bluetooth® device to protect privacy.
- In downloading a phonebook from a Bluetooth® device, operations may be necessary on the Bluetooth® device side in addition to this unit. For details, refer to the Bluetooth® device's owner's manual.
- Contacts with no telephone number are not registered.

Communication

▼ Registering contacts to Favorites

Up to 100 contacts can be registered. Registering the phone number saves time by you not having to search for the person you want to call in the phonebook.

NOTE

The contacts need to be input (downloaded phonebook) beforehand. Refer to Downloading a phonebook on page 2-98.

Registering to Favorites

1. Select "Communication" on the home screen.

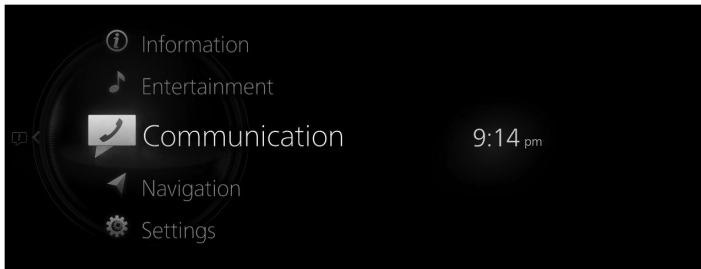

2. Select "Contacts".

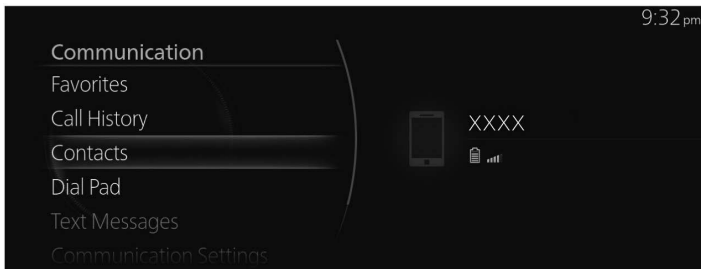

3. Select the contact you want to register to Favorites from the displayed contact list.



4. Select "Add to Favorites".

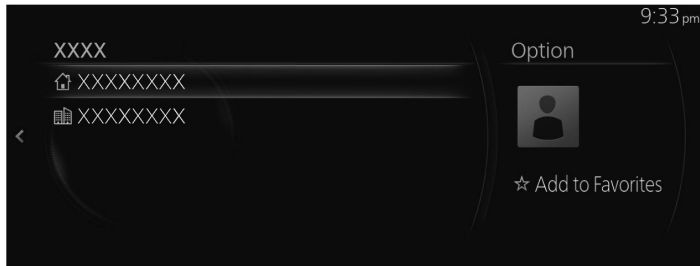

NOTE

If the battery is disconnected, your Favorites list will not be deleted.

Deleting Favorites/changing contact name of your Favorites

For deleting and changing contact names from your Favorites, refer to Favorites on page 1-17.

▼ Receiving and replying to messages*

SMS (Short Message Service) messages received by the connected Bluetooth® device can be downloaded, displayed on the center display, and read out loud. In addition, preset replies can also be made to calls and messages in the received messages.

NOTE

You may need to configure settings on your Bluetooth® device to utilize this function.

Downloading messages

You can download up to 50 recent messages from a connected Bluetooth® device and display them.

Automatic downloading

When the Message Sync setting is turned on, messages are automatically downloaded when the Bluetooth® device is connected. Refer to Communication Settings on page 2-106.

Manually downloading

If the Message Sync setting is turned off, messages can be downloaded using the following procedure.

Communication

1. Select "Communication" on the home screen.

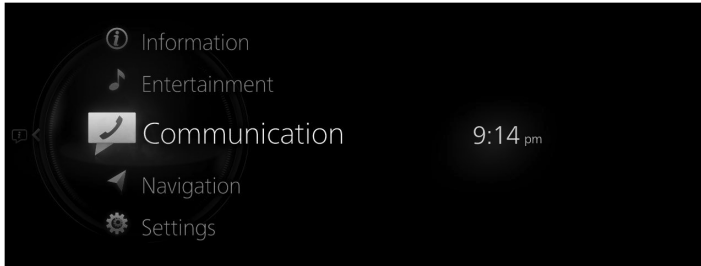

2. Select "Text Messages".

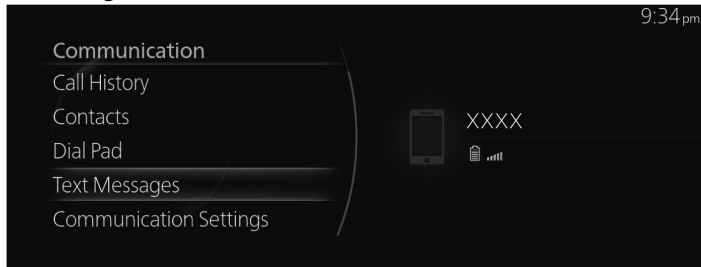

3. When "Update List" is selected, the messages are downloaded from your Bluetooth® device.



NOTE

- Attached data is not downloaded.
- Messages up to 160 characters can be downloaded.
- The messages that are stored are exclusive to each paired Bluetooth® device to protect privacy.
- The short message function uses the Bluetooth® MAP profile.
- To receive and reply to messages from your Bluetooth® device, operations and settings may be necessary on the Bluetooth® device side in addition to this unit. For details, refer to the Bluetooth® device's owner's manual.

iPhone®

NOTE

- When you connect an iPhone®, the following functions cannot be used.
 - Downloading past messages
 - Replying to messages

Do the following operation while connected after pairing is completed.

1. **(iPhone® operation)**
Select the Settings menu → Bluetooth → Device “Mazda”.
2. **(iPhone® operation)**
Turn on the Display notifications item.
3. **(Operation on this unit)**
Turn off Bluetooth®.
Refer to Connectivity Settings on page 2-126.

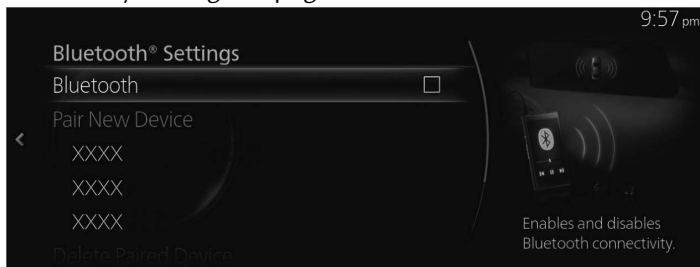

4. **(Operation on this unit)**
Turn on Bluetooth® again and wait until the iPhone® automatically reconnects.

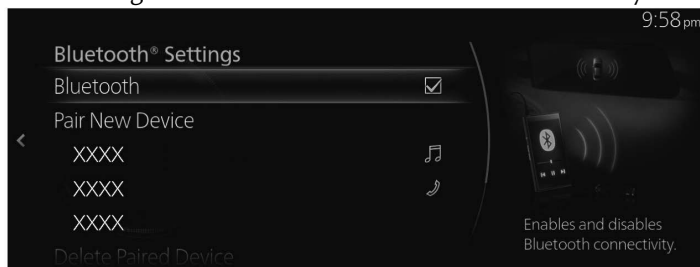

Communication

5. (Operation on this unit)

After connecting the iPhone®, "Text Messages" can be used if it can be selected.

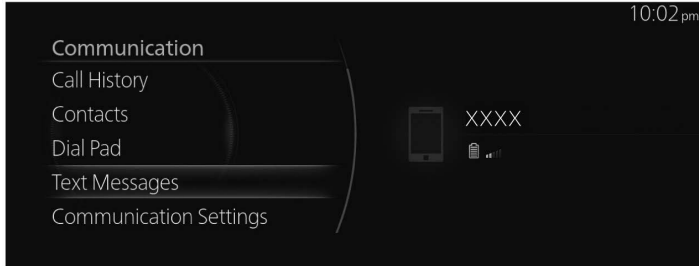

Receiving messages

When the Text Message Notifications setting is on and your Bluetooth® device receives a message, the message notification will be displayed.

Refer to Communication Settings on page 2-106.

When "Read" is selected, messages are displayed.

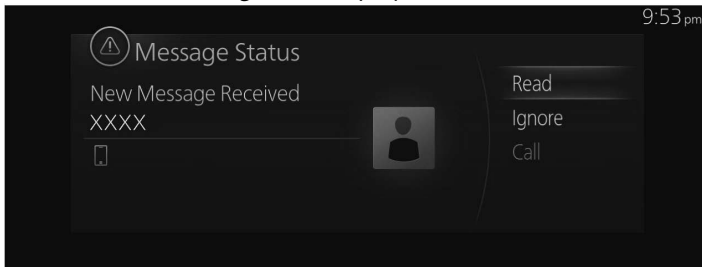

The following menu is displayed on the message details screen. The displayed menu differs depending on the use conditions.

Menu	Explanation
Play	Reads out the currently displayed message.
Pause	Pauses the read out of a received message.
Previous	Displays the previous message.
Next	Displays the next message.
Reply	Only replies to the sender of the currently displayed message. Select the sentence on the displayed reply screen and select the sentence for sending from the preset message.
Call	Makes a call to the sender of the currently displayed message. If a phone number of a person who sent a message is unknown, a call cannot be made.

Editing preset messages

1. Select "Communication" on the home screen.

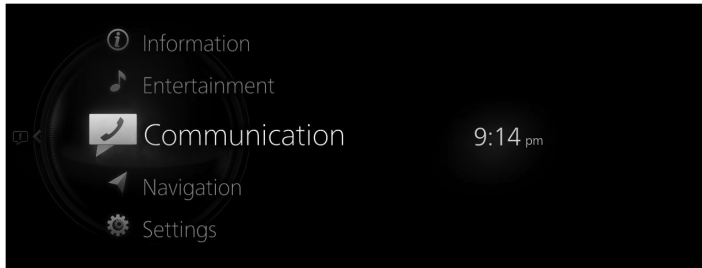

2. Select "Communication Settings".

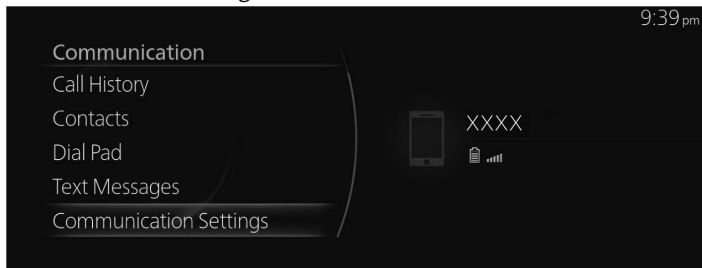

3. Select "Preset Text Messages".

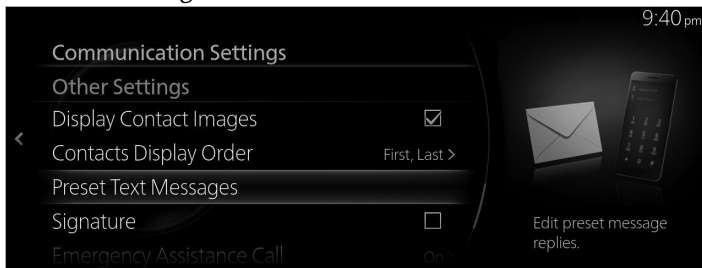

4. Select the preset message you want to edit from the preset message list.

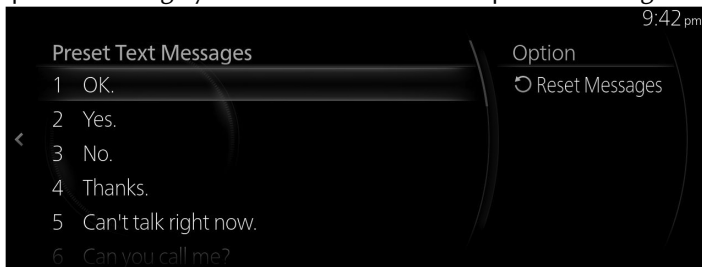



Communication

- When inputting the message you want to change and selecting ✓, the message is stored as a preset message.



NOTE

- Select  to delete the previous input character. Press and hold it to delete all of the input characters.
- Slide the  to the left to return to the previous screen without storing the edit.

▼ Communication Settings

- Select "Communication" on the home screen.

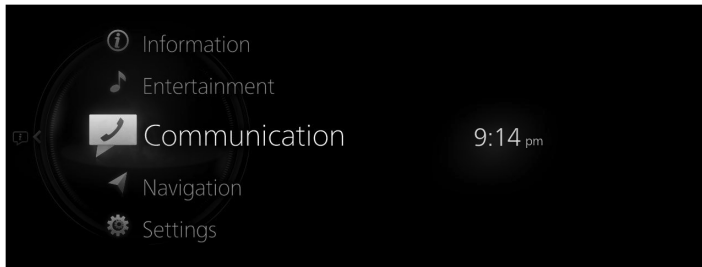

- When "Communication Settings" is selected, the settings list is displayed. Select the menu you want to change from the settings list and change the setting.

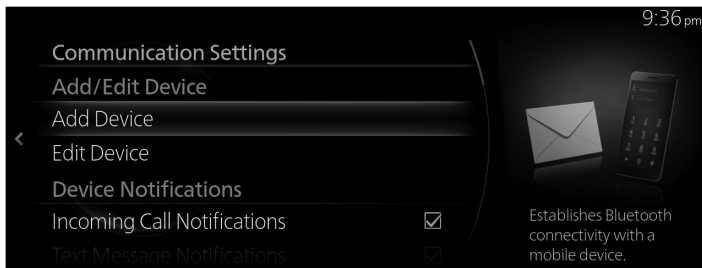

Menu		Explanation
Add/Edit Device	Add Device	Performs the Bluetooth® device's connection settings. Refer to Connectivity Settings on page 2-126.
	Edit Device	You can change the connected Bluetooth® device. Refer to Connectivity Settings on page 2-126.
Device Notifications	Incoming Call Notifications	By changing the check status, you can set the notification on/off for when a call is received.
	Text Message Notifications*	By changing the check status, you can set the notification on/off for when a new message is received.
	Phone Sync Notification	By changing the check status, you can set the notification on/off for when the synchronization with a Bluetooth® device is completed.
Synchronization Settings	Message Sync*	When checked to turn the function on, SMS messages are downloaded automatically when your Bluetooth® device is connected.
	Contacts and Call History Sync	When checked to turn the function on, the phonebook and call history are downloaded automatically when your Bluetooth® device is connected.
Communication Audio Settings	Ringer* ¹	Changes the type of ring tone. Vehicle: Standard ring tone set on the vehicle Phone: Ring tone set on the Bluetooth® device
	Ringer Volume	Adjusts the ring tone volume.
	Text Message Notification Vol.*	Adjusts the volume of the message received notification.
	Automatically Read Selected Messages*	When checked to turn the function on, received messages are read out automatically.
	Text Message Playback Vol.*	Adjusts the volume the message read out.
Other Settings	Display Contact Images	When checked to turn the function on, an image is displayed for the contact.
	Contacts Display Order	The display order of the contacts can be changed. First, Last: Displays in the order of first name, last name. Last, First: Displays in the order of last name, first name.
	Preset Text Messages*	Edits the preset message Refer to Receiving and replying to messages on page 2-101.
	Signature*	When checked to turn the function on, a signature is added when sending a message.
	Emergency Assistance Call*	Automatic 911 dialing can be set to enabled/disabled by changing the check status.

*1 Depending on the connected Bluetooth® device, it may not be possible to select "Phone".

Navigation*

The navigation system (vehicles with navigation system) can only be used when the SD card for the navigation system is inserted.

If the SD card for the navigation system is not inserted, the compass indicating the direction in which the vehicle is moving is displayed. The compass may not indicate the correct bearing when the vehicle is stopped or traveling at a slow speed. For the navigation system operation, refer to the navigation system manual.

Settings

Your vehicle has systems and equipment with settings that you can change to operate according to your preferences. Consult an Authorized Mazda Dealer for details.

NOTE

- Available settings depend on vehicle equipment and features.
- The system automatically displays only the available settings for your vehicle. Depending on your vehicle's specifications, you may be unable to change some setting even though they are indicated in the manual.
- Depending on the function, some settings linked to other functions cannot be changed.
- The content of setting changes due to updates to the vehicle software may change without notice.

How To Make Setting Changes

1. Select "Settings" from the Mazda Connect home screen.
2. Select the item setting you would like to change from the displayed content.
3. Change the function setting.

NOTE

Place a check in the check box for the function you want to enable () or uncheck it to disable () the function.

Changeable System Settings/Equipment List

In-Vehicle Displays

Configures settings and content for all in-vehicle displays. Refer to In-Vehicle Displays on page 2-113.

- Active Driving Display
- Center Display
- Instrument Cluster Display

Sound Settings

Configures the in-vehicle listening experience.
Refer to Sound Settings on page 2-115.

- Audio Settings
- Vehicle Notification and Warning Volume

Safety Settings

Configures safety and driver assistance features.
Refer to Safety Settings on page 2-117.

- Driver Assistance System
- Safety Alerts
- Active Safety
- Collision Avoidance
- View Monitor
- Parking Sensor
- Speed Alert
- Pedal Misuse Alert

Vehicle Settings

Configures vehicle convenience features.
Refer to Vehicle Settings on page 2-122.

- Door Locks
- Exterior Lighting
- Interior Lighting
- Rain-Sensing Wipers
- Automatic Folding Side Mirrors
- Turn Signals
- Rear Window Defogger
- Link Seat & Climate Control Temperatures
- Fuel Door Lock Delay

Connectivity Settings

Configures Bluetooth and other device connectivity settings.
Refer to Connectivity Settings on page 2-126.

- Bluetooth® Settings
- Smartphone Connectivity Settings

System Settings

Configures language, time, and other general settings.
Refer to System Settings on page 2-136.

- Clock
- Driver Settings
- Voice Recognition Settings
- Language
- Temperature
- Distance/Speed
- Fuel Efficiency
- Pressure
- Gracenote Database Update
- Use Gracenote Database Album Art
- System Information
- Restore All Factory Settings

In-Vehicle Displays

Configures settings and content for all in-vehicle displays.

Active Driving Display

Adjusts the content and visibility of the display.

Function	Available setting changes
Height Adjusts the height of the Active Driving Display.	Height (31 levels)
Brightness Adjusts the brightness of the Active Driving Display.	Brightness (11 levels)
Tilt Adjustment Adjusts the rotation of the Active Driving Display.	Tilt (11 levels)
Active Driving Display Content Enables the display and selected content to be shown.	Enable, Disable
Navigation Guidance Displays navigation route guidance information	Enable, Disable
Street Name Displays street names.	Enable, Disable
Lane Guidance Displays navigation lane guidance information.	Enable, Disable
Traffic Sign Recognition Displays stop signs, speed limit signs, and do not enter signs.	Enable, Disable
Speed Limit Displays a speed limit.	Enable, Disable
Restore Factory Settings Restores the Active Driving Display to the original factory settings.	—

Center Display

Adjusts the display brightness, contrast, and more.

Function	Available setting changes
Display Off Turns off the display while still providing audio content.	—
Day/Night Mode Selects the center display brightness mode.	Automatic, Day, Night
Brightness Adjusts the brightness of the center display.	Brightness (11 levels)
Contrast Adjusts the contrast of the center display.	Contrast (11 levels)
Show Drive Results at Ignition Off Provides energy efficiency results at the end of the drive.	Enable, Disable
Home Screen Clock Selects the clock style displayed on the Home screen.	Analog, Digital
Ambient Display Enables a simplified interface accessible from the Home screen.	Blank, Clock
Restore Factory Settings Restores the display to the original factory settings.	—

Instrument Cluster Display

Selects the content shown on the instrument cluster.

Function	Available setting changes
Fuel Efficiency & Range Display Configures how the fuel efficiency and driving range is shown.	Type 1, Type 2, Off
Restore Factory Settings Restores instrument cluster display settings to factory defaults.	—

Sound Settings

Configures the in-vehicle listening experience.

Audio Settings

Adjusts the in-vehicle listening experience.

Function	Available setting changes
Sound Adjustment Mode Selects a Basic or Advanced sound adjustment mode.	Basic, Advanced
Bass Adjusts the bass output level.	Bass range (19 levels)
Treble Adjusts the treble output level.	Treble range (19 levels)
Equalizer Selects or creates the desired equalizer curve.	Flat, Pop, Rock, Jazz, R&B, Classical, Custom 1 ¹ , Custom 2 ¹ , Custom 3 ¹ , Customize EQ ²
Listening Position Selects the desired listening position.	Driver's Seat, All Seats
Fader Moves the audio emphasis forward or rearward.	Front — Rear (19 levels)
Balance Moves the audio emphasis to the left or right.	Left — Right (19 levels)
Automatic Level Control ³ Automatically adjusts volume level to compensate for vehicle speed.	Off, 1 — 7 (8 levels)
Automatic Source Level Adjustment ⁴ Automatically stabilizes volume levels across sources.	Enable, Disable
Bose® Stereo Mode Selects the desired stereo listening experience.	Standard, Linear
Bose® Centerpoint ⁵ Creates a virtual surround sound listening experience.	Off, 1 — 3 (4 levels)

Settings

Function	Available setting changes
Bose® AudioPilot™⁶ Automatically adjusts the music to compensate for road noise.	Off, 1 — 3 (4 levels)

- ^{*1} Equalizer setting saved in “Customize EQ” of the “Equalizer” item.
- ^{*2} You can edit and save the equalizer setting manually according to your preferences.
- ^{*3} The automatic level control (ALC) changes the audio volume automatically according to the vehicle speed. The faster the vehicle speed, the higher the volume increases. The slower the vehicle speed, the lower the volume decreases.
- ^{*4} This function adjusts the volume automatically, therefore the volume level changes depending on the content.
- ^{*5} Centerpoint lets vehicle owners enjoy a Bose surround sound experience. Specifically engineered to meet the unique demands of reproducing surround sound in a vehicle. Converts stereo signals to multiple channels allowing greater precision when reproducing the sound. An enhanced algorithm to simultaneously create a wider, more spacious sound field. Centerpoint is a registered trademark of Bose Corporation.
- ^{*6} When driving, background noise can interfere with enjoying music. AudioPilot Noise compensation technology continuously adjusts the music to compensate for background noise and vehicle speed. It reacts only to sustained noise sources and not intermittent ones, such as speed bumps. An enhanced DSP algorithm allows faster and more effective compensation for unusual situations, such as driving on a very rough road or at high speeds. AudioPilot is a registered trademark of Bose Corporation.

Vehicle Notification and Warning Volume

Adjusts the alert volume for notifications and warnings.

Available setting changes
Low, Moderate, High

Safety Settings

Configures safety and driver assistance features.

Driver Assistance System

Configures desired level of support and notification for driver assist functions.

Function	Available setting changes
Mazda Radar Cruise Control Enables automatic control of following distance when using cruise control.	Enable, Disable
Audible Cruise Confirmation Enables audible tones when interacting with cruise control.	Enable, Disable
Speed Limit Sign Alert Selects the desired notification type for posted speed limit sign alerts.	Visual, Visual + Audible, Off
Speed Limit Sign Threshold Sets threshold for alert notifications when the posted speed limit is exceeded.	+ 0 km/h (+ 0 mph), + 5 km/h (+ 3 mph), + 10 km/h (+ 5 mph)
Speed Limit Alert Selects the desired notification type for speed limit alerts.	Visual, Visual + Audible, Off
Speed Limit Alert Threshold Selects the desired speed threshold for speed limit alert notifications.	+ 0 km/h (+ 0 mph), + 5 km/h (+ 3 mph), + 10 km/h (+ 5 mph)
Driver Attention Alert Enables driver attention monitoring and provides alerts when fatigue is detected.	Enable, Disable
Driver Monitoring Enables camera-based driver monitoring to detect fatigue and provide alerts.	Enable, Disable
Restore Factory Settings Restores the Driver Assistance System settings to the factory defaults.	—

Safety Alerts

Configures alert notifications used for i-ACTIVSENSE safety features.

Function	Available setting changes
Front Cross Traffic Alert Enables alerts when a moving object may cross into the vehicle's forward path.	Enable, Disable
Rear Cross Traffic Alert Enables alerts when a moving object may cross into the vehicle's rearward path.	Enable, Disable
Lane Departure Warning System Enables Lane Departure Warning System to alert driver of lane departure risks.	Enable, Disable
Lane Departure Warning System Alert Type Sets the desired notification type for Lane Departure Warning System alerts.	Audible, Steering Wheel Vibration, Audible+Steering Wheel Vibration
Blind Spot Monitoring Selects the desired Blind Spot Monitoring alert notification type.	Visual, Visual + Audible, Off
Blind Spot Monitoring Alert Timing Selects the desired alert timing for Blind Spot Monitoring.	Early, Normal, Late
Restore Factory Settings Restores the safety alert settings to the factory defaults.	—

Active Safety

Configures i-ACTIVSENSE active safety features.

Function	Available setting changes
Distance & Speed Alert Enables the vehicle to provide alerts for following distance.	Enable, Disable
Lane-keep Assist System Enables lane-keep steering assistance to help the vehicle stay within the lane.	Enable, Disable
Restore Factory Settings Restores the Active Safety settings to the factory defaults.	—

Collision Avoidance

Configures i-ACTIVSENSE collision avoidance features.

Function	Available setting changes
Smart Brake Support Enables Smart Brake Support to alert and intervene when collision is imminent.	Enable, Disable
Smart Brake Support Alert Timing Selects the desired timing for the Collision Avoidance Alert notification.	Early, Normal, Late
Smart Brake Support [Rear]^{*1} Enables Smart Brake Support [Rear] to alert & intervene when collision is imminent.	Enable, Disable
Restore Factory Settings Restores the Collision Avoidance settings to the factory defaults.	—

*1 Including Smart Brake Support [Rear Crossing].

View Monitor

Configures View Monitor camera view angles and display settings.

Function	Available setting changes
Display Priority View at Start Up Enables View Monitor to be displayed after vehicle is started.	Enable, Disable
Priority View Selects the default view to be displayed after vehicle is started.	Side, Front, Front Wide, Last
Automatic Front View Display Enables front view to be automatically displayed after vehicle is taken out of reverse.	Enable, Disable
Dynamic Guidelines Enables dynamic path guidelines to be shown on the rear view display.	Enable, Disable
Restore Factory Settings Restores the View Monitor settings to the factory defaults.	—

Parking Sensor

Configures Parking Sensor settings.

Function	Available setting changes
Parking Sensor Display Guidance Enables Parking Sensor display guidance to be shown on the View Monitor display.	Enable, Disable
Rear Parking Sensor Alert Volume Sets desired volume level for rear parking sensor alerts.	Low, Moderate, High, Off
Front Parking Sensor Alert Volume Sets desired volume level for front parking sensor alerts.	Low, Moderate, High, Off
Restore Factory Settings Restores Parking Sensor settings to the factory defaults.	—

Speed Alert

Configures Speed Alert notifications.

Function	Available setting changes
Speed Alert Enables alerts for when the desired speed is exceeded.	Enable, Disable
Speed Alert Threshold Selects a desired speed that when exceeded will provide an alert notification.	30 km/h — 250 km/h
	20mph — 150mph
Speed Alert Notification Type Selects the type of alert provided when speed threshold is exceeded.	Visual, Audible, Visual + Audible
Restore Factory Settings Restores the speed alert settings to the factory defaults.	—

Pedal Misuse Alert

Alerts the driver when the accelerator and brake pedals are depressed simultaneously.

Available setting changes
Enable, Disable

Vehicle Settings

Configures vehicle convenience features.

Door Locks

Adjusts settings for door locks and keyless entry.

Function	Available setting changes
Automatic Door Locks Configures when the automatic door locks operate.	Lock: While Driving, Lock: While Driving, Unlock: Ignition Off, Lock: In Gear, Lock: In Gear, Unlock: In Park, Lock: While Driving, Unlock: In Park, Off
Automatic Re-Lock Wait Time Sets the time for the doors to re-lock if a door is not opened.	30 seconds, 60 seconds, 90 seconds
Keyless Auto-Lock Enables the vehicle to automatically lock when the driver walks away.	Enable, Disable
Keyless Beep Confirmation Volume Adjusts the beep volume when locking/unlocking doors.	Low, Medium, High, Off
Keyless Unlock Mode Selects which doors unlock with the keyless entry switch.	Once: All Doors, Once: Driver's Door, Twice: All Doors
Restore Factory Settings Restores door lock settings to the factory defaults.	—

Exterior Lighting

Configures settings for the vehicle's exterior lighting.

Function	Available setting changes
Automatic Headlight Sensitivity Adjusts the sensitivity of the automatic headlight illumination feature.	Low, Medium-Low, Medium, Medium-High, High
Automatic Headlight Timeout Sets the length of delay before headlights turn off.	30 seconds, 60 seconds, 90 seconds, 120 seconds, Off
Adaptive LED Headlights (ALH) Switches between high and low beam automatically.	Enable, Disable
High Beam Control System (HBC) Switches between high and low beam automatically.	Enable, Disable
Adaptive Front-Lighting System (AFS) Adjusts lighting output based on driving conditions.	Enable, Disable
Daytime Running Lights (DRL) Enables the daytime running lights.	Enable, Disable
Manual Headlight Leveling Adjusts the headlight beam angle.	Beam angle (11 levels)
Coming Home Light Sets the length of delay before headlights turn off.	30 seconds, 60 seconds, 90 seconds, 120 seconds, Off
Leaving Home Light Turns headlights on with unlock button press on key.	Enable, Disable
Restore Factory Settings Restores exterior lighting settings to factory defaults.	—

Settings

Interior Lighting

Configures settings for the vehicle's interior lighting.

Function	Available setting changes
Ambient Lighting Sets the intensity of ambient interior lighting.	Low, Med, High, Off
Illuminated Entry Duration Selects the desired illuminated entry lighting durations.	7.5 seconds, 15 seconds, 30 seconds, 60 seconds
Restore Factory Settings Restores interior lighting settings to factory defaults.	—

Rain-Sensing Wipers

Enables automatic rain-sensing windshield wipers.

Available setting changes
Enable, Disable

Automatic Folding Side Mirrors

Enables the side mirrors to fold automatically.

Available setting changes
Enable, Disable

Turn Signals

Configures settings for turn signal operation.

Function	Available setting changes
Three Flash Turn Signal Enables the turn signal to flash three times then stop.	Enable, Disable
Turn Signal Indicator Volume Adjusts the volume of the turn signal indicator.	Low, Medium, High
Restore Factory Settings Restores the turn signal settings to the factory defaults.	—

Rear Window Defogger

Selects the duration of rear window defogger operation.

Available setting changes
Automatic Shut Off, Continuous

Link Seat & Climate Control Temperatures

Enables climate control to activate seat heating/cooling functions when set to AUTO.

Available setting changes
Enable, Disable

Fuel Door Lock Delay

Sets length of delay until fuel door locks after vehicle is locked.

Available setting changes
0 seconds, 30 seconds, 60 seconds, 90 seconds, 120 seconds

Connectivity Settings

Connection settings can be configured for linking Bluetooth® and Smartphone functions.

Bluetooth® Settings

Configures Bluetooth connectivity and related settings.

Function	Explanation
Bluetooth®	Turns on when using Bluetooth®. When checked, the status is ON. When unchecked, the status is OFF.
Pair New Device	Establishes Bluetooth connectivity with a mobile device.
[Name of registered Bluetooth® device]	Selects the connection type used for the device.
Delete Paired Device	Terminates Bluetooth connectivity with a mobile device.
Advanced Settings	You can change the Bluetooth® automatic connection ON/OFF, set the connection order, and reset the Bluetooth® settings.

NOTE

- The Bluetooth® connection cannot be used while Apple CarPlay™ is connected. If you want to connect to Bluetooth®, disconnect Apple CarPlay™.
- If you want to register (pair) a device or change the connection device while Android Auto™ is connected, disconnect Android Auto™.

Bluetooth® Registration

Device registration (pairing)

To use Bluetooth® Audio and Hands-Free, register a Bluetooth® device using the following procedure. You can register up to 5 devices that are equipped with the Bluetooth® communication function, such as mobile devices or mobile phones.

NOTE

Bluetooth® may not operate for 1 or 2 minutes after the ignition is switched to ACC or ON. However, this does not indicate a problem. If the Bluetooth® device is not connected automatically after 1 or 2 minutes have passed, make sure that the Bluetooth® setting on the device is enabled and attempt to reconnect the Bluetooth® device from the Mazda Connect side.

Pairing procedure

1. Select "Pair New Device".

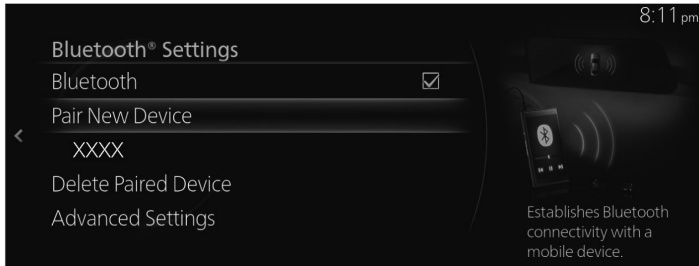

2. Check the content on the displayed Bluetooth Search screen and select "Continue".

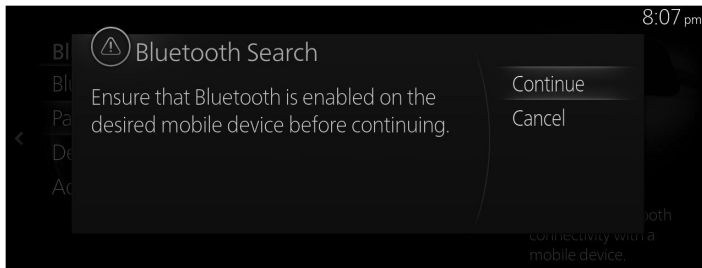

3. Select the name of the device you want to connect from the displayed Bluetooth® device list.

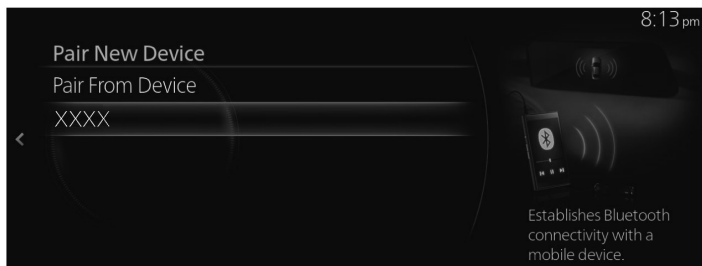

4. (Device with Bluetooth® version 2.0 or lower)

[Operations using the Bluetooth® device]

Check the 4-digit passcode displayed on the center display and press the confirmation button or input the passcode.

(Device with Bluetooth® version 2.1 or higher)

[Operations using the Bluetooth® device]

Make sure that the 6-digit passcode displayed on the center display is also displayed on the Bluetooth® device.

5. When the pairing is successful, the Device Connected screen is displayed on the center display.**The Bluetooth® device name you want to connect in Step 3 is not displayed in the list.****1. Select "Pair From Device" at the top of the list.**

[Operations using the Bluetooth® device]

Select "Mazda" displayed in the search result list of the Bluetooth® device and confirm the passcode or input the passcode.

3. When the pairing is successful, the Device Connected screen is displayed.**NOTE**

- If the Bluetooth® device is compatible with the phonebook import and short message functions, the phonebook, call history, and short messages (SMS) are downloaded.
- A download permission operation on the Bluetooth® device might be required for the phonebook import and short message functions to operate.
- Regarding the connection of your Bluetooth® device to Bluetooth®, always refer to the Bluetooth® device's owner's manual.

Pairing and automatic reconnection

After the pairing is completed, the previous Bluetooth® connection is automatically restored the next time the system is activated. When Bluetooth® Hands-Free is turned on or the ignition is switched from OFF to ACC, the device's connection status is displayed on the screen.

NOTE

- If pairing is redone on the same Bluetooth® device, you need to delete "Mazda" from the Bluetooth® device once.
- If pairing information is deleted only on the Bluetooth® device or the vehicle, it is necessary to delete the registration on the pairing partner as well and do pairing again.
- The Bluetooth® automatic connection when the Mazda Connect is activated may require that the Bluetooth® device be in a connectible state.

- Before pairing, make sure that Bluetooth® is on, both on your device and on the vehicle.

Bluetooth® device selection

When several Bluetooth® devices have been registered, you can select the Bluetooth® device to be connected. When you want to connect a different Bluetooth® device that has already been paired, change the Bluetooth® device connection using the following procedure.

Connecting a different Bluetooth® device

1. Select the name of the device you want to connect from the Bluetooth® device list displayed on the Bluetooth® Settings screen.

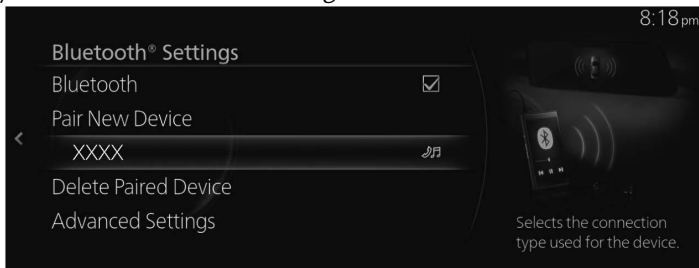

2. Select the connection method.



- **Phone and Audio:** Connects as both a Hands-Free and Bluetooth® Audio device.
- **Phone:** Connects as a Hands-Free device.
- **Audio:** Connects as Bluetooth® Audio.

NOTE

- The following functions can be used for the Hands-free or audio.
 - **Hands-Free:** Telephone, SMS (Refer to Bluetooth® Hands-Free on page 2-89.)
 - **Audio:** Bluetooth® Audio (Refer to Bluetooth® on page 2-55.), Pandora® (Refer to Pandora® on page 2-49.)

Settings

- Some Bluetooth® devices cannot separate pairing for Bluetooth® Hands-Free and Bluetooth® Audio, therefore, it may be connected as “Phone and Audio” even if only “Phone” or “Audio” is selected.

Disconnecting a Bluetooth® device connection

1. Select the name of the device currently connected from the Bluetooth® device list displayed on the Bluetooth® Settings screen.

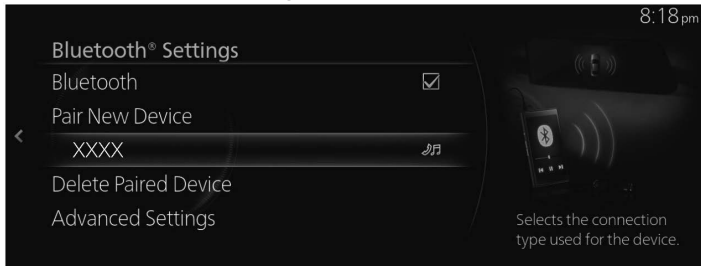

2. Select “Disconnect”.

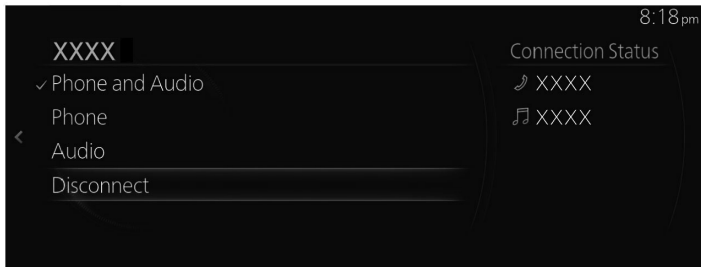

NOTE

A connection can also be disconnected by setting the Bluetooth® connection setting to OFF.

Deleting a Bluetooth® device

1. Select “Delete Paired Device”.

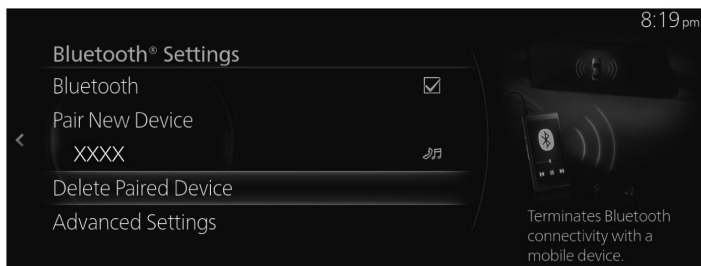

2. Select the name of the device you want to delete from the registration.

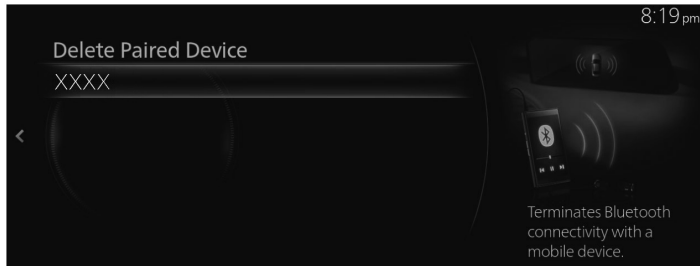

3. Select "Delete" on the Delete Device screen.

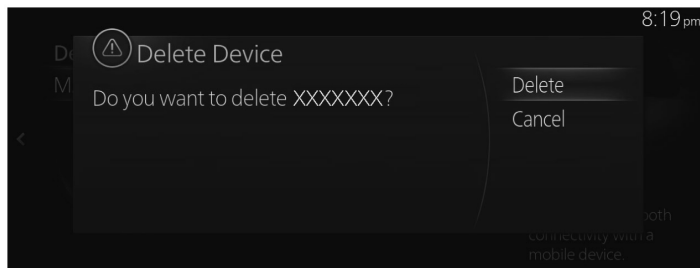

NOTE

- When a Bluetooth® device is deleted from the registration, the phonebook, call history, and short messages of the deleted Bluetooth® device are also deleted.
- If a Bluetooth® device is deleted from the registration, also delete "Mazda" from Bluetooth® device.

Changing the Pairing Code

The Pairing Code used when pairing can be changed using the following procedure.

1. Select "Advanced Settings".

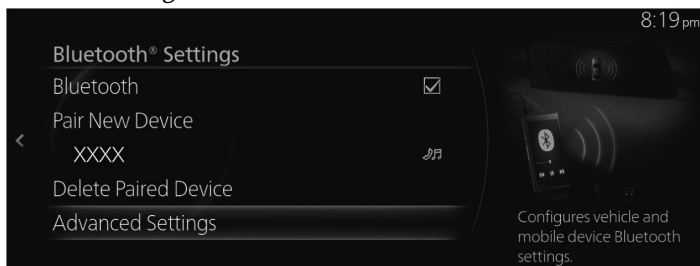

Settings

2. Select "Vehicle Bluetooth Settings".

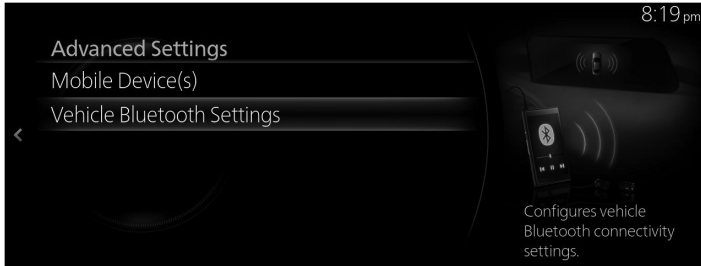

3. Select "Pairing Code".

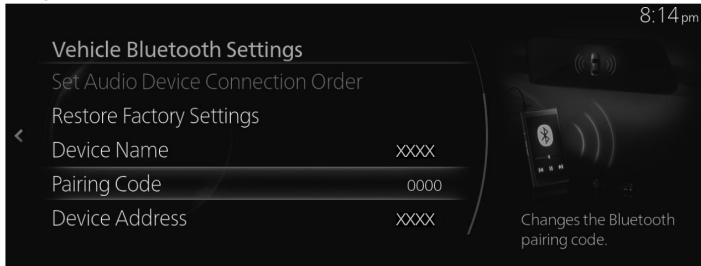

4. Input the new Pairing Code.



5. Select ✓.

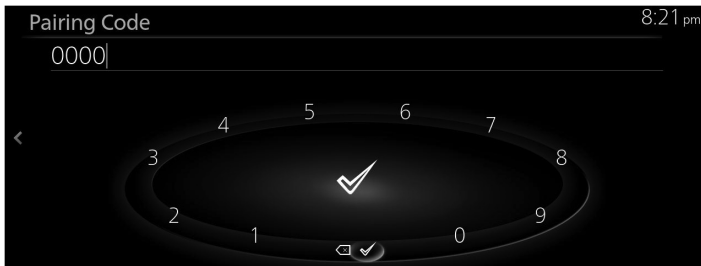

NOTE

The connection of already paired Bluetooth® devices is unaffected even if the Pairing Code is changed.

Smartphone Connectivity Settings

Configures device-dependent settings including Android Auto & Apple CarPlay.

Function	Explanation
Apple CarPlay Settings	Configures Apple CarPlay settings for connected devices.
Android Auto Settings	Configures Android Auto settings for connected devices.

Changing the Apple CarPlay™/Android Auto™ connection settings

The setting for each iPhone®/Android™ Smartphone can be changed. For the setting to take effect, it is necessary to connect the device again.

(Example: Changing the Apple CarPlay™ connection settings)

1. Select "Apple CarPlay Settings".

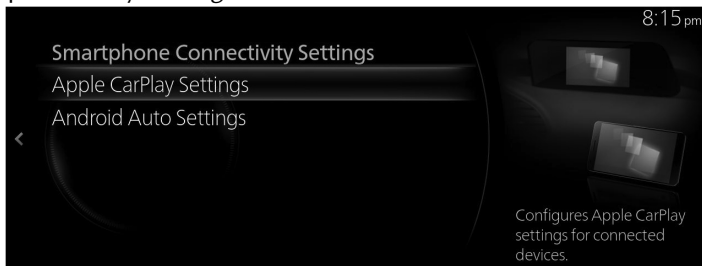

2. Select the name of the device for which you want to change the settings from the list of currently registered iPhone®.

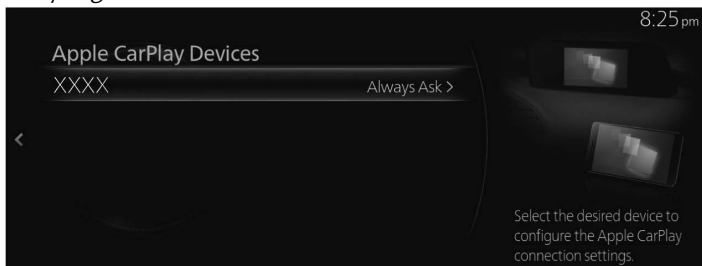

3. Select "Device Connection Status".



4. Select the connection method.

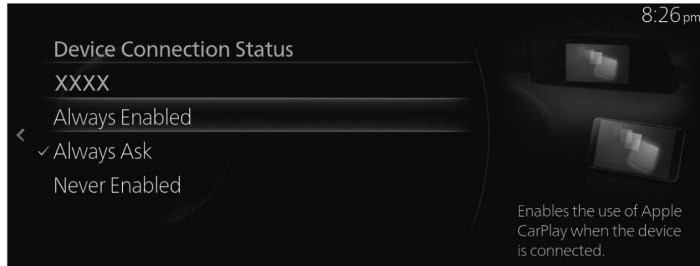

Deleting the Apple CarPlay™/Android Auto™ registration

(Example: Deleting an iPhone® registration)

1. Select "Apple CarPlay Settings".

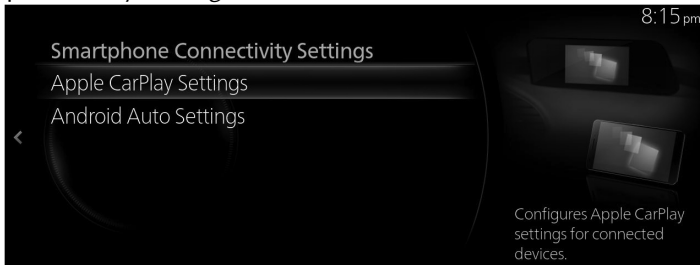

2. Select the name of the device you want to delete from the registration from the list of currently registered iPhone®.

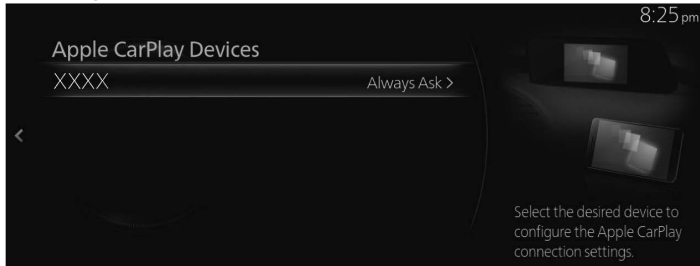

3. Select "Delete Device".

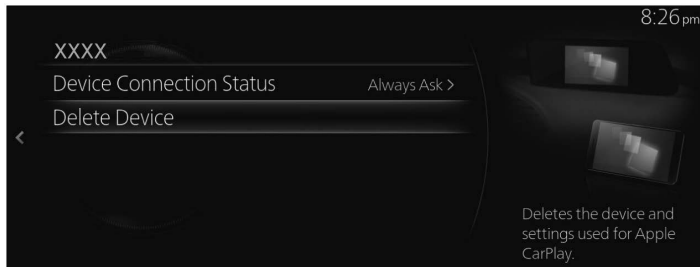

4. Select "Delete" on the Apple CarPlay Device Deletion screen.

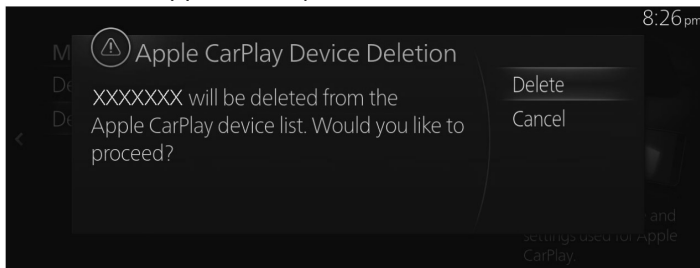

System Settings

Configures language, time, and other general settings.

Clock

Adjusts the time and how it is displayed.

Function	Available setting changes
Manual Time Adjustment ^{*1} Manually sets the clock to the desired time.	Select “+” to advance the hours/minutes, and select “-” to move the hours/minutes back. You can select “am/pm” only when the “24-Hour Clock” item has been disabled.
GPS Time Synchronization Automatically synchronizes the clock using GPS location data.	Enable, Disable
24-Hour Clock Displays the time on a 24-Hour clock.	Enable, Disable
Daylight Saving Time ^{*1} Enables or disables Daylight Saving Time.	Enable, Disable
Time Zone ^{*1} Selects the desired time zone.	Time Zone

^{*1} You can make setting changes only when the “GPS Time Synchronization” item or the “Navigation” is disabled.

Driver Settings

Configures driver-specific vehicle personalization settings.

Function	Available setting changes
Driver Identification Automatically identifies the driver based on the key.	Enable, Disable
Driver Selection Manually selects the desired driver.	Driver
Edit Driver Name(s) Edits the name of the selected driver.	Driver's name

Voice Recognition Settings

Configures voice recognition and voice guidance settings.

Function	Available setting changes
Guidance Volume Adjusts the volume of the Voice Guidance responses.	Volume (63 levels)
Guidance Length Selects the length of Voice Guidance responses.	Normal, Brief
Barge-In Allows user to interrupt with desired commands during Voice Guidance responses.	Enable, Disable
Voice Recognition User's Guide Provides example phrases for a variety of Voice Recognition-compatible functions.	—

Settings

Language

Sets the system display language.

Available setting changes
Language

Temperature

Selects the desired unit of temperature.

Available setting changes
°C, °F

Distance/Speed

Selects the desired unit of distance and speed.

Available setting changes
mi • mph, km • km/h

Fuel Efficiency

Selects the desired unit of expression for fuel efficiency.

Available setting changes
L/100km, km/L, km/gallon

Pressure

Selects the desired unit of air pressure.

Available setting changes
psi, kPa, bar, kgf/cm ²

Gracenote Database Update

Updates the Gracenote Database metadata database.

Function	Content
Update	Starts the Gracenote Database update process.
Update History	Displays the update history of the Gracenote Database.

Use Gracenote Database Album Art

Utilizes Gracenote Database for displayed Album Art.

Available setting changes
Enable, Disable

System Information

Displays system software information.

Function	Content
Legal Notices	Displays system software licensing information.
Version Information	Displays system software version information.

Restore All Factory Settings

Removes all personal information and restores all settings to the factory defaults.

MEMO

3

Convenience

Using Apple CarPlay

Apple CarPlay™	3-2
Apple CarPlay™	3-2
Android Auto™	3-6
Android Auto™	3-6

Connected Service (U.S.A. only)	3-10
Connected Service	
Overview	3-10

Apple CarPlay™

Apple CarPlay™ allows you to make calls, send or receive messages, and listen to music using your iPhone® with the Mazda Connect, or search for destinations using the maps. In addition, voice recognition using Siri® is available.

! WARNING

Do not allow the cord connected to the USB port to get tangled in the selector lever/shift lever.

If the cord gets tangled, it could be a distraction to your driving and result in an unexpected accident.

! CAUTION

- Do not place items or apply force to the USB port or console box lid with the plug connected.
- Depending on the mobile device to be connected, noise may occur when using the device with it connected to the accessory power socket equipped on the vehicle (if noise occurs, do not use the accessory power socket).
- Do not leave your iPhone® in the cabin. Otherwise, the cabin temperature will increase to a high temperature under direct sunlight which could cause damage.

NOTE

- Before use, carefully read the user instructions for the iPhone®.
- Do not use the Mazda Connect for a long time with the engine stopped. Otherwise, the battery power could be depleted.
- Insert the Apple®-genuine connector cord into the USB port securely.

Connecting an iPhone®

Insert an Apple®-genuine connector cord into the USB port and connect the iPhone®. Insert or pull out the plug with the plug perpendicular to the USB port.

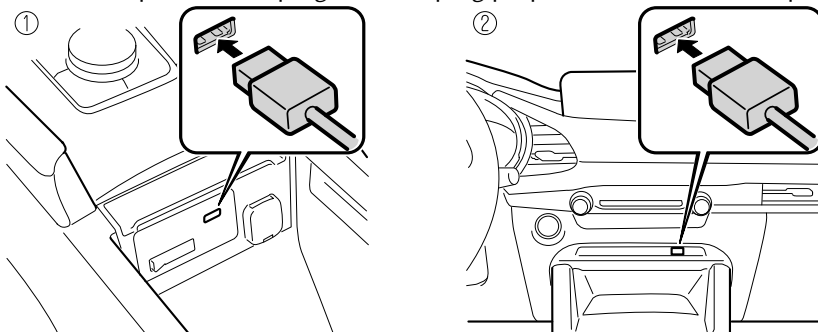

1. Located on center console

2. Located on front console

The location of the USB port differs depending on the vehicle model.

NOTE

- When an iPhone® connected to Bluetooth® is connected to the vehicle's USB port, the system switches to Apple CarPlay™. Applications that you were using when connected to Bluetooth® can continue to be used. However, the functions that can be used with a Bluetooth® connection and the functions which can be used by Apple CarPlay™ differ depending on the application.
- **(U.S.A./Canada)**
Mobile 911 can be activated even when connected to Apple CarPlay™. When using Apple CarPlay™ again after activating Mobile 911, you need to disconnect the connector cord from the USB port and then reconnect it.
- Up to 5 iPhone® devices can be registered as devices connected to Apple CarPlay™.
- When setting the Device Connection Status of a connected iPhone® to "Never Enabled", Apple CarPlay™ will not activate even if your iPhone® is connected to the vehicle's USB terminal. When you want to use Apple CarPlay™, change the setting. Refer to Connectivity Settings on page 2-126.

Connecting Apple CarPlay™ for the first time

When connecting Apple CarPlay™ for the first time, a confirmation screen concerning Apple CarPlay™ activation is displayed.

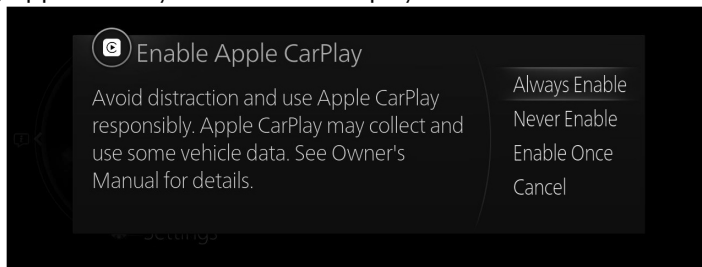

Always Enable: Enables Apple CarPlay™ each time without a confirmation.

Never Enable: Disables the currently connected device hereafter.

Enable Once: Enables the device only this time.

Cancel: Disables the device this time.

NOTE



If you select "Enable Once", the confirmation screen is displayed again the next time the engine is started.

However, if the interval between stopping and starting the engine is short, the confirmation screen may not be displayed.

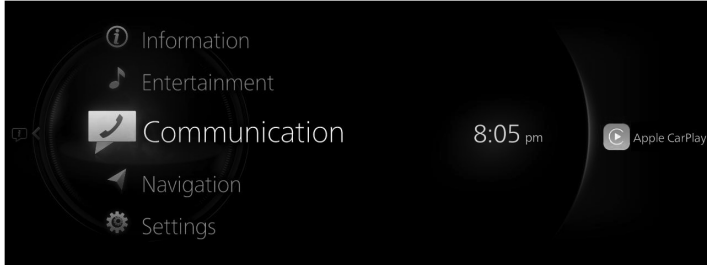
Displaying the Apple CarPlay™ screen



 is displayed on the Mazda Connect home screen while Apple CarPlay™ is connected or press and hold the Home button.

Slide the  to the right while  is displayed to display the Apple CarPlay™ screen or press and hold the Home button.

Apple CarPlay™ home screen

You can display the Apple CarPlay™ home screen by pressing the  on the commander switch while any Apple CarPlay™ screen is displayed or press and hold the Home button.

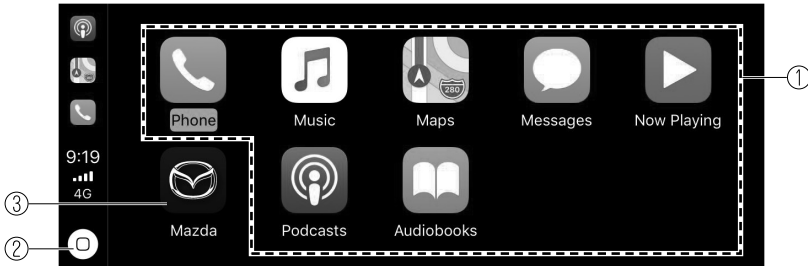



Rotate the  or slide it to select the icon you want to operate.





Press the  to activate the application of the selected icon.

NOTE

- The icon displayed on the Apple CarPlay™ home screen and the display position of the icons may differ depending on the connected iPhone® and iOS version or market.

No.	Icon	Explanation
1	Available CarPlay applications	Activates the Apple CarPlay™ application. Refer to the help information available with each application for the method of using each application.
2		Displays the Apple CarPlay™ Home screen. Select and hold to activate Siri®.
3		Returns to the Mazda Connect screen.

Convenient Ways to Use Apple CarPlay™

Item	Operation method
To Activate the voice recognition function (Siri®) *1	You can operate Apple CarPlay™ using voice by activating Siri® using one of the following methods. <ul style="list-style-type: none"> · Press the  on the audio remote control switch. · Press and hold .
To display the NowPlaying screen	While music is playing using Apple CarPlay™, press the  on the commander switch to return to the Apple CarPlay™ playback screen.
To display the MAP screen	During route guidance using Apple CarPlay™, press the  on the commander switch to return to the Apple CarPlay™ map screen.

*1 The voice recognition function of Mazda Connect cannot be used while Apple CarPlay™ is connected.

Ending Apple CarPlay™

To end Apple CarPlay™ mode, disconnect the connector cord from the USB port or disconnect the iPhone® from the connector cord.

The screen displayed before Apple CarPlay™ was activated is displayed. In addition, the Bluetooth® device connected prior to the Apple CarPlay™ activation is reconnected.

Android Auto™

Android Auto™ is an application which allows the operation of an Android™ Smartphone using the Mazda Connect. Available contents such as the phone, messages, music, and maps that are compatible with Android Auto™ can be used with the Mazda Connect.

WARNING

Do not allow the cord connected to the USB port to get tangled in the selector lever/shift lever.

If the cord gets tangled, it could be a distraction to your driving and result in an unexpected accident.

CAUTION

- Do not place items or apply force to the USB port or console box lid with the plug connected.
- Depending on the mobile device to be connected, noise may occur when using the device with it connected to the accessory power socket equipped on the vehicle (if noise occurs, do not use the accessory power socket).
- Do not leave your Android™ Smartphone in the cabin. Otherwise, the cabin temperature will increase to a high temperature under direct sunlight which could cause damage.

NOTE

- Before you use Android Auto™ with your vehicle, you need to download the Android Auto™ application from the Google Play™ on your Android™ Smartphone.
- Before use, carefully read the user instructions for the Android™ Smartphone.
- Do not use the Mazda Connect for a long time with the engine stopped. Otherwise, the battery power could be depleted.
- Insert the Android™ Smartphone genuine connector cord into the USB port securely.

Connecting an Android™ Smartphone

Insert an Android™ Smartphone-genuine connector cord into the USB port to connect the Android™ Smartphone. Insert or pull out the plug with the plug perpendicular to the USB port.

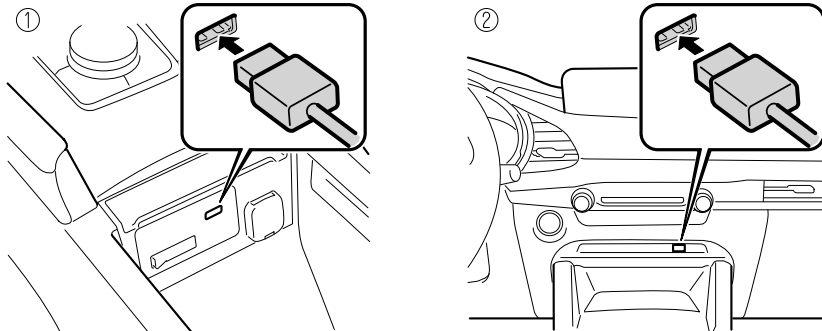

1. Located on center console
2. Located on front console

The location of the USB port differs depending on the vehicle model.

NOTE

- To use Android Auto™, you need to enable Bluetooth®.
- The parking brake must be engaged when connecting the Android Auto™ device for the first time.
- Android™ Smartphones can be connected to Android Auto™.
Up to 5 Android™ Smartphones can be registered.
- When setting the Device Connection Status of a connected Android™ Smartphone to “Never Enabled”, Android Auto™ will not activate even if your Android™ Smartphone is connected to the vehicle’s USB port. When you want to use Android Auto™, change the setting.
Refer to Connectivity Settings on page 2-126.

Connecting Android Auto™ for the first time

When connecting Android Auto™ for the first time, a confirmation screen concerning the Android Auto™ activation is displayed.

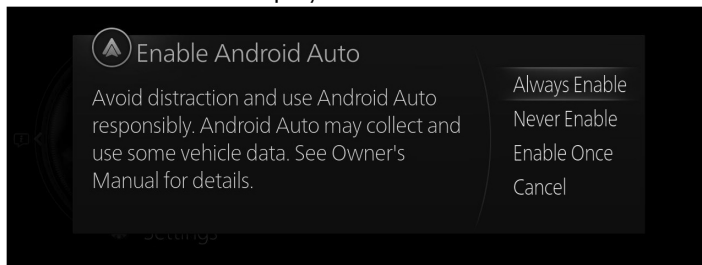

Always Enable: Enables Android Auto™ each time without a confirmation.

Android Auto™

Never Enable: Disables the currently connected device hereafter.

Enable Once: Enables the device only this time.

Cancel: Disables the device this time.

NOTE



If you select "Enable Once", the confirmation screen is displayed again the next time the engine is started.

However, if the interval between stopping and starting the engine is short, the confirmation screen may not be displayed.

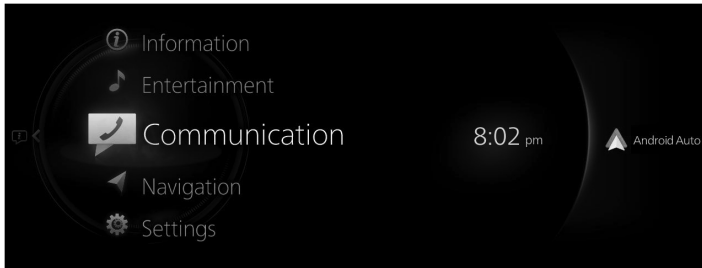
Displaying the Android Auto™ screen



 is displayed on the Mazda Connect home screen while Android Auto™ is connected.

Slide the  to the right while  is displayed to display the Android Auto™ screen or press and hold the Home button to display Android Auto™.

Android Auto™ home screen

You can display the Android Auto™ home screen by pressing the  on the commander switch while any Android Auto™ screen is displayed.

To move from the Mazda Connect screen to the Android Auto™ screen, press and hold the  on the commander switch.

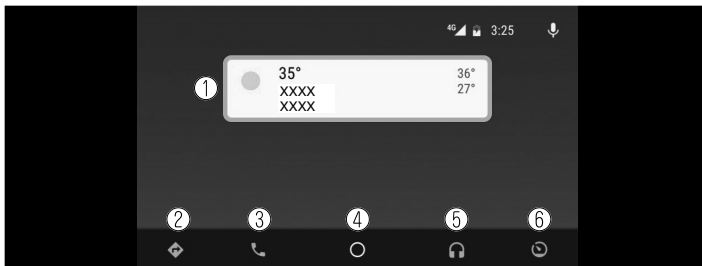





Rotate the  or slide it to select the item or icon.







Press the  to activate the application of a selected item or icon.

NOTE

- The media displayed on the Android Auto™ home screen may differ depending on the use conditions and version of the connected Android™ Smartphone.

No.	Icon	Explanation
1	—	Displays the information for each application. The displayed contents differ depending on the application that has been activated and its status.
2		Activates the map application.
3		Activates the call function.
4		Displays the Android Auto™ home screen.
5		Activates the music application.
6		Displays other menus. You can return to the Mazda Connect screen from the menu.

Convenient ways to use Android Auto™

Item	Operation method
To operate using voice*1	Any of the following methods can be used to start voice recognition mode and operate Android Auto™ using voice. <ul style="list-style-type: none"> · Slide the  to the right and select the . · Press the   on the audio remote control switch.
To display the NowPlaying screen	While music is playing using Android Auto™, press the  on the commander switch to return to the Android Auto™ playback screen.
To display the MAP screen	During route guidance using Android Auto™, press the  on the commander switch to return to the Android Auto™ map screen.
To return to the Mazda Connect screen	Press and hold  on the commander switch.

*1 The voice recognition function of Mazda Connect cannot be used while Android Auto™ is connected.

Ending Android Auto™

To end Android Auto™, disconnect the connector cord from the USB port or disconnect the Android™ Smartphone from the connector cord.

Connected Service (U.S.A. only)

Connected Service Overview

There are several types of connected services available via Mazda Connect. Some services may require you to download the MyMazda app to your smartphone and subscribe to the services, while others may require you to pair your smartphone to the vehicle via Bluetooth®. In addition, on a regular basis and unless you opt-out, your vehicle will automatically transmit certain geo-location, driving behavior data, and vehicle health information to Mazda for product quality, data analysis, research, and product development. Using the QR codes or URLs below, refer to the Connected Service Owner's Manual and Privacy Policy for more details and opt-out options.

- Connected Service Owner's Manual
<https://www.mazdausa.com/static/manuals/mazda-connected-service/index.html>



Privacy

Mazda maintains a Privacy Statement which describes how we collect, use, share, store and secure data from your vehicle equipped with connected services.

We provide you with connected services by collecting and using your personal information and vehicle location, health and driving data.

To learn more about our Privacy Statement, please visit: <https://www.mazdausa.com/site/privacy-connectedservices>



4

Trouble

Taking action such as when functions cannot be set or other problems arise

Troubleshooting.....	4-2	
Troubleshooting.....	4-2	



Troubleshooting

AM, FM and SiriusXM® use-related issues

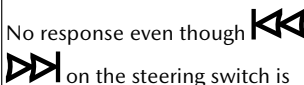
Symptom	Cause	Solution method
No response even though  on the steering switch is pressed.	These buttons are for selecting radio stations in the order of the items registered to your Favorites. If there are no items registered to your Favorites, the buttons will not function.	Register one or more items to your Favorites. Refer to Favorites on page 1-17.
SiriusXM® loads slowly.*	Since SiriusXM Travel Link® receives data from geo-synchronous satellites and the data is transmitted at preset intervals. When the system is loading the SiriusXM® data in the background, there may be occasions when the SiriusXM® function is waiting on data before it can be accessed.	Allow time for SiriusXM Travel Link® to complete the loading of the SiriusXM® data.

Problems related to USB Audio and Bluetooth® Audio

Symptom	Cause	Solution method
<u>USB Audio</u> No music playback.	A USB device incompatible with mass storage is connected.	Connect a USB device compatible with mass storage.
	A USB hub is being used.	Connect without using the USB hub.
	A USB device formatted by a file system incompatible with Mazda Connect is connected.	Connect a USB device formatted by FAT16 and FAT32.
A music file cannot be found.	The folder hierarchy is deeper than 8-layers.	This unit cannot display or play files with a folder hierarchy deeper than 8-layers. Save files within an 8-layer hierarchy.

Apple CarPlay™ use-related issues

Symptom	Cause	Solution method
Apple CarPlay™ cannot be activated even though an Apple®-genuine connector cord is inserted into the USB port and it is connected to my iPhone®.	There is mis-communication between the vehicle's audio system and your iPhone®.	Disconnect the connector cord from the USB port once and then reconnect it.

Symptom	Cause	Solution method
Or, the error message, "Unable to connect to Apple CarPlay." is displayed.	The Device Connection Status of the connected iPhone® has been set to "Never Enabled".	Set the Device Connection Status to "Always Enable" or "Enable Once".
	Apple CarPlay™ is already activated using another iPhone®.	If Apple CarPlay™ is already activated using another iPhone®, Apple CarPlay™ cannot be used with an additional iPhone®. Disconnect Apple CarPlay™ once and then reconnect it to the iPhone® you want to use to activate Apple CarPlay™.
The icon of the application I want to use is not displayed on the home screen of Apple CarPlay™.	Only applications compatible with Apple CarPlay™ are displayed on the screen.	Contact the application's supplier.
Voice recognition using Siri® is poor or incorrect for commands or contact names.	There are many possible reasons for this such as: 1. Poor network connectivity 2. Road noise/sound of air blowing from air conditioner 3. Incorrect iPhone® language setting	1. Use the commander switch to complete the task or wait until there is sufficient network connectivity before using Siri® again. 2. For better voice recognition, speak loud and clear. 3. Make sure that the iPhone® language is set correctly (Example: US English vs UK English). If you are still having difficulty using Siri®, visit the Apple® support site or contact Apple®.
There is a difference in the audio volume between Bluetooth® audio and Apple CarPlay™.	—	Check the volume of the audio on the device connected via Bluetooth®. The volume on some devices connected via Bluetooth® can be adjusted.
Apple CarPlay™ is activated each time an Apple®-genuine connector cord connected to your iPhone® is inserted into the USB port. (You have an iPhone® which you do not want to use to activate Apple CarPlay™)	The Device Connection Status of the connected iPhone® is set to "Always Enable".	Set the Device Connection Status to "Never Enabled" or "Always Ask".

Android Auto™ use-related issues

Symptom	Cause	Solution method
The Android Auto™ mode does not launch even though the Android™-genuine connector cord is inserted into the USB port and it is connected to my Android™ Smartphone.	The Android Auto™ application has not been downloaded to your Android™ Smartphone.	To use Android Auto™ with your vehicle, the Android Auto™ application is required on your Android™ Smartphone. Download the Android Auto™ application from the Google Play™.
Android Auto™ mode cannot be activated even though an Android™-genuine connector cord connected to my Android™ Smartphone is inserted into the USB port. Or, the error message, "Android Auto ended due to a Bluetooth communication error." is displayed.	There is mis-communication between the vehicle's audio system and your Android™ Smartphone.	Disconnect the connector cord from the USB port once and then reconnect it.
	Your Android™ Smartphone cannot be paired because another device is connected via Bluetooth®.	Disconnect the other device's Bluetooth® connection, disconnect the connector cord of the Android™ Smartphone from the USB terminal once, and then reconnect it.
	The Device Connection Status of the connected Android™ Smartphone is set to "Never Enabled".	Set the "Device Connection Status" to "Always Enable" or "Enable Once". Refer to Connectivity Settings on page 2-126.
	Android Auto™ mode is already activated using another Android™ Smartphone.	If Android Auto™ mode is already activated using another Android™, Android Auto™ mode cannot be used with an additional Android™ Smartphone. Disconnect Android Auto™ mode once and then reconnect it to the Android™ Smartphone you want to use with Android Auto™ mode.
The icon of the application I want to use is not displayed on the home screen while in Android Auto™ mode.	Only applications compatible with Android Auto™ are displayed on the screen.	Contact the application's supplier.
<ul style="list-style-type: none"> • Voice recognition is poor or incorrect. • Voice recognition responds slowly or it does not work. 	—	If you are having difficulty using the voice recognition, visit the Android Auto™ support site or contact Google™.

Symptom	Cause	Solution method
There is a difference in the audio volume between Bluetooth® audio and Android Auto™.	—	Check the volume of the audio on the device connected via Bluetooth®. The volume on some devices connected via Bluetooth® can be adjusted.
Android Auto™ is activated each time an Android™-genuine connector cord connected to your Android™ Smartphone is inserted into the USB port. (You have an Android™ Smartphone which you do not want to use to activate Android Auto™ mode)	Set the “Device Connection Status” of the connected Android™ Smartphone to “Always Enable”.	Set the “Device Connection Status” to “Never Enabled”. Refer to Connectivity Settings on page 2-126.

Mazda Bluetooth® Hands-Free Customer Service*

If you have any problems with Bluetooth®, contact our toll-free customer service center.

- Website: <https://connect.mazda.com/en/>
- **U.S.A.**
Phone: 800-430-0153 (Toll-free)
- **Canada**
Phone: 800-430-0153 (Toll-free)
- **Mexico**
Center of Attention to Client (CAC)
Phone: 01-800-01-MAZDA (Toll-free)
- **Australia**
- **New Zealand**
- **Germany**
Phone: 0800 4263 738 (8:00—18:00 Central European Time)
- **Europe (Except Germany)**
Phone: 00800 4263 7383 (8:00—18:00 Central European Time)
- **Worldwide**
Phone: + 49 (0) 6838 907 287 (8:00—18:00 Central European Time)

*Some models.

Problems with pairing and connecting Bluetooth® devices

- Bluetooth® operations differ depending on the settings of the Bluetooth® device being used.
- If your Bluetooth® device no longer operates normally, refer to the device's owner's manual.

Symptom	Cause	Solution method
Unable to perform pairing	—	Refer to the website to check whether or not your Bluetooth® device is compatible with Mazda Connect. Make sure that Bluetooth® and Find Mode*1 are turned on in the Bluetooth® device's settings. Additionally, make sure that Airplane mode is turned off. Turn off the Bluetooth® device's power once and then turn it back on. If pairing is still not possible after this, contact an Authorized Mazda Dealer.
Pairing cannot be performed again	Pairing information registered to this unit or your Bluetooth® device is not recognized correctly.	Perform pairing using the following procedure: <ol style="list-style-type: none"> 1. Delete the target Bluetooth® device on the Mazda Connect. 2. Delete "Mazda" from the Bluetooth® search screen of the Bluetooth® device. 3. Perform pairing again. If pairing is not possible using the above procedure, turn off the Bluetooth® device's power once and then turn it back on. If pairing is still not possible after this, contact an Authorized Mazda Dealer.
Automatically connects, but then disconnects suddenly	Depending on the Bluetooth® device, Bluetooth® and Find Mode*1 may turn off automatically after a period of time has passed.	<ul style="list-style-type: none"> • Make sure that Bluetooth® and Find Mode*1 are turned on and reconnect. • Turn off the Bluetooth® device's power once and then turn it back on.

Symptom	Cause	Solution method
Does not connect automatically when starting the engine	The programmed pairing information is updated when the Bluetooth® device's OS is updated.	<p>Perform pairing using the following procedure:</p> <ol style="list-style-type: none"> 1. Delete the target Bluetooth® device on the Mazda Connect. 2. Delete "Mazda" from the Bluetooth® search screen of the Bluetooth® device. 3. Perform pairing again. <p>If pairing is not possible using the above procedure, turn off the Bluetooth® device's power once and then turn it back on. If pairing is still not possible after this, contact an Authorized Mazda Dealer.</p>
	Depending on the Bluetooth® device, Bluetooth® and Find Mode* ¹ may turn off automatically after a period of time has passed.	<ul style="list-style-type: none"> • Make sure that Bluetooth® and Find Mode*¹ are turned on and reconnect. • Turn off the Bluetooth® device's power once and then turn it back on.
Disconnects intermittently	The Bluetooth® device is in a location where reception interference can occur easily, such as inside a bag on a rear seat or in a rear pocket of a pair of pants.	<ul style="list-style-type: none"> • Move the Bluetooth® device to a location where radio wave interference is less likely to occur. • Turn off the Bluetooth® device's power once and then turn it back on.

*1 Setting for making the presence of a Bluetooth® device detectable from the outside.

Voice recognition related problems

Symptom	Cause	Solution method
<ul style="list-style-type: none"> Poor voice recognition False recognition of numbers 	<ul style="list-style-type: none"> You are speaking excessively slow You are speaking in an excessively forceful voice (Shouting) Airflow from the air conditioner is blowing against the microphone You are using off-standard expressions (dialect) 	<ul style="list-style-type: none"> Regarding the causes indicated on the left, be careful with how you speak. In addition, when numbers are spoken in a sequence, recognition ability will improve if no stop is placed between the numbers. Turn off the Bluetooth® device's power once and then turn it back on.
	There is a malfunction in the microphone.	A poor connection or malfunction with the microphone may have occurred. Consult an Authorized Mazda Dealer.
When a voice command is made during voice guidance, the voice recognition is poor.	The Guidance Volume setting value is too high.	The recognition accuracy improves by setting the Guidance Volume to the 50 level or lower.
Names in the phonebook are not easily recognized	It is difficult for the system to recognize the data registered in the phonebook.	The recognition accuracy improves by taking the following steps. <ul style="list-style-type: none"> Avoid shortened names, use full names. (Recognition improves the longer the name is. By not using names such as "Mom", "Dad", recognition will improve.)
	There is a problem with connecting the Bluetooth® device.	If there is a problem with the connection after checking the pairing situation, check the "Problems with pairing and connecting Bluetooth® devices" in this section.
You want to skip guidance	—	Guidance can be skipped at any time by pressing the talk/pick-up button.

Call related problems

Symptom	Cause	Solution method
When a call begins, vehicle noise from the other party can be heard	For about 3 seconds after a call begins, the Bluetooth® device's noise suppression function requires time to adapt to the call environment, therefore you may hear the noise from the other party's vehicle, making it difficult to carry voice.	There is no problem with the Bluetooth® device.
The other party's voice cannot be heard or it is difficult to hear	The volume is set at 0 or low.	Increase the conversation volume.
The phone does not receive calls.	The "Incoming Call Notifications" setting in the Communication Settings is off.	Turn the "Incoming Call Notifications" setting on.

Problems related to messages

Symptom	Cause	Solution method
Contacts cannot be displayed.	Downloading to Mazda Connect is not being permitted from the Bluetooth® device.	Set the permissions to allow downloads from the Bluetooth® device.
The message list cannot be displayed.	Downloading to Mazda Connect is not being permitted from the Bluetooth® device.	<ul style="list-style-type: none"> • Set the permissions to allow downloads from the Bluetooth® device. • If an Apple® product is to be connected, set the device's permissions to allow downloads from the Apple® product, and then reconnect. After reconnecting, only the received messages are displayed.

Other problems

Symptom	Cause	Solution method
The remaining battery charge indicated on the Bluetooth® device differs from that indicated in the center display.	This is because there is a deviation in the remaining battery charge information from the Bluetooth® device and the display scale of this unit.	—
When making a call from the vehicle, the telephone number is updated in the incoming/outgoing call history but the name does not appear.	The name has not been registered to the phonebook.	If the number has been registered into the phonebook, the incoming/outgoing call history is updated by the name in the phonebook when the engine is restarted.
The incoming/outgoing call history does not synchronize between the Bluetooth® device and the vehicle.	Depending on the Bluetooth® device, the incoming/outgoing call history might be downloaded after the engine is started.	It may be necessary to operate the Bluetooth® device. Refer to the owner's manual for the Bluetooth® device.

5

Index



Index

A

- Android Auto™.....3-6
- Appendix.....1-22
- Apple CarPlay™.....3-2
- Audio Remote Control Switch
Operation.....1-10

B

- Bluetooth®
 - Bluetooth® audio.....2-55
 - Bluetooth® Hands-Free.....2-89
 - Communication Settings.....2-106
 - Pairing.....2-126

C

- CD.....2-71
- Commander Switch Operation.....1-7
- Communication.....2-88
 - Bluetooth® Hands-Free.....2-89
 - Communication Settings.....2-106
- Connected Service.....3-10

D

- DVD.....2-78

E

- Entertainment.....2-15
 - AM.....2-35
 - Bluetooth®.....2-55
 - CD.....2-71
 - DAB.....2-45
 - DVD.....2-78
 - FM.....2-30
 - Pandora®.....2-49
 - SiriusXM®.....2-38
 - USB1 Audio/USB2 Audio.....2-59
 - USB1 Video/USB2 Video.....2-66

F

- Favorites.....1-17
- Fuel Efficiency Monitor.....2-2

I

- Information
 - Fuel Efficiency Monitor.....2-2
 - Owner's Manual.....2-14
 - SiriusXM Travel Link®.....2-9
 - Vehicle Status Monitor.....2-11

M

- Mazda Connect Basic
Operations.....1-6
 - Audio remote control switch
operation.....1-10
 - Commander Switch
Operation.....1-7
 - Operation using voice recognition
function.....1-13

N

- Navigation.....2-109

P

- Pandora®.....2-49
- Personalization Features.....2-110
 - Connectivity Settings.....2-126
 - In-Vehicle Displays.....2-113
 - Safety Settings.....2-117
 - Sound Settings.....2-115
 - System Settings.....2-136
 - Vehicle Settings.....2-122

R

- Radio
 - AM.....2-35
 - DAB.....2-45

FM.....	2-30
SiriusXM®.....	2-38
S	
Settings.....	2-110
Connectivity Settings.....	2-126
In-Vehicle Displays.....	2-113
Safety Settings.....	2-117
Sound Settings.....	2-115
System Settings.....	2-136
Vehicle Settings.....	2-122
SiriusXM®.....	2-38
SiriusXM Travel Link®.....	2-9
T	
Troubleshooting.....	4-2
U	
USB1 Audio/USB2 Audio.....	2-59
USB1 Video/USB2 Video.....	2-66
V	
Vehicle Status Monitor.....	2-11
Voice Recognition Function	
Operation using voice recognition	
function.....	1-13
W	
What is Mazda Connect ?.....	1-2

