



UCONNECT 3 WITH 5 INCH DISPLAY

TABLE OF CONTENTS

SECTION

PAGE

1	SAFETY AND GENERAL INFORMATION	3	1
2	INTRODUCTION	7	2
3	RADIO MODE	11	3
4	MEDIA MODE	17	4
5	PHONE MODE	23	5
6	VOICE RECOGNITION QUICK TIPS	33	6

SAFETY AND GENERAL INFORMATION

CONTENTS

■ SAFETY GUIDELINES	4	■ GENERAL INFORMATION	6
□ Safe Usage Of The Uconnect System	4	□ External Audio Sources	6
□ Care And Maintenance	5		
□ FCC Declaration	6		

SAFETY GUIDELINES

WARNING!

ALWAYS drive safely with your hands on the steering wheel. You have full responsibility and assume all risks related to the use of the Uconnect features and applications in this vehicle. Only use Uconnect when it is safe to do so. Failure to do so may result in an accident involving serious injury or death.

Ensure that all persons read this manual carefully before using the system. It contains instructions on how to use the system in a safe and effective manner.

Do NOT attach any object to the touchscreen, doing so can result in damage to the touchscreen.

Please read and follow these safety precautions. Failure to do so may result in injury or property damage.

- Glance at screen only when safe to do so. If prolonged viewing of the screen is required, park in a safe location and set the parking brake.
- Stop use immediately if a problem occurs. Failure to do so may cause injury or damage to the product. Return it to an authorized dealer to repair.

- Ensure the volume level of the system is set to a level that still allows you to hear outside traffic and emergency vehicles.

Safe Usage Of The Uconnect System

- Read all instructions in this manual carefully before using your system to ensure proper usage!
- Your system is a sophisticated electronic device. Do not let young children use your system.
- Permanent hearing loss may occur if you play your music or the system at loud volumes. Exercise caution when setting the volume on your system.
- Keep drinks, rain and other sources of moisture away from your system. Besides damage to your system, moisture can cause electric shocks as with any electronic device.

NOTE: Many features of this system are speed dependent. For your own safety, it is not possible to use some of the touchscreen features while the vehicle is in motion.

Exposure To Radio Frequency Radiation

The internal wireless radio operates within guidelines found in radio frequency safety standards and recommendations, which reflect the consensus of the scientific community. The radio manufacturer believes the internal wireless radio is safe for use by consumers. The level of energy emitted is far less than the electromagnetic energy emitted by wireless devices such as mobile phones. However, the use of wireless radios may be restricted in some situations or environments, such as aboard airplanes. If you are unsure of restrictions, you are encouraged to ask for authorization before turning on the wireless radio.

Care And Maintenance

Touchscreen

- Do not press the touchscreen with any hard or sharp objects (pen, USB stick, jewelry, etc.) which could scratch the touchscreen surface!
- Do not spray any liquid or caustic chemicals directly on the screen! Use a clean and dry micro fiber lens cleaning cloth in order to clean the touchscreen.
- If necessary, use a lint-free cloth dampened with a cleaning solution, such as isopropyl alcohol or an isopropyl alcohol and water solution ratio of 50:50. Be sure to follow the solvent manufacturer's precautions and directions.

Disc Drive — If Equipped

- Do not insert any damaged, warped, scratched or dirty Discs into the Disc Player.
- Discs that have been modified with an adhesive label should not be used in the Disc Player.
- Do not insert more than one Disc at a time into the drive slot.

FCC Declaration

General Information

The following regulatory statement applies to all Radio Frequency (RF) devices equipped in this vehicle:

This device complies with Part 15 of the FCC Rules and with Industry Canada license-exempt RSS standard(s). Operation is subject to the following two conditions:

1. This device may not cause harmful interference, and
2. This device must accept any interference received, including interference that may cause undesired operation.

NOTE: Changes or modifications not expressly approved by the party responsible for compliance could void the user's authority to operate the equipment.

GENERAL INFORMATION

External Audio Sources

Other electronic devices (e.g. iPod, PDA, etc.) can be used on the car. Some of them may cause electromagnetic interference however. Disconnect these devices if the system performance worsens.

NOTE:

- The system supports only FAT32-formatted USB devices. For optimal results, devices 64GB or lower is recommended for support.
- The system does not support USB hubs connected with the USB port of the car. Connect your multimedia device directly to the USB port, using the specific connection cable for the device if necessary.

INTRODUCTION

CONTENTS

- UCONNECT 3 WITH 5-INCH DISPLAY SYSTEM . . .8
 - Identifying Your Radio.8
 - Uconnect 3 System Without Integrated Center Stack8
 - Uconnect Settings10

UCONNECT 3 WITH 5-INCH DISPLAY SYSTEM

Identifying Your Radio



1001121607US

Key Features:

- 5" Touchscreen
- Three buttons on either side of the display
- Hands-free/Bluetooth

Uconnect 3 System Without Integrated Center Stack



1001121608US

1 — RADIO

Push the RADIO button on the faceplate to enter Radio Mode. The different tuner modes; FM/AM/SW/LW/MW/DAB/DAB+ (if equipped), can be selected by pressing the corresponding buttons on the touchscreen in Radio Mode.

2 — COMPASS

Push the COMPASS button on the faceplate to display the current direction of the vehicle.

3 — SETTINGS

Push the SETTINGS button on the faceplate to display the customer programmable features.

4 — MORE

Push the MORE button on the faceplate to access additional options.

5 — ENTER/BROWSE & TUNE/SCROLL

Push the ENTER/BROWSE button to accept a highlighted selection on the screen. Rotate the TUNE/SCROLL rotary knob to scroll through a list or tune a radio station.

6 — SCREEN OFF

Push the SCREEN OFF button to turn the touchscreen OFF. To turn the touchscreen back ON, just press the screen.

7 — MUTE

Push the MUTE button to turn off the audio of the radio system. Press it again to turn the audio back on.

8 — VOLUME/POWER

Rotate the rotary knob to adjust the Volume. Push the VOLUME/POWER button to turn the system ON or OFF.

9 — PHONE

Push the PHONE button on the faceplate to access the Uconnect Phone feature.

10 — MEDIA

Pushing the MEDIA button on the faceplate will allow you to switch to Media mode: CD (if equipped), USB/iPOD, AUX, and Bluetooth.

Uconnect Settings

Push the SETTINGS button on your faceplate, if one exists, to display the Settings Main Menu. If not, push the MORE button on the faceplate then the “Settings” button on your touchscreen. The Settings Main Menu may contain the following options:

- Display
- Units
- Voice Command
- Clock & Date
- Safety/Assistance
- Brakes
- Lights
- Doors & Locks
- Auto Comfort Systems — If Equipped
- Vehicle Off Options
- Suspension — If Equipped
- Trailer Brake — If Equipped
- Compass Setting — If Equipped
- Audio
- Phone/Bluetooth
- Radio Setup — If Equipped
- Restore Settings
- Clear Personal Data
- System Information

Refer to “Uconnect Settings” in the Owner’s Manual for further information.

RADIO MODE

CONTENTS

■ OPERATING RADIO MODE	12	□ Direct Tune Functions	13
□ Switching The System ON/OFF	12	□ SiriusXM Satellite Radio Mode — If Equipped . . .	13
□ Volume/Mute	12	□ Setting Presets	14
□ Tune/Scroll Control	12	□ Audio Settings	15
□ Seek Functions	13	□ Clock Settings	16

OPERATING RADIO MODE

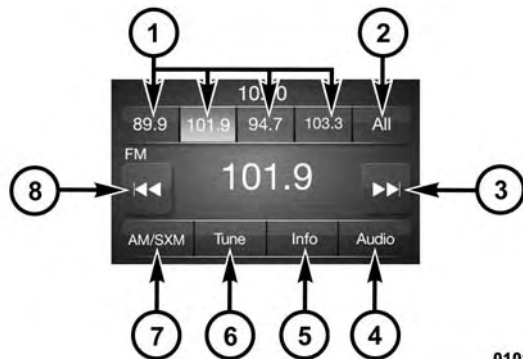

0101073162

- 1 — Station Presets
- 2 — All Presets
- 3 — SEEK Up▶▶
- 4 — Audio

- 5 — Info
- 6 — Tune
- 7 — AM/FM/SXM
- 8 — SEEK Down◀◀

The radio is equipped with the following modes:

- FM
- AM (SW/LW/MW – If Equipped)
- SiriusXM Radio – If Equipped

Push the RADIO button on the faceplate, to enter the Radio Mode. The different tuner modes; FM/AM/SXM – If Equipped, can then be selected by pressing the corresponding buttons on the touchscreen in the Radio mode.

Switching The System ON/OFF

The screen will switch on/off when the power button is pushed.

Volume/Mute

Rotate the VOLUME rotary knob to adjust the Volume. When the audio system is turned on, the sound will be set at the same volume level as last played.

Push the MUTE button to mute the system. Push the MUTE button again to unmute the system.

Tune/Scroll Control

Turn the rotary TUNE/SCROLL control knob clockwise to increase or counterclockwise to decrease the radio station frequency. Push the ENTER/BROWSE button to choose a selection.

Seek Functions

Seek Up▶▶

Press and release the “Seek Up” ▶▶ button on the touchscreen to tune the radio to the next listenable station or channel.

During a Seek Up function, if the radio reaches the starting station after passing through the entire band two times, the radio will stop at the station where it began.

Fast Seek Up▶▶

Press and hold the “Seek Up” ▶▶ button on the touchscreen to advance the radio through the available stations or channels at a faster rate, the radio stops at the next available station or channel when the button on the touchscreen is released.

Seek Down◀◀

Press and release the “Seek Down” ◀◀ button on the touchscreen to tune the radio to the next listenable station or channel.

During a Seek Down function, if the radio reaches the starting station after passing through the entire band two times, the radio will stop at the station where it began.

Fast Seek Down◀◀

Press and hold the “Seek Down” ◀◀ button on the touchscreen to advance the radio through the available stations or channel at a faster rate, the radio stops at the next available station or channel when the button on the touchscreen is released.

Direct Tune Functions

Press the “Tune” button on the touchscreen to directly tune to a specific radio station. A keypad will appear. On the keypad, enter in your desired radio station, and the system will automatically tune to it.

SiriusXM Satellite Radio Mode — If Equipped

SiriusXM Satellite Radio uses direct satellite-to-receiver broadcasting technology to provide clear, coast to coast radio content. SiriusXM is a subscription based service.

Get over 160 channels on your satellite radio, and enjoy all you want, all in one place. Hear commercial-free music plus sports, news, talk and entertainment. Get all the premium programming, including Howard Stern, every NFL game, Oprah Radio, every MLB and NHL game, every NASCAR race, Martha Stewart and more. And get 20+ extra channels, including SiriusXM Latino, offering 20 channels of commercial free music, news, talk, comedy, sports and more dedicated to Spanish language programming.

SiriusXM services require subscriptions, sold separately after the trial included with the new vehicle purchase. If you decide to continue your service at the end of your trial subscription, the plan you choose will automatically renew and bill at then-current rates until you call SiriusXM at 1-866-635-2349 to cancel. See SiriusXM Customer Agreement for complete terms at www.siriusxm.com. All fees and programming subject to change. Our satellite service is available only to those at least 18 and older in the 48 contiguous USA and D.C. Our Sirius satellite service is also available in PR (with coverage limitations). Our Internet radio service is available throughout our satellite service area and in AK and HI. © 2017 SiriusXM Radio Inc. Sirius,

XM and all related marks and logos are trademarks of SiriusXM Radio Inc. Service available in Canada; see www.siriusxm.ca.

This functionality is only available for radios equipped with a Satellite receiver. To receive satellite radio, the vehicle needs to be outside with a clear view to the sky.

If the screen displays Acquiring Signal, you may need to change the vehicle's position to receive a signal. In most cases, the satellite radio does not receive a signal in underground parking garages or tunnels.

Setting Presets

The Presets are available for all Radio Modes and are activated by pressing any of the four "Preset" buttons on the touchscreen, located at the top of the screen.

When you are receiving a station that you wish to commit into memory, press and hold the desired numbered button on the touchscreen for more than two seconds or until you hear a confirmation beep.

The Radio stores up to 12 presets in each of the Radio modes. Four presets are visible at the top of the radio screen.

Audio Settings

1. Push the **SETTINGS** button on the right side of the radio faceplate. If the settings button is not present, push the **MORE** button on the faceplate then the “Settings” button on the touchscreen.
2. Scroll down and press the “Audio” button on the touchscreen to open the Audio menu.
3. The Audio Menu shows the following options for you to customize your audio settings:
 - **Auto Play**
 - Press the “Auto Play” button on the touchscreen to select between ON or OFF. This feature determines if music automatically starts playing from a device when it is first connected to the Media hubs USB port.
 - **Equalizer**
 - Press the “Equalizer” button on the touchscreen to adjust the Bass, Mid and Treble. Use the “+” or “-” buttons on the touchscreen to adjust the equalizer to your desired settings. Press the “Back Arrow” button on the touchscreen when done.

- **Balance/Fade**

- Press the “Balance/Fade” button on the touchscreen to adjust the sound from the speakers. Use the “arrow” button on the touchscreen to adjust the sound level from the front and rear or right and left side speakers. Press the Center “C” button on the touchscreen to reset the balance and fade to the factory setting. Press the “Back Arrow” button on the touchscreen when done.

- **Speed Adjustable**

- Press the “Speed Adjusted Volume” button on the touchscreen to select between OFF, 1, 2 or 3. This will decrease the radio volume relative to a decrease in vehicle speed. Press the “Back Arrow” button on the touchscreen when done.

- **Loudness**

- Press the “Loudness” button on the touchscreen to select the Loudness feature. When this feature is activated it improves sound quality at lower volumes.

Clock Settings

1. If a SETTINGS button on the right side of faceplate exists, push this button. If not, push the MORE button on the faceplate then the “Settings” button on the touchscreen.
2. Select the “Clock and Date” button on the touchscreen.
3. Next, select “Set Time” to change the time.
4. Select “Set Date” to change the date.
5. To set the time, select the “Seek Up” ►► or “Seek Down” ◄◄ arrows as appropriate. Select “12 hrs vs 24 hrs”, “AM” or “PM” or select the “Time Zones” (if equipped).
6. Select “Done” when complete.

MEDIA MODE

CONTENTS

■ OPERATING MEDIA MODE	18	□ Audio	20
□ Audio Source Selection	18	■ IPOD/USB MODE	20
□ Seek Up/Seek Down	19	■ BLUETOOTH MODE	20
□ Track Selection (Browse)	19	■ AUX MODE	21
□ Repeat	19	■ DISC MODE — IF EQUIPPED	21
□ Shuffle	19		
□ Track Info	19		

OPERATING MEDIA MODE

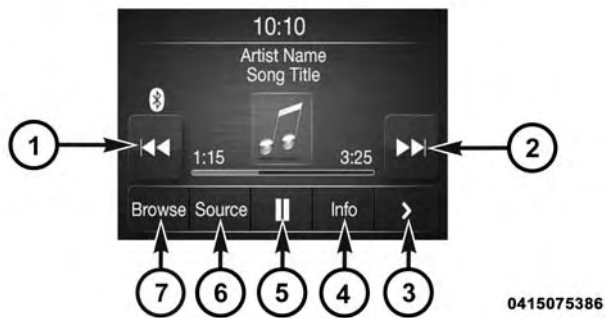

1 — SEEK Down◀◀

2 — SEEK Up▶▶

3 — Additional Functions

4 — Info

5 — Pause/Play

6 — Source

7 — Browse

Media Mode is entered by pushing the MEDIA button located on the faceplate.

Audio Source Selection

Once in Media Mode, press the “Source” button on the touchscreen and the desired mode button on the touchscreen. Disc (if equipped), USB, SD Card (if equipped), AUX and Bluetooth (if equipped), are the Media sources available. When available, you can select the “Browse” button on the touchscreen to be given these options:

- Now Playing
- Artists
- Albums
- Genres
- Songs
- Playlists
- Folders

You can press the “Source,” “Pause/Play” or the “Info” button on the touchscreen for artist information on the current song playing.

Seek Up/Seek Down

Seek Up ►►/Seek Down◀◀

Press and release the “Right Arrow” ►► button on the touchscreen for the next selection. Press and release the “Left Arrow” ◀◀ button on the touchscreen to return to the beginning of the current selection, or return to the beginning of the previous selection if the track is within the first second of the current selection.

Fast Seek Up►►►

Press and hold the “Right Arrow” ►► button on the touchscreen and the desired mode will begin to fast forward through the current track until the button on the touchscreen is released.

Fast Seek Down◀◀◀

Press and hold the “Left Arrow” ◀◀ button on the touchscreen and the desired mode will begin to rewind through the current track until the button on the touchscreen is released.

Track Selection (Browse)

Press the “Browse” button on the touchscreen to scroll through and select a desired track on the iPod, MP3 player, phone, or USB. Press the “Exit” button on the touchscreen if you wish to cancel the browse function.

Repeat

Press the “Repeat” button on the touchscreen to repeat the song selection. To cancel repeat, press the “Repeat” button on the touchscreen a second time.

Shuffle

Press the “Shuffle” button on the touchscreen to play the selections on the USB/iPod device in random order to provide an interesting change of pace. Press the “Shuffle” button on the touchscreen a second time to turn this feature off.

Track Info

Press the “Info” button on the touchscreen to display the current track information. Press the “X” button on the touchscreen to cancel this feature.

Audio

Refer to “Operating Radio Mode” for the adjustable audio settings.

IPOD/USB MODE

USB/iPod Mode is entered by either inserting a USB Jump Drive or iPod cable into the USB port, or by pushing the MEDIA button located on the faceplate. Once in Media Mode, press the “Source” button on the touchscreen and select “USB/iPod.”

Inserting USB/iPod Device

Gently insert the USB/iPod device into the USB Port. If you insert a USB/iPod device with the ignition ON, the unit will switch to USB/iPod mode and begin to play when you insert the device. The display will show the track number and index time in minutes and seconds. Play will begin at the start of track 1.

Browse

Press the “Browse” button on the touchscreen to select Artist, Albums, Genres, Songs, Playlists or Folders from the USB/iPod device. Once the desired selection is made you can chose from the available media by pressing the button

on the touchscreen. Press the “Exit” button on the touchscreen if you wish to cancel the browse function.

BLUETOOTH MODE

Bluetooth Streaming Audio (BTSA) or Bluetooth Mode is entered by pairing a Bluetooth device containing music to the Uconnect system.

Before proceeding, the Bluetooth device must be paired with the Uconnect Phone to communicate with the Uconnect system.

See the pairing procedure within this manual.

Once the Bluetooth device is paired to the Uconnect system, push the MEDIA button located on the faceplate. Once in Media Mode, press the “Source” button on the touchscreen and select “Bluetooth.”

NOTE: For mobile phone compatibility and pairing instructions, please visit UconnectPhone.com.

AUX MODE

AUX Mode is entered by inserting a AUX device using a stereo cable with a 3.5 mm audio jack into the AUX port, or by pushing the MEDIA button located on the faceplate. Once in Media Mode, press the “Source” button on the touchscreen and select “AUX.”

Inserting Auxiliary Device

Gently insert the Auxiliary device cable into the AUX Port. If you insert a Auxiliary device with the ignition ON, the unit will switch to AUX mode and begin to play when you insert the device cable.

Controlling The Auxiliary Device

The control of the Auxiliary device (e.g., selecting playlists, play, fast forward, etc.) cannot be provided by the radio; use the device controls instead. Adjust the volume with the VOLUME rotary knob, or with the volume of the attached device.

The vehicle radio unit is acting as the amplifier for audio output from the Auxiliary device. Therefore if the volume control on the Auxiliary device is set too low, there will be insufficient audio signal for the radio unit to play the music on the device.

DISC MODE — IF EQUIPPED

Your vehicle may have a remote Disc player located in the center console storage bin.

Disc Mode is entered by either inserting a CD/Disc or by pushing the MEDIA button on the faceplate. Once in Media Mode, press the “Source” button on the touchscreen and select “Disc.”

Inserting Compact Disc

Gently insert one Disc into the Disc player with the Disc label following the illustration indicated on the player. The Disc will automatically be pulled into the Disc player and the Disc icon will illuminate on the radio display. If a Disc does not go into the slot more than 1.0 inch (2.5 cm), a Disc may already be loaded and must be ejected before a new Disc can be loaded.

If you insert a Disc with the ignition ON and the radio ON, the unit will switch to Disc mode and begin to play when you insert the Disc. The display will show the track number and index time in minutes and seconds. Play will begin at the start of track 1.

Browse

Press the “Browse” button on the touchscreen to scroll through and select a desired track on the Disc. Press the “Exit” button on the touchscreen if you wish to cancel the browse function.

Eject Button — Ejecting a Disc

Push the EJECT button to eject the Disc. If you have ejected a Disc and have not removed it within ten seconds, it will be reloaded. If the Disc is not removed, the radio will reinsert the Disc but will not play it. A Disc can be ejected with the radio and ignition OFF.

PHONE MODE

CONTENTS

■ OPERATING PHONE MODE24	□ Deletion Of Phone Data (Phonebook And Recent Calls)29
□ Phone Mode Activation24	□ Making A Phone Call29
□ Main Functions25	□ Answering An Incoming Call30
□ Connecting/Disconnecting A Mobile Phone Or Bluetooth Device25	□ Managing Two Phone Calls31
□ Deletion Of A Mobile Phone Or A Bluetooth Audio Device28	□ Transferring/Call Continuation31
□ Setting A Mobile Phone Or A Bluetooth Audio Device As Favorite.28	□ Ending A Call31
□ Downloading A Phonebook From Your Mobile Phone.28	■ UCONNECT PHONE FEATURES32
		□ Mute/Unmute.32
		□ Reading Messages32

OPERATING PHONE MODE

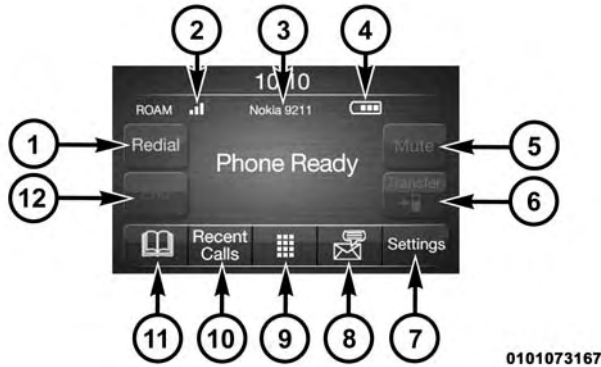

1 — Call/Redial/Hold
 2 — Phone Signal Strength
 3 — Paired Phone
 4 — Phone Battery Life
 5 — Mute Microphone
 6 — Transfer To/From Uconnect System

7 — Uconnect Phone Settings
 8 — Text Messaging
 9 — Direct Dial Pad
 10 — Recent Call Log
 11 — Browse Phone Book (Contains 911)
 12 — End Call

The Uconnect Phone is a voice-activated, hands-free, in-vehicle communications system with Voice Command Capability (see Voice Command section).

The Uconnect Phone allows you to dial a phone number with your mobile phone using simple voice commands.

NOTE: The Uconnect Phone requires a mobile phone equipped with the Bluetooth Hands-Free Profile. To check mobile phone compatibility please visit UconnectPhone.com.

For Uconnect customer support:

- U.S. residents - visit UconnectPhone.com or call 1-877-855-8400
- Canadian residents - visit UconnectPhone.com or call 1-800-465-2001 (English) or 1-800-387-9983 (French)

Phone Mode Activation

Press the PHONE button on the front panel to activate the Phone mode.

Main Functions

The buttons on the display can be used to:

- Compose phone numbers (using the graphic keypad on the display)
- Display and call the contacts on the mobile phone phonebook
- Display and call contacts from the “recent calls” menu
- Pair up to ten phones/audio devices to make access and connection easier and quicker
- Transfer calls from the system to the mobile phone and vice versa
- Deactivate the microphone audio for private conversations

The mobile phone audio is transmitted through the vehicle’s audio system. The system automatically mutes the radio when the Phone function is used.

Connecting/Disconnecting A Mobile Phone Or Bluetooth Device

Pairing A Phone

To begin using your Uconnect Phone, you must pair your compatible Bluetooth enabled mobile phone. Mobile phone pairing is the process of establishing a wireless connection between a cellular phone and the Uconnect system

To complete the pairing process, you will need to reference your mobile phone Owner’s Manual. Please visit UconnectPhone.com for complete mobile phone compatibility information.

NOTE:

- You must have Bluetooth enabled on your phone to complete this procedure.
 - The vehicle must be in PARK.
1. Place the ignition in the ACC or ON position.

2. Push the PHONE button on the faceplate.
 - If there is no phones currently connected with the system, a pop-up will appear asking if you would like to pair a mobile phone.
3. Select “Yes” to begin the pairing process.
4. Search for available devices on your Bluetooth enabled mobile phone.
 - Press the Settings button on your mobile phone.
 - Select Bluetooth and ensure it is enabled. Once enabled, the mobile phone will begin to search for Bluetooth connections.
5. If No is selected, and you still would like to pair a mobile phone, press the “Settings” button from the Uconnect Phone main screen.
 - Select “Paired Phones” then press the “Add Device” button on the touchscreen.
 - Search for available devices on your Bluetooth enabled mobile phone (see below). When prompted on the phone, select “Uconnect” and accept the connection request.
6. Uconnect Phone will display an in progress screen while the system is connecting.
7. When your mobile phone finds the Uconnect system, select “Uconnect.”
8. When prompted on the mobile phone, accept the connection request from Uconnect Phone.
 - Some mobile phones will require you to enter the PIN number.
9. When the pairing process has successfully completed, the system will prompt you to choose whether or not this is your favorite phone. Selecting “Yes” will make this phone the highest priority. This phone will take precedence over other paired phones within range and will connect to the Uconnect system automatically when entering the vehicle. Only one mobile phone and/or one Bluetooth audio device can be connected to the Uconnect system at a time. If “No” is selected, simply select “Uconnect” from the mobile phone/audio device Bluetooth screen, and the Uconnect system will reconnect to the Bluetooth device. Phonebook Download — Phonebook Transfer

Storing Names/Numbers in The Mobile Phone

Before pairing your mobile phone, you must make sure you have stored the names you want to contact in the phonebook on your mobile phone so that you can call them using the vehicle's hands-free system.

If your phonebook does not contain any names, enter new names for the most frequently used numbers.

For further details, consult your mobile phone owner's handbook.

NOTE: The names in the phonebook which do not contain phone numbers or where both fields (name and surname) are empty will not be displayed.

Connection

The system connects automatically to the paired mobile phone with the highest priority.

To choose a specific mobile phone or Bluetooth audio device, proceed as follows:

- Access the Settings menu
- Select "Phone/Bluetooth"

- Select the "Paired Phones" or "Paired Audio" list using the corresponding button on the display
- Select the specific device (mobile phone or Bluetooth device)
- Press the "Connect" button
- During the connection stage a screen is displayed showing the progress of the operation
- The device connected is highlighted in the list.

Disconnection

To disconnect a specific mobile phone or Bluetooth audio device, proceed as follows:

- Access the Settings menu
- Select "Phone/Bluetooth"
- Select the "Paired Phones" or "Paired Audio" list using the corresponding button on the display
- Select the specific device (mobile phone or Bluetooth device)
- Press the "Disconnect" button.

Deletion Of A Mobile Phone Or A Bluetooth Audio Device

To delete a mobile phone or Bluetooth audio device from a list, proceed as follows:

- Access the "Settings" menu
- Select "Phone/Bluetooth"
- Select the "Paired Phones" or "Paired Audio" list using the corresponding button on the display
- Select the device (mobile phone or Bluetooth device)
- Press the "Delete Device" button;
- A confirmation screen will appear on the display:
 - Press "Yes" to delete the device
 - Press "No" to cancel the operation

Setting A Mobile Phone Or A Bluetooth Audio Device As Favorite

To set a mobile phone or Bluetooth audio device as favorite, proceed as follows:

- Access the "Settings" menu
- Select "Phone/Bluetooth"

- Select the "Paired Phones" or "Paired Audio" list using the corresponding button on the display
- Select the specific device (mobile phone or Bluetooth device)
- Press the "Make Favorite" button;
- The device selected is moved to the top of the list

Downloading A Phonebook From Your Mobile Phone

If equipped and specifically supported by your phone, Uconnect Phone will ask you if you want to download names (text names) and number entries from your mobile phone's phonebook. Specific Bluetooth Phones with Phone Book Access Profile may support this feature. See UconnectPhone.com for supported phones.

NOTE:

- Download and update, if supported, begins as soon as the Bluetooth wireless phone connection is made to the Uconnect Phone, for example, after you start the vehicle.
- You may be asked for permission to initiate the phonebook download.

- A maximum of 2,000 contact names with six numbers per contact will be downloaded and updated every time a phone is connected to the Uconnect Phone.
- Depending on the maximum number of entries downloaded, there may be a short delay before the latest downloaded names can be used. Until then, if available, the previously downloaded phonebook is available for use.
- Only the phonebook of the currently connected mobile phone is accessible.
- Only the mobile phones phonebook is downloaded. SIM card phonebook is not part of the Mobile phonebook.
- This downloaded phonebook cannot be edited or deleted on the Uconnect Phone. These can only be edited on the mobile phone. The changes are transferred and updated to Uconnect Phone on the next phone connection.

Deletion Of Phone Data (Phonebook And Recent Calls)

Select "Delete Phone Data" on the display to delete the list of recent calls and the phonebook copy.

Making A Phone Call

Dialling The Phone Number Using The "Keyboard" Icon On The Display

Enter the phone number using the graphic keypad displayed.

Proceed as follows:

1. Press the "Keyboard" icon on the display and use the number buttons to enter the number.
2. Press the "Call" button to make a call.

Call By Saying A Phonebook Name Or Phone Number

1. Push the PHONE button on the steering wheel.
2. After the BEEP, say "dial" (or "call" a full name or phone number).

Recent Calls

The list of the last calls made for each of the following call types can be displayed:

- Calls received
- Calls made
- Calls without a reply
- All calls

To access these types of call, press the "Recent Calls" button on the Phone menu main screen.

Making A Second Call While Current Call Is In Progress

When a phone conversation is active, a second phone call can be made as follows:

- Select the number/contact from the list of recent calls.
- Select the contact from the phonebook.
- Press the "Hold" button and dial the number using the graphic keyboard of the display.

Redial

To call the number/contact of last call made, press the "Redial" button.

Answering An Incoming Call

Call Controls

The buttons on the display allow the following phone call functions to be managed:

- Answer
- End
- Ignore
- Put on hold/resume
- Deactivate/activate the microphone
- Transfer the call
- Switch from one call to the other
- Conference/merge two active calls

Answering Or Ignoring A Call With No Call Currently In Progress

When an incoming call rings or is announced on Uconnect, push the PHONE button.

Answering Or Ignore An Incoming Call With A Call Currently In Progress

When an incoming call rings or is announced on Uconnect, push the PHONE button to answer the call and put the ongoing call on hold.

NOTE: Not all mobile phones may support the management of an incoming call when another phone conversation is active.

Managing Two Phone Calls

If two calls are in progress (one active and one on hold), it is possible to switch between them pressing the "Call On Hold" button or to merge the two calls in a conference pressing the "Merge calls" button.

NOTE: Check whether the telephone in use supports the management of a second call and the "Conference" mode.

Transferring/Call Continuation

Transferring

The ongoing calls can be transferred from the mobile phone to the system and vice versa without ending the call.

To transfer the call, press the "Transfer" button.

Call Continuation

After the engine is switched off, it is still possible to continue a phone call.

The call continues until it is ended manually or for a maximum period of about 20 minutes.

When the system is switched off the call is transferred to the mobile phone.

Ending A Call

Press the "End" button on the touchscreen or the PHONE button on the steering wheel controls to end a call in progress.

Only the ongoing call is ended and any call on hold becomes the new active call.

Depending on the type of mobile phone, if the ongoing call is ended by the caller, the call on hold may not be activated automatically.

UCONNECT PHONE FEATURES

Mute/Unmute

1. During a call, push the VOICE COMMAND button on the steering wheel.
2. After the BEEP, say "mute" (or "mute off").

Reading Messages

The system can read the messages received by the mobile phone.

To use this function the mobile phone must support the SMS exchange function via Bluetooth.

If this function is not supported by the phone, the corresponding message button is deactivated (greyed out) or may only accept incoming messages.

When a text message is received, the display will show a screen where the options "Listen", "Call" or "Ignore" can be selected.

Press the message button to access the list of SMS messages received by the mobile phone (the list displays a maximum of 60 messages received).

VOICE RECOGNITION QUICK TIPS

CONTENTS

■ OPERATING VOICE RECOGNITION.34	□ Media.37
□ Introducing Uconnect.34	□ Phone.38
□ How To Activate Voice Commands34	□ Voice Text Reply38
□ Basic Voice Commands.36	□ General Information.39
□ Radio36	□ Additional Information.39

OPERATING VOICE RECOGNITION

WARNING!

ALWAYS drive safely with your hands on the wheel. You have full responsibility and assume all risks related to the use of the Uconnect features and applications in this vehicle. Only use Uconnect when it is safe to do so. Failure to do so may result in an accident involving serious injury or death.

Introducing Uconnect

Start using Uconnect Voice Recognition with these helpful quick tips. It provides the key Voice Commands and tips you need to know to control your Uconnect 3 system. Key Features:

- 5" touchscreen
- Three buttons on either side of the display



1001121607US

How To Activate Voice Commands

1. Visit UconnectPhone.com to check mobile device and feature compatibility and to find phone pairing instructions.
2. Reduce background noise. Wind and passenger conversations are examples of noise that may impact recognition.
3. Speak clearly at a normal pace and volume while facing straight ahead. The microphone is positioned on the rearview mirror and aimed at the driver.

4. Each time you give a Voice Command, you must first push either the VR or PHONE button, wait until after the beep, then say your Voice Command.
5. You can interrupt the help message or system prompts by pushing the VR or PHONE button and saying a Voice Command from current category.

All you need to control your Uconnect system with your voice are the buttons on your steering wheel.

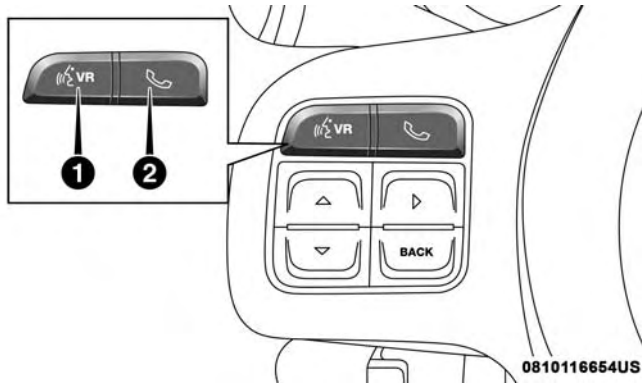

- 1 — Push To Begin Radio Or Media Functions
- 2 — Push To Initiate, Answer/End A Phone Call, Send Or Receive A Text

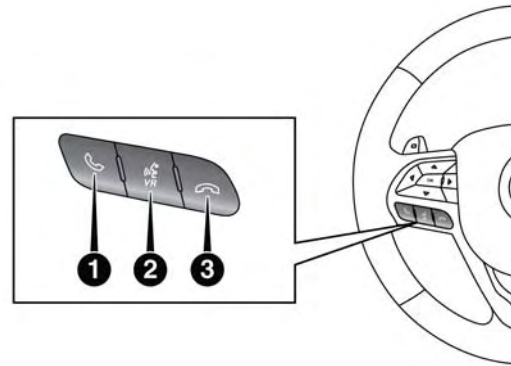

- 1 — Push To Initiate Or To Answer A Phone Call, Send Or Receive A Text
- 2 — Push To Begin Radio Or Media Functions
- 3 — Push To End Call

Basic Voice Commands

The basic Voice Commands below can be given at any point while using your Uconnect system.

Push the VR button . After the beep, say:

- “Cancel” to stop a current voice session
- “Help” to hear a list of suggested Voice Commands
- “Repeat” to listen to the system prompts again

Notice the visual cues that inform you of your voice recognition system’s status. Cues appear on the touch-screen.



Radio

Use your voice to quickly get to the AM or FM radio stations.

Push the VR button . After the beep, say:

- “ Tune to ninety-five-point-five FM”
- “ Tune to Satellite Hits 1”

TIP: At any time, if you are not sure of what to say or want to learn a Voice Command, push the VR button  and say “Help.” The system will provide you with a list of commands.



Media

Uconnect offers connections via USB, SD, Bluetooth and Auxiliary ports (If Equipped). Voice operation is only available for connected USB and iPod devices. (Remote CD player optional and not available on all vehicles.)

Push the VR button . After the beep, say one of the following commands and follow the prompts to switch your media source or choose an artist.

- “ Change source to Bluetooth”
- “ Change source to iPod”
- “ Change source to USB”
- “ Play artist Beethoven”; “ Play album Greatest Hits”; “ Play song Moonlight Sonata”; “ Play genre Classical”

TIP: Press the “Browse” button on the touchscreen to see all of the music on your iPod or USB device. Your Voice Command must match **exactly** how the artist, album, song and genre information is displayed.

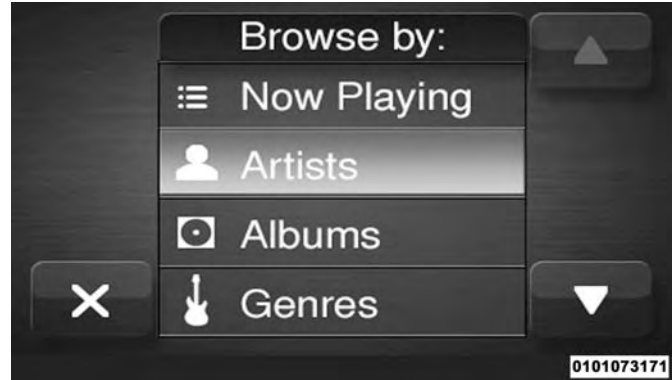

Phone

Making and answering hands-free phone calls is easy with Uconnect. When the Phonebook button is illuminated on your touchscreen, your system is ready. Check UconnectPhone.com for mobile phone compatibility and pairing instructions.

Push the PHONE button . After the beep, say one of the following commands:

- “ Call John Smith”
- “ Dial 123-456-7890 and follow the system prompts”
- “ Redial (call previous outgoing phone number)”
- “ Call back (call previous incoming phone number)”

TIP: When providing a Voice Command, push the PHONE button  and say “Call,” then pronounce the name **exactly** as it appears in your phone book. When a contact has multiple phone numbers, you can say “ Call John Smith **work**.”



Voice Text Reply

Uconnect will announce **incoming** text messages. Push the PHONE button  and say **Listen**. (Must have compatible mobile phone paired to Uconnect system.)

1. Once an incoming text message is read to you, push the PHONE button . After the beep, say... “**Reply**”
2. Listen to the Uconnect prompts. After the beep, repeat one of the pre-defined messages and follow the system prompts.

PRE-DEFINED VOICE TEXT REPLY RESPONSES		
Yes.	Stuck in traffic.	See you later.
No.	Start without me.	I'll be late.
Okay.	Where are you?	I will be <number> minutes late.
Call me.	Are you there yet?	
I'll call you later.	I need directions.	See you in <number> of minutes.
I'm on my way.	Can't talk right now.	
I'm lost.		Thanks.

TIP: Your mobile phone must have the full implementation of the **Message Access Profile (MAP)** to take advantage of this feature. For details about MAP, visit UconnectPhone.com. Apple iPhone iOS6 or later supports reading **incoming** text messages only.

General Information

The following regulatory statement applies to all Radio Frequency (RF) devices equipped in this vehicle:

This device complies with Part 15 of the FCC Rules and with Industry Canada license-exempt RSS standard(s). Operation is subject to the following two conditions

1. This device may not cause harmful interference, and
2. This device must accept any interference received, including interference that may cause undesired operation.

NOTE: Changes or modifications not expressly approved by the party responsible for compliance could void the user's authority to operate the equipment.

Additional Information

© 2017 FCA US LLC. All rights reserved. Mopar and Uconnect are registered trademarks and Mopar Owner Connect is a trademark of FCA US LLC. Android is a trademark of Google Inc.

For Uconnect system support, visit DriveUconnect.com (U.S. Residents) or DriveUconnect.ca (Canadian Residents).



18UC35RF-526-AB

Second Edition
Uconnect 3 with 5" Display
Printed in the USA



©2017 FCA US LLC. All Rights Reserved.

Chrysler, Dodge, Jeep, Ram, Mopar and Uconnect are trademarks of FCA US LLC.

FIAT is a registered trademark of FCA Group Marketing S.p.A.,
used under license by FCA US LLC.