



## 2018 JEEP® WRANGLER USER GUIDE

ALL NEW

Jeep

## Important

---

Get warranty and other information online – you can review and print or download a copy of the Owner’s Manual, Navigation/Uconnect manuals and the limited warranties provided by FCA US LLC for your vehicle by visiting [www.mopar.com](http://www.mopar.com) (U.S.) or [www.owners.mopar.ca](http://www.owners.mopar.ca) (Canada). Click on the applicable link in the “Popular Topics” area of the [www.mopar.com](http://www.mopar.com) (U.S.) or [www.owners.mopar.ca](http://www.owners.mopar.ca) (Canada) homepage and follow the instructions to select the applicable year, make and model of your vehicle.

If you are the first registered retail owner of your vehicle, you may obtain a complimentary printed copy of the Warranty Booklet by calling **1-877-426-5337** (U.S.) or **1-800-387-1143** (Canada) or by contacting your dealer.

The driver’s primary responsibility is the safe operation of the vehicle. Driving while distracted can result in loss of vehicle control, resulting in a collision and personal injury. FCA US LLC strongly recommends that the driver use extreme caution when using any device or feature that may take their attention off the road.

Use of any electrical devices, such as cellular telephones, computers, portable radios, vehicle navigation or other devices, by the driver while the vehicle is moving is dangerous and could lead to a serious collision. Texting while driving is also dangerous and should never be done while the vehicle is moving.

If you find yourself unable to devote your full attention to vehicle operation, pull off the road to a safe location and stop your vehicle. Some states or provinces prohibit the use of cellular telephones or texting while driving. It is always the driver’s responsibility to comply with all local laws.

 **WARNING:** Operating, servicing and maintaining a passenger vehicle or off-road highway motor can expose you to chemicals including engine exhaust, carbon monoxide, phthalates, and lead, which are known to the State of California to cause cancer and birth defects or other reproductive harm. To minimize exposure, avoid breathing exhaust, do not idle the engine except as necessary, service your vehicle in a well-ventilated area and wear gloves or wash your hands frequently when servicing your vehicle. For more information go to: [www.p65Warnings.ca.gov/passenger-vehicle](http://www.p65Warnings.ca.gov/passenger-vehicle).

Congratulations on selecting your new FCA US LLC vehicle. Be assured that it represents precision workmanship, distinctive styling, and high quality.

ALWAYS drive safely and pay attention to the road. ALWAYS drive safely with your hands on the steering wheel. You have full responsibility and assume all risks related to the use of the features and applications in this vehicle. Only use the features and applications when it is safe to do so. Failure to do so may result in an accident involving serious injury or death.

This guide illustrates and describes the operation of features and equipment that are either standard or optional on this vehicle. This guide may also include a description of features and equipment that are no longer available or were not ordered on this vehicle. Please disregard any features and equipment described in this guide that are not available on this vehicle. FCA US LLC reserves the right to make changes in design and specifications and/or make additions to or improvements to its products without imposing any obligation upon itself to install them on products previously manufactured.

This User Guide has been prepared to help you quickly become acquainted with the important features of your vehicle. It contains most things you will need to operate and maintain the vehicle, including emergency information.

When it comes to service, remember that your authorized dealer knows your Jeep® vehicle best, has factory-trained technicians and genuine MOPAR® parts, and cares about your satisfaction.

## HOW TO FIND YOUR OWNER'S MANUAL ONLINE

This publication has been prepared as a reference item to help you quickly become acquainted with the most important features and processes of your vehicle. It contains most things you will need to operate and maintain the vehicle, including emergency information and procedures.

**This User Guide is not a replacement for the full Owner's Manual, and does not fully cover every operation and procedure possible with your vehicle.**

For more detailed descriptions of the topics discussed in this User Guide, as well as information covering features and processes not covered in this User Guide, the full vehicle Owner's Manual can be accessed for free online in a printer-friendly PDF format.

**To get the full Owner's Manual or applicable supplement for your vehicle, follow the appropriate web address below:**

[www.mopar.com/en-us/care/owners-manual.html](http://www.mopar.com/en-us/care/owners-manual.html)  
(U.S. Residents)

[www.owners.mopar.ca](http://www.owners.mopar.ca) (Canadian Residents)

FCA US LLC is committed to protecting our environment and natural resources. By converting from paper to electronic delivery for the majority of the user information for your vehicle, together we greatly reduce the demand for tree-based products and lessen the stress on our environment. ♻️

## HOW TO USE THIS MANUAL

### Essential Information

Each time direction instructions (left/right or forwards/backwards) about the vehicle are given, these must be intended as regarding an occupant in the driver's seat. Special cases not complying with this rule will be properly specified in the text.

The figures in this User Guide are provided by way of example only: this might imply that some details of the image do not correspond to the actual arrangement of your vehicle.

In addition, the User Guide has been conceived considering vehicles with the steering wheel on the left side; it is therefore possible that in vehicles with the steering wheel on the right side, the position or construction of some controls is not exactly mirror-like with respect to the figure.

To identify the chapter with the information needed you can consult the index at the end of this User Guide.

Chapters can be rapidly identified with dedicated graphic tabs, at the side of each odd page. A few pages further there is a key for getting to know the chapter order and the relevant symbols in the tabs. There is always a textual indication of the current chapter at the side of each even page.

### Symbols

Some vehicle components have colored labels whose symbols indicate precautions to be observed when using this component. Refer to “Warning Lights and Messages” in “Getting To Know Your Instrument Panel” for further information on the symbols used in your vehicle.

## ROLLOVER WARNING

Utility vehicles have a significantly higher rollover rate than other types of vehicles. This vehicle has a higher ground clearance and a higher center of gravity than many passenger vehicles. It is capable of performing better in a wide variety of off-road applications. Driven in an unsafe manner, all vehicles can go out of control. Because of the higher center of gravity, if this vehicle is out of control it may roll over while some other vehicles may not.

Do not attempt sharp turns, abrupt maneuvers, or other unsafe driving actions that can cause loss of vehicle control. Failure to operate this vehicle safely may result in a collision, rollover of the vehicle, and severe or fatal injury. Drive carefully.



Rollover Warning Label











Failure to use the driver and passenger seat belts provided is a major cause of severe or fatal injury. In fact, the U.S. government notes that the universal use of existing seat belts could cut the highway death toll by 10,000 or more each year and could reduce disabling injuries by two million annually. In a rollover crash, an unbelted person is significantly more likely to die than a person wearing a seat belt. Always buckle up.

## **WARNINGS AND CAUTIONS**

While reading this User Guide you will find a series of WARNINGS to be followed to prevent incorrect use of components which could cause accidents or injuries.

There are also CAUTIONS that must be followed to prevent against procedures that could result in damage to your vehicle.



<b>GRAPHICAL TABLE OF CONTENTS</b>	
<b>GETTING TO KNOW YOUR VEHICLE</b>	
<b>GETTING TO KNOW YOUR INSTRUMENT PANEL</b>	
<b>SAFETY</b>	
<b>STARTING AND OPERATING</b>	
<b>IN CASE OF EMERGENCY</b>	
<b>SERVICING AND MAINTENANCE</b>	
<b>TECHNICAL SPECIFICATIONS</b>	
<b>MULTIMEDIA</b>	
<b>CUSTOMER ASSISTANCE</b>	
<b>INDEX</b>	





# GRAPHICAL TABLE OF CONTENTS

**INSTRUMENT PANEL . . . . .8**

**INTERIOR . . . . .9**



## INSTRUMENT PANEL

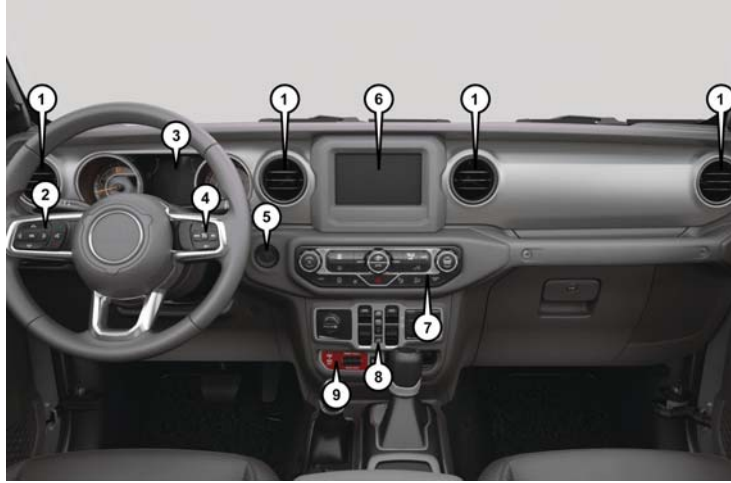

Instrument Panel

- 1 — Air Outlets
- 2 — Instrument Cluster Display Controls
- 3 — Instrument Cluster

- 4 — Speed Control Buttons
- 5 — Ignition Button
- 6 — Uconnect Radio

- 7 — Climate Controls
- 8 — Power Window Switches
- 9 — Offroad Switch Panel

## INTERIOR



Interior Features

1 — Steering Wheel  
2 — Seats

3 — Gear Selector  
4 — Glove Compartment





# GETTING TO KNOW YOUR VEHICLE

<b>VEHICLE USER GUIDE — IF EQUIPPED</b> . . . . .	<b>.13</b>	<b>SEATS</b> . . . . .	<b>.27</b>	High/Low Beam Switch . . . . .	.37
<b>KEYS</b> . . . . .	<b>.14</b>	Heated Seats — If Equipped . . . . .	.28	Flash-To-Pass . . . . .	.38
Key Fob . . . . .	.14	Front Passenger Easy Entry Seat — Two Door Models . . . . .	.29	Automatic Headlights — If Equipped . . . . .	.38
<b>IGNITION SWITCH</b> . . . . .	<b>.16</b>	60/40 Split Folding Rear Seat — Four Door Models . . . . .	.29	Front Fog Lights — If Equipped . . . . .	.38
Keyless Enter-N-Go — Ignition . . . . .	.16	Fold And Tumble Rear Seat — Two Door Models . . . . .	.30	Turn Signals . . . . .	.38
<b>REMOTE STARTING SYSTEM — IF EQUIPPED</b> . . . . .	<b>.17</b>	<b>HEAD RESTRAINTS</b> . . . . .	<b>.32</b>	Lane Change Assist — If Equipped . . . . .	.38
How To Use Remote Start . . . . .	.18	Front Head Restraints . . . . .	.32	Lights-On Reminder . . . . .	.38
To Enter Remote Start Mode . . . . .	.18	Rear Head Restraints — Two Door Models . . . . .	.33	<b>WINDSHIELD WIPERS AND WASHERS</b> . . . . .	<b>.39</b>
General Information . . . . .	.19	Rear Head Restraints — Four Door Models . . . . .	.34	Windshield Wiper Operation . . . . .	.39
<b>VEHICLE SECURITY ALARM — IF EQUIPPED</b> . . . . .	<b>.19</b>	<b>STEERING WHEEL</b> . . . . .	<b>.35</b>	<b>CLIMATE CONTROLS</b> . . . . .	<b>.40</b>
To Arm The System . . . . .	.19	Tilt/Telescoping Steering Column . . . . .	.35	Automatic Climate Controls Overview . . . . .	.40
To Disarm The System . . . . .	.19	Heated Steering Wheel — If Equipped . . . . .	.35	Climate Control Functions . . . . .	.46
<b>DOORS</b> . . . . .	<b>.20</b>	<b>MIRRORS</b> . . . . .	<b>.36</b>	Automatic Temperature Control (ATC) — If Equipped . . . . .	.46
Keyless Enter-N-Go — Passive Entry (If Equipped) . . . . .	.20	Heated Mirrors — If Equipped . . . . .	.36	Operating Tips . . . . .	.47
Front Door Removal . . . . .	.23	<b>EXTERIOR LIGHTS</b> . . . . .	<b>.37</b>	<b>POWER WINDOWS — IF EQUIPPED</b> . . . . .	<b>.48</b>
Rear Door Removal (Four-Door Models) . . . . .	.26	Headlight Switch . . . . .	.37	Auto-Down Feature . . . . .	.49
		Daytime Running Lights — If Equipped . . . . .	.37	Wind Buffeting . . . . .	.49



<b>REMOVABLE TOP INFORMATION . . . . .</b>	<b>49</b>	<b>HOOD . . . . .</b>	<b>59</b>	Programming HomeLink To A Garage Door Opener . . . . .	62
Soft Top — Two And Four Door Models . . . . .	50	Opening The Hood . . . . .	59	Programming HomeLink To A Miscellaneous Device . . . . .	63
Freedom Top And Hard Top . . . . .	54	Closing The Hood . . . . .	59	Reprogramming A Single HomeLink Button . . . . .	63
Dual Top — If Equipped . . . . .	56	<b>REAR SWING GATE . . . . .</b>	<b>59</b>	General Information . . . . .	63
Wind Buffeting . . . . .	57	<b>UNIVERSAL GARAGE DOOR OPENER (HOMELINK) . . . . .</b>	<b>60</b>	<b>INTERNAL EQUIPMENT . . . . .</b>	<b>64</b>
<b>POWER SLIDING TOP — IF EQUIPPED . . . . .</b>	<b>57</b>	Before You Begin Programming HomeLink . . . . .	61	Electrical Power Outlets . . . . .	64
Opening The Power Top . . . . .	58	Erasing All The HomeLink Channels . . . . .	61	Power Inverter — If Equipped . . . . .	66
Closing The Power Top . . . . .	58	Identifying Whether You Have A Rolling Code Or Non-Rolling Code Device . . . . .	61	Auxiliary Switches — If Equipped . . . . .	67
Pinch Protect Feature . . . . .	58				

## VEHICLE USER GUIDE — IF EQUIPPED

Access your Owner's Information right through your Uconnect 4C or 4C NAV touch-screen system — If Equipped.

To access the Vehicle User Guide on your Uconnect Touchscreen: Press the Uconnect **Apps** button. From there, press the **Vehicle User Guide** icon on your touchscreen. No Uconnect registration is required.



Uconnect 4C NAV With 8.4-inch Display  
Vehicle User Guide Touchscreen Icon

### NOTE:

Vehicle User Guide features are not available while the vehicle is moving. If you try to access while the vehicle is in motion, the system will display: Feature not available while the vehicle is in motion.

### Pre-Installed Features

<ul style="list-style-type: none"><li>Your User Guide — Updated in real-time</li></ul>	<ul style="list-style-type: none"><li>Available when and where you need it</li></ul>
<ul style="list-style-type: none"><li>Touchscreen convenience</li></ul>	<ul style="list-style-type: none"><li>Customizable interface</li></ul>
<ul style="list-style-type: none"><li>Maintenance schedules and information</li></ul>	<ul style="list-style-type: none"><li>Multilingual</li></ul>
<ul style="list-style-type: none"><li>Comprehensive icon &amp; symbol glossary</li></ul>	

Once you launch your Vehicle User Guide, you will be able to explore your warranty information and radio manual when and where you need them. Your Uconnect system displays the Vehicle User Guide on your touchscreen radio to assist in better understanding your vehicle.

There's no app to download, no phone to connect and no external device needed for playback. Plus, it's updated throughout the year, in real-time, so it never goes out of date.

### Features/Benefits

- Pre-installed on your Uconnect touchscreen radio
- Enhanced search and browsing capability
- Robust NAV application — If Equipped
- Add selected topics to a fast-access Favorites category
- Icon and symbol glossary
- Warranty information
- Crucial driver information and assistance:

<ul style="list-style-type: none"><li>Operating Instructions</li></ul>	<ul style="list-style-type: none"><li>Maintenance Schedules</li></ul>
<ul style="list-style-type: none"><li>Warranty Information</li></ul>	<ul style="list-style-type: none"><li>Emergency Procedures</li></ul>
<ul style="list-style-type: none"><li>Fluid Level Standards</li></ul>	<ul style="list-style-type: none"><li>911 Contact and More</li></ul>

**Tip:** When viewing a topic, tap the star icon to add it to your Favorites, for easy access in the future.



## KEYS

### Key Fob

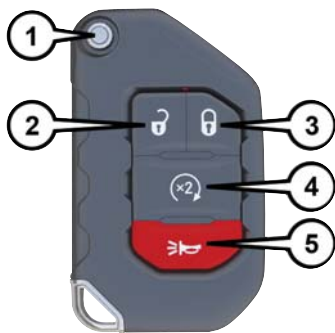

Key Fob

- 1 — Key Release Button
- 2 — Unlock Button
- 3 — Lock Button
- 4 — Remote Start
- 5 — Panic Button

### WARNING!

Push the Mechanical Key Release Button only with the key fob facing away from your body, especially your eyes and objects that may be damaged, such as clothing.

Your vehicle uses a keyless ignition system. The ignition system consists of a key fob with Keyless Go and a START/STOP push button ignition system. The Remote Keyless Entry system consists of a key fob with a mechanical key and Keyless Enter-N-Go feature if equipped.

### NOTE:

The key fob may not be detected by the vehicle if it is located next to a mobile phone, laptop or other electronic device; these devices may block the key fob's wireless signal.

### CAUTION!

The electrical components inside of the key fob may be damaged if the key fob is subjected to strong electrical shocks. In order to ensure complete efficiency of the

### CAUTION!

electronic devices inside of the key fob, avoid exposing the key fob to direct sunlight.

The key fob allows you to lock or unlock the doors and swing gate from distances up to approximately 66 ft (20 m) by pressing the appropriate button on the fob. The key fob does not need to be pointed at the vehicle to activate the system.

### NOTE:

With the ignition in ON/RUN position and with the vehicle doors open, the lock button will be disabled, and only the unlock button will be enabled. All RKE commands will be disabled once the vehicle begins moving at 5 mph (8 km/h) or above.

### Backup Mode Starting

In case the ignition switch does not change with the push of a button, the key fob may have a low or fully depleted battery. A low key fob battery can be verified by referring to the instrument cluster, which will display directions to follow.



**NOTE:**

A low key fob battery condition may be indicated by a message in the instrument cluster display, or by the LED light on the key fob. If the LED key fob light no longer illuminates from key fob button pushes, then the key fob battery requires replacement.

In this situation, a back up method can be used to operate the ignition switch. Put the nose side of the key fob against the ENGINE START/STOP button, and push to operate the ignition switch.



**Backup Starting Method**

**To Unlock The Doors And Swing Gate**

Push and release the key fob unlock button once to unlock the driver's door only, or twice to unlock all the doors and swing gate. When the key fob unlock button is pushed, the Illuminated Entry will initiate, and the turn signal lights will flash twice.

**To Lock The Doors And Swing Gate**

Push and release the lock button on the key fob to lock all doors. The turn signals will flash, and the horn will chirp once to acknowledge the lock signal.

**Request For Additional Key Fobs****NOTE:**

Only key fobs that are programmed to the vehicle electronics can be used to start and operate the vehicle. Once a key fob is programmed to a vehicle, it cannot be programmed to any other vehicle.

**WARNING!**

- Always remove the key fobs from the vehicle and lock all doors when leaving the vehicle unattended.
- Always remember to place the ignition in the OFF mode.

Duplication of key fobs may be performed at an authorized dealer. This procedure consists of programming a blank key fob to the vehicle electronics. A blank key fob is one that has never been programmed.

**NOTE:**

- When having the Sentry Key Immobilizer System serviced, bring all vehicle keys with you to an authorized dealer.
- Keys must be ordered to the correct key cut to match the vehicle locks.



## General Information

The following regulatory statement applies to all radio frequency (RF) devices equipped in this vehicle:

This device complies with Part 15 of the FCC Rules and with Industry Canada license-exempt RSS standard(s). Operation is subject to the following two conditions:

1. This device may not cause harmful interference, and
2. This device must accept any interference received, including interference that may cause undesired operation.

### NOTE:

Changes or modifications not expressly approved by the party responsible for compliance could void the user's authority to operate the equipment.

## IGNITION SWITCH

### Keyless Enter-N-Go – Ignition

This feature allows the driver to operate the ignition switch with the push of a button as long as the key fob is in the passenger compartment.

The Keyless Push Button Ignition has several operating modes that are labeled and will illuminate when in position. These modes are OFF, ACC, RUN, and START.

### NOTE:

In case the ignition switch does not change with the push of a button, the key fob may have a low or dead battery. In this situation, a back up method can be used to operate the ignition switch. Put the nose side of the key fob (side opposite of the Emergency Key) against the ENGINE START/STOP button and push to operate the ignition switch.



**START/STOP Ignition Button**

The push button ignition can be placed in the following modes:

### OFF

- The engine is stopped.
- Some electrical devices (e.g. Central locking, alarm, etc.) are available.

## ACC

- Engine is not started.
- Some electrical devices are available.

## RUN

- Driving position.
- All electrical devices are available.

## START

- The engine will start.

### WARNING!

- When exiting the vehicle, always remove the key fob from the vehicle and lock your vehicle.
- Never leave children alone in a vehicle, or with access to an unlocked vehicle.
- Allowing children to be in a vehicle unattended is dangerous for a number of reasons. A child or others could be seriously or fatally injured. Children should be warned not to touch the parking brake, brake pedal or the gear selector.

### WARNING!

- Do not leave the key fob in or near the vehicle, or in a location accessible to children, and do not leave the ignition of a vehicle equipped with Keyless Enter-N-Go in the ON/RUN mode. A child could operate power windows, other controls, or move the vehicle.
- Do not leave children or animals inside parked vehicles in hot weather. Interior heat build-up may cause serious injury or death.

### CAUTION!

An unlocked vehicle is an invitation for thieves. Always remove key fob from the vehicle and lock all doors when leaving the vehicle unattended.

### NOTE:

Refer to "Starting The Engine," in "Starting And Operating" in the Owner's Manual for further information.

## REMOTE STARTING SYSTEM – IF EQUIPPED



This system uses the key fob to start the engine conveniently from outside the vehicle while still maintaining security. The system has a range of 328 ft (100 m).

The Remote Starting System also activates the Climate Control, vented seats (if equipped) in temperatures above 80° F (26.7° C), and the heated seats (if equipped), and heated steering wheel (if equipped) in temperatures below 40° F (4.4° C). Refer to "Heated Seats" in "Getting To Know Your Vehicle" in the Owner's Manual for further information.

### NOTE:

- The vehicle must be equipped with an automatic transmission to be equipped with Remote Start.
- Obstructions between the vehicle and key fob may reduce this range.



## How To Use Remote Start

- Push Remote Start button on the key fob twice within five seconds. Pushing the Remote Start button a third time shuts the engine off.
- To drive the vehicle, push unlock button, and place the ignition in the ON/RUN position.
- With remote start, the engine will only run for 15 minutes (timeout) unless the ignition key is placed in the ON/RUN position.
- The vehicle must be started with the key after two consecutive timeouts.

All of the following conditions must be met before the engine will remote start:

- Gear Selector in PARK
- Doors closed
- Hood closed
- Swing Gate closed
- Hazard switch off
- Brake switch inactive (brake pedal not pushed)
- Battery at an acceptable charge level

- PANIC button not pushed
- System not disabled from previous remote start event
- Vehicle alarm system indicator flashing
- Ignition in STOP/OFF position
- Fuel level meets minimum requirement
- All removable doors must not be removed
- Malfunction indicator light not illuminated

### WARNING!

- Do not start or run an engine in a closed garage or confined area. Exhaust gas contains Carbon Monoxide (CO) which is odorless and colorless. Carbon Monoxide is poisonous and can cause serious injury or death when inhaled.
- Keep key fobs away from children. Operation of the Remote Start System, windows, door locks or other controls could cause serious injury or death.

## To Enter Remote Start Mode

Push and release the Remote Start button on the key fob twice within five seconds. The vehicle doors will lock, the turn signals will flash twice, and the horn will chirp twice. Then the engine will start, and the vehicle will remain in the Remote Start mode for a 15-minute cycle.

### NOTE:

- If an engine fault is present or fuel level is low, the vehicle will start and then shut down in 10 seconds.
- The park lamps will turn on and remain on during Remote Start mode.
- For security, power window operation is disabled when the vehicle is in the Remote Start mode.
- The engine can be started two consecutive times (two 15-minute cycles) with the key fob. However, the ignition must be placed in the ON/RUN position before you can repeat the start sequence for a third cycle.

## General Information

The following regulatory statement applies to all radio frequency (RF) devices equipped in this vehicle:

This device complies with Part 15 of the FCC Rules and with Industry Canada license-exempt RSS standard(s). Operation is subject to the following two conditions:

1. This device may not cause harmful interference, and
2. This device must accept any interference received, including interference that may cause undesired operation.

### NOTE:

Changes or modifications not expressly approved by the party responsible for compliance could void the user's authority to operate the equipment.

## VEHICLE SECURITY ALARM — IF EQUIPPED

The vehicle security alarm monitors the vehicle doors for unauthorized entry and the ignition switch for unauthorized operation. When the alarm is activated, the interior switches for door locks are disabled. The vehicle security alarm provides both audible and visible signals. If something triggers the alarm, the vehicle security alarm will provide the following audible and visible signals: the horn will pulse, the park lamps and/or turn signals will flash, and the vehicle security light in the instrument cluster will flash.

### To Arm The System

Follow these steps to arm the vehicle security alarm:

1. Make sure the vehicle's ignition is cycled to the "OFF" position (refer to "Starting The Engine" in "Starting And Operating" for further information).

2. Perform one of the following methods to lock the vehicle:

- Push lock on the interior power door lock switch with the driver and/or passenger door open.
- Push the lock button on the exterior Passive Entry Door Handle with a valid key fob available in the same exterior zone (refer to "Keyless Enter-N-Go — Passive Entry" in "Getting To Know Your Vehicle" for further information).
- Push the lock button on the key fob.

3. If any doors are open, close them.

### To Disarm The System

The vehicle security alarm can be disarmed using any of the following methods:

- Push the unlock button on the key fob.
- Grasp the Passive Entry Unlock Door Handle (if equipped, refer to "Keyless Enter-N-Go — Passive Entry" in "Getting To Know Your Vehicle" for further information).



- Cycle the vehicle ignition system out of the OFF position.

**NOTE:**

- The driver's door key cylinder cannot arm or disarm the vehicle security alarm.
- When the vehicle security alarm is armed, the interior power door lock switches will not unlock the doors.

The vehicle security alarm is designed to protect your vehicle. However, you can create conditions where the system will give you a false alarm. If one of the previously described arming sequences has occurred, the vehicle security alarm will arm regardless of whether you are in the vehicle or not. If you remain in the vehicle and open a door, the alarm will sound. If this occurs, disarm the vehicle security alarm.

If the vehicle security alarm is armed and the battery becomes disconnected, the vehicle security alarm will remain armed when the battery is reconnected; the exterior lights will flash, and the horn will sound. If this occurs, disarm the vehicle security alarm.

**DOORS****CAUTION!**

Careless handling and storage of the removable door panels may damage the seals, causing water to leak into the vehicle's interior.

**Keyless Enter-N-Go – Passive Entry (If Equipped)**

The Passive Entry system is a feature that allows you to lock and unlock the vehicle's door(s) and swing gate without having to push the key fob lock or unlock buttons.

**NOTE:**

- Passive Entry may be programmed ON/OFF; refer to “Uconnect Settings” in “Multimedia” in your Owner's Manual for further information.
- The key fob may not be detected by the vehicle passive entry system if it is located next to a mobile phone, laptop, or other electronic device; these devices may inter-

fer with the key fob's wireless signal and prevent the passive entry system from locking/unlocking the vehicle.

- Passive Entry Unlock initiates illuminated approach (Low Beams, License Plate Lamp, Position Lamps) for whichever time duration is set between 0, 30 (default), 60 or 90 seconds. Passive Entry Unlock also initiates two flashes of the turn signal lamps.
- If wearing gloves on your hands, or if it has been raining/snowing on the Passive Entry door handle, the unlock sensitivity can be affected, resulting in a slower response time.
- If the vehicle is unlocked by Passive Entry and no door is opened within 60 seconds, the vehicle will re-lock and if equipped will arm the security alarm.

**To Unlock From The Driver Side**

With a valid Passive Entry key fob within 5 ft (1.5 m) of the driver's door handle, grab the front driver door handle to unlock the driver's door automatically.



**Grab The Door Handle To Unlock**

**NOTE:**

If “1st Press Of Key Fob Unlock” is programmed all doors will unlock when you grab hold of the front driver’s door handle. To select between “Unlock Driver Door 1st Press” and “Unlock All Doors 1st Press,” refer to “Uconnect Settings” in “Multimedia” in your Owner’s Manual for further information.

### To Unlock From The Passenger Side

With a valid Passive Entry key fob within 5 ft (1.5 m) of the passenger door handle, grab the front passenger door handle to unlock all doors and the swing gate automatically.

**NOTE:**

All doors will unlock when the front passenger door handle is grabbed regardless of the driver’s door unlock preference setting (“Unlock Driver Door 1st Press” or “Unlock All Doors 1st Press”).

### Preventing Inadvertent Locking Of Passive Entry Key Fob In Vehicle (FOBIK-Safe)

To minimize the possibility of unintentionally locking a Passive Entry key fob inside your vehicle, the Passive Entry system is equipped with an automatic door unlock feature which will function only if the ignition switch is in the OFF position.

FOBIK-Safe only executes in vehicles with passive entry. There are three situations that trigger a FOBIK-Safe search in any passive entry vehicle:

- A lock request is made by a valid Passive Entry key fob while a door is open.

- A lock request is made by the Passive Entry door handle while a door is open.
- A lock request is made by the door panel lock switch while the door is open.

When any of these situations occur, after all open doors are shut, the FOBIK-Safe search will be executed. If it finds a Passive Entry key fob inside the car, the car will unlock and alert the customer. If Passive Entry is disabled using Uconnect System, the key protection described in "Preventing Inadvertent Locking of Passive Entry Key Fob in Vehicle" remains active/functional.

**NOTE:**

The vehicle will only unlock the doors during a FOBIK-Safe operation when a valid Passive Entry key fob is detected inside the vehicle. The vehicle will not unlock the doors when any of the following conditions are true:

- A second valid passive entry key fob is detected outside of the vehicle (within 5ft of a passive entry door handle).
- The doors are manually locked using the door lock knobs.



- Three attempts are made to lock the doors using the door panel switch and then close the doors.

#### To Lock The Vehicle's Doors And Swing Gate

With one of the vehicle's Passive Entry key fob within 5 ft (1.5 m) of the driver or passenger front door handles, pushing the passive entry lock button will lock the vehicle doors and the swing gate.



**Push The Door Handle Button To Lock**

#### NOTE:

DO NOT grab the door handle, when pushing the door handle lock button. This could unlock the door(s).



**DO NOT Grab The Door Handle When Locking**

The vehicle doors can also be locked by using the lock button located on the vehicle's interior door panel.

#### To Unlock/Enter The Swing Gate

The Swing Gate passive entry unlock feature is built into handle of the Swing Gate. With a valid Passive Entry key fob within 5 ft (1.5 m) of the Swing Gate, grab the Swing Gate handle to unlock the Swing Gate automatically, and pull the Swing Gate to open.

#### NOTE:

If "Unlock All Doors 1st Press" is programmed all doors & the swing gate will unlock when you grab hold of the swing gate handle. To select between "Unlock Driver Door 1st Press" and "Unlock All Doors 1st Press," refer to "Uconnect Settings" in "Multimedia" in your Owner's Manual for further information.





**Swing Gate Passive Entry Location**

### To Lock The Swing Gate

With a valid Passive Entry key fob within 5 ft (1.5 m) of the swing gate, pushing the passive entry lock button will lock the vehicle doors and the swing gate.

### NOTE:

- After pushing the door handle button, you must wait two seconds before you can lock or unlock the doors, using any Passive Entry door handle. This is done to allow you to check if the vehicle is locked by pulling the door handle without the vehicle reacting and unlocking.
- If Passive Entry is disabled using Uconnect System, the key protection described in "Preventing Inadvertent Locking of Passive Entry Key Fob in Vehicle" remains active/functional.
- The Passive Entry system will not operate if the key fob battery is dead.

### Front Door Removal

#### **WARNING!**

Do not drive your vehicle on public roads with the doors removed as you will lose the protection they can provide. This procedure is furnished for use during off-road operation only.



**Door Removal Warning Label**

#### **WARNING!**

- All occupants must wear seat belts during off-road operation with doors removed. Refer to "Off-Road Driving Tips" in "Starting And Operating" in the Owner's Manual for further information.
- Do not store detached doors inside of the vehicle, as they may cause personal injury in the event of an accident.



**NOTE:**

- Doors are heavy; use caution when removing them.
  - Hinge pin can break if overtightened during door reinstall (Max Torque: 7.5 ft·lb / 10 N·m).
1. Roll down the glass window to prevent any damage.

2. Remove the hinge pin screws from the upper and lower outside hinges (using a #T50 Torx head driver).

**NOTE:**

The hinge pin screws and nuts can be stowed in the rear cargo tray located under the rear loadfloor.



Hinge Pin Screw

3. Remove the plastic wiring access door under the instrument panel by sliding the plastic panel along the door frame toward the seats until the tabs are detached.

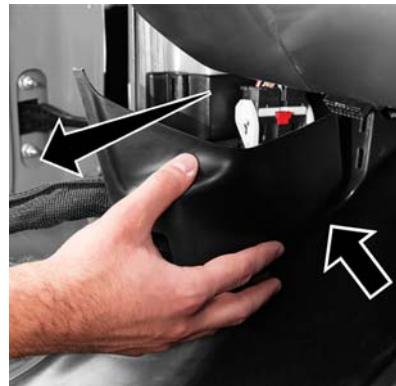

Wiring Access Door

**NOTE:**

Do not pry back to open, as this will break the plastic cover.

4. Pull up on the red locking tab to unlock the wiring harness.

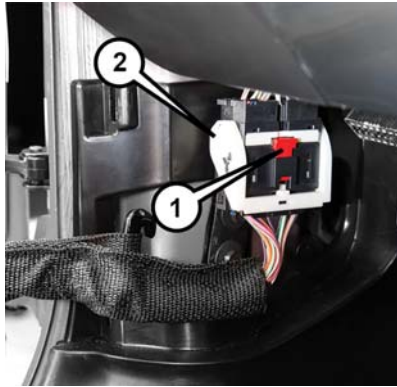

**Closed Wiring Harness**

- 1 – Locking Tab
- 2 – Wiring Harness

5. Push and hold down the black security tab under the wiring harness, and lift the harness into the open position.

6. With the wiring harness open, pull downward on the wiring connector to unplug. Store wiring connector in the lower door basket.
7. Remove the check screw from the center door check (using a #T40 Torx head driver).

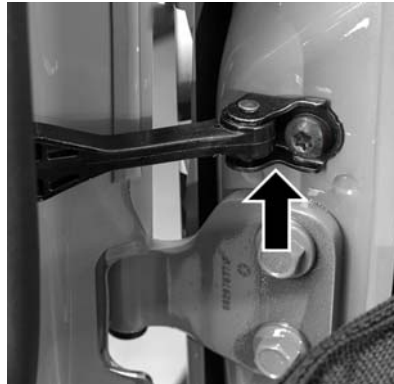

**Door Check**

8. With the door open, lift the door with the help of another person, to clear the hinge pins from their hinges and remove the door.

To reinstall the door(s), perform the previous steps in the opposite order.

**NOTE:**

The upper hinge has a longer pin, which can be used to assist in guiding the door into place when reinstalling.



## Rear Door Removal (Four-Door Models)

### WARNING!

Do not drive your vehicle on public roads with the doors removed as you will lose the protection they can provide. This procedure is furnished for use during off-road operation only.

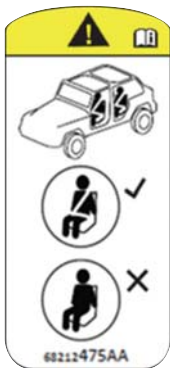

Door Removal Warning Label

### WARNING!

- All occupants must wear seat belts during off-road operation with doors removed. Refer to “Off-Road Driving Tips” in “Starting And Operating” in the Owner’s Manual for further information.
- Do not store detached doors inside of the vehicle, as they may cause personal injury in the event of an accident.

### NOTE:

- Doors are heavy; use caution when removing them.
  - Hinge pin can break if overtightened during door reinstall (Max Torque: 7.5 ft·lb / 10 N·m).
1. Roll down the glass window to prevent any damage.

2. Remove the hinge pin screws from the upper and lower outside hinges (using a #T50 Torx head driver).

### NOTE:

The hinge pin screws and nuts can be stowed in the rear cargo tray located under the rear load floor.



Hinge Pin Screw

3. Slide the front seat(s) fully forward.
4. Pry open and remove the plastic wiring access door from the bottom of the B-pillar.

5. Unplug the wiring connector.

**NOTE:**

Squeeze the tab on the base of the wiring harness. This will unlock the connector tab, allowing the wiring connector to be unplugged.



**Wiring Connector**

6. Remove the check screw from the center door check (using a #T40 Torx head driver).



**Door Check**

7. With the door open, lift the door with the help of another person, to clear the hinge pins from their hinges and remove the door.

To reinstall the door(s), perform the previous steps in the reverse order.

**NOTE:**

The upper hinge has a longer pin, which can be used to assist in guiding the door into place when reinstalling.

## SEATS

Seats are a part of the Occupant Restraint System of the vehicle.

### WARNING!

- It is dangerous to ride in a cargo area, inside or outside of a vehicle. In a collision, people riding in these areas are more likely to be seriously injured or killed.
- Do not allow people to ride in any area of your vehicle that is not equipped with seats and seat belts. In a collision, people riding in these areas are more likely to be seriously injured or killed.
- Be sure everyone in your vehicle is in a seat and using a seat belt properly.







## Heated Seats — If Equipped

The heated seats control buttons are located on the center instrument panel below the touchscreen, and are also located within the climate or controls screen of the touchscreen.



**Heated Seat Buttons**

- Push the heated seat button  once to turn the HI setting on.
- Push the heated seat button  a second time to turn the MED setting on.

- Push the heated seat button  a third time to turn the LO setting on.
- Push the heated seat button  a fourth time to turn the heating elements off.

### NOTE:

- The engine must be running for the heated seats to operate.
- The level of heat selected will stay on until the operator changes it.

### Vehicles Equipped With Remote Start

On models that are equipped with remote start, the driver's seat can be programmed to come on during a remote start.

This feature can be programmed through the Uconnect system. Refer to "Uconnect Settings" in "Multimedia" in your Owner's Manual for further information.

## WARNING!

- Persons who are unable to feel pain to the skin because of advanced age, chronic illness, diabetes, spinal cord injury, medication, alcohol use, exhaustion or other physical condition must exercise care when using the seat heater. It may cause burns even at low temperatures, especially if used for long periods of time.
- Do not place anything on the seat or seatback that insulates against heat, such as a blanket or cushion. This may cause the seat heater to overheat. Sitting in a seat that has been overheated could cause serious burns due to the increased surface temperature of the seat.

## Front Passenger Easy Entry Seat – Two Door Models

Pull upward on the easy entry lever located on the outboard side of the seat back, and slide the entire seat forward.



**Easy Entry Lever**

To return the seat to a sitting position, fold the seatback upright until it locks and push the seat rearward until the track locks.

### NOTE:

- The front passenger seats have a track memory, which returns the seat to its original position.
- The recline strap and easy entry lever should not be used during the automatic returning of the seat to its sitting position.

## 60/40 Split Folding Rear Seat – Four Door Models

To provide additional storage area, each rear seat can be folded flat to allow for extended cargo space.

### NOTE:

- Be sure that the front seats are fully upright and positioned forward. This will allow the rear seat to fold down easily.
- The center head restraints must be in the lowest position to avoid contact with the center console when folding the seat.

## WARNING!

- It is extremely dangerous to ride in a cargo area, inside or outside of a vehicle. In a collision, people riding in these areas are more likely to be seriously injured or killed.
- Do not allow people to ride in any area of your vehicle that is not equipped with seats and seat belts.
- Be sure everyone in your vehicle is in a seat and using a seat belt properly.

### To Fold Down The Rear Seat

There are two release levers located on each upper outboard side of the rear seat. The larger of the two release levers folds down the seat and the head restraint simultaneously. The smaller lever folds down the head restraint independently for improved visibility.



To fold the seat, lift upward on the large release lever and slowly fold down the seatback. The head restraint will fold automatically with the seat when this lever is pulled.



**Seatback Release Lever**

- 1 — Seatback Release Lever  
2 — Head Restraint Release Lever

**NOTE:**

You may experience deformation in the seat cushion from the seat belt buckles if the seats are left folded for an extended period of time. This is normal. By simply opening the seats to the open position, the seat cushion will return to its normal shape over time.

**To Raise The Rear Seat**

Raise the seatback and lock it into place. Then, raise the head restraint until it locks into place. If interference from the cargo area prevents the seatback from fully locking, you will have difficulty returning the seat to its proper position.

**WARNING!**

Be certain that the seatback is securely locked into position. If the seatback is not securely locked into position the seat will not provide the proper stability for child seats and/or passengers. An improperly latched seat could cause serious injury.

**Fold And Tumble Rear Seat –  
Two Door Models**

**NOTE:**

- Prior to folding the rear seat, it may be necessary to reposition the front seats.
- Be sure that the front seats are fully upright and positioned forward. This will allow the rear seat to fold down easily.



## Folding The Rear Seat

1. Lift the seatback release lever and fold the seatback forward.



**Rear Seatback Release Lever**

2. Slowly flip the entire seat forward.

## Using The Retention Straps

1. There are two retention straps located on the back of the rear seat and two corresponding wire loops located on the back of each b-pillar. Open the hook-and-loop fastener on the strap and thread through the wire loop. Fold the hook-and-loop fastener over to keep the seat in the folded position. This should be done on both sides.



**Rear Seat Tumble Position  
Retention Strap**

2. To return the seat to its normal upright position, reverse these steps.

## Removing The Rear Seat

1. Push down on the release bar on each side, and pull the seat out and away from the lower bracket.
2. Remove the seat from the vehicle.
3. To reinstall the rear seat, just reverse these steps.

### NOTE:

Do not drive the vehicle without reattaching the rear seat latches.

### WARNING!

- It is extremely dangerous to ride in a cargo area, inside or outside of a vehicle. In a collision, people riding in these areas are more likely to be seriously injured or killed.
- Do not allow people to ride in any area of your vehicle that is not equipped with seats and seat belts.
- Be sure everyone in your vehicle is in a seat and using a seat belt properly.



**WARNING!**

- In a collision, you or others in your vehicle could be injured if seats are not properly latched to their floor attachments. Always be sure that the seats are fully latched.

**HEAD RESTRAINTS**

Head restraints are designed to reduce the risk of injury by restricting head movement in the event of a rear impact. Head restraints should be adjusted so that the top of the head restraint is located above the top of your ear.

**WARNING!**

- All occupants, including the driver, should not operate a vehicle or sit in a vehicle's seat until the head restraints are placed in their proper positions in order to minimize the risk of neck injury in the event of a crash.

**WARNING!**

- Head restraints should never be adjusted while the vehicle is in motion. Driving a vehicle with the head restraints improperly adjusted or removed could cause serious injury or death in the event of a collision.

**Front Head Restraints**

To raise the head restraint, pull upward on the head restraint. To lower the head restraint, push the adjustment button located on the base of the head restraint, and push downward on the head restraint. The release button does not need to be pushed to adjust the head restraint.

To remove the head restraint, raise it as far as it can go then push the adjustment button and the release button at the base of each post while pulling the head restraint up.

To reinstall the head restraint, put the head restraint posts into the holes and push downward. Then adjust it to the appropriate height.

**Front Head Restraint**

- 1 — Release Button  
2 — Adjustment Button

## WARNING!

- A loose head restraint thrown forward in a collision or hard stop could cause serious injury or death to occupants of the vehicle. Always securely stow removed head restraints in a location outside the occupant compartment.
- ALL the head restraints MUST be reinstalled in the vehicle to properly protect the occupants. Follow the re-installation instructions above prior to operating the vehicle or occupying a seat.

### NOTE:

Do not reposition the head restraint 180 degrees to the incorrect position in an attempt to gain additional clearance to the back of the head.

### Rear Head Restraints – Two Door Models

The rear seat is equipped with non-adjustable, but foldable head restraints.

To fold the outboard head restraint, pull on the release strap located on the upper outboard side of each rear seat.



**Rear Head Restraint  
Folding Strap Location**



**Rear Head Restraints Folded**

To return the head restraint to its upward position, lift up on the head restraint until it locks into place.

Refer to “Occupant Restraint Systems” in “Safety” for information on child seat tether routing.



**WARNING!**

- Do not drive the vehicle without the rear seat head restraints installed while passengers are occupying the rear seat. In a collision, people riding in this area without the head restraints installed are more likely to be seriously injured or killed.
- A loose head restraint thrown forward in a collision or hard stop could cause serious injury or death to occupants of the vehicle. Always securely stow removed head restraints in a location outside the occupant compartment.
- ALL the head restraints MUST be reinstalled in the vehicle to properly protect the occupants. Follow the reinstallation instructions above prior to operating the vehicle or occupying a seat.

**Rear Head Restraints — Four Door Models**

The rear seat is equipped with nonadjustable, but foldable, outboard head restraints, as well as an adjustable, removable center head restraint.

To fold the outboard head restraint, pull on the inner release lever, located on the upper part of the rear seat.



**Rear Head Restraint Lever Location**

- 1 — Seatback Release Lever  
2 — Head Restraint Release Lever

To return the head restraint to its upward position, lift up on the head restraint until it locks into place.

To raise the center head restraint, lift up on the head restraint. To lower the center head restraint, push the adjustment button, located at the base of the head restraint, and push down on the head restraint.

To remove the center head restraint, push the release button, located on the base of the head restraint, and pull upward on the head restraint.

To install the head restraint, hold the release button while pushing downward on the head restraint. Refer to “Occupant Restraint Systems” in “Safety” for information on child seat tether routing.

**NOTE:**

Lower the center head restraint to avoid contact with the center console when folding the seat down.

## WARNING!

- Do not drive the vehicle without the rear seat head restraints installed while passengers are occupying the rear seat. In a collision, people riding in this area without the head restraints installed are more likely to be seriously injured or killed.
- A loose head restraint thrown forward in a collision or hard stop could cause serious injury or death to occupants of the vehicle. Always securely stow removed head restraints in a location outside the occupant compartment.
- ALL the head restraints MUST be reinstalled in the vehicle to properly protect the occupants. Follow the reinstallation instructions above prior to operating the vehicle or occupying a seat.

## STEERING WHEEL

### Tilt/Telescoping Steering Column

This feature allows you to tilt the steering column upward or downward. It also allows you to lengthen or shorten the steering column. The tilt/telescoping lever is located on the steering column, below the turn signal lever.



Tilt/Telescoping Steering Column Lever

To unlock the steering column, push the control handle downward (toward the floor). To tilt the steering column, move the steering wheel upward or downward as desired. To lengthen or shorten the steering column, pull the steering wheel outward or push it inward as desired. To lock the steering column in position, push the control handle upward until fully engaged.

## WARNING!

Do not adjust the steering column while driving. Adjusting the steering column while driving or driving with the steering column unlocked, could cause the driver to lose control of the vehicle. Failure to follow this warning may result in serious injury or death.

### Heated Steering Wheel – If Equipped

The steering wheel contains a heating element that helps warm your hands in cold weather. The heated steering wheel has only one temperature setting. Once the heated





steering wheel has been turned on, it will stay on until the operator turns it off. The heated steering wheel may not turn on when it is already warm.

The heated steering wheel control button is located on the center of the instrument panel below the touchscreen and within the climate or controls screen of the touchscreen.



**Heated Steering Wheel Button**

- Push the heated steering wheel button  once to turn the heating element on.
- Push the heated steering wheel button  a second time to turn the heating element off.

**NOTE:**

The engine must be running for the heated steering wheel to operate.

**Vehicles Equipped With Remote Start**

On models that are equipped with remote start, the heated steering wheel can be programmed to come on during a remote start.

This feature can be programmed through the Uconnect system. Refer to “Uconnect Settings” in “Multimedia” in your Owner’s Manual for further information.

**WARNING!**

- Persons who are unable to feel pain to the skin because of advanced age, chronic illness, diabetes, spinal cord injury, medication, alcohol use, exhaustion, or other physical conditions must exercise care when using the steering wheel heater. It may cause burns even at low temperatures, especially if used for long periods.

**WARNING!**

- Do not place anything on the steering wheel that insulates against heat, such as a blanket or steering wheel covers of any type and material. This may cause the steering wheel heater to overheat.

**MIRRORS**

**Heated Mirrors – If Equipped**

These mirrors are heated to melt frost or ice. This feature will be activated whenever you turn on the rear window defroster (if equipped). Refer to “Climate Controls” in “Getting To Know Your Vehicle” for further information.

## EXTERIOR LIGHTS

### Headlight Switch

The headlight switch is located on the left side of the instrument panel. This switch controls the operation of the headlights, parking lights, automatic headlights — if equipped, instrument panel lights, instrument panel light dimming, interior lights, and fog lights — if equipped.



Headlight Switch

Rotate the headlight switch clockwise to the first detent for parking light and instrument panel light operation. Rotate the headlight switch to the second detent for headlight, parking light, and instrument panel light operation.

### Daytime Running Lights — If Equipped

The Daytime Running Lights (DRLs) are in a dedicated position below the headlight assembly. DRLs are active when the Low Beams are not and when the vehicle is shifted into any position other than PARK (auto transmission), or when the vehicle begins to move (manual transmission).

#### NOTE:

The Daytime Running Lights, on the same side of the vehicle as the active turn signal, will turn off automatically when a turn signal is in operation and turn on again when the turn signal is not operating.

### High/Low Beam Switch



Push the multifunction lever toward the instrument panel to switch the headlights to high beams. The lever will return to the centered position. To return the headlights to low beam, pull the lever toward the steering wheel, or push the lever toward the instrument panel.



Multifunction Lever



### Flash-To-Pass

You can signal another vehicle with your headlights by lightly pulling the multifunction lever toward you. This will cause the high beam headlights to turn on, and remain on, until the lever is released.

### Automatic Headlights – If Equipped

This system automatically turns the headlights on or off according to ambient light levels. To turn the system on, rotate the headlight switch clockwise to the last detent for automatic headlight operation. When the system is on, the headlight time delay feature is also on. This means the headlights will stay on for up to 90 seconds after you place the ignition into the OFF position. To turn the automatic system off, move the headlight switch out of the AUTO position.

#### NOTE:

The engine must be running before the headlights will come on in the automatic mode.

### Front Fog Lights – If Equipped

To activate the front fog lights, turn on the parking lights or low beam headlights and push in the center of the headlight switch control knob. Pushing the headlight switch control knob a second time will turn the front fog lights off.



Front Fog Light Switch

### Turn Signals

Move the multifunction lever up or down and the arrows on each side of the instrument cluster flash to show proper operation of the front and rear turn signal lights.

#### NOTE:

If either light remains on and does not flash, or there is a very fast flash rate, check for a defective outside light bulb. If an indicator fails to light when the lever is moved, it would suggest that the indicator bulb is defective.

### Lane Change Assist – If Equipped

Tap the multifunction lever up or down once, without moving beyond the detent, and the turn signal (right or left) will flash three times then automatically turn off.

### Lights-On Reminder

If the headlights, parking lights, or cargo lights are left on after the ignition is turned OFF, a chime will sound when the driver's door is opened.



## WINDSHIELD WIPERS AND WASHERS

The windshield wiper/washer control lever is located on the right side of the steering column. The front wipers are operated by rotating a switch, located at the end of the lever.

Refer to “Rear Window Wiper/Washer” in this section for further information on using the rear window wiper/washer.



Windshield Wiper/Washer Lever

### Windshield Wiper Operation

Rotate the end of the lever upward to the second detent past the intermittent settings for low-speed wiper operation. Rotate the end of the lever upward to the third detent past the intermittent settings for high-speed wiper operation.

#### CAUTION!

In cold weather, always turn off the wiper switch and allow the wipers to return to the park position before turning off the engine. If the wiper switch is left on and the wipers freeze to the windshield, damage to the wiper motor may occur when the vehicle is restarted.

### Intermittent Wiper System

Use the intermittent wiper when weather conditions make a single wiping cycle, with a variable pause between cycles, desirable. Rotate the end of the lever to the first detent position for one of four intermittent settings. The delay cycle can be set anywhere between 1 to 18 seconds.

### NOTE:

The wiper delay times depend on vehicle speed. If the vehicle is moving less than 10 mph (16 km/h), delay times will be doubled.

### Windshield Washers

To use the washer, pull the lever toward you and hold while spray is desired. If the lever is pulled while in the delay range, the wiper will start and continue to operate for two or three wiper cycles after the lever is released. Then, the intermittent interval previously selected will resume.

If the lever is pulled while in the off position, the wipers will operate for two or three wiper cycles. Then, the wipers will turn off.

#### WARNING!

Sudden loss of visibility through the windshield could lead to a collision. You might not see other vehicles or other obstacles. To avoid sudden icing of the windshield during freezing weather, warm the windshield with the defroster before and during windshield washer use.



### Mist Feature

Push upward on the wiper lever to activate a single wipe to clear off road mist or spray from a passing vehicle. As long as the lever is held up, the wipers will continue to operate.

#### **NOTE:**

The mist feature does not activate the washer pump; therefore, no washer fluid will be sprayed on the windshield. The wash function must be used in order to spray the windshield with washer fluid.

### Rear Window Wiper/Washer — If Equipped

A rotary switch on the center portion of the windshield wiper/washer lever controls the operation of the rear wiper/washer function.

Rotate the switch upward to the first detent position for intermittent operation and to the second detent for continuous rear wiper operation.

Push the wiper lever toward the instrument panel to activate the rear washer. The washer pump and wiper will continue to operate as long as the lever is held.

If the rear wiper is operating when the ignition is placed in the OFF position, the wiper will automatically return to the “park” position. When the vehicle is restarted, the wiper will resume function at whichever position the switch is set at.

## CLIMATE CONTROLS

### Automatic Climate Controls Overview

The Climate Control System allows you to regulate the temperature, air flow, and direction of air circulating throughout the vehicle. The controls are located on the instrument panel below the radio.



**Automatic Climate Controls**







**Uconnect 4 With 7-inch Display  
Automatic Climate Controls**







**Uconnect 4C/4C NAV With 8.4-inch  
Display Automatic Climate Controls**





### Automatic Control Descriptions

Icon	Description
<p><b>MAX A/C</b></p>	<p><b>MAX A/C Button</b> Press to change to the coldest setting, the indicator illuminates when MAX A/C is on. Pressing the button again causes the MAX A/C operation to switch into manual mode and the MAX A/C indicator turns off.</p> <p><b>NOTE:</b> The MAX A/C button is only available on the touchscreen.</p>
<p><b>A/C</b></p>	<p><b>A/C Button</b> Press and release to change the current setting. The indicator illuminates when A/C is on.</p>

Icon	Description
	<p><b>Recirculation Button</b></p> <p>Press and release this button on the touchscreen, or push the button on the faceplate, to change the system between recirculation mode and outside air mode.</p> <p>Recirculation can be used when outside conditions such as smoke, odors, dust, or high humidity are present. Recirculation can be used in all modes. Recirculation may be unavailable (button on the touchscreen greyed out) if conditions exist that could create fogging on the inside of the windshield. The A/C can be deselected manually without disturbing the mode control selection. Continuous use of the Recirculation mode may make the inside air stuffy and window fogging may occur. Extended use of this mode is not recommended.</p>
<p>AUTO</p>	<p><b>AUTO Button</b></p> <p>Automatically controls the interior cabin temperature by adjusting airflow distribution and amount. Toggling this button causes the system to switch between manual mode and automatic modes. Refer to “Automatic Operation” within this section for more information.</p>
	<p><b>Front Defrost Button</b></p> <p>Press and release the touchscreen button, or push and release the button on the faceplate, to change the current airflow setting to Defrost mode. The indicator illuminates when this feature is on. Air comes from the windshield and side window demist outlets. When the defrost button is selected, the blower level may increase. Use Defrost mode with maximum temperature settings for best windshield and side window defrosting and defogging. When toggling the front defrost mode button, the climate system returns to the previous setting.</p>
	<p><b>Rear Defrost Button</b></p> <p>Push and release the button on the touchscreen, or push and release the button on the faceplate, to turn on the rear window defroster and the heated outside mirrors (if equipped). An indicator illuminates when the rear window defroster is on. The rear window defroster automatically turns off after ten minutes.</p>



Icon	Description
	<p><b>Driver And Passenger Temperature Up And Down Buttons</b> Provides the driver and passenger with independent temperature control. Push the red button on the faceplate or touchscreen or press and slide the temperature bar towards the red arrow button on the touchscreen for warmer temperature settings. Push the blue button on the faceplate or touchscreen or press and slide the temperature bar towards the blue arrow button on the touchscreen for cooler temperature settings.</p>
<p><b>SYNC</b></p>	<p><b>SYNC Button</b> Press the SYNC button on the touchscreen to toggle the SYNC feature on/off. The SYNC indicator is illuminated when this feature is enabled. SYNC is used to synchronize the passenger temperature setting with the driver temperature setting. Changing the passenger's temperature setting while in SYNC will automatically exit this feature.</p> <p><b>NOTE:</b> The SYNC button is only available on the touchscreen.</p>
<p><b>Faceplate Knob</b></p>  <p><b>Touchscreen Buttons</b></p> 	<p><b>Blower Control</b> Blower Control is used to regulate the amount of air forced through the climate system. There are seven blower speeds available. The speeds can be selected using either the blower control knob on the faceplate or the buttons on the touchscreen.</p> <ul style="list-style-type: none"> <li>• <b>Faceplate:</b> The blower speed increases as you turn the blower control knob clockwise from the lowest blower setting. The blower speed decreases as you turn the blower control knob counterclockwise.</li> <li>• <b>Touchscreen:</b> Use the small blower icon to reduce the blower setting and the large blower icon to increase the blower setting. The blower can also be selected by pressing the blower bar area between the icons.</li> </ul>
 <p><b>MODE</b></p>	<p><b>Modes Control</b> Press the button to adjust airflow distribution. The airflow distribution mode can be adjusted so air comes from the instrument panel outlets, floor outlets, defrost outlets and demist outlets.</p>

Icon	Description
<p><b>Panel Mode</b></p> 	<p><b>Panel Mode</b> Air comes from the outlets in the instrument panel. Each of these outlets can be individually adjusted to direct the flow of air. The air vanes of the center outlets and outboard outlets can be moved up and down or side to side to regulate airflow direction. There is a shut off wheel located below the air vanes to shut off or adjust the amount of airflow from these outlets.</p>
<p><b>Bi-Level Mode</b></p> 	<p><b>Bi-Level Mode</b> Air comes from the instrument panel outlets and floor outlets. A slight amount of air is directed through the defrost and side window demister outlets.</p> <p><b>NOTE:</b> Bi-Level mode is designed under comfort conditions to provide cooler air out of the panel outlets and warmer air from the floor outlets.</p>
<p><b>Floor Mode</b></p> 	<p><b>Floor Mode</b> Air comes from the floor outlets. A slight amount of air is directed through the defrost and side window demister outlets.</p>
<p><b>Mix Mode</b></p> 	<p><b>Mix Mode</b> Air is directed through the floor, defrost, and side window demister outlets. This setting works best in cold or snowy conditions that require extra heat to the windshield. This setting is good for maintaining comfort while reducing moisture on the windshield.</p>
<p><b>OFF</b></p>	<p><b>Climate Control OFF Button</b> This button turns the Climate Control System off.</p>



## Climate Control Functions

### Air Conditioning (A/C)

The Air Conditioning (A/C) button allows the operator to turn the air conditioning system on and off. When the system is turned on, cool dehumidified air flows through the vents into the cabin.

For improved fuel economy, press the A/C button to turn off the air conditioning off and adjust the blower and airflow mode settings. Make sure to only select Panel, Bi-Level, or Floor modes.

#### NOTE:

- If fog or mist appears on the windshield or windows, select Defrost mode and increase the blower speed.
- If the air conditioning performance is lower than expected, there may be a blockage. Gently clean the area around the radiator with water.

### MAX A/C

The MAX A/C setting provides the maximum cooling performance.

Press the button to toggle between MAX A/C and your prior setting. The button illuminates when MAX A/C is on.

In the MAX A/C setting, you can adjust the blower level and mode position. Pressing other settings causes the MAX A/C operation to switch to your desired setting.

### Recirculation

In cold weather, use of Recirculation mode may lead to excessive window fogging. The Recirculation feature may be unavailable (button on the touchscreen greyed out) if conditions exist that could create fogging on the inside of the windshield.

## Automatic Temperature Control (ATC) – If Equipped

### Automatic Operation

1. Push the AUTO button on the faceplate, or the AUTO button on the touchscreen on the Automatic Temperature Control (ATC) Panel.
2. Next, adjust the temperature you would like the system to maintain by adjusting the driver and passenger temperature control buttons. Once the desired temperature is displayed, the system will achieve and automatically maintain that comfort level.
3. When the system is set up for your comfort level, it is not necessary to change the settings. You will experience the greatest efficiency by simply allowing the system to function automatically.



## NOTE:

- It is not necessary to move the temperature settings for cold or hot vehicles. The system automatically adjusts the temperature, mode, and blower speed to provide comfort as quickly as possible.
- The temperature can be displayed in U.S. or Metric units by selecting the US/Metric customer-programmable feature. Refer to the “Uconnect Settings” in “Multimedia” in your Owner’s Manual for further information.

To provide you with maximum comfort in the Automatic mode during cold start-ups, the blower fan will remain on low until the engine warms up. The blower will increase in speed and transition into Auto mode.

## Manual Operation Override

This system offers a full complement of manual override features. The AUTO symbol in the front ATC display will be turned off when the system is being used in the manual mode.

## Operating Tips

### Summer Operation

The engine cooling system must be protected with a high-quality antifreeze coolant to provide proper corrosion protection and to protect against engine overheating. OAT coolant (conforming to MS.90032) is recommended.

### Winter Operation

To ensure the best possible heater and defroster performance, make sure the engine cooling system is functioning properly and the proper amount, type, and concentration of coolant is used. Use of the Air Recirculation mode during Winter months is not recommended, because it may cause window fogging.

### Vacation/Storage

Before you store your vehicle, or keep it out of service (i.e., vacation) for two weeks or more, run the air conditioning system at idle for about five minutes, in fresh air with the blower setting on high. This will ensure adequate system lubrication to minimize the possibility of compressor damage when the system is started again.

## Window Fogging

Vehicle windows tend to fog on the inside in mild, rainy, and/or humid weather. To clear the windows, select Defrost or Mix mode and increase the front blower speed. Do not use the Recirculation mode without A/C for long periods, as fogging may occur.

### CAUTION!

Failure to follow these cautions can cause damage to the heating elements:

- Use care when washing the inside of the rear window. Do not use abrasive window cleaners on the interior surface of the window. Use a soft cloth and a mild washing solution, wiping parallel to the heating elements. Labels can be peeled off after soaking with warm water.
- Do not use scrapers, sharp instruments, or abrasive window cleaners on the interior surface of the window.
- Keep all objects a safe distance from the window.



### Outside Air Intake

Make sure the air intake, located directly in front of the windshield, is free of obstructions, such as leaves. Leaves collected in the air intake may reduce airflow, and if they enter the plenum, they could plug the water drains. In Winter months, make sure the air intake is clear of ice, slush, and snow.

### Cabin Air Filter

The climate control system filters out dust and pollen from the air. Contact an authorized dealer to service your cabin air filter, and to have it replaced when needed.

## POWER WINDOWS — IF EQUIPPED

The power window switches are located on the instrument panel below the climate controls. Push the switch downward to open the window and upward to close the window.

The top left switch controls the left front window and the top right switch controls the right front window.

### WARNING!

Never leave children unattended in a vehicle, and do not let children play with power windows. Do not leave the key fob in or near the vehicle, or in a location accessible to children. Occupants, particularly unattended children, can become entrapped by the windows while operating the power window switches. Such entrapment may result in serious injury or death.



**Power Window Switches**

- 1 — Driver Side Front Window Switch
- 2 — Passenger Side Front Window Switch
- 3 — Passenger Side Rear Window Switch
- 4 — Driver Side Rear Window Switch
- 5 — Window Lockout Switch

**NOTE:**

- The power window switches will remain active for up to 10 minutes after ignition is switched to the OFF position. Opening either front door will cancel this feature.

**Four-Door Models**

The lower left switch controls the left rear passenger window, and the lower right switch controls the right rear passenger window.

**NOTE:**

There are window switches located on the rear of the center console for the rear passenger windows in the four-door model.

**Auto-Down Feature**

The driver door power window switch and the passenger door power window switches have an Auto-Down feature. Push the window switch down, for a short period of time, and release and the window will go down automatically.

To open the window part way, push the window switch down briefly and release it when you want the window to stop.

To stop the window from going all the way down during the Auto-Down operation, pull up on the switch briefly.

**WARNING!**

There is no anti-pinch protection when the window is almost closed. Be sure to clear all objects from the window before closing.

**Wind Buffeting**

Wind buffeting can be described as the perception of pressure on the ears or a helicopter-type sound in the ears. Your vehicle may exhibit wind buffeting with the windows down in certain open or partially open positions. This is a normal occurrence and can be minimized by adjusting the window opening.

**REMOVABLE TOP INFORMATION**

For your convenience, a tool kit is provided with your vehicle located in the center console. This kit includes the necessary tools required for the operations described in the following sections.



All pieces fit into the ratchet for easy use.



#### Provided Tools

- 1 — #50 Torx Head Driver
- 2 — #40 Torx Head Driver
- 3 — 15mm Socket
- 4 — Ratchet

For complete owner information, refer to your Owner's Manual for further details.

### Soft Top — Two And Four Door Models

#### To Lower The Soft Top

Follow these simple steps to lower the soft top:

1. With the swing gate open, remove the swing gate bar from the bottom of the rear window from right to left. Store in a safe location. Remove the rear window by sliding it to the left keeping the window level.
2. Push outward on the bottom of the rear window pillars to release them from their retaining tabs.

3. Undo the hook-and-loop-fastener located at the upper front corner of each quarter window.



Hook-And-Loop Fastener Location

4. Remove both quarter windows while keeping the plastic retainers along the top level. Store in soft top window bag or safe location.



**Quarter Window Top Retainers**

5. From inside the vehicle, fold the sun visors against the windshield and release header latches from above the sun visors, making sure the hook is completely disengaged from its receiver.



**Header Latch Disengaged**

6. From outside the vehicle, lift up on the front of the soft top, and fold back into the Sunrider position.

**NOTE:**

If leaving the soft top in the Sunrider position, secure the top by using the two hook-and-loop fasteners provided in the center console.



**Sunrider Straps In Position**



7. Pull the Sunrider latch, located beneath the last bow of the soft top.



**Sunrider Latch Position**

8. Allow the soft top to slide rearward freely in the guide tracks to the stowed position.

9. While pushing downward slightly on the folded soft top, slide the lock lever on the driver and passenger side lift assist mechanisms to the “lock” position.



**Lock Position**

10. Once the lock is in the “lock” position, push downward on each side of the folded soft top to ensure it is secure. An audible “click” may be heard.



**Push Downward To Lock In Place**

## To Raise The Soft Top

Follow these simple steps to raise the soft top:

1. While pushing down on the folded soft top, slide the lock lever on the driver and passenger side Lift Assist Mechanisms to the “unlock” position.
2. Push up and forward from underneath the folded soft top along the guide track until it locks into the Sunrider position with an audible “click”.
3. Using the side link, lift and push the soft top toward the front of the vehicle guiding the top into the closed position.

4. From inside the vehicle, pull the handle on the header latch downward to engage the hook into its receiver. Then, pull the handle back upward while squeezing the latch plate, locking the latch into place. Repeat on the other side.



**Squeeze Latch Plate And Pull Handle Upward**

5. Reinstall the quarter windows while keeping the top plastic retainers level.



**Quarter Window Top Retainers**

6. Place the top of the quarter window pillars (rear corner) into the top cover, and insert the bottom retaining tab into the clips.
7. Engage the retainers up the front of the windows, ensuring they are fully engaged.
8. Engage the plastic retainers along the bottom of the quarter windows.



- Secure the hook-and-loop-fastener at the upper front corner of each quarter window by pressing firmly.



**Firmly Secure Hook-And-Loop Fastener**

- Reinstall the rear window along the top, followed by the swing gate bar into the bottom of the rear window.

**NOTE:**

When reinstalling the rear window, be sure to engage the retainers on the right side of the rear window, followed by the left side.

### Freedom Top And Hard Top

#### To Remove Freedom Top Panels

**NOTE:**

The driver's side panel must be removed before removing the passenger's side panel.

- Fold down the sun visor against the windshield.
- Turn the three L-shaped locks on the driver's side panel (one at the front, the rear, and outside), unlocking them from the roof.

- Unlatch the driver's side header panel latch located at the top of the windshield.



**Driver's Side Panel Latches**

- 1 — L-Shape Locks  
2 — Header Latch

- Remove the driver's side panel.
- Repeat the steps above to remove the passenger's side panel.

**NOTE:**

Vehicles equipped with a Freedom Top, come with a Freedom Top storage bag that allows you to store your Freedom Top panels.



## To Reinstall Freedom Top Panels

Follow the removal instructions in reverse order, replacing the passenger's side panel **before** the driver's side panel.

### NOTE:

To prevent water leaks, the seals and Freedom Top Panels should be clear of any dust and debris prior to reinstallation.

### Hard Top Removal

1. Remove both front panels as described above.
2. Open both doors.

3. Using the provided #50 Torx head driver and ratchet, remove the Torx head screw that secures the hard top at the B-pillar (near the top of the front door) on each side.



**Torx Head Screw Location —  
Driver's Side Shown**

4. Remove the six Torx head screws that secure the hard top to the vehicle (along the interior bodyside — three screws on each side) using the #50 Torx head driver.

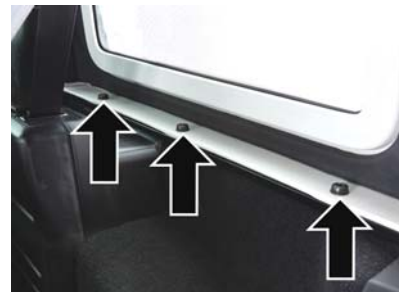

**Torx Head Screw Locations —  
Passenger Side Shown**

5. Open the swing gate all the way to ensure clearance of the rear window glass. Lift the rear window glass.
6. Locate the wire harness and washer hose on the left rear inside corner of the vehicle.



7. Disconnect the wire harness by its release tab, followed by the washer hose by pushing the release button on the hose.



**Wire Harness And Washer Hose Location**

- 1 — Wire Harness  
2 — Washer Hose

8. Lower the rear window glass and close the swing gate.
9. Remove the hard top from the vehicle. Place the hard top on a soft surface to prevent damage.

**NOTE:**

To reinstall the hard top, follow the removal instructions in reverse order.

**For complete owner information, refer to your Owner's Manual for further details.**

**CAUTION!**

- The front panel(s) must be positioned properly to ensure sealing. Improper installation can cause water to leak into the vehicle's interior.
- The hard top assembly must be positioned properly to ensure sealing. Improper installation can cause water to leak into the vehicle's interior.

**CAUTION!**

- The hard top is not designed to carry any additional loads such as roof racks, spare tires, building, hunting, or camping supplies, and/or luggage, etc. Also, it was not designed as a structural member of the vehicle, and thus cannot properly carry any additional loads other than environmental (rain, snow, etc.).
- Do not move your vehicle until the top has been either fully attached to the windshield frame and bodyside, or fully removed.
- The removal of the hard top requires four adults located on each corner. Failure to follow this caution could damage the hard top.

**Dual Top – If Equipped**

If your vehicle is equipped with a Dual Top, the soft top system will be provided in a separate box located in the rear of the vehicle for shipping purposes only.

If the soft top is removed, ensure the lift assist mechanisms on **both** sides of the folded soft top are in the “lock” position before removal, and that an audible “click” is heard when pushing down on the #1 bow from each of the lift assist mechanisms.



**Lift Assist Mechanism**

- 1 — Lock Position  
2 — #40 Torx Head Screws

**NOTE:**

- The soft top and the hard top are to be used independently.
- Your vehicle warranty will not cover damage resulting from both tops being installed at the same time.
- **For complete owner information, refer to your Owner's Manual for further details.**

**Wind Buffeting**

Wind buffeting can be described as a helicopter-type percussion sound. If buffeting occurs with the rear windows open, adjust the front and rear windows together.

**POWER SLIDING TOP –  
IF EQUIPPED**

If your vehicle is equipped with a Power Sliding Top, the control switch can be found on the front trim panel, to the right of the driver's side sun visor.



**Power Sliding Top Control Switch**

- 1 — Open Switch  
2 — Close Switch

**NOTE:**

- The Power Top is non-removable. If desired, the rear quarter windows can be removed and stored in provided storage bags. Refer to “Quarter Window Removal” in your Owner's Manual for further information.
- The Power Top will not open in temperatures below  $-4^{\circ}\text{F}$  ( $-20^{\circ}\text{C}$ ). However, if it is opened at a higher temperature, it can be closed at temperatures above  $-40^{\circ}\text{F}$  ( $-40^{\circ}\text{C}$ ).



- The Power Top will not operate at vehicle speeds above 60 mph (96 km/h).

### WARNING!

- Never leave children unattended in a vehicle, or with access to an unlocked vehicle. Never leave the key fob in or near the vehicle, or in a location accessible to children. Do not leave the ignition of a vehicle equipped with Keyless Enter-N-Go in the ACC or ON/RUN mode. Occupants, particularly unattended children, can become entrapped by the power top while operating the power top switch. Such entrapment may result in serious injury or death.
- In a collision, there is a greater risk of being thrown from a vehicle with an open power top. You could also be seriously injured or killed. Always fasten your seat belt properly and make sure all passengers are also properly secured.

### WARNING!

- Do not allow small children to operate the power top. Never allow your fingers, other body parts, or any object, to project through the power top opening. Injury may result.

### Opening The Power Top

#### Express Mode

Push the open switch and release it within one-half second. The power top will open automatically to the open position. This is called “Express Open”. During Express Open operation, any movement of the switch will stop the power top.

#### Manual Mode

To open the power top manually, push and hold the open switch. The power top will stop automatically at the open position. Any release of the switch will stop the movement. The power top will remain in a partially opened position until the switch is pushed and held again.

### Closing The Power Top

#### Express Mode

Push the close switch and release it within one-half second. The power top will close fully and stop automatically. This is called “Express Close”. During Express Close operation, any movement of the switch will stop the power top.

#### Manual Mode

To close the power top manually, push and hold the close switch. The power top will move forward and automatically stop at the fully closed position. Any release of the switch will stop the movement. The power top will remain in a partially closed position until the switch is pushed and held again.

#### Pinch Protect Feature

This feature will detect an obstruction in the opening of the power top during Express Close operation. If an obstruction in the path of the power top is detected, the power top will automatically retract. Remove the obstruction if this occurs. Next, push the close switch and release to Express Close.

## WARNING!

There is no anti-pinch protection when the power top is almost closed. To avoid personal injury be sure to clear your arms, hands, fingers and all objects from the top's path before closing.

### NOTE:

If three consecutive power top close attempts result in Pinch Protect reversals, Pinch Protect will disable and the power top must be closed in Manual Mode.

## HOOD

### Opening The Hood

Release both the hood latches.



### Hood Latch Locations

Raise the hood and locate the safety latch, located in the middle of the hood opening. Push the safety latch to the left side of the vehicle, to open the hood. You may have to push down slightly on the hood before pushing the safety latch. Insert the support rod into the slot on the hood.

### Closing The Hood

To close the hood, remove the support rod from the hood panel and place it in the retaining clip. Lower the hood slowly. Secure both of the hood latches.

## WARNING!

Be sure the hood is fully latched before driving your vehicle. If the hood is not fully latched, it could open when the vehicle is in motion and block your vision. Failure to follow this warning could result in serious injury or death.

## REAR SWING GATE

The rear swing gate can be unlocked by using the key, Remote Keyless Entry key fob, by activating the power door lock switches located on the front doors, or grabbing the handle if equipped with Keyless Enter-N-Go.



To open the swing gate, pull on the gate handle.



**Swing Gate Handle**

**NOTE:**

Close the rear flip-up window before attempting to close the swing gate (hard top models only).

**WARNING!**

Driving with the flip-up window open can allow poisonous exhaust gases into your vehicle. You and your passengers could be injured by these fumes. Keep the flip-up window closed when you are operating the vehicle.

**CAUTION!**

Do not push on rear wiper blade when closing the rear flip-up window, as damage to the blade will result.

**UNIVERSAL GARAGE DOOR OPENER (HOMELINK)**



**HomeLink Buttons And Indicator Light**

- HomeLink replaces up to three hand-held transmitters that operate devices such as garage door openers, motorized gates, lighting or home security systems. The HomeLink unit is powered by your vehicle's 12 Volt battery.
- The HomeLink buttons that are located in the overhead console or sunvisor designate the three different HomeLink channels.

- To operate HomeLink, push and release any of the programmed HomeLink buttons. These buttons will activate the devices they are programmed to with each press of the corresponding HomeLink button.
- The HomeLink indicator light is located above the center button.

### Before You Begin Programming HomeLink

For efficient programming and accurate transmission of the radio-frequency signal, it is recommended that a new battery be placed in the hand-held transmitter of the device that is being programmed to the HomeLink system. Make sure your hand-held transmitter is programmed to activate the device you are trying to program your HomeLink button to.

Ensure that your vehicle is parked outside of the garage before you begin programming.

It is recommended that you erase all the channels of your HomeLink before you use it for the first time.

If you have any problems, or require assistance, please call toll-free 1-800-355-3515 or, on the Internet at HomeLink.com for information or assistance.

### Erasing All The HomeLink Channels

To erase the channels, follow this procedure:

1. Place the ignition switch into the ON/RUN position.
2. Push and hold the two outside HomeLink buttons (I and III) for up to 20 seconds, or until the HomeLink indicator light flashes.

#### NOTE:

Erasing all channels should only be performed when programming HomeLink for the first time. Do not erase channels when programming additional buttons.

### Identifying Whether You Have A Rolling Code Or Non-Rolling Code Device

Before programming a device to one of your HomeLink buttons, you must determine whether the device has a rolling code or non-rolling code.

#### Rolling Code Devices

To determine if your device has a rolling code, a good indicator is its manufacturing date. Typically, devices manufactured after 1995 have rolling codes. A device with a rolling code will also have a “LEARN” or “TRAIN” button located where the antenna is attached to the device. The button may not be immediately visible when looking at the device. The name and color of the button may vary slightly by manufacturer.

#### NOTE:

The “LEARN” or “TRAIN” button is not the button you normally use to operate the device.

#### Non-rolling Code Devices

Most devices manufactured before 1995 will not have a rolling code. These devices will also not have a “LEARN” or “TRAIN” button.



## Programming HomeLink To A Garage Door Opener

To program any of the HomeLink buttons to activate your garage door opener motor, follow the steps below:

### NOTE:

All HomeLink buttons are programmed using this procedure. You do not need to erase all channels when programming additional buttons.

1. Place the ignition switch into the ON/RUN position.
2. Place the garage door opener transmitter 1 to 3 inches (3 to 8 cm) away from the HomeLink button you wish to program, while keeping the HomeLink indicator light in view.
3. Push and hold the HomeLink button you want to program while you push and hold the garage door opener transmitter button you are trying to replicate.

4. Continue to hold both buttons and observe the HomeLink indicator light. The HomeLink indicator light will flash slowly and then rapidly. Once this happens, release both buttons.

### NOTE:

Make sure the garage door opener motor is plugged in before moving on to the rolling code/non-rolling code final steps.

### Rolling Code Garage Door Opener Final Steps

#### NOTE:

You have 30 seconds in which to initiate rolling code final step 2, after completing rolling code final step 1.

1. At the garage door opener motor (in the garage), locate the "LEARN" or "TRAIN" button. This can usually be found where the hanging antenna wire is attached to the garage door opener motor. Firmly push and release the "LEARN" or "TRAIN" button.

2. Return to the vehicle and push the programmed HomeLink button three times (holding the button for two seconds each time). If the garage door opener motor operates, programming is complete.
3. Push the programmed HomeLink button to confirm that the garage door opener motor operates. If the garage door opener motor does not operate, repeat the final steps for the rolling code procedure.

### Non-Rolling Code Garage Door Opener Final Steps

1. Push and hold the programmed HomeLink button and observe the HomeLink indicator light. If the HomeLink indicator light stays on constantly, programming is complete.
2. Push the programmed HomeLink button to confirm that the garage door opener motor operates. If the garage door opener motor does not operate, repeat the steps from the beginning.



## WARNING!

- Your motorized door or gate will open and close while you are programming the universal transceiver. Do not program the transceiver if people or pets are in the path of the door or gate.
- Do not run your vehicle in a closed garage or confined area while programming the transceiver. Exhaust gas from your vehicle contains Carbon Monoxide (CO) which is odorless and colorless. Carbon Monoxide is poisonous when inhaled and can cause you and others to be severely injured or killed.

### Programming HomeLink To A Miscellaneous Device

Refer to “Programming HomeLink To A Garage Door Opener” for the procedure on how to program HomeLink to a miscellaneous device, as it follows the same procedure. Be sure to determine if the device has a rolling code, or non-rolling code before beginning the programming process.

#### NOTE:

Canadian radio frequency laws require transmitter signals to time-out (or quit) after several seconds of transmission, which may not be long enough for HomeLink to pick up the signal during programming. Similar to this Canadian law, some U.S. gate operators are designed to time-out in the same manner. The procedure may need to be performed multiple times to successfully pair the device to your HomeLink buttons.

### Reprogramming A Single HomeLink Button

To reprogram a single HomeLink button that has been previously trained, without erasing all the channels, follow the procedure below. Be sure to determine whether the new device you want to program the HomeLink button to has a Rolling Code, or Non-rolling Code.

1. Cycle the ignition to the ON/RUN position, without starting the engine.
2. Push and hold the desired HomeLink button until the HomeLink Indicator light begins to flash after 20 seconds. **Do not release the button.**

3. **Without releasing the button**, proceed with Step 2 in “Programming HomeLink To A Garage Door Opener” and follow all remaining steps.

### General Information

The following regulatory statement applies to all Radio Frequency (RF) devices equipped in this vehicle:

This device complies with Part 15 of the FCC Rules and with Innovation, Science and Economic Development Canada license-exempt RSS standard(s). Operation is subject to the following two conditions:

1. This device may not cause harmful interference, and
2. This device must accept any interference received, including interference that may cause undesired operation.

#### NOTE:

Changes or modifications not expressly approved by the party responsible for compliance could void the user's authority to operate the equipment.



## INTERNAL EQUIPMENT

### Electrical Power Outlets

There are two 12 Volt (13 Amp) auxiliary power outlets that can provide power for accessories designed for use with the standard power outlet adapters.

The front power outlet is located in the center of the instrument panel below the climate controls, and is powered from the ignition switch. Power is available when the ignition switch is in the ON or ACC position.



**Front Power Outlet**

On vehicles equipped with a rear subwoofer, there is a second power outlet located in the rear cargo area and is powered directly from the vehicle battery.



**Rear Cargo Power Outlet**

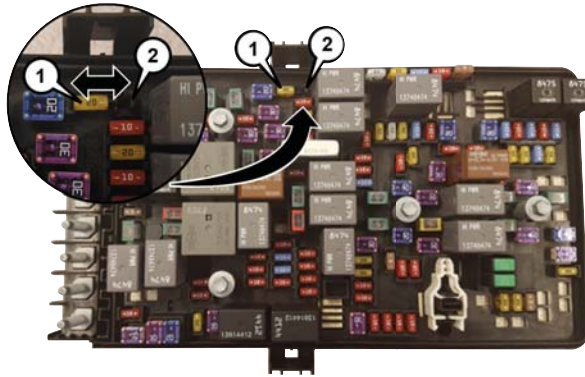

### Power Outlets Fuse Locations

- 1 — F81 Fuse 20A Yellow Rear Power Outlet (battery powered at all times)
- 2 — F91 Fuse 20A Yellow Rear Power Outlet (powered when the ignition switch is in the ON or ACC position)



**CAUTION!**

- Do not exceed the maximum power of 160 Watts (13 Amps) at 12 Volts. If the 160 Watt (13 Amp) power rating is exceeded the fuse protecting the system will need to be replaced.
- Power outlets are designed for accessory plugs only. Do not insert any other object in the power outlets as this will damage the outlet and blow the fuse. Improper use of the power outlet can cause damage not covered by your New Vehicle Limited Warranty.

**WARNING!**

To avoid serious injury or death:

- Do not insert any objects into the receptacles.
- Do not touch with wet hands.
- Close the lid when not in use.
- If this outlet is mishandled, it may cause an electric shock and failure.

**CAUTION!**

- Many accessories that can be plugged in draw power from the vehicle's battery, even when not in use (i.e., cellular phones, etc.). Eventually, if plugged in long enough, the vehicle's battery will discharge sufficiently to degrade battery life and/or prevent the engine from starting.
- Accessories that draw higher power (i.e., coolers, vacuum cleaners, lights, etc.), will degrade the battery even more quickly. Only use these intermittently and with greater caution.
- After the use of high power draw accessories, or long periods of the vehicle not being started (with accessories still plugged in), the vehicle must be driven a sufficient length of time to allow the alternator to recharge the vehicle's battery.
- Power outlets are designed for accessory plugs only. Do not hang any type of accessory or accessory bracket from the plug. Improper use of the power outlet can cause damage.

**Power Inverter – If Equipped**

There is a 115 Volt, 150 Watt inverter outlet located on the back of the center console to convert DC current to AC current.

This outlet can power cellular phones, electronics and other low power devices requiring power up to 150 Watts. Certain high-end video game consoles exceed this power limit, as will most power tools.



**Power Inverter**

The power inverter is designed with built-in overload protection. If the power rating of 150 Watts is exceeded, the power inverter automatically shuts down. Once the electrical device has been removed from the outlet,

the inverter should automatically reset. If the power rating exceeds approximately 170 Watts, the power inverter may have to be reset manually.

### WARNING!

To avoid serious injury or death:

- Do not insert any objects into the receptacles.
- Do not touch with wet hands.
- Close the lid when not in use.
- If this outlet is mishandled, it may cause an electric shock and failure.

### Auxiliary Switches – If Equipped

Four auxiliary switches located in the lower switch bank of the instrument panel can be used to power various electrical devices. You have the ability to configure the functionality of the auxiliary switches via the Uconnect settings. All switches can be configured for setting the switch type operation to latching or momentary, power source of either battery or ignition, and ability to hold last state across key cycles.



Auxiliary Switches

### NOTE:

Holding last state conditions are met when switch type is set to latching and power source is set to ignition.

For more information, refer to “Uconnect Settings” in “Multimedia” in your owner’s manual.

The auxiliary switches manage the relays that power four blunt cut wires. These wires are located under the instrument panel in the passenger compartment and under the hood to the right, near the battery.



Auxiliary Switch Connections – Under Hood



Auxiliary Switch Connections – Under Instrument Panel

In addition to the four auxiliary switch wires, a fused battery wire and ignition wire are also located in the interior, in the passenger side under the instrument panel.



A kit of splices and heat shrink tubing are provided with the auxiliary switches to aid in the connection/installation of your electrical devices.

### Wire Color Chart

Circuit Function	Fuse	Wire Color	Locations
Aux Switch 1	F93 – 40 Amp	Beige/Pink	Interior (passenger side under instrument panel) & Underhood (right side near battery)
Aux Switch 2	F92 – 40 Amp	Green/Pink	Interior (passenger side under instrument panel) & Underhood (right side near battery)
Aux Switch 3	F103 – 15 Amp	Orange/Pink	Interior (passenger side under instrument panel) & Underhood (right side near battery)
Aux Switch 4	F108 – 15 Amp	Dark Blue/Pink	Interior (passenger side under instrument panel) & Underhood (right side near battery)
Battery	F72 – 10 Amp	Red/White	Interior (passenger side under instrument panel)
Ignition	F50 – 10 Amp	Pink/Orange	Interior (passenger side under instrument panel)

# GETTING TO KNOW YOUR INSTRUMENT PANEL

## **INSTRUMENT CLUSTER**

### **DISPLAY . . . . .70**

Instrument Cluster Display Location And Controls . . . . .	70
Oil Change Reset — If Equipped. . . . .	71
Instrument Cluster Display Selectable Items . . . . .	72

## **WARNING LIGHTS**

### **AND MESSAGES . . . . .72**

Red Warning Lights. . . . .	73
Yellow Warning Lights . . . . .	76
Yellow Indicator Lights. . . . .	79
Green Indicator Lights . . . . .	80
White Indicator Lights . . . . .	81
Blue Indicator Lights . . . . .	81
Gray Indicator Lights . . . . .	82

## **ONBOARD DIAGNOSTIC**

### **SYSTEM — OBD II . . . . .82**

Onboard Diagnostic System (OBD II) Cybersecurity . . . . .	82
---	----

## **EMISSIONS INSPECTION AND MAINTENANCE PROGRAMS . . . .83**



## INSTRUMENT CLUSTER DISPLAY

Your vehicle may be equipped with an instrument cluster display, which offers useful information to the driver. With the ignition in the STOP/OFF mode, opening/closing of a door will activate the display for viewing, and display the total miles, or kilometers, in the odometer. Your instrument cluster display is designed to display important information about your vehicle's systems and features. Using a driver interactive display located on the instrument panel, your instrument cluster display can show you how systems are working and give you warnings when they aren't. The steering wheel mounted controls allow you to scroll through and enter the main menus and submenus. You can access the specific information you want and make selections and adjustments.

### Instrument Cluster Display Location And Controls

The instrument cluster display is located in the center of the instrument cluster.



**3.5 Inch Instrument Cluster Display Location**



**7.0 Inch Instrument Cluster Display Location**

- The top line where Reconfigurable Tell-tales, Compass Direction, Outside Temperature, Time, Range, MPG or Trip are displayed. This also displays the speedometer when other menu pages are displayed.
- The main display area where the menus and pop up messages are displayed.



- The lower line where reconfigurable tell-tales, menu name and menu page are displayed.



**Instrument Cluster Display Control Buttons**

- 1 — OK Button
- 2 — Up Arrow Button
- 3 — Right Arrow Button
- 4 — Down Arrow Button
- 5 — Left Arrow Button

- Push the **up** arrow button to scroll upward through the main menus (Speedometer, MPH/km/h, Vehicle Info, Terrain, Driver Assist, Fuel Economy, Trip A, Trip B, Stop/Start, Audio, Navigation, Stored Messages, Screen Setup and Speed Warning).
- Push the **down** arrow button to scroll downward through the main menu and submenus (Speedometer, MPH/km/h, Vehicle Info, Terrain, Driver Assist, Fuel Economy, Trip A, Trip B, Stop/Start, Audio, Navigation, Stored Messages, Screen Setup and Speed Warning).
- Push the **right** arrow button to access the information screens or submenu screens of a main menu item.
- Push the **left** arrow button to access the information screens or submenu screens of a main menu item.
- Push the **OK** button to access/select the information screens or submenu screens of a main menu item. Push and hold the **OK** button for two seconds to reset displayed/selected features that can be reset.

### **Oil Change Reset — If Equipped**

Your vehicle may be equipped with an engine oil change indicator system. The “Oil Change Required” message will display in the instrument cluster display for five seconds after a single chime has sounded to indicate the next scheduled oil change interval. The engine oil change indicator system is duty cycle based, which means the engine oil change interval may fluctuate, dependent upon your personal driving style.

Unless reset, this message will continue to display each time you place the ignition in the ON/RUN position. To turn off the message temporarily, push and release the **OK** button. To reset the oil change indicator system (after performing the scheduled maintenance), refer to the following procedure.

### **Oil Life Reset**

1. Without pushing the brake pedal, place the ignition in the ON/RUN mode (do not start the engine).
2. Navigate to "Oil Life" submenu in "Vehicle Info" in the instrument cluster display.



3. Push and hold the **OK** button until the gauge resets to 100%.

### Secondary Method For Oil Change Reset Procedure

1. Without pushing the brake pedal, place the ignition in the ON/RUN position (do not start the engine).
2. Fully press the accelerator pedal, slowly, three times within ten seconds.
3. Without pushing the brake pedal, place the ignition in the OFF/LOCK position.

#### **NOTE:**

If the indicator message illuminates when you start the vehicle, the oil change indicator system did not reset. If necessary, repeat this procedure.

### Instrument Cluster Display Selectable Items

The instrument cluster display can be used to view the following main menu items:

#### **NOTE:**

Depending on the vehicles options, feature settings may vary.

- Speedometer
- Vehicle Info
- Off Road
- Fuel Economy
- Trip Info
- Stop/Start
- Audio
- Messages
- Screen Setup

#### **NOTE:**

Refer to your Owner's Manual for further information.

## WARNING LIGHTS AND MESSAGES

The warning/indicator lights will illuminate in the instrument panel together with a dedicated message and/or acoustic signal when applicable. These indications are indicative and precautionary and as such must not be considered as exhaustive and/or alternative to the information contained in the Owner's Manual, which you are advised to read carefully in all cases. Always refer to the information in this chapter in the event of a failure indication. All active telltales will display first if applicable. The system check menu may appear different based upon equipment options and current vehicle status. Some telltales are optional and may not appear.

## Red Warning Lights

### — Air Bag Warning Light

This warning light will illuminate to indicate a fault with the air bag, and will turn on for four to eight seconds as a bulb check when the ignition is placed in the ON/RUN or ACC/ON/RUN position. This light will illuminate with a single chime when a fault with the air bag has been detected, it will stay on until the fault is cleared. If the light is either not on during startup, stays on, or turns on while driving, have the system inspected at an authorized dealer as soon as possible.

### **BRAKE** — Brake Warning Light

This warning light monitors various brake functions, including brake fluid level and parking brake application. If the brake light turns on it may indicate that the parking brake is applied, that the brake fluid level is low, or that there is a problem with the anti-lock brake system reservoir.

If the light remains on when the parking brake has been disengaged, and the fluid level is at the full mark on the master cylinder reservoir, it indicates a possible brake hy-

draulic system malfunction or that a problem with the Brake Booster has been detected by the Anti-Lock Brake System (ABS) / Electronic Stability Control (ESC) system. In this case, the light will remain on until the condition has been corrected. If the problem is related to the brake booster, the ABS pump will run when applying the brake, and a brake pedal pulsation may be felt during each stop.

The dual brake system provides a reserve braking capacity in the event of a failure to a portion of the hydraulic system. A leak in either half of the dual brake system is indicated by the Brake Warning Light, which will turn on when the brake fluid level in the master cylinder has dropped below a specified level.

The light will remain on until the cause is corrected.

#### **NOTE:**

The light may flash momentarily during sharp cornering maneuvers, which change fluid level conditions. The vehicle should have service performed, and the brake fluid level checked.

If brake failure is indicated, immediate repair is necessary.

### **WARNING!**

Driving a vehicle with the red brake light on is dangerous. Part of the brake system may have failed. It will take longer to stop the vehicle. You could have a collision. Have the vehicle checked immediately.

Vehicles equipped with the Anti-Lock Brake System (ABS) are also equipped with Electronic Brake Force Distribution (EBD). In the event of an EBD failure, the Brake Warning Light will turn on along with the ABS Light. Immediate repair to the ABS system is required.

Operation of the Brake Warning Light can be checked by turning the ignition switch from the OFF position to the ON/RUN position. The light should illuminate for approximately two seconds. The light should then turn off unless the parking brake is applied or a brake fault is detected. If the light does not illuminate, have the light inspected by an authorized dealer.



The light also will turn on when the parking brake is applied with the ignition switch in the ON/RUN position.

**NOTE:**

This light shows only that the parking brake is applied. It does not show the degree of brake application.



**— Battery Charge Warning Light**

This warning light will illuminate when the battery is not charging properly. If it stays on while the engine is running, there may be a malfunction with the charging system. Contact an authorized dealer as soon as possible.

This indicates a possible problem with the electrical system or a related component.



**— Door Open Warning Light**

This indicator will illuminate when a door is ajar/open and not fully closed.

**NOTE:**

If the vehicle is moving, there will also be a single chime.



**— Electric Power Steering Fault  
Warning Light**

This warning light will turn on when there's a fault with the EPS (Electric Power Steering) system. Refer to “Power Steering” in “Starting And Operating” in the Owner’s Manual for further information.

**WARNING!**

Continued operation with reduced assist could pose a safety risk to yourself and others. Service should be obtained as soon as possible.



**— Electronic Throttle Control (ETC)  
Warning Light**

This warning light will illuminate to indicate a problem with the Electronic Throttle Control (ETC) system. If a problem is detected while the vehicle is running, the light will either stay on or flash depending on the nature of the problem. Cycle the ignition when the vehicle is safely and completely stopped and the transmission is placed in the PARK position. The light should turn off. If

the light remains on with the vehicle running, your vehicle will usually be drivable; however, see an authorized dealer for service as soon as possible.

**NOTE:**

This light may turn on if the accelerator and brake pedals are pressed at the same time.

If the light continues to flash when the vehicle is running, immediate service is required and you may experience reduced performance, an elevated/rough idle, or engine stall and your vehicle may require towing. The light will come on when the ignition is placed in the ON/RUN or ACC/ON/RUN position and remain on briefly as a bulb check. If the light does not come on during starting, have the system checked by an authorized dealer.



**— Engine Coolant Temperature  
Warning Light**

This warning light warns of an overheated engine condition. If the engine coolant temperature is too high, this indicator will illuminate and a single chime will sound. If the

temperature reaches the upper limit, a continuous chime will sound for four minutes or until the engine is able to cool: whichever comes first.

If the light turns on while driving, safely pull over and stop the vehicle. If the A/C system is on, turn it off. Also, shift the transmission into NEUTRAL and idle the vehicle. If the temperature reading does not return to normal, turn the engine off immediately and call for service.

Refer to “If Your Engine Overheats” in “In Case Of Emergency” for further information.

### — Hood Open Warning Light

This indicator will illuminate when the hood is ajar/open and not fully closed.

#### **NOTE:**

If the vehicle is moving, there will also be a single chime.

### — Oil Pressure Warning Light

This warning light will illuminate to indicate low engine oil pressure. If the light turns on while driving, stop the vehicle, shut off the engine as soon as possible, and contact an authorized dealer. A chime will sound when this light turns on.

Do not operate the vehicle until the cause is corrected. This light does not indicate how much oil is in the engine. The engine oil level must be checked under the hood.

### — Oil Temperature Warning Light

This warning light will illuminate to indicate the engine oil temperature is high. If the light turns on while driving, stop the vehicle and shut off the engine as soon as possible. Wait for oil temperature to return to normal levels.

### — Seat Belt Reminder Warning Light

This warning light indicates when the driver or passenger seat belt is unbuckled. When the ignition is first placed in the ON/RUN or ACC/ON/RUN position and if the driver's seat belt is unbuckled, a chime will sound and the light will turn on. When driving, if the driver

or front passenger seat belt remains unbuckled, the Seat Belt Reminder Light will flash or remain on continuously and a chime will sound.

Refer to “Occupant Restraint Systems” in “Safety” for further information.

### — Swing Gate Open Warning Light

This warning light will illuminate when the swing gate is open.

#### **NOTE:**

If the vehicle is moving, there will also be a single chime.

### — Transmission Temperature Warning Light — If Equipped

This warning light will illuminate to warn of a high transmission fluid temperature. This may occur with strenuous usage such as trailer towing. If this light turns on, stop the vehicle and run the engine at idle or slightly faster, with the transmission in PARK or NEUTRAL, until the light turns off. Once the light turns off, you may continue to drive normally.



**WARNING!**

If you continue operating the vehicle when the Transmission Temperature Warning Light is illuminated you could cause the fluid to boil over, come in contact with hot engine or exhaust components and cause a fire.

**CAUTION!**

Continuous driving with the Transmission Temperature Warning Light illuminated will eventually cause severe transmission damage or transmission failure.

● — **Vehicle Security Warning Light** —  
If Equipped

This light will flash at a fast rate for approximately 15 seconds when the vehicle security alarm is arming, and then will flash slowly until the vehicle is disarmed.

**Yellow Warning Lights**

 — **Anti-Lock Brake (ABS)  
Warning Light**

This warning light monitors the Anti-Lock Brake System (ABS). The light will turn on when the ignition is placed in the ON/RUN or ACC/ON/RUN position and may stay on for as long as four seconds.

If the ABS light remains on or turns on while driving, then the Anti-Lock portion of the brake system is not functioning and service is required as soon as possible. However, the conventional brake system will continue to operate normally, assuming the Brake Warning Light is not also on.

If the ABS light does not turn on when the ignition is placed in the ON/RUN or ACC/ON/RUN position, have the brake system inspected by an authorized dealer.

 — **Electronic Stability Control (ESC)  
Active Warning Light** — If Equipped

This warning light will indicate when the Electronic Stability Control system is Active.

The “ESC Indicator Light” in the instrument cluster will come on when the ignition is placed in the ON/RUN or ACC/ON/RUN position, and when ESC is activated. It should go out with the engine running. If the “ESC Indicator Light” comes on continuously with the engine running, a malfunction has been detected in the ESC system. If this warning light remains on after several ignition cycles, and the vehicle has been driven several miles (kilometers) at speeds greater than 30 mph (48 km/h), see an authorized dealer as soon as possible to have the problem diagnosed and corrected.

- The “ESC Off Indicator Light” and the “ESC Indicator Light” come on momentarily each time the ignition is placed in the ON/RUN or ACC/ON/RUN position.
- The ESC system will make buzzing or clicking sounds when it is active. This is normal; the sounds will stop when ESC becomes inactive.
- This light will come on when the vehicle is in an ESC event.

 — **Electronic Stability Control (ESC)  
Off Warning Light — If Equipped**

This warning light indicates the Electronic Stability Control (ESC) is off.

Each time the ignition is turned to ON/RUN or ACC/ON/RUN, the ESC system will be on, even if it was turned off previously.

 — **Loose Fuel Filler Cap Warning Light  
— If Equipped**

This warning light will illuminate when the fuel filler cap is loose. Properly close the filler cap to disengage the light. If the light does not turn off, please see an authorized dealer.

 — **Low Fuel Warning Light**

When the fuel level reaches approximately 2.0 gal (7.5 L), this light will turn on and a chime will sound. The light will remain on until fuel is added.

 — **Low Washer Fluid Warning Light —  
If Equipped**

This warning light will illuminate when the windshield washer fluid is low.

 — **Engine Check/Malfunction  
Indicator Warning Light (MIL)**

The Engine Check/Malfunction Indicator Light (MIL) is a part of an Onboard Diagnostic System called OBD II that monitors engine and automatic transmission control systems. This warning light will illuminate when the ignition is in the ON/RUN position before engine start. If the bulb does not come on when turning the ignition switch from OFF to ON/RUN, have the condition checked promptly.

Certain conditions, such as a loose or missing gas cap, poor quality fuel, etc., may illuminate the light after engine start. The vehicle should be serviced if the light stays on through several typical driving styles. In most situations, the vehicle will drive normally and will not require towing.

When the engine is running, the MIL may flash to alert serious conditions that could lead to immediate loss of power or severe catalytic converter damage. The vehicle should be serviced by an authorized dealer as soon as possible if this occurs.

**WARNING!**

A malfunctioning catalytic converter, as referenced above, can reach higher temperatures than in normal operating conditions. This can cause a fire if you drive slowly or park over flammable substances such as dry plants, wood, cardboard, etc. This could result in death or serious injury to the driver, occupants or others.

**CAUTION!**

Prolonged driving with the Malfunction Indicator Light (MIL) on could cause damage to the vehicle control system. It also could affect fuel economy and driveability. If the MIL is flashing, severe catalytic converter damage and power loss will soon occur. Immediate service is required.

 — **Service 4WD Warning Light —  
If Equipped**

This warning light will illuminate to signal a fault with the 4WD system. If the light stays on or comes on during driving, it means that



the 4WD system is not functioning properly and that service is required. We recommend you drive to the nearest service center and have the vehicle serviced immediately.

 — **Service Stop/Start System Warning Light — If Equipped**

This warning light will illuminate when the Stop/Start system is not functioning properly and service is required. Contact an authorized dealer for service.

 — **Speed Control Fault Warning Light**

This warning light will illuminate to indicate the Speed Control System is not functioning properly and service is required. Contact an authorized dealer.

 — **Sway Bar Fault Warning Light**

This light will illuminate when there is a fault in the sway bar disconnect system.

 — **Tire Pressure Monitoring System (TPMS) Warning Light**

The warning light switches on and a message is displayed to indicate that the tire pressure is lower than the recommended value and/or

that slow pressure loss is occurring. In these cases, optimal tire duration and fuel consumption may not be guaranteed.

Should one or more tires be in the condition mentioned above, the display will show the indications corresponding to each tire.

**CAUTION!**

Do not continue driving with one or more flat tires as handling may be compromised. Stop the vehicle, avoiding sharp braking and steering. If a tire puncture occurs, repair immediately using the dedicated tire repair kit and contact your authorized dealer as soon as possible.

Each tire, including the spare (if provided), should be checked monthly when cold and inflated to the inflation pressure recommended by the vehicle manufacturer on the vehicle placard or tire inflation pressure label. (If your vehicle has tires of a different size than the size indicated on the vehicle placard or tire inflation pressure label, you should determine the proper tire inflation pressure for those tires.)

As an added safety feature, your vehicle has been equipped with a Tire Pressure Monitoring System (TPMS) that illuminates a low tire pressure telltale when one or more of your tires is significantly under-inflated. Accordingly, when the low tire pressure telltale illuminates, you should stop and check your tires as soon as possible, and inflate them to the proper pressure. Driving on a significantly under-inflated tire causes the tire to overheat and can lead to tire failure. Under-inflation also reduces fuel efficiency and tire tread life, and may affect the vehicle's handling and stopping ability.

Please note that the TPMS is not a substitute for proper tire maintenance, and it is the driver's responsibility to maintain correct tire pressure, even if under-inflation has not reached the level to trigger illumination of the TPMS low tire pressure telltale.

Your vehicle has also been equipped with a TPMS malfunction indicator to indicate when the system is not operating properly. The TPMS malfunction indicator is combined with the low tire pressure telltale. When the system detects a malfunction, the telltale will



flash for approximately one minute and then remain continuously illuminated. This sequence will continue upon subsequent vehicle start-ups as long as the malfunction exists. When the malfunction indicator is illuminated, the system may not be able to detect or signal low tire pressure as intended. TPMS malfunctions may occur for a variety of reasons, including the installation of replacement or alternate tires or wheels on the vehicle that prevent the TPMS from functioning properly. Always check the TPMS malfunction telltale after replacing one or more tires or wheels on your vehicle to ensure that the replacement or alternate tires and wheels allow the TPMS to continue to function properly.

### CAUTION!

The TPMS has been optimized for the original equipment tires and wheels. TPMS pressures and warning have been established for the tire size equipped on your vehicle. Undesirable system operation or sensor damage may result when using replacement equipment that is not

### CAUTION!

of the same size, type, and/or style. Aftermarket wheels can cause sensor damage. Using aftermarket tire sealants may cause the Tire Pressure Monitoring System (TPMS) sensor to become inoperable. After using an aftermarket tire sealant it is recommended that you take your vehicle to your authorized dealer to have your sensor function checked.

### Yellow Indicator Lights

#### **4H / <sup>4WD</sup>** — 4WD Indicator Light — If Equipped

This light alerts the driver that the vehicle is in the four-wheel drive mode, and the front and rear driveshafts are mechanically locked together forcing the front and rear wheels to rotate at the same speed.

#### **4L / <sup>4WD</sup><sub>LOW</sub>** — 4WD Low Indicator Light — If Equipped

This light alerts the driver that the vehicle is in the four-wheel drive LOW mode. The front and rear driveshafts are mechanically locked

together forcing the front and rear wheels to rotate at the same speed. Low range provides a greater gear reduction ratio to provide increased torque at the wheels.

#### **4H / <sup>4WD</sup><sub>PART TIME</sub>** — 4WD Part Time Indicator Light — If Equipped

This light alerts the driver that the vehicle is in the four-wheel drive part time mode, and the front and rear driveshafts are mechanically locked together forcing the front and rear wheels to rotate at the same speed.

#### **!** — Active Speed Limiter Fault Indicator Light — If Equipped

This warning light will illuminate to signal when there is a fault detected with the Active Speed Limiter.

#### **!** — Axle Locker Fault Indicator Light

This light indicates when the front and/or rear axle locker fault has been detected.



 — **Front And Rear Axle Lock Indicator Light**

This light indicates when the front, rear, or both axles have been locked. The telltale will display the lock icon on the front and rear axles to indicate the current lock status.

**N / NEUTRAL — Neutral Indicator Light — If Equipped**

This light alerts the driver that the vehicle is in the neutral mode.

 — **Rear Axle Lock Indicator Light**

This light indicates when the rear axle lock has been activated.

 — **Sway Bar Indicator Light — If Equipped**

This indicator light will illuminate when the front sway bar is disconnected.

**Green Indicator Lights**
 — **4WD Auto Indicator Light — If Equipped**

This light alerts the driver that the vehicle is in the four-wheel drive auto mode. The system will provide power to all four wheels and shift the power between the front and rear axles as needed. This will provide maximum traction in dry and slippery conditions.

 — **Active Speed Limiter SET Indicator Light — If Equipped With A Premium Instrument Cluster**

This indicator light will illuminate when the Active Speed Limiter is on and set to a specific speed.

 — **Cruise Control SET Indicator Light — If Equipped With A Premium Instrument Cluster**

This indicator light will illuminate when the speed control is set to the desired speed. Refer to “Speed Control — If Equipped” in “Starting And Operating” for further information.

 — **Front Fog Indicator Light — If Equipped**

This indicator light will illuminate when the front fog lights are on.

 — **Park/Headlight On Indicator Light**

This indicator light will illuminate when the park lights or headlights are turned on.

 — **Stop/Start Active Indicator Light — If Equipped**

This indicator light will illuminate when the Stop/Start function is in “Autostop” mode.

 — **Turn Signal Indicator Lights**

When the left or right turn signal is activated, the turn signal indicator will flash independently and the corresponding exterior turn signal lamps will flash. Turn signals can be activated when the multifunction lever is moved down (left) or up (right).

**NOTE:**

- A continuous chime will sound if the vehicle is driven more than 1 mile (1.6 km) with either turn signal on.

- Check for an inoperative outside light bulb if either indicator flashes at a rapid rate.

## White Indicator Lights

### 2H — Two Wheel Drive High Indicator Light — If Equipped With a Premium Cluster

This light alerts the driver that the vehicle is in the two wheel drive high mode.

### — Active Speed Limiter Ready Indicator Light — If Equipped With A Premium Instrument Cluster

This light will illuminate when the Active Speed Limiter has been turned on, but not set.

### — Active Speed Limiter SET Indicator Light — If Equipped With A Base Instrument Cluster

This light will turn on when the Active Speed Limiter is on and set to a specific speed.

### — Hill Descent Control (HDC) Indicator Light — If Equipped

This indicator shows when the Hill Descent Control (HDC) feature is turned on. The lamp will be on solid when HDC is armed. HDC can only be armed when the transfer case is in the “4WD LOW” position and the vehicle speed is less than 30 mph (48 km/h). If these conditions are not met while attempting to use the HDC feature, the HDC indicator light will flash on/off.

### — Speed Warning Indicator Light — If Equipped

When Set Speed Warning is turned on, the speed warning telltale will illuminate in the instrument cluster with a number matching the set speed. When the set speed is exceeded, the indication will light up yellow and flash along with a continuous chime (up to ten seconds or until the speed is no longer exceeded). Speed Warning can be turned on and off in the instrument cluster display, for further information refer to “Instrument Cluster Display Menu Items” in “Getting To Know Your Instrument Panel.”

The number “55” is only an example of a speed that can be set.

### — Cruise Control Ready Indicator Light — If Equipped With A Premium Instrument Cluster

This light will turn on when the speed control has been turned on, but not set. Refer to “Speed Control — If Equipped” in “Starting And Operating” for further information.

### — Cruise Control SET Indicator Light — If Equipped With Base Instrument Cluster

This indicator light will illuminate when the speed control is set.

Refer to “Speed Control — If Equipped” in “Starting And Operating” for further information.

## Blue Indicator Lights

### — High Beam Indicator Light

This indicator light will illuminate to indicate that the high beam headlights are on. With the low beams activated, push the multifunction lever forward (toward the front of the vehicle) to turn on the high beams. Pull the



multifunction lever rearward (toward the rear of the vehicle) to turn off the high beams. If the high beams are off, pull the lever toward you for a temporary high beam on, "flash to pass" scenario.

### Gray Indicator Lights

 — **Cruise Control Ready Indicator Light — If Equipped With Base Instrument Cluster**

This light will turn on when the speed control has been turned on, but not set. Refer to "Speed Control — If Equipped" in "Starting And Operating" for further information.

 — **Active Speed Limiter Ready Indicator Light — If Equipped With A Base Instrument Cluster**

This light will turn on when the Active Speed Limiter is on, but not set.

## ONBOARD DIAGNOSTIC SYSTEM — OBD II

Your vehicle is equipped with a sophisticated Onboard Diagnostic system called OBD II. This system monitors the performance of the emissions, engine, and transmission control systems. When these systems are operating properly, your vehicle will provide excellent performance and fuel economy, as well as engine emissions well within current government regulations.

If any of these systems require service, the OBD II system will turn on the Malfunction Indicator Light (MIL). It will also store diagnostic codes and other information to assist your service technician in making repairs. Although your vehicle will usually be drivable and not need towing, see an authorized dealer for service as soon as possible.

### CAUTION!

- Prolonged driving with the MIL on could cause further damage to the emission control system. It could also affect fuel economy and driveability. The vehicle must be serviced before any emissions tests can be performed.
- If the MIL is flashing while the vehicle is running, severe catalytic converter damage and power loss will soon occur. Immediate service is required.

### Onboard Diagnostic System (OBD II) Cybersecurity

Your vehicle is required to have an Onboard Diagnostic system (OBD II) and a connection port to allow access to information related to the performance of your emissions controls. Authorized service technicians may need to access this information to assist with the diagnosis and service of your vehicle and emissions system.

## WARNING!

- ONLY an authorized service technician should connect equipment to the OBD II connection port in order to read the VIN, diagnose, or service your vehicle.
- If unauthorized equipment is connected to the OBD II connection port, such as a driver-behavior tracking device, it may:
  - Be possible that vehicle systems, including safety related systems, could be impaired or a loss of vehicle control could occur that may result in an accident involving serious injury or death.
  - Access, or allow others to access, information stored in your vehicle systems, including personal information.

For further information, refer to “Cybersecurity” in “Multimedia”.

## EMISSIONS INSPECTION AND MAINTENANCE PROGRAMS

In some localities, it may be a legal requirement to pass an inspection of your vehicle's emissions control system. Failure to pass could prevent vehicle registration.



For states that require an Inspection and Maintenance (I/M), this check verifies the “Malfunction Indicator Light (MIL)” is functioning and is not on when the engine is running, and that the OBD II system is ready for testing.

Normally, the OBD II system will be ready. The OBD II system may **not** be ready if your vehicle was recently serviced, recently had a dead battery or a battery replacement. If the OBD II system should be determined not ready for the I/M test, your vehicle may fail the test.

Your vehicle has a simple ignition actuated test, which you can use prior to going to the test station.

To check if your vehicle's OBD II system is ready, you must do the following:

1. Cycle the ignition switch to the ON position, but do not crank or start the engine.

### NOTE:

If you crank or start the engine, you will have to start this test over.

2. As soon as you cycle the ignition switch to the ON position, you will see the “Malfunction Indicator Light (MIL)” symbol come on as part of a normal bulb check.

3. Approximately 15 seconds later, one of two things will happen:

- The MIL will flash for about ten seconds and then return to being fully illuminated until you turn OFF the ignition or start the engine. This means that your vehicle's OBD II system is **not ready** and you should **not** proceed to the I/M station.

- The MIL will not flash at all and will remain fully illuminated until you place the ignition in the off position or start the engine. This means that your vehicle's OBD II system is **ready** and you can proceed to the I/M station.



If your OBD II system is **not ready**, you should see an authorized dealer or repair facility. If your vehicle was recently serviced or had a battery failure or replacement, you may need to do nothing more than drive your vehicle as you normally would in order for your OBD II system to update. A recheck with the above test routine may then indicate that the system is **now ready**.

Regardless of whether your vehicle's OBD II system is ready or not, if the MIL is illuminated during normal vehicle operation you should have your vehicle serviced before going to the I/M station. The I/M station can fail your vehicle because the MIL is on with the engine running.

# SAFETY

## SAFETY FEATURES . . . . .86

- Anti-Lock Brake System (ABS) . . . . .86
- Electronic Brake Control System . . . . .87

## AUXILIARY DRIVING SYSTEMS . .95

- Blind Spot Monitoring (BSM) —  
If Equipped . . . . .95
- Tire Pressure Monitor System (TPMS) . .98

## OCCUPANT RESTRAINT SYSTEMS . . . . .104

- Occupant Restraint Systems Features .104
- Important Safety Precautions . . . . .104
- Seat Belt Systems . . . . .105
- Supplemental Restraint Systems (SRS) . . . . .112
- Child Restraints . . . . .128
- Transporting Pets . . . . .144

## SAFETY TIPS . . . . .144

- Transporting Passengers . . . . .144
- Exhaust Gas . . . . .144
- Safety Checks You Should Make  
Inside The Vehicle . . . . .145
- Periodic Safety Checks You Should  
Make Outside The Vehicle . . . . .146



## SAFETY FEATURES

### Anti-Lock Brake System (ABS)

The Anti-Lock Brake System (ABS) provides increased vehicle stability and brake performance under most braking conditions. The system automatically prevents wheel lock, and enhances vehicle control during braking.

The ABS performs a self-check cycle to ensure that the ABS is working properly each time the vehicle is started and driven. During this self-check, you may hear a slight clicking sound as well as some related motor noises.

ABS is activated during braking when the system detects one or more wheels begin to lock. Road conditions such as ice, snow, gravel, bumps, railroad tracks, loose debris, or panic stops may increase the likelihood of ABS activation(s).

You also may experience the following when ABS activates:

- The ABS motor noise (it may continue to run for a short time after the stop).
- The clicking sound of solenoid valves.
- Brake pedal pulsations.
- A slight drop of the brake pedal at the end of the stop.

These are all normal characteristics of ABS.

#### WARNING!

- The ABS contains sophisticated electronic equipment that may be susceptible to interference caused by improperly installed or high output radio transmitting equipment. This interference can cause possible loss of anti-lock braking capability. Installation of such equipment should be performed by qualified professionals.

#### WARNING!

- Pumping of the Anti-Lock Brakes will diminish their effectiveness and may lead to a collision. Pumping makes the stopping distance longer. Just press firmly on your brake pedal when you need to slow down or stop.
- The ABS cannot prevent the natural laws of physics from acting on the vehicle, nor can it increase braking or steering efficiency beyond that afforded by the condition of the vehicle brakes and tires or the traction afforded.
- The ABS cannot prevent collisions, including those resulting from excessive speed in turns, following another vehicle too closely, or hydroplaning.
- The capabilities of an ABS equipped vehicle must never be exploited in a reckless or dangerous manner that could jeopardize the user's safety or the safety of others.

ABS is designed to function with the OEM tires. Modification may result in degraded ABS performance.



## Anti-Lock Brake Warning Light

The yellow “Anti-Lock Brake Warning Light” will turn on when the ignition is turned to the ON/RUN mode and may stay on for as long as four seconds.

If the “Anti-Lock Brake Warning Light” remains on or comes on while driving, it indicates that the anti-lock portion of the brake system is not functioning and that service is required. However, the conventional brake system will continue to operate normally if the “Anti-Lock Brake Warning Light” is on.

If the “Anti-Lock Brake Warning Light” is on, the brake system should be serviced as soon as possible to restore the benefits of anti-lock brakes. If the “Anti-Lock Brake Warning Light” does not come on when the ignition is turned to the ON/RUN mode, have the light repaired as soon as possible.

## Electronic Brake Control System

Your vehicle is equipped with an advanced Electronic Brake Control system (EBC). This system includes Electronic Brake Force Distribution (EBD), Anti-Lock Brake System (ABS), Brake Assist System (BAS), Hill Start

Assist (HSA), Traction Control System (TCS), Electronic Stability Control (ESC), and Electronic Roll Mitigation (ERM). These systems work together to enhance both vehicle stability and control in various driving conditions.

Your vehicle may also be equipped with Trailer Sway Control (TSC), Ready Alert Braking (RAB), Rain Brake Support (RBS), Dynamic Steering Torque (DST), and Hill Descent Control (HDC).

## Electronic Brake Force Distribution (EBD)

This function manages the distribution of the braking torque between the front and rear axles by limiting braking pressure to the rear axle. This is done to prevent overslip of the rear wheels to avoid vehicle instability, and to prevent the rear axle from entering ABS before the front axle.

## Brake System Warning Light

The red “Brake System Warning Light” will turn on when the ignition is turned to the ON/RUN mode and may stay on for as long as four seconds.

If the “Brake System Warning Light” remains on or comes on while driving, it indicates that the brake system is not functioning properly and that immediate service is required. If the “Brake System Warning Light” does not come on when the ignition is turned to the ON/RUN mode, have the light repaired as soon as possible.

## Brake Assist System (BAS)

The BAS is designed to optimize the vehicle’s braking capability during emergency braking maneuvers. The system detects an emergency braking situation by sensing the rate and amount of brake application and then applies optimum pressure to the brakes. This can help reduce braking distances. The BAS complements the anti-lock brake system (ABS). Applying the brakes very quickly results in the best BAS assistance. To receive the benefit of the system, you must apply continuous braking pressure during the stopping sequence, (do not “pump” the brakes). Do not reduce brake pedal pressure unless braking is no longer desired. Once the brake pedal is released, the BAS is deactivated.



**WARNING!**

The Brake Assist System (BAS) cannot prevent the natural laws of physics from acting on the vehicle, nor can it increase the traction afforded by prevailing road conditions. BAS cannot prevent collisions, including those resulting from excessive speed in turns, driving on very slippery surfaces, or hydroplaning. The capabilities of a BAS-equipped vehicle must never be exploited in a reckless or dangerous manner, which could jeopardize the user's safety or the safety of others.

**Hill Start Assist (HSA)**

The HSA system is designed to mitigate roll back from a complete stop while on an incline. If the driver releases the brake while stopped on an incline, HSA will continue to hold the brake pressure for a short period. If the driver does not apply the throttle before this time expires, the system will release brake pressure and the vehicle will roll down the hill as normal.

The following conditions must be met in order for HSA to activate:

- The feature must be enabled.
- The vehicle must be stopped.
- Park brake must be off.
- Driver door must be closed. (If the doors are attached, then the door must be closed. If the doors are detached then the driver's seatbelt must be buckled.)
- The vehicle must be on a sufficient grade.
- The gear selection must match vehicle uphill direction (i.e., vehicle facing uphill is in forward gear; vehicle backing uphill is in REVERSE gear).
- HSA will work in REVERSE gear and all forward gears. The system will not activate if the transmission is in PARK or NEUTRAL. For vehicles equipped with a manual transmission, if the clutch is pressed, HSA will remain active.

**WARNING!**

There may be situations where the Hill Start Assist (HSA) will not activate and slight rolling may occur, such as on minor hills or with a loaded vehicle, or while pulling a trailer. HSA is not a substitute for active driving involvement. It is always the driver's responsibility to be attentive to distance to other vehicles, people, and objects, and most importantly brake operation to ensure safe operation of the vehicle under all road conditions. Your complete attention is always required while driving to maintain safe control of your vehicle. Failure to follow these warnings can result in a collision or serious personal injury.

**Disabling And Enabling HSA**

This feature can be turned on or turned off. To change the current setting, refer to "Instrument Cluster Display" in "Getting To Know Your Instrument Panel" for further information.

## Towing With HSA

HSA will also provide assistance to mitigate roll back while towing a trailer.

### WARNING!

- If you use a trailer brake controller with your trailer, the trailer brakes may be activated and deactivated with the brake switch. If so, there may not be enough brake pressure to hold both the vehicle and the trailer on a hill when the brake pedal is released. In order to avoid rolling down an incline while resuming acceleration, manually activate the trailer brake or apply more vehicle brake pressure prior to releasing the brake pedal.
- HSA is not a parking brake. Always apply the parking brake fully when exiting your vehicle. Also, be certain to place the transmission in PARK.
- Failure to follow these warnings can result in a collision or serious personal injury.

## Traction Control System (TCS)

This system monitors the amount of wheel spin of each of the driven wheels. If wheel spin is detected, the TCS may apply brake pressure to the spinning wheel(s) and/or reduce engine power to provide enhanced acceleration and stability. A feature of the TCS, Brake Limited Differential (BLD), functions similar to a limited slip differential and controls the wheel spin across a driven axle. If one wheel on a driven axle is spinning faster than the other, the system will apply the brake of the spinning wheel. This will allow more engine torque to be applied to the wheel that is not spinning. BLD may remain enabled even if TCS and ESC are in a reduced mode.

## Electronic Stability Control (ESC)

This system enhances directional control and stability of the vehicle under various driving conditions. ESC corrects for oversteering or understeering of the vehicle by applying the brake of the appropriate wheel(s) to assist in counteracting the oversteer or understeer condition. Engine power may also be reduced to help the vehicle maintain the desired path.

ESC uses sensors in the vehicle to determine the vehicle path intended by the driver and compares it to the actual path of the vehicle. When the actual path does not match the intended path, ESC applies the brake of the appropriate wheel to assist in counteracting the oversteer or understeer condition.

- Oversteer — when the vehicle is turning more than appropriate for the steering wheel position.
- Understeer — when the vehicle is turning less than appropriate for the steering wheel position.

The “ESC Activation/Malfunction Indicator Light” located in the instrument cluster will start to flash as soon as the ESC system becomes active. The “ESC Activation/Malfunction Indicator Light” also flashes when the TCS is active. If the “ESC Activation/Malfunction Indicator Light” begins to flash during acceleration, ease up on the accelerator and apply as little throttle as possible. Be sure to adapt your speed and driving to the prevailing road conditions.



**WARNING!**

- Electronic Stability Control (ESC) cannot prevent the natural laws of physics from acting on the vehicle, nor can it increase the traction afforded by prevailing road conditions. ESC cannot prevent accidents, including those resulting from excessive speed in turns, driving on very slippery surfaces, or hydroplaning. ESC also cannot prevent accidents resulting from loss of vehicle control due to inappropriate driver input for the conditions. Only a safe, attentive, and skillful driver can prevent accidents. The capabilities of an ESC equipped vehicle must never be exploited in a reckless or dangerous manner which could jeopardize the user's safety or the safety of others.
- Vehicle modifications, or failure to properly maintain your vehicle, may change the handling characteristics of your vehicle, and may negatively affect the performance of the ESC system. Changes to the steering system, suspension, braking system, tire type and size or wheel

**WARNING!**

size may adversely affect ESC performance. Improperly inflated and unevenly worn tires may also degrade ESC performance. Any vehicle modification or poor vehicle maintenance that reduces the effectiveness of the ESC system can increase the risk of loss of vehicle control, vehicle rollover, personal injury and death.

**ESC Operating Modes****NOTE:**

Depending upon model and mode of operation, the ESC system may have multiple operating modes.

**ESC On**

This is the normal operating mode for the ESC. Whenever the vehicle is started, the ESC system will be in this mode. This mode should be used for most driving conditions. Alternate ESC modes should only be used for specific reasons as noted in the following paragraphs.

**Partial Off**

The "Partial Off" mode is intended for times when a more spirited driving experience is desired. This mode may modify TCS and ESC thresholds for activation, which allows for more wheel spin than normally allowed. This mode may be useful if the vehicle becomes stuck.

To enter the "Partial Off" mode, momentarily push the "ESC Off" switch and the "ESC Off Indicator Light" will illuminate. To turn the ESC on again, momentarily push the "ESC Off" switch and the "ESC Off Indicator Light" will turn off.

**NOTE:**

For vehicles with multiple partial ESC modes a momentary button push will toggle the ESC mode. Multiple momentary button pushed may be required to return to ESC On.

**WARNING!**

- When in "Partial Off" mode, the TCS functionality of ESC, (except for the limited slip feature described in the TCS

## WARNING!

section), has been disabled and the “ESC Off Indicator Light” will be illuminated. When in “Partial Off” mode, the engine power reduction feature of TCS is disabled, and the enhanced vehicle stability offered by the ESC system is reduced.

- Trailer Sway control (TSC) is disabled when the ESC system is in the “Partial Off” mode.

### Full Off — If Equipped

This mode is intended for off-highway or off-road use only and should not be used on any public roadways. In this mode, TCS and ESC features are turned OFF. To enter the “Full Off” mode, push and hold the “ESC Off” switch for five seconds while the vehicle is stopped with the engine running. After five seconds, a chime will sound, the “ESC Off Indicator Light” will illuminate, and the “ESC OFF” message will display in the instrument cluster. To turn ESC ON again, momentarily push the “ESC Off” switch.

## NOTE:

System may switch from ESC “Full Off” to “Partial Off” mode when vehicle exceeds a predetermined speed. When the vehicle speed slows below the predetermined speed the system will return to ESC “Full Off”.

ESC modes may also be affected by drive modes if so equipped.

## WARNING!

- In the ESC “Full Off” mode, the engine torque reduction and stability features are disabled. Therefore, enhanced vehicle stability offered by the ESC system is unavailable. In an emergency evasive maneuver, the ESC system will not engage to assist in maintaining stability. ESC “Full Off” mode is intended for off-highway or off-road use only.
- With the ESC switched off, the enhanced vehicle stability offered by ESC is unavailable. In an emergency evasive maneuver, the ESC system will not engage to assist in maintaining stability.

## WARNING!

ESC “Full Off” mode is only intended for off-highway or off-road use.

- The Electronic Stability Control (ESC) cannot prevent the natural laws of physics from acting on the vehicle, nor can it increase the traction afforded by prevailing road conditions. ESC cannot prevent all accidents, including those resulting from excessive speed in turns, driving on very slippery surfaces, or hydroplaning. ESC also cannot prevent collisions.

### ESC Activation/Malfunction Indicator Light And ESC OFF Indicator Light



The “ESC Activation/Malfunction Indicator Light” in the instrument cluster will come on when the ignition is turned to the ON mode.

It should go out with the engine running. If the “ESC Activation/Malfunction Indicator Light” comes on continuously with the engine running, a malfunction has been detected in the ESC system. If this light



remains on after several ignition cycles, and the vehicle has been driven several miles (kilometers) at speeds greater than 30 mph (48 km/h), see an authorized dealer as soon as possible to have the problem diagnosed and corrected.

The “ESC Activation/Malfunction Indicator Light” (located in the instrument cluster) starts to flash as soon as the tires lose traction and the ESC system becomes active. The “ESC Activation/Malfunction Indicator Light” also flashes when TCS is active. If the “ESC Activation/Malfunction Indicator Light” begins to flash during acceleration, ease up on the accelerator and apply as little throttle as possible. Be sure to adapt your speed and driving to the prevailing road conditions.

**NOTE:**

- The “ESC Activation/Malfunction Indicator Light” and the “ESC OFF Indicator Light” come on momentarily each time the ignition is turned ON.
- Each time the ignition is turned ON, the ESC system will be on even if it was turned off previously.

- The ESC system will make buzzing or clicking sounds when it is active. This is normal; the sounds will stop when ESC becomes inactive following the maneuver that caused the ESC activation.



The “ESC OFF Indicator Light” indicates the customer has elected to have the Electronic Stability Control (ESC) in a reduced mode.

**Electronic Roll Mitigation (ERM)**

This system anticipates the potential for wheel lift by monitoring the driver’s steering wheel input and the speed of the vehicle. When ERM determines that the rate of change of the steering wheel angle and vehicle’s speed are sufficient to potentially cause wheel lift, it then applies the appropriate brake and may also reduce engine power to lessen the chance that wheel lift will occur. ERM can only reduce the chance of wheel lift occurring during severe or evasive driving maneuvers; it cannot prevent wheel lift due to other factors, such as road conditions, leaving the roadway, or striking objects or other vehicles.

**NOTE:**

ERM is disabled anytime the ESC is in “Full Off” mode (if equipped). Refer to “Electronic Stability Control (ESC)” in this section for a complete explanation of the available ESC modes.

**WARNING!**

Many factors, such as vehicle loading, road conditions and driving conditions, influence the chance that wheel lift or rollover may occur. ERM cannot prevent all wheel lift or roll overs, especially those that involve leaving the roadway or striking objects or other vehicles. The capabilities of an ERM-equipped vehicle must never be exploited in a reckless or dangerous manner which could jeopardize the user’s safety or the safety of others.

## Trailer Sway Control (TSC)

TSC uses sensors in the vehicle to recognize an excessively swaying trailer and will take the appropriate actions to attempt to stop the sway. TSC will become active automatically once an excessively swaying trailer is recognized.

### NOTE:

TSC cannot stop all trailers from swaying. Always use caution when towing a trailer and follow the trailer tongue weight recommendations. Refer to “Trailer Towing” in “Starting And Operating” for further information.

When TSC is functioning, the “ESC Activation/Malfunction Indicator Light” will flash, the engine power may be reduced and you may feel the brakes being applied to individual wheels to attempt to stop the trailer from swaying. TSC is disabled when the ESC system is in the “Partial Off” or “Full Off” modes.

## WARNING!

If TSC activates while driving, slow the vehicle down, stop at the nearest safe location, and adjust the trailer load to eliminate trailer sway.

## Ready Alert Braking (RAB)

Ready Alert Braking may reduce the time required to reach full braking during emergency braking situations. It anticipates when an emergency braking situation may occur by monitoring how fast the throttle is released by the driver. The EBC will prepare the brake system for a panic stop.

## Rain Brake Support (RBS)

Rain Brake Support may improve braking performance in wet conditions. It will periodically apply a small amount of brake pressure to remove any water buildup on the front brake rotors. It functions when the windshield wipers are in LO or HI speed. When Rain Brake Support is active, there is no notification to the driver and no driver interaction is required.

## Hill Descent Control (HDC) — If Equipped

HDC is intended for low speed off road driving while in 4WD Low Range. HDC maintains vehicle speed while descending hills during various driving situations. HDC controls vehicle speed by actively controlling the brakes.

### HDC has three states:

1. Off (feature is not enabled and will not activate).
2. Enabled (feature is enabled and ready but activation conditions are not met, or driver is actively overriding with brake or throttle application).
3. Active (feature is enabled and actively controlling vehicle speed).

### Enabling HDC

HDC is enabled by pushing the HDC switch, but the following conditions must also be met to enable HDC:

- Driveline is in 4WD Low Range
- Vehicle speed is below 5 mph (8 km/h).
- Parking brake is released.



- Driver door is closed. (If doors are attached, then door must be closed. If doors are detached, then driver seatbelt must be buckled.)

### Activating HDC

Once HDC is enabled it will activate automatically if driven down a grade of sufficient magnitude. The set speed for HDC is selectable by the driver, and can be adjusted by using the gear shift +/- . The following summarizes the HDC set speeds:

#### HDC Target Set Speeds

- P = No set speed. HDC may be enabled but will not activate
- R = 0.6 mph (1 km/h)
- N = 1.2 mph (2 km/h)
- D = 0.6 mph (1 km/h)
- 1st = 0.6 mph (1 km/h)
- 2nd = 1.2 mph (2 km/h)
- 3rd = 1.8 mph (3 km/h)
- 4th = 2.5 mph (4 km/h)
- 5th = 3.1 mph (5 km/h)

- 6th = 3.7 mph (6 km/h)
- 7th = 4.3 mph (7 km/h)
- 8th = 5.0 mph (8 km/h)
- 9th = 5.6 mph (9 km/h) – If Equipped

#### NOTE:

During HDC the +/- shifter input is used for HDC target speed selection, but will not affect the gear chosen by the transmission. When actively controlling HDC the transmission will shift appropriately for the driver-selected set speed and corresponding driving conditions.

#### Driver Override

The driver may override HDC activation with throttle or brake application at anytime.

#### Deactivating HDC

HDC will be deactivated but remain available if any of the following conditions occur:

- Driver overrides HDC set speed with throttle or brake application.
- Vehicle speed exceeds 20 mph (32 km/h) but remains below 40 mph (64 km/h).

- Vehicle is on a downhill grade of insufficient magnitude, is on level ground, or is on an uphill grade.
- Vehicle is shifted to park.

#### Disabling HDC

HDC will be deactivated and disabled if any of the following conditions occur:

- The driver pushes the HDC switch.
- The driveline is shifted out of 4WD Low Range.
- The parking brake is applied.
- Driver door opens (Driver door opens if doors are attached or driver seatbelt is unbuckled if doors are detached).
- The vehicle is driven greater than 20 mph (32 km/h) for greater than 70 seconds.
- The vehicle is driven greater than 40 mph (64 km/h) (HDC exits immediately).
- HDC detects excessive brake temperature.



## Feedback To The Driver

The instrument cluster has an HDC icon and the HDC switch has an indicator light, which offers feedback to the driver about the state HDC is in.

- The cluster icon and switch indicator light will illuminate and remain on solid when HDC is enabled or activated. This is the normal operating condition for HDC.
- The cluster icon and switch indicator light will flash for several seconds then extinguish when the driver pushes the HDC switch but enable conditions are not met.
- The cluster icon and switch indicator light will flash for several seconds then extinguish when HDC disables due to excess speed.
- The cluster icon and switch indicator light will flash when HDC deactivates due to overheated brakes. The flashing will stop and HDC will activate again once the brakes have cooled sufficiently.

## WARNING!

HDC is only intended to assist the driver in controlling vehicle speed when descending hills. The driver must remain attentive to the driving conditions and is responsible for maintaining a safe vehicle speed.

## AUXILIARY DRIVING SYSTEMS

### Blind Spot Monitoring (BSM) — If Equipped

The Blind Spot Monitoring (BSM) system uses two radar-based sensors, located inside the taillights, to detect highway licensable vehicles (automobiles, trucks, motorcycles, etc.) that enter the blind spot zones from the rear/front/side of the vehicle.

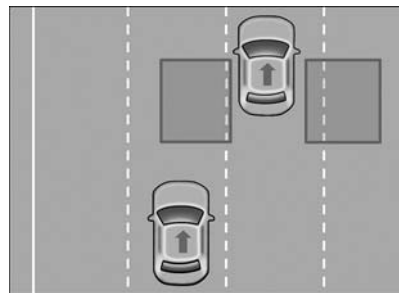

Rear Detection Zones

When the vehicle is started, the BSM warning light will momentarily illuminate in both outside rear view mirrors to let the driver know that the system is operational. The BSM system sensors operate when the vehicle is in any forward gear or REVERSE and enters stand-by mode when the vehicle is in PARK.

The BSM detection zone covers approximately one lane width on both sides of the vehicle 12 ft (3.8 m). The zone length starts at the outside rear view mirror and extends approximately 10 ft (3 m) beyond the rear bumper of the vehicle. The BSM system monitors the detection zones on both sides of



the vehicle when the vehicle speed reaches approximately 6 mph (10 km/h) or higher and will alert the driver of vehicles in these areas.

**NOTE:**

- The BSM system DOES NOT alert the driver about rapidly approaching vehicles that are outside the detection zones.
- The BSM system detection zone DOES NOT change if your vehicle is towing a trailer. Therefore, visually verify the adjacent lane is clear for both your vehicle and trailer before making a lane change. If the trailer or other object (i.e., bicycle, sports equipment) extends beyond the side of your vehicle, this may result in the BSM warning light remaining illuminated the entire time the vehicle is in a forward gear.
- The Blind Spot Monitoring (BSM) system may experience drop outs (blinking on and off) of the side mirror Warning Indicator lamps when a motorcycle or any small object remains at the side of the vehicle for extended periods of time (more than a couple of seconds).

The area on taillights, where the radar sensors are located, must remain free of snow, ice, and dirt/road contamination so that the BSM system can function properly. Do not block the taillights where the radar sensors are located with foreign objects (bumper stickers, bicycle racks, etc.).

The BSM system notifies the driver of objects in the detection zones by illuminating the BSM warning light located in the outside mirrors in addition to sounding an audible (chime) alert and reducing the radio volume. Refer to “Modes Of Operation” for further information.

The BSM system monitors the detection zone from three different entry points (side, rear, front) while driving to see if an alert is necessary. The BSM system will issue an alert during these types of zone entries.

**Entering From The Side**

Vehicles that move into your adjacent lanes from either side of the vehicle.

**Entering From The Rear**

Vehicles that come up from behind your vehicle on either side and enter the rear detection zone with a relative speed of less than 30 mph (48 km/h).

**Overtaking Traffic**

If you pass another vehicle slowly with a relative speed less than 15 mph (24 km/h) and the vehicle remains in the blind spot for approximately 1.5 seconds, the warning light will be illuminated. If the difference in speed between the two vehicles is greater than 15 mph (24 km/h), the warning light will not illuminate.

The BSM system is designed not to issue an alert on stationary objects such as guardrails, posts, walls, foliage, berms, etc. However, occasionally the system may alert on such objects. This is normal operation and your vehicle does not require service.

The BSM system will not alert you of objects that are traveling in the opposite direction of the vehicle in adjacent lanes.

## WARNING!

The Blind Spot Monitoring system is only an aid to help detect objects in the blind spot zones. The BSM system is not designed to detect pedestrians, bicyclists, or animals. Even if your vehicle is equipped with the BSM system, always check your vehicle's mirrors, glance over your shoulder, and use your turn signal before changing lanes. Failure to do so can result in serious injury or death.

### Rear Cross Path (RCP)

The Rear Cross Path (RCP) feature is intended to aid the driver when backing out of parking spaces where their vision of oncoming vehicles may be blocked. Proceed slowly and cautiously out of the parking space until the rear end of the vehicle is exposed. The RCP system will then have a clear view of the cross traffic and if an oncoming vehicle is detected, alert the driver.

RCP monitors the rear detection zones on both sides of the vehicle, for objects that are moving toward the side of the vehicle with a minimum speed of approximately 3 mph (5 km/h), to objects moving a maximum of approximately 20 mph (32 km/h), such as in parking lot situations.

#### NOTE:

In a parking lot situation, oncoming vehicles can be obscured by vehicles parked on either side. If the sensors are blocked by other structures or vehicles, the system will not be able to alert the driver.

When RCP is on and the vehicle is in REVERSE, the driver is alerted using both the visual and audible alarms, including reducing the radio volume.

## WARNING!

Rear Cross Path Detection (RCP) is not a back up aid system. It is intended to be used to help a driver detect an oncoming vehicle in a parking lot situation. Drivers must be careful when backing up, even when using RCP. Always check carefully

## WARNING!

behind your vehicle, look behind you, and be sure to check for pedestrians, animals, other vehicles, obstructions, and blind spots before backing up. Failure to do so can result in serious injury or death.

### Modes Of Operation

Three selectable modes of operation are available in the Uconnect System. Refer to "Uconnect Settings" in "Multimedia" in the Owner's Manual for further information.

### Blind Spot Alert Lights Only

When operating in Blind Spot Alert mode, the BSM system will provide a visual alert in the appropriate side view mirror based on a detected object. However, when the system is operating in Rear Cross Path (RCP) mode, the system will respond with both visual and audible alerts when a detected object is present. Whenever an audible alert is requested, the radio is muted.



### Blind Spot Alert Lights/Chime

When operating in Blind Spot Alert Lights/Chime mode, the BSM system will provide a visual alert in the appropriate side view mirror based on a detected object. If the turn signal is then activated, and it corresponds to an alert present on that side of the vehicle, an audible chime will also be sounded. Whenever a turn signal and detected object are present on the same side at the same time, both the visual and audible alerts will be issued. In addition to the audible alert the radio (if on) will also be muted.

**NOTE:**

Whenever an audible alert is requested by the BSM system, the radio is also muted.

When the system is in RCP, the system shall respond with both visual and audible alerts when a detected object is present. Whenever an audible alert is requested, the radio is also muted. Turn/hazard signal status is ignored; the RCP state always requests the chime.

### Blind Spot Alert Off

When the BSM system is turned off there will be no visual or audible alerts from either the BSM or RCP systems.

**NOTE:**

The BSM system will store the current operating mode when the vehicle is shut off. Each time the vehicle is started the previously stored mode will be recalled and used.

### General Information

The following regulatory statement applies to all Radio Frequency (RF) devices equipped in this vehicle:

This device complies with Part 15 of the FCC Rules and with Industry Canada license-exempt RSS standard(s). Operation is subject to the following two conditions:

1. This device may not cause harmful interference.
2. This device must accept any interference received, including interference that may cause undesired operation.

**NOTE:**

Changes or modifications not expressly approved by the party responsible for compliance could void the user's authority to operate the equipment.

### Tire Pressure Monitor System (TPMS)

The Tire Pressure Monitor System (TPMS) will warn the driver of a low tire pressure based on the vehicle recommended cold placard pressure.

**NOTE:**

The alert warning on the cluster will stay on until the tire is inflated to the placard pressure.

The tire pressure will vary with temperature by approximately 1 psi (7 kPa) for every 12°F (6.5°C). This means that when the outside temperature decreases, the tire pressure will decrease. Tire pressure should always be set based on cold inflation tire pressure. This is defined as the tire pressure after the vehicle has not been driven for at least three hours, or driven less than 1 mile (1.6 km) after a three hour period. The cold tire inflation pressure must not exceed the maximum inflation pres-

sure molded into the tire sidewall. Refer to “Tires” in “Servicing And Maintenance” for information on how to properly inflate the vehicle’s tires. The tire pressure will also increase as the vehicle is driven. This is normal and there should be no adjustment for this increased pressure.

The TPMS will warn the driver of a low tire pressure if the tire pressure falls below the low-pressure warning limit for any reason, including low temperature effects and natural pressure loss through the tire.

The TPMS will continue to warn the driver of low tire pressure as long as the condition exists, and will not turn off until the tire pressure is at or above the recommended cold placard pressure. Once the low tire pressure warning (Tire Pressure Monitoring System Warning Light) illuminates, you must increase the tire pressure to the recommended cold placard pressure in order for the TPMS Light to turn off.

**NOTE:**

When filling warm tires, the tire pressure may need to be increased up to an additional 4 psi (28 kPa) above the recommended cold placard pressure in order to turn the TPMS Warning Light off.

The system will automatically update and the TPMS Warning Light will turn off once the system receives the updated tire pressures. The vehicle may need to be driven for up to 20 minutes above 15 mph (24 km/h) in order for the TPMS to receive this information.

For example, your vehicle may have a recommended cold (parked for more than three hours) placard pressure of 33 psi (227 kPa). If the ambient temperature is 68°F (20°C) and the measured tire pressure is 28 psi (193 kPa), a temperature drop to 20°F (-7°C) will decrease the tire pressure to approximately 24 psi (165 kPa). This tire pressure is low enough to turn on the TPMS Warning Light. Driving the vehicle may cause the tire pressure to rise to approximately 28 psi (193 kPa), but the TPMS Warning Light will still be on. In this situation, the TPMS Warn-

ing Light will turn off only after the tires are inflated to the vehicle’s recommended cold placard pressure value.

**NOTE:**

When filling warm tires, the tire pressure may need to be increased up to an additional 4 psi (28 kPa) above the recommended cold placard pressure in order to turn the TPMS Warning Light off.

<b>CAUTION!</b>	
<ul style="list-style-type: none"><li>• The TPMS has been optimized for the original equipment tires and wheels. TPMS pressures and warning have been established for the tire size equipped on your vehicle. Undesirable system operation or sensor damage may result when using replacement equipment that is not of the same size, type, and/or style. The TPM sensor is not designed for use on aftermarket wheels, and may contribute to a poor overall system performance. Customers are encouraged to use OEM wheels to assure TPMS feature operation.</li></ul>	



**CAUTION!**

- Using aftermarket tire sealants may cause the Tire Pressure Monitoring System (TPMS) sensor to become inoperable. After using an aftermarket tire sealant it is recommended that you take your vehicle to an authorized dealer to have your sensor function checked.
- After inspecting or adjusting the tire pressure always reinstall the valve stem cap. This will prevent moisture and dirt from entering the valve stem, which could damage the TPMS sensor.

**NOTE:**

- The TPMS is not intended to replace normal tire care and maintenance, or to provide warning of a tire failure or condition.
- The TPMS should not be used as a tire pressure gauge while adjusting your tire pressure.

- Driving on a significantly underinflated tire causes the tire to overheat and can lead to tire failure. Underinflation also reduces fuel efficiency and tire tread life, and may affect the vehicle's handling and stopping ability.
- The TPMS is not a substitute for proper tire maintenance, and it is the driver's responsibility to maintain correct tire pressure using an accurate tire pressure gauge, even if underinflation has not reached the level to trigger illumination of the TPMS Warning Light.
- Seasonal temperature changes will affect tire pressure, and the TPMS will monitor the actual tire pressure in the tire.

**System Operation**

The Tire Pressure Monitor System (TPMS) uses wireless technology with wheel rim mounted electronic sensors to monitor tire pressure levels. Sensors, mounted to each wheel as part of the valve stem, transmit tire pressure readings to the receiver module.

**Tire Pressure Monitoring Display****NOTE:**

It is particularly important for you to check the tire pressure in all of the tires on your vehicle monthly and to maintain the proper pressure.

The TPMS consists of the following components:

- Receiver module
- Four tire pressure monitoring sensors

- Various tire pressure monitoring system messages, which display in the instrument cluster
- Tire pressure monitoring telltale light

### Tire Pressure Monitoring Low Pressure Warnings

 The TPMS Warning Light will illuminate in the instrument cluster and a chime will sound when tire pressure is low in one or more of the four active road tires. In addition, the instrument cluster will display a "Tire Low" message for a minimum of five seconds, an "Inflate to XX" message and a graphic showing the pressure values of each tire with the low tire pressure values in a different color.



#### Tire Pressure Monitoring Low Pressure Warning

Should this occur, you should stop as soon as possible and inflate the tires with low pressure (those in a different color in the instrument cluster graphic) to the vehicle's recommended cold placard pressure value as shown in the "Inflate to XX" message. Once the system receives the updated tire pressures, the system will automatically update,

the pressure values in the graphic display in the instrument cluster will return to their original color, and the TPMS Warning Light will turn off.

#### NOTE:

When filling warm tires, the tire pressure may need to be increased up to an additional 4 psi (28 kPa) above the recommended cold placard pressure in order to turn the TPMS Warning Light off. The vehicle may need to be driven for up to 20 minutes above 15 mph (24 km/h) in order for the TPMS to receive this information.

#### Service TPMS Warning

When a system fault is detected, the TPMS Warning Light will flash on and off for 75 seconds and then remain on solid. The system fault will also sound a chime. In addition, the instrument cluster will display a "SERVICE TIRE PRESSURE SYSTEM" message for a minimum of five seconds and then display dashes (- -) in place of the pressure value to indicate which sensor is not being received.



If the ignition is cycled, this sequence will repeat, providing the system fault still exists. If the system fault no longer exists, the TPMS Warning Light will no longer flash, and the “SERVICE TIRE PRESSURE SYSTEM” message will no longer display, and a pressure value will display in place of the dashes. A system fault can occur due to any of the following:

- Jamming due to electronic devices or driving next to facilities emitting the same radio frequencies as the TPMS sensors.
- Installing some form of aftermarket window tinting that affects radio wave signals.
- Lots of snow or ice around the wheels or wheel housings.
- Using tire chains on the vehicle.
- Using wheels/tires not equipped with TPMS sensors.

### **Vehicles With Compact Spare or Non-Matching Full Size Spare**

1. The compact spare tire or non-matching full size does not have a tire pressure monitoring sensor. Therefore, the TPMS will not monitor the pressure in the compact spare tire.
2. If you install the compact or non-matching full size spare tire in place of a road tire that has a pressure below the low-pressure warning limit, upon the next ignition cycle, the TPMS Warning Light will remain on and a chime will sound. In addition, the graphic in the instrument cluster will still display a different color pressure value and an "Inflate to XX" message.
3. After driving the vehicle for up to 20 minutes above 15 mph (24 km/h), the TPMS Warning Light will flash on and off for 75 seconds and then remain on solid. In addition, the instrument cluster will display a “Service Tire Pressure System” message for five seconds and then display dashes (- -) in place of the pressure value.
4. For each subsequent ignition cycle, a chime will sound, the TPMS Warning Light will flash on and off for 75 seconds and then remain on solid, and the instrument cluster will display a “SERVICE TIRE PRESSURE SYSTEM” message for five seconds and then display dashes (- -) in place of the pressure value.
5. Once you repair or replace the original road tire and reinstall it on the vehicle in place of the compact spare or non-matching full size, the TPMS will update automatically. In addition, the TPMS Warning Light will turn off and the graphic in the instrument cluster will display a new pressure value instead of dashes (- -), as long as no tire pressure is below the low-pressure warning limit in any of the four active road tires. The vehicle may need to be driven for up to 20 minutes above 15 mph (24 km/h) in order for the TPMS to receive this information.



## Vehicles With a Full Size Matching Spare

1. If your vehicle is equipped with a matching full-size spare wheel and tire assembly, it has a tire pressure monitoring sensor, and can be monitored by the Tire Pressure Monitoring System (TPMS) when swapped with a low pressure road tire.
2. In the event that the matching full-size spare tire is swapped with a low pressure road tire, the next ignition switch cycle will still show the TPMS Warning Light to be on, a chime to sound, an Inflate to XX message to appear in the instrument cluster, and the graphic display will still show the low tire pressure value in a different color.
3. Driving the vehicle for up to 20 minutes above 15 mph (24 km/h) will turn off the TPMS Warning Light as long as none of road tires are below the low pressure warning threshold.

## TPMS Deactivation — If Equipped

The TPMS can be deactivated if replacing all four wheel and tire assemblies (road tires) with wheel and tire assemblies that do not have TPMS sensors, such as when installing winter wheel and tire assemblies on your vehicle.

To deactivate the TPMS, first replace all four wheel and tire assemblies (road tires) with tires not equipped with Tire Pressure Monitoring (TPM) Sensors. Then, drive the vehicle for 20 minutes above 15 mph (24 km/h). The TPMS will chime, the TPMS Warning Light will flash on and off for 75 seconds and then remain on. The instrument cluster will display the “SERVICE TIRE PRESSURE SYSTEM” message and then display dashes (--) in place of the pressure values.

Beginning with the next ignition cycle, the TPMS will no longer chime or display the “SERVICE TIRE PRESSURE SYSTEM” message in the instrument cluster but dashes (--) will remain in place of the pressure values.

To reactivate the TPMS, replace all four wheel and tire assemblies (road tires) with tires equipped with TPMS sensors. Then,

drive the vehicle for up to 20 minutes above 15 mph (24 km/h). The TPMS will chime, the TPMS Warning Light will flash on and off for 75 seconds and then turn off. The instrument cluster will display the “SERVICE TIRE PRESSURE SYSTEM” message and then display pressure values in place of the dashes. On the next ignition cycle the "SERVICE TIRE PRESSURE SYSTEM" message will no longer be displayed as long as no system fault exists.

## General Information

The following regulatory statement applies to all radio frequency (RF) devices equipped in this vehicle:

This device complies with Part 15 of the FCC Rules and with Industry Canada license-exempt RSS standard(s). Operation is subject to the following two conditions:

- (1) This device may not cause harmful interference, and
- (2) This device must accept any interference received, including interference that may cause undesired operation.



**NOTE:**

Changes or modifications not expressly approved by the party responsible for compliance could void the user's authority to operate the equipment.

## OCCUPANT RESTRAINT SYSTEMS

Some of the most important safety features in your vehicle are the restraint systems:

### Occupant Restraint Systems Features

- Seat Belt Systems
- Supplemental Restraint Systems (SRS) Air Bags
- Child Restraints

Some of the safety features described in this section may be standard equipment on some models, or may be optional equipment on others. If you are not sure, ask an authorized dealer.

### Important Safety Precautions

Please pay close attention to the information in this section. It tells you how to use your restraint system properly, to keep you and your passengers as safe as possible.

Here are some simple steps you can take to minimize the risk of harm from a deploying air bag:

1. Children 12 years old and under should always ride buckled up in the rear seat of a vehicle with a rear seat.
2. If a child from 2 to 12 years old (not in a rear-facing child restraint) must ride in the front passenger seat, move the seat as far back as possible and use the proper child restraint (refer to "Child Restraints" in this section for further information).
3. Children that are not big enough to wear the vehicle seat belt properly (refer to "Child Restraints" in this section for further information) should be secured in the rear seat of a vehicle with a rear seat in child restraints or belt-positioning booster seats. Older children who do not use child

restraints or belt-positioning booster seats should ride properly buckled up in the rear seat of a vehicle with a rear seat.

4. Never allow children to slide the shoulder belt behind them or under their arm.
5. You should read the instructions provided with your child restraint to make sure that you are using it properly.
6. All occupants should always wear their lap and shoulder belts properly.
7. The driver and front passenger seats should be moved back as far as practical to allow the front air bags room to inflate.
8. Do not lean against the door or window. If your vehicle has side air bags, and deployment occurs, the side air bags will inflate forcefully into the space between occupants and the door and occupants could be injured.
9. If the air bag system in this vehicle needs to be modified to accommodate a disabled person, refer to the "Customer Assistance" section for customer service contact information.

## WARNING!

- Never place a rear-facing child restraint in front of an air bag. A deploying passenger front air bag can cause death or serious injury to a child 12 years or younger, including a child in a rear-facing child restraint.
- Only use a rear-facing child restraint in the rear seat of a vehicle with a rear seat.

### Seat Belt Systems

Buckle up even though you are an excellent driver, even on short trips. Someone on the road may be a poor driver and could cause a collision that includes you. This can happen far away from home or on your own street.

Research has shown that seat belts save lives, and they can reduce the seriousness of injuries in a collision. Some of the worst injuries happen when people are thrown from the vehicle. Seat belts reduce the possibility of ejection and the risk of injury caused by striking the inside of the vehicle. Everyone in a motor vehicle should be belted at all times.

### Enhanced Seat Belt Use Reminder System (BeltAlert)

#### Driver and Passenger BeltAlert (if equipped)

 BeltAlert is a feature intended to remind the driver and outboard front seat passenger (if equipped with outboard front passenger seat BeltAlert) to buckle their seat belts. The Belt Alert feature is active whenever the ignition switch is in the START or ON/RUN position.

#### Initial Indication

If the driver is unbuckled when the ignition switch is first in the START or ON/RUN position, a chime will signal for a few seconds. If the driver or outboard front seat passenger (if equipped with outboard front passenger seat BeltAlert) is unbuckled when the ignition switch is first in the START or ON/RUN position the Seat Belt Reminder Light will turn on and remain on until both outboard front seat belts are buckled. The outboard front passenger seat BeltAlert is not active when an outboard front passenger seat is unoccupied.

### BeltAlert Warning Sequence

The BeltAlert warning sequence is activated when the vehicle is moving above a specified vehicle speed range and the driver or outboard front seat passenger is unbuckled (if equipped with outboard front passenger seat BeltAlert) (the outboard front passenger seat BeltAlert is not active when the outboard front passenger seat is unoccupied). The BeltAlert warning sequence starts by blinking the Seat Belt Reminder Light and sounding an intermittent chime. Once the BeltAlert warning sequence has completed, the Seat Belt Reminder Light will remain on until the seat belts are buckled. The BeltAlert warning sequence may repeat based on vehicle speed until the driver and occupied outboard front seat passenger seat belts are buckled. The driver should instruct all occupants to buckle their seat belts.



## Change of Status

If the driver or outboard front seat passenger (if equipped with outboard front passenger seat BeltAlert) unbuckles their seat belt while the vehicle is traveling, the BeltAlert warning sequence will begin until the seat belts are buckled again.

The outboard front passenger seat BeltAlert is not active when the outboard front passenger seat is unoccupied. BeltAlert may be triggered when an animal or other items are placed on the outboard front passenger seat or when the seat is folded flat (if equipped). It is recommended that pets be restrained in the rear seat (if equipped) in pet harnesses or pet carriers that are secured by seat belts, and cargo is properly stowed.

BeltAlert can be activated or deactivated by an authorized dealer. FCA US LLC does not recommend deactivating BeltAlert.

## NOTE:

If BeltAlert has been deactivated and the driver or outboard front seat passenger (if equipped with outboard front passenger seat BeltAlert) is unbuckled the Seat Belt Reminder Light will turn on and remain on until the driver and outboard front seat passenger seat belts are buckled.

## Lap/Shoulder Belts

All seating positions in your vehicle are equipped with lap/shoulder belts.

The seat belt webbing retractor will lock only during very sudden stops or collisions. This feature allows the shoulder part of the seat belt to move freely with you under normal conditions. However, in a collision the seat belt will lock and reduce your risk of striking the inside of the vehicle or being thrown out of the vehicle.

## WARNING!

- Relying on the air bags alone could lead to more severe injuries in a collision. The air bags work with your seat belt to

## WARNING!

restrain you properly. In some collisions, the air bags won't deploy at all. Always wear your seat belt even though you have air bags.

- In a collision, you and your passengers can suffer much greater injuries if you are not properly buckled up. You can strike the interior of your vehicle or other passengers, or you can be thrown out of the vehicle. Always be sure you and others in your vehicle are buckled up properly.
- It is dangerous to ride in a cargo area, inside or outside of a vehicle. In a collision, people riding in these areas are more likely to be seriously injured or killed.
- Do not allow people to ride in any area of your vehicle that is not equipped with seats and seat belts.
- Be sure everyone in your vehicle is in a seat and using a seat belt properly. Occupants, including the driver, should always wear their seat belts whether or not an air bag is also provided at their seat-

### WARNING!

ing position to minimize the risk of severe injury or death in the event of a crash.

- Wearing your seat belt incorrectly could make your injuries in a collision much worse. You might suffer internal injuries, or you could even slide out of the seat belt. Follow these instructions to wear your seat belt safely and to keep your passengers safe, too.
- Two people should never be belted into a single seat belt. People belted together can crash into one another in a collision, hurting one another badly. Never use a lap/shoulder belt or a lap belt for more than one person, no matter what their size.

### WARNING!

- A lap belt worn too high can increase the risk of injury in a collision. The seat belt forces won't be at the strong hip and pelvic bones, but across your abdomen.

### WARNING!

Always wear the lap part of your seat belt as low as possible and keep it snug.

- A twisted seat belt may not protect you properly. In a collision, it could even cut into you. Be sure the seat belt is flat against your body, without twists. If you can't straighten a seat belt in your vehicle, take it to an authorized dealer immediately and have it fixed.
- A seat belt that is buckled into the wrong buckle will not protect you properly. The lap portion could ride too high on your body, possibly causing internal injuries. Always buckle your seat belt into the buckle nearest you.
- A seat belt that is too loose will not protect you properly. In a sudden stop, you could move too far forward, increasing the possibility of injury. Wear your seat belt snugly.
- A seat belt that is worn under your arm is dangerous. Your body could strike the inside surfaces of the vehicle in a collision, increasing head and neck injury. A seat belt worn under the arm can cause

### WARNING!

internal injuries. Ribs aren't as strong as shoulder bones. Wear the seat belt over your shoulder so that your strongest bones will take the force in a collision.

- A shoulder belt placed behind you will not protect you from injury during a collision. You are more likely to hit your head in a collision if you do not wear your shoulder belt. The lap and shoulder belt are meant to be used together.
- A frayed or torn seat belt could rip apart in a collision and leave you with no protection. Inspect the seat belt system periodically, checking for cuts, frays, or loose parts. Damaged parts must be replaced immediately. Do not disassemble or modify the seat belt system. Seat belt assemblies must be replaced after a collision.

#### Lap/Shoulder Belt Operating Instructions

1. Enter the vehicle and close the door. Sit back and adjust the seat.



2. The seat belt latch plate is above the back of the front seat, and next to your arm in the rear seat (for vehicles equipped with a rear seat). Grasp the latch plate and pull out the seat belt. Slide the latch plate up the webbing as far as necessary to allow the seat belt to go around your lap.



**Pulling Out The Latch Plate**

3. When the seat belt is long enough to fit, insert the latch plate into the buckle until you hear a “click.”



**Inserting Latch Plate Into Buckle**

4. Position the lap belt so that it is snug and lies low across your hips, below your abdomen. To remove slack in the lap belt portion, pull up on the shoulder belt. To loosen the lap belt if it is too tight, tilt the latch plate and pull on the lap belt. A snug seat belt reduces the risk of sliding under the seat belt in a collision.



**Positioning The Lap Belt**

5. Position the shoulder belt across the shoulder and chest with minimal, if any slack so that it is comfortable and not resting on your neck. The retractor will withdraw any slack in the shoulder belt.
6. To release the seat belt, push the red button on the buckle. The seat belt will automatically retract to its stowed position. If necessary, slide the latch plate down the webbing to allow the seat belt to retract fully.

## Lap/Shoulder Belt Untwisting Procedure

Use the following procedure to untwist a twisted lap/shoulder belt.

1. Position the latch plate as close as possible to the anchor point.
2. At about 6 to 12 inches (15 to 30 cm) above the latch plate, grasp and twist the seat belt webbing 180 degrees to create a fold that begins immediately above the latch plate.
3. Slide the latch plate upward over the folded webbing. The folded webbing must enter the slot at the top of the latch plate.
4. Continue to slide the latch plate up until it clears the folded webbing and the seat belt is no longer twisted.

## Adjustable Upper Shoulder Belt Anchorage

In the driver and front passenger seats, the top of the shoulder belt can be adjusted upward or downward to position the seat belt away from your neck. Push or squeeze the anchorage button to release the anchorage, and move it up or down to the position that serves you best.



**Adjustable Upper Anchorage**

As a guide, if you are shorter than average, you will prefer the shoulder belt anchorage in a lower position, and if you are taller than average, you will prefer the shoulder belt anchorage in a higher position. After you release the anchorage button, try to move it up or down to make sure that it is locked in position.

## NOTE:

The adjustable upper shoulder belt anchorage is equipped with an Easy Up feature. This feature allows the shoulder belt anchorage to be adjusted in the upward position without pushing or squeezing the release button. To verify the shoulder belt anchorage is latched, pull downward on the shoulder belt anchorage until it is locked into position.

## WARNING!

- Wearing your seat belt incorrectly could make your injuries in a collision much worse. You might suffer internal injuries, or you could even slide out of the seat belt. Follow these instructions to wear your seat belt safely and to keep your passengers safe, too.
- Position the shoulder belt across the shoulder and chest with minimal, if any slack so that it is comfortable and not resting on your neck. The retractor will withdraw any slack in the shoulder belt.
- Misadjustment of the seat belt could reduce the effectiveness of the safety belt in a crash.



## Seat Belt Extender

If a seat belt is not long enough to fit properly, even when the webbing is fully extended and the adjustable upper shoulder belt anchorage (if equipped) is in its lowest position, an authorized dealer can provide you with a Seat Belt Extender. The Seat Belt Extender should be used only if the existing seat belt is not long enough. When the Seat Belt Extender is not required for a different occupant, it must be removed.

### WARNING!

- ONLY use a Seat Belt Extender if it is physically required in order to properly fit the original seat belt system. DO NOT USE the Seat Belt Extender if, when worn, the distance between the front edge of the Seat Belt Extender buckle and the center of the occupant's body is LESS than 6 inches.
- Using a Seat Belt Extender when not needed can increase the risk of serious injury or death in a collision. Only use the Seat Belt Extender when the lap belt

### WARNING!

is not long enough and only use in the recommended seating positions. Remove and store the Seat Belt Extender when not needed.

## Seat Belts And Pregnant Women

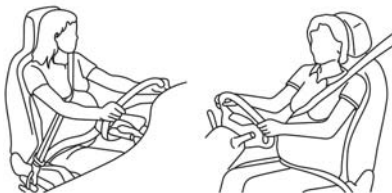

### Pregnant Women And Seat Belts

Seat belts must be worn by all occupants including pregnant women: the risk of injury in the event of an accident is reduced for the mother and the unborn child if they are wearing a seat belt.

Position the lap belt snug and low below the abdomen and across the strong bones of the hips. Place the shoulder belt across the chest and away from the neck. Never place the shoulder belt behind the back or under the arm.

## Seat Belt Pretensioner

The front seat belt system is equipped with pretensioning devices that are designed to remove slack from the seat belt in the event of a collision. These devices may improve the performance of the seat belt by removing slack from the seat belt early in a collision. Pretensioners work for all size occupants, including those in child restraints.

### NOTE:

These devices are not a substitute for proper seat belt placement by the occupant. The seat belt still must be worn snugly and positioned properly.

The pretensioners are triggered by the Occupant Restraint Controller (ORC). Like the air bags, the pretensioners are single use items. A deployed pretensioner or a deployed air bag must be replaced immediately.



## Energy Management Feature

The front seat belt system is equipped with an Energy Management feature that may help further reduce the risk of injury in the event of a collision. The seat belt system has a retractor assembly that is designed to release webbing in a controlled manner.

## Switchable Automatic Locking Retractor (ALR)

The seat belts in the passenger seating positions are equipped with a Switchable Automatic Locking Retractor (ALR) which is used to secure a child restraint system. For additional information, refer to “Installing Child Restraints Using The Vehicle Seat Belt” under the “Child Restraints” section of this manual. The figure below illustrates the locking feature for each seating position.

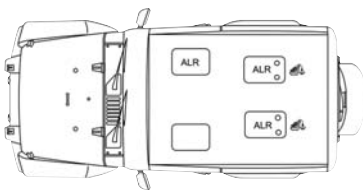

**ALR — Switchable Automatic Locking Retractor (Two-Door Models)**

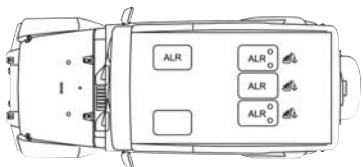

**ALR — Switchable Automatic Locking Retractor (Four-Door Models)**

If the passenger seating position is equipped with an ALR and is being used for normal usage, only pull the seat belt webbing out far enough to comfortably wrap around the occupant's mid-section so as to not activate the ALR. If the ALR is activated, you will hear a clicking sound as the seat belt retracts. Allow the webbing to retract completely in this case and then carefully pull out only the amount of webbing necessary to comfortably wrap around the occupant's mid-section. Slide the latch plate into the buckle until you hear a "click."

In Automatic Locking Mode, the shoulder belt is automatically pre-locked. The seat belt will still retract to remove any slack in the shoulder belt. Use the Automatic Locking Mode anytime a child restraint is installed in a seating position that has a seat belt with this feature. Children 12 years old and under should always be properly restrained in the rear seat of a vehicle with a rear seat.



**WARNING!**

- Never place a rear-facing child restraint in front of an air bag. A deploying passenger front air bag can cause death or serious injury to a child 12 years or younger, including a child in a rear-facing child restraint.
- Only use a rear-facing child restraint in the rear seat of a vehicle with a rear seat.

**How To Engage The Automatic Locking Mode**

1. Buckle the combination lap and shoulder belt.
2. Grasp the shoulder portion and pull downward until the entire seat belt is extracted.
3. Allow the seat belt to retract. As the seat belt retracts, you will hear a clicking sound. This indicates the seat belt is now in the Automatic Locking Mode.

**How To Disengage The Automatic Locking Mode**

Unbuckle the combination lap/shoulder belt and allow it to retract completely to disengage the Automatic Locking Mode and activate the vehicle sensitive (emergency) locking mode.

**WARNING!**

- The seat belt assembly must be replaced if the switchable Automatic Locking Retractor (ALR) feature or any other seat belt function is not working properly when checked according to the procedures in the Service Manual.
- Failure to replace the seat belt assembly could increase the risk of injury in collisions.
- Do not use the Automatic Locking Mode to restrain occupants who are wearing the seat belt or children who are using booster seats. The locked mode is only used to install rear-facing or forward-facing child restraints that have a harness for restraining the child.

**Supplemental Restraint Systems (SRS)**

Some of the safety features described in this section may be standard equipment on some models, or may be optional equipment on others. If you are not sure, ask an authorized dealer.

The air bag system must be ready to protect you in a collision. The Occupant Restraint Controller (ORC) monitors the internal circuits and interconnecting wiring associated with the electrical Air Bag System Components. Your vehicle may be equipped with the following Air Bag System Components:

**Air Bag System Components**

- Occupant Restraint Controller (ORC)
- Air Bag Warning Light 
- Steering Wheel and Column
- Instrument Panel
- Knee Impact Bolsters
- Driver and Front Passenger Air Bags
- Seat Belt Buckle Switch
- Supplemental Side Air Bags
- Front and Side Impact Sensors

- Seat Belt Pretensioners
- Seat Track Position Sensors
- Occupant Classification System

## Air Bag Warning Light

 The ORC monitors the readiness of the electronic parts of the air bag system whenever the ignition switch is in the START or ON/RUN position. If the ignition switch is in the OFF position or in the ACC position, the air bag system is not on and the air bags will not inflate.

The ORC contains a backup power supply system that may deploy the air bag system even if the battery loses power or it becomes disconnected prior to deployment.

The ORC turns on the Air Bag Warning Light in the instrument panel for approximately four to eight seconds for a self-check when the ignition switch is first in the ON/RUN position. After the self-check, the Air Bag Warning Light will turn off. If the ORC detects a malfunction in any part of the system, it turns on the Air Bag Warning Light, either

momentarily or continuously. A single chime will sound to alert you if the light comes on again after initial startup.

The ORC also includes diagnostics that will illuminate the instrument panel Air Bag Warning Light if a malfunction is detected that could affect the air bag system. The diagnostics also record the nature of the malfunction. While the air bag system is designed to be maintenance free, if any of the following occurs, have an authorized dealer service the air bag system immediately.

- The Air Bag Warning Light does not come on during the four to eight seconds when the ignition switch is first in the ON/RUN position.
- The Air Bag Warning Light remains on after the four to eight-second interval.
- The Air Bag Warning Light comes on intermittently or remains on while driving.

## NOTE:

If the speedometer, tachometer, or any engine related gauges are not working, the Occupant Restraint Controller (ORC) may also be disabled. In this condition the air bags may not be ready to inflate for your protection. Have an authorized dealer service the air bag system immediately.

## WARNING!

Ignoring the Air Bag Warning Light in your instrument panel could mean you won't have the air bag system to protect you in a collision. If the light does not come on as a bulb check when the ignition is first turned on, stays on after you start the vehicle, or if it comes on as you drive, have an authorized dealer service the air bag system immediately.

## Redundant Air Bag Warning Light



If a fault with the Air Bag Warning Light is detected, which could affect the Supplemental Restraint System (SRS), the Redundant Air Bag Warning Light will illuminate on the



instrument panel. The Redundant Air Bag Warning Light will stay on until the fault is cleared. In addition, a single chime will sound to alert you that the Redundant Air Bag Warning Light has come on and a fault has been detected. If the Redundant Air Bag Warning Light comes on intermittently or remains on while driving have an authorized dealer service the vehicle immediately.

For additional information regarding the Redundant Air Bag Warning Light refer to “Getting To Know Your Instrument Panel” section of this manual.

### Front Air Bags

This vehicle has front air bags and lap/shoulder belts for both the driver and front passenger. The front air bags are a supplement to the seat belt restraint systems. The driver front air bag is mounted in the center of the steering wheel. The passenger front air bag is mounted in the instrument panel, above the glove compartment. The words “SRS AIRBAG” or “AIRBAG” are embossed on the air bag covers.



**Front Air Bag/Knee Impact Bolster Locations**

- 1 — Driver And Passenger Front Air Bags
- 2 — Driver And Passenger Knee Impact Bolsters

### WARNING!

- Being too close to the steering wheel or instrument panel during front air bag

### WARNING!

deployment could cause serious injury, including death. Air bags need room to inflate. Sit back, comfortably extending your arms to reach the steering wheel or instrument panel.

- Never place a rear-facing child restraint in front of an air bag. A deploying passenger front air bag can cause death or serious injury to a child 12 years or younger, including a child in a rear-facing child restraint.
- Only use a rear-facing child restraint in the rear seat of a vehicle with a rear seat.

### Driver And Passenger Front Air Bag Features

The Advanced Front Air Bag system has multistage driver and front passenger air bags. This system provides output appropriate to the severity and type of collision as determined by the Occupant Restraint Controller (ORC), which may receive information from the front impact sensors (if equipped) or other system components.

The first stage inflator is triggered immediately during an impact that requires air bag deployment. A low energy output is used in less severe collisions. A higher energy output is used for more severe collisions.

This vehicle may be equipped with a driver and/or front passenger seat belt buckle switch that detects whether the driver or front passenger seat belt is buckled. The seat belt buckle switch may adjust the inflation rate of the Advanced Front Air Bags.

This vehicle may be equipped with driver and/or front passenger seat track position sensors that may adjust the inflation rate of the Advanced Front Air Bags based upon seat position.

This vehicle has an Occupant Classification System (“OCS”) in the front passenger seat. The OCS is designed to activate or deactivate the Passenger Advanced Front Air Bag depending on the occupant’s seated weight.

It is designed to deactivate the Passenger Advanced Front Air Bag for an unoccupied seat and for occupants whose seated weight classifies them in a category other than a properly seated adult. This could be a child, teenager, or even an adult.

The Passenger Air Bag Disable (“PAD”) Indicator Light (an amber light located on the overhead sports bar) tells the driver and front passenger when the Passenger Advanced Front Air Bag is deactivated. The PAD Indicator Light illuminates the words “PASSENGER AIR BAG OFF” to show that the Passenger Advanced Front Air Bag will not deploy during a collision.

**NOTE:**

When the front passenger seat is empty or when very light objects are placed on the seat, the Passenger Advanced Front Air Bag will not deploy even though the Passenger Air Bag Disable (PAD) System Indicator Light is NOT illuminated.

**WARNING!**

- No objects should be placed over or near the air bag on the instrument panel or steering wheel because any such objects could cause harm if the vehicle is in a collision severe enough to cause the air bag to inflate.
- Do not put anything on or around the air bag covers or attempt to open them manually. You may damage the air bags and you could be injured because the air bags may no longer be functional. The protective covers for the air bag cushions are designed to open only when the air bags are inflating.
- Relying on the air bags alone could lead to more severe injuries in a collision. The air bags work with your seat belt to restrain you properly. In some collisions, air bags won’t deploy at all. Always wear your seat belts even though you have air bags.



## Front Air Bag Operation

Front Air Bags are designed to provide additional protection by supplementing the seat belts. Front air bags are not expected to reduce the risk of injury in rear, side, or rollover collisions. The front air bags will not deploy in all frontal collisions, including some that may produce substantial vehicle damage — for example, some pole collisions, truck underrides, and angle offset collisions.

On the other hand, depending on the type and location of impact, front air bags may deploy in crashes with little vehicle front-end damage but that produce a severe initial deceleration.

Because air bag sensors measure vehicle deceleration over time, vehicle speed and damage by themselves are not good indicators of whether or not an air bag should have deployed.

Seat belts are necessary for your protection in all collisions, and also are needed to help keep you in position, away from an inflating air bag.



When the ORC detects a collision requiring the front air bags, it signals the inflator units. A large quantity of non-toxic gas is generated to inflate the front air bags.

The steering wheel hub trim cover and the upper passenger side of the instrument panel separate and fold out of the way as the air bags inflate to their full size. The front air bags fully inflate in less time than it takes to blink your eyes. The front air bags then quickly deflate while helping to restrain the driver and front passenger.

## Occupant Classification System (OCS) — Front Passenger Seat

The OCS is part of a Federally regulated safety system for this vehicle. It is designed to activate or deactivate the Passenger Advanced Front Air Bag depending on the occupant's seated weight. It is designed to deactivate the Passenger Advanced Front Air Bag for an unoccupied seat and for occupants whose seated weight classifies them in a category other than a properly seated adult. This could be a child, teenager, or even an adult.

## The Occupant Classification System (OCS) Consists Of The Following:

- Occupant Restraint Controller (ORC)
- Occupant Classification Module (OCM) and Sensor located in the front passenger seat
- Passenger Air Bag Disabled (PAD) Indicator Light – an amber light located on the overhead sports bar 
- Air Bag Warning Light 
- Passenger Seat Belt

## Occupant Classification Module (OCM) And Sensor

The Occupant Classification Module (OCM) is located underneath the front passenger seat. The Sensor is located beneath the passenger seat cushion foam. Any weight on the seat will be sensed by the Sensor. The OCM uses input from the Sensor to determine the front passenger's most probable classification. The OCM communicates this information to the ORC. The ORC uses the classification to determine whether it should activate or deactivate the Passenger Advanced Front Air Bag.

In order for the OCS to operate as designed, it is important for the front passenger to be seated properly and properly wearing the seat belt. Properly seated passengers are:

- Sitting upright.
- Facing forward.
- Sitting in the center of the seat with their feet comfortably on or near the floor.
- Sitting with their back against the seat back and the seat back in an upright position.

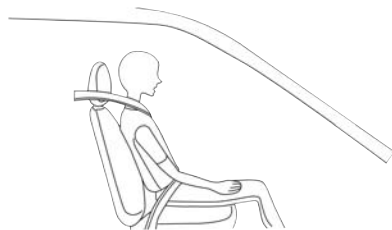

**Seated Properly**

The OCS may deactivate the deployment of the Passenger Advanced Front Air Bag if the OCS estimates that:

- The front passenger seat is unoccupied or has very light objects in it.
- The front passenger seat is occupied by a rear-facing child restraint.
- The front passenger seat is occupied by a child, including a child seated in a forward-facing child restraint or booster seat.
- The front passenger seat is occupied by a small passenger, including a child or small adult.
- The front passenger is not properly seated or his or her weight is taken off of the seat for a period of time.

<b>Passenger Air Bag Disable (PAD) System</b>		
<b>Front Passenger Seat Occupant Status</b>	<b>Front Passenger Advanced Air Bag Disabled Indicator Light ("PAD") Status</b>	<b>Front Passenger Air Bag Status</b>
Unoccupied seat* Unbuckled	NOT ILLUMINATED	DEACTIVATED
Unoccupied seat* Buckled	"PASSENGER AIR BAG OFF"	DEACTIVATED
Grocery bags, heavy briefcases, and other relatively light objects	"PASSENGER AIR BAG OFF"	DEACTIVATED
Rear-facing child restraint**	"PASSENGER AIR BAG OFF"	DEACTIVATED



Passenger Air Bag Disable (PAD) System		
Front Passenger Seat Occupant Status	Front Passenger Advanced Air Bag Disabled Indicator Light ("PAD") Status	Front Passenger Air Bag Status
Child, including a child in a forward-facing child restraint or booster seat**	"PASSENGER AIR BAG OFF"	DEACTIVATED
Small adult	"PASSENGER AIR BAG OFF"	DEACTIVATED
Properly seated adult	NOT ILLUMINATED	ACTIVATED

\* When the front passenger seat is empty or when very light objects are placed on the seat and the seat belt is unbuckled, the Passenger Advanced Front Air Bag will not deploy even though the PAD System Indicator Light is NOT illuminated.

\*\* It is possible for a child to be classified as an adult, allowing the deployment of the Passenger Advanced Front Air Bag. Never allow children to ride in the front passenger seat and never install a child restraint system, including a rear-facing child restraint, in the front passenger seat.

### WARNING!

- Never place a rear-facing child restraint in front of an air bag. A deploying passenger front air bag can cause death or serious injury to a child 12 years or younger, including a child in a rear-facing child restraint.
- Only use a rear-facing child restraint in the rear seat of a vehicle with a rear seat.

### Passenger Advanced Front Air Bag Disabled (PAD) Indicator Light

The Passenger Advanced Front Air Bag Disabled (PAD) Indicator Light (an amber light located on the overhead sports bar) tells the driver and front passenger when the Passenger Advanced Front Air Bag is deactivated.

The PAD Indicator light illuminates the words "PASSENGER AIR BAG OFF" to show that the Passenger Advanced Front Air Bag will not deploy during a collision. When the front passenger seat is empty or when very light objects are placed on the seat and the seat belt is unbuckled, the Passenger Advanced Front Air Bag will not deploy even though the PAD indicator light is NOT illuminated.

The PAD indicator light should not be illuminated when an adult passenger is properly seated in the front passenger seat. The driver and adult passenger should verify that the PAD Indicator Light is not illuminated when an adult is riding in the front passenger seat. If an adult is not seated properly, the Passenger Advanced Front Air Bag may deactivate and the PAD Indicator Light will be illuminated.

The PAD Indicator Light should be illuminated and the Passenger Advanced Front Air Bag should be deactivated for most properly seated and restrained children in the passenger seat and for most properly installed child restraint systems.



However, under certain conditions, even with a properly installed child restraint system, the PAD Indicator Light may not be illuminated, even though the Passenger Advanced Front Air Bag is deactivated. This can occur if the child restraint is lighter than the lightest weight necessary to illuminate the PAD Indicator Light. **NEVER** assume the Passenger Advanced Front Air Bag is deactivated unless the PAD Indicator Light is illuminated with the words "PASSENGER AIR BAG OFF."

**NOTE:**

If the seat belt is buckled for an empty seat, the PAD Indicator Light will illuminate.

**If The PAD Indicator Light Is Illuminated For An Adult Passenger:**

If an adult passenger is seated in the front passenger seat and the PAD Indicator Light is illuminated, the passenger may be sitting improperly.

Follow the steps below to allow the OCS to detect the adult passenger's seated weight to activate the Passenger Advanced Front Air Bag:

1. Turn off the vehicle and have the adult passenger step out of the vehicle.
2. Remove any extra materials from the passenger seat, such as cushions, pads, seat covers, seat massagers, blankets, extra clothing, etc.
3. Place the seatback in the full upright position.
4. Have the adult passenger sit in the center of the seat, with the passenger's feet comfortably on or near the floor, and with their back against the seatback.
5. Restart the vehicle and have the passenger remain in this seated position for two to three minutes after restarting the vehicle.

**WARNING!**

- If the PAD Indicator Light remains illuminated for an adult passenger, have an authorized dealer service the air bag system immediately. Failure to do so may cause serious injury or death. If the PAD Indicator Light is illuminated with the words "PASSENGER AIR BAG OFF," the Passenger Advanced Front Air Bag will not deploy in the event of a collision.
- Never place a rear-facing child restraint in front of an air bag. A deploying passenger front air bag can cause death or serious injury to a child 12 years or younger, including a child in a rear-facing child restraint.
- Never install a rear-facing child restraint in the front seat of a vehicle. Only use a rear-facing child restraint in the rear seat. If the vehicle does not have a rear seat, do not transport a rear-facing child restraint in that vehicle.
- Children 12 years or younger should always ride buckled up in the rear seat of a vehicle with a rear seat.



### Lighter Weight Passengers (Including Small Adults)

When a lighter weight passenger, including a small adult, occupies the passenger seat, the Passenger Advanced Front Air Bag may be deactivated. Therefore, the Passenger Advanced Front Air Bag may or may not be activated for a lighter weight passenger, including a small adult (depending on size) who is seated in the passenger seat. This does not mean that the OCS is working improperly.

The driver and passenger must always use the PAD Indicator Light as a determination of whether the Passenger Advanced Front Air Bag is activated or deactivated. If the PAD Indicator Light is illuminated with the words "PASSENGER AIR BAG OFF" when an adult is in the front passenger seat, have the passenger reposition his or her body in the seat until the PAD Indicator Light goes out.

If the PAD Indicator Light is illuminated with the words "PASSENGER AIR BAG OFF" the Passenger Advanced Front Air Bag will not inflate in the event of a collision.

### Do Not Decrease OR Increase The Front Passenger's Seated Weight On The Front Passenger Seat

The front passenger's seated weight must be properly positioned on the front passenger seat. Failure to do so may result in serious injury or death. The OCS determines the most probable classification of the occupant that it detects. The OCS will detect the front passenger's decreased or increased seated weight, which may result in deactivation or activation of the Passenger Advanced Front Air Bag in a collision. This does not mean that the OCS is working improperly. Decreasing the front passenger's seated weight on the front passenger seat may result in deactivation of the Passenger Advanced Front Air Bag causing serious injury or death. Increasing the front passenger's seated weight on the front passenger seat may result in activation of the Passenger Advanced Front Air Bag. Examples of improper front passenger seating include:

- The front passenger's weight is transferred to another part of the vehicle (like the door, arm rest or instrument panel).

- The front passenger leans forward, sideways, or turns to face the rear of the vehicle.
- The front passenger's seatback is not in the full upright position.
- The front passenger carries or holds an object while seated (e.g., backpack, box, etc.).
- Objects are lodged under the front passenger seat.
- Objects are lodged between the front passenger seat and center console.
- Accessories that may change the seated weight on the front passenger seat are attached to the front passenger seat.
- Anything that may decrease or increase the front passenger's seated weight.

The OCS determines the front passenger's most probable classification. If an occupant in the front passenger seat is seated improperly, the occupant may provide an output signal to the OCS that is different from the occupant's properly seated weight input, for example:

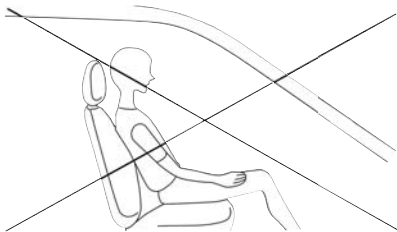

**Not Seated Properly**

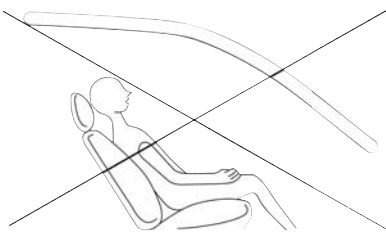

**Not Seated Properly**

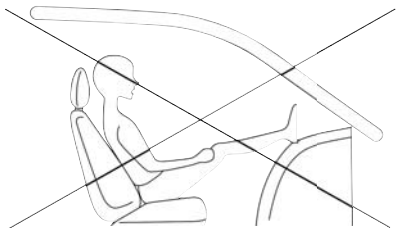

**Not Seated Properly**

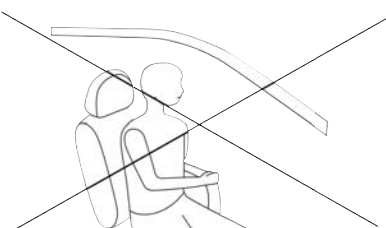



**Not Seated Properly**

## WARNING!

- If a child restraint system, child, small teenager or adult in the front passenger seat is seated improperly, the occupant may provide an output signal to the OCS that is different from the occupant's properly seated weight input. This may result in serious injury or death in a collision.
- Always wear your seat belt and sit properly, with the seatback in an upright position, your back against the seatback, sitting upright, facing forward, in the center of the seat, with your feet comfortably on or near the floor.
- Do not carry or hold any objects (e.g., backpacks, boxes, etc.) while seated in the front passenger seat. Holding an object may provide an output signal to the OCS that is different than the occupant's properly seated weight input, which may result in serious injury or death in a collision.



The Air Bag Warning Light  will illuminate whenever the OCS is unable to classify the front passenger seat status.

A malfunction in the OCS may affect the operation of the air bag system. If the Air Bag Warning Light  does not come on, or stays on after you start the vehicle, or it comes on as you drive, take the vehicle to an authorized dealer for service immediately.

### WARNING!

- Ignoring the Air Bag Warning Light in your instrument panel could mean you won't have the air bags to protect you in a collision. If the light does not come on as a bulb check when the ignition is first turned on, stays on after you start the vehicle, or if it comes on as you drive, have an authorized dealer service the air bag system immediately.
- Placing an object on the floor under the front passenger seat may prevent the OCS from working properly, which may result in serious injury or death in a

### WARNING!

collision. Do not place any objects on the floor under the front passenger seat.

- If there is a fault present in the OCS, both the PAD Indicator Light and the Air Bag Warning Light will illuminate to show that the Passenger Advanced Front Air Bag is deactivated. Should this occur, the Passenger Advanced Front Air Bag will remain deactivated until the fault is cleared. This indicates that you should take the vehicle to an authorized dealer for service immediately.

The passenger seat assembly contains critical OCS components that may affect Passenger Advanced Front Air Bag inflation. In order for the OCS to properly classify the seated weight of a front seat passenger, the OCS components must function as designed. Do not make any modifications to the front passenger seat components, assembly, or to the seat cover. If the seat, trim cover, or cushion needs service for any reason, take the vehicle to an authorized dealer. Only FCA US LLC approved seat accessories may be used.

The following requirements must be strictly followed:

- Do not modify the front passenger seat assembly or components in any way.
- Do not use prior or future model year seat covers or cushions not designated by FCA US LLC for the specific model being repaired. Always use the correct seat cover and cushion specified for the vehicle.
- Do not replace the seat cover or cushion with an aftermarket seat cover or cushion.
- Do not add a secondary seat cover or mat.
- At no time should any Supplemental Restraint System (SRS) component or SRS related component or fastener be modified or replaced with any part except those which are approved by FCA US LLC.

### WARNING!

- Unapproved modifications or service procedures to the passenger seat assembly, its related components, seat cover, or cushion may inadvertently change the air bag deployment in case of a frontal

## WARNING!

collision. This could result in death or serious injury to the front passenger if the vehicle is involved in a collision. A modified vehicle may not comply with required Federal Motor Vehicle Safety Standards (FMVSS) and/or Canadian Motor Vehicle Safety Standards (CMVSS).

- If it is necessary to modify the air bag system for persons with disabilities, contact your authorized dealer.

## Knee Impact Bolsters

The Knee Impact Bolsters help protect the knees of the driver and front passenger, and position the front occupants for improved interaction with the front air bags.

## WARNING!

- Do not drill, cut, or tamper with the knee impact bolsters in any way.

## WARNING!

- Do not mount any accessories to the knee impact bolsters such as alarm lights, stereos, citizen band radios, etc.

## Supplemental Side Air Bags

### Supplemental Seat-Mounted Side Air Bags (SABs)

This vehicle is equipped with Supplemental Seat-Mounted Side Air Bags (SABs).

Supplemental Seat-Mounted Side Air Bags (SABs) are located in the outboard side of the front seats. The SABs are marked with a “SRS AIRBAG” or “AIRBAG” on a label or on the seat trim on the outboard side of the seats.

The SABs may help to reduce the risk of occupant injury during certain side impacts, in addition to the injury reduction potential provided by the seat belts and body structure.



### Supplemental Seat-Mounted Side Air Bag Label

When the SAB deploys, it opens the seam on the outboard side of the seatback's trim cover. The inflating SAB deploys through the seat seam into the space between the occupant and the door. The SAB moves at a very high speed and with such a high force that it could injure occupants if they are not seated properly, or if items are positioned in the area where the SAB inflates. Children are at an even greater risk of injury from a deploying air bag.



**WARNING!**

Do not use accessory seat covers or place objects between you and the Side Air Bags; the performance could be adversely affected and/or objects could be pushed into you, causing serious injury.

**Side Impacts**

The Side Air Bags are designed to activate in certain side impacts. The Occupant Restraint Controller (ORC) determines whether the deployment of the Side Air Bags in a particular impact event is appropriate, based on the severity and type of collision. The side impact sensors aid the ORC in determining the appropriate response to impact events. The system is calibrated to deploy the Side Air Bags on the impact side of the vehicle during impacts that require Side Air Bag occupant protection. In side impacts, the Side Air Bags deploy independently; a left side impact deploys the left Side Air Bags only and a right-side impact deploys the right Side Air Bags only. Vehicle damage by itself is not a good indicator of whether or not Side Air Bags should have deployed.

The Side Air Bags will not deploy in all side collisions, including some collisions at certain angles, or some side collisions that do not impact the area of the passenger compartment. The Side Air Bags may deploy during angled or offset frontal collisions where the front air bags deploy.

Side Air Bags are a supplement to the seat belt restraint system. Side Air Bags deploy in less time than it takes to blink your eyes.

**WARNING!**

- Occupants, including children, who are up against or very close to Side Air Bags can be seriously injured or killed. Occupants, including children, should never lean on or sleep against the door, side windows, or area where the side air bags inflate, even if they are in an infant or child restraint.
- Seat belts (and child restraints where appropriate) are necessary for your protection in all collisions. They also help keep you in position, away from an inflating Side Air Bag. To get the best

**WARNING!**

protection from the Side Air Bags, occupants must wear their seat belts properly and sit upright with their backs against the seats. Children must be properly restrained in a child restraint or booster seat that is appropriate for the size of the child.

**WARNING!**

- Side Air Bags need room to inflate. Do not lean against the door or window. Sit upright in the center of the seat.
- Being too close to the Side Air Bags during deployment could cause you to be severely injured or killed.
- Relying on the Side Air Bags alone could lead to more severe injuries in a collision. The Side Air Bags work with your seat belt to restrain you properly. In some collisions, Side Air Bags won't deploy at all. Always wear your seat belt even though you have Side Air Bags.

**NOTE:**

Air bag covers may not be obvious in the interior trim, but they will open during air bag deployment.

**Air Bag System Components****NOTE:**

The Occupant Restraint Controller (ORC) monitors the internal circuits and interconnecting wiring associated with electrical Air Bag System Components listed below:

- Occupant Restraint Controller (ORC)
- Air Bag Warning Light 
- Steering Wheel and Column
- Instrument Panel
- Knee Impact Bolsters
- Driver and Front Passenger Air Bags
- Seat Belt Buckle Switch
- Supplemental Side Air Bags
- Front and Side Impact Sensors
- Seat Belt Pretensioners
- Seat Track Position Sensors
- Occupant Classification System

**If A Deployment Occurs**

The front air bags are designed to deflate immediately after deployment.

**NOTE:**

Front and/or side air bags will not deploy in all collisions. This does not mean something is wrong with the air bag system.

If you do have a collision which deploys the air bags, any or all of the following may occur:

- The air bag material may sometimes cause abrasions and/or skin reddening to the occupants as the air bags deploy and unfold. The abrasions are similar to friction rope burns or those you might get sliding along a carpet or gymnasium floor. They are not caused by contact with chemicals. They are not permanent and normally heal quickly. However, if you haven't healed significantly within a few days, or if you have any blistering, see your doctor immediately.
- As the air bags deflate, you may see some smoke-like particles. The particles are a normal by-product of the process that generates the non-toxic gas used for air bag inflation. These airborne particles may irritate the skin, eyes, nose, or throat. If you

have skin or eye irritation, rinse the area with cool water. For nose or throat irritation, move to fresh air. If the irritation continues, see your doctor. If these particles settle on your clothing, follow the garment manufacturer's instructions for cleaning.

Do not drive your vehicle after the air bags have deployed. If you are involved in another collision, the air bags will not be in place to protect you.

**WARNING!**

Deployed air bags and seat belt pretensioners cannot protect you in another collision. Have the air bags, seat belt pretensioners, and the seat belt retractor assemblies replaced by an authorized dealer immediately. Also, have the Occupant Restraint Controller System serviced as well.

**NOTE:**

- Air bag covers may not be obvious in the interior trim, but they will open during air bag deployment.



- After any collision, the vehicle should be taken to an authorized dealer immediately.

### Enhanced Accident Response System

In the event of an impact, if the communication network remains intact, and the power remains intact, depending on the nature of the event, the ORC will determine whether to have the Enhanced Accident Response System perform the following functions:

- Cut off fuel to the engine (If Equipped)
- Cut off battery power to the electric motor (If Equipped)
- Flash hazard lights as long as the battery has power
- Turn on the interior lights, which remain on as long as the battery has power or for 15 minutes from the intervention of the Enhanced Accident Response System.
- Unlock the power door locks.

Your vehicle may also be designed to perform any of these other functions in response to the Enhanced Accident Response System:

- Turn off the Fuel Filter Heater, Turn off the HVAC Blower Motor, Close the HVAC Circulation Door
- Cut off battery power to the:
  - Engine
  - Electric Motor (if equipped)
  - Electric power steering
  - Brake booster
  - Electric park brake
  - Automatic transmission gear selector
  - Horn
  - Front wiper
  - Headlamp washer pump

### NOTE:

After an accident, remember to cycle the ignition to the STOP (OFF/LOCK) position and remove the key from the ignition switch to avoid draining the battery. Carefully check the vehicle for fuel leaks in the engine compartment and on the ground near the engine compartment and fuel tank before resetting the system and starting the engine. If there are no fuel leaks or damage to the vehicle electrical devices (e.g. headlights) after an accident, reset the system by following the procedure described below. If you have any doubt, contact an authorized dealer.

### Enhanced Accident Response System Reset Procedure

In order to reset the Enhanced Accident Response System functions after an event, the ignition switch must be changed from ignition START or ON/RUN to ignition OFF. Carefully check the vehicle for fuel leaks in the engine compartment and on the ground near the engine compartment and fuel tank before resetting the system and starting the engine.



## Maintaining Your Air Bag System

### WARNING!

- Modifications to any part of the air bag system could cause it to fail when you need it. You could be injured if the air bag system is not there to protect you. Do not modify the components or wiring, including adding any kind of badges or stickers to the steering wheel hub trim cover or the upper passenger side of the instrument panel. Do not modify the front bumper, vehicle body structure, or add aftermarket side steps or running boards.
- It is dangerous to try to repair any part of the air bag system yourself. Be sure to tell anyone who works on your vehicle that it has an air bag system.
- Do not attempt to modify any part of your air bag system. The air bag may inflate accidentally or may not function properly if modifications are made. Take your vehicle to an authorized dealer for any air bag system service. If your seat, including your trim cover and cushion, needs to be serviced in any way (includ-

### WARNING!

ing removal or loosening/tightening of seat attachment bolts), take the vehicle to an authorized dealer. Only manufacturer approved seat accessories may be used. If it is necessary to modify the air bag system for persons with disabilities, contact an authorized dealer.

### Event Data Recorder (EDR)

This vehicle is equipped with an event data recorder (EDR). The main purpose of an EDR is to record, in certain crash or near crash-like situations, such as an air bag deployment or hitting a road obstacle, data that will assist in understanding how a vehicle's systems performed. The EDR is designed to record data related to vehicle dynamics and safety systems for a short period of time, typically 30 seconds or less. The EDR in this vehicle is designed to record such data as:

- How various systems in your vehicle were operating;
- Whether or not the driver and passenger safety belts were buckled/fastened;

- How far (if at all) the driver was depressing the accelerator and/or brake pedal; and,
- How fast the vehicle was traveling.

These data can help provide a better understanding of the circumstances in which crashes and injuries occur.

### NOTE:

EDR data are recorded by your vehicle only if a non-trivial crash situation occurs; no data are recorded by the EDR under normal driving conditions and no personal data (e.g., name, gender, age, and crash location) are recorded. However, other parties, such as law enforcement, could combine the EDR data with the type of personally identifying data routinely acquired during a crash investigation.

To read data recorded by an EDR, special equipment is required, and access to the vehicle or the EDR is needed. In addition to the vehicle manufacturer, other parties, such as law enforcement, that have the special equipment, can read the information if they have access to the vehicle or the EDR.



## Child Restraints

Everyone in your vehicle needs to be buckled up at all times, including babies and children. Every state in the United States, and every Canadian province, requires that small children ride in proper restraint systems. This is the law, and you can be prosecuted for ignoring it.

Children 12 years or younger should ride properly buckled up in a rear seat, if available. According to crash statistics, children are safer when properly restrained in the rear seats rather than in the front.

### WARNING!

In a collision, an unrestrained child can become a projectile inside the vehicle. The force required to hold even an infant on your lap could become so great that you could not hold the child, no matter how strong you are. The child and others could be badly injured or killed. Any child riding in your vehicle should be in a proper restraint for the child's size.

There are different sizes and types of restraints for children from newborn size to the child almost large enough for an adult safety belt. Always check the child seat Owner's Manual to make sure you have the correct seat for your child. Carefully read and follow all the instructions and warnings in the child restraint Owner's Manual and on all the labels attached to the child restraint.

Before buying any restraint system, make sure that it has a label certifying that it meets all applicable Safety Standards. You should also make sure that you can install it in the vehicle where you will use it.

### NOTE:

- For additional information, refer to <http://www.nhtsa.gov/parents-and-caregivers> or call: 1-888-327-4236
- Canadian residents should refer to Transport Canada's website for additional information: <http://www.tc.gc.ca/eng/motorvehiclesafety/safedrivers-childsafety-index-53.htm>

## Summary Of Recommendations For Restraining Children In Vehicles

	Child Size, Height, Weight Or Age	Recommended Type Of Child Restraint
Infants and Toddlers	Children who are two years old or younger and who have not reached the height or weight limits of their child restraint	Either an Infant Carrier or a Convertible Child Restraint, facing rearward in the rear seat of the vehicle
Small Children	Children who are at least two years old or who have outgrown the height or weight limit of their rear-facing child restraint	Forward-Facing Child Restraint with a five-point Harness, facing forward in the rear seat of the vehicle
Larger Children	Children who have outgrown their forward-facing child restraint, but are too small to properly fit the vehicle's seat belt	Belt Positioning Booster Seat and the vehicle seat belt, seated in the rear seat of the vehicle
Children Too Large for Child Restraints	Children 12 years old or younger, who have outgrown the height or weight limit of their booster seat	Vehicle Seat Belt, seated in the rear seat of the vehicle

### Infant And Child Restraints

Safety experts recommend that children ride rear-facing in the vehicle until they are two years old or until they reach either the height or weight limit of their rear-facing child restraint. Two types of child restraints can be used rear-facing: infant carriers and convertible child seats.

The infant carrier is only used rear-facing in the vehicle. It is recommended for children from birth until they reach the weight or

height limit of the infant carrier. Convertible child seats can be used either rear-facing or forward-facing in the vehicle. Convertible child seats often have a higher weight limit in the rear-facing direction than infant carriers do, so they can be used rear-facing by children who have outgrown their infant carrier but are still less than at least two years old. Children should remain rear-facing until they reach the highest weight or height allowed by their convertible child seat.

### WARNING!

- Never place a rear-facing child restraint in front of an air bag. A deploying passenger front air bag can cause death or serious injury to a child 12 years or younger, including a child in a rear-facing child restraint.
- Only use a rear-facing child restraint in the rear seat of a vehicle with a rear seat.



## Older Children And Child Restraints

Children who are two years old or who have outgrown their rear-facing convertible child seat can ride forward-facing in the vehicle. Forward-facing child seats and convertible child seats used in the forward-facing direction are for children who are over two years old or who have outgrown the rear-facing weight or height limit of their rear-facing convertible child seat. Children should remain in a forward-facing child seat with a harness for as long as possible, up to the highest weight or height allowed by the child seat.

All children whose weight or height is above the forward-facing limit for the child seat should use a belt-positioning booster seat until the vehicle's seat belts fit properly. If the child cannot sit with knees bent over the vehicle's seat cushion while the child's back is against the seatback, they should use a belt-positioning booster seat. The child and belt-positioning booster seat are held in the vehicle by the seat belt.

### WARNING!

- Improper installation can lead to failure of an infant or child restraint. It could come loose in a collision. The child could be badly injured or killed. Follow the child restraint manufacturer's directions exactly when installing an infant or child restraint.
- After a child restraint is installed in the vehicle, do not move the vehicle seat forward or rearward because it can loosen the child restraint attachments. Remove the child restraint before adjusting the vehicle seat position. When the vehicle seat has been adjusted, re-install the child restraint.
- When your child restraint is not in use, secure it in the vehicle with the seat belt or LATCH anchorages, or remove it from the vehicle. Do not leave it loose in the vehicle. In a sudden stop or accident, it could strike the occupants or seatbacks and cause serious personal injury.

## Children Too Large For Booster Seats

Children who are large enough to wear the shoulder belt comfortably, and whose legs are long enough to bend over the front of the seat when their back is against the seatback, should use the seat belt in a rear seat. Use this simple 5-step test to decide whether the child can use the vehicle's seat belt alone:

1. Can the child sit all the way back against the back of the vehicle seat?
2. Do the child's knees bend comfortably over the front of the vehicle seat – while the child is still sitting all the way back?
3. Does the shoulder belt cross the child's shoulder between their neck and arm?
4. Is the lap part of the belt as low as possible, touching the child's thighs and not the stomach?
5. Can the child stay seated like this for the whole trip?

If the answer to any of these questions was "no," then the child still needs to use a booster seat in this vehicle. If the child is using the lap/shoulder belt, check seat belt fit periodically and make sure the seat belt

buckle is latched. A child's squirming or slouching can move the belt out of position. If the shoulder belt contacts the face or neck, move the child closer to the center of the vehicle, or use a booster seat to position the seat belt on the child correctly.

### WARNING!

Never allow a child to put the shoulder belt under an arm or behind their back. In a crash, the shoulder belt will not protect a child properly, which may result in serious injury or death. A child must always wear both the lap and shoulder portions of the seat belt correctly.

### Recommendations For Attaching Child Restraints

Restraint Type	Combined Weight of the Child + Child Restraint	Use Any Attachment Method Shown With An "X" Below			
		LATCH – Lower Anchors Only	Seat Belt Only	LATCH – Lower Anchors + Top Tether Anchor	Seat Belt + Top Tether Anchor
Rear-Facing Child Restraint	Up to 65 lbs (29.5 kg)	X	X		
Rear-Facing Child Restraint	More than 65 lbs (29.5 kg)		X		
Forward-Facing Child Restraint	Up to 65 lbs (29.5 kg)			X	X
Forward-Facing Child Restraint	More than 65 lbs (29.5 kg)				X



## Lower Anchors And Tethers For CHildren (LATCH) Restraint System



LATCH Label



Your vehicle is equipped with the child restraint anchorage system called LATCH, which stands for Lower Anchors and Tethers for CHildren. The LATCH system has three vehicle anchor points for installing LATCH-equipped child seats. There are two lower anchorages located at the back of the seat cushion where it meets the seatback and one top tether anchorage located behind the seating position.

These anchorages are used to install LATCH-equipped child seats without using the vehicle's seat belts. Some seating positions may have a top tether anchorage but no lower anchorages. In these seating positions, the seat belt must be used with the top tether anchorage to install the child restraint. Please see the following table for more information.

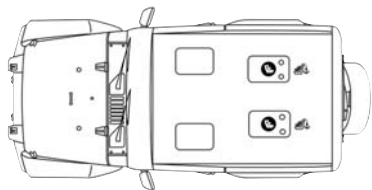
## LATCH Positions For Installing Child Restraints In This Vehicle



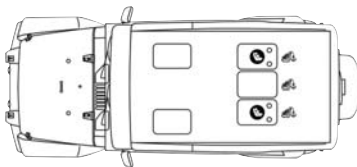

### LATCH Positions (Two-Door Models)

-  — Lower Anchorage Symbol (2 Anchorages Per Seating Position)
-  — Top Tether Anchorage Symbol



### LATCH Positions (Four-Door Models)

-  — Lower Anchorage Symbol (2 Anchorages Per Seating Position)
-  — Top Tether Anchorage Symbol

### Frequently Asked Questions About Installing Child Restraints With LATCH

<p>What is the weight limit (child's weight + weight of the child restraint) for using the LATCH anchorage system to attach the child restraint?</p>	<p>65 lbs (29.5 kg)</p>	<p>Use the LATCH anchorage system until the combined weight of the child and the child restraint is 65 lbs (29.5 kg). Use the seat belt and tether anchor instead of the LATCH system once the combined weight is more than 65 lbs (29.5 kg).</p>
--	-------------------------	---



Frequently Asked Questions About Installing Child Restraints With LATCH		
Can the LATCH anchorages and the seat belt be used together to attach a rear-facing or forward-facing child restraint?	No	Do not use the seat belt when you use the LATCH anchorage system to attach a rear-facing or forward-facing child restraint. Booster seats may be attached to the LATCH anchorages if allowed by the booster seat manufacturer. See your booster seat owner's manual for more information.
Can a child seat be installed in the center position using the inner LATCH lower anchorages?	Two Door Models- No	Four Door Only: You can install child restraints with flexible lower anchors in the center position. The inner anchorages are 18.5 inches (484 mm) apart. Do not install child restraints with rigid lower anchors in the center position.
Can two child restraints be attached using a common lower LATCH anchorage?	No	Never "share" a LATCH anchorage with two or more child restraints. If the center position does not have dedicated LATCH lower anchorages, use the seat belt to install a child seat in the center position next to a child seat using the LATCH anchorages in an outboard position.
Can the rear-facing child restraint touch the back of the front passenger seat?	Yes	The child seat may touch the back of the front passenger seat if the child restraint manufacturer also allows contact. See your child restraint owner's manual for more information.
Can the head restraints be removed?	Two Door Models — No Four Door Models — Yes	Two Door Models — None Four Door Models — Center Only



## NOTE:

If the folding, non-adjustable head restraint interferes with the installation of the child restraint, the head restraint may be folded and the child seat installed in front of it (Two-Door Models).

### WARNING!

Always make sure the head restraint is in its upright position when the seat is to be used by an occupant who is not in a child restraint. Sitting in a seat with the head restraint in its lowered position could result in serious injury or death in a collision.



**Car Seat With Head Restraint Folded**

- 1 — Folded Headrest
- 2 — Child Restraint

## Locating The LATCH Anchorages

 The lower anchorages are round bars that are found at the rear of the seat cushion where it meets the seatback, below the anchorage symbols on the seatback. They are just visible when you lean into the rear seat to install the child restraint. You will easily feel them if you run your finger along the gap between the seatback and seat cushion.



**LATCH Anchorages  
(Two-Door Models)**





**LATCH Anchorages  
(Four-Door Models)**

## Locating The Upper Tether Anchorages

### Two-Door Models:

 There are tether strap anchorages behind each rear seating position located on the back of the seat, near the floor.



**Tether Strap Anchorages  
(Two-Door Models)**

### Four-Door Models:

There are tether strap anchorages behind each rear seating position located on the back of the seat.



**Tether Strap Anchorages  
(Four-Door Models)**

LATCH-compatible child restraint systems will be equipped with a rigid bar or a flexible strap on each side. Each will have a hook or connector to attach to the lower anchorage and a way to tighten the connection to the anchorage. Forward-facing child restraints and some rear-facing child restraints will also be equipped with a tether strap. The tether strap will have a hook at the end to attach to the top tether anchorage and a way to tighten the strap after it is attached to the anchorage.

### Center Seat LATCH

#### Two-Door Models:

#### WARNING!

This vehicle does not have a center seating position. Do not use the center lower LATCH anchorages to install a child seat in the center of the back seat.

#### Four-Door Models:

Do not install child restraints with rigid lower attachments in the center seating position. Only install this type of child restraint in the outboard seating positions. Child restraints with flexible, webbing mounted lower attachments can be installed in any rear seating position.

#### WARNING!

Never use the same lower anchorage to attach more than one child restraint. If you are installing LATCH-compatible child restraints next to each other, you must use the seat belt for the center position. You can then use either the LATCH anchors or the vehicle's seat belt for installing child seats in the outboard positions. Please refer to "Installing The LATCH-Compatible Child Restraint System" for typical installation instructions.

**Always follow the directions of the child restraint manufacturer when installing your child restraint. Not all child restraint systems will be installed as described here.**

### To Install A LATCH-Compatible Child Restraint

If the selected seating position has a Switchable Automatic Locking Retractor (ALR) seat belt, stow the seat belt, following the instructions below. See the section "Installing Child Restraints Using the Vehicle Seat Belt" to check what type of seat belt each seating position has.

1. Loosen the adjusters on the lower straps and on the tether strap of the child seat so that you can more easily attach the hooks or connectors to the vehicle anchorages.
2. Place the child seat between the lower anchorages for that seating position. For some second row seats, you may need to recline the seat and / or raise the head restraint to get a better fit. If the rear seat can be moved forward and rearward in the vehicle, you may wish to move it to its rear-most position to make room for the child seat. You may also move the front seat forward to allow more room for the child seat.



3. Attach the lower hooks or connectors of the child restraint to the lower anchorages in the selected seating position.
4. If the child restraint has a tether strap, connect it to the top tether anchorage. See the section “Installing Child Restraints Using the Top Tether Anchorage” for directions to attach a tether anchor.
5. Tighten all of the straps as you push the child restraint rearward and downward into the seat. Remove slack in the straps according to the child restraint manufacturer’s instructions.
6. Test that the child restraint is installed tightly by pulling back and forth on the child seat at the belt path. It should not move more than 1 inch (25.4 mm) in any direction.

#### **How To Stow An Unused Switchable-ALR (ALR) Seat Belt:**

When using the LATCH attaching system to install a child restraint, stow all ALR seat belts that are not being used by other occupants or being used to secure child restraints.

An unused belt could injure a child if they play with it and accidentally lock the seat belt retractor. Before installing a child restraint using the LATCH system, buckle the seat belt behind the child restraint and out of the child’s reach. If the buckled seat belt interferes with the child restraint installation, instead of buckling it behind the child restraint, route the seat belt through the child restraint belt path and then buckle it. Do not lock the seat belt. Remind all children in the vehicle that the seat belts are not toys and that they should not play with them.

#### **WARNING!**

- Improper installation of a child restraint to the LATCH anchorages can lead to failure of the restraint. The child could be badly injured or killed. Follow the child restraint manufacturer’s directions exactly when installing an infant or child restraint.

#### **WARNING!**

- Child restraint anchorages are designed to withstand only those loads imposed by correctly-fitted child restraints. Under no circumstances are they to be used for adult seat belts, harnesses, or for attaching other items or equipment to the vehicle.

#### **Installing Child Restraints Using The Vehicle Seat Belt**

Child restraint systems are designed to be secured in vehicle seats by lap belts or the lap belt portion of a lap/shoulder belt.

#### **WARNING!**

- Improper installation or failure to properly secure a child restraint can lead to failure of the restraint. The child could be badly injured or killed.
- Follow the child restraint manufacturer’s directions exactly when installing an infant or child restraint.

The seat belts in the passenger seating positions are equipped with a Switchable Automatic Locking Retractor (ALR) that is designed to keep the lap portion of the seat belt tight around the child restraint so that it is not necessary to use a locking clip. The ALR retractor can be “switched” into a locked mode by pulling all of the webbing out of the retractor and then letting the webbing retract back into the retractor. If it is locked, the ALR will make a clicking noise while the webbing is pulled back into the retractor.

Refer to the “Automatic Locking Mode” description in “Switchable Automatic Locking Retractors (ALR)” under “Occupant Restraint Systems” for additional information on ALR.

Please see the table below and the following sections for more information.

### Lap/Shoulder Belt Systems For Installing Child Restraints In This Vehicle

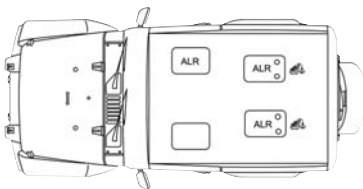

#### Automatic Locking Retractor Locations (Two-Door Models)

ALR = Switchable Automatic Locking Retractor  
TTAS = Top Tether Anchorage Symbol

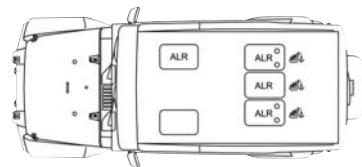

#### Automatic Locking Retractor Locations (Four-Door Models)

ALR = Switchable Automatic Locking Retractor  
TTAS = Top Tether Anchorage Symbol



### Frequently Asked Questions About Installing Child Restraints With Seat Belts

What is the weight limit (child's weight + weight of the child restraint) for using the Tether Anchor with the seat belt to attach a forward facing child restraint?	Weight limit of the Child Restraint	Always use the tether anchor when using the seat belt to install a forward facing child restraint, up to the recommended weight limit of the child restraint.
Can the rear-facing child restraint touch the back of the front passenger seat?	Yes	Contact between the front passenger seat and the child restraint is allowed, if the child restraint manufacturer also allows contact.
Can the head restraints be removed?	Two Door Models — No Four Door Models — Yes	Two Door — None Four Door — Center Only
Can the buckle stalk be twisted to tighten the seat belt against the belt path of the child restraint?	No	Do not twist the buckle stalk in a seating position with an ALR retractor.

#### NOTE:

If the folding, non-adjustable head restraint interferes with the installation of the child restraint, the head restraint may be folded and the child seat installed in front of it (Two-Door Models).

#### WARNING!

Always make sure the head restraint is in its upright position when the seat is to be used by an occupant who is not in a child restraint. Sitting in a seat with the head restraint in its lowered position could result in serious injury or death in a collision.



**Car Seat With Head Restraint Folded**

- 1 — Folded Headrest
- 2 — Child Restraint

### **Installing A Child Restraint With A Switchable Automatic Locking Retractor (ALR):**

Child restraint systems are designed to be secured in vehicle seats by lap belts or the lap belt portion of a lap/shoulder belt.

### **WARNING!**

- Improper installation or failure to properly secure a child restraint can lead to failure of the restraint. The child could be badly injured or killed.
- Follow the child restraint manufacturer's directions exactly when installing an infant or child restraint.

1. Place the child seat in the center of the seating position. For some second row seats, you may need to recline the seat and/or raise the head restraint to get a better fit. If the rear seat can be moved forward and rearward in the vehicle, you may wish to move it to its rear-most position to make room for the child seat. You may also move the front seat forward to allow more room for the child seat.
2. Pull enough of the seat belt webbing from the retractor to pass it through the belt path of the child restraint. Do not twist the belt webbing in the belt path.

3. Slide the latch plate into the buckle until you hear a “click.”
4. Pull on the webbing to make the lap portion tight against the child seat.
5. To lock the seat belt, pull down on the shoulder part of the belt until you have pulled all the seat belt webbing out of the retractor. Then, allow the webbing to retract back into the retractor. As the webbing retracts, you will hear a clicking sound. This means the seat belt is now in the Automatic Locking mode.
6. Try to pull the webbing out of the retractor. If it is locked, you should not be able to pull out any webbing. If the retractor is not locked, repeat step 5.
7. Finally, pull up on any excess webbing to tighten the lap portion around the child restraint while you push the child restraint rearward and downward into the vehicle seat.



8. If the child restraint has a top tether strap and the seating position has a top tether anchorage, connect the tether strap to the anchorage and tighten the tether strap. See the section “Installing Child Restraints Using the Top Tether Anchorage” for directions to attach a tether anchor.
9. Test that the child restraint is installed tightly by pulling back and forth on the child seat at the belt path. It should not move more than 1 inch (25.4 mm) in any direction.

Any seat belt system will loosen with time, so check the belt occasionally, and pull it tight if necessary.

### Installing Child Restraints Using The Top Tether Anchorage

#### WARNING!

Do not attach a tether strap for a rear-facing car seat to any location in front of the car seat, including the seat frame or a tether anchorage. Only attach the tether strap of a rear-facing car seat to the tether anchorage that is approved for that seating position, located behind the top of the vehicle seat. See the section “Lower Anchors and Tethers for CHildren (LATCH) Restraint System” for the location of approved tether anchorages in your vehicle.

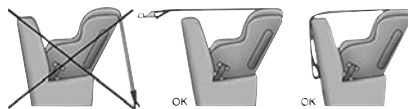

1. Look behind the seating position where you plan to install the child restraint to find the tether anchorage. You may need to move the seat forward to provide better access to the tether anchorage. If there is no top tether anchorage for that seating position, move the child restraint to another position in the vehicle if one is available.



2. Route the tether strap to provide the most direct path for the strap between the anchor and the child seat. If your vehicle is equipped with adjustable rear head restraints, raise the head restraint, and where possible, route the tether strap under the head restraint and between the two posts. If not possible, lower the head restraint and pass the tether strap around the outboard side of the head restraint.



#### Tether Strap Mounting (Four-Door Models With Center Armrest)

3. Attach the tether strap hook of the child restraint to the top tether anchorage as shown in the diagram.
4. Remove slack in the tether strap according to the child restraint manufacturer's instructions.



#### Tether Strap Mounting (Two-Door Models)

### WARNING!

- An incorrectly anchored tether strap could lead to increased head motion and possible injury to the child. Use only the anchorage position directly behind the child seat to secure a child restraint top tether strap.
- If your vehicle is equipped with a split rear seat, make sure the tether strap does not slip into the opening between the seatbacks as you remove slack in the strap.

#### Center Tether Attachment — Four-Door Without Center Armrest

1. Lower the adjustable center head restraint to the full down position.
2. Attach the tether strap hook of the child restraint to the center tether anchorage located on the back of the seat.
3. Remove slack in the tether strap according to the child restraint manufacturer's instructions.



## Transporting Pets

Air Bags deploying in the front seat could harm your pet. An unrestrained pet will be thrown about and possibly injured, or injure a passenger during panic braking or in a collision.

Pets should be restrained in the rear seat (if equipped) in pet harnesses or pet carriers that are secured by seat belts.

## SAFETY TIPS

### Transporting Passengers

NEVER TRANSPORT PASSENGERS IN THE CARGO AREA.

### WARNING!

- Do not leave children or animals inside parked vehicles in hot weather. Interior heat build-up may cause serious injury or death.
- It is extremely dangerous to ride in a cargo area, inside or outside of a vehicle. In a collision, people riding in these areas are more likely to be seriously injured or killed.

### WARNING!

- Do not allow people to ride in any area of your vehicle that is not equipped with seats and seat belts.
- Be sure everyone in your vehicle is in a seat and using a seat belt properly.

### Exhaust Gas

### WARNING!

Exhaust gases can injure or kill. They contain carbon monoxide (CO), which is colorless and odorless. Breathing it can make you unconscious and can eventually poison you. To avoid breathing (CO), follow these safety tips:

- Do not run the engine in a closed garage or in confined areas any longer than needed to move your vehicle in or out of the area.
- If you are required to drive with the trunk/liftgate/rear doors open, make sure that all windows are closed and the climate control BLOWER switch is set at

### WARNING!

- high speed. DO NOT use the recirculation mode.
- If it is necessary to sit in a parked vehicle with the engine running, adjust your heating or cooling controls to force outside air into the vehicle. Set the blower at high speed.

The best protection against carbon monoxide entry into the vehicle body is a properly maintained engine exhaust system.

Whenever a change is noticed in the sound of the exhaust system, when exhaust fumes can be detected inside the vehicle, or when the underside or rear of the vehicle is damaged, have a competent mechanic inspect the complete exhaust system and adjacent body areas for broken, damaged, deteriorated, or mispositioned parts. Open seams or loose connections could permit exhaust fumes to seep into the passenger compartment. In addition, inspect the exhaust system each time the vehicle is raised for lubrication or oil change. Replace as required.

## Safety Checks You Should Make Inside The Vehicle

### Seat Belts

Inspect the seat belt system periodically, checking for cuts, frays, and loose parts. Damaged parts must be replaced immediately. Do not disassemble or modify the system.

Front seat belt assemblies must be replaced after a collision. Rear seat belt assemblies must be replaced after a collision if they have been damaged (i.e., bent retractor, torn webbing, etc.). If there is any question regarding seat belt or retractor condition, replace the seat belt.

### Air Bag Warning Light

The Air Bag warning light  will turn on for four to eight seconds as a bulb check when the ignition switch is first turned to ON/RUN. If the light is either not on during starting, stays on, or turns on while driving, have the system inspected at an authorized dealer as soon as possible. This light will illuminate with a single chime when a fault with the Air Bag Warning Light has been detected, it will

stay on until the fault is removed. If the light comes on intermittently or remains on while driving, have an authorized dealer service the vehicle immediately. Refer to “Occupant Restraint Systems” in “Safety” for further information.

### Defroster



Check operation by selecting the defrost mode and place the blower control on high speed. You should be able to feel the air directed against the windshield. See your authorized dealer for service if your defroster is inoperable.

### Floor Mat Safety Information

Always use floor mats designed to fit your vehicle. Only use a floor mat that does not interfere with the operation of the pedal assemblies. Only use a floor mat that is securely attached using the floor mat fasteners so it cannot slip out of position and interfere with the pedal assemblies or impair safe operation of your vehicle in other ways.

## WARNING!

An improperly attached, damaged, folded, or stacked floor mat, or damaged floor mat fasteners may cause your floor mat to interfere with the accelerator, brake, or clutch pedals and cause a loss of vehicle control. To prevent SERIOUS INJURY or DEATH:

- ALWAYS securely attach  your floor mat using the floor mat fasteners. DO NOT install your floor mat upside down or turn your floor mat over. Lightly pull to confirm mat is secured using the floor mat fasteners on a regular basis.
- ALWAYS REMOVE THE EXISTING FLOOR MAT FROM THE VEHICLE  before installing any other floor mat. NEVER install or stack an additional floor mat on top of an existing floor mat.
- ONLY install floor mats designed to fit your vehicle. NEVER install a floor mat that cannot be properly attached and secured to your vehicle. If a floor mat needs to be replaced, only use a FCA approved floor mat for the specific make, model, and year of your vehicle.



**WARNING!**

- ONLY use the driver's side floor mat on the driver's side floor area. To check for interference, with the vehicle properly parked with the engine off, fully depress the accelerator, the brake, and the clutch pedal (if present) to check for interference. If your floor mat interferes with the operation of any pedal, or is not secure to the floor, remove the floor mat from the vehicle and place the floor mat in your trunk.
- ONLY use the passenger's side floor mat on the passenger's side floor area.
- ALWAYS make sure objects cannot fall or slide into the driver's side floor area when the vehicle is moving. Objects can become trapped under accelerator, brake, or clutch pedals and could cause a loss of vehicle control.
- NEVER place any objects under the floor mat (e.g., towels, keys, etc.). These objects could change the position of the floor mat and may cause interference with the accelerator, brake, or clutch pedals.

**WARNING!**

- If the vehicle carpet has been removed and re-installed, always properly attach carpet to the floor and check the floor mat fasteners are secure to the vehicle carpet. Fully depress each pedal to check for interference with the accelerator, brake, or clutch pedals then re-install the floor mats.
- It is recommended to only use mild soap and water to clean your floor mats. After cleaning, always check your floor mat has been properly installed and is secured to your vehicle using the floor mat fasteners by lightly pulling mat.

**Periodic Safety Checks You Should Make Outside The Vehicle****Tires**

Examine tires for excessive tread wear and uneven wear patterns. Check for stones, nails, glass, or other objects lodged in the tread or sidewall. Inspect the tread for cuts

and cracks. Inspect sidewalls for cuts, cracks, and bulges. Check the wheel nuts for tightness. Check the tires (including spare) for proper cold inflation pressure.

**Lights**

Have someone observe the operation of brake lights and exterior lights while you work the controls. Check turn signal and high beam indicator lights on the instrument panel.

**Door Latches**

Check for proper closing, latching, and locking.

**Fluid Leaks**

Check area under vehicle after overnight parking for fuel, coolant, oil, or other fluid leaks. Also, if gasoline fumes are detected or if fuel, or brake fluid leaks are suspected. The cause should be located and corrected immediately.

# STARTING AND OPERATING

<b>STARTING THE ENGINE . . . . .</b>	<b>.149</b>	Electronic Sway Bar Disconnect — If Equipped . . . . .	.165	To Manually Turn Off The Start/Stop System . . . . .	.171
Normal Starting . . . . .	.149			To Manually Turn On The Stop/Start System . . . . .	.171
<b>ENGINE BREAK-IN RECOMMENDATIONS . . . . .</b>	<b>.152</b>	<b>STOP/START SYSTEM — AUTOMATIC TRANSMISSION (IF EQUIPPED). . . . .</b>	<b>.166</b>	System Malfunction . . . . .	.171
<b>MANUAL TRANSMISSION — IF EQUIPPED . . . . .</b>	<b>.152</b>	Automatic Mode . . . . .	.166	<b>SPEED CONTROL . . . . .</b>	<b>.172</b>
Shifting . . . . .	.153	Possible Reasons The Engine Does Not Autostop . . . . .	.167	To Activate . . . . .	.173
Downshifting . . . . .	.154	To Start The Engine While In Autostop Mode . . . . .	.168	To Set A Desired Speed . . . . .	.173
<b>AUTOMATIC TRANSMISSION — IF EQUIPPED . . . . .</b>	<b>.156</b>	To Manually Turn Off The Stop/Start System . . . . .	.168	To Vary The Speed Setting. . . . .	.173
Ignition Park Interlock . . . . .	.157	To Manually Turn On The Stop/Start System . . . . .	.169	To Accelerate For Passing . . . . .	.174
Brake/Transmission Shift Interlock System . . . . .	.157	System Malfunction . . . . .	.169	To Resume Speed . . . . .	.174
Eight-Speed Automatic Transmission . . . . .	.157	<b>STOP/START SYSTEM — MANUAL TRANSMISSION (IF EQUIPPED). . . . .</b>	<b>.169</b>	To Deactivate . . . . .	.174
<b>FOUR-WHEEL DRIVE OPERATION. . . . .</b>	<b>.159</b>	Automatic Mode . . . . .	.169	<b>PARKSENSE REAR PARK ASSIST — IF EQUIPPED . . . . .</b>	<b>.174</b>
Four-Position Transfer Case . . . . .	.159	Possible Reasons The Engine Does Not Autostop . . . . .	.170	ParkSense Sensors . . . . .	.175
Five-Position Transfer Case . . . . .	.161	To Start The Engine While In Autostop Mode. . . . .	.170	Enabling And Disabling ParkSense . . . . .	.175
Trac-Lok Rear Axle — If Equipped . . . . .	.164			ParkSense System Usage Precautions. . . . .	.175
Axle Lock (Tru-Lok) — Rubicon Models . . . . .	.164			<b>PARKVIEW REAR BACK UP CAMERA . . . . .</b>	<b>.176</b>
				<b>REFUELING THE VEHICLE . . . . .</b>	<b>.178</b>
				Fuel Filler Cap . . . . .	.178
				Loose Fuel Filler Cap Message . . . . .	.179



**TRAILER TOWING . . . . .180**

Trailer Towing Weights (Maximum Trailer Weight Ratings) . . . . .	180
--	-----

**RECREATIONAL TOWING  
(BEHIND MOTORHOME, ETC.) . .181**

Towing This Vehicle Behind Another Vehicle . . . . .	181
Recreational Towing — Four-Wheel Drive Models . . . . .	181

## STARTING THE ENGINE

Before starting your vehicle, adjust your seat, adjust both inside and outside mirrors, and fasten your seat belts.

### WARNING!

- When exiting the vehicle, always remove the key fob from the ignition and lock your vehicle.
- Never leave children alone in a vehicle, or with access to an unlocked vehicle.
- Allowing children to be in a vehicle unattended is dangerous for a number of reasons. A child or others could be seriously or fatally injured. Children should be warned not to touch the parking brake, brake pedal or the gear selector.
- Do not leave the key fob in or near the vehicle, or in a location accessible to children. A child could operate power windows, other controls, or move the vehicle.
- Do not leave children or animals inside parked vehicles in hot weather. Interior heat build-up may cause serious injury or death.

## Normal Starting

### To Turn On The Engine Using The ENGINE START/STOP Button

1. The transmission must be in PARK or NEUTRAL.
2. Press and hold the brake pedal while pushing the ENGINE START/STOP button once.
3. The system takes over and attempts to start the vehicle. If the vehicle fails to start, the starter will disengage automatically after 10 seconds.
4. If you wish to stop the cranking of the engine prior to the engine starting, push the button again.

### NOTE:

Normal starting of either a cold or a warm engine is obtained without pumping or pressing the accelerator pedal.

### To Turn Off The Engine Using ENGINE START/STOP Button

1. Place the gear selector in PARK, then push and release the ENGINE START/STOP button.
2. The ignition will return to the OFF mode.
3. If the gear selector is not in PARK (with vehicle stopped) and the ENGINE START/STOP button is pushed once, the transmission will automatically select PARK and the engine will turn off, however the ignition will remain in the ACC mode (NOT the OFF mode). Never leave a vehicle out of the PARK position, or it could roll.
4. If the gear selector is in NEUTRAL, and the vehicle speed is below 5 mph (8 km/h), pushing the START/STOP button once will turn the engine off. The ignition will remain in the ACC mode.
5. If the vehicle speed is above 5 mph (8 km/h), the ENGINE START/STOP button must be held for two seconds (or three short pushes in a row) to turn the engine



off. The ignition will remain in the ACC mode (NOT the OFF mode) if the engine is turned off when the transmission is not in PARK.

**NOTE:**

The system will automatically time out and the ignition will cycle to the OFF mode after 30 minutes of inactivity if the ignition is left in the ACC or RUN (engine not running) mode and the transmission is in PARK.

**ENGINE START/STOP Button Functions — With Driver's Foot OFF The Brake Pedal (In PARK Or NEUTRAL Position)**

The ENGINE START/STOP button operates similar to an ignition switch. It has three modes: OFF, ACC, and RUN. To change the ignition modes without starting the vehicle and use the accessories, follow these steps:

1. Starting with the ignition in the OFF mode,
2. Push the ENGINE START/STOP button once to place the ignition to the ACC mode (instrument cluster will display "ACC"),

3. Push the ENGINE START/STOP button a second time to place the ignition to the RUN mode (instrument cluster will display "ON/RUN"),
4. Push the ENGINE START/STOP button a third time to return the ignition to the OFF mode (instrument cluster will display "OFF").

**AutoPark**

AutoPark is a supplemental feature to assist in placing the vehicle in PARK should the situations on the following pages occur. It is a back up system and should not be relied upon as the primary method by which the driver shifts the vehicle into PARK.

The conditions under which AutoPark will engage are outlined on the following pages.

**WARNING!**

- Driver inattention could lead to failure to place the vehicle in PARK. ALWAYS DO A VISUAL CHECK that your vehicle is in PARK by verifying that a solid (not blinking) "P" is indicated in the instrument cluster display and on the gear selector.

**WARNING!**

If the "P" indicator is blinking, your vehicle is not in PARK. As an added precaution, always apply the parking brake when exiting the vehicle.

- AutoPark is a supplemental feature. It is not designed to replace the need to shift your vehicle into PARK. It is a back up system and should not be relied upon as the primary method by which the driver shifts the vehicle into PARK.

**If the vehicle is not in PARK and the driver turns off the engine, the vehicle may AutoPark.**

AutoPark will engage when all of these conditions are met:

- Vehicle is equipped with an 8-speed transmission
- Drivers door is ajar or in conditions where driver door is removed an additional trigger would be if the driver is off the seat (seat pad sensor detects driver missing).
- Vehicle is not in PARK
- Vehicle Speed is 0 mph (0 km/h)
- Ignition switched from RUN to OFF



**NOTE:**

For Keyless Go equipped vehicles, The engine will turn off and the ignition switch will change to ACC mode. After 30 minutes the ignition switches to OFF automatically, unless the driver turns the ignition switch OFF.

**If the vehicle is not in PARK and the driver exits the vehicle with the engine running, the vehicle may AutoPark.**

AutoPark will engage when all of these conditions are met:

- Vehicle is equipped with an 8-speed transmission
- Drivers door is ajar or in conditions where driver door is removed an additional trigger would be if the driver is off the seat (seat pad sensor detects driver missing).
- Vehicle is not in PARK
- Driver's door is removed
- Vehicle speed is 1.2 mph (2.0 km/h) or less
- Driver's seat belt is unbuckled
- Driver's door is ajar
- Brake Pedal is not depressed

The MESSAGE “**AutoPark Engaged Shift to P then Shift to Gear**” will display in the instrument cluster.

**NOTE:**

In some cases the ParkSense graphic will be displayed in the instrument cluster. In these cases, the shifter must be returned to “P” to select desired gear.

**If the driver shifts into PARK while moving, the vehicle may AutoPark.**

AutoPark will engage **ONLY** when vehicle speed is 1.2 mph (2.0 km/h) or less.

The MESSAGE “**Vehicle Speed is Too High to Shift to P**” will be displayed in the instrument cluster if vehicle speed is above 1.2 mph (2.0 km/h).

**WARNING!**

If vehicle speed is above 1.2 mph (2.0 km/h), the transmission will default to NEUTRAL until the vehicle speed drops below 1.2 mph (1.9 km/h). A vehicle left in the NEUTRAL position can roll. As an added precaution, always apply the parking brake when exiting the vehicle.

**4WD LOW**

**AutoPark will be disabled when operating the vehicle in 4WD LOW.**

The MESSAGE “**AutoPark Disabled**” will be displayed in the instrument cluster.

**Additional customer warnings will be given when both of these conditions are met:**

- Vehicle is not in PARK
- Driver's Door is ajar

The MESSAGE “**AutoPark Not Engaged**” will be displayed in the instrument cluster. A warning chime will continue until you shift the vehicle into PARK or the Driver's Door is closed.

**ALWAYS DO A VISUAL CHECK** that your vehicle is in PARK by looking for the "P" in the instrument cluster display and on the shifter. As an added precaution, always apply the parking brake when exiting the vehicle.



## ENGINE BREAK-IN RECOMMENDATIONS

A long break-in period is not required for the engine and drivetrain (transmission and axle) in your vehicle.

Drive moderately during the first 300 miles (500 km). After the initial 60 miles (100 km), speeds up to 50 or 55 mph (80 or 90 km/h) are desirable.

While cruising, brief full-throttle acceleration within the limits of local traffic laws contributes to a good break-in. Wide-open throttle acceleration in low gear can be detrimental and should be avoided.

The engine oil installed in the engine at the factory is a high-quality energy conserving type lubricant. Oil changes should be consistent with anticipated climate conditions under which vehicle operations will occur. For the recommended viscosity and quality grades, refer to “Fluids And Lubricants” in “Technical Specifications”.

### CAUTION!

Never use Non-Detergent Oil or Straight Mineral Oil in the engine or damage may result.

#### NOTE:

A new engine may consume some oil during its first few thousand miles (kilometers) of operation. This should be considered a normal part of the break-in and not interpreted as a problem.

## MANUAL TRANSMISSION – IF EQUIPPED

### WARNING!

You or others could be injured if you leave the vehicle unattended without having the parking brake fully applied. The parking brake should always be applied when the driver is not in the vehicle, especially on an incline.

### CAUTION!

- Never drive with your foot resting on the clutch pedal, or attempt to hold the vehicle on a hill with the clutch pedal partially engaged, as this will cause abnormal wear on the clutch.
- Do not drive with your hand resting on the gear selector as the force exerted, even if slight, could lead over time to premature wear of the gearbox internal components.

#### NOTE:

During cold weather, you may experience increased effort in shifting until the transmission fluid warms up. This is normal.



**Manual Transmission Shifter**

To shift the gears, fully press the clutch pedal and place the gear selector into the desired gear position (the diagram for the engagement of the gears is displayed on the handle of the selector).

To engage REVERSE gear from the NEUTRAL position, lift the REVERSE ring, located below the knob and move the gear selector all the way left and then forward.

## Shifting

Fully press the clutch pedal before shifting gears. As you release the clutch pedal, lightly press the accelerator pedal.

You should always use first gear when starting from a standing position.

### NOTE:

A certain amount of noise from the transmission is normal. This noise can be most noticeable when the vehicle is idling in NEUTRAL with the clutch engaged (clutch pedal released), but it may also be heard when driving. The noise may also be more noticeable when the transmission is warm. This noise is normal and is not an indication of a problem with your clutch or transmission.

## Recommended Vehicle Shift Speeds

To utilize your manual transmission efficiently for both fuel economy and performance, it should be upshifted as listed in recommended shift speed chart. Shift at the vehicle speeds listed for acceleration. When heavily loaded or pulling a trailer these recommended up-shift speeds may not apply.



Manual Transmission Shift Speeds in MPH (KM/H)						
Engine	Speeds	1 to 2	2 to 3	3 to 4	4 to 5	5 to 6
3.6L	Accel.	15 (24)	24 (39)	50 (80)	65 (104)	70 (112)
	Cruise	10 (16)	19 (31)	40 (64)	55 (88)	65 (105)

**NOTE:**

Vehicle speeds shown in the chart above are for 2H and 4H only, vehicle speeds in 4L would be significantly less.

**Downshifting**

Moving from a high gear down to a lower gear is recommended to preserve brakes when driving down steep hills. In addition, downshifting at the right time provides better acceleration when you desire to resume speed. Downshift progressively. Do not skip gears to avoid overspeeding the engine and clutch.

**NOTE:**

Above certain speeds downshifts may be blocked and not available.

**WARNING!**

Do not downshift for additional engine braking on a slippery surface. The drive wheels could lose their grip, and the vehicle could skid.

**CAUTION!**

- Skipping gears and downshifting into lower gears at higher vehicle speeds can damage the engine and clutch systems. Any attempt to shift into lower gear with clutch pedal depressed may result damage to the clutch system. Shifting into lower gear and releasing the clutch may result in engine damage.

**CAUTION!**

- When descending a hill, be very careful to downshift one gear at a time to prevent overspeeding the engine which can cause engine damage, and/or clutch damage, even if the clutch pedal is pressed. If transfer case is in low range the vehicle speeds to cause engine and clutch damage are significantly lower.
- Failure to follow the maximum recommended downshifting speeds may cause the engine damage and/or damage the clutch, even if the clutch pedal is pressed.
- Descending a hill in low range with clutch pedal depressed could result in clutch damage.

## Maximum Recommended Downshift Speeds

### CAUTION!

Failure to follow the maximum recommended downshifting speeds may cause the engine to overspeed and/or damage the clutch disc, even if the clutch pedal is pressed.

Manual Transmission Downshift Speeds in MPH (KM/H)

Gear Selection	6 to 5	5 to 4	4 to 3	3 to 2	2 to 1
Maximum Speed	80 (129)	70 (113)	50 (81)	30 (48)	15 (24)

### NOTE:

Vehicle speeds shown in the chart above are for 2H and 4H only, vehicle speeds in 4L would be significantly less.



## AUTOMATIC TRANSMISSION — IF EQUIPPED

### CAUTION!

Damage to the transmission may occur if the following precautions are not observed:

- Shift into or out of PARK or REVERSE only after the vehicle has come to a complete stop.
- Do not shift between PARK, REVERSE, NEUTRAL, or DRIVE when the engine is above idle speed.
- Before shifting into any gear, make sure your foot is firmly pressing the brake pedal.

### NOTE:

You must press and hold the brake pedal while shifting out of PARK.

### WARNING!

- Never use the PARK position as a substitute for the parking brake. Always apply the parking brake fully when exiting the vehicle to guard against vehicle movement and possible injury or damage.
- Your vehicle could move and injure you and others if it is not in PARK. Check by trying to move the transmission gear selector out of PARK with the brake pedal released. Make sure the transmission is in PARK before exiting the vehicle.
- The transmission may not engage PARK if the vehicle is moving. Always bring the vehicle to a complete stop before shifting to PARK, and verify that the transmission gear position indicator solidly indicates PARK (P) without blinking. Ensure that the vehicle is completely stopped, and the PARK position is properly indicated, before exiting the vehicle.

### WARNING!

- It is dangerous to shift out of PARK or NEUTRAL if the engine speed is higher than idle speed. If your foot is not firmly pressing the brake pedal, the vehicle could accelerate quickly forward or in reverse. You could lose control of the vehicle and hit someone or something. Only shift into gear when the engine is idling normally and your foot is firmly pressing the brake pedal.
- Unintended movement of a vehicle could injure those in or near the vehicle. As with all vehicles, you should never exit a vehicle while the engine is running. Before exiting a vehicle, always come to a complete stop, then apply the parking brake, shift the transmission into PARK, and turn the ignition OFF. When the ignition is in the OFF mode, the transmission is locked in PARK, securing the vehicle against unwanted movement.

## WARNING!

- When exiting the vehicle, always make sure the ignition is in the OFF mode, remove the key fob from the vehicle, and lock the vehicle.
- Never leave children alone in a vehicle, or with access to an unlocked vehicle. Allowing children to be in a vehicle unattended is dangerous for a number of reasons. A child or others could be seriously or fatally injured. Children should be warned not to touch the parking brake, brake pedal or the transmission gear selector.
- Do not leave the key fob in or near the vehicle (or in a location accessible to children), and do not leave the ignition in the ACC or ON/RUN mode. A child could operate power windows, other controls, or move the vehicle.

### Ignition Park Interlock

This vehicle is equipped with an Ignition Park Interlock which requires the transmission to be in PARK before the ignition can be turned to the OFF mode. This helps the driver avoid

inadvertently leaving the vehicle without placing the transmission in PARK. This system also locks the transmission in PARK whenever the ignition is in the OFF mode.

### NOTE:

The transmission is NOT locked in PARK when the ignition is in the ACC mode (even though the engine will be off). Ensure that the transmission is in PARK, and the ignition is **OFF** (not in ACC mode) before exiting the vehicle.

### Brake/Transmission Shift Interlock System

This vehicle is equipped with a Brake Transmission Shift Interlock system (BTSI) that holds the transmission gear selector in PARK unless the brakes are applied. To shift the transmission out of PARK, the engine must be running and the brake pedal must be pressed. The brake pedal must also be pressed to shift from NEUTRAL into DRIVE or REVERSE when the vehicle is stopped or moving at low speeds.

### Eight-Speed Automatic Transmission

Your vehicle is equipped with a fuel efficient 8 speed transmission. The gear selector is located in the center console.



Transmission Gear Selector

The transmission gear selector provides PARK, REVERSE, NEUTRAL, DRIVE and MANUAL (AutoStick) shift positions. Manual shifts can be made using the AutoStick shift control. Toggling the gear selector forward (-) or rearward (+) while in the MANUAL (AutoStick) position (beside the DRIVE posi-



tion) will manually select the transmission gear, and will display the current gear in the instrument cluster. Refer to "AutoStick" in this section for further information.

**NOTE:**

If the gear selector cannot be moved to the PARK, REVERSE, or NEUTRAL position (when pushed forward), it is probably in the AutoStick (+/-) position (beside the DRIVE position). In AutoStick mode, the transmission gear (1, 2, 3, etc.) is displayed in the instrument cluster. Move the gear selector to the right (into the DRIVE [D] position) for access to PARK, REVERSE, and NEUTRAL.

**AutoStick**

AutoStick is a driver-interactive transmission feature providing manual shift control, giving you more control of the vehicle. AutoStick allows you to maximize engine braking, eliminate undesirable upshifts and downshifts, and improve overall vehicle performance. This system can also provide you with more control during passing, city driving, cold slippery conditions, mountain driving, trailer towing, and many other situations.

**Operation**

To activate AutoStick mode, move the gear selector into the MANUAL (M) position (beside the DRIVE position). The current transmission gear will be displayed in the instrument cluster. In AutoStick mode, you can use the gear selector (in the MANUAL position) to manually shift the transmission. Tapping the gear selector forward (-) while in the MANUAL (M) position will downshift the transmission to the next lower gear. Tapping the selector rearward (+) will command an upshift.

In AutoStick mode, the transmission will shift up or down when (+/-) is manually selected by the driver, unless an engine lugging or overspeed condition would result. It will remain in the selected gear until another upshift or downshift is chosen, except as described below.

- The transmission will automatically downshift as the vehicle slows (to prevent engine lugging) and will display the current gear.

- The transmission will automatically downshift to first gear when coming to a stop. After a stop, the driver should manually upshift (+) the transmission as the vehicle is accelerated.
- You can start out, from a stop, in first or second gear (or third gear, in 4LO range). Tapping (+) (at a stop) will allow starting in second gear. Starting out in second or third gear can be helpful in snowy or icy conditions.
- If a requested downshift would cause the engine to over-speed, that shift will not occur.
- The system will ignore attempts to upshift at too low of a vehicle speed.
- Holding the gear selector in the (-) position will downshift the transmission to the lowest gear possible at the current speed.
- Transmission shifting will be more noticeable when AutoStick is enabled.
- The system may revert to automatic shift mode if a fault or overheat condition is detected.

**NOTE:**

When Hill Descent Control is enabled, AutoStick is not active.



To disengage AutoStick mode, return the gear selector to the DRIVE position. You can shift in or out of the AutoStick position at any time without taking your foot off the accelerator pedal.

### **WARNING!**

Do not downshift for additional engine braking on a slippery surface. The drive wheels could lose their grip and the vehicle could skid, causing a collision or personal injury.

## **FOUR-WHEEL DRIVE OPERATION**

### **WARNING!**

Failure to engage a transfer case position completely can cause transfer case damage or loss of power and vehicle control. You could have a collision. Do not drive the vehicle unless the transfer case is fully engaged.

### **Four-Position Transfer Case**



**Four-Wheel Drive Gear Selector**

The transfer case provides four mode positions:

- 2H (Two-Wheel Drive High Range)
- 4H (Four-Wheel Drive High Range)
- N (Neutral)
- 4L (Four-Wheel Drive Low Range)

For additional information on the appropriate use of each transfer case mode position, see the information below:

### **2H**

Rear Wheel Drive High Range — This range is for normal street and highway driving on dry, hard surfaced roads.

### **4H**

Four-Wheel Drive High Range — This range maximizes torque to the front driveshaft, forcing the front and rear wheels to rotate at the same speed. This range provides additional traction for loose, slippery road surfaces only.

### **NEUTRAL (N)**

### **WARNING!**

You or others could be injured or killed if you leave the vehicle unattended with the transfer case in the NEUTRAL (N) position without first fully engaging the parking brake. The transfer case NEUTRAL (N) position disengages both the front and rear driveshafts from the powertrain, and will



**WARNING!**

allow the vehicle to roll, even if the automatic transmission is in PARK (or manual transmission is in gear). The parking brake should always be applied when the driver is not in the vehicle.

Neutral — This range disengages both the front and rear driveshafts from the powertrain. To be used for flat towing behind another vehicle.

Refer to “Recreational Towing” in “Starting And Operating” for further information.

**4L**

Four-Wheel Drive Low Range — This range provides low speed four-wheel drive. It maximizes torque to the front driveshaft, forcing the front and rear wheels to rotate at the same speed. This range provides additional traction and maximum pulling power for loose, slippery road surfaces only. Do not exceed 25 mph (40 km/h).

The transfer case is intended to be driven in the 2H position for normal street and highway conditions, such as hard-surfaced roads.

In the event that additional traction is required, the transfer case 4H and 4L positions can be used to lock the front and rear driveshafts together, forcing the front and rear wheels to rotate at the same speed. The 4H and 4L positions are intended for loose, slippery road surfaces only and not intended for normal driving. Driving in the 4H and 4L positions on hard-surfaced roads will cause increased tire wear and damage to the driveline components. Refer to “Shifting Procedures” in this section for further information on shifting into 4H or 4L.

The instrument cluster alerts the driver that the vehicle is in four-wheel drive, and the front and rear driveshafts are locked together. The light will illuminate when the transfer case is shifted into the 4H position.

When operating your vehicle in 4L, the engine speed will be approximately three times (four times for Rubicon models) that of the 2H or 4H positions at a given road speed. Take care not to overspeed the engine.

Proper operation of four-wheel drive vehicles depends on tires of equal size, type, and circumference on each wheel. Any difference will adversely affect shifting and cause damage to the transfer case.

Because four-wheel drive provides improved traction, there is a tendency to exceed safe turning and stopping speeds. Do not go faster than road conditions permit.

**Shifting Procedures****2H To 4H Or 4H To 2H**

Shifting between 2H and 4H can be made with the vehicle stopped or in motion. The preferred shifting speed would be 0 to 45 mph (72 km/h). With the vehicle in motion, the transfer case will engage/disengage faster if you momentarily release the accelerator pedal after completing the shift. Do not accelerate while shifting the transfer case. Apply a constant force when shifting the transfer case lever.

## NOTE:

- Do not attempt to make a shift while only the front or rear wheels are spinning. The front and rear driveshaft speeds must be equal for the shift to take place. Shifting while only the front or rear wheels are spinning can cause damage to the transfer case.
- Delayed shifts out of four-wheel drive may be experienced due to uneven tire wear, low or uneven tire pressures, excessive vehicle loading, or cold temperatures.
- Shifting effort will increase with speed, this is normal.

During cold weather, you may experience increased effort in shifting until the transfer case fluid warms up. This is normal.

### 4H To 4L Or 4L To 4H

With the vehicle rolling at 2 to 3 mph (3 to 5 km/h), shift an automatic transmission into NEUTRAL (N), or press the clutch pedal on a manual transmission. While the vehicle is coasting at 2 to 3 mph (3 to 5 km/h), shift the transfer case lever firmly to the desired position. Do not pause with the transfer case in N

(Neutral). Once the shift is completed, place the automatic transmission into DRIVE or release the clutch pedal on a manual transmission.

## NOTE:

Shifting into or out of 4L is possible with the vehicle completely stopped; however, difficulty may occur due to the mating teeth not being properly aligned. Several attempts may be required for clutch teeth alignment and shift completion to occur. The preferred method is with the vehicle rolling at 2 to 3 mph (3 to 5 km/h). Avoid attempting to engage or disengage 4L with the vehicle moving faster than 2 to 3 mph (3 to 5 km/h).

## WARNING!

Failure to engage a transfer case position completely can cause transfer case damage or loss of power and vehicle control. You could have a collision. Do not drive the vehicle unless the transfer case is fully engaged.

## Five-Position Transfer Case



### Four-Wheel Drive Gear Selector

The transfer case provides five mode positions:

- 2H (Two-Wheel Drive High Range)
- 4H Auto (Four-Wheel Drive Auto High Range)
- 4H PT (Four-Wheel Drive Part Time High Range)
- N (Neutral)
- 4L (Four-Wheel Drive Low Range)



For additional information on the appropriate use of each transfer case mode position, see the information below:

## 2H

Rear Wheel Drive High Range — This range is for normal street and highway driving on dry, hard surfaced roads.

## 4H AUTO

Four-Wheel Drive Auto High Range — This range sends power to the front wheels. The four-wheel drive system will be automatically engaged when the vehicle senses a loss of traction. Additional traction for varying road conditions.

## 4H P-T

Four-Wheel Drive Part Time High Range — This range maximizes torque to the front driveshaft, forcing the front and rear wheels to rotate at the same speed. This range provides additional traction for loose, slippery road surfaces only.

## NEUTRAL (N)

### WARNING!

You or others could be injured or killed if you leave the vehicle unattended with the transfer case in the NEUTRAL (N) position without first fully engaging the parking brake. The transfer case NEUTRAL (N) position disengages both the front and rear driveshafts from the powertrain, and will allow the vehicle to roll, even if the automatic transmission is in PARK (or manual transmission is in gear). The parking brake should always be applied when the driver is not in the vehicle.

Neutral — This range disengages both the front and rear driveshafts from the powertrain. To be used for flat towing behind another vehicle.

Refer to “Recreational Towing” in “Starting And Operating” for further information.

## 4L

Four-Wheel Drive Low Range — This range provides low speed four-wheel drive. It maximizes torque to the front driveshaft, forcing

the front and rear wheels to rotate at the same speed. This range provides additional traction and maximum pulling power for loose, slippery road surfaces only. Do not exceed 25 mph (40 km/h).

This transfer case is designed to be driven in the two-wheel drive position (2WD) or four-wheel drive position (4WD AUTO) for normal street and highway conditions on dry hard surfaced roads). Driving the vehicle in 2WD will have greater fuel economy benefits as the front axle is not engaged in 2WD.

For variable driving conditions, the 4WD AUTO mode can be used. In this mode, the front axle is engaged, but the vehicle's power is sent to the rear wheels. Four-wheel drive will be automatically engaged when the vehicle senses a loss of traction. Because the front axle is engaged, this mode will result in lower fuel economy than the 2WD mode.

In the event that additional traction is required, the transfer case 4H and 4L positions can be used to lock the front and rear driveshafts together, forcing the front and rear wheels to rotate at the same speed. The 4H and 4L positions are intended for loose, slip-

pery road surfaces only and not intended for normal driving. Driving in the 4H and 4L positions on hard-surfaced roads will cause increased tire wear and damage to the drive-line components. Refer to “Shifting Procedures” in this section for further information on shifting into 4H or 4L.

The instrument cluster alerts the driver that the vehicle is in four-wheel drive, and the front and rear driveshafts are locked together. The light will illuminate when the transfer case is shifted into the 4H position.

When operating your vehicle in 4L, the engine speed will be approximately three times (four times for Rubicon models) that of the 2H or 4H positions at a given road speed. Take care not to overspeed the engine.

Proper operation of four-wheel drive vehicles depends on tires of equal size, type, and circumference on each wheel. Any difference will adversely affect shifting and cause damage to the transfer case.

Because four-wheel drive provides improved traction, there is a tendency to exceed safe turning and stopping speeds. Do not go faster than road conditions permit.

## Shifting Procedures

### 2H To 4H Auto Or 4H Auto To 2H

Shifting between 2H and 4H Auto can be made with the vehicle stopped or in motion. The preferred shifting speed would be 0 to 45 mph (72 km/h). With the vehicle in motion, the transfer case will engage/disengage faster if you momentarily release the accelerator pedal after completing the shift. Do not accelerate while shifting the transfer case. Apply a constant force when shifting the transfer case lever.

### 2H/4H Auto To 4H Part Time Or 4H Part Time To 2H/4H Auto

Shifting between 2H/4H AUTO to 4H PART TIME can be made with the vehicle stopped or in motion. The preferred shifting speed would be 0 to 45 mph (72 km/h). With the vehicle in motion, the transfer case will engage/disengage faster if you momentarily release the accelerator pedal after completing the shift. Do not accelerate while shifting the transfer case. Apply a constant force when shifting the transfer case lever.

## NOTE:

- Do not attempt to make a shift while only the front or rear wheels are spinning. The front and rear driveshaft speeds must be equal for the shift to take place. Shifting while only the front or rear wheels are spinning can cause damage to the transfer case.
- Delayed shifts out of four-wheel drive may be experienced due to uneven tire wear, low or uneven tire pressures, excessive vehicle loading, or cold temperatures.
- Shifting effort will increase with speed, this is normal.

During cold weather, you may experience increased effort in shifting until the transfer case fluid warms up. This is normal.

### 4H Part Time/4H Auto To 4L Or 4L To 4H Part Time/4H Auto

With the vehicle rolling at 2 to 3 mph (3 to 5 km/h), shift an automatic transmission into NEUTRAL (N), or press the clutch pedal on a manual transmission. While the vehicle is coasting at 2 to 3 mph (3 to 5 km/h), shift the transfer case lever firmly to the desired posi-



tion. Do not pause with the transfer case in N (Neutral). Once the shift is completed, place the automatic transmission into DRIVE or release the clutch pedal on a manual transmission.

**NOTE:**

Shifting into or out of 4L is possible with the vehicle completely stopped; however, difficulty may occur due to the mating teeth not being properly aligned. Several attempts may be required for clutch teeth alignment and shift completion to occur. The preferred method is with the vehicle rolling at 2 to 3 mph (3 to 5 km/h). Avoid attempting to engage or disengage 4L with the vehicle moving faster than 2 to 3 mph (3 to 5 km/h).

**WARNING!**

Failure to engage a transfer case position completely can cause transfer case damage or loss of power and vehicle control. You could have a collision. Do not drive the vehicle unless the transfer case is fully engaged.

**Trac-Lok Rear Axle – If Equipped**

The Trac-Lok rear axle provides a constant driving force to both rear wheels and reduces wheel spin caused by the loss of traction at one driving wheel. If traction differs between the two rear wheels, the differential automatically proportions the usable torque by providing more torque to the wheel that has traction.

Trac-Lok is especially helpful during slippery driving conditions. With both rear wheels on a slippery surface, a slight application of the accelerator will supply maximum traction.

**WARNING!**

On vehicles equipped with a limited-slip differential, never run the engine with one rear wheel off the ground. The vehicle may drive through the rear wheel remaining on the ground and cause you to lose control of your vehicle.

**Axle Lock (Tru-Lok) – Rubicon Models**

The AXLE LOCK switch is located on the instrument panel (to the right of the steering column).



**Axle Lock Switch Panel**

This feature will only activate when the following conditions are met:

- Ignition in RUN position, vehicle in 4L (Low) range.
- Vehicle speed should be 10 mph (16 km/h) or less.

- Both right and left wheels on axle are at the same speed.

To activate the system, push the AXLE LOCK switch down to lock the rear axle only (the “REAR ONLY” will illuminate), push the switch up to lock the front axle and rear axle (the “FRONT + REAR” will illuminate). When the rear axle is locked, pushing the bottom of switch again will lock or unlock the front axle.

**NOTE:**

The indicator lights will flash until the axles are fully locked or unlocked.

To unlock the axles, push the AXLE LOCK OFF button.

Axle lock will disengage if the vehicle is taken out of 4L (Low) range, or the ignition switch is turned to the OFF position.

The axle lock disengages at speeds above 30 mph (48 km/h), and will automatically re-lock once vehicle speed is less than 10 mph (16 km/h).

**Electronic Sway Bar Disconnect – If Equipped**

Your vehicle may be equipped with an electronic disconnecting stabilizer/sway bar. This system allows greater front suspension travel in off-road situations.

This system is controlled by the SWAY BAR switch located on the instrument panel (to the right of the steering column).



**Sway Bar Switch**

Push the SWAY BAR switch to activate the system. Push the switch again to deactivate the system. The “Sway Bar Indicator Light” (located in the instrument cluster) will illuminate when the bar is disconnected. The “Sway Bar Indicator Light” will flash during activation transition, or when activation conditions are not met. The stabilizer/sway bar should remain in on-road mode during normal driving conditions.

<b>WARNING!</b>
<p>Ensure the stabilizer/sway bar is reconnected before driving on hard surfaced roads or at speeds above 18 mph (29 km/h); a disconnected stabilizer/sway bar may contribute to the loss of vehicle control, which could result in serious injury. Under certain circumstances, the front stabilizer/sway bar enhances vehicle stability and assists with vehicle control. The system monitors vehicle speed and will attempt to reconnect the stabilizer/sway bar at speeds over 18 mph (29 km/h). This is indicated by a flashing or solid “Sway Bar Indicator Light.” Once</p>



**WARNING!**

vehicle speed is reduced below 14 mph (22 km/h), the system will once again attempt to return to off-road mode.

To disconnect the stabilizer/sway bar, shift to either 4H or 4L and push the SWAY BAR switch to obtain the off-road position. Refer to “Four-Wheel Drive Operation” in this section for further information. The “Sway Bar Indicator Light” will flash until the stabilizer/sway bar has been fully disconnected.

**NOTE:**

The stabilizer/sway bar may be torque locked due to left and right suspension height differences. This condition is due to driving surface differences or vehicle loading. In order for the stabilizer/sway bar to disconnect/reconnect, the right and left halves of the bar must be aligned. This alignment may require that the vehicle be driven onto level ground or rocked from side to side.

To return to on-road mode, push the SWAY BAR switch again.

**WARNING!**

If the stabilizer/sway bar will not return to on-road mode, the “Sway Bar Indicator Light” will flash in the instrument cluster and vehicle stability may be reduced. Do not attempt to drive the vehicle over 18 mph (29 km/h). Driving faster than 18 mph (29 km/h) with a disconnected stabilizer/sway bar may contribute to the loss of vehicle control, which could result in serious injury.

## STOP/START SYSTEM – AUTOMATIC TRANSMISSION (IF EQUIPPED)

The Stop/Start function is developed to reduce fuel consumption. The system will stop the engine automatically during a vehicle stop if the required conditions are met. Releasing the brake pedal or pressing the accelerator pedal will automatically re-start the engine.

ESS vehicles have been upgraded with a heavy duty starter, enhanced battery, and other upgraded engine parts, to handle the additional engine starts. Vehicles equipped with eTorque contain a heavy duty motor generator and an additional hybrid electric battery to store energy from vehicle deceleration for use on engine startup after a stop as well as providing launch torque assist.

**NOTE:**

It is recommended that the Start/Stop System be disabled during off-road use.

**Automatic Mode**

The Stop/Start feature is enabled after every normal customer engine start. At that time, the system will go into STOP/START READY and if all other conditions are met, can go into a STOP/START AUTOSTOP ACTIVE “Autostop” mode.



### To Activate The Autostop Mode, The Following Must Occur:

- The system must be in STOP/START READY state. A STOP/START READY message will be displayed in the instrument cluster display within the Stop/Start section. Refer to “Instrument Cluster” in “Getting To Know Your Instrument Panel” in your Owner’s Manual for further information.
- The vehicle must be completely stopped.
- The shifter must be in a forward gear and the brake pedal depressed.

The engine will shut down, the tachometer will move to the zero position and the Stop/Start telltale will illuminate indicating you are in Autostop. Customer settings will be maintained upon return to an engine running condition.

Refer to the “Stop/Start System” in the “Starting And Operating” section located in your Owner’s Manual for further information.

### Possible Reasons The Engine Does Not Autostop

Prior to engine shut down, the system will check many safety and comfort conditions to see if they are fulfilled. Detailed information about the operation of the Stop/Start system may be viewed in the instrument cluster display Stop/Start Screen. In the following situations, the engine will not stop:

- Driver’s seat belt is not buckled.
- Driver’s door is not closed.
- Battery temperature is too warm or cold.
- Battery charge is low.
- The vehicle is on a steep grade.
- Cabin heating or cooling is in process and an acceptable cabin temperature has not been achieved.
- HVAC is set to full defrost mode at a high blower speed.
- HVAC set to MAX A/C.
- Engine has not reached normal operating temperature.
- Engine temperature too high.

- The transmission is not in a forward gear.
- Hood is open.
- Transfer case is in 4LO or Neutral.
- Brake pedal is not pressed with sufficient pressure.

### Other Factors Which Can Inhibit Autostop Include:

- Accelerator pedal input.
- Vehicle speed threshold not achieved from previous auto-stop.
- Steering angle beyond threshold. (ESS Models Only)
- ACC is on and speed is set.
- Vehicle is at high altitude.
- System fault present.

It may be possible for the vehicle to be driven several times without the STOP/START system going into a STOP/START READY state under more extreme conditions of the items listed above.



### To Start The Engine While In Autostop Mode

While in a forward gear, the engine will start when the brake pedal is released or the throttle pedal is depressed. The transmission will automatically re-engage upon engine restart.

### Conditions That Will Cause The Engine To Start Automatically While In Autostop Mode:

- The transmission selector is moved out of DRIVE.
- To maintain cabin temperature comfort.
- Actual cabin temperature is significantly different than temperature set on Auto HVAC.
- HVAC is set to full defrost mode.
- HVAC system temperature or fan speed is manually adjusted.
- Battery voltage drops too low.
- Low brake vacuum (e.g. after several brake pedal applications).

- STOP/START OFF switch is pushed.
- A STOP/START system error occurs.
- STOP/START AUTO STOP ACTIVE time exceeds 5 minutes.
- 4WD system is put into 4LO or Neutral mode.
- Steering wheel is turned beyond threshold. (ESS Models Only)

### To Manually Turn Off The Stop/Start System

1. Push the STOP/START OFF switch (located on the switch bank). The light on the switch will illuminate.



**STOP/START Off Switch**

2. The “STOP/START OFF” message will appear in instrument cluster display within the Stop/Start section. Refer to “Instrument Cluster” in “Getting To Know Your Instrument Panel” in your Owner’s Manual for further information.
3. At the next vehicle stop (after turning off the STOP/START system), the engine will not be stopped.

4. The STOP/START system will reset itself back to an ON condition every time the ignition is turned off and back on.

### To Manually Turn On The Stop/Start System

Push the STOP/START OFF switch (located on the switch bank). The light on the switch will turn off.

For complete details on the Stop/Start System refer to the “Stop/Start System” in the “Starting And Operating” section located in your Owner’s Manual for further information.

### System Malfunction

If there is a malfunction in the STOP/START system, the system will not shut down the engine. A “SERVICE STOP/START SYSTEM” message will appear in the instrument cluster display. Refer to “Instrument Cluster Display” in “Getting to Know Your Instrument Panel” for further information.

If the “SERVICE STOP/START SYSTEM” message appears in the instrument cluster display, have the system checked by an authorized dealer.

## STOP/START SYSTEM — MANUAL TRANSMISSION (IF EQUIPPED)

The Stop/Start function is developed to reduce fuel consumption. The system will stop the engine automatically during a vehicle stop if the required conditions are met. Pressing the clutch pedal will automatically restart the vehicle.

ESS vehicles have been upgraded with a heavy duty starter, enhanced battery, and other upgraded engine parts, to handle the additional engine starts. Vehicles equipped with eTorque contain a heavy duty motor generator and an additional hybrid electric battery to store energy from vehicle deceleration for use on engine startup after a stop as well as providing launch torque assist.

### NOTE:

It is recommended that the Start/Stop System be disabled during off-road use.

### Automatic Mode



The Stop/Start feature is enabled after every normal customer engine start. It will remain in STOP/START NOT READY until you drive forward with a vehicle speed greater than 5 mph (8 km/h). At that time, the system will go into STOP/START READY and if all other conditions are met, can go into a STOP/START AUTO STOP ACTIVE mode.

### To Activate The STOP/START AUTO STOP ACTIVE Mode, The Following Must Occur:

- The system must be in STOP/START READY state. A STOP/START READY message will be displayed in the instrument cluster. Refer to “Instrument Cluster Display” in “Getting To Know Your Instrument Panel” for further information.
- Vehicle speed must be less than 2 mph (3 km/h).
- The gear selector must be in the NEUTRAL position and the clutch pedal must be fully released



The engine will shut down, **the tachometer will fall to the Stop/Start position**, the STOP/START AUTO STOP ACTIVE message will appear, and the heater/air conditioning (HVAC) air flow will be reduced.

### Possible Reasons The Engine Does Not Autostop

Prior to engine shut down, the system will check many safety and comfort conditions to see if they are fulfilled. In following situations the engine will not stop:

- Driver's seat belt is not buckled.
- Outside temperature is less than 10°F (-12°C) or greater than 109°F (43°C).
- Actual cabin temperature is significantly different than temperature set on Auto HVAC.
- HVAC is set to full defrost mode.
- Engine has not reached normal operating temperature.
- Battery discharged.
- When driving in REVERSE.
- Hood is open.

- Transfer case is in 4LO or Neutral
- Driver's seat is not occupied or driver door is open.
- Vehicle is at high altitude.
- The vehicle is on a steep grade.
- Forward Gear is engaged.
- Steering angle beyond threshold. (ESS Models Only)
- System fault is present.
- HVAC set to MAX A/C.

It may be possible for the vehicle to be driven several times without the STOP/START system going into a STOP/START READY state under more extreme conditions of the items listed above.

### To Start The Engine While In Autostop Mode

When the gear selector is in NEUTRAL, the engine will start when the clutch pedal is pressed (does not require complete/full pedal press). The vehicle will go into STOP/START SYSTEM NOT READY mode until the vehicle speed is greater than 5 mph (8 km/h).

### Conditions that will cause the engine to start automatically while in STOP/START AUTO STOP ACTIVE mode

#### The Engine Will Start Automatically When:

- Actual cabin temperature is significantly different than temperature set on Auto HVAC.
- HVAC is set to full defrost mode.
- STOP/START AUTO STOP ACTIVE time exceeds 5 minutes.
- Battery voltage drops too low.
- Low brake vacuum e.g. after several brake pedal applications.
- Vehicle is moving faster than 5 mph (8 km/h).
- STOP/START OFF switch is pressed.
- 4WD system is put into 4LO or Neutral mode.
- Steering wheel is turned beyond threshold. (ESS Models Only)

## To Manually Turn Off The Start/Stop System

1. Push the STOP/START Off switch (located on the switch bank). The light on the switch will illuminate.



**STOP/START Off Switch**

2. The STOP/START OFF message will appear in the instrument cluster. Refer to “Instrument Cluster Display” in “Getting To Know Your Instrument Panel” for further information.
3. At the next vehicle stop (after turning off the STOP/START system), the engine will not be stopped.
4. If the STOP/START system is manually turned off, the engine can only be started and stopped by cycling the ignition switch.
5. The STOP/START system will reset itself back to an ON condition every time the ignition is turned off and back on.

## To Manually Turn On The Stop/Start System

Push the STOP/START OFF switch (located on the switch bank). The light on the switch will turn off.

For complete details on the Stop/Start System refer to the “Stop/Start System” in the “Starting And Operating” section located in your Owner’s Manual for further information.

## System Malfunction

If there is a malfunction in the STOP/START system, the system will not shut down the engine. A “SERVICE STOP/START SYSTEM” message will appear in the instrument cluster display. Refer to “Instrument Cluster Display” in “Getting to Know Your Instrument Panel” for further information.

If the “SERVICE STOP/START SYSTEM” message appears in the instrument cluster display, have the system checked by an authorized dealer.



## SPEED CONTROL

When engaged, the Speed Control takes over accelerator operations at speeds greater than 20 mph (32 km/h).

The Speed Control buttons are located on the right side of the steering wheel.

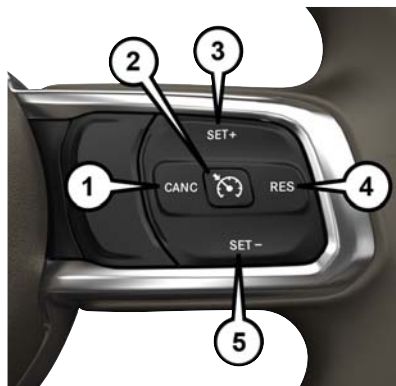

**Speed Control Buttons**

- 1 — CANCEL/Cancel
- 2 — On/Off
- 3 — SET (+)/Accel
- 4 — RES/Resume
- 5 — SET (-)/Decel

### NOTE:

- In order to ensure proper operation, the Speed Control System has been designed to shut down if multiple Speed Control functions are operated at the same time. If this occurs, the Speed Control System can be reactivated by pushing the Speed Control on/off button and resetting the desired vehicle set speed.

### WARNING!

Speed Control can be dangerous where the system cannot maintain a constant speed. Your vehicle could go too fast for the conditions, and you could lose control and have an accident. Do not use Speed Control in heavy traffic or on roads that are winding, icy, snow-covered or slippery.

## To Activate

Push the on/off button to activate the Speed Control. The cruise indicator light in the instrument cluster display will illuminate. To turn the system off, push the on/off button a second time. The cruise indicator light will turn off. The system should be turned off when not in use.

### WARNING!

Leaving the Speed Control system on when not in use is dangerous. You could accidentally set the system or cause it to go faster than you want. You could lose control and have an accident. Always leave the system off when you are not using it.

## To Set A Desired Speed

Turn the Speed Control on.

### NOTE:

The vehicle should be traveling at a steady speed and on level ground before pushing the SET (+) or SET (-) button.

When the vehicle has reached the desired speed, push the SET (+) or SET (-) button and release. Release the accelerator and the vehicle will operate at the selected speed.

## To Vary The Speed Setting

### To Increase Speed

When the Speed Control is set, you can increase speed by pushing the SET (+) button.

The driver's preferred units can be selected through the instrument panel settings. Refer to "Instrument Cluster Display" in "Getting To Know Your Instrument Panel" in your Owner's Manual for more information. The speed increment shown is dependent on the chosen speed unit of U.S. (mph) or Metric (km/h):

U.S. Speed (mph)

- Pushing the SET (+) button once will result in a 1 mph increase in set speed. Each subsequent tap of the button results in an increase of 1 mph.
- If the button is continually pushed, the set speed will continue to increase until the button is released, then the new set speed will be established.

Metric Speed (km/h)

- Pushing the SET (+) button once will result in a 1 km/h increase in set speed. Each subsequent tap of the button results in an increase of 1 km/h.
- If the button is continually pushed, the set speed will continue to increase until the button is released, then the new set speed will be established.

### To Decrease Speed

When the Speed Control is set, you can decrease speed by pushing the SET (-) button.

The driver's preferred units can be selected through the instrument panel settings. Refer to "Instrument Cluster Display" in "Getting To Know Your Instrument Panel" in your Owner's Manual for more information. The speed increment shown is dependent on the chosen speed unit of U.S. (mph) or Metric (km/h):

U.S. Speed (mph)

- Pushing the SET (-) button once will result in a 1 mph decrease in set speed. Each subsequent tap of the button results in a decrease of 1 mph.



- If the button is continually pushed, the set speed will continue to decrease until the button is released, then the new set speed will be established.

Metric Speed (km/h)

- Pushing the SET (-) button once will result in a 1 km/h decrease in set speed. Each subsequent tap of the button results in a decrease of 1 km/h.
- If the button is continually pushed, the set speed will continue to decrease until the button is released, then the new set speed will be established.

### To Accelerate For Passing

Press the accelerator as you would normally. When the pedal is released, the vehicle will return to the set speed.

### Using Speed Control On Hills

The transmission may downshift on hills to maintain the vehicle set speed.

#### NOTE:

The Speed Control system maintains speed up and down hills. A slight speed change on moderate hills is normal.

On steep hills, a greater speed loss or gain may occur so it may be preferable to drive without Speed Control.

### WARNING!

Speed Control can be dangerous where the system cannot maintain a constant speed. Your vehicle could go too fast for the conditions, and you could lose control and have an accident. Do not use Speed Control in heavy traffic or on roads that are winding, icy, snow-covered or slippery.

### To Resume Speed

To resume a previously set speed, push the RES button and release. Resume can be used at any speed above 20 mph (32 km/h).

### To Deactivate

A soft tap on the brake pedal, pushing the CANC (cancel) button, or normal brake pressure while slowing the vehicle will deactivate the speed control without erasing the set speed from memory.

Pushing the on/off button or cycling the ignition to OFF, erases the set speed from memory.

## PARKSENSE REAR PARK ASSIST – IF EQUIPPED

The ParkSense Rear Park Assist system provides visual and audible indications of the distance between the rear fascia and a detected obstacle when backing up, e.g. during a parking maneuver. Refer to “ParkSense System Usage Precautions” in this section for limitations of this system and recommendations.

ParkSense will retain the last system state (enabled or disabled) from the last ignition cycle when the ignition is changed to the ON/RUN position.

ParkSense can be active only when the gear selector is in REVERSE. If ParkSense is enabled at this gear selector position, the system will remain active until the vehicle speed is increased to approximately 7 mph (11 km/h) or above. When in REVERSE and above the system's operating speed, a warn-



ing will appear within the instrument cluster display indicating the vehicle speed is too fast. The system will become active again if the vehicle speed is decreased to speeds less than approximately 6 mph (9 km/h).

### ParkSense Sensors

The four ParkSense sensors, located in the rear fascia/bumper, monitor the area behind the vehicle that is within the sensors' field of view. The sensors can detect obstacles from approximately 12 inches (30 cm) up to 79 inches (200 cm) from the rear fascia/bumper in the horizontal direction, depending on the location, type and orientation of the obstacle.

### Enabling And Disabling ParkSense

ParkSense can be enabled and disabled with the ParkSense switch, located on the switch panel below the climate controls.

When the ParkSense switch is pushed to disable the system, the instrument cluster display will show the "PARKSENSE OFF" message for approximately five seconds.

Refer to "Instrument Cluster Display" in "Getting To Know Your Instrument Panel" in your Owner's Manual for further information. When the gear selector is moved to REVERSE and the system is disabled, the instrument cluster display will show the "PARKSENSE OFF" message for as long as the vehicle is in REVERSE.

The ParkSense switch LED will be on when ParkSense is disabled or requires service. The ParkSense switch LED will be off when the system is enabled. If the ParkSense switch is pushed, and requires service, the ParkSense switch LED will blink momentarily, and then the LED will be on.

### ParkSense System Usage Precautions

#### NOTE:

- Ensure that the rear bumper is free of snow, ice, mud, dirt and debris to keep the ParkSense system operating properly.
- Jackhammers, large trucks, and other vibrations could affect the performance of ParkSense.

- When you turn ParkSense OFF, the instrument cluster display will read "PARKSENSE OFF" Furthermore, once you turn ParkSense OFF, it remains off until you turn it on again, even if you cycle the ignition.
- ParkSense, when on, will reduce the volume of the radio when it is sounding a tone.
- Clean the ParkSense sensors regularly, taking care not to scratch or damage them. The sensors must not be covered with ice, snow, slush, mud, dirt or debris. Failure to do so can result in the system not working properly. The ParkSense system might not detect an obstacle behind the fascia/bumper, or it could provide a false indication that an obstacle is behind the fascia/bumper.
- Use the ParkSense switch to turn the ParkSense system OFF if objects such as bicycle carriers, trailer hitches, etc. are placed within 12 inches (30 cm) from the rear fascia/bumper. Failure to do so can result in the system misinterpreting a close object as a sensor problem, causing the "PARKSENSE UNAVAILABLE SERVICE REQUIRED" message to be displayed in the instrument cluster display.



- The operation of the rear sensors is automatically deactivated when the trailer's electric plug is inserted in the vehicle's tow hook socket. The rear sensors are automatically reactivated when the trailer's cable plug is removed.

**WARNING!**

- Drivers must be careful when backing up even when using ParkSense. Always check carefully behind your vehicle, look behind you, and be sure to check for pedestrians, animals, other vehicles, obstructions, and blind spots before backing up. You are responsible for safety and must continue to pay attention to your surroundings. Failure to do so can result in serious injury or death.
- Before using ParkSense, it is strongly recommended that the ball mount and hitch ball assembly is disconnected from the vehicle when the vehicle is not used for towing. Failure to do so can result in injury or damage to vehicles or obstacles because the hitch ball will be much closer to the obstacle than the

**WARNING!**

rear fascia when the loudspeaker sounds the continuous tone. Also, the sensors could detect the ball mount and hitch ball assembly, depending on its size and shape, giving a false indication that an obstacle is behind the vehicle.

**CAUTION!**

- ParkSense is only a parking aid and it is unable to recognize every obstacle, including small obstacles. Parking curbs might be temporarily detected or not detected at all. Obstacles located above or below the sensors will not be detected when they are in close proximity.
- The vehicle must be driven slowly when using ParkSense in order to be able to stop in time when an obstacle is detected. It is recommended that the driver looks over his/her shoulder when using ParkSense.

**PARKVIEW REAR BACK UP CAMERA**

The ParkView Rear Back Up Camera allows you to see an on-screen image of the rear surroundings of your vehicle whenever the gear selector is put into REVERSE. The image will be displayed in the touchscreen display along with a caution note to “check entire surroundings” across the top of the screen. After five seconds this note will disappear. The ParkView camera is located on the rear of the vehicle in the center of the spare tire.

**Manual Activation Of The Rear View Camera**

1. Press the “Controls” button located on the bottom of the Uconnect display.
2. Press the “Backup Camera” button to turn the Rear View Camera system on.

**NOTE:**

The ParkView Rear Back Up Camera has programmable modes of operation that may be selected through the Uconnect System.

Refer to “Uconnect Settings” in “Multimedia” in your Owner’s Manual for further information.

When the vehicle is shifted out of REVERSE (with camera delay turned off), the rear camera mode is exited and the previous screen appears again. When the vehicle is shifted out of REVERSE (with camera delay turned on), the camera image will continue to be displayed for up to ten seconds after shifting out of REVERSE unless the vehicle speed exceeds 8 mph (13 km/h), the vehicle is shifted into PARK, the vehicle’s ignition is cycled to the OFF position, or the user presses image defeat [X] to exit out of the camera video display.

**NOTE:**

- If the vehicle speed remains below 8 mph (13 km/h), the Rear View Camera image will be displayed continuously until deactivated via the touchscreen button “X”, the vehicle is shifted into PARK, or the ignition is placed in the OFF position.
- The touchscreen button “X” to disable display of the camera image is made available ONLY when the vehicle is not in REVERSE.

When enabled, active guide lines are overlaid on the image to illustrate the width of the vehicle and its projected backup path based on the steering wheel position. A dashed center line overlay indicates the center of the vehicle to assist with parking or aligning to a hitch/receiver.

When enabled, fixed guide lines are overlaid on the image to illustrate the width of the vehicle.

Different colored zones indicate the distance to the rear of the vehicle.

**WARNING!**

Drivers must be careful when backing up even when using the ParkView Rear Back Up Camera. Always check carefully behind your vehicle, and be sure to check for pedestrians, animals, other vehicles, obstructions, or blind spots before backing up. You are responsible for the safety of your surroundings and must continue to pay attention while backing up. Failure to do so can result in serious injury or death.

**CAUTION!**

- To avoid vehicle damage, ParkView should only be used as a parking aid. The ParkView camera is unable to view every obstacle or object in your drive path.
- To avoid vehicle damage, the vehicle must be driven slowly when using ParkView to be able to stop in time when an obstacle is seen. It is recommended that the driver look frequently over his/her shoulder when using ParkView.



**NOTE:**

If snow, ice, mud, or any foreign substance builds up on the camera lens, clean the lens, rinse with water, and dry with a soft cloth. Do not cover the lens.

**REFUELING THE VEHICLE****Fuel Filler Cap**

The fuel filler cap is located on the driver's side of the vehicle. If the fuel filler cap is lost or damaged, be sure the replacement cap is the correct one for this vehicle.

**Fuel Filler Door****Fuel Filler Cap**

## WARNING!

- Never have any smoking materials lit in or near the vehicle when the fuel door is open or the tank is being filled.
- Never add fuel when the engine is running. This is in violation of most state and federal fire regulations and may cause the “Malfunction Indicator Light” to turn on.
- A fire may result if fuel is pumped into a portable container that is inside of a vehicle. You could be burned. Always place fuel containers on the ground while filling.

## CAUTION!

- Damage to the fuel system or emission control system could result from using an improper fuel filler cap. A poorly fitting cap could let impurities into the fuel system. Also, a poorly fitting aftermarket cap can cause the “Malfunction Indicator Light (MIL)” to illuminate, due to fuel vapors escaping from the system.
- To avoid fuel spillage and overfilling, do not “top off” the fuel tank after filling.

### NOTE:

- When the fuel nozzle “clicks” or shuts off, the fuel tank is full.
- Tighten the fuel filler cap about 1/4 turn until you hear one click. This is an indication that the cap is properly tightened.
- If the fuel filler cap is not tightened properly, the MIL will come on. Be sure the cap is tightened every time the vehicle is refueled.

## Loose Fuel Filler Cap Message

After fuel has been added, the vehicle diagnostic system can determine if the fuel filler cap is possibly loose, improperly installed, or damaged. If the system detects a malfunction, the “gASCAP” message will display in the odometer display. Tighten the gas cap until a “clicking” sound is heard. This is an indication that the gas cap is properly tightened. Push the odometer reset button to turn the message off. If the problem persists, the message will appear the next time the vehicle is started. This might indicate a damaged cap. If the problem is detected twice in a row, the system will turn on the MIL. Resolving the problem will turn the MIL off.



## TRAILER TOWING

### Trailer Towing Weights (Maximum Trailer Weight Ratings)

Engine/Transmission	Model	GCWR (Gross Combined Wt. Rating)	Frontal Area	Max. GTW (Gross Trailer Wt.)	Max. Trailer Tongue Wt. (See Note)
2.0L	Two-Door	8,016 lbs (3 636 kg)	20 ft <sup>2</sup> (1.86 m <sup>2</sup> )	2,000 lbs (907 kg)	200 lbs (91 kg)
	Four-Door	8,117 lbs (3 682 kg)	30 ft <sup>2</sup> (2.79 m <sup>2</sup> )	3,500 lbs (1 587 kg)	350 lbs (158 kg)
3.6L	Two-Door	8,016 lbs (3 636 kg)	20 ft <sup>2</sup> (1.86 m <sup>2</sup> )	2,000 lbs (907 kg)	200 lbs (91 kg)
	Four-Door	8,117 lbs (3 682 kg)	30 ft <sup>2</sup> (2.79 m <sup>2</sup> )	3,500 lbs (1 587 kg)	350 lbs (158 kg)
Refer to local laws for maximum trailer towing speeds.					

#### NOTE:

The trailer tongue weight must be considered as part of the combined weight of occupants and cargo (ie. the GVWR), and the GVWR should never exceed the weight referenced on the Tire and Loading Information placard. Refer to “Tire Safety Information” in “Servicing And Maintenance” in the Owner’s information for further details.

## RECREATIONAL TOWING (BEHIND MOTORHOME, ETC.)

### Towing This Vehicle Behind Another Vehicle

Towing Condition	Wheels OFF the Ground	Four-Wheel Drive Models
Flat Tow	NONE	<b>See Instructions</b> <ul style="list-style-type: none"><li>• Automatic transmission in PARK.</li><li>• Manual transmission in gear (NOT in NEUTRAL [N]).</li><li>• Transfer case in NEUTRAL (N).</li><li>• Tow in forward direction.</li></ul>
		NOT ALLOWED
Dolly Tow	Front	NOT ALLOWED
	Rear	NOT ALLOWED
On Trailer	ALL	OK

**NOTE:**

When towing your vehicle, always follow applicable state and provincial laws. Contact state and provincial Highway Safety offices for additional details.

### Recreational Towing – Four-Wheel Drive Models

**NOTE:**

The transfer case must be shifted into NEUTRAL (N), automatic transmission must be in PARK, and manual transmission must be in gear (NOT in NEUTRAL) for recreational towing.



**CAUTION!**

- DO NOT dolly tow any 4WD vehicle. Towing with only one set of wheels on the ground (front or rear) will cause severe transmission and/or transfer case damage. Tow with all four wheels either ON the ground, or OFF the ground (using a vehicle trailer).
- Tow only in the forward direction. Towing this vehicle backwards can cause severe damage to the transfer case.
- Automatic transmissions must be placed in PARK for recreational towing.
- Manual transmissions must be placed in gear (not in Neutral) for recreational towing.
- Before recreational towing, perform the procedure outlined under “Shifting Into NEUTRAL (N)” to be certain that the transfer case is fully in NEUTRAL (N). Otherwise, internal damage will result.
- Towing this vehicle in violation of the above requirements can cause severe transmission and/or transfer case damage. Damage from improper towing is

**CAUTION!**

not covered under the New Vehicle Limited Warranty.

- Do not use a bumper-mounted clamp-on tow bar on your vehicle. The bumper face bar will be damaged.

**Shifting Into NEUTRAL (N)**

Use the following procedure to prepare your vehicle for recreational towing.

**WARNING!**

You or others could be injured or killed if you leave the vehicle unattended with the transfer case in the NEUTRAL (N) position without first fully engaging the parking brake. The transfer case NEUTRAL (N) position disengages both the front and rear driveshafts from the powertrain, and will allow the vehicle to roll, even if the automatic transmission is in PARK (or manual transmission is in gear). The parking brake should always be applied when the driver is not in the vehicle.

**CAUTION!**

It is necessary to follow these steps to be certain that the transfer case is fully in NEUTRAL (N) before recreational towing to prevent damage to internal parts.

1. Bring the vehicle to a complete stop on level ground.
2. Press and hold the brake pedal.
3. Shift the automatic transmission into NEUTRAL or depress the clutch pedal on a manual transmission.
4. Turn the engine OFF.
5. Shift the transfer case lever into NEUTRAL (N).
6. Start the engine.
7. Shift the transmission into REVERSE.
8. Release the brake pedal (and clutch pedal on manual transmissions) for five seconds and ensure that there is no vehicle movement.



- Repeat steps seven and eight with automatic transmission in DRIVE or manual transmission in first gear.
- Turn the engine OFF.
- Firmly apply the parking brake.
- Shift the transmission into PARK or place manual transmission in gear (NOT in NEUTRAL).

### CAUTION!

Damage to the transmission may occur if the transmission is shifted into PARK with the transfer case in NEUTRAL (N) and the engine running. With the transfer case in NEUTRAL (N) ensure that the engine is OFF before shifting the transmission into PARK.

- Attach the vehicle to the tow vehicle using a suitable tow bar.
- Release the parking brake.

### Shifting Out of NEUTRAL (N)

Use the following procedure to prepare your vehicle for normal usage.

- Bring the vehicle to a complete stop, leaving it connected to the tow vehicle.
- Firmly apply the parking brake.
- Start the engine.
- Press and hold the brake pedal.
- Shift the transmission into NEUTRAL.
- Turn the engine OFF.
- Shift the transfer case lever to the desired position.

#### NOTE:

When shifting the transfer case out of NEUTRAL (N), the engine should remain OFF to avoid gear clash.

- Shift the automatic transmission into PARK, or place manual transmission in NEUTRAL.
- Release the brake pedal.
- Disconnect vehicle from the tow vehicle.
- Start the engine.
- Press and hold the brake pedal.
- Release the parking brake.
- Shift the transmission into gear, release the brake pedal (and clutch pedal on manual transmissions), and check that the vehicle operates normally.





# IN CASE OF EMERGENCY

<b>HAZARD WARNING FLASHERS</b> . . . . .	<b>.186</b>
<b>ASSIST AND SOS MIRROR — IF EQUIPPED</b> . . . . .	<b>.186</b>
<b>BULB REPLACEMENT</b> . . . . .	<b>.191</b>
Replacement Bulbs . . . . .	.191
Bulb Replacement . . . . .	.193
<b>FUSES</b> . . . . .	<b>.196</b>
General Information. . . . .	.196
Power Distribution Center (PDC) . . . . .	.196

<b>JACKING AND TIRE CHANGING</b> . . . . .	<b>.203</b>
Jack Location . . . . .	.203
Spare Tire Removal . . . . .	.203
Preparations For Jacking . . . . .	.204
Jacking Instructions . . . . .	.204
Road Tire Installation . . . . .	.206
<b>JUMP STARTING</b> . . . . .	<b>.207</b>
Preparations For Jump Start. . . . .	.207
Jump Starting Procedure. . . . .	.208
<b>IF YOUR ENGINE OVERHEATS</b> . . . . .	<b>.209</b>

<b>MANUAL PARK RELEASE</b> . . . . .	<b>.210</b>
<b>FREEING A STUCK VEHICLE</b> . . . . .	<b>.211</b>
<b>TOWING A DISABLED VEHICLE</b> . . . . .	<b>.212</b>
Four-Wheel Drive Models . . . . .	.213
Emergency Tow Hooks — If Equipped . . . . .	.214
<b>ENHANCED ACCIDENT RESPONSE SYSTEM (EARS)</b> . . . . .	<b>.214</b>
<b>EVENT DATA RECORDER (EDR)</b> . . . . .	<b>.214</b>



## HAZARD WARNING FLASHERS

The Hazard Warning flasher switch is located on the instrument panel below the climate controls.



Push the switch to turn on the Hazard Warning flasher. When the switch is activated, all directional turn signals will flash on and off to warn oncoming traffic of an emergency. Push the switch a second time to turn off the Hazard Warning flashers.

This is an emergency warning system and it should not be used when the vehicle is in motion. Use it when your vehicle is disabled and it is creating a safety hazard for other motorists.

When you must leave the vehicle to seek assistance, the Hazard Warning flashers will continue to operate even though the ignition is placed in the OFF position.

### NOTE:

With extended use the Hazard Warning flashers may wear down your battery.

## ASSIST AND SOS MIRROR — IF EQUIPPED

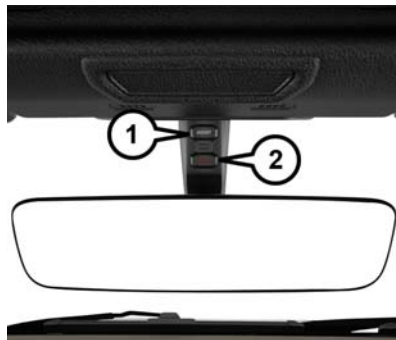

Assist And SOS Mirror

- 1 — ASSIST Button  
2 — SOS Button

If equipped, the rearview mirror contains an ASSIST and a SOS button.

### WARNING!

ALWAYS obey traffic laws and pay attention to the road. ALWAYS drive safely with your hands on the steering wheel. You have full responsibility and assume all risks related to the use of the features and applications in this vehicle. Only use the features and applications when it is safe to do so. Failure to do so may result in an accident involving serious injury or death.

### NOTE:

- Your vehicle may be transmitting data as authorized by the subscriber.
- The SOS and ASSIST buttons will only function if you are connected to an operable LTE (voice/data) or 4G (data) network. Other Uconnect services will only be operable if your SiriusXM Guardian service is active and you are connected to an operable LTE (voice/data) or 4G (data) network.

## ASSIST Call

The ASSIST Button is used to automatically connect you to any one of the following support centers:

- Roadside Assistance – If you get a flat tire, or need a tow, just push the ASSIST button and you'll be connected to someone who can help. Roadside Assistance will know what vehicle you're driving and its location. Additional fees may apply for roadside assistance.
- SiriusXM Guardian Customer Care – In-vehicle support for SiriusXM Guardian.
- Vehicle Customer Care – Total support for all other vehicle issues.

## SOS Call

1. Push the SOS Call button on the Rearview Mirror.

### NOTE:

In case the SOS Call button is pushed in error, there will be a ten second delay before the SOS Call system initiates a call to a SOS operator. To cancel the SOS Call connection, push the SOS call button on the Rearview Mirror or press the cancellation button on the Device Screen. Termination of the SOS Call will turn off the green LED light on the Rearview Mirror.

2. The LED light located between the ASSIST and SOS buttons on the Rearview Mirror will turn green once a connection to a SOS operator has been made.

3. Once a connection between the vehicle and a SOS operator is made, the SOS Call system may transmit the following important vehicle information to a SOS operator:

- Indication that the occupant placed a SOS Call.
- The vehicle brand.
- The last known GPS coordinates of the vehicle.

4. You should be able to speak with the SOS operator through the vehicle audio system to determine if additional help is needed.

## WARNING!

ALWAYS obey traffic laws and pay attention to the road. ALWAYS drive safely with your hands on the steering wheel. You have full responsibility and assume all risks related to the use of the features and applications in this vehicle. Only use the features and applications when it is safe to do so. Failure to do so may result in an accident involving serious injury or death.



**NOTE:**

- Your vehicle may be transmitting data as authorized by the subscriber.
  - Once a connection is made between the vehicle's SOS Call system and the SOS operator, the SOS operator may be able to open a voice connection with the vehicle to determine if additional help is needed. Once the SOS operator opens a voice connection with the vehicle's SOS Call system, the operator should be able to speak with you or other vehicle occupants and hear sounds occurring in the vehicle. The vehicle's SOS Call system will attempt to remain connected with the SOS operator until the SOS operator terminates the connection.
5. The SOS operator may attempt to contact appropriate emergency responders and provide them with important vehicle information and GPS coordinates.

**WARNING!**

- If anyone in the vehicle could be in danger (e.g., fire or smoke is visible, dangerous road conditions or location), do not wait for voice contact from an Emergency Services Agent. All occupants should exit the vehicle immediately and move to a safe location.
- Never place anything on or near the vehicle's operable network and GPS antennas. You could prevent operable network and GPS signal reception, which can prevent your vehicle from placing an emergency call. An operable network and GPS signal reception is required for the SOS Call system to function properly.
- The SOS Call system is embedded into the vehicle's electrical system. Do not add aftermarket electrical equipment to the vehicle's electrical system. This may prevent your vehicle from sending a signal to initiate an emergency call. To avoid interference that can cause the SOS Call system to fail, never add aftermarket equipment (e.g., two-way mobile

**WARNING!**

- radio, CB radio, data recorder, etc.) to your vehicle's electrical system or modify the antennas on your vehicle. IF YOUR VEHICLE LOSES BATTERY POWER FOR ANY REASON (INCLUDING DURING OR AFTER AN ACCIDENT), THE UCONNECT FEATURES, APPS AND SERVICES, AMONG OTHERS, WILL NOT OPERATE.
- Modifications to any part of the SOS Call system could cause the air bag system to fail when you need it. You could be injured if the air bag system is not there to help protect you.

## SOS Call System Limitations

Vehicles sold in Mexico **DO NOT** have SOS Call system capabilities.

SOS or other emergency line operators in Mexico may not answer or respond to SOS system calls.

If the SOS Call system detects a malfunction, any of the following may occur at the time the malfunction is detected, and at the beginning of each ignition cycle:

- The Rearview Mirror light located between the ASSIST and SOS buttons will continuously be illuminated red.
- The Device Screen will display the following message “Vehicle device requires service. Please contact your dealer.”
- An In-Vehicle Audio message will state “Vehicle device requires service. Please contact your dealer.”

### WARNING!

- Ignoring the Rearview Mirror light could mean you will not have SOS Call services. If the Rearview Mirror light is illuminated, have your authorized dealer service the SOS Call system immediately.
- The Occupant Restraint Control module turns on the air bag Warning Light on the instrument panel if a malfunction in any part of the system is detected. If the Air Bag Warning Light is illuminated, have your authorized dealer service the Occupant Restraint Control system immediately.

Even if the SOS Call system is fully functional, factors beyond FCA US LLC's control may prevent or stop the SOS Call system operation. These include, but are not limited to, the following factors:

- Delayed accessories mode is active.
- The ignition is in the OFF position.

- The vehicle's electrical systems are not intact.
- The SOS Call system software and/or hardware are damaged during a crash.
- The vehicle battery loses power or becomes disconnected during a vehicle crash.
- LTE (voice/data) or 4G (data) network and/or Global Positioning Satellite signals are unavailable or obstructed.
- Equipment malfunction at the SOS operator facility.
- Operator error by the SOS operator.
- LTE (voice/data) or 4G (data) network congestion.
- Weather.
- Buildings, structures, geographic terrain, or tunnels.



**WARNING!**

ALWAYS obey traffic laws and pay attention to the road. ALWAYS drive safely with your hands on the steering wheel. You have full responsibility and assume all risks related to the use of the features and applications in this vehicle. Only use the features and applications when it is safe to do so. Failure to do so may result in an accident involving serious injury or death.

**NOTE:**

- Your vehicle may be transmitting data as authorized by the subscriber.
- Never place anything on or near the vehicle's LTE (voice/data) or 4G (data) and GPS antennas. You could prevent LTE (voice/data) or 4G (data) and GPS signal reception, which can prevent your vehicle from placing an emergency call. An operable LTE (voice/data) or 4G (data) network connection and a GPS signal is required for the SOS Call system to function properly.

**General Information**

This device complies with Part 15 of the FCC Rules. Operation is subject to the following two conditions: (1) This device may not cause harmful interference, and (2) this device must accept any interference received, including interference that may cause undesired operation.

**NOTE:**

Changes or modifications not expressly approved by the party responsible for compliance could void the user's authority to operate the equipment.

**CAUTION!**

To avoid damage to the mirror during cleaning, never spray any cleaning solution directly onto the mirror. Apply the solution onto a clean cloth and wipe the mirror clean.



# BULB REPLACEMENT

## Replacement Bulbs

### Interior Bulbs

	Bulb Number
Automatic Transmission Indicator Lamp	658
Heater Control Lamps (2)	194
Rocker Switch Indicator Lamp (Rear Window Defogger, and Rear Wash/Wipe)	**
Soundbar Dome Lamp	912
** Bulbs only available from an authorized dealer.	



**Exterior Bulbs**

	<b>Bulb Number</b>
Headlamps (2)	H13
Premium Head Lamps	LED – (Serviced At Authorized Dealer)
Sport Front Park/Turn Signal Lamps (2)	7442NALL
Premium Front Park/Turn Signal Lamps (2)	LED – (Serviced At Authorized Dealer)
Base (Sahara/Rubicon) Turn Lamp	7440NA
Base (Sahara/Rubicon) Park DRL Lamp	7443
Front Side Marker Lamps (2)	LED – (Serviced At Authorized Dealer)
Base Fog Lamps	PSX24W
Premium Fog Lamps	LED – (Serviced At Authorized Dealer)
Rear Premium LED Tail Lamps	LED – (Serviced At Authorized Dealer)
Rear Base Tail Lamp Stop/Tail/Turn Bulb	3157
Rear Base Tail Lamp Backup Bulb	7440
Rear Base Tail Lamp Side Marker	LED – (Serviced At Authorized Dealer)
Center High-Mounted Stop Lamp	LED – (Serviced At Authorized Dealer)
License Lamp	LED – (Serviced At Authorized Dealer)

**NOTE:**

Numbers refer to commercial bulb types that can be purchased from an authorized dealer.  
If a bulb needs to be replaced, visit an authorized dealer or refer to the applicable Service Manual.

## Bulb Replacement

### NOTE:

Lens fogging can occur under certain atmospheric conditions. This will usually clear as atmospheric conditions change to allow the condensation to change back into a vapor. Turning the lamps on will usually accelerate the clearing process.

### Halogen Headlamps

1. Open hood and support using prop rod.
2. Remove the front grille. Turn the retainers along the top 1/4 turn counterclockwise and remove.
3. Pull the bottom of the grille away starting at one side and working toward the other.
4. Remove the three screws holding the headlamp to the vehicle.
5. Remove lamp from the vehicle.
6. Remove the lamp from the collar.

7. Grasp the bulb and turn 1/4 turn counterclockwise.
8. Pull the bulb from the housing.
9. Push connector locking tab to the unlock position.
10. Remove connector from bulb.
11. Push connector onto new bulb base, and push the connector locking tab to the lock position.

### CAUTION!

Do not touch the new bulb with your fingers. Oil contamination will severely shorten bulb life. If the bulb comes in contact with any oily surface, clean the bulb with rubbing alcohol.

12. Reinstall bulb housing. Rotate the bulb 1/4 turn clockwise.

## Front Park/Turn Signal

1. Remove the front wheel liner fasteners to access bulb sockets.



Wheel Liner

2. Turn the socket assembly 1/4 turn counterclockwise and remove from housing. Pull the bulb straight from the socket to replace.



**LED Front Side Marker**

1. Remove the front wheel liner fasteners to access side maker screw and electrical connector.
2. Remove fastening screw in the back of the front side maker assembly and disconnect electrical connector.
3. Remove and replace LED front side marker light assembly.

**Halogen Front Fog Lamp**

1. Reach under the vehicle to access the back of the front fog lamp.
2. Disconnect the wire harness connector from the front fog lamp connector receptacle.
3. Firmly grasp the bulb by the two latch features and squeeze them together to unlock the bulb from the back of the front fog lamp housing.

4. Pull the bulb straight out from the keyed opening in the housing and then connect the replacement bulb.

**CAUTION!**

Do not touch the new bulb with your fingers. Oil contamination will severely shorten bulb life. If the bulb comes in contact with any oily surface, clean the bulb with rubbing alcohol.

**LED Front Fog Lamp**

If your vehicle is equipped with LED fog lamps they are replaced as an assembly.

**Rear Tail, Stop, Turn Signal, And Backup Lamp**

1. Remove interior trim panel cap to access single retaining screw for tail lamp assembly.



**Trim Cap**

2. Remove retaining screw and disconnect electrical connector, then remove tail lamp assembly from the vehicle.

**NOTE:**

If necessary, push in on the assembly tab located inboard behind the lamp housing.



**Retaining Screw**

3. Remove the three screws from assembly bracket to access bulb sockets.



**Assembly Bracket**

4. Rotate the appropriate socket 1/4 turn counterclockwise, then remove it from the housing.
5. Pull the bulb straight from the socket to replace.

### **Center High-Mounted Stop Lamp (CHMSL)**

The stop lamp is mounted on a bracket that extends upward from the tailgate behind the spare tire. If service is needed, obtain the LED Assembly from an authorized dealer.

1. Remove the spare tire.
2. Remove the screws holding the tire carrier cover.
3. Remove two screws from lamp assembly and disconnect electrical connector.

### **License Plate Lamps**

See an authorized dealer to replace these LED assemblies.



## FUSES

### WARNING!

- When replacing a blown fuse, always use an appropriate replacement fuse with the same amp rating as the original fuse. Never replace a fuse with another fuse of higher amp rating. Never replace a blown fuse with metal wires or any other material. Failure to use proper fuses may result in serious personal injury, fire and/or property damage.
- Before replacing a fuse, make sure that the ignition is off and that all the other services are switched off and/or disengaged.
- If the replaced fuse blows again, contact an authorized dealer.
- If a general protection fuse for safety systems (air bag system, braking system), power unit systems (engine system, gearbox system) or steering system blows, contact an authorized dealer.

### General Information

The fuses protect electrical systems against excessive current.

When a device does not work, you must check the fuse element inside the blade fuse for a break/melt.

Also, please be aware that when using power outlets for extended periods of time with the engine off may result in vehicle battery discharge.

### Power Distribution Center (PDC)

The Power Distribution Center is located in the engine compartment near the battery. This center contains cartridge fuses, mini fuses, and relays. The PDC top cover is labelled with each serviceable fuse/relay location, function, and size.

<b>Cavity</b>	<b>Cartridge Fuse</b>	<b>Micro Fuse</b>	<b>Description</b>
F01	–	–	Spare
F02	40 Amp Green	–	Starter
F03	–	5 Amp Tan	Intelligent Battery Sensor (IBS)
F04	–	20 Amp Yellow	Fuel Pump MTR/FPCM
F05	–	5 Amp Tan	Security Gateway
F06	–	–	Spare
F07	–	15 Amp Blue	Low Temp Radiator Cooling Pump (LTR) — If Equipped
F08	–	15 Amp Blue	Trans Control Module TCM-8HP CYGNUS
F09	–	–	Spare
F10	–	15 Amp Blue	Key Ignition Node (KIN)/Radio Frequency Hub(RF HUB)/ Electric Steering Column Lock (ESCL)
F11	–	10 Amp Red	UCI Port (USB & AUX)
F12	–	25 Amp Clear	HIFI Amplifier
F13	–	–	Spare
F14	–	–	Spare
F15	–	15 Amp Blue	Instrument Panel Cluster (IPC)/Switch Bank-Heavy Duty Electrical Pkg (SWITCH BANK-HD ELEC)
F16	–	–	Spare
F17	–	–	Spare
F18	–	10 Amp Red	Air Conditioning Clutch (AC CLUTCH)
F19	–	–	Spare
F20	30 Amp Pink	–	Central Body Controller (CBC) 1-INTERIOR LIGHTS
F21	–	20 Amp Yellow	REAR WIPER



<b>Cavity</b>	<b>Cartridge Fuse</b>	<b>Micro Fuse</b>	<b>Description</b>
F22	–	10 Amp Red	Engine Control Module (ECM)/Powertrain Control Module (PCM)/ Motor Generator Unit (MGU) WAKE UP/ Power Pack Unit (PPU) WAKE UP
F23	–	10 Amp Red	Powertrain Control Module (PCM)/Engine Control Module (ECM)
F24	–	–	Spare
F25	–	10 Amp Red	Module Shift By Wire (MOD_SBW)
F26	40 Amp Green	–	Central Body Controller (CBC) 2-EXTERIOR LIGHTS #1
F27	30 Amp Pink	–	Front Wipers
F28	40 Amp Green	–	Central Body Controller (CBC) 3-POWER LOCKS
F29	40 Amp Green	–	Central Body Controller (CBC) 4-EXTERIOR LIGHTS #2
F30	–	–	Spare
F31	–	10 Amp Red	DIAGNOSTIC PORT
F32	–	10 Amp Red	Heating Ventilation Air Conditioning Mod (HVAC CTRL MOD)/ Steering Column Lock (SCL)/Occupant Classification Module (OCM)/Driver Presence Detection Module (DPDM)
F33	–	10 Amp Red	ParkTronics System (PTS)/Infrared Camera Module (IRCM)/ Airbag Disable Lamps (AIRBAG DISABLE LMPS)
F34	–	10 Amp Red	Electronic Stability Control (ESC)/Electric Hydraulic Power Steering (EHPS)/Smart Bar Control Module (SBCM) WAKE UP
F35	30 Amp Pink	–	BRAKE VAC PMP — If Equipped
F36	30 Amp Pink	–	TRLR TOW MOD — If Equipped
F37	30 Amp Pink	–	TRLR TOW CONN 7W — If Equipped
F38	20 Amp Blue	–	Engine Control Module ECM
F39	–	–	Spare



<b>Cavity</b>	<b>Cartridge Fuse</b>	<b>Micro Fuse</b>	<b>Description</b>
F40	–	15 Amp Blue	DriveTrain Control Module (DTCM)/Axle Lock (AXLE LOC) FT_RR
F41	–	15 Amp Blue	Instrument Cluster (IC)/Security GateWay (SGW) WAKE UP
F42	–	10 Amp Red	Power Control Relay Control Feed (Electric Stop/Start)/ Spare (Belt Starter Generator) -- If Equipped
F43	–	20 Amp Yellow	PWR OUTLET (CARGO) BATT
F44	–	10 Amp Red	InfraRed Camera (IRCAM) HEATERS
F45	–	20 Amp Yellow	PWR OUTLET (CARGO) IGN*
F46	–	10 Amp Red	AUTO HDLP LVL MOD/LVL MTR/HDLP SW
F47	–	–	Spare
F48	–	–	Spare
F49	–	10 Amp Red	Occupant Restraint Controller ORC
F50	–	10 Amp Red	HD ACC — If Equipped
F51	–	10 Amp Red	Digital TV (DSRC)/USB/InSide RearView Mirror (ISRVM)/ Compass Module (CSGM)
F52	–	20 Amp Yellow	CIGAR LTR
F53	–	–	Spare
F54	–	–	Spare
F55	–	–	Spare
F56	–	10 Amp Red	IN-CAR TEMP SENSOR
F57	–	20 Amp Yellow	Frnt Drvr Htd Seat
F58	–	20 Amp Yellow	Frnt Pass Htd Seat
F59	–	–	Spare
F60	–	15 Amp Blue	Comfort Steering Wheel Module (CSWM) (HTD STR WHEEL)



<b>Cavity</b>	<b>Cartridge Fuse</b>	<b>Micro Fuse</b>	<b>Description</b>
F61	-	10 Amp Red	Left Blind Spot Sensor (LBSS)/Right Blind Spot Sensor (RBSS)
F62	-	-	Spare
F63	-	10 Amp Red	Occupant Restraint Controller (ORC)
F64	-	-	Spare
F65	-	-	Spare
F66	40 Amp Green	-	HVAC BLOWER MTR FRT
F67	-	-	Spare
F68	-	-	Spare
F69	-	5 Amp Tan	Motor Generator Unit MGU Belt Starter Generator (BSG) — If Equipped
F70	-	25 Amp Clear	INJ/IGN COIL (GAS)/GLO PLUG MOD (DSL)
F71	-	-	Spare
F72	-	10 Amp Red	HD ELEC ACC PKG — If Equipped
F73	20 Amp Blue	-	PWR TOP LT
F74	20 Amp Blue	-	PWR TOP RT
F75	-	10 Amp Red	Power Pack Unit - Battery Pack Control Module & Auxiliary Power Module (PPU-BPCM & APM) Belt Starter Generator (BSG) — If Equipped
F76	-	20 Amp Yellow	ECM (GAS)/PCM (DSL)
F77	-	10 Amp Red	HTD MIRRORS
F78	-	10 Amp Red	COMP/INTRUSION/SIREN/INTRUSION SNSRS
F79	-	20 Amp Yellow	SMART BAR CTRL MOD
F80	-	15 Amp Blue	Powertrain Control Module (PCM)
F81	30 Amp Pink	-	REAR DEFROSTER (EBL)

<b>Cavity</b>	<b>Cartridge Fuse</b>	<b>Micro Fuse</b>	<b>Description</b>
F82	30 Amp Pink	–	FUEL HTR — If Equipped
F83	60 Amp Yellow	–	GLOW PLUG — If Equipped
F84	30 Amp Pink	–	UREA HTR CTRL UNIT — If Equipped
F85	–	10 Amp Red	PM SENSOR — If Equipped
F86	30 Amp Pink	–	BRAKE VAC PMP 2 — If Equipped
F87	–	10 Amp Red	SUPPLY/PURGING PMP — If Equipped
F88	20 Amp Blue	–	NOx SENSOR #1/ #2 — IF Equipped
F89	–	10 Amp Red	Steering Column Control Module (SCCM)/ Cruise Control (CRUISE CTL)/Digital TV (DTV)
F90	20 Amp Blue	–	TRLR TOW PARK LMP — If Equipped
F91	–	20 Amp Yellow	HORN
F92	40 Amp Green	–	HD ACCY #2 — If Equipped
F93	40 Amp Green	–	HD ACCY #1 — If Equipped
F94	–	10 Amp Red	Tire Pressure Monitor (TPM)/RF Hub system (CORAX)
F95	–	–	Spare
F96	–	10 Amp Red	PWR MIRROR SW
F97	–	20 Amp Yellow	RADIO/TBM
F98	–	10 Amp Red	SW BANK-HD ELEC/OFF ROAD
F99	–	–	Spare
F100	30 Amp Pink	–	ESC-ECU & VALVES
F101	30 Amp Pink	–	DriveTrain Control Module (DTCM)
F102	–	15 Amp Blue	DUAL USB PORT
F103	–	15 Amp Blue	HD ACCY #3 — If Equipped



Cavity	Cartridge Fuse	Micro Fuse	Description
F104	–	15 Amp Blue	PPU COOL PUMP — If Equipped
F105	–	10 Amp Red	Integrated Center Stack (ICS)/Heat Ventilation Air Conditioning (HVAC)
F106	40 Amp Green	–	Electronic Speed Control (ESC)-PUMP MTR
F107	–	20 Amp Yellow	TRLR TOW STOP/TURN LT — If Equipped
F108	–	15 Amp Blue	HD ACCY #4 — If Equipped
F109	–	20 Amp Yellow	TRLR TOW STOP/TURN RT — If Equipped
F110	30 Amp Pink	–	POWER INVERTER
F111	20 Amp Blue	–	TRLR TOW BACKUP — If Equipped

\* Customer can select to switch the Cargo Power Outlet from F43 battery fed power to this position F45 which is fed when the ignition is ON.

### CAUTION!

- When installing the power distribution center cover, it is important to ensure the cover is properly positioned and fully latched. Failure to do so may allow water to get into the power distribution center and possibly result in an electrical system failure.

### CAUTION!

- When replacing a blown fuse, it is important to use only a fuse having the correct amperage rating. The use of a fuse with a rating other than indicated may result in a dangerous electrical system overload. If a properly rated fuse continues to blow, it indicates a problem in the circuit that must be corrected.

## JACKING AND TIRE CHANGING

### WARNING!

- Do not attempt to change a tire on the side of the vehicle close to moving traffic. Pull far enough off the road to avoid the danger of being hit when operating the jack or changing the wheel.
- Being under a jacked-up vehicle is dangerous. The vehicle could slip off the jack and fall on you. You could be crushed. Never put any part of your body under a vehicle that is on a jack. If you need to get under a raised vehicle, take it to a service center where it can be raised on a lift.
- Never start or run the engine while the vehicle is on a jack.
- The jack is designed to be used as a tool for changing tires only. The jack should not be used to lift the vehicle for service purposes. The vehicle should be jacked on a firm level surface only. Avoid ice or slippery areas.

### Jack Location

The jack and lug wrench are located in the rear cargo area. To remove jack and tools proceed as follows:

1. Lift the load floor in the cargo area.

#### NOTE:

The load floor can be removed for easier access by pulling the load floor directly rearward.

2. Remove the hardware storage cover by pinching the latch on the left side and pulling upward.
3. Turn the black plastic wing nut counterclockwise to loosen the jack from the storage bin.
4. Remove tool kit and assemble tools.

### Spare Tire Removal

1. To remove the spare tire from the carrier, remove the tire cover, if equipped.
2. Remove the Rear Camera Cover by turning the lock bolt to the left with the #T40 Torx head driver and ratchet from the supplied tool kit.

3. Remove the lug nuts with the lug wrench turning them counterclockwise. If equipped, remove the locking lug nut with the lock key (located in the glove box) turning it counterclockwise.

### Stowing The Replaced Spare Tire

1. Mount the spare tire onto the carrier. Torque down lug nuts and locking lug nut.
2. Return the lock bolt to the lock position on the camera cover by turning the lock to the right using the provided #40 Torx head driver and ratchet. Then, reinstall the camera cover by slipping it over the camera/tire carrier until it snaps into place.
3. Reinstall the tire cover if applicable.

#### NOTE:

If you have added aftermarket accessories to the spare tire mounted carrier, it cannot exceed a gross weight of 85 lbs (38.5 kg) including the weight of the spare tire.



## Preparations For Jacking

1. Park on a firm, level surface. Avoid ice or slippery areas.

### WARNING!

Do not attempt to change a tire on the side of the vehicle close to moving traffic. Pull far enough off the road to avoid being hit when operating the jack or changing the wheel.

2. Turn on the Hazard Warning flasher.
3. Apply the parking brake.
4. Shift the automatic transmission into PARK, or a manual transmission into REVERSE.
5. Turn the ignition OFF.
6. Block both the front and rear of the wheel diagonally opposite the jacking position. For example, if the right front wheel is being changed, block the left rear wheel.

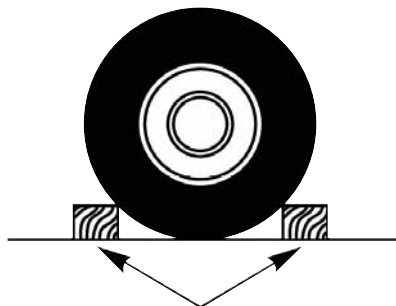

Wheel Blocked

### NOTE:

Passengers should not remain in the vehicle when the vehicle is being jacked.

### Jacking Instructions

### WARNING!

Carefully follow these tire changing warnings to help prevent personal injury or damage to your vehicle:

- Always park on a firm, level surface as far from the edge of the roadway as possible before raising the vehicle.

### WARNING!

- Turn on the Hazard Warning flashers.
- Block the wheel diagonally opposite the wheel to be raised.
- Apply the parking brake firmly and shift an automatic transmission in PARK; a manual transmission to REVERSE.
- Never start or run the engine with the vehicle on a jack.
- Do not let anyone sit in the vehicle when it is on a jack.
- Do not get under the vehicle when it is on a jack. If you need to get under a raised vehicle, take it to a service center where it can be raised on a lift.
- Only use the jack in the positions indicated and for lifting this vehicle during a tire change.
- If working on or near a roadway, be extremely careful of motor traffic.
- To assure that spare tires, flat or inflated, are securely stowed, spares must be stowed with the valve stem facing the ground.



### Warning Label

#### CAUTION!

Do not attempt to raise the vehicle by jacking on locations other than those indicated.

1. Remove the spare tire, jack and tools from the stored location.

2. Loosen (but do not remove) the wheel lug nuts by turning them to the left one turn while the wheel is still on the ground.
3. Assemble the jack and jacking tools. Connect the jack handle driver to the extension, then to the lug wrench.
4. Operate the jack from the front or the rear of the vehicle. Place the jack under the axle tube, as shown. **Do not raise the vehicle until you are sure the jack is fully engaged.**



Front Jack Engagement Location



Rear Jack Engagement Location

5. Raise the vehicle by turning the jack screw clockwise. Raise the vehicle only until the tire just clears the surface and enough clearance is obtained to install the spare tire. Minimum tire lift provides maximum stability.



**WARNING!**

Raising the vehicle higher than necessary can make the vehicle less stable. It could slip off the jack and hurt someone near it. Raise the vehicle only enough to remove the tire.

6. Remove the lug nuts and wheel.
7. Position the spare wheel/tire on the vehicle and install the lug nuts with the cone-shaped end toward the wheel. Lightly tighten the lug nuts clockwise.

**WARNING!**

To avoid the risk of forcing the vehicle off the jack, do not tighten the wheel nuts fully until the vehicle has been lowered. Failure to follow this warning may result in serious injury.

8. Lower the vehicle by turning the jack screw to the left, and remove the jack.
9. Finish tightening the lug nuts. Push down on the wrench while tightening for increased leverage. Alternate nuts until

each nut has been tightened twice. Refer to “Torque Specifications” in “Technical Specifications” for correct lug nut torque.

10. Remove the jack assembly and wheel blocks.
11. Secure the jack and tools in their proper locations.
12. Secure the damaged wheel/tire on the spare tire carrier. Torque down lug nuts and locking lug nut.
13. Return the lock bolt to the lock position on the camera cover by turning the lock to the right using the provided #40 Torx head driver and ratchet. Then, reinstall the camera cover by slipping it over the camera/tire carrier until it snaps into place.

**WARNING!**

A loose tire or jack thrown forward in a collision or hard stop, could endanger the occupants of the vehicle. Always stow the jack parts and the spare tire in the places provided.

**Road Tire Installation**

1. Mount the road tire on the axle.
2. Install the remaining lug nuts with the cone shaped end of the nut toward the wheel. Lightly tighten the lug nuts.

**WARNING!**

To avoid the risk of forcing the vehicle off the jack, do not tighten the wheel nuts fully until the vehicle has been lowered. Failure to follow this warning may result in serious injury.

3. Lower the vehicle to the ground by turning the jack handle counterclockwise.
4. Finish tightening the lug nuts. Push down on the wrench while at the end of the handle for increased leverage. Tighten the lug nuts in a star pattern until each nut has been tightened twice. For the correct lug nut torque refer to “Torque Specifications” in “Technical Specifications”. If in doubt about the correct tightness, have them checked with a torque wrench by an authorized dealer or service station.



5. After 25 miles (40 km), check the lug nut torque with a torque wrench to ensure that all lug nuts are properly seated against the wheel.

## JUMP STARTING

If your vehicle has a discharged battery, it can be jump started using a set of jumper cables and a battery in another vehicle, or by using a portable battery booster pack. Jump starting can be dangerous if done improperly, so please follow the procedures in this section carefully.

### WARNING!

Do not attempt jump starting if the battery is frozen. It could rupture or explode and cause personal injury.

### CAUTION!

Do not use a portable battery booster pack or any other booster source with a system voltage greater than 12 Volts or damage to the battery, starter motor, alternator or electrical system may occur.

### NOTE:

When using a portable battery booster pack, follow the manufacturer's operating instructions and precautions.

### Preparations For Jump Start

The battery in your vehicle is located in the right rear of the engine compartment, behind the Power Distribution Center.



Positive Battery Post

### NOTE:

The positive battery post is covered with a protective cap. Lift up on the cap to gain access to the post.



**WARNING!**

- Take care to avoid the radiator cooling fan whenever the hood is raised. It can start anytime the ignition switch is ON. You can be injured by moving fan blades.
- Remove any metal jewelry such as rings, watch bands and bracelets that could make an inadvertent electrical contact. You could be seriously injured.
- Batteries contain sulfuric acid that can burn your skin or eyes and generate hydrogen gas which is flammable and explosive. Keep open flames or sparks away from the battery.

1. Apply the parking brake, shift the automatic transmission into PARK (manual transmission in NEUTRAL) and turn the ignition OFF.
2. Apply the parking brake, shift the automatic transmission into PARK and turn the ignition OFF.
3. Turn off the heater, radio, and all unnecessary electrical accessories.

4. If using another vehicle to jump start the battery, park the vehicle within the jumper cable's reach, apply the parking brake and make sure the ignition is OFF.

**WARNING!**

Do not allow vehicles to touch each other as this could establish a ground connection and personal injury could result.

**Jump Starting Procedure****WARNING!**

Failure to follow this jump starting procedure could result in personal injury or property damage due to battery explosion.

**CAUTION!**

Failure to follow these procedures could result in damage to the charging system of the booster vehicle or the discharged vehicle.

**NOTE:**

Make sure at all times that unused ends of jumper cables are not contacting each other or either vehicle while making connections.

**Connecting The Jumper Cables**

1. Connect the positive (+) end of the jumper cable to the remote positive (+) post of the discharged vehicle.
2. Connect the opposite end of the positive (+) jumper cable to the positive (+) post of the booster battery.
3. Connect the negative end (-) of the jumper cable to the negative (-) post of the booster battery.
4. Connect the opposite end of the negative (-) jumper cable to a good engine ground (exposed metal part of the discharged vehicle's engine) away from the battery and the fuel injection system.

**WARNING!**

Do not connect the jumper cable to the negative (-) post of the discharged battery. The resulting electrical spark could cause the battery to explode and could result in personal injury. Only use the specific ground point, do not use any other exposed metal parts.

5. Start the engine in the vehicle that has the booster battery, let the engine idle a few minutes, and then start the engine in the vehicle with the discharged battery.

### CAUTION!

Do not run the booster vehicle engine above 2,000 rpm since it provides no charging benefit, wastes fuel, and can damage booster vehicle engine.

6. Once the engine is started, remove the jumper cables in the reverse sequence:

#### Disconnecting The Jumper Cables

1. Disconnect the negative (-) end of the jumper cable from the engine ground of the vehicle with the discharged battery.
2. Disconnect the opposite end of the negative (-) jumper cable from the negative (-) post of the booster battery.
3. Disconnect the positive (+) end of the jumper cable from the positive (+) post of the booster battery.

4. Disconnect the opposite end of the positive (+) jumper cable from the remote positive (+) post of the discharged vehicle.
5. Reinstall the protective cover over the remote positive (+) post of the discharged vehicle.

If frequent jump starting is required to start your vehicle you should have the battery and charging system tested at an authorized dealer.

### CAUTION!

Accessories plugged into the vehicle power outlets draw power from the vehicle's battery, even when not in use (i.e., cellular devices, etc.). Eventually, if plugged in long enough without engine operation, the vehicle's battery will discharge sufficiently to degrade battery life and/or prevent the engine from starting.

## IF YOUR ENGINE OVERHEATS

In any of the following situations, you can reduce the potential for overheating by taking the appropriate action.

- On the highways — slow down.
- In city traffic — while stopped, shift transmission into NEUTRAL, but do not increase engine idle speed.

### CAUTION!

Driving with a hot cooling system could damage your vehicle. If the temperature gauge reads HOT (H), pull over and stop the vehicle. Idle the vehicle with the air conditioner turned off until the pointer drops back into the normal range. If the pointer remains on HOT (H), and you hear continuous chimes, turn the engine off immediately and call for service.



**NOTE:**

There are steps that you can take to slow down an impending overheat condition:

- If your air conditioner (A/C) is on, turn it off. The A/C system adds heat to the engine cooling system and turning the A/C off can help remove this heat.
- You can also turn the temperature control to maximum heat, the mode control to floor and the blower control to high. This allows the heater core to act as a supplement to the radiator and aids in removing heat from the engine cooling system.

**WARNING!**

You or others can be badly burned by hot engine coolant (antifreeze) or steam from your radiator. If you see or hear steam coming from under the hood, do not open the hood until the radiator has had time to cool. Never try to open a cooling system pressure cap when the radiator or coolant bottle is hot.

**MANUAL PARK RELEASE****WARNING!**

Always secure your vehicle by fully applying the parking brake before activating the Manual Park Release. In addition, you should be seated in the driver's seat with your foot firmly on the brake pedal when activating the Manual Park Release. Activating the Manual Park Release will allow your vehicle to roll away if it is not secured by the parking brake, or by proper connection to a tow vehicle. Activating the Manual Park Release on an unsecured vehicle could lead to serious injury or death for those in or around the vehicle.

In order to push or tow the vehicle in cases where the transmission will not shift out of PARK (such as a dead battery), a Manual Park Release is available.

Follow these steps to use the Manual Park Release:

1. Firmly apply the parking brake.
2. Remove the manual park release cover, located above the gear selector, to access the release tether strap.



**Manual Park Release Cover**

3. Using a small screwdriver or similar tool, fish the tether strap up through the opening in the console base.



**Tether Strap**

4. Press and maintain firm pressure on the brake pedal.
5. Pull the tether strap up and to the left until the release lever locks into place in the vertical position. The vehicle is now out of PARK and can be moved. Release the parking brake only when the vehicle is securely connected to a tow vehicle.

### **To Reset The Manual Park Release:**

1. Pull upward on the tether strap, releasing it from the “locked” position.
2. Lower the Manual Park Release lever downward and to the right, into its original position.
3. Tuck the tether strap into the base of the console, and reinstall the cover.

## **FREEING A STUCK VEHICLE**

If your vehicle becomes stuck in mud, sand or snow, it can often be moved using a rocking motion. Turn the steering wheel right and left to clear the area around the front wheels. For vehicles with automatic transmission, push and hold the lock button on the gear selector. Then, shift back and forth between DRIVE and REVERSE (with automatic transmission) or SECOND GEAR and REVERSE (with manual transmission), while gently pressing the accelerator. Use the least amount of accelerator pedal pressure that will maintain the rocking motion, without spinning the wheels or racing the engine.

### **NOTE:**

- For vehicles with automatic transmission: Shifts between DRIVE and REVERSE can only be achieved at wheel speeds of 5 mph (8 km/h) or less. Whenever the transmission remains in NEUTRAL for more than 2 seconds, you must press the brake pedal to engage DRIVE or REVERSE.
- Push the "ESC Off" switch, to place the Electronic Stability Control (ESC) system in "Partial Off" mode, before rocking the vehicle. Refer to “Electronic Brake Control System” in “Safety” in your Owner’s Manual for further details. Once the vehicle has been freed, push the "ESC Off" switch again to restore "ESC On" mode.



**WARNING!**

Fast spinning tires can be dangerous. Forces generated by excessive wheel speeds may cause damage, or even failure, of the axle and tires. A tire could explode and injure someone. Do not spin your vehicle's wheels faster than 30 mph (48 km/h) or for longer than 30 seconds continuously without stopping when you are stuck and do not let anyone near a spinning wheel, no matter what the speed.

**CAUTION!**

- Racing the engine or spinning the wheels may lead to transmission overheating and failure. Allow the engine to idle with the transmission in NEUTRAL for at least one minute after every five rocking-motion cycles. This will minimize overheating and reduce the risk of clutch or transmission failure during prolonged efforts to free a stuck vehicle.
- When “rocking” a stuck vehicle by shifting between DRIVE/SECOND GEAR and REVERSE, do not spin the wheels faster than 15 mph (24 km/h), or drivetrain damage may result.
- Revving the engine or spinning the wheels too fast may lead to transmission overheating and failure. It can also damage the tires. Do not spin the wheels above 30 mph (48 km/h) while in gear (no transmission shifting occurring).

**TOWING A DISABLED VEHICLE**

This section describes procedures for towing a disabled vehicle using a commercial towing service. If the transmission and drivetrain are operable, disabled vehicles may also be towed as described under “Recreational Towing” in the “Starting And Operating” section.

Towing Condition	Wheels OFF The Ground	4WD MODELS
Flat Tow	NONE	<p>See instructions under "Recreational Towing" in "Starting And Operating".</p> <ul style="list-style-type: none"> <li>• Automatic Transmission in <b>PARK</b></li> <li>• Manual Transmission in gear ( <b>NOT</b> in NEUTRAL)</li> <li>• Transfer Case in <b>NEUTRAL</b></li> <li>• Tow in <b>forward</b> direction</li> </ul>
Wheel Lift Or Dolly Tow	Front	<b>NOT ALLOWED</b>
	Rear	<b>NOT ALLOWED</b>
Flatbed	<b>ALL</b>	<b>BEST METHOD</b>

Proper towing or lifting equipment is required to prevent damage to your vehicle. Use only tow bars and other equipment designed for this purpose, following equipment manufacturer's instructions. Use of safety chains is mandatory. Attach a tow bar or other towing device to main structural members of the vehicle, not to bumpers or associated brackets. State and local laws regarding vehicles under tow must be observed.

If you must use the accessories (wipers, defrosters, etc.) while being towed, the ignition must be in the ON/RUN position, not the ACC position.

If the vehicle's battery is discharged, refer to "Manual Park Release" in this section for instructions on shifting the automatic transmission out of PARK in order to move the vehicle.

### CAUTION!

- Do not use sling type equipment when towing. Vehicle damage may occur.
- When securing the vehicle to a flatbed truck, do not attach to front or rear suspension components. Damage to your vehicle may result from improper towing.

### CAUTION!

- If the vehicle being towed requires steering, the ignition switch must be in the ACC or ON/RUN mode, not in the OFF mode.

### Four-Wheel Drive Models

The manufacturer recommends towing with all wheels **OFF** the ground. Acceptable methods are to tow the vehicle on a flatbed or with one end of the vehicle raised and the opposite end on a towing dolly.



If flatbed equipment is not available and the transfer case is operable, the vehicle may be towed (in the forward direction, with **ALL** wheels on the ground), **IF** the transfer case is in **NEUTRAL** (N) and the transmission is in **PARK** (for automatic transmissions) or in gear (**NOT** in **NEUTRAL**, for manual transmissions). Refer to “Recreational Towing” in “Starting And Operating” for detailed instructions.

### CAUTION!

- Front or rear wheel lifts must not be used (if the remaining wheels are on the ground). Internal damage to the transmission or transfer case will occur if a front or rear wheel lift is used when towing.
- Towing this vehicle in violation of the above requirements can cause severe transmission and/or transfer case damage. Damage from improper towing is not covered under the New Vehicle Limited Warranty.

### Emergency Tow Hooks – If Equipped

If your vehicle is equipped with tow hooks, they are mounted in the front and the rear.

#### NOTE:

For off-road recovery, it is recommended to use both of the front tow hooks to minimize the risk of damage to the vehicle. Always use an appropriately rated tow strap.

### WARNING!

- Do not use a chain for freeing a stuck vehicle. Chains may break, causing serious injury or death.
- Stand clear of vehicles when pulling with tow hooks. Tow straps may become disengaged, causing serious injury.

### CAUTION!

Tow hooks are for emergency use only, to rescue a vehicle stranded off road. Do not use tow hooks for tow truck hookup or highway towing. You could damage your vehicle. Tow straps are recommended when towing the vehicle, chains may cause vehicle damage.

## ENHANCED ACCIDENT RESPONSE SYSTEM (EARS)

This vehicle is equipped with an Enhanced Accident Response System.

Please refer to “Occupant Restraint Systems” in “Safety” for further information on the Enhanced Accident Response System (EARS) function.

## EVENT DATA RECORDER (EDR)

This vehicle is equipped with an Event Data Recorder (EDR). The main purpose of an EDR is to record data that will assist in understanding how a vehicle’s systems performed under certain crash or near crash-like situations, such as an air bag deployment or hitting a road obstacle.

Please refer to “Occupant Restraint Systems” in “Safety” for further information on the Event Data Recorder (EDR).



# SERVICING AND MAINTENANCE

## **SCHEDULED SERVICING . . . . .216**

Maintenance Plan . . . . .	217
Heavy Duty Use Of The Vehicle . . . . .	219

## **ENGINE COMPARTMENT . . . . .220**

2.0L Engine . . . . .	220
3.6L Engine . . . . .	221
Checking Oil Level . . . . .	222
Adding Washer Fluid . . . . .	222
Maintenance-Free Battery . . . . .	222

## **DEALER SERVICE . . . . .223**

Air Conditioner Maintenance . . . . .	223
Windshield Wiper Blades . . . . .	225
Cooling System . . . . .	227
Brake System . . . . .	228
Manual Transmission . . . . .	229
Automatic Transmission . . . . .	229

## **RAISING THE VEHICLE . . . . .229**

## **TIRES . . . . .229**

Tire Safety Information . . . . .	229
Tires — General Information . . . . .	238
Tire Types . . . . .	242
Spare Tires — If Equipped . . . . .	243
Wheel And Wheel Trim Care . . . . .	244
Tire Chains (Traction Devices). . . . .	246
Tire Rotation Recommendations . . . . .	246

## **DEPARTMENT OF TRANSPORTATION UNIFORM TIRE QUALITY GRADES . . . . .247**

Treadwear . . . . .	247
Traction Grades . . . . .	247
Temperature Grades. . . . .	248

## **STORING THE VEHICLE . . . . .248**

## **BODYWORK . . . . .248**

Body And Underbody Maintenance . . . . .	248
Preserving The Bodywork . . . . .	249

## **INTERIORS . . . . .251**

Seats And Fabric Parts . . . . .	251
Plastic And Coated Parts. . . . .	251
Leather Parts. . . . .	252
Glass Surfaces . . . . .	252



## SCHEDULED SERVICING

Your vehicle is equipped with an automatic oil change indicator system. The oil change indicator system will remind you that it is time to take your vehicle in for scheduled maintenance.

Based on engine operation conditions, the oil change indicator message will illuminate. This means that service is required for your vehicle. Operating conditions such as frequent short-trips, trailer tow, extremely hot or cold ambient temperatures will influence when the “Change Oil” or “Oil Change Required” message is displayed. Severe Operating Conditions can cause the change oil message to illuminate as early as 3,500 miles (5,600 km) since last reset. Have your vehicle serviced as soon as possible, within the next 500 miles (805 km).

On vehicles equipped with instrument cluster display, “Oil Change Required” will be displayed and a single chime will sound, indicating that an oil change is necessary.

On non-instrument cluster display equipped vehicles, “Change Oil” will flash in the instrument cluster odometer and a single chime will sound, indicating that an oil change is necessary.

An authorized dealer will reset the oil change indicator message after completing the scheduled oil change. If a scheduled oil change is performed by someone other than an authorized dealer, the message can be reset by referring to the steps described under “Instrument Cluster Display” in “Getting To Know Your Instrument Panel” for further information.

### NOTE:

Under no circumstances should oil change intervals exceed 10,000 miles (16,000 km), twelve months or 350 hours of engine run time, whichever comes first. The 350 hours of engine run or idle time is generally only a concern for fleet customers.

### Severe Duty All Models

Change Engine Oil at 4,000 miles (6,500 km) or 350 hours of engine run time if the vehicle is operated in a dusty and off road environment or is operated predominately at idle or only very low engine RPM's. This type of vehicle use is considered Severe Duty.

#### Once A Month Or Before A Long Trip:

- Check engine oil level
- Check windshield washer fluid level
- Check the tire inflation pressures and look for unusual wear or damage
- Check the fluid levels of the coolant reservoir, brake master cylinder, and power steering, and fill as needed
- Check function of all interior and exterior lights

## Maintenance Plan

### Required Maintenance Intervals

Refer to the maintenance plan on the following pages for the required maintenance intervals.

At Every Oil Change Interval As Indicated By Oil Change Indicator System:
<ul style="list-style-type: none"> <li>Change oil and filter</li> </ul>

At Every Oil Change Interval As Indicated By Oil Change Indicator System:
<ul style="list-style-type: none"> <li>Rotate the tires <b>Rotate at the first sign of irregular wear, even if it occurs before the oil indicator system turns on</b></li> </ul>
<ul style="list-style-type: none"> <li>Inspect battery and clean and tighten terminals as required</li> </ul>
<ul style="list-style-type: none"> <li>Inspect brake pads, shoes, rotors, drums, hoses and park brake</li> </ul>

At Every Oil Change Interval As Indicated By Oil Change Indicator System:
<ul style="list-style-type: none"> <li>Inspect engine cooling system protection and hoses</li> </ul>
<ul style="list-style-type: none"> <li>Inspect exhaust system</li> </ul>
<ul style="list-style-type: none"> <li>Inspect engine air cleaner if using in dusty or off-road conditions</li> </ul>
<ul style="list-style-type: none"> <li>Inspect all door latches for presence of grease, reapply if necessary.</li> </ul>

Mileage or time passed (whichever comes first)	20,000	30,000	40,000	50,000	60,000	70,000	80,000	90,000	100,000	110,000	120,000	130,000	140,000	150,000
Or Years:	2	3	4	5	6	7	8	9	10	11	12	13	14	15
Or Kilometers:	32,000	48,000	64,000	80,000	96,000	112,000	128,000	144,000	160,000	176,000	192,000	208,000	224,000	240,000
<b>Additional Inspections</b>														
Inspect the CV/Universal joints.	X		X		X		X		X		X		X	
Inspect front suspension, tie rod ends, and replace if necessary.	X		X		X		X		X		X		X	
Inspect the front and rear axle fluid.	X				X				X				X	
Inspect the brake linings, replace as necessary	X		X		X		X		X		X		X	
Adjust parking brake on vehicles equipped with four wheel disc brakes.	X		X		X		X		X		X		X	



Mileage or time passed (whichever comes first)	20,000	30,000	40,000	50,000	60,000	70,000	80,000	90,000	100,000	110,000	120,000	130,000	140,000	150,000
Or Years:	2	3	4	5	6	7	8	9	10	11	12	13	14	15
Or Kilometers:	32,000	48,000	64,000	80,000	96,000	112,000	128,000	144,000	160,000	176,000	192,000	208,000	224,000	240,000
Inspect transfer case fluid.		X						X						X
<b>Additional Maintenance</b>														
Replace engine air cleaner filter.		X			X			X			X			X
Replace air conditioning/cabin air filter.	X		X		X		X		X		X		X	
Replace Spark Plugs – 2.0L Engine**					X						X			
Replace spark plugs – 3.6L Engine**									X					
Flush and replace the engine, intercooler (if equipped), battery (if equipped), and Motor Generator Unit (MGU) (if equipped) coolant at 10 years or 150,000 miles (240,000 km) whichever comes first.									X					X
Change the manual transmission fluid if using your vehicle for any of the following: trailer towing, snow plowing, heavy loading, taxi, police, delivery service (commercial service), off-road, desert operation or more than 50% of your driving is at sustained high speeds during hot weather, above 90°F (32°C).		X			X			X			X			X
Change transfer case fluid if using your vehicle for any of the following: police, taxi, fleet, or frequent trailer towing.					X						X			
Inspect and replace PCV valve if necessary.									X					

Mileage or time passed (whichever comes first)	20,000	30,000	40,000	50,000	60,000	70,000	80,000	90,000	100,000	110,000	120,000	130,000	140,000	150,000
Or Years:	2	3	4	5	6	7	8	9	10	11	12	13	14	15
Or Kilometers:	32,000	48,000	64,000	80,000	96,000	112,000	128,000	144,000	160,000	176,000	192,000	208,000	224,000	240,000
Change front and rear axle fluid if using your vehicle for police, taxi, fleet, off-road or frequent trailer towing.			X				X				X			

\*\* The spark plug change interval is mileage based only, yearly intervals do not apply.

### WARNING!

- You can be badly injured working on or around a motor vehicle. Do only service work for which you have the knowledge and the right equipment. If you have any doubt about your ability to perform a service job, take your vehicle to a competent mechanic.
- Failure to properly inspect and maintain your vehicle could result in a component malfunction and effect vehicle handling and performance. This could cause an accident.

### Heavy Duty Use Of The Vehicle

Change engine oil at 4,000 miles (6,500 km) or 350 hours of engine run time if the vehicle is operated in a dusty and off road environment or is operated predominately at idle or only very low engine RPM's. This type of vehicle use is considered Severe Duty.



## ENGINE COMPARTMENT

### 2.0L Engine



- 1 — Power Distribution Center (Fuses)
- 2 — Battery
- 3 — Engine Oil Dipstick
- 4 — Engine Oil Fill
- 5 — Engine Coolant Reservoir
- 6 — Engine Coolant Pressure Cap
- 7 — Brake Fluid Reservoir

- 8 — Power Pack Unit Pressure Cap — If Equipped
- 9 — Power Pack Unit Pressure Reservoir — If Equipped
- 10 — Washer Fluid Reservoir
- 11 — Intercooler/Motor Generator Unit (If Equipped) Coolant Pressure Cap
- 12 — Intercooler/Motor Generator Unit (If Equipped) Coolant Reservoir
- 13 — Power Steering Fluid Reservoir
- 14 — Engine Air Cleaner

### 3.6L Engine

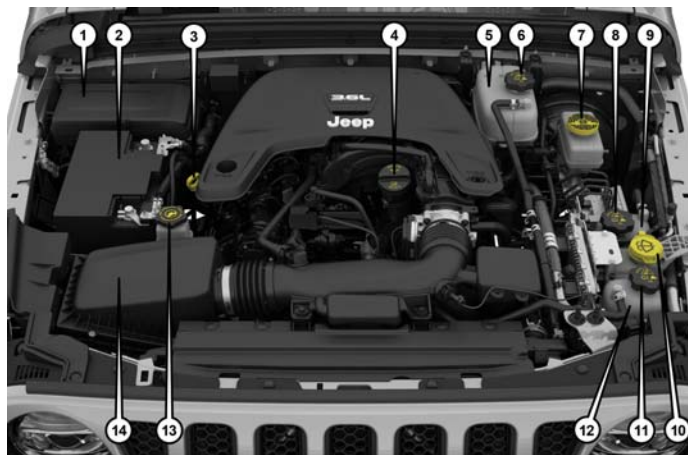

- 1 — Power Distribution Center (Fuses)
- 2 — Battery
- 3 — Engine Oil Dipstick
- 4 — Engine Oil Fill
- 5 — Engine Coolant Reservoir
- 6 — Engine Coolant Pressure Cap
- 7 — Brake Fluid Reservoir

- 8 — Power Pack Unit Pressure Cap — If Equipped
- 9 — Power Pack Unit Pressure Reservoir — If Equipped
- 10 — Washer Fluid Reservoir
- 11 — Motor Generator Unit Coolant Pressure Cap — If Equipped
- 12 — Motor Generator Unit Coolant Reservoir — If Equipped
- 13 — Power Steering Fluid Reservoir
- 14 — Engine Air Cleaner



## Checking Oil Level

To ensure proper lubrication of your vehicle's engine, the engine oil must be maintained at the correct level. The engine oil level should be checked five minutes after a warmed up engine has been shut off.

Checking the oil while the vehicle is on level ground will improve the accuracy of the oil level readings. Always maintain the oil level within the SAFE zone on the dipstick. Adding 1 quart (0.95 liters) of oil when the reading is at the bottom of the crosshatch zone will result in a reading at the top of the crosshatch zone on these engines.

### CAUTION!

Overfilling or underfilling the crankcase will cause aeration or loss of oil pressure. This could damage your engine.

## Adding Washer Fluid

The fluid reservoir for the windshield washers and the rear window washer (if equipped) is shared. The fluid reservoir is located in the engine compartment. Be sure to check the fluid level at regular intervals. Fill the reservoir with windshield washer solvent only (not radiator antifreeze). When refilling the washer fluid reservoir, take some washer fluid and apply it to a cloth or towel and wipe clean the wiper blades; this will help blade performance.

To prevent freeze-up of your windshield washer system in cold weather, select a solution or mixture that meets or exceeds the temperature range of your climate. This rating information can be found on most washer fluid containers.

### WARNING!

Commercial windshield washer solvents are flammable. They could ignite and burn you. Care must be exercised when filling or working around the washer solution.

## Maintenance-Free Battery

Your vehicle is equipped with a maintenance-free battery. You will never have to add water, nor is periodic maintenance required.

### WARNING!

- Battery fluid is a corrosive acid solution and can burn or even blind you. Do not allow battery fluid to contact your eyes, skin, or clothing. Do not lean over a battery when attaching clamps. If acid splashes in eyes or on skin, flush the area immediately with large amounts of water. Refer to "Jump Starting Procedure" in "In Case Of Emergency" for further information.
- Battery gas is flammable and explosive. Keep flame or sparks away from the battery. Do not use a booster battery or any other booster source with an output greater than 12 Volts. Do not allow cable clamps to touch each other.
- Battery posts, terminals, and related accessories contain lead and lead compounds. Wash hands after handling.



### CAUTION!

- It is essential when replacing the cables on the battery that the positive cable is attached to the positive post and the negative cable is attached to the negative post. Battery posts are marked positive (+) and negative (-) and are identified on the battery case. Cable clamps should be tight on the terminal posts and free of corrosion.
- If a “fast charger” is used while the battery is in the vehicle, disconnect both vehicle battery cables before connecting the charger to the battery. Do not use a “fast charger” to provide starting voltage.

## DEALER SERVICE

An authorized dealer has the qualified service personnel, special tools, and equipment to perform all service operations in an expert manner. Service Manuals are available which include detailed service information for your vehicle. Refer to these Service Manuals before attempting any procedure yourself.

### NOTE:

Intentional tampering with emissions control systems may void your warranty and could result in civil penalties being assessed against you.

### WARNING!

You can be badly injured working on or around a motor vehicle. Only do service work for which you have the knowledge and the proper equipment. If you have any doubt about your ability to perform a service job, take your vehicle to a competent mechanic.

### Air Conditioner Maintenance

For best possible performance, your air conditioner should be checked and serviced by an authorized dealer at the start of each warm season. This service should include cleaning of the condenser fins and a performance test. Drive belt tension should also be checked at this time.

### WARNING!

- Use only refrigerants and compressor lubricants approved by the manufacturer for your air conditioning system. Some unapproved refrigerants are flammable and can explode, injuring you. Other unapproved refrigerants or lubricants can cause the system to fail, requiring costly repairs. Refer to Warranty Information Book, located in your owner's information kit, for further warranty information.
- The air conditioning system contains refrigerant under high pressure. To avoid risk of personal injury or damage to the system, adding refrigerant or any repair requiring lines to be disconnected should be done by an experienced technician.

### CAUTION!

Do not use chemical flushes in your air conditioning system as the chemicals can damage your air conditioning components.



**CAUTION!**

Such damage is not covered by the New Vehicle Limited Warranty.

**Air Conditioning Filter Replacement  
(A/C Air Filter)****WARNING!**

Do not remove the cabin air filter while the vehicle is running, or while the ignition is in the ACC or ON/RUN mode. With the cabin air filter removed and the blower operating, the blower can contact hands and may propel dirt and debris into your eyes, resulting in personal injury.

The A/C air filter is located in the fresh air inlet behind the glove compartment. Perform the following procedure to replace the filter:

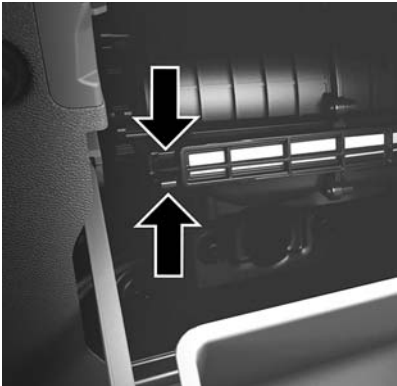
1. Open the glove compartment and remove all contents.
2. Push up on the glove compartment travel stop and lower the door.  
  
**Glove Compartment Travel Stop**
3. Pivot the glove compartment downward.
4. Disengage the two retaining tabs that secure the air filter access door to the HVAC housing.  
  
**Air Filter Retaining Tabs**

- Remove the air filter from the HVAC air inlet housing. Pull the filter elements out pinching them to the right for clearance.



**Air Filter**

- Install the A/C air filter with the air filter position indicators pointing in the same direction as removal.

### **CAUTION!**

The cabin air filter is identified with an arrow to indicate airflow direction through the filter. Failure to properly install the filter will result in the need to replace it more often.

- Close A/C Air Filter access door and secure retaining tabs.
- Rotate the glove compartment door back into position ensuring you have properly engaged the travel damper.

Refer to the "Maintenance Plan" in this section for the proper maintenance intervals.

### **Windshield Wiper Blades**

Clean the rubber edges of the wiper blades and the windshield periodically with a sponge or soft cloth and a mild nonabrasive cleaner. This will remove accumulations of salt or road film.

Operation of the wipers on dry glass for long periods may cause deterioration of the wiper blades. Always use washer fluid when using the wipers to remove salt or dirt from a dry windshield.

Avoid using the wiper blades to remove frost or ice from the windshield. Keep the blade rubber out of contact with petroleum products such as engine oil, gasoline, etc.

#### **NOTE:**

Life expectancy of wiper blades varies depending on geographical area and frequency of use. Poor performance of blades may be present with chattering, marks, water lines or wet spots. If any of these conditions are present, clean the wiper blades or replace as necessary.



The wiper blades and wiper arms should be inspected periodically, not just when wiper performance problems are experienced. This inspection should include the following points:

- Wear or uneven edges
- Foreign material
- Hardening or cracking
- Deformation or fatigue

If a wiper blade or wiper arm is damaged, replace the affected wiper arm or blade with a new unit. Do not attempt to repair a wiper arm or blade that is damaged.

**Wiper Blade Removal/Installation**

**CAUTION!**

Do not allow the wiper arm to spring back against the glass without the wiper blade in place or the glass may be damaged.

1. Lift the wiper arm to raise the wiper blade off of the glass, until the wiper arm is in the full up position.

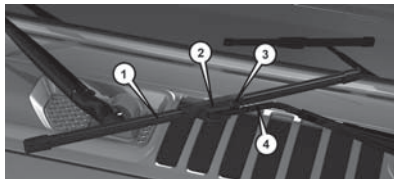

**Wiper Blade With Release Tab  
In Locked Position**

- 1 — Wiper Blade
- 2 — Cover
- 3 — Release Tab
- 4 — Wiper Arm

2. To disengage the wiper blade from the wiper arm, raise the cover, press the release tab on the wiper blade and while holding the wiper arm with one hand, slide the wiper blade down towards the base of the wiper arm.
3. With the wiper blade disengaged, remove the wiper blade from the wiper arm.
4. Gently lower the wiper arm onto the glass.

**Installing The Front Wipers**

1. Lift the wiper arm off of the glass, until the wiper arm is in the full up position.
2. Position the wiper blade near the hook on the tip of the wiper arm.
3. Insert the hook on the tip of the arm through the opening in the wiper blade.
4. Slide the wiper blade up into the hook on the wiper arm, latch engagement will be accompanied by an audible click then close the cover.
5. Gently lower the wiper blade onto the glass.

## Rear Wiper Blade Removal/Installation

1. Open tailgate to access the wiper arm.



**Rear Wiper Assembly**

- 1 — Wiper Arm
- 2 — Wiper Blade

2. Lift wiper arm off of the glass and rotate wiper blade outward to disengage the wiper blade from the wiper arm.



**Wiper Blade Removed From Wiper Arm**

- 1 — Wiper Arm
- 2 — Wiper Blade

3. Gently set the arm on the glass.

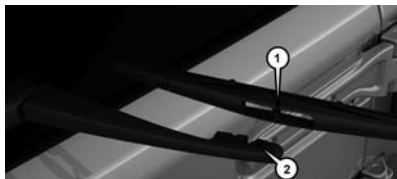

**Wiper Blade Removed From Wiper Arm**

- 1 — Wiper Blade Pivot Pin
- 2 — Wiper Arm Receptacle

## Installing The Rear Wiper

1. Lift the wiper arm off of the glass.
2. Insert the wiper blade pivot pin into the opening on the end of the wiper arm and rotate the wiper in to place.
3. Place with wiper on the glass and close the tail gate.

## Cooling System

### WARNING!

- You or others can be badly burned by hot engine coolant (antifreeze) or steam from your radiator. If you see or hear steam coming from under the hood, do not open the hood until the radiator has had time to cool. Never open a cooling system pressure cap when the radiator or coolant bottle is hot.
- Keep hands, tools, clothing, and jewelry away from the radiator cooling fan when the hood is raised. The fan starts automatically and may start at any time, whether the engine is running or not.
- When working near the radiator cooling fan, disconnect the fan motor lead or turn the ignition to the OFF mode. The fan is temperature controlled and can start at any time the ignition is in the ON mode.



## Coolant Checks

Check the engine, battery (if equipped), intercooler (if equipped), and Motor Generator Unit (MGU) (if equipped) coolant (antifreeze) protection every 12 months (before the onset of freezing weather, where applicable). If the engine, battery (if equipped), intercooler (if equipped), and MGU (if equipped) coolant (antifreeze) is dirty or rusty in appearance, the system should be drained, flushed and refilled with fresh OAT coolant (conforming to MS.90032) by an authorized dealer. Check the front of the A/C condenser (if equipped) or radiator for any accumulation of bugs, leaves, etc. If dirty, clean by gently spraying water from a garden hose vertically down the face of the A/C condenser (if equipped) or the back of the radiator core.

Check the engine, battery (if equipped), intercooler (if equipped), and MGU (if equipped) cooling system hoses for brittle rubber, cracking, tears, cuts, and tightness of the connection at the coolant recovery bottle and radiator. Inspect the entire system for leaks. **DO NOT REMOVE THE COOLANT PRESSURE CAP WHEN THE COOLING SYSTEM IS HOT.**

## Brake System

In order to assure brake system performance, all brake system components should be inspected periodically. Refer to the “Maintenance Plan” in this section for the proper maintenance intervals.

### WARNING!

Riding the brakes can lead to brake failure and possibly a collision. Driving with your foot resting or riding on the brake pedal can result in abnormally high brake temperatures, excessive lining wear, and possible brake damage. You would not have your full braking capacity in an emergency.

### Fluid Level Check — Brake Master Cylinder

The fluid level of the master cylinder should be checked whenever the vehicle is serviced, or immediately if the brake system warning light is on. If necessary, add fluid to bring level within the designated marks on the side of the reservoir of the brake master cylinder. Be sure to clean the top of the master cylinder area before removing cap.

With disc brakes, fluid level can be expected to fall as the brake pads wear. Brake fluid level should be checked when pads are replaced. If the brake fluid is abnormally low, check the system for leaks.

Refer to “Fluids And Lubricants” in “Technical Specifications” for further information.

### WARNING!

- Use only manufacturer's recommended brake fluid. Refer to “Fluids And Lubricants” in “Technical Specifications” for further information. Using the wrong type of brake fluid can severely damage your brake system and/or impair its performance. The proper type of brake fluid for your vehicle is also identified on the original factory installed hydraulic master cylinder reservoir.
- To avoid contamination from foreign matter or moisture, use only new brake fluid or fluid that has been in a tightly closed container. Keep the master cylinder reservoir cap secured at all times. Brake fluid in an open container absorbs

## WARNING!

moisture from the air resulting in a lower boiling point. This may cause it to boil unexpectedly during hard or prolonged braking, resulting in sudden brake failure. This could result in a collision.

- Overfilling the brake fluid reservoir can result in spilling brake fluid on hot engine parts, causing the brake fluid to catch fire. Brake fluid can also damage painted and vinyl surfaces, care should be taken to avoid its contact with these surfaces.
- Do not allow petroleum based fluid to contaminate the brake fluid. Brake seal components could be damaged, causing partial or complete brake failure. This could result in a collision.

## Manual Transmission

### Fluid Level Check

Check the fluid level by removing the fill plug. The fluid level should be between the bottom of the fill hole and a point not more than 3/16 of an inch (4.76 mm) below the bottom of the hole.

Add fluid, if necessary, to maintain the proper level.

## Automatic Transmission

### Fluid Level Check

The fluid level is preset at the factory and does not require adjustment under normal operating conditions. Routine fluid level checks are not required; therefore the transmission has no dipstick. An authorized dealer can check your transmission fluid level using special service tools. If you notice fluid leakage or transmission malfunction, visit an authorized dealer immediately to have the transmission fluid level checked. Operating the vehicle with an improper fluid level can cause severe transmission damage.

## CAUTION!

If a transmission fluid leak occurs, visit an authorized dealer immediately. Severe transmission damage may occur. An authorized dealer has the proper tools to adjust the fluid level accurately.

## RAISING THE VEHICLE

In the case where it is necessary to raise the vehicle, go to an authorized dealer or service station.

## TIRES

### Tire Safety Information

Tire safety information will cover aspects of the following information: Tire Markings, Tire Identification Numbers, Tire Terminology and Definitions, Tire Pressures, and Tire Loading.



## Tire Markings

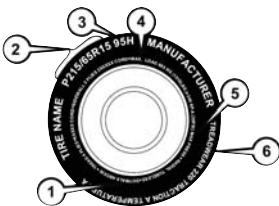

### Tire Markings

- 1 — U.S. DOT Safety Standards Code (TIN)
- 2 — Size Designation
- 3 — Service Description
- 4 — Maximum Load
- 5 — Maximum Pressure
- 6 — Treadwear, Traction and Temperature Grades

### NOTE:

- P (Passenger) — Metric tire sizing is based on U.S. design standards. P-Metric tires have the letter “P” molded into the sidewall preceding the size designation.  
Example: P215/65R15 95H.
- European — Metric tire sizing is based on European design standards. Tires designed to this standard have the tire size molded into the sidewall beginning with the section width. The letter “P” is absent from this tire size designation.  
Example: 215/65R15 96H.
- LT (Light Truck) — Metric tire sizing is based on U.S. design standards. The size designation for LT-Metric tires is the same as for P-Metric tires except for the letters “LT” that are molded into the sidewall preceding the size designation.  
Example: LT235/85R16.

- Temporary spare tires are designed for temporary emergency use only. Temporary high pressure compact spare tires have the letter “T” or “S” molded into the sidewall preceding the size designation.  
Example: T145/80D18 103M.
- High flotation tire sizing is based on U.S. design standards and it begins with the tire diameter molded into the sidewall.  
Example: 31x10.5 R15 LT.



## Tire Sizing Chart

### EXAMPLE:

**Example Size Designation: P215/65R15XL 95H, 215/65R15 96H, LT235/85R16C, T145/80D18 103M, 31x10.5 R15 LT**

**P** = Passenger car tire size based on U.S. design standards, or

**"...blank..."** = Passenger car tire based on European design standards, or

**LT** = Light truck tire based on U.S. design standards, or

**T or S** = Temporary spare tire or

**31** = Overall diameter in inches (in)

**215, 235, 145** = Section width in millimeters (mm)

**65, 85, 80** = Aspect ratio in percent (%)

- Ratio of section height to section width of tire, or

**10.5** = Section width in inches (in)

**R** = Construction code

- "R" means radial construction, or
- "D" means diagonal or bias construction

**15, 16, 18** = Rim diameter in inches (in)

### Service Description:

**95** = Load Index

- A numerical code associated with the maximum load a tire can carry



**EXAMPLE:**

---

**Example Size Designation:** P215/65R15XL 95H, 215/65R15 96H, LT235/85R16C, T145/80D18 103M, 31x10.5 R15 LT

---

**H** = Speed Symbol

- A symbol indicating the range of speeds at which a tire can carry a load corresponding to its load index under certain operating conditions
  - The maximum speed corresponding to the speed symbol should only be achieved under specified operating conditions (i.e., tire pressure, vehicle loading, road conditions, and posted speed limits)
- 

**Load Identification:**

Absence of the following load identification symbols on the sidewall of the tire indicates a Standard Load (SL) tire:

- **XL** = Extra load (or reinforced) tire, or
  - **LL** = Light load tire or
  - **C, D, E, F, G** = Load range associated with the maximum load a tire can carry at a specified pressure
- 

**Maximum Load** – Maximum load indicates the maximum load this tire is designed to carry

---

**Maximum Pressure** – Maximum pressure indicates the maximum permissible cold tire inflation pressure for this tire

---

**Tire Identification Number (TIN)**

The TIN may be found on one or both sides of the tire; however, the date code may only be on one side. Tires with white sidewalls will have the full TIN, including the date code, located on the white sidewall side of the tire.

Look for the TIN on the outboard side of black sidewall tires as mounted on the vehicle. If the TIN is not found on the outboard side, then you will find it on the inboard side of the tire.

<b>EXAMPLE:</b>
DOT MA L9 ABCD 0301
<p><b>DOT</b> = Department of Transportation</p> <ul style="list-style-type: none"> <li>This symbol certifies that the tire is in compliance with the U.S. Department of Transportation tire safety standards and is approved for highway use</li> </ul>
<b>MA</b> = Code representing the tire manufacturing location (two digits)
<b>L9</b> = Code representing the tire size (two digits)
<b>ABCD</b> = Code used by the tire manufacturer (one to four digits)
<p><b>03</b> = Number representing the week in which the tire was manufactured (two digits)</p> <ul style="list-style-type: none"> <li>03 means the 3rd week</li> </ul>
<p><b>01</b> = Number representing the year in which the tire was manufactured (two digits)</p> <ul style="list-style-type: none"> <li>01 means the year 2001</li> <li>Prior to July 2000, tire manufacturers were only required to have one number to represent the year in which the tire was manufactured. Example: 031 could represent the 3rd week of 1981 or 1991</li> </ul>



**Tire Terminology And Definitions**

<b>Term</b>	<b>Definition</b>
<b>B-Pillar</b>	The vehicle B-Pillar is the structural member of the body located behind the front door.
<b>Cold Tire Inflation Pressure</b>	Cold tire inflation pressure is defined as the tire pressure after the vehicle has not been driven for at least three hours, or driven less than 1 mile (1.6 km) after sitting for a minimum of three hours. Inflation pressure is measured in units of PSI (pounds per square inch) or kPa (kilopascals).
<b>Maximum Inflation Pressure</b>	The maximum inflation pressure is the maximum permissible cold tire inflation pressure for this tire. The maximum inflation pressure is molded into the sidewall.
<b>Recommended Cold Tire Inflation Pressure</b>	Vehicle manufacturer's recommended cold tire inflation pressure as shown on the tire placard.
<b>Tire Placard</b>	A label permanently attached to the vehicle describing the vehicle's loading capacity, the original equipment tire sizes and the recommended cold tire inflation pressures.

## Tire Loading And Tire Pressure

### NOTE:

The proper cold tire inflation pressure is listed on the driver's side B-Pillar or the rear edge of the driver's side door.

Check the inflation pressure of each tire, including the spare tire (if equipped), at least monthly and inflate to the recommended pressure for your vehicle.



Example Tire Placard Location (Door)



Example Tire Placard Location (B-Pillar)

### Tire And Loading Information Placard

TIRE AND LOADING INFORMATION			
SEATING CAPACITY - TOTAL 5 FRONT 2 REAR 3			
THE COMBINED WEIGHT OF OCCUPANTS AND CARGO SHOULD NEVER EXCEED XXX KG OR XXX LBS			
TIRE	FRONT	REAR	SPARE
ORIGINAL TIRE SIZE	P195/70R14	P195/70R14	T125/70D15
COLD TIRE INFLATION PRESSURE	200kPa, 29PSI	200kPa, 29PSI	420kPa, 60PSI
SEE OWNER'S MANUAL FOR ADDITIONAL INFORMATION			
4N109268			

Tire And Loading Information Placard

This placard tells you important information about the:

1. Number of people that can be carried in the vehicle.
2. Total weight your vehicle can carry.
3. Tire size designed for your vehicle.
4. Cold tire inflation pressures for the front, rear, and spare tires.

### Loading

The vehicle maximum load on the tire must not exceed the load carrying capacity of the tire on your vehicle. You will not exceed the tire's load carrying capacity if you adhere to the loading conditions, tire size, and cold tire inflation pressures specified on the Tire and Loading Information placard in "Vehicle Loading" in the "Starting And Operating" section of your Owner's Manual.

### NOTE:

Under a maximum loaded vehicle condition, gross axle weight ratings (GAWRs) for the front and rear axles must not be exceeded.



To determine the maximum loading conditions of your vehicle, locate the statement “The combined weight of occupants and cargo should never exceed XXX kg or XXX lbs” on the Tire and Loading Information placard. The combined weight of occupants, cargo/luggage and trailer tongue weight (if applicable) should never exceed the weight referenced here.

### Steps For Determining Correct Load Limit—

- (1) Locate the statement “The combined weight of occupants and cargo should never exceed XXX kg or XXX lbs.” on your vehicle's placard.
- (2) Determine the combined weight of the driver and passengers that will be riding in your vehicle.
- (3) Subtract the combined weight of the driver and passengers from XXX kg or XXX lbs.

(4) The resulting figure equals the available amount of cargo and luggage load capacity. For example, if “XXX” amount equals 1400 lbs. and there will be five 150 lb passengers in your vehicle, the amount of available cargo and luggage load capacity is 650 lbs. (1400-750 (5x150) = 650 lbs.)

(5) Determine the combined weight of luggage and cargo being loaded on the vehicle. That weight may not safely exceed the available cargo and luggage load capacity calculated in Step 4.

(6) If your vehicle will be towing a trailer, load from your trailer will be transferred to your vehicle. Consult this manual to determine how this reduces the available cargo and luggage load capacity of your vehicle.

### Metric Example For Load Limit

For example, if “XXX” amount equals 635 kg and there will be five 68 kg passengers in your vehicle, the amount of available cargo and luggage load capacity is 295 kg (635-340 (5x68) = 295 kg) as shown in step 4.

### NOTE:

- If your vehicle will be towing a trailer, load from your trailer will be transferred to your vehicle. The following table shows examples on how to calculate total load, cargo/luggage, and towing capacities of your vehicle with varying seating configurations and number and size of occupants. This table is for illustration purposes only and may not be accurate for the seating and load carry capacity of your vehicle.

- For the following example, the combined weight of occupants and cargo should never exceed 865 lbs (392 kg).

Occupants			Combined weight of occupants and cargo from Tire Placard	MINUS	Combined Occupant's weight	=	AVAILABLE Cargo/Luggage and Trailer Tongue Weight
TOTAL	FRONT	REAR					
<b>EXAMPLE 1</b>			865 lbs	minus	670 lbs	=	195 lbs
5	2	3					
<b>EXAMPLE 2</b>			865 lbs	minus	540 lbs	=	325 lbs
3	2	1					
<b>EXAMPLE 3</b>			865 lbs	minus	400 lbs	=	465 lbs
2	2	0					

EXAMPLE

811a4d11



**WARNING!**

Overloading of your tires is dangerous. Overloading can cause tire failure, affect vehicle handling, and increase your stopping distance. Use tires of the recommended load capacity for your vehicle. Never overload them.

**Tires – General Information****Tire Pressure**

Proper tire inflation pressure is essential to the safe and satisfactory operation of your vehicle. Four primary areas are affected by improper tire pressure:

- Safety and Vehicle Stability
- Economy
- Tread Wear
- Ride Comfort

**Safety****WARNING!**

- Improperly inflated tires are dangerous and can cause collisions.
- Underinflation increases tire flexing and can result in overheating and tire failure.
- Overinflation reduces a tire's ability to cushion shock. Objects on the road and chuckholes can cause damage that result in tire failure.
- Overinflated or underinflated tires can affect vehicle handling and can fail suddenly, resulting in loss of vehicle control.
- Unequal tire pressures can cause steering problems. You could lose control of your vehicle.
- Unequal tire pressures from one side of the vehicle to the other can cause the vehicle to drift to the right or left.
- Always drive with each tire inflated to the recommended cold tire inflation pressure.

Both under-inflation and over-inflation affect the stability of the vehicle and can produce a feeling of sluggish response or over responsiveness in the steering.

**NOTE:**

- Unequal tire pressures from side to side may cause erratic and unpredictable steering response.
- Unequal tire pressure from side to side may cause the vehicle to drift left or right.

**Fuel Economy**

Underinflated tires will increase tire rolling resistance resulting in higher fuel consumption.

**Tread Wear**

Improper cold tire inflation pressures can cause abnormal wear patterns and reduced tread life, resulting in the need for earlier tire replacement.

**Ride Comfort And Vehicle Stability**

Proper tire inflation contributes to a comfortable ride. Over-inflation produces a jarring and uncomfortable ride.



## Tire Inflation Pressures

The proper cold tire inflation pressure is listed on the driver's side B-Pillar or rear edge of the driver's side door.

At least once a month:

- Check and adjust tire pressure with a good quality pocket-type pressure gauge. Do not make a visual judgement when determining proper inflation. Tires may look properly inflated even when they are under-inflated.
- Inspect tires for signs of tire wear or visible damage.

### CAUTION!

After inspecting or adjusting the tire pressure, always reinstall the valve stem cap. This will prevent moisture and dirt from entering the valve stem, which could damage the valve stem.

Inflation pressures specified on the placard are always "cold tire inflation pressure". Cold tire inflation pressure is defined as the tire pressure after the vehicle has not been driven for at least three hours, or driven less than 1 mile (1.6 km) after sitting for a minimum of three hours. The cold tire inflation pressure must not exceed the maximum inflation pressure molded into the tire sidewall.

Check tire pressures more often if subject to a wide range of outdoor temperatures, as tire pressures vary with temperature changes.

Tire pressures change by approximately 1 psi (7 kPa) per 12°F (7°C) of air temperature change. Keep this in mind when checking tire pressure inside a garage, especially in the Winter.

Example: If garage temperature = 68°F (20°C) and the outside temperature = 32°F (0°C) then the cold tire inflation pressure should be increased by 3 psi (21 kPa), which equals 1 psi (7 kPa) for every 12°F (7°C) for this outside temperature condition.

Tire pressure may increase from 2 to 6 psi (13 to 40 kPa) during operation. DO NOT reduce this normal pressure build up or your tire pressure will be too low.

## Tire Pressures For High Speed Operation

The manufacturer advocates driving at safe speeds and within posted speed limits. Where speed limits or conditions are such that the vehicle can be driven at high speeds, maintaining correct tire inflation pressure is very important. Increased tire pressure and reduced vehicle loading may be required for high-speed vehicle operation. Refer to an authorized tire dealer or original equipment vehicle dealer for recommended safe operating speeds, loading and cold tire inflation pressures.

### WARNING!

High speed driving with your vehicle under maximum load is dangerous. The added strain on your tires could cause them to fail. You could have a serious collision. Do not drive a vehicle loaded to the maximum capacity at continuous speeds above 75 mph (120 km/h).



## Radial Ply Tires

### WARNING!

Combining radial ply tires with other types of tires on your vehicle will cause your vehicle to handle poorly. The instability could cause a collision. Always use radial ply tires in sets of four. Never combine them with other types of tires.

### Tire Repair

If your tire becomes damaged, it may be repaired if it meets the following criteria:

- The tire has not been driven on when flat.
- The damage is only on the tread section of your tire (sidewall damage is not repairable).
- The puncture is no greater than a  $\frac{1}{4}$  of an inch (6 mm).

Consult an authorized tire dealer for tire repairs and additional information.

Damaged Run Flat tires, or Run Flat tires that have experienced a loss of pressure should be replaced immediately with another Run Flat tire of identical size and service description (Load Index and Speed Symbol).

### Run Flat Tires — If Equipped

Run Flat tires allow you the capability to drive 50 miles (80 km) at 50 mph (80 km/h) after a rapid loss of inflation pressure. This rapid loss of inflation is referred to as the Run Flat mode. A Run Flat mode occurs when the tire inflation pressure is of/or below 14 psi (96 kPa). Once a Run Flat tire reaches the run flat mode it has limited driving capabilities and needs to be replaced immediately. A Run Flat tire is not repairable.

It is not recommended driving a vehicle loaded at full capacity or to tow a trailer while a tire is in the run flat mode.

See the tire pressure monitoring section for more information.

## Tire Spinning

When stuck in mud, sand, snow, or ice conditions, do not spin your vehicle's wheels above 30 mph (48 km/h) or for longer than 30 seconds continuously without stopping.

Refer to “Freeing A Stuck Vehicle” in “In Case Of Emergency” for further information.

### WARNING!

Fast spinning tires can be dangerous. Forces generated by excessive wheel speeds may cause tire damage or failure. A tire could explode and injure someone. Do not spin your vehicle's wheels faster than 30 mph (48 km/h) for more than 30 seconds continuously when you are stuck, and do not let anyone near a spinning wheel, no matter what the speed.

## Tread Wear Indicators

Tread wear indicators are in the original equipment tires to help you in determining when your tires should be replaced.

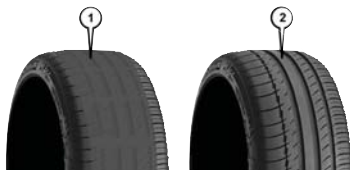

Tire Tread

- 1 — Worn Tire
- 2 — New Tire

These indicators are molded into the bottom of the tread grooves. They will appear as bands when the tread depth becomes a 1/16 of an inch (1.6 mm). When the tread is worn to the tread wear indicators, the tire should be replaced. Refer to “Replacement Tires” in this section for further information.

## Life Of Tire

The service life of a tire is dependent upon varying factors including, but not limited to:

- Driving style.
- Tire pressure - Improper cold tire inflation pressures can cause uneven wear patterns to develop across the tire tread. These abnormal wear patterns will reduce tread life, resulting in the need for earlier tire replacement.
- Distance driven.
- Performance tires, tires with a speed rating of V or higher, and Summer tires typically have a reduced tread life. Rotation of these tires per the vehicle scheduled maintenance is highly recommended.

### WARNING!

Tires and the spare tire should be replaced after six years, regardless of the remaining tread. Failure to follow this warning can result in sudden tire failure. You could lose control and have a collision resulting in serious injury or death.

## NOTE:

Wheel Valve Stem must be replaced as well when installing new tires due to wear and tear in existing tires.

Keep dismantled tires in a cool, dry place with as little exposure to light as possible. Protect tires from contact with oil, grease, and gasoline.

## Replacement Tires

The tires on your new vehicle provide a balance of many characteristics. They should be inspected regularly for wear and correct cold tire inflation pressures. The manufacturer strongly recommends that you use tires equivalent to the originals in size, quality and performance when replacement is needed. Refer to the paragraph on “Tread Wear Indicators” in this section. Refer to the Tire and Loading Information placard or the Vehicle Certification Label for the size designation of your tire. The Load Index and Speed Symbol for your tire will be found on the original equipment tire sidewall.



See the Tire Sizing Chart example found in the “Tire Safety Information” section of this manual for more information relating to the Load Index and Speed Symbol of a tire.

It is recommended to replace the two front tires or two rear tires as a pair. Replacing just one tire can seriously affect your vehicle’s handling. If you ever replace a wheel, make sure that the wheel’s specifications match those of the original wheels.

It is recommended you contact an authorized tire dealer or original equipment dealer with any questions you may have on tire specifications or capability. Failure to use equivalent replacement tires may adversely affect the safety, handling, and ride of your vehicle.

### WARNING!

- Do not use a tire, wheel size, load rating, or speed rating other than that specified for your vehicle. Some combinations of unapproved tires and wheels may change suspension dimensions and performance characteristics, resulting in changes to steering, handling, and brak-

### WARNING!

ing of your vehicle. This can cause unpredictable handling and stress to steering and suspension components. You could lose control and have a collision resulting in serious injury or death. Use only the tire and wheel sizes with load ratings approved for your vehicle.

- Never use a tire with a smaller load index or capacity, other than what was originally equipped on your vehicle. Using a tire with a smaller load index could result in tire overloading and failure. You could lose control and have a collision.
- Failure to equip your vehicle with tires having adequate speed capability can result in sudden tire failure and loss of vehicle control.

### CAUTION!

Replacing original tires with tires of a different size may result in false speedometer and odometer readings.

## Tire Types

### All Season Tires — If Equipped

All Season tires provide traction for all seasons (Spring, Summer, Fall, and Winter). Traction levels may vary between different all season tires. All season tires can be identified by the M+S, M&S, M/S or MS designation on the tire sidewall. Use all season tires only in sets of four; failure to do so may adversely affect the safety and handling of your vehicle.

### Summer Or Three Season Tires — If Equipped

Summer tires provide traction in both wet and dry conditions, and are not intended to be driven in snow or on ice. If your vehicle is equipped with Summer tires, be aware these tires are not designed for Winter or cold driving conditions. Install Winter tires on your vehicle when ambient temperatures are less than 40°F (5°C) or if roads are covered with ice or snow. For more information, contact an authorized dealer.

Summer tires do not contain the all season designation or mountain/snowflake symbol

on the tire sidewall. Use Summer tires only in sets of four; failure to do so may adversely affect the safety and handling of your vehicle.

### **WARNING!**

Do not use Summer tires in snow/ice conditions. You could lose vehicle control, resulting in severe injury or death. Driving too fast for conditions also creates the possibility of loss of vehicle control.

### **Snow Tires**

Some areas of the country require the use of snow tires during the Winter. Snow tires can be identified by a “mountain/snowflake” symbol on the tire sidewall.



If you need snow tires, select tires equivalent in size and type to the original equipment tires. Use snow tires only in sets of four; failure to do so may adversely affect the

safety and handling of your vehicle.

Snow tires generally have lower speed ratings than what was originally equipped with your vehicle and should not be operated at sustained speeds over 75 mph (120 km/h). For speeds above 75 mph (120 km/h) refer to original equipment or an authorized tire dealer for recommended safe operating speeds, loading and cold tire inflation pressures.

While studded tires improve performance on ice, skid and traction capability on wet or dry surfaces may be poorer than that of non-studded tires. Some states prohibit studded tires; therefore, local laws should be checked before using these tire types.

### **Spare Tires — If Equipped**

For vehicles equipped with Tire Service Kit instead of a spare tire, please refer to “Tire Service Kit” in “In Case Of Emergency” in the Owner’s Manual for further information.

### **CAUTION!**

Because of the reduced ground clearance, do not take your vehicle through an automatic car wash with a compact or limited use temporary spare installed. Damage to the vehicle may result.

### **Spare Tire Matching Original Equipped Tire And Wheel — If Equipped**

Your vehicle may be equipped with a spare tire and wheel equivalent in look and function to the original equipment tire and wheel found on the front or rear axle of your vehicle. This spare tire may be used in the tire rotation for your vehicle. If your vehicle has this option, refer to an authorized tire dealer for the recommended tire rotation pattern.

### **Compact Spare Tire — If Equipped**

The compact spare is for temporary emergency use only. You can identify if your vehicle is equipped with a compact spare by looking at the spare tire description on the Tire and Loading Information Placard located on the driver’s side door opening or on the



sidewall of the tire. Compact spare tire descriptions begin with the letter “T” or “S” preceding the size designation. Example: T145/80D18 103M.

T, S = Temporary Spare Tire

Since this tire has limited tread life, the original equipment tire should be repaired (or replaced) and reinstalled on your vehicle at the first opportunity.

Do not install a wheel cover or attempt to mount a conventional tire on the compact spare wheel, since the wheel is designed specifically for the compact spare tire. Do not install more than one compact spare tire and wheel on the vehicle at any given time.

### WARNING!

Compact and collapsible spares are for temporary emergency use only. With these spares, do not drive more than 50 mph (80 km/h). Temporary use spares have limited tread life. When the tread is worn to the tread wear indicators, the temporary use spare tire needs to be replaced. Be sure to follow the warnings, which apply to

### WARNING!

your spare. Failure to do so could result in spare tire failure and loss of vehicle control.

#### Full Size Spare — If Equipped

The full size spare is for temporary emergency use only. This tire may look like the originally equipped tire on the front or rear axle of your vehicle, but it is not. This spare tire may have limited tread life. When the tread is worn to the tread wear indicators, the temporary use full size spare tire needs to be replaced. Since it is not the same as your original equipment tire, replace (or repair) the original equipment tire and reinstall on the vehicle at the first opportunity.

#### Limited Use Spare — If Equipped

The limited use spare tire is for temporary emergency use only. This tire is identified by a label located on the limited use spare wheel. This label contains the driving limitations for this spare. This tire may look like the original equipped tire on the front or rear axle of your vehicle, but it is not. Installation of

this limited use spare tire affects vehicle handling. Since it is not the same as your original equipment tire, replace (or repair) the original equipment tire and reinstall on the vehicle at the first opportunity.

### WARNING!

Limited use spares are for emergency use only. Installation of this limited use spare tire affects vehicle handling. With this tire, do not drive more than the speed listed on the limited use spare wheel. Keep inflated to the cold tire inflation pressures listed on your Tire and Loading Information Placard located on the driver’s side B-Pillar or the rear edge of the driver’s side door. Replace (or repair) the original equipment tire at the first opportunity and reinstall it on your vehicle. Failure to do so could result in loss of vehicle control.

#### Wheel And Wheel Trim Care

All wheels and wheel trim, especially aluminum and chrome plated wheels, should be cleaned regularly using mild (neutral Ph) soap and water to maintain their luster and to

prevent corrosion. Wash wheels with the same soap solution recommended for the body of the vehicle and remember to always wash when the surfaces are not hot to the touch.

Your wheels are susceptible to deterioration caused by salt, sodium chloride, magnesium chloride, calcium chloride, etc., and other road chemicals used to melt ice or control dust on dirt roads. Use a soft cloth or sponge and mild soap to wipe away promptly. Do not use harsh chemicals or a stiff brush. They can damage the wheel's protective coating that helps keep them from corroding and tarnishing.

### CAUTION!

Avoid products or automatic car washes that use acidic solutions or strong alkaline additives or harsh brushes. Many aftermarket wheel cleaners and automatic car washes may damage the wheel's protective finish. Such damage is not covered by the New Vehicle Limited Warranty. Only car wash soap, Mopar Wheel Cleaner or equivalent is recommended.

When cleaning extremely dirty wheels including excessive brake dust, care must be taken in the selection of tire and wheel cleaning chemicals and equipment to prevent damage to the wheels. Mopar Wheel Treatment or Mopar Chrome Cleaner or their equivalent is recommended or select a non-abrasive, non-acidic cleaner for aluminum or chrome wheels.

### CAUTION!

Do not use scouring pads, steel wool, a bristle brush, metal polishes or oven cleaner. These products may damage the wheel's protective finish. Such damage is not covered by the New Vehicle Limited Warranty. Only car wash soap, Mopar Wheel Cleaner or equivalent is recommended.

### NOTE:

If you intend parking or storing your vehicle for an extended period after cleaning the wheels with wheel cleaner, drive your vehicle and apply the brakes to remove the water droplets from the brake components. This activity will remove the red rust on the brake rotors and prevent vehicle vibration when braking.

### Dark Vapor Chrome, Black Satin Chrome, or Low Gloss Clear Coat Wheels

### CAUTION!

If your vehicle is equipped with these specialty wheels, DO NOT USE wheel cleaners, abrasives, or polishing compounds. They will permanently damage this finish and such damage is not covered by the New Vehicle Limited Warranty. HAND WASH ONLY USING MILD SOAP AND WATER WITH A SOFT CLOTH. Used on a regular basis; this is all that is required to maintain this finish.



### Tire Chains (Traction Devices)

Use of traction devices require sufficient tire-to-body clearance. Follow these recommendations to guard against damage.

- Traction device must be of proper size for the tire, as recommended by the traction device manufacturer.
- Install on Rear Tires Only.
- P225/75R16 or a P235/65R17 tire with the use of a traction device that meets the SAE type “Class S” specification is recommended.

#### WARNING!

Using tires of different size and type (M+S, Snow) between front and rear axles can cause unpredictable handling. You could lose control and have a collision.

#### CAUTION!

To avoid damage to your vehicle or tires, observe the following precautions:

#### CAUTION!

- Because of restricted traction device clearance between tires and other suspension components, it is important that only traction devices in good condition are used. Broken devices can cause serious damage. Stop the vehicle immediately if noise occurs that could indicate device breakage. Remove the damaged parts of the device before further use.
- Install device as tightly as possible and then retighten after driving about ½ mile (0.8 km).
- Do not exceed 30 mph (48 km/h).
- Drive cautiously and avoid severe turns and large bumps, especially with a loaded vehicle.
- Do not drive for a prolonged period on dry pavement.
- Observe the traction device manufacturer’s instructions on the method of installation, operating speed, and conditions for use. Always use the suggested operating speed of the device manufacturer’s if it is less than 30 mph (48 km/h).

#### CAUTION!

- Do not use traction devices on a compact spare tire.

### Tire Rotation Recommendations

The tires on the front and rear of your vehicle operate at different loads and perform different steering, handling, and braking functions. For these reasons, they wear at unequal rates.

These effects can be reduced by timely rotation of tires. The benefits of rotation are especially worthwhile with aggressive tread designs such as those on On/Off Road type tires. Rotation will increase tread life, help to maintain mud, snow, and wet traction levels, and contribute to a smooth, quiet ride.

Refer to the “Maintenance Plan” for the proper maintenance intervals. The reasons for any rapid or unusual wear should be corrected prior to rotation being performed.



The suggested rotation method is the “rearward-cross” shown in the following diagram.

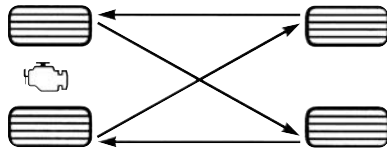

Tire Rotation

### CAUTION!

Proper operation of four-wheel drive vehicles depends on tires of equal size, type and circumference on each wheel. Any difference in tire size can cause damage to the transfer case. Tire rotation schedule should be followed to balance tire wear.

## DEPARTMENT OF TRANSPORTATION UNIFORM TIRE QUALITY GRADES

The following tire grading categories were established by the National Highway Traffic Safety Administration. The specific grade rating assigned by the tire's manufacturer in each category is shown on the sidewall of the tires on your vehicle.

All passenger vehicle tires must conform to Federal safety requirements in addition to these grades.

### Treadwear

The Treadwear grade is a comparative rating, based on the wear rate of the tire when tested under controlled conditions on a specified government test course. For example, a tire graded 150 would wear one and one-half times as well on the government

course as a tire graded 100. The relative performance of tires depends upon the actual conditions of their use, however, and may depart significantly from the norm due to variations in driving habits, service practices, and differences in road characteristics and climate.

### Traction Grades

The Traction grades, from highest to lowest, are AA, A, B, and C. These grades represent the tire's ability to stop on wet pavement, as measured under controlled conditions on specified government test surfaces of asphalt and concrete. A tire marked C may have poor traction performance.

### WARNING!

The traction grade assigned to this tire is based on straight-ahead braking traction tests, and does not in-



**WARNING!**

clude acceleration, cornering, hydroplaning, or peak traction characteristics.

**Temperature Grades**

The Temperature grades are A (the highest), B, and C, representing the tire's resistance to the generation of heat and its ability to dissipate heat, when tested under controlled conditions on a specified indoor laboratory test wheel.

Sustained high temperature can cause the material of the tire to degenerate and reduce tire life, and excessive temperature can lead to sudden tire failure. The grade C corresponds to a level of performance, which all passenger vehicle tires must meet under the Federal Motor Vehicle Safety Standard No. 109. Grades B and A repre-

sent higher levels of performance on the laboratory test wheel, than the minimum required by law.

**WARNING!**

The temperature grade for this tire is established for a tire that is properly inflated and not overloaded. Excessive speed, under-inflation, or excessive loading, either separately or in combination, can cause heat buildup and possible tire failure.

**STORING THE VEHICLE**

If you are storing your vehicle for more than 21 days, we recommend that you take the following steps to minimize the drain on your vehicle's battery:

- Disconnect the negative cable from battery.
- Any time you store your vehicle or keep it out of service (i.e., vacation) for two weeks or more, run the air conditioning system at idle for about five minutes in the fresh air

and high blower setting. This will ensure adequate system lubrication to minimize the possibility of compressor damage when the system is started again.

**BODYWORK****Body And Underbody Maintenance****Cleaning Headlights**

Your vehicle is equipped with plastic headlights and fog lights that are lighter and less susceptible to stone breakage than glass headlights.

Plastic is not as scratch resistant as glass and therefore different lens cleaning procedures must be followed.

To minimize the possibility of scratching the lenses and reducing light output, avoid wiping with a dry cloth. To remove road dirt, wash with a mild soap solution followed by rinsing.

Do not use abrasive cleaning components, solvents, steel wool or other aggressive material to clean the lenses.

## Preserving The Bodywork

### Washing

- Wash your vehicle regularly. Always wash your vehicle in the shade using Mopar Car Wash, or a mild car wash soap, and rinse the panels completely with clear water.
- If insects, tar, or other similar deposits have accumulated on your vehicle, use Mopar Super Kleen Bug and Tar Remover to remove.
- Use a high quality cleaner wax, such as Mopar Cleaner Wax to remove road film, stains and to protect your paint finish. Take care never to scratch the paint.
- Avoid using abrasive compounds and power buffing that may diminish the gloss or thin out the paint finish.

### CAUTION!

- Do not use abrasive or strong cleaning materials such as steel wool or scouring powder that will scratch metal and painted surfaces.

### CAUTION!

- Use of power washers exceeding 1,200 psi (8,274 kPa) can result in damage or removal of paint and decals.

### Special Care

- If you drive on salted or dusty roads or if you drive near the ocean, hose off the undercarriage at least once a month.
- It is important that the drain holes in the lower edges of the doors, rocker panels, and trunk be kept clear and open.
- If you detect any stone chips or scratches in the paint, touch them up immediately. The cost of such repairs is considered the responsibility of the owner.
- If your vehicle is damaged due to a collision or similar cause that destroys the paint and protective coating, have your vehicle repaired as soon as possible. The cost of such repairs is considered the responsibility of the owner.

- If you carry special cargo such as chemicals, fertilizers, de-icer salt, etc., be sure that such materials are well packaged and sealed.
- If a lot of driving is done on gravel roads, consider mud or stone shields behind each wheel.
- Use Mopar Touch Up Paint on scratches as soon as possible. An authorized dealer has touch up paint to match the color of your vehicle.

### Appearance Care For Fabric Top Models

To maintain the appearance of your vehicle's interior trim and top, follow these precautions:

- Avoid leaving your vehicle unattended with the top down, as exposure to sun or rain may damage interior trim.
- Do not use harsh cleaners or bleaching agents on top material, as damage may result.
- Do not allow any vinyl cleaner to run down and dry on the paint, leaving a streak.



- After cleaning your vehicle's fabric top, always make sure it is completely dry before lowering.
- Be especially careful when washing the windows by following the directions for "Care of Fabric Top Windows."

**Washing** – Use Mopar Car Wash or equivalent, or mild soap suds, lukewarm water, and a brush with soft bristles. If extra cleaning is required, use Mopar Convertible Cloth Top Cleaner or equivalent, or a mild foaming cleaner on the entire top, but support the top from underneath.

**Rinsing** – Be sure to remove all traces of cleaner by rinsing the top thoroughly with clean water. Remember to allow the top to dry before lowering it.

### CAUTION!

Failure to follow these cautions may cause interior water damage, stains or mildew on the top material:

- Avoid high-pressure car washes, as they can damage the top material. Also, increased water pressure may force past the weather strips.
- It is recommended that the top be free of water prior to opening it. Operating the top, opening a door or lowering a window while the top is wet may allow water to drip into the vehicle's interior.
- Use care when washing the vehicle, water pressure directed at the weather strip seals may cause water to leak into the vehicle's interior.
- Careless handling and storage of the removable roof panels may damage the seals, causing water to leak into the vehicle's interior.
- The front panel(s) must be positioned properly to ensure sealing. Improper installation can cause water to leak into the vehicle's interior.

### Care Of Fabric Top Windows

Your vehicle's fabric top has pliable plastic windows which can be scratched unless special care is taken by following these directions:

- Never use a dry cloth to remove dust. Instead, **use a microfiber towel or soft cotton cloth moistened with cold or warm, clean water, and wipe across the window, not up and down.** Mopar Jeep Soft Glass Window Cleaner or equivalent will safely clean all plastic windows without scratching. It removes fine scratches to improve visibility and provides UV protection to help prevent yellowing.
- When washing, **never use hot water** or anything stronger than a mild soap. Never use solvents such as alcohol or harsh cleaning agents.
- Always rinse thoroughly with cold water, then wipe with a soft and slightly moist, clean cloth.

- When removing frost, snow or ice, **never use a scraper or de-icing chemicals**. Use warm water only if you must clean the window quickly.
- Debris (sand, mud/dirt, dust, or salt) from off-road driving will have an impact on plastic retainer operation. Even normal on-road driving and vehicle washing will eventually impact window plastic retainer operation. To maintain ease of use of the window plastic retainers, each window plastic retainer should be cleaned and lubricated regularly. Clean them with a mild soap solution and a small brush. Cleaning products are available through an authorized dealer.
- Never paste stickers, gummed labels or any tape to the windows. Adhesives are hard to remove and may damage the windows.

## INTERIORS

### Seats And Fabric Parts

Use Mopar Total Clean to clean fabric upholstery and carpeting.

#### WARNING!

Do not use volatile solvents for cleaning purposes. Many are potentially flammable, and if used in closed areas they may cause respiratory harm.

### Seat Belt Maintenance

Do not bleach, dye or clean the belts with chemical solvents or abrasive cleaners. This will weaken the fabric. Sun damage can also weaken the fabric.

If the belts need cleaning, use a mild soap solution or lukewarm water. Do not remove the belts from the vehicle to wash them. Dry with a soft cloth.

Replace the belts if they appear frayed or worn or if the buckles do not work properly.

#### WARNING!

A frayed or torn belt could rip apart in a collision and leave you with no protection. Inspect the belt system periodically, checking for cuts, frays, or loose parts. Damaged parts must be replaced immediately. Do not disassemble or modify the system. Seat belt assemblies must be replaced after a collision if they have been damaged (i.e., bent retractor, torn webbing, etc.).

### Plastic And Coated Parts

Use Mopar Total Clean to clean vinyl upholstery.

#### CAUTION!

- Direct contact of air fresheners, insect repellents, suntan lotions, or hand sanitizers to the plastic, painted, or decorated surfaces of the interior may cause permanent damage. Wipe away immediately.



**CAUTION!**

- Damage caused by these type of products may not be covered by your New Vehicle Limited Warranty.

**Cleaning Plastic Instrument Cluster Lenses**

The lenses in front of the instruments in this vehicle are molded in clear plastic. When cleaning the lenses, care must be taken to avoid scratching the plastic.

1. Clean with a wet soft cloth. A mild soap solution may be used, but do not use high alcohol content or abrasive cleaners. If soap is used, wipe clean with a clean damp cloth.
2. Dry with a soft cloth.

**Leather Parts**

Mopar Total Clean is specifically recommended for leather upholstery.

Your leather upholstery can be best preserved by regular cleaning with a damp soft cloth. Small particles of dirt can act as an abrasive and damage the leather upholstery and should be removed promptly with a damp cloth. Stubborn soils can be removed easily with a soft cloth and Mopar Total Clean. Care should be taken to avoid soaking your leather upholstery with any liquid. Please do not use polishes, oils, cleaning fluids, solvents, detergents, or ammonia-based cleaners to clean your leather upholstery. Application of a leather conditioner is not required to maintain the original condition.

**NOTE:**

If equipped with light colored leather, it tends to show any foreign material, dirt, and fabric dye transfer more so than darker colors. The leather is designed for easy cleaning, and FCA recommends Mopar total care leather cleaner applied on a cloth to clean the leather seats as needed.

**CAUTION!**

Do not use Alcohol and Alcohol-based and/or Ketone based cleaning products to clean leather seats, as damage to the seat may result.

**Glass Surfaces**

All glass surfaces should be cleaned on a regular basis with Mopar Glass Cleaner, or any commercial household-type glass cleaner. Never use an abrasive type cleaner. Use caution when cleaning the inside rear window equipped with electric defrosters or windows equipped with radio antennas. Do not use scrapers or other sharp instruments that may scratch the elements.

When cleaning the rear view mirror, spray cleaner on the towel or cloth that you are using. Do not spray cleaner directly on the mirror.

# TECHNICAL SPECIFICATIONS

<b>VEHICLE IDENTIFICATION NUMBER</b> . . . . .	<b>.254</b>	<b>FUEL REQUIREMENTS</b> . . . . .	<b>.255</b>	<b>FLUIDS AND LUBRICANTS</b> . . . . .	<b>.258</b>
<b>WHEEL AND TIRE TORQUE SPECIFICATIONS</b> . . . . .	<b>.254</b>	2.0L Engine . . . . .	.255	Engine . . . . .	.258
Torque Specifications . . . . .	.254	3.6L Engine . . . . .	.255	Chassis . . . . .	.259
		Materials Added To Fuel . . . . .	.256	<b>MOPAR ACCESSORIES</b> . . . . .	<b>.260</b>
		<b>FLUID CAPACITIES</b> . . . . .	<b>.256</b>	Authentic Accessories And Jeep Performance Parts By Mopar . . . . .	.260



## VEHICLE IDENTIFICATION NUMBER

The Vehicle Identification Number (VIN) is found on the left front corner of the A pillar, visible from outside of the vehicle through the windshield. This number also appears underbody, on the right side of the frame rail near the center of the vehicle, as well as on the Automobile Information Disclosure Label affixed to a window on your vehicle. Save this label for a convenient record of your vehicle identification number and optional equipment.

The VIN is also stamped on either right or left hand side of the engine block.



Vehicle Identification Number

### NOTE:

It is illegal to remove or alter the VIN plate.

## WHEEL AND TIRE TORQUE SPECIFICATIONS

Proper lug nut/bolt torque is very important to ensure that the wheel is properly mounted to the vehicle. Any time a wheel has been removed and reinstalled on the vehicle, the lug

nuts/bolts should be torqued using a properly calibrated torque wrench using a high quality six sided (hex) deep wall socket.

### Torque Specifications

Lug Nut/Bolt Torque	**Lug Nut/Bolt Size	Lug Nut/Bolt Socket Size
130 Ft-Lbs (176 N·m)	M14 x 1.50	22 mm

\*\*Use only your authorized dealer recommended lug nuts/bolts and clean or remove any dirt or oil before tightening.

Inspect the wheel mounting surface prior to mounting the tire and remove any corrosion or loose particles.

### Spare Tire Torque Specifications

Lug Nut/Bolt Torque	**Lug Nut/Bolt Size	Lug Nut/Bolt Socket Size
59 Ft-Lbs (80 N·m)	M14 x 1.50	22 mm

Spare tire torque is for the spare tire carrier located on the tailgate.



Tighten the lug nuts/bolts in a star pattern until each nut/bolt has been tightened twice. Ensure that the socket is fully engaged on the lug nut/bolt (do not insert it halfway).



### Torque Patterns

After 25 miles (40 km), check the lug nut/bolt torque to be sure that all the lug nuts/bolts are properly seated against the wheel.

### WARNING!

To avoid the risk of forcing the vehicle off the jack, do not tighten the lug nuts/bolts fully until the vehicle has been lowered. Failure to follow this warning may result in personal injury.

## FUEL REQUIREMENTS

### 2.0L Engine



This engine is designed to meet all emission regulations, and provide satisfactory fuel economy and performance when using high-quality unleaded “Regular” gasoline having

a posted octane number of 87 as specified by the (R+M)/2 method. For optimal performance the use of 91 or higher octane “Premium” gasoline is recommended in these engines.

While operating on gasoline with the required octane number, hearing a light knocking sound from the engine is not a cause for concern. However, if the engine is heard making a heavy knocking sound, see your dealer immediately. Use of gasoline with a lower than recommended octane number can cause engine failure and may void or not be covered by the New Vehicle Limited Warranty.

Poor quality gasoline can cause problems such as hard starting, stalling, and hesitations. If you experience these symptoms, try another brand of gasoline before considering service for the vehicle.

### 3.6L Engine

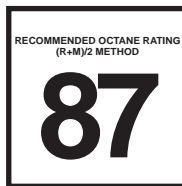

This engine is designed to meet all emissions regulations and provide excellent fuel economy and performance when using high-quality unleaded “Regular” gasoline having an octane

rating of 87 as specified by the (R+M)/2 method. The use of higher octane “Premium” gasoline will not provide any benefit over “Regular” gasoline in these engines.

While operating on gasoline with an octane number of 87, hearing a light knocking sound from the engine is not a cause for concern. However, if the engine is heard making a heavy knocking sound, see your dealer immediately. Use of gasoline with an octane num-



ber lower than 87 can cause engine failure and may void or not be covered by the New Vehicle Limited Warranty.

Poor quality gasoline can cause problems such as hard starting, stalling, and hesitations. If you experience these symptoms, try another brand of gasoline before considering service for the vehicle.

### Materials Added To Fuel

Designated TOP TIER Detergent Gasoline contains a higher level of detergents to further aid in minimizing engine and fuel system deposits. When available, the usage of TOP TIER Detergent gasoline is recommended.



Visit [www.toptiergas.com](http://www.toptiergas.com) for a list of TOP TIER Detergent Gasoline Retailers.

Indiscriminate use of fuel system cleaning agents should be avoided. Many of these materials intended for gum and varnish removal may contain active solvents or similar ingredients. These can harm fuel system gasket and diaphragm materials.

## FLUID CAPACITIES

	U.S.	Metric
<b>Fuel (Approximate)</b>		
Two Door Models	18.5/17.5 Gallons	70/66 Liters
Four Door Models	21.5 Gallons	81 Liters
<b>Engine Oil with Filter</b>		
2.0L Engine	5 Quarts	4.73 Liters
3.6L Engine	5 Quarts	4.73 Liters

	U.S.	Metric
<b>Cooling System *</b>		
2.0L Engine (Mopar Antifreeze/ Engine Coolant 10 Year/150,000 Mile Formula or equivalent)	10.3 Quarts	9.7 Liters
2.0L Engine Intercooler without Motor Generator Unit (MGU) (Mopar Antifreeze/Engine Coolant 10 Year/150,000 Mile Formula or equivalent)	3.2 Quarts	3.0 Liters
2.0L Engine Intercooler with Motor Generator Unit (MGU) (Mopar Antifreeze/Engine Coolant 10 Year/150,000 Mile Formula or equivalent)	3.5 Quarts	3.3 Liters
2.0L Battery Coolant (Mopar Antifreeze/ Engine Coolant 10 Year/150,000 Mile Formula or equivalent)	2.5 Quarts	2.4 Liters
3.6L Engine (Mopar Antifreeze/ Engine Coolant 10 Year/150,000 Mile Formula or equivalent)	11.2 Quarts	10.6 Liters
3.6L Motor Generator Unit (MGU) (Mopar Antifreeze/ Engine Coolant 10 Year/150,000 Mile Formula or equivalent)	1.9 Quarts	1.8 Liters
3.6L Battery Coolant (Mopar Antifreeze/ Engine Coolant 10 Year/150,000 Mile Formula or equivalent)	2.5 Quarts	2.4 Liters
* Includes coolant recovery bottle filled to MAX level.		



## FLUIDS AND LUBRICANTS

### Engine

Component	Fluid, Lubricant, or Genuine Part
Engine Coolant	We recommend you use Mopar Antifreeze/Coolant 10 Year/150,000 Mile Formula OAT (Organic Additive Technology) or equivalent meeting the requirements of FCA Material Standard MS.90032.
Intercooler/Motor Generator Unit (if equipped)	We recommend you use Mopar Antifreeze/Coolant 10 Year/150,000 Mile Formula OAT (Organic Additive Technology) or equivalent meeting the requirements of FCA Material Standard MS.90032.
Battery Coolant (if equipped)	We recommend you use Mopar Antifreeze/Coolant 10 Year/150,000 Mile Formula OAT (Organic Additive Technology) or equivalent meeting the requirements of FCA Material Standard MS.90032.
Engine Oil — 2.0L Engine	We recommend you use Mopar API SN PLUS Certified SAE 5W-30 Full Synthetic Engine Oil which meets the requirements of FCA Material Standard MS-13340. Equivalent full synthetic SAE 5W-30 engine oil can be used if it meets API SN PLUS Certification. If SN PLUS or equivalent oil is unavailable then please contact your local dealership for recommendation.
	<b>CAUTION!</b>
	<b>Failure to use the recommended SN PLUS or equivalent oil can cause engine damage not covered by the vehicle warranty.</b>
Engine Oil — 3.6L Engine	We recommend you use API Certified SAE 0W-20 Engine Oil, meeting the requirements of FCA Material Standard MS-6395 such as Mopar, Pennzoil, and Shell Helix. Refer to your engine oil filler cap for correct SAE grade.
Engine Oil Filter	We recommend you use Mopar Engine Oil Filter or equivalent.
Spark Plugs	We recommend you use Mopar Spark Plugs.
Fuel Selection — 2.0L Engine	87 Octane Minimum – 91 Octane Recommended, 0-15% Ethanol.
Fuel Selection — 3.6L Engine	87 Octane, 0-15% Ethanol.

### CAUTION!

- Mixing of engine coolant (antifreeze) other than specified Organic Additive Technology (OAT) engine coolant (antifreeze), may result in engine damage and may decrease corrosion protection. Organic Additive Technology (OAT) engine coolant is different and should not be mixed with Hybrid Organic Additive Technology (HOAT) engine coolant (antifreeze) or any “globally compatible”

### CAUTION!

- coolant (antifreeze). If a non-OAT engine coolant (antifreeze) is introduced into the cooling system in an emergency, the cooling system will need to be drained, flushed, and refilled with fresh OAT coolant (conforming to MS.90032), by an authorized dealer as soon as possible.
- Do not use water alone or alcohol-based engine coolant (antifreeze) products. Do not use additional rust inhibitors or an-

### CAUTION!

- tirust products, as they may not be compatible with the radiator engine coolant and may plug the radiator.
- This vehicle has not been designed for use with propylene glycol-based engine coolant (antifreeze). Use of propylene glycol-based engine coolant (antifreeze) is not recommended.

## Chassis

Component	Fluid, Lubricant, or Genuine Part
Automatic Transmission – If Equipped	Use only Mopar ZF 8&9 Speed ATF Automatic Transmission Fluid or equivalent. Failure to use the correct fluid may affect the function or performance of your transmission.
Manual Transmission – If Equipped	We recommend you use Mopar ATF+4 Automatic Transmission Fluid.
Transfer Case	We recommend you use Mopar ATF+4 Automatic Transmission Fluid.
Axle Differential (Front)	We recommend you use Mopar Gear & Axle Lubricant (SAE 75W85)(API GL-5)
Axle Differential (Rear)	We recommend you use Mopar Gear & Axle Lubricant (SAE 75W85)(API GL-5). Models equipped with Trac-Lok Limited Slip Differential require a friction modifier additive.
Brake Master Cylinder	We recommend you use Mopar DOT 3 Brake Fluid, SAE J1703. If DOT 3, SAE J1703 brake fluid is not available, then DOT 4 is acceptable.
Power Steering Reservoir	We recommend you use Mopar Electric Steering Pump Fluid.



## MOPAR ACCESSORIES

### Authentic Accessories And Jeep Performance Parts By Mopar

- Mopar Accessories and Jeep performance parts are developed with the same engineering that went into your Wrangler.

Choose these products with confidence knowing that they have passed the same rigid standards for function, fit, durability and performance as your Wrangler.

- For the full line of Authentic Jeep Accessories by Mopar, visit your local dealership or online at [mopar.com](http://mopar.com) for U.S. residents and [mopar.ca](http://mopar.ca) for Canadian residents.

#### NOTE:

All parts are subject to availability.

#### Off Road & Performance:

- Bumpers
- Winches
- Performance Axles
- Performance Hoods
- Lift Kits

- Performance Brakes
- Axle Locker Kit
- Differential Covers
- LED Off Road Lights
- Skid Plates

- Rock Rails
- Grille Guard
- Spare Tire Carrier
- Fender Flares
- Tailgate Reinforcement

#### Exterior:

- Wheels
- Spare Tire Covers
- Fuel Doors
- Air Deflectors
- Locking Gas Cap
- Tubular Steps
- Molded Side Steps
- Windshield Tie Down Strap
- Splash Guards

- Hood Lock
- Wheel Locks
- Trailer Hitches
- Body Graphics
- Hood Graphics
- Satin Black Grille
- Camping Tent
- Hood Cover

- Front End Cover
- Parking Cover
- LED Lights
- Valve Stem Caps
- Ski And Snowboard Carriers
- Roof Basket
- Roof Basket Net
- Towing Kit

**Interior:**

- Hard Top Headliner
- Premium Carpet Floor Mats
- All Weather Floor Mats
- Radio Screen Protector
- Grab Handles

**Electronics:**

- Electronic Vehicle Tracking System

- Door Sill Guards
- Storage Bags
- Cargo Tub
- Cargo Tray
- Cargo Net

- Trailrail Cargo Rail
- Trailrail Vertical Cargo Divider
- Tailgate Table
- Dog Kennel
- Dog Partition







# MULTIMEDIA

## **CYBERSECURITY . . . . .265**

### **STEERING WHEEL**

## **AUDIO CONTROLS . . . . .266**

Radio Operation . . . . .266

Media Mode . . . . .266

### **SIRIUSXM GUARDIAN —**

## **IF EQUIPPED . . . . .266**

SiriusXM Guardian — If Equipped  
(Available on Uconnect 4C/4C NAV  
With 8.4-inch Display) . . . . .266

SiriusXM Guardian Activation . . . . .267

Download The Uconnect App . . . . .268

Renewing Subscriptions (Uconnect 4C/4C  
NAV With 8.4-inch Display) . . . . .268

Maintaining Your SiriusXM Guardian  
Account . . . . .269

Built-In Features . . . . .269

SiriusXM Guardian Remote Features . .272

## **UCONNECT 3 WITH 5-INCH DISPLAY — IF EQUIPPED . . . . .274**

Uconnect 3 With 5-inch Display  
At A Glance. . . . .274

Clock Setting . . . . .275

Audio Setting . . . . .275

Radio Operation . . . . .276

Voice Text Reply (Not Compatible  
With iPhone) . . . . .276

## **UCONNECT 4 WITH 7-INCH DISPLAY . . . . .277**

Uconnect 4 At A Glance . . . . .277

Drag & Drop Menu Bar . . . . .279

Radio . . . . .280

Android Auto — If Equipped . . . . .281

Apple CarPlay Integration —  
If Equipped. . . . .283

## **UCONNECT 4C/4C NAV WITH 8.4-INCH DISPLAY . . . . .284**

Uconnect 4C/4C NAV At A Glance . . .284

Drag & Drop Menu Bar . . . . .285

Radio . . . . .286

Android Auto — If Equipped . . . . .287

Apple CarPlay Integration —  
If Equipped. . . . .291

## **UCONNECT SETTINGS . . . . .293**

## **AUX/USB/MP3 CONTROL — IF EQUIPPED. . . . .294**

## **NAVIGATION — IF EQUIPPED . . . . .296**

Changing The Navigation Voice Prompt  
Volume . . . . .296

Finding Points Of Interest . . . . .298

Finding A Place By Spelling  
The Name. . . . .298

One-Step Voice Destination Entry . . .298

Setting Your Home Location. . . . .298

Home . . . . .299

Adding A Stop . . . . .300

Taking A Detour . . . . .300

SiriusXM Traffic Plus (4C NAV  
With 8.4-inch Display). . . . .300

SiriusXM Travel Link (4C NAV  
With 8.4-inch Display) . . . . .300

## **UCONNECT PHONE . . . . .302**

Uconnect Phone (Bluetooth  
Hands Free Calling) . . . . .302



Pairing (Wirelessly Connecting) Your Mobile Phone To The Uconnect System . . . . .	.305
Common Phone Commands (Examples) . . . . .	.309
Mute (Or Unmute) Microphone During Call . . . . .	.309
Transfer Ongoing Call Between Handset And Vehicle . . . . .	.309
Phonebook . . . . .	.309
Voice Command Tips . . . . .	.309
Changing The Volume . . . . .	.310
Using Do Not Disturb . . . . .	.310
Incoming Text Messages . . . . .	.310
Helpful Tips And Common Questions To Improve Bluetooth Performance With Your Uconnect System . . . . .	.311

## **UCONNECT VOICE RECOGNITION QUICK TIPS . . . .312**

Introducing Uconnect . . . . .	.312
Get Started . . . . .	.313
Basic Voice Commands. . . . .	.314
Radio . . . . .	.314
Media . . . . .	.314
Phone . . . . .	.315
Voice Text Reply . . . . .	.316
Climate . . . . .	.317
Navigation (4C NAV) . . . . .	.317
SiriusXM Guardian (4C/4C NAV)— If Equipped. . . . .	.318
Register (4C/4C NAV). . . . .	.318

Vehicle Health Report/Alert (4C/4C NAV) . . . . .	.319
Mobile App (4C/4C NAV). . . . .	.319
SiriusXM Travel Link (4C NAV) . . . . .	.319
Siri Eyes Free — If Equipped . . . . .	.320
Using Do Not Disturb. . . . .	.320
Android Auto — If Equipped . . . . .	.321
Apple CarPlay — If Equipped. . . . .	.321
General Information. . . . .	.322
Additional Information . . . . .	.323

## CYBERSECURITY

Your vehicle may be a connected vehicle and may be equipped with both wired and wireless networks. These networks allow your vehicle to send and receive information. This information allows systems and features in your vehicle to function properly.

Your vehicle may be equipped with certain security features to reduce the risk of unauthorized and unlawful access to vehicle systems and wireless communications. Vehicle software technology continues to evolve over time and FCA US LLC, working with its suppliers, evaluates and takes appropriate steps as needed. Similar to a computer or other devices, your vehicle may require software updates to improve the usability and performance of your systems or to reduce the potential risk of unauthorized and unlawful access to your vehicle systems.

The risk of unauthorized and unlawful access to your vehicle systems may still exist, even if the most recent version of vehicle software (such as Uconnect software) is installed.

### WARNING!

- It is not possible to know or to predict all of the possible outcomes if your vehicle's systems are breached. It may be possible that vehicle systems, including safety related systems, could be impaired or a loss of vehicle control could occur that may result in an accident involving serious injury or death.
- ONLY insert media (e.g., USB, SD card, or CD) into your vehicle if it came from a trusted source. Media of unknown origin could possibly contain malicious software, and if installed in your vehicle, it may increase the possibility for vehicle systems to be breached.
- As always, if you experience unusual vehicle behavior, take your vehicle to your nearest authorized dealer immediately.

### NOTE:

- FCA US LLC or your dealer may contact you directly regarding software updates.

- To help further improve vehicle security and minimize the potential risk of a security breach, vehicle owners should:
  - Routinely check [www.driveuconnect.com/support/software-update.html](http://www.driveuconnect.com/support/software-update.html) (U.S. Residents) or [www.driveuconnect.ca](http://www.driveuconnect.ca) (Canadian Residents) to learn about available Uconnect software updates.
  - Only connect and use trusted media devices (e.g. personal mobile phones, USBs, CDs).

Privacy of any wireless and wired communications cannot be assured. Third parties may unlawfully intercept information and private communications without your consent. For further information, refer to "Data Collection & Privacy" in your Uconnect Owner's Manual Supplement or "Onboard Diagnostic System (OBD II) Cybersecurity" in "Getting To Know Your Instrument Panel" in your Owner's Manual.



## STEERING WHEEL AUDIO CONTROLS

The remote sound system controls are located on the rear surface of the steering wheel. Reach behind the wheel to access the switches.



**Audio Controls**  
(Back View Of Steering Wheel)

The right-hand control is a rocker-type switch with a push-button in the center and controls the volume and mode of the sound system. Pushing the top of the rocker switch increases the volume, and pushing the bottom of the rocker switch decreases the volume.

Pushing the center button will make the radio switch between the various modes available (AM/FM/SAT/CD/USB/AUX, etc.).

The left-hand control is a rocker-type switch with a push-button in the center. The function of the left-hand control is different depending on which mode you are in.

The following describes the left-hand control operation in each mode.

### Radio Operation

Pushing the top of the switch will “Seek” up for the next listenable station and pushing the bottom of the switch will “Seek” down for the next listenable station.

The button located in the center of the left-hand control will tune to the next preset station that you have programmed in the radio preset button.

### Media Mode

Pushing the top of the switch once goes to the next track on the selected media (AUX/USB/Bluetooth). Pushing the bottom of the switch once goes to the beginning of the

current track, or to the beginning of the previous track if it is within eight seconds after the current track begins to play.

## SIRIUSXM GUARDIAN – IF EQUIPPED

**SiriusXM Guardian – If Equipped**  
(Available on Uconnect 4C/4C NAV  
With 8.4-inch Display)

### WARNING!

ALWAYS obey traffic laws and pay attention to the road. ALWAYS drive safely with your hands on the steering wheel. You have full responsibility and assume all risks related to the use of the features and applications in this vehicle. Only use the features and applications when it is safe to do so. Failure to do so may result in an accident involving serious injury or death.

### NOTE:

Your vehicle may be transmitting data as authorized by the subscriber.

SiriusXM Guardian enhances your ownership and driving experience. When connected to an operable network, you can:

- Place a SOS Call to a SiriusXM Guardian operator who can connect you to emergency responders.
- Remotely lock/unlock your doors and start your vehicle from virtually anywhere, using the Uconnect App from your device. You can also do so by logging into your owner site, or by calling SiriusXM Guardian Care when your vehicle has an operable network connection. Services can only be used where coverage is available.
- Receive text or email notifications if your vehicle's security alarm goes off.
- Receive stolen vehicle assistance, using GPS technology to help authorities locate your vehicle if it is stolen.
- Get operator assistance using the ASSIST button on your interior rearview mirror.

### **Before you drive, familiarize yourself with the easy-to-use SiriusXM Guardian services.**

1. The ASSIST and SOS Call buttons are located on your rearview mirror. The ASSIST button is used for contacting Roadside Assistance, Vehicle Care, SiriusXM Guardian Care, and Uconnect Care. The SOS Call button connects you to a SiriusXM Guardian Care Agent, who can connect you to emergency services.
2. The Uconnect “Apps ” button is located in the center of the menu bar of the radio touchscreen. This is where you can manage your Apps.
3. The Uconnect Voice Command and Uconnect Phone buttons are located on the left side of your steering wheel. These buttons let you use your voice to give commands, make phone calls, send and receive text messages, enter navigation destinations, and control your radio and media devices.

### **Included Trial Period For New Vehicles**

Your new vehicle may come with an included trial period for use of the SiriusXM Guardian services starting at the date of vehicle purchase (date based on vehicle sales notification from your dealer). **To activate the trial, you must first register with SiriusXM Guardian.** After the trial period, if you wish to continue your SiriusXM Guardian services you can choose to purchase a subscription.

#### **NOTE:**

You can check [UconnectPhone.com](http://UconnectPhone.com) for system and device compatibility.

### **SiriusXM Guardian Activation**

To unlock the full potential of SiriusXM Guardian in your vehicle, you must activate your SiriusXM Guardian services.

1. Press the Apps icon on the bottom of your in-vehicle touchscreen.
2. Select the Activate Services icon from your list of apps.



3. Select “Customer Care” to speak with a SiriusXM Guardian Customer Care agent who will activate services in your vehicle, or select “Enter Email” to activate on the web.

**Why sign up for SiriusXM Guardian?** Here are just a few examples of things you’ll be able to do:

- Know that help, if you need it, is only a button press away with Assist.
- Lock and unlock your vehicle doors from hundreds of miles away.
- Find your vehicle, no matter where you parked, using the convenient Vehicle Finder function.
- Use Send & Go to send a navigation route from your mobile phone to your vehicle’s navigation system.

For further information:

- U.S. residents visit:  
[www.siriusxm.com/guardian](http://www.siriusxm.com/guardian)
- Canadian residents visit:  
[www.siriusxm.ca/guardian](http://www.siriusxm.ca/guardian)

### Download The Uconnect App

You’re only a few steps away from using remote commands and other valuable services.



**Mobile App**

To use the Uconnect App:

- Search for and download the Uconnect App from the store on your compatible iPhone or Android powered device.

- Log in to the app using the email address and password you created when you activated the services.
- Press the “Remote” button on the bottom menu bar of the app to Lock/Unlock, Remote Start (if equipped), and activate your horn and lights remotely.
- Press the “Location” button on the bottom menu bar of the app to bring up a map to locate your vehicle or send a location to your vehicle’s navigation system.
- Press the menu button (three horizontal lines) in the upper left corner of the app to access settings and support information.

### Renewing Subscriptions (Uconnect 4C/4C NAV With 8.4-inch Display)

Subscriptions can be purchased online by logging into your owner account. If you need help push the ASSIST button on the rearview mirror, then select SiriusXM Guardian Care or:

- U.S. residents dial:1-844-796-4827
- Canadian residents dial:1-877-324-9091

## Maintaining Your SiriusXM Guardian Account

### Selling Your Vehicle

When you sell your vehicle, we recommend that you remove your SiriusXM Guardian Account information from the vehicle. You can do this by pressing the ASSIST button in your vehicle and selecting SiriusXM Guardian, or call:

- U.S. residents: 1-844-796-4827
- Canadian residents: 1-877-324-9091

### Built-In Features

#### WARNING!

ALWAYS drive safely with your hands on the wheel. You have full responsibility and assume all risks related to the use of the Uconnect features, SiriusXM Guardian services, and applications in this vehicle. Only use Uconnect features and SiriusXM Guardian services when it is safe to do so. Failure to do so may result in an accident involving serious injury or death.

#### WARNING!

- ALWAYS obey traffic laws and pay attention to the road. Some features are limited while the vehicle is in motion. Some services, including SOS, will NOT work without a subscription and an operable network connection.
- Ignoring the rearview mirror light could mean you may not have SOS Call service if needed. If the rearview mirror light is illuminated, have an authorized dealer service the SOS Call system immediately.
- The Occupant Restraint Controller (ORC) turns on the Air Bag Warning Light on the instrument panel if a malfunction is detected in any part of the airbag system. If the Air Bag Warning Light is illuminated, the air bag system may not be working properly and the SOS Call system may not send a signal to a SOS Call operator if an air bag is deployed. If the Air Bag Warning Light is illuminated, have an authorized dealer service your vehicle immediately.

#### WARNING!

- If anyone in the vehicle could be in danger (e.g., fire or smoke is visible, dangerous road conditions or location), do not wait for voice contact from a SOS Call operator. All occupants should exit the vehicle immediately and move to a safe location.
- The SOS Call system is embedded into the vehicle's electrical system. Do not add aftermarket electrical equipment to the vehicle's electrical system. This may prevent your vehicle from sending a signal to initiate an emergency call. To avoid interference that can cause the SOS Call system to fail, never add aftermarket equipment (e.g., two-way mobile radio, CB radio, data recorder, etc.) to your vehicle's electrical system or modify the antennas on your vehicle.
- IF YOUR VEHICLE LOSES BATTERY POWER FOR ANY REASON (INCLUDING DURING OR AFTER AN ACCIDENT), the Uconnect features, apps, and SiriusXM Guardian services, among others, will not operate.



**NOTE:**

Your vehicle may be transmitting data as authorized by the subscriber.

1. **ASSIST Call (4C/4C NAV) — If Equipped** — The rearview mirror contains an ASSIST button, allowing you to speak to a call center agent for support:

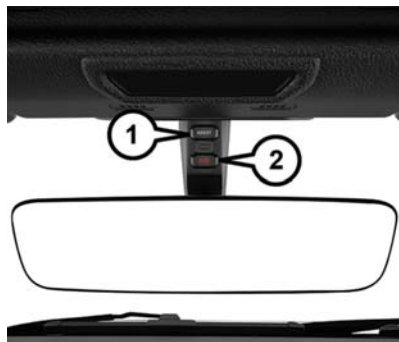

**Assist And SOS**

- 1 — ASSIST Button  
2 — SOS Button

- **Roadside Assistance Call** — If you get a flat tire, or need a tow, you'll be connected to someone who can help anytime. Additional fees may apply. Additional information in this section.
- **Uconnect Care** — In vehicle support for Uconnect Apps and Features.
- **SiriusXM Guardian Care** — In vehicle support for SiriusXM Guardian services.
- **Vehicle Care** — Total support for your FCA US LLC vehicle.

**NOTE:**

In order to provide SiriusXM Guardian Services to you, we may record and monitor your conversations with Roadside Assistance, Uconnect Care, SiriusXM Guardian Care, or Vehicle Care, whether such conversations are initiated through the SiriusXM Guardian services in your vehicle, your device, or via a landline device, and may share information obtained through such recording and monitoring in accordance with regulatory requirements. You acknowledge, agree, and consent to any recording, monitoring or sharing of information obtained through any such call recordings.

2. **Emergency SOS Call (If Equipped)** — The rearview mirror contains a SOS Call button that, when pressed, may place a call from your vehicle to a SiriusXM Guardian Care operator, who can connect you to emergency service operators, to request help from local police, fire or ambulance personnel. If this button is accidentally pressed, you will have ten seconds to stop the call. To cancel, press the SOS Call button again or press the “Cancel” button shown on the touchscreen. After ten seconds has passed, the SOS call will be placed and only the SOS Call operator can cancel it. The LED light on the rearview mirror will turn green once a connection to a SOS Call operator has been made. The green LED light will turn off once the SOS Call is terminated. Have an authorized dealer service the vehicle if the rearview mirror light is continuously red. On equipped vehicles, this feature requires a functioning electrical system, a subscription, and an operable network connection. **If a connection is made between a SOS Call operator and your vehicle, you understand and agree that SOS Call operators will stay**



on the line, even after you connect with emergency services. The Emergency services operator may, like any other emergency call, record conversations and sounds in and near your vehicle upon connection.

3. **Theft Alarm Notification — If Equipped** —

The Theft Alarm Notification feature notifies you via email or text (SMS) message when the vehicle's factory-installed security alarm system has been triggered. There are a number of reasons why your alarm may have been triggered, one of which could be that your vehicle was stolen. If so, please see the details of the Stolen Vehicle Assistance service below. When activated, Theft Alarm Notification is automatically set to send you an email at the email address you provide should the alarm go off. You may also opt to have a text message sent to your device.

4. **Stolen Vehicle Assistance** — If your vehicle is stolen, contact local law enforcement immediately to file a stolen vehicle report. Once this report has been filed, SiriusXM Guardian Care can help locate your vehicle. The SiriusXM Guardian Care agent

will ask for the stolen vehicle report number issued by local law enforcement. As long as your vehicle has a SiriusXM Guardian subscription and an operable network connection, the agent may be able to locate the stolen vehicle and work with law enforcement to help recover it. Your vehicle must have an operable network connection and must be registered with SiriusXM Guardian with an active subscription that includes the applicable feature.

5. **4G Wi-Fi Hotspot — If Equipped** — Allows you and your passengers to connect their portable devices to the built-in 4G Wi-Fi capabilities of your Uconnect system. Purchasing 4G Wi-Fi Hotspot requires the use of an Internet-enabled portable device.

**NOTE:**

Uconnect offers a complimentary 3-month trial period that includes 1GB of total data. The trial can be activated any time within the first year of new vehicle ownership.

- a. To start, the **Enable Wi-Fi Hotspot** box should be un-checked.
- b. Select the **Wi-Fi Hotspot Setup** option from the touchscreen to locate your Hotspot Name and Password. Make note of this information.
- c. Tap the Back Arrow to return to the main Wi-Fi Hotspot page, then check the box to **Enable Wi-Fi Hotspot**.
- d. From your portable device Wi-Fi settings menu, select the Hotspot Name from the list of available networks and enter the provided Password.
- e. Open the web browser on your portable device and enter the following web address:  
<https://myvehicle.att.com/#/login>.
- f. Create a myVehicle account or log in to your existing one.
- g. Select and purchase the desired subscription option. The Wi-Fi Hotspot will activate after a few minutes.

For additional assistance, call AT&T Customer Care at: 866-595-1330.



**NOTE:**

Your vehicle must have a working electrical system for any of the in vehicle SiriusXM Guardian services to operate.

**SiriusXM Guardian Remote Features**

If you own a compatible iPhone or Android powered device, the Uconnect App allows you to remotely lock or unlock your doors, start your engine or activate your horn and lights from virtually anywhere. Your vehicle must be equipped with remote start, must have a SiriusXM Guardian subscription, and must have an operable network connection. Services can only be used where coverage is available. You can download the App from Mopar Owner Connect or from the App Store (iPhone) or Google Play Store (Android). Visit UconnectPhone.com to determine if your device is compatible. For Uconnect Phone customer support and to determine if your device is compatible.

U.S. residents - visit UconnectPhone.com or call 1-877-855-8400.

Canadian residents - visit UconnectPhone.com or call: 1-800-465-2001 (English) or call: 1-800-387-9983 (French).

**Remote Start (If Equipped)** — This feature provides the ability to start the engine on your vehicle, without the keys and from virtually any distance. You can send a request to your vehicle in one of two ways:

1. Using the Uconnect App from a compatible device.
  - After 15 minutes if you have not entered your vehicle with the key, the engine will shut off automatically.
  - You can also send a command to turn-off an engine that has been remote started.
  - This remote function requires your vehicle to be equipped with a factory-installed Remote Start system. To utilize this feature after the Uconnect App is downloaded, login with your user name and password.
2. From the Mopar Owner Connect website.

You will need your four digit SiriusXM Guardian Security PIN to confirm the request. Press the “remote start” icon on your Uconnect App to remotely start the vehicle.

You can set-up notifications for your account to receive an email or text (SMS) message every time a command is sent. Login to Mopar Owner Connect at mopar.com and click on Edit Profile to manage SiriusXM Guardian Notifications.

**Remote Door Lock/Unlock — If Equipped** — This feature provides the ability to lock or unlock the door on your vehicle, without the keys and from virtually any distance. You can send a request to your vehicle in one of three ways:

1. Using the Uconnect App from a compatible device.
2. From the Mopar Owner Connect website.
3. By contacting SiriusXM Guardian Care on the phone.

To use this feature after the Uconnect App is downloaded, login using your user name and password. You will need your four digit SiriusXM Guardian Security PIN to confirm

the request. Press the “closed lock” icon on your Uconnect App to lock the doors, and press the “open lock” icon to unlock the driver’s door.

You can set-up notifications for your account to receive an email or text (SMS) message every time a command is sent. Login to Mopar Owner Connect at [mopar.com](http://mopar.com) and click on Edit Profile to manage SiriusXM Guardian Notifications.

**Remote Horn And Lights — If Equipped** — It’s easy to locate a vehicle in a dark, crowded or noisy parking area by activating the horn and lights. It may also help if you need to draw attention to your vehicle for any reason. You can send a request to your vehicle in one of three ways:

1. Using the Uconnect App from a compatible device.
2. From the Mopar Owner Connect website.
3. By contacting the SiriusXM Guardian Care on the phone.

To use this feature after the Uconnect App is downloaded, login using your user name and password. You will need your four digit

SiriusXM Guardian Security PIN to confirm the request. You can set-up notifications for your account to receive an email or text (SMS) message every time a command is sent. Login to Mopar Owner Connect at [mopar.com](http://mopar.com) and click on Edit Profile to manage SiriusXM Guardian Notifications.

### Vehicle Finder

The Vehicle Finder feature of the Uconnect Mobile App allows you to find the location of your vehicle when you can’t remember where it’s parked. You can also sound the alarm and flash the lights to make finding your vehicle even easier.

To find your vehicle:

1. Press the “Location” tab on the Uconnect Mobile App bottom bar.
2. Select the “Vehicle” icon to determine the location of your vehicle.
3. Select the “Find Route” button that appears, once your vehicle is located.
4. Select your preferred Navigation App to route a path to your vehicle.

### Send & Go

The Send & Go feature of the Uconnect Mobile App allows you to search for a destination on your mobile device and then send the route to your vehicle’s Uconnect Navigation system.

To send a navigation route to your vehicle:

1. Press the “Location” tab on the Uconnect Mobile App bottom bar.
2. Either type in the destination you would like to navigate to, or search through one of the categories provided.
3. Select the destination you want to route to from the list that appears.
4. Press the “Send To Vehicle” button, and then confirm the destination by pressing “Yes,” to send the navigation route to the Uconnect Navigation in your vehicle.
5. Finally, confirm the route inside your vehicle by pressing the “Go Now” option on the pop-up that appears on the touchscreen, when the vehicle is started.



## UCONNECT 3 WITH 5-INCH DISPLAY – IF EQUIPPED

### Uconnect 3 With 5-inch Display At A Glance



**Uconnect 3 With 5-inch Display Radio Buttons**

- |  |  |
|--|--|
| 1 — RADIO Button                           | 5 — BROWSE/ENTER Button — TUNE/SCROLL Knob |
| 2 — COMPASS Button                         | 6 — SCREEN OFF Button                      |
| 3 — SETTINGS Button                        | 7 — MUTE Button                            |
| 4 — MORE Functions Button                  | 8 — System On/Off — Volume Control Knob    |
| 5 — BROWSE/ENTER Button — TUNE/SCROLL Knob | 9 — Uconnect PHONE Button                  |
|  | 10 — MEDIA Button                          |

## CAUTION!

**Do NOT attach any object to the touchscreen, doing so can result in damage to the touchscreen.**

### Clock Setting

To start the clock setting procedure:

1. Press the Settings button on the faceplate, then press the “Clock and Date” button.
2. Press the “Set Time” button on the touchscreen.
3. Press the “Up” or “Down” arrows to adjust the hours or minutes, then select the “AM” or “PM” button on the touchscreen. You can also select 12hr or 24hr format by pressing the desired button on the touchscreen.
4. Once the time is set, press the “Done” button on the touchscreen to exit the time screen.

#### NOTE:

In the Clock Setting Menu you can also select Display Clock. Display Clock turns the clock display in the status bar on or off.

### Audio Setting

1. Press the “Settings” button on the faceplate.
2. Scroll down and press the “Audio” button on the touchscreen to open the Audio menu.
3. The Audio Menu shows the following options for you to customize your audio settings.

#### Equalizer

Press the “Equalizer” button on the touchscreen to adjust the Bass, Mid and Treble. Use the “+” or “-” button on the touchscreen to adjust the equalizer to your desired settings.

#### Balance/Fade

Press the “Balance/Fade” button on the touchscreen to adjust the sound from the speakers. Use the arrow buttons on the touchscreen to adjust the sound level from the front and rear or right and left side speakers. Press the Center “C” button on the touchscreen to reset the balance and fade to the factory setting.

### Speed Adjusted Volume — If Equipped

Press the “Speed Adjusted Volume” button on the touchscreen to select between OFF, 1, 2 or 3. This will decrease the radio volume relative to a decrease in vehicle speed.

### Loudness — If Equipped

Press the “Loudness” button on the touchscreen to select the Loudness feature. When this feature is activated it improves sound quality at lower volumes.

### Surround Sound — If Equipped

Press the “Surround Sound” button on the touchscreen, select On or Off followed by pressing the back arrow button on the touchscreen. When this feature is activated, it provides simulated surround sound mode.



## Radio Operation



**Radio Operation**

- 1 — Radio Station Preset
- 2 — All Presets
- 3 — Seek Next
- 4 — Audio Settings
- 5 — Station Information
- 6 — Direct Tune
- 7 — Radio Band
- 8 — Seek Previous

### Store Radio Presets Manually

The Radio stores up to 12 presets in each of the Radio modes. There are four visible presets at the top of the radio screen. Pressing the “All” button on the touchscreen on the radio home screen displays all of the preset stations for that mode.

To store a radio preset manually, follow the steps below:

1. Tune to the desired station.
2. Press and hold the desired numbered button on the touchscreen for more than two seconds, or until you hear a confirmation beep.

### Seek Next/Previous Buttons

- Press the Seek up or Seek down button to seek through radio stations in AM, FM or SXM bands.
- Hold either button to bypass stations without stopping.

### Voice Text Reply (Not Compatible With iPhone)

Once your Uconnect system is paired with a compatible mobile device, the system can announce a new incoming text message, and read it to you over the vehicle audio system. You can reply to the message using Voice Recognition by selecting, or saying, one of the 18 pre-defined messages.

#### Here's How:

1. Push the Voice Recognition (VR) (VR or the Phone button) and wait for the beep, then say “reply.” Uconnect gives the following prompt: “Please say the message you would like to send.”
2. Wait for the beep and say one of the pre-defined messages. (If you are not sure, you can say “help”). Uconnect will then read the pre-defined messages allowed.
3. As soon as you hear the message you would like to send, you can interrupt the list of prompts by pushing the Uconnect phone button and saying the phrase. Uconnect will confirm the message by reading it back to you.

4. Push the Phone button and say “Send.”

PRE-DEFINED VOICE TEXT REPLY RESPONSES		
Yes.	Stuck in traffic.	See you later.
No.	Start without me.	I'll be late.
Okay.	Where are you?	I will be <5, 10, 15, 20, 25, 30, 45, 60>* minutes late.
Call me.	Are you there yet?	
I'll call you later.	I need directions.	See you in <5, 10, 15, 20, 25, 30, 45, 60>* minutes.
I'm on my way.	Can't talk right now.	
I'm lost.		Thanks.

\*Use only the numbering listed or the system may not transcribe the message properly.

### Siri Eyes Free — If Equipped

Siri lets you use your voice to send text messages, select media, place phone calls and much more. Siri uses natural language to understand what you mean and responds back to confirm your requests. The system is designed to keep your eyes on the road and your hands on the wheel by letting Siri help you perform useful tasks.

To enable Siri, push and hold, then release the Uconnect Voice Recognition (VR) button on the steering wheel. After you hear a double beep you can ask Siri to play podcasts and music, get directions, read text messages and many other useful requests.

## UCONNECT 4 WITH 7-INCH DISPLAY

### Uconnect 4 At A Glance

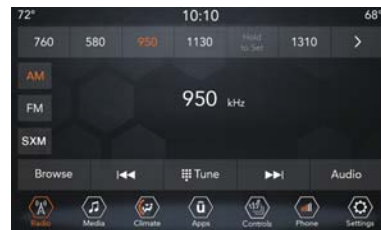

### Uconnect 4 With 7-inch Display Radio Screen

#### CAUTION!

Do NOT attach any object to the touchscreen, doing so can result in damage to the screen.

#### NOTE:

Uconnect screen images are for illustration purposes only and may not reflect exact software for your vehicle.



## Setting The Time

- For Uconnect 4, turn the unit on, and then press the time display at the top of the screen. Press “Yes.”
- If the time is not displayed at the top of the screen, press the “Settings” button on the touchscreen. In the Settings screen, press the “Clock & Date” button on the touchscreen, then check or uncheck this option.
- Press “+” or “-” next to Set Time Hours and Set Time Minutes to adjust the time.
- If these features are not available, uncheck the Sync Time box.
- Press “X” to save your settings and exit out of the Clock Setting screen.

## Audio Settings

- Press the “Audio” button on the touchscreen to activate the Audio settings screen to adjust Balance\Fade, Equalizer, Speed Adjusted Volume, Surround Sound, Loudness, AUX Volume Offset, Auto Play, and Radio Off With Door.
- You can return to the Radio screen by pressing the “X” located at the top right.

## Balance/Fade

- Press the “Balance/Fade” button on the touchscreen to Balance audio between the front speakers or fade the audio between the rear and front speakers.
- Pressing the “Front,” “Rear,” “Left,” or “Right” buttons on the touchscreen or press and drag the Speaker Icon to adjust the Balance/Fade.

## Equalizer

- Press the “Equalizer” button on the touchscreen to activate the Equalizer screen.
- Press the “+” or “-” buttons on the touchscreen, or press and drag over the level bar for each of the equalizer bands. The level value, which spans between plus or minus nine, is displayed at the bottom of each of the bands.

## Speed Adjusted Volume

- Press the “Speed Adjusted Volume” button on the touchscreen to activate the Speed Adjusted Volume screen. The Speed Adjusted Volume is adjusted by pressing the volume level indicator. This alters the automatic adjustment of the audio volume with variation to vehicle speed.

## Loudness — If Equipped

- Press the “On” button on the touchscreen to activate Loudness. Press “Off” to deactivate this feature. When Loudness is On, the sound quality at lower volumes improves.

## AUX Volume Offset

- Press the “AUX Volume Offset” button on the touchscreen to activate the AUX Volume Offset screen. The AUX Volume Offset is adjusted by pressing of the “+” and “-” buttons. This alters the AUX input audio volume. The level value, which spans between plus or minus three, is displayed above the adjustment bar.



## Auto Play — If Equipped

- Press the “Auto Play” button on the touchscreen to activate the Auto Play screen. The Auto Play feature has two settings “On” and “Off.” With Auto Play on, music begins playing from a connected device, immediately after it is connected to the radio.

## Auto On Radio — If Equipped

- The Radio automatically turns on when vehicle is in run or will recall whether it was on or off at last ignition off.

## Radio Off With Door — If Equipped

- Press the “Radio Off With Door” button on the touchscreen to activate the Radio Off With Door screen. The Radio Off With Door feature, when activated, keeps the radio on until the driver or passenger door is opened, or when the Radio Off Delay selected time has expired.

## Drag & Drop Menu Bar

The Uconnect features and services in the main menu bar are easily changed for your convenience. Simply follow these steps:



Uconnect 4 Main Menu

1. Press the “Apps  ” button to open the App screen.
2. Press and hold, then drag the selected App to replace an existing shortcut in the main menu bar.

The new app shortcut, that was dragged down onto the main menu bar, will now be an active App/shortcut.

## NOTE:

This feature is only available if the vehicle is in PARK.



## Radio



## Uconnect 4 With 7-inch Display Radio

- 1 — Radio Station Presets
- 2 — Toggle Between Presets
- 3 — Status Bar
- 4 — Main Category Bar
- 5 — Audio Settings

- 6 — Seek Up
- 7 — Direct Tune To A Radio Station
- 8 — Seek Down
- 9 — Browse And Manage Presets
- 10 — Radio Bands

## WARNING!

ALWAYS drive safely with your hands on the wheel. You have full responsibility and assume all risks related to the use of the Uconnect features, SiriusXM Guardian services, and applications in this vehicle. Only use Uconnect features and SiriusXM Guardian services when it is safe to do so. Failure to do so may result in an accident involving serious injury or death.

- To access the Radio mode, press the “Radio” button on the touchscreen.

### Selecting Radio Stations

- Press the desired radio band (AM, FM or SXM) button on the touchscreen.

### Seek Up/Seek Down

- Press the Seek up or down arrow buttons on the touchscreen for less than two seconds to seek through radio stations.

- Press and hold either arrow button on the touchscreen for more than two seconds to bypass stations without stopping. The radio will stop at the next listenable station once the arrow button on the touchscreen is released.

### Direct Tune

- Tune directly to a radio station by pressing the “Tune” button on the screen, and entering the desired station number.

### Store Radio Presets Manually

Your radio can store 36 total preset stations, 12 presets per band (AM, FM and SXM). They are shown at the top of your radio screen. To see the 12 preset stations per band, press the arrow button on the touchscreen at the top right of the screen to toggle between the two sets of six presets.

To store a radio preset manually, follow the steps below:

1. Tune to the desired station.
2. Press and hold the desired numbered button on the touchscreen for more than two seconds or until you hear a confirmation beep.

## Android Auto – If Equipped

### NOTE:

Feature availability depends on your carrier and mobile phone manufacturer. Some Android Auto features may or may not be available in every region and/or language.

Android Auto is a feature of your Uconnect system, and your Android 5.0 Lollipop, or higher, powered smartphone with a data plan, that allows you to project your smartphone and a number of its apps onto the touchscreen radio display. Android Auto automatically brings you useful information, and organizes it into simple cards that appear just when they are needed. Android Auto can be used with Google's best-in-class speech technology, the steering wheel controls, the knobs and buttons on your radio faceplate, and the radio display's touchscreen to control many of your apps.



To use Android Auto follow the following steps:

1. Download the Android Auto app from the Google Play store on your Android-powered smartphone.
2. Connect your Android powered smartphone to one of the media USB ports in your vehicle. If you have not downloaded the Android Auto app to your smartphone before plugging in the device for the first time, the app begins to download.

**NOTE:**

Be sure to use the factory-provided USB cable that came with your phone, as after-market cables may not work.

Your phone may ask you to approve the use of the Android Auto app before use.

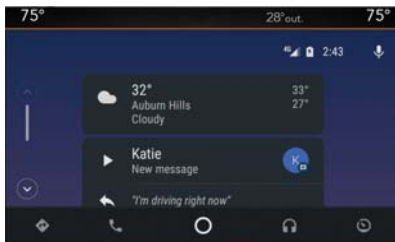

**Android Auto**

3. Once the device is connected and recognized, Android Auto should automatically launch, but you can also launch it by touching the Android Auto icon on the touchscreen, located under Apps.

Once Android Auto is up and running on your Uconnect system, the following features can be utilized using your smartphone's data plan:

- Google Maps for navigation
- Google Play Music, Spotify, iHeart Radio, etc. for music
- Handsfree Calling, and Texting for communication
- Hundred of compatible apps, and many more!

**NOTE:**

To use Android Auto, make sure you are in an area with cellular coverage. Android Auto may use cellular data and your cellular coverage is shown in the upper right corner of the radio screen. Once Android Auto has made a connection through USB, Android Auto will also connect via Bluetooth.

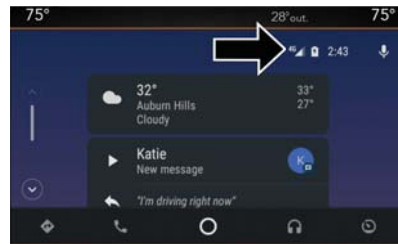

**Google Maps Data And Cellular Coverage**

**NOTE:**

Requires compatible smartphone running Android™ 5.0 Lollipop or higher and download app on Google Play. Android, Android Auto and Google Play are trademarks of Google Inc.

## Apple CarPlay Integration – If Equipped

### NOTE:

Feature availability depends on your carrier and mobile phone manufacturer. Some Apple CarPlay features may or may not be available in every region and/or language.

Uconnect works seamlessly with Apple CarPlay, the smarter, more secure way to use your iPhone in the car, and stay focused on the road. Use your Uconnect Touchscreen display, the vehicle's knobs and controls, and your voice with Siri to get access to Apple Music, Maps, Messages, and more.

To use CarPlay, make sure you are using iPhone 5 or later, have Siri enabled in Settings, that your iPhone is unlocked for the very first connection only, and then use the following procedure:

1. Connect your iPhone to one of the media USB ports in your vehicle.

### NOTE:

Be sure to use the factory-provided Lightning cable that came with your phone, as aftermarket cables may not work.

2. Once the device is connected and recognized, CarPlay should automatically launch, but you can also launch it by touching the CarPlay icon on the touchscreen, located under Apps.



CarPlay

Once CarPlay is up and running on your Uconnect system, the following features can be utilized using your iPhone's data plan:

- Phone
- Music
- Messages
- Maps

### NOTE:

To use CarPlay make sure that cellular data is turned on, and that you are in an area with cellular coverage. Your data and cellular coverage is shown on the left side of the radio screen.



CarPlay Data And Cellular Coverage

### NOTE:

Requires compatible iPhone. See dealer for phone compatibility. Data plan rates apply. Vehicle user interface is a product of Apple®. Apple CarPlay is a trademark of Apple Inc. iPhone is a trademark of Apple Inc., registered in the US and other countries. Apple terms of use and privacy statements apply.



## UCONNECT 4C/4C NAV WITH 8.4-INCH DISPLAY

### Uconnect 4C/4C NAV At A Glance



Uconnect 4/4C NAV Radio

### WARNING!

ALWAYS drive safely with your hands on the wheel. You have full responsibility and assume all risks related to the use of the Uconnect features, SiriusXM Guardian services, and applications in this vehicle. Only use Uconnect features and SiriusXM Guardian services when it is safe to do so.

### WARNING!

Failure to do so may result in an accident involving serious injury or death.

### CAUTION!

Do NOT attach any object to the touchscreen, doing so can result in damage to the screen.

### NOTE:

Uconnect screen images are for illustration purposes only and may not reflect exact software for your vehicle.

### Setting The Time

- Model 4C NAV synchronizes time automatically via GPS, so it should not require any time adjustment. If you do need to set the time manually, follow the instructions below for Model 4C NAV.
- For Model 4C, turn the unit on, and then press the time display at the top of the screen. Press “Yes.”

- If the time is not displayed at the top of the screen, press the “Settings” button on the touchscreen. In the Settings screen, press the “Clock” button on the touchscreen, then check or uncheck this option.
- Press “+” or “-” next to Set Time Hours and Set Time Minutes to adjust the time.
- If these features are not available, uncheck the Sync Time box.
- Press “X” to save your settings and exit out of the Clock Setting screen.

### Background Themes

- Screen background themes are selectable from a pre-loaded list of themes. If you’d like to set a theme, follow the instructions below.
- Press the “Settings” button on the touchscreen and select the display menu.
- Then press “Set Theme” button on the touchscreen and select a theme.

## Audio Settings

- Press the “Audio” button on the touchscreen to activate the Audio settings screen to adjust Balance/Fade, Equalizer, and Speed Adjusted Volume.
- You can return to the Radio screen by pressing the “X” located at the top right.

## Balance/Fade

- Press the “Balance/Fade” button on the touchscreen to Balance audio between the front speakers or fade the audio between the rear and front speakers.
- Pressing the “Front,” “Rear,” “Left,” or “Right” buttons on the touchscreen or press and drag the Speaker Icon to adjust the Balance/Fade.

## Equalizer

- Press the “Equalizer” button on the touchscreen to activate the Equalizer screen.
- Press the “+” or “-” buttons on the touchscreen, or press and drag over the level bar for each of the equalizer bands. The level value, which spans between plus or minus nine, is displayed at the bottom of each of the Bands.

## Speed Adjusted Volume

- Press the “Speed Adjusted Volume” button on the touchscreen to activate the Speed Adjusted Volume screen. The Speed Adjusted Volume is adjusted by pressing the volume level indicator. This alters the automatic adjustment of the audio volume with variation to vehicle speed.

## Drag & Drop Menu Bar

The Uconnect features and services in the main menu bar are easily changed for your convenience. Simply follow these steps:



**Uconnect 4C/4C NAV With 8.4-inch Display Main Menu**

1. Press the “Apps ” button to open the App screen.
2. Press and hold, then drag the selected App to replace an existing shortcut in the main menu bar.

The new app shortcut, that was dragged down onto the main menu bar, will now be an active App/shortcut.

### NOTE:

This feature is only available if the vehicle is in PARK.



## Radio



## Uconnect 4C NAV Radio

- |                               |                                    |
|-------------------------------|------------------------------------|
| 1 — Radio Station Presets     | 7 — Audio Settings                 |
| 2 — Toggle Between Presets    | 8 — Seek Up                        |
| 3 — Status Bar                | 9 — Direct Tune To A Radio Station |
| 4 — View Small Navigation Map | 10 — Seek Down                     |
| 5 — HD Radio                  | 11 — Browse And Manage Presets     |
| 6 — Main Category Bar         | 12 — Radio Bands                   |



## WARNING!

ALWAYS drive safely with your hands on the wheel. You have full responsibility and assume all risks related to the use of the Uconnect features, SiriusXM Guardian services, and applications in this vehicle. Only use Uconnect features and SiriusXM Guardian services when it is safe to do so. Failure to do so may result in an accident involving serious injury or death.

- To access the Radio mode, press the “Radio” button on the touchscreen.

### Selecting Radio Stations

- Press the desired radio band (AM, FM or SXM) button on the touchscreen.

### Seek Up/Seek Down

- Press the Seek up or down arrow buttons on the touchscreen for less than two seconds to seek through radio stations.

- Press and hold either arrow button on the touchscreen for more than two seconds to bypass stations without stopping. The radio will stop at the next listenable station once the arrow button on the touchscreen is released.

### Direct Tune

- Tune directly to a radio station by pressing the “Tune” button on the screen, and entering the desired station number.

### Store Radio Presets Manually

Your radio can store 36 total preset stations, 12 presets per band (AM, FM and SXM). They are shown at the top of your radio screen. To see the 12 preset stations per band, press the arrow button on the touchscreen at the top right of the screen to toggle between the two sets of six presets.

To store a radio preset manually, follow the steps below:

1. Tune to the desired station.
2. Press and hold the desired numbered button on the touchscreen for more than two seconds or until you hear a confirmation beep.

### HD Radio — If Equipped

- HD Radio (available on Uconnect 4C/4C NAV) operates similar to conventional radio except it allows broadcasters to transmit a high-quality digital signal.
- With an HD radio receiver, the listener is provided with a clear sound that enhances the listening experience. HD radio can also transmit data such as song title or artist.

### Android Auto — If Equipped

#### NOTE:

Feature availability depends on your carrier and mobile phone manufacturer. Some Android Auto features may or may not be available in every region and/or language.

Android Auto is a feature of your Uconnect system, and your Android 5.0 Lollipop, or higher, powered smartphone with a data plan, that allows you to project your smartphone and a number of its apps onto the touchscreen radio display. Android Auto automatically brings you useful information, and organizes it into simple cards that appear just when they are needed. Android Auto can be used with Google's best-in-class speech tech-



nology, the steering wheel controls, the knobs and buttons on your radio faceplate, and the radio display's touchscreen to control many of your apps. To use Android Auto follow these steps:

1. Download the Android Auto app from the Google Play store on your Android-powered smartphone.
2. Connect your Android powered smartphone to one of the media USB ports in your vehicle. If you have not downloaded the Android Auto app to your smartphone before plugging in the device for the first time, the app begins to download.

**NOTE:**

Be sure to use the factory-provided USB cable that came with your phone, as after-market cables may not work.

Your phone may ask you to approve the use of the Android Auto app before use.



**Android Auto**

3. Once Android Auto has made a connection through USB, Android Auto will also connect via Bluetooth. The system displays the Android Auto home screen. Android Auto automatically launches, but if it does not, refer to the Uconnect Owner's Manual Supplement for the procedure to enable the feature "AutoShow." You can also launch it by pressing Android Auto located in the "Apps" menu. If you use Android Auto frequently you can move the app to the menu bar at the bottom of the touchscreen. Press the "Apps" button and locate the Android Auto app; then drag the selected App to replace an existing shortcut in the main menu bar.

Once Android Auto is up and running on your Uconnect system, the following features can be utilized using your smartphone's data plan:

- Google Maps for navigation
- Google Play Music, Spotify, iHeart Radio, etc. for music
- Handsfree Calling, and Texting for communication
- Hundred of compatible apps, and many more!

**NOTE:**

To use Android Auto, make sure you are in an area with cellular coverage. Android Auto may use cellular data and your cellular coverage is shown in the upper right corner of the radio screen.



### Google Maps Data And Cellular Coverage

#### NOTE:

Requires compatible smartphone running Android™ 5.0 Lollipop or higher and download app on Google Play. Android, Android Auto and Google Play are trademarks of Google Inc.

#### Maps

Push and hold the VR button on the steering wheel or tap the microphone icon to ask Google to take you to a desired destination by voice. You can also touch the Navigation icon in Android Auto to access Google Maps.

#### NOTE:

If the VR button is not held, and is only pushed, the built-in Uconnect VR prompts you and any spoken navigation command launches the built-in Uconnect navigation system.

While using Android Auto, Google Maps provides voice-guided:

- Navigation
- Live traffic information
- Lane guidance



### Google Maps

#### NOTE:

If you are using the built-in Uconnect navigation system, and you try and start a new route using Android Auto, via voice or any other method, a pop-up appears asking if you would like to switch from Uconnect navigation to smartphone navigation. A pop-up also appears, asking if you'd like to switch, if Android Auto is currently in use and you attempt to launch a built-in Uconnect route. Selecting "Yes" switches the navigation type to the newly used method of navigation and a route is planned for the new destination. If "No" is selected the navigation type remains unchanged.

For further information, refer to [www.android.com/auto/](http://www.android.com/auto/) (U.S. Residents) or [https://www.android.com/intl/en\\_ca/auto/](https://www.android.com/intl/en_ca/auto/) (Canadian Residents).

For further information on the navigation function, please refer to <https://support.google.com/android> or <https://support.google.com/androidauto/>.



## Music

Android Auto allows you to access and stream your favorite music with apps like Google Play Music, iHeartRadio, and Spotify. Using your smartphone's data plan, you can stream endless music on the road.

### NOTE:

For music apps, playlists, and stations to work with Android Auto, they must be set up on your smartphone before using Android Auto.

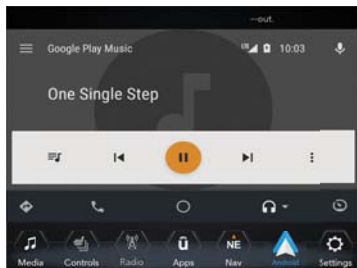

Android Auto Music

### NOTE:

To see the metadata for the music playing through Android Auto, select the Uconnect System's media screen.

For further information refer to <https://support.google.com/androidauto>.

## Communication

With Android Auto connected, press and hold the VR button on the steering wheel to activate voice recognition specific to the Android Auto. This will allow you to send and reply to text messages, have incoming text messages read out loud, and place and receive hands-free calls.

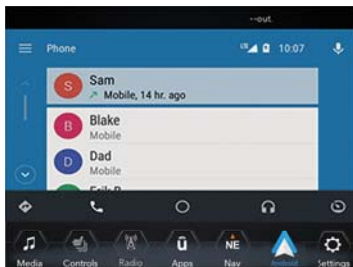

Android Auto Contact



Android Auto Phone

## Apps

The Android Auto App will display all the compatible apps that are available to use with Android Auto, every time it is launched. You must have the compatible app downloaded, and you must be signed in to the app for it to work with Android Auto. Refer to [g.co/androidauto](http://g.co/androidauto) to see the latest list of available apps for Android Auto.

## Apple CarPlay Integration – If Equipped

### NOTE:

Feature availability depends on your carrier and mobile phone manufacturer. Some Apple CarPlay features may or may not be available in every region and/or language.

Uconnect works seamlessly with Apple CarPlay, the smarter, more secure way to use your iPhone in the car, and stay focused on the road. Use your Uconnect Touchscreen display, the vehicle's knobs and controls, and your voice with Siri to get access to Apple Music, Maps, Messages, and more.

To use CarPlay, make sure you are using iPhone 5 or later, have Siri enabled in Settings, that your iPhone is unlocked for the very first connection only, and then use the following procedure:

1. Connect your iPhone to one of the media USB ports in your vehicle.

### NOTE:

Be sure to use the factory-provided Lightning cable that came with your phone, as aftermarket cables may not work.

2. Once the device is connected, the system displays the CarPlay home screen. Apple CarPlay automatically launches, but if not, refer to the Uconnect Owner's Manual Supplement for the procedure to enable the feature "AutoShow." You can also launch it by pressing the CarPlay icon located in the "Apps" menu. If you use Apple CarPlay frequently you can move the app to the menu bar at the bottom of the touchscreen. Press the "Apps" button and locate the CarPlay app; then drag and drop the selected App to replace an existing shortcut in the main menu bar.

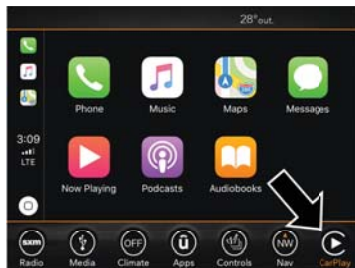

CarPlay

Once CarPlay is up and running on your Uconnect system, the following features can be utilized using your iPhone's data plan:

- Phone
- Music
- Messages
- Maps

### NOTE:

To use CarPlay make sure that cellular data is turned on, and that you are in an area with cellular coverage. Your data and cellular coverage is shown on the left side of the radio screen.

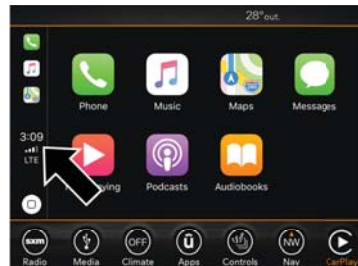

CarPlay Data And Cellular Coverage



**NOTE:**

Requires compatible iPhone. See dealer for phone compatibility. Data plan rates apply. Vehicle user interface is a product of Apple®. Apple CarPlay is a trademark of Apple Inc. iPhone is a trademark of Apple Inc., registered in the US and other countries. Apple terms of use and privacy statements apply.

**Phone**

With CarPlay, press and hold the VR button on the steering wheel to activate a Siri voice recognition session. You can also press and hold the Home button within CarPlay to start talking to Siri. This allows you to make calls or listen to voice mail as you normally would using Siri on your iPhone.

**NOTE:**

Only temporarily pushing the VR button on the steering wheel launches a built-in VR session, not a Siri session, and it will not function with CarPlay.

**Music**

CarPlay allows you to access all your artists, playlists, and music from iTunes. Using your iPhone's data plan, you can also use select third party audio apps including music, news, sports, podcasts and more.

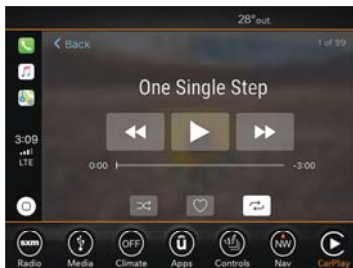
**Apple Music****Messages**

Just like your iPhone, CarPlay allows you to use Siri to send or reply to text messages. Since everything is done by voice, Siri can also read incoming text messages so you don't have to.

**Maps**

To use your Apple Maps for navigation on your Uconnect system, launch CarPlay, and push and hold the VR button on the steering wheel to use Siri to set your desired destination. Alternatively, choose a Nearby destination by pressing Destinations and selecting a category, by launching Siri from the destinations page, or even by typing in a destination.

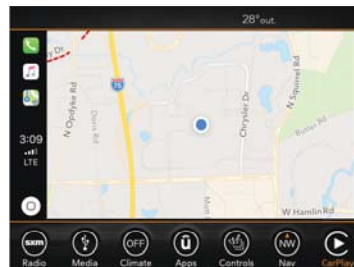
**Maps****NOTE:**

- If the VR button is not held, and is only pushed, the built-in Uconnect VR prompts you and any navigation command said launches the built-in Uconnect navigation system.

- If you are using the built-in Uconnect navigation system, and you try and start a new route using CarPlay, via voice or any other method, a pop-up appears asking if you would like to switch from Uconnect navigation to iPhone navigation. A pop-up also appears, asking if you'd like to switch, if CarPlay navigation is currently in use and you attempt to launch a built-in Uconnect route. Selecting “Yes” switches the navigation type to the newly used method of navigation and a route will be planned for the new destination. If “No” is selected the navigation type remains unchanged.



**Navigation Pop-Up**

## Apps

To use an app that is compatible with CarPlay, you must have the compatible app already downloaded to your iPhone and you must also be signed in. Refer to <http://www.apple.com/ios/carplay/> (U.S. Residents) or <https://www.apple.com/ca/ios/carplay/> (Canadian Residents) to see the latest list of available apps for CarPlay.

## UCONNECT SETTINGS

The Uconnect system allows you to access Customer Programmable feature settings such as Display, Voice, Clock, Safety & Driving Assistance, Lights, Doors & Locks, Auto-On Comfort & Remote Start, Engine Off Options, Compass Settings, Audio, Phone/Bluetooth, Suspension, SiriusXM Setup, Restore Settings, Clear Personal Data, and System Information through buttons on the touchscreen.

Push the SETTINGS button (Uconnect 3), or press the “Apps” button (Uconnect 4 or 4C/4C NAV) located near the bottom of the touchscreen, then press the “Settings” button on the touchscreen to access the Settings

screen. When making a selection, scroll up or down until the preferred setting is highlighted, then press the preferred setting until a check-mark appears next to the setting, showing that setting has been selected. The following feature settings are available:

- Language
- Display
- Units
- Voice
- Clock
- Camera — If Equipped
- Safety & Driving Assistance
- Brakes
- Mirrors & Wipers — If Equipped
- Lights
- Doors & Locks
- Auto-On Comfort
- SiriusXM Setup
- Engine Off Options
- Compass — If Equipped
- Audio
- Phone/Bluetooth
- Suspension — If Equipped
- AUX Switches
- Restore Settings
- Clear Personal Data
- System Information



**NOTE:**

Depending on the vehicles options, feature settings may vary.

Refer to “Uconnect Settings” in “Multimedia” in the Owner’s Manual for further information.

## AUX/USB/MP3 CONTROL – IF EQUIPPED

The Media Hub is located on the Instrument Panel, below the Climate Controls. Behind the Media Hub access door contains one AUX port, a Type C USB Port and one standard USB Port. Both USB Ports allow you to play music from iPod/MP3 players or USB devices through your vehicle’s sound system.

The Smart Charging USB ports provide power to your device up to an hour after the vehicle is turned off.

**NOTE:**

- The Type C USB port is the primary media port for the radio. Two devices can be plugged in at the same time and both ports provide charging capabilities, but only one port can transfer data to the head unit at a time.
- Both ports share a single data connection. However, the user cannot switch between Type A or Type C.

For example, if a device is plugged into the Type A USB port and another device is plugged into the Type C port, connection to the Type A port will be lost. Alternatively, if a device is plugged into the Type C port and another device is plugged into the Type A port, the Type C device maintains primary connection.



**USB Connection**

- 
- 1 — Type A Plugged In
  - 2 — Type C Plugged In
  - 3 — Type A And Type C Plugged In





### Media Hub

- 1 — AUX Port
- 2 — Type C USB Port
- 3 — Type A USB Port

Located inside the center console, a second USB Port allows you to play music from iPod/MP3 players or USB devices through your vehicle's sound system.



### Center Console USB

A third and fourth USB Ports are located behind the center console, above the Power Inverter. One is a charge only port, and can only charge USB devices. The other USB Port allows you to play music from iPod/MP3 players or USB devices through your vehicle's sound system.



### USB On The Back Of The Center Console

- 1 — Type C And Standard USB Ports
- 2 — Type C And Standard Charge Only USB Ports

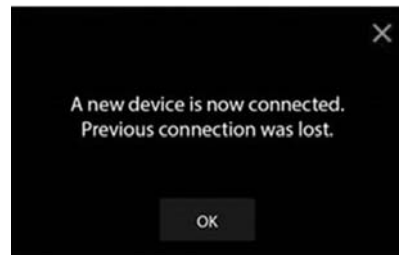

### Device Plugged In Message Screen



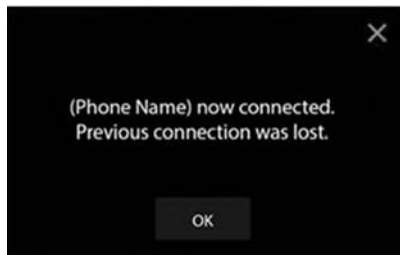

Phone Plugged In Message Screen



Phone or USB Plugged In Message Screen

**NOTE:**

Plugging in a phone or another USB device may cause the connection to a previous device to be lost.

Refer to your Owner's Manual for further information.

**NOTE:**

The USB port supports various Android and Apple devices. The USB port also supports playing music from compatible external USB Mass Storage Class memory devices. Refer to [UconnectPhone.com](http://UconnectPhone.com) for a list of tested devices. Some software versions may not fully support the USB port features. Please visit the device website for software updates.

**WARNING!**

Do not plug in or remove the iPod or external device while driving. Failure to follow this warning could result in a collision.

## NAVIGATION — IF EQUIPPED

- The information in the section below is only applicable if you have the Uconnect 4C NAV With 8.4-inch Display system.

Press the “Nav” button on the touchscreen in the menu bar to access the Navigation system.

### Changing The Navigation Voice Prompt Volume

#### Changing The Navigation Voice Prompt Volume

1. Press the “Settings” button on the touchscreen in the lower right area of the screen.
2. In the Settings menu, press the “Guidance” button on the touchscreen.
3. In the Guidance menu, adjust the Nav Volume by pressing the “+” or “-” buttons on the touchscreen.



### Uconnect 4C NAV With 8.4-inch Display Navigation

- 1 — Search For A Destination In All Categories
- 2 — Find A Destination
- 3 — View Map
- 4 — Navigate To Saved Home Destination

- 5 — Navigate To Saved Work Destination
- 6 — Navigation Settings
- 7 — Emergency
- 8 — Information



### Finding Points Of Interest

- From the main Navigation menu, press the “Where To?” button on the touchscreen, then press the “Points of Interest” button on the touchscreen.
- Select a category and then a subcategory, if necessary.
- Select your destination and press the “GO!” button on the touchscreen.

### Finding A Place By Spelling The Name

- From the Main Navigation Menu press the “Where to?” button on the touchscreen, press the “Points of Interest” button on the touchscreen, then press the “Spell Name” or “Search All” button on the touchscreen.
- Enter the name of your destination.
- Press the “List” or “OK” button on the touchscreen.
- Select your destination and press the “GO!” button on the touchscreen.

### One-Step Voice Destination Entry

- Enter a navigation destination without taking your hands off the wheel.
- Just push the Uconnect Voice Command (UVR) button on the steering wheel, wait for the beep and say something like, “**Find Address** 800 Chrysler Drive Auburn Hills MI.”

#### NOTE:

Using your touchscreens keyboard is not available while your vehicle is in motion. However, you can also use Voice Commands to enter an address while moving. Refer to “Uconnect Voice Recognition Quick Tips” in this section for further information.

### Setting Your Home Location

- To add a Home location, press the “Nav” button on the touchscreen in the menu bar to access the Navigation system and the Main Navigation menu.

- Press the “Home” button on the touchscreen. You can add a Home location by either selecting “Spell City,” “Spell Street,” or “Select Country.” Select County is automatically filled out based on your state.
- Once you have entered your Home location, select the “Save Home” button located on the lower left-hand side of your touchscreen.
- To delete a saved Home location (or other saved locations), so you can save a new Home location, press the “Nav” button on the touchscreen, and in the “Where To” screen, press “Edit Where To” and then press the “Home” button on the touchscreen. Under the Manage screen press the “Reset Location” button. A confirmation screen will appear asking if you “Are you sure you want to reset this location?” Press “Reset” to confirm the deletion. Set a new Home location by following the previous instructions.

## Home

- A Home location must be saved in the system.  
From the Main Navigation menu, press the “Home” button on the touchscreen.

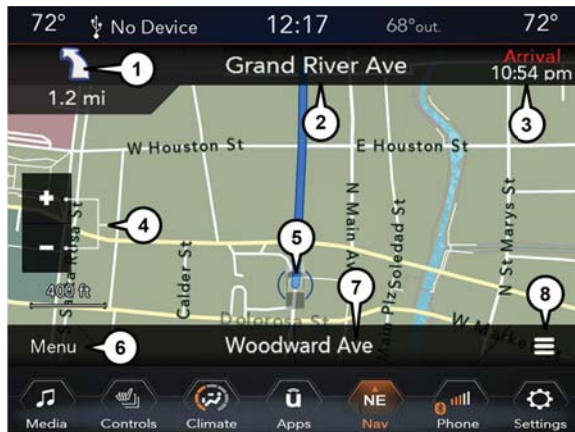

Uconnect 4C NAV With 8.4-inch Display Map

- 1 — Distance To Next Turn
- 2 — Next Turn Street
- 3 — Estimated Time Of Arrival
- 4 — Zoom In And Out

- 5 — Your Location On The Map
- 6 — Navigation Main Menu
- 7 — Current Street Location
- 8 — Navigation Routing Options



Your route is marked with a blue line on the map. If you depart from the original route, your route is recalculated. A speed limit icon could appear as you travel on major roadways.

### Adding A Stop

- To add a stop you must be navigating a route.
- Press the “Menu” button on the touchscreen to return to the Main Navigation menu.
- Press the “Where To?” button on the touchscreen, then search for the extra stop. When another location has been selected, you can choose to cancel your previous route, add as the first destination or add as the last destination.
- Press the desired selection and press the “GO!” button on the touchscreen.

### Taking A Detour

- To take a detour you must be navigating a route.
- Press the “Detour” button on the touchscreen.

#### NOTE:

If the route you are currently taking is the only reasonable option, the device may not calculate a detour. For more information, see your Uconnect Owner's Manual Supplement.

### SiriusXM Traffic Plus

(4C NAV With 8.4-inch Display)

#### Don't Drive Through Traffic. Drive Around It.

Avoid congestion before you reach it. By enhancing your vehicle's navigation system with the ability to see detailed traffic information, you can pinpoint traffic incidents, determine average traffic speed and estimate travel time along your route. Since the service is integrated with a vehicle's navigation system, SiriusXM Traffic Plus can help drivers pick the fastest route based on traffic conditions.

- Detailed information on traffic speed, accidents, construction, and road closings.
- Traffic information from multiple sources, including police and emergency services, cameras and road sensors.
- Coast-to-coast delivery of traffic information.
- View conditions for points along your route and beyond. Available in over 130 markets.

### SiriusXM Travel Link

(4C NAV With 8.4-inch Display)

In addition to delivering over 130 channels of the best sports, entertainment, talk, and commercial-free music, SiriusXM offers premium data services that work in conjunction with compatible navigation systems. SiriusXM Travel Link brings a wealth of useful information into your vehicle and right to your fingertips.

- **Fuel Prices** — Check local gas and diesel prices in your area and route to the station of your choice.

- **Movie Listings** — Check local movie theatres and listings in your area and route to the theater of your choice.
- **Sports Scores** — In-game and final scores as well as weekly schedules.
- **Weather** — Check variety of local and national weather information from radar maps to current and 5-day forecast.

SiriusXM Travel Link feature is completely integrated into your vehicle. A few minutes after you start your vehicle, Travel Link information arrives and updates in the background. You can access the information whenever you like, with no waiting.

To access SiriusXM Travel Link, press “Apps” button on the touchscreen, then press the “SiriusXM Travel Link” button on the touchscreen.

**NOTE:**

SiriusXM Travel Link requires a subscription, sold separately after the trial subscription included with your vehicle purchase.



## UCONNECT PHONE

Uconnect Phone (Bluetooth Hands Free Calling)



Uconnect 3 With 5-inch Display Radio Phone Menu

- 1 — Call/Redial/Hold
- 2 — Mobile Phone Signal Strength
- 3 — Currently Paired Mobile Phone
- 4 — Mobile Phone Battery Life
- 5 — Mute Microphone
- 6 — Transfer To/From Uconnect System

- 7 — Uconnect Phone Settings Menu
- 8 — Text Messaging
- 9 — Direct Dial Pad
- 10 — Recent Call Log
- 11 — Browse Phone Book
- 12 — End Call





**Uconnect 4 With 7-inch Display Radio Phone Menu**

- 1 — Favorite Contacts
- 2 — Mobile Phone Battery Life
- 3 — Currently Paired Mobile Phone
- 4 — Siri
- 5 — Mute Microphone
- 6 — Transfer To/From Uconnect System
- 7 — Conference Call\*
- 8 — Phone Settings
- 9 — Text Messaging\*\*
- 10 — Direct Dial Pad

- 11 — Recent Call Log
- 12 — Browse Phone Book Entries
- 13 — End Call
- 14 — Call/Redial/Hold
- 15 — Do Not Disturb
- 16 — Reply with Text Message

\* — Conference call feature only available on GSM mobile devices

\*\* — Text messaging feature not available on all mobile phones (requires Bluetooth MAP profile)





**Uconnect 4C/4C NAV With 8.4-inch Display Radio Phone Menu**

- 1 — Currently Paired Mobile Phone
- 2 — Mobile Phone Signal Strength
- 3 — Do Not Disturb
- 4 — Reply with Text Message\*\*
- 5 — Current Phone Contact's Name
- 6 — Conference Call\*
- 7 — Phone Pairing
- 8 — Text Messaging Menu\*\*
- 9 — Direct Dial Pad
- 10 — Contact Menu
- 11 — Recent Call Log

- 12 — Favorite Contacts
- 13 — Mute Microphone
- 14 — Decline Incoming Call
- 15 — Answer/Redial/Hold
- 16 — Mobile Phone Battery Life
- 17 — Transfer To/From Uconnect System
- \* — Conference call feature only available on GSM mobile devices

\*\* — Text messaging feature not available on all mobile phones (requires Bluetooth MAP profile)

The Uconnect Phone feature enables you to place and receive hands-free mobile phone calls. Drivers can also place mobile phone calls using their voice or by using the buttons on the touchscreen (see Voice Command section).

The hands-free calling feature is made possible through Bluetooth technology — the global standard that enables different electronic devices to connect to each other wirelessly.

If the Uconnect Phone Button  exists on your steering wheel, you then have the Uconnect Phone features.

**NOTE:**

- The Uconnect Phone requires a mobile phone equipped with the Bluetooth Hands-Free Profile, Version 1.0 or higher.
- Most mobile phones/devices are compatible with the Uconnect system, however some mobile phones/devices may not be equipped with all of the required features to utilize all of the Uconnect system features.

- For Uconnect Customer Care:
- U.S. residents visit [UconnectPhone.com](http://UconnectPhone.com) or call 1-877-855-8400.

**Pairing (Wirelessly Connecting) Your Mobile Phone To The Uconnect System**

Mobile phone pairing is the process of establishing a wireless connection between a cellular phone and the Uconnect system.

**NOTE:**

- To use the Uconnect Phone feature, you first must determine if your mobile phone and software are compatible with the Uconnect system. Please visit [UconnectPhone.com](http://UconnectPhone.com) for complete mobile phone compatibility information.
- Mobile phone pairing is not available while the vehicle is in motion.
- A maximum of ten mobile phones can be paired to the Uconnect system.

**Start Pairing Procedure On The Radio**

**Uconnect 3 With 5–inch Display:**



**Uconnect 3**

1. Place the ignition in the ACC or ON position.
2. Press the “Phone” button.
3. Select “Settings.”
4. Select “Paired Phones.”
5. Select “Add device.”
  - Uconnect Phone will display an “In progress” screen while the system is connecting.



### Uconnect 4 With 7-inch Display:



**Uconnect 4**

1. Place the ignition in the ACC or ON position.
2. Press the “Phone” button in the Menu Bar on the touchscreen. A message will display asking “No phone connected. Do you want to pair a phone?” Select Yes.
3. After selecting “Yes,” go through the steps to pair your phone using your Bluetooth connectivity.
4. Once pairing is successful, a message will display asking, “Make this your Favorite?” Then select Yes or No.

### Uconnect 4C/4C NAV With 8.4-inch Display:



**Uconnect 4C/4C NAV**

1. Place the ignition in the ACC or ON position.
2. Press the “Phone” button in the Menu Bar on the touchscreen.
  - A message will display asking, “No Phone Connected. Would you like to pair a phone?” Select Yes. After pressing Yes, the radio prompts will take you through the steps to connect your phone via Bluetooth.

- Uconnect Phone will display an “In progress” screen while the system is connecting. Once the pairing has been successful, a message will display “Bluetooth pairing successful: The device supports Phone and Audio.” Click “OK.”

3. Select “Settings.”
4. Select “Phone/Bluetooth,” and then select “Paired Phones and Audio Devices.”

5. The “Add Device” option will be listed under the “Paired Phones” section.

#### Pair Your iPhone:



**Bluetooth On/Uconnect Device**

To search for available devices on your Bluetooth enabled iPhone:

1. Press the Settings button.

2. Select Bluetooth.

- Ensure the Bluetooth feature is enabled. Once enabled, the mobile phone will begin to search for Bluetooth connections.

3. When your mobile phone finds the Uconnect system, select “Uconnect”.

#### Complete The iPhone Pairing Procedure:



**Pairing Request**

1. When prompted on the mobile phone, accept the connection request from Uconnect Phone.

#### NOTE:

Some mobile phones will require you to enter the PIN number.

#### Select The iPhone's Priority Level

When the pairing process has successfully completed, the system will prompt you to choose whether or not this is your favorite mobile phone. Selecting “Yes” will make this mobile phone the highest priority. This mobile phone will take precedence over other paired mobile phones within range and will connect to the Uconnect system automatically when entering the vehicle. Only one mobile phone and/or one Bluetooth audio device can be connected to the Uconnect system at a time. If “No” is selected, simply select “Uconnect” from the mobile phone/audio device Bluetooth screen, and the Uconnect system will reconnect to the Bluetooth device.



**Pair Your Android Device:****Uconnect Device**

To search for available devices on your Bluetooth enabled Android Device:

1. Push the Menu button.
2. Select Settings.
3. Select Connections.
4. Turn Bluetooth setting to “On.”
  - Ensure the Bluetooth feature is enabled. Once enabled, the mobile phone will begin to search for Bluetooth connections.

5. Once your mobile phone finds the Uconnect system, select “Uconnect”.

- You may be prompted by your mobile phone to download the phonebook, check “Do Not Ask Again” to automatically download the phonebook. This is so you can make calls by saying the name of your contact.

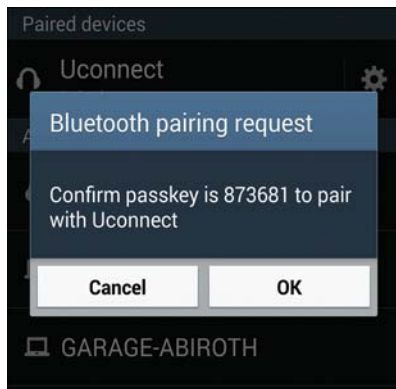
**Complete The Android Pairing Procedure:****Pairing Request**

1. Confirm the passkey shown on the mobile phone matches the passkey shown on the Uconnect system then accept the Bluetooth pairing request.

**NOTE:**

Some mobile phones require the PIN to be entered manually, enter the PIN number shown on the Uconnect screen.

**Select The Android Mobile Phone's Priority Level**

When the pairing process has successfully completed, the system will prompt you to choose whether or not this is your favorite mobile phone. Selecting “Yes” will make this mobile phone the highest priority. This mobile phone will take precedence over other paired mobile phones within range and will connect to the Uconnect system automatically when entering the vehicle. Only one mobile phone and/or one Bluetooth audio device can be connected to the Uconnect system at a time. If “No” is selected, simply select “Uconnect” from the mobile phone/audio device Bluetooth screen, and the Uconnect system will reconnect to the Bluetooth device.

## NOTE:

Keep in mind that software updates – either on your phone or Uconnect system – may interfere with the Bluetooth connection. If this happens, simply repeat the pairing process. However, first, make sure to delete the device from the list of phones on your Uconnect system. Next, be sure to remove Uconnect from the list of devices in your phone's Bluetooth settings.

You are now ready to make hands-free calls. Press the Uconnect “Phone” button  on your steering wheel to begin.

## NOTE:

Refer to [UconnectPhone.com](http://UconnectPhone.com) or [www.DriveUconnect.com](http://www.DriveUconnect.com) (U.S. Residents) or [www.DriveUconnect.ca](http://www.DriveUconnect.ca) (Canadian Residents) or an authorized dealer for additional information on mobile phone pairing and for a list of compatible phones.

## Common Phone Commands (Examples)

- “Call John Smith”
- “Call John Smith mobile”
- “Dial 1 248 555 1212”

- “Redial”

## Mute (Or Unmute) Microphone During Call

- During a call, press the “Mute” button on the Phone main screen, that appears only when a call is in progress, to mute and unmute the call.

## Transfer Ongoing Call Between Handset And Vehicle

- During an on-going call, press the “Transfer” button on the Phone main screen to transfer an on-going call between handset and vehicle.

## Phonebook

The Uconnect system will automatically sync your phonebook from your paired phone, if this feature is supported by your phone. Phonebook contacts are updated each time that the phone is connected. Phonebook entries are displayed in the Contacts menu. If your phone book entries do not appear, check the settings on your phone. Some phones require you to enable this feature manually.

- Your phonebook can be browsed on the Uconnect system touchscreen, but editing can only be done on your phone. To browse, press the “Phone” button on the touchscreen, then the “Phonebook” button on the touchscreen.

Favorite phonebook entries can be saved as Favorites for quicker access. Favorites are shown in the Favorites menu.

## Voice Command Tips

- Speaking complete names (i.e; Call John Doe vs. Call John) will result in greater system accuracy.
- You can “link” commands together for faster results. Say “Call John Doe, mobile,” for example.
- If you are listening to available voice command options, you do not have to listen to the entire list. When you hear the command that you need, push the  button on the steering wheel, wait for the beep and say your command.





## Changing The Volume

- Start a dialogue by pushing the VR button , then say a command. For example, "Help".
- Use the radio VOLUME/MUTE rotary knob to adjust the volume to a comfortable level while the Uconnect system is speaking.

### NOTE:

The volume setting for Uconnect is different than the audio system.

### NOTE:

To access help, push the VR button  on the steering wheel and say "help." Push the VR button  and say "cancel" to cancel the help session.

## Using Do Not Disturb

With Do Not Disturb, you can disable notifications from incoming calls and texts, allowing you to keep your eyes on the road and hands on the wheel. For your convenience, there is a counter display to keep track of your missed calls and text messages while you were using Do Not Disturb.

To activate Do Not Disturb, select "Pairing" on the phone menu bar, and select "Do Not Disturb" from the Settings menu. You can also activate it using the "Do Not Disturb" button at the top of every Phone screen.

Do Not Disturb can automatically reply with a text message, a call or both, when declining an incoming call and send it to voicemail.

Automatic reply messages can be:

- "I am driving right now, I will get back to you shortly."
- Create a custom auto reply message up to 160 characters.

While in Do Not Disturb, Conference Call can be selected so you can still place a second call without being interrupted by incoming calls.

### NOTE:

- Only the beginning of your custom message will be seen on the touchscreen.
- Reply with text message is not compatible with iPhones.

- Auto reply with text message is only available on phones that supporting Bluetooth MAP.

## Incoming Text Messages

After pairing your Uconnect system with a Bluetooth enabled mobile device with the Message Access Profile (MAP), the Uconnect system can announce a new incoming text message and read it to you over the vehicle's audio system.

To listen to incoming text messages, or any messages currently on the mobile phone, select the "Messages" menu and press the "Listen" button next to the message you want to listen to.

### NOTE:

Only incoming text messages received during the current ignition cycle can be viewed/read.

### To Enable Incoming Text Messaging:

#### iPhone

1. Press the settings button on the mobile phone.
2. Select Bluetooth.



- Ensure Bluetooth is enabled, and the mobile phone is paired to the Uconnect system.
3. Select ⓘ located under DEVICES next to Uconnect.
  4. Turn “Show Notifications” to on.



#### Enable iPhone Incoming Text Messages

#### Android Devices

1. Push the Menu button on the mobile phone.

2. Select Settings.
3. Select Connections.
4. Turn “Show Notifications” to on.

- A pop up will appear asking you to accept a request for permission to connect to your messages. Select “Don’t ask again” and press OK.

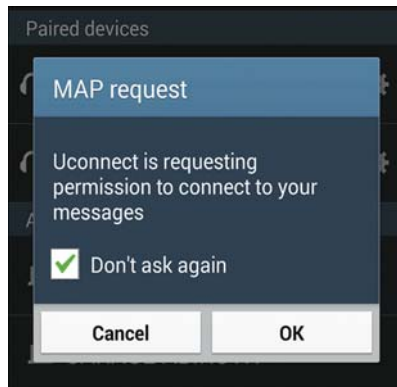

#### Enable Android Device Incoming Text Messages

#### NOTE:

All incoming text messages received during the current ignition cycle will be deleted from the Uconnect system when the ignition is turned to the OFF position.

#### Helpful Tips And Common Questions To Improve Bluetooth Performance With Your Uconnect System

##### Mobile Phone won't reconnect to system after pairing:

- Set mobile phone to auto-connect or trusted device in mobile phone Bluetooth settings (Blackberry devices).
- Many mobile phones do not automatically reconnect after being restarted (hard reboot). Your mobile phone can still be connected manually. Close all applications that may be operating (refer to mobile phone manufacturer's instructions), and follow “Pairing (Wirelessly Connecting) Your Mobile Phone To The Uconnect System”.



- Perform a factory reset on your mobile phone. Refer to your mobile phone manufacturer or cellular provider for instructions. This should only be done as a last resort.

#### Mobile Phone won't pair to system:

- Delete pairing history in mobile phone and Uconnect system; usually found in phone's Bluetooth connection settings.
- Verify you are selecting "Uconnect" in the discovered Bluetooth devices on your mobile phone.
- If your vehicle system generates a pin code the default is 0000.
- Perform a hard reset in the mobile phone by removing the battery (if removable — see your mobile phone's owner manual). This should only be done as a last resort.

#### Mobile Phonebook didn't download:

- Check "Do not ask again," then accept the "phonebook download" request on your mobile phone.
- Up to 5,000 contact names with four numbers per contact will transfer to the Uconnect 4C/4C NAV system phonebook.

- Up to 2,000 contact names with six numbers per contact will transfer to the Uconnect 4 system phonebook.

#### Can't make a conference call:

- CDMA (Code-Division Multiple Access) carriers do not support conference calling. Refer to your mobile phone user's manual for further information.

#### Making calls while connected to AUX:

- Plugging in your mobile phone to AUX while connected to Bluetooth will disable Hands-Free Calling. Do not make calls while your mobile phone is plugged into the AUX jack.

## UCONNECT VOICE RECOGNITION QUICK TIPS

### Introducing Uconnect

Start using Uconnect Voice Recognition with these helpful quick tips. It provides the key Voice Commands and tips you need to know to control your Uconnect 3, Uconnect 4, or Uconnect 4/4C NAV system.

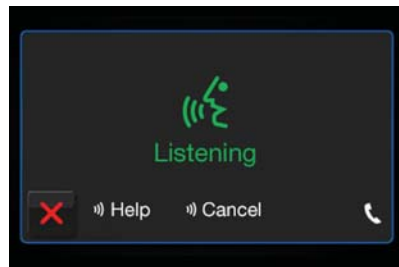

Uconnect 3 With 5-inch Display  
Radio Visual Cues

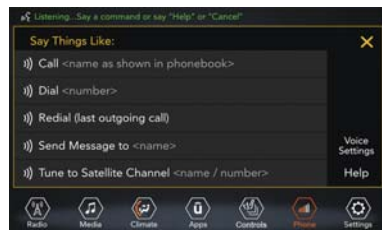

Uconnect 4



### Uconnect 4C NAV

If you see the NAV icon on the bottom bar or in the Apps menus of your 8.4-inch touchscreen, you have the Uconnect 4C NAV system. If not, you have a Uconnect 4C with 8.4-inch display system.

### Get Started

All you need to control your Uconnect system with your voice are the buttons on your steering wheel.

1. Visit [UconnectPhone.com](http://UconnectPhone.com) to check mobile device and feature compatibility and to find phone pairing instructions.
2. Reduce background noise. Wind and passenger conversations are examples of noise that may impact recognition.
3. Speak clearly at a normal pace and volume while facing straight ahead. The microphone is positioned on the rearview mirror and aimed at the driver.
4. Each time you give a Voice Command, you must first push either the Voice Recognition (VR) or Phone button, wait until **after** the beep, then say your Voice Command.
5. You can interrupt the help message or system prompts by pushing the VR or Phone button and saying a Voice Command from current category.



### Uconnect Voice Command Buttons — If Equipped

- 1 — Push To Initiate Or To Answer A Phone Call, Send Or Receive A Text
- 2 — For All Radios: Push To Begin Radio Or Media Functions.  
For 8.4-inch Displays Only: Push To Begin Navigation, Apps And Climate Functions.
- 3 — Push To End Call



## Basic Voice Commands

The basic Voice Commands below can be given at any point while using your Uconnect system.

Push the VR button . After the beep, say:

- **“Cancel”** to stop a current voice session
- **“Help”** to hear a list of suggested Voice Commands
- **“Repeat”** to listen to the system prompts again

Notice the visual cues that inform you of your voice recognition system’s status. Cues appear on the touchscreen.

## Radio

Use your voice to quickly get to the AM, FM or SiriusXM Satellite Radio stations you would like to hear. (Subscription or included SiriusXM Satellite Radio trial required.)

Push the VR button . After the beep, say:

- **“Tune to ninety-five-point-five FM”**

## • “Tune to Satellite Channel Hits 1”

**TIP:** At any time, if you are not sure of what to say or want to learn a Voice Command, push the VR button  and say **“Help.”** The system provides you with a list of commands.



Uconnect 3 Radio



Uconnect 4 Radio



Uconnect 4C/4C NAV Radio

## Media

Uconnect offers connections via USB, Bluetooth and auxiliary ports (If Equipped). Voice operation is only available for connected USB and AUX devices. (Remote CD player optional and not available on all vehicles.)

Push the VR button . After the beep, say one of the following commands and follow the prompts to switch your media source or choose an artist.

- **“Change source to Bluetooth”**
- **“Change source to AUX”**

- “Change source to USB”
- “Play artist Beethoven”; “Play album Greatest Hits”; “Play song Moonlight Sonata”; “Play genre Classical”

**TIP:** Press the Browse button on the touchscreen to see all of the music on your USB device. Your Voice Command must match **exactly** how the artist, album, song and genre information is displayed.

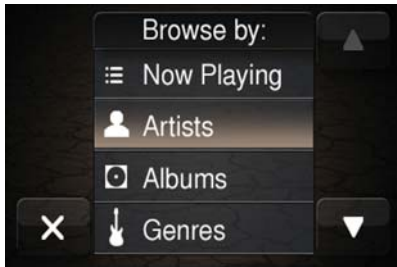

Uconnect 3 Media

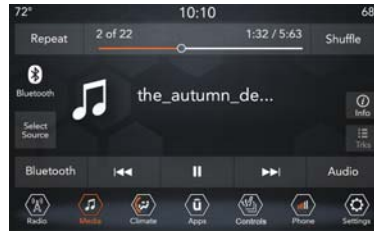

Uconnect 4 Media



Uconnect 4C/4C NAV Media

## Phone

Making and answering hands-free phone calls is easy with Uconnect. When the Phonebook button is illuminated on your touchscreen, your system is ready. Check [UconnectPhone.com](http://UconnectPhone.com) for mobile phone compatibility and pairing instructions.

Push the VR button  and the Phone button. After the beep, say one of the following commands:

- “Call John Smith”
- “Dial 123-456-7890 and follow the system prompts”
- “Redial (call previous outgoing phone number)”
- “Call back (call previous incoming phone number)”



**TIP:** When providing a Voice Command, push the VR button  and the Phone button and say **“Call,”** then pronounce the name **exactly** as it appears in your phone book. When a contact has multiple phone numbers, you can say **“Call John Smith work.”**



Uconnect 3 Phone





Uconnect 4 Phone



Uconnect 4C/4C NAV Phone

### Voice Text Reply

Uconnect announces **incoming** text messages. Push the Phone button  and say **“Listen.”** (Must have compatible mobile phone paired to Uconnect system.)

1. Once an incoming text message is read to you, push the Phone button . After the beep, say: **“Reply.”**
2. Listen to the Uconnect prompts. After the beep, repeat one of the pre-defined messages and follow the system prompts.

PRE-DEFINED VOICE TEXT REPLY RESPONSES		
Yes.	Stuck in traffic.	See you later.
No.	Start without me.	I'll be late.
Okay.	Where are you?	I will be <number> minutes late.
Call me.	Are you there yet?	
I'll call you later.	I need directions.	See you in <number> of minutes.
I'm on my way.	Can't talk right now.	
I'm lost.		Thanks.

**TIP:** Your mobile phone must have the full implementation of the **Message Access Profile (MAP)** to take advantage of this feature. For details about MAP, visit [UconnectPhone.com](http://UconnectPhone.com).

Apple iPhone iOS 6 or later supports reading **incoming** text messages only. To enable this feature on your Apple iPhone, follow these four simple steps:



### iPhone Notification Settings

- 1 — Select “Settings”
- 2 — Select “Bluetooth”
- 3 — Select The (i) For The Paired Vehicle
- 4 — Turn On “Show Notifications”

**TIP:** Voice Text Reply is not compatible with iPhone, but if your vehicle is equipped with Siri Eyes Free, you can use your voice to send a text message.

## Climate

Too hot? Too cold? Adjust vehicle temperatures hands-free and keep everyone comfortable while you keep moving ahead. (If vehicle is equipped with climate control.)

Push the VR button (⌘). After the beep, say one of the following commands:

- “Set driver temperature to 70 degrees”
- “Set passenger temperature to 70 degrees”

**TIP:** Voice Command for Climate may only be used to adjust the interior temperature of your vehicle. Voice Command will not work to adjust the heated seats or steering wheel if equipped.



Uconnect 4 With 7-inch Display Climate



Uconnect 4C/4C NAV With 8.4-Inch Display Climate

## Navigation (4C NAV)

The Uconnect navigation feature helps you save time and become more productive when you know exactly how to get to where you want to go.

1. To enter a destination, push the VR button (⌘). After the beep, say: “**Find address** 800 Chrysler Drive Auburn Hills, Michigan.”
2. Then follow the system prompts.



**TIP:** To start a POI search, push the VR button (📍). After the beep, say: “**Find nearest** coffee shop.”



**Uconnect 4C NAV Navigation**

### SiriusXM Guardian (4C/4C NAV)— If Equipped

#### CAUTION!

Some SiriusXM Guardian services, including SOS Call and Roadside Assistance Call will NOT work without an operable LTE (voice/data) or 3G or 4G (data) network connection compatible with your device.

#### NOTE:

Your vehicle may be transmitting data as authorized by the subscriber.

An included trial and/or subscription is required to take advantage of the SiriusXM Guardian services in the next section of this guide. To register with SiriusXM Guardian, press the Apps button on the Uconnect 4C/4C NAV touchscreen to get started.

#### NOTE:

SiriusXM Guardian is available only on equipped vehicles purchased within the continental United States, Alaska, Hawaii and Canada. Services can only be used where coverage is available; see coverage map for details.

**CALL SOS** SOS Call

- 🚨 Theft Alarm Notification
- 🔒 Remote Door Lock/Unlock
- 👤 Send & Go
- 📍 Vehicle Finder
- 🚗 Stolen Vehicle Assistance
- 🔑 Remote Vehicle Start\*\*
- 📻 Remote Horn & Lights
- 🚑 Roadside Assistance Call

Vehicle Health Reports\*\*

Vehicle Health Alert\*\*

Performance Pages Plus\*\*

\*\*If vehicle is equipped.

### Register (4C/4C NAV)

To unlock the full potential of SiriusXM Guardian in your vehicle, you must activate your SiriusXM Guardian services.

1. Press the Apps icon on the bottom of your in-vehicle touchscreen.
  2. Select the Activate Services icon from your list of apps.
  3. Select “Customer Care” to speak with a SiriusXM Guardian Customer Care agent who will activate services in your vehicle, or select “Enter Email” to activate on the web.
- U.S. residents visit:  
[www.siriusxm.com/guardian](http://www.siriusxm.com/guardian).
  - Canadian residents visit:  
[www.siriusxm.ca/guardian](http://www.siriusxm.ca/guardian).



## Vehicle Health Report/Alert (4C/4C NAV)

Your vehicle will send you a monthly email report, which summarizes the performance of your vehicle's key systems so you can stay on top of your vehicle's maintenance needs if you are registered for SiriusXM Guardian. Your vehicle will also send you Vehicle Health Alerts when it detects issues with its key systems that need your attention. For further information, refer to your Uconnect Owner's Manual Supplement.

## Mobile App (4C/4C NAV)

You're only a few steps away from using remote commands and sending a destination from your phone to your vehicle.



Mobile App

To use the Uconnect Mobile App:

- Once you have registered your SiriusXM Guardian services, download the Uconnect App to your mobile device. Use your Owner Account login and password to open the app.
- Once on the “Remote” screen, you can begin using Remote Door Lock/Unlock, Remote Vehicle Start, and activate your horn and lights remotely, if equipped.

- Press the “Location” button on the bottom menu bar of the app to bring up a map to locate your vehicle or send a location to your Uconnect Navigation using Vehicle Finder and Send & Go , if equipped.
- Press the “Settings” side menu in the upper left corner of the app to bring up app settings.

### NOTE:

For further information please visit [DriveUconnect.com](http://DriveUconnect.com) (U.S. Residents) or [DriveUconnect.ca](http://DriveUconnect.ca) (Canadian Residents).

## SiriusXM Travel Link (4C NAV)

Need to find a gas station, view local movie listings, check a sports score or the 5 - day weather forecast? SiriusXM Travel Link is a suite of services that brings a wealth of information right to your Uconnect 4C NAV system. (Not available for Uconnect 4 system.)

Push the VR button (Ⓜ️). After the beep, say one of the following commands:

- “Show fuel prices”
- “Show 5 - day weather forecast”
- “Show extended weather”



**TIP:** Traffic alerts are not accessible with Voice Command.



SiriusXM Travel Link

### Siri Eyes Free – If Equipped

Siri lets you use your voice to send text messages, select media, place phone calls and much more. Siri uses your natural language to understand what you mean and responds back to confirm your requests. The system is designed to keep your eyes on the road and your hands on the wheel by letting Siri help you perform useful tasks.

To enable Siri, push and hold, then release the Uconnect Voice Recognition (VR) button on the steering wheel. After you hear a double beep you can ask Siri to play podcasts and music, get directions, read text messages and many other useful requests.



Uconnect 4 Siri Eyes Free Available



Uconnect 4C/4C NAV With 8.4-inch Siri Eyes Free Available

### Using Do Not Disturb

With Do Not Disturb, you can disable notifications from incoming calls and texts, allowing you to keep your eyes on the road and hands on the wheel. For your convenience, there is a counter display to keep track of your missed calls and text messages while you were using Do Not Disturb.

Do Not Disturb can automatically reply with a text message, a call or both, when declining an incoming call and send it to voicemail.

Automatic reply messages can be:

- “I am driving right now, I will get back to you shortly.”
- Create a custom auto reply message up to 160 characters.

While in Do Not Disturb, Conference Call can be selected so you can still place a second call without being interrupted by incoming calls.

#### NOTE:

- Only the beginning of your custom message will be seen on the touchscreen.

- Reply with text message is not compatible with iPhones.
- Auto reply with text message is only available on phones that supporting Bluetooth MAP.

### Android Auto – If Equipped

#### NOTE:

Feature availability depends on your carrier and mobile phone manufacturer. Some Android Auto features may or may not be available in every region and/or language.

Android Auto allows you to use your voice to interact with Android’s best-in-class speech technology through your vehicle’s voice recognition system, and use your smartphone’s data plan to project your Android powered smartphone and a number of its apps onto your Uconnect touchscreen. Connect your Android 5.0 (Lollipop), or higher, to one of the media USB ports, using the factory-provided USB cable, and press the new Android Auto icon that replaces your “Phone” icon on the main menu bar to begin Android Auto.

Push and hold the VR button on the steering wheel, or press and hold the “Microphone” icon within Android Auto, to activate Android’s VR, which recognizes natural voice commands, to use a list of your smartphone’s features:

- Maps
- Music
- Phone
- Text Messages
- Additional Apps

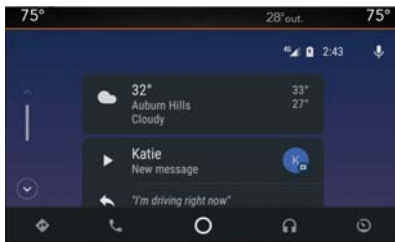

Android Auto On 7-inch Display



Android Auto On 8.4-inch Display

Refer to your Uconnect Owner’s Manual Supplement for further information.

#### NOTE:

Requires compatible smartphone running Android™ 5.0 Lollipop or higher and download app on Google Play. Android, Android Auto, and Google Play are trademarks of Google Inc.

### Apple CarPlay – If Equipped

#### NOTE:

Feature availability depends on your carrier and mobile phone manufacturer. Some Apple CarPlay features may or may not be available in every region and/or language.



Apple CarPlay allows you to use your voice to interact with Siri through your vehicle's voice recognition system, and use your smartphone's data plan to project your iPhone and a number of its apps onto your Uconnect touchscreen. Connect your iPhone 5, or higher, to one of the media USB ports, using the factory-provided Lightning cable, and press the new CarPlay icon that replaces your "Phone" icon on the main menu bar to begin Apple CarPlay. Press and hold the VR button on the steering wheel, or press and hold the "Home" button within Apple CarPlay, to activate Siri, which recognizes natural voice commands to use a list of your iPhone's features:

- Phone
- Music
- Messages
- Maps
- Additional Apps



Apple CarPlay On 7-inch Display



Apple CarPlay On 8.4-inch Display

Refer to your Uconnect Owner's Manual Supplement for further information.

#### NOTE:

Requires compatible iPhone. See dealer for phone compatibility. Data plan rates apply. Vehicle user interface is a product of Apple®. Apple CarPlay is a trademark of Apple Inc. iPhone is a trademark of Apple Inc., registered in the US and other countries. Apple terms of use and privacy statements apply.

#### General Information

The following regulatory statement applies to all Radio Frequency (RF) devices equipped in this vehicle:

This device complies with Part 15 of the FCC Rules and with Industry Canada license-exempt RSS standard(s). Operation is subject to the following two conditions:

1. This device may not cause harmful interference, and
2. This device must accept any interference received, including interference that may cause undesired operation.

**NOTE:**

Changes or modifications not expressly approved by the party responsible for compliance could void the user's authority to operate the equipment.

**Additional Information**

© 2018 FCA US LLC. All rights reserved. Mopar and Uconnect are registered trademarks and Mopar Owner Connect is a trademark of FCA US LLC. Android is a trademark of Google Inc. SiriusXM and all related marks and logos are trademarks of SiriusXM Radio Inc.

**Uconnect System Support:**

- U.S. residents visit [DriveUconnect.com](http://DriveUconnect.com) or call: 1-877-855-8400 (24 hours a day 7 days a week)
- Canadian residents visit [DriveUconnect.ca](http://DriveUconnect.ca) or call: 1-800-465-2001 (English) or 1-800-387-9983 (French)

**SiriusXM Guardian services support:**

- U.S. residents visit [www.siriusxm.com/guardian](http://www.siriusxm.com/guardian) or call: 1-844-796-4827
- Canadian residents visit [www.siriusxm.ca/guardian](http://www.siriusxm.ca/guardian) or call: 1-877-324-9091





# CUSTOMER ASSISTANCE

## IF YOU NEED ASSISTANCE . . . .326

FCA US LLC Customer Center . . . . .	326
FCA Canada Inc. Customer Center . . . .	326
In Mexico Contact . . . . .	326
Puerto Rico And U.S. Virgin Islands . .	326
Customer Assistance For The Hearing Or Speech Impaired (TDD/TTY) . . . . .	327
Service Contract . . . . .	327

## WARRANTY INFORMATION . . . .328

### MOPAR PARTS . . . . .328

### REPORTING SAFETY DEFECTS . . . . .328

In The 50 United States And Washington, D.C. . . . .	328
In Canada . . . . .	328

## PUBLICATION ORDER FORMS . . . . .329



## IF YOU NEED ASSISTANCE

The manufacturer and its authorized dealer are vitally interested in your satisfaction. We want you to be happy with our products and services.

Warranty service must be done by an authorized dealer. We strongly recommend that you take the vehicle to an authorized dealer. They know your vehicle the best, and are most concerned that you get prompt and high quality service. The manufacturer's authorized dealer have the facilities, factory-trained technicians, special tools, and the latest information to ensure the vehicle is fixed correctly and in a timely manner.

This is why you should always talk to an authorized dealer service manager first. Most matters can be resolved with this process.

- If for some reason you are still not satisfied, talk to the general manager or owner of the authorized dealer. They want to know if you need assistance.

- If an authorized dealer is unable to resolve the concern, you may contact the manufacturer's customer center.

Any communication to the manufacturer's customer center should include the following information:

- Owner's name and address
- Owner's telephone number (home and office)
- Authorized dealer name
- Vehicle Identification Number (VIN)
- Vehicle delivery date and mileage

### FCA US LLC Customer Center

P.O. Box 21-8004

Auburn Hills, MI 48321-8004

Phone: (877) 426-5337

### FCA Canada Inc. Customer Center

P.O. Box 1621

Windsor, Ontario N9A 4H6

Phone: (800) 465-2001 English /  
(800) 387-9983 French

### In Mexico Contact

Av. Prolongacion Paseo de la Reforma, 1240  
Sante Fe C.P. 05109

Mexico, D. F.

In Mexico City: 800-505-1300

Outside Mexico City: +(52)55 50817568

### Puerto Rico And U.S. Virgin Islands

FCA Caribbean LLC

P.O. Box 191857

San Juan 00919-1857

Phone: (877) 426-5337

Fax: (787) 782-3345



## Customer Assistance For The Hearing Or Speech Impaired (TDD/TTY)

To assist customers who have hearing difficulties, the manufacturer has installed special TDD (Telecommunication Devices for the Deaf) equipment at its customer center. Any hearing or speech impaired customer, who has access to a TDD or a conventional teletypewriter (TTY) in the United States, can communicate with the manufacturer by dialing 1-800-380-CHRY.

Canadian residents with hearing difficulties that require assistance can use the special needs relay service offered by Bell Canada. For TTY teletypewriter users, dial 711 and for Voice callers, dial 1-800-855-0511 to connect with a Bell Relay Service operator.

## Service Contract

You may have purchased a service contract for a vehicle to help protect you from the high cost of unexpected repairs after the manufacturer's New Vehicle Limited Warranty expires. The manufacturer stands behind only the manufacturer's service contracts. If you purchased a manufacturer's service contract, you will receive Plan Provisions and an Owner Identification Card in the mail within three weeks of the vehicle delivery date. If you have any questions about the service contract, call the manufacturer's Service Contract National Customer Hotline at 1-800-521-9922 (Canadian residents, call (800) 465-2001 English / (800) 387-9983 French).

The manufacturer will not stand behind any service contract that is not the manufacturer's service contract. It is not responsible for any service contract other than the manufacturer's service contract. If you purchased a service contract that is not a manufacturer's service contract, and you require service after

the manufacturer's New Vehicle Limited Warranty expires, please refer to the contract documents, and contact the person listed in those documents.

We appreciate that you have made a major investment when you purchased the vehicle. An authorized dealer has also made a major investment in facilities, tools, and training to assure that you are absolutely delighted with the ownership experience. You will be pleased with their sincere efforts to resolve any warranty issues or related concerns.

### WARNING!

Engine exhaust (internal combustion engines only), some of its constituents, and certain vehicle components contain, or emit, chemicals known to the State of California to cause cancer and birth defects, or other reproductive harm. In addition, certain fluids contained in vehicles and certain products of component wear contain, or emit, chemicals known to the State of California to cause cancer and birth defects, or other reproductive harm.



## WARRANTY INFORMATION

See the Warranty Information Booklet for the terms and provisions of FCA US LLC warranties applicable to this vehicle and market.

## MOPAR PARTS

Mopar fluids, lubricants, parts, and accessories are available from an authorized dealer. They are recommended for your vehicle in order to help keep the vehicle operating at its best.

## REPORTING SAFETY DEFECTS

### In The 50 United States And Washington, D.C.

If you believe that your vehicle has a defect that could cause a crash or cause injury or death, you should immediately inform the National Highway Traffic Safety Administration (NHTSA) in addition to notifying FCA US LLC.

If NHTSA receives similar complaints, it may open an investigation, and if it finds that a safety defect exists in a group of vehicles, it may order a recall and remedy campaign. However, NHTSA cannot become involved in individual problems between you, an authorized dealer or FCA US LLC.

To contact NHTSA, you may call the Vehicle Safety Hotline toll free at 1-888-327-4236 (TTY: 1-800-424-9153); or go to <http://www.safercar.gov>; or write to: Administrator, NHTSA, 1200 New Jersey Avenue, SE., West Building, Washington, D.C. 20590. You can also obtain other information about motor vehicle safety from <http://www.safercar.gov>.

### In Canada

If you believe that your vehicle has a safety defect, you should contact the Customer Service Department immediately. Canadian customers who wish to report a safety defect to the Canadian government should contact Transport Canada, Motor Vehicle Defect Investigations and Recalls at 1-800-333-0510 or go to <http://www.tc.gc.ca/roadsafety/>.

## PUBLICATION ORDER FORMS

- You can purchase a copy of the Owner's Manual, Navigation/Uconnect Manuals or Warranty Booklet. United States customers may visit the Jeep Contact Us page at [www.jeep.com](http://www.jeep.com) scroll to the bottom of the page and select the "Contact Us" link, then select the "Owner's Manual and Glove Compartment Material" from the left menu. You can also purchase a copy by calling 1-877-426-5337 (U.S.) or 1-800-387-1143 (Canada).
- Replacement User Guide kits or, if you prefer, additional printed copies of the Owner's Manual, Warranty Booklet or Radio Manuals may be purchased by visiting [www.techauthority.com](http://www.techauthority.com) or by calling 1-877-890-4038 (U.S.) or 1-800-387-1143 (Canada). Visa, Master Card, American Express and Discover orders are accepted.

### NOTE:

- The Owner's Manual and User Guide electronic files are also available on the Chrysler, Jeep, Ram Truck, Dodge and SRT websites.
- Click on the "For Owners" tab, select "Owner/Service Manuals". Then select your desired model year and vehicle from the drop down lists.





# INDEX

Accessories . . . . .	260	Alarm	Fluid Type . . . . .	259	
Mopar . . . . .	260	Arm The System . . . . .	19	Auxiliary Electrical Outlet	
Adding Fuel . . . . .	178	Disarm The System . . . . .	19	(Power Outlet) . . . . .	64
Additives, Fuel . . . . .	256	Security Alarm . . . . .	19, 76	Auxiliary Power Outlet . . . . .	64
Air Bag		Android Auto . . . . .	281, 287, 321	Auxiliary Switches . . . . .	67
Air Bag Operation . . . . .	116	Apps . . . . .	290	Axle Fluid . . . . .	259
Air Bag Warning Light . . . . .	113, 116	Communication . . . . .	290	Axle Lock . . . . .	164
Enhanced Accident Response . . . . .	126, 214	Maps . . . . .	289		
Event Data Recorder (EDR) . . . . .	214	Music . . . . .	290	Battery . . . . .	74, 222
Front Air Bag . . . . .	114, 116	Antifreeze (Engine Coolant) . . . . .	256	Charging System Light . . . . .	74
If Deployment Occurs . . . . .	125	Anti-Lock Brake System (ABS) . . . . .	86	Belts, Seat . . . . .	145
Knee Impact Bolsters . . . . .	123	Anti-Lock Warning Light . . . . .	76	Blind Spot Monitoring . . . . .	95
Maintaining Your Air Bag System . . . . .	127	Apple CarPlay . . . . .	283, 291, 321	B-Pillar Location . . . . .	235
Maintenance . . . . .	127	Apps . . . . .	293	Brake Assist System . . . . .	87
Redundant Air Bag Warning Light . . . . .	113	Maps . . . . .	292	Brake Control System . . . . .	87
Transporting Pets . . . . .	144	Messages . . . . .	292	Brake Fluid . . . . .	228, 259
Air Bag Light . . . . .	73, 113, 145	Music . . . . .	292	Brake System . . . . .	228
Air Conditioner Maintenance . . . . .	223	Phone . . . . .	292	Fluid Check . . . . .	228
Air Conditioner Refrigerant . . . . .	223	Assist, Hill Start . . . . .	88	Master Cylinder . . . . .	228
Air Conditioner System . . . . .	223	Audio Systems (Radio) . . . . .	276	Warning Light . . . . .	73
Air Conditioning Filter . . . . .	48, 224	Auto Down Power Windows . . . . .	49	Brake/Transmission Interlock . . . . .	157
Air Conditioning, Operating Tips . . . . .	47	Automatic Headlights . . . . .	38	Bulb Replacement . . . . .	191, 193
Air Conditioning System . . . . .	46	Automatic Temperature Control (ATC) . . . . .	46	Bulbs, Light . . . . .	146, 191
Air Pressure		Automatic Transmission . . . . .	157		
Tires . . . . .	239	Fluid Level Check . . . . .	229	Camera, Rear . . . . .	176



- Capacities, Fluid . . . . .256
- Caps, Filler
  - Fuel . . . . .178
  - Oil (Engine) . . . . .220
- Carbon Monoxide Warning . . . . .144
- Car Washes . . . . .249
- Center High Mounted Stop Light . . . .195
- Chains, Tire. . . . .246
- Changing A Flat Tire . . . . .229
- Chart, Tire Sizing . . . . .231
- Check Engine Light (Malfunction Indicator Light) . . . . .83
- Checking Your Vehicle For Safety . . .144
- Checks, Safety. . . . .144
- Child Restraint. . . . .128
- Child Restraints
  - Booster Seats . . . . .130
  - Child Seat Installation . . . . .141
  - How To Stow An unused ALR Seat Belt . . . . .138
  - Infant And Child Restraints . . . .129
  - LATCH Positions . . . . .133
  - Locating The LATCH Anchorages . .135
  - Lower Anchors And Tethers For Children . . . . .132
  - Older Children And Child Restraints . . . . .130
- Seating Positions . . . . .131
- Cleaning
  - Wheels . . . . .244
- Climate Control
  - Automatic . . . . .40
- Clock Settings . . . . .275
- Compact Spare Tire . . . . .243
- Connector
  - UCI . . . . .294
  - Universal Consumer Interface (UCI) . . . . .294
- Contract, Service . . . . .327
- Cooling System . . . . .227
  - Coolant Capacity . . . . .256
  - Inspection . . . . .228
  - Selection Of Coolant (Antifreeze) . . . . .256, 258
- Cruise Light . . . . .80, 81, 82
- Customer Assistance . . . . .326
- Cybersecurity. . . . .265
- Daytime Running Lights . . . . .37
- Dealer Service . . . . .223
- Defroster, Windshield. . . . .145
- Delay (Intermittent) Wipers . . . . .39
- Diagnostic System, Onboard . . . . .82
- Dimmer Switch, Headlight . . . . .37
- Dipsticks
  - Oil (Engine) . . . . .222
- Disabled Vehicle Towing . . . . .212
- Disturb . . . . .310, 320
- Door Ajar . . . . .74, 75
- Door Ajar Light . . . . .74, 75
- Doors . . . . .20
  - Removal . . . . .23, 26
  - Removal, Front . . . . .23
  - Removal, Rear . . . . .26
- Drag And Drop Menu . . . . .279, 285
- Driver's Seat Back Tilt . . . . .27
- Dual Top . . . . .56
- Electrical Outlet, Auxiliary (Power Outlet) . . . . .64
- Electrical Power Outlets . . . . .64
- Electric Brake Control System . . . . .87
  - Anti-Lock Brake System . . . . .86
  - Electronic Roll Mitigation . . . . .89, 92
- Electronic Speed Control (Cruise Control). . . . .172
- Electronic Stability Control (ESC) . . . .89
- Electronic Throttle Control Warning Light . . . . .74
- Emergency, In Case Of
  - Jacking . . . . .203, 229

Jump Starting . . . . .	207	Filters		Freedom Panels . . . . .	54
Tow Hooks . . . . .	214	Air Conditioning . . . . .	48, 224	Freeing A Stuck Vehicle . . . . .	211
Emission Control System		Engine Oil . . . . .	258	Fuel . . . . .	255
Maintenance . . . . .	83	Flashers		Adding . . . . .	178
Engine . . . . .	220	Hazard Warning . . . . .	186	Additives . . . . .	256
Break-In Recommendations . . . . .	152	Turn Signal . . . . .	146, 193, 194	Filler Cap (Gas Cap) . . . . .	178
Compartment . . . . .	220, 221	Turn Signals . . . . .	80	Gasoline . . . . .	255
Compartment Identification . . . . .	220, 221	Flash-To-Pass . . . . .	38	Materials Added . . . . .	256
Coolant (Antifreeze) . . . . .	258	Fluid, Brake . . . . .	259	Octane Rating . . . . .	255, 258
Cooling . . . . .	227	Fluid Capacities . . . . .	256	Requirements . . . . .	256
Exhaust Gas Caution . . . . .	144	Fluid Leaks . . . . .	146	Specifications . . . . .	258
Fuel Requirements . . . . .	255, 256	Fluid Level Checks		Tank Capacity . . . . .	256
Jump Starting . . . . .	207	Brake . . . . .	228	Fueling . . . . .	178
Oil . . . . .	256, 258	Engine Oil . . . . .	222	Fuses . . . . .	196
Oil Filler Cap . . . . .	220	Manual Transmission . . . . .	229		
Oil Reset . . . . .	71	Fluids And Lubricants . . . . .	258	Garage Door Opener (HomeLink) . . . . .	60
Oil Selection . . . . .	256	Fog Lights . . . . .	194	Gas Cap (Fuel Filler Cap) . . . . .	178, 179
Overheating . . . . .	209	Fog Light Service . . . . .	194	Gasoline (Fuel) . . . . .	255
Starting . . . . .	149	Fold And Tumble Rear Seat . . . . .	30	Gear Ranges . . . . .	153
Enhanced Accident Response		Fold-Flat Seats . . . . .	27	Glass Cleaning . . . . .	252
Feature . . . . .	126, 214	Folding Rear Seats . . . . .	29		
Exhaust Gas Caution . . . . .	144	Four-Way Hazard Flasher . . . . .	186	Hard Top . . . . .	54
Exhaust System . . . . .	144	Four Wheel Drive . . . . .	159	Hazard Warning Flasher . . . . .	186
Exterior Lights . . . . .	37, 146	Operation . . . . .	159	Headlights	
		Shifting . . . . .	159	Automatic . . . . .	38
Fabric Care . . . . .	249	Systems . . . . .	159	Bulb Replacement . . . . .	193
Fabric Top . . . . .	249	Four Wheel Drive Operation . . . . .	159, 161	Cleaning . . . . .	248



- High Beam/Low Beam
  - Select Switch . . . . . 37
  - Passing . . . . . 38
  - Replacing . . . . . 193
- Head Restraints . . . . . 32
- Heated Mirrors . . . . . 36
- High Beam/Low Beam Select
  - (Dimmer) Switch . . . . . 37
- Hill Descent Control . . . . . 93
- Hill Descent Control Indicator . . . . . 93
- Hill Start Assist . . . . . 88
- HomeLink (Garage Door Opener) . . . . . 60
- Hood Prop . . . . . 59
- Hood Release . . . . . 59
- Ignition . . . . . 16
  - Switch . . . . . 16
- Inside Rearview Mirror . . . . . 186
- Installation . . . . . 54
- Installing . . . . . 56
- Instrument Cluster
  - Descriptions . . . . . 80
  - Display . . . . . 70
  - Engine Oil Reset . . . . . 71
  - Menu Items . . . . . 72
- Instrument Panel Lens Cleaning . . . . . 252
- Integrated Power Module (Fuses) . . . . . 196
- Interior Appearance Care . . . . . 251
- Intermittent Wipers (Delay Wipers) . . . . . 39
- Introduction . . . . . 1
- In Vehicle Help
  - Vehicle User Guide . . . . . 13
- Inverter, Power . . . . . 66
- Jacking Instructions . . . . . 204
- Jack Location . . . . . 203
- Jack Operation . . . . . 204, 205, 229
- Jump Starting . . . . . 207
- Key Fob
  - Arm The System . . . . . 19
  - Disarm The System . . . . . 19
- Keyless Enter-N-Go . . . . . 20
  - Passive Entry . . . . . 20
- Keys . . . . . 14
  - Replacement . . . . . 15
- Lane Change Assist . . . . . 38
- Lap/Shoulder Belts . . . . . 106
- Latches . . . . . 146
  - Hood . . . . . 59
- Leaks, Fluid . . . . . 146
- Life Of Tires . . . . . 241
- Light Bulbs . . . . . 146, 191
- Lights . . . . . 146
  - Air Bag . . . . . 73, 113, 145
  - Automatic Headlights . . . . . 38
  - Back-Up . . . . . 194
  - Brake Assist Warning . . . . . 91
  - Brake Warning . . . . . 73
  - Bulb Replacement . . . . . 191, 193
  - Center Mounted Stop . . . . . 195
  - Cruise . . . . . 80, 81, 82
  - Daytime Running . . . . . 37
  - Dimmer Switch, Headlight . . . . . 37
  - Engine Temperature Warning . . . . . 74
  - Exterior . . . . . 146
  - Fog . . . . . 194
  - Hazard Warning Flasher . . . . . 186
  - Headlights . . . . . 193
  - High Beam . . . . . 37
  - High Beam/Low Beam Select . . . . . 37
  - Hill Descent Control Indicator . . . . . 93
  - Malfunction Indicator
    - (Check Engine) . . . . . 77
  - Park . . . . . 80
  - Passing . . . . . 38
  - Rear Servicing . . . . . 194
  - Rear Tail Lamps . . . . . 194
  - Seat Belt Reminder . . . . . 75
  - Security Alarm . . . . . 76



Service . . . . .	191, 193	Memory Feature (Memory Seats) . . . . .	27	Owner's Manual (Operator Manual) . . . . .	329
Side Marker . . . . .	194	Memory Seat . . . . .	27	Paddle Shifters . . . . .	158
Tire Pressure Monitoring (TPMS) . . . . .	98	Memory Seats And Radio . . . . .	27	ParkSense System, Rear . . . . .	174
Traction Control . . . . .	91	Mirrors . . . . .	36	Passive Entry . . . . .	20
Turn Signal . . . . .	146, 193, 194	Heated . . . . .	36	Personalized Main Menu . . . . .	279, 285
Turn Signals . . . . .	80	Rearview . . . . .	186	Pets . . . . .	144
Warning Instrument Cluster		Monitor, Tire Pressure System . . . . .	98	Phonebook . . . . .	309
Descriptions . . . . .	74, 80	Mopar Accessories . . . . .	260	Phone (Uconnect) . . . . .	302
Loading Vehicle		Mopar Parts . . . . .	328	Pairing . . . . .	305
Tires . . . . .	235	Navigation . . . . .	296	Placard, Tire And Loading	
Locking Axle . . . . .	164	New Vehicle Break-In Period . . . . .	152	Information . . . . .	235
Lowering . . . . .	50	Occupant Restraints . . . . .	104	Power	
Lowering The Top . . . . .	50	Octane Rating, Gasoline (Fuel) . . . . .	255, 258	Inverter . . . . .	66
Low Tire Pressure System . . . . .	98	Oil, Engine . . . . .	258	Windows . . . . .	48
Lug Nuts . . . . .	254	Capacity . . . . .	256	Power Sliding Top . . . . .	57
Maintenance . . . . .	57	Dipstick . . . . .	222	Operation . . . . .	57
Maintenance Free Battery . . . . .	222	Filter . . . . .	258	Pinch Protect . . . . .	57
Maintenance Schedule . . . . .	216	Pressure Warning Light . . . . .	75	Power Steering Fluid . . . . .	259
Malfunction Indicator Light		Recommendation . . . . .	256	Pregnant Women And Seat Belts . . . . .	110
(Check Engine) . . . . .	77, 83	Viscosity . . . . .	256	Preparation For Jacking . . . . .	204
Manual Park Release . . . . .	210	Oil Pressure Light . . . . .	75	Pretensioners	
Manual, Service . . . . .	329	Oil Reset . . . . .	71	Seat Belts . . . . .	110
Manual Transmission . . . . .	152, 229	Onboard Diagnostic System . . . . .	82	Radial Ply Tires . . . . .	240
Fluid Level Check . . . . .	229	Operating Precautions . . . . .	82	Radio	
Lubricant Selection . . . . .	259	Overheating, Engine . . . . .	209	Presets . . . . .	276, 280, 286
Shift Speeds . . . . .	153				



- Radio Frequency
    - General Information . . . . .16, 19
  - Radio Operation . . . . .274, 277, 284
  - Radio Screens . . . . .277, 284
  - Raising . . . . .50
  - Raising The Soft Top . . . . .50
  - Rear Camera . . . . .176
  - Rear Cross Path . . . . .97
  - Rear ParkSense System . . . . .174
  - Rear Swing Gate . . . . .59
  - Rear Wiper/Washer . . . . .40
  - Recreational Towing . . . . .181
    - Shifting Into Transfer Case
      - Neutral (N) . . . . .182
    - Shifting Out Of Transfer Case
      - Neutral (N) . . . . .183
  - Release, Hood . . . . .59
  - Reminder, Seat Belt . . . . .105
  - Remote Control
    - Starting System . . . . .17
  - Remote Keyless Entry
    - Arm The Alarm . . . . .19
    - Disarm The Alarm . . . . .19
  - Remote Sound System (Radio)
    - Controls . . . . .266
  - Remote Starting System . . . . .17
  - Removable Doors . . . . .23, 26
    - Front . . . . .23
    - Rear . . . . .26
  - Removable Top . . . . .49, 50, 54, 56, 57
    - Dual Top Operation . . . . .49
  - Removal . . . . .54
  - Removing . . . . .56
  - Replacement Bulbs . . . . .191
  - Replacement Keys . . . . .15
  - Replacement Tires . . . . .241
  - Reporting Safety Defects . . . . .328
  - Restraints, Child . . . . .128
  - Restraints, Head . . . . .32
  - Roll Over Warning . . . . .2
  - Rotation, Tires . . . . .246
  - Safety Checks Inside Vehicle . . . . .145
  - Safety Checks Outside Vehicle . . . . .146
  - Safety Defects, Reporting . . . . .328
  - Safety, Exhaust Gas . . . . .144
  - Safety Information, Tire . . . . .229
  - Safety Tips . . . . .144
  - Schedule, Maintenance . . . . .216
  - Seat Belt
    - Automatic Locking Retractor (ALR) .111
  - Seat Belt Maintenance . . . . .251
  - Seat Belt Reminder . . . . .75
  - Seat Belts . . . . .105, 145
    - Adjustable Shoulder Belt . . . . .109
    - Adjustable Upper Shoulder
      - Anchorage . . . . .109
    - Adjustable Upper Shoulder Belt
      - Anchorage . . . . .109
    - Child Restraints . . . . .128
    - Energy Management Feature . . . . .111
    - Extender . . . . .110
    - Front Seat . . . . .105, 106, 107
    - Inspection . . . . .145
    - Lap/Shoulder Belt Operation . . . . .107
    - Lap/Shoulder Belts . . . . .106
    - Lap/Shoulder Belt Untwisting . . . . .109
    - Operating Instructions . . . . .107
    - Pregnant Women . . . . .110
    - Pretensioners . . . . .110
  - Rear Seat . . . . .106
  - Reminder . . . . .105
  - Seat Belt Extender . . . . .110
  - Seat Belt Pretensioner . . . . .110
  - Untwisting Procedure . . . . .109
- Seats . . . . .27
  - Adjustment . . . . .27
  - Fold And Tumble Rear . . . . .30
  - Rear Folding . . . . .27
  - Tilting . . . . .27
- Security Alarm . . . . .19, 76

Arm The System . . . . .	19	Renewing Subscriptions . . . . .	268	Steering Wheel Audio Controls . . . . .	266
Disarm The System . . . . .	19	Send & Go . . . . .	273	Steering Wheel Mounted Sound System Controls . . . . .	266
Selection Of Coolant (Antifreeze). . . . .	258	Vehicle Finder . . . . .	273	Stop/Start System . . . . .	166, 169
Sentry Key Replacement. . . . .	15	Vehicle Health Alert . . . . .	319	Storage, Vehicle . . . . .	47, 248
Service Assistance . . . . .	326	Snow Chains (Tire Chains). . . . .	246	Storing Your Vehicle . . . . .	248
Service Contract . . . . .	327	Snow Tires . . . . .	243	Stuck, Freeing . . . . .	211
Service Manuals . . . . .	329	Soft Top . . . . .	50, 56	Sun Roof . . . . .	57
Shifting . . . . .	156	Spare Tire . . . . .	203	Sway Bar Disconnect, Electronic . . . . .	165
Automatic Transmission . . . . .	156, 157	Spare Tires. . . . .	243, 244	Sway Control, Trailer . . . . .	93
Manual Transmission . . . . .	152	Spark Plugs. . . . .	258	Swing Gate, Rear . . . . .	59
Transfer Case, Shifting Into		Specifications		System, Remote Starting . . . . .	17
Transfer Case Neutral (N) . . . . .	182	Fuel (Gasoline) . . . . .	258		
Transfer Case, Shifting Out Of		Oil . . . . .	258		
Transfer Case Neutral (N) . . . . .	183	Speed Control			
Shoulder Belts . . . . .	106	Accel/Decel . . . . .	174	Telescoping Steering Column . . . . .	35
Signals, Turn . . . . .	80, 146, 193, 194	Cancel . . . . .	174	Temperature Control, Automatic (ATC) . . . . .	46
Siri . . . . .	320	Resume . . . . .	174	Text Messages. . . . .	276, 310
Sirius Satellite Radio		Speed Control (Cruise Control) . . . . .	172	Tilt Steering Column . . . . .	35
Traffic & Weather . . . . .	300	Starting . . . . .	149	Tire And Loading Information Placard . . . . .	235
Sirius Travel Link . . . . .	300	Button . . . . .	16	Tire Markings. . . . .	230
SiriusXM Guardian . . . . .	266	Remote . . . . .	17	Tires. . . . .	146, 238, 243, 247
Account . . . . .	266	Starting And Operating . . . . .	149	Aging (Life Of Tires) . . . . .	241
App . . . . .	268	Starting Procedures . . . . .	149	Air Pressure . . . . .	238
In Vehicle Features . . . . .	269	Steering. . . . .	35	Chains . . . . .	246
Maintaining Your Account . . . . .	269	Tilt Column . . . . .	35	Changing . . . . .	203, 229
Registration . . . . .	267	Wheel, Heated . . . . .	35	Compact Spare . . . . .	243
Remote Features . . . . .	272	Wheel, Tilt . . . . .	35	General Information . . . . .	238, 243



- Inflation Pressure . . . . . 239
- Jacking . . . . . 205, 229
- Life Of Tires . . . . . 241
- Load Capacity . . . . . 235
- Pressure Monitoring System (TPMS) . 78
- Pressure Monitor System (TPMS) . . 98
- Quality Grading . . . . . 247
- Radial . . . . . 240
- Replacement . . . . . 241
- Rotation . . . . . 246
- Safety . . . . . 229, 238
- Sizes . . . . . 231
- Snow Tires . . . . . 243
- Spare Tire . . . . . 203
- Spare Tires . . . . . 243, 244
- Spinning . . . . . 240
- Tread Wear Indicators . . . . . 241
- Wheel Nut Torque . . . . . 254
- Tire Safety Information . . . . . 229
- To Open Hood . . . . . 59
- Top
  - Dual . . . . . 49, 56
  - Freedom . . . . . 54
  - Hard . . . . . 54
  - Power Sliding . . . . . 57
  - Removable . . . . . 49, 50, 54, 56, 57
  - Soft . . . . . 50, 56
- Tow Hooks, Emergency . . . . . 214
- Towing . . . . . 180, 212
  - Disabled Vehicle . . . . . 212
  - Recreational . . . . . 181
  - Weight . . . . . 180
- Towing Vehicle Behind A Motorhome . 181
- Trac-Lok Rear Axle . . . . . 164
- Traction Control . . . . . 89
- Trailer Sway Control (TSC) . . . . . 93
- Trailer Towing . . . . . 180
  - Trailer And Tongue Weight . . . . . 180
- Trailer Towing Guide . . . . . 180
- Trailer Weight . . . . . 180
- Transfer Case
  - Fluid . . . . . 259
  - Four-Wheel-Drive Operation . 159, 161
- Transmission . . . . . 157
  - Automatic . . . . . 157, 229
  - Fluid . . . . . 259
  - Maintenance . . . . . 229
  - Manual . . . . . 152
  - Shifting . . . . . 156
- Transporting Pets . . . . . 144
- Tread Wear Indicators . . . . . 241
- Turn Signals . . . . . 80, 193, 194
- UCI Connector . . . . . 294
- Uconnect
  - Uconnect Settings . . . . . 293
- Uconnect 3 With 5-Inch Display . . . . 274
- Uconnect 4C/4C Nav With
  - 8.4-Inch Display . . . . . 284
- Uconnect 4 With 7-Inch Display . . . . 277
- Uconnect Phone . . . . . 302
  - Making A Call . . . . . 309
  - Pairing . . . . . 305
- Uconnect Settings
  - Customer Programmable
    - Features . . . . . 20, 293
    - Passive Entry Programming . . . . . 20
- Uniform Tire Quality Grades . . . . . 247
- Universal Consumer Interface
  - (UCI) Connector . . . . . 294
- Untwisting Procedure, Seat Belt . . . . 109
- Vehicle Identification Number (VIN) . . 254
- Vehicle Loading . . . . . 235
- Vehicle Storage . . . . . 47, 248
- Vehicle User Guide
  - In Vehicle Help . . . . . 13
- Voice Command . . . . . 309, 312
- Voice Recognition System (VR) . . 309, 312

Warning Lights (Instrument Cluster Descriptions) . . . . .	.77
Warnings, Roll Over . . . . .	.2
Warranty Information . . . . .	.328
Washers, Windshield . . . . .	.222
Washing Vehicle . . . . .	.249
Wheel And Wheel Tire Care . . . . .	.244
Wheel And Wheel Tire Trim . . . . .	.244
Wind Buffeting . . . . .	.49
Window Fogging . . . . .	.47
Windows . . . . .	.48
Power . . . . .	.48
Windshield Defroster . . . . .	.145
Windshield Washers . . . . .	.39, 222
Fluid . . . . .	.222
Windshield Wiper Blades . . . . .	.225
Windshield Wipers . . . . .	.39
Wiper, Rear . . . . .	.40
Wipers Blade Replacement . . . . .	.225







This guide has been prepared to help you get quickly acquainted with your new Jeep® brand vehicle and to provide a convenient reference source for common questions. However, it is not a substitute for your Owner's Manual.

For complete operational instructions, maintenance procedures and important safety messages, please consult your Owner's Manual, Navigation/Uconnect manuals found on the website on the back cover and other Warning Labels in your vehicle.

Not all features shown in this guide may apply to your vehicle. For additional information on accessories to help personalize your vehicle, visit **[www.mopar.com](http://www.mopar.com)** (U.S.), **[www.mopar.ca](http://www.mopar.ca)** (Canada) or your local Jeep® brand dealer.

## Driving and Alcohol

---

Drunken driving is one of the most frequent causes of collisions. Your driving ability can be seriously impaired with blood alcohol levels far below the legal minimum. If you are drinking, don't drive. Ride with a designated non-drinking driver, call a cab, a friend, or use public transportation.

## WARNING!

---

Driving after drinking can lead to a collision. Your perceptions are less sharp, your reflexes are slower, and your judgment is impaired when you have been drinking. Never drink and then drive.

The Jeep logo, featuring the word "Jeep" in a stylized, blocky font with a registered trademark symbol.



Whether it's providing information about specific product features, taking a tour through your vehicle's heritage, knowing what steps to take following an accident, or scheduling your next appointment, we know you'll find the app an important extension of your Jeep® brand vehicle. Simply download the app, select your make and model and enjoy the ride.

To get this app, go directly to the App Store or Google Play and enter the search keyword "JEEP" (U.S. residents only).

[www.jeep.com/en/owners](http://www.jeep.com/en/owners) (U.S.) provides special offers tailored to your needs, customized vehicle galleries, personalized service records and more. To get this information, just create an account and check back often.

Get warranty and other information online – you can review and print or download a copy of the Owner's Manual, Navigation/Uconnect manuals and the limited warranties provided by FCA US LLC for your vehicle by visiting [www.mopar.com](http://www.mopar.com) (U.S.) or [www.owners.mopar.ca](http://www.owners.mopar.ca) (Canada). Click on the applicable link in the "Popular Topics" area of the [mopar.com](http://www.mopar.com) (U.S.) or [www.owners.mopar.ca](http://www.owners.mopar.ca) (Canada) homepage and follow the instructions to select the applicable year, make and model of your vehicle.

**DOWNLOAD A FREE ELECTRONIC COPY** of the most up-to-date Owner's Manual, media and warranty booklet by visiting:

[www.mopar.com/en-us/care/owners-manual.html](http://www.mopar.com/en-us/care/owners-manual.html) (U.S. residents);

[www.owners.mopar.ca](http://www.owners.mopar.ca) (Canadian residents).

[Jeep.com](http://Jeep.com) (U.S.)

[Jeep.ca](http://Jeep.ca) (Canada)



18JL-926-AA  
WRANGLER  
Third Edition Rev 1  
User Guide