

Panasonic[®]

LUMIX

S1H

Owner's Manual

<Basic>

Digital Camera

DC-S1H

Please read these instructions carefully before using this product, and save this manual for future use.

More detailed operating instructions are available in “Owner’s Manual” (PDF format). To read it, download it from the website. (→ 4)

Register online at <http://shop.panasonic.com/support> (U.S. customers only)

If you have any questions, visit:
USA : <http://shop.panasonic.com/support>

Dear Customer,

Thank you for choosing Panasonic!

You have purchased one of the most sophisticated and reliable products on the market today. Used properly, we’re sure it will bring you and your family years of enjoyment. Please take time to fill in the information below. The serial number is on the tag located on the underside of your camera. Be sure to **retain this manual** as your convenient camera information source.

Date of Purchase

Dealer Phone No.

Dealer Purchased From

Model No.

Dealer Address

Serial No.

Please note that the actual controls and components, menu items, etc. of your Digital Camera may look somewhat different from those shown in the illustrations in this Owner’s Manual.

Carefully observe copyright laws.

Recording of pre-recorded tapes or discs or other published or broadcast material for purposes other than your own private use may infringe copyright laws. Even for the purpose of private use, recording of certain material may be restricted.

About Owner's Manual

This document mainly describes video recording. It also describes preparations before using the camera and its basic operation, and connection with a smartphone.

Refer to the “Owner’s Manual” (PDF format) for details about picture recording and operations.

❖ Reading the “Owner’s Manual” (PDF Format)



To download the “Owner’s Manual” (PDF Format) from a website, either enter the URL below directly, or scan the QR code.

<https://panasonic.jp/support/dsc/oi/index.html?model=DC-S1H&dest=P>

- Click the desired language.



The URL and QR code above can also be accessed from the [Setup] menu, [Online Manual].

 ⇒ [] ⇒ [] ⇒ Select [Online Manual]
Settings: [URL display]/[QR Code display]

- You will need Adobe Reader to browse or print the “Owner’s Manual” (PDF format). Download and install Adobe Reader from the following site (As of August 2019):
<http://www.adobe.com/products/acrobat/readstep2.html>

❖ Symbols Used in This Document

Symbols for recording modes, pictures, and videos that can be used













In this document, symbols are placed at the start of functional explanations (recording modes, pictures, and videos) showing conditions in which these functions can be used.

Black icons show conditions in which these can be used, and gray icons show conditions in which these cannot be used.

Example: 

Operating symbols

In this document, camera operation is explained using the following symbols:

	(A)		Front dial
	(B)		Rear dial
	(C)	 or 	Cursor button up/down/left/right or Joystick up/down/left/right
	(D)		Press the center of the joystick
	(E)		[MENU/SET] button
	(F)		Control dial





- For information about operation methods of the operation part, refer to page 48.
- Other symbols, such as icons shown on the camera screen, are also used in explanations.
- This document describes the procedure for selecting menu items as follows:
Example) Set [Picture Quality] of the [Photo] ([Image Quality]) menu to [STD.].

 ⇒  ⇒  ⇒ [Picture Quality] ⇒ Select [STD.]

For information about menu operation methods, refer to page 57.

Notification classification symbols

In this document, notifications are classified and described using the following symbols:

	To confirm prior to using the function
	Hints for better use of the camera and tips for recording
	Notifications and supplementary items regarding specifications
	Related information and page number

- This document provides an explanation with the assumption that menu settings are in the default settings.
Furthermore, illustrations of screens used assume the following settings.
– [Style] ([Clock Set]): [Y.M.D]/[24hrs]
- Description in this document is based on the interchangeable lens (S-R24105: optional).

Information for Your Safety

WARNING:

To reduce the risk of fire, electric shock or product damage,

- Do not expose this unit to rain, moisture, dripping or splashing.
- Use the recommended accessories.
- Do not remove covers.
- Do not repair this unit by yourself. Refer servicing to qualified service personnel.

The socket outlet shall be installed near the equipment and shall be easily accessible.

■ Product identification marking

Product	Location
Digital camera	Bottom
Battery charger	Bottom

THE FOLLOWING APPLIES ONLY IN THE U.S.A.

FCC Note:

This equipment has been tested and found to comply with the limits for a Class B digital device, pursuant to Part 15 of the FCC Rules.

These limits are designed to provide reasonable protection against harmful interference in a residential installation. This equipment generates, uses, and can radiate radio frequency energy and, if not installed and used in accordance with the instructions, may cause harmful interference to radio communications. However, there is no guarantee that interference will not occur in a particular installation. If this equipment does cause harmful interference to radio or television reception, which can be determined by turning the equipment off and on, the user is encouraged to try to correct the interference by one or more of the following measures:

- Reorient or relocate the receiving antenna.
- Increase the separation between the equipment and receiver.
- Connect the equipment into an outlet on a circuit different from that to which the receiver is connected.
- Consult the dealer or an experienced radio/TV technician for help.

FCC Caution:

- Any unauthorized changes or modifications to this equipment would void the user's authority to operate this device.
- To assure continued compliance, follow the attached installation instructions and use only shielded interface cables with ferrite core when connecting to computer or peripheral devices.

This device complies with Part 15 of the FCC Rules. Operation is subject to the following two conditions: (1) This device may not cause harmful interference, and (2) this device must accept any interference received, including interference that may cause undesired operation.

Supplier's Declaration of Conformity

Trade name: Panasonic

Model No.: DC-S1H



Responsible Party: Panasonic Corporation of North America

Two Riverfront Plaza, Newark, NJ 07102-5490

Support Contact: <http://shop.panasonic.com/support>

THE FOLLOWING APPLIES ONLY IN THE U.S.A.**How to Display Certification and Compliance Information**

Certification and compliance information for this camera can be viewed on the menu screen.

- 1 Select the  [Others] tab of the  [Setup] menu.
- 2 Select [Approved Regulations] and confirm your selection.

Contains FCC ID: VPYLB1JS955

This transmitter must not be co-located or operated in conjunction with any other antenna or transmitter.

This equipment complies with FCC radiation exposure limits set forth for an uncontrolled environment and meets the FCC radio frequency (RF) Exposure Guidelines as this equipment has very low levels of RF energy.

Compliance with FCC requirement 15.407(c)

Data transmission is always initiated by software, which is then passed down through the MAC, through the digital and analog baseband, and finally to the RF chip. Several special packets are initiated by the MAC. These are the only ways the digital baseband portion will turn on the RF transmitter, which it then turns off at the end of the packet. Therefore, the transmitter will be on only while one of the aforementioned packets is being transmitted. In other words, this device automatically discontinues transmission in case of either absence of information to transmit or operational failure.

Frequency Tolerance: $\pm 20\text{ppm}$

■ About the battery pack**CAUTION**

Battery pack (Lithium ion battery pack)

- Use the specified unit to recharge the battery pack.
- Do not use the battery pack with equipment other than the specified unit.
- Do not get dirt, sand, liquids, or other foreign matter on the terminals.
- Do not touch the plug terminals (+ and -) with metal objects.
- Do not disassemble, remodel, heat or throw into fire.

If any electrolyte should come into contact with your hands or clothes, wash it off thoroughly with water.

If any electrolyte should come into contact with your eyes, never rub the eyes. Rinse eyes thoroughly with water, and then consult a doctor.

CAUTION

- Danger of explosion if battery is incorrectly replaced. Replace only with the type recommended by the manufacturer.
 - When disposing of the batteries, please contact your local authorities or dealer and ask for the correct method of disposal.
-
- Do not heat or expose to flame.
 - Do not leave the battery(ies) in a car exposed to direct sunlight for a long period of time with doors and windows closed.

Warning

Risk of fire, explosion and burns. Do not disassemble, heat above 60 °C (140 °F) or incinerate.

■ About the AC adaptor (supplied)

CAUTION!

To reduce the risk of fire, electric shock or product damage,

- **Do not install or place this unit in a bookcase, built-in cabinet or in another confined space. Ensure this unit is well ventilated.**

AC adaptor

This AC adaptor operates on AC between 100 V and 240 V.

But

- In the U.S.A. and Canada, the AC adaptor must be connected to a 120 V AC power supply only.
- When connecting to an AC supply outside of the U.S.A. or Canada, use a plug adaptor to suit the AC outlet configuration.
- When connecting to a supply of greater than AC 125 V, ensure the cord you use is suited to the voltage of the AC supply and the rated current of the AC adaptor.
- Contact an electrical parts distributor for assistance in selecting a suitable AC plug adaptor or AC cord set.

Cautions for Use

- Do not use any other USB connection cables except the supplied USB connection cables (C–C and A–C).
- Do not use any other AC cables except the supplied one.
- Do not use any other BNC conversion cables (for TC IN/OUT) except the supplied one.
- Always use a genuine Panasonic Shutter Remote Control (DMW-RS2: optional).
- Use a “High Speed HDMI cable” with the HDMI logo.
Cables that do not comply with the HDMI standards will not work.
“High Speed HDMI cable” (Type A–Type A plug, up to 1.5 m (4.9 feet) long)
- Do not use the BNC cables with the length of 2.8 m (9.2 feet) or more.
- Do not use the headphone cables with the length of 3 m (9.8 feet) or more.
- Do not use the synchro cables with the length of 3 m (9.8 feet) or more.
- Do not use the stereo microphone cables with the length of 3 m (9.8 feet) or more.

Keep this unit as far away as possible from electromagnetic equipment (such as microwave ovens, TVs, video games etc.).

- If you use this unit on top of or near a TV, the pictures and/or sound on this unit may be disrupted by electromagnetic wave radiation.
- Do not use this unit near cell phones because doing so may result in noise adversely affecting the pictures and/or sound.
- Recorded data may be damaged, or pictures may be distorted, by strong magnetic fields created by speakers or large motors.
- Electromagnetic wave radiation may adversely affect this unit, disturbing the pictures and/or sound.
- If this unit is adversely affected by electromagnetic equipment and stops functioning properly, turn this unit off and remove the battery or disconnect AC adaptor. Then reinsert the battery or reconnect AC adaptor and turn this unit on.

Do not use this unit near radio transmitters or high-voltage lines.

- If you record near radio transmitters or high-voltage lines, the recorded pictures and/or sound may be adversely affected.

-
- **Before cleaning the camera, remove the battery or the DC Coupler (DMW-DCC16: optional), or disconnect the power plug from the electrical outlet.**
 - **Do not press the monitor with excessive force.**

- Do not press the lens with excessive force.
 - Do not spray the camera with insecticides or volatile chemicals.
 - Do not keep products made of rubber, PVC or similar materials in contact with the camera for a long period of time.
 - Do not use solvents such as benzine, thinner, alcohol, kitchen detergents, etc., to clean the camera, since it may deteriorate the external case or the coating may peel off.
 - Do not leave the camera with the lens facing the sun, as rays of light from the sun may cause it to malfunction.
 - Always use the supplied cords and cables.
 - Do not extend the cords or the cables.
 - The data on the card may be damaged or lost due to electromagnetic waves, static electricity or breakdown of the camera or the card. We recommend storing important data on another device, such as a PC.
 - Do not format the card on your PC or other equipment. Format it on the camera only to ensure proper operation.
-

- **The battery is a rechargeable lithium ion battery. If the temperature is too high or too low, the operating time of the battery will become shorter.**
 - Store the battery in a cool and dry place with a relatively stable temperature. (Recommended temperature: 15 °C to 25 °C (59 °F to 77 °F); recommended humidity: 40%RH to 60%RH)
 - **Do not store the battery for a long time while fully charged.** When storing the battery for a long period of time, we recommend charging it once a year. Remove the battery from the camera and store it again after it has completely discharged.
-

For the U.S.A. and Canada only



A lithium ion battery that is recyclable powers the product you have purchased. Please call 1-800-8-BATTERY for information on how to recycle this battery.

Contents

About Owner's Manual	4
Information for Your Safety.....	7

1. Introduction

Before Use.....	15
Standard Accessories.....	17
Lenses That Can Be Used	18
Memory Cards That Can Be Used	19
Names of Parts.....	21

2. Getting Started

Attaching a Shoulder Strap.....	27
Charging the Battery.....	28
Inserting Cards (Optional)	38
Attaching a Lens.....	40
Adjusting the Monitor Direction and Angle	41
Setting the Clock (When Turning On for the First Time)	42

3. Basic Operations

Basic Recording Operations.....	44
Camera Setting Operations	48
Display Settings.....	51
Quick Menu	55
Control Panel.....	56
Menu Operation Methods	57
Intelligent Auto Mode.....	60
Recording Using Touch Functions	61

4. Image Recording

[Aspect Ratio]/[Picture Size]/[Picture Quality]	63
[Double Card Slot Function]	64
[Folder / File Settings].....	65

5. Focus/Zoom

Using AF	66
Selecting the AF Mode	67
AF Area Movement Operation	71
Record Using MF	72
Recording with Zoom.....	74

6. Image Stabilizer

Image Stabilizer	75
------------------------	----

7. Metering/Exposure/ISO Sensitivity

[Metering Mode].....	80
Exposure Compensation	80
ISO Sensitivity	81

8. White Balance/Image Quality

White Balance (WB)	84
[Photo Style]	87

9. Flash

Using an External Flash (Optional).....	90
---	----

10. Recording Videos

Recording Videos	92
Creative Video Mode	95
Recording Video	100
Time Code	110
Synchronizing the Time Code with an External Device.....	112
Using AF (Video)	115
Video Brightness and Coloring	117
Audio Settings.....	119

Main Assist Functions	121	[Save/Restore Camera Setting].....	164
-----------------------------	-----	------------------------------------	-----

11. Special Video Recording

Variable Frame Rate	125
High Frame Rate Video	127
[Focus Transition]	128
[Live Cropping].....	130
Log Recording.....	132
HLG Videos.....	134
Anamorphic Recording	136
[Synchro Scan].....	137
[Loop Recording (video)].....	138
[Segmented File Recording]	139

12. Connections with External Devices (Video)

HDMI Devices (HDMI Output).....	140
HDMI Output Settings	144
External Microphones (Optional)	146
XLR Microphone Adaptor (Optional)	149
Headphones.....	150

13. Playing Back and Editing of Images

Playing Back Pictures	152
Playing Back Videos	153
Switching the Display Mode	154
Deleting Images	155

14. Camera Customization

Fn Buttons.....	156
[Dial Operation Switch]	158
Quick Menu Customization	159
Custom Mode.....	161
My Menu	163

15. List of Menu

List of Menu.....	165
-------------------	-----

16. Wi-Fi/Bluetooth

Connecting to a Smartphone.....	171
Operating the Camera with a Smartphone.....	176

17. Connecting to Other Devices

Viewing on a TV	180
Importing Images to a PC.....	181
Tethered Recording.....	185

18. Materials

Digital Camera Accessory System	187
Monitor/Viewfinder Displays	188
Message Displays	194
Troubleshooting.....	195
Specifications	201
Index.....	211
Trademarks and Licences	217
Limited Warranty (ONLY FOR U.S.A.)	220

1. Introduction

Before Use

❖ Firmware of Your Camera/Lens

Firmware updates may be provided in order to improve camera capabilities or to add functionality. For smoother recording, we recommend updating the firmware of the camera/lens to the latest version.

- **For the latest information on the firmware or to download/update the firmware, visit the following support site:**

<https://panasonic.jp/support/global/cs/dsc/>

(English only)

- To check the firmware version of the camera/lens, attach the lens to the camera and select [Firmware Version] in the [Setup] ([Others]) menu. You can also update the firmware in [Firmware Version].
- This document provides explanations for camera firmware version 1.0. Changes after firmware update are detailed in the "Owner's Manual" (PDF format). Refer to this by downloading from the website. (→ 4)



❖ Handling of the Camera

When using the camera, take care not to drop it, bump it, or apply undue force. These may cause malfunction or damage to the camera and lens.

If sand, dust, or liquid gets on the monitor, wipe it off with a dry soft cloth.

- Touch operations may be incorrectly recognized.

When using in low temperatures (–10 °C to 0 °C (14 °F to 32 °F))

- Before use, attach a Panasonic lens with a minimum recommended operating temperature of –10 °C (14 °F).

Do not place a hand inside the camera mount.

This may cause a failure or damage because the sensor is a precision device.

If you shake the camera while turning the camera off, a sensor may operate or a rattling sound may be heard. This is caused by the image stabilizer mechanism in the body. It is not a malfunction.

❖ **Splash Resistant**

Splash Resistant is a term used to describe an extra level of protection this camera offers against exposure to a minimal amount of moisture, water or dust. Splash Resistant does not guarantee that damage will not occur if this camera is subjected to direct contact with water.

In order to minimize the possibility of damage please be sure the following precautions are taken:

- Splash Resistant works in conjunction with the lenses that were specifically designed to support this feature.
- Securely close the doors, socket caps, contact points cover, etc.
- When the lens or cap is removed or a door is open, do not allow sand, dust, and moisture to enter inside.
- If liquid gets on the camera, wipe it off with a dry soft cloth.

❖ **Condensation (When the Lens, the Viewfinder or Monitor is Fogged Up)**

- Condensation occurs when there are temperature or humidity differences. Take care as this may lead to soiling, mold, and malfunctions in the lens, viewfinder, and monitor.
- If condensation occurs, turn off the camera and leave it for approx. 2 hours. The fog will disappear naturally when the temperature of the camera becomes close to the ambient temperature.

❖ **Be Sure to Perform Trial Recording in Advance**

Perform trial recording in advance of an important event (wedding, etc.) to check that recording can be performed normally.

❖ **No Compensation Regarding Recording**

Please note that compensation cannot be provided in the event that recording could not be performed due to a problem with the camera or a card.

❖ **Be Careful with Regard to Copyrights**

Under copyright law, you may not use the images and audio you have recorded for other than personal enjoyment without the permission of the copyright holder. Be careful because there are cases where restrictions apply to recording even for the purpose of personal enjoyment.

❖ **Also Refer to the Cautions for Use in the “Owner’s Manual” (PDF Format)**

Standard Accessories

Digital camera body

(This is referred to as **camera** in this document.)



USB connection cable (C-C)

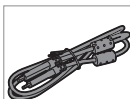

K1HY24YY0022

Check that all the accessories are supplied before using the camera.

- Product numbers correct as of August 2019. These may be subject to change.

USB connection cable (A-C)



K1HY24YY0021

Battery pack

(This is referred to as **battery pack** or **battery** in this document.)

- Charge the battery before use.

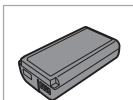

DMW-BLJ31

BNC conversion cable (for TC IN/OUT)



K1TYYYY00286

Battery charger*1

(This is referred to as **battery charger** or **charger** in this document.)



DMW-BTC14
(A: DVLC1004Z)

Cable holder

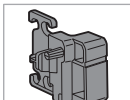

1QB1MC893Z

AC adaptor

- This is used for charging and power supply.

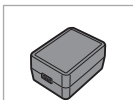

DVLV1001Z

Shoulder strap



DVPW1020Z

AC cable



K2CA2CA00025

Body cap*2

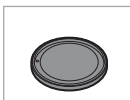

1HE1MC891Z

*1 Order the part number (A) if you would like to purchase the battery charger alone.

Eye cup*2



7YE1MC891Z

Cover for the battery grip connector*2

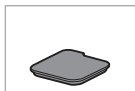

DVKK1054Z

Hot shoe cover*2

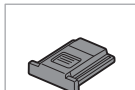

DVYE1121Z

Flash synchro socket cap*2



VKF5108

*2 This is attached to the camera at the time of purchase.

- **The memory card is optional.**
- The Interchangeable Lens is optional.
- If accessories are lost, customers can visit us at <http://shop.panasonic.com/support> for further information about obtaining replacement parts.



Lenses That Can Be Used

The lens mount of this camera is compliant with the L-Mount standard of Leica Camera AG. It can be used with 35 mm full-frame compatible interchangeable lenses and APS-C size interchangeable lenses of this standard. This camera is capable of sensor read out suited to the image circles of 35 mm full-frame interchangeable lenses and Super 35 mm interchangeable lenses.

- When using an APS-C size interchangeable lens, sensor read out is possible across the same range as a Super 35 mm interchangeable lens.
- The interchangeable lenses used in the explanations are designated as follows in this document.

Types of interchangeable lens	Designation in this document
35 mm full-frame interchangeable lens	full-frame lens
Super 35 mm interchangeable lens	Super 35 mm lens
APS-C-size interchangeable lens	APS-C lens

- When there is no distinguishing the type of lens, the explanation will use **lens**.
- When using a lens that cannot communicate with this camera, you can register the lens information using the following menu item. The settings on this camera enable you to switch settings to suit full-frame or Super 35 mm/APS-C lenses. (→ 78)

[] ⇒ [] ⇒ [Image Stabilizer] ⇒ [Lens Information] ⇒ [Lens1] to [Lens12] ⇒ [Image Circle]

[] ⇒ [] ⇒ [Lens Information] ⇒ [Lens1] to [Lens12] ⇒ [Image Circle]

❖ Notes on the Use of Super 35 mm/APS-C Lenses

As the image area is narrowed when using Super 35 mm/APS-C lenses, the following functions may not be available or their behaviour may be different.

[Aspect Ratio]	[Filter Settings]
[Picture Size]	[High Resolution Mode]
[Ex. Tele Conv.]	[HLG Photo]
[6K/4K PHOTO]	[Image Quality] → 107
[Post-Focus]	[Image Area of Video] → 108
[Shutter Type]	[Multiple Exposure]

- Refer to catalogs/websites for most current information regarding supported lenses.

<https://panasonic.jp/support/global/cs/dsc/>

(English only)



Memory Cards That Can Be Used

You can use the following memory cards with this camera.

- **SD memory card** (512 MB to 2 GB)
- **SDHC memory card** (4 GB to 32 GB)
- **SDXC memory card** (48 GB to 128 GB)
- Operation has been confirmed with the above Panasonic cards.
- SD memory card, SDHC memory card, and SDXC memory card are referred to by the generic name of **card** in this document.

- The camera supports SDHC/SDXC memory cards compliant with UHS Speed Class 3 of the UHS-I/UHS-II standard.
- The camera supports SDHC/SDXC memory cards compliant with Video Speed Class 90 of the UHS-II standard.
- **For the latest information, check the following support site:**
<https://panasonic.jp/support/global/cs/dsc/>
 (English only)



❖ Cards That Can Be Used Stably with This Camera

When recording video using the following video image qualities (bit rates) or recording using picture functions, use cards that have the correct Speed Class*.

* Standards guaranteeing the minimum speed necessary for continuous writing

Recording qualities (bit rates) Picture functions	Speed Classes	Indication examples
72 Mbps video	Class 10	CLASS10 10
	UHS Speed Class 1 or higher	U1
	Video Speed Class 10 or higher	V10
Video between 100 Mbps and 200 Mbps [6K/4K PHOTO] [Post-Focus]	UHS Speed Class 3	U3
	Video Speed Class 30 or higher	V30
400 Mbps video	Video Speed Class 60 or higher	V60 V90



- The data stored on a card may be damaged due to electromagnetic waves, static electricity or a failure of the camera or card. We recommend backing up important data.
- Keep the memory card out of reach of children to prevent swallowing.

Names of Parts

Camera

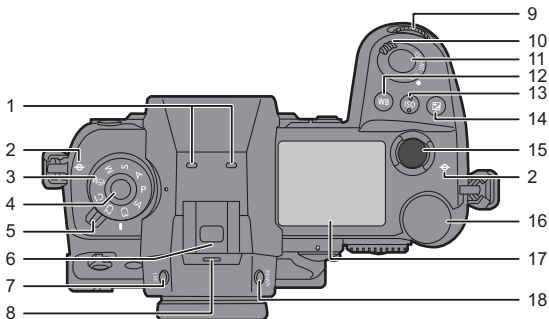

1	Stereo microphone (→ 120) • Do not block the microphone with a finger. Audio will be difficult to record.	10	Camera on/off switch (→ 42)/ [:] (Status LCD backlight) (→ 54)
2	[-] (Recording distance reference mark)	11	Shutter button (→ 45)
3	Mode dial (→ 46)	12	[WB] (White balance) button (→ 84)
4	Mode dial lock button (→ 46)	13	[ISO] (ISO sensitivity) button (→ 81)
5	Drive mode dial (→ 47)	14	[] (Exposure compensation) button (→ 80)
6	Hot shoe (hot shoe cover) (→ 90) • Keep the hot shoe cover out of reach of children to prevent swallowing.	15	Video rec. button (→ 46, 92)
7	[LVF] button (→ 52)	16	Rear dial (→ 49)
8	Speaker	17	Status LCD (→ 26, 96)
9	Front dial (→ 49)	18	[V.MODE] button (→ 52)

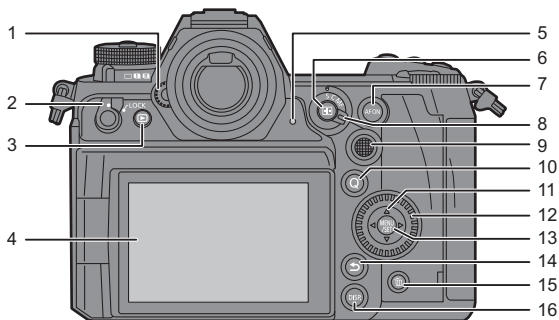

1	Diopter adjustment dial (→ 51)	10	[Q] (Quick menu) button (→ 55)
2	Operation lock lever (→ 51)	11	Cursor buttons (→ 49)/ Fn buttons (→ 156)
3	[▶] (Playback) button (→ 152)		▲: Fn13, ▶: Fn14, ▼: Fn15, ◀: Fn16
4	Monitor (→ 25, 188)/ Touch screen (→ 50)	12	Control dial (→ 49)
5	Rear tally lamp (→ 92)	13	[MENU/SET] button (→ 49, 57)
6	[] (AF mode) button (→ 66)	14	[↶] (Cancel) button (→ 59)
7	[AF ON] button (→ 66)	15	[] (Delete) button (→ 155)
8	Focus mode lever (→ 47, 66, 72)	16	[DISP.] button (→ 53)
9	Joystick (→ 50)/ Fn buttons (→ 156) Center: Fn8, ▲: Fn9, ▶: Fn10, ▼: Fn11, ◀: Fn12		



- The following buttons light when the camera on/off switch is set to [:]. The lighting timing can be changed in [Illuminated Button] in the [Custom] ([Operation]) menu.
 - [▶] button/[Q] button/[↶] button/[] button/[DISP.] button

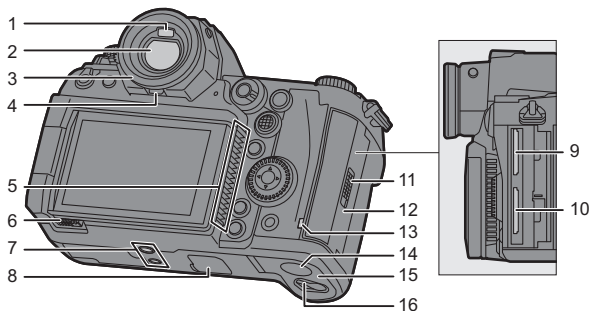

1	Eye sensor (→ 52)
2	Viewfinder (→ 25, 52, 188)
3	Eye cup
4	Eye cup lock lever
5	Fan inlet <ul style="list-style-type: none"> • The fan inlet for the cooling fan. • Do not obstruct this unit's ventilation openings with newspapers, tablecloths, curtains, and similar items.
6	Monitor lock lever (→ 42)
7	Tripod mount <ul style="list-style-type: none"> • If you attempt to attach a tripod with a screw length of 5.5 mm (0.22 inch) or more, you may not be able to securely fix it in place or it may damage the camera.
8	Battery grip connector (cover for the battery grip connector) <ul style="list-style-type: none"> • Keep the cover for the battery grip connector out of reach of children to prevent swallowing.
9	Card slot 1 (→ 38)

10	Card slot 2 (→ 38)
11	Card door lock lever (→ 38)
12	Card door (→ 38)
13	Card access light (→ 39)
14	DC Coupler cover <ul style="list-style-type: none"> • When using an AC adaptor, ensure that the Panasonic DC Coupler (DMW-DCC16: optional) and AC Adaptor (DMW-AC10PP: optional) are used. • Always use a genuine Panasonic AC Adaptor (DMW-AC10PP: optional). • When using an AC Adaptor (optional), use the AC cable supplied with the AC Adaptor (optional).
15	Battery door (→ 30)
16	Battery door release lever (→ 30)

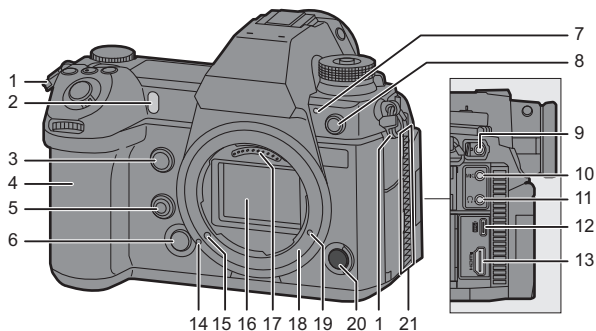

1	Shoulder strap eyelet (→ 27)	10	[MIC] socket (→ 146)
2	Self-timer light/ AF assist light	11	Headphone socket (→ 150) • Excessive sound pressure from earphones and headphones can cause hearing loss.
3	Fn button (Fn1) (→ 156)	12	USB port (→ 32, 179)
4	Grip	13	[HDMI] socket (→ 140, 179)
5	Preview button/ Fn button (Fn2) (→ 156)	14	Lens fitting mark (→ 40)
6	Lens release button (→ 40)	15	Lens lock pin
7	Front tally lamp (→ 92)	16	Sensor
8	Flash synchro socket (flash synchro socket cap) (→ 90) • Connect the supplied BNC conversion cable (for TC IN/OUT) when synchronizing the time code with an external device. (→ 110) • Keep the flash synchro socket cap out of reach of children to prevent swallowing.	17	Contact points
9	[REMOTE] socket	18	Mount
		19	Screw hole for function expansion • This is a hole that will be used in a future function expansion.
		20	Sub video rec. button (→ 46, 92)
		21	Fan outlet • The fan outlet for the cooling fan. • Do not obstruct this unit's ventilation openings with newspapers, tablecloths, curtains, and similar items.

Viewfinder/Monitor Displays

At the time of purchase, the viewfinder/monitor displays the following icons.

- For information about the icons other than those described here, refer to page 188.

Viewfinder

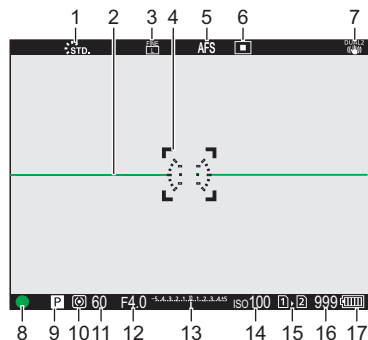

Monitor

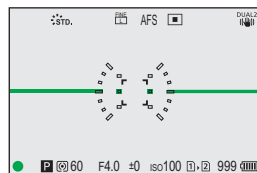

1	Photo Style (→ 87)	11	Shutter speed (→ 45)
2	Level gauge (→ 168)	12	Aperture value (→ 45)
3	Picture quality (→ 63)/ Picture size (→ 63)	13	Exposure compensation value (→ 80)/ Manual Exposure Assist
4	AF area (→ 71)	14	ISO sensitivity (→ 81)
5	Focus mode (→ 47, 72)	15	Card slot (→ 38)/ Double card slot function (→ 64)
6	AF mode (→ 67)	16	Number of still images that can be taken/ Number of pictures that can be taken continuously
7	Image stabilizer (→ 75)	17	Battery indication (→ 35)
8	Focus (green) (→ 45, 66)/ Recording state (red) (→ 92)		
9	Recording mode (→ 46)		
10	Metering mode (→ 80)		



- Press [] to switch between display/hide of the level gauge.

Status LCD Display

The following recording settings are displayed when recording pictures.

- Refer to page 96 for information on the [CAM] mode (Creative Video mode) display.

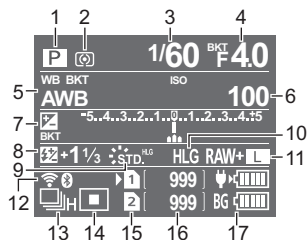

1	Recording mode (→ 46)	10	HLG photo (→ 165)
2	Metering mode (→ 80)	11	Picture quality (→ 63)/ Picture size (→ 63)
3	Shutter speed (→ 45)	12	Wi-Fi/Bluetooth connection state
4	Aperture value (→ 45)/ Aperture Bracket (→ 166)	13	Drive mode (→ 47)/ Post-Focus (→ 166)/ High Resolution mode (→ 165)
5	White balance (→ 84)/ White Balance Bracket (→ 166)	14	AF mode (→ 67)
6	ISO sensitivity (→ 81)/ Dual Native ISO setting (→ 83)	15	Card slot (→ 38)/ Double card slot function (→ 64)
7	Exposure compensation (→ 80)/ Exposure Bracket (→ 166)	16	Number of still images that can be taken/ Number of pictures that can be taken continuously
8	Flash output adjustment (→ 165)	17	Battery indication (→ 35)/ Power supply (→ 34)
9	Photo Style (→ 87)/ Filter setting (→ 165)		

- ➔ • Turning on the status LCD backlight (→ 54)

2. Getting Started

Attaching a Shoulder Strap

Attach a shoulder strap to the camera with the following procedure to prevent it from dropping.

- 1 Pass the shoulder strap through the shoulder strap eyelet (A).**
- 2 Pass the end of the shoulder strap through the ring and then pass it through the fastener.**
- 3 Pass the end of the shoulder strap through the other hole of the fastener.**
- 4 Pull the shoulder strap and check that it will not come out.**
 - Attach the opposite end of the shoulder strap with the same procedure.

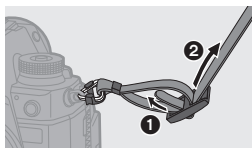
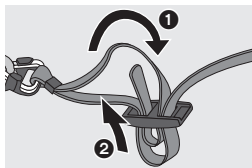
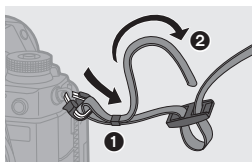
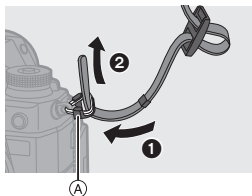



- Use the shoulder strap around your shoulder.
 - Do not wrap the strap around your neck. It may result in injury or accident.
- Do not leave the shoulder strap where an infant can reach it.
 - It may result in an accident by mistakenly wrapping around the neck.

Charging the Battery

You can charge the battery either using the supplied charger, or in the camera body.

You can also charge by connecting to a USB PD (USB Power Delivery) compatible device using the supplied USB connection cable (C–C).

Furthermore, you can turn the camera on while it is charging and record.

- The battery that can be used with the camera is DMW-BLJ31. (As of August 2019)



- The battery is not charged at the time of purchase. Charge the battery before use.

Charging with the Charger

Charging time	Approx. 130 min
---------------	-----------------

- Use the supplied charger and AC adaptor.
- The indicated charging time is for when the battery has been discharged completely. The charging time may vary depending on how the battery has been used. The charging time for the battery in hot/cold environments or a battery that has not been used for a long time may be longer than normal.



- **Use the products supplied with the camera for charging.**
- Use the charger indoors.

1 Connect the charger and the AC adaptor with the USB connection cable (C-C).

- Hold the plugs and insert them straight in or pull them straight out.
(Inserting these at an angle may cause deformation or malfunction)

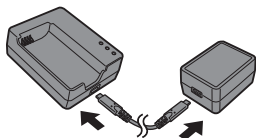

2 Connect the AC cable to the AC adaptor and then insert into the electrical outlet.

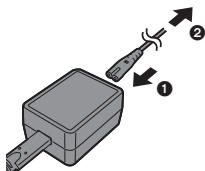

3 Insert the battery.

- Insert the terminal end of the battery and push.
- The [CHARGE] light (A) blinks and charging begins.

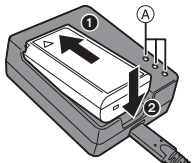

- Do not use any other USB connection cables except the supplied USB connection cable (C-C).
This may cause malfunction.
- Do not use any other AC adaptors except the supplied one.
This may cause malfunction.
- Do not use any other AC cables except the supplied one.
This may cause malfunction.

❖ [CHARGE] Light Indications

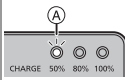
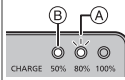
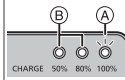
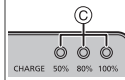
Charging status	0% to 49%	50% to 79%	80% to 99%	100%
[CHARGE] light				
	(A) Blinking	(B) On	(C) Off	



- After charging, disconnect the power source connection and remove the battery.
- If the [50%] light is blinking quickly, then charging is not occurring.
 - The temperature of the battery or surroundings is either too high or too low. Try charging at an ambient temperature between 10 °C and 30 °C (50 °F and 86 °F).
 - The terminals of the charger or the battery are dirty. Remove the connection to the power source, and wipe with a dry cloth.

Battery Insertion

- Always use genuine Panasonic batteries (DMW-BLJ31).
- If you use other batteries, we cannot guarantee the quality of this product.

1 Set the camera on/off switch to [OFF].

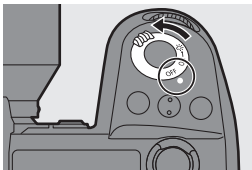

2 Open the battery door.

- Move the battery door release lever to the [OPEN] position.

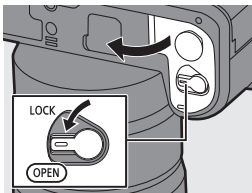

3 Insert the battery.

- Insert the terminal end of the battery and push until a locking sound is heard.
- Check that the lever (A) is holding the battery in place.

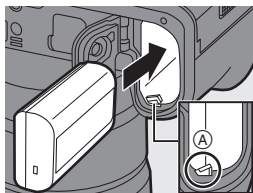

4 Close the battery door.

- Close the battery door, and move the battery door release lever to the [LOCK] position.

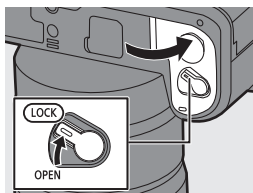

❖ Removing the Battery

- 1 Set the camera on/off switch to [OFF].
- 2 Open the battery door.
 - Check that the card access light (B) is turned off and then open the battery door.
- 3 Push the lever (A) in the direction of the arrow and then remove the battery.

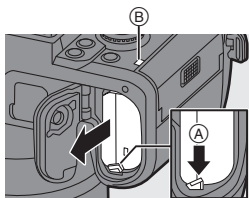

- Ensure that no foreign objects are adhering to the inner side (rubber seal) of the battery door.
- Remove the battery after use.
(The battery will drain if left inserted in the camera for a long period of time.)
- The battery becomes warm after use, during charging, and immediately after charging.
The camera also becomes warm during use. This is not a malfunction.
- Be careful when removing the battery as the battery will jump out.

Inserting a Battery into the Camera for Charging

Charging time

Approx. 140 min

- Using the camera body and the supplied AC adaptor.
The camera is turned off.
- The indicated charging time is for when the battery has been discharged completely.
The charging time may vary depending on how the battery has been used.
The charging time for the battery in hot/cold environments or a battery that has not been used for a long time may be longer than normal.

 • Use the products supplied with the camera for charging.

- 1 Set the camera on/off switch to [OFF].**
- 2 Insert the battery into the camera.**
- 3 Connect the camera USB port and the AC adaptor using the USB connection cable (C-C).**

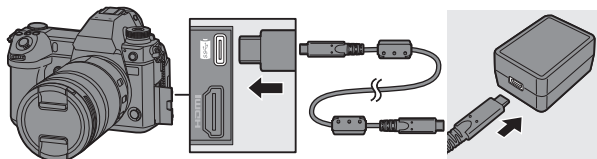

- Hold the plugs and insert them straight in or pull them straight out.
(Inserting these at an angle may cause deformation or malfunction)

- 4 Connect the AC cable to the AC adaptor and then insert into the electrical outlet.**

- [CHARGE] is displayed on the status LCD and charging starts.
[FULL] is displayed when charging is complete.

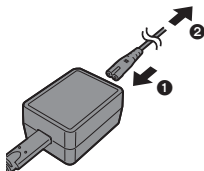



- You can also charge the battery by connecting a USB device (PC, etc.) and the camera with the USB connection cable (C–C or A–C).

In that case, charging may take a while.

- When using the Battery Grip (DMW-BGS1: optional), the battery within the Battery Grip will also be charged.



- Do not use any other USB connection cables except the supplied USB connection cables (C–C and A–C).

This may cause malfunction.

- Do not use any other AC adaptors except the supplied one.

This may cause malfunction.

- Do not use any other AC cables except the supplied one.

This may cause malfunction.

- After charging, disconnect the connection to the power source.

- When an [ERROR] is displayed on the status LCD, charging is not possible.

– The temperature of the battery or surroundings is either too high or too low.

Try charging at an ambient temperature between 10 °C and 30 °C (50 °F and 86 °F).

– The terminals of the battery are dirty.

Remove the battery and wipe off the dirt with a dry cloth.

- Even when the camera on/off switch is set to [OFF] thus turning the camera off, it consumes power.

When the camera will not be used for a long time, remove the power plug from the electrical outlet in order to save power.

Using the Camera While Supplying It with Power (Supplying Power/Charging)

When charging with both the camera body and the supplied AC adaptor (→ 32), you can charge while the camera is being supplied with power by turning the camera on. You can record while charging.

This is also possible by connecting devices that support USB PD (USB Power Delivery) to the camera.

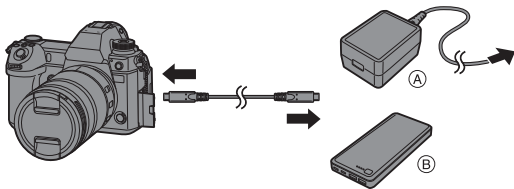

Ⓐ AC adaptor

Ⓑ Devices that support USB PD (mobile battery, etc.)

- Insert the battery into the camera.
- Connect using the supplied USB connection cable (C–C).
- Use a device (mobile battery, etc.) with an output of 9 V/3 A (27 W or more) that supports USB PD.
- When the camera is on, charging will take longer than when the camera is off.



- Even when connecting with devices that support USB PD, you may not be able to charge while using the camera.
- If connecting with devices (PC, etc.) that do not support USB PD and turning the camera on, then this will supply power only.
- Turn off the camera before connecting or disconnecting the power plug.
- Remaining charge in the battery may decrease depending on usage conditions. When the battery level is depleted, the camera will turn off.
- Depending on the power supply capabilities of the connected device, it may not be possible to supply power.

Notifications Regarding Charging/Power Supply

❖ Power Indications

Indication on status LCD

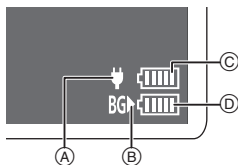

- (A) USB connection cable supplying power
- (B) Power source
- (C) The battery level of the battery in the camera
- (D) The battery level of the battery in the Battery Grip
- (E) Battery indication
- (F) Using the battery in the Battery Grip

Indication on monitor

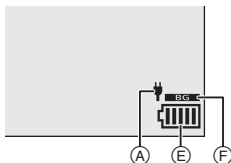

	80% or higher
	60% to 79%
	40% to 59%
	20% to 39%
	19% or below
 Blinking	Low battery <ul style="list-style-type: none"> • Charge or replace the battery.



- The battery level indicated on the screen is approximate. The exact level varies depending on the environment and the operating conditions.
- The highest battery level reading of (C) or (D) blinks during charging.
- When a charging error occurs, the status LCD display icon (A) blinks.



- **It has been found that counterfeit battery packs which look very similar to the genuine product are made available for purchase in some markets. Some of these battery packs are not adequately protected with internal protection to meet the requirements of appropriate safety standards. There is a possibility that these battery packs may lead to fire or explosion. Please be advised that we are not liable for any accident or failure occurring as a result of use of a counterfeit battery pack. To ensure that safe products are used, we recommend that a genuine Panasonic battery pack is used.**
- Do not leave any metal items (such as clips) near the contact areas of the power plug.
Otherwise, a fire and/or electric shocks may be caused by short-circuiting or the resulting heat generated.
- Do not use the AC adaptor, AC cable, or USB connection cables (C–C and A–C) on other devices.
This may cause a malfunction.
- Do not use USB extension cables or USB conversion adaptors.
- The battery can be charged even when it still has some charge left, but it is not recommended that the battery charge be frequently topped up while the battery is fully charged.
(Since characteristic swelling may occur.)
- If there is a power outage or other problem with the electrical outlet, then charging may not complete successfully.
Reconnect the power plug.
- Do not connect to keyboard or printer USB ports, or to USB hubs.
- If the connected PC enters sleep status, then charging/power supply may stop.

[Power Save Mode]

This is a function to automatically turn the camera to sleep (power save) status or turn off the viewfinder/monitor if no operation is performed for a set time. Reduces battery consumption.

 → [] → [] → Select [Power Save Mode]

[Sleep Mode]	Sets the amount of time until the camera is put to sleep.	
[Sleep Mode(Wi-Fi)]	Sets the camera to sleep 15 minutes after being disconnected from Wi-Fi.	
[Auto LVF/Monitor Off]	Sets the amount of time it takes for the viewfinder/monitor to turn off. (The camera is not turned off.)	
[Power Save LVF Shooting]	Puts the camera to sleep when the recording screen is being displayed on the monitor when automatic viewfinder/monitor switching is active. <ul style="list-style-type: none"> • [Power Save LVF Shooting] does not work when [Time to Sleep] is set to [OFF]. 	
	[Time to Sleep]	Sets the amount of time until the camera is put to sleep.
	[Method of Activation]	Sets the screen where the camera is put to sleep. [Only Control Panel]: Puts the camera to sleep only when the control panel (→ 53) is displayed. [While Recording Standby]: Puts the camera to sleep from any screen during recording standby.

- To recover from [Sleep Mode], [Sleep Mode(Wi-Fi)], or [Power Save LVF Shooting], perform one of the following operations:
 - Press the shutter button halfway.
 - Set the camera on/off switch to [OFF] and then [ON] again.
- To recover from [Auto LVF/Monitor Off], press any button.

Inserting Cards (Optional)

This camera supports the double card slot function. When two cards are used, relay recording, backup recording, and allocation recording are available.

For information about the cards that can be used, refer to page 19.

1 Open the card door.

- Slide the card door in the direction of the arrow while pushing down the card door lock lever.

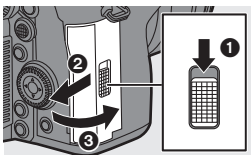

2 Insert the cards.

- (A) Card slot 1
- (B) Card slot 2

- Match the orientation of the cards as shown in the figure and then insert them firmly until they click.
- Do not touch the card connection contacts (C).

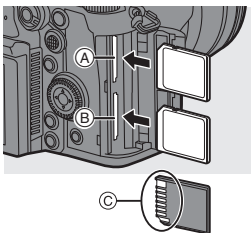

3 Close the card door.

- Close the card door and slide it firmly in the direction of the arrow until it clicks.
- The cards are displayed on the status LCD.

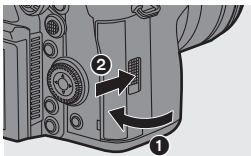

- ➔ You can set the way to record to card slots 1 and 2.
[] ➔ [] ➔ [Double Card Slot Function] (➔ 64)

❖ Card Access Indications

The card access light turns on while the card is being accessed.

❖ Removing a Card

- ❶ Open the card door.
 - Check that the card access light (A) is turned off and then open the card door.
- ❷ Push the card until it clicks and then pull the card out straight.

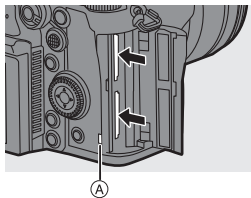

- The card may be warm just after the camera has been used. Be careful when removing.
- **Do not perform the following operations during access.**
The camera may operate incorrectly or the card and recorded images may be damaged.
 - Turn off the camera.
 - Remove the battery or card or disconnect the power plug.
 - Subject the camera to vibration, impacts, or static electricity.



Formatting Cards (Initialization)

Format the cards with the camera before use in order to ensure optimal card performance.



- **When a card is formatted, all of the data stored in the card is erased and cannot be restored.**
Save a backup of necessary data before formatting the card.



➔ [] ➔ [] ➔ Select [Card Format]
 Settings: [Card Slot 1]/[Card Slot 2]



- Do not turn off the camera or perform another operation during formatting.
- Take care not to turn off the camera while formatting is in progress.
- Cards that have not been formatted after purchase should be formatted on the camera.
- If the card has been formatted with a PC or other device, format it again with the camera.

Attaching a Lens

- ✎ Change the lens in a location where there is not a lot of dirt and dust.
- Change the lens while the lens cap is attached.

- 1 Set the camera on/off switch to [OFF].**
- 2 Turn the lens rear cap and the body cap in the direction of the arrow to remove them.**
 - When removing the body cap, rotate it while pressing the lens release button (A).

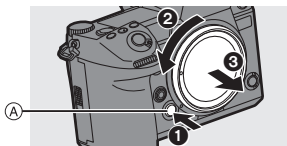
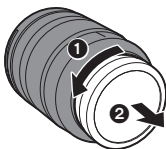

- 3 Align the lens fitting marks (B) on the lens and camera and then rotate the lens in the direction of the arrow.**
 - Attach the lens by rotating it until it clicks.
 - Insert the lens straight in.

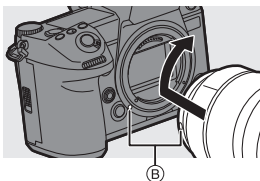

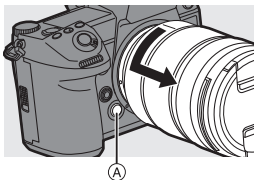

❖ Removing a Lens

- 1 Set the camera on/off switch to [OFF].**
- 2 While pressing the lens release button (A), rotate the lens in the direction of the arrow until it stops and then remove it.**
 - After removing the lens, be sure to attach the body cap and the lens rear cap.





- When you have attached a lens that does not have a communication function with this camera, after turning on the camera, a message asking for confirmation of the lens information is displayed. You can register items such as the image circle and focal length for the lens when you select [Yes]. (→ 78)
- You can change the settings so that the confirmation message is not displayed:
[] → [] → [Lens Info. Confirmation]

Adjusting the Monitor Direction and Angle

The monitor on this camera has angling and tilting that you can adjust in combinations to freely change the orientation and angle.

At the time of purchase, the monitor is stowed in the camera body. Turn the monitor surface out before use.

1 Open the monitor.

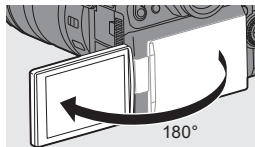

2 Rotate the monitor.

- You can rotate 180° towards the lens and 90° down.

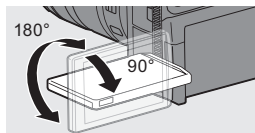

3 Return the monitor to the original position.

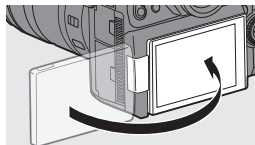

❖ Tilt

While sliding the monitor lock lever in the direction of the arrow, push the monitor up.

- The monitor of this camera can be tilted in two stages.
- The monitor can still be opened when tilted to 30°.

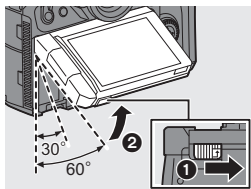



- The angles of adjustment are guides only.
- Take care not to trap a finger in the monitor.
- Do not apply an excessive force to the monitor. This may cause damage or malfunction.
- When not using the camera, close the monitor with the monitor surface facing in.



Setting the Clock (When Turning On for the First Time)

When you turn the camera on for the first time, a screen to set the time zone and clock appears.

Be sure to set these settings before use to ensure images are recorded with the correct date and time information.

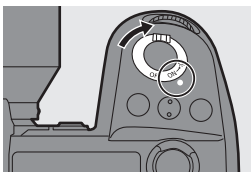





- 1 Set the camera on/off switch to [ON].**
- 2 When [Please set the language] appears, press  or .**
- 3 Set the language.**



- Press **▲▼** to select the language and then press  or .

4 When [Please set the time zone] appears, press  or .

5 Set the time zone.





- Press   to select the time zone and then press  or .
- If you are using Daylight Savings [], press . (The time will move forward by 1 hour.)
To return to the normal time, press  again.



(A) Time difference from GMT (Greenwich Mean Time)

6 When [Please set the clock] appears, press  or .

7 Set the clock.

-  : Select an item (year, month, day, hour, minute, or second).
-  : Select a value.

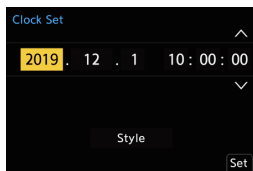

8 Confirm your selection.

- Press  or .

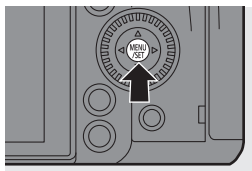

9 When [The clock setting has been completed.] appears, press  or .

3. Basic Operations

Basic Recording Operations

How to Hold the Camera

To minimize camera shake, hold the camera so that it will not move during recording.

Hold the camera with both hands, keep your arms still at your side, and stand with your feet shoulder width apart.

- Hold the camera firmly by wrapping your right hand around the camera grip.
- Support the lens from below with your left hand.
- Do not cover the AF assist light (A) or microphone (B) with your fingers or other objects.
- Do not cover the fan inlet (C) and fan outlet (D) of the cooling fan with your hand, etc.

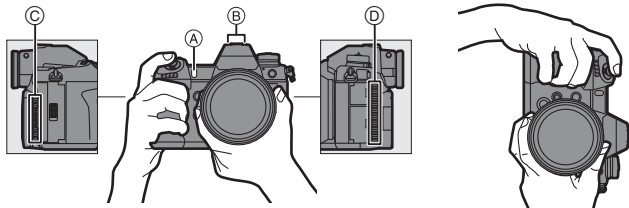

Taking Pictures

1 Adjust the focus.

- Press the shutter button halfway (press it gently).

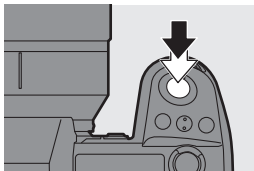

- The aperture value (A) and shutter speed (B) are displayed. (When the correct exposure cannot be obtained, the indications blink in red.)

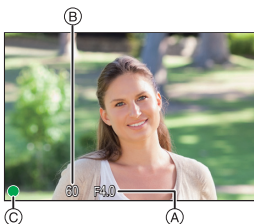

- Once the subject is in focus, the focus indication (C) lights. (When the subject is not in focus, the indication blinks.)

- You can also perform the same operation by pressing [AF ON].

2 Start recording.

- Press the shutter button fully (press it further).

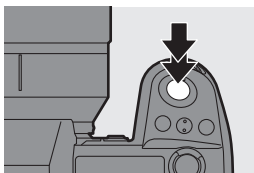

- Recorded pictures can be displayed automatically by setting [Auto Review] of the [Custom] ([Monitor / Display (Photo)]) menu. You can also change the picture display duration to your preferred setting.



- **With the default settings, you cannot take a picture until the subject is brought into focus.**

If you set [Focus/Shutter Priority] in the [Custom] ([Focus/Shutter]) menu to [BALANCE] or [RELEASE], you will be able to take a picture even when the subject is not in focus.

Recording Videos

1 Start recording.

- Press the video rec. button (A).
- You can also perform the same operation by pressing the sub video rec. button (B).
- Release the video rec. button right after you press it.

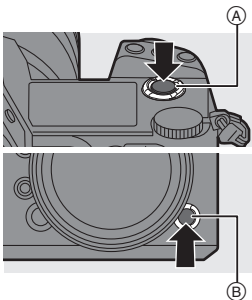

2 Stop recording.

- Press the video rec. button (A) again.
- You can also perform the same operation by pressing the sub video rec. button (B).

Selecting the Recording Mode

While pressing the mode dial lock button ①, rotate the mode dial ②.

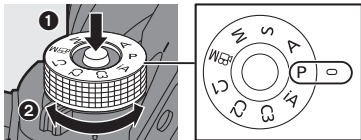





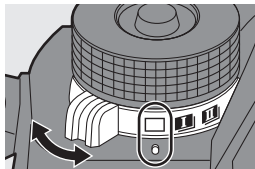

[iA]	Intelligent Auto mode (→ 60)
[P]	Program AE mode <ul style="list-style-type: none"> • The camera automatically sets the shutter speed and aperture value for the brightness of the subject.
[A]	Aperture-Priority AE mode <ul style="list-style-type: none"> • You can set the aperture value before recording. The shutter speed will be automatically set by the camera.
[S]	Shutter-Priority AE mode <ul style="list-style-type: none"> • You can set the shutter speed before recording. The aperture value will be automatically set by the camera.

[M]	Manual Exposure mode • You can take pictures by manually setting the aperture value and shutter speed.
[ M]	Creative Video mode (→ 95)
[C1]/[C2]/[C3]	Custom mode (→ 161)

Selecting the Drive Mode

Rotating the drive mode dial.



[]	Single	Takes one picture each time the shutter button is pressed.
[]/ []	Burst	Takes pictures continuously while the shutter button is pressed and held. 6K/4K photo recording is also possible.
[]	Time Lapse Shot/ Stop Motion Animation	Takes pictures with Time Lapse Shot or Stop Motion Animation.
[]	Self-timer	Takes pictures when the set time elapses after the shutter button is pressed.

Selecting the Focus Mode

Set the focus mode lever.

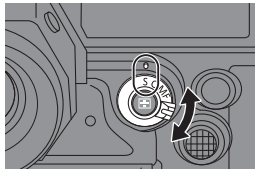

[S] ([AFS])	When the shutter button is pressed halfway, the camera focuses once. The focus stays locked while the shutter button is pressed halfway.
[C] ([AFC])	While the shutter button is pressed halfway, the focus is constantly adjusted according to the movement of the subject. <ul style="list-style-type: none"> • This predicts the movement of the subject, maintaining focusing. (Movement prediction)
[MF]	Manual focusing. (→ 72)

Camera Setting Operations

When changing the camera settings, operate the camera using the following operation parts.

To prevent accidental operation, you can disable operation with the operation lock lever.

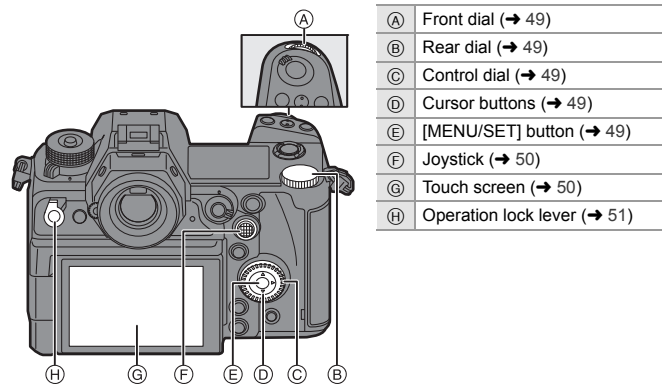

❖ Front Dial (☀️)/Rear Dial (☀️)

Rotate:

Selects an item or numeric value.

- Sets the aperture, shutter speed, and other settings when you are recording in the [P]/[A]/[S]/[M] modes.

The operation method can be changed in [Dial Set.].

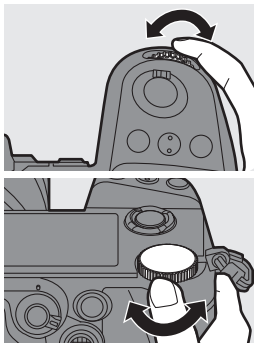

❖ Control Dial (⚙️)

Rotate:

Selects an item or numeric value.

- Adjusts the headphone volume during recording. The function can be changed in [Control Dial Assignment] of [Dial Set.].

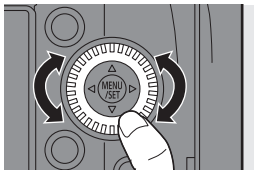

❖ Cursor Buttons (▲▼◀▶)

Press:

Selects an item or numeric value.

❖ [MENU/SET] Button (⊙)

Press:

Confirms a setting.

- Displays the menu during recording and playback.

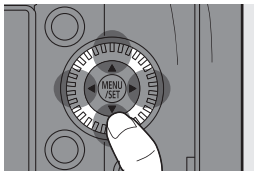

❖ Joystick (▲▼◀▶/👁)

The joystick can be operated in 8 directions by tilting it up, down, left, right and diagonally and by pressing the center part.

Ⓐ **Tilt:** Selects an item or numeric value, or moves a position.

- Place your finger on the center of the joystick before tilting. The joystick may not work as expected when the sides are pressed.

Ⓑ **Press:** Confirms a setting.

- When recording, this moves the AF area and MF Assist.

The joystick functions for recording can be changed in [Joystick Setting].

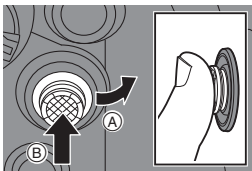

❖ Touch Screen

Operations can be performed by touching the icons, slide bars, menus, and other items displayed on the screen.

Ⓐ **Touch**

Operation of touching and then lifting your finger from the touch screen.

Ⓑ **Drag**

Operation of moving a finger while it touches the touch screen.

Ⓒ **Pinch (widen/narrow)**

Operations of widening the distance between two fingers (pinch out) and narrowing the distance between two fingers (pinch in) while they are touching the touch screen.

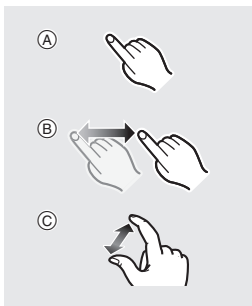



- Touch the screen with clean and dry fingers.
- If you will use a commercially available monitor protection sheet, observe the precautions for the sheet.
(Visibility and operability may be impaired depending on the type of monitor protection sheet.)
- The touch screen may not operate correctly in the following cases:
 - When you are wearing gloves
 - When the touch screen is wet

❖ Operation Lock Lever

Aligning the operation lock lever with the [LOCK] position disables the following operation parts.

The operation parts to disable can be set in [Lock Lever Setting] of the [Custom] ([Operation]) menu.

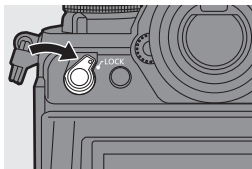

- | | |
|---------------------|----------------|
| – Cursor buttons | – Front dial |
| – [MENU/SET] button | – Rear dial |
| – Joystick | – Control dial |
| – Touch screen | |

Display Settings

Setting the Viewfinder

❖ Adjusting the Viewfinder Diopter

Rotate the diopter adjustment dial while looking through the viewfinder.

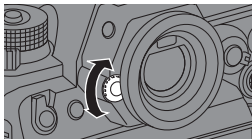

- Adjust until you can clearly see the text on the viewfinder.

❖ Switching the Viewfinder Display Magnification

Press [V.MODE].

- The display magnification of the viewfinder can be switched between 3 levels.

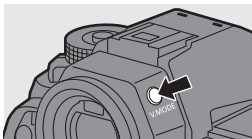

Switching Between the Monitor and Viewfinder

With the default settings, automatic viewfinder/monitor switching is set. When you look through the viewfinder, the eye sensor (A) works and the camera switches from monitor display to viewfinder display. You can switch to viewfinder display or monitor display with [LVF] button (B).

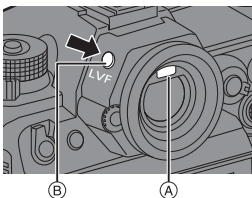

Press [LVF].

**Automatic viewfinder/
monitor switching**

Viewfinder display

Monitor display

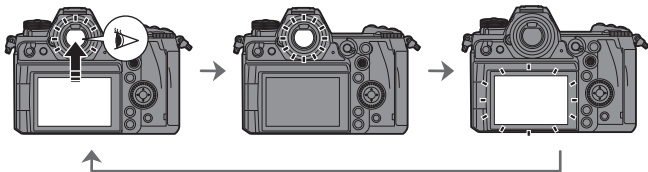

- The eye sensor does not work while the monitor is tilted.
- During video playback or slide show, automatic viewfinder/monitor switching does not work.

Switching the Display Information

The recording information (icons) on the recording screen and playback screen can be hidden.

The monitor on the back can display the control panel, be turned off, etc.

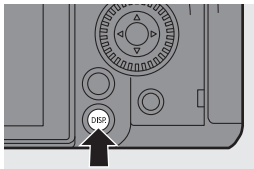

Press [DISP.].

- The display information is switched.

❖ Recording Screen

Monitor

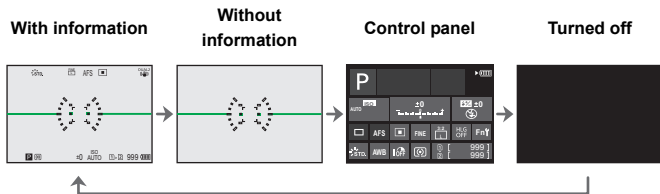

Viewfinder

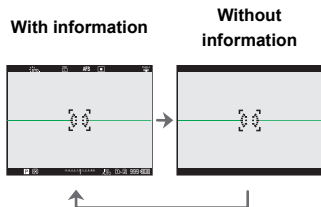

- Press [] to switch between display/hide of the level gauge. This can also be set by using [Level Gauge].

❖ Playback Screen

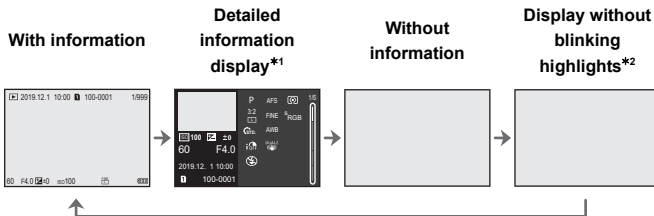

*1 Pressing ▲▼ switches the display information.

- Detailed information display
- Histogram display
- Photo Style display
- White balance display
- Lens information display

*2 This is a screen without blinking highlights display that is shown when [Blinking Highlights] of the [Custom] ([Monitor / Display (Photo)]) is set to [ON]. In other than this screen, overexposed parts of the screen will blink.

Turning On the Status LCD Backlight

Set the camera on/off switch to [ⓘ:]:

- The backlight will turn on.
- When you release the camera on/off switch, it returns to the [ON] position.
- If the camera is left without any operations for a certain period of time, the backlight turns off.
- With the default settings, the illuminated buttons turn on.
- Set the camera on/off switch to [ⓘ:]: again or press the shutter button fully to turn off the backlight.
- The status LCD backlight and illuminated buttons do not turn on while you are using the following functions:
 - Video recording/[6K/4K PHOTO]/ [Post-Focus]
 - Burst recording
 - Playback
 - Menu
 - Quick menu

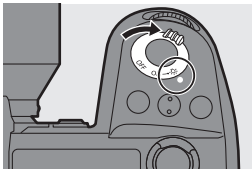

Quick Menu

This menu enables you to quickly set functions that are frequently used during recording without calling up the menu screen. You can also change the Quick menu display method and the items to display.

1 Display the Quick menu.

- Press [Q].

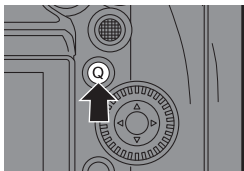

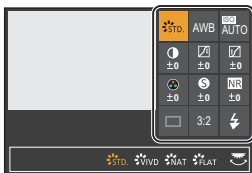

2 Select a menu item.

- Press ▲▼◀▶.
- Directions on the diagonal can also be selected using the joystick.
- Selection is also possible by rotating .
- Selection is also possible by touching a menu item.



3 Select a setting item.

- Rotate  or .
- Selection is also possible by touching a setting item.





4 Close the Quick menu.

- Press the shutter button halfway.
- You can also close the menu by pressing [Q].



- Some items cannot be set depending on the recording mode or camera settings.



- The Quick menu can be customized:
[] ⇒ [] ⇒ [Q.MENU Settings] (→ 159)

Control Panel

This screen allows you to view the current recording settings on the monitor. You can also touch the screen to change the settings.

In the [M] mode (Creative Video mode), the display changes to one especially for video. (→ 193)

1 Display the control panel.

- Press [DISP.] several times.

2 Touch the items.

- The setting screens for each of the items are displayed.

3 Change the setting.

Example) Changing the AF mode

- Touch the setting item.

4 Touch [Set].



❖ Changing Directly Using the Dial

Steps **2** to **4** can also be changed using the following operations.

- 1 Press one of ▲▼◀▶ to enable selection of items.
 - Selected items are displayed in yellow.
- 2 Press ▲▼◀▶ to select an item.
 - Selection is also possible by rotating or .
- 3 Rotate to change the settings values.



- Some items cannot be set depending on the recording mode or camera settings.

Menu Operation Methods



In this camera, the menu is used for setting a wide variety of functions and performing camera customizations.

Menu operations can be performed using the cursors, joystick, dial, or by touch.

Configuration and operation parts of the menu

The menu can be operated by pressing ◀▶ to move between menu screens. Use the operation parts indicated below to operate the main tab, the sub tab, the page tab, and menu items without moving to the corresponding menu levels.

- You can also operate by touching the icons, menu items, and setting items.

- (A) Main tab ([Q] button)
- (B) Sub tab ()
- (C) Menu item ()
- (D) Page tab ()
- (E) Setting item

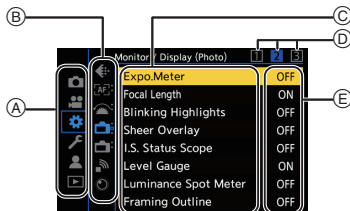

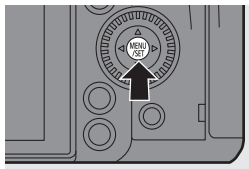

1 Display the menu.

- Press .







2 Select a main tab.

- Press ▲▼ to select a main tab and then press ▶.
- You can also perform the same operation by rotating  to select the main tab and then pressing  or .





3 Select a sub tab.

- Press ▲▼ to select a sub tab and then press ►.
- You can also perform the same operation by rotating  to select the sub tab and then pressing  or .
- If there are page tabs , then after the page tabs have finished switching, the next sub tab is switched to.





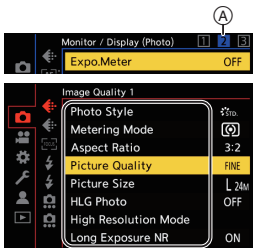

4 Select a menu item.

- Press ▲▼ to select a menu item and then press ►.
- You can also perform the same operation by rotating  to select the menu item and then pressing  or .



5 Select a setting item and then confirm your selection.

- Press ▲▼ to select a setting item and then press  or .
- You can also perform the same operation by rotating  to select the setting item and then pressing  or .
- The display and selection methods of setting items differ depending on the menu item.



6 Close the menu.

- Press the shutter button halfway.
- You can also close the menu by pressing [↵] several times.

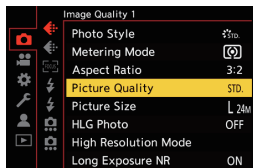

➔ • Refer to the “Owner’s Manual” (PDF format) for details about menu items.

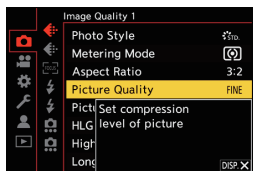

❖ Displaying Descriptions About Menu Items and Settings

If you press [DISP.] while a menu item or setting item is selected, a description about the item is displayed on the screen.



❖ Grayed Out Menu Items

Menu items that cannot be set are displayed grayed out.

If you press  or  while a grayed out menu item is selected, the reason why it cannot be set is displayed.

- The reason why a menu item cannot be set may not be displayed depending on the menu item.

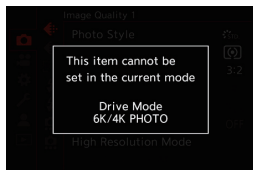



[Reset]

Return each of the following settings to the default setting:

- Recording settings
- Network settings (settings of [Wi-Fi Setup] and [Bluetooth])
- Setup and custom settings (other than [Wi-Fi Setup] and [Bluetooth])

 ➔  ➔  ➔ Select [Reset]

-  If the setup and custom settings are reset, the [Playback] menu is also reset.
 - If the setup and custom settings are reset, [Lens Information] in [Image Stabilizer] in the [Photo] ([Others (Photo)]) menu/[Video] ([Others (Video)]) menu is also returned to the default setting.
 - The folder numbers and clock settings are not reset.
-  Refer to the "Owner's Manual" (PDF format) for a list of default settings and reset targets.

Intelligent Auto Mode



The [iA] mode (Intelligent Auto mode) can record images using settings automatically selected by the camera.

The camera detects the scene to set the optimal recording settings automatically to match the subject and recording conditions.

1 Set the mode dial to [iA].

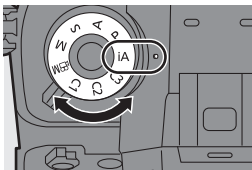

2 Aim the camera at the subject.

- When the camera detects the scene, the recording mode icon changes.

(Automatic Scene Detection)



3 Adjust the focus.

- Press the shutter button halfway.
- Once the subject is in focus, the focus indication lights.
(When the subject is not in focus, the indication blinks.)

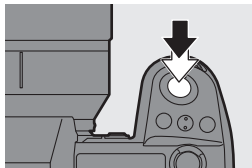

- [AF-ON] of the AF mode works and the AF area is displayed aligned to any humans or animals.

4 Start recording.

- Press the shutter button fully.



- Backlight compensation operates automatically to prevent subjects from appearing dark when there is a backlight.
- Each press of [AF-ON] changes the AF mode ([Face/Eye/Body/Animal Detect.]/[Tracking]).
For information about AF modes, refer to page 68 and 69.
- When recording using a flash, the camera switches to the appropriate flash mode for the recording conditions.

Recording Using Touch Functions



- With the default settings, the Touch Tab is not displayed.
Set [Touch Tab] to [ON] in [Touch Settings] in the [Custom] ([Operation]) menu. (→ 168)

Touch AF/Touch Shutter



Touch functions allow you to focus on the point that you touch, release the shutter, etc.

1 Touch [].

2 Touch the icon.

[]: Touch AF

[]: Touch Shutter

[]: OFF

- The icon switches each time you touch it.



3 (When set to anything other than OFF) Touch the subject.

Touch AE



This function adjusts the brightness according to a touched position.

1 Touch [].

2 Touch [].

3 Touch the subject to which you wish to adjust the brightness.

4 Touch [Set].



How to Disable Touch AE

Touch [].

4. Image Recording

[Aspect Ratio]/[Picture Size]/[Picture Quality]

iA P A S M 



[Aspect Ratio]

You can select the image aspect ratio.

 → [] → [] → Select [Aspect Ratio]

Settings: [4:3]/[3:2]/[16:9]/[1:1]/[65:24]/[2:1]

[Picture Size]



Sets the picture's image size.

 → [] → [] → Select [Picture Size]

Settings: [L]/[M]/[S]

[Picture Quality]

Set the compression rate used for storing pictures.

 → [] → [] → Select [Picture Quality]



Setting	File format	Setting	File format
[FINE]	JPEG	[RAW+FINE]	RAW+JPEG
[STD.]		[RAW+STD.]	
		[RAW]	RAW





- Refer to the "Owner's Manual" (PDF format) for details about [Aspect Ratio], [Picture Size], and [Picture Quality].

[Double Card Slot Function]

This sets the way recording to the card slots 1 and 2 is performed.

 ⇒  ⇒  ⇒ Select [Double Card Slot Function]

[Recording Method]	 [Relay Rec]	Selects the priority of card slots for recording. [Destination Card Slot]: [1 → 2]/[2 → 1] Relays recording to the card in the other card slot after the first card runs out of free space.
	 [Backup Rec]	Records the same images to both cards simultaneously.
	 [Allocation Rec]	Allows you to specify the card slot to be used for recording for different image formats. [JPEG/HLG Photo Destn.]/[RAW Destination]/[6K/4K Photo Destination]/[Video Destination]



Notes about relay recording

- The following video cannot be continued to be recorded on another card:
 - [AVCHD] videos
 - [Loop Recording (video)]

Notes about Backup Recording

- We recommend using cards with the same Speed Class rating and capacity. If the card Speed Class or capacity is insufficient when video recording, recording to both cards stops.
- Backup recording is not available with the following video. They can only be recorded on a single card:
 - [AVCHD] videos
 - [Loop Recording (video)]
- When using the following combinations of cards, recording videos, 6K/4K photos, and recording with [Post-Focus] are not available:
 - SD memory card or SDHC memory card, and SDXC memory card

[Folder / File Settings]

Set the folder and file name where to save the images.

Folder name		File name	
100ABCDE 		PABC0001.JPG 	
1	Folder number (3 digits, 100 to 999)	3	Color space ([P]: sRGB, [_]: AdobeRGB)
2	5-character user-defined segment	4	3-character user-defined segment
		5	File number (4 digits, 0001 to 9999)
		6	Extension



⇒ [MENU/SET] ⇒ [Wrench] ⇒ [Folder] ⇒ Select [Folder / File Settings]

[Select Folder]*	Selects a folder for storing images. <ul style="list-style-type: none"> The folder name and the number of files that can be stored will be indicated. 	
[Create a New Folder]	Creates a new folder with an incremented folder number. <ul style="list-style-type: none"> If there are no recordable folders in the card, a screen for resetting the folder number is displayed. 	
	[OK]	Increments the folder number without changing the 5-character user-defined segment (2 above).
	[Change]	Changes the 5-character user-defined segment (2 above). This will also increment the folder number.
[File Name Setting]	[Folder Number Link]	Uses the 3-character user-defined segment (4 above) to set the folder number (1 above).
	[User Setting]	Changes the 3-character user-defined segment (4 above).

* When [Double Card Slot Function] is set to [Allocation Rec], [Select Folder (Slot 1)] and [Select Folder (Slot 2)] will be displayed.

- Follow the steps on page 170 when the character entry screen is displayed.
Available characters: alphabetic characters (upper-case), numerals, [_]



- Each folder can store up to 1000 files.
- [Select Folder] is not available when [Backup Rec] in [Double Card Slot Function] is being used.

5. Focus/Zoom

Using AF

iA P A S M



AF (Auto Focus) refers to automatic focusing.

Select the focus mode and the AF mode appropriate for the subject and scene.

1 Set the focus mode to [S] or [C].

- Set the focus mode lever. (→ 47)

2 Select the AF mode.

- Press [] to display the AF mode selection screen, and set using or . (→ 67)

3 Press the shutter button halfway.

- The AF operates.
- You can also activate AF by pressing [AF ON].

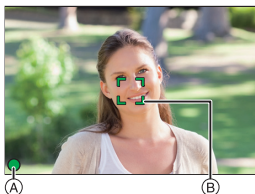

	Focus: In focus	Focus: Not in focus
Focus icon (A)	Lights	Blinking
AF area (B)	Green	Red
AF beep	Two beeps	—

- In dark environments, low illumination AF automatically operates, and the focus icon is indicated as [].
- If the camera detects stars in the night sky after determining low illumination AF, then Starlight AF will be activated.
When focus is achieved, the focus icon will display [].
- **[AF-Point Scope]**
This magnifies the focus point when the AF mode is [], [], or [].
Use the Fn button registered with [AF-Point Scope] to operate.
For information about the Fn button, refer to page 156.

Selecting the AF Mode

iA P A S M 





Select the focusing method to match the position and number of subjects. This document gives an overview of AF mode. Refer to the “Owner’s Manual” (PDF format) for details about AF mode.









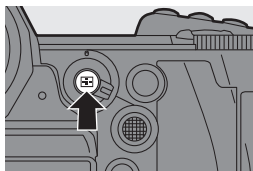



1 Press [].

- The AF mode selection screen appears.

2 Select the AF mode.

- Press ◀▶ to select an item and then press  or .
- Selection is also possible by pressing [].



	[Face/Eye/Body/Animal Detect.]	→ 68
	[Tracking]	→ 69
	[225-Area]	→ 69
	[Zone (Vert./ Horz.)]	→ 69
	[Zone (Square)]*	→ 69
	[Zone (Oval)]	→ 70
	[1-Area+]	→ 70
	[1-Area]	→ 70
	[Pinpoint]	→ 70
 	[Custom1]*, [Custom2]*,	→ 70
	[Custom3]*	

- * This is not displayed with the default settings. From [Show/Hide AF Mode] in the [Custom] ([Focus/Shutter]) menu, you can set the items to display on the selection screen.

[Face/Eye/Body/Animal Detect.]

The camera detects a person's face, eyes, and body (entire body or upper half of the body) and adjusts the focus.

With the default settings, animal detection will also operate, enabling detection of animals, such as birds, canines (including wolves), and felines (including lions).

When the camera detects a person's face (A)/(B) or body or an animal's body (C), an AF area is displayed.

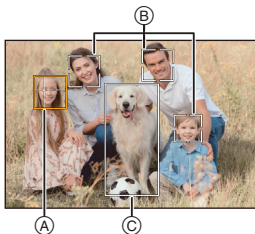

Yellow	AF area to be brought into focus. The camera selects this automatically.
White	Displayed when multiple subjects are detected.



- Eye detection works only for the eyes inside the yellow frame (A).



Specify the Person, Animal, or Eye to Bring into Focus

Touch the person, animal or eye indicated with the white AF area.

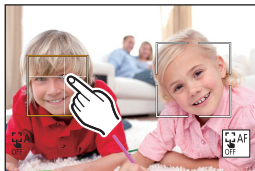
- The AF area will change to yellow.
- Touching outside the AF area displays the AF area setting screen. Touch [Set] to set the [■] AF area at the position touched.
- To cancel the setting, touch [].
- Each press of  switches the person, animal or eye to be brought into focus.
To cancel the settings specified, press  again.



Enable/Disable Animal Detection

- 1 Press [] to display the AF mode selection screen.
- 2 Select [] and then press ▲.

[Tracking]

When the focus mode is set to [AFC], the AF area follows the movement of the subject, maintaining focusing.

Start tracking.

Aim the AF area over the subject, and press the shutter button halfway.

The camera will track the subject while the shutter button is pressed halfway or pressed fully.



- If tracking fails, the AF area blinks red.
- When set to [AFS], the focus will be on the AF area position. Tracking will not work.

[225-Area]

The camera selects the most optimal AF area to focus from 225 areas. When multiple AF areas are selected, all selected AF areas will be brought into focus.

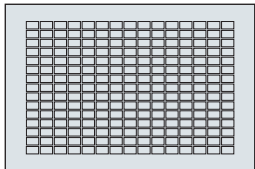

Specify the [AFC] start point.

When the focus mode is set to [AFC], you can specify at which area to start [AFC].

 →  →  → [AFC Start Point (225-Area)] → [ON]

- Refer to page 71 for details about AF area movement.

 [Zone (Vert./ Horz.)]/  [Zone (Square)]/  [Zone (Oval)]

 [Zone (Vert./ Horz.)]

Within the 225 AF areas, vertical and horizontal zones can be focused.

 [Zone (Square)]

Within the 225 AF areas, a central square zone can be focused.

[Zone (Oval)]

Within the 225 AF areas, a central oval zone can be focused.

[1-Area+]/ [1-Area]

[1-Area+]

Emphasis within a single AF area can be focused.

Even when the subject moves out of the single AF area, the subject remains focused in a supplementary AF area (A).

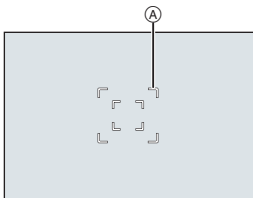

[1-Area]









Specify the point to be brought into focus.

[Pinpoint]

You can achieve a more precise focus on a small point.

If you press the shutter button halfway, the screen that lets you check the focus will be enlarged.

Move the Position of the AF Area

- 1 Press [] to display the AF mode selection screen.
- 2 Select [] and then press \blacktriangledown .
- 3 Press \blacktriangle \blacktriangledown \blacktriangleleft to set the position of [] and then press  or .
 - Positions can be moved to the diagonal directions using the joystick.
 - The selected position on the screen will be enlarged.
- 4 Press \blacktriangle \blacktriangledown \blacktriangleleft to fine-adjust the position of [].
- 5 Press  or .

[Custom1] to [Custom3]

The shape of the AF area can be set freely in the 225 AF areas.

The set AF area can be registered using [] to [].

The AF area can also be moved while maintaining the set shape.

- This is not displayed with default settings. In [Show/Hide AF Mode] in the [Custom] ([Focus/Shutter]) menu, set [Custom1] to [Custom3] to [ON]. (→ 167)

Register the AF Area Shape

- 1 Press [] to display the AF mode selection screen.
- 2 Select one of [C1] to [C3] and then press \blacktriangle .
- 3 Select the AF area.
 - Touch the area to make the AF area.
 - To select consecutive points, drag the screen.
 - To cancel selection of the selected AF area, touch it again.
- 4 Press [Q].

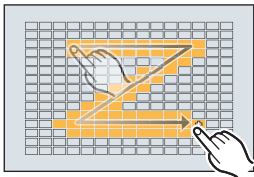

AF Area Movement Operation



iA P A S M 



In default settings, you can use the joystick to directly move and change the size of the AF area when recording.



- Refer to the “Owner’s Manual” (PDF format) for details about AF area movement operations using other than the joystick.

1 Move the position of the AF area.

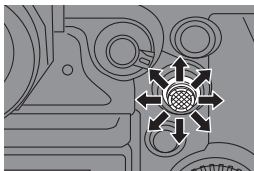
- On the recording screen, tilt the joystick.
- Pressing  enables switching between the default and set AF area positions.
 - In [], this operation switches the person, animal or eye to be brought into focus.
 - In [], this operation displays the enlarged screen.



2 Change the size of the AF area.

- Rotate  or .
- Use  for more detailed adjustments.
- The first press of [DISP.] returns the AF area position to the center. The second press returns the size of the AF area to the default.

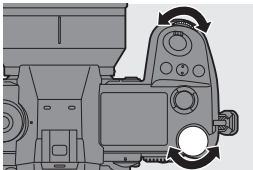

3 Confirm your selection.

- Press the shutter button halfway.
- This will return you to the recording screen.

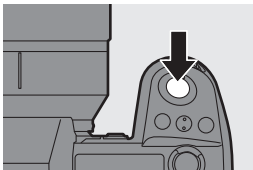



Record Using MF



MF (Manual Focus) refers to manual focusing.

Use this function when you want to fix the focus or when the distance between the lens and the subject is determined and you do not want to activate AF.

- 1 **Set the focus mode lever to [MF].**
- 2 **Select the focus point.**
 - Tilt the joystick to select the focus point.
 - To return the point to be brought into focus to the center, press [DISP.].
- 3 **Confirm your selection.**
 - Press .
 - This switches to the MF Assist screen, and shows an enlarged display.
- 4 **Adjust the focus.**
 - Rotate the focus ring.
 - Ⓐ MF Assist (enlarged screen)
 - This will display the in-focus portion highlighted with color. (Focus Peaking Ⓑ)
 - A recording distance guideline is displayed. (MF Guide Ⓒ)
 - Ⓓ Indicator for ∞ (infinity)
- 5 **Close the MF Assist screen.**
 - Press the shutter button halfway.
 - This operation can also be performed by pressing .
- 6 **Start recording.**
 - Press the shutter button fully.

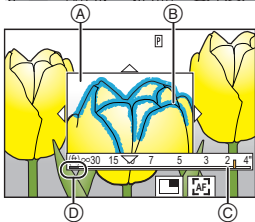
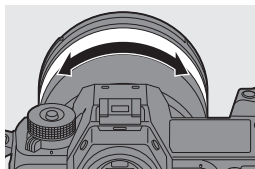
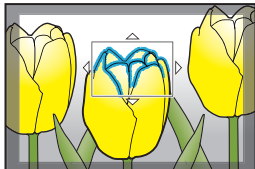
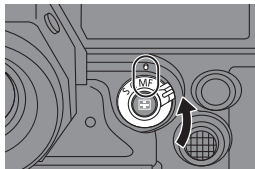

❖ Operations on the MF Assist Screen

Button operation	Touch operation	Description of operation
▲▼◀▶	Drag	Moves the enlarged display position. • Positions can be moved to the diagonal directions using the joystick.
	Pinch out/ pinch in	Enlarges/reduces the screen in small steps.
	—	Enlarges/reduces the screen.
		Switches magnification window (windowed mode/full screen mode).
[DISP.]	[Reset]	First time: Returns the MF Assist position to the center. Second time: Returns the MF Assist magnification to the default setting.
[AF ON]		The AF operates.

Recording with Zoom

iA P A S M



Use the optical zoom of the lens to zoom to telephoto or wide-angle.

When taking pictures, use [Ex. Tele Conv.] to increase a telescopic effect without image deterioration.

When recording videos, use [Image Area of Video] to obtain the same telescopic effect as [Ex. Tele Conv.].

- Refer to the “Owner’s Manual” (PDF format) for details about [Ex. Tele Conv.].
- For details about [Image Area of Video], refer to page 108.

Rotate the zoom ring.

- T**: Telephoto
- W**: Wide-angle

- Rotating the zoom ring displays the focal length on the recording screen.

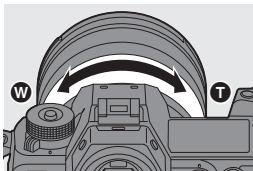

6. Image Stabilizer

Image Stabilizer



This camera can use both the in-body image stabilizer and the in-lens image stabilizer.

Of the Dual I.S. modes that effectively combine two image stabilizers, this supports Dual I.S.2 with high correction efficiency.

Furthermore, during video recording, you can use the 5-Axis Hybrid Image Stabilizer that incorporates electronic stabilization.

Combinations of lenses and image stabilizers (As of August 2019)

Attached lens	Available image stabilizer	Example of icon
Panasonic lenses with image stabilization function	Body+Lens (Dual I.S.2)	DUAL2
Other manufacturer's lenses with image stabilization function	Body or Lens	BODY / LENS
Lenses without image stabilizer	Body	BODY
Lenses without communication function	Body	BODY

- The 5-Axis Hybrid Image Stabilizer (→ 76) can be used with any lenses.

❖ Using the Image Stabilizer

- When using a lens with an O.I.S. switch, set the switch on the lens to [ON].
- When using a lens that does not have a communication function with this camera, after turning on the camera, a message asking for confirmation of the lens information is displayed.

For the image stabilizer function to operate correctly, it is necessary to set the image circle, focal length, and image stabilizer range to suit the lens. Follow the message to make the settings.

This can also be set using the menu. (→ 78)







-  When the shutter button is pressed halfway, the camera shake alert icon [] may be displayed on the recording screen.
If this is displayed, we recommend using a tripod, the self timer or the Shutter Remote Control (DMW-RS2: optional).
- We recommend turning off the image stabilizer function when using a tripod.
-  When the following function is being used, the image stabilizer function is not available:
 - [High Resolution Mode]

Image Stabilizer Settings



Set the image stabilizer operation to match the recording situation.

 ⇒ [] ⇒ [] ⇒ Select [Image Stabilizer]

[Operation Mode]	Sets the stabilization movement (blur) to match the recording method (normal, panning). (→ 77)	
[Body(B.I.S.) / Lens(O.I.S.)]	[] ([Body])	Uses the in-body image stabilizer.
	[] ([Lens])	Uses the in-lens image stabilizer.
	<ul style="list-style-type: none"> • This can be set when using other manufacturer's lenses with an image stabilization function. 	
[When to Activate]	[ALWAYS]	The image stabilizer is always operating.
	[HALF-SHUTTER]	The image stabilizer operates when the shutter button is pressed halfway.
[E-Stabilization (Video)]	<p>Camera shake during video recording is corrected along the vertical, horizontal, roll, pitch, and yaw axes through the combined use of the in-lens, in-body, and electronic image stabilizers. (5-Axis Hybrid Image Stabilizer)</p> <ul style="list-style-type: none"> • The [] on the recording screen changes to [] while [E-Stabilization (Video)] is functioning. • The angle of view may become narrower if set to [ON]. 	





[Boost I.S. (Video)]	Increases the effectiveness of the image stabilizer during video recording. This effect can help provide a stable composition when you want to perform recording from a fixed perspective. (→ 78)
[Anamorphic (Video)]	You can switch to an image stabilizer that suits anamorphic recording. (→ 78)
[Lens Information]	When using a lens that does not have a communication function with the camera, register the lens information in the camera. (→ 78)



- When the following functions are being used, [When to Activate] is fixed to [ALWAYS]:
 - [] ([Body(B.I.S.) / Lens(O.I.S.)])
 - [] mode
 - Video recording/[6K/4K PHOTO]/[Post-Focus]
- When the following functions are being used, [E-Stabilization (Video)] is not available:
 - 6K video/5.9K video/5.4K video
 - [Variable Frame Rate]
 - [Live Cropping]

❖ [Operation Mode]

Set the stabilization movement (blur) to match the recording method (normal, panning).

 [Normal]	Corrects vertical, horizontal, and rotational camera shake. This function is suitable for normal recording.
 [Panning (Auto)]	Automatically detects the panning direction, and corrects vertical and horizontal camera shake. This function is suitable for panning.
 [Panning (Left/Right)]	Corrects vertical camera shake. This is suitable for horizontal panning.
 [Panning (Up/Down)]	Corrects horizontal camera shake. This is suitable for vertical panning.
[OFF]	Turns the image stabilization function OFF.

- Operation modes that can be used will differ depending on the used lenses and on [Body(B.I.S.) / Lens(O.I.S.)] settings.
- When using lenses with an O.I.S. switch, the camera's operation mode cannot be set to [OFF]. Set the switch on the lens to [OFF].
- When the following functions are being used, [Operation Mode] switches to [] ([Normal]):
 - [] mode
 - Video recording/[6K/4K PHOTO]/[Post-Focus]

❖ [Boost I.S. (Video)]

Increase the effectiveness of the image stabilizer during video recording. This effect can help provide a stable composition when you want to perform recording from a fixed perspective.

Settings: [ON]/[OFF]

- When [Boost I.S. (Video)] is operating, [] is displayed on the recording screen.
- To change composition while recording, first set this to [OFF] before moving the camera.
 - To set this to [OFF] during recording, use the Fn button. (→ 156)
- Longer focal lengths will result in weaker stabilization.

❖ [Anamorphic (Video)]

You can switch to an image stabilizer that suits anamorphic recording.

Settings: []^{A2.0} [(2.0×)]/[]^{A1.8} [(1.8×)]/[]^{A1.5} [(1.5×)]/[]^{A1.33} [(1.33×)]/[]^{A1.30} [(1.30×)]/[OFF]

- Make settings to suit the magnification of the anamorphic lens you are using.
- While [Anamorphic (Video)] is functioning, the set magnification appears on the image stabilizer icons on the recording screen, as shown by []^{A2.0} and []^{A2.0}.



- When [Boost I.S. (Video)] is set, [Boost I.S. (Video)] is prioritized.

❖ [Lens Information]





Register the information for lenses that cannot communicate with the camera. Match the in-body image stabilizer with the information of the lens you register. The settings on this camera enable you to switch settings to suit full-frame or Super 35 mm/APS-C lenses. (→ 19)

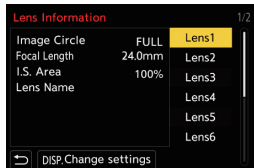

Press ▲▼ to select the lens information to use and then press  or .

- In the default setting, the lens information for 6 lenses with a focal length of between 24 mm and 135 mm is registered.
The lens information for up to 12 lenses can be registered.



Registering, modifying, and deleting lens information

- Press ▲▼ to select the lens information and then press [DISP.].
 - If lens information that has not been registered is selected, press  or  to proceed to Step 3.
- Press ▲▼ to select [Edit] or [Delete] and then press  or .
 - The lens information is deleted when you select [Delete].
- Enter the lens information.
 - The lens information changes if the lens information has already been registered.
- (If lens information that has not been registered is selected) Press [DISP.] to register the lens information.

[Image Circle]	Select the image circle for the lens. [FULL] : Full-frame lens [S35mm] : Lens for Super 35 mm/lens for APS-C
[Focal Length]	Enter the focal length.
[I.S. Area]	You can set the range of stabilization for the image stabilizer so that vignetting does not occur due to the image stabilizer. [70%]/[80%]/[90%]/[100%] <ul style="list-style-type: none"> Rotate  to select the range of stabilization, then press  or  to confirm. When the four edges are selected by pressing ▲▼◀▶, the in-body image stabilizer works and you can see if there is any vignetting. If vignetting has occurred, set again to a smaller range.
[Lens Name]	Register the lens. <ul style="list-style-type: none"> For information on how to enter characters, refer to page 170.



7. Metering/Exposure/ISO Sensitivity





[Metering Mode]

iA P A S M 



Type of optical measurement to measure brightness can be changed.

 →  →  → Select [Metering Mode]

 (Multi-metering)	Method in which the most suitable exposure is measured by judging the allocation of brightness on the whole screen.
 (Center-weighted)	Method used to perform measuring which focuses on the center of the screen.
 (Spot)	Method used to measure the extremely small part around the spot-metering target.
 (Highlight-weighted)	Method used to perform measuring which focuses on the highlighted parts of the screen to prevent overexposure. This is suitable for theatre photography, etc.

Exposure Compensation

iA P A S M 



You can compensate the exposure when the correct exposure determined by the camera is too bright or too dark.



You can adjust the exposure in 1/3 EV steps in a range of ± 5 EV.

When recording videos or recording with 6K/4K photo or Post-Focus, the range changes to ± 3 EV.

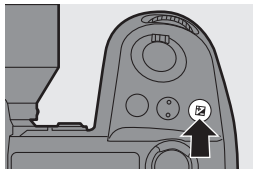
1 Press [].



2 Compensate the exposure.

- Rotate [], [], or [].

3 Confirm your selection.

- Press the shutter button halfway.

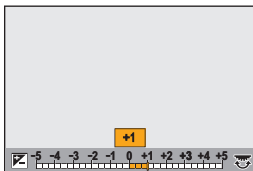

- In [M] mode, you can compensate the exposure by setting the ISO sensitivity to [AUTO].

ISO Sensitivity

iA P A S M 



You can set light sensitivity (ISO sensitivity).



With the default settings, you can set 100 to 51200 in 1/3 EV increments.

This camera supports Dual Native ISO which enables recording at high sensitivity with reduced noise by switching the base sensitivity. The base sensitivity can also be fixed as necessary.

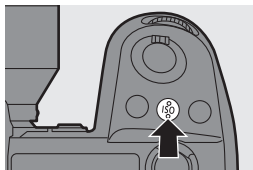
1 Press [ISO].



2 Select ISO sensitivity.

- Rotate , , or .
- Selection is also possible by pressing [ISO].

3 Confirm your selection.

- Press the shutter button halfway.

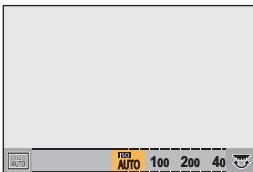

❖ Setting Items (ISO Sensitivity)

[AUTO]	<p>The ISO sensitivity is automatically adjusted according to the brightness.</p> <ul style="list-style-type: none"> • Taking picture: Maximum [6400]^{*1} • Video recording: Maximum [6400]^{*2}
[100] to [51200]	<p>The ISO sensitivity is fixed at the selected value.</p> <ul style="list-style-type: none"> • The available ISO sensitivity range changes according to the setting of [Dual Native ISO Setting] in the [Photo] ([Image Quality]) menu. (→ 83) • You can extend the ISO sensitivity range in between a lower limit of [50] and an upper limit of [204800] by setting [Extended ISO] to [ON] in the [Custom] ([Image Quality]) menu.

*1 Default setting. The upper limit can be changed with [ISO Sensitivity (photo)].

*2 Default setting. The upper limit can be changed with [ISO Sensitivity (video)].

- When the following functions are being used, the ISO sensitivity that can be set is restricted.
 - [High Resolution Mode]: Up to an upper limit of [3200]
 - [High Dynamic] ([Filter Settings]): Down to a lower limit of [400], up to an upper limit of [6400]
 - Other than [High Dynamic] ([Filter Settings]): Up to an upper limit of [6400]
 - [Multiple Exposure]: Down to a lower limit of [100], up to an upper limit of [6400]
 - [Cinelike D2]/[Cinelike V2] ([Photo Style]): Down to a lower limit of [200]
(The lower limit changes to [100] when [Extended ISO] is set.)
 - [Like709] ([Photo Style]): Down to a lower limit of [100]

- [V-Log] ([Photo Style]): Down to a lower limit of [640], up to an upper limit of [51200]
(The lower limit changes to [320] when [Extended ISO] is set.)
- [Standard(HLG)]/[Monochrome(HLG)]/[Like2100(HLG)] ([Photo Style]): Down to a lower limit of [400]

[Dual Native ISO Setting]

You can set whether to switch the base sensitivity automatically or to fix it.

 → [] → [] → Select [Dual Native ISO Setting]

[AUTO]	The base sensitivity is automatically switched according to the brightness.	
	ISO sensitivity that can be set	[AUTO]/[100] to [51200] When [Extended ISO] is set: [AUTO]/[50] to [204800]
[LOW]	Sets the base sensitivity for low sensitivity.	
	ISO sensitivity that can be set	[AUTO]/[100] to [800] When [Extended ISO] is set: [AUTO]/[50] to [800]
[HIGH]	Sets the base sensitivity for high sensitivity.	
	ISO sensitivity that can be set	[AUTO]/[640] to [51200] When [Extended ISO] is set: [AUTO]/[320] to [204800]

8. White Balance/Image Quality

White Balance (WB)

iA P A S M 



White balance (WB) is a function that corrects the color cast produced by the light illuminating the subject.

It corrects the colors so that white objects appear in white to make the overall color closer to what is seen by the eye.



Normally, you can use auto ([AWB], [AWBc] or [AWBw]) to obtain the optimal white balance.

Set this function when the coloring of the image is different from what you expected, or you want to change the coloring to capture the ambience.

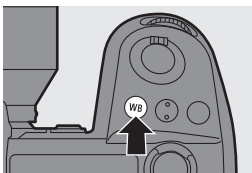
1 Press [WB].



2 Select the white balance.

- Rotate ,  or .
- Selection is also possible by pressing [WB].

3 Confirm your selection.

- Press the shutter button halfway.

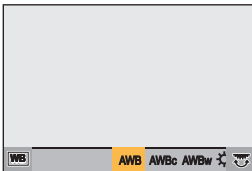

❖ Setting Items (White Balance)

[AWB]	Auto
[AWBc]	Auto (Reduces the reddish hue under an incandescent light source)
[AWBw]	Auto (Leaves the reddish hue under an incandescent light source)
[☀️]	Clear sky
[☁️]	Cloudy sky
[🏠]	Shade under a clear sky
[💡]	Incandescent light
[🔍]	Flash
[1] to [4]	Set mode 1 to 4 (→ 86)
[1K] to [4K]	Color temperatures 1 to 4 (→ 86)

* It operates as [AWB] during video recording or when recording with [6K/4K PHOTO] or [Post-Focus].

- [AWB] will work within this range.
- Blue sky
- Cloudy sky (Rain)
- Shade
- Sunlight
- White fluorescent light
- Incandescent light bulb
- Sunrise and sunset
- Candlelight

K=Kelvin Color Temperature

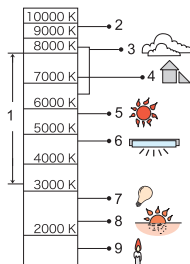



• Under lighting such as fluorescent or LED lighting, the appropriate white balance will vary depending on the lighting type.
Use [AWB], [AWBc], [AWBw] or [1] to [4].



• The white balance is fixed to [AWB] while [Filter Settings] is being used.

❖ Registering the White Set ([, , , , , , , , , , , , , , , , ,) to [, ,

- ◀: [A] (AMBER: ORANGE)
- ▲: [G] (GREEN: GREENISH)
- ▶: [B] (BLUE: BLUISH)
- ▼: [M] (MAGENTA: REDDISH)

- You can also make adjustments in diagonal directions by using the joystick.
- You can also touch the graph to make adjustments.
- Press [DISP.] to return to the unadjusted state.
- You can set the White Balance Bracket by rotating ,  or .

4 Confirm your selection.

- Press the shutter button halfway.



- When the white balance is adjusted, the color of its recording screen icon changes to the adjusted color.
Adjusting toward the [G] side will display [+], while adjusting toward the [M] side will display [-].

[Photo Style]

















You can select the finishing settings of images to suit your subjects and expression styles.

The image quality can be adjusted for each Photo Style.





→ [] → [] → Select [Photo Style]

 [Standard]	The standard setting.
 [Vivid]	A setting that produces a more vivid quality with higher saturation and contrast.
 [Natural]	A setting that produces a softer quality with lower contrast.
 [Flat]	A setting that produces a flatter image quality with lower saturation and contrast.
 [Landscape]	A setting suited for sceneries with vivid blue skies and greens.

 PORT [Portrait]	A setting suited for portraits with a healthy and beautiful skin tone.
 MONO [Monochrome]	A monochrome setting with no color shades.
 L.MONO [L.Monochrome]	A black-and-white setting with rich gradation and crisp black accents.
 L.MONOD [L.Monochrome D]	A monochrome setting that creates a dynamic impression with enhanced highlights and shadows.
 CINED2 [Cinelike D2]	A setting that creates a film-like finishing touch using a gamma curve and gives priority to the dynamic range. <ul style="list-style-type: none"> • This function is suitable for video editing processes.
 CNEV2 [Cinelike V2]	A setting that creates a film-like finishing touch using a gamma curve that gives priority to the contrast.
 709L [Like709]	A setting that minimizes overexposure by applying a gamma curve correction equivalent to Rec.709 to perform compression (knee adjustment) of high-luminance areas. <ul style="list-style-type: none"> • Rec.709 is an abbreviation of "ITU-R Recommendation BT.709", a standard for high-definition broadcasting.
 V-Log [V-Log]	Gamma curve setting intended for post-production processing. <ul style="list-style-type: none"> • It allows you to add rich gradation to images during post production editing.
 2100^{HLG} [Like2100(HLG)]*¹	A setting used to record HLG format video.
 [MY PHOTO STYLE 1]*² to [MY PHOTO STYLE 10]*²	Adjusts the image quality of Photo Style items to your preferred settings and registers these as My Photo Style items. <ul style="list-style-type: none"> • Refer to the "Owner's Manual" (PDF format) for details.



- *1 Can only be selected when in the [M] mode and set to a 10-bit [Rec Quality]. (→ 101)
 - *2 Effects up to [MY PHOTO STYLE 4] are displayed with the default settings. You can set the items to display in the menu with [Show/Hide Photo Style] in [Photo Style Settings].
- When [HLG Photo] is set, the items will be as follows.

 [Standard(HLG)]	Standard [HLG Photo] setting.
 [Monochrome(HLG)]	Black and white setting for [HLG Photo].



- In [iA] mode, operation differs from that in other recording modes.
 - [Standard] or [Monochrome] can be set.
 - The setting will be reset to [Standard] when the camera is switched to another recording mode or it is turned off.
 - Image quality cannot be adjusted.
- When [Filter Settings] is being used, [Photo Style] is not available.

❖ Adjusting the Image Quality

- 1 Press ◀▶ to select the type of Photo Style.
- 2 Press ▲▼ to select an item and then press ◀▶ to adjust.
 - Adjusted items are indicated with [*].
- 3 Press  or  .
 - When the image quality is adjusted, the Photo Style icon on the recording screen is indicated with [*].

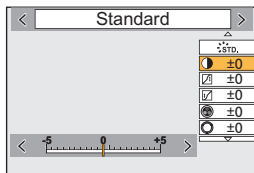

- Refer to the "Owner's Manual" (PDF format) for details about setting items.

9. Flash

Using an External Flash (Optional)

This document gives an overview of recording with a flash. Refer to the "Owner's Manual" (PDF format) for details about recording using a flash and recording with a wireless flash.



- Flash recording is not possible when the following functions are being used:
 - [6K/4K PHOTO]/[Post-Focus]
 - [ELEC.]/[Silent Mode]/[High Resolution Mode]
 - [Filter Settings]

Removing the Hot Shoe Cover

Before attaching the Flash (optional), remove the hot shoe cover. Refer to the operating instructions for the Flash for details about how to attach it.

Remove the hot shoe cover by pulling it in the direction indicated by arrow ② while pressing it in the direction indicated by arrow ①.

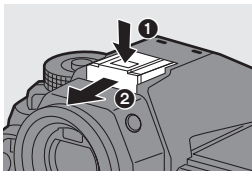

❖ Flash Synchro Socket

You can use a commercially available external flash by connecting a synchro cable to the flash synchro socket.



- Use an external flash with a synchronization voltage of 250 V or less.
- In the [Ⓜ] mode, the flash synchro socket is used to synchronize time codes with an external device. (→ 111) Do not connect an external flash to the flash synchro socket when set to the [Ⓜ] mode. Doing so may cause a malfunction in the camera.

[Flash Mode]



Sets the flash mode.

MENU/SET → [📷] → [⚡] → **Select [Flash Mode]**



[⚡] (Forced Flash On)	The flash fires every time regardless of the recording conditions.
[⚡👁] (Forced On/Red-Eye)	This is suitable for recording when there is backlighting or under lighting such as fluorescent lighting.
[⚡S] (Slow Sync.)	When recording images against a nightscape, this will slow the shutter speed when the flash fires to make not only the subject but also the nightscape appear brighter.
[⚡S👁] (Slow Sync./Red-Eye)	<ul style="list-style-type: none"> Slower shutter speeds may result in blurry images. To avoid this, we recommend using a tripod.
[🚫] (Forced Flash Off)	The flash does not fire.

10. Recording Videos

Recording Videos

iA P A S M 



It is possible to record video with a maximum resolution of 6K (5952×3968) on this camera.

It also supports switching of the system frequency and 3 types of recording file format; AVCHD, MP4, and MOV.

In the [] mode (Creative Video mode), which is specifically for video recording, you can use all of the video functions.

1 Start recording.

- Press the video rec. button (A).
- You can also perform the same operation by pressing the sub video rec. button (B).
- Release the video rec. button right after you press it.
- During video recording, the front tally lamp (C) and rear tally lamp (D) light.

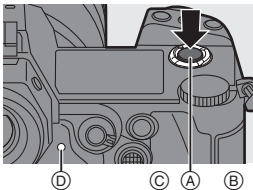

2 Stop recording.

- Press the video rec. button (A) again.
- You can also perform the same operation by pressing the sub video rec. button (B).

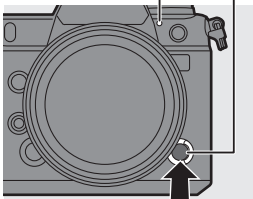

❖ Screen Displays While Video Recording

The live view angle of view changes to the angle of view for video recording, and video recording time (E) and elapsed recording time (F) are displayed.

- h: hour, m: minute, s: second
- The recording state indication (G) and card access indication (H) turn red while videos are being recorded.

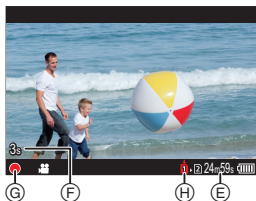

❖ Exposure Control While Video Recording

Videos will be recorded using the aperture, shutter speed, ISO sensitivity, and Dual Native ISO settings below.

Recording mode	Aperture value/shutter speed/ISO sensitivity/Dual Native ISO setting
[iA]	The camera automatically makes the settings to suit the scene.
[P]/[A]/[S]/[M]	The settings vary depending on the [Auto Exposure in P/A/S/M] in the [Custom] ([Image Quality]) menu. The default setting is [ON]. [ON]: Records with values set automatically by the camera. [OFF]: Records with manually set values.
[M]	Records with manually set values.

❖ Size Interval for Dividing Files

[Rec. File Format]	[Rec Quality]	Size interval for dividing files
[AVCHD]	All	A new file will be created to continue recording if the file size exceeds 4 GB. The files recorded can be played back continuously.
[MP4]	[FHD]	A new file will be created to continue recording if the continuous recording time exceeds 30 minutes or the file size exceeds 4 GB.
	[4K]	When using an SDHC memory card: A new file will be created to continue recording if the continuous recording time exceeds 30 minutes or the file size exceeds 4 GB.
[MOV]	All	When using an SDXC memory card: A new file will be created to continue recording if the continuous recording time exceeds 3 hours and 4 minutes or the file size exceeds 96 GB.



- If maintaining focus on the subject is difficult during video recording with AF, press the shutter button halfway to re-adjust the focus.



- When the remaining capacity of the battery or card gets low during video recording, the tally lamps blink at long intervals. When there is no remaining capacity in the battery or card, video recording is stopped and the tally lamps blink at short intervals.
- If an operation such as a zoom or button operation is performed during video recording, that operation sound may be recorded.
- If the operation sound of pressing the video rec. button or sub video rec. button to end recording bothers you, try the following:
 - Record the video about 3 seconds longer, and then divide the last part of the video using [Video Divide] in the [Playback] ([Edit Image]) menu.
 - Use the Shutter Remote Control (DMW-RS2: optional) for recording.
- Depending on the type of card, the card access indication may appear for a while after video recording. This is not a malfunction.

Displays Suited to Video Recording

❖ Recording Screen

In the recording screen, the following parts switch to displays suited to video recording.

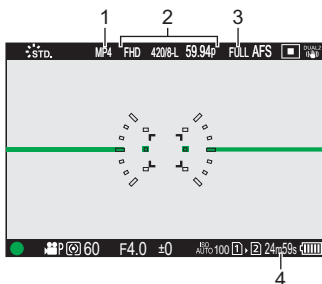

1 Recording file format (→ 100)

2 Recording quality (→ 101)

3 Image area of video (→ 108)

4 Video recording time

- Examples of displays at the time of purchase. For information about the icons other than those described here, refer to page 188.

❖ Status LCD

You can switch the status LCD between 2 types of information display.

- Use the Fn button registered with [Status-LCD Display(Video)] to operate. In default settings, this is registered in the [Fn1] button. For information about the Fn button, refer to page 156.

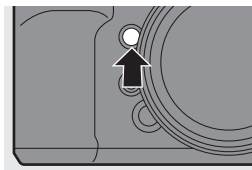

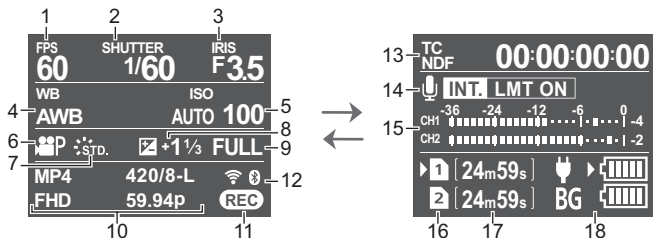

1	Frame rate (→ 101)/ Variable frame rate (→ 125)
2	Shutter speed (→ 45)
3	Aperture value (→ 45)
4	White balance (→ 84)
5	ISO sensitivity (→ 81)/ Dual Native ISO setting (→ 83)
6	Exposure mode (→ 98)
7	Photo Style (→ 87)/ Filter setting (→ 165)
8	Exposure compensation value (→ 80)
9	Image area of video (→ 108)
10	Recording file format (→ 100)/ Recording quality (→ 101)

11	Recording state (→ 92)
12	Wi-Fi/Bluetooth connection state
13	Time code (→ 110)
14	Built-in microphone/ External microphone (→ 119, 146)/ XLR microphone adaptor setting (→ 149)/Sound recording level limiter (→ 120)
15	Sound recording level display (→ 119)
16	Card slot (→ 38)/ Double card slot function (→ 64)
17	Video recording time
18	Battery indication (→ 35)/ Power supply (→ 34)



- Even in the [iA]/[P]/[A]/[S]/[M] modes, as with the [M] mode, you can switch to the display suited to video recording:
[Settings] → [Video] → [Video-Priority Display]

Recording with Creative Video

1 Set the mode dial to [M].

2 Set the exposure mode.

-  → [] → [] → [Exposure Mode] → [P]/[A]/[S]/[M]

- You can perform the same exposure operations as the [P]/[A]/[S]/[M] modes.

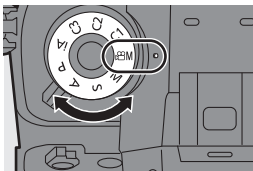

3 Close the menu.

- Press the shutter button halfway.

4 Start recording.

- Press the shutter button, video rec. button or sub video rec. button.

5 Stop recording.

- Press the shutter button, video rec. button or sub video rec. button again.

❖ Operations During Video Recording

Change the exposure and audio settings with touch operation to prevent operation sounds from being recorded.



- With the default settings, the Touch Tab is not displayed.
Set [Touch Tab] to [ON] in [Touch Settings] in the [Custom] ([Operation]) menu. (→ 168)

1 Touch [].

2 Touch an icon.

F	Aperture value
SS	Shutter speed
	Exposure compensation

ISO / GAIN	ISO sensitivity/Gain (dB)
	Sound recording level adjustment

3 Drag the slide bar to set the item.

[▼]/[▲]: Changes the setting slowly.

[▽]/[△]: Changes the setting quickly.

- If you touch icon (A), the screen of Step 2 is redisplayed.

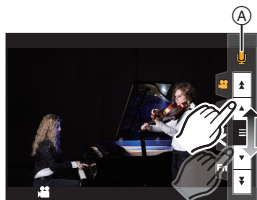

[CreativeVideo Combined Set.]

iA P A S M



In default settings, settings such as exposure and white balance changed in [P/M] mode are also reflected in picture recording in [P]/[A]/[S]/[M] modes.

From the [CreativeVideo Combined Set.] menu, you can separate settings for video recording and for picture recording.

→ → → Select [CreativeVideo Combined Set.]

[F/SS/ISO/Exposure Comp.]	<p>:</p> <p>Links recording settings in [P/M] mode and [P]/[A]/[S]/[M] mode.</p> <ul style="list-style-type: none"> • Select to use the same settings in [P/M] mode and [P]/[A]/[S]/[M] mode.
[White Balance]	
[Photo Style]	
[Metering Mode]	<p>:</p> <p>Configures recording settings in [P/M] mode and [P]/[A]/[S]/[M] mode individually.</p> <ul style="list-style-type: none"> • Select to separate [P/M] mode and [P]/[A]/[S]/[M] mode settings.
[AF Mode]	

Recording Video

This section describes the settings used when video recording.

- The functions described below work with both pictures and videos:

Please also refer to that section.

– [Double Card Slot Function]: → 64

– [Folder / File Settings]: → 65

[System Frequency]



This changes the system frequency of videos that are recorded and played back with the camera.

→ → → Select [System Frequency]

[59.94Hz (NTSC)]	System frequency for regions using the NTSC broadcasting system
[50.00Hz (PAL)]	System frequency for regions using the PAL broadcasting system
[24.00Hz (CINEMA)]	System frequency for producing cinema film



- If you record using a system frequency that differs from the broadcasting system of your region, it may not be possible for you to properly play back videos on your TV.

We recommend using the setting as it was at the time of purchase if you are unsure about broadcasting systems or if you will not be involved in producing cinema film.

- After changing the setting, it is recommended to insert another card and format it with this camera.

[Rec. File Format]



Sets the recording file format of videos to be recorded.

→ → → Select [Rec. File Format]

[AVCHD]	This file format is suitable for playback on high-definition TVs.
[MP4]	This file format is suitable for playback on PCs.
[MOV]	This file format is suitable for image editing.

[Rec Quality]



Sets the image quality of videos to be recorded. The image qualities you can select depend on the [System Frequency] and [Rec. File Format] settings. The [Image Area of Video] you can select differs depending on the [Rec Quality] settings.

[Rec Quality] settings can also be made using [Filtering] (→ 107) to display only items that meet your conditions and [add to list] (→ 108) to register recording qualities you use often.

→ → → Select [Rec Quality]

- To record video with a bit rate of 72 Mbps or more, you require a card with the corresponding Speed Class.

For information about the cards that can be used, refer to page 20.

❖ [Rec. File Format]: [AVCHD]

- YUV, Bit value, Image compression: 4:2:0, 8-bit, Long GOP
- Audio format: Dolby Audio™ (2ch)

- (A) Recording frame rate
- (B) Bit rate
- (C) Video compression format (**AVC**: H.264/MPEG-4 AVC)

[System Frequency]: [59.94Hz (NTSC)]										
[Rec Quality]	[Image Area of Video]			Resolution	Aspect ratio	(A)	(B) (Mbps)	(C)		
	FULL	S35	P/P							
[FHD/28M/60p]*1	✓	✓	✓	1920×1080	16:9	59.94p	28	AVC		
[FHD/17M/60i]	✓	✓	✓	1920×1080	16:9	59.94i	17	AVC		
[FHD/24M/30p]	✓	✓	✓	1920×1080	16:9	59.94i*2	24	AVC		
[FHD/24M/24p]	✓	✓	✓	1920×1080	16:9	23.98p	24	AVC		

[System Frequency]: [50.00Hz (PAL)]								
[Rec Quality]	[Image Area of Video]			Resolution	Aspect ratio	Ⓐ	Ⓑ (Mbps)	Ⓒ
	FULL	S35	P/P					
[FHD/28M/50p]*1	✓	✓	✓	1920×1080	16:9	50.00p	28	AVC
[FHD/17M/50i]	✓	✓	✓	1920×1080	16:9	50.00i	17	AVC
[FHD/24M/25p]	✓	✓	✓	1920×1080	16:9	50.00i*3	24	AVC

*1 AVCHD Progressive

*2 Sensor output: 29.97 fps

*3 Sensor output: 25.00 fps

❖ [Rec. File Format]: [MP4]

- YUV, Bit value, Image compression
 - [10bit] recording quality: 4:2:0, 10-bit, Long GOP
 - [8bit] recording quality: 4:2:0, 8-bit, Long GOP
- Audio format: AAC (2ch)

Ⓐ Recording frame rate

Ⓑ Bit rate

Ⓒ Video compression format (**HEVC**: H.265/HEVC, **AVC**: H.264/MPEG-4 AVC)

[System Frequency]: [59.94Hz (NTSC)]								
[Rec Quality]	[Image Area of Video]			Resolution	Aspect ratio	Ⓐ	Ⓑ (Mbps)	Ⓒ
	FULL	S35	P/P					
[4K/10bit/100M/60p]		✓	✓	3840×2160	16:9	59.94p	100	HEVC
[4K/8bit/100M/30p]	✓	✓	✓	3840×2160	16:9	29.97p	100	AVC
[4K/10bit/72M/30p]	✓	✓	✓	3840×2160	16:9	29.97p	72	HEVC
[4K/8bit/100M/24p]	✓	✓	✓	3840×2160	16:9	23.98p	100	AVC
[4K/10bit/72M/24p]	✓	✓	✓	3840×2160	16:9	23.98p	72	HEVC
[FHD/8bit/28M/60p]	✓	✓	✓	1920×1080	16:9	59.94p	28	AVC
[FHD/8bit/24M/24p]	✓	✓	✓	1920×1080	16:9	23.98p	24	AVC
[FHD/8bit/20M/30p]	✓	✓	✓	1920×1080	16:9	29.97p	20	AVC

[System Frequency]: [50.00Hz (PAL)]								
[Rec Quality]	[Image Area of Video]			Resolution	Aspect ratio	Ⓐ	Ⓑ (Mbps)	Ⓒ
	FULL	S35	P/P					
[4K/10bit/100M/50p]		✓	✓	3840×2160	16:9	50.00p	100	HEVC
[4K/8bit/100M/25p]	✓	✓	✓	3840×2160	16:9	25.00p	100	AVC
[4K/10bit/72M/25p]	✓	✓	✓	3840×2160	16:9	25.00p	72	HEVC
[FHD/8bit/28M/50p]	✓	✓	✓	1920×1080	16:9	50.00p	28	AVC
[FHD/8bit/20M/25p]	✓	✓	✓	1920×1080	16:9	25.00p	20	AVC

❖ [Rec. File Format]: [MOV]

- YUV, Bit value, Image compression
 - [422/10-I] recording quality: 4:2:2, 10-bit, ALL-Intra
 - [422/10-L] recording quality: 4:2:2, 10-bit, Long GOP
 - [420/10-L] recording quality: 4:2:0, 10-bit, Long GOP
 - [420/8-L] recording quality: 4:2:0, 8-bit, Long GOP
 - Audio format: LPCM (2ch)
- Ⓐ Recording frame rate
 Ⓑ Bit rate
 Ⓒ Video compression format (**HEVC**: H.265/HEVC, **AVC**: H.264/MPEG-4 AVC)

[System Frequency]: [59.94Hz (NTSC)]								
[Rec Quality]	[Image Area of Video]			Resolution	Aspect ratio	Ⓐ	Ⓑ (Mbps)	Ⓒ
	FULL	S35	P/P					
[6K/24p/420/10-L]	✓			5952×3968	3:2	23.98p	200	HEVC
[5.9K/30p/420/10-L]	✓			5888×3312	16:9	29.97p	200	HEVC
[5.9K/24p/420/10-L]	✓			5888×3312	16:9	23.98p	200	HEVC
[5.4K/30p/420/10-L]	✓			5376×3584	3:2	29.97p	200	HEVC
[4K-A/48p/420/10-L]		✓	✓	3328×2496	4:3	47.95p	200	HEVC
[4K-A/30p/422/10-I]		✓	✓	3328×2496	4:3	29.97p	400	AVC
[4K-A/30p/422/10-L]		✓	✓	3328×2496	4:3	29.97p	150	AVC
[4K-A/30p/420/8-L]		✓	✓	3328×2496	4:3	29.97p	100	AVC
[4K-A/24p/422/10-I]		✓	✓	3328×2496	4:3	23.98p	400	AVC
[4K-A/24p/422/10-L]		✓	✓	3328×2496	4:3	23.98p	150	AVC

[System Frequency]: [59.94Hz (NTSC)]								
[Rec Quality]	[Image Area of Video]			Resolution	Aspect ratio	Ⓐ	Ⓑ (Mbps)	Ⓒ
	FULL	S35	P/P					
[4K-A/24p/420/8-L]		✓	✓	3328×2496	4:3	23.98p	100	AVC
[C4K/60p/420/10-L]		✓	✓	4096×2160	17:9	59.94p	200	HEVC
[C4K/60p/420/8-L]		✓	✓	4096×2160	17:9	59.94p	150	AVC
[C4K/48p/420/10-L]		✓	✓	4096×2160	17:9	47.95p	200	HEVC
[C4K/30p/422/10-I]	✓	✓	✓	4096×2160	17:9	29.97p	400	AVC
[C4K/30p/422/10-L]	✓	✓	✓	4096×2160	17:9	29.97p	150	AVC
[C4K/30p/420/8-L]	✓	✓	✓	4096×2160	17:9	29.97p	100	AVC
[C4K/24p/422/10-I]	✓	✓	✓	4096×2160	17:9	23.98p	400	AVC
[C4K/24p/422/10-L]	✓	✓	✓	4096×2160	17:9	23.98p	150	AVC
[C4K/24p/420/8-L]	✓	✓	✓	4096×2160	17:9	23.98p	100	AVC
[4K/60p/420/10-L]		✓	✓	3840×2160	16:9	59.94p	200	HEVC
[4K/60p/420/8-L]		✓	✓	3840×2160	16:9	59.94p	150	AVC
[4K/48p/420/10-L]		✓	✓	3840×2160	16:9	47.95p	200	HEVC
[4K/30p/422/10-I]	✓	✓	✓	3840×2160	16:9	29.97p	400	AVC
[4K/30p/422/10-L]	✓	✓	✓	3840×2160	16:9	29.97p	150	AVC
[4K/30p/420/8-L]	✓	✓	✓	3840×2160	16:9	29.97p	100	AVC
[4K/24p/422/10-I]	✓	✓	✓	3840×2160	16:9	23.98p	400	AVC
[4K/24p/422/10-L]	✓	✓	✓	3840×2160	16:9	23.98p	150	AVC
[4K/24p/420/8-L]	✓	✓	✓	3840×2160	16:9	23.98p	100	AVC
[FHD/120p/420/10-L]	✓	✓		1920×1080	16:9	119.88p	150	HEVC
[FHD/60p/422/10-I]	✓	✓	✓	1920×1080	16:9	59.94p	200	AVC
[FHD/60p/422/10-L]	✓	✓	✓	1920×1080	16:9	59.94p	100	AVC
[FHD/60p/420/8-L]	✓	✓	✓	1920×1080	16:9	59.94p	100	AVC
[FHD/60i/422/10-I]	✓	✓	✓	1920×1080	16:9	59.94i	100	AVC
[FHD/60i/422/10-L]	✓	✓	✓	1920×1080	16:9	59.94i	50	AVC
[FHD/48p/420/10-L]	✓	✓	✓	1920×1080	16:9	47.95p	100	HEVC
[FHD/30p/422/10-I]	✓	✓	✓	1920×1080	16:9	29.97p	200	AVC

[System Frequency]: [59.94Hz (NTSC)]								
[Rec Quality]	[Image Area of Video]			Resolution	Aspect ratio	Ⓐ	Ⓑ (Mbps)	Ⓒ
	FULL	S35	P/P					
[FHD/30p/422/10-L]	✓	✓	✓	1920×1080	16:9	29.97p	100	AVC
[FHD/30p/420/8-L]	✓	✓	✓	1920×1080	16:9	29.97p	100	AVC
[FHD/24p/422/10-I]	✓	✓	✓	1920×1080	16:9	23.98p	200	AVC
[FHD/24p/422/10-L]	✓	✓	✓	1920×1080	16:9	23.98p	100	AVC
[FHD/24p/420/8-L]	✓	✓	✓	1920×1080	16:9	23.98p	100	AVC

Ⓐ Recording frame rate

Ⓑ Bit rate

Ⓒ Video compression format (**HEVC**: H.265/HEVC, **AVC**: H.264/MPEG-4 AVC)

[System Frequency]: [50.00Hz (PAL)]								
[Rec Quality]	[Image Area of Video]			Resolution	Aspect ratio	Ⓐ	Ⓑ (Mbps)	Ⓒ
	FULL	S35	P/P					
[5.9K/25p/420/10-L]	✓			5888×3312	16:9	25.00p	200	HEVC
[5.4K/25p/420/10-L]	✓			5376×3584	3:2	25.00p	200	HEVC
[4K-A/50p/420/10-L]		✓	✓	3328×2496	4:3	50.00p	200	HEVC
[4K-A/50p/420/8-L]		✓	✓	3328×2496	4:3	50.00p	150	AVC
[4K-A/25p/422/10-I]		✓	✓	3328×2496	4:3	25.00p	400	AVC
[4K-A/25p/422/10-L]		✓	✓	3328×2496	4:3	25.00p	150	AVC
[4K-A/25p/420/8-L]		✓	✓	3328×2496	4:3	25.00p	100	AVC
[C4K/50p/420/10-L]		✓	✓	4096×2160	17:9	50.00p	200	HEVC
[C4K/50p/420/8-L]		✓	✓	4096×2160	17:9	50.00p	150	AVC
[C4K/25p/422/10-I]	✓	✓	✓	4096×2160	17:9	25.00p	400	AVC
[C4K/25p/422/10-L]	✓	✓	✓	4096×2160	17:9	25.00p	150	AVC
[C4K/25p/420/8-L]	✓	✓	✓	4096×2160	17:9	25.00p	100	AVC
[4K/50p/420/10-L]		✓	✓	3840×2160	16:9	50.00p	200	HEVC
[4K/50p/420/8-L]		✓	✓	3840×2160	16:9	50.00p	150	AVC
[4K/25p/422/10-I]	✓	✓	✓	3840×2160	16:9	25.00p	400	AVC
[4K/25p/422/10-L]	✓	✓	✓	3840×2160	16:9	25.00p	150	AVC
[4K/25p/420/8-L]	✓	✓	✓	3840×2160	16:9	25.00p	100	AVC

[System Frequency]: [50.00Hz (PAL)]								
[Rec Quality]	[Image Area of Video]			Resolution	Aspect ratio	Ⓐ	Ⓑ (Mbps)	Ⓒ
	FULL	S35	P/P					
[FHD/100p/420/10-L]	✓	✓		1920×1080	16:9	100.00p	150	HEVC
[FHD/50p/422/10-I]	✓	✓	✓	1920×1080	16:9	50.00p	200	AVC
[FHD/50p/422/10-L]	✓	✓	✓	1920×1080	16:9	50.00p	100	AVC
[FHD/50p/420/8-L]	✓	✓	✓	1920×1080	16:9	50.00p	100	AVC
[FHD/50i/422/10-I]	✓	✓	✓	1920×1080	16:9	50.00i	100	AVC
[FHD/50i/422/10-L]	✓	✓	✓	1920×1080	16:9	50.00i	50	AVC
[FHD/25p/422/10-I]	✓	✓	✓	1920×1080	16:9	25.00p	200	AVC
[FHD/25p/422/10-L]	✓	✓	✓	1920×1080	16:9	25.00p	100	AVC
[FHD/25p/420/8-L]	✓	✓	✓	1920×1080	16:9	25.00p	100	AVC

Ⓐ Recording frame rate

Ⓑ Bit rate

Ⓒ Video compression format (**HEVC**: H.265/HEVC, **AVC**: H.264/MPEG-4 AVC)



[System Frequency]: [24.00Hz (CINEMA)]								
[Rec Quality]	[Image Area of Video]			Resolution	Aspect ratio	Ⓐ	Ⓑ (Mbps)	Ⓒ
	FULL	S35	P/P					
[6K/24p/420/10-L]	✓			5952×3968	3:2	24.00p	200	HEVC
[5.9K/24p/420/10-L]	✓			5888×3312	16:9	24.00p	200	HEVC
[4K-A/48p/420/10-L]		✓	✓	3328×2496	4:3	48.00p	200	HEVC
[4K-A/24p/422/10-I]		✓	✓	3328×2496	4:3	24.00p	400	AVC
[4K-A/24p/422/10-L]		✓	✓	3328×2496	4:3	24.00p	150	AVC
[4K-A/24p/420/8-L]		✓	✓	3328×2496	4:3	24.00p	100	AVC
[C4K/48p/420/10-L]		✓	✓	4096×2160	17:9	48.00p	200	HEVC
[C4K/24p/422/10-I]	✓	✓	✓	4096×2160	17:9	24.00p	400	AVC
[C4K/24p/422/10-L]	✓	✓	✓	4096×2160	17:9	24.00p	150	AVC
[C4K/24p/420/8-L]	✓	✓	✓	4096×2160	17:9	24.00p	100	AVC

[System Frequency]: [24.00Hz (CINEMA)]								
[Rec Quality]	[Image Area of Video]			Resolution	Aspect ratio	Ⓐ	Ⓑ (Mbps)	Ⓒ
	FULL	S35	P/P					
[4K/48p/420/10-L]		✓	✓	3840×2160	16:9	48.00p	200	HEVC
[4K/24p/422/10-I]	✓	✓	✓	3840×2160	16:9	24.00p	400	AVC
[4K/24p/422/10-L]	✓	✓	✓	3840×2160	16:9	24.00p	150	AVC
[4K/24p/420/8-L]	✓	✓	✓	3840×2160	16:9	24.00p	100	AVC
[FHD/48p/420/10-L]	✓	✓	✓	1920×1080	16:9	48.00p	100	HEVC
[FHD/24p/422/10-I]	✓	✓	✓	1920×1080	16:9	24.00p	200	AVC
[FHD/24p/422/10-L]	✓	✓	✓	1920×1080	16:9	24.00p	100	AVC
[FHD/24p/420/8-L]	✓	✓	✓	1920×1080	16:9	24.00p	100	AVC



- In this document, videos are indicated as follows according to their resolution:
 - 6K (5952×3968) video: **6K video**
 - 5.9K (5888×3312) video: **5.9K video**
 - 5.4K (5376×3584) video: **5.4K video**
 - 4K-A (3328×2496) video: **Anamorphic (4:3) video**
 - C4K (4096×2160) video: **C4K video**
 - 4K (3840×2160) video: **4K video**
 - Full High Definition (1920×1080) video: **FHD video**
- When using Super 35 mm/APS-C lenses, 6K, 5.9K, and 5.4K [Rec Quality] cannot be set.

❖ [Filtering]

When the [Rec. File Format] is set to [MOV], you can specify items such as frame rate, resolution, and codec (YUV, Bit value, Image compression), and just display recording quality that meets those conditions.

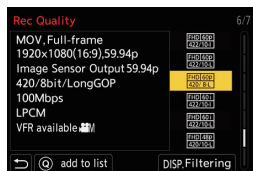
- In the [Rec Quality] setting screen, press [DISP.].
- Press ▲▼ to select a setting item and then press  or .
 - Settings: [Frame Rate]/[Resolution]/[Codec]/[Variable Frame Rate]/[Hybrid Log Gamma]



- 3 Press ▲▼ to select the filtering conditions and then press  or .
- 4 Press [DISP.] to set.
 - You are returned to the [Rec Quality] setting screen.

Clearing the filtering conditions

Select [ANY] in Step 3.

- The filtering conditions are also cleared when you do the following:
 - Changing the [System Frequency]
 - Select a recording quality from [Rec Quality (My List)]



- When you change recording quality using a filter, the current filtering conditions are stored.





❖ [add to list]

Select a recording quality and register it in My List. The recording quality you register can be set in [Rec Quality (My List)].

In the [Rec Quality] setting screen, press [Q].

- The following settings are also registered at the same time:
 - [System Frequency]
 - [Rec. File Format]
 - [Image Area of Video]

Setting or deleting in My List



- 1 Select [Rec Quality (My List)].
 -  ⇒ [] ⇒ [] ⇒ [Rec Quality (My List)]
 - 2 Press ▲▼ to select a setting item and then press  or .
- You cannot select setting items that have different system frequencies.
 - To delete from My List, select the item and press [Q].

[Image Area of Video]



Set the image area during video recording. The angle of view differs depending on the image area. Narrowing the image area allows you to achieve a telescopic effect without image deterioration.

 →  →  → Select [Image Area of Video]

Item	Settings details	Angle of view	Telescopic effect
[FULL]	Recording is within the area suited to the image circle of a full-frame lens.	Wide  Narrow	None  High
[S35mm]	Recording is within the area suited to the image circle of a Super 35 mm lens.		
[PIXEL/PIXEL]	Records with one pixel on the sensor, which is equal to one pixel of the video. Records a range corresponding to the resolution range in [Rec Quality]. (→ 101)		

- The [Image Area of Video] settings you can select differ depending on the [Rec Quality] setting.
For details, refer to page 101.
- It is not possible to set to [FULL] in the following cases.
 - When using Super 35 mm/APS-C lenses
 - When [Image Circle] in [Lens Information] is set to [S35mm]
- When set to [Live Cropping], the setting is fixed to [FULL]. However, the setting is fixed to [S35mm] in the following cases:
 - When a 59.94p or 50.00p [Rec Quality] is set

Image area (Ex.: FHD video)

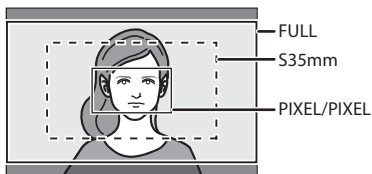

- To check the image area in recording modes other than [M] mode, set [Video-Priority Display] in the [Custom] ([Monitor / Display (Video)]) menu to [ON].

Time Code



When [Rec. File Format] is set to [AVCHD] or [MOV], the time code is automatically recorded during video recording. If [MP4], the time code is not recorded.

Setting the Time Code

Sets the recording, display, and output of the time code.

1 Set [Rec. File Format] to [AVCHD] or [MOV].

- → → → [Rec. File Format] → [AVCHD]/[MOV]

2 Select [Time Code].

- → → → [Time Code]

[Time Code Display]	Displays the time code on the recording screen/playback screen.	
[Count Up]	[REC RUN]	Counts the time code only when recording videos.
	[FREE RUN]	Counts the time code also when video recording is stopped and when the camera is turned off.
	<ul style="list-style-type: none"> • When the following function is being used, [Count Up] is fixed to [REC RUN]: <ul style="list-style-type: none"> – [Variable Frame Rate] 	

[Time Code Value]	[Reset]	Sets to 00:00:00:00 (hour: minute: second: frame)
	[Manual Input]	Manually input hour, minute, second and frame.
	[Current Time]	Sets hour, minute and second to current time and sets frame to 00.
[Time Code Mode]	[DF]	Drop Frame. The camera modifies the difference between recorded time and time code. <ul style="list-style-type: none"> Seconds and frames are separated by ":". (Example: 00:00:00.00)
	[NDF]	Non-Drop Frame. Records the time code without drop frame. <ul style="list-style-type: none"> Seconds and frames are separated by ":". (Example: 00:00:00.00)
		<ul style="list-style-type: none"> When the following functions are being used, [Time Code Mode] is fixed to [NDF]: <ul style="list-style-type: none"> – [50.00Hz (PAL)]/[24.00Hz (CINEMA)] ([System Frequency]) – 47.95p or 23.98p [Rec Quality]
[HDMI Time Code Output]	<p>Time code information is added to images output via HDMI when recording with the [pM] mode.</p> <ul style="list-style-type: none"> The time code can also be output via HDMI by setting the mode dial to [pM] during playback. In the [Setup] ([IN/OUT]) menu, set [HDMI Mode (Playback)] in [TV Connection] to [AUTO]. The device screen may go dark depending on the connected device. 	
[External TC Setting]	Synchronize the time code default value with an external device that supports time code input and output. (→ 112)	
	[TC Synchronization]	Selects the input (→ 114) and output (→ 113) for time code signals.
	[TC Output Reference]	Sets the timing for time code signal output. (→ 113)

Synchronizing the Time Code with an External Device

iA P A S M 

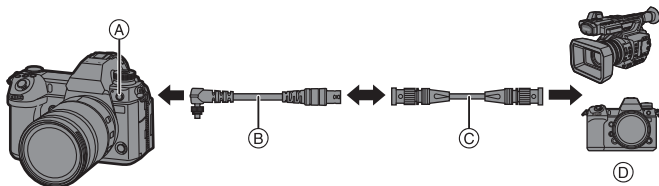

Synchronize the time code default value with an external device that supports time code signal input and output.



- (A) Flash synchro socket
- (B) BNC conversion cable (for TC IN/OUT) (supplied)
- (C) BNC cable (commercially available)
- (D) External devices

❖ Preparations for Time Code Synchronization

When [Count Up] is set to [FREE RUN] in the [M] mode, you can synchronize the initial value of the time code with an external device.

- 1 Set the mode dial to [M].
- 2 Set [Count Up] to [FREE RUN].
 -  ⇒  ⇒  ⇒ [Time Code] ⇒ [Count Up] ⇒ [FREE RUN]

- 3 Rotate the flash synchro socket cap in the direction of the arrow to remove.
 - Be careful not to lose the flash synchro socket cap.

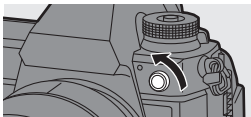

- 4 Insert the BNC conversion cable (for TC IN/OUT), and then rotate the locking screw in the direction of the arrow to attach the cable.



- 5 Connect the BNC conversion cable (for TC IN/OUT) and the external device with the BNC cable.



- Do not use any other BNC conversion cables (for TC IN/OUT) except the supplied one.
- Do not use the BNC cables with the length of 2.8 m (9.2 feet) or more.
- We recommend using a 5C-FB equivalent double-shielded BNC cables.

Synchronize the Time Code of the External Device with That of the Camera (TC OUT)

The initial time code value of the external device is synchronized according to the time code signal (LTC signal) of the camera.

1 Prepare for time code synchronizing. (→ 112)

2 Select [TC Output Reference].

- → → → [Time Code] → [External TC Setting] → [TC Output Reference]

[Recording Reference]	Outputs the time code signal for the images that you record.
[HDMI Reference]	When connected with an external device (external recorder, etc.) via HDMI, the time code signal output is delayed slightly to match the HDMI images.

3 Set [TC Synchronization] to [TC OUT].

- → → → [Time Code] → [External TC Setting] → [TC Synchronization] → [TC OUT]
- The time code signal is output according to the recording frame rate of the [Rec Quality] and the [Time Code Mode] ([DF]/[NDF]) setting.

4 Operate the external device to synchronize the time code.

❖ Outputting the Time Code Signal Again

By setting as follows, the time code signal (LTC signal) can be output just by connecting with the external device with the BNC cable:

- [M] mode
- [Count Up] ([Time Code]): [FREE RUN]
- [TC Synchronization] ([External TC Setting] in [Time Code]): [TC OUT]

Synchronize the Time Code of the Camera with That of the External Device (TC IN)

The initial time code value of the camera is synchronized according to the time code signal (LTC signal) of the external device.



- In advance, change the [System Frequency] (→ 100), [Rec Quality] (→ 101), and [Time Code Mode] (→ 111) to match the external device.

- 1 **Prepare for time code synchronizing. (→ 112)**
- 2 **Set [TC Synchronization] to [TC IN].**
 - → [] → [] → [Time Code] → [External TC Setting] → [TC Synchronization] → [TC IN]
- 3 **Operate the external device to output the time code signal.**
 - Set the time code count method of the external device to free run, and output the signal.
 - When synchronized with the time code of an external device, this camera is in a slave state, and the [TC] of the time code shown on the screen switches to [**TC**].

❖ Maintaining, Releasing, and Restoring the Slave State

Even if you disconnect the BNC cable, the camera will remain in slave state.

- Perform one of the following operations to release the camera from the slave state.
 - Operate the camera on/off switch
 - Switch the recording mode

- Change the [System Frequency]
- Set the [Variable Frame Rate]
- Switch the [Rec Quality] between 47.95p/23.98p and a different recording frame rate
- Change the following [Time Code] setting items
[Count Up], [Time Code Value], [Time Code Mode], [TC Synchronization]
- To restore the slave state, reconnect the BNC cable to the external device while set as follows.

The time code signal (LTC signal) can be input just by connecting.

- [M] mode
- [Count Up] ([Time Code]): [FREE RUN]
- [TC Synchronization] ([External TC Setting] in [Time Code]): [TC IN]



- Even when the system frequency differs between the camera and the external device, their initial time code values may be synchronized. Bear in mind, however, that the time codes lose sync as they count up.

Using AF (Video)

This section describes the use of AF when video recording.

- The functions described below work with both pictures and videos:

Please also refer to that section.

- Focus Mode: → 47
- AF Mode: → 67
- AF Area Movement Operation: → 71
- MF: → 72
- Zoom: → 74

[Continuous AF]



You can select how to set the focus in AF when recording videos.

→ → → Select [Continuous AF]

[MODE1]	The camera continues to automatically focus only during recording.
[MODE2]	The camera automatically keeps focusing on subjects during recording standby and during recording. <ul style="list-style-type: none"> To keep focusing on subjects during recording standby while in the [P]/[A]/[S]/[M] modes, set [Video-Priority Display] to [ON] in the [Custom] ([Monitor / Display (Video)]) menu.
[OFF]	The camera maintains the focus point at the start of recording.



- In the [iA] mode, the camera automatically keeps focusing during recording standby, irrespective of the [Continuous AF] setting.
- When the following function is being used, [MODE1] switches to [MODE2]:
 - HDMI output

[AF Custom Setting(Video)]



You can fine-adjust the focusing method for video recording using [Continuous AF].



⇒ [Video] ⇒ [FOCUS] ⇒ Select [AF Custom Setting(Video)]

[ON]	Enables the following settings.	
[OFF]	Disables the following settings.	
[SET]	[AF Speed]	<p>[+] side: Focus moves at a faster speed.</p> <p>[-] side: Focus moves at a slower speed.</p>
	[AF Sensitivity]	<p>[+] side: When the distance to the subject changes significantly, the camera immediately readjusts the focus.</p> <p>[-] side: When the distance to the subject changes significantly, the camera waits for a little before readjusting the focus.</p>

Video Brightness and Coloring

This section describes the brightness and coloring settings used during video recording.

- The functions described below work with both pictures and videos:
Please also refer to that section.
 - [Metering Mode]: → 80
 - Exposure Compensation: → 80
 - ISO Sensitivity: → 81
 - White Balance: → 84
 - [Photo Style]: → 87

[Luminance Level]



You can set the luminance range to suit the purpose of video recording.

- → → Select [Luminance Level]
Settings: [0-255]/[16-235]/[16-255]



- When [Rec. File Format] is set to [AVCHD], [0-255] cannot be set.
- When [Photo Style] is set to [V-Log], this is fixed to [0-255] ([0-1023]).
- When [Photo Style] is set to [Like2100(HLG)], this is fixed to [64-940].

[Master Pedestal Level]



You can adjust the black level, which serves as the reference for images.

- 1 **Set the mode dial to [M].**
- 2 **Select [Master Pedestal Level].**
 - → → → [Master Pedestal Level]
- 3 **Adjust master pedestal.**
 - Rotate , or .



- [Master Pedestal Level] is not available when using the following function:
 - [V-Log] ([Photo Style])

Recording While Controlling Overexposure (Knee)



When [Photo Style] is set to [Like709], you can adjust the knee so that recording can be performed with minimal overexposure.

1 Set [Photo Style] to [Like709].

- → [] → [] → [Like709]

2 Press [Q].

3 Select a knee setting.

- Press to select a setting item.

[AUTO]	Adjusts the compression levels of high-luminance areas automatically.
[MANUAL]	Press to select an item and then press to adjust. [POINT]: Master knee point [SLOPE]: Master knee slope
[Off]	—

4 Confirm your selection.

- Press or .

[ISO Sensitivity (video)]



Sets the lower and upper limits for ISO sensitivity when ISO sensitivity is set to [AUTO].

1 Set the mode dial to [].

2 Set [ISO Sensitivity (video)].

- → [] → [] → [ISO Sensitivity (video)]

[ISO Auto Lower Limit Setting]	Sets the lower limit for ISO sensitivity when ISO sensitivity is [AUTO].
[ISO Auto Upper Limit Setting]	Sets the upper limit for ISO sensitivity when ISO sensitivity is [AUTO].

Audio Settings

iA P A S M 



[Sound Rec Level Disp.]



The sound recording level is displayed on the recording screen.

 → [] → [] → Select [Sound Rec Level Disp.]

Settings: [ON]/[OFF]

[Mute Sound Input]



This mutes audio input.

 → [] → [] → Select [Mute Sound Input]

Settings: [ON]/[OFF]

[Sound Rec Gain Level]







This switches the gain of audio input.

 → [] → [] → Select [Sound Rec Gain Level]

[STANDARD]	This is the standard input gain setting. (0 dB)
[LOW]	Audio input is reduced for recording in environments with loud noises. (−12 dB)

[Sound Rec Level Adj.]

Manually adjust the sound recording level.

- 1 Select [Sound Rec Level Adj.].
 -  → [] → [] → [Sound Rec Level Adj.]
- 2 Press   to adjust the sound recording level and then press  or .
 - You can adjust the sound recording level within the range from [MUTE], [-18dB] to [+12dB] in steps of 1 dB.
 - Displayed dB values are approximate.

[Sound Rec Level Limiter]

The sound recording level is adjusted automatically to minimize sound distortion (crackling noise).

 → [] → [] → Select [Sound Rec Level Limiter]

Settings: [ON]/[OFF]

[Wind Noise Canceller]

This reduces the wind noise coming into the built-in microphone while maintaining sound quality.

 → [] → [] → Select [Wind Noise Canceller]

[HIGH]	This effectively reduces the wind noise by reducing the low-pitched sound when a strong wind is detected.
[STANDARD]	This reduces wind noise without loss of sound quality by filtering out only wind noise.
[OFF]	—

- This function works only with the built-in microphone.
When an external microphone is connected, [Wind Cut] is displayed. (→ 148)

Main Assist Functions

[SS/Gain Operation]



You can switch the units of shutter speed values and gain (sensitivity) values.

→ → → Select [SS/Gain Operation]

[SEC/ISO]	Displays the shutter speed in seconds and the gain in ISO.
[ANGLE/ISO]	Displays the shutter speed in degrees and the gain in ISO.
[SEC/dB]	<p>Displays the shutter speed in seconds and the gain in dB.</p> <ul style="list-style-type: none"> • 0 dB corresponds to either of the following ISO sensitivity values. <ul style="list-style-type: none"> – When [Dual Native Gain Setting] is set to [AUTO] or [LOW]: [100] – When [Dual Native Gain Setting] is set to [HIGH]: [640]

[WFM/Vector Scope]



This displays the waveform monitor or the vector scope on the recording screen. You can change the size of the waveform display.

1 Set the mode dial to [M].

2 Set [WFM/Vector Scope].

• → → → [WFM/Vector Scope]

[WAVE]	Displays a waveform.
[VECTOR]	Displays the vector scope.
[OFF]	—

3 Select the position to display.

- Press to select and then press or .
- Positions can be moved to the diagonal directions using the joystick.
- You can also move using touch operations.
- You can also rotate to change the size of the waveform.



- You can also change the position by dragging on the recording screen.
- The waveform and vector scope are not output through HDMI.

[Luminance Spot Meter]



Specify any spot on the subject to measure the luminance over a small area.

1 Set [Luminance Spot Meter].

- → [] → [] → [Luminance Spot Meter] → [ON]

2 Select the position where you want to measure the luminance.

- Press to select and then press or .
- Positions can be moved to the diagonal directions using the joystick.
- You can also change the position by dragging the frame on the recording screen.

❖ Measurement Range

Measuring is possible in the range -7% to 109% (IRE).

- When [Photo Style] is set to [V-Log], this can be measured with Stop units.
(Calculated as 0 Stop=42% (IRE))

[Zebra Pattern]



Parts that are brighter than the benchmark value are displayed with stripes.

You can also set the benchmark value and the breadth of the range so that the stripes are displayed on parts that are within the range of brightness you specify.

→ → → Select [Zebra Pattern]

[ZEBRA1]	Parts that are brighter than the benchmark value are displayed with [ZEBRA1] stripes.		
[ZEBRA2]	Parts that are brighter than the benchmark value are displayed with [ZEBRA2] stripes.		
[ZEBRA1+2]	Both [ZEBRA1] and [ZEBRA2] are displayed.		
[OFF]	—		
[SET]	[Zebra 1]	50% to 105%/ [BASE/RANGE]	Sets the benchmark brightness.
	[Zebra 2]	50% to 105%/ [BASE/RANGE]	

❖ When [BASE/RANGE] Was Selected with [SET]

Centered on the brightness set with [Base Level], parts with the brightness in the range set in [Range] are displayed with the stripes.

- [Base Level] can be set in the range between 0% and 109% (IRE).
- [Range] can be set in the range between $\pm 1\%$ and $\pm 10\%$ (IRE).
- When [Photo Style] is set to [V-Log], this can be set at Stop units. (Calculated as 0 Stop=42% (IRE))



• [ZEBRA1+2] cannot be selected while you are setting [BASE/RANGE].

[Video Frame Marker]



A frame with the set aspect ratio is displayed on the recording screen. This allows you to see during recording the angle of view that will be achieved with trimming (cropping) in post-processing.

⇒ [] ⇒ [] ⇒ Select [Video Frame Marker]

	[ON]	Displays video grid lines on the recording screen.
	[OFF]	—
[SET]	[Frame Aspect]	Sets the aspect ratio of video grid lines. [2.39:1]/[2.35:1]/[2.00:1]/[1.85:1]/[16:9]/[4:3]/[1:1]/[4:5]
	[Frame Color]	Sets the color of video grid lines.
	[Frame Mask]	Sets the opacity of the outside of video grid lines. [100%]/[75%]/[50%]/[25%]/[OFF]

Color bars/Test Tone



The color bars are displayed on the recording screen.
A test tone is output while the color bars are being displayed.

⇒ [] ⇒ [] ⇒ Select [Color Bars]

Settings: [SMPTE]/[EBU]/[ARIB]

- To end the display, press .

❖ Adjusting the Test Tone

Rotate , or to select the test tone level.

- There are 4 levels ([−12dB], [−18dB], [−20dB], and [MUTE]) of test tone to select.



- The color bars and test tone will be recorded on the video if video recording is started while the color bars are being displayed.

11. Special Video Recording

Variable Frame Rate



iA P A S M 





By recording using a frame rate that is different to the playback frame rate, you can record smooth slow motion video and fast motion video.

1 Set the mode dial to [M].



2 Set [Rec. File Format] to [AVCHD] or [MOV].

-  ⇒ [] ⇒ [] ⇒ [Rec. File Format] ⇒ [AVCHD]/[MOV]

3 Select a recording quality with which you can use [Variable Frame Rate] recording.



-  ⇒ [] ⇒ [] ⇒ [Rec Quality]
- Items with which you can use [Variable Frame Rate] are indicated as [VFR available].

4 Select an [Image Area of Video] with which you can use [Variable Frame Rate].





-  ⇒ [] ⇒ [] ⇒ [Image Area of Video]
- [Variable Frame Rate] is not available with the following combinations of [Rec Quality] and [Image Area of Video]. Change the [Image Area of Video] as necessary.

[Rec Quality]	[Image Area of Video]
4K video, C4K video	[FULL]
[FHD/60p/420/8-L]/[FHD/50p/420/8-L]	[PIXEL/PIXEL]

5 Set [Variable Frame Rate].

-  ⇒ [] ⇒ [] ⇒ [Variable Frame Rate] ⇒ [ON]
- Press ◀▶ to switch between [ON] and [OFF].

6 Set the frame rate.

- Rotate ,  or  to select a numeric value, then press  or .
- The angle of view is reduced when you set to a frame rate exceeding 150 fps.

◆ Available Frame Rate Setting Ranges

The frame rate you can set differs depending on the [Rec. File Format] and [Rec Quality] settings.

[Rec. File Format]	[Rec Quality]	Frame rate
[AVCHD]	FHD video	2 fps to 60 fps
[MOV]	Anamorphic (4:3) video	2 fps to 50 fps* ¹
	C4K video/4K video	2 fps to 60 fps
	FHD video	2 fps to 180 fps* ²

*1 When set to a 23.98p or 24.00p [Rec Quality], a frame rate exceeding 48 fps cannot be set.

*2 When [Image Area of Video] is set to [PIXEL/PIXEL], it is not possible to set to a frame rate exceeding 60 fps.



- When the [Rec. File Format] has been set to [MOV], you can filter to show just the recording qualities where [Variable Frame Rate] can be used. (→ 107)
- We recommend using a tripod when recording images with [Variable Frame Rate].



- Focus mode switches to MF.
- Audio will not be recorded during variable frame rate recording.
- When the following functions are being used, [Variable Frame Rate] is not available:
 - [Filter Settings]
 - [Live Cropping]

High Frame Rate Video

iA P A S M 



[MOV] video with high frame rates can be recorded to cards. By converting it with the compatible software, it is possible to produce slow motion video. AF recording and audio recording, not possible with [Variable Frame Rate], also become possible.

❖ Recording Qualities for High Frame Rate Video

[Rec. File Format]	[System Frequency]	[Rec Quality]	Recording frame rate
[MOV]	[59.94Hz (NTSC)]	[4K-A/48p/420/10-L] [C4K/48p/420/10-L] [4K/48p/420/10-L] [FHD/48p/420/10-L]	47.95p
		[FHD/120p/420/10-L]	119.88p
	[50.00Hz (PAL)]	[FHD/100p/420/10-L]	100.00p
	[24.00Hz (CINEMA)]	[4K-A/48p/420/10-L] [C4K/48p/420/10-L] [4K/48p/420/10-L] [FHD/48p/420/10-L]	48.00p



- By filtering the [Rec Quality] by the frame rate, you can display just those recording qualities that match the frame rate conditions. For details, refer to page 107.



- When outputting via HDMI, the frame rate is down-converted to 59.94p, 23.98p, 50.00p, or 24.00p for output.

[Focus Transition]



Smoothly transitions the focus position from the current position to a position registered in advance.

- 1 **Set the mode dial to [iA/M].**
- 2 **Select [Focus Transition].**
 - → [] → [] → [Focus Transition]
- 3 **Set the recording settings.**

[Start]	Start recording.
[Focus Pull Setting]	Registers the focus position. <ul style="list-style-type: none"> • The setting screen for the focus position is displayed when you select either [1], [2], or [3]. Use the same procedure as MF (→ 72) to check the focus, then press or to register the focus position.
[Focus Transition Speed]	Sets the moving speed of focus. <ul style="list-style-type: none"> • Moving speed: [SH] (fast) to [SL] (slow)
[Focus Transition Rec]	Starts Focus Transition when recording starts. <ul style="list-style-type: none"> • Select the position registered with [Focus Pull Setting].
[Focus Transition Wait]	Sets the wait time before the start of Focus Transition.

- 4 **Close the menu.**
 - Selects [Start], and press or .
 - The recording screen is displayed.
 - To return to the setting screen, press [DISP.].
- 5 **Start recording.**
 - Press the video rec. button.
 - If you have enabled [Focus Transition Rec], Focus Transition will start when you start recording a video.

6 Start Focus Transition.

- Press ◀▶ to select [1], [2], or [3], and then press  or .

(A) Current focus position

(B) Registered focus position

- When [Focus Transition Wait] is set, Focus Transition starts after the set time has elapsed.

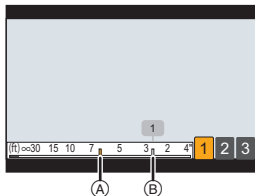

7 End Focus Transition.

- Press [Q].

8 Stop recording.

- Press the video rec. button once again.



- Maintain the same distance to the subject after setting the focus position.
- The moving speed of focus varies depending on the lens being used.
- While using [Focus Transition], it is not possible to focus on anything other than the registered focus position.
- Any of the operations below will clear the focus position settings.
 - Operating the camera on/off switch
 - Zoom operation
 - Switching the focus mode
 - Switching the recording mode
 - Replacing the lens
- When the following functions are being used, [Focus Transition] is not available:
 - [Variable Frame Rate]
 - [Live Cropping]
- [Focus Transition] cannot be used when using an interchangeable lens that does not support the focus mode [AFC].

[Live Cropping]



iA P A S M 

By cropping a part of the image from the image displayed in the live view, it is possible to record FHD video that incorporates panning and zooming with the camera staying in a fixed position.



-  • Use a tripod to minimize camera shake.

1 Set the mode dial to [M].



2 Set [Rec. File Format] to [MP4] or [MOV].

-  → [] → [] → [Rec. File Format] → [MP4]/[MOV]

3 Select a recording quality with which you can record [Live Cropping] video.

-  → [] → [] → [Rec Quality]



4 Set the time for panning or zooming.

-  → [] → [] → [Live Cropping] → [40SEC]/[20SEC]

- If you have selected a recording format or recording quality where Live Cropping recording is not available, the camera switches to a recording format or FHD video recording quality where recording is possible.



5 Set the cropping start frame.

(A) Cropping start frame

- Select the range to be cropped and press  or .

6 Set the cropping end frame.

(B) Cropping end frame

- Select the range to be cropped and press  or .

- To redo the settings for the position and size of the start frame and the end frame, press .

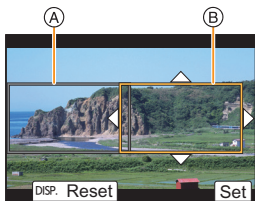

7 Start Live Cropping recording.

- Press the video rec. button.
- Ⓒ Elapsed recording time
- Ⓓ Set operating time
- When the set operating time has elapsed, recording automatically ends.
To end recording midway, press the video rec. button again.

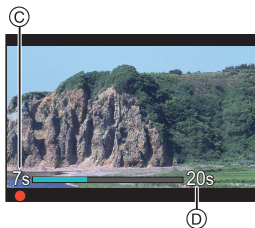

❖ Operations for Setting the Cropping Frame

Button operation	Touch operation	Description of operation
▲▼◀▶	Touch	Moves the frame. <ul style="list-style-type: none"> ● Positions can be moved to the diagonal directions using the joystick.
🌞 / ⚙️	Pinch out/ pinch in	Enlarges/reduces the frame in small steps.
🌞	—	Enlarges/reduces the frame.
[DISP.]	[Reset]	Start frame: Returns the frame position and size to the default settings. End frame: Cancels the settings for the position and size of the frame.
ⓘ / SET	[Set]	Confirms the frame position and size.

- 📌 AF mode switches to [👤] (face detection). (Human bodies cannot be detected. It is not possible to specify the person to bring into focus.)
- Brightness measurements and focusing are performed within the cropping frame. To lock the focus point, set [Continuous AF] to [OFF], or set the focus mode to [MF].
- [Metering Mode] will be [☉] (multi-metering).

Log Recording



Setting [Photo Style] to [V-Log] enables Log recording.

Images finished with rich gradation can be created through post production processing.

→ [] → [] → [Photo Style] → Select [V-Log]



- Post-production processing is enabled by utilizing LUT (Look-Up Table). You can download LUT data from the following support site:
<https://panasonic.jp/support/global/cs/dsc/download/index3.html>
 (English only)

❖ Exposure When [V-Log] Is Set

The [V-Log] curve characteristics comply with “V-Log/V-Gamut REFERENCE MANUAL Rev.1.0”. When set to [V-Log], the standard exposure when gray with a reflectance ratio of 18% is imaged is IRE 42%.

- Refer to the “Owner’s Manual” (PDF format) for details.

[V-Log View Assist]

When [Photo Style] is set to [V-Log], the recording screen and images output via HDMI will darken. Using [V-Log View Assist] means you can show images with LUT data applied on the monitor/viewfinder and output them via HDMI.

→ [] → [] → Select [V-Log View Assist]

[Read LUT File]	Reads LUT data from the card.
[LUT Select]	Selects the LUT data to be applied from among the preset ([Vlog_709]) and registered LUT data.
[LUT View Assist (Monitor)]	Displays the images with LUT data applied on the monitor/viewfinder of the camera.
[LUT View Assist (HDMI)]	Applies LUT data to images output over HDMI.









- When applying the LUT data, [LUT] is displayed on the recording screen.
- Up to 4 LUT data files can be registered.

❖ Reading LUT Files



- The following LUT data can be used:
 - The “.vlt” format, which meets the requirements specified in the “VARICAM 3DLUT REFERENCE MANUAL Rev.1.0”
 - File names consisting of up to 8 alphanumeric characters (excluding extension)
- Save the LUT data with a file extension of “.vlt” in the root directory of the card (the folder opened when the card is opened on a PC).

- 1 Insert a card on which LUT data is saved into the camera.
- 2 Select [Read LUT File].
 -  ⇒ [] ⇒ [] ⇒ [V-Log View Assist] ⇒ [Read LUT File] ⇒ [Card Slot 1]/[Card Slot 2]
- 3 Press ▲▼ to select the LUT data to read and then press  or .
- 4 Press ▲▼ to select the location to register the data, and then press  or .
 - When registered items are selected, they will be overwritten.

HLG Videos



Record videos with the wide dynamic range of the HLG format. You can record in very bright light where overexposure can occur or in dark areas where underexposure can occur, maintaining the rich yet subtle colors you can see with your naked eye.

You can view the video that you record by outputting via HDMI to devices (TVs, etc.) that support the HLG format, or playing back directly on supporting devices.

- “HLG (Hybrid Log Gamma)” is an international standard (ITU-R BT.2100) HDR format.

1 Set the mode dial to [M].

2 Set [Rec. File Format] to [MP4] or [MOV].

- → [] → [] → [Rec. File Format] → [MP4]/[MOV]

3 Select a recording quality with which you can record HLG video.

- → [] → [] → [Rec Quality]

- Items available for recording with HLG video are indicated as [HLG available].

4 Set [Photo Style] to [Like2100(HLG)].

- → [] → [] → [Photo Style] → [Like2100(HLG)]



- When the [Rec. File Format] has been set to [MOV], you can display just the recording qualities where HLG video recording can be used. (→ 107)
- The monitor and viewfinder on this camera do not support display of HLG format images.

With [Monitor] in [HLG View Assist] in the [Custom] ([Monitor / Display (Video)]) menu, you can display the images converted for monitoring on the monitor/viewfinder of this camera. (→ 135)



- HLG images are shown dark on devices that do not support the HLG format. With [HDMI] in [HLG View Assist] in the [Custom] ([Monitor / Display (Video)]) menu, you can set the conversion method for images displayed for monitoring. (→ 135)

[HLG View Assist]

At recording or playback of [HLG Photo] and HLG video, this displays images with converted color gamut and brightness on the camera monitor/viewfinder, or outputs these over HDMI.



⇒ [] ⇒ [] ⇒ [HLG View Assist] ⇒ [Monitor]/[HDMI]

[AUTO]*	Converts images before outputting them via HDMI while applying the effect of [MODE2]. This conversion setting works only when the camera is connected to a device that does not support HDR (HLG format).
[MODE1]	Converts with an emphasis on bright areas such as sky. <ul style="list-style-type: none"> • [MODE1] is displayed on the recording screen.
[MODE2]	Converts with an emphasis on the brightness of a main subject. <ul style="list-style-type: none"> • [MODE2] is displayed on the recording screen.
[OFF]	Displays without converting color gamut and brightness.

* Can only be set while [HDMI] is selected.

Anamorphic Recording



This camera can record video with a resolution of 4K-A (anamorphic (4:3) video) that is compatible with anamorphic recording with an aspect ratio of 4:3. It can also record video with an aspect ratio of 3:2 that has 6K resolution or 5.4K resolution. You can select a recording quality that suits anamorphic recording from a variety of different video formats (recording qualities).

- Refer to page 78 for information about image stabilizers suited to anamorphic recording.



- When [Rec. File Format] is set to [MOV], by filtering [Rec Quality] by the number of pixels, you can display just those recording qualities with resolutions and aspect ratios that meet the conditions.

For details, refer to page 107.

- [ANAMOR] is displayed in anamorphic (4:3) video items in the [Rec Quality] setting screen.



- This camera is not compatible with de-squeeze editing of video recorded with anamorphic recording. Use compatible software.

[Anamorphic Desqueeze Display]









Display the desqueezed images suited to the magnification of the anamorphic lens on this camera.

Using the [Video Frame Marker], it is also possible to impose on display the frame of the angle of view when cropping after de-squeeze editing.

1 Set the mode dial to [iM].

2 Set [Anamorphic Desqueeze Display].

-  → [] → [] → [Anamorphic Desqueeze Display]

Settings: []([2.0×])/[]([1.8×])/[]([1.5×])/[]([1.33×])/[]([1.30×])/[OFF]

- Make settings to suit the magnification of the anamorphic lens you are using.

3 Set [Video Frame Marker].

-  → [] → [] → [Video Frame Marker]

- For details, refer to page 124.



- Images output via HDMI are not de-squeezed.

[Synchro Scan]

iA P A S M 





Fine-adjust the shutter speed to reduce flickering and horizontal stripes. The shutter speed set in Synchro Scan is saved separately from the shutter speed used for normal recording.

In the Synchro Scan setting screen you can call up the current shutter speed for normal recording and adjust it.

1 Set the mode dial to [iM].





2 Set the exposure mode to [S] or [M].

-  → [] → [] → [Exposure Mode] → [S]/[M]

3 Set [Synchro Scan].

-  → [] → [] → [Synchro Scan] → [ON]

4 Set the shutter speed.

- Rotate ,  or  to select a numeric value, then press  or .
- You can call up the current shutter speed for normal recording by pressing [DISP].
- Adjust the shutter speed while looking at the screen so that flickering and horizontal stripes will be minimized.



- When you set [Synchro Scan] to [ON], the available shutter speed range becomes narrower.

[Loop Recording (video)]



iA P A S M 







Even when recording uses up the card's free space, the camera continues the recording by deleting the oldest segment of the recorded data.

1 Set the mode dial to [M].

2 Set [Rec. File Format] to [MOV].

-  → [] → [] → [Rec. File Format] → [MOV]

3 Set [Loop Recording (video)].

-  → [] → [] → [Loop Recording (video)] → [ON]
- [] is displayed on the recording screen.



- When the following functions are being used, [Loop Recording (video)] is not available:
 - [Rec Quality] with a bit rate of 400 Mbps
 - [Variable Frame Rate]
 - [Live Cropping]



[Segmented File Recording]





To avoid video loss due to unforeseen interruptions to the power supply, recorded video is divided every minute while MOV video is being recorded.

- The divided videos are saved as one group image.

1 Set [Rec. File Format] to [MOV].

-  → [] → [] → [Rec. File Format] → [MOV]

2 Set [Segmented File Recording].

-  → [] → [] → [Segmented File Recording] → [ON]



- When the following function is being used, [Segmented File Recording] is not available:
 - [Loop Recording (video)]

12. Connections with External Devices (Video)

HDMI Devices (HDMI Output)

iA P A S M



You can record while outputting the camera images to an external monitor or external recorder connected with an HDMI cable.

- HDMI output control differs between during recording and during playback.
HDMI output for playback is set in [TV Connection] in the [Setup] ([IN/OUT]) menu.

Getting started:

- Turn off the camera and the external monitor/external recorder.

Connect the camera and an external monitor or external recorder with a commercially available HDMI cable.

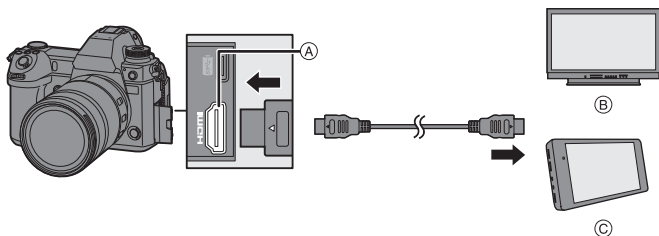

(A) [HDMI] socket (Type A)

(C) External recorder

(B) External monitor

- Check the direction of the terminals and plug in/out straight holding onto the plug. (Inserting at an angle can deform the terminal and cause malfunction.)
- Do not connect the cable to the wrong terminals. This may cause a malfunction.



- Use a “High Speed HDMI cable” with the HDMI logo.

Cables that do not comply with the HDMI standards will not work.

“High Speed HDMI cable” (Type A–Type A plug, up to 1.5 m (4.9 feet) long)

Attaching the Cable Holder

Use of the supplied cable holder prevents detachment of the cable and damage to the terminals.

- Put the camera on a stable surface to perform this task.

- While pushing (A), slide the clamp portion (B) of the cable holder to remove it.

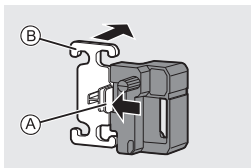

- Open the door of the terminal section and slide the door into the part marked (C).

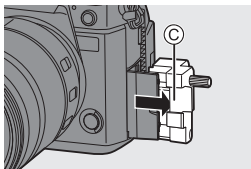

- Loosely mount the cable holder to the mount on the camera, and then rotate the screws in the direction of the arrows to secure the cable holder. (D)

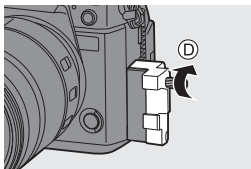

- Fit the USB connection cable (C-C or A-C) (E) and HDMI cable (F) to the clamp.

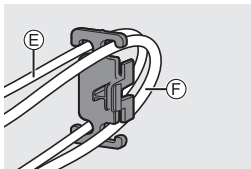

- 5 Slide the clamp portion ⑥ to attach it to the cable holder.

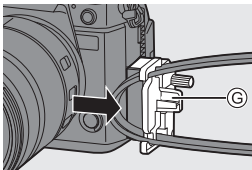

- 6 Connect the USB connection cable (C-C or A-C) to the USB port ⑨.

- 7 Connect the HDMI cable to the [HDMI] socket ⑩.

- ⑧ Leave some slack so that this section has a length of at least 10 cm (0.33 feet).

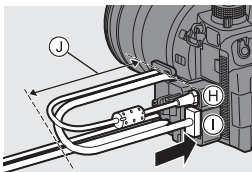

Removing the cable holder

To remove the cable holder, follow the steps for attaching it in the reverse order.

❖ Adjusting the Monitor Angle

You can adjust the angle of the monitor while it is tilted (→ 42) by rotating it, without interfering with the connection cables.

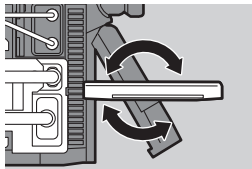

- Do not use any other USB connection cables except the supplied USB connection cables (C-C and A-C).
- We recommend using an HDMI cable with a thickness diameter of 6.5 mm (0.26 inch) or less.
- It may not be possible to attach HDMI cables of certain shapes.

Images Output via HDMI

The images output via HDMI differ depending on the recording mode.

❖ [iM] Mode

Aspect ratio, resolution, and frame rate output is according to the [Rec Quality] settings in the [Video] ([Image Format]) menu. Resolution and frame rate can be down-converted for output according to the application.

YUV 4:2:2 is used for YUV and bit value output, as shown on the right.

Recording to card	HDMI output
4:2:2 10-bit	4:2:2 10-bit
4:2:0 10-bit	4:2:2 10-bit
4:2:0 8-bit	4:2:2 8-bit

Resolution, frame rate

Resolution and frame rate output is according to the following menu combinations:

- [Rec Quality] in the [Video] ([Image Format]) menu.
- [Down Convert] in [HDMI Rec Output] in the [Custom] ([IN/OUT]) menu
- 6K, 5.9K, and 5.4K videos are output with a 4K or FHD resolution. Output is not possible during recording.
- Anamorphic (4:3) video is output with a 4K or FHD resolution.
- When set to a recording quality for high frame rate video, the frame rate is down-converted for output.



- When set to a 4:3 or 3:2 [Rec Quality], bands are added to the images and they are output with a 16:9 aspect ratio.
- Output may be in 8-bit if you output to devices that do not support 10-bit.



- Refer to the "Owner's Manual" (PDF format) for details about the content output for each combination of [Rec Quality] and [Down Convert].

❖ [iA]/[P]/[S]/[M] Mode

Output is the same as [iM] mode during video recording or when [Video-Priority Display] is set to [ON].

Output is with a 16:9 aspect ratio during recording standby. Resolution, frame rate, YUV, and bit value output matches the connected device.



- When set to any [Aspect Ratio] other than 16:9, bands are added to the images and they are output with a 16:9 aspect ratio.

❖ Notice Regarding HDMI Output

- It may take some time for the output method to change.
- When you use the HDMI output during recording, the image may be displayed with a time lag.
- Beep sounds, AF beep, and electronic shutter sounds are muted during HDMI output.
- When you check the image and audio from the TV connected to the camera, the microphone of the camera may pick up the sound from the speakers of the TV, producing an abnormal sound (audio feedback).
If this occurs, move the camera away from the TV or lower the volume on the TV.
- Certain setting screens are not output via HDMI.
- There is no output via HDMI while you are using the following functions:
 - [6K/4K PHOTO]/[Post-Focus]

HDMI Output Settings





Outputting the Camera Information Display via HDMI

Output the camera information display to an external device connected by HDMI.

⇒ [] ⇒ [] ⇒ [HDMI Rec Output] ⇒ Select [Info Display]
Settings: [ON]/[OFF]

Down-Converting Resolution and Frame Rate for Output

Make settings for the down-conversion of resolution and frame rate for HDMI output in the [] mode.



 → [] → [] → [HDMI Rec Output] → Select [Down Convert]

[AUTO]	Outputs by down-converting to match the connected device.
[4K/30p] ([4K/25p])	Outputs by down-converting resolution to 4K and frame rate to either 29.97p or 25.00p.
[1080p]	Down-converts resolution to FHD (1080), and outputs as progressive.
[1080i]	Down-converts resolution to FHD (1080), and outputs as interlaced.
[OFF]	Outputs at the resolution and recording frame rate of the [Rec Quality].

- The items you can select depend on the [System Frequency] setting.
- 6K, 5.9K, and 5.4K videos are output with a 4K or FHD resolution. Output is not possible during recording.
- Anamorphic (4:3) video is output with a 4K or FHD resolution.
- When set to a recording quality for high frame rate video, the frame rate is down-converted for output.

Outputting Control Information to an External Recorder

Recording start and stop control information is output to an external recorder connected by HDMI.



 → [] → [] → [HDMI Rec Output] → Select [HDMI Recording Control]

Settings: [ON]/[OFF]

- [HDMI Recording Control] can be set when [HDMI Time Code Output] is set to [ON] in [M] Mode.
- Control information is output when pressing the video rec. button or shutter button, even if the video cannot be recorded (such as when there is no card inserted into the camera).
- Only compatible external devices can be controlled.

Outputting Down-converted Audio to an HDMI Device



When an XLR Microphone Adaptor (DMW-XLR1: optional) is attached, audio is down-converted to a format suitable for the connected HDMI external device before being output.

 ⇒ [] ⇒ [] ⇒ [HDMI Rec Output] ⇒ Select [Sound Down Convert]

[AUTO]	Output is down-converted to match the connected device.
[OFF]	Output is according to the settings in [XLR Mic Adaptor Setting].

Outputting Audio via HDMI

Output audio to an external device connected by HDMI.

 ⇒ [] ⇒ [] ⇒ [HDMI Rec Output] ⇒ Select [Sound Output (HDMI)]
Settings: [ON]/[OFF]

External Microphones (Optional)

iA P A S M 



With a Stereo Shotgun Microphone (DMW-MS2: optional) or Stereo Microphone (VW-VMS10: optional), you can record higher-quality audio compared to the built-in microphone.

1 Set the [Mic Socket] that suits the device to be connected.

- **MENU/SET** → [] → [] → [] → [Mic Socket]

MIC [Mic Input (Plug-in Power)]	When connecting an external microphone that requires a power supply from the camera [MIC] socket.
MIC [Mic Input]	When connecting an external microphone that does not require a power supply from the camera [MIC] socket.
LINE [Line Input]	When connecting an external audio device for line output.

- The setting will be fixed to [MIC] when a Stereo Shotgun Microphone (DMW-MS2: optional) is connected.
- When using [MIC], if you connect an external microphone that does not require power supply, the connected external microphone may malfunction. Check the device before connecting.

2 Set the camera on/off switch to [OFF].

3 Connect the camera and external microphone.

- If mounting the external microphone on the camera hot shoe (A), remove the hot shoe cover. (→ 90)

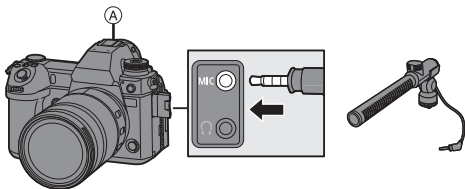

- Do not use the stereo microphone cables with the length of 3 m (9.8 feet) or more.

❖ Setting the Sound Pickup Range (DMW-MS2: Optional)



When using the Stereo Shotgun Microphone (DMW-MS2: optional), you can set the microphone sound pickup range.

1 Select [Special Mic.].

-  ⇒  ⇒  ⇒ [Special Mic.]



[STEREO]	Picks up sound over a wide area.
[LENS AUTO]	Picks up sound from a range automatically set by the lens angle of view.
[SHOTGUN]	Helps prevent picking up background noise, and records sound from a specific direction.
[S.SHOTGUN]	Narrows the sound pickup range more than with [SHOTGUN].
[MANUAL]	Sets the range manually for sound pickup.

2 (When [MANUAL] is selected)

Press ◀▶ to adjust the sound pickup range and then press  or .

❖ Reduction of Wind Noise

This reduces wind noise when an external microphone is connected.

-  ⇒  ⇒  ⇒ Select [Wind Cut]

Settings: [HIGH]/[STANDARD]/[LOW]/[OFF]



- While the external microphone is connected, [EXT.MIC] is displayed on the screen.
- When an external microphone is connected, [Sound Rec Level Disp.] automatically turns [ON], and the recording level is displayed on the screen.
- When [Mute Sound Input] is set to [ON], the audio input from the external microphone is muted.
- If noises are recorded when using the AC adaptor, use the battery.
- When a Stereo Microphone (VW-VMS10: optional) is used, [Special Mic.] is fixed to [STEREO].
- Setting [Wind Cut] may alter the usual sound quality.
- For details, refer to the operating instructions for the external microphone.

XLR Microphone Adaptor (Optional)

iA P A S M



By attaching an XLR Microphone Adaptor (DMW-XLR1: optional) to the camera, you can use a commercially available XLR microphone to enable the recording of superior-quality high-res/stereo audio.

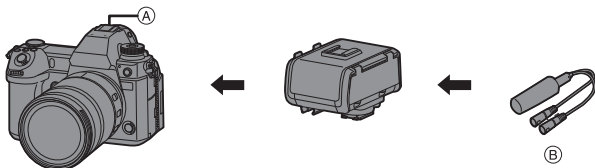

- Ⓐ Hot shoe
- Ⓑ Commercially available XLR microphone

Getting started:

- Turn off the camera, and remove the hot shoe cover. (→ 90)

- 1 Attach the XLR Microphone Adaptor to the hot shoe.**
- 2 Set the camera on/off switch to [ON].**
- 3 Select [XLR Mic Adaptor Setting].**

- → → → [XLR Mic Adaptor Setting]

[96kHz/24bit]	Records high resolution audio at 96 kHz/24-bit.	Only available when [Rec. File Format] is set to [MOV].
[48kHz/24bit]	Records high-quality audio at 48 kHz/24-bit.	
[48kHz/16bit]	Records standard-quality audio at 48 kHz/16-bit.	
[OFF]	Records audio using the built-in microphone of the camera.	



- While an XLR Microphone Adaptor is attached, [XLR] is displayed on the screen.
- When [XLR Mic Adaptor Setting] is set to other than [OFF], the following settings are fixed:
 - [Sound Rec Level Limiter]: [OFF]
 - [Wind Noise Canceller]: [OFF]
 - [Sound Output]: [REC SOUND]
- [Sound Rec Gain Level] and [Sound Rec Level Adj.] cannot be used when [XLR Mic Adaptor Setting] is set to other than [OFF].
- When the XLR Microphone Adaptor is attached, [Sound Rec Level Disp.] automatically turns [ON], and the recording level is displayed on the screen.
- When [Mute Sound Input] is set to [ON], the audio input from the XLR Microphone Adaptor is muted.
- If noises are recorded when using the AC adaptor, use the battery.
- For details, refer to the operating instructions for the XLR Microphone Adaptor.

Headphones

iA P A S M



You can record videos while monitoring their sound by connecting commercially available headphones to the camera.

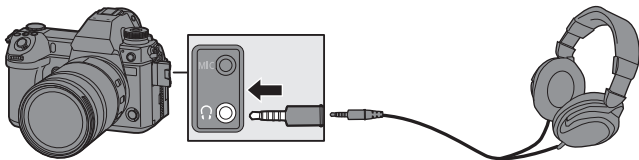

- Do not use the headphone cables with the length of 3 m (9.8 feet) or more.
- When headphones are connected, beep sounds, AF beep, and electronic shutter sounds are muted.

❖ Switching the Sound Output Method

 → [] → [] → Select [Sound Output]

[REALTIME]	Audio without time lag. It may differ from the sound recorded in videos.
[REC SOUND]	Audio to be recorded in videos. Output sound may be delayed from actual sound.





- The setting is fixed to [REC SOUND] in the following cases:
 - During output of audio via HDMI
 - When [Special Mic.] is set to [LENS AUTO], [SHOTGUN], [S.SHOTGUN], or [MANUAL]
 - When using an XLR Microphone Adaptor (DMW-XLR1: optional)

❖ Adjusting the Headphone Volume

Connect the headphones and rotate .



: Reduces the volume.





: Increases the volume.

- You can also adjust the volume by touching []/[] on the playback screen.

To adjust the volume using the menu:

❶ Select [Headphone Volume].

-  → [] → [] → [Headphone Volume]

❷ Press /  to adjust the headphone volume and then press  or .

13. Playing Back and Editing of Images

This document gives an overview of recorded image playback and deletion.

Refer to the “Owner’s Manual” (PDF format) for details about recorded image playback and editing.

Playing Back Pictures

1 Display the playback screen.

- Press [▶].

2 Select a picture.

(A) Card slot

- Select the pictures by pressing



◀: Move to the previous image

▶: Move to the next image

- You can move continuously through images by pressing and holding



3 Stop playback.

- Press the shutter button halfway.
- You can also stop playback by pressing [▶].

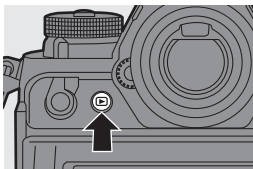

❖ Switching the Card to Display

Images are displayed separately by card slot.

You can switch the card displayed just by pressing the Fn button during playback.

- Use the Fn button registered with [Card Slot Change] to operate. In default settings, this is registered in [Fn] button.

For information about the Fn button, refer to page 156.

Playing Back Videos

1 Display the playback screen.

- Press [▶].

2 Select a video.

- The [👤] video icon is displayed for a video.

3 Play back the video.

- Press ▲.

4 Stop playback.

- Press ▼.

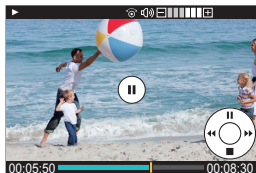





❖ Operations During Video Playback

Button operation	Touch operation	Description of operation
▲	▶ / ⏸	Plays/pauses.
▼	—	Stops.
◀	—	Performs fast-rewind playback.
		Performs frame-by-frame rewinding (while paused).
▶	—	Performs fast-forward playback.
		Performs frame-by-frame forwarding (while paused).
—		Selects the frame to display.
/	Save	Extracts a picture (while paused).
	—	Reduces the volume.
	+	Increases the volume.

Switching the Display Mode

❖ Enlarged Display



Rotate  to the right to enlarge the playback screen.

- The playback screen is enlarged in the order of 2x  4x  8x  16x.









❖ Thumbnail Screen

1 Rotate  to the left to use thumbnail display.

- The display is switched in the order of thumbnail screen (12 images)  Thumbnail screen (30 images)  Calendar playback.
- Images are displayed separately by card slot.

To switch the card to display, press [] during thumbnail display.







(A) Card







2 Press     to select an image and then press  or .



❖ Calendar Playback

1 Rotate  to the left to use calendar display.

2 Press     to select a date and then press  or .

3 Press     to select an image and then press  or .





- The card to display cannot be switched during calendar display.

Deleting Images



- ❗ Images cannot be restored once they have been deleted. Carefully confirm the images before deletion.
- You can only delete the images in the card of the selected card slot.



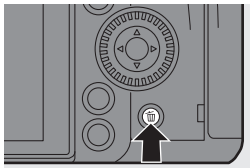

❖ [Delete Single]



- 1 Press [] in playback state.
- 2 Press ▲▼ to select [Delete Single] and then press  or .



❖ [Delete Multi]/[Delete All]

- 1 Press [] in playback state.
- 2 Press ▲▼ to select the deletion method and then press  or .

[Delete Multi]	<p>Selecting and deleting multiple images.</p> <ol style="list-style-type: none"> 1 Press ▲▼◀▶ to select the image to delete and then press  or . • [] is displayed for the selected image. • If you press  or  again, the selection is canceled. 2 Press [DISP.] to delete the selected image.
[Delete All]	<p>Deleting all images in a card.</p> <ul style="list-style-type: none"> • If you select [Delete All], all images in the card are deleted. • If you select [Delete All Non-rating], all images except those with a rating set are deleted.

- 💡 To switch the card selected for deleting images, press [] and then select the card slot.
-  Depending on the number of images to be deleted, it may take some time to delete them.

14. Camera Customization

Fn Buttons



You can register functions to the Fn (Function) buttons. Additionally, you can register other functions to specialized buttons such as [WB] button, in the same way as with the Fn buttons.

Different functions can be set for both during recording and playback.





Register Functions to the Fn Buttons

- With default settings, [Fn8] to [Fn12] on the joystick cannot be used. When using functions, set the [Joystick Setting] in the [Custom] ([Operation]) menu to [Fn]. (→ 168)



1 Select [Fn Button Set].

-  →  →  → [Fn Button Set] → [Setting in REC mode]/[Setting in PLAY mode]

2 Select the button.



- Press   to select the button and then press  or .
- Press [DISP.] to change the page.

3 Find the function to register.

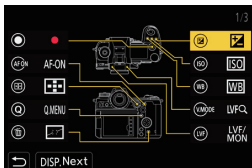
- Rotate  to select the sub tab where the function to register is categorized and then press  or .
- Switch the [1] to [3] tabs by pressing [Q].



4 Register the function.

- Press ▲▼ to select a function and then press  or .
- Select items with [>] by selecting the item again.
- Depending on the button, some functions cannot be registered.



- Refer to the "Owner's Manual" (PDF format) for functions you can register.





- You can also touch [Fn \uparrow] on the control panel (→ 53) to display the screen in Step 2.
- You can also press and hold the Fn button (2 sec.) to display the screen in Step 4.
(This may not be displayed depending on the registered function and on the button type.)

Use the Fn Buttons

During recording, pressing the Fn buttons enables usage of the functions registered in [Setting in REC mode], and during playback, usage of the functions registered in [Setting in PLAY mode].

1 Press the Fn button.

2 Select a setting item.

- Press ◀▶ to select a setting item and then press  or .
- Display and selection methods of a setting item differ depending on the menu item.

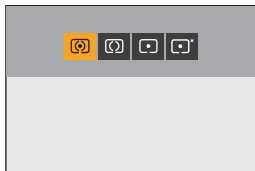

❖ Use [Fn3] to [Fn7] (Touch Icons)

During recording, you can use the Fn buttons within the Touch Tab.



- With the default settings, the Touch Tab is not displayed. Set [Touch Tab] to [ON] in [Touch Settings] in the [Custom] ([Operation]) menu. (→ 168)

- 1 Touch [Fn].
- 2 Touch one of [Fn3] to [Fn7].



[Dial Operation Switch]

This temporarily changes the functions operated with (front dial) and (rear dial).

Register Functions to the Dials

1 Select [Dial Operation Switch Setup].

- → [] → [] → [Dial Set.] → [Dial Operation Switch Setup] → []/[]

2 Register the function.

- Press to select a function and then press or .

• Refer to the “Owner’s Manual” (PDF format) for functions you can register.

Temporarily Change Dial Operation

Use the Fn button to temporarily change dial operation.

1 Set [Dial Operation Switch] to the Fn button. (→ 156)

2 Switch dial operation.

- Press the Fn button set in Step 1.
- A guide will display the functions registered to ☀️ and 🌧️.
- If no operations are performed, then several seconds later, the guide disappears.



3 Set the registered function.

- Rotate ☀️ or 🌧️ while the guide is displayed.

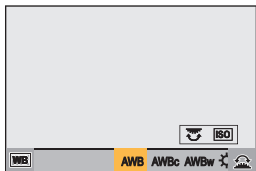

4 Confirm your selection.

- Press the shutter button halfway.

Quick Menu Customization

You can change Quick menu items depending on the recording mode. Additionally, you can change the items to display on the Quick menu and their order to suit your preferences. For information about Quick menu operation methods, refer to page 55.

Register to the Quick Menu

Change the menus to be displayed in the Quick menu. These can be set separately for [M] mode (Video) and for other recording modes (Photo).

1 Select [Q.MENU Settings].



- [MENU/SET] ⇒ [⚙️] ⇒ [☀️] ⇒ [Q.MENU Settings] ⇒ [Item Customize (Photo)]/[Item Customize (Video)]

2 Select the item position (① to ⑫).

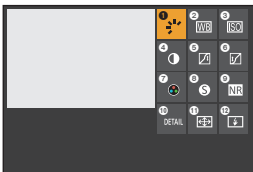
- Press ▲▼◀▶ to select the position and then press **MENU/SET** or .
- Directions on the diagonal can also be selected using the joystick.



3 Find the function to register.

- Rotate  to select the sub tab where the function to register is categorized and then press **MENU/SET** or .
- Each press of [Q] switches between tabs [1] and [2].



4 Register menu items.

- Press ▲▼ to select an item and then press **MENU/SET** or .
- Select items with [>] by selecting the item again.



- Refer to the "Owner's Manual" (PDF format) for functions you can register.

Custom Mode

C1 C2 C3



Recording modes and menu settings that match your preferences can be registered in Custom mode. You can use registered settings by switching the mode dial to [C1] to [C3] modes.

Register in Custom Mode

You can register the currently set information of the camera. At the time of purchase, the default settings of the [P] mode menus are registered with all Custom modes.

1 Set to recording mode and menu settings of the state you wish to save.

2 Select [Save to Custom Mode].

- → [] → [] → [Save to Custom Mode]

3 Register.

- Select the save-to number and then press or .
- A confirmation screen will be displayed. Press [DISP.] to change the Custom mode name.

For information on how to enter characters, refer to page 170.



- You cannot register [iA] mode in Custom mode.



- Refer to the "Owner's Manual" (PDF format) for the list of settings that can be registered in Custom mode.

Using Custom Mode

Set the mode dial to one of [C1] to [C3].

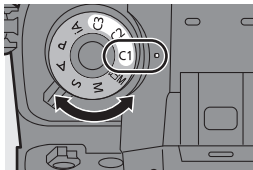

- If [C3], the last-used Custom mode will be called up.

❖ [C3] Custom Mode Selection

- 1 Set the mode dial to [C3].
- 2 Press .
 - The Custom mode selection menu appears.
- 3 Press to select the Custom mode and then press or .

❖ Changing Registered Details

Registered settings do not change even if you change the camera settings temporarily with the mode dial set to [C1] to [C3].

To change the registered details, overwrite them by using [Save to Custom Mode] in the [Setup] ([Setting]) menu.

Calling Up Settings

Call up registered Custom mode settings to the selected recording mode and overwrite the current settings with these.

- 1 **Set to the mode dial to use.**
- 2 **Select [Load Custom Mode].**
 - → [] → [] → [Load Custom Mode]
- 3 **Select the Custom mode to call up.**
 - Select the Custom mode and then press or .



- Calling up of Custom modes is not possible between those created from [P]/[A]/[S]/[M] modes and those created from [] mode.

My Menu

Register frequently-used menus in My Menu.

Registration in My Menu

Select a menu, and register this in My Menu.

1 Select [Add].

-  ⇒ [] ⇒ [] ⇒ [Add]



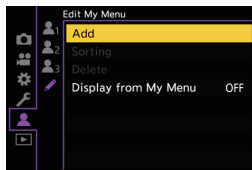

2 Register.

- Select the menu to register and then press  or .



❖ Calling up My Menu

Call up the menus registered in My Menu.

-  ⇒ [] ⇒ []/[]/[] ⇒ Registered menus

Edit My Menu



-  ⇒ [] ⇒ Select []

[Add]	Selects and registers the menus to be displayed in My Menu.
[Sorting]	Changes the order of My Menu. Select the menu to change, then set the destination.
[Delete]	[Delete Item]: Selects the menu, then deletes. [Delete All]: Deletes all menus registered in My Menu.
[Display from My Menu]	Displays My Menu first when displaying a menu. [ON]: Displays My Menu. [OFF]: Displays the last-used menu.

[Save/Restore Camera Setting]

Saves the camera's settings information to the card.

Saved settings information can be loaded to the camera, letting you set the same settings on multiple cameras.

 →  →  → Select [Save/Restore Camera Setting]

[Save]	Saves the camera's settings information to the card.	
	<ul style="list-style-type: none"> • If saving new data, then select [New File], and if overwriting an existing file, select that existing file. • When [New File] is selected, a screen to select the file name to save as is displayed. 	
	[OK]	Saves using the file name on the screen.
	[Change the file name]	Changes the file name and saves the file. <ul style="list-style-type: none"> • Available characters: alphabetic characters (upper-case), numerals, up to 8 characters • For information on how to enter characters, refer to page 170.
[Load]	Loads the settings information on the card and copies it to the camera.	
[Delete]	Deletes settings information on the card.	
[Keep Settings While Format]	When formatting the card, formats the card while keeping camera settings information stored on the card.	



- Only settings information from the same model can be loaded.
- Up to 10 instances of settings information can be saved on one card.



- Refer to the "Owner's Manual" (PDF format) for the list of functions for which saving of settings information is possible.

15. List of Menu









This chapter introduces the menu list.





- For information about menu operation methods, refer to page 57.
- For information on how to enter characters, refer to page 170.
- Refer to the “Owner’s Manual” (PDF format) for detailed information about menus.

List of Menu





: Menu items common to the [Photo] menu and [Video] menu.
Their settings are synchronized.

[Photo] menu















 [Image Quality]	
[Photo Style]	 → 87
[Metering Mode]	 → 80
[Aspect Ratio]	→ 63
[Picture Quality]	→ 63
[Picture Size]	→ 63
[HLG Photo]	
[High Resolution Mode]	
[Long Exposure NR]	
[Dual Native ISO Setting]	 → 83
[ISO Sensitivity (photo)]	
[Min. Shutter Speed]	
[i.Dynamic Range]	
[Vignetting Comp.]	
[Diffraction Compensation]	
[Filter Settings]	



 [Focus]	
[AF Custom Setting(Photo)]	
[AF Assist Light]	
[Focus Peaking]	
[1-Area AF Moving Speed]	
 [Flash]	
[Flash Mode]	→ 91
[Firing Mode]	
[Flash Adjust.]	
[Flash Synchro]	
[Manual Flash Adjust.]	
[Auto Exposure Comp.]	
[Red-Eye Removal]	
[Wireless]	
[Wireless Channel]	
[Wireless FP]	
[Communication Light]	
[Wireless Setup]	









 **[Photo] menu (Continued)**

 [Others (Photo)]	
[Bracketing]	
[Silent Mode]	 
[Image Stabilizer]	  → 75
[Burst Shot 1 Setting]	
[Burst Shot 2 Setting]	
[Shutter Type]	
[Shutter Delay]	

 **[Video] menu**

 [Image Quality]	
[Exposure Mode]	→ 98
[Photo Style]	  → 87
[Metering Mode]	  → 80
[Dual Native ISO Setting]	  → 83
[ISO Sensitivity (video)]	→ 118
[Synchro Scan]	→ 137
[Flicker Decrease (Video)]	
[Master Pedestal Level]	→ 117
[SS/Gain Operation]	→ 121
[i.Dynamic Range]	 
[Vignetting Comp.]	 
[Diffraction Compensation]	 
[Filter Settings]	 

[Ex. Tele Conv.]	
[Time Lapse/Animation]	
[Self Timer]	
[Flicker Decrease (Photo)]	
[6K/4K PHOTO]	
[Post-Focus]	
[Multiple Exposure]	
[Time Stamp Rec.]	 





 [Image Format]	
[Rec. File Format]	→ 100
[Image Area of Video]	→ 108
[Rec Quality]	→ 101
[Rec Quality (My List)]	→ 108
[Variable Frame Rate]	→ 125
[Time Code]	→ 110
[Luminance Level]	→ 117
 [Focus]	
[AF Custom Setting(Video)]	→ 116
[Continuous AF]	→ 115
[AF Assist Light]	 
[Focus Peaking]	 
[1-Area AF Moving Speed]	 

 **[Video] menu (Continued)**

 [Audio]	
[Sound Rec Level Disp.]	→ 119
[Mute Sound Input]	→ 119
[Sound Rec Gain Level]	→ 119
[Sound Rec Level Adj.]	→ 120
[Sound Rec Level Limiter]	→ 120
[Wind Noise Canceller]/	→ 120
[Wind Cut]	→ 148
[Mic Socket]	→ 146
[Special Mic.]	→ 148
[XLR Mic Adaptor Setting]	→ 149



 **[Custom] menu**



 [Image Quality]	
[Photo Style Settings]	
[ISO Increments]	
[Extended ISO]	
[Exposure Offset Adjust.]	
[Color Space]	
[Exposure Comp. Reset]	
[Auto Exposure in P/A/S/M]	→ 93
[CreativeVideo Combined Set.]	

[Sound Output]	→ 151
[Headphone Volume]	→ 151
 [Others (Video)]	
[Silent Mode]	
[Image Stabilizer]	 → 75
[Focus Transition]	→ 128
[Loop Recording (video)]	→ 138
[Segmented File Recording]	→ 139
[Live Cropping]	→ 130
[Time Stamp Rec.]	



 [Focus/Shutter]	
[Focus/Shutter Priority]	
[Focus Switching for Vert / Hor]	
[AF/AE Lock Hold]	
[AF+MF]	
[MF Assist]	
[MF Guide]	
[Focus Ring Lock]	
[Show/Hide AF Mode]	
[Pinpoint AF Setting]	
[AF-Point Scope Setting]	
[Shutter AF]	
[Half-Press Shutter]	
[Quick AF]	
[Eye Sensor AF]	
[Looped Focus Frame]	
[AFC Start Point (225-Area)]	→ 69

[Custom] menu (Continued)

 [Operation]	
[Q.MENU Settings]	→ 159
[Touch Settings]	
[Lock Lever Setting]	
[Fn Button Set]	→ 156
[WB/ISO/Expo. Button]	
[ISO Displayed Setting]	
[Exposure Comp. Disp. Setting]	
[Dial Set.]	
[Joystick Setting]	
[Illuminated Button]	
[Video Rec. Button (Remote)]	
 [Monitor / Display (Photo)]	
[Auto Review]	
[Constant Preview]	
[Histogram]	
[Photo Grid Line]	
[AF Area Display]	
[Live View Boost]	
[Night Mode]	
[LVF/Monitor Disp. Set]	
[Expo.Meter]	
[Focal Length]	
[Blinking Highlights]	
[Sheer Overlay]	
[I.S. Status Scope]	
[Level Gauge]	
[Luminance Spot Meter]	→ 122
[Framing Outline]	
[Show/Hide Monitor Layout]	→ 53



 [Monitor / Display (Video)]	
[V-Log View Assist]	→ 132
[HLG View Assist]	→ 135
[Anamorphic Desqueeze Display]	→ 136
[Monochrome Live View]	
[Center Marker]	
[Video Frame Marker]	→ 124
[Zebra Pattern]	→ 123
[WFM/Vector Scope]	→ 121
[Color Bars]	→ 124
[Video-Priority Display]	
[Red REC Frame Indicator]	
 [IN/OUT]	
[HDMI Rec Output]	→ 144
[Fan Mode]	
[Tally Lamp]	
 [Lens / Others]	
[Lens Focus Resume]	
[Focus Ring Control]	
[Lens Information]	→ 78
[Lens Info. Confirmation]	

 **[Setup] menu**

 [Card/File]	
[Card Format]	
[Double Card Slot Function]	
[Folder / File Settings]	
[File Number Reset]	
[Copyright Information]	
 [Monitor / Display]	
[Power Save Mode]	→ 37
[Monitor Frame Rate]	
[LVF Frame Rate]	
[Monitor Settings]/[Viewfinder]	
[Monitor Backlight]/ [LVF Luminance]	
[Remaining Battery Level]	
[Status-LCD]	
[Eye Sensor]	
[Level Gauge Adjust.]	
 [IN/OUT]	
[Beep]	
[Headphone Volume]	
[Wi-Fi]	
[Bluetooth]	→ 173



 **[My Menu]**



 [Page 1]	→ 163
 [Page 2]	→ 163
 [Page 3]	→ 163

[USB]	
[Battery Information]	
[Battery Use Priority]	
[TV Connection]	
[Card Access Light]	
 [Setting]	
[Save to Custom Mode]	→ 161
[Load Custom Mode]	→ 162
[Custom Mode Settings]	
[Save/Restore Camera Setting]	→ 164
[Reset]	→ 59
 [Others]	
[Clock Set]	
[Time Zone]	
[System Frequency]	→ 100
[Pixel Refresh]	
[Sensor Cleaning]	
[Language]	
[Firmware Version]	
[Online Manual]	
[Approved Regulations]	

 [Edit My Menu]	→ 163
[Add]	→ 163
[Sorting]	→ 163
[Delete]	→ 163
[Display from My Menu]	→ 163

▶ [Playback] menu

 [Playback Mode]	
[Playback Mode]	
[Slide Show]	
[Rotate Disp.]	
[Picture Sort]	
[Magnify from AF Point]	
[LUT View Assist (Monitor)]	→ 132
[HLG View Assist (Monitor)]	→ 135
[Anamorphic Desqueeze Display]	→ 136
 [Process Image]	
[RAW Processing]	
[6K/4K PHOTO Bulk Saving]	

[6K/4K PHOTO Noise Reduction]
[Time Lapse Video]
[Stop Motion Video]
 [Add/Delete Info.]
[Protect]
[Rating]
 [Edit Image]
[Resize]
[Rotate]
[Video Divide]
[Copy]
 [Others]
[Delete Confirmation]

❖ Entering Characters

Follow the steps below when the character entry screen is displayed.

- 1 Press **▲▼◀▶** to select characters and then press **MENU/SET** or **⌂** until the character to enter is displayed. (Repeat this)

- To repeatedly enter the same character, rotate **☀** or **☂** to the right to move the entry position cursor.
- If you select an item and press **MENU/SET** or **⌂**, you can perform the following operations:

– [A⁺]: Change the character type	– [<]: Move the entry position cursor to the left
– [□]: Enter a blank	– [>]: Move the entry position cursor to the right
– [Delete]: Delete a character	
- When entering a password, **A** shows the number of characters you have entered and the number of characters you can enter.



- 2 Select [Set] and then press **MENU/SET** or **⌂**.

16. Wi-Fi/Bluetooth

This document gives an overview of remote operations from a smartphone. Refer to the “Owner’s Manual” (PDF format) for details about camera Wi-Fi®/Bluetooth® functions.

- This document refers to smartphones and tablets collectively as **smartphones**.

Connecting to a Smartphone

Flow of connecting a smartphone

1	Install “LUMIX Sync” on your smartphone. (→ 172) Connect to a network, and install “LUMIX Sync”  .	
2	Connect to a smartphone. Connect the camera and the smartphone using a method depending on the smartphone.	
	Using a smartphone that supports Bluetooth Low Energy • Bluetooth connection (→ 173) Connect using simple connection setup procedure (pairing).	Using a smartphone that does not support Bluetooth Low Energy • Wi-Fi connection Connect with Wi-Fi. You can also use a QR code to connect easily. Refer to the “Owner’s Manual” (PDF format) for details.
3	Operate the camera using the smartphone. (→ 176)	



- The camera cannot be used to connect to a public wireless LAN connection.
- We strongly recommend that you set an encryption to maintain information security.

Installing “LUMIX Sync”

“LUMIX Sync” is an application for smartphones provided by Panasonic.

Supported OS

Android™: Android 5 or higher

iOS: iOS 11 or higher

- 1 Connect the smartphone to a network.**
- 2 (Android) Select “Google Play™ Store”.**
(iOS) Select “App Store”.
- 3 Enter “Panasonic LUMIX Sync” or “LUMIX” into the search box.**
- 4 Select and install the “Panasonic LUMIX Sync”** .



- Use the latest version.
- Supported OSs are current as of August 2019 and are subject to change.
- Some of the screens and information provided in this document may differ from your device depending on the supported OS and “LUMIX Sync” version.
- Read the [Help] in the “LUMIX Sync” menu for further details on how to operate.
- The app may not operate correctly depending on your smartphone.
For information on the “LUMIX Sync”, refer to the following support site:
<https://panasonic.jp/support/global/cs/dsc/>
(English only)
- Depending on your data plan, downloading the app or transferring pictures and videos via a mobile network, such as 4G (LTE) or 3G, may incur high data usage charges.



Connecting to a Smartphone (Bluetooth Connection)

Follow a simple connection setup procedure (pairing) to connect to a smartphone that supports Bluetooth Low Energy.

When pairing is set up, the camera also automatically connects to the smartphone via Wi-Fi.

- For the first-time connection, pairing settings are required.
For information about connecting for the second and subsequent times, refer to page 175.

Supported smartphones

Android™:	Android 5 or higher with Bluetooth 4.0 or higher (excluding those that do not support Bluetooth Low Energy)
iOS:	iOS 11 or higher

1 On the smartphone, start up “LUMIX Sync”.

- A message regarding device (camera) registration is displayed. Select [Next].
- If you have closed the message, select [, then register the camera using [Camera registration (pairing)].
- A message is displayed if the Bluetooth function of the smartphone is turned off. (For Android devices) Allow turning on the Bluetooth function.
(For iOS devices) Follow the message to turn on the Bluetooth function in the settings screen of the smartphone and then display “LUMIX Sync”.

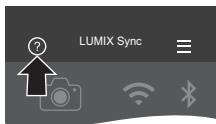
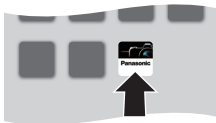

2 Check the content in the displayed guide and select [Next] until the screen to register the camera is displayed.

Operating the camera in accordance with the smartphone guide.

3 Set the camera to Bluetooth pairing standby state.

- **MENU/SET** → [**Wrench**] → [**Bluetooth**] → [**Bluetooth**] → [**SET**] → [**Pairing**]
- The camera enters pairing standby state and the device name **(A)** is displayed.

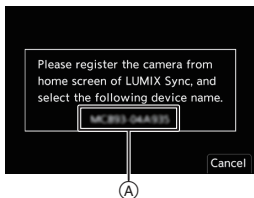

4 On the smartphone, select the camera's device name.

- (iOS devices) When a message to confirm the change of destination is displayed, select [Join].

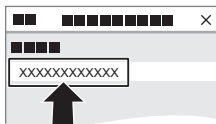

5 When a message indicating that device registration is complete, select [OK].

- A Bluetooth connection between the camera and the smartphone will be made.

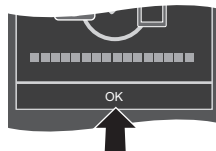

- The paired smartphone is registered as a paired device.
- During Bluetooth connection, [**Bluetooth**] is displayed in the recording screen. When the Bluetooth function is enabled, but a connection is not established with the smartphone, [**Bluetooth**] appears translucent.
- (iOS devices) If the Wi-Fi connection attempt fails during Bluetooth connection, follow the message displayed to allow connection to the camera. If you still cannot connect, select the SSID of the camera on the Wi-Fi setup screen of the smartphone to connect. If the SSID is not displayed, turn off and on the camera, then perform the Bluetooth connection settings again.

❖ End Bluetooth Connection



MENU/SET ⇒ [] ⇒ [] ⇒ [Bluetooth] ⇒ [Bluetooth] ⇒ Select [OFF]



- Even if you terminate the connection, the pairing information for it will not be deleted.

❖ Connecting to a Paired Smartphone

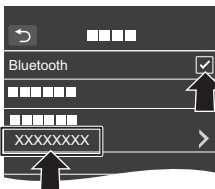
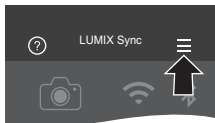

Connect paired smartphones using the following procedure.

- 1 Enable the Bluetooth function of the camera.
 - **MENU/SET** ⇒ [] ⇒ [] ⇒ [Bluetooth] ⇒ [Bluetooth] ⇒ [ON]
- 2 On the smartphone, start up “LUMIX Sync”.
 - If a message is displayed indicating that the smartphone is searching for cameras, close the message.
- 3 Select [].
- 4 Select [Bluetooth Setup].
- 5 Turn Bluetooth ON.
- 6 From [Camera registered] items, select the camera's device name.



- Even if you set up pairing with more than one smartphone, you can only connect to one smartphone at a time.
- When pairing takes some time, canceling the pairing settings on both the smartphone and camera and re-establishing the connection may result in the camera being detected correctly.

❖ Terminating the Wi-Fi Connection

- 1 Press the shutter button halfway to set the camera to recording mode.
- 2 Terminate the Wi-Fi connection.
 - **MENU/SET** ⇒ [] ⇒ [] ⇒ [Wi-Fi] ⇒ [Wi-Fi Function] ⇒ [Yes]
- 3 On the smartphone, close the “LUMIX Sync”.

Operating the Camera with a Smartphone

When you start up “LUMIX Sync”, the home screen is displayed.

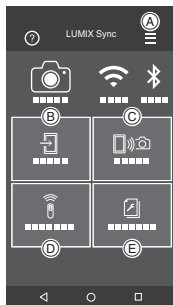

<p>(A) </p>	<p>App settings (→ 175) This allows connection settings, camera power operations, and displays Help.</p>
<p>(B) </p>	<p>[Import images] (→ 177)</p>
<p>(C) </p>	<p>[Remote shooting] (→ 176)</p>
<p>(D) </p>	<p>[Shutter Remote Control] (→ 177)</p>
<p>(E) </p>	<p>[Camera settings copy] This saves the camera's settings information to the smartphone. Saved settings information can be loaded to the camera, letting you set the same settings on multiple cameras.</p>

[Remote shooting]

You can use the smartphone to record from a remote location while viewing the live view images from the camera.

Getting started:

- Connect the camera to a smartphone. (→ 173)
- On the smartphone, start up “LUMIX Sync”.

1 Select ([Remote shooting]) in the home screen.

- (iOS devices) When a message to confirm the change of destination is displayed, select [Join].

2 Start recording.

(A)	Takes a picture
(B)	Starts/ends the video recording

- The recorded image is saved on the camera.

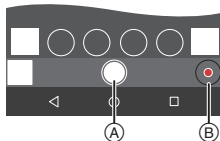

[Shutter Remote Control]



You can use the smartphone as a remote control for the shutter.

Getting started:

- Connect the camera to a smartphone by Bluetooth. (→ 173)
- On the smartphone, start up “LUMIX Sync”.

1 Select [] ([Shutter Remote Control]) in the home screen.

2 Start recording.

	Starts/ends the video recording
	Takes a picture



- Slide [] in the direction of [LOCK] to record with the shutter button locked in a fully-pressed state.

[Import images]

Transfer an image stored on the card to the smartphone connected via Wi-Fi.

Getting started:

- Connect the camera to a smartphone. (→ 173)
- On the smartphone, start up “LUMIX Sync”.

1 Select [] ([Import images]) in the home screen.

- (iOS devices) When a message to confirm the change of destination is displayed, select [Join].

2 Select the image to transfer.

- You can switch the card displayed by touching (A).



3 Transfer the image.

- Select [📷].
- If the image is a video, you can play it back by touching [▶] at the center of the screen.



- You will need Android 7.0 or higher to save RAW pictures on an Android device.

Depending on the smartphone or the OS, these may not be displayed correctly.

- When a video is played back, this has a small data size and is transmitted using "LUMIX Sync", therefore its image quality will differ from that of the actual video recording.

Depending on the smartphone and on the usage conditions, the image quality may deteriorate or the sound may skip during video or picture playback.

- Images recorded using the following functions cannot be transferred:
 - [AVCHD] videos, [MP4] 4K videos, [MOV] videos
 - [6K/4K PHOTO]/[Post-Focus]
 - [HLG Photo] (HLG format pictures)

17. Connecting to Other Devices

Connect using either the [HDMI] socket or the USB port on the camera.

- Refer to the “Owner’s Manual” (PDF format) for details about the following:
 - Using VIERA Link (HDMI)
 - Saving still pictures and motion pictures on a Recorder
 - Printing

[HDMI] socket

Connect the camera and TV with a commercially available HDMI cable.

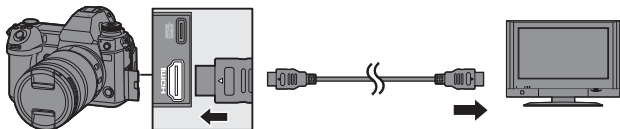

- Check the direction of the terminals and plug in/out straight holding onto the plug. (Inserting these at an angle may cause deformation or malfunction)
- Use a “High Speed HDMI cable” with the HDMI logo. Cables that do not comply with the HDMI standards will not work. “High Speed HDMI cable” (Type A–Type A plug, up to 1.5 m (4.9 feet) long)

USB port

Use a USB connection cable (C–C or A–C) to connect the camera to a PC, recorder, or printer.

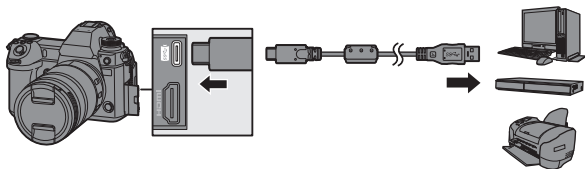

- Plug in/out straight holding onto the plug. (Inserting these at an angle may cause deformation or malfunction)
- Do not use any other USB connection cables except the supplied USB connection cables (C–C and A–C).



- Do not connect the cable to the wrong terminals. This may cause a malfunction.

Viewing on a TV

You can connect the camera to a TV to view recorded pictures and videos on the TV.

Getting started:

- Turn off the camera and TV.

- 1 Connect the camera and TV with a commercially available HDMI cable. (→ 179)**
- 2 Turn on the TV.**
- 3 Switch the input of the TV.**
 - Switch the input of the TV to match the terminal to which you connected the HDMI cable.
- 4 Turn on the camera.**
- 5 Display the playback screen.**
 - Press .
 - The recorded images are displayed on the TV. (The monitor and viewfinder of the camera will turn off.)



- HDMI output is not possible if you connect a USB connection cable at the same time while [USB Mode] is set to [PC(Storage)] or [PictBridge(PTP)].
- Please also refer to the operating instructions for the TV.

Importing Images to a PC

If you connect the camera to a PC, you can copy the recorded images to the PC.

When using Windows, you can also copy using the “PHOTOfunSTUDIO” software for LUMIX.

You can also use software to perform operations such as organizing and correcting recorded images, processing RAW images, and editing videos. (→ 183)

Copying Images to a PC

After connecting to the PC, you can copy the recorded images by dragging files and folders on this camera to the PC.



– Windows: We recommend importing AVCHD videos using “PHOTOfunSTUDIO”.

When importing using “PHOTOfunSTUDIO”, refer to page 183.

- You cannot play back or edit AVCHD videos using “PHOTOfunSTUDIO” if you imported them by dragging them.

– Mac: Supported by “Final Cut Pro X”.

For details on “Final Cut Pro X”, please contact Apple Inc.

- The camera can be connected to a PC running any of the following OSs which can detect mass storage devices.



Supported OS

Windows: Windows 10/Windows 8.1/Windows 8/Windows 7

Mac: OS X v10.5 to v10.11, macOS 10.12 to macOS 10.14

Getting started:

- Turn on the camera and PC.

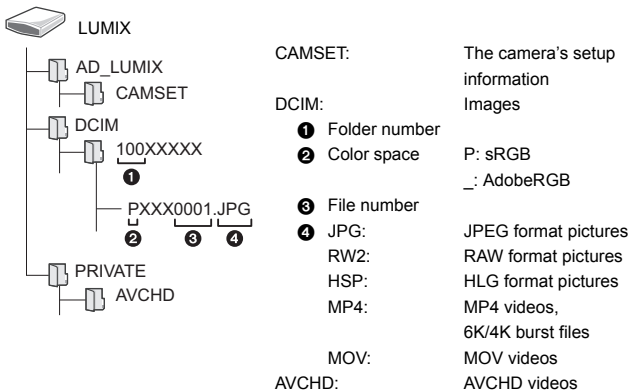

- 1 Connect the camera and PC with the USB connection cable (C-C or A-C). (→ 179)**
- 2 Press ▲▼ to select [PC(Storage)] and then press  or .**
 - Windows: A drive (“LUMIX”) is displayed in [This PC].
 - Mac: A drive (“LUMIX”) is displayed on the desktop.
 - A message about charging may be displayed. Wait for a while until the message disappears.
- 3 Drag the files and folders from the camera to the PC.**

❖ Folder Structure Inside Card



❖ Copying Images to PCs Using “PHOTOfunSTUDIO”

Getting started:

- Turn on the camera and PC.
 - Install “PHOTOfunSTUDIO” on PC. (→ 183)
- ❶ Connect the camera and PC with the USB connection cable (C–C or A–C). (→ 179)
 - ❷ Press ▲▼ to select [PC(Storage)] and then press  or  .
 - A message about charging may be displayed. Wait for a while until the message disappears.
 - ❸ Copy images to the PC using “PHOTOfunSTUDIO”.
 - Do not delete or move the copied files and folders in, for example, Windows Explorer.
Playback and editing using “PHOTOfunSTUDIO” will become no longer possible.



- Take care not to turn off the camera while images are being imported.
- After importing of the images is completed, perform the operation to safely remove the USB connection cable on the PC.
- Turn off the camera and disconnect the USB connection cable before removing the card from the camera. Otherwise, the recorded data may be damaged.

Installing Software

Install the software to perform operations such as organizing and correcting recorded images, processing RAW images, and editing videos.



- To download the software, your PC needs to be able to connect to the internet.
- Downloading may take a while depending on the communication environment.
- Supported OSs are current as of August 2019 and are subject to change.

❖ PHOTOfunSTUDIO 10.1 PE

This software allows you to manage your images. For example, it allows you to import pictures and videos to your PC and then sort them by recording date, model name.

You can also perform operations such as writing images to a DVD, correcting images, and editing videos.

Check the following site and then download and install the software:

https://panasonic.jp/support/global/cs/soft/download/d_pfs101pe.html
(English only)

Download expiration: September 2024

Operating environment

Supported OS	Windows 10 (32-bit/64-bit) Windows 8.1 (32-bit/64-bit) Windows 7 (32-bit/64-bit) SP1 • For 4K videos, videos in 10-bit format, and 6K/4K photos, a 64-bit version of the Windows 10/Windows 8.1/Windows 7 OS is required.
CPU	Pentium® 4 (2.8 GHz or higher)
Display	1024×768 or higher (1920×1080 or higher is recommended)
Installed memory	1 GB or more for 32-bit, 2 GB or more for 64-bit
Free hard disk space	450 MB or more for installing the software

- A high-performance PC environment is required to use the playback and editing functions for 4K videos and videos in 10-bit format or the picture cropping function for 6K/4K photos.

For details, refer to the operating instructions for "PHOTOfunSTUDIO".

- "PHOTOfunSTUDIO" is not available for Mac.

❖ SILKYPIX Developer Studio SE

This software processes and edits RAW images.

Edited images can be saved in a format (JPEG, TIFF, etc.) that can be displayed on a PC.

Check the following site and then download and install the software:

<http://www.isl.co.jp/SILKYPIX/english/p/>

Operating environment

Supported OS	Windows	Windows 10, Windows 8.1, Windows 7 (64-bit recommended)
	Mac	OS X v10.10 to v10.11 macOS 10.12 to macOS 10.14

- For more information such as how to use “SILKYPIX Developer Studio”, refer to the Help or the Ichikawa Soft Laboratory's support site.

❖ 30-Day Full Trial Version of “LoiLoScope”

This software allows you to easily edit videos.

Check the following site and then download and install the software:

<http://loilo.tv/product/20>

Operating environment

Supported OS	Windows	Windows 10, Windows 8.1, Windows 8, Windows 7
--------------	---------	---

- You can download a trial version that can be used for free for 30 days.
- For more information on how to use “LoiLoScope”, refer to the “LoiLoScope” manual available for download at the site.
- “LoiLoScope” is not available for Mac.

Tethered Recording

If you install the “LUMIX Tether” camera control software on your PC, you can connect the camera to the PC via USB and then control the camera from the PC and record while checking the live view on the PC screen (tethered recording).

Installing the “LUMIX Tether” Software

Check the following site and then download and install the software:

https://panasonic.jp/support/global/cs/soft/download/d_lumixtether.html

(English only)

Operating environment

Supported OS	Windows	Windows 10, Windows 8.1, Windows 7
	Mac	OS X v10.10 to v10.11, macOS 10.12 to macOS 10.14
Interface	USB port (SuperSpeed USB (USB 3.0))	





- Supported OSs are current as of August 2019 and are subject to change.
- To download the software, your PC needs to be able to connect to the internet.
- Downloading may take a while depending on the communication environment.
- For how to operate the software, refer to the operation guide for “LUMIX Tether”.

Operating the Camera from a PC

Getting started:

- Turn on the camera and PC.
- Install “LUMIX Tether” on PC.

- 1 Connect the camera and PC with the USB connection cable (C–C or A–C). (→ 179)**
- 2 Press ▲▼ to select [PC(Tether)] and then press  or .**
 - [] is displayed on the camera's screen.
 - A message about charging may be displayed. Wait for a while until the message disappears.
- 3 Use “LUMIX Tether” to operate the camera from the PC.**



- The Wi-Fi/Bluetooth functions are not available while there is a PC connection with [PC(Tether)].

18. Materials

Digital Camera Accessory System

Product name	Model number
Battery Pack	DMW-BLJ31
Battery Charger* ¹	DMW-BTC14
AC Adaptor* ²	DMW-AC10
DC Coupler* ²	DMW-DCC16
Flash	DMW-FL580L, DMW-FL360L, DMW-FL200L
LED Video Light	VW-LED1
Stereo Shotgun Microphone	DMW-MS2
Stereo Microphone	VW-VMS10
XLR Microphone Adaptor	DMW-XLR1
Shutter Remote Control	DMW-RS2
Battery Grip	DMW-BGS1
Eye Cup	DMW-EC6
Shoulder Strap	DMW-SSTG9

*1 Supplied with an AC adaptor, an AC cable and a USB connection cable (C–C).

*2 The AC Adaptor (optional) can only be used with the designated Panasonic DC Coupler (optional). The AC Adaptor (optional) cannot be used by itself.

Product numbers correct as of August 2019. These may be subject to change.

- Some optional accessories may not be available in some countries.
- For lens-related optional accessories such as compatible lenses and filters, refer to our catalogs/web pages, etc.
- Refer to the “Owner’s Manual” (PDF format) for details about using this camera when using optional accessories.
- To order optional accessories please visit <http://shop.panasonic.com> or your local Photo Specialty Dealer.

Monitor/Viewfinder Displays

- The screen is an monitor display example of when [LVF/Monitor Disp. Set] is set to [].

Recording Screen

- Refer to the “Owner’s Manual” (PDF format) for details on indications during playback.

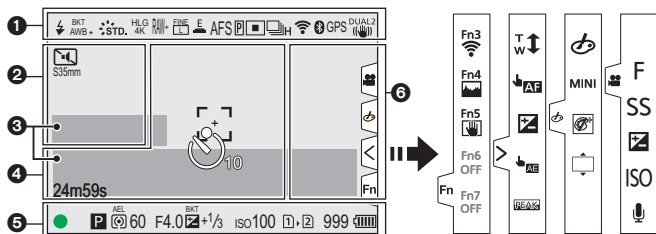

	Flash mode (→ 91)
	Flash setting (→ 165)
 	White balance (→ 84)
 	White Balance Bracket, White Balance Bracket (Color Temperature) (→ 166)
	Adjusting the white balance (→ 86)
	Photo Style (→ 87)
	Filter setting (→ 165)/ Filter effect adjustment

	HLG photo (→ 165)
	LUT View Assist (→ 132)
	HLG View Assist (→ 135)
	Picture quality (→ 63)/
	Picture size (→ 63)
	Extended Tele Conversion (→ 166)
	Recording file format (→ 100)/Recording quality (→ 101)
	Recording file format (→ 100)/
	Recording quality (→ 101)
	Recording frame rate (→ 101)/Variable frame rate (→ 125)
	Electronic shutter

5

2019.12.1 10:00:00	Time stamp recording (→ 167)
	Focus (turns green) (→ 45)/ Recording state (turns red) (→ 92)
LOW 	Focus (Low illumination AF) (→ 66)
STAR 	Focus (Starlight AF) (→ 66)
	Flash adjustment (→ 165)
iA P A S M P C3-1 P	Recording mode (→ 46)
P ↗	Program Shift
	Metering mode (→ 80)
AEL	AE Lock
60	Shutter speed (→ 45)
F4.0	Aperture value (→ 45)
BKT F4.0	Aperture Bracket (→ 166)
BKT +1/3	Exposure compensation value (→ 80) Exposure Bracket (→ 166)
MM+1	Manual Exposure Assist
ISO100	ISO sensitivity (→ 81)/ Dual Native ISO setting (→ 83)
	Card access indication (turns red) (→ 92)
	Card slot (→ 38)/Double card slot function (→ 64)
	No card
	Card full



999	Number of still images that can be taken
r20	Number of pictures that can be taken continuously
24m59s	Video recording time
	Battery indication (→ 35)
	Power supply (→ 34)
BG	Battery Grip



6

	Temperature rise warning icon (→ 196)
	Fan error warning icon (→ 200)

Touch Tab

Fn	
Fn3 	Fn button (→ 157)
T W ↑ ↓	Touch Zoom
	Touch AF, Touch Shutter (→ 62)
	Exposure compensation (→ 80)
	Touch AE (→ 62)
PEAK	Focus Peaking (→ 165)
	(→ 98)
	Type of defocus ([Miniature Effect])
	One Point Color
	Light source position ([Sunshine])





	Filter effect adjustment
	Filter on/off
MINI	Filter setting (→ 165)
F	Aperture value (→ 98)
SS	Shutter speed (→ 98)

	Exposure compensation (→ 98)
ISO	ISO sensitivity (→ 98)
	Sound recording level adjustment (→ 98)



❖ Control Panel







1

P	Recording mode (→ 46)
1/60	Shutter speed (→ 45)
F4.0	Aperture value (→ 45)
	Battery indication (→ 35)
	Power supply (→ 34)
BG 	Battery indication (battery grip) (→ 35)
	Wi-Fi/Bluetooth connection state









2

ISO 100	ISO sensitivity (→ 81)/ Dual Native ISO setting (→ 83)
±0 	Exposure compensation value (→ 80)/ Manual Exposure Assist
 ±0 	Flash setting (→ 165)/ Flash mode (→ 91)

3

	Drive mode (→ 47)/ Post-Focus (→ 166)/ High Resolution mode (→ 165)
AFS	Focus mode (→ 47, 72)
	AF mode (→ 67)
FINE	Picture quality (→ 63)
S35mm	Image area of video (→ 108)/Recording file format (→ 100)/Recording quality (→ 101)
	
3:2	Picture size/Aspect ratio (→ 63)
HLG OFF	HLG photo (→ 165)
Fn 	Fn button settings (→ 156)

4

	Photo Style (→ 87)
AWB	White balance (→ 84)
iOFF	i.Dynamic Range (→ 165)
	Metering mode (→ 80)
	Card slot (→ 38)/Double card slot function (→ 64)
	
	No card
	
	Card full
	
999	Number of still images that can be taken
r20	Number of pictures that can be taken continuously
R24m59s	Video recording time
----	No card

❖ Control Panel ([CAM] Mode)

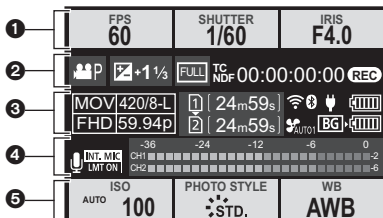

1	
FPS 60	Frame rate (→ 101)/ Variable frame rate (→ 125)
SHUTTER 1/60	Shutter speed (→ 45)
IRIS F4.0	Aperture value (→ 45)

2	
	Exposure mode (→ 98)
	Exposure compensation value (→ 80)/Manual Exposure Assist
	Image area of video (→ 108)
TC NDF 00:00:00:00	Time code (→ 110)
	Recording state (→ 92)

3	
	Recording file format (→ 100)/Recording quality (→ 101)
	Card slot (→ 38)/Double card slot function (→ 64)
24m59s	Video recording time
	Wi-Fi/Bluetooth connection state

	Fan operating mode (→ 168)
	Battery indication (→ 35)
	Power supply (→ 34)
	Battery indication (battery grip) (→ 35)

4	
	Built-in microphone,
	External microphone (→ 119, 146)
96kHz/24bit 	XLR microphone adaptor setting (→ 149)
	Sound recording level limiter (→ 120)
	Mute (→ 119)
Sound recording level (→ 119)	

5	
ISO AUTO 100	ISO sensitivity (→ 81)/ Dual Native ISO setting (→ 83)
PHOTO STYLE 	Photo Style (→ 87)/
	LUT View Assist (→ 132)/
	HLG View Assist (→ 135)
WB AWB	White balance (→ 84)

Message Displays

Meanings of main messages displayed on the camera screen, and response methods.

- Please also refer to the "Owner's Manual" (PDF format), which describes more detailed information.

[Memory Card Error]/[Format this card?]

- It is a format that cannot be used with the camera.
Either insert another card, or back up any necessary data before formatting. (→ 39)

[Memory Card Error]/[This memory card cannot be used]

- Use a card compatible with the camera. (→ 19)

[Read Error]/[Write Error]/[Please check the card]

- Failure to read or write data.
Turn off the camera, reinsert the card, and then turn it on again.
- The card may be broken.
- Insert a different card.

[Now writing]

- The card door or battery door is opened while writing to a card. Wait until writing is finished, then turn the camera off and remove.

[The lens is not attached properly. Do not push lens release button while lens is attached.]

- Remove the lens once, and then attach it again without pressing the lens release button. (→ 40)
Turn on the camera again, and if it is still displaying, contact the dealer.

[This battery cannot be used]

- Use a genuine Panasonic battery.
If this message is displayed even when a genuine Panasonic battery is used, contact the dealer.
- If the terminal of the battery is dirty, remove the dirt and dust from the terminal.

[Failed to connect wireless access point]/[Connection failed]/[No destination found]

- The wireless access point information set on the camera is wrong.
Check the authentication type and encryption key.
- Radio waves from other devices may block the connection to a wireless access point.
Check the status of other devices that are connected to the wireless access point as well as the status of other wireless devices.

[Some pictures cannot be deleted]/[This picture cannot be deleted]

- Images that do not comply with the DCF standard cannot be deleted.
Back up any necessary data before formatting the card. (→ 39)

[Please turn camera off and then on again]/[System Error]

- Turn off and on the camera.
If the message is displayed even when doing this several times, contact the dealer.

[The fan is not functioning correctly.]

- The fan has stopped. Turn off and on the camera. If the fan does not work after turning the camera off and then on again, consult the dealer.
- The temperature of the camera will rise if you continue to use the camera with the fan stopped. Do not use over long periods of time.

Troubleshooting

First, try out the following procedures (→ 195 to 200).

If the problem is not resolved, it may be improved by selecting [Reset] (→ 59) on the [Setup] ([Setting]) menu.

- Please also refer to the “Owner’s Manual” (PDF format), which describes more detailed information.

The battery becomes flat too quickly.

- When [6K/4K Pre-Burst] or [Pre-Burst Recording] is set, the battery drains faster.
Set these settings only when recording.

Striping or flicker may appear under lighting such as fluorescent or LED lighting.

- This is characteristic of CMOS sensors which serve as the camera's pickup sensors.

This is not a malfunction.

- When using the electronic shutter, lowering the shutter speed may reduce the effect of the horizontal stripes.
- If flicker is noticeable when recording pictures, set [Flicker Decrease (Photo)].
- If flicker or horizontal stripes are noticeable when recording video, this can be mitigated by fixing the shutter speed.
Either set [Flicker Decrease (Video)], or record in [M] mode (→ 95).



The brightness or coloring of the recorded image is different from the actual scene.

- When recording under lighting such as fluorescent or LED lighting, increasing the shutter speed may introduce slight changes to brightness or coloring. These are a result of the characteristics of the light source and do not indicate a malfunction.
- When recording subjects in extremely bright locations or recording under lighting such as fluorescent, LED, mercury, or sodium lighting, the coloring or screen brightness may change or horizontal striping may appear on the screen.

Cannot record videos.

- If you change the [System Frequency], you may no longer be able to record video to the same card.
Try again after either returning the [System Frequency] to the original setting or inserting another card.
- When using a large capacity card, you may not be able to record for a while after turning on the camera.

Cannot play back.

There are no recorded pictures.

- Folders and images processed on a PC cannot be played on the camera.
We recommend using the software "PHOTOfunSTUDIO" to write images from the PC to the card.

- Some images are not displayed when the [Playback Mode] is set. Set to [Normal Play].
- Videos recorded with a different [System Frequency] setting cannot be played back. Return the [System Frequency] setting to the one you used during the recording. (→ 100)

The flash does not fire.

- The flash does not fire when using the following functions:
 - Video recording (→ 92)/[6K/4K PHOTO]/[Post-Focus]
 - [ELEC.]/[Silent Mode]/[High Resolution Mode]
 - [Filter Settings]

A Wi-Fi connection cannot be established.

Radio waves get disconnected.

Wireless access point is not displayed.

General tips for using a Wi-Fi connection

- Use within the communication range of the device to be connected.
- Usage near devices that utilize the 2.4 GHz frequency such as microwave ovens and cordless telephones may result in the radio wave being lost. Use the camera at a sufficient distance from these devices.
- When the remaining battery level is low, it may not be possible to connect to or maintain communication with other devices. (A message such as [Communication error] is displayed.)
- If you place the camera on a metal table or shelf, the radio waves may be adversely affected. In such cases, you may not be able to establish a connection. Move the camera away from the metal surface.

Wireless access point

- Confirm that the connected wireless access point can be used.
- Confirm the radio wave conditions of the wireless access point.
 - Move the camera closer to the wireless access point.
 - Change the location and angle of the wireless access point.

- Depending on the wireless access point, the radio wave may not be displayed even though it is present.
 - Turn off and then on the wireless access point.
 - If the wireless channel of the wireless access point cannot be set automatically, manually set the channel supported by the camera.
 - If the wireless access point SSID is set not to broadcast, it may not be detected. Enter the SSID, and then connect.

The PC is not recognized when I use a Wi-Fi connection.

The camera cannot be connected to the PC using the Wi-Fi function.

- At the time of purchase, this camera is set to use a workgroup name of "WORKGROUP".
If you have changed the workgroup name of the PC, this will not be recognized. In the [Wi-Fi Setup] menu, [PC Connection], change the workgroup name of the PC to which to connect.
- Check that the login name and password are correctly typed.
- When the clock settings of the PC connected to the camera differs considerably from those of the camera, the camera cannot be connected to the PC depending on the OS.

It takes time to transmit an image to the web service.

Transmission of the image fails midway.

Some images cannot be transmitted.

- Is the size of the image too large?
 - Reduce the image size at [Size], and then send.
 - Transmit after dividing the video with [Video Divide].
- It may take longer time to transmit when distance to the wireless access point is far. Transmit closer to the wireless access point.
- File format of the video that can be sent differs depending on the destination.

The TV images are displayed with gray bands.

- Depending on the [Aspect Ratio], gray bands may be displayed on the top and bottom or the left and right of the images. You can change the band color in [Background Color(Playback)] in [TV Connection] of the [Setup] ([IN/OUT]) menu.

[] is displayed on the screen.

- The fan has stopped. Turn off and on the camera. If the fan does not work after turning the camera off and then on again, consult the dealer.
- The temperature of the camera will rise if you continue to use the camera with the fan stopped. Do not use over long periods of time.

An alarm sounds when the card door or battery door is opened.

- An alarm may sound when a door is opened while writing to a card. Wait until writing finishes, then turn the camera off and remove the card or battery.

When the camera is shaken, a rattling sound is heard from the camera.

- The sound is caused by the in-body stabilizer. This is not a malfunction.

There is rattling noise from the lens when the camera is turned on or off, or when the camera is swung.

There is a sound from the lens when recording.

- This is the sound of the lens moving and aperture operation. It is not a malfunction.

An unreadable language was selected by mistake.

- Reselect the language from the menu using the following procedure:

 ⇒ [] ⇒ [] ⇒ [] ⇒ Select desired language (→ 169)

The camera becomes warm.

- The camera surface and back of the monitor may become warm during use, but this does not indicate a problem with performance or quality.

The clock is wrong.

- When the camera is left for a long time, the clock may reset.
Reset the clock. (→ 42)

Specifications

The specifications are subject to change for performance enhancement.

Digital camera body (DC-S1H):

Information for your safety

Power source:	9.0 V===
Power consumption:	6.3 W (when recording with the monitor), 4.8 W (when playing back with the monitor) [When using the interchangeable lens (S-R24105)]

Type

Type	Digital Single Lens Mirrorless camera
Recording media	SD memory card / SDHC memory card* / SDXC memory card* * Compliant with UHS-I/UHS-II UHS Speed Class 3, UHS-II Video Speed Class 90 Double slot recording function is available.
Lens mount	Leica Camera AG L-Mount

Image sensor

Image sensor	35 mm full-frame (35.6 mm×23.8 mm) CMOS sensor, a total of 25,280,000 pixels, primary color filter
Effective number of pixels of the camera	24,200,000 pixels

Latitude

14+ stops ([V-Log])

Recording format for still images

File format for still images	JPEG (DCF compliant, Exif 2.31 compliant) / RAW / HLG photo (CTA-2072 compliant)
File format for 6K/4K photos	6K photo: MP4 (H.265/HEVC, AAC (2ch)) 4K photo: MP4 (H.264/MPEG-4 AVC, AAC (2ch))

Picture size (pixels)	When the aspect ratio setting is [4:3]
	[L]: 5328×4000 (3536×2656)*
	[M]: 3792×2848 (2560×1920)*
	[S]: 2688×2016 (1840×1376)*
	[High Resolution Mode]: 10656×8000
	6K photo: 4992×3744
	4K photo: 3328×2496 (3328×2496)*
	[HLG Photo] ([Full-Res.]): 5312×3984
	[HLG Photo] ([4K-Res.]): 2880×2160 (2880×2160)*
	When the aspect ratio setting is [3:2]
	[L]: 6000×4000 (3888×2592)*
	[M]: 4272×2848 (2784×1856)*
	[S]: 3024×2016 (1968×1312)*
[High Resolution Mode]: 12000×8000	
6K photo: 5184×3456	
4K photo: 3504×2336 (3504×2336)*	
[HLG Photo] ([Full-Res.]): 5984×4000	
[HLG Photo] ([4K-Res.]): 3232×2160 (3232×2160)*	
When the aspect ratio setting is [16:9]	
[L]: 6000×3368 (4064×2288)*	
[M]: 4272×2400 (2816×1584)*	
[S]: 3024×1704 (1920×1080)*	
[High Resolution Mode]: 12000×6736	
4K photo: 3840×2160 (3840×2160)*	
[HLG Photo] ([Full-Res.]): 5888×3312	
[HLG Photo] ([4K-Res.]): 3840×2160 (3840×2160)*	
When the aspect ratio setting is [1:1]	
[L]: 4000×4000 (2656×2656)*	
[M]: 2848×2848 (1920×1920)*	
[S]: 2016×2016 (1376×1376)*	
[High Resolution Mode]: 8000×8000	
4K photo: 2880×2880 (2880×2880)*	
[HLG Photo] ([Full-Res.]): 4000×4000	
[HLG Photo] ([4K-Res.]): 2144×2144 (2144×2144)*	
* Figures in parentheses are for Super 35 mm/APS-C lenses	

Picture size (pixels)	When the aspect ratio setting is [65:24] [L]: 6000×2208 When the aspect ratio setting is [2:1] [L]: 6000×3000
Image quality for pictures	Fine / Standard / RAW+Fine / RAW+Standard / RAW

Recording format for video

Video format	AVCHD Progressive / AVCHD / MP4 (H.264/MPEG-4 AVC, H.265/HEVC) / MOV (H.264/MPEG-4 AVC, H.265/HEVC)	
Audio format	AVCHD	Dolby Audio (2ch)
	MP4	AAC (2ch)
	MOV	LPCM (2ch, 48 kHz/16-bit)* * When an XLR Microphone Adaptor (DMW-XLR1: optional) is attached, LPCM (2ch, 48 kHz/24-bit, 96 kHz/24-bit) can be selected
System frequency	59.94 Hz / 50.00 Hz / 24.00 Hz	
Image quality for video	Refer to page 101 in this document for information about resolution, recording frame rate, and other elements of recording quality.	

Viewfinder

System	Aspect ratio 4:3, 0.5 inches, approx. 5,760,000 dots, organic EL (OLED) live view viewfinder
Field of view ratio	Approx. 100%
Magnification	Approx. 0.78× (−1.0 m ⁻¹ 50 mm at infinity, with aspect ratio set to [3:2])
Eye point	Approx. 21 mm (at −1.0 m ⁻¹)
Diopter adjustment range	−4.0 to +2.0 diopter
Eye sensor	Yes

Monitor	
System	Aspect ratio 3:2, 3.2 inches, approx. 2,330,000 dots monitor, capacitive touch screen
Field of view ratio	Approx. 100%
Status LCD	
1.8 inches, 303×230 dots, black and white LCD monitor	
Focus	
AF type	TTL type based on image detection (Contrast AF)
Focus mode	AFS / AFC / MF
AF mode	Automatic detection (Face/Eye/Body/Animal) / Tracking / 225-Area / Zone (Vertical/Horizontal) / Zone (Square) / Zone (Oval) / 1-Area+Supplementary / 1-Area / Pinpoint / Custom1, 2, 3, Focus area selection is possible by touching or with the joystick
Exposure control	
Light metering system, Light metering mode	1728-zone metering, multi-metering / center-weighted metering / spot metering / highlight-weighted metering
Metering range	EV 0 to EV 18 (F2.0 lens, ISO100 conversion)
Exposure	Program AE (P) / Aperture-Priority AE (A) / Shutter- Priority AE (S) / Manual Exposure (M)
Exposure compensation	1/3 EV steps, ±5 EV
ISO sensitivity (standard output sensitivity)	AUTO / 100 to 51200, When [Extended ISO] is set: AUTO / 50 to 204800, 1/3 EV steps

Dual Native ISO setting	Auto	Base sensitivity: 100/640 (dB display values are based on 100) AUTO / 100 to 51200 When [Extended ISO] is set: AUTO / 50 to 204800
	Low sens.	Base sensitivity: 100 AUTO / 100 to 800 When [Extended ISO] is set: AUTO / 50 to 800
	High sens.	Base sensitivity: 640 AUTO / 640 to 51200 When [Extended ISO] is set: AUTO / 320 to 204800
Dual Native ISO setting (V-Log)	Auto	Base sensitivity: 640/4000 (dB display values are based on 640) AUTO / 640 to 51200 When [Extended ISO] is set: AUTO / 320 to 51200
	Low sens.	Base sensitivity: 640 AUTO / 640 to 5000 When [Extended ISO] is set: AUTO / 320 to 5000
	High sens.	Base sensitivity: 4000 AUTO / 4000 to 51200 When [Extended ISO] is set: AUTO / 2000 to 51200
Dual Native ISO setting (Cinelike D2/ Cinelike V2)	Auto	Base sensitivity: 200/1250 (dB display values are based on 200) AUTO / 200 to 51200 When [Extended ISO] is set: AUTO / 100 to 204800
	Low sens.	Base sensitivity: 200 AUTO / 200 to 1600 When [Extended ISO] is set: AUTO / 100 to 1600
	High sens.	Base sensitivity: 1250 AUTO / 1250 to 51200 When [Extended ISO] is set: AUTO / 640 to 204800

Dual Native ISO setting (HLG video/ HLG photo)	Auto	Base sensitivity: 400/2500 (dB display values are based on 400) AUTO / 400 to 51200 When [Extended ISO] is set: AUTO / 400 to 204800
	Low sens.	Base sensitivity: 400 AUTO / 400 to 3200
	High sens.	Base sensitivity: 2500 AUTO / 2500 to 51200 When [Extended ISO] is set: AUTO / 2500 to 204800
Image stabilizer		
Image stabilizer type	Compliant with Image sensor shift type, 5-axis stabilizer, Dual I.S.2	
Image stabilizer effect	In-body image stabilizer: 6.0 stops [Focal length f=50 mm, using an interchangeable lens (S-X50)] Dual I.S.2: 6.5 stops [Focal length f=105 mm, using an interchangeable lens (S-R24105)]* (Based on the CIPA standard, Yaw/Pitch direction) * Firmware version 1.1 or higher	
White balance		
White balance mode	AWB / AWBc / AWBw / Daylight / Cloudy / Shade / Incandescent lights / Flash / Set mode 1, 2, 3, 4 / Color temperature 1, 2, 3, 4	

Shutter		
Format	Focal-plane shutter	
Shutter speed	Pictures: Mechanical shutter: Bulb (max. approx. 30 minutes), 60 seconds to 1/8000 of a second Electronic front curtain: Bulb (max. approx. 30 minutes), 60 seconds to 1/2000 of a second Electronic shutter: Bulb (max. approx. 60 seconds), 60 seconds to 1/8000 of a second Videos: 1/25* of a second to 1/16000 of a second * When [Exposure Mode] is set to [M] in [⊞M] and focus mode is set to [MF], this can be set up to 1/2	
Burst recording		
Mechanical shutter/ Electronic front curtain	High speed	9 frames/second ([AFS], [MF]) / 6 frames/second ([AFC])
	Medium speed	5 frames/second
	Low speed	2 frames/second
Electronic shutter	High speed	9 frames/second ([AFS], [MF]) / 5 frames/second ([AFC])
	Medium speed	5 frames/second
	Low speed	2 frames/second
Maximum number of frames recordable	[FINE] / [STD.]: 999 frames or more [RAW+FINE] / [RAW+STD.] / [RAW]: 60 frames or more (When recording is performed under the test conditions specified by Panasonic)	
Minimum illumination		
Approx. 6 lx (system frequency 59.94 Hz, shutter speed 1/30 of a second) Approx. 6 lx (system frequency 50.00 Hz, shutter speed 1/25 of a second) [When using the interchangeable lens (S-R24105)]		

Flash (when using an external flash)	
Flash mode	Auto / Auto/Red-Eye / Forced Flash On / Forced On/Red-Eye / Slow Sync. / Slow Sync./Red-Eye / Forced Flash Off
Flash synchronization speed	Equal to or smaller than 1/320 of a second* * The guide number decreases at 1/320 of a second, only during [S]/[M] modes
Zoom	
Extended Tele Conversion (Picture)	Max. 2×* (when a picture size of [S] is selected.) * Max. 1.9× when using Super 35 mm/APS-C lenses
Display language	
[ENGLISH]/[DEUTSCH]/[FRANÇAIS]/[ITALIANO]/[ESPAÑOL]/[繁體中文]/[PORTUGUÊS]/[日本語]	
Microphone / Speaker	
Microphone	Stereo
Speaker	Monaural
Interface	
USB	USB Type-C™, SuperSpeed USB3.1 GEN1, Supports USB Power Delivery (9.0 V/3.0 A)
[HDMI]	HDMI Type A
[REMOTE]	∅ 2.5 mm jack
[MIC]	∅ 3.5 mm stereo mini jack, Mic Input (Plug-in Power) / Mic Input / Line Input (Operate the menu to switch between these inputs), Standard input level: -55 dBV (Mic Input) / -10 dBV (Line Input)
Headphones	∅ 3.5 mm stereo mini jack
Flash Synchro	Yes
TC IN/OUT	Yes (connect the BNC conversion cable (supplied) to the flash synchro socket) Input: 1.0 V to 4.0 V [p-p], 10 kΩ Output: 2.0 V ±0.5 V [p-p], low impedance

Splash Resistant	
Yes	
External dimensions / Mass	
External dimensions	Approx. 151.0 mm (W)×114.2 mm (H)×110.4 mm (D) (5.94" (W)×4.50" (H)×4.35" (D)) (excluding the projecting parts)
Mass (Weight)	Approx. 1164 g/2.57 lb (with one card and the battery) Approx. 1052 g/2.32 lb (only camera body)
Operating environment	
Recommended operating temperature	– 10 °C to 40 °C (14 °F to 104 °F) <ul style="list-style-type: none"> Battery performance temporarily worsens at low temperatures (– 10 °C to 0 °C (14 °F to 32 °F)), reducing the number of pictures that can be taken and the available recording time.
Permissible relative humidity	10%RH to 80%RH
Wi-Fi	
Compliance standard	IEEE 802.11a/b/g/n/ac (standard wireless LAN protocol)
Frequency range used (central frequency)	2412 MHz to 2462 MHz (1 to 11ch) 5180 MHz to 5320 MHz (36/40/44/48/52/56/60/64ch) 5500 MHz to 5720 MHz (100/104/108/112/116/120/124/128/132/136/140/144ch) 5745 MHz to 5825 MHz (149/153/157/161/165ch)
Encryption method	Wi-Fi compliant WPA™ / WPA2™
Access method	Infrastructure mode
Bluetooth	
Compliance standard	Bluetooth v4.2, Bluetooth Low Energy (BLE)
Frequency range used (central frequency)	2402 MHz to 2480 MHz

Battery charger (Panasonic DMW-BTC14):

Information for your safety

Input:	9.0 V===	3.0 A
Output:	8.4 V===	3.1 A
Operating temperature:	0 °C to 40 °C (32 °F to 104 °F)	

AC adaptor (Panasonic DVLV1001Z):

Information for your safety

Input:	100–240 V~	50/60 Hz	0.7 A
Output:	5 V===	3.0 A,	9 V=== 3.0 A
Operating temperature:	0 °C to 40 °C (32 °F to 104 °F)		

Battery pack (lithium-ion) (Panasonic DMW-BLJ31):

Information for your safety

Voltage/capacity:	7.4 V / 3050 mAh
--------------------------	------------------

The symbols on this product (including the accessories) represent the following:

~	AC
===	DC
	Class II equipment (The construction of the product is double-insulated.)

Refer to the “Owner’s Manual” (PDF format) for details about the following specifications:

- Number of pictures that can be taken and available recording time with the battery
- Number of still images that can be taken and video recording time with cards
- List of default settings/custom saving/settings available for copying
- List of functions that can be set in each recording mode

Index

Numerics

1-Area (AF).....	70
1-Area AF Moving Speed	165
1-Area+ (AF).....	70
225-Area (AF).....	69
6K/4K PHOTO	166
6K/4K PHOTO Bulk Saving	170
6K/4K PHOTO Noise Reduction.....	170

A

AF	66
AF Area Display.....	168
AF Assist Light.....	165
AF Custom Setting (Photo).....	165
AF Custom Setting (Video).....	116, 166
AF mode	67
AF ON.....	66, 74
AF/AE Lock Hold	167
AF+MF	167
AFC	48
AFC Start Point (225-Area)	69, 167
AF-Point Scope	66
AF-Point Scope Setting	167
AFS.....	48
Anamorphic (Video).....	78
Anamorphic Desqueeze Display	136, 168, 170
Anamorphic recording	136
Android	172
Aperture-Priority AE mode.....	46
Approved Regulations	169
Aspect Ratio	63, 165
Auto Exposure Comp.	165
Auto Exposure in P/A/S/M.....	93, 167
Auto focus.....	66
Auto LVF/Monitor Off.....	37

Auto Review.....	168
Auto White Balance	85
AVCHD	101
AVCHD Progressive	102

B

Backlight compensation.....	61
Battery	28, 30
Battery Information	169
Battery Use Priority.....	169
Beep	169
Blinking Highlights	168
Bluetooth.....	169, 173
Boost I.S. (Video).....	78
Bracketing	166
Burst Shot	47
Burst Shot 1 Setting	166
Burst Shot 2 Setting	166

C

Cable holder	141
Calendar screen	154
Card	19, 38, 64
Card Access Light.....	39, 169
Card Format.....	39, 169
Card Slot Change	152
Center Marker.....	168
Center-weighted metering	80
Charge	28
Clock Set	42, 169
Color Bars	124, 168
Color Space	167, 182
Communication Light.....	165
Compression rate	63
Condensation.....	16
Constant Preview.....	168

-
- Continuous AF 115, 166
 - Control dial 49
 - Control panel 53, 56, 191
 - Copy 170
 - Copyright Information 169
 - Creative Video Combined Set 99, 167
 - Creative Video mode 95
 - Custom (AF) 70
 - Custom menu 167
 - Custom mode 161
 - Custom Mode Settings 169
- D**
-
- Delete 155
 - Delete Confirmation 170
 - Delete Single 155
 - Destination Card Slot 64
 - Dial Operation Switch Setup 158
 - Dial Setting 168
 - Diffraction Compensation 165
 - Diopeter adjustment 51
 - Double Card Slot Function 64, 169
 - Down Convert
(During HDMI Output) 144
 - Drive mode 47
 - Dual Native ISO Setting 83, 165
- E**
-
- Enlarged display 154
 - Entering characters 170
 - E-Stabilization (Video) 76
 - Exposure compensation 80
 - Exposure Compensation Display
Setting 168
 - Exposure Compensation Reset 167
 - Exposure Meter 168
 - Exposure Mode 98, 166
 - Exposure Offset Adjustment 167
 - Extended ISO 167
 - Extended Tele Conversion 166
 - External microphone 146
 - External monitor/external recorder 140
 - External TC Setting 111
 - Eye Sensor 169
 - Eye Sensor AF 167
- F**
-
- Face/Eye/Body/Animal Detect 68
 - Fan inlet 44
 - Fan Mode 168
 - Fan outlet 44
 - File number 65, 182
 - File Number Reset 169
 - Filter Settings 165
 - Firing Mode 165
 - Firmware update 15
 - Firmware Version 169
 - Flash 90
 - Flash Adjust 165
 - Flash Mode 91, 165
 - Flash Synchro 165
 - Flash synchro socket 90
 - Flicker Decrease (Photo) 166
 - Flicker Decrease (Video) 166
 - Fn button 156
 - Fn Button Set 156
 - Focal Length 168
 - Focus 66, 115
 - Focus mode 47
 - Focus Peaking 165
 - Focus Ring Control 168
 - Focus Ring Lock 167
 - Focus Switching for Vert/Hor 167
 - Focus Transition 128, 167
 - Focus/Shutter Priority 167

-
- Folder number 65, 182
- Folder/File Settings..... 65, 169
- Forced Flash Off..... 91
- Framing Outline 168
- Front dial..... 49
- G**
-
- Gain 121
- Gamma setting (Photo Style) 88
- H**
-
- Half-Press Shutter 167
- HDMI cable..... 140, 179, 180
- HDMI output 140
- HDMI Rec Output 144, 168
- HDMI Recording Control 145
- HDMI socket 140, 179
- Headphone socket..... 150
- Headphone Volume..... 151, 167, 169
- High frame rate video 127
- High Resolution Mode 165
- Highlight-weighted metering 80
- Histogram 168
- HLG Photo..... 165
- HLG video..... 134
- HLG View Assist..... 135, 168
- HLG View Assist (Monitor) 170
- Hot shoe cover 90
- I**
-
- i.Dynamic Range 165
- I.S. Status Scope..... 168
- Illuminated Button..... 168
- Image Area of Video..... 108, 166
- Image Quality 89
- Image Stabilizer..... 75, 166
- Info Display (During HDMI Output).... 144
- Intelligent Auto mode..... 60
- iOS..... 172
- ISO Displayed Setting..... 168
- ISO Increments 167
- ISO sensitivity 81
- ISO Sensitivity (photo) 165
- ISO Sensitivity (video) 118, 166
- J**
-
- Joystick 50
- Joystick Setting 168
- K**
-
- Knee 118
- L**
-
- Lens 18, 40
- Lens Focus Resume..... 168
- Lens Info. Confirmation..... 168
- Lens Information 78, 168
- Level Gauge 168
- Level Gauge Adjustment 169
- Live Cropping..... 130, 167
- Live View Boost 168
- Load Custom Mode 162, 169
- Lock Lever Setting 168
- Log recording..... 132
- Long Exposure NR 165
- Loop Recording (video) 138, 167
- Looped Focus Frame..... 167
- Low illumination AF..... 66
- Luminance Level..... 117, 166
- Luminance Spot Meter..... 122, 168
- LUMIX Sync..... 172
- LUT View Assist (Monitor) 170
- LVF Frame Rate 169
- LVF Luminance..... 169
- LVF/Monitor Display Set 168

M	
Magnify from AF Point	170
Manual Exposure mode	47
Manual Flash Adjust.	165
Manual focus	72
Master Pedestal Level	117, 166
Metering Mode	80, 165
MF	72
MF Assist	167
MF Guide	167
Mic Socket	147, 167
Minimum Shutter Speed	165
Monitor	41, 188
Monitor Backlight	169
Monitor Frame Rate	169
Monitor Settings	169
Monochrome Live View	168
MOV	101
MP4	101
Multi-metering	80
Multiple Exposure	166
Mute Sound Input	119, 167
My Menu	163
N	
Night Mode	168
O	
Online Manual	169
Operation lock lever	51
Optical zoom	74
P	
PC connection	181, 185
Photo Grid Line	168
Photo menu	165
Photo Style	87, 165
Photo Style Settings	167
PHOTOfunSTUDIO	184
Picture Quality	63, 165
Picture Size	63, 165
Picture Sort	170
Pinpoint (AF)	70
Pinpoint AF Setting	167
Pixel Refresh	169
Play back	152
Play back picture	152
Play back video	153
Playback menu	170
Playback Mode	170
Post-Focus	166
Power Save LVF Shooting	37
Power Save Mode	37, 169
Program AE mode	46
Protect	170
Q	
Q.Menu Settings	159, 168
Quick AF	167
Quick menu	55, 159
R	
Rating	170
RAW	63
RAW Processing	170
Rear dial	49
Rec Quality	101, 166
Rec Quality (My List)	108, 166
Rec. File Format	100, 166
Recording mode	46
Recording videos	92
Red REC Frame Indicator	168
Red-Eye Removal	165
Registering to My List	108

-
- Remaining Battery Level 169
 - Remote shooting 176
 - Reset 59, 169
 - Resize..... 170
 - Rotate 170
 - Rotate Display 170
- S**
-
- Save to Custom Mode 161, 169
 - Save/Restore Camera Setting
..... 164, 169
 - SD Speed Class 20
 - Segmented File Recording 139, 167
 - Self-timer 47, 166
 - Sensor Cleaning 169
 - Setup menu 169
 - Sheer Overlay..... 168
 - Shoulder strap 27
 - Show/Hide AF Mode..... 167
 - Show/Hide Monitor Layout 168
 - Shutter AF 167
 - Shutter Delay..... 166
 - Shutter Remote Control..... 177
 - Shutter type 166
 - Shutter-Priority AE mode..... 46
 - Silent Mode..... 166
 - Sleep Mode 37
 - Sleep Mode (Wi-Fi)..... 37
 - Slide Show..... 170
 - Sound Down Convert 146
 - Sound Output 151, 167
 - Sound Output (HDMI)..... 146
 - Sound Rec Gain Level..... 119, 167
 - Sound Rec Level Adj. 120, 167
 - Sound Rec Level Disp. 119, 167
 - Sound Rec Level Limiter 120, 167
 - Special Mic. 148, 167
 - Spot metering 80
 - SS/Gain Operation..... 121, 166
 - Starlight AF 66
 - Status LCD 26, 96, 169
 - Status LCD backlight 54, 169
 - Stereo Shotgun Microphone 146
 - Stop Motion Animation..... 47, 166
 - Stop Motion Video 170
 - Sub video rec. button..... 46, 92
 - Supplying power 34
 - Synchro Scan 137, 166
 - System Frequency..... 100, 169
- T**
-
- Tally Lamp 92, 168
 - Tethered recording 185
 - Thumbnail screen 154
 - Time Code 110, 166
 - Time Lapse Shot..... 47, 166
 - Time Lapse Video 170
 - Time Stamp Rec. 166
 - Time Zone..... 169
 - Touch AE 62
 - Touch AF 62
 - Touch screen 50
 - Touch Settings..... 168
 - Touch Shutter 62
 - Tracking (AF)..... 69
 - TV Connection 169
 - TV playback 180
- U**
-
- UHS Speed Class 20
 - USB 169
 - USB connection cable
..... 29, 32, 34, 179, 182, 183, 186
 - USB PD (USB Power Delivery)..... 34

USB port 32, 179

V

V.MODE button 52

Variable Frame Rate 125, 166

Video Divide 170

Video Frame Marker 124, 168

Video menu 166

Video rec. button 46, 92

Video Rec. Button (Remote) 168

Video Speed Class 20

Video-Priority Display 168

Viewfinder 51, 169, 188

Vignetting Compensation 165

V-Log 132

V-Log View Assist 132, 168

W

WB/ISO/Exposure Button 168

WFM/Vector Scope 121, 168

White balance 84

White balance adjustment 86

Wi-Fi 169, 171

Wind Cut 148, 167

Wind Noise Canceller 120, 167

Wireless 165

Wireless Channel 165

Wireless FP 165

Wireless Setup 165

X

XLR Mic Adaptor Setting 149, 167

XLR Microphone Adaptor 149

Z

Zebra Pattern 123, 168

Zone (AF) 69

Zoom 74

Trademarks and Licences



- L-Mount is a trademark or registered trademark of Leica Camera AG.
- SDXC Logo is a trademark of SD-3C, LLC.
- The terms HDMI and HDMI High-Definition Multimedia Interface, and the HDMI Logo are trademarks or registered trademarks of HDMI Licensing Administrator, Inc. in the United States and other countries.
- USB Type-C™ and USB-C™ are trademarks of USB Implementers Forum.
- The USB Type-C™ Charging Trident Logos are trademarks of USB Implementers Forum, Inc.
- The SuperSpeed USB Trident Logo is a registered trademark of USB Implementers Forum, Inc.
- “AVCHD”, “AVCHD Progressive” and the “AVCHD Progressive” logo are trademarks of Panasonic Corporation and Sony Corporation.
- QuickTime and the QuickTime logo are trademarks or registered trademarks of Apple Inc., used under license therefrom.
- Manufactured under license from Dolby Laboratories. Dolby, Dolby Audio, and the double-D symbol are trademarks of Dolby Laboratories.
- HDAVI Control™ is a trademark of Panasonic Corporation.
- Adobe is a trademark or registered trademark of Adobe Systems Incorporated in the United States and/or other countries.
- Pentium is a trademark of Intel Corporation in the U.S. and/or other countries.
- Windows is a registered trademark or trademark of Microsoft Corporation in the United States and/or other countries.



- Final Cut Pro, Mac, OS X and macOS are trademarks of Apple Inc., registered in the U.S. and other countries.
- App Store is a service mark of Apple Inc.
- Google, Android and Google Play are trademarks of Google LLC.
- The Bluetooth® word mark and logos are registered trademarks owned by Bluetooth SIG, Inc. and any use of such marks by Panasonic Corporation is under license. Other trademarks and trade names are those of their respective owners.
- The Wi-Fi CERTIFIED™ Logo is a certification mark of Wi-Fi Alliance®.
- The Wi-Fi Protected Setup™ Logo is a certification mark of Wi-Fi Alliance®.
- “Wi-Fi®” is a registered trademarks of Wi-Fi Alliance®.
- “Wi-Fi Protected Setup™”, “WPA™”, and “WPA2™” are trademarks of Wi-Fi Alliance®.
- This product uses “DynaFont” from DynaComware Corporation. DynaFont is a registered trademark of DynaComware Taiwan Inc.
- QR Code is a registered trademark of DENSO WAVE INCORPORATED.
- Other names of systems and products mentioned in these instructions are usually the registered trademarks or trademarks of the manufacturers who developed the system or product concerned.

This product incorporates the following software:

- (1) the software developed independently by or for Panasonic Corporation,
- (2) the software owned by third party and licensed to Panasonic Corporation,
- (3) the software licensed under the GNU General Public License, Version 2.0 (GPL V2.0),
- (4) the software licensed under the GNU LESSER General Public License, Version 2.1 (LGPL V2.1), and/or
- (5) open source software other than the software licensed under the GPL V2.0 and/or LGPL V2.1.

The software categorized as (3) - (5) are distributed in the hope that it will be useful, but WITHOUT ANY WARRANTY, without even the implied warranty of MERCHANTABILITY or FITNESS FOR A PARTICULAR PURPOSE. Please refer to the detailed terms and conditions thereof displayed by selecting [MENU/SET] → [Setup] → [Others] → [Firmware Version] → [Software info].

At least three (3) years from delivery of this product, Panasonic will give to any third party who contacts us at the contact information provided below, for a charge no more than our cost of physically performing source code distribution, a complete machine-readable copy of the corresponding source code covered under GPL V2.0 or LGPL V2.1, as well as the respective copyright notice thereof.

Contact Information: oss-cd-request@gg.jp.panasonic.com

The source code and the copyright notice are also available for free in our website below.

<https://panasonic.net/cns/oss/index.html>

This product is licensed under the AVC Patent Portfolio License for the personal use of a consumer or other uses in which it does not receive remuneration to (i) encode video in compliance with the AVC Standard ("AVC Video") and/or (ii) decode AVC Video that was encoded by a consumer engaged in a personal activity and/or was obtained from a video provider licensed to provide AVC Video. No license is granted or shall be implied for any other use. Additional information may be obtained from MPEG LA, L.L.C.

See <http://www.mpegla.com>

Limited Warranty (ONLY FOR U.S.A.)

Panasonic Products Limited Warranty

Limited Warranty Coverage (For USA Only)

If your product does not work properly because of a defect in materials or workmanship, Panasonic Corporation of North America (referred to as "the warrantor") will, for the length of the period indicated on the chart below, which starts with the date of original purchase ("warranty period"), at its option either (a) repair your product with new or refurbished parts, (b) replace it with a new or a refurbished equivalent value product, or (c) refund your purchase price. The decision to repair, replace or refund will be made by the warrantor.

Product or Part Name	Parts	Labor
Digital Camera	1 Year	1 Year
All included Accessories (Except Non-Rechargeable Batteries)	90 Days	Not Applicable
Only Non-Rechargeable Batteries	10 Days	Not Applicable

During the "Labor" warranty period there will be no charge for labor. During the "Parts" warranty period, there will be no charge for parts. This Limited Warranty excludes both parts and labor for non-rechargeable batteries, antennas, and cosmetic parts (cabinet). This warranty only applies to products purchased and serviced in the United States. This warranty is extended only to the original purchaser of a new product which was not sold "as is".

Mail-In Service--Online Repair Request

Online Repair Request

To submit a new repair request and for quick repair status visit our Web Site at <http://shop.panasonic.com/support>.

When shipping the unit, carefully pack, include all supplied accessories listed in the Owner's Manual, and send it prepaid, adequately insured and packed well in a carton box. When shipping Lithium Ion batteries please visit our Web Site at <http://shop.panasonic.com/support> as Panasonic is committed to providing the most up to date information. Include a letter detailing the complaint, a return address and provide a daytime phone number where you can be reached. A valid registered receipt is required under the Limited Warranty.

IF REPAIR IS NEEDED DURING THE WARRANTY PERIOD, THE PURCHASER WILL BE REQUIRED TO FURNISH A SALES RECEIPT/PROOF OF PURCHASE INDICATING DATE OF PURCHASE, AMOUNT PAID AND PLACE OF PURCHASE. CUSTOMER WILL BE CHARGED FOR THE REPAIR OF ANY UNIT RECEIVED WITHOUT SUCH PROOF OF PURCHASE.

Limited Warranty Limits and Exclusions

This warranty ONLY COVERS failures due to defects in materials or workmanship, and DOES NOT COVER normal wear and tear or cosmetic damage. The warranty ALSO DOES NOT COVER damages which occurred in shipment, or failures which are caused by products not supplied by the warrantor, or failures which result from accidents, misuse, abuse, neglect, mishandling, misapplication, alteration, faulty installation, set-up adjustments, misadjustment of consumer controls, improper maintenance, power line surge, lightning damage, modification, introduction of sand, humidity or liquids, commercial use such as hotel, office, restaurant, or other business or rental use of the product, or service by anyone other than a Factory Service Center or other Authorized Servicer, or damage that is attributable to acts of God.

THERE ARE NO EXPRESS WARRANTIES EXCEPT AS LISTED UNDER “LIMITED WARRANTY COVERAGE”.

THE WARRANTOR IS NOT LIABLE FOR INCIDENTAL OR CONSEQUENTIAL DAMAGES RESULTING FROM THE USE OF THIS PRODUCT, OR ARISING OUT OF ANY BREACH OF THIS WARRANTY.

(As examples, this excludes damages for lost time, travel to and from the servicer, loss of or damage to media or images, data or other memory or recorded content. The items listed are not exclusive, but for illustration only.)

ALL EXPRESS AND IMPLIED WARRANTIES, INCLUDING THE WARRANTY OF MERCHANTABILITY, ARE LIMITED TO THE PERIOD OF THE LIMITED WARRANTY.

Some states do not allow the exclusion or limitation of incidental or consequential damages, or limitations on how long an implied warranty lasts, so the exclusions may not apply to you.

This warranty gives you specific legal rights and you may also have other rights which vary from state to state. If a problem with this product develops during or after the warranty period, you may contact your dealer or Service Center. If the problem is not handled to your satisfaction, then write to:

Consumer Affairs Department
Panasonic Corporation of North America
661 Independence Pkwy
Chesapeake, VA 23320

PARTS AND SERVICE, WHICH ARE NOT COVERED BY THIS LIMITED WARRANTY, ARE YOUR RESPONSIBILITY.

Shop
Accessories!

for all your Panasonic gear

Go to

<http://shop.panasonic.com/support>

Get everything you need to get the most out of
your Panasonic products

Accessories & Parts for your Camera, Phone, A/V
products, TV, Computers & Networking, Personal
Care, Home Appliances, Headphones, Batteries,
Backup Chargers & more...

Customer Services Directory

For Product Information, Operating Assistance,
Parts, Owner's Manuals, Dealer and Service info

go to <http://shop.panasonic.com/support>

For the hearing or speech impaired TTY: 1- 877-833-8855

As of July 2015

Panasonic Corporation of North America

Two Riverfront Plaza, Newark, NJ 07102-5490

<http://shop.panasonic.com>

© Panasonic Corporation 2019



DVQX1939ZA

F0819HN0

Printed in China