



Multi-Protocol On-board Ethernet Multi-function Print Server and  
Wireless (IEEE 802.11b/g) Ethernet Multi-function Print Server



# NETWORK USER'S GUIDE

Please read this manual thoroughly before using this machine on your network. You can view this manual in HTML format from the CD-ROM at any time, please keep the CD-ROM in a convenient place for quick and easy reference at all times. You can also download the manual in PDF format from the Brother Solutions Center. (<http://solutions.brother.com/>)

The Brother Solutions Center (<http://solutions.brother.com/>) is your one stop resource for all your printing needs. Download the latest drivers and utilities for your machine, read FAQs and troubleshooting tips or learn about special printing solutions.

## Definitions of notes

We use the following icon throughout this User's Guide:

 <b>IMPORTANT</b>	IMPORTANT describes procedures you must follow or avoid to prevent possible machine problems or damage to other objects.
 <b>Note</b>	Notes tell you how you should respond to a situation that may arise or give tips about how the operation works with other features.

## Trademarks

The Brother logo is a registered trademark of Brother Industries, Ltd.

Brother is a registered trademark of Brother Industries, Ltd.

Microsoft, Windows, Windows Server, Outlook and Internet Explorer are registered trademarks of Microsoft Corporation in the United States and/or other countries.

Windows Vista is either a registered trademark or a trademark of Microsoft Corporation in the United States and/or other countries.

Apple, Macintosh, Safari and TrueType are trademarks of Apple Inc., registered in the United States and other countries.

Linux is the registered trademark of Linus Torvalds in the U.S. and other countries.

UNIX is a registered trademark of The Open Group in the United States and other countries.

Adobe, Flash, Illustrator, Photoshop, PostScript and PostScript 3 are either registered trademarks or trademarks of Adobe Systems Incorporated in the United States and/or other countries.

BROADCOM, SecureEasySetup and the SecureEasySetup logo are trademarks or registered trademarks of Broadcom Corporation in the United States and/or other countries.

Wi-Fi and Wi-Fi Alliance are registered trademarks of the Wi-Fi Alliance.

AOSS is a trademark of Buffalo Inc.

OpenLDAP is a registered trademark of the OpenLDAP Foundation.

Each company whose software title is mentioned in this manual has a Software License Agreement specific to its proprietary programs.

**Any trade names and product names of companies appearing on Brother products, related documents and any other materials are all trademarks or registered trademarks of those respective companies.**

## Compilation and publication notice

Under the supervision of Brother Industries Ltd., this manual has been compiled and published, covering the latest product's descriptions and specifications.

The contents of this manual and the specifications of this product are subject to change without notice.

Brother reserves the right to make changes without notice in the specifications and materials contained herein and shall not be responsible for any damages (including consequential) caused by reliance on the materials presented, including but not limited to typographical and other errors relating to the publication.

©2009 Brother Industries Ltd.

## IMPORTANT NOTE

- This product is approved for use in the country of purchase only.  
Do not use this product outside the country of purchase as it may violate the wireless telecommunication and power regulations of that country.
- Windows® XP in this document represents Windows® XP Professional, Windows® XP Professional x64 Edition and Windows® XP Home Edition.
- Windows Server® 2003 in this document represents Windows Server® 2003 and Windows Server® 2003 x64 Edition.
- Windows Vista® in this document represents all editions of Windows Vista®.
- The machine illustrations are based on MFC-8890DW.
- Not all models are available in all countries.

## Brother numbers

### ! IMPORTANT

For technical and operational assistance, you must call the country where you purchased the machine. Calls must be made **from within** that country.

## For Customer Service

<b>In USA</b>	1-877-BROTHER (1-877-276-8437)
<b>In Canada</b>	1-877-BROTHER
<b>In Brazil</b>	helpline@brother.com.br
<b>In Europe</b>	Visit <a href="http://www.brother.com/">http://www.brother.com/</a> for contact information on your local Brother office.

#### ■ Service center locator (USA)

For the location of a Brother authorized service center, call 1-877-BROTHER (1-877-276-8437).

#### ■ Service center locations (Canada)

For the location of a Brother authorized service center, call 1-877-BROTHER.

If you have any comments or suggestions, please write to us at:

<b>In USA</b>	Customer Support Brother International Corporation 100 Somerset Corporate Boulevard Bridgewater NJ 08807-0911
<b>In Canada</b>	Brother International Corporation (Canada), Ltd. - Marketing Dept. 1 Hôtel de Ville Dollard des Ormeaux, QC H9B 3H6 Canada
<b>In Brazil</b>	Brother International Corporation do Brasil Ltda. Av. Paulista, 854 - 15 and. - Ed. Top Center CEP: 01310-100 - São Paulo - SP - Brasil
<b>In Europe</b>	European Product & Service Support 1 Tame Street Audenshaw Manchester, M34 5JE, UK

## Internet address

---

Brother Global Web Site: <http://www.brother.com/>

For Frequently Asked Questions (FAQs), Product Support, Driver Updates and Utilities:  
<http://solutions.brother.com/>

## Ordering accessories and supplies

---

**In USA:** 1-877-552-MALL (1-877-552-6255)  
1-800-947-1445 (fax)

<http://www.brothermall.com/>

**In Canada:** 1-877-BROTHER

<http://www.brother.ca/>

# Table of Contents

<b>1</b>	<b>Introduction</b>	<b>1</b>
	Overview.....	1
	Network features.....	2
	Network printing.....	2
	Network scanning.....	2
	Network PC Fax (Not available for DCP-8080DN and DCP-8085DN).....	2
	Fax to Server (For MFC-8690DW, MFC-8880DN and MFC-8890DW).....	2
	Management utilities.....	2
	Internet fax/scan to E-mail server (MFC-8690DW, MFC-8880DN and MFC-8890DW only).....	4
	Types of network connections.....	5
	Wired network connection example.....	5
	Wireless network connection examples (For MFC-8690DW and MFC-8890DW only).....	7
	Protocols.....	8
	TCP/IP protocols and functionalities.....	8
	Other protocol.....	11
<b>2</b>	<b>Configuring your machine for a network</b>	<b>12</b>
	Overview.....	12
	IP addresses, subnet masks and gateways.....	12
	IP address.....	12
	Subnet mask.....	13
	Gateway (and router).....	14
	Step by step chart.....	14
	Setting the IP address and subnet mask.....	15
	Using the BRAdmin Light utility to configure your machine as a network printer.....	15
	Using the control panel to configure your machine for a network.....	17
	Using other methods to configure your machine for a network.....	17
	Changing the print server settings.....	18
	Using the BRAdmin Light utility to change the print server settings.....	18
	Using the BRAdmin Professional 3 utility to change print server settings (Windows®).....	18
	Using the control panel to change the print server settings.....	19
	Using Web Based Management (web browser) to change the print/scan server settings.....	20
	Using Remote Setup to change the print server settings (Not available for Windows Server® 2003/2008) (Not available for DCP-8085DN and DCP-8080DN).....	20
	Using other methods to change print server settings.....	20
<b>3</b>	<b>Configuring your machine for a wireless network (For MFC-8690DW and MFC-8890DW)</b>	<b>21</b>
	Overview.....	21
	Wireless network terms and concepts.....	22
	SSID (Service Set Identifier) and channels.....	22
	Authentication and encryption.....	22
	Step by step chart for wireless network configuration.....	25
	For Infrastructure mode.....	25
	For Ad-hoc mode.....	26

Confirm your network environment.....	27
Connected to a computer with an access point in the network (Infrastructure mode).....	27
Connected to a wireless capable computer without an access point in the network (Ad-hoc mode).....	27
Confirm your wireless network setup method.....	28
Configuration using the machine's control panel Setup Wizard to configure your machine for a wireless network.....	28
Configuration using the SES/WPS or AOSS™ control panel menu (Automatic Wireless mode) (Infrastructure mode only).....	28
Configuration using the PIN Method of Wi-Fi Protected Setup (Infrastructure mode only).....	29
Configuration using the Brother installer application on the CD-ROM to configure your wireless network machine.....	30
Configure your machine for a wireless network.....	31
Using the Setup Wizard from the control panel.....	31
Using the SES/WPS or AOSS™ control panel menu to configure your machine for a wireless network (Automatic Wireless mode).....	36
Using the PIN Method of Wi-Fi Protected Setup.....	39
Using the Brother installer application on the CD-ROM to configure your machine for a wireless network.....	40

#### **4 Wireless configuration for Windows® using the Brother installer application (For MFC-8690DW and MFC-8890DW) 41**

---

Configuration in Infrastructure mode.....	41
Before configuring the wireless settings.....	41
Configure the wireless settings.....	43
Configuration using the SES/WPS or AOSS™ from the control panel menu (Automatic Wireless mode).....	51
Before configuring the wireless settings.....	51
Configure the wireless settings.....	51
Configuration in Ad-hoc mode.....	56
Before configuring the wireless settings.....	56
Configure the wireless settings.....	56

#### **5 Wireless configuration for Macintosh using the Brother installer application (For MFC-8690DW and MFC-8890DW) 68**

---

Configuration in Infrastructure mode.....	68
Before configuring the wireless settings.....	68
Configure the wireless settings.....	70
Configuration using the SES/WPS or AOSS™ from the control panel menu (Automatic Wireless mode).....	78
Configuration in Ad-hoc mode.....	83
Before configuring the wireless settings.....	83
Configure the wireless settings.....	83

#### **6 Control panel setup 93**

---

Network menu.....	93
TCP/IP.....	93
Ethernet (wired network only).....	101
Setup Wizard (MFC-8690DW and MFC-8890DW wireless network only).....	101
SES/WPS or AOSS™ (MFC-8690DW and MFC-8890DW wireless network only).....	102

	WPS w/PIN Code (MFC-8690DW and MFC-8890DW wireless network only).....	102
	WLAN Status (MFC-8690DW and MFC-8890DW wireless network only) .....	102
	Set to Default (MFC-8690DW and MFC-8890DW only).....	104
	Wired Enable (MFC-8690DW and MFC-8890DW wired network only).....	105
	WLAN Enable (MFC-8690DW and MFC-8890DW wireless network only) .....	105
	E-mail / IFAX (MFC-8690DW, MFC-8880DN and MFC-8890DW only) .....	106
	How to set a new default for Scan to E-mail (E-mail server) (MFC-8690DW, MFC-8880DN and MFC-8890DW only) .....	117
	How to set a new default for Scan to FTP .....	118
	How to set a new default for Scan to Network .....	119
	Fax to Server (For MFC-8690DW, MFC-8880DN and MFC-8890DW) .....	120
	Time Zone .....	122
	Restoring the network settings to factory default.....	123
	Printing the Network Configuration List .....	123
<b>7</b>	<b>Driver Deployment Wizard (Windows® only)</b>	<b>124</b>
	Overview.....	124
	Connection methods.....	124
	Peer-to-peer .....	124
	Network Shared.....	125
	How to install the Driver Deployment Wizard software.....	125
	Using the Driver Deployment Wizard software .....	126
<b>8</b>	<b>Network printing from Windows®: basic TCP/IP Peer-to-Peer printing</b>	<b>129</b>
	Overview.....	129
	Configuring the standard TCP/IP port.....	130
	Printer driver not yet installed .....	130
	Printer driver already installed .....	131
	Other sources of information .....	131
<b>9</b>	<b>Internet printing for Windows®</b>	<b>132</b>
	Overview.....	132
	IPP printing for Windows® 2000/XP, Windows Vista® and Windows Server® 2003/2008 .....	132
	Windows Vista® and Windows Server® 2008.....	132
	Windows® 2000/XP and Windows Server® 2003.....	134
	Specifying a different URL.....	136
	Other sources of information .....	136
<b>10</b>	<b>Network printing from Macintosh using the BR-Script 3 driver</b>	<b>137</b>
	Overview.....	137
	How to choose the BR-Script 3 printer driver (TCP/IP) .....	137
	For Mac OS X 10.3.9 to 10.4.x users .....	137
	For Mac OS X 10.5.x .....	139
	Other sources of information .....	140



<b>11</b>	<b>Web Based Management</b>	<b>141</b>
	Overview.....	141
	How to configure the machine settings using Web Based Management (web browser).....	142
	Password information.....	143
	Secure Function Lock 2.0.....	144
	How to configure the Secure Function Lock 2.0 settings using Web Based Management (web browser).....	145
	Changing the Scan to FTP configuration using a web browser.....	148
	Changing the Scan to Network configuration using a web browser.....	150
	Changing the LDAP configuration using a web browser (For MFC-8690DW, MFC-8880DN and MFC-8890DW).....	152
<b>12</b>	<b>LDAP operation (For MFC-8690DW, MFC-8880DN and MFC-8890DW)</b>	<b>153</b>
	Overview.....	153
	Changing the LDAP configuration using a Browser.....	153
	LDAP operation using the control panel.....	153
<b>13</b>	<b>Internet fax and Scan to E-mail (E-mail server) (For MFC-8690DW, MFC-8880DN and MFC-8890DW)</b>	<b>154</b>
	Internet fax Overview.....	154
	Getting connected.....	154
	Control panel key functions.....	155
	Sending an Internet fax.....	155
	Manually entering text.....	156
	Receiving E-mail or Internet fax.....	156
	Receiving an Internet fax to your computer.....	157
	Forwarding received E-mail and fax messages.....	157
	Relay broadcasting.....	157
	TX Verification Mail.....	160
	Setup Mail TX.....	160
	Setup Mail RX.....	160
	Error mail.....	160
	Important information on Internet fax.....	161
	Scan to E-mail (E-mail server) overview.....	162
	How to operate Scan to E-mail (E-mail server).....	162
	Using One Touch or Speed Dial number.....	163
<b>14</b>	<b>Security features</b>	<b>164</b>
	Overview.....	164
	Security terms.....	164
	Security protocols.....	165
	Security methods for E-mail notification.....	165
	Configuring the protocol settings.....	166
	Managing your network printer securely.....	167
	Secure Management using Web Based Management (web browser).....	167
	Secure Management using BRAdmin Professional 3 (Windows®).....	169

Printing documents securely using IPPS.....	170
Specifying a different URL.....	170
Using E-mail notification with user authentication (For MFC-8690DW, MFC-8880DN and MFC-8890DW).....	171
Creating and installing a certificate.....	173
Creating and installing a self-signed certificate.....	175
Creating CSR and installing a certificate.....	188
Import and export the certificate and private key.....	190

---

## **15 Troubleshooting** **191**

Overview.....	191
General problems.....	191
Network print software installation problems.....	192
Printing problems.....	194
Scanning and PC Fax problems.....	196
Wireless network troubleshooting (MFC-8690DW and MFC-8890DW only).....	198
Wireless setup problems.....	198
Wireless connection problem.....	199
Protocol-specific troubleshooting.....	200
Windows® 2000/XP, Windows Vista® and Windows Server® 2003/2008 IPP troubleshooting.....	200
Web Based Management (web browser) troubleshooting (TCP/IP).....	200
LDAP troubleshooting.....	200

---

## **A Appendix A** **201**

Using services.....	201
Other ways to set the IP address (for advanced users and administrators).....	201
Using DHCP to configure the IP address.....	201
Using BOOTP to configure the IP address.....	202
Using RARP to configure the IP address.....	203
Using APIPA to configure the IP address.....	203
Using ARP to configure the IP address.....	204
Using the TELNET console to configure the IP address.....	205
Using the Brother Web BRAdmin server software for IIS to configure the IP address.....	206
Installation when using web services (Windows Vista®).....	207
Installation when using a Network Print Queue or Share (printer driver only).....	208

---

## **B Appendix B** **209**

Print server specifications.....	209
Ethernet wired network.....	209
Wireless network.....	210
Function table and default factory settings.....	212
DCP-8080DN, DCP-8085DN, MFC-8480DN and MFC-8680DN.....	212
MFC-8880DN.....	215
MFC-8690DW and MFC-8890DW.....	219
Entering Text.....	225

---

**C    Appendix C** **227**

---

Open Source Licensing Remarks .....	227
Part of the software embedded in this product is gSOAP software .....	227
This product includes SNMP software from WestHawk Ltd. ....	227
MIT Kerberos statements .....	228
Cyrus SASL statements .....	231
OpenSSL statements .....	232
OpenLDAP Statements .....	234

**D    Index** **237**

---

## Overview

Your Brother machine can be shared on a 10/100 Mb wired or IEEE 802.11b/802.11g wireless Ethernet network using the internal network print server. The print server supports various functions and methods of connection depending on the operating system you are running on a network supporting TCP/IP. These functions include printing, scanning, PC Fax send, PC Fax receive, Remote Setup and Status Monitor. The following chart shows what network features and connections are supported by each operating system.

Operating Systems	Windows® 2000/XP Windows® XP Professional x64 Edition Windows Vista®	Windows Server® 2003/2008 Windows Server® 2003 x64 Edition	Mac OS X 10.3.9 or greater
10/100BASE-TX wired Ethernet (TCP/IP)	✓	✓	✓
IEEE 802.11b/g wireless Ethernet (TCP/IP) <sup>1</sup>	✓	✓	✓
Printing	✓	✓	✓
BRAdmin Light	✓	✓	✓
BRAdmin Professional 3 <sup>2</sup>	✓	✓	
Web BRAdmin <sup>2</sup>	✓	✓	
BRPrint Auditor <sup>3</sup>	✓	✓	
Web Based Management (web browser)	✓	✓	✓
Internet Printing (IPP)	✓	✓	
Scanning	✓		✓
PC Fax Send <sup>4</sup>	✓		✓
PC Fax Receive <sup>4</sup>	✓		
Remote Setup <sup>4</sup>	✓		✓
Status Monitor	✓		✓
Driver Deployment Wizard	✓	✓	

<sup>1</sup> Only the MFC-8690DW and MFC-8890DW have IEEE 802.11b/802.11g wireless Ethernet (TCP/IP) available.

<sup>2</sup> BRAdmin Professional 3 and Web BRAdmin are available as a download from <http://solutions.brother.com/>.

<sup>3</sup> Available when using BRAdmin Professional 3 or Web BRAdmin with devices that are connected to your client PC via the USB or parallel interface.

<sup>4</sup> Not available for DCP-8080DN and DCP-8085DN

To use the Brother machine through a network, you need to configure the print server, and set up the computers you use.

## Network features

Your Brother machine has the following basic network features.

### Network printing

---

The print server provides printing services for Windows® 2000/XP, Windows Vista® and Windows Server® 2003/2008 supporting the TCP/IP protocols and Macintosh (Mac OS X 10.3.9 or greater) supporting TCP/IP.

### Network scanning

---

You can scan documents over the network to your computer (See *Network Scanning* in the *Software User's Guide*).

### Network PC Fax (Not available for DCP-8080DN and DCP-8085DN)

---

You can directly send a file from your computer as a PC Fax over your network (See *Brother PC-FAX Software* for Windows® and *Sending a Fax* for Macintosh in the *Software User's Guide* for a complete description). Windows® users can also PC Fax receive (See *PC-FAX receiving* in the *Software User's Guide*).

### Fax to Server (For MFC-8690DW, MFC-8880DN and MFC-8890DW)

---

The Fax to Server feature allows the machine to scan documents and send them via a separate fax server. Unlike Internet fax or I-Fax, the Fax to Server feature utilizes a server to send the documents as fax data over phone or T-1 lines.

### Management utilities

---

#### BRAdmin Light

BRAdmin Light is a utility for initial setup of Brother network connected devices. This utility can search for Brother products on your network, view the status and configure basic network settings, such as IP address. The BRAdmin Light utility is available for Windows® 2000/XP, Windows Vista® and Windows Server® 2003/2008 and Mac OS X 10.3.9 or greater computers. For installing BRAdmin Light on Windows®, please see the *Quick Setup Guide* provided with the machine. For Macintosh users, BRAdmin Light will be installed automatically when you install the printer driver. If you have already installed the printer driver, you don't have to install it again.

For more information on BRAdmin Light, visit us at <http://solutions.brother.com/>.

## **BRAdmin Professional 3 (Windows®)**

BRAdmin Professional 3 is a utility for more advanced management of network connected Brother devices. This utility can search for Brother products on your network and view the device status from an easy to read explorer style window that changes color identifying the status of each device. You can configure network and device settings along with the ability to update device firmware from a Windows® computer on your LAN. BRAdmin Professional 3 can also log activity of brother devices on your network and export the log data in an HTML, CSV, TXT or SQL format.

For users who want to monitor locally connected printers, install the Print Auditor Client software on the client PC. This utility allows you to monitor printers that are connected to a client PC via the USB or parallel interface from BRAdmin Professional 3.

For more information and to download the software, visit us at <http://solutions.brother.com/>.

## **Web BRAdmin (Windows®)**

Web BRAdmin is a utility for managing network connected Brother devices. This utility can search for Brother products on your network, view the status and configure the network settings.

Unlike BRAdmin Professional 3, which is designed for Windows® only, Web BRAdmin is a server based utility that can be accessed from any client PC with a web browser that supports JRE (Java Runtime Environment). By installing the Web BRAdmin server utility on a computer running IIS<sup>1</sup>, administrators can connect to the Web BRAdmin server using a web browser, which then communicates with the device itself.

For more information and to download the software, visit us at <http://solutions.brother.com/>.

<sup>1</sup> Internet Information Server 4.0 or Internet Information Services 5.0/5.1/6.0/7.0

## **BRPrint Auditor (Windows®)**

The BRPrint Auditor software brings the monitoring power of Brother network management tools to locally connected machines. This utility allows a client computer to collect usage and status information from a MFC or DCP connected via the parallel or USB interface. The BRPrint Auditor can then pass this information to another computer on the network running BRAdmin Professional 3 or Web BRAdmin 1.45 or greater. This allows the administrator to check items such as page counts, toner and drum status and the firmware version. In addition to reporting to Brother network management applications this utility can E-mail the usage and status information directly to a predefined E-mail address in a CSV or XML file format (SMTP Mail support required). The BRPrint Auditor utility also supports E-mail notification for reporting warning and error conditions.

## **Web Based Management (web browser)**

The Web Based Management allows you to monitor Brother printer's status or change some of its configuration settings using a web browser.



### **Note**

We recommend Microsoft® Internet Explorer® 6.0 (or greater) or Firefox 1.0 (or greater) for Windows® and Safari 1.3 (or greater) for Macintosh. Please also make sure that JavaScript and Cookies are always enabled in whichever browser you use. If a different web browser is used, make sure it is compatible with HTTP 1.0 and HTTP 1.1.

## Remote Setup

The Remote Setup software allows you to configure network settings from a Windows® or Macintosh (Mac OS X 10.3.9 or greater) computer. (See *Remote Setup* in the *Software User's Guide*.)

## Internet fax/scan to E-mail server (MFC-8690DW, MFC-8880DN and MFC-8890DW only)

---

The Brother machine can be assigned an E-mail address allowing you to send, receive or forward documents over a Local Area Network or the Internet to PC's or other Internet fax machines. Before using this function, you have to configure the necessary machine settings by using the machine's control panel. (For details, see *Internet fax and Scan to E-mail (E-mail server) (For MFC-8690DW, MFC-8880DN and MFC-8890DW)* on page 154.) You can also configure these settings using Web Based Management (web browser) see *Web Based Management* on page 141, or Remote Setup see *Using Remote Setup to change the print server settings (Not available for Windows Server® 2003/2008) (Not available for DCP-8085DN and DCP-8080DN)* on page 20.)

# Types of network connections

## Wired network connection example

Generally there are two types of network connections: Peer-to-Peer and Network Shared environment.

### Peer-to-Peer printing using TCP/IP

In a Peer-to-Peer environment, each computer directly sends and receives data to each device. There is no central server controlling file access or printer sharing.

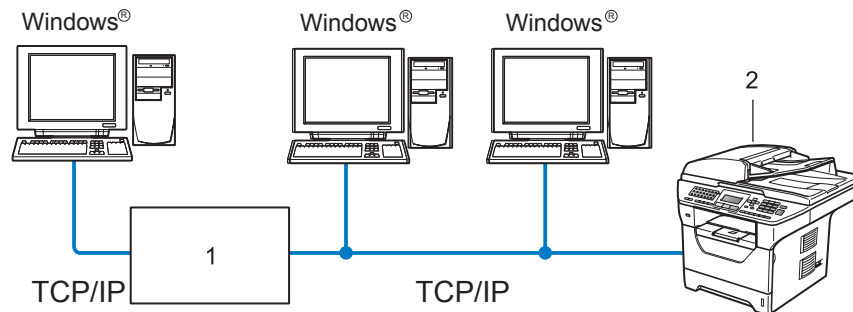

#### 1 Router

#### 2 Network printer (your machine)

- In a smaller network of 2 or 3 computers, we recommend the Peer-to-Peer printing method as it is easier to configure than the Network Shared printing method described on the following page. See *Network Shared printing* on page 6.
- Each computer must use the TCP/IP Protocol.
- The Brother machine needs to have an appropriate IP address configuration.
- If you are using routers, the Gateway address must be configured on the computers and the Brother machine.
- The Brother machine can also communicate with Macintosh (TCP/IP compatible operating systems).



## Network Shared printing

In a Network Shared environment, each computer sends data via a centrally controlled computer. This type of computer is often called a “Server” or a “Print Server”. Its job is to control the printing of all print jobs.

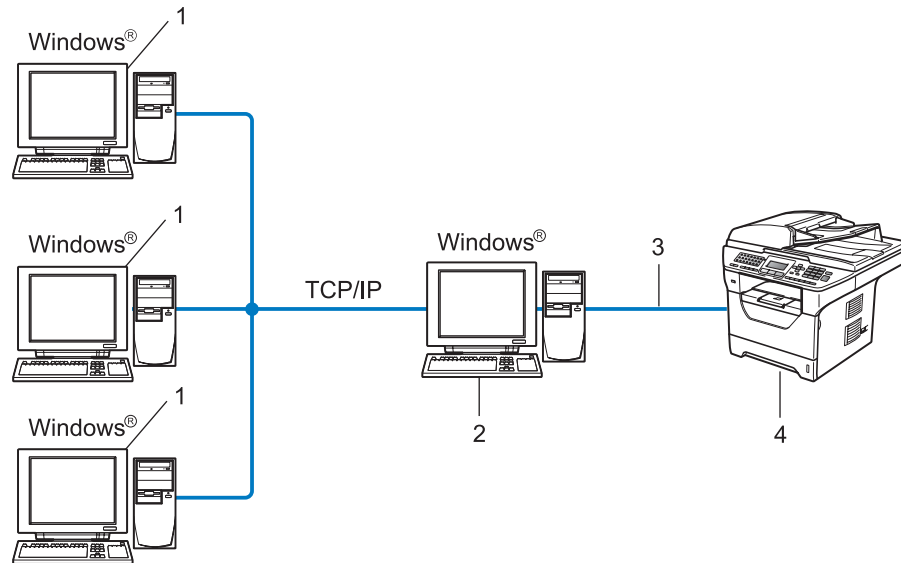

- 1 Client computer
- 2 Also known as “Server” or “Print server”
- 3 TCP/IP, USB or parallel (where available)
- 4 Printer (your machine)

- In a larger network, we recommend a Network Shared printing environment.
- The “server” or the “print server” must use the TCP/IP print protocol.
- The Brother machine needs to have an appropriate IP address configuration unless the machine is connected via the USB or the parallel interface at the server.

## Wireless network connection examples (For MFC-8690DW and MFC-8890DW only)

1

### Connected to a computer with an access point on the network (Infrastructure mode)

This type of network has a central access point at the heart of the network. The access point can also act as a bridge or a gateway to a wired network. When the Brother wireless machine (your machine) is part of this network, it receives all print jobs via an access point.

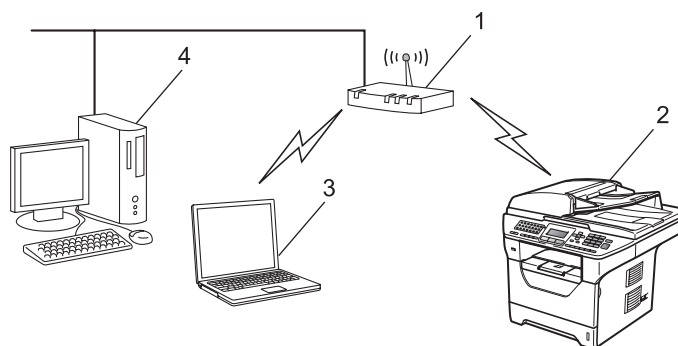

- 1 Access point
- 2 Wireless network printer (your machine)
- 3 Wireless capable computer communicating with the access point
- 4 Wired computer which is not wireless capable connected to the access point with the Ethernet cable

### Connected to a wireless capable computer without an access point on the network (Ad-hoc mode)

This type of network does not have a central access point. Each wireless client communicates directly with each other. When the Brother wireless machine (your machine) is part of this network, it receives all print jobs directly from the computer sending the print data.

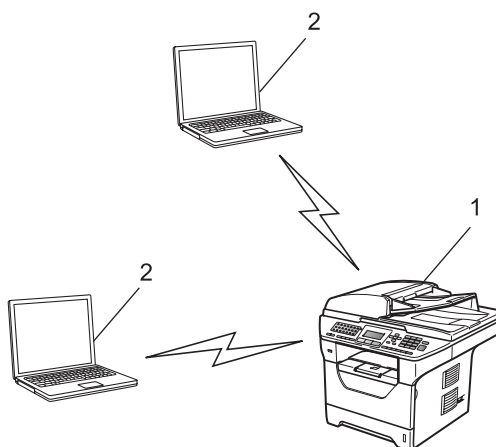

- 1 Wireless network printer (your machine)
- 2 Wireless capable computer

# Protocols

## TCP/IP protocols and functionalities

---

Protocols are the standardized sets of rules for transmitting data on a network. Protocols allow users to gain access to network connected resources.

The print server used on this Brother product supports the TCP/IP (Transmission Control Protocol/Internet Protocol) protocol.

TCP/IP is the most popular set of protocols used for communication such as Internet and E-mail. This protocol can be used in almost all operating systems such as Windows<sup>®</sup>, Windows Server<sup>®</sup>, Macintosh and Linux<sup>®</sup>. The following TCP/IP protocols are available on this Brother product.



### Note

---

- You can configure the protocol settings by using the HTTP interface (web browser).  
See *How to configure the machine settings using Web Based Management (web browser)* on page 142.
  - For information about supported security protocols, see *Security protocols* on page 165.
- 

## DHCP/BOOTP/RARP

By using the DHCP/BOOTP/RARP protocols, the IP address can be automatically configured.



### Note

---

To use the DHCP/BOOTP/RARP protocols, please contact your network administrator.

---

## APIPA

If you do not assign an IP address manually (using the control panel of the machine or the BRAdmin software) or automatically (using a DHCP/BOOTP/RARP server), the Automatic Private IP Addressing (APIPA) protocol will automatically assign an IP address from the range 169.254.1.0 to 169.254.254.255.

## ARP

Address Resolution Protocol performs mapping of an IP address to MAC address in a TCP/IP network.

## DNS client

The Brother print server supports the Domain Name System (DNS) client function. This function allows the print server to communicate with other devices by using its DNS name.

## NetBIOS name resolution

Network Basic Input/Output System name resolution enables you to obtain the IP address of the other device using its NetBIOS name during the network connection.

## WINS

Windows Internet Name Service is an information providing service for the NetBIOS name resolution by consolidating an IP address and a NetBIOS name that is in the local network.

## LPR/LPD

Commonly used printing protocols on a TCP/IP network.

## SMTP client

Simple Mail Transfer Protocol (SMTP) client is used to send E-mails via the Internet or Intranet.

## Custom Raw Port (Default is Port 9100)

Another commonly used printing protocol on a TCP/IP network. It enables interactive data transmission.

## IPP

The Internet Printing Protocol (IPP Version 1.0) allows you to print documents directly to any accessible printer via the internet.



### Note

---

For the IPPS protocol, see *Security protocols* on page 165.

---

## mDNS

mDNS allows the Brother print server to automatically configure itself to work in a Mac OS X Simple Network Configured system. (Mac OS X 10.3.9 or greater).

## TELNET

The Brother print server supports TELNET server for command line configuration.

## SNMP

The Simple Network Management Protocol (SNMP) is used to manage network devices including computers, routers and Brother network ready machines. The Brother print server supports SNMPv1, SNMPv2c and SNMPv3.



### Note

---

For the SNMPv3 protocol, see *Security protocols* on page 165.

---

## LLMNR

The Link-Local Multicast Name Resolution protocol (LLMNR) resolves the names of neighboring computers, if the network does not have a Domain Name System (DNS) server. The LLMNR Responder function works in both the IPv4 or IPv6 environment when using a computer that has the LLMNR Sender function such as Windows Vista®.

## Web services

The Web Services protocol enables Windows Vista® users to install the Brother printer driver by right clicking the machine icon from the **Start / Network** selection.

See *Installation when using web services (Windows Vista®)* on page 207.

The Web Services also lets you check the current status of the machine from your computer.

## Web server (HTTP)

The Brother print server is equipped with a built in web server that allows you to monitor its status or change some of its configuration settings using a web browser.



### Note

---

- We recommend Microsoft® Internet Explorer® 6.0 (or greater) or Firefox 1.0 (or greater) for Windows® and Safari 1.3 (or greater) for Macintosh. Please also make sure that JavaScript and Cookies are always enabled in whichever browser you use. If a different web browser is used, make sure it is compatible with HTTP 1.0 and HTTP 1.1.
  - For the HTTPS protocol, see *Security protocols* on page 165.
- 

## FTP

The File Transfer Protocol (FTP) allows the Brother machine to scan black and white or color documents directly to an FTP server located locally on your network or on the internet.

## SNTP

The Simple Network Time Protocol is used to synchronize computer clocks on a TCP/IP network. You can configure the SNTP settings using Web Based Management (web browser). (For the details, see *Web Based Management* on page 141.)

## CIFS

The Common Internet File System is the standard way that computer users share files and printers in Windows®.

## LDAP (For MFC-8690DW, MFC-8880DN and MFC-8890DW only)

The Lightweight Directory Access Protocol (LDAP) allows the Brother machine to search for information such as fax numbers and E-mail addresses from an LDAP server.

## IPv6

This machine is compatible with IPv6, the next generation internet protocol. For more information on the IPv6 protocol, visit <http://solutions.brother.com/>.

## Other protocol

---

### LLTD

The Link Layer Topology Discovery protocol (LLTD) lets you locate the Brother machine easily on the Windows Vista® network map. Your Brother machine will be shown with a distinctive icon and the node name. The default setting for this protocol is Off. You can activate LLTD using the BRAdmin Professional 3 utility software. Visit the download page for your model at <http://solutions.brother.com/> to download BRAdmin Professional 3.

## Overview

Before using your Brother machine in a network environment, you must install the Brother software and also configure the appropriate TCP/IP network settings on the machine itself. In this chapter, you will learn the basic steps required to print over the network using TCP/IP protocol.

We recommend that you use the Brother installer on the Brother CD-ROM to install the Brother software as this will guide you through the software and network installation. Please follow the instructions in the supplied *Quick Setup Guide*.



### Note

If you do not wish to, or are unable to use the Brother installer or any of Brother's software tools, you can also use the machine's control panel to change network settings. For more information, see *Control panel setup* on page 93.

## IP addresses, subnet masks and gateways

To use the machine in a networked TCP/IP environment, you need to configure the IP address and subnet mask. The IP address you assign to the print server must be on the same logical network as your host computers. If it is not, you must properly configure the subnet mask and the gateway address.

### IP address

An IP address is a series of numbers that identifies each computer connected to a network. An IP address consists of four numbers separated by dots. Each number is between 0 and 255.

■ Example: In a small network, you would normally change the final number.

- 192.168.1.1
- 192.168.1.2
- 192.168.1.3

## How the IP address is assigned to your print server:

If you have a DHCP/BOOTP/RARP server in your network (typically a UNIX<sup>®</sup>/Linux or Windows<sup>®</sup> 2000/XP, Windows Vista<sup>®</sup> or Windows Server<sup>®</sup> 2003/2008 network) the print server will automatically obtain its IP address from the DHCP server and register its name with any RFC 1001 and 1002-compliant dynamic name services.



### Note

On smaller networks, the DHCP server may also be the router.

For more information on DHCP, BOOTP and RARP, see:

*Using DHCP to configure the IP address* on page 201.

*Using BOOTP to configure the IP address* on page 202.

*Using RARP to configure the IP address* on page 203.

If you do not have a DHCP/BOOTP/RARP server, the Automatic Private IP Addressing (APIPA) protocol will automatically assign an IP address from the range 169.254.1.0 to 169.254.254.255. For more information on APIPA, see *Using APIPA to configure the IP address* on page 203.

## Subnet mask

Subnet masks restrict network communication.

### ■ Example: Computer 1 can talk to Computer 2

#### • Computer 1

IP Address: 192.168. 1. 2

Subnet Mask: 255.255.255.000

#### • Computer 2

IP Address: 192.168. 1. 3

Subnet Mask: 255.255.255.000



### Note

0 denotes that there is no limit to communication at this part of the address.

In the above example, we can communicate with anything that has an IP address that begins with 192.168.1.x. (where x.x. are numbers between 0 and 255.)



## Gateway (and router)

---

A gateway is a network point that acts as an entrance to another network and sends data transmitted via the network to an exact destination. The router knows where to direct data that arrives at the gateway. If a destination is located on an external network, the router transmits data to the external network. If your network communicates with other networks, you may need to configure the Gateway IP address. If you do not know the Gateway IP address then contact your Network Administrator.

## Step by step chart

### 1 Configure the TCP/IP settings.

- Configure the IP address → See page 15
- Configure the subnet mask → See page 15
- Configure the gateway → See page 15

### 2 Change the print server settings.

- Using the BRAdmin Light utility → See page 18
- Using the BRAdmin Professional 3 utility → See page 18
- Using the control panel → See page 19
- Using the Web Based Management (web browser) → See page 20
- Using the Remote Setup → See page 20
- Using other methods → See page 20

## Setting the IP address and subnet mask

### Using the BRAdmin Light utility to configure your machine as a network printer

#### BRAdmin Light

The BRAdmin Light utility is designed for initial setup of the Brother network connected devices. It also can search for Brother products in a TCP/IP environment, view the status and configure basic network settings, such as IP address. The BRAdmin Light utility is available for Windows® 2000/XP, Windows Vista®, Windows Server® 2003/2008 and Mac OS X 10.3.9 or greater.

#### How to configure your machine using the BRAdmin Light utility



#### Note

- Please use the BRAdmin Light utility that was supplied on the CD-ROM of your Brother product. You can also download the latest Brother BRAdmin Light utility from <http://solutions.brother.com/>.
- If you require more advanced printer management, use the latest version of BRAdmin Professional 3 utility that is available as a download from <http://solutions.brother.com/>. This utility is only available for Windows® users.
- If you are using a firewall function of anti-spyware or antivirus applications, temporarily disable them. Once you are sure that you can print, configure the software settings following the instructions.
- Node name: Node name appears in the current BRAdmin Light window. The default node name of the print server in the machine is “BRNxxxxxxxxxxx” for a wired network or “BRWxxxxxxxxxxx” for a wireless network. (“xxxxxxxxxxx” is your machine’s MAC Address / Ethernet Address.)
- The default password for Brother print servers is “**access**”.

#### 1 Start the BRAdmin Light utility.

- For Windows® 2000/XP, Windows Vista® and Windows Server® 2003/2008 users

Click **Start / All Programs**<sup>1</sup> / **Brother / BRAdmin Light / BRAdmin Light**.

<sup>1</sup> **Programs** for Windows® 2000 users

- For Mac OS X 10.3.9 or greater users

Double-click **Mac OS X** or **Macintosh HD** (Startup Disk) / **Library / Printers / Brother / Utilities / BRAdmin Light.jar** file.

#### 2 BRAdmin Light will search for new devices automatically.

- 3 Double-click the unconfigured device.

Windows®

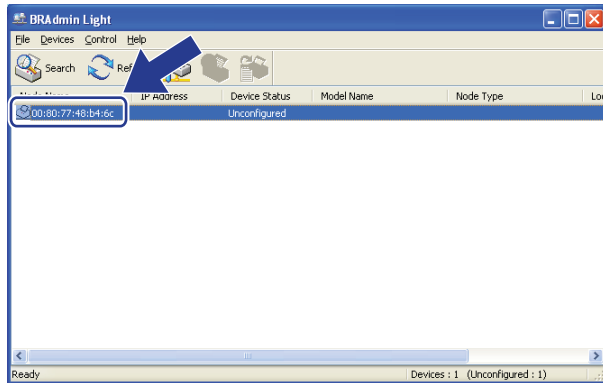

Macintosh

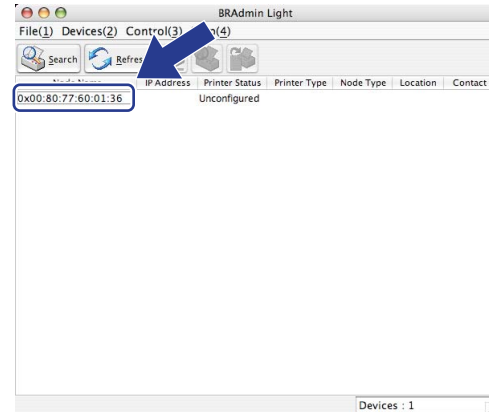

2

 **Note**

- If the print server is set to its factory default settings (if you do not use a DHCP/BOOTP/RARP server), the device will appear as **Unconfigured** in the BRAdmin Light utility screen.
- You can find the node name and MAC Address (Ethernet Address) by printing the Network Configuration List.  
See *Printing the Network Configuration List* on page 123.

- 4 Choose **STATIC** from **Boot Method (BOOT Method)**. Enter the **IP Address**, **Subnet Mask** and **Gateway** (if needed) of your print server.

Windows®

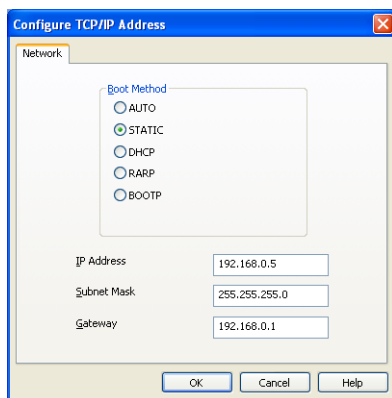

Macintosh

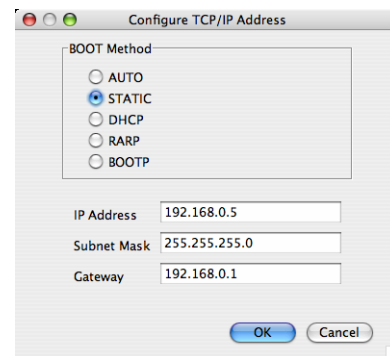

- 5 Click **OK**.
- 6 With the correctly programmed IP address, you will see the Brother print server in the device list.

## Using the control panel to configure your machine for a network

---

You can configure your machine for a network using the control panel `Network` menu.  
See *Control panel setup* on page 93.

## Using other methods to configure your machine for a network

---

You can configure your machine for a network using other methods.  
See *Other ways to set the IP address (for advanced users and administrators)* on page 201.

## Changing the print server settings



### Note

(MFC-8690DW and MFC-8890DW only) For wireless network users, you need to configure the wireless settings to change the print server settings.  
See *Configure your machine for a wireless network* on page 31.

## Using the BRAdmin Light utility to change the print server settings

- 1 Start the BRAdmin Light utility.
  - For Windows® 2000/XP, Windows Vista® and Windows Server® 2003/2008 users  
Click **Start / All Programs** <sup>1</sup> / **Brother / BRAdmin Light / BRAdmin Light**.
  - <sup>1</sup> **Programs** for Windows® 2000 users
  - For Mac OS X 10.3.9 or greater users  
Double-click **Mac OS X or Macintosh HD (Startup Disk) / Library / Printers / Brother / Utilities / BRAdmin Light.jar** file.
- 2 Choose the print server which you want to change the settings.
- 3 Choose **Network Configuration** from the **Control** menu.
- 4 Enter a password. The default password is “**access**”.
- 5 You can now change the print server settings.



### Note

If you want to change more advanced settings, use the BRAdmin Professional 3 utility that is available as a download from <http://solutions.brother.com/>. (Windows® only)

## Using the BRAdmin Professional 3 utility to change print server settings (Windows®)



### Note

- Please use the latest version of the BRAdmin Professional 3 utility that is available as a download from <http://solutions.brother.com/>. This utility is only available for Windows® users.
- If you are using a firewall function of anti-spyware or antivirus applications, temporarily disable them. Once you are sure that you can print, configure the software settings following the instructions.
- Node name: The Node name for each Brother device on the network appears in BRAdmin Professional 3. The default Node name is “BRNxxxxxxxxxxx” for a wired network or “BRWxxxxxxxxxxx” for a wireless network. (“xxxxxxxxxxx” is your machine’s MAC Address / Ethernet Address.)

- 1 Start the BRAdmin Professional utility (from Windows® 2000/XP, Windows Vista® and Windows Server® 2003/2008), by clicking **Start / All Programs** <sup>1</sup> / **Brother Administrator Utilities / Brother BRAdmin Professional 3 / BRAdmin Professional 3**.

<sup>1</sup> **Programs** for Windows® 2000 users

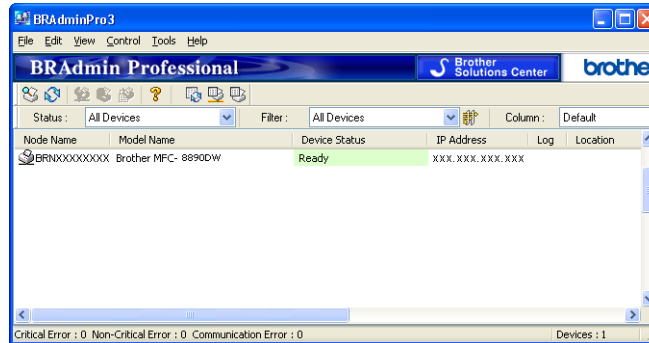

- 2 Choose the print server which you want to configure.
- 3 Choose **Configure Device** from the **Control** menu.
- 4 Enter a password if you have set one. The default password is “**access**”.
- 5 You can now change the print server settings.



#### Note

- If the print server is set to its factory default settings without using a DHCP/BOOTP/RARP server, the device will appear as APIPA in the BRAdmin Professional 3 utility screen.
- You can find the node name and MAC Address / Ethernet Address by printing out the Network Configuration List. (See *Printing the Network Configuration List* on page 123 for information on how to print the Network Configuration List on your print server.)

## Using the control panel to change the print server settings

You can configure and change the print server settings using the control panel **Network** menu. See *Control panel setup* on page 93.

## Using Web Based Management (web browser) to change the print/scan server settings

---

A standard web browser can be used to change your print server settings using the HTTP (Hyper Text Transfer Protocol). (See *How to configure the machine settings using Web Based Management (web browser)* on page 142.)

## Using Remote Setup to change the print server settings (Not available for Windows Server<sup>®</sup> 2003/2008) (Not available for DCP-8085DN and DCP-8080DN)

---

### Remote Setup for Windows<sup>®</sup>

The Remote Setup application allows you to configure network settings from a Windows<sup>®</sup> application. When you access this application, the settings on your machine will be downloaded automatically to your PC and displayed on your PC screen. If you change the settings, you can upload them directly to the machine.

- 1 Click the **Start** button, **All Programs**<sup>1</sup>, **Brother**, **MFC-XXXX LAN**, then **Remote Setup**.

<sup>1</sup> **Programs** for Windows<sup>®</sup> 2000 users

- 2 Enter a password. The default password is “**access**”.
- 3 Click **TCP/IP**.
- 4 You can now change the print server settings.

### Remote Setup for Macintosh

The Remote Setup application allows you to configure many MFC settings from a Macintosh application. When you access this application, the settings on your machine will be downloaded automatically to your Macintosh and displayed on your Macintosh screen. If you change the settings, you can upload them directly to the machine.

- 1 Double click the **Mac OS X** or **Macintosh HD** (Startup Disk) icon on your desktop, **Library**, **Printers**, **Brother**, then **Utilities**.
- 2 Double click the **Remote Setup** icon.
- 3 Enter a password. The default password is “**access**”.
- 4 Click **TCP/IP**.
- 5 You can now change the print server settings.

## Using other methods to change print server settings

---

You can configure your network printer using other methods.

See *Other ways to set the IP address (for advanced users and administrators)* on page 201.

# Configuring your machine for a wireless network (For MFC-8690DW and MFC-8890DW)

## Overview

To connect your machine to your wireless network, we recommend you to follow the steps in the *Quick Setup Guide* using the Setup Wizard from the machine's control panel **Network** menu. By using this method, you can easily connect your machine to your wireless network.

Please read this chapter for additional methods on how to configure the wireless network settings. For information on TCP/IP settings, see *Setting the IP address and subnet mask* on page 15. Then, in *Network printing from Windows®: basic TCP/IP Peer-to-Peer printing* on page 129 or *Network printing from Macintosh using the BR-Script 3 driver* on page 137, you will learn how to install the network software and drivers into the operating system running on your computer.



### Note

- To achieve optimum results with normal everyday document printing, place the Brother machine as close to the network access point/router as possible with minimal obstructions. Large objects and walls between the two devices as well as interference from other electronic devices can affect the data transfer speed of your documents.

Due to these factors, wireless may not be the best method of connection for all types of documents and applications. If you are printing large files, such as multi-page documents with mixed text and large graphics, you may want to consider choosing wired Ethernet for a faster data transfer, or USB for the fastest throughput speed.

- Although the Brother MFC-8690DW and MFC-8890DW can be used in a both wired and wireless network, only one connection method can be used at a time.



## Wireless network terms and concepts

If you want to use your machine in a wireless network you **must** configure the machine to match the settings of the existing wireless network. This section provides some of the main terms and concepts of these settings, which may be helpful when you configure your machine for a wireless network.

### SSID (Service Set Identifier) and channels

You need to configure the SSID and a channel to specify the wireless network you want to connect to.

#### ■ SSID

Each wireless network has its own unique network name and it is technically referred to as SSID or ESSID (Extended Service Set Identifier). The SSID is a 32-byte or less value and is assigned to the access point. The wireless network devices you want to associate to the wireless network should match the access point. The access point and wireless network devices regularly send wireless packets (referred to as a beacon) which has the SSID information. When your wireless network device receives a beacon, you can identify the wireless network that is close enough for the radio waves to reach your device.

#### ■ Channels

Wireless networks use channels. Each wireless channel is on a different frequency. There are up to 14 different channels that can be used when using a wireless network. However, in many countries the number of channels available are restricted. (For more information, see *Wireless network* on page 210.)

## Authentication and encryption

Most wireless networks use some kind of security settings. These security settings define the authentication (how the device identifies itself to the network) and encryption (how the data is encrypted as it is sent on the network). **If you do not correctly specify these options when you are configuring your Brother wireless device, it will not be able to connect to the wireless network.** Therefore care must be taken when configuring these options. Please refer to the information below to see which authentication and encryption methods your Brother wireless device supports.

### Authentication methods

The Brother printer supports the following methods:

#### ■ Open system

Wireless devices are allowed to access the network without any authentication.

#### ■ Shared key

A secret pre-determined key is shared by all devices that will access the wireless network.

The Brother wireless machine uses the WEP keys as the pre-determined key.

#### ■ WPA-PSK/WPA2-PSK

Enables a Wi-Fi Protected Access Pre-shared key (WPA-PSK/WPA2-PSK), which enables the Brother wireless machine to associate with access points using TKIP for WPA-PSK or AES for WPA-PSK and WPA2-PSK (WPA-Personal).

#### ■ LEAP

Cisco LEAP (Light Extensible Authentication Protocol) has been developed by Cisco Systems, Inc. which uses a user ID and password for authentication.

#### ■ EAP-FAST

EAP-FAST (Extensible Authentication Protocol-Flexible Authentication via Secured Tunnel) has been developed by Cisco Systems, Inc. which uses a user ID and password for authentication, and symmetric key algorithms to achieve a tunneled authentication process.

The Brother machine supports the following inner authentications:

- EAP-FAST/NONE

EAP-FAST authentication for CCXv3 networks. Does not use an inner authentication method.

- EAP-FAST/MS-CHAPv2

EAP-FAST authentication for CCXv4 networks. Uses MS-CHAPv2 for the inner authentication method.

- EAP-FAST/GTC

EAP-FAST authentication for CCXv4 networks. Uses GTC for the inner authentication method.

### Encryption methods

Encryption is used to secure the data that is sent over the wireless network. The Brother wireless machine supports the following encryption methods:

#### ■ None

No encryption method is used.

#### ■ WEP

By using WEP (Wired Equivalent Privacy), the data is transmitted and received with a secure key.

#### ■ TKIP

TKIP (Temporal Key Integrity Protocol) provides per-packet key mixing a message integrity check and rekeying mechanism.

#### ■ AES

AES (Advanced Encryption Standard) is the Wi-Fi® authorized strong encryption standard.

#### ■ CKIP

The original Key Integrity Protocol for LEAP by Cisco Systems, Inc.

## Network key

There are some rules for each security method:

### ■ Open system/Shared key with WEP

This key is a 64-bit or 128-bit value that must be entered in an ASCII or hexadecimal format.

- 64 (40) bit ASCII:

Uses 5 text characters. e.g. "WLAN" (this is case sensitive).

- 64 (40) bit hexadecimal:

Uses 10 digits of hexadecimal data. e.g. "71f2234aba"

- 128 (104) bit ASCII:

Uses 13 text characters. e.g. "Wirelesscomms" (this is case sensitive)

- 128 (104) bit hexadecimal:

Uses 26 digits of hexadecimal data. e.g. "71f2234ab56cd709e5412aa2ba"

### ■ WPA-PSK/WPA2-PSK and TKIP or AES

Uses a Pre-Shared Key (PSK) that is 8 or more characters in length, up to a maximum of 63 characters.

### ■ LEAP

Uses User ID and Password.

- User ID: less than 64 characters in length.
- Password: less than 32 characters in length.

### ■ EAP-FAST

Uses User ID and Password.

- User ID: less than 64 characters in length.
- Password: less than 32 characters in length.

# Step by step chart for wireless network configuration

## For Infrastructure mode

**1** Confirm your network environment. See page 27.

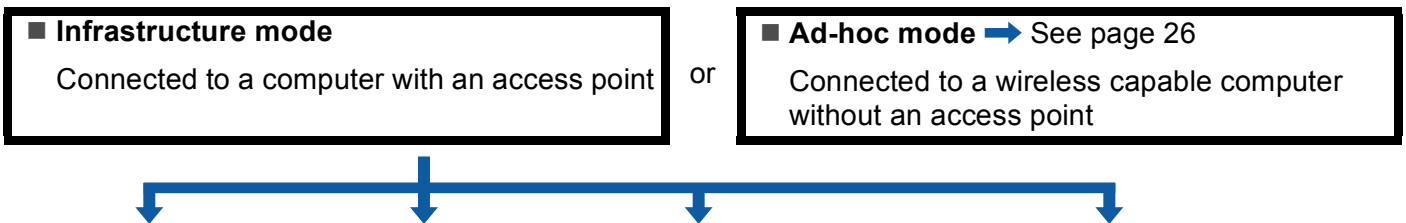

**2** Confirm your wireless network setup method. See page 28.

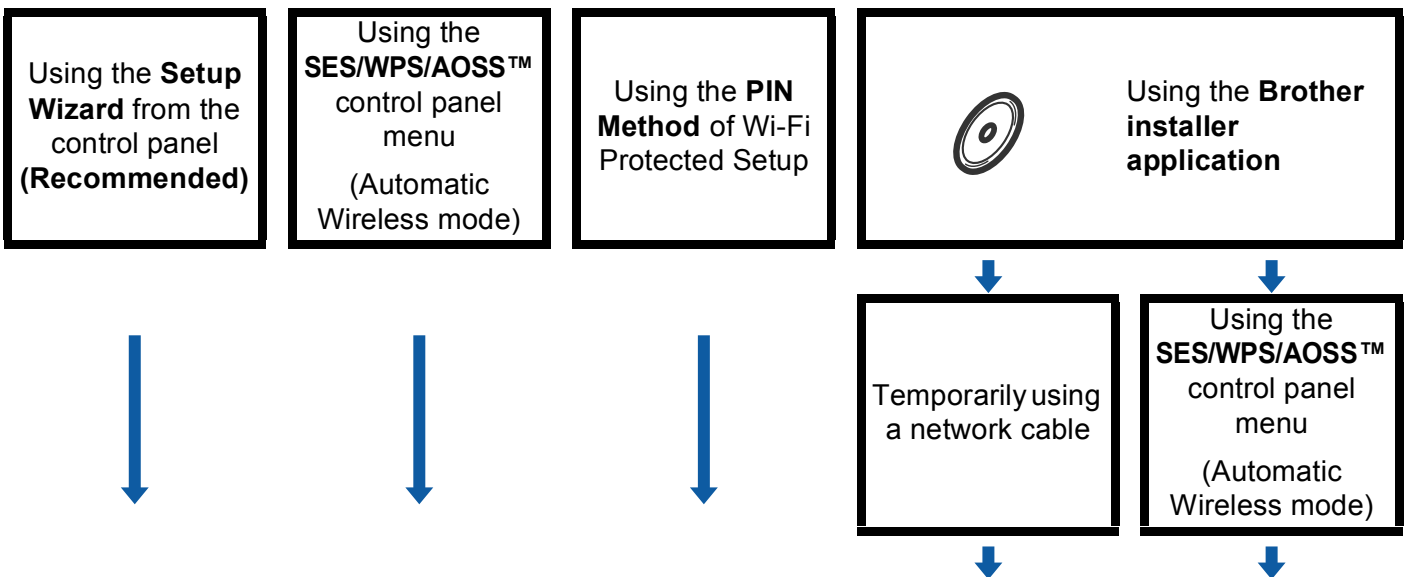

**3** Configure your machine for a wireless network. See page 31.

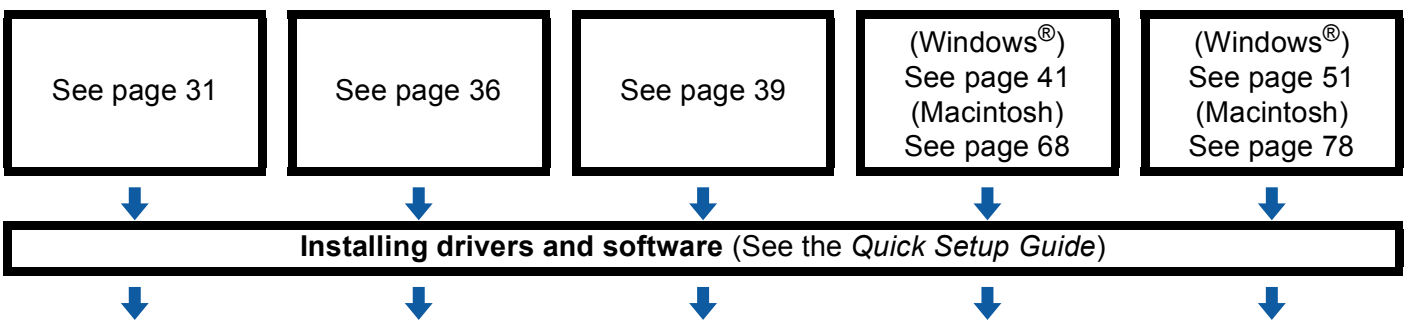

**OK!** Wireless configuration and installing drivers and software have been completed.

## For Ad-hoc mode

1 Confirm your network environment. See page 27.

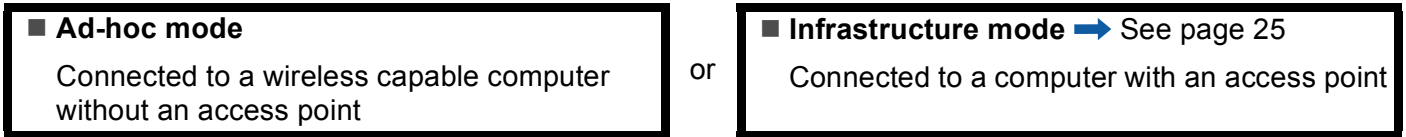

2 Confirm your wireless network setup method. See page 28.

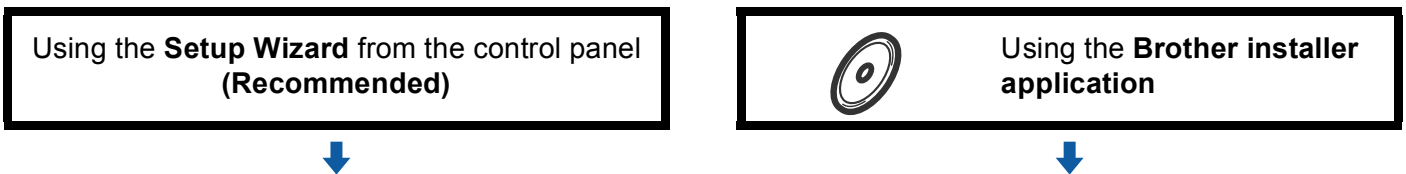

3 Configure your machine for a wireless network. See page 31.

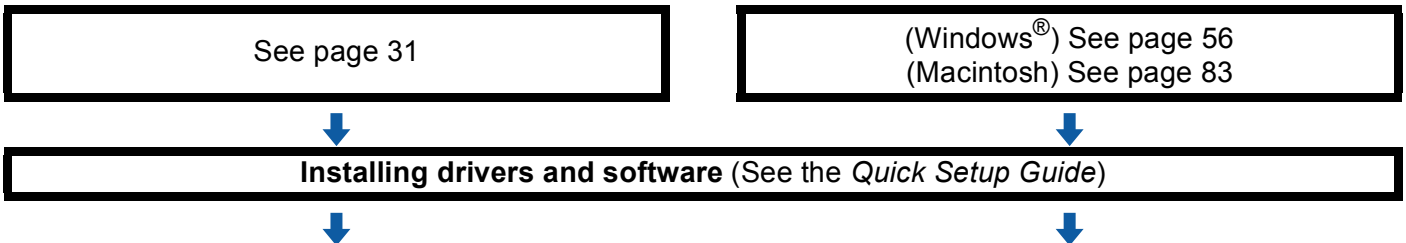

 **Wireless configuration and installing drivers and software have been completed.**

## Confirm your network environment

### Connected to a computer with an access point in the network (Infrastructure mode)

---

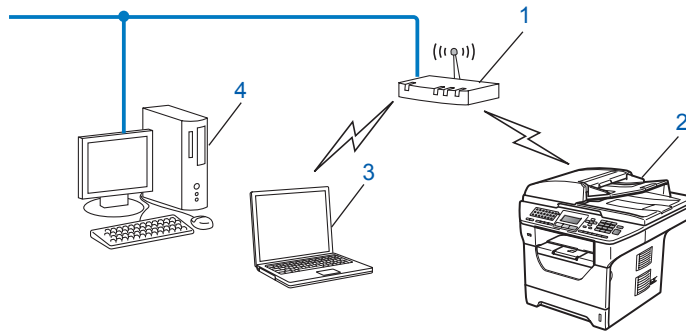

- 1 Access point
- 2 Wireless network printer (your machine)
- 3 Wireless capable computer connected to the access point
- 4 Wired computer which is not wireless capable connected to the access point with an Ethernet cable

### Connected to a wireless capable computer without an access point in the network (Ad-hoc mode)

---

This type of network does not have a central access point. Each wireless client communicates directly with each other. When the Brother wireless machine (your machine) is part of this network, it receives all print jobs directly from the computer sending the print data.

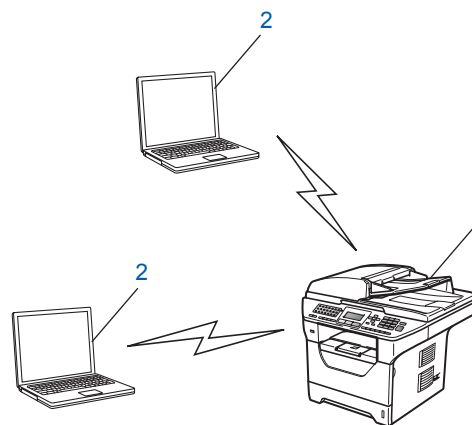

- 1 Wireless network printer (your machine)
- 2 Wireless capable computer



#### Note

We do not guarantee the wireless network connection with Windows Server® products in Ad-hoc mode.

---

## Confirm your wireless network setup method

There are four methods to configure your wireless network machine. Use the machine's control panel (recommended), SES/WPS/AOSS™ from the control panel menu, the PIN Method of Wi-Fi Protected Setup or the Brother installer application. The setup process will be different depending on your network environment.

### Configuration using the machine's control panel Setup Wizard to configure your machine for a wireless network

We recommend that you use the machine's control panel to configure your wireless network settings. By using the control panel *Setup Wizard* function, you can easily connect your Brother machine to your wireless network. **You must know your wireless network settings before you proceed with this installation.** (See *Using the Setup Wizard from the control panel* on page 31.)

### Configuration using the SES/WPS or AOSS™ control panel menu (Automatic Wireless mode) (Infrastructure mode only)

If your wireless access point (A) supports either SecureEasySetup™, Wi-Fi Protected Setup (PBC<sup>1</sup>) or AOSS™, you can configure the machine without a computer. (See *Using the SES/WPS or AOSS™ control panel menu to configure your machine for a wireless network (Automatic Wireless mode)* on page 36.)

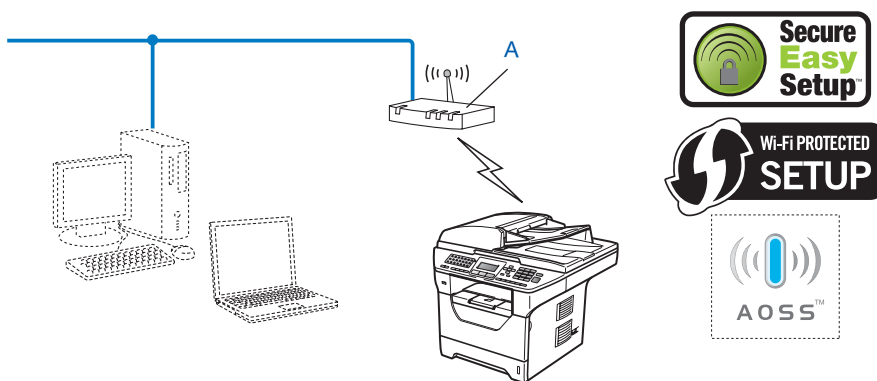

For MFC-8890DW only.

<sup>1</sup> Push Button Configuration

## Configuration using the PIN Method of Wi-Fi Protected Setup (Infrastructure mode only)

If your wireless access point (A) supports Wi-Fi Protected Setup, you can also configure using the PIN Method of Wi-Fi Protected Setup. (See *Using the PIN Method of Wi-Fi Protected Setup* on page 39.)

- Connection when the wireless access point/router (A) doubles as a Registrar <sup>1</sup>

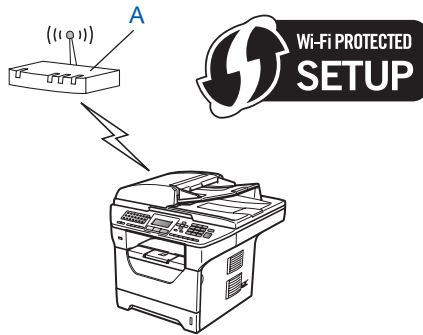

- Connection when another device (C), such as a computer is used as a Registrar <sup>1</sup>.

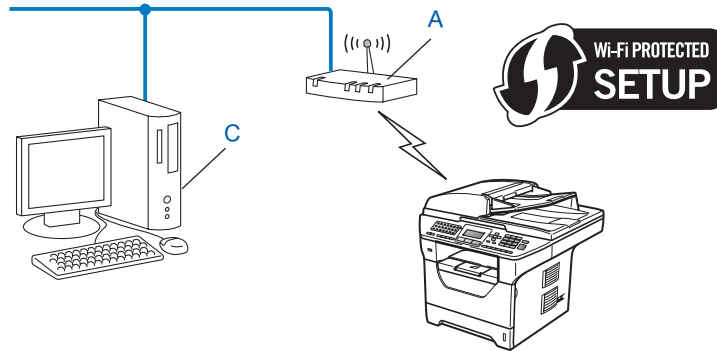

<sup>1</sup> The Registrar is a device that manages the wireless LAN.



## Configuration using the Brother installer application on the CD-ROM to configure your wireless network machine

You can also use the Brother installer application on the CD-ROM we have provided with the printer. You will be guided by the on-screen instructions until you are able to use your Brother wireless network machine. You must know your wireless network settings before you proceed with this installation. (See *Using the Brother installer application on the CD-ROM to configure your machine for a wireless network* on page 40.)

### Configuration temporarily using a network cable

If there is an Ethernet Hub or Router in the same network as the wireless access point (A) of your machine, you can temporarily connect the Hub or Router to the machine using an Ethernet cable (B), this is an easy way to configure your machine. You can then remotely configure the machine from a computer on the network.

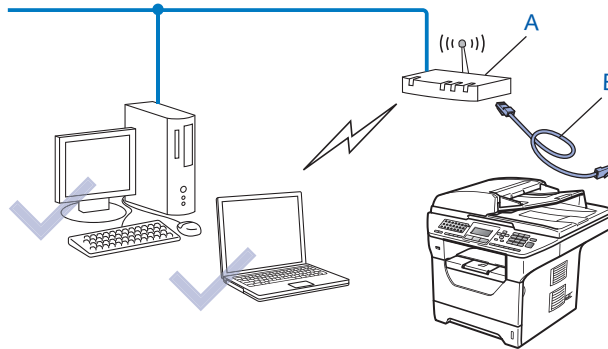

## Configure your machine for a wireless network

### ! IMPORTANT

- If you are going to connect your Brother machine to your network, we recommend that you contact your system administrator prior to installation. **You must know your wireless network settings before you proceed with this installation.**
- If you have previously configured the wireless settings of the machine, you must reset the network LAN settings before you can configure the wireless settings again. Press **Menu, 7, 0** for `Network Reset`, press **1** for `Reset` and then choose **1** for `Yes` to accept the change. The machine will restart automatically.

### Using the Setup Wizard from the control panel

You can configure your Brother machine by using the `Setup Wizard` function. This is located in the `Network` menu on the machine's control panel. See to the steps below for further information.

- 1 Write down the wireless network settings of your access point or wireless router. If you do not know them, contact your network administrator or the manufacture of your access point/router. Check and record the current wireless network settings.

Network name:(SSID, ESSID)

Communication Mode	Authentication method	Encryption mode	Network key <sup>4</sup>
Infrastructure	Open system	WEP <sup>2</sup>	
		NONE	—
	Shared key	WEP <sup>2</sup>	
		WPA/WPA2-PSK <sup>1</sup>	AES
		TKIP <sup>3</sup>	
	LEAP	CKIP	
	EAP-FAST/NONE	AES	
EAP-FAST/MS-CHAPv2 EAP-FAST/GTC	TKIP		
Ad-hoc	Open system	WEP <sup>2</sup>	
		NONE	—

- <sup>1</sup> WPA/WPA2-PSK is a Wi-Fi Protected Access Pre-Shared Key, which lets the Brother wireless machine associate with access points using TKIP or AES encryption (WPA-Personal). WPA2-PSK (AES) and WPA-PSK (TKIP/AES) uses a Pre-Shared Key (PSK) that is 8 or more characters in length, up to a maximum of 63 characters.
- <sup>2</sup> The WEP key is for 64-bit encrypted networks or 128-bit encrypted networks and can contain both numbers and letters. If you do not know this information you should see the documentation provided with your access point or wireless router. This key is a 64-bit or 128-bit value that must be entered in an ASCII or HEXADECIMAL format.

**For example:**

64-bit ASCII:	Uses 5 text characters e.g. "Hello" (this is case sensitive)
64-bit Hexadecimal:	Uses 10 digits of hexadecimal data e.g. "71f2234aba"
128-bit ASCII:	Uses 13 text characters e.g. "Wirelesscomms" (this is case sensitive)
128-bit Hexadecimal:	Uses 26 digits of hexadecimal data e.g. "71f2234ab56cd709e5412aa3ba"

- <sup>3</sup> This is supported for WPA-PSK only.
- <sup>4</sup> Encryption key, WEP key, Passphrase. For LEAP and EAP-FAST, record the Name and Password.

**For example:**

Network name:(SSID, ESSID)
HELLO

Communication Mode	Authentication method	Encryption mode	Network key
Infrastructure	WPA2-PSK	AES	12345678

- 2** Plug the machine's power cord into the AC power outlet. Turn on the machine's power switch.
- 3** Press **Menu** on the control panel of the Brother machine.
- 4** Press **▲** or **▼** to choose `Network`. Press **OK**.
- 5** Press **▲** or **▼** to choose `WLAN`. Press **OK**.
- 6** Press **▲** or **▼** to choose `Setup Wizard`. Press **OK**.
- 7** If the following message appears, press **▲** or **▼** to choose `On` and press **OK**. The wired network interface will become inactive with this setting.

```

72.WLAN
   WLAN Enable ?
▲      On
▼      Off
Select ▲▼ or OK
    
```

- 8 The machine will search for your network and display a list of available SSIDs. You should see the SSID you wrote down earlier. If the machine finds more than one network use the ▲ or ▼ keys to choose your network, then press **OK**. Go to step 12.

If your access point is set to not broadcast the SSID, you will have to manually add the SSID name. Go to step 9.

- 9 Choose <New SSID> using ▲ or ▼. Press **OK**. Go to step 10.

```

72.WLAN
  SSID
  ▲   <New SSID>
  ▼
-----
Select ▲▼ or OK

```

- 10 Enter a new SSID name. (To manually enter the text, see *Entering Text* on page 225.) Press **OK**.

```

72.WLAN
  SSID:
-----
Enter & OK Key

```

- 11 Press ▲ or ▼ to choose Infrastructure. Press **OK**. Go to step 12. If you chose Ad-hoc, go to step 13.

```

72.WLAN
  Mode Select
  ▲   Ad-hoc
  ▼   Infrastructure
-----
Select ▲▼ or OK

```

- 12 Choose the Authentication method using ▲ or ▼, and press **OK**.

```

72.WLAN
  Auth. Select
  ▲   Open System
  ▼   Shared Key
-----
Select ▲▼ or OK

```

If you chose Open System, go to step 13.

If you chose Shared Key, go to step 14.

If you chose WPA/WPA2-PSK, go to step 17.

If you chose LEAP, go to step 18.

If you chose EAP-FAST/NONE, EAP-FAST/MSCHAP<sup>1</sup> or EAP-FAST/GTC, go to step 17.

<sup>1</sup> Shown on the LCD as EAP-FAST/MSCHAPv2.

- 13 Choose the Encryption type, None or WEP using ▲ or ▼, and press **OK**.

```

72.WLAN
Encryption Type?
▲  None
▼  WEP
-----
Select ▲▼ or OK
    
```

If you chose None, go to step 20.  
 If you chose WEP, go to step 14.

- 14 Choose the key option; KEY1, KEY2, KEY3, KEY4 using ▲ or ▼, and press **OK**.

```

72.WLAN
WEP key
▲  KEY1:xxxxxx
▼  KEY2:
-----
Select ▲▼ or OK
    
```

If you chose the key which shows \*\*\*\*\* , go to step 15.  
 If you chose a blank key, go to step 16.

- 15 If you want to change the key you chose in step 14, press ▲ or ▼ to choose Change. Press **OK**. Go to step 16.  
 If you want to keep the key you chose in step 14, press ▲ or ▼ to choose Keep. Press **OK**. Go to step 20.

```

72.WLAN
KEY1:xxxxxx
▲  1.Change
▼  2.Keep
-----
Select ▲▼ or OK
    
```

- 16 Enter a new WEP key. Press **OK**. Go to step 20. (To manually enter the text, see *Entering Text* on page 225.)

```

72.WLAN
WEP:
-----
Enter & OK Key
    
```

- 17 Choose the Encryption type, TKIP or AES using ▲ or ▼. Press **OK**.  
 If you have chosen WPA/WPA2-PSK in step 12, go to step 19.  
 If you have chosen EAP-FAST in step 12, go to step 18.

```

72.WLAN
Encryption Type?
▲  TKIP
▼  AES
-----
Select ▲▼ or OK
    
```

- 18 Enter the user name and press **OK**. Go to step 19. (To manually enter the text, see *Entering Text* on page 225.)

```

72.WLAN
USER:
-----
Enter & OK Key
    
```

- 19 Enter the password and press **OK**. Go to step 20. (To manually enter the text, see *Entering Text* on page 225.)

```

72.WLAN
PASS:
-----
Enter & OK Key

```

- 20 To apply the settings, choose **Yes**. To cancel, choose **No**.

```

72.WLAN
Apply Settings?
▲ 1.Yes
▼ 2.No
-----
Select ▲▼ or OK

```

If you chose **Yes**, go to step 21.  
If you chose **No**, go back to step 8.

- 21 The machine starts to connect to the wireless device you have chosen.
- 22 If your wireless device is connected successfully, the display shows **Connected** for one minute and configuration is completed.

```

72.WLAN
-----
Connected

```

If the connection failed, the display shows **Connection Fail** for one minute. See *Wireless network troubleshooting (MFC-8690DW and MFC-8890DW only)* on page 198.

### OK! (Windows®)

**You have completed the wireless network setup. If you would like to continue installing drivers and software necessary for operating your device, please choose Install MFL-Pro Suite from the CD-ROM menu.**

### (Macintosh)

**You have completed the wireless network setup. If you would like to continue installing drivers and software necessary for operating your device, please choose Start Here OSX from the CD-ROM menu.**

## Using the SES/WPS or AOSS™ control panel menu to configure your machine for a wireless network (Automatic Wireless mode)

If your wireless access point/router supports either SecureEasySetup™, Wi-Fi Protected Setup (PBC<sup>1</sup>) or AOSS™, you can configure the machine easily without knowing your wireless network settings. Your Brother machine has the SES/WPS/AOSS™ menu on the control panel. This feature automatically detects which mode your access point uses, SecureEasySetup™, Wi-Fi Protected Setup or AOSS™. By pushing a button on the wireless access point/router and the machine, you can setup the wireless network and security settings. See the user's guide for your wireless access point/router for instructions on how to access one-push mode.

<sup>1</sup> Push Button Configuration



### Note

Routers or access points that support SecureEasySetup™, Wi-Fi Protected Setup or AOSS™ have the symbols shown below.



For MFC-8890DW only.



- 1 Plug the machine's power cord into the AC power outlet. Turn on the machine's power switch.
- 2 Press **Menu**, **7**, **2**, **7**. Using **▲** or **▼**, choose **On** and press **OK**. Press **Stop/Exit**.

```

72.WLAN
 7.WLAN Enable
▲      On
▼      Off
-----
Select ▲▼ or OK
    
```

- 3 Press **Menu**, **7**, **2**, **3** for SES/WPS/AOSS. This feature will automatically detect which mode (SecureEasySetup™, Wi-Fi Protected Setup or AOSS™) your access point uses to configure your machine.



### Note

If your wireless access point supports Wi-Fi Protected Setup (PIN Method) and you want to configure your machine using the PIN (Personal Identification Number) Method, see *Using the PIN Method of Wi-Fi Protected Setup* on page 39.

- 4 The machine will search for an access point that supports SecureEasySetup™, Wi-Fi Protected Setup or AOSS™ for 2 minutes.

```

72.WLAN
 3.SES/WPS/AOSS

Setting WLAN

```

- 5 Put your access point in the SecureEasySetup™ mode, Wi-Fi Protected Setup mode or AOSS™ mode, depending on what is supported by your access point. Please refer to the instruction manual that came with your access point. You will see `Connecting AOSS`, `Connecting SES` or `Connecting WPS` on the LCD while the machine searches your access point.
- 6 If the LCD shows `Connected`, the machine has successfully connected to your access point/router. You can now use your machine in a wireless network.

If the LCD shows `Connection Error`, a session overlap has been detected. The machine has detected more than one access point/router on your network with the SecureEasySetup™ mode, the Wi-Fi Protected Setup mode or AOSS™ mode enabled. Make sure that only one access point/router has the SecureEasySetup™ mode, the Wi-Fi Protected Setup mode or the AOSS™ mode enabled and try starting from step 4 again.

If the LCD shows `No Access Point`, the machine has not detected your access point/router on your network with the SecureEasySetup™ mode, the Wi-Fi Protected Setup mode or AOSS™ mode enabled. Move the machine closer to your access point/router and try starting from step 4 again.

If the LCD shows `Connection Fail`, the machine has not successfully connected to your access point/router. Try starting from step 4 again. If the same message is indicated again, reset the machine back to the default factory settings and try again. (For resetting, see *Restoring the network settings to factory default* on page 123.)



### LCD messages when using the SES/WPS/AOSS™ control panel menu

LCD shows	Connection status	Action
Setting WLAN	Searching or accessing the access point, and downloading settings from the access point	—
Connecting SES Connecting WPS Connecting AOSS	Connecting the access point	—
Connected	Connection succeeded.	—
Connection Error	Session overlap has been detected.	Check that only one router or access point has the SecureEasySetup™ mode, the Wi-Fi Protected Setup mode or AOSS™ mode enabled and try starting from step ③ again.
No Access Point	The access point detection failed.	Move the machine closer to your access point/router and try starting from step ③ again.
Connection Fail	Connection failed.	1 Try starting from step ③ again. 2 If the same message continues, reset the machine back to the factory settings and try again.



#### (Windows®)

**You have completed the wireless network setup. If you would like to continue installing drivers and software necessary for operating your device, please choose Install MFL-Pro Suite from the CD-ROM menu.**

#### (Macintosh)

**You have completed the wireless network setup. If you would like to continue installing drivers and software necessary for operating your device, please choose Start Here OSX from the CD-ROM menu.**

## Using the PIN Method of Wi-Fi Protected Setup

If your wireless access point/router supports Wi-Fi Protected Setup (PIN Method), you can configure the machine easily without a computer. The PIN (Personal Identification Number) Method is one of the connection methods developed by the Wi-Fi Alliance®. By inputting a PIN which is created by an Enrollee (your machine) to the Registrar (a device that manages the wireless LAN), you can setup the wireless network and security settings. See the user's guide for your wireless access point/router for instructions on how to access the Wi-Fi Protected Setup mode.



### Note

Routers or access points that support Wi-Fi Protected Setup have a symbol as shown below.



1 Plug the machine's power cord into the AC power outlet. Turn on the machine's power switch.

2 Press **Menu**, **7**, **2**, **7**. Using **▲** or **▼**, choose **On** and press **OK**. Press **Stop/Exit**.

```

72.WLAN
 7.WLAN Enable
▲      On
▼      Off
Select ▲▼ or OK
  
```

3 Press **Menu**, **7**, **2**, **4** for WPS w/PIN Code.

4 The LCD will show an 8 digit PIN and the machine starts searching for an access point for 5 minutes.

```

72.WLAN
 4.WPS w/PIN Code

PIN:XXXXXXXX
Connecting WPS
  
```

5 Using a computer that is on the network, type "http://access point's IP address/" into your browser. (Where "access point's IP address" is the IP address of the device that is used as the Registrar<sup>1</sup>) Go to the WPS (Wi-Fi Protected Setup) setting page and input the PIN which the LCD shows in step 4 to the Registrar and follow the on-screen instructions.

<sup>1</sup> The Registrar is normally the access point/router.



### Note

The setting page is different, depending on the brand of access point/router. See the instruction manual that came with your access point/router.

### Windows Vista®

If you are using your Windows Vista® computer as a Registrar, follow these steps:

**Note**

To use a Windows Vista® computer as a Registrar, you need to register it to your network in advance. See the instruction manual that came with your access point/router.

- 1 Click the  button and then **Network**.
- 2 Click **Add a wireless device**.
- 3 Choose your printer and click **Next**.
- 4 Input the PIN which the LCD shows in step ④ and then click **Next**.
- 5 Choose your network that you want to connect to, and then click **Next**.
- 6 Click **Close**.

- ⑥ If the LCD shows `Connected`, the machine has successfully connected to your access point/router. You can now use your machine in a wireless network.

If the LCD shows `Connection Fail`, the machine has not successfully connected to your access point/router. Try starting from step ③ again. If the same message is indicated again, reset the machine back to the default factory settings and try again. (For resetting, see *Restoring the network settings to factory default* on page 123.)

If the LCD shows `No Access Point`, the machine has not detected your access point/router on your network with the Wi-Fi Protected Setup mode enabled. Move the machine closer to your access point/router and try starting from step ③ again.

Or an incorrect PIN has typed into the WPS (Wi-Fi Protected Setup) setting page on your router or access point. Retype the correct PIN and try starting from step ③ again.

**(Windows®)**

**You have completed the wireless network setup. If you would like to continue installing drivers and software necessary for operating your device, please choose Install MFL-Pro Suite from the CD-ROM menu.**

**(Macintosh)**

**You have completed the wireless network setup. If you would like to continue installing drivers and software necessary for operating your device, please choose Start Here OSX from the CD-ROM menu.**

## Using the Brother installer application on the CD-ROM to configure your machine for a wireless network

For installation, see *Wireless configuration for Windows® using the Brother installer application (For MFC-8690DW and MFC-8890DW)* in Chapter 4 and *Wireless configuration for Macintosh using the Brother installer application (For MFC-8690DW and MFC-8890DW)* in Chapter 5.

## 4

# Wireless configuration for Windows<sup>®</sup> using the Brother installer application (For MFC-8690DW and MFC-8890DW)



## Note

The screens in this section are for MFC-8890DW.

## Configuration in Infrastructure mode

### Before configuring the wireless settings

#### ! IMPORTANT

- The following instructions will install your Brother machine in a network environment using the Brother installer application for Windows<sup>®</sup> found on the CD-ROM we have provided with the machine.
- You can also setup your Brother machine using the machine's control panel which we recommended. You can find instructions in the supplied *Quick Setup Guide* or see *Configuring your machine for a wireless network (For MFC-8690DW and MFC-8890DW)* on page 21.
- **You must know your wireless network settings before you proceed with this installation.**

Make sure you take notes on all the current settings such as SSID, authentication and encryption of your wireless network environment. If you do not know them, contact your network administrator or the manufacturer of your access point/router.

Check and record the current wireless network settings.

Network name:(SSID, ESSID)

Communication Mode	Authentication method	Encryption mode	Network key <sup>4</sup>
Infrastructure	Open system	WEP <sup>2</sup>	
		NONE	—
	Shared key	WEP <sup>2</sup>	
	WPA/WPA2-PSK <sup>1</sup>	AES	
		TKIP <sup>3</sup>	
	LEAP	CKIP	
	EAP-FAST/NONE	AES	
	EAP-FAST/MS-CHAPv2	TKIP	
EAP-FAST/GTC			

- <sup>1</sup> WPA/WPA2-PSK is a Wi-Fi Protected Access Pre-Shared Key, which lets the Brother wireless machine associate with access points using TKIP or AES encryption (WPA-Personal). WPA2-PSK (AES) and WPA-PSK (TKIP/AES) uses a Pre-Shared Key (PSK) that is 8 or more characters in length, up to a maximum of 63 characters.
- <sup>2</sup> The WEP key is for 64-bit encrypted networks or 128-bit encrypted networks and can contain both numbers and letters. If you do not know this information you should see the documentation provided with your access point or wireless router. This key is a 64-bit or 128-bit value that must be entered in an ASCII or HEXADECIMAL format.

**For example:**

64-bit ASCII:	Uses 5 text characters e.g. "Hello" (this is case sensitive)
64-bit Hexadecimal:	Uses 10 digits of hexadecimal data e.g. "71f2234aba"
128-bit ASCII:	Uses 13 text characters e.g. "Wirelesscomms" (this is case sensitive)
128-bit Hexadecimal:	Uses 26 digits of hexadecimal data e.g. "71f2234ab56cd709e5412aa3ba"

- <sup>3</sup> This is supported for WPA-PSK only.
- <sup>4</sup> Encryption key, WEP key, Passphrase. For LEAP and EAP-FAST, record the Name and Password.

**For example:**

Network name:(SSID, ESSID)
HELLO

Communication Mode	Authentication method	Encryption mode	Network key
Infrastructure	WPA2-PSK	AES	12345678

- If you have previously configured the wireless settings of the machine, you must reset the network LAN settings before you can configure the wireless settings again. Press **Menu, 7, 0** for **Network Reset**, press **1** for **Reset** and then choose **1** for **Yes** to accept the change. The machine will restart automatically.
- If you are using Windows® Firewall or a firewall function of anti-spyware or antivirus applications, temporarily disable them. Once you are sure that you can print, configure the software settings following the instructions.
- You need to temporarily use an Ethernet cable during configuration. (The Ethernet cable is not a standard accessory.)

## Configure the wireless settings

- 1 Plug the machine's power cord into the AC power outlet. Turn on the machine's power switch.
- 2 Turn on your computer.  
Close any applications running before configuration.
- 3 Put the supplied CD-ROM into your CD-ROM drive. The opening screen will appear automatically.  
If the model name screen appears, choose your machine. If the language screen appears, choose your language.
- 4 The CD-ROM main menu will appear. Click **Initial Installation**.



### Note

If this window does not appear, use Windows® Explorer to run the Start.exe program from the root folder of the Brother CD-ROM.

- 5 Click **Wireless LAN Setup Wizard**.



- 6 Choose **Step by Step install (Recommended)** and then click **Next**.

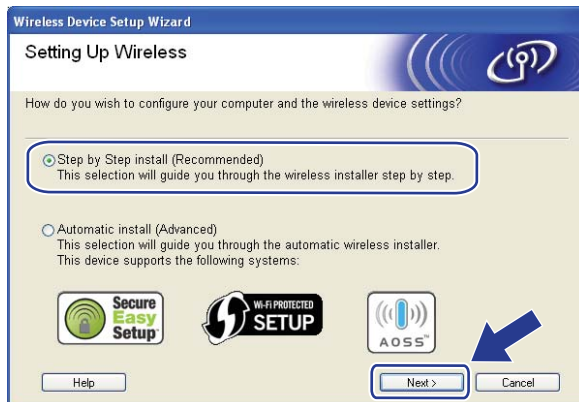

- 7 Choose **With cable (Recommended)** and then click **Next**.

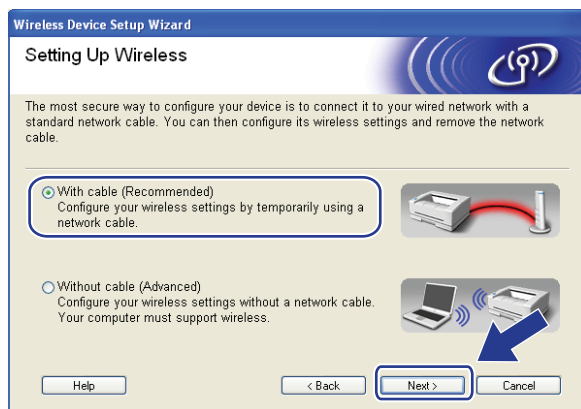

- 8 Connect the Brother wireless device to your access point using a network cable and click **Next**.

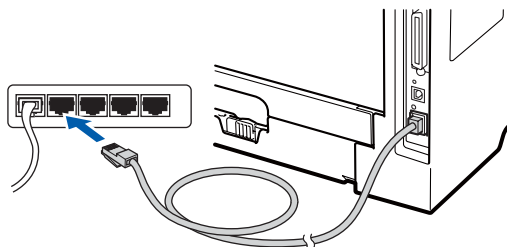

- 9 Choose the machine you wish to configure, and click **Next**. If the list is blank, check if the access point and the machine are powered on, and then click **Refresh**.

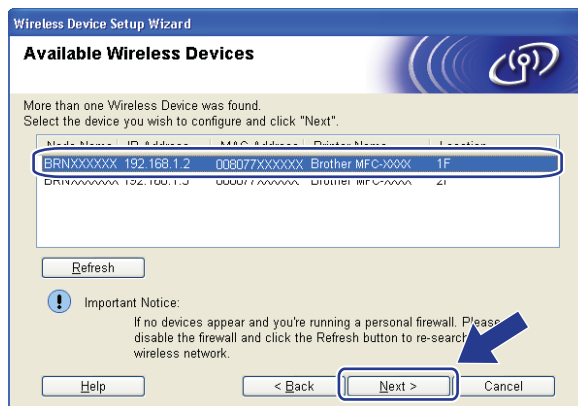

 **Note**

- The default Node name is "BRNxxxxxxxxxxx". ("xxxxxxxxxxx" is your machine's MAC Address / Ethernet Address.)
- You can find your machine's MAC Address / Ethernet Address by printing out the Network Configuration List. See *Printing the Network Configuration List* on page 123.



- 10 The wizard will search for wireless networks available from your machine. Choose the access point you wish to associate the machine with, and then click **Next**.

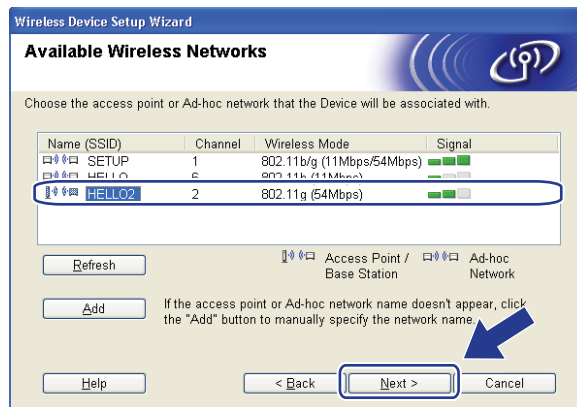

**Note**

- "SETUP" is the default SSID of the machine. Do not choose this SSID.
- If the list is blank, check that the access point has power and is broadcasting the SSID, and then see if the machine and the access point are within range for wireless communication. Then, click **Refresh**.
- If your access point is set to not broadcast the SSID you can manually add it by clicking the **Add** button. Follow the on-screen instructions for entering the **Name(SSID)**, and then click **Next**.

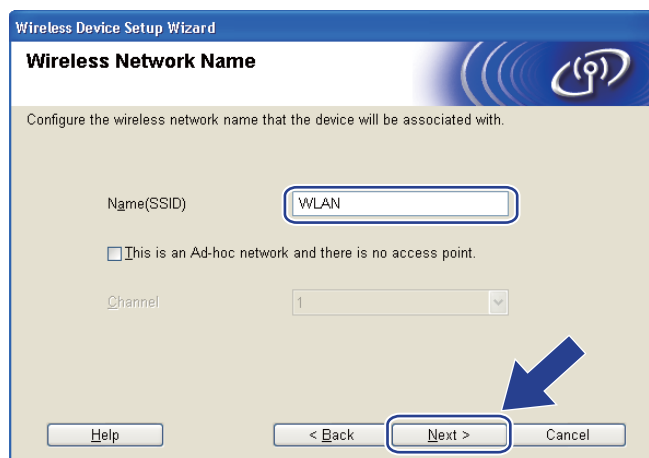

- 11 If your network is not configured for Authentication and Encryption, the following screen will appear. To continue configuration, click **OK** and go to step 13.



- 12 If your network is configured for Authentication and Encryption, the following screen will appear. **When configuring your Brother wireless machine, you must configure your machine to match the Authentication and Encryption settings you wrote down on page 41 for your existing wireless network.** Choose the **Authentication Method** and **Encryption Mode** from the pull-down list in each setting box. Then enter the **Network Key** and **Confirm Network Key**, and then click **Next**.

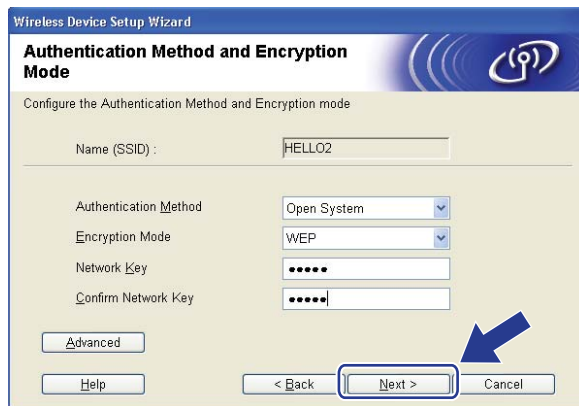

The screenshot shows the 'Authentication Method and Encryption Mode' screen in the Wireless Device Setup Wizard. The title bar reads 'Wireless Device Setup Wizard'. The main title is 'Authentication Method and Encryption Mode'. Below the title, it says 'Configure the Authentication Method and Encryption mode'. The form contains the following fields and controls:

- Name (SSID): HELLO2
- Authentication Method: Open System (dropdown menu)
- Encryption Mode: WEP (dropdown menu)
- Network Key: [masked with dots]
- Confirm Network Key: [masked with dots]
- Buttons: Advanced, Help, < Back, Next >, Cancel

A blue arrow points to the 'Next >' button.

 **Note**

- If you want to setup or configure additional WEP key indexes other than WEP key1, click **Advanced**.
- If you do not know the Authentication or Encryption settings for your network, contact your network administrator or the manufacture of your access point / router.
- If you are using WEP and the printed Network Configuration page in step 13 shows Link OK in the **Wireless Link Status**, but the machine is not found on your network, make sure you entered the WEP key correctly. The WEP key is case sensitive.

- 13 Click **Next**. The settings will be sent to your machine. The settings will remain unchanged if you click **Cancel**. The Network Configuration page will be printed.

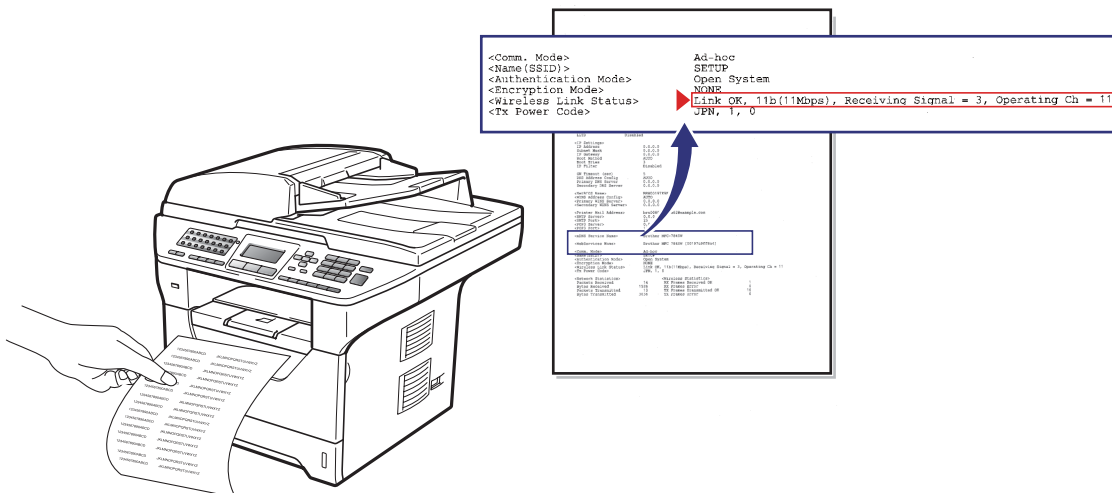
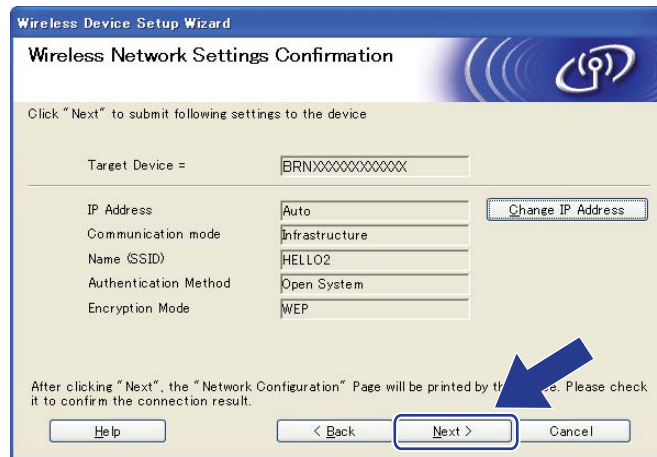

#### Note

- If you want to manually enter the IP address settings of your machine, click **Change IP Address** and enter the necessary IP address settings for your network.
- The control panel settings will be automatically changed to **WLAN** when the wireless settings are sent to your machine.

- 14 Check the printed Network Configuration page. Choose the status as it is shown for the **Wireless Link Status** on the Network Configuration page. Click **Next**.  
If your status is "Link OK.", go to step 16.  
If your status is "Failed To Associate", go to step 15.

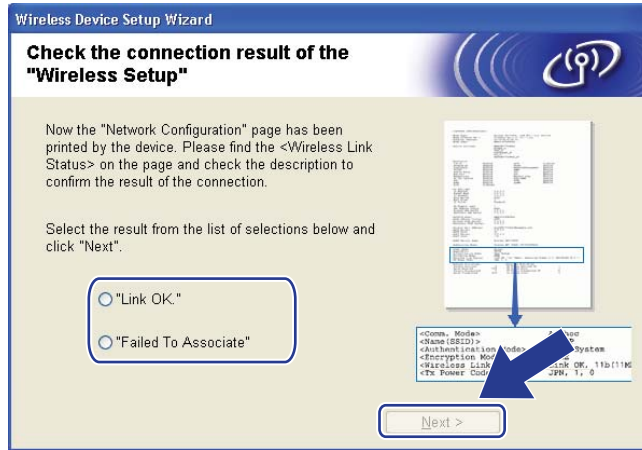

- 15 Click **Finish**. Wireless setup failed as it was unable to associate with a wireless network. This is probably due to incorrect security settings. Reset the print server back to its factory default settings. (See *Restoring the network settings to factory default* on pages 123) Confirm the security settings of your wireless network and try starting from step 5 again.

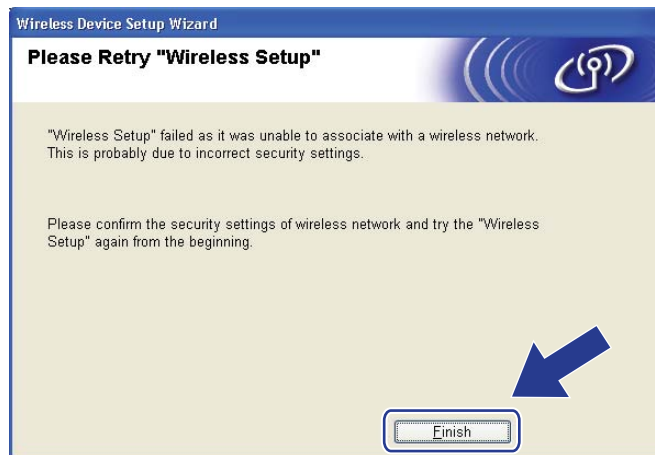

- 16 Disconnect the network cable between your access point (hub or router) and the machine, and click **Next**.

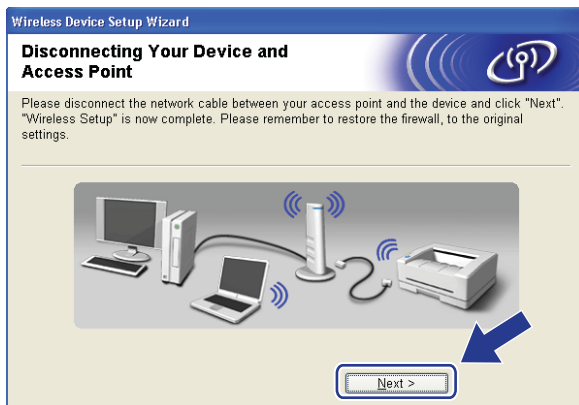

- 17 Check the box after you confirm that you have completed the wireless settings, and then click **Finish**.

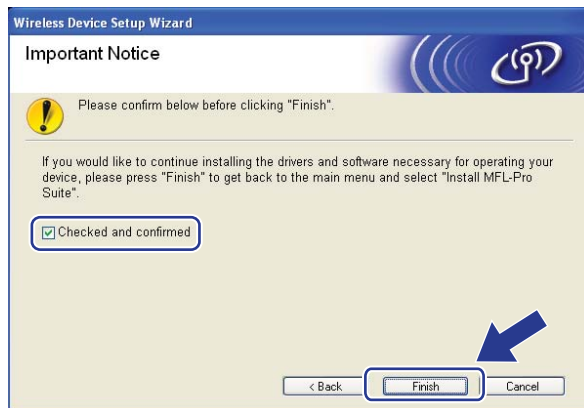

- OK! You have completed the wireless network setup. If you would like to continue installing drivers and software necessary for operating your device, please choose Install MFL-Pro Suite from the CD-ROM menu.

## Configuration using the SES/WPS or AOSS™ from the control panel menu (Automatic Wireless mode)

### Before configuring the wireless settings

#### ! IMPORTANT

- If you are going to connect your Brother machine to your network, we recommend that you contact your system administrator prior to installation. You must know your wireless network settings before you proceed with this installation.
- If you have previously configured the wireless settings of the machine, you must reset the network LAN settings before you can configure the wireless settings again. Press **Menu, 7, 0** for `Network Reset`, press **1** for `Reset` and then choose **1** for `Yes` to accept the change. The machine will restart automatically.

4

### Configure the wireless settings

- 1 Plug the machine's power cord into the AC power outlet. Turn on the machine's power switch.
- 2 Press **Menu, 7, 2, 7**. Using **▲** or **▼**, choose `On` and press **OK**.

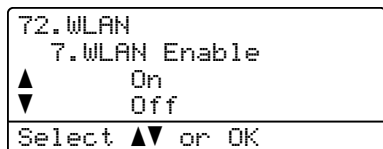

- 3 Turn on your computer.  
Close any applications running before configuration.
- 4 Put the supplied CD-ROM into your CD-ROM drive. The opening screen will appear automatically. If the model name screen appears, choose your machine. If the language screen appears, choose your language.

- 5 The CD-ROM main menu will appear. Click **Initial Installation**.



 **Note**

If this window does not appear, use Windows® Explorer to run the Start.exe program from the root folder of the Brother CD-ROM.

- 6 Click **Wireless LAN Setup Wizard**.



- 7 Choose **Automatic install (Advanced)** and click **Next**.

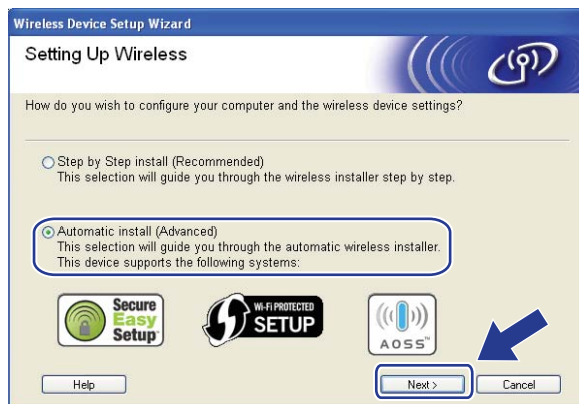

- 8 Confirm the on-screen message and click **Next**.



- 9 Press **Menu, 7, 2, 3** for **SES/WPS/AOSS**. This feature will automatically detect which mode (SecureEasySetup™, Wi-Fi Protected Setup or AOSS™) your access point uses to configure your machine.

 **Note**

If your wireless access point supports Wi-Fi Protected Setup (PIN Method) and you want to configure your machine using the PIN (Personal Identification Number) Method, see *Using the PIN Method of Wi-Fi Protected Setup* on page 39.

- 10 The machine searches for an access point that supports SecureEasySetup™, Wi-Fi Protected Setup or AOSS™ for 2 minutes.

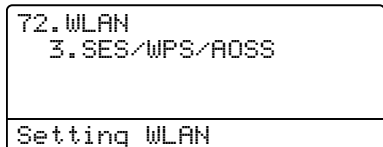

- 11 Put your access point in the SecureEasySetup™ mode, Wi-Fi Protected Setup mode or AOSS™ mode, depending on what is supported by your access point. Please refer to the instruction manual that came with your access point. You will see *Connecting AOSS*, *Connecting SES* or *Connecting WPS* on the LCD while the machine searches your access point.



- 12 If the LCD shows `Connected`, the machine has successfully connected to your access point/router. You can now use your machine in a wireless network.

If the LCD shows `Connection Error`, a session overlap has been detected. The machine has detected more than one access point/router on your network with the SecureEasySetup™ mode, the Wi-Fi Protected Setup mode or AOSS™ mode enabled. Make sure that only one access point/router has the SecureEasySetup™ mode, the Wi-Fi Protected Setup mode or the AOSS™ mode enabled and try starting from step 9 again.

If the LCD shows `No Access Point`, the machine has not detected your access point/router on your network with the SecureEasySetup™ mode, the Wi-Fi Protected Setup mode or AOSS™ mode enabled. Move the machine closer to your access point/router and try starting from step 9 again.

If the LCD shows `Connection Fail`, the machine has not successfully connected to your access point/router. Try starting from step 9 again. If the same message is indicated again, reset the machine back to the default factory settings and try again. (For resetting, see *Restoring the network settings to factory default* on page 123.)

#### LCD messages when using the SES/WPS/AOSS™ control panel menu

LCD shows	Connection status	Action
Setting WLAN	Searching or accessing the access point, and downloading settings from the access point	—
Connecting SES Connecting WPS Connecting AOSS	Connecting the access point	—
Connected	Connection succeeded.	—
Connection Error	Session overlap has been detected.	Check that only one router or access point has the SecureEasySetup™ mode, the Wi-Fi Protected Setup mode or AOSS™ mode enabled and try starting from step 9 again.
No Access Point	The access point detection failed.	Move the machine closer to your access point/router and try starting from step 9 again.
Connection Fail	Connection failed.	1 Try starting from step 9 again. 2 If the same message continues, reset the machine back to the factory settings and try again.

- 13 Click **Next**.

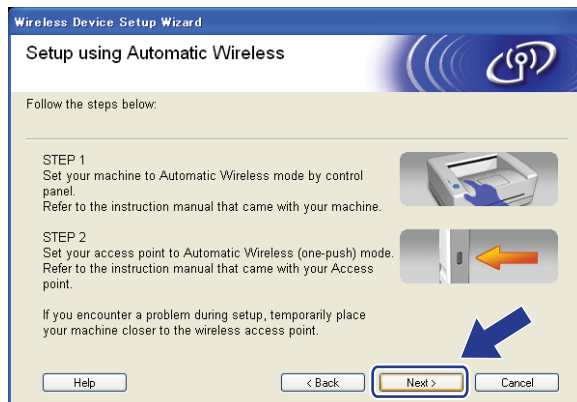

- 14 Check the box after you confirm that you have completed the wireless settings, and then click **Finish**.

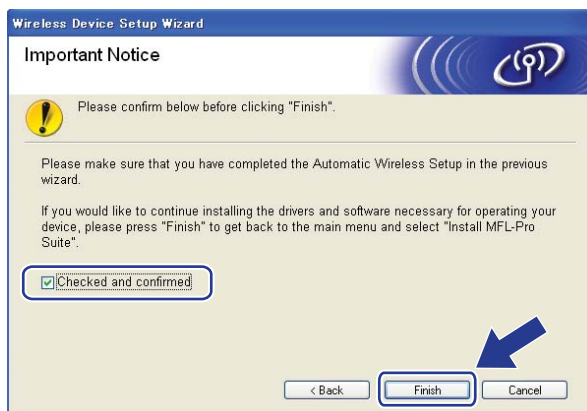

- OK! You have completed the wireless network setup. If you would like to continue installing drivers and software necessary for operating your device, please choose Install MFL-Pro Suite from the CD-ROM menu.

## Configuration in Ad-hoc mode

### Before configuring the wireless settings

#### ! IMPORTANT

- The following instructions will install your Brother machine in a network environment using the Brother installer application for Windows® found on the CD-ROM we have provided with the machine.
- You can also setup your Brother machine using the machine's control panel which we recommended. See *Configuring your machine for a wireless network (For MFC-8690DW and MFC-8890DW)* on page 21.
- If you have previously configured the wireless settings of the machine, you must reset the network LAN settings before you can configure the wireless settings again. Press **Menu, 7, 0** for **Network Reset**, press **1** for **Reset** and then choose **1** for **Yes** to accept the change. The machine will restart automatically.
- If you are using Windows® Firewall or a firewall function of anti-spyware or antivirus applications, temporarily disable them. Once you are sure that you can print, configure the software settings following the instructions.

4

### Configure the wireless settings

- 1 Plug the machine's power cord into the AC power outlet. Turn on the machine's power switch.
- 2 Press **Menu, 7, 2, 7**. Using **▲** or **▼**, choose **On** and press **OK**.

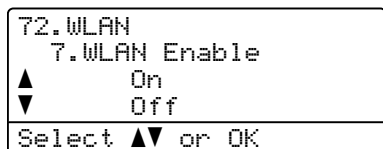

- 3 Turn on your computer.  
Close any applications running before configuration.
- 4 Put the supplied CD-ROM into your CD-ROM drive. The opening screen will appear automatically.  
If the model name screen appears, choose your machine. If the language screen appears, choose your language.

- 5 The CD-ROM main menu will appear. Click **Initial Installation**.



 **Note**

If this window does not appear, use Windows® Explorer to run the Start.exe program from the root folder of the Brother CD-ROM.

- 6 Click **Wireless LAN Setup Wizard**.



- 7 Choose **Step by Step install (Recommended)** and then click **Next**.

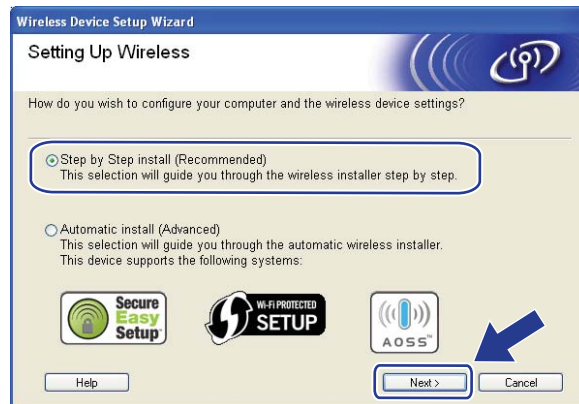

- 8 Choose **Without cable (Advanced)** and then click **Next**.

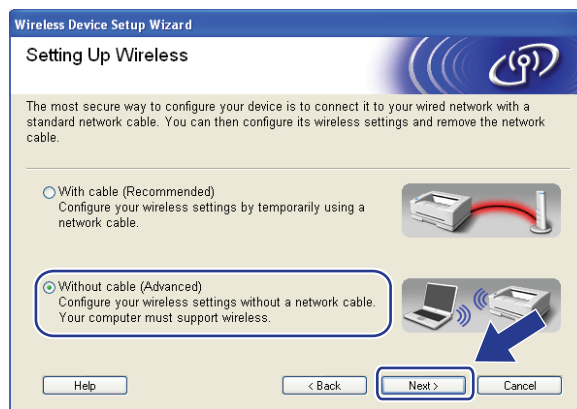

- 9 Read the **Important Notice**. Check the box after you confirm the wireless setting is enabled, and then click **Next**.

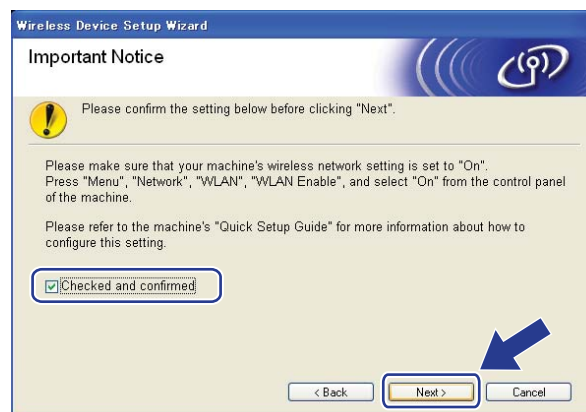

- 10 You need to temporarily change your computer's wireless settings. Follow the on-screen instructions. Make sure you take notes on all the settings such as SSID, channel, authentication and encryption of your computer. You will need them to return your computer back to its original wireless settings, and then click **Next**.

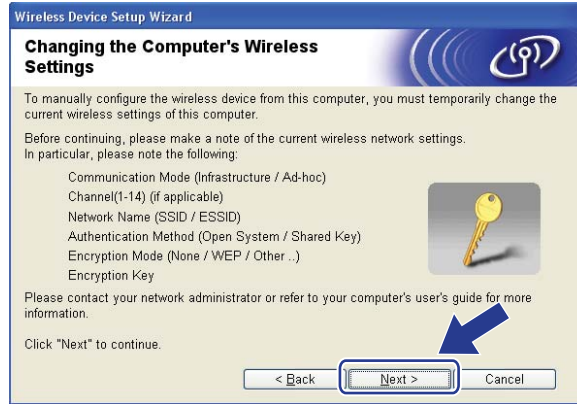

If you want to configure your machine for the wireless network you have been using, write down your wireless network settings before configuration. Check and record the current wireless network settings.

Network name:(SSID, ESSID)

Communication Mode	Authentication method	Encryption mode	Network key
Ad-hoc	Open system	WEP <sup>1</sup>	
		NONE	—

<sup>1</sup> The WEP key is for 64-bit encrypted networks or 128-bit encrypted networks and can contain both numbers and letters. If you do not know this information you should see the documentation provided with your access point or wireless router. This key is a 64-bit or 128-bit value that must be entered in an ASCII or HEXADECIMAL format.

**For example:**

- 64-bit ASCII: Uses 5 text characters e.g. "Hello" (this is case sensitive)
- 64-bit Hexadecimal: Uses 10 digits of hexadecimal data e.g. "71f2234aba"
- 128-bit ASCII: Uses 13 text characters e.g. "Wirelesscomms" (this is case sensitive)
- 128-bit Hexadecimal: Uses 26 digits of hexadecimal data e.g. "71f2234ab56cd709e5412aa3ba"

**For example:**

Network name:(SSID, ESSID)
HELLO

Communication Mode	Authentication method	Encryption mode	Network key
Ad-hoc	Open system	WEP	12345

- 11 To communicate with the un-configured wireless machine, temporarily change the wireless settings on your computer to match the machine's default settings shown on this screen. Check the box after you confirm these settings, and then click **Next**.

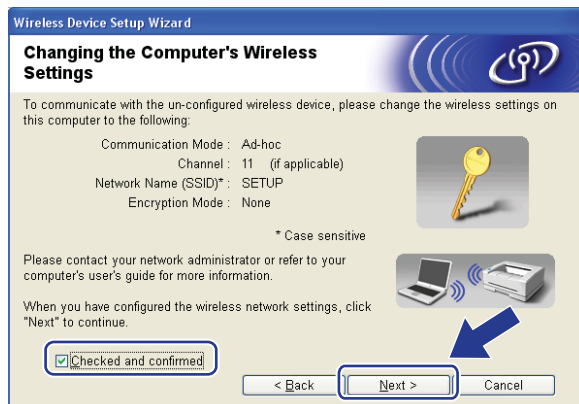

 **Note**

- If a message to restart your computer appears after the wireless settings have been changed, restart your computer and then go back to step ④ and continue with the install skipping steps ⑩ and ⑪.

- Windows Vista® users:

You can temporarily change the wireless settings on your computer, following the steps below:

- 1 Click the  button and then **Control Panel**.
- 2 Click **Network and Internet** and then the **Network and Sharing Center** icon.
- 3 Click **Connect to a network**.
- 4 You can see the SSID of the wireless printer in the list. Choose **SETUP** and click **Connect**.
- 5 Click **Connect Anyway** and then **Close**.
- 6 Click **View status** of **Wireless Network Connection (SETUP)**.
- 7 Click **Details....** and check the **Network Connection Details**. It may take a few minutes to change from 0.0.0.0 to 169.254.x.x IP address to be shown on screen (where x.x. are numbers between 1 and 254).

- Windows® XP SP2 users:

You can temporarily change the wireless settings on your computer, following the steps below:

- 1 Click **Start** and then **Control Panel**.
- 2 Click the **Network and Internet Connections** icon.
- 3 Click the **Network Connections** icon.
- 4 Choose and right-click **Wireless Network Connection**. Click **View Available Wireless Networks**.
- 5 You can see the SSID of the wireless printer in the list. Choose **SETUP** and click **Connect**.
- 6 Check the **Wireless Network Connection** status. It may take a few minutes to change from 0.0.0.0 to 169.254.x.x IP address to be shown on screen (where x.x. are numbers between 1 and 254).



- 12 Choose the machine you wish to configure, and click **Next**. If the list is blank, check if the machine is powered on, and then click **Refresh**.

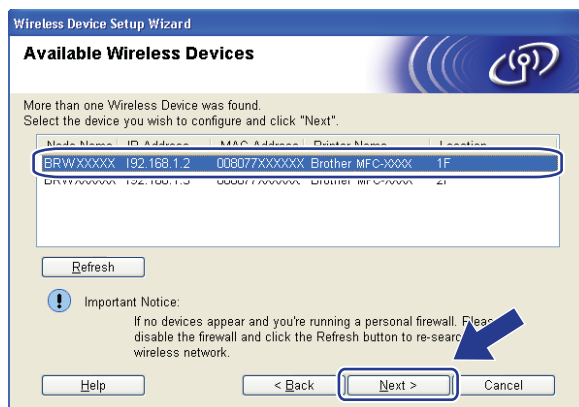

### Note

- The default Node name is "BRWxxxxxxxxxxxx". ("xxxxxxxxxxxx" is your machine's MAC Address / Ethernet Address.)
- You can find your machine's MAC Address / Ethernet Address by printing out the Network Configuration List. See *Printing the Network Configuration List* on page 123.

- 13 The wizard will search for wireless networks available from your machine. Choose the Ad-hoc network you wish to associate the machine with, and then click **Next**.

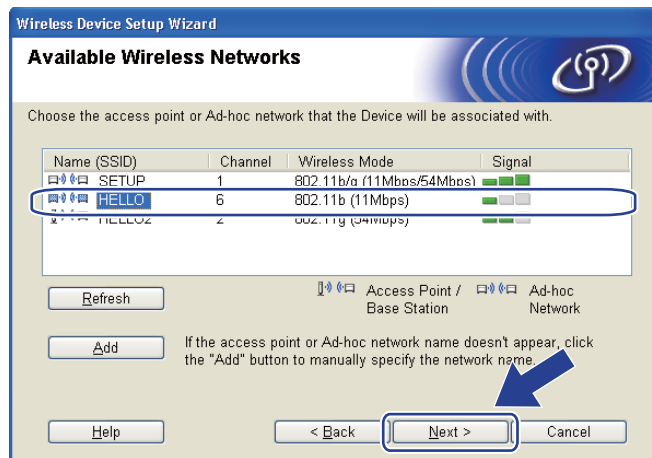

**Note**

- If the list is blank, check if the machine is within range for wireless communication. Then, click **Refresh**.
- If your target Ad-hoc network does not appear on the list, you can manually add it by clicking the **Add** button. Check **This is an Ad-hoc network and there is no access point.**, and then enter the **Name(SSID)** and the **Channel** number, and then click **Next**.

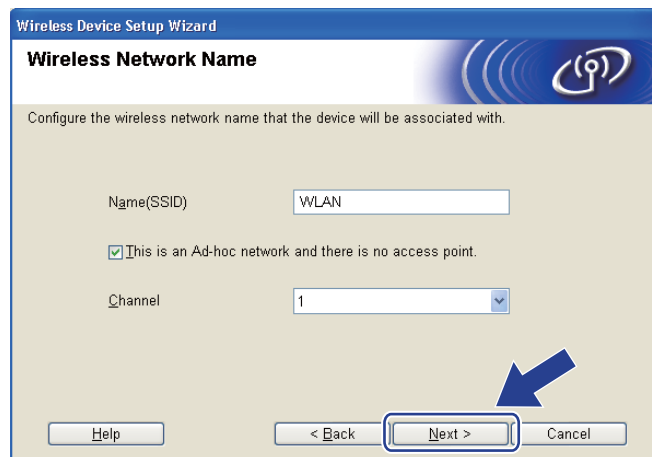

- 14 If your network is not configured for Authentication and Encryption, the following screen will appear. To continue configuration, click **OK** and go to step 16.



- 15 If your network is configured for Authentication and Encryption, the following screen will appear. **When configuring your Brother wireless machine, you must configure your machine to match the Authentication and Encryption settings you wrote down on page 59 for your existing wireless network.** Choose the **Authentication Method** and **Encryption Mode** from the pull-down list in each setting box. Then enter the **Network Key** and **Confirm Network Key**, and then click **Next**.

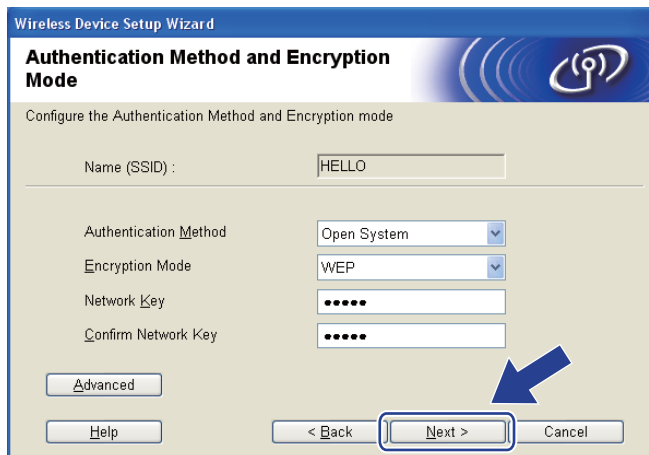

The screenshot shows the 'Authentication Method and Encryption Mode' screen in the Wireless Device Setup Wizard. The title bar reads 'Wireless Device Setup Wizard'. Below the title, the screen is titled 'Authentication Method and Encryption Mode' and contains the instruction 'Configure the Authentication Method and Encryption mode'. The fields are as follows: Name (SSID) is 'HELLO'; Authentication Method is 'Open System'; Encryption Mode is 'WEP'; Network Key is masked with five dots; Confirm Network Key is also masked with five dots. At the bottom, there are buttons for 'Advanced', 'Help', '< Back', 'Next >', and 'Cancel'. A blue arrow points to the 'Next >' button.



#### Note

- If you want to setup or configure additional WEP key indexes other than WEP key1, click **Advanced**.
- If you do not know the Authentication or Encryption settings for your network, contact your network administrator or the manufacture of your access point / router.
- If you are using WEP and the printed Network Configuration page in step 16 shows Link OK in the **Wireless Link Status**, but the machine is not found, make sure you entered the WEP key correctly. The WEP key is case sensitive.

- 16 Click **Next**. The settings will be sent to your machine. The settings will remain unchanged if you click **Cancel**. The Network Configuration page will be printed.

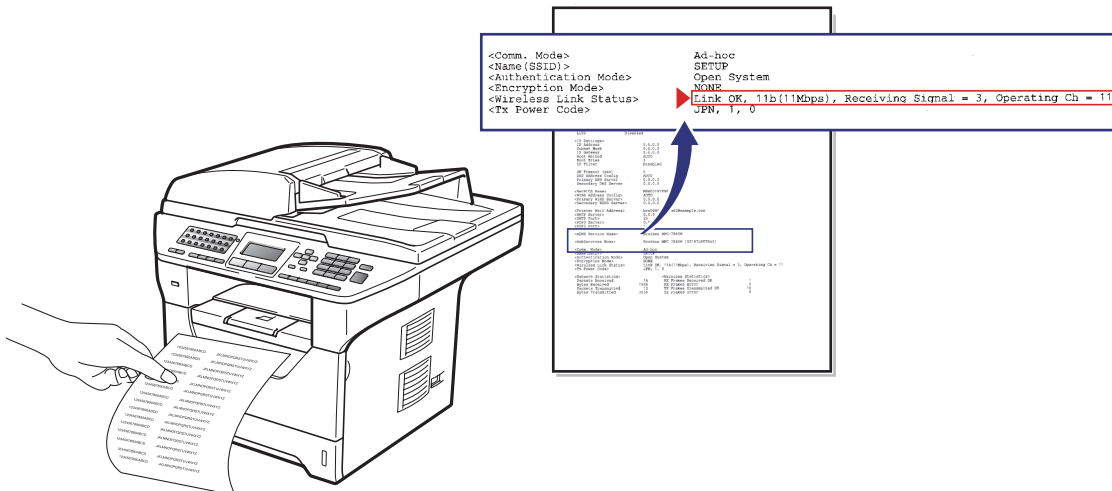
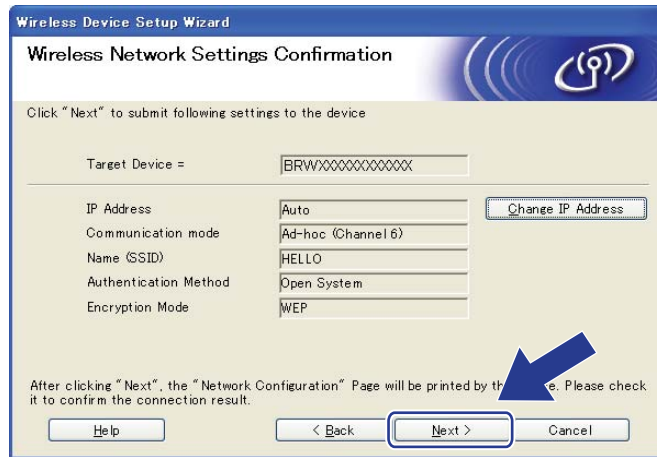

**Note**

If you want to manually enter the IP address settings of your machine, click **Change IP Address** and enter the necessary IP address settings for your network.

- 17 Check the printed Network Configuration page. Choose the status as it is shown in the **Wireless Link Status** on the Network Configuration page. Click **Next**.  
If your status is "Link OK.", go to step 19.  
If your status is "Failed To Associate", go to step 18.

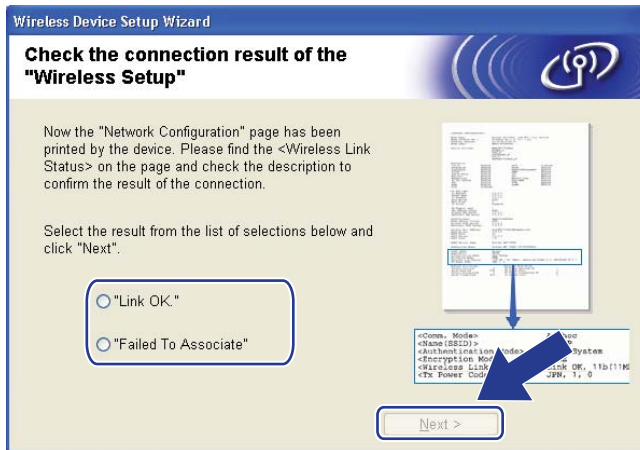

- 18 Click **Finish**. Wireless setup was unable to associate with a wireless network. This is probably due to incorrect security settings. Reset the print server back to its factory default settings. (See *Restoring the network settings to factory default* on pages 123) Confirm the security settings of your wireless network and try starting from step 6 again.

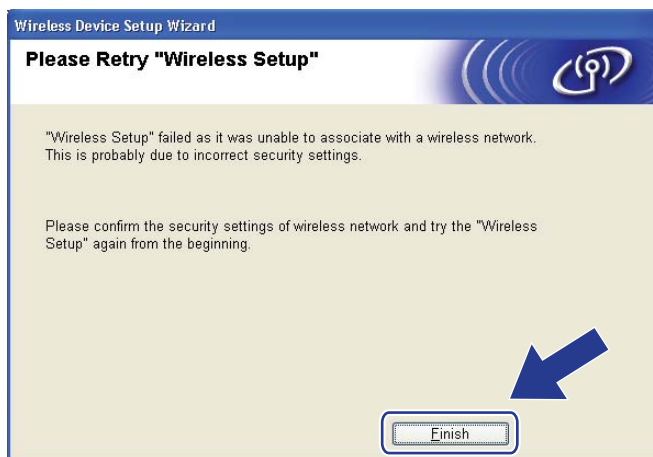

- 19 To communicate with the configured wireless device, you must configure your computer to use the same wireless settings. Manually change the wireless settings on your computer to match the machine's wireless settings shown on this screen. Check the box after you confirm these settings, and then click **Next**.  
(The settings shown on this screen are for example only. Your settings will not be the same.)

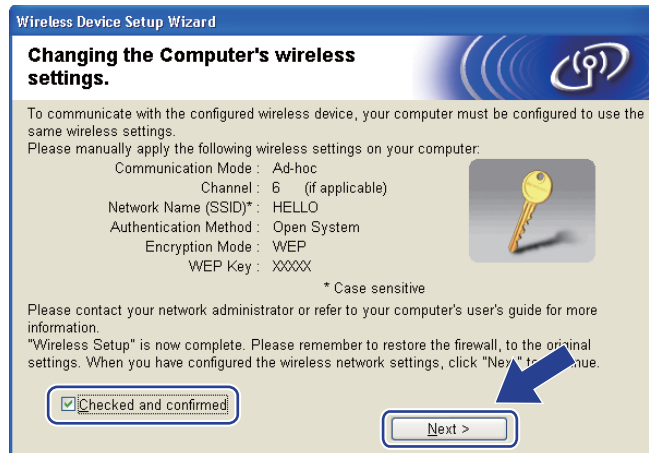

- 20 Check the box after you confirm that you have completed the wireless settings, and then click **Finish**.

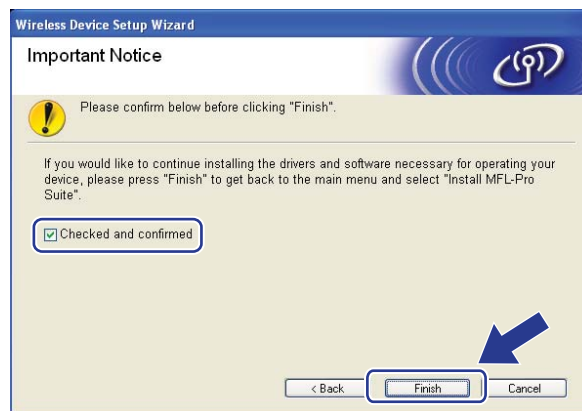

- OK! You have completed the wireless network setup. If you would like to continue installing drivers and software necessary for operating your device, please choose Install MFL-Pro Suite from the CD-ROM menu.

# Wireless configuration for Macintosh using the Brother installer application (For MFC-8690DW and MFC-8890DW)



## Note

The screens in this section are for MFC-8890DW.

## Configuration in Infrastructure mode

### Before configuring the wireless settings

#### ! IMPORTANT

- The following instructions will install your Brother machine in a network environment using the Brother installer application for Macintosh found on the CD-ROM we have provided with the machine.
- You can also setup your Brother machine using the machine's control panel which we recommended. You can find instructions in the supplied *Quick Setup Guide* or see *Configuring your machine for a wireless network (For MFC-8690DW and MFC-8890DW)* on page 21.
- **You must know your wireless network settings before you proceed with this installation.**

Make sure you take notes on all the current settings such as SSID, authentication and encryption of your wireless network environment. If you do not know them, contact your network administrator or the manufacturer of your access point/router.

Check and record the current wireless network settings.

Network name:(SSID, ESSID)

Communication Mode	Authentication method	Encryption mode	Network key <sup>4</sup>
Infrastructure	Open system	WEP <sup>2</sup>	
		NONE	—
	Shared key	WEP <sup>2</sup>	
		WPA/WPA2-PSK <sup>1</sup>	AES
		TKIP <sup>3</sup>	
	LEAP	CKIP	
	EAP-FAST/NONE	AES	
	EAP-FAST/MS-CHAPv2	TKIP	
EAP-FAST/GTC			

- <sup>1</sup> WPA/WPA2-PSK is a Wi-Fi Protected Access Pre-Shared Key, which lets the Brother wireless machine associate with access points using TKIP or AES encryption (WPA-Personal). WPA2-PSK (AES) and WPA-PSK (TKIP/AES) uses a Pre-Shared Key (PSK) that is 8 or more characters in length, up to a maximum of 63 characters.
- <sup>2</sup> The WEP key is for 64-bit encrypted networks or 128-bit encrypted networks and can contain both numbers and letters. If you do not know this information you should see the documentation provided with your access point or wireless router. This key is a 64-bit or 128-bit value that must be entered in an ASCII or HEXADECIMAL format.

**For example:**

64-bit ASCII:	Uses 5 text characters e.g. "Hello" (this is case sensitive)
64-bit Hexadecimal:	Uses 10 digits of hexadecimal data e.g. "71f2234aba"
128-bit ASCII:	Uses 13 text characters e.g. "Wirelesscomms" (this is case sensitive)
128-bit Hexadecimal:	Uses 26 digits of hexadecimal data e.g. "71f2234ab56cd709e5412aa3ba"

- <sup>3</sup> This is supported for WPA-PSK only.
- <sup>4</sup> Encryption key, WEP key, Passphrase. For LEAP and EAP-FAST, record the Name and Password.

**For example:**

Network name:(SSID, ESSID)
HELLO

Communication Mode	Authentication method	Encryption mode	Network key
Infrastructure	WPA2-PSK	AES	12345678

- If you have previously configured the wireless settings of the machine, you must reset the network LAN settings before you can configure the wireless settings again. Press **Menu, 7, 0** for *Network Reset*, press **1** for *Reset* and then choose **1** for *Yes* to accept the change. The machine will restart automatically.
- If you are using a firewall function of anti-spyware or antivirus applications, temporarily disable them. Once you are sure that you can print, configure the software settings following the instructions.
- You need to temporarily use an Ethernet cable during configuration. (The Ethernet cable is not a standard accessory.)



## Configure the wireless settings

- 1 Plug the machine's power cord into the AC power outlet. Turn on the machine's power switch.
- 2 Turn on your Macintosh.
- 3 Put the supplied CD-ROM into your CD-ROM drive. Double-click the **MFL-Pro Suite** icon on your desktop.
- 4 Double-click the **Utilities** icon.

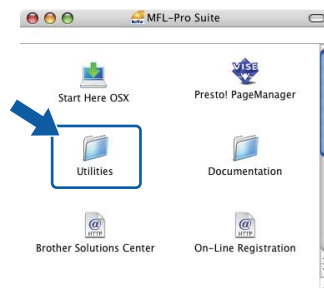

- 5 Double-click the **Wireless Device Setup Wizard**.

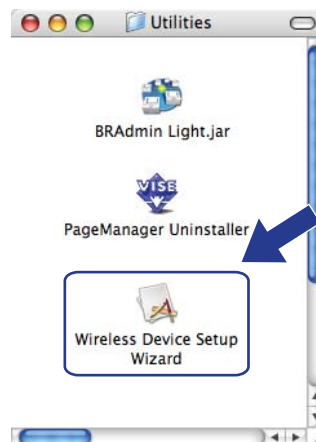

- 6 Choose **Step by Step install (Recommended)** and then click **Next**.



5

- 7 Choose **With cable (Recommended)** and then click **Next**.



- 8 Connect the Brother wireless device to your access point using a network cable and click **Next**.

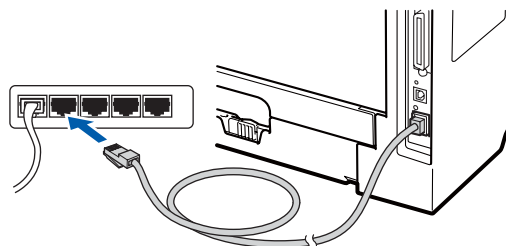
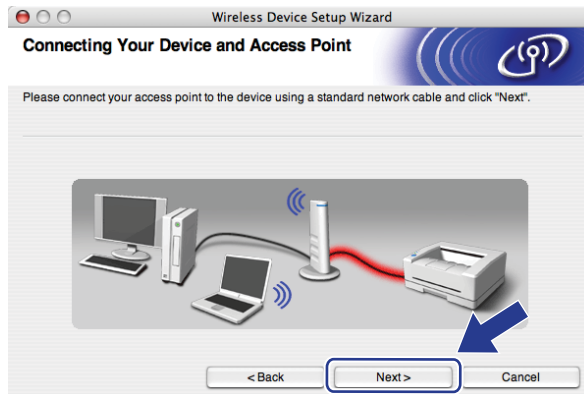

- 9 Choose the machine you wish to configure, and click **Next**. If the list is blank, check if the access point and the printer are powered on, and then click **Refresh**.

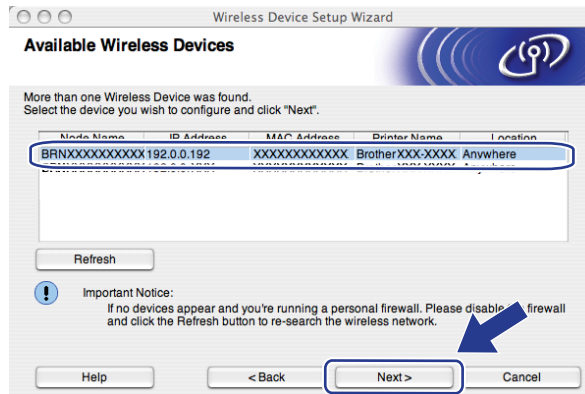

 **Note**

- The default Node name is “BRNxxxxxxxxxxx”. (“xxxxxxxxxxx” is your machine’s MAC Address / Ethernet Address.)
- You can find your machine’s MAC Address / Ethernet Address by printing out the Network Configuration List. See *Printing the Network Configuration List* on page 123.

- 10 The wizard will search for wireless networks available from your machine. Choose the access point you wish to associate the machine with, and then click **Next**.

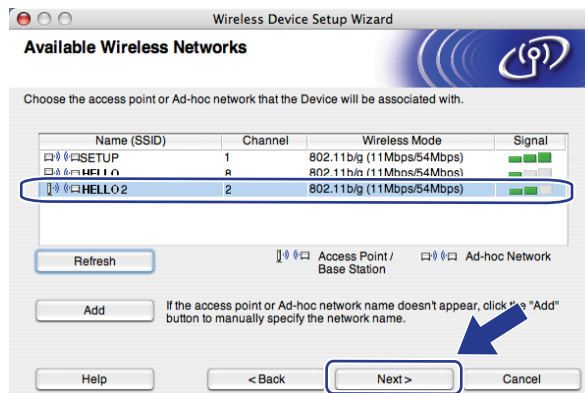

 **Note**

- "SETUP" is the default SSID of the machine. Do not choose this SSID.
- If the list is blank, check that the access point has power and is broadcasting the SSID, and then see if the machine and the access point are within range for wireless communication. Then, click **Refresh**.
- If your access point is set to not broadcast the SSID you can manually add it by clicking the **Add** button. Follow the on-screen instructions for entering the **Name(SSID)**, and then click **Next**.

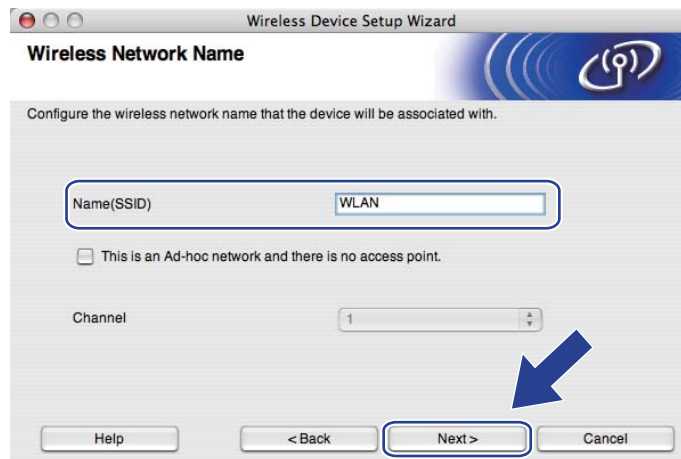

- 11 If your network is not configured for Authentication and Encryption, the following screen will appear. To continue configuration, click **OK** and go to step 13.



- 12 If your network is configured for Authentication and Encryption, the following screen will appear. **When configuring your Brother wireless machine, you must configure your machine to match the Authentication and Encryption settings you wrote down on page 68 for your existing wireless network.** Choose the **Authentication Method** and **Encryption Mode** from the pop-up menu in each setting box. Then enter the **Network Key** and **Confirm Network Key**, and then click **Next**.

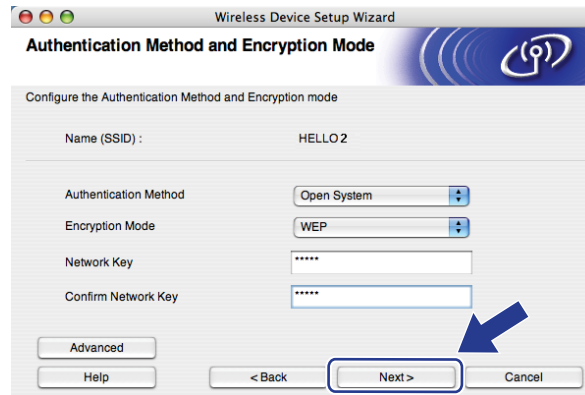

#### Note

- If you want to setup or configure additional WEP key indexes other than WEP key1, click **Advanced**.
- If you do not know the Authentication or Encryption settings for your network, contact your network administrator or the manufacture of your access point / router.
- If you are using WEP and the printed Network Configuration page in step 13 shows Link OK in the **Wireless Link Status**, but the machine is not found on your network, make sure you entered the WEP key correctly. The WEP key is case sensitive.

- 13 Click **Next**. The settings will be sent to your machine. The settings will remain unchanged if you click **Cancel**. The Network Configuration page will be printed.

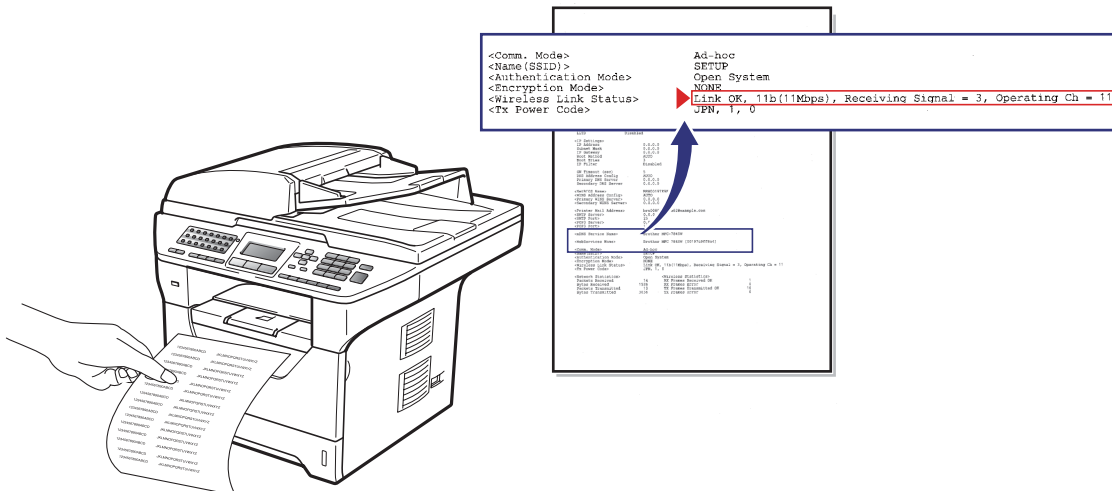
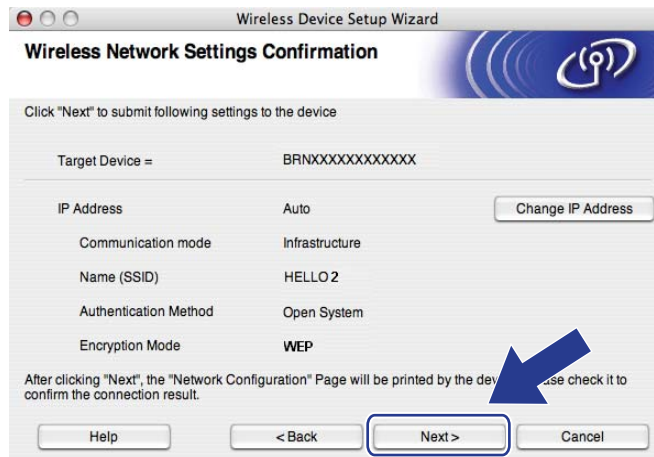

**Note**

- If you want to manually enter the IP address settings of your machine, click **Change IP Address** and enter the necessary IP address settings for your network.
- The control panel settings will be automatically changed to **WLAN** when the wireless settings are sent to your machine.

- 14 Check the printed Network Configuration page. Choose the status as it is shown in the **Wireless Link Status** on the Network Configuration page. Click **Next**.  
If your status is "Link OK.", go to step 16.  
If your status is "Failed To Associate", go to step 15.

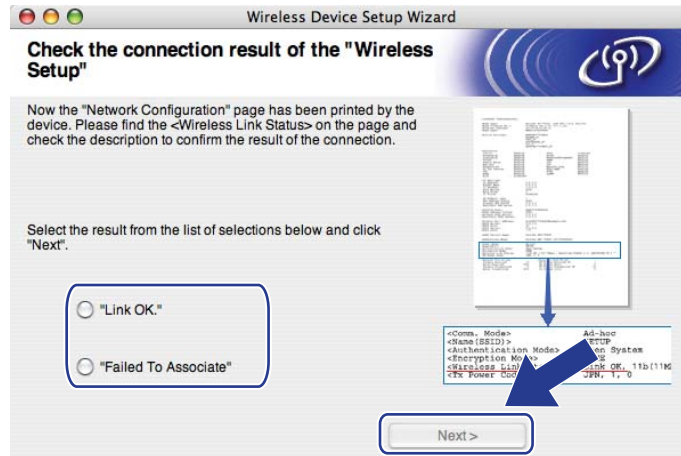

- 15 Click **Finish**. Wireless setup was unable to associate with a wireless network. This is probably due to incorrect security settings. Reset the print server back to its factory default settings. (See *Restoring the network settings to factory default* on pages 123) Confirm the security settings of your wireless network and try starting from step 5 again.



- 16 Disconnect the network cable between your access point (hub or router) and the machine, and click **Next**.



- 17 Check the box after you confirm that you have completed the wireless settings, and then click **Finish**.

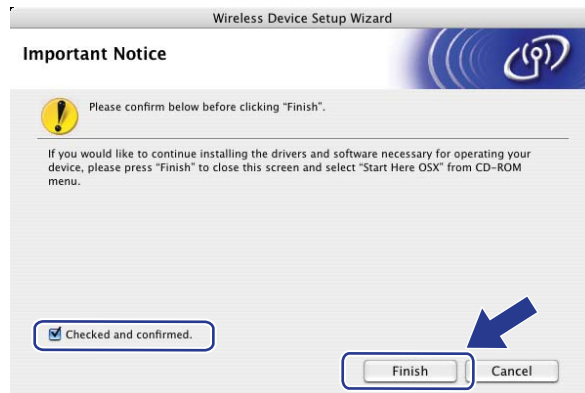

- OK! You have completed the wireless network setup. If you would like to continue installing drivers and software necessary for operating your device, please choose Start Here OSX from the CD-ROM menu.



## Configuration using the SES/WPS or AOSS™ from the control panel menu (Automatic Wireless mode)

### ! IMPORTANT

- If you are going to connect your Brother machine to your network, we recommend that you contact your system administrator prior to installation.
- If you have previously configured the wireless settings of the machine, you must reset the network LAN settings before you can configure the wireless settings again. Press **Menu, 7, 0** for *Network Reset*, press **1** for *Reset* and then choose **1** for *Yes* to accept the change. The machine will restart automatically.

1 Plug the machine's power cord into the AC power outlet. Turn on the machine's power switch.

2 Press **Menu, 7, 2, 7**. Using **▲** or **▼**, choose *On* and press **OK**.

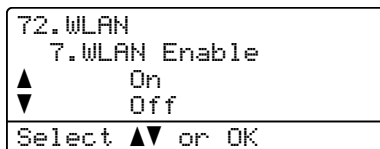

3 Turn on your Macintosh.

4 Put the supplied CD-ROM into your CD-ROM drive. Double-click the **MFL-Pro Suite** icon on your desktop.

5 Double-click the **Utilities** icon.

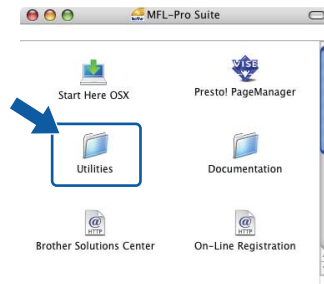

6 Double-click the **Wireless Device Setup Wizard**.

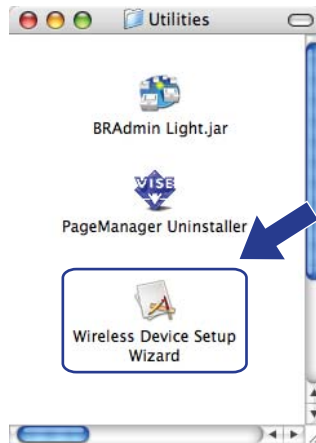

7 Choose **Automatic install (Advanced)** and click **Next**.



8 Confirm the on-screen message and click **Next**.



- 9 Press **Menu, 7, 2, 3** for `SES/WPS/AOSS`. This feature will automatically detect which mode (SecureEasySetup™, Wi-Fi Protected Setup or AOSS™) your access point uses to configure your machine.

 **Note**

If your wireless access point supports Wi-Fi Protected Setup (PIN Method) and you want to configure your machine using the PIN (Personal Identification Number) Method, see *Using the PIN Method of Wi-Fi Protected Setup* on page 39.

- 10 The machine searches for an access point that supports SecureEasySetup™, Wi-Fi Protected Setup or AOSS™ for 2 minutes.

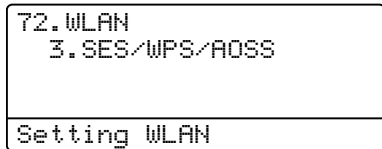

- 11 Put your access point in the SecureEasySetup™ mode, Wi-Fi Protected Setup mode or AOSS™ mode, depending on what is supported by your access point. Please refer to the instruction manual that came with your access point. You will see `Connecting AOSS`, `Connecting SES` or `Connecting WPS` on the LCD while the machine searches your access point.

- 12 If the LCD shows `Connected`, the machine has successfully connected to your access point/router. You can now use your machine in a wireless network.

If the LCD shows `Connection Error`, a session overlap has been detected. The machine has detected more than one access point/router on your network with the SecureEasySetup™ mode, the Wi-Fi Protected Setup mode or AOSS™ mode enabled. Make sure that only one access point/router has the SecureEasySetup™ mode, the Wi-Fi Protected Setup mode or the AOSS™ mode enabled and try starting from step 9 again.

If the LCD shows `No Access Point`, the machine has not detected your access point/router on your network with the SecureEasySetup™ mode, the Wi-Fi Protected Setup mode or AOSS™ mode enabled. Move the machine closer to your access point/router and try starting from step 9 again.

If the LCD shows `Connection Fail`, the machine has not successfully connected to your access point/router. Try starting from step 9 again. If the same message is indicated again, reset the machine back to the default factory settings and try again. (For resetting, see *Restoring the network settings to factory default* on page 123.)

### LCD messages when using the SES/WPS/AOSS™ control panel menu

LCD shows	Connection status	Action
Setting WLAN	Searching or accessing the access point, and downloading settings from the access point	—
Connecting SES Connecting WPS Connecting AOSS	Connecting the access point	—
Connected	Connection succeeded.	—
Connection Error	Session overlap has been detected.	Check that only one router or access point has the SecureEasySetup™ mode, the Wi-Fi Protected Setup mode or AOSS™ mode enabled and try starting from step ⑨ again.
No Access Point	The access point detection failed.	Move the machine closer to your access point/router and try starting from step ⑨ again.
Connection Fail	Connection failed.	1 Try starting from step ⑨ again. 2 If the same message continues, reset the machine back to the factory settings and try again.

5

13 Click **Next**.



- 14 Check the box after you confirm that you have completed the wireless settings, and then click **Finish**.

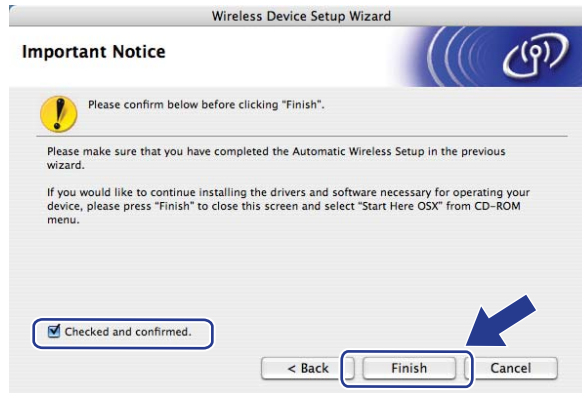

- OK! You have completed the wireless network setup. If you would like to continue installing drivers and software necessary for operating your device, please choose Start Here OSX from the CD-ROM menu.

## Configuration in Ad-hoc mode

### Before configuring the wireless settings

#### ! IMPORTANT

- The following instructions will install your Brother machine in a network environment using the Brother installer application for Macintosh found on the CD-ROM we have provided with the machine.
- You can also setup your Brother machine using the machine's control panel which we recommended. See *Configuring your machine for a wireless network (For MFC-8690DW and MFC-8890DW)* on page 21.
- If you have previously configured the wireless settings of the machine, you must reset the network LAN settings before you can configure the wireless settings again. Press **Menu, 7, 0** for *Network Reset*, press **1** for *Reset* and then choose **1** for *Yes* to accept the change. The machine will restart automatically.
- If you are using a firewall function of anti-spyware or antivirus applications, temporarily disable them. Once you are sure that you can print, configure the software settings following the instructions.

5

### Configure the wireless settings

- 1 Plug the machine's power cord into the AC power outlet. Turn on the machine's power switch.
- 2 Press **Menu, 7, 2, 7**. Using **▲** or **▼**, choose *On* and press **OK**.

```
72.WLAN
 7.WLAN Enable
▲      On
▼      Off
Select ▲▼ or OK
```

- 3 Turn on your Macintosh.
- 4 Put the supplied CD-ROM into your CD-ROM drive. Double-click the **MFL-Pro Suite** icon on your desktop.

- 5 Double-click the **Utilities** icon.

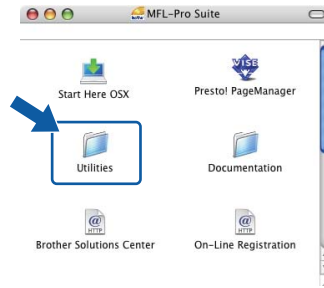

- 6 Double-click the **Wireless Device Setup Wizard**.

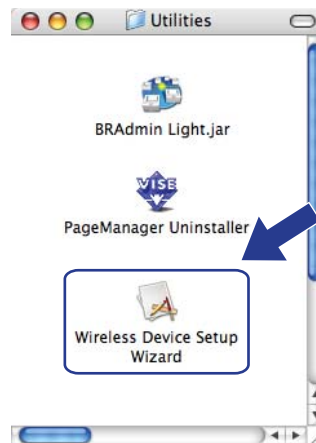

- 7 Choose **Step by Step install (Recommended)** and then click **Next**.



- 8 Choose **Without cable (Advanced)** and then click **Next**.



- 9 Read the **Important Notice**. Check the box after you confirm the wireless setting is enabled, and then click **Next**.





- 10 You need to temporarily change your computer’s wireless settings. Follow the on-screen instructions. Make sure you take notes on all the settings such as SSID, channel, authentication and encryption of your computer. You will need them to return your computer back to its original wireless settings, and then click **Next**.

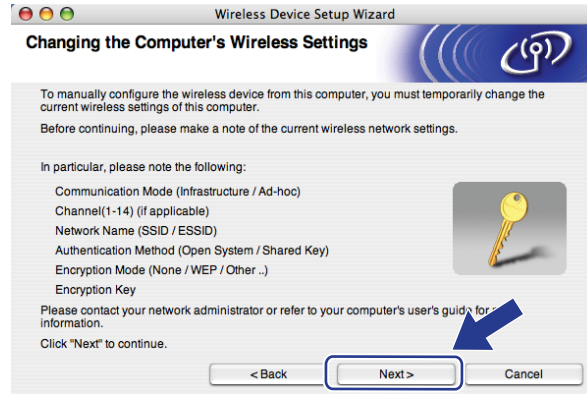

If you want to configure your machine for the wireless network you have been using, write down your wireless network settings before configuration. Check and record the current wireless network settings.

Network name:(SSID, ESSID)

Communication Mode	Authentication method	Encryption mode	Network key
Ad-hoc	Open system	WEP <sup>1</sup>	
		NONE	—

<sup>1</sup> The WEP key is for 64-bit encrypted networks or 128-bit encrypted networks and can contain both numbers and letters. If you do not know this information you should see the documentation provided with your access point or wireless router. This key is a 64-bit or 128-bit value that must be entered in an ASCII or HEXADECIMAL format.

**For example:**

- 64-bit ASCII: Uses 5 text characters e.g. “Hello” (this is case sensitive)
- 64-bit Hexadecimal: Uses 10 digits of hexadecimal data e.g. “71f2234aba”
- 128-bit ASCII: Uses 13 text characters e.g. “Wirelesscomms” (this is case sensitive)
- 128-bit Hexadecimal: Uses 26 digits of hexadecimal data e.g. “71f2234ab56cd709e5412aa3ba”

**For example:**

Network name:(SSID, ESSID)
HELLO

Communication Mode	Authentication method	Encryption mode	Network key
Ad-hoc	Open system	WEP	12345

- 11 To communicate with the un-configured wireless machine, temporarily change the wireless settings on your computer to match the machine's default settings shown on this screen. Check the box after you confirm these settings, and then click **Next**.

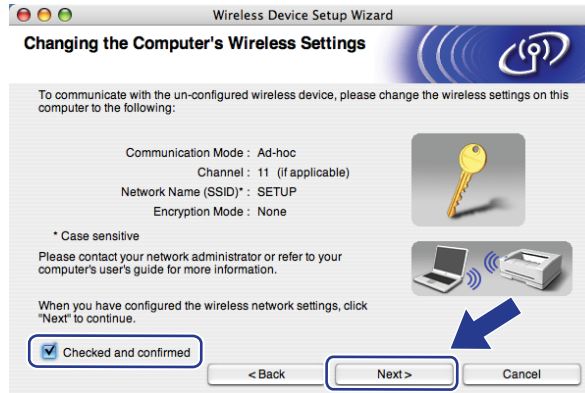

**Note**

You can temporarily change the wireless settings on your computer, following the steps below:

- 1 Click the AirPort status icon.
- 2 Select **SETUP** from the pull-down list.
- 3 Your wireless network is connected successfully.

- 12 Choose the machine you wish to configure, and click **Next**. If the list is blank, check if the machine is powered on, and then click **Refresh**.



**Note**

- The default Node name is "BRWxxxxxxxxxxxx". ("xxxxxxxxxxxx" is your machine's MAC Address / Ethernet Address.)
- You can find your machine's MAC Address / Ethernet Address by printing out the Network Configuration List. See *Printing the Network Configuration List* on page 123.

- 13 The wizard will search for wireless networks available from your machine. Choose the Ad-hoc network you wish to associate the printer with, and then click **Next**.

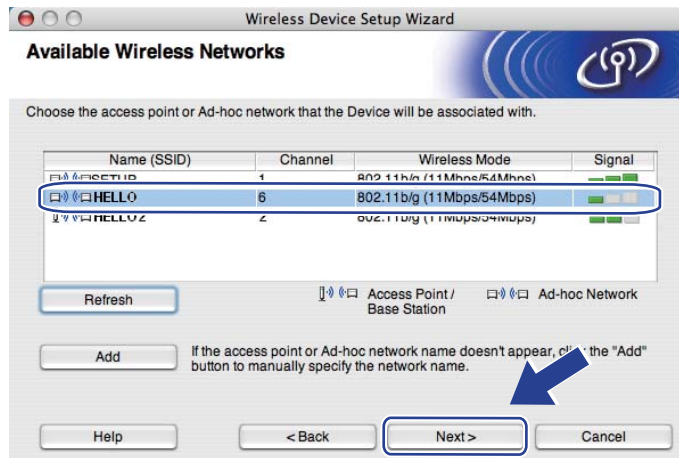

**Note**

- If the list is blank, check if the machine is within range for wireless communication. Then, click **Refresh**.
- If your target Ad-hoc network does not appear on the list, you can manually add it by clicking the **Add** button. Check **This is an Ad-hoc network and there is no access point.**, and then enter the **Name(SSID)** and the **Channel** number, and then click **Next**.

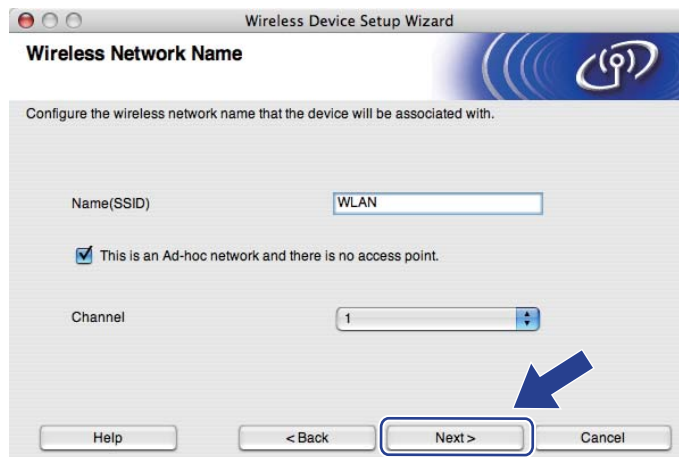

- 14 If your network is not configured for Authentication and Encryption, the following screen will appear. To continue configuration, click **OK** and go to step 16.



- 15 If your network is configured for Authentication and Encryption, the following screen will appear. **When configuring your Brother wireless machine, you must configure your machine to match the Authentication and Encryption settings you wrote down on page 86 for your existing wireless network.** Choose the **Authentication Method** and **Encryption Mode** from the pop-up menu in each setting box. Then enter the **Network Key** and **Confirm Network Key**, and then click **Next**.

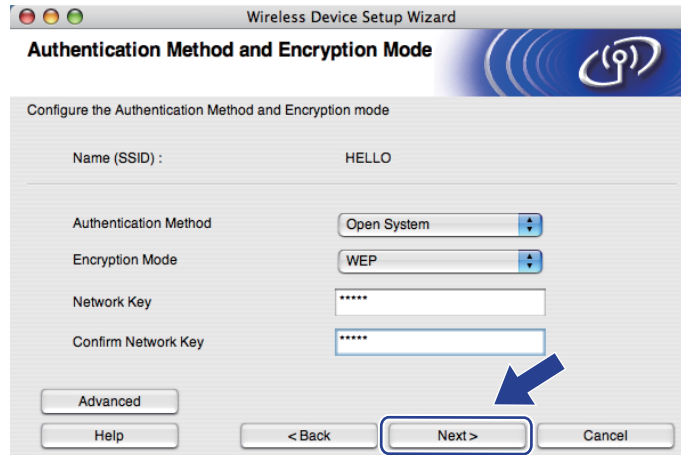

#### Note

- If you want to setup or configure additional WEP key indexes other than WEP key1, click **Advanced**.
- If you do not know the Authentication or Encryption settings for your network, contact your network administrator or the manufacture of your access point / router.
- If you are using WEP and the printed Network Configuration page in step 16 shows Link OK in the **Wireless Link Status**, but the machine is not found, make sure you entered the WEP key correctly. The WEP key is case sensitive.

- 16 Click **Next**. The settings will be sent to your machine. The settings will remain unchanged if you click **Cancel**. The Network Configuration page will be printed.

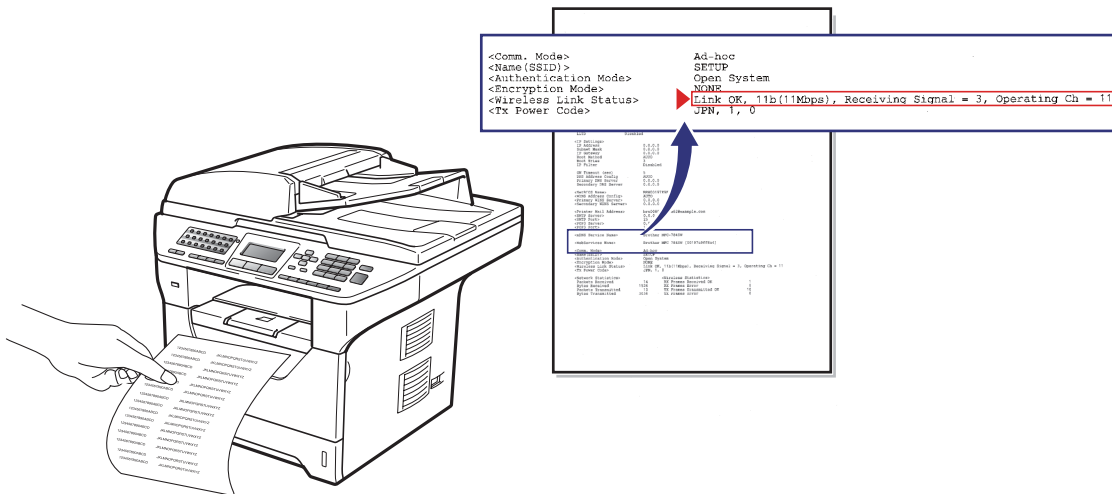
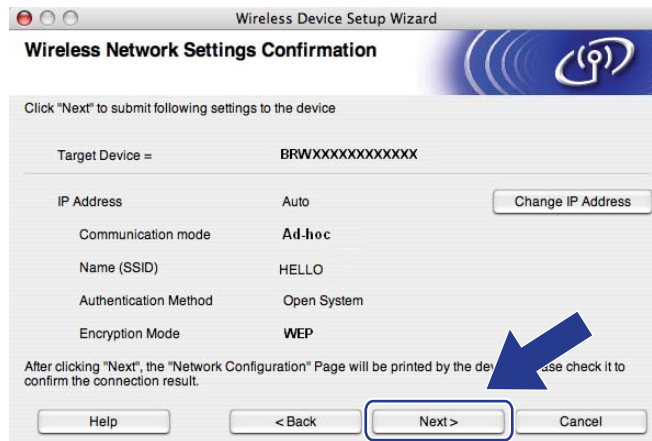

**Note**

If you want to manually enter the IP address settings of your machine, click **Change IP Address** and enter the necessary IP address settings for your network.

- 17 Check the printed Network Configuration page. Choose the status as it is shown for the **Wireless Link Status** on the Network Configuration page. Click **Next**.  
If your status is **"Link OK."**, go to step 19.  
If your status is **"Failed To Associate"**, go to step 18.

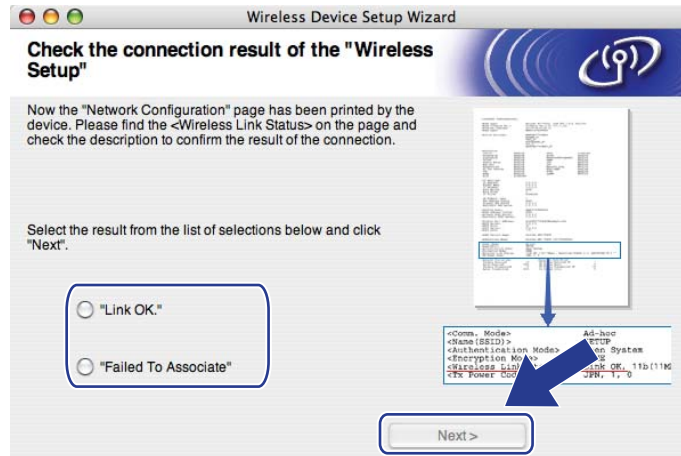

- 18 Click **Finish**. Wireless setup was unable to associate with a wireless network. This is probably due to incorrect security settings. Reset the print server back to its factory default settings. (See *Restoring the network settings to factory default* on pages 123) Confirm the security settings of your wireless network and try starting from step 6 again.



- 19 To communicate with the configured wireless device, you must configure your computer to use the same wireless settings. Manually change the wireless settings on your computer to match the machine's wireless settings shown on this screen. Check the box after you confirm these settings, and then click **Next**.  
(The settings shown on this screen are for example only. Your settings will not be the same.)



- 20 Check the box after you confirm that you have completed the wireless settings, and then click **Finish**.

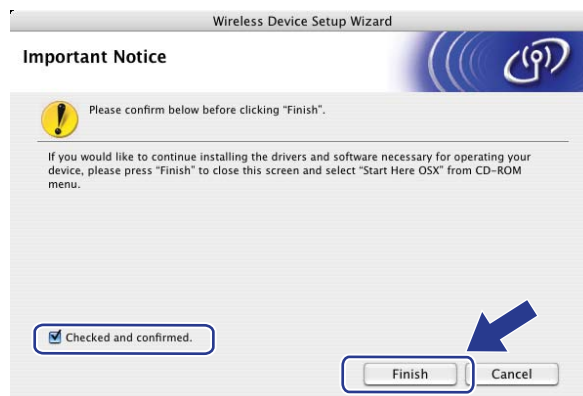

- OK! You have completed the wireless network setup. If you would like to continue installing drivers and software necessary for operating your device, please choose Start Here OSX from the CD-ROM menu.

## Network menu

Before using your Brother product in a network environment, you need to configure the correct TCP/IP settings.

In this chapter, you will learn how to configure the network settings using the control panel, located on the front of the machine.

The **Network** menu selections of the control panel allow you to set up the Brother machine for your network configuration. Press **Menu**, then press **▲** or **▼** to choose **Network**. Proceed to the menu selection you wish to configure. For additional information on the menu, see *Function table and default factory settings* on page 212.

Please note that the machine is supplied with the BRAdmin Light utility and Remote Setup applications, which also can be used to configure many aspects of the network. (See *Changing the print server settings* on page 18.)

## TCP/IP

If you connect the machine with an Ethernet cable to your network, use the **Wired LAN** menu selections. If you connect the machine to a wireless Ethernet network, use the **WLAN** menu selections.

This menu has ten sections: **Boot Method**, **IP Address**, **Subnet Mask**, **Gateway**, **Node Name**, **WINS Config**, **WINS Server**, **DNS Server**, **APIPA** and **IPv6**.

### Boot Method

This selection controls how the machine obtains an IP address. The default setting is **Auto**.



#### Note

If you do not want your print server configured via DHCP, BOOTP or RARP, you must set the **Boot Method** to **Static** so that the print server has a static IP address. This will prevent the print server from trying to obtain an IP address from any of these systems. To change the **Boot Method**, use the machine's control panel, BRAdmin Light utility, Remote Setup or Web Based Management (web browser).

- 1 Press **Menu**.
- 2 Press **▲** or **▼** to choose **Network**.  
Press **OK**.  
(DCP-8080DN, DCP-8085DN, MFC-8480DN, MFC-8680DN and MFC-8880DN) Go to step 4.  
(MFC-8690DW and MFC-8890DW) Go to step 3.
- 3 (MFC-8690DW and MFC-8890DW only)  
(For Wired) Press **▲** or **▼** to choose **Wired LAN**.  
(For Wireless) Press **▲** or **▼** to choose **WLAN**.  
Press **OK**.
- 4 Press **▲** or **▼** to choose **TCP/IP**.  
Press **OK**.



- 5 Press ▲ or ▼ to choose `Boot Method`. Press **OK**.
- 6 Press ▲ or ▼ to choose `Auto`<sup>1</sup>, `Static`<sup>2</sup>, `RARP`<sup>3</sup>, `BOOTP`<sup>4</sup> or `DHCP`<sup>5</sup>. Press **OK**.
  - If you chose `Auto`, `RARP`, `BOOTP` or `DHCP`, go to step 7.
  - If you chose `Static`, go to step 8.
- 7 Enter how many times the machine tries to obtain the IP address. We recommend you to enter 3 or more. Press **OK**.
- 8 Press **Stop/Exit**.

<sup>1</sup> Auto mode

In this mode, the machine will scan the network for a DHCP server, if it can find one, and if the DHCP server is configured to allocate an IP address to the machine, then the IP address supplied by the DHCP server will be used. If no DHCP server is available, then the machine will scan for a BOOTP server. If a BOOTP server is available, and it is configured correctly, the machine will take its IP address from the BOOTP server. If a BOOTP server is not available, the machine will scan for a RARP server. If a RARP server also does not answer, the IP Address is set using the APIPA protocol. After the machine is initially powered ON, it may take a few minutes for the machine to scan the network for a server.

<sup>2</sup> Static mode

In this mode the machine's IP address must be manually assigned. Once entered the IP address is locked to the assigned address.

<sup>3</sup> RARP mode

The Brother print server's IP address can be configured using the Reverse ARP (RARP) facility on your host computer. (For more information on RARP, see *Using RARP to configure the IP address* on page 203.)

<sup>4</sup> BOOTP mode

BOOTP is an alternative to RARP that has the advantage of allowing configuration of the subnet mask and gateway. (For more information on BOOTP, see *Using BOOTP to configure the IP address* on page 202.)

<sup>5</sup> DHCP mode

Dynamic Host Configuration Protocol (DHCP) is one of several automated mechanisms for IP address allocation. If you have a DHCP server in your network (typically a UNIX, Windows® 2000/XP, Windows Vista® network) the print server will automatically obtain its IP address from a DHCP server and register its name with any RFC 1001 and 1002 compliant dynamic name services.



### Note

- If you do not want your print server configured via DHCP, BOOTP or RARP, you must set the BOOT Method to static so that the print server has a static IP address. This will prevent the print server from trying to obtain an IP address from any of these systems. To change the BOOT Method, use the machine's control panel `Network` menu, BRAdmin applications, Remote Setup or Web Based Management (web browser).
- On smaller networks, the DHCP server may be the router.

## IP Address

This field displays the current IP address of the machine. If you have chosen a Boot Method of Static, enter the IP address that you wish to assign to the machine (check with your network administrator for the IP address to use). If you have chosen a method other than Static, the machine will attempt to determine its IP address using the DHCP or BOOTP protocols. The default IP address of your machine will probably be incompatible with the IP address numbering scheme of your network. We recommend that you contact your network administrator for an IP address for the network the unit will be connected on.

- 1 Press **Menu**.
- 2 Press **▲** or **▼** to choose `Network`.  
Press **OK**.  
(DCP-8080DN, DCP-8085DN, MFC-8480DN, MFC-8680DN and MFC-8880DN) Go to step 4.  
(MFC-8690DW and MFC-8890DW) Go to step 3.
- 3 (MFC-8690DW and MFC-8890DW only)  
(For Wired) Press **▲** or **▼** to choose `Wired LAN`.  
(For Wireless) Press **▲** or **▼** to choose `WLAN`.  
Press **OK**.
- 4 Press **▲** or **▼** to choose `TCP/IP`.  
Press **OK**.
- 5 Press **▲** or **▼** to choose `IP Address`.  
Press **OK**.
- 6 Enter the IP address using the dial pad. (To enter numbers and text, see *Entering Text* on page 225.)  
Press **OK**.
- 7 Press **Stop/Exit**.

## Subnet Mask

This field displays the current subnet mask used by the machine. If you are not using DHCP or BOOTP to obtain the subnet mask, enter the desired subnet mask. Check with your network administrator for the subnet mask to use.

- 1 Press **Menu**.
- 2 Press **▲** or **▼** to choose `Network`.  
Press **OK**.  
(DCP-8080DN, DCP-8085DN, MFC-8480DN, MFC-8680DN and MFC-8880DN) Go to step 4.  
(MFC-8690DW and MFC-8890DW) Go to step 3.
- 3 (MFC-8690DW and MFC-8890DW only)  
(For Wired) Press **▲** or **▼** to choose `Wired LAN`.  
(For Wireless) Press **▲** or **▼** to choose `WLAN`.  
Press **OK**.

- 4 Press ▲ or ▼ to choose `TCP/IP`.  
Press **OK**.
- 5 Press ▲ or ▼ to choose `Subnet Mask`.  
Press **OK**.
- 6 Enter the Subnet Mask address using the dial pad. (To enter numbers and text, see *Entering Text* on page 225.)  
Press **OK**.
- 7 Press **Stop/Exit**.

## Gateway

This field displays the current gateway or router address used by the machine. If you are not using DHCP or BOOTP to obtain the gateway or router address, enter the address you wish to assign. If you do not have a gateway or router, leave this field blank. Check with your network administrator if you are unsure.

- 1 Press **Menu**.
- 2 Press ▲ or ▼ to choose `Network`.  
Press **OK**.  
(DCP-8080DN, DCP-8085DN, MFC-8480DN, MFC-8680DN and MFC-8880DN) Go to step 4.  
(MFC-8690DW and MFC-8890DW) Go to step 3.
- 3 (MFC-8690DW and MFC-8890DW only)  
(For Wired) Press ▲ or ▼ to choose `Wired LAN`.  
(For Wireless) Press ▲ or ▼ to choose `WLAN`.  
Press **OK**.
- 4 Press ▲ or ▼ to choose `TCP/IP`.  
Press **OK**.
- 5 Press ▲ or ▼ to choose `Gateway`.  
Press **OK**.
- 6 Enter the Gateway address using the dial pad. (To enter numbers and text, see *Entering Text* on page 225.)  
Press **OK**.
- 7 Press **Stop/Exit**.

## Node Name

You can register the machine name on the Network. This name is often referred to as a NetBIOS name; it will be the name that is registered by the WINS server on your network. Brother recommends the name “BRNxxxxxxxxxxx” for a wired network or “BRWxxxxxxxxxxx” for a wireless network. (“xxxxxxxxxxx” is your machine’s MAC Address / Ethernet Address.)

- 1 Press **Menu**.
- 2 Press **▲** or **▼** to choose `Network`.  
Press **OK**.  
(DCP-8080DN, DCP-8085DN, MFC-8480DN, MFC-8680DN and MFC-8880DN) Go to step 4.  
(MFC-8690DW and MFC-8890DW) Go to step 3.
- 3 (MFC-8690DW and MFC-8890DW only)  
(For Wired) Press **▲** or **▼** to choose `Wired LAN`.  
(For Wireless) Press **▲** or **▼** to choose `WLAN`.  
Press **OK**.
- 4 Press **▲** or **▼** to choose `TCP/IP`.  
Press **OK**.
- 5 Press **▲** or **▼** to choose `Node Name`.  
Press **OK**.
- 6 Press **1** to choose `Change`.
- 7 Enter the Node Name using the dial pad. (To enter numbers and text, see *Entering Text* on page 225.)  
Press **OK**.
- 8 Press **Stop/Exit**.

## WINS Config

This selection controls how the machine obtains the IP address of the WINS server.

- 1 Press **Menu**.
- 2 Press **▲** or **▼** to choose `Network`.  
Press **OK**.  
(DCP-8080DN, DCP-8085DN, MFC-8480DN, MFC-8680DN and MFC-8880DN) Go to step 4.  
(MFC-8690DW and MFC-8890DW) Go to step 3.
- 3 (MFC-8690DW and MFC-8890DW only)  
(For Wired) Press **▲** or **▼** to choose `Wired LAN`.  
(For Wireless) Press **▲** or **▼** to choose `WLAN`.  
Press **OK**.
- 4 Press **▲** or **▼** to choose `TCP/IP`.  
Press **OK**.

- 5 Press ▲ or ▼ to choose `WINS Config`. Press **OK**.
- 6 Press ▲ or ▼ to choose `Auto` or `Static`. Press **OK**.
- 7 Press **Stop/Exit**.

### Auto

Automatically uses a DHCP request to determine the IP addresses for the primary and secondary WINS servers. You must set the BOOT Method to Auto for this feature to work.

### Static

Uses a specified IP address for the primary and secondary WINS servers.

## WINS Server

### Primary WINS Server IP Address

This field specifies the IP address of the primary WINS (Windows® Internet Name Service) server. If set to a non-zero value, the machine will contact this server to register its name with the Windows® Internet Name Service.

### Secondary WINS Server IP Address

This field specifies the IP address of the secondary WINS server. It is used as a backup to the Primary WINS server address. If the Primary server is unavailable, the machine still can register itself with a secondary server. If set to a non-zero value, the machine will contact this server to register its name with the Windows® Internet Name Service. If you have a primary WINS server, but no secondary WINS server, simply leave this field blank.

- 1 Press **Menu**.
- 2 Press ▲ or ▼ to choose `Network`. Press **OK**.  
(DCP-8080DN, DCP-8085DN, MFC-8480DN, MFC-8680DN and MFC-8880DN) Go to step 4.  
(MFC-8690DW and MFC-8890DW) Go to step 3.
- 3 (MFC-8690DW and MFC-8890DW only)  
(For Wired) Press ▲ or ▼ to choose `Wired LAN`.  
(For Wireless) Press ▲ or ▼ to choose `WLAN`. Press **OK**.
- 4 Press ▲ or ▼ to choose `TCP/IP`. Press **OK**.
- 5 Press ▲ or ▼ to choose `WINS Server`. Press **OK**.

- 6 Press ▲ or ▼ to choose `Primary` or `Secondary`. Press **OK**.
- 7 Enter the WINS Server address using the dial pad. (To enter numbers and text, see *Entering Text* on page 225.) Press **OK**.
- 8 Press **Stop/Exit**.

## DNS Server

### Primary DNS Server IP Address

This field specifies the IP address of the primary DNS (Domain Name System) server.

### Secondary DNS Server IP Address

This field specifies the IP address of the secondary DNS server. It is used as a backup to the Primary DNS server address. If the Primary server is unavailable, the machine will contact the Secondary DNS server. If you have a primary DNS server, but no secondary DNS server, simply leave this field blank.

- 1 Press **Menu**.
- 2 Press ▲ or ▼ to choose `Network`. Press **OK**.  
(DCP-8080DN, DCP-8085DN, MFC-8480DN, MFC-8680DN and MFC-8880DN) Go to step 4.  
(MFC-8690DW and MFC-8890DW) Go to step 3.
- 3 (MFC-8690DW and MFC-8890DW only)  
(For Wired) Press ▲ or ▼ to choose `Wired LAN`.  
(For Wireless) Press ▲ or ▼ to choose `WLAN`. Press **OK**.
- 4 Press ▲ or ▼ to choose `TCP/IP`. Press **OK**.
- 5 Press ▲ or ▼ to choose `DNS Server`. Press **OK**.
- 6 Press ▲ or ▼ to choose `Primary` or `Secondary`. Press **OK**.
- 7 Enter the DNS Server address using the dial pad. (To enter numbers and text, see *Entering Text* on page 225.) Press **OK**.
- 8 Press **Stop/Exit**.

## APIPA

The setting of **On** will cause the print server to automatically allocate a Link-Local IP address in the range (169.254.1.0 - 169.254.254.255) when the print server cannot obtain an IP address through the Boot Method you have set. (See *Boot Method* on page 93.) Choosing **Off** means the IP address does not change, when the print server cannot obtain an IP address through the Boot Method you have set.

- 1 Press **Menu**.
- 2 Press **▲** or **▼** to choose **Network**.  
Press **OK**.  
(DCP-8080DN, DCP-8085DN, MFC-8480DN, MFC-8680DN and MFC-8880DN) Go to step 4.  
(MFC-8690DW and MFC-8890DW) Go to step 3.
- 3 (MFC-8690DW and MFC-8890DW only)  
(For Wired) Press **▲** or **▼** to choose **Wired LAN**.  
(For Wireless) Press **▲** or **▼** to choose **WLAN**.  
Press **OK**.
- 4 Press **▲** or **▼** to choose **TCP/IP**.  
Press **OK**.
- 5 Press **▲** or **▼** to choose **APIPA**.  
Press **OK**.
- 6 Press **▲** or **▼** to choose **On** or **Off**.  
Press **OK**.
- 7 Press **Stop/Exit**.

## IPv6

This machine is compatible with IPv6, the next generation internet protocol. If you want to use the IPv6 protocol, choose **On**. The default setting for IPv6 is **Off**. For more information on the IPv6 protocol, visit <http://solutions.brother.com/>.

- 1 Press **Menu**.
- 2 Press **▲** or **▼** to choose **Network**.  
Press **OK**.  
(DCP-8080DN, DCP-8085DN, MFC-8480DN, MFC-8680DN and MFC-8880DN) Go to step 4.  
(MFC-8690DW and MFC-8890DW) Go to step 3.
- 3 (MFC-8690DW and MFC-8890DW only)  
(For Wired) Press **▲** or **▼** to choose **Wired LAN**.  
(For Wireless) Press **▲** or **▼** to choose **WLAN**.  
Press **OK**.
- 4 Press **▲** or **▼** to choose **TCP/IP**.  
Press **OK**.

- 5 Press ▲ or ▼ to choose IPv6.  
Press **OK**.
- 6 Press ▲ or ▼ to choose On or Off.  
Press **OK**.
- 7 Press **Stop/Exit**.

**Note**

- If you set IPv6 to On, turn off the power switch and then turn it back on to enable this protocol.
- After you choose IPv6 On, this setting will be applied to both the wired and wireless LAN interface.

## Ethernet (wired network only)

Ethernet link mode. Auto allows the print server to operate in 100BASE-TX full or half duplex, or in 10BASE-T full or half duplex mode by auto negotiation.

You can fix the server link mode to 100BASE-TX Full Duplex (100B-FD) or Half Duplex (100B-HD) and 10BASE-T Full Duplex (10B-FD) or Half Duplex (10B-HD). This change is valid after the print server has been reset (default is Auto).

**Note**

If you incorrectly set this value, you may not be able to communicate with your print server.

- 1 Press **Menu**.
- 2 Press ▲ or ▼ to choose Network.  
Press **OK**.
- 3 (MFC-8690DW and MFC-8890DW only)  
Press ▲ or ▼ to choose Wired LAN.  
Press **OK**.
- 4 Press ▲ or ▼ to choose Ethernet.  
Press **OK**.
- 5 Press ▲ or ▼ to choose Auto, 100B-FD, 100B-HD, 10B-FD or 10B-HD.  
Press **OK**.
- 6 Press **Stop/Exit**.

## Setup Wizard (MFC-8690DW and MFC-8890DW wireless network only)

The **Setup Wizard** guides you through the wireless network configuration. (For more information, see the *Quick Setup Guide* or *Using the Setup Wizard from the control panel* on page 31.)



## SES/WPS or AOSS™ (MFC-8690DW and MFC-8890DW wireless network only)

If your wireless access point supports either SecureEasySetup™, Wi-Fi Protected Setup (PBC<sup>1</sup>) or AOSS™ (one-push method), you can configure the machine easily without a computer. Your Brother machine has the SES/WPS/AOSS™ menu on the control panel. This feature automatically detects which mode your access point uses, SecureEasySetup™, Wi-Fi Protected Setup or AOSS™. By pushing a button on the wireless access point/router and the machine, you can setup the wireless network and security settings. See the user's guide for your wireless access point/router for instructions on how to access one-push mode. (For more information, see the *Quick Setup Guide* or *Using the SES/WPS or AOSS™ control panel menu to configure your machine for a wireless network (Automatic Wireless mode)* on page 36.)

<sup>1</sup> Push Button Configuration

## WPS w/PIN Code (MFC-8690DW and MFC-8890DW wireless network only)

If your wireless access point supports Wi-Fi Protected Setup (PIN Method), you can configure the machine easily without a computer. The PIN (Personal Identification Number) Method is one of the connection methods developed by the Wi-Fi Alliance®. By inputting a PIN which is created by an Enrollee (your machine) to the Registrar (a device that manages the wireless LAN), you can setup the wireless network and security settings. See the user's guide for your wireless access point/router for instructions on how to access the Wi-Fi Protected Setup mode. (For more information, see *Using the PIN Method of Wi-Fi Protected Setup* on page 39.)

## WLAN Status (MFC-8690DW and MFC-8890DW wireless network only)

### Status

This field displays the current wireless network status; `Active(11b)`, `Active(11g)`, `Wired LAN Active`, `WLAN OFF`, `AOSS Active` or `Connection Fail`.

- 1 Press **Menu**.
- 2 Press **▲** or **▼** to choose `Network`.  
Press **OK**.
- 3 Press **▲** or **▼** to choose `WLAN`.  
Press **OK**.
- 4 Press **▲** or **▼** to choose `WLAN Status`.  
Press **OK**.
- 5 Press **▲** or **▼** to choose `Status`.  
Press **OK**.
- 6 The current wireless network status will be displayed; `Active(11b)`, `Active(11g)`, `Wired LAN Active`, `WLAN OFF`, `AOSS Active` or `Connection Fail`.
- 7 Press **Stop/Exit**.

## Signal

This field displays the current wireless network signal strength; Strong, Medium, Weak or None.

- 1 Press **Menu**.
- 2 Press **▲** or **▼** to choose `Network`.  
Press **OK**.
- 3 Press **▲** or **▼** to choose `WLAN`.  
Press **OK**.
- 4 Press **▲** or **▼** to choose `WLAN Status`.  
Press **OK**.
- 5 Press **▲** or **▼** to choose `Signal`.  
Press **OK**.
- 6 The current wireless network signal strength will be displayed; Strong, Medium, Weak or None.
- 7 Press **Stop/Exit**.

## SSID

This field displays the current wireless network SSID. The display shows up to 32 characters of the SSID name.

- 1 Press **Menu**.
- 2 Press **▲** or **▼** to choose `Network`.  
Press **OK**.
- 3 Press **▲** or **▼** to choose `WLAN`.  
Press **OK**.
- 4 Press **▲** or **▼** to choose `WLAN Status`.  
Press **OK**.
- 5 Press **▲** or **▼** to choose `SSID`.  
Press **OK**.
- 6 The current wireless network SSID will be displayed.
- 7 Press **Stop/Exit**.

## Comm.Mode

This field displays the current wireless network communication mode; Ad-hoc or Infrastructure.

- 1 Press **Menu**.
- 2 Press **▲** or **▼** to choose `Network`.  
Press **OK**.
- 3 Press **▲** or **▼** to choose `WLAN`.  
Press **OK**.
- 4 Press **▲** or **▼** to choose `WLAN Status`.  
Press **OK**.
- 5 Press **▲** or **▼** to choose `Comm. Mode`.  
Press **OK**.
- 6 The current wireless network communication mode will be displayed; Ad-hoc or Infrastructure.
- 7 Press **Stop/Exit**.

## Set to Default (MFC-8690DW and MFC-8890DW only)

---

The `Set to Default` allows you to reset each wired or wireless settings to the factory default. If you want to reset both wired and wireless settings, see *Restoring the network settings to factory default* on page 123.

- 1 Press **Menu**.
- 2 Press **▲** or **▼** to choose `Network`.  
Press **OK**.
- 3 (For Wired) Press **▲** or **▼** to choose `Wired LAN`.  
(For Wireless) Press **▲** or **▼** to choose `WLAN`.  
Press **OK**.
- 4 Press **▲** or **▼** to choose `Set to Default`.  
Press **OK**.
- 5 Press **1** to choose `Reset`.
- 6 Press **Stop/Exit**.

## Wired Enable (MFC-8690DW and MFC-8890DW wired network only)

---

If you want to use the wired network connection, set `Wired Enable` to `On`.

- 1 Press **Menu**.
- 2 Press **▲** or **▼** to choose `Network`.  
Press **OK**.
- 3 Press **▲** or **▼** to choose `Wired LAN`.  
Press **OK**.
- 4 Press **▲** or **▼** to choose `Wired Enable`.  
Press **OK**.
- 5 Press **▲** or **▼** to choose `On` or `Off`.  
Press **OK**.
- 6 Press **Stop/Exit**.

## WLAN Enable (MFC-8690DW and MFC-8890DW wireless network only)

---

If you want to use the wireless network connection, set `WLAN Enable` to `On`.

- 1 Press **Menu**.
- 2 Press **▲** or **▼** to choose `Network`.  
Press **OK**.
- 3 Press **▲** or **▼** to choose `WLAN`.  
Press **OK**.
- 4 Press **▲** or **▼** to choose `WLAN Enable`.  
Press **OK**.
- 5 Press **▲** or **▼** to choose `On` or `Off`.  
Press **OK**.
- 6 Press **Stop/Exit**.

## E-mail / IFAX (MFC-8690DW, MFC-8880DN and MFC-8890DW only)

This menu has five selections: Mail Address, Setup Server, Setup Mail RX, Setup Mail TX and Setup Relay. As this section requires you to enter a lot of text characters, you may find that it is more convenient to use Web Based Management and your favorite web browser to configure these settings. (see *Web Based Management* on page 141) These settings must be configured for the IFAX feature to work. (For more details about Internet fax, see *Internet fax and Scan to E-mail (E-mail server)* (For MFC-8690DW, MFC-8880DN and MFC-8890DW) on page 154.)

You can also access the character you want by repeatedly pressing the appropriate number key using the machine's control panel. (For more information, see *Entering Text* on page 225.)

### Mail Address

- 1 Press **Menu**.
- 2 Press **▲** or **▼** to choose `Network`.  
Press **OK**.
- 3 Press **▲** or **▼** to choose `E-mail/IFAX`.  
Press **OK**.
- 4 Press **▲** or **▼** to choose `Mail Address`.  
Press **OK**.
- 5 Press **1** to change. Enter the mail address. (up to 60 characters)  
Press **OK**.
- 6 Press **Stop/Exit**.

### Setup Server

#### SMTP Server

This field displays the node name or IP address of an SMTP mail server (outgoing E-mail server) on your network.

(Ex, "mailhost.brothermail.net" or "192.000.000.001")

- 1 Press **Menu**.
- 2 Press **▲** or **▼** to choose `Network`.  
Press **OK**.
- 3 Press **▲** or **▼** to choose `E-mail/IFAX`.  
Press **OK**.
- 4 Press **▲** or **▼** to choose `Setup Server`.  
Press **OK**.
- 5 Press **▲** or **▼** to choose `SMTP Server`.  
Press **OK**.

- 6 Press ▲ or ▼ to choose `Name?` or `IP Address?`.  
Press **OK**.
- 7 Enter the SMTP server address (up to 64 characters).  
Press **OK**.
- 8 Press **Stop/Exit**.

### SMTP Port

This field displays the SMTP port number (for outgoing E-mails) on your network.

- 1 Press **Menu**.
- 2 Press ▲ or ▼ to choose `Network`.  
Press **OK**.
- 3 Press ▲ or ▼ to choose `E-mail/IFAX`.  
Press **OK**.
- 4 Press ▲ or ▼ to choose `Setup Server`.  
Press **OK**.
- 5 Press ▲ or ▼ to choose `SMTP Port`.  
Press **OK**.
- 6 Enter the SMTP port number.  
Press **OK**.
- 7 Press **Stop/Exit**.

### Auth. for SMTP

You can specify the security method for E-mail notification. (For details on security the methods for E-mail notification, see *Security methods for E-mail notification* on page 165.)

- 1 Press **Menu**.
- 2 Press ▲ or ▼ to choose `Network`.  
Press **OK**.
- 3 Press ▲ or ▼ to choose `E-mail/IFAX`.  
Press **OK**.
- 4 Press ▲ or ▼ to choose `Setup Server`.  
Press **OK**.
- 5 Press ▲ or ▼ to choose `Auth. for SMTP`.  
Press **OK**.

- 6 Press ▲ or ▼ to choose `None`, `SMTP-AUTH` or `POP bef. SMTP`. Press **OK**.
- 7 If you chose `None` or `POP bef. SMTP` in step 6, go to step 11. If you chose `SMTP-AUTH` in step 6, go to step 8.
- 8 Enter the account name for SMTP authentication. Press **OK**.
- 9 Enter the account password for SMTP authentication. Press **OK**.
- 10 Enter the account password again. Press **OK**.
- 11 Press **Stop/Exit**.

### POP3 Server

This field displays the node name or IP address of the POP3 server (incoming E-mail server) used by the Brother machine. This address is necessary for the Internet fax features to function correctly.

(Ex, "mailhost.brothermail.net" or "192.000.000.001")

- 1 Press **Menu**.
- 2 Press ▲ or ▼ to choose `Network`. Press **OK**.
- 3 Press ▲ or ▼ to choose `E-mail/IFAX`. Press **OK**.
- 4 Press ▲ or ▼ to choose `Setup Server`. Press **OK**.
- 5 Press ▲ or ▼ to choose `POP3 Server`. Press **OK**.
- 6 Press ▲ or ▼ to choose `Name?` or `IP Address?`. Press **OK**.
- 7 Enter the POP3 server address (up to 64 characters). Press **OK**.
- 8 Press **Stop/Exit**.

### POP3 Port

This field displays the POP3 port number (for incoming E-mails) used by the Brother machine.

- 1 Press **Menu**.
- 2 Press **▲** or **▼** to choose `Network`.  
Press **OK**.
- 3 Press **▲** or **▼** to choose `E-mail/IFAX`.  
Press **OK**.
- 4 Press **▲** or **▼** to choose `Setup Server`.  
Press **OK**.
- 5 Press **▲** or **▼** to choose `POP3 Port`.  
Press **OK**.
- 6 Enter the POP3 port number.  
Press **OK**.
- 7 Press **Stop/Exit**.

### Mailbox Name

You can specify a mailbox name on the POP3 server where the internet print jobs are to be retrieved.

- 1 Press **Menu**.
- 2 Press **▲** or **▼** to choose `Network`.  
Press **OK**.
- 3 Press **▲** or **▼** to choose `E-mail/IFAX`.  
Press **OK**.
- 4 Press **▲** or **▼** to choose `Setup Server`.  
Press **OK**.
- 5 Press **▲** or **▼** to choose `Mailbox Name`.  
Press **OK**.
- 6 Enter the user account name assigned to the Brother machine that will login to the POP3 server (up to 60 characters).  
Press **OK**.
- 7 Press **Stop/Exit**.



### Mailbox Pwd

You can specify the password for the POP3 server account where the internet print jobs are to be retrieved.

- 1 Press **Menu**.
- 2 Press **▲** or **▼** to choose `Network`.  
Press **OK**.
- 3 Press **▲** or **▼** to choose `E-mail/IFAX`.  
Press **OK**.
- 4 Press **▲** or **▼** to choose `Setup Server`.  
Press **OK**.
- 5 Press **▲** or **▼** to choose `Mailbox Pwd`.  
Press **OK**.
- 6 Enter the user password assigned to the machine that will login to the POP3 server (up to 32 characters).  
Please note that this password is case sensitive.  
Press **OK**.
- 7 Enter the password again.  
Press **OK**.
- 8 Press **Stop/Exit**.



#### Note

---

To set for no password, enter a single space.

---

### APOP

You can enable or disable the APOP (Authenticated Post Office Protocol).

- 1 Press **Menu**.
- 2 Press **▲** or **▼** to choose `Network`.  
Press **OK**.
- 3 Press **▲** or **▼** to choose `E-mail/IFAX`.  
Press **OK**.
- 4 Press **▲** or **▼** to choose `Setup Server`.  
Press **OK**.
- 5 Press **▲** or **▼** to choose `APOP`.  
Press **OK**.
- 6 Press **▲** or **▼** to choose `On` or `Off`.  
Press **OK**.
- 7 Press **Stop/Exit**.

## Setup Mail RX

### Auto Polling

When set to **On**, the machine automatically checks the POP3 server for new messages.

- 1 Press **Menu**.
- 2 Press **▲** or **▼** to choose **Network**.  
Press **OK**.
- 3 Press **▲** or **▼** to choose **E-mail/IFAX**.  
Press **OK**.
- 4 Press **▲** or **▼** to choose **Setup Mail RX**.  
Press **OK**.
- 5 Press **▲** or **▼** to choose **Auto Polling**.  
Press **OK**.
- 6 Press **▲** or **▼** to choose **On** or **Off**.  
Press **OK**.
- 7 Press **Stop/Exit**.

### Poll Frequency

Sets the interval for checking for new messages on the POP3 server (default is 10Min).

- 1 Press **Menu**.
- 2 Press **▲** or **▼** to choose **Network**.  
Press **OK**.
- 3 Press **▲** or **▼** to choose **E-mail/IFAX**.  
Press **OK**.
- 4 Press **▲** or **▼** to choose **Setup Mail RX**.  
Press **OK**.
- 5 Press **▲** or **▼** to choose **Poll Frequency**.  
Press **OK**.
- 6 Enter the polling frequency (up to 60 minutes).  
Press **OK**.
- 7 Press **Stop/Exit**.

## Header

This selection allows the contents of the mail header to be printed when the received message is printed.

- 1 Press **Menu**.
- 2 Press **▲** or **▼** to choose `Network`.  
Press **OK**.
- 3 Press **▲** or **▼** to choose `E-mail/IFAX`.  
Press **OK**.
- 4 Press **▲** or **▼** to choose `Setup Mail RX`.  
Press **OK**.
- 5 Press **▲** or **▼** to choose `Header`.  
Press **OK**.
- 6 Press **▲** or **▼** to choose `All, Subject+From+To` or `None`.  
Press **OK**.
- 7 Press **Stop/Exit**.

## Del Error Mail

When set to `On`, the machine automatically deletes error mails that the machine cannot receive from the POP server.

- 1 Press **Menu**.
- 2 Press **▲** or **▼** to choose `Network`.  
Press **OK**.
- 3 Press **▲** or **▼** to choose `E-mail/IFAX`.  
Press **OK**.
- 4 Press **▲** or **▼** to choose `Setup Mail RX`.  
Press **OK**.
- 5 Press **▲** or **▼** to choose `Del Error Mail`.  
Press **OK**.
- 6 Press **▲** or **▼** to choose `On` or `Off`.  
Press **OK**.
- 7 Press **Stop/Exit**.

## Notification

The notification feature allows a confirmation of receipt message to be transmitted to the sending station when the Internet Fax has been received.

This feature only works on Internet Fax machines that support the “MDN” specification.

- 1 Press **Menu**.
- 2 Press **▲** or **▼** to choose `Network`.  
Press **OK**.
- 3 Press **▲** or **▼** to choose `E-mail/IFAX`.  
Press **OK**.
- 4 Press **▲** or **▼** to choose `Setup Mail RX`.  
Press **OK**.
- 5 Press **▲** or **▼** to choose `Notification`.  
Press **OK**.
- 6 Press **▲** or **▼** to choose `On, MDN or Off`.  
Press **OK**.
- 7 Press **Stop/Exit**.

## Setup Mail TX

### Sender Subject

This field displays the subject that is attached to the Internet fax data being sent from the Brother machine to a computer (default is “Internet Fax Job”).

- 1 Press **Menu**.
- 2 Press **▲** or **▼** to choose `Network`.  
Press **OK**.
- 3 Press **▲** or **▼** to choose `E-mail/IFAX`.  
Press **OK**.
- 4 Press **▲** or **▼** to choose `Setup Mail TX`.  
Press **OK**.
- 5 Press **▲** or **▼** to choose `Sender Subject`.  
Press **OK**.
- 6 If you want to change the Sender Subject, press **1** to choose `Change` to change the Sender Subject.  
Go to step 7.  
If you don't want to change the Sender Subject, press **2** to choose `Exit`.  
Go to step 8.
- 7 Enter the subject information (up to 40 characters).  
Press **OK**.
- 8 Press **Stop/Exit**.

### Size Limit

Some E-mail servers do not allow you to send large E-mail documents (the System Administrator will often place a limit on the maximum E-mail size). With this function enabled, the machine will display `Out of Memory` when trying to send E-mail documents over 1 Mbyte in size. The document will not be sent and an error report will be printed. The document you are sending should be separated into smaller documents that will be accepted by the mail server. (For your information, a 42 page document based on the ITU-T Test Chart #1 test chart is approximately 1 Mbyte in size.)

- 1 Press **Menu**.
- 2 Press **▲** or **▼** to choose `Network`.  
Press **OK**.
- 3 Press **▲** or **▼** to choose `E-mail/IFAX`.  
Press **OK**.
- 4 Press **▲** or **▼** to choose `Setup Mail TX`.  
Press **OK**.
- 5 Press **▲** or **▼** to choose `Size Limit`.  
Press **OK**.
- 6 Press **▲** or **▼** to choose `On or Off`.  
Press **OK**.
- 7 Press **Stop/Exit**.

### Notification

The notification feature allows a confirmation of receipt message to be transmitted to the sending station when the Internet Fax has been received.

This feature only works on Internet Fax machines that support the “MDN” specification.

- 1 Press **Menu**.
- 2 Press **▲** or **▼** to choose `Network`.  
Press **OK**.
- 3 Press **▲** or **▼** to choose `E-mail/IFAX`.  
Press **OK**.
- 4 Press **▲** or **▼** to choose `Setup Mail TX`.  
Press **OK**.
- 5 Press **▲** or **▼** to choose `Notification`.  
Press **OK**.
- 6 Press **▲** or **▼** to choose `On or Off`.  
Press **OK**.
- 7 Press **Stop/Exit**.

## Setup Relay

### Rly Broadcast

This function allows the machine to receive a document over the Internet, and then relay it to other fax machines through conventional analog landlines.

- 1 Press **Menu**.
- 2 Press ▲ or ▼ to choose `Network`.  
Press **OK**.
- 3 Press ▲ or ▼ to choose `E-mail/IFAX`.  
Press **OK**.
- 4 Press ▲ or ▼ to choose `Setup Relay`.  
Press **OK**.
- 5 Press ▲ or ▼ to choose `Rly Broadcast`.  
Press **OK**.
- 6 Press ▲ or ▼ to choose `On or Off`.  
Press **OK**.
- 7 Press **Stop/Exit**.

### Relay Domain

You can register the Domain Names (Max. 10) that are allowed to request a Relay Broadcast.

- 1 Press **Menu**.
- 2 Press ▲ or ▼ to choose `Network`.  
Press **OK**.
- 3 Press ▲ or ▼ to choose `E-mail/IFAX`.  
Press **OK**.
- 4 Press ▲ or ▼ to choose `Setup Relay`.  
Press **OK**.
- 5 Press ▲ or ▼ to choose `Relay Domain`.  
Press **OK**.
- 6 Press ▲ or ▼ to choose `Relay (01 - 10)`.  
Press **OK**.
- 7 Enter the Relay Domain name for the Domain that is being allowed to request a Relay Broadcast.  
Press **OK**.
- 8 Press **Stop/Exit**.

## Relay Report

A Relay Broadcast Report can be printed at the machine that will act as a Relay Station for all Relay Broadcasts.

Its primary function is to print reports of any relayed broadcasts that have been sent through the machine. Please note: In order to use this function, you must assign the relay domain in the “Trusted Domains” section of the Relay function settings.

- 1 Press **Menu**.
- 2 Press **▲** or **▼** to choose `Network`.  
Press **OK**.
- 3 Press **▲** or **▼** to choose `E-mail/IFAX`.  
Press **OK**.
- 4 Press **▲** or **▼** to choose `Setup Relay`.  
Press **OK**.
- 5 Press **▲** or **▼** to choose `Relay Report`.  
Press **OK**.
- 6 Press **▲** or **▼** to choose `On or Off`.  
Press **OK**.
- 7 Press **Stop/Exit**.



### Note

---

For more information on Relay Broadcast, see *Relay broadcast from a computer* on page 159.

---

## How to set a new default for Scan to E-mail (E-mail server) (MFC-8690DW, MFC-8880DN and MFC-8890DW only)

---

You can choose the default color file type for the Scan to E-mail (E-mail server) function. (For the details on how to operate Scan to E-mail (E-mail server), see *Internet fax and Scan to E-mail (E-mail server) (For MFC-8690DW, MFC-8880DN and MFC-8890DW)* on page 154.)

- 1 Press **Menu**.
- 2 Press **▲** or **▼** to choose `Network`.  
Press **OK**.
- 3 Press **▲** or **▼** to choose `Scan to E-mail`.  
Press **OK**.
- 4 Press **▲** or **▼** to choose `Color 100 dpi, Color 200 dpi, Color 300 dpi, Color 600 dpi, Gray 100 dpi, Gray 200 dpi, Gray 300 dpi, B&W 200 dpi` or `B&W 200x100 dpi`.  
Press **OK**.
- 5 If you chose `Color 100 dpi, Color 200 dpi, Color 300 dpi, Color 600 dpi, Gray 100 dpi, Gray 200 dpi` or `Gray 300 dpi` in step 4, press **▲** or **▼** to choose `PDF, Secure PDF, JPEG` or `XPS`.  
If you chose `B&W 200 dpi` or `B&W 200x100 dpi` in step 4, press **▲** or **▼** to choose `PDF, Secure PDF` or `TIFF`.  
Press **OK**.
- 6 Press **Stop/Exit**.



## How to set a new default for Scan to FTP

---

You can choose the default color file type for the Scan to FTP function.

- 1 Press **Menu**.
- 2 Press **▲** or **▼** to choose `Network`.  
Press **OK**.
- 3 Press **▲** or **▼** to choose `Scan to FTP`.  
Press **OK**.
- 4 Press **▲** or **▼** to choose `Color 100 dpi`, `Color 200 dpi`, `Color 300 dpi`, `Color 600 dpi`, `Gray 100 dpi`, `Gray 200 dpi`, `Gray 300 dpi`, `B&W 200 dpi` or `B&W 200x100 dpi`.  
Press **OK**.
- 5 If you chose `Color 100 dpi`, `Color 200 dpi`, `Color 300 dpi`, `Color 600 dpi`, `Gray 100 dpi`, `Gray 200 dpi` or `Gray 300 dpi` in step 4, press **▲** or **▼** to choose `PDF`, `Secure PDF`, `JPEG` or `XPS`.  
If you chose `B&W 200 dpi` or `B&W 200x100 dpi` in step 4, press **▲** or **▼** to choose `PDF`, `Secure PDF` or `TIFF`.  
Press **OK**.
- 6 Press **Stop/Exit**.



### Note

For how to operate Scan to FTP, see *Network Scanning* in the *Software User's Guide* on the CD-ROM we have provided with the machine.

---

## How to set a new default for Scan to Network

---

You can choose the default color and file type for the Scan to Network function to scan a document directly to a server supporting CIFS on your local network or on the internet. (For the CIFS protocol, see *Protocols* on page 8.)

- 1 Press **Menu**.
- 2 Press **▲** or **▼** to choose `Network`.  
Press **OK**.
- 3 Press **▲** or **▼** to choose `ScanTo Network`.  
Press **OK**.
- 4 Press **▲** or **▼** to choose `Color 100 dpi`, `Color 200 dpi`, `Color 300 dpi`, `Color 600 dpi`, `Gray 100 dpi`, `Gray 200 dpi`, `Gray 300 dpi`, `B&W 200 dpi` or `B&W 200x100 dpi`.  
Press **OK**.
- 5 If you chose `Color 100 dpi`, `Color 200 dpi`, `Color 300 dpi`, `Color 600 dpi`, `Gray 100 dpi`, `Gray 200 dpi` or `Gray 300 dpi` in step 4, press **▲** or **▼** to choose `PDF`, `Secure PDF`, `JPEG` or `XPS`.  
If you chose `B&W 200 dpi` or `B&W 200x100 dpi` in step 4, press **▲** or **▼** to choose `PDF`, `Secure PDF` or `TIFF`.  
Press **OK**.
- 6 Press **Stop/Exit**.



### Note

---

For how to operate Scan to Network, see *Network Scanning* in the *Software User's Guide* on the CD-ROM we have provided with the machine.

---

## Fax to Server (For MFC-8690DW, MFC-8880DN and MFC-8890DW)

The Fax to Server feature allows the machine to scan a document and send it over the network to a separate fax server. The document will then be sent from the server as fax data to the destination fax number over standard phone lines. When the Fax to Server feature is set to **On** all automatic fax transmissions from the machine will be sent to the fax server for fax transmission. You can continue to send a fax directly from the machine using the manual fax feature.

To send a document to the fax server the correct syntax for that server must be used. The destination fax number must be sent with a prefix and a suffix that match the parameters used by the fax server. In most cases the syntax for the prefix is "fax=" and the syntax for the suffix would be the domain name of the fax server E-mail gateway. The suffix must also include the "@" symbol at the beginning of the suffix. The prefix and the suffix information must be stored in the machine before you can use the fax to server function. Destination fax numbers can be saved in the One Touch or Speed Dial locations or entered using the dial pad (up to 20 digit numbers). For example if you wanted to send a document to a destination fax number of 123-555-0001 the following syntax would be used.



### Note

Your fax server application must support an E-mail gateway.

## Setting Fax to Server to On

You can store the prefix/suffix address for the fax server in the machine.

- 1 Press **Menu**.
- 2 Press **▲** or **▼** to choose **Network**.  
Press **OK**.
- 3 Press **▲** or **▼** to choose **Fax to Server**.  
Press **OK**.
- 4 Press **▲** or **▼** to choose **On**.  
Press **OK**.
- 5 Press **▲** or **▼** to choose **Prefix**.  
Press **OK**.
- 6 Enter the prefix using dial pad.
- 7 Press **OK**.
- 8 Press **▲** or **▼** to choose **Suffix**.  
Press **OK**.

- 9 Enter the suffix using dial pad.
- 10 Press **OK**.
- 11 Press **Stop/Exit**.

**Note**

---

You can enter the prefix and suffix address using up to a total of 40 characters.

---

### How to operate Fax to Server

- 1 Place the document in the ADF or on the scanner glass.
- 2 Enter the fax number.
- 3 The machine will send the message over a TCP/IP network to the fax server.

## Time Zone

---

This field displays your country time zone. The time shown is the time difference between your country and Greenwich Mean Time. For example, the Time Zone for Eastern Time in the USA and Canada is UTC-05:00.

- 1 Press **Menu**.
- 2 Press **▲** or **▼** to choose `Network`. Press **OK**.
- 3 Press **▲** or **▼** to choose `Time Zone`. Press **OK**.
- 4 Press **▲** or **▼** to choose the time. Press **OK**.
- 5 Press **Stop/Exit**.

### Windows® Time Zone setting

You can see the time difference for your country by using the Time Zone setting in Windows®.

- 1 Windows Vista®:  
Click the  button, **Control Panel**, **Date and Time**, and then **Change time zone**.  
Windows® XP and Windows Server® 2003/2008:  
Click the **Start button**, **Control Panel**, **Date and Time**, and then choose **Time Zone**.  
Windows® 2000:  
Click the **Start button**, **Settings**, **Control Panel**, **Date/Time**, and then choose **Time Zone**.
- 2 Change the date and time. Verify your time zone settings from the pull-down menu (this menu displays the time difference from GMT).

## Restoring the network settings to factory default

If you wish to reset the print server back to its default factory settings (resetting all information such as the password and IP address information), please follow these steps:



### Note

This function restores all wired and wireless network settings to the factory default.

- 1 Press **Menu**.
- 2 Press **▲** or **▼** to choose `Network`.  
Press **OK**.
- 3 Press **▲** or **▼** to choose `Network Reset`.  
Press **OK**.
- 4 Press **1** to choose `Reset`.
- 5 Press **1** to choose `Yes` for reboot.
- 6 The machine will re-start. You can now reconnect the network cable and configure the network settings to work with your network.

6

## Printing the Network Configuration List



### Note

Node name: Node name appears on the Network Configuration List. The default node name is “BRNxxxxxxxxxxx” for a wired network or “BRWxxxxxxxxxxx” for a wireless network. (“xxxxxxxxxxx” is your machine’s MAC Address / Ethernet Address.)

The Network Configuration List prints a report listing all the current network configuration including the network print server settings.

- 1 Press **Menu**.
- 2 (For MFC model) Press **▲** or **▼** to choose `Print Reports`.  
(For DCP model) Press **▲** or **▼** to choose `Machine Info..`  
Press **OK**.
- 3 Press **▲** or **▼** to choose `Network Config`.  
Press **OK**.
- 4 Press **Start**.



### Note

If the **IP Address** on the Network Configuration List shows **0.0.0.0**, wait for one minute and try again.

# 7

## Driver Deployment Wizard (Windows<sup>®</sup> only)

### Overview

The Driver Deployment Wizard software can be used to ease the installation or even automate the installation of a locally connected or network connected printer. The Driver Deployment Wizard can also be used to create self running executable files which when run on a remote PC, completely automates the installation of a printer driver. The remote PC does not have to be connected to a network.

### Connection methods

The Driver Deployment Wizard supports the two connection methods.

#### Peer-to-peer

The device is connected to the network but each user prints directly to the printer WITHOUT printing through a central queue.

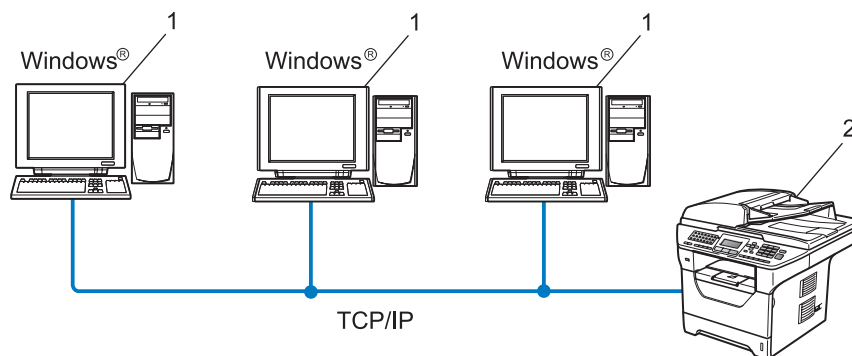

- 1 Client computer
- 2 Network printer (your machine)

## Network Shared

The device is connected to a network and a central print queue is used to manage all print jobs.

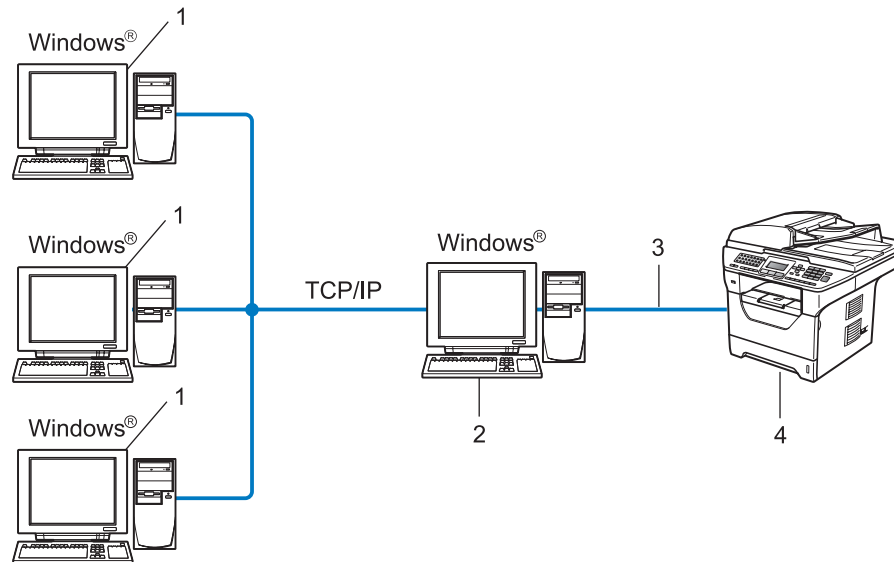

- 1 Client computer
- 2 Also known as “Server” or “Print Server”
- 3 TCP/IP, USB or parallel
- 4 Printer (your machine)

## How to install the Driver Deployment Wizard software

- 1 Put the supplied CD-ROM into your CD-ROM drive. If the model name screen appears, choose your machine. If the language screen appears, choose your language.
- 2 The CD-ROM main menu will appear. Click **Network Utilities**.
- 3 Choose the **Driver Deployment Wizard** installation program.



### Note

For Windows Vista®, when the **User Account Control** screen appears, click **Continue**.

- 4 Click **Next** in response to the Welcome message.
- 5 Read the License Agreement carefully. Then follow the on-screen instructions.
- 6 Click **Finish**. Now the Driver Deployment Wizard software has been installed.



## Using the Driver Deployment Wizard software

- 1 When you run the Wizard for the first time you will see a welcome screen. Click **Next**.
- 2 Choose **MFC**, and then click **Next**.
- 3 Choose your connection type to the machine that you want to print to.
- 4 Choose the option you require, and follow the on-screen instructions.  
If you choose **Brother Peer-to-Peer Network Printer**, the following screen is displayed.

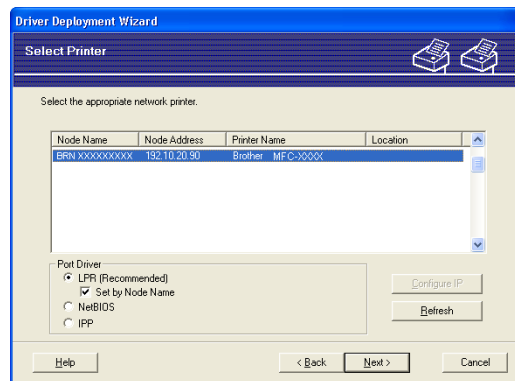

### ■ Setting the IP Address

If the printer does not have an IP address, the Wizard will allow you to change the IP address by selecting the printer from the list and by selecting the **Configure IP** option. A dialog box then appears which allows you to specify information such as the IP address, subnet mask and also the gateway address.

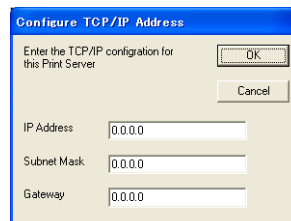

- 5 Choose the printer driver if you wish to install.
- If the printer driver you wish to use is installed on your computer:
 

Check the box of **Currently installed drivers** and choose the printer you wish to install, and then click **Next**.
  - If the driver you wish to use is not installed on your computer:
    - 1 Click **Have Disk...**
    - 2 Choose the OS you wish to use, and then click **OK**.
    - 3 Click **Browse...** and choose the appropriate printer driver that is contained in the CD-ROM or in the network share. Click **Open**.
    - 4 For example, choose the “X:\driver\win2kxpvista<sup>1</sup>\your language” folder (where X is your drive letter). Click **OK**.

<sup>1</sup> **win2kxpvista** folder for 32-bit OS users and **winpx64vista64** folder for 64-bit OS users

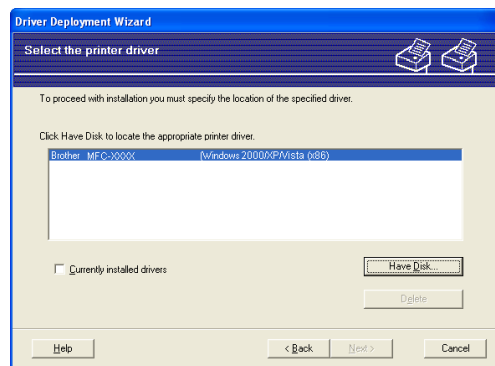

- 6 Click **Next** after you choose the correct driver.
- 7 A summary screen will appear. Confirm the settings of the driver.

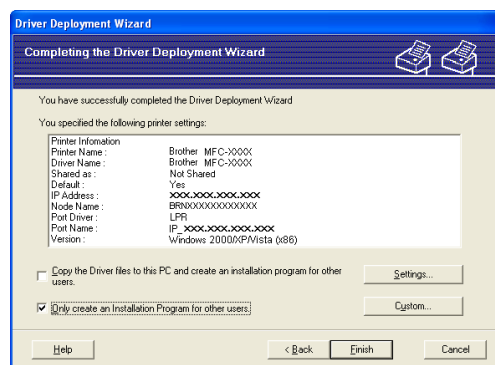

### ■ Creating an executable file

The Driver Deployment Wizard software can also be used to create self running .EXE files. These self-running .EXE files can be saved to the network, copied to a CD-ROM, USB Flash memory drive or even E-mailed to another user. Once run, the driver and its settings are automatically installed without any user intervention.

- **Copy the Driver files to this PC and create an installation program for other users.**

Choose this option if you wish to install the driver onto your computer and also create a self-running executable file for use with another computer using the same operating system as your own.

- **Only create an Installation Program for other users.**

Choose this option if the driver is already installed on your computer and you wish to create a self-running executable file without installing the driver again on your own computer.

**Note**

- If you work in a "queue" based network and you create an executable file for another user who does not have access to the same printer queue that you define into the executable file, the driver when installed on the remote computer will default to LPT1 printing.
- If you check the box of **Currently installed drivers** in step ⑤, you can change the default settings of the printer driver, such as paper size by clicking **Custom...**

- 
- ⑧ Click **Finish**. The driver is automatically installed to your computer.

## Overview

To connect your machine to your network, you need to follow the steps in the *Quick Setup Guide*. We recommend that you use the Brother installer application on the CD-ROM which we have provided with the machine. By using this application, you can easily connect your machine to your network and install the network software and printer driver which you need to complete the configuration of your printer for a network. You will be guided by the on-screen instructions until you are able to use your Brother network machine.

If you are a Windows<sup>®</sup> user and want to configure your machine without using the Brother installer application, use the TCP/IP protocol in a Peer-to-Peer environment. Please follow the instructions in this chapter. This chapter explains how to install the network software and the printer driver which you will need to be able to print using your network machine.



### Note

- You must configure the IP address on your machine before you proceed with this chapter. If you need to configure the IP address, see *Setting the IP address and subnet mask* on page 15 first.
- Verify the host computer and the machine are either on the same subnet, or that the router is properly configured to pass data between the two devices.
- If you are connecting to a Network Print Queue or Share (printing only), see *Installation when using a Network Print Queue or Share (printer driver only)* on page 208 for installation details.
- The default password for Brother print server is “**access**”.

## Configuring the standard TCP/IP port

### Printer driver not yet installed

---

- 1 Put the supplied CD-ROM into your CD-ROM drive. If the model name screen appears, choose your machine. If the language screen appears, choose your language.
- 2 The CD-ROM main menu will appear. Click **Initial Installation**.
- 3 Click **Printer Driver Only (for Network)**.
- 4 Click **Next** in response to the Welcome message. Follow the on-screen instructions.
- 5 Choose **Standard Installation** and click **Next**.
- 6 Choose **Brother Peer-to-Peer Network Printer**, and then click **Next**.
- 7 Follow the on-screen instruction, and then click **Next**.



#### Note

---

Contact your administrator if you are not sure about the location and name of the printer on the network.

---

- 8 Continue through the wizard clicking **Finish** when complete.

## Printer driver already installed

---

If you have already installed the printer driver and wish to configure it for network printing, follow these steps:

**1** (Windows Vista®)

Click the  button, **Control Panel**, **Hardware and Sound**, and then **Printers**.

(Windows Server® 2008)

Click the **Start** button, **Control Panel**, **Hardware and Sound**, and then **Printers**.

(Windows® XP and Windows Server® 2003)

Click the **Start** button and choose **Printers and Faxes**.

(Windows® 2000)

Click the **Start** button and choose **Settings** and then **Printers**.

**2** Right click on the printer driver you wish to configure, and then choose **Properties**.

**3** Click the **Ports** tab and click **Add Port**.

**4** Choose the port that you wish to use. Typically this would be **Standard TCP/IP Port**. Then click the **New Port...** button.

**5** The **Standard TCP/IP Port Wizard** will start.

**6** Enter the IP address of your network printer. Click **Next**.

**7** Click **Finish**.

**8** Close **Printer Ports** and **Properties** dialog box.

## Other sources of information

See *Configuring your machine for a network* on page 12 to learn how to configure the IP address of the printer.

## Overview

Windows® 2000/XP, Windows Vista® and Windows Server® 2003/2008 users can print using TCP/IP and the standard Network Printing IPP protocol software built into Windows® 2000/XP, Windows Vista® and Windows Server® 2003/2008 installation.



### Note

- You must configure the IP address on your printer before you proceed with this chapter. If you need to configure the IP address, see *Chapter 2* first.
- Verify the host computer and machine are either on the same subnet, or that the router is properly configured to pass data between the two devices.
- The default password for Brother print servers is “**access**”.
- This print server also supports the IPPS printing. (See *Printing documents securely using IPPS* on page 170.)

## IPP printing for Windows® 2000/XP, Windows Vista® and Windows Server® 2003/2008

Use the following instructions if you wish to use the IPP printing capabilities of Windows® 2000/XP, Windows Vista® and Windows Server® 2003/2008.

### Windows Vista® and Windows Server® 2008

- 1 (Windows Vista®)  
Click the  button, **Control Panel, Hardware and Sound**, and then **Printers**.  
(Windows Server® 2008)  
Click the **Start** button, **Control Panel, Hardware and Sound**, and then **Printers**.
- 2 Click **Add a printer**.
- 3 Choose **Add a network, wireless or Bluetooth printer**.
- 4 Click **The printer that I want isn't listed**.
- 5 Choose **Select a shared printer by name** and then enter the following in the URL field:  
`http://printer's IP address:631/ipp` (where “printer's IP address” is the printer's IP address or the node name.)

**Note**

If you have edited the hosts file on your computer or are using a Domain Name System (DNS), you can also enter the DNS name of the print server. As the print server supports TCP/IP and NetBIOS names, you can also enter the NetBIOS name of the print server. The NetBIOS name can be seen in the Network Configuration List. (To learn how to print the Network Configuration List, see *Printing the Network Configuration List* on page 123.) The NetBIOS name assigned is the first 15 characters of the node name, and by default it will appear as “BRNxxxxxxxxxxx” for a wired network or “BRWxxxxxxxxxxx” for a wireless network. (“xxxxxxxxxxx” is your machine’s MAC Address / Ethernet Address.)

- 6 When you click **Next**, Windows Vista® and Windows Server® 2008 will make a connection with the URL that you specified.

- If the printer driver has already been installed:

You will see the printer selection screen in the **Add Printer Wizard**. Click **OK**.

If the appropriate printer driver is already installed on your computer, Windows Vista® and Windows Server® 2008 will automatically use that driver. In this case, you will simply be asked if you wish to make the driver the default printer, after which the Driver installation wizard will complete. You are now ready to print.

Go to step 11.

- If the printer driver has NOT been installed:

One of the benefits of the IPP printing protocol is that it establishes the model name of the printer when you communicate with it. After successful communication you will see the model name of the printer automatically. This means that you do not need to inform Windows Vista® and Windows Server® 2008 about the type of printer driver to be used.

Go to step 7.

- 7 If your printer is not in the list of supported printers, click **Have Disk**. You will then be asked to insert the driver disk.
- 8 Click **Browse** and choose the appropriate Brother printer driver that is contained on the CD-ROM or in the network share. Click **Open**.
- 9 Click **OK**.
- 10 Specify the model name of the printer. Click **OK**.

**Note**

- When the **User Account Control** screen appears, click **Continue**.
- If the printer driver that you are installing does not have a Digital Certificate you will see a warning message. Click **Install this driver software anyway** to continue with the installation. The **Add Printer Wizard** will then complete.

- 11 You will see the **Type a printer name** screen in the **Add Printer Wizard**. Check the **Set as the default printer** check box if you want to use this printer as the default printer, and then click **Next**.



- 12 To test the printer connection, click **Print a test page**, and then click **Finish**. The printer is now configured and ready to print.

## Windows® 2000/XP and Windows Server® 2003

---

- 1 (Windows® XP and Windows Server® 2003)  
Click the **Start** button and choose **Printers and Faxes**.  
(Windows® 2000)  
Click the **Start** button and choose **Settings** and then **Printers**.
- 2 (Windows® XP and Windows Server® 2003)  
Click **Add a printer** to start the **Add Printer Wizard**.  
(Windows® 2000)  
Double click the **Add Printer** icon to start the **Add Printer Wizard**.
- 3 Click **Next** when you see the **Welcome to the Add Printer Wizard** screen.
- 4 Choose **Network Printer**.  
(Windows® XP and Windows Server® 2003)  
Choose **A network printer, or a printer attached to another computer**.  
(Windows® 2000)  
Choose **Network Printer**.
- 5 Click **Next**.
- 6 (Windows® XP and Windows Server® 2003)  
Choose **Connect to a printer on the Internet or on a home or office network** and then enter the following in the URL field:  
`http://printer's IP address:631/ipp`  
(where "printer's IP address" is the printer's IP address or the node name.)  
(Windows® 2000)  
Choose **Connect to a printer on the Internet or on your intranet** and then enter the following in the URL field:  
`http://printer's IP address:631/ipp`  
(Where "printer's IP address" is the printer's IP address or the node name).



### Note

If you have edited the hosts file on your computer or are using a Domain Name System (DNS), you can also enter the DNS name of the print server. As the print server supports TCP/IP and NetBIOS names, you can also enter the NetBIOS name of the print server. The NetBIOS name can be seen in the Network Configuration List. (To learn how to print the Network Configuration List, see *Printing the Network Configuration List* on page 123.) The NetBIOS name assigned is the first 15 characters of the node name and by default it will appear as "BRNxxxxxxxxxxx" for a wired network or "BRWxxxxxxxxxxx" for a wireless network. ("xxxxxxxxxxx" is your machine's MAC Address / Ethernet Address.)

7 When you click **Next**, Windows® 2000/XP and Windows Server® 2003 will make a connection with the URL that you specified.

- If the printer driver has already been installed:

You will see the printer selection screen in the **Add Printer Wizard**.

If the appropriate printer driver is already installed on your computer, Windows® 2000/XP and Windows Server® 2003 will automatically use that driver. In this case, you will simply be asked if you wish to make the driver the default printer, after which the Add Printer wizard will complete. You are now ready to print.

Go to step 12.

- If the printer driver has NOT been installed:

One of the benefits of the IPP printing protocol is that it establishes the model name of the printer when you communicate with it. After successful communication you will see the model name of the printer automatically. This means that you do not need to inform Windows® 2000/XP and Windows Server® 2003 about the type of printer driver to be used.

Go to step 8.

8 The driver installation starts automatically.



#### Note

If the printer driver that you are installing does not have a Digital Certificate you will see a warning message. Click **Continue Anyway**<sup>1</sup> to continue with the installation.

<sup>1</sup> **Yes** for Windows® 2000 users

9 (Windows® XP and Windows Server® 2003)  
Click **Have Disk**. You will then be asked to insert the driver disk.

(Windows® 2000)

Click **OK** when you see the **Insert Disk** screen.

10 Click **Browse** and choose the appropriate Brother printer driver that is contained on the CD-ROM or in the network share.

For example, choose the “**X:\driver\win2kxpvista**<sup>1</sup>**\your language**” folder (where X is your drive letter). Click **Open**.

<sup>1</sup> **winxp64vista64** for 64-bit OS users

11 Click **OK**.

12 Check **Yes** if you want to use this printer as the default printer. Click **Next**.

13 Click **Finish** and the printer is now configured and ready to print. To test the printer connection, print a test page.

## Specifying a different URL

---

Please note that there are several possible entries that you can enter for the URL field.

`http://printer's IP address:631/ipp`

This is the default URL and we recommend that you use this URL.

`http://printer's IP address:631/ipp/port1`

This is for HP Jetdirect compatibility.

`http://printer's IP address:631/`



### Note

---

If you forget the URL details, you can simply enter the above text (`http://printer's IP address/`) and the printer will still receive and process data.

Where “printer's IP address” is the printer's IP address or the node name.

- For example:

`http://192.168.1.2/`

`http://BRN123456765432/`

---

## Other sources of information

For how to configure the IP address of the printer, see *Configuring your machine for a network* on page 12.

## Overview

This chapter explains how to configure the BR-Script 3 (PostScript® 3™ language emulation) printer driver on a Network using Mac OS X 10.3.9 or greater.

### ! IMPORTANT

For the latest drivers and information on the Mac OS X you are using, visit the Brother Solutions Center at: <http://solutions.brother.com/>.

## How to choose the BR-Script 3 printer driver (TCP/IP)

### For Mac OS X 10.3.9 to 10.4.x users

- 1 Turn the power of the machine ON.
- 2 From the **Go** menu, choose **Applications**.
- 3 Open the **Utilities** folder.
- 4 Double click the **Printer Setup Utility** icon.
- 5 Click **Add**.
- 6 (Mac OS X 10.3.9) Choose **IP Printing**.  
(Mac OS X 10.4.x) Choose **IP Printer**.

(Mac OS X 10.3.9)

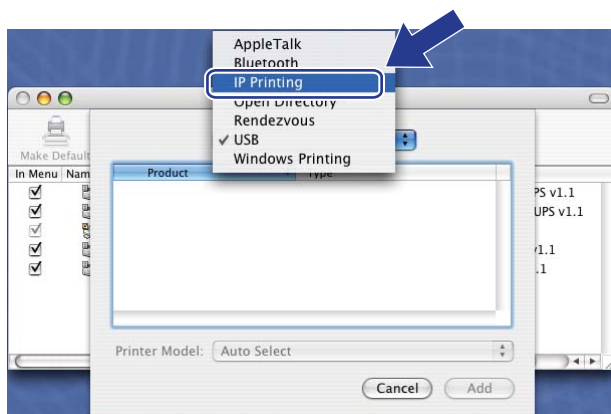

(Mac OS X 10.4.x)

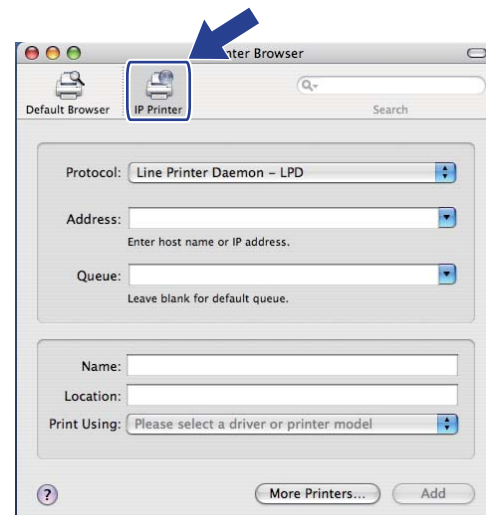

- 7 (Mac OS X 10.3.9) Enter the IP address of the printer into the **Printer Address** box.  
 (Mac OS X 10.4.x) Enter the IP address of the printer into the **Address** box.

(Mac OS X 10.3.9)

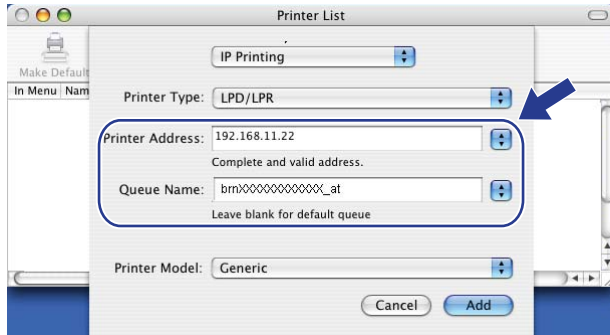

(Mac OS X 10.4.x)

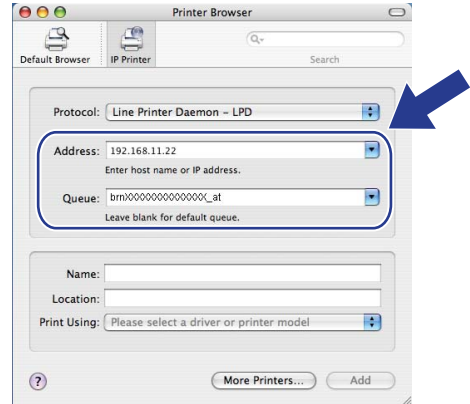

**Note**

- The Network Configuration List will allow you to confirm the IP address. For more information on how to print the configuration page, see *Printing the Network Configuration List* on page 123.
- When specifying the **Queue Name (Queue)**, use the PostScript® service “BRNXXXXXXXXXXXX\_AT” for Macintosh. (“XXXXXXXXXXXX” is your machine’s MAC Address / Ethernet Address.)

- 8 From the **Printer Model (Print Using)** pull-down list choose your model. For example, choose **Brother MFC-XXXX BR-Script3**.

10

(Mac OS X 10.3.9)

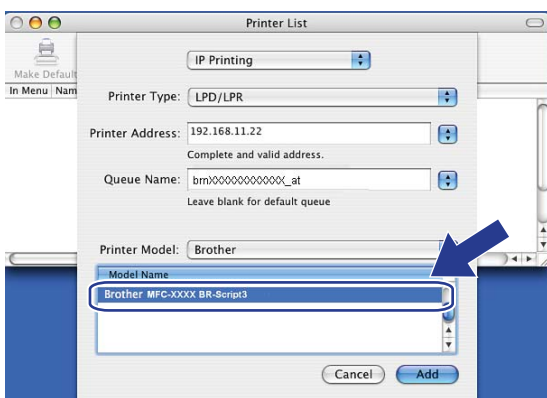

(Mac OS X 10.4.x)

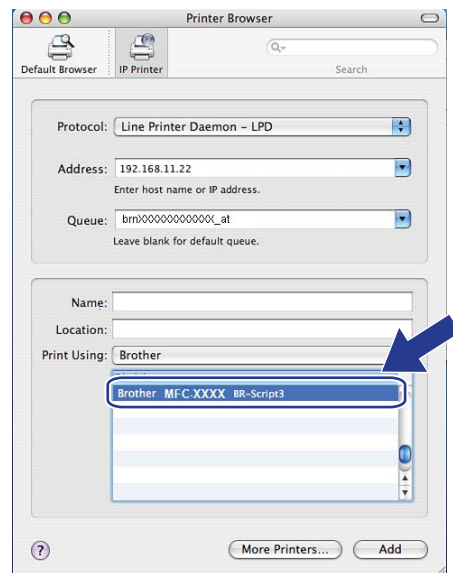

- 9 Click **Add** and the printer will be available from the **Printer List**. The machine is now ready to print.

## For Mac OS X 10.5.x

- 1 Turn the power of the machine ON.
- 2 From the **Apple** menu, choose **System Preferences**.
- 3 Click **Print & Fax**.
- 4 Click **+** button to add your machine.
- 5 Choose **IP**.

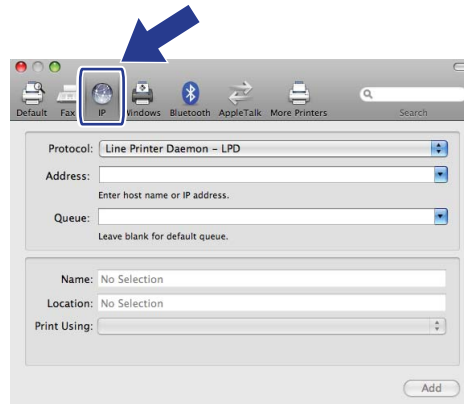

- 6 Choose **Line Printer Daemon-LPD** from the **Protocol** list.
- 7 Enter the IP address of the printer into the **Address** box.

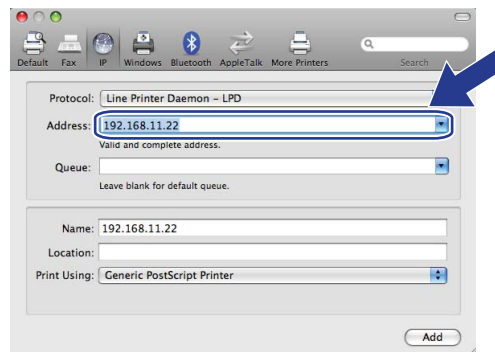

### Note

- The Network Configuration List will allow you to confirm the IP address. For more information on how to print the configuration page, see *Printing the Network Configuration List* on page 123.
- When specifying the **Queue Name (Queue)**, use the PostScript® service “BRNxxxxxxxxxxx\_AT” for Macintosh. (“xxxxxxxxxxx” is your machine’s MAC Address / Ethernet Address.)

- 8 From the **Print Using** pop-up menu choose **Select a driver to use**, and then from the printer model scrolling list choose your model. For example, choose **Brother MFC-XXXX BR-Script3**, and then click **Add**.

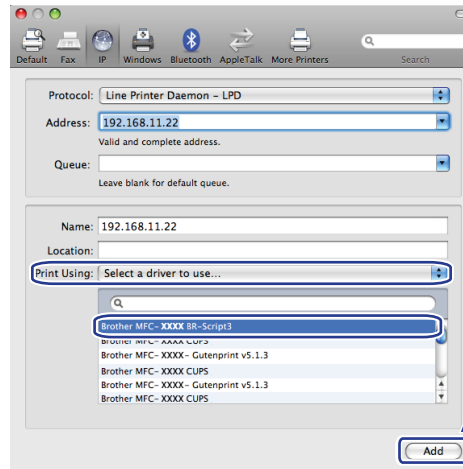

- 9 From the **Default Printer** pop-up menu choose your model to set as the default printer. The printer is now ready.

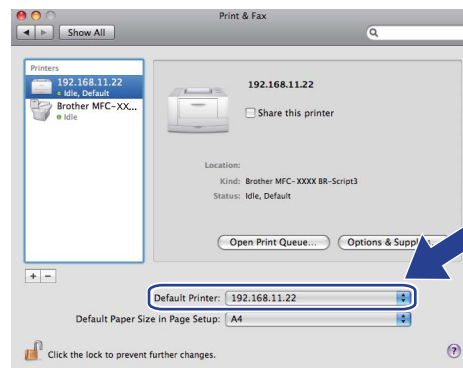

## Other sources of information

See *Chapter 2* of this *User's Guide* to learn how to configure the IP address of the printer.

## Overview

A standard Web Browser can be used to manage your machine using the HTTP (Hyper Text Transfer Protocol). You can get the following information from a machine on your network using a web browser.

- Printer status information
- Change Fax configuration items, such as General Setup, Quick-Dial settings and Remote Fax
- Change network settings such as TCP/IP information.
- Configure Secure Function Lock 2.0
- Configure Scan to FTP
- Configure Scan to Network
- Configure LDAP
- Software version information of the machine and print server
- Change network and machine configuration details



### Note

We recommend Microsoft® Internet Explorer® 6.0 (or greater) or Firefox 1.0 (or greater) for Windows® and Safari 1.3 (or greater) for Macintosh. Please also make sure that JavaScript and Cookies are always enabled in whichever browser you use. If a different web browser is used, make sure it is compatible with HTTP 1.0 and HTTP 1.1.

You must use the TCP/IP protocol on your network and have a valid IP address programmed into the print server and your computer.



### Note

- To learn how to configure the IP address on your machine, see *Configuring your machine for a network* on page 12.
- You can use a web browser on most computing platforms, for example, Macintosh and UNIX users are also able to connect to the machine and manage it.
- You can also use the BRAdmin applications to manage the printer and its network configuration.
- This print server also supports HTTPS for secure management using SSL. (See *Managing your network printer securely* on page 167.)



## How to configure the machine settings using Web Based Management (web browser)

A standard web browser can be used to change your print server settings using the HTTP (Hyper Text Transfer Protocol).



### Note

- We recommend to use HTTPS protocol for your internet security when configuring the settings using Web Based Management. To enable the HTTPS protocol, see *Configuring the protocol settings* on page 166.
- To use a web browser, you will need to know the IP address or node name of the print server.



1 Start your web browser.



2 Type “http://printer’s IP address/” into your browser. (where “printer’s IP address” is the printer’s IP address or the node name)

- For example:

```
http://192.168.1.2/
```



### Note

- If you have edited the hosts file on your computer or are using a Domain Name System (DNS), you can also enter the DNS name of the print server. As the print server supports TCP/IP and NetBIOS names, you can also enter the NetBIOS name of the print server. The NetBIOS name can be seen in the Network Configuration List. (To learn how to print the Network Configuration List, see *Printing the Network Configuration List* on page 123.) The NetBIOS name assigned is the first 15 characters of the node name and by default it will appear as “BRNxxxxxxxxxxx” for a wired network or “BRWxxxxxxxxxxx” for a wireless network. (“xxxxxxxxxxx” is your machine’s MAC Address / Ethernet Address.)
- For Macintosh users, you can have easy access to the Web Based Management System by clicking the machine icon on **Status Monitor** screen. For more information, see the *Software User’s Guide* on the CD-ROM.



3 Click **Network Configuration**.



4 Enter a user name and a password. The default User Name is “admin” and the default password is “access”.



5 Click **OK**.



6 You can now change the print server settings.



### Note

If you have changed the protocol settings, restart the printer after clicking **Submit** to activate the configuration.

## Password information

Web Based Management offers two levels of password access. Users are able to access to the **General Setup, Fax Settings, I-Fax Settings** (MFC-8690DW, MFC-8880DN and MFC-8890DW only), **Copy Settings, Printer Settings** and **USB Direct I/F**. The default user name for User is “**user**” (case sensitive) and the default password is “**access**”.

Administrators are able to access all settings. The login name for the Administrator is “**admin**” (case sensitive) and the default password is “**access**”.

## Secure Function Lock 2.0

Secure Function Lock 2.0 from Brother helps you to save money and increase security by restricting the functions available on your Brother machine.

Secure Function Lock allows you to configure passwords for selected users, granting them access to some, or all, of these functions, or limiting them to a page limit. This means that only authorized people can use them.

You can configure and change the following Secure Function Lock settings using a web browser.

- **PC print**<sup>1</sup>
- **USB Direct Print**
- **Copy**
- **Page Limit**
- **Fax TX**<sup>2</sup>
- **Fax RX**<sup>2</sup>
- **Scan**

<sup>1</sup> If you register the PC user login names, you can restrict PC print without the user entering a password. For more detail, see *Restricting PC print by PC user login name* on page 146

<sup>2</sup> Not available for DCP-8080DN and DCP-8085DN.

## How to configure the Secure Function Lock 2.0 settings using Web Based Management (web browser)

### Basic configuration

- 1 Click **Administrator Settings** on the MFC-XXXX (or DCP-XXXX) web page, and then click **Secure Function Lock**.

The screenshot shows the 'Secure Function Lock' configuration page. At the top, there are navigation links for Home Page, Maintenance Information, Live Reports, Find Device, Administrator Settings, and Network Configuration. The main configuration area includes:

- Function Lock:** Radio buttons for 'Off' and 'On'. A 'Counter Auto Reset Settings' field is set to '200'.
- Administrator Password:** A text field containing '1234'.
- Retype Password:** A text field.
- Table:** A table with columns for ID Number/Name, PIN, PC Print, USB Direct Print, Copy, Print (On/Max), Page Limit, Fax TX, Scan, and Page Counter. The table lists users from 1 to 25, with various settings for each.
- Buttons:** 'Cancel' and 'Submit' buttons at the bottom.

- 2 Choose **On** from **Function Lock**.

#### Note

To configure Secure Function Lock through the embedded web server, you have to enter the Administrator Password (four digit number). If the settings have been configured previously using the Panel menu and you want to change the settings, you must fill in the blank in the **Administrator Password** box first.

- 3 Enter an up to 15 digit alphanumeric group name or user name in the **ID Number/Name** box and then enter a four-digit password in the **PIN** box.
- 4 Uncheck the functions that you want to restrict in the **Print** box or the **Others** box. If you want to configure the maximum page count, check the **On** box in **Page Limit**, and then enter the number in the **Max** box. Then click **Submit**.

- 5 If you want to restrict the PC printing by PC login user name, click **PC Print Restriction by Login Name** and configure the settings. (See *Restricting PC print by PC user login name* on page 146.)

## Scanning when using Secure Function Lock 2.0

The Secure Function Lock 2.0 feature allows the administrator to restrict which users are allowed to scan. When the scan feature is set to off for the public user setting, only users who have scan selected in the check box will be able to scan. To push scan from the control panel of the machine users must enter their PIN to access the scan mode. To pull scan from their computer, restricted users must also enter their PIN on the control panel of the machine before they can scan from their computer. If the PIN is not entered at the machines control panel the user will get an error message on their computer when they attempt to pull scan.

## Restricting PC print by PC user login name

By configuring this setting, the printer can authenticate by PC user login name to allow a print job from a registered computer.

- 1 Click **PC Print Restriction by Login Name**. The **PC Print Restriction by Login Name** screen will appear.

PC Print Restriction by Login Name

By configuring this setting, the device can authenticate user by PC login name at PC print.

Select ID Number/ Name, and enter user's login name. If you want to restrict PC print per group, select the same ID Number/Name for multiple user's login name.

PC Print Restriction:  Off  On

	Login Name	ID Number	Login Name	ID Number
1	PCUSER01	01 USER01	--	--
2	PCUSER02	01 USER01	--	--
3	PCUSER03	02 USER02	--	--
4	PCUSER04	02 USER02	--	--
5	PCUSER05	02 USER02	--	--
6	PCUSER06	03 USER03	--	--
7	PCUSER07	03 USER03	--	--
8	PCUSER08	04 USER04	--	--
9	PCUSER09	04 USER04	--	--
10	--	--	--	--
11	--	--	--	--
12	--	--	--	--
13	--	--	--	--
14	--	--	--	--
15	--	--	--	--
16	--	--	--	--
17	--	--	--	--
18	--	--	--	--
19	--	--	--	--
20	--	--	--	--
21	--	--	--	--
22	--	--	--	--
23	--	--	--	--
24	--	--	--	--
25	--	--	--	--

Cancel Submit

Copyright © 2000-2009 Brother Industries, Ltd. All Rights Reserved.

- 2 Choose the ID Number you set in the **ID Number/Name** in step ③ in *Basic configuration* from the **ID Number** pull-down list for each Login Name and then enter the PC user login name in the **Login Name** box.

- 3 Click **Submit**.

#### **Note**

- If you want to restrict PC print per group, choose the same ID Number for each PC login name you want in the group.
- If you are using the PC login name feature you must also make sure that the **Use PC Login Name** box in the printer driver is checked. For more information about the printer driver, see *Chapter 1* in the *Software User's Guide* on the CD-ROM.
- The Secure Function Lock Feature does not support the BRScript driver for printing.

### Setting up public mode

You can set up the public mode to restrict what functions are available for public users. Public users do not need to enter a password to access the features made available through this setting.

- 1 Uncheck the check box for the function that you want to restrict in the **Public Mode** box.
- 2 Click **Submit**.

### Other features

You can set up the following features in the Secure Function Lock 2.0:

#### ■ All Counter Reset

You can reset the page counter by clicking **All Counter Reset**.

#### ■ Export to CSV file

You can export the current page counter including ID Number / Name information as a CSV file.

#### ■ Last Counter Record

The machine retains the page count after the counter has been reset.

#### ■ Counter Auto Reset Settings

You can automatically reset the page counters by configuring the time interval based on Daily, Weekly or Monthly settings.

#### **Note**

- Secure Function Lock 2.0 can be configured using BRAdmin Professional 3; this is available as a download from <http://solutions.brother.com/>. This utility is only available for Windows® users.
- The configuration you have set on the control panel for Secure Function Lock is applied to the Web Based Management settings automatically.

## Changing the Scan to FTP configuration using a web browser

Scan to FTP allows you to scan a document directly to an FTP server on your local network or on the Internet. (See *Chapter 4* in the *Software User's Guide* for more details on Scan to FTP.)

- 1 Click **Administrator Settings** on the MFC-XXXX (or DCP-XXXX) web page, and then click **FTP/Network Scan Settings**.
- 2 You can choose what profile numbers (1 to 10) to use for Scan to FTP settings. You can also store two user defined file names that can be used for creating an FTP Server Profile in addition to the seven present file names in **Create a User Defined File Name**. A maximum of 15 characters can be entered in each of the two fields. After setting, click **Submit**.

- 3 Click **FTP/Network Scan Profile** on **Administrator Settings** page.  
Now you can configure and change the following Scan to FTP settings using a web browser.

The screenshot shows the Brother Administrator Settings web interface. The main content area is titled "Profile Name 1 (FTP)" and contains the following configuration fields:

- Profile Name:
- Host Address:
- Username:
- Password:
- Retype Password:
- Store Directory:
- File Name:
- Quality:
- File Type:
- Passive Mode:  Off  On
- Port Number:

At the bottom of the form are "Cancel" and "Submit" buttons. The footer of the page reads "Copyright(C) 2000-2009 Brother Industries, Ltd. All Rights Reserved."

- **Profile Name** (Up to 15 characters)
- **Host Address** (FTP server address)
- **Username**
- **Password**
- **Store Directory**
- **File Name**
- **Quality**
- **File Type**
- **Passive Mode**
- **Port Number**

You can set **Passive Mode** to OFF or ON depending on your FTP server and network firewall configuration. By default this setting is OFF, you can also change the port number used to access the FTP server. The default for this setting is port 21. In most cases these two settings can remain as default.



#### Note

Scan to FTP is available when FTP server profiles are configured using Web Based Management.



## Changing the Scan to Network configuration using a web browser

Scan to Network allows you to scan documents directly to a shared folder on a CIFS server located on your local network or the Internet. (For more information on CIFS protocol, see *Protocols* on page 8.) To enable the CIFS protocol, check the box for **CIFS** from the **Network Configuration** page. (See *Chapter 4* in the *Software User's Guide* for more details on Scan to Network.)



### Note

---

Scan to Network supports Kerberos Authentication and NTLMv2 Authentication.<sup>1</sup>

<sup>1</sup> Available for Windows® 2000 or greater.

---

- 1 Click **Administrator Settings** on the MFC-XXXX (or DCP-XXXX) web page, and then click **FTP/Network Scan Settings**.
- 2 You can choose what profile numbers (1 to 10) to use for Scan to Network settings. You can also store two user defined file names that can be used for creating a Scan to Network Profile in addition to the seven present file names in **Create a User Defined File Name**. A maximum of 15 characters can be entered in each of the two fields. After setting, click **Submit**.

- 3 Click **FTP/Network Scan Profile** on **Administrator Settings** page.  
Now you can configure and change the following Scan to Network settings using a web browser.

brother  
MFC-XXXX

- Home Page
- Maintenance Information
- Last Reports
- Fax Device
- Administrator Settings
- Network Configuration
- General Setup
- Fax Settings
- Fax Settings
- Copy Settings
- Printer Settings
- USB Direct I/F

Administrator Settings

- Configure Password
- Web Settings
- FTP/Network Scan Profile
- FTP/Network Scan Settings
- Secure Function Lock
- Profile Name 1
- Profile Name 2
- Profile Name 3
- Profile Name 4
- Profile Name 5
- Profile Name 6
- Profile Name 7
- Profile Name 8
- Profile Name 9
- Profile Name 10

Profile Name 6(Network)

Profile Name:

Host Address:

Store Directory:

File Name: BRN001BA3000954

Quality: Color 100

File Type: PDF

Use PIN for authentication:  Off  On

PIN Code:

Authentication Setting

Auth. Method:  Auto  Kerberos  NTLMv2

Username:

If the user name is part of domain, please input the username in one of the following styles:  
user@domain  
domain\user

Password:

Retype Password:

Kerberos Server Address:

Cancel Submit

Copyright(C) 2000-2009 Brother Industries, Ltd. All Rights Reserved.

- Profile Name (Up to 15 characters)
- Host Address
- Store Directory
- File Name
- Quality
- File Type
- Use PIN for authentication
- PIN Code
- Auth. Method
- Username
- Password
- Kerberos Server Address

## Changing the LDAP configuration using a web browser (For MFC-8690DW, MFC-8880DN and MFC-8890DW)

You can configure and change the LDAP settings using a web browser. Click **Network Configuration** on the MFC-XXXX web page, and then click **Configure Protocol**. Make sure that the check box for LDAP is on and then click **Advanced Settings**.

- **Status Enable/Disable**
- **LDAP Server Address**
- **Port** (The default port number is 389.)
- **Timeout for LDAP**
- **Authentication**
- **Username**
- **Password**
- **Kerberos Server Address**
- **Search Root**
- **Attribute of Name (Search Key)**
- **Attribute of E-mail**
- **Attribute of Fax Number**

After setting, make sure that the **Status** is **OK** on the Test Result page.



### Note

- If the LDAP server supports Kerberos Authentication, we recommend to choose Kerberos on **Authentication** setting. It provides strong authentication between LDAP server and your machine.
- For the details of each item, see the Help Text in the Web Based Management.

# LDAP operation (For MFC-8690DW, MFC-8880DN and MFC-8890DW)

## Overview

The LDAP protocol allows you to search for information such as fax numbers and E-mail addresses from your server. You can configure LDAP settings using a web browser.

## Changing the LDAP configuration using a Browser

---

You can configure and change LDAP settings using a web browser. (For more information, see *Changing the LDAP configuration using a web browser (For MFC-8690DW, MFC-8880DN and MFC-8890DW)* on page 152.)

## LDAP operation using the control panel

---

- 1 Press **Search/Speed Dial**.
- 2 Enter initial characters for your search by using the dial pad.

 **Note**

- You can enter up to 15 characters.
  - For more information on using the dial pad, see *Entering Text* on page 225.
- 

- 3 Press **Search/Speed Dial** or **OK**.  
The LDAP search result will be shown on LCD before the local address book search result with ▶. If there is no match on the server and the local address book, the LCD will show `No Contact Found` for 2 seconds.
- 4 Press ▲ or ▼ to scroll until you find the name you are looking for.  
To confirm details of the result information, highlight the result and press ▶.
- 5 Press **OK**.  
If the result includes both a fax number and an E-mail address, the machine will prompt you to press ▲ or ▼ to choose either a fax number or an E-mail address.
- 6 Press **OK**.
- 7 Load your document and press **Start**.

 **Note**

- The LDAP function of this machine supports LDAPv3.
  - You need to use Kerberos Authentication or Simple Authentication to communicate with your LDAP server.
  - SSL/TLS is not supported.
  - For more information, visit us at <http://solutions.brother.com/>.
-

# Internet fax and Scan to E-mail (E-mail server) (For MFC-8690DW, MFC-8880DN and MFC-8890DW)

## Internet fax Overview

Internet faxing (IFAX) allows you to send and receive fax documents using the Internet as the transport mechanism. Documents are transmitted in E-mail messages as attached TIFF-F files. This means that computers are also able to receive and send documents, providing that the computer has as an application that can generate and view TIFF-F files, you can use any TIFF-F viewer application. Any documents sent via the machine will automatically be converted into a TIFF-F format. If you wish to send and receive messages to and from your machine, your mail application on the computer must be able to support the MIME format.

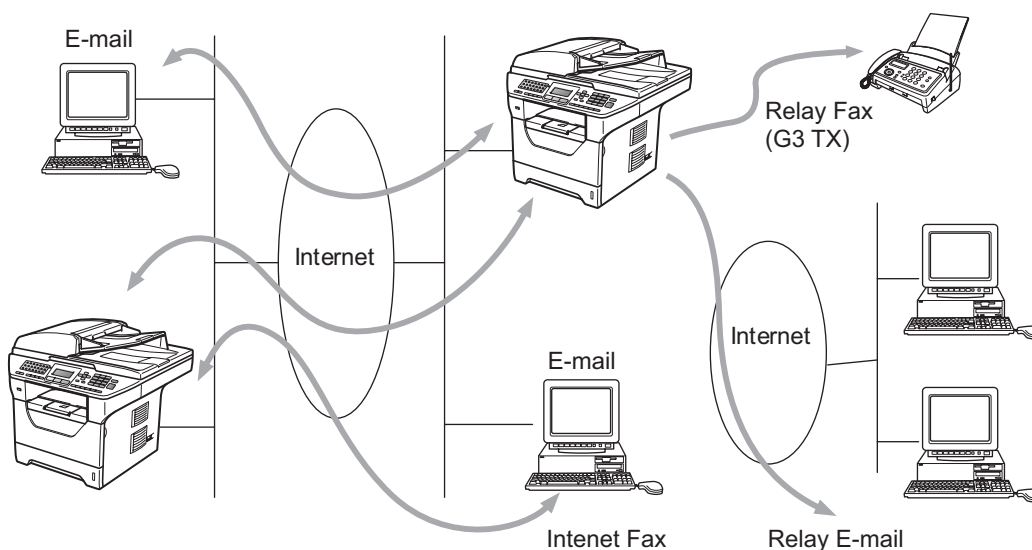

### Note

Internet Fax is available in Black & White only.

## Getting connected

Before sending or receiving an Internet fax you must configure your Brother machine to communicate with your network and mail server. You must ensure the following: a correctly configured IP address for your machine, an E-mail address for your machine, the mail server(s) IP address, mailbox name and password for your Brother machine. If you are unsure of any of these items, please contact your systems Administrator. (For details of how to configure this information, see *Web Based Management* on page 141.)

## Control panel key functions

---

### Shift + 1

Used to change input mode. You can use dial pad keys as Standard alphabet character keys.

### Dial Pad

Used to enter Standard Alpha characters (26 letters), as well as @. space ! " # % & ' ( ) + / : ; < > = ? [ ] ^ - \$ , \* \_ and Numbers.

### ◀ or ▶

Moves the LCD cursor to the left or right when you enter text.

### OK

Used to store multiple numbers.

### Start

Begins transmitting the document.

### Stop/Exit

Deletes entered data and stops the scanning or transmitting process.

### One Touch

#### Search/Speed Dial

These functions work the same way as with conventional machine's. However, please note that you cannot use chain dialing for E-mail address.

### Shift + Start

Used to receive E-mail from the POP3 server manually.

## Sending an Internet fax

---

Sending an Internet fax is the same as sending a normal fax. If you have already programmed the addresses of the destination Internet fax machines as One Touch or Speed-Dial locations, you can send the Internet fax by loading the document into the machine, use the Fax **Resolution** key to set the preferred resolution and choose a Speed Dial or One Touch number and press **Start**.

If you wish to manually enter the Internet fax address, load the document into the machine and press **Shift** and **1** simultaneously to change into the "alphabet" dialing mode.

To manually enter the Internet fax address, see *Entering Text* on page 225.

## Manually entering text

---

Press **Shift** and **1** simultaneously to change into the “alphabet” dialing mode.

You can use the Dial Pad to enter the E-mail address. For more information, see *Entering Text* on page 225.

Please note that also you can connect to the machine using a web browser and store the E-mail address information to a Speed Dial or One Touch location through Web Based Management. (For more information on Web Based Management, see *Web Based Management* on page 141.)

As you enter an Internet fax address, the address will appear character by character on the LCD panel. If you specify more than 22 characters, the LCD panel will scroll the name to the left character by character. You can enter up to 60 characters.

Press **Start** to send the document.

After the document is scanned, it is transmitted to the recipient Internet fax machine automatically via your SMTP server. You can cancel the send operation by pressing the **Stop/Exit** key during scanning. After the transmission is finished, the machine will return to standby mode.

Some E-mail servers do not allow you to send large E-mail documents (the System Administrator will often place a limit on the maximum E-mail size). With this function enabled, the machine will display *Out of Memory* when trying to send E-mail documents over 1 Mbyte in size. The document will not be sent and an error report will be printed. The document you are sending should be separated into smaller documents that will be accepted by the mail server. (For your information, a 42 page document based on the ITU-T Test Chart #1 test chart is approximately 1 Mbyte in size.)

## Receiving E-mail or Internet fax

---

There are 2 ways you can receive E-mail messages:

- POP3 receiving (manually initiated)
- POP3 receiving at regular intervals

Using POP3 receiving the machine must poll the E-mail server to receive the print jobs. This polling can occur at set intervals (for example, you can configure the machine to poll the E-mail server at 10 minute intervals) or you can manually poll the server by pressing the **Shift + Start** keys.

If your machine starts to receive E-mail print jobs, the LCD panel will reflect this activity. For example, you will see *Receiving* on the LCD panel followed by *xx E-mail(s)*. If you press the **Shift + Start** keys to manually poll the E-mail server for E-mail print jobs and there are no mail documents waiting to be printed, the machine will display *No Mail* on the LCD panel for two seconds.

If your machine is out of paper when receiving data, the received data will be held in the machine's memory. This data will be printed automatically after paper is re-inserted into the machine. (For European, Asian and Oceanic machines, *Memory Receive* must be switched *On*.)

If the received mail is not in a plain text format or an attached file is not in the TIFF-F format, the following error message will be printed: “ATTACHED FILE FORMAT NOT SUPPORTED. FILE NAME:XXXXXX.doc” If the received mail is too large, the following error message will be printed: “E-MAIL FILE TOO LARGE.”. If Delete POP Receive Error Mail is ON (default) then the error mail is automatically deleted from the E-mail server.

## Receiving an Internet fax to your computer

---

When a computer receives an Internet fax document, the document is attached to a mail message that informs the computer that it has received a document from an Internet fax. This is notified in the subject field of the received mail message.

If the computer to which you wish to send a document is not running Windows® 2000/XP, Windows Server® 2003/2008 or Windows Vista® operating system, please inform the computer's owner that they must install some software that can view TIFF-F files.

## Forwarding received E-mail and fax messages

---

You can forward received E-mail or standard fax messages to another E-mail address or fax machine. Received messages can be forwarded via E-mail to a computer or Internet fax. They can also be forwarded via standard phone lines to another machine.

The setting can be enabled using a web browser or through the front panel of the machine. The steps for configuring fax forward can be found in the *User's Guide* supplied with your machine.

Please see the *User's Guide* included with the machine to check that this feature is supported.

## Relay broadcasting

---

This function allows the Brother machine to receive a document over the Internet, and then relay it to other fax machines through conventional telephone lines.

If you wish to use your machine as a relay broadcast device, you must specify the domain name that you trust at the machine, in other words, the portion of the name after the "@" sign.

A trusted domain refers to the E-mail address. For example, if the other party's address is bob@brother.com, then we identify the domain as brother.com. If the E-mail address is jack@brother.co.uk, then we identify the domain as brother.co.uk.

Use care in selecting a trusted domain since any user on a trusted domain will be able to send a relay broadcast. You can register up to 10 domain names.

Relay broadcast can support the relay of a document up to a maximum of 48 fax machines through conventional telephone lines.



## Relay broadcast from a machine

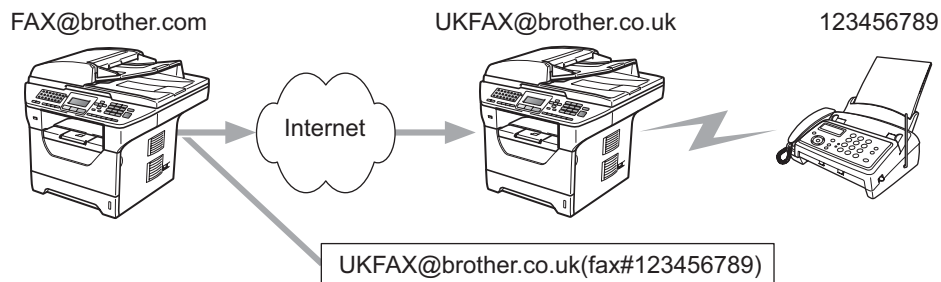

In this example, your machine has an E-mail address of FAX@brother.com, you wish to send a document from this machine to another machine in England with an E-mail address of UKFAX@brother.co.uk, this machine will then forward the document to a standard fax machine using a conventional telephone line. If your E-mail address is FAX@brother.com, you must configure a trusted domain name of brother.com on the machine in England that will broadcast the document to the conventional fax machine. If you do not enter the domain name information, then the machine in the middle (the machine that will broadcast the document) will not trust any internet jobs that it receives from the machine in the @brother.com domain.

After the trusted domain is set you can send the document from your machine [e.g. FAX@brother.com] by entering the E-mail address of the machine [e.g. UKFAX@brother.co.uk] that will forward the document followed by the phone number of the fax that will receive the document. The following is an example of how to enter the E-mail address and phone number.

UKFAX@brother.co.uk(fax#123456789)

└──────────────────┘      └──────────┘  
E-mail address              Fax Phone Number

The word "fax#" must be included with the phone number inside the parenthesis.

## Sending to multiple phone numbers:

If you want to have the document relayed to more than one standard fax machine the address can be entered using the following method:

- 1 Enter the phone number of the first Fax machine UKFAX@brother.co.uk(fax#123).
- 2 Press **OK**.
- 3 Enter the phone number of the second Fax machine UKFAX@brother.co.uk(fax#456).
- 4 Press **Start**.

## Relay broadcast from a computer

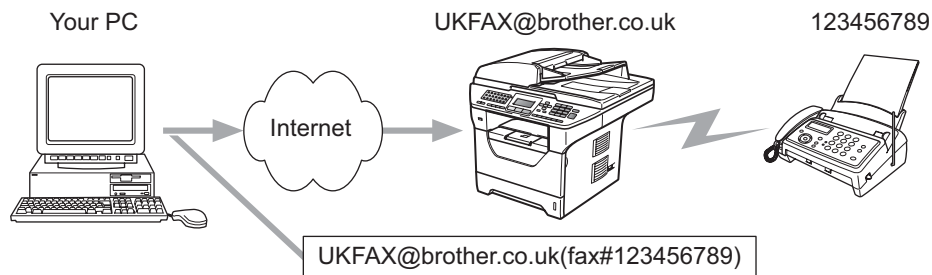

You can also send E-mail from your computer and have it relayed to a conventional fax machine. The method of entering the phone number of the conventional fax machine that will receive the relayed E-mail will vary depending on the mail application you are using. The following are some examples of different mail applications:

Some E-mail applications do not support sending to multiple phone numbers. If your E-mail application cannot support multiple phone numbers you will only be able to relay to one fax machine at a time.

Enter the address of the relay machine and phone number of the fax in the “TO” box using the same method used when sending from a machine.

UKFAX@brother.co.uk(fax#123456789)

### Microsoft® Outlook®:

For Microsoft® Outlook® 97 or greater, the address information must be entered into the address book as follows:

Name: fax#123456789

E-mail address: UKFAX@brother.co.uk

## TX Verification Mail

---

Transmission Verification Mail supports two separate functions. Verification Mail for sending allows you to request notification from the receiving station that the Internet Fax or E-mail was received and processed. Verification Mail for receiving allows you to transmit a default report back to the sending station after successfully receiving and processing an Internet Fax or E-mail.

To use this feature you must set the `Notification` option within the `Setup Mail RX` and `Setup Mail TX` options.

## Setup Mail TX

---

You can set the `Notification` option in the `Setup Mail TX` option to either `On` or `Off`. When switched to `On` an additional field of information is sent with the image data. This field is named "MDN".

MDN (Mail Disposition Notification):

This field requests the status of the Internet Fax/E-mail message after delivery through the SMTP (Send Mail Transfer Protocol) transport system. Once the message has arrived at the receiving station this data is used when the machine or user reads or prints the received Internet Fax or E-mail. For example, if the message is opened for reading or is printed the receiving station sends back a notification to the original sending machine or user.

The receiving station must support the MDN field in order to be able to send a notification report, otherwise the request will be ignored.

## Setup Mail RX

---

There are three possible settings for this option `On`, `MDN` or `Off`.

### Receive Notification "On"

When switched to "On" a fixed message is sent back to the sending station to indicate successful reception and processing of the message. These fixed messages depend on the operation requested by the sending station.

Report messages consist of:

SUCCESS: Received From <mail address>

### Receive Notification "MDN"

When switched to "MDN" a report as described above is sent back to the sending station if the originating station sent the "MDN" field to request confirmation.

### Receive Notification "Off"

Off switches all forms of receive notification `Off`, no message are sent back to the sending station regardless of the request.

## Error mail

---

If there is a mail delivery error while sending an Internet fax, the mail server will send an error message back to the machine and the error message will be printed. If there is an error while receiving mail, an error message will be printed (Example: "The message being sent to the machine was not in a TIFF-F format.").

## Important information on Internet fax

---

Internet fax communication on a LAN system is basically the same as communication via E-mail; however, it is different from fax communication using standard phone lines. The following is important information for using Internet fax:

- Factors such as the receiver's location, structure of the LAN system, and how busy the circuit (such as the internet) is, may cause the system to take a long time to send back an error mail. (normally 20 sec. to 30 sec.).
- In the case of transmission through the Internet, due to its low level of security, we recommend that you use standard phone lines to send confidential documents.
- If the receiver's mail system is not compatible with the MIME format, you cannot transmit a document to the receiver. Depending on the receiver's server, there may be some cases in which the error mail will not be sent back.
- If the size of a document's image data is too large, there is a possibility of unsuccessful transmission.
- You cannot change the font or character size of Internet mail that you received.

## Scan to E-mail (E-mail server) overview

When you choose Scan to E-mail (E-mail Server) you can scan a black and white or color document and send it directly to an E-mail address from the machine. You can choose PDF or TIFF for Black and White and PDF or JPEG for color.



### Note

Scan to E-mail (E-mail Server) requires SMTP/POP3 mail server support. (See *Security methods for E-mail notification* on page 165.)

## How to operate Scan to E-mail (E-mail server)

- 1 Put the document face up in the ADF, or face down on the scanner glass.
- 2 Press  (**Scan**).
- 3 Press **▲** or **▼** to choose `Scan to E-mail`. Press **OK**.
- 4 Press **▲** or **▼** to choose `2sided (L)edge`, `2sided (S)edge` or `1sided`. Press **OK**.
- 5 Press **▲** or **▼** to choose `Change Setting`. Press **OK**.  
If you don't have to change the quality, press **▲** or **▼** to choose `Enter Address`. Press **OK** and then go to step 9.
- 6 Press **▲** or **▼** to choose `Color 100 dpi`, `Color 200 dpi`, `Color 300 dpi`, `Color 600 dpi`, `Gray 100 dpi`, `Gray 200 dpi`, `Gray 300 dpi`, `B&W 200 dpi` or `B&W 200x100 dpi`. Press **OK**.  
If you chose `Color 100 dpi`, `Color 200 dpi`, `Color 300 dpi`, `Color 600 dpi`, `Gray 100 dpi`, `Gray 200 dpi` or `Gray 300 dpi`, go to step 7.  
If you chose `B&W 200 dpi` or `B&W 200x100 dpi`, go to step 8.
- 7 Press **▲** or **▼** to choose `PDF`, `Secure PDF`, `JPEG` or `XPS`. Press **OK** and go to step 9.
- 8 Press **▲** or **▼** to choose `PDF`, `Secure PDF` or `TIFF`. Press **OK** and go to step 9.
- 9 The LCD prompts you to enter an address. Enter the destination E-mail address from the dial pad or use the One Touch key or Speed Dial number. Press **Start**. The machine starts the scanning process.



### Note

You can only choose a One Touch key or Speed Dial number that has an E-mail address registered as the scan profile.

## Using One Touch or Speed Dial number

---

You can also scan a document directly to an address you registered in a One Touch or Speed Dial number. When you scan the document, the settings you registered with the One Touch or Speed Dial will be used for the quality and the file type. Only One Touch or Speed Dials with an E-mail address registered can be used when you scan data using One Touch or Speed Dial. (Internet Fax addresses are not available for use.)

- 1 Put the document face up in the ADF, or face down on the scanner glass.
- 2 Press  (**Scan**).
- 3 Choose One Touch or Speed Dial number.
- 4 Press **Start**. The machine starts the scanning process.



### Note

---

You can store the scan resolution (scan profile) for each E-mail address if you store the E-mail address in a One Touch or Speed Dial number.

---

## Overview

In today's world there are many security threats to your network and the data that travels over it. Your Brother machine employs some of the latest network security and encryption protocols available today. These network features can be integrated into your overall network security plan to help protect your data and prevent unauthorized access to the machine. This chapter explains various security protocols supported and how to configure them.

## Security terms

---

### ■ CA (Certificate Authority)

A CA is an entity that issues digital certificates (especially X.509 certificates) and vouches for the binding between the data items in a certificate.

### ■ CSR (Certificate Signing Request)

A CSR is a message sent from an applicant to a CA in order to apply for issue of a certificate. The CSR contains information identifying the applicant, the public key generated by the applicant and the digital signature of the applicant.

### ■ Certificate

A Certificate is the information that binds together a public key with an identity. The certificate can be used to verify that a public key belongs to an individual. The format is defined by the x.509 standard.

### ■ Digital signature

A Digital signature is a value computed with a cryptographic algorithm and appended to a data object in such a way that any recipient of the data can use the signature to verify the data's origin and integrity.

### ■ Public key cryptosystem

A Public key cryptosystem is a modern branch of cryptography in which the algorithms employ a pair of keys (a public key and a private key) and use a different component of the pair for different steps of the algorithm.

### ■ Shared key cryptosystem

A Shared key cryptosystem is a branch of cryptography involving algorithms that use the same key for two different steps of the algorithm (such as encryption and decryption).

## Security protocols

---

The Brother print server supports the following security protocols.



### Note

How to configure the protocol settings, see *Using Web Based Management (web browser) to change the print/scan server settings* on page 20.

---

## SSL (Secure Socket Layer) / TLS (Transport Layer Security)

These security communication protocols encrypt data to prevent security threats.

## Web server (HTTPS)

The internet protocol that the Hyper Text Transfer Protocol (HTTP) uses SSL.

## IPPS

The printing protocol that the Internet Printing Protocol (IPP Version 1.0) uses SSL.

## SNMPv3

The Simple Network Management Protocol version 3 (SNMPv3) provides user authentication and data encryption to manage network devices securely.

## Security methods for E-mail notification

---

The Brother print server supports the following security methods for E-mail notification.



### Note

How to configure the settings of security methods, see *Using Web Based Management (web browser) to change the print/scan server settings* on page 20.

---

## POP before SMTP (PbS)

The user authentication method for sending E-mail from a client. The client is given permission to use the SMTP server by accessing the POP3 server before sending the E-mail.

## SMTP-AUTH (SMTP Authentication)

SMTP-AUTH expands SMTP (the Internet E-mail sending protocol) to include an authentication method that ensures the true identity of the sender is known.

## APOP (Authenticated Post Office Protocol)

APOP expands POP3 (the Internet receiving protocol) to include an authentication method that encrypts the password when the client receives E-mail.



## Configuring the protocol settings

You can enable or disable each protocol and security method using Web Based Management (web browser).



### Note

We recommend Microsoft® Internet Explorer® 6.0 (or greater) or Firefox 1.0 (or greater) for Windows® and Safari 1.3 for Macintosh. Please also make sure that JavaScript and Cookies are always enabled in whichever browser you use. To use a web browser, you will need to know the IP address of the print server.

- 1 Start your web browser.
- 2 Type "http://printer's IP address/" into your browser (where "printer's IP address" is the printer's IP address or the node name).

- For example:

```
http://192.168.1.2/
```



### Note

- If you have edited the hosts file on your computer or are using a Domain Name System, you can also enter the DNS name of the print server.
- For Windows® users, as the print server supports TCP/IP and NetBIOS names, you can also enter the NetBIOS name of the print server. The NetBIOS name can be seen on the Network Configuration List. To learn how to print the Network Configuration List, see *Printing the Network Configuration List* on page 123. The NetBIOS name assigned is the first 15 characters of the node name and by default it will appear as "BRNxxxxxxxxxxx" for a wired network or "BRWxxxxxxxxxxx" for a wireless network.

- 3 Click **Network Configuration**.
- 4 Enter a user name and a password. The default User Name is **admin** and the default Password is **access**.
- 5 Click **OK**.
- 6 Click **Configure Protocol**.  
Now you can configure the protocol settings.



### Note

If you change the protocol settings, restart the printer after clicking **Submit** to activate the configuration.

## Managing your network printer securely

To manage your network printer securely, you need to use the management utilities with security protocols.

### Secure Management using Web Based Management (web browser)

We recommend to use HTTPS and SNMPv3 protocol for secure management. To use the HTTPS protocol, the following printer settings are required.

- A certificate and private key must be installed in the printer. (For how to install a certificate and private key, see *Creating and installing a certificate* on page 173.)
- The HTTPS protocol must be enabled. To enable the HTTPS protocol, enable **SSL communication is used (port 443)** from the **Advanced Setting** page of **Web Based Management (web server)** on the **Configure Protocol** page. (To enable the HTTPS protocol, see *Configuring the protocol settings* on page 166.)



#### Note

- We recommend Microsoft® Internet Explorer® 6.0 (or greater) or Firefox 1.0 (or greater) for Windows® and Safari 1.3 for Macintosh. Please also make sure that JavaScript and Cookies are always enabled in whichever browser you use. To use a web browser, you will need to know the IP address of the print server.
- We recommend to disable the Telnet, FTP and TFTP protocols. Accessing the machine using these protocols is not secure. See *Configuring the protocol settings* on page 166.



1 Start your web browser.



2 Type "https://Common Name/" into your browser. (Where "Common Name" is the Common Name that you assigned for the certificate, such as an IP address, node name or domain name. (For how to assign a Common Name for the certificate, see *Creating and installing a certificate* on page 173.)

- For example:

`https://192.168.1.2/` (if the Common Name is the printer's IP address)



#### Note

- If you have edited the hosts file on your computer or are using a Domain Name System, you can also enter the DNS name of the print server.
- For Windows® users, as the print server supports TCP/IP and NetBIOS names, you can also enter the NetBIOS name of the print server. The NetBIOS name can be seen on the Network Configuration List. To learn how to print the Network Configuration List, see *Printing the Network Configuration List* on page 123. The NetBIOS name assigned is the first 15 characters of the node name and by default it will appear as "BRNxxxxxxxxxxx" for a wired network or "BRWxxxxxxxxxxx" for a wireless network.

- 3 You can now access the printer using HTTPS.  
We recommend secure management (SNMPv3) be used along with the HTTPS protocol. If you use the SNMPv3 protocol, follow the steps below.

 **Note**

You can also change the SNMP settings by using BRAdmin Professional 3 or Web BRAdmin.

- 4 Click **Network Configuration**.
- 5 Enter a user name and a password. The default User Name is “**admin**” and the default Password is “**access**”.
- 6 Click **Configure Protocol**.
- 7 Make sure that the **SNMP** setting is enabled, and then click **Advanced Setting of SNMP**.
- 8 You can configure the SNMP settings from the screen below.

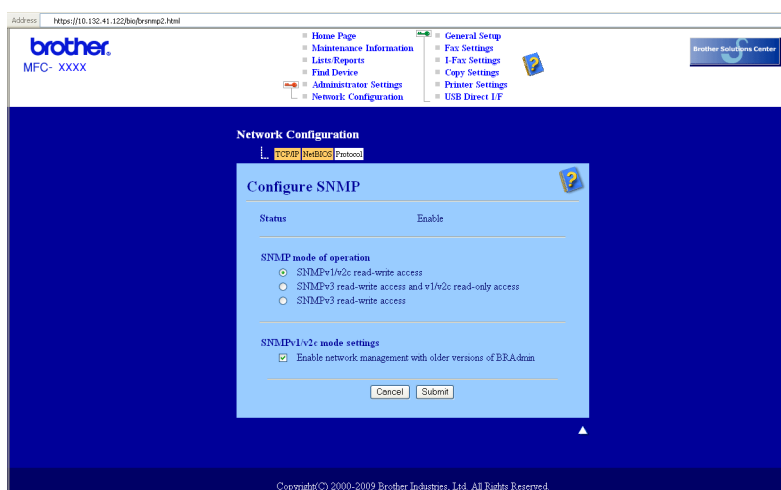

We have three SNMP connection modes of operation.

■ **SNMPv3 read-write access**

With this mode the print server uses version 3 of SNMP protocol. If you want to manage the print server securely, use this mode.

 **Note**

When you use the **SNMPv3 read-write access** mode, please note the following.

- You can manage the print server by using BRAdmin Professional 3, Web BRAdmin or Web Based Management (web browser) only.
- We recommend secure SSL communication (HTTPS) be used.
- Except for BRAdmin Professional 3 and Web BRAdmin, all applications that use SNMPv1/v2c will be restricted. To allow the use of SNMPv1/v2c applications, use **SNMPv3 read-write access and v1/v2c read-only access** or **SNMPv1/v2c read-write access** mode.

### ■ SNMPv3 read-write access and v1/v2c read-only access

In this mode the print server uses the read-write access of version 3 and the read-only access of version 1 and version 2c of the SNMP protocol.



#### Note

When you use the **SNMPv3 read-write access and v1/v2c read-only access** mode, some of Brother applications (e.g. BRAdmin Light) that access to the print server do not work properly since they authorize the read-only access of version 1 and version 2c. If you want to use all applications, use the **SNMPv1/v2c read-write access** mode.

### ■ SNMPv1/v2c read-write access

In this mode the print server uses version 1 and version 2c of the SNMP protocol. You can use all Brother applications under this mode. However, it is not secure since it will not authenticate the user and the data will not be encrypted.



#### Note

For more information, see the Help text in Web Based Management.

## Secure Management using BRAdmin Professional 3 (Windows®)

To use the BRAdmin Professional utility securely, you need to follow the points below.

- We strongly recommend to use the latest version of the BRAdmin Professional 3 utility or Web BRAdmin that are available as a download from <http://solutions.brother.com/>. If you use an older version of BRAdmin <sup>1</sup> to manage your brother machines the user authentication will not be secure.
- If you want to avoid access to your printer from older versions of BRAdmin <sup>1</sup>, you need to disable the access from older versions of BRAdmin <sup>1</sup> from **Advanced Setting** of **SNMP** on **Configure Protocol** page using Web Based Management (web browser). (See *Using Web Based Management (web browser) to change the print/scan server settings* on page 20.)
- Disable the Telnet, FTP and TFTP protocols. Accessing the machine using these protocols is not secure. (For how to configure the protocol settings, see *Using Web Based Management (web browser) to change the print/scan server settings* on page 20.) If you disable the FTP, Scan to FTP function will be disabled.
- If you use BRAdmin Professional and Web Based Management (web browser) together, use Web Based Management with the HTTPS protocol. (See *Secure Management using Web Based Management (web browser)* on page 167.)
- If you are managing a mixed group of older print servers <sup>2</sup> and the new NC-6800h or NC-7600w print servers with BRAdmin Professional, we recommend using a different password in each group. This will ensure security is maintained on the new NC-6800h or NC-7600w print servers.

<sup>1</sup> BRAdmin Professional older than Ver. 2.80, Web BRAdmin older than Ver. 1.40, BRAdmin Light for Macintosh older than Ver. 1.10

<sup>2</sup> NC-2000 series, NC-2100p, NC-3100h, NC-3100s, NC-4100h, NC-5100h, NC-5200h, NC-6100h, NC-6200h, NC-6300h, NC-6400h, NC-8000, NC-100h, NC-110h, NC-120w, NC-130h, NC-140w, NC-8100h, NC-9100h, NC-7100w, NC-7200w, NC-2200w

## Printing documents securely using IPPS

To print documents securely over the internet, you can use the IPPS protocol.



### Note

- Communication using IPPS cannot prevent unauthorized access to the print server.
- IPPS is available for Windows® 2000/XP, Windows Vista® and Windows Server® 2003/2008.

To use the IPPS protocol, the following printer settings are required.

- A certificate and private key must be installed in the printer. For how to install certificate and private key, see *Creating and installing a certificate* on page 173.
- The IPPS protocol must be enabled. To enable the IPPS protocol, enable **SSL communication is used (port 443)** from the **Advanced Setting** page of **IPP** on the **Configure Protocol** page. For information on how to access the **Configure Protocol** page, see *Configuring the protocol settings* on page 166.

The basic steps for IPPS printing are the same as IPP printing. For detailed information, see *Internet printing for Windows®* in Chapter 9.

## Specifying a different URL

Please note that there are several possible entries that you can enter for the URL field.

`https://Common Name/ipp/`

This is the default URL and we recommend that you use this URL. Please note the **Get More Info** option will not display any printer data.

`https://Common Name/ipp/port1/`

This is for HP Jetdirect compatibility. Please note the **Get More Info** option will not display any printer data.



### Note

If you forget the URL details, you can simply enter the above text (`https://Common Name/`) and the printer will still receive and process data.

Where “Common Name” is the Common Name that you assigned for the certificate, such as an IP address, node name or domain name. (For how to assign a Common Name for the certificate, see *Creating and installing a certificate* on page 173.)

- For example:

`https://192.168.1.2/` (if the Common Name is the printer’s IP address.)

## Using E-mail notification with user authentication (For MFC-8690DW, MFC-8880DN and MFC-8890DW)

To use the E-mail notification function via secure SMTP server that requires a user authentication, you need to use POP before SMTP or SMTP-AUTH method. These methods prevent an unauthorized user from accessing the mail server. You can use Web Based Management (web browser), BRAdmin Professional and Web BRAdmin to configure these settings.



### Note

You need to match the settings of POP3/SMTP authentication with one of the E-mail servers. Contact your network administrator or your internet service provider about the configuration before using.

How to configure the POP3/SMTP settings using Web Based Management (web browser).

- 1 Start your web browser.
- 2 Type "http://printer's IP address/" into your browser (where "printer's IP address" is the printer's IP address or the node name.).

■ For example:

```
http://192.168.1.2/
```



### Note

- If you have edited the hosts file on your computer or are using a Domain Name System, you can also enter the DNS name of the print server.
- For Windows® users, as the print server supports TCP/IP and NetBIOS names, you can also enter the NetBIOS name of the print server. The NetBIOS name can be seen on the Network Configuration List. To learn how to print the Network Configuration List, see *Printing the Network Configuration List* on page 123. The NetBIOS name assigned is the first 15 characters of the node name and by default it will appear as "BRNxxxxxxxxxxx" for a wired network or "BRWxxxxxxxxxxx" for a wireless network.

- 3 Click **Network Configuration**.
- 4 Enter a user name and a password. The default User Name is **admin** and the default Password is **access**.
- 5 Click **Configure Protocol**.
- 6 Make sure that the **POP3/SMTP** setting is **Enable**, and then click **Advanced Setting of POP3/SMTP**.

- 7 You can configure the **POP3/SMTP** settings on this page.

The screenshot shows the 'Configure POP3/SMTP' configuration page in the Brother MFC-XXXX Web Based Management interface. The page is titled 'Network Configuration' and 'Configure POP3/SMTP'. It includes the following fields and options:

- Status: Enable
- SMTP Server Address: 0.0.0.0
- SMTP Port: 25
- SMTP Server Authentication Method:
  - None
  - SMTP-AUTH
  - POP before SMTP
- SMTP-AUTH Account Name: [Text Field]
- SMTP-AUTH Account Password:
  - Enter password: [Text Field]
  - Retype password: [Text Field]
- Printex E-mail Address: bm00807cac75e@example.com
- POP3 Server Address: 0.0.0.0
- POP3 Port: 110
- Mailbox Name: [Text Field]
- Mailbox Password:
  - Enter password: [Text Field]
  - Retype password: [Text Field]
- Using APOP
- Segmented Message Timeout: 120 min

At the bottom of the form, there are 'Cancel' and 'Submit' buttons. The page footer contains the text: Copyright(C) 2000-2009 Brother Industries, Ltd. All Rights Reserved.

 **Note**

- You can also change the SMTP port number using Web Based Management. This is useful if your ISP (Internet Service Provider) implements the “Outbound Port 25 Blocking (OP25B)” service. By changing the SMTP port number to a specific number which your ISP is using for the SMTP server (for example, port 587), you would then be able to send an E-mail via the SMTP server. You will also need to check **SMTP-AUTH** of **SMTP Server Authentication Method** to enable the SMTP server authentication.
- If you can use both POP before SMTP and SMTP-AUTH, we recommend choosing SMTP-AUTH.
- If you choose POP before SMTP for the SMTP Server Authentication Method, you need to configure the POP3 settings. You can also use the APOP method.
- For more information, see the Help text in the Web Based Management.
- You can also confirm whether the E-mail settings are correct after configuration by sending a test E-mail.

- 8 After configuring, click **Submit**. The Test E-mail Send/Receive Configuration dialog appears.

- 9 Follow the instructions on-screen if you want to test with the current settings.

## Creating and installing a certificate

The Brother print server allows you to use SSL/TLS communication by configuring a certificate and corresponding private key. This print server supports two certification methods. A self-signed certificate and a certificate that is issued by a CA (Certificate Authority).

### ■ Using self-signed certificate

This print server issues its own certificate. Using this certificate, you can easily use the SSL/TLS communication without having a certificate from a CA. (See *Creating and installing a self-signed certificate* on page 175.)

### ■ Using a certificate from a CA

There are two methods for installing a certificate from a CA. If you already have a CA or if you want to use a certificate from an outside trusted CA:

- When using a CSR (Certificate Signing Request) from this print server. (See *Creating CSR and installing a certificate* on page 188.)
- When importing a certificate and a private key. (See *Import and export the certificate and private key* on page 190.)



### Note

- If you are going to use SSL/TLS communication, we recommend that you contact your system administrator before using.
- This print server stores only one pair of a certificate and a private key that you installed or previously imported. This printer overwrites the certificate and the private key if you install a new one.
- When you reset the print server back to its default factory settings, the certificate and the private key that are installed will be deleted. If you want to keep the same certificate and the private key after resetting the print server, export them before resetting and re-install them. (See *How to export the certificate and private key* on page 190.)

This feature can be configured using Web Based Management (web browser) only. Follow these steps to access the configure certificate page using Web Based Management.

- 1 Start your web browser.
- 2 Type “`http://printer’s IP address/`” into your browser. (where “printer’s IP address” is the printer’s IP address or the node name.)
  - For example:
 

```
http://192.168.1.2/
```



 **Note**

- If you have edited the hosts file on your computer or are using a Domain Name System, you can also enter the DNS name of the print server.
- For Windows® users, as the print server supports TCP/IP and NetBIOS names, you can also enter the NetBIOS name of the print server. The NetBIOS name can be seen on the Network Configuration List. To learn how to print the Network Configuration List, see *Printing the Network Configuration List* on page 123. The NetBIOS name assigned is the first 15 characters of the node name and by default it will appear as "BRNxxxxxxxxxxx" for a wired network or "BRWxxxxxxxxxxx" for a wireless network.

- 3 Click **Network Configuration**.
- 4 Enter a user name and a password. The default User Name is "**admin**" and the default Password is "**access**".
- 5 Click **OK**.
- 6 Click **Configure Certificate**.
- 7 You can configure the certificate settings from the screen below.

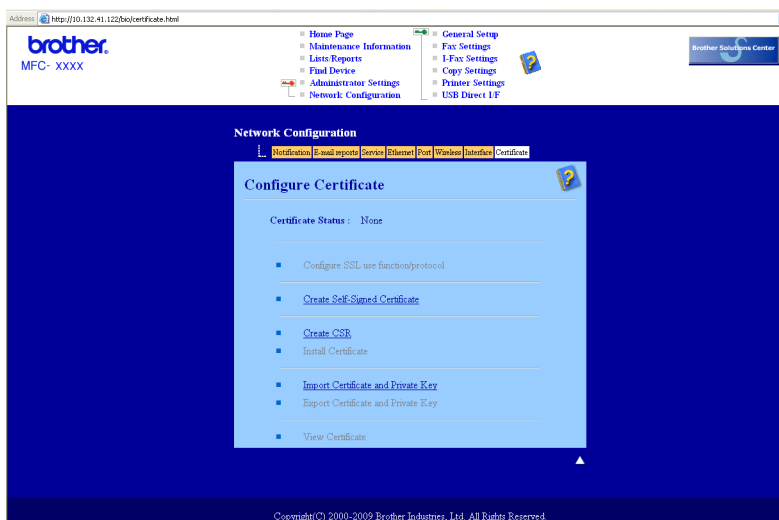
 **Note**

- The functions that are grayed and unlinked indicate they are not available.
- For more information on configuration, see the Help text in the Web Based Management.

## Creating and installing a self-signed certificate

---

### How to create and install a self-signed certificate

- 1 Click **Create Self-Signed Certificate** on the **Configure Certificate** page.
- 2 Enter a **Common Name** and a **Valid Date**, then click **Submit**.



#### Note

- The length of the **Common Name** is less than 64 bytes. Enter an identifier such as an IP address, node name or domain name to use when accessing this printer through SSL/TLS communication. The node name is displayed by default.
- A warning will pop-up if you use the IPPS or HTTPS protocol and enter a different name in the URL than the **Common Name** that was used for the self-signed certificate.

- 3 Now the self-signed certificate is created successfully.
- 4 Follow the on-screen instructions to configure the other security settings.
- 5 Restart the printer to activate the configuration.
- 6 Now the self-signed certificate is saved in your printer memory. To use SSL/TLS communication, the self-signed certificate also needs to be installed on your computer. Proceed to the next section.

## How to install the self-signed certificate on your computer

### Note

The following steps are for Microsoft® Internet Explorer®. If you use another web browser, follow the help text of the web browser itself.

### For Windows Vista® users that have administrator rights

- 1 Click the  button and **All Programs**.
- 2 Right-click **Internet Explorer**, and then click **Run as administrator**.

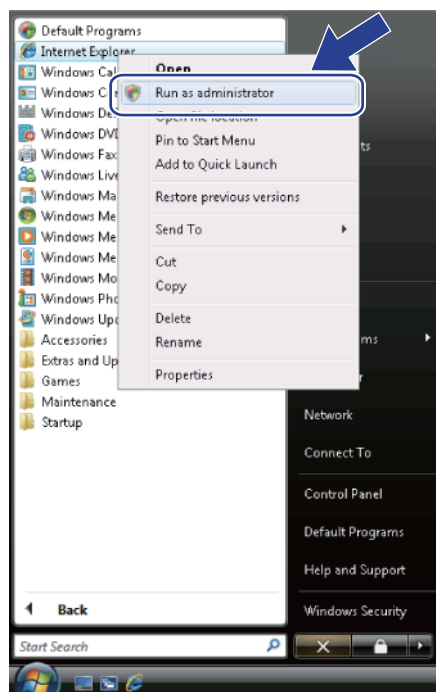

- 3 Click **Allow**.

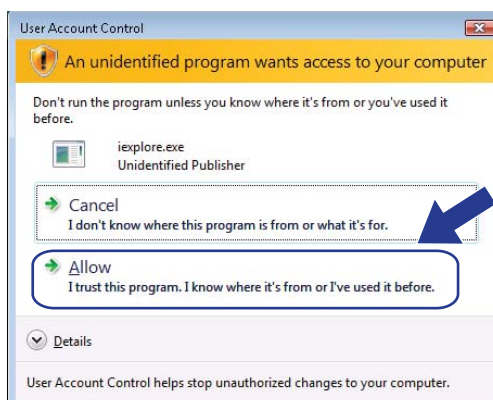

- 4 Type “https://printer’s IP address/” into your browser to access your printer (where “printer’s IP address” is the printer’s IP address or the node name). Then, click **Continue to this website (not recommended)**.

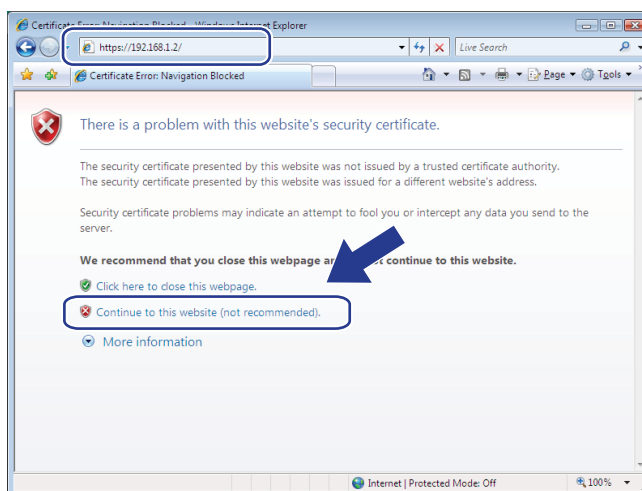

- 5 Click **Certificate Error**, and then click **View certificates**. For the rest of the instructions, follow the steps from step 4 in *For Windows® 2000/XP and Windows Server® 2003/2008 users* on page 183.

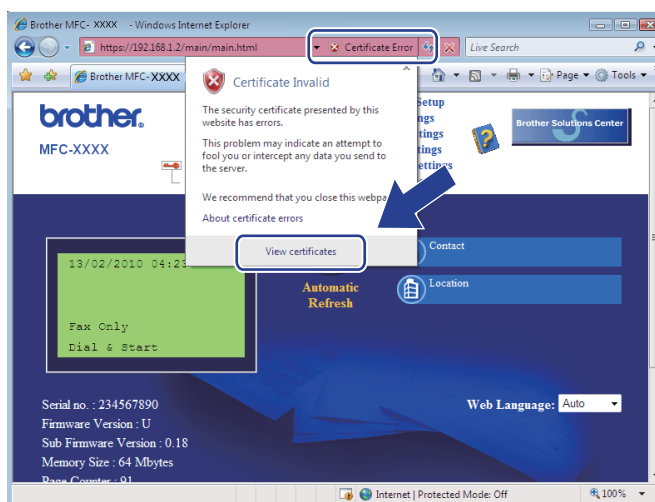

## For Windows Vista® users that do not have administrator rights

- 1 Click the  button and **All Programs**.
- 2 Right click **Internet Explorer**, and then click **Run as administrator**.

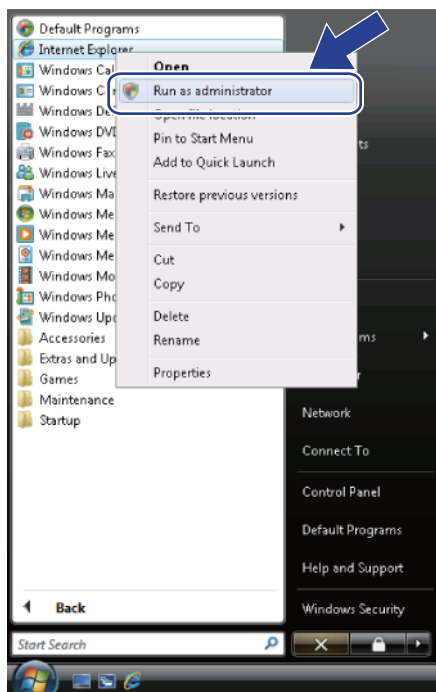

- 3 Choose the Administrator that you want to install with and enter the administrator password, and then click **OK**.

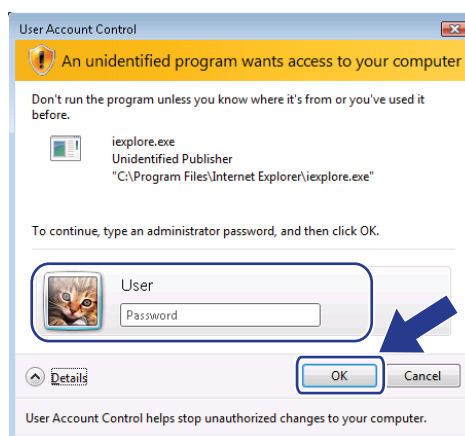

- 4 Type “https://printer’s IP address/” into your browser to access your printer (where “printer’s IP address” is the printer’s IP address or the node name). Then, click **Continue to this website (not recommended)**.

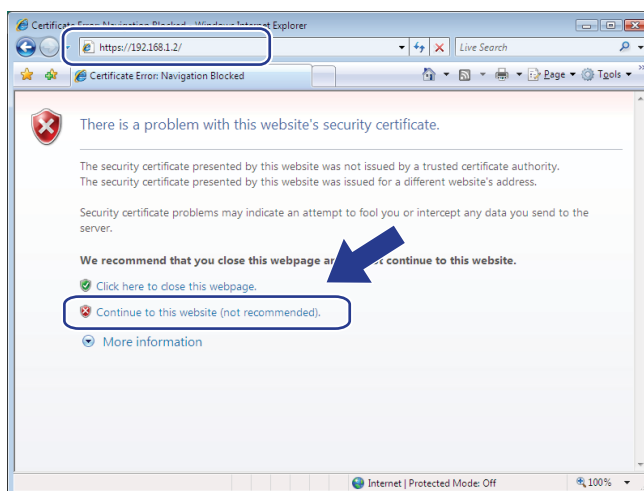

- 5 Click **Certificate Error**, and then click **View certificates**.

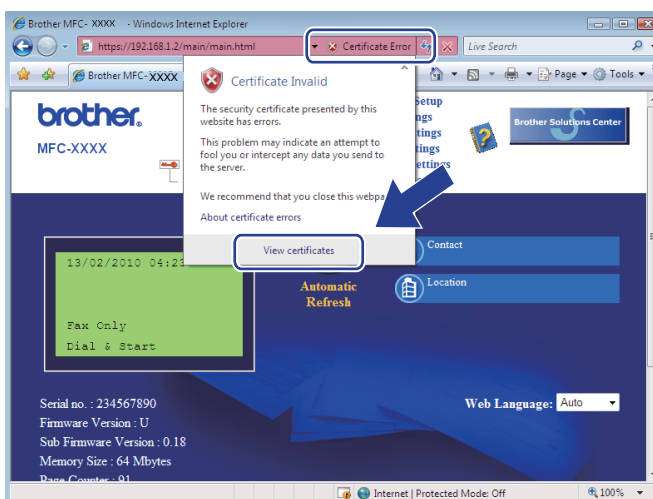

- 6 Choose the **Details** tab, and then click **Copy to File...**

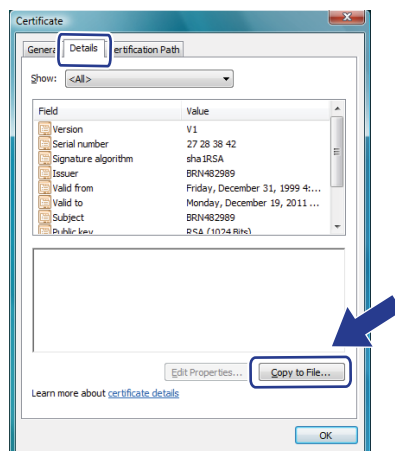

- 7 Click **Next**.

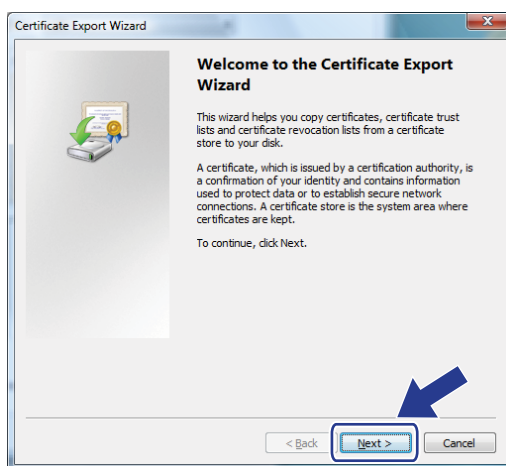

- 8 Make sure that **DER encoded binary X.509 (.CER)** is chosen, and then click **Next**.

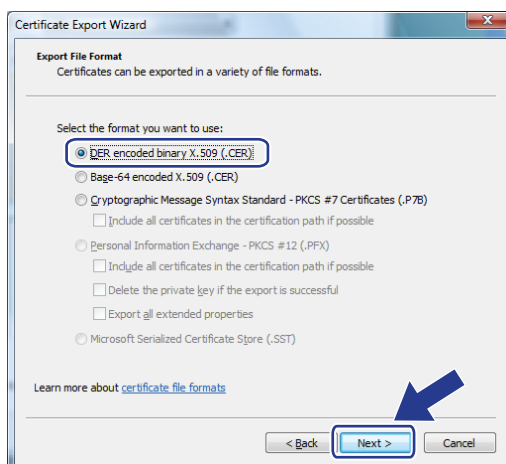

- 9 Click **Browse...**

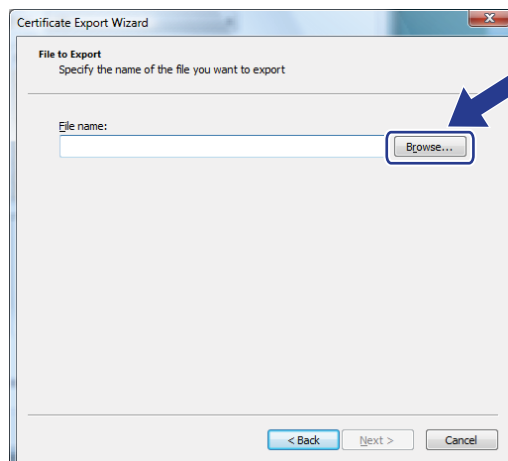

- 10 Click **Browse Folders**.

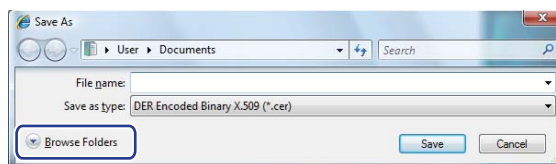

- 11 Choose a folder you want to save the certificate file in and enter a file name, and then click **Save**.

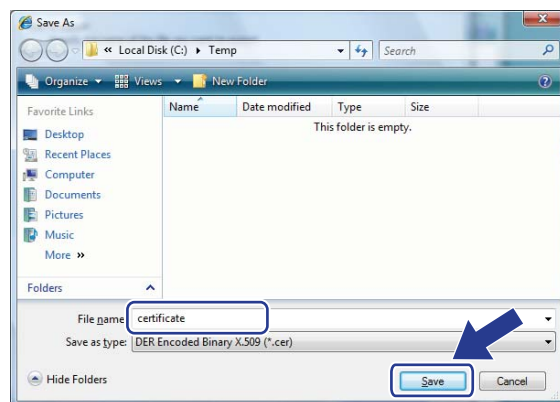
**Note**

If you choose **Desktop**, the certificate file is saved to the Desktop of the Administrator that you chose.



12 Click **Next**.

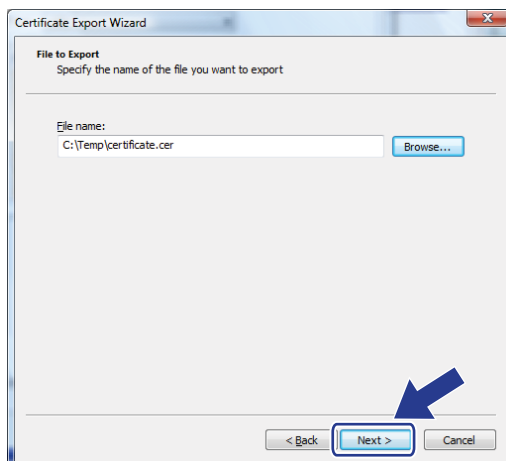

13 Click **Finish**.

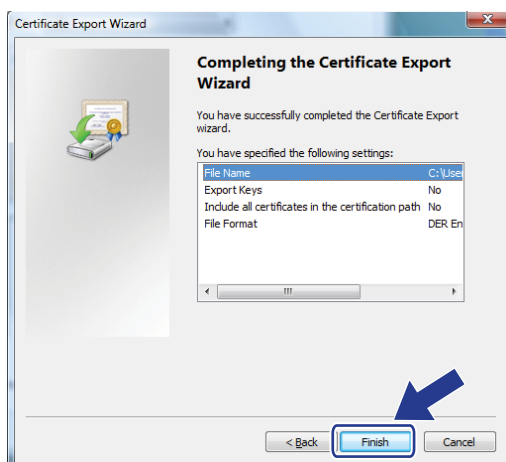

14 Click **OK**.

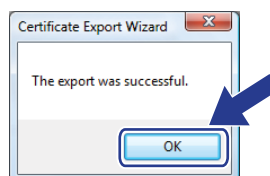

- 15 Click **OK**.

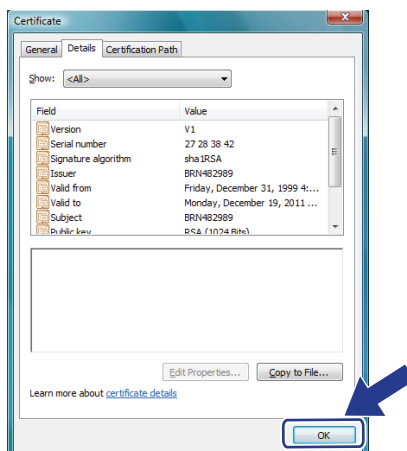

- 16 Open the folder that you saved the certificate file in step 11 and double-click the certificate file. For the rest of the instructions, follow the steps from step 4 in *For Windows® 2000/XP and Windows Server® 2003/2008 users* on page 183.

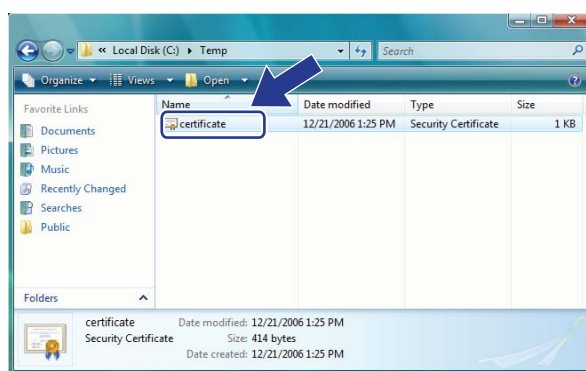

### For Windows® 2000/XP and Windows Server® 2003/2008 users

- 1 Start your web browser.
- 2 Type "https://printer's IP address/" into your browser to access your printer (where "printer's IP address" is the IP address or the node name that you assigned for the certificate).

- 3 When the following dialog appears, click **View Certificate**.

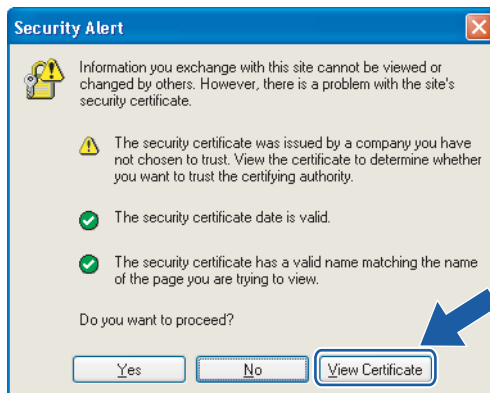

- 4 Click **Install Certificate...** from the **General** tab.

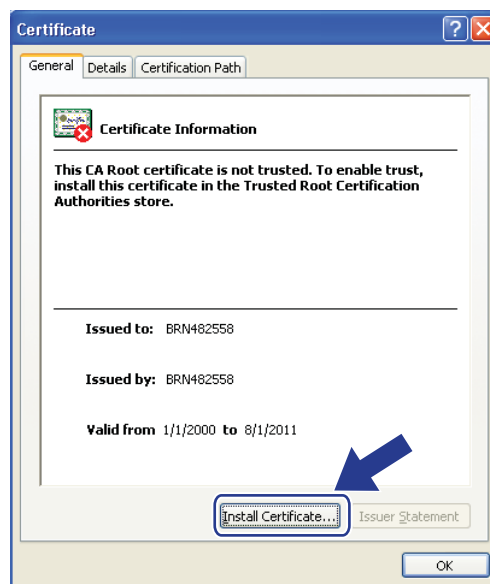

- 5 When the **Certificate Import Wizard** appears, click **Next**.

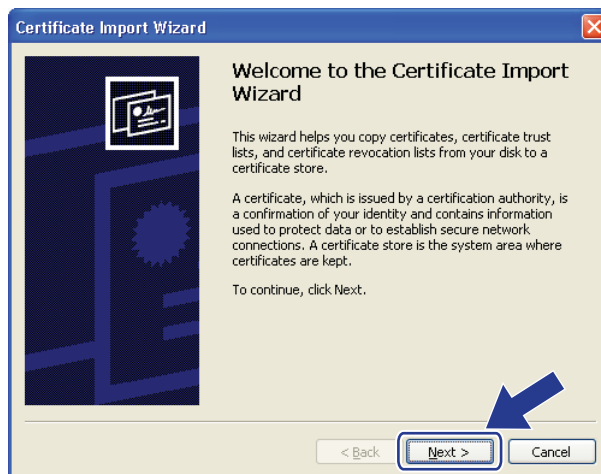

- 6 Choose **Place all certificates in the following store** and then, click **Browse...**

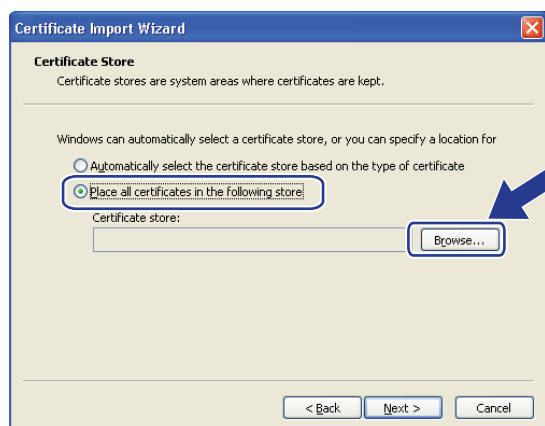

- 7 Choose **Trusted Root Certification Authorities** and then, click **OK**.



8 Click **Next**.

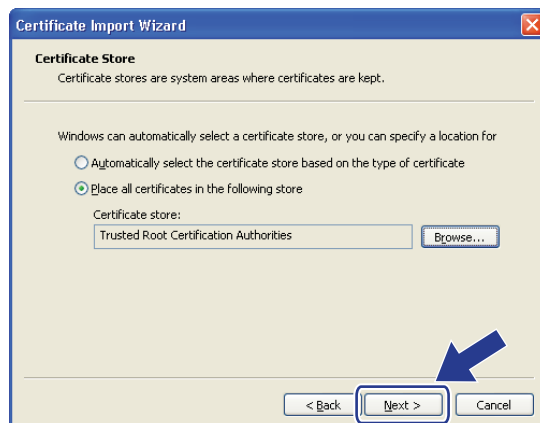

9 Click **Finish**.

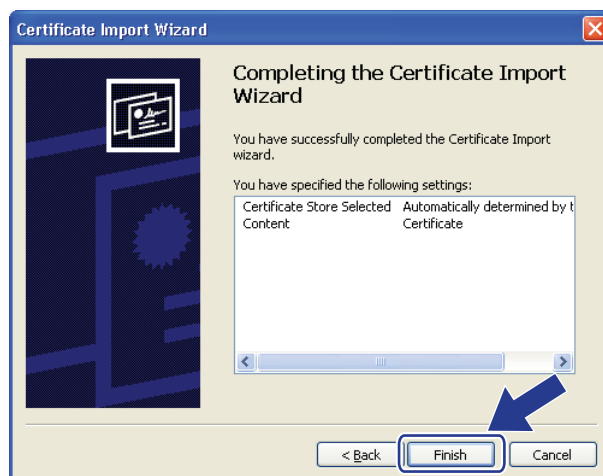

10 Click **Yes**, if the fingerprint (thumbprint) is correct.

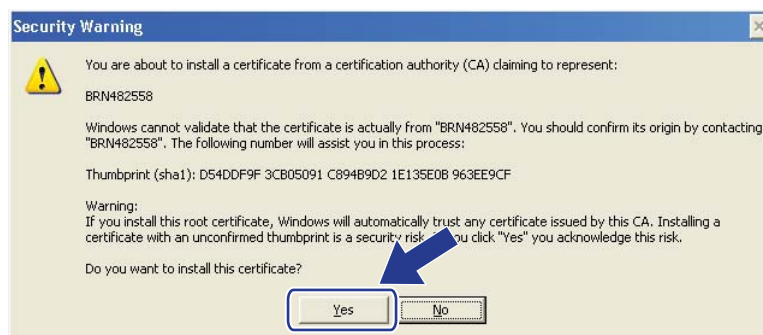

**Note**

The fingerprint (thumbprint) is printed on the Network Configuration List. (To learn how to print the Network Configuration List, see *Printing the Network Configuration List* on page 123.)

- 11 Click **OK**.



- 12 Now the self-signed certificate is installed on your computer, and the SSL/TLS communication is available.

## Creating CSR and installing a certificate

---

### How to create the CSR

- 1 Click **Create CSR** on the **Configure Certificate** page.
- 2 Enter a **Common Name** and your information, such as **Organization**. Then click **Submit**.



#### Note

---

- We recommend that the Root Certificate from the CA be installed on your computer before creating the CSR.
  - The length of the **Common Name** is less than 64 bytes. Enter an identifier such as an IP address, node name or domain name to use when accessing this printer through SSL/TLS communication. The node name is displayed by default. The **Common Name** is required.
  - A warning will pop-up if you enter a different name in the URL than the Common Name that was used for the certificate.
  - The length of the **Organization**, the **Organization Unit**, the **City/Locality** and the **State/Province** is less than 64 bytes.
  - The **Country/Region** should be an ISO 3166 country code composed of two characters.
- 

- 3 When the contents of the CSR appear, click **Save** to save the CSR file to your computer.
- 4 Now the CSR is created.



#### Note

---

- Follow your CA policy regarding the method to send a CSR to your CA.
  - If you are using **Enterprise root CA** of Windows Server® 2003/2008, we recommend using the **Web Server Certificate Template** when creating the certificate. For more information, visit us at <http://solutions.brother.com/>.
-

## How to install the certificate to your printer

When you receive the certificate from a CA, follow the steps below to install it into the print server.



### Note

---

Only a certificate issued with this printer's CSR can be installed.

---

- 1 Click **Install Certificate** on the **Configure Certificate** page.
- 2 Specify the file of the certificate that has been issued by a CA, and then click **Submit**.
- 3 Now the certificate is created successfully.
- 4 Follow the on-screen instructions to configure the other security settings.
- 5 Restart the printer to activate the configuration.
- 6 Now the certificate is saved in your printer. To use SSL/TLS communication, the Root Certificate from the CA needs to be installed on your computer. Contact your network administrator about installation.



## Import and export the certificate and private key

---

### How to import the certificate and private key

- 1 Click **Import Certificate and Private Key** on the **Configure Certificate** page.
- 2 Specify the file that you want to import.
- 3 Enter the password if the file is encrypted, and then click **Submit**.
- 4 Now the certificate and private key are imported successfully.
- 5 Follow the on-screen instructions to configure the other security settings.
- 6 Restart the printer to activate the configuration.
- 7 Now the certificate and private key are imported to your printer. To use SSL/TLS communication, the Root Certificate from the CA needs to also be installed on your computer. Contact your network administrator about the installation.

### How to export the certificate and private key

- 1 Click **Export Certificate and Private Key** on the **Configure Certificate** page.
- 2 Enter the password if you want to encrypt the file.

**Note**

If a blank password is used, the output is not encrypted.

---

- 3 Enter the password again for confirmation, and then click **Submit**.
- 4 Specify the location where you want to save the file.
- 5 Now the certificate and private key are exported to your computer.

**Note**

You can import the file that you exported.

---

## Overview

This chapter explains how to resolve typical network problems you may encounter when using the machine. If, after reading this chapter, you are unable to resolve your problem, please visit the Brother Solutions Center at: <http://solutions.brother.com/>

This chapter is divided into the following sections:

- General problems
- Network print software installation problems
- Printing problems
- Scanning and PC Fax problems
- Protocol-specific troubleshooting
- Wireless network specific troubleshooting (For MFC-8690DW and MFC-8890DW)

## General problems

### CD-ROM is inserted, but does not start automatically

If your computer does not support Autorun, the menu will not start automatically after inserting the CD-ROM. In this case, execute **Start.exe** in the root directory of the CD-ROM.

### How to reset the Brother print server back to the factory default

You can reset the print server back to its factory default settings (resetting all information such as the password and IP address information). (See *Restoring the network settings to factory default* on page 123.)

### My computer cannot find the machine/print server.

I cannot make a necessary connection to the machine/print server.

My machine/print server does not appear in the window of Remote Setup, BRAdmin Light or BRAdmin Professional.

- Windows®

The Firewall setting on your computer may be rejecting the necessary network connection to the machine. In this case, you will need to disable the Firewall on your computer and re-install the drivers.

#### Windows® XP SP2 users:

- 1 Click the **Start** button, **Control Panel**, **Network and Internet Connections**.
- 2 Click **Windows Firewall**.
- 3 Click the **General** tab. Make sure that **Off (not recommended)** is selected.
- 4 Click **OK**.

**Note**

After the Brother software package is installed, turn your Firewall back on.

**Windows Vista® users:**

- 1 Click the  button, **Control Panel, Network and Internet, Windows Firewall** and click **Change settings**.
- 2 When the **User Account Control** screen appears, do the following.
  - Users who have administrator rights: Click **Continue**.
  - For users who do not have administrator rights: Enter the administrator password and click **OK**.
- 3 Click the **General** tab. Make sure that **Off (not recommended)** is selected.
- 4 Click **OK**.

**Note**

After the Brother software package is installed, turn your Firewall back on.

- Macintosh

Choose your machine again in the DeviceSelector application located in **Mac OS X** or **Macintosh HD** (Startup Disk) / **Library / Printers / Brother / Utilities / DeviceSelector** or from the model pop-up menu of ControlCenter2.

## Network print software installation problems

**The Brother print server is not found during the setup of the network print software or from the installation of the printer driver of the Brother machine in Windows®.**

**The Brother print server is not found using the Simple Network Configuration capabilities of Mac OS X.**

- For a network with an Ethernet cable connection

Make sure you have completed the IP address setting of the Brother print server according to Chapter 2 of this User's Guide before installing the network print software or printer driver.

- For a wireless network

Make sure you have completed the IP address setting and wireless network settings of the Brother print server according to Chapter 3 of this User's Guide before installing the network print software or printer driver.

Check the following:

- 1 Make sure that the machine is powered on, is on-line and ready to print.

- 2 Check the connection status for your network.

**For wired network users:**

Check to see if there is any LED activity. Brother print servers have two LEDs on the back panel of the machine. The upper orange LED shows Speed status. The lower green LED shows Link/Activity (Received/Transmit) status.

- The upper LED is orange: The Speed LED will be orange if the print server is connected to a 100BASE-TX Fast Ethernet network.
- The upper LED is off: The Speed LED will be off if the print server is connected to a 10BASE-T Ethernet network.
- The lower LED is green: The Link/Activity LED will be green if the print server is connected to a Ethernet network.
- The lower LED is off: The Link/Activity LED will be off if the print server is not connected to the network.

**For wireless network users (MFC-8690DW and MFC-8890DW only):**



**Note**

Make sure that your machine setting for a wireless network is ON.

Check to see if the wireless signal on the LCD display is following in Ready mode or Sleep mode with infrastructure mode: (Strong) / (Medium) / (Weak)

Your machine is connected to the wireless network.

If the signal is (None), your machine is not connected to the wireless network. To configure your machine for a wireless network, see *Configuring your machine for a wireless network (For MFC-8690DW and MFC-8890DW)* on page 21.



**Note**

If you attempt to connect to any network (ad-hoc or infrastructure mode) using open system authentication the wireless signal strength indicator will show a full signal even if the machine cannot connect.

- 3 Print the Network Configuration List and check if the settings such as IP address settings are correct for your network. The problem may be the result of a mismatched or duplicate IP address. Verify that the IP address is correctly loaded into the print server, and make sure that no other nodes on the network have this IP address. (For information on how to print the Network Configuration List, see *Printing the Network Configuration List* on page 123.)

- 4 Verify that the print server is on your network as follows:

■ **Windows®**

Try pinging the print server from the host operating system command prompt with the command: Click **Start, All Programs**<sup>1</sup>, **Accessories** then choose **Command Prompt**.

<sup>1</sup> **Programs** for Windows® 2000 users

```
ping ipaddress
```

Where `ipaddress` is the print server IP address (note that in some instances it can take up to two minutes for the print server to load its IP address after setting the IP address).

■ **Mac OS X 10.3.9 or greater**

- 1 From the **Go** menu, choose **Applications**.
- 2 Open the **Utilities** folder.
- 3 Double click the **Terminal** icon.
- 4 Try pinging the print server from the Terminal window:

```
ping ipaddress
```

Where `ipaddress` is the print server IP address (note that in some instances it can take up to two minutes for the print server to load its IP address after setting the IP address).

- 5 If you have tried step 1 to step 4 above and it does not work, then reset the print server back to the default factory settings and try from the initial setup again. (For information on how to reset to the default factory settings, see *Restoring the network settings to factory default* on page 123.)

6 (Windows®)

If the installation failed, the Firewall on your computer may be blocking the necessary network connection to the machine. In this case, you will need to disable the Firewall on your computer and re-install the drivers. (For how to disable the Firewall, see *General problems* on page 191.) If you are using personal Firewall software, see the user's guide for your software or contact the software manufacturer.

## Printing problems

### Print job is not printed

Check the status and configuration of the print server.

- 1 Make sure that the machine is powered on, is on-line and ready to print.
- 2 Print the Network Configuration List of the machine and check if the settings such as IP address settings are correct for your network. The problem may be the result of mismatched or duplicate IP address. Verify that the IP address is correctly loaded into the print server, and make sure that no other nodes on the network have this IP address. (For information on how to print the Network Configuration List, see *Printing the Network Configuration List* on page 123.)

3 Verify that the print server is on your network as follows:

■ **Windows®**

- 1 Try pinging the print server from the host operating system command prompt with the command:

```
ping ipaddress
```

Where `ipaddress` is the print server IP address (note that in some instances it can take up to two minutes for the print server to load its IP address after setting the IP address).

- 2 If a successful response is received, then proceed to *Windows® 2000/XP, Windows Vista® and Windows Server® 2003/2008 IPP troubleshooting* on page 200. Otherwise, proceed to step 4.

■ **Mac OS X 10.3.9 or greater**

- 1 From the **Go** menu, choose **Applications**.
- 2 Open the **Utilities** folder.
- 3 Double click the **Terminal** icon.
- 4 Try pinging the print server from the Terminal window:

```
ping ipaddress
```

Where `ipaddress` is the print server IP address (note that in some instances it can take up to two minutes for the print server to load its IP address after setting the IP address).

- 5 If a successful response is received, then proceed to step 4.

- 4 If you have tried step 1 to step 3 above and it does not work, then reset the print server back to the default factory settings and try from the initial setup again. (For information how to reset to the default factory settings, see *Restoring the network settings to factory default* on page 123.)

### Error during printing

If you try to print while other users are printing large amounts of data (e.g. many pages or pages with a large amount of graphics at high resolution), the printer is unable to accept your print job until the ongoing printing is finished. If the waiting time of your print job exceeds a certain limit, a time out situation occurs, which causes the error message. In such situations, execute the print job again after the other jobs are completed.

## Scanning and PC Fax problems

**The network scanning feature does not work in Windows®**

**The network PC Fax feature does not work in Windows®**

Firewall settings on your PC may be rejecting the necessary network connection. Follow the instructions below to disable the Firewall. If you are using personal Firewall software, see the user's guide for your software or contact the software manufacturer.

**Windows® XP SP2 users:**

- 1 Click the **Start** button, **Control Panel**, **Network and Internet Connections** and then **Windows Firewall**. Make sure that **Windows Firewall** on the **General** tab is set to On.
- 2 Click the **Advanced** tab and **Settings...** button of **Network Connection Settings**.
- 3 Click the **Add** button.
- 4 To add port 54925 for network scanning, enter the information below:
  1. In **Description of service**: Enter any description, for example, "Brother Scanner".
  2. In **Name or IP address (for example 192.168.0.12) or the computer hosting this service on your network**: Enter "Localhost".
  3. In **External Port number for this service**: Enter "54925".
  4. In **Internal Port number for this service**: Enter "54925".
  5. Make sure **UDP** is selected.
  6. Click **OK**.
- 5 Click the **Add** button.
- 6 To add port 54926 for network PC Fax, enter the information below:
  1. In **Description of service**: Enter any description, for example, "Brother PC Fax".
  2. In **Name or IP address (for example 192.168.0.12) or the computer hosting this service on your network**: Enter "Localhost".
  3. In **External Port number for this service**: Enter "54926".
  4. In **Internal Port number for this service**: Enter "54926".
  5. Make sure **UDP** is selected.
  6. Click **OK**.
- 7 If you still have trouble with your network connection, click the **Add** button.
- 8 To add port 137 for network scanning, network printing and network PC Fax receiving, enter the information below:
  1. In **Description of service**: Enter any description, for example, "Brother PC Fax receiving".
  2. In **Name or IP address (for example 192.168.0.12) or the computer hosting this service on your network**: Enter "Localhost".
  3. In **External Port number for this service**: Enter "137".
  4. In **Internal Port number for this service**: Enter "137".
  5. Make sure **UDP** is selected.
  6. Click **OK**.

- 9 Make sure if the new setting is added and is checked, and then click **OK**.

**Note**

---

After the Brother software package is installed, turn your Firewall back on.

---

**Windows Vista® users:**

- 1 Click the  button, **Control Panel, Network and Internet, Windows Firewall** and click **Change settings**.
- 2 When the **User Account Control** screen appears, do the following.
  - Users who have administrator rights: Click **Continue**.
  - For users who do not have administrator rights: Enter the administrator password and click **OK**.
- 3 Make sure that **on (recommended)** is selected on the **General** tab.
- 4 Click the **Exceptions** tab.
- 5 Click the **Add port...** button.
- 6 To add port 54925 for network scanning, enter the information below:
  1. In **Name**: Enter any description, for example, "Brother Scanner".
  2. In **Port number**: Enter "54925".
  3. Make sure **UDP** is selected.
  4. Click **OK**.
- 7 Click the **Add port...** button.
- 8 To add port 54926 for network PC Fax, enter the information below:
  1. In **Name**: Enter any description, for example, "Brother PC Fax".
  2. In **Port number**: - Enter "54926".
  3. Make sure **UDP** is selected.
  4. Click **OK**.
- 9 Make sure that the new setting is added and is checked, and then click **Apply**.
- 10 If you still have trouble with your network connection such as network scanning or printing, check **File and Printer Sharing** box in the **Exceptions** tab and then click **Apply**.

**Note**

---

After the Brother software package is installed, turn your Firewall back on.

---



# Wireless network troubleshooting (MFC-8690DW and MFC-8890DW only)

## Wireless setup problems

---

**The Brother print server is not found during setup by the Wireless Device Setup Wizard.**

- 1 Make sure that the machine is powered on, is on-line and ready to print.
- 2 Move your Brother machine closer to your access point/router (or your computer for Ad-hoc) and try again.
- 3 Reset the print server back to its default factory settings and try again. (For the information how to reset to the factory default settings, see *Restoring the network settings to factory default* on page 123.)

**Why do I have to change my machine's network setting to "Wired LAN" during setup although I am trying to setup Wireless LAN?**

If you are using Windows® 2000, Mac OS X 10.3.9 or greater or your computer is connected to the wireless network using a network cable, it is recommended you temporarily connect the machine to your access point/router, hub or router using a network cable. You will also need to change your machine's network setting to wired LAN temporarily. Your machine's network setting will be changed to wireless LAN automatically during the course of the setup.

■ Windows®:

*Using the Setup Wizard from the control panel on page 31*

*Wireless configuration for Windows® using the Brother installer application (For MFC-8690DW and MFC-8890DW) on page 41*

■ Macintosh:

*Using the Setup Wizard from the control panel on page 31*

*Wireless configuration for Macintosh using the Brother installer application (For MFC-8690DW and MFC-8890DW) on page 68*

## Wireless connection problem

---

### **The wireless network connection is sometimes disabled.**

The wireless network connection status is affected by the environment where the Brother printer and other wireless devices are located. The following conditions may cause connection problems:

- A concrete or metal framed wall is installed between the Brother machine and the access point/router.
- Electric appliances such as televisions, computer appliances, microwave ovens, intercoms, mobile/cellular phones and the battery chargers and AC power adapters are installed close to your network.
- A broadcast station or high-tension wire is located close to your network.
- A nearby fluorescent light is being switched on or off.

## Protocol-specific troubleshooting

### Windows® 2000/XP, Windows Vista® and Windows Server® 2003/2008 IPP troubleshooting

---

#### I want to use a different Port number other than 631.

If you are using Port 631 for IPP printing, you may find that your Firewall may not let the print data through. If this is the case, use a different port number (port 80), or configure your Firewall to allow Port 631 data through.

To send a print job using IPP to a printer using Port 80 (the standard HTTP port) enter the following when configuring your Windows® 2000/XP, Windows Vista® and Windows Server® 2003/2008 system.

```
http://ipaddress/ipp/
```

**The “Go to printer’s Web site” option in Windows® XP and Windows Vista® is not working.**

**The “Get More Info” option in Windows® 2000 and Windows Server® 2003/2008 is not working.**

If you are using a URL of:

```
http://ipaddress:631/ or http://ipaddress:631/ipp/
```

the **Get More Info** option in Windows® 2000/XP, Windows Vista® and Windows Server® 2003/2008 will not function. If you wish to use the **Get More Info** option, use the following URL:

```
http://ipaddress/
```

This will then force Windows® 2000/XP, Windows Vista® and Windows Server® 2003/2008 to use Port 80 to communicate with the Brother print server.

### Web Based Management (web browser) troubleshooting (TCP/IP)

---

- 1 If you cannot connect to the print server using your web browser it may be worth checking the Proxy Settings of your browser. Look in the Exceptions setting and if necessary, type in the IP address of the print server. This will stop your computer from trying to connect to your ISP or proxy server every time you wish to look at the print server.
- 2 Make sure that you are using the correct web browser, we recommend Microsoft® Internet Explorer® 6.0 (or greater) or Firefox 1.0 (or greater) for Windows® and Safari 1.3 for Macintosh. Please also make sure that JavaScript and Cookies are always enabled in whichever browser you use. If a different web browser is used, make sure it is compatible with HTTP 1.0 and HTTP 1.1.

### LDAP troubleshooting

---

If you are having trouble connecting to a Windows® LDAP server, please contact your Network Administrator and check the LDAP Security Options.

For more information, please visit <http://solutions.brother.com/>.

## Using services

A service is a resource that can be accessed by computers that wish to print to the Brother print server. The Brother print server provides the following predefined services (do a `SHOW SERVICE` command in the Brother print server remote console to see a list of available services): Enter `HELP` at the command prompt for a list of supported commands.

Service (Example)	Definition
BINARY_P1	TCP/IP binary
TEXT_P1	TCP/IP text service (adds carriage return after each line feed)
PCL_P1	PCL service (switches PJL-compatible printer to PCL mode)
BRNxxxxxxxxxxxx	TCP/IP binary
BRNxxxxxxxxxxxx_AT	PostScript® service for Macintosh
POSTSCRIPT_P1	PostScript® service (switches PJL-compatible printer to PostScript® mode)

Where “xxxxxxxxxxxx” is your machine’s MAC Address (Ethernet Address)

## Other ways to set the IP address (for advanced users and administrators)

For information on how to configure your machine for a network using the BRAdmin Light utility, see *Setting the IP address and subnet mask* on page 15.

### Using DHCP to configure the IP address

The Dynamic Host Configuration Protocol (DHCP) is one of several automated mechanisms for IP address allocation. If you have a DHCP server in your network, the print server will automatically obtain its IP address from the DHCP server and register its name with any RFC 1001 and 1002-compliant dynamic name services.



#### Note

If you do not want your print server configured via DHCP, BOOTP or RARP, you must set the Boot Method to static so that the print server has a static IP address. This will prevent the print server from trying to obtain an IP address from any of these systems. To change the Boot Method, use the machine’s control panel `Network` menu, BRAdmin applications, Remote Setup or Web Based Management (web browser).

## Using BOOTP to configure the IP address

BOOTP is an alternative to RARP that has the advantage of allowing configuration of the subnet mask and gateway. In order to use BOOTP to configure the IP address make sure that BOOTP is installed and running on your host computer (it should appear in the `/etc/services` file on your host as a real service; type `man bootpd` or refer to your system documentation for information). BOOTP is usually started up via the `/etc/inetd.conf` file, so you may need to enable it by removing the “#” in front of the `bootp` entry in that file. For example, a typical `bootp` entry in the `/etc/inetd.conf` file would be:

```
#bootp dgram udp wait /usr/etc/bootpd bootpd -i
```

Depending on the system, this entry might be called “`bootps`” instead of “`bootp`”.



### Note

In order to enable BOOTP, simply use an editor to delete the “#” (if there is no “#”, then BOOTP is already enabled). Then edit the BOOTP configuration file (usually `/etc/bootptab`) and enter the name, network type (1 for Ethernet), MAC Address (Ethernet Address) and the IP address, subnet mask and gateway of the print server. Unfortunately, the exact format for doing this is not standardized, so you will need to refer to your system documentation to determine how to enter this information (many UNIX systems also have template examples in the `bootptab` file that you can use for reference). Some examples of typical `/etc/bootptab` entries include: (“BRN” below is “BRW” for a wireless network.)

```
BRN310107 1 00:80:77:31:01:07 192.168.1.2
```

and:

```
BRN310107:ht=ethernet:ha=008077310107:\ip=192.168.1.2:
```

Certain BOOTP host software implementations will not respond to BOOTP requests if you have not included a download filename in the configuration file. If this is the case, simply create a null file on the host and specify the name of this file and its path in the configuration file.

As with RARP, the print server will load its IP address from the BOOTP server when the printer is powered on.

## Using RARP to configure the IP address

---

The Brother print server's IP address can be configured using the Reverse ARP (RARP) facility on your host computer. This is done by editing the `/etc/ethers` file (if this file does not exist, you can create it) with an entry similar to the following:

```
00:80:77:31:01:07    BRN008077310107 (or BRW008077310107 for a wireless network)
```

Where the first entry is the MAC Address (Ethernet Address) of the print server and the second entry is the name of the print server (the name must be the same as the one you put in the `/etc/hosts` file).

If the RARP daemon is not already running, start it (depending on the system the command can be `rarpd`, `rarpd -a`, `in.rarpd -a` or something else; type `man rarpd` or refer to your system documentation for additional information). To verify that the RARP daemon is running on a Berkeley UNIX based system, type the following command:

```
ps -ax | grep -v grep | grep rarpd
```

For AT&T UNIX-based systems, type:

```
ps -ef | grep -v grep | grep rarpd
```

The Brother print server will get the IP address from the RARP daemon when the printer is powered on.

## Using APIPA to configure the IP address

---

The Brother print server supports the Automatic Private IP Addressing (APIPA) protocol. With APIPA, DHCP clients automatically configure an IP address and subnet mask when a DHCP server is not available. The device chooses its own IP address in the range 169.254.1.0 through to 169.254.254.255. The subnet mask is automatically set to 255.255.0.0 and the gateway address is set to 0.0.0.0.

By default, the APIPA protocol is enabled. If you want to disable the APIPA protocol, you can disable it using control panel of the machine. (For more information, see *APIPA* on page 100.)

## Using ARP to configure the IP address

---

If you are unable to use the BRAdmin application and your network does not use a DHCP server, you can also use the ARP command. The ARP command is available on Windows® systems that have TCP/IP installed as well as UNIX systems. To use ARP enter the following command at the command prompt:

```
arp -s ipaddress ethernetaddress  
ping ipaddress
```

Where `ethernetaddress` is the MAC Address (Ethernet Address) of the print server and `ipaddress` is the IP address of the print server. For example:

### ■ Windows® systems

Windows® systems require the dash “-” character between each digit of the MAC Address (Ethernet Address).

```
arp -s 192.168.1.2 00-80-77-31-01-07  
ping 192.168.1.2
```

### ■ UNIX/Linux systems

Typically, UNIX and Linux systems require the colon “:” character between each digit of the MAC Address (Ethernet Address).

```
arp -s 192.168.1.2 00:80:77:31:01:07  
ping 192.168.1.2
```



### Note

You must be on the same Ethernet segment (that is, there cannot be a router between the print server and operating system) to use the `arp -s` command.

If there is a router, you may use BOOTP or other methods described in this chapter to enter the IP address. If your administrator has configured the system to deliver IP addresses using BOOTP, DHCP or RARP your Brother print server can receive an IP address from any one of these IP address allocation systems. In which case, you will not need to use the ARP command. The ARP command only works once. For security reasons, once you have successfully configured the IP address of a Brother print server using the ARP command, you cannot use the ARP command again to change the address. The print server will ignore any attempts to do this. If you wish to change the IP address again, use a Web Based Management (web browser), TELNET (using the SET IP ADDRESS command) or factory reset the print server (which will then allow you to use the ARP command again).

---

## Using the TELNET console to configure the IP address

You can also use the TELNET command to change the IP address.

TELNET is an effective method to change the machine's IP address. But a valid IP address must already be programmed into the print server.

Type `TELNET <command line>` at the command prompt of the system prompt, where `<command line>` is the IP address of the print server. When you are connected, push the Return or Enter key to get the “#” prompt. Enter the password “**access**” (the password will not appear on the screen).

You will be prompted for a user name. Enter anything in response to this prompt.

You will then get the `Local>` prompt. Type `SET IP ADDRESS ipaddress`, where `ipaddress` is the desired IP address you wish to assign to the print server (check with your network administrator for the IP address to use). For example:

```
Local> SET IP ADDRESS 192.168.1.3
```

You will now need to set the subnet mask by typing `SET IP SUBNET subnet mask`, where `subnet mask` is the desired subnet mask you wish to assign to the print server (check with your network administrator for the subnet mask to use). For example:

```
Local> SET IP SUBNET 255.255.255.0
```

If you do not have any subnets, use one of the following default subnet masks:

255.0.0.0 for class A networks

255.255.0.0 for class B networks

255.255.255.0 for class C networks

The leftmost group of digits in your IP address can identify the type of network you have. The value of this group ranges from 1 through 127 for Class A networks (e.g., 13.27.7.1), 128 through 191 for Class B networks (e.g., 128.10.1.30), and 192 through 255 for Class C networks (e.g., 192.168.1.4).

If you have a gateway (router), enter its address with the command `SET IP ROUTER routeraddress`, where `routeraddress` is the desired IP address of the gateway you wish to assign to the print server. For example:

```
Local> SET IP ROUTER 192.168.1.4
```

Type `SET IP METHOD STATIC` to set the method of IP access configuration to static.

To verify that you have entered the IP information correctly, type `SHOW IP`.

Type `EXIT` or Ctrl-D (i.e., hold down the control key and type “D”) to end the remote console session.



## Using the Brother Web BRAdmin server software for IIS to configure the IP address

---

A

The Web BRAdmin server software is designed to manage all LAN/WAN Brother network connected devices. By installing the Web BRAdmin server software on a computer running IIS <sup>1</sup>, administrators with a web browser can connect to the Web BRAdmin server, which then communicates with the device itself. Unlike the BRAdmin Professional utility, which is designed for Windows<sup>®</sup> systems only, the Web BRAdmin server software can be accessed from any client computer with a web browser that supports Java.

Please note this software is not included on the CD-ROM that was supplied with your Brother product.

Please visit <http://solutions.brother.com/> to learn more about this software and to download it.

<sup>1</sup> Internet Information Server 4.0 or Internet Information Services 5.0/5.1/6.0/7.0

## Installation when using web services (Windows Vista®)



### Note

- You must configure the IP address on your machine before you proceed with this section. If you have not configured the IP address, see *Setting the IP address and subnet mask* on page 15.
- Verify the host computer and print server are either on the same subnet, or that the router is properly configured to pass data between the two devices.



1 Click the  button and then choose **Network**.



2 The machine's Web Services Name will be shown with the printer icon. Right-click the machine you want to install.



### Note

The Web Services Name for the Brother machine is your model name and the MAC Address (Ethernet Address) of your machine (e.g. Brother MFC-XXXX (model name) [XXXXXX] (MAC Address / Ethernet Address)).



3 Click **Install**.



4 When the **User Account Control** screen appears, do the following.

- Users who have administrator rights: Click **Continue**.
- For users who do not have administrator rights: Enter the administrator password and click **OK**.



5 Choose **Locate and install driver software (recommended)**.



6 Insert Brother CD-ROM.



7 Choose **Don't search online** and then **Browse my computer for driver software (advanced)** on your computer.



8 Choose your CD-ROM drive and then the **driver \ win2kxpvista<sup>1</sup> \ your language** folder. Click **OK**.

<sup>1</sup> **win2kxpvista** folder for 32-bit OS users and **winxpx64vista64** for 64-bit OS users



9 Click **Next** to begin installation.

## Installation when using a Network Print Queue or Share (printer driver only)



### Note

---

If you are going to connect to a shared printer on your network, we recommend that you ask your system administrator about the queue or share name for the printer prior to installation.

---

- 1 Start the CD-ROM installation menu program according to the *Quick Setup Guide*.
- 2 Choose the model name and your language (if necessary), and then click **Initial Installation**.
- 3 Click **Printer Driver Only (for Network)**.
- 4 Click **Next** in response to the Welcome message. Follow the on-screen instructions.
- 5 Choose **Standard Installation** and click **Next**.
- 6 Choose **Network Shared Printer**, and then click **Next**.
- 7 Choose your printer's queue, and then click **OK**.



### Note

---

Contact your administrator if you are not sure about the location and name of the printer in the network.

---

- 8 Click **Finish**. Setup is now complete.

## Print server specifications

### Ethernet wired network

<b>Network Board Model name</b>	NC-6800h type2
<b>LAN</b>	You can connect your machine to a network for Network Printing, Network Scanning, PC Fax and Remote Setup. <sup>1 2</sup>
<b>Support for</b>	Windows <sup>®</sup> 2000 Professional, Windows <sup>®</sup> XP, Windows <sup>®</sup> XP Professional x64 Edition, Windows Vista <sup>®</sup> , Windows Server <sup>®</sup> 2003/2008 and Windows Server <sup>®</sup> 2003 x64 Edition <sup>2</sup> Mac OS X 10.3.9 or greater <sup>3</sup>
<b>Protocols</b>	IPv4: ARP, RARP, BOOTP, DHCP, APIPA (Auto IP), WINS/NetBIOS name resolution, DNS resolver, mDNS, LLNMR responder, LPR/LPD, Custom Raw Port/Port9100, IPP/IPPS, FTP server, FTP client, POP before SMTP, SMTP AUTH, APOP, TELNET Server, SNMPv1/v2c/v3, HTTP/HTTPS server, TFTP client and server, SMTP client, ICMP, Web services Print, SNTP, LDAP <sup>4</sup> , CIFS Client, SSL/TLS, LLTD responder, POP3/SMTP <sup>4</sup> IPv6: (Turned off as default) NDP, RA, DNS resolver, mDNS, LLNMR responder, LPR/LPD, Custom Raw Port/Port9100, IPP/IPPS, FTP server, FTP client, POP before SMTP, SMTP AUTH, APOP, TELNET Server, SNMPv1/v2c/v3, HTTP/HTTPS server, TFTP client and server, SMTP client, ICMPv6, Web services Print, SNTP, LDAP <sup>4</sup> , CIFS Client, SSL/TLS, LLTD responder, POP3/SMTP <sup>4</sup>
<b>Network type</b>	Ethernet 10/100 BASE-TX Auto Negotiation (Wired LAN)
<b>Management utilities</b>	BRAdmin Light BRAdmin Professional 3 <sup>5</sup> Web BRAdmin <sup>5 6</sup> BRPrint Auditor <sup>7</sup> Web Based Management (web browser)

<sup>1</sup> PC Fax Send for Mac

<sup>2</sup> Printing only for Windows Server<sup>®</sup> 2003/2008

<sup>3</sup> For the latest driver updates, visit <http://solutions.brother.com/>

<sup>4</sup> For MFC-8880DN only

<sup>5</sup> BRAdmin Professional and Web BRAdmin are available as a download from <http://solutions.brother.com/>. They are for Windows<sup>®</sup> only.

<sup>6</sup> Client computers with a web browser supporting Java.

<sup>7</sup> Available when using BRAdmin Professional 3 or Web BRAdmin with devices that are connected to your client PC via the USB or parallel interface.

## Wireless network

<b>Network board model name</b>	NC-7600w type2
<b>LAN</b>	You can connect your machine to a network for Network Printing, Network Scanning, PC Fax and Remote Setup <sup>1 2</sup> .
<b>Support for</b>	Windows <sup>®</sup> 2000 Professional, Windows <sup>®</sup> XP, Windows <sup>®</sup> XP Professional x64 Edition, Windows Vista <sup>®</sup> , Windows Server <sup>®</sup> 2003/2008 and Windows Server <sup>®</sup> 2003 x64 Edition Mac OS X 10.3.9 or greater <sup>3</sup>
<b>Protocols</b>	IPv4: ARP, RARP, BOOTP, DHCP, APIPA (Auto IP), WINS/NetBIOS name resolution, DNS resolver, mDNS, LLNMR responder, LPR/LPD, Custom Raw Port/Port9100, IPP/IPPS, FTP server, FTP client, POP before SMTP, SMTP AUTH, APOP, TELNET Server, SNMPv1/v2c/v3, HTTP/HTTPS server, TFTP client and server, SMTP client, ICMP, Web services Print, SNTP, LDAP, CIFS Client, SSL/TLS, LLTD responder, POP3/SMTP IPv6: (Turned off as default) NDP, RA, DNS resolver, mDNS, LLNMR responder, LPR/LPD, Custom Raw Port/Port9100, IPP/IPPS, FTP server, FTP client, POP before SMTP, SMTP AUTH, APOP, TELNET Server, SNMPv1/v2c/v3, HTTP/HTTPS server, TFTP client and server, SMTP client, ICMPv6, Web services Print, SNTP, LDAP, CIFS Client, SSL/TLS, LLTD responder, POP3/SMTP
<b>Management utilities</b>	BRAdmin Light BRAdmin Professional <sup>3 4</sup> Web BRAdmin <sup>4 5</sup> BRPrint Auditor <sup>6</sup> Web Based Management (web browser)
<b>Network type</b>	IEEE 802.11 b/g (Wireless LAN)
<b>Frequency</b>	2412-2472 MHz
<b>RF channels</b>	USA/Canada 1-11 Japan 802.11b: 1-14, 802.11g: 1-13 Others 1-13
<b>Communication mode</b>	Infrastructure, Ad-hoc (802.11b only)
<b>Data rates</b>	802.11b 11/5.5/2/1 Mbps 802.11g 54/48/36/24/18/12/11/9/6/5.5/2/1 Mbps
<b>Link distance</b>	70m (233 ft.) at lowest data rate (The distance rate will vary upon environment and other equipment location.)

<b>Network security</b>	SSID/ESSID, 128 (104) / 64 (40) bit WEP, WPA2-PSK (AES), WPA-PSK (TKIP/AES), LEAP (CKIP), EAP-FAST
<b>Setup support utilities</b>	SecureEasySetup™ <sup>7</sup> , Wi-Fi Protected Setup, AOSS™

<sup>1</sup> PC Fax Send for Mac

<sup>2</sup> Printing only for Windows Server® 2003/2008

<sup>3</sup> For the latest driver updates, visit <http://solutions.brother.com/>

<sup>4</sup> BRAdmin Professional and Web BRAdmin are available as a download from <http://solutions.brother.com/>. They are for Windows® only.

<sup>5</sup> Client computers with a web browser supporting Java.

<sup>6</sup> Available when using BRAdmin Professional 3 or Web BRAdmin with devices that are connected to your client PC via a USB or parallel port.

<sup>7</sup> For MFC-8890DW only.

## Function table and default factory settings

### DCP-8080DN, DCP-8085DN, MFC-8480DN and MFC-8680DN

The factory settings are shown in Bold with an asterisk.

Main menu	Submenu	Menu selections	Options	
<b>5.Network</b> (DCP-8080DN and DCP-8085DN)  <b>7.Network</b> (MFC-8480DN and MFC-8680DN)	1.TCP/IP	1.Boot Method	<b>Auto*</b> Static RARP BOOTP DHCP (If you choose <b>Auto</b> , <b>RARP</b> , <b>BOOTP</b> or <b>DHCP</b> , you will be asked to enter how many times the machine tries to obtain the IP address.)	
		2.IP Address	[000-255] . [000-255] . [000-255] . [000-255] [000] . [000] . [000] . [000]* <sup>1</sup>	
		3.Subnet Mask	[000-255] . [000-255] . [000-255] . [000-255] [000] . [000] . [000] . [000]* <sup>1</sup>	
		4.Gateway	[000-255] . [000-255] . [000-255] . [000-255] [000] . [000] . [000] . [000]*	
		5.Node Name	BRNxxxxxxxxxxxxxx (up to 32 characters)	
		6.WINS Config	<b>Auto*</b> Static	
		7.WINS Server	Primary	[000-255] . [000-255] . [000-255] . [000-255] [000] . [000] . [000] . [000]*
			Secondary	[000-255] . [000-255] . [000-255] . [000-255] [000] . [000] . [000] . [000]*
		8.DNS Server	Primary	[000-255] . [000-255] . [000-255] . [000-255] [000] . [000] . [000] . [000]*
			Secondary	[000-255] . [000-255] . [000-255] . [000-255] [000] . [000] . [000] . [000]*
9.APIPA	<b>On*</b> Off			

Main menu	Submenu	Menu selections	Options
<b>5.Network</b> (DCP-8080DN and DCP-8085DN)  <b>7.Network</b> (MFC-8480DN and MFC-8680DN) (continued)	<b>1.TCP/IP</b> (continued)	<b>0.IPv6</b>	On <b>Off*</b>
	<b>2.Ethernet</b>	—	<b>Auto*</b> 100B-FD 100B-HD 10B-FD 10B-HD
	<b>3.Scan to FTP</b>	—	<b>Color 100 dpi*</b> Color 200 dpi Color 300 dpi Color 600 dpi Gray 100 dpi Gray 200 dpi Gray 300 dpi B&W 200 dpi B&W 200x100 dpi



Main menu	Submenu	Menu selections	Options
5. Network (DCP-8080DN and DCP-8085DN)  7. Network (MFC-8480DN and MFC-8680DN) (continued)	4. ScanTo Network	—	Color 100 dpi* Color 200 dpi Color 300 dpi Color 600 dpi Gray 100 dpi Gray 200 dpi Gray 300 dpi B&W 200 dpi B&W 200x100 dpi (If you choose Color option) <b>PDF*</b> Secure PDF JPEG XPS (If you choose Gray option) <b>PDF*</b> Secure PDF JPEG XPS (If you choose B&W option) <b>PDF*</b> Secure PDF TIFF
	7. Time Zone	—	— UTC+XX:XX UTC-XX:XX
	0. Network Reset	1. Reset	1. Yes 2. No
		2. Exit	—

<sup>1</sup> On connection to the network, the machine will automatically set the IP address and Subnet Mask to values appropriate for your network.

## MFC-8880DN

The factory settings are shown in Bold with an asterisk.

Main menu	Submenu	Menu selections	Options	
7.Network	1.TCP/IP	1.Boot Method	<b>Auto*</b> Static RARP BOOTP DHCP (If you choose <b>Auto</b> , RARP, BOOTP or DHCP, you will be asked to enter how many times the machine tries to obtain the IP address.)	
		2.IP Address	[000-255]. [000-255]. [000-255]. [000-255] [000]. [000]. [000]. [000]* <sup>1</sup>	
		3.Subnet Mask	[000-255]. [000-255]. [000-255]. [000-255] [000]. [000]. [000]. [000]* <sup>1</sup>	
		4.Gateway	[000-255]. [000-255]. [000-255]. [000-255] [000]. [000]. [000]. [000]*	
		5.Node Name	BRNxxxxxxxxxxxxx (up to 32 characters)	
		6.WINS Config	<b>Auto*</b> Static	
		7.WINS Server	Primary	[000-255]. [000-255]. [000-255]. [000-255] [000]. [000]. [000]. [000]*
			Secondary	[000-255]. [000-255]. [000-255]. [000-255] [000]. [000]. [000]. [000]*
		8.DNS Server	Primary	[000-255]. [000-255]. [000-255]. [000-255] [000]. [000]. [000]. [000]*
			Secondary	[000-255]. [000-255]. [000-255]. [000-255] [000]. [000]. [000]. [000]*
		9.APIPA	<b>On*</b> Off	
		0.IPv6	On <b>Off*</b>	

Main menu	Submenu	Menu selections	Options	
7.Network (continued)	2.Ethernet	—	Auto* 100B-FD 100B-HD 10B-FD 10B-HD	
	3.E-mail/IFAX	1.Mail Address	Name (up to 60 characters)	
		2.Setup Server	1.SMTP Server	Name? (Up to 64 characters) IP Address? [000-255].[000-255].[000-255].[000-255]
			2.SMTP Port	00025* [00001-65535]
			3.Auth. for SMTP	None* SMTP-AUTH POP bef.SMTP
			4.POP3 Server	Name? (Up to 64 characters) IP Address? [000-255].[000-255].[000-255].[000-255]
			5.POP3 Port	00110* [00001-65535]
			6.Mailbox Name	(Up to 60 characters)
			7.Mailbox Pwd	(Up to 32 characters)
			8.APOP	On Off*
		3.Setup Mail RX	1.Auto Polling	On* Off
			2.Poll Frequency	10Min* (01Min to 60Min)
			3.Header	All Subject+From+To None*
			4.Del Error Mail	On* Off

Main menu	Submenu	Menu selections	Options		
7.Network (continued)	3.E-mail/IFAX (continued)	3.Setup Mail RX (continued)	5.Notification	On MDN <b>Off*</b>	
		4.Setup Mail TX	1.Sender Subject	(Up to 40 characters)	
			2.Size Limit	On <b>Off*</b>	
			3.Notification	On <b>Off*</b>	
		5.Setup Relay	1.Rly Broadcast	On <b>Off*</b>	
			2.Relay Domain	RelayXX: Relay(01 - 10)	
			3.Relay Report	On <b>Off*</b>	
		4.Scan to E-mail	—	Color 100 dpi*	(If you choose Color option)
				Color 200 dpi	<b>PDF*</b>
			Color 300 dpi	Secure PDF	
		Color 600 dpi	JPEG		
		Gray 100 dpi	XPS		
		Gray 200 dpi	(If you choose Gray option)		
		Gray 300 dpi	<b>PDF*</b>		
		B&W 200 dpi	Secure PDF		
		B&W 200x100 dpi	JPEG		
			XPS		
			(If you choose B&W option)		
			<b>PDF*</b>		
			Secure PDF		
			TIFF		

Main menu	Submenu	Menu selections	Options	
7. Network (continued)	5. Scan to FTP	—	Color 100 dpi*	(If you choose Color option)
			Color 200 dpi	PDF*
			Color 300 dpi	Secure PDF
			Color 600 dpi	JPEG
			Gray 100 dpi	XPS
		Gray 200 dpi	(If you choose Gray option)	
		Gray 300 dpi	PDF*	
		B&W 200 dpi	Secure PDF	
		B&W 200x100 dpi	JPEG	
			XPS	
			(If you choose B&W option)	
			PDF*	
			Secure PDF	
			TIFF	
	6. ScanTo Network	—	Color 100 dpi*	(If you choose Color option)
			Color 200 dpi	PDF*
			Color 300 dpi	Secure PDF
			Color 600 dpi	JPEG
			Gray 100 dpi	XPS
			Gray 200 dpi	(If you choose Gray option)
			Gray 300 dpi	PDF*
			B&W 200 dpi	Secure PDF
			B&W 200x100 dpi	JPEG
				XPS
				(If you choose B&W option)
				PDF*
				Secure PDF
				TIFF
	7. Fax to Server	—	—	On
				Off*
	8. Time Zone	—	—	UTC+XX:XX
				UTC-XX:XX
	0. Network Reset	1. Reset	1. Yes	
			2. No	
		2. Exit	—	

<sup>1</sup> On connection to the network, the machine will automatically set the IP address and Subnet Mask to values appropriate for your network.

## MFC-8690DW and MFC-8890DW

The factory settings are shown in Bold with an asterisk.

Main Menu	Submenu	Menu Selections		Options
7.Network	1.Wired LAN	1.TCP/IP	1.Boot Method	<b>Auto*</b> Static RARP BOOTP DHCP (If you choose <b>Auto</b> , RARP, BOOTP or DHCP, you will be asked to enter how many times the machine tries to obtain the IP address.)
			2.IP Address	[000-255]. [000-255]. [000-255]. [000-255] <b>[000]. [000]. [000]. [000]*<sup>1</sup></b>
			3.Subnet Mask	[000-255]. [000-255]. [000-255]. [000-255] <b>[000]. [000]. [000]. [000]*<sup>1</sup></b>
			4.Gateway	[000-255]. [000-255]. [000-255]. [000-255] <b>[000]. [000]. [000]. [000]*</b>
			5.Node Name	BRNxxxxxxxxxxxxxx (up to 32 characters)
			6.WINS Config	<b>Auto*</b> Static
			7.WINS Server	(Primary) [000-255]. [000-255]. [000-255]. [000-255] <b>[000]. [000]. [000]. [000]*</b> (Secondary) [000-255]. [000-255]. [000-255]. [000-255] <b>[000]. [000]. [000]. [000]*</b>

B

Main Menu	Submenu	Menu Selections		Options	
7. Network (continued)	1. Wired LAN (continued)	1. TCP/IP (continued)	8. DNS Server	(Primary) [000-255]. [000-255]. [000-255]. [000-255] [000]. [000]. [000]. [000]* (Secondary) [000-255]. [000-255]. [000-255]. [000-255] [000]. [000]. [000]. [000]*	
			9. APIPA	On* Off	
			0. IPv6	On Off*	
		2. Ethernet	—	Auto* 100B-FD 100B-HD 10B-FD 10B-HD	
		3. Set to Default	1. Reset	—	
			2. Exit	—	
		4. Wired Enable	—	On* Off	
		2. WLAN	1. TCP/IP	1. Boot Method	Auto* Static RARP BOOTP DHCP (If you choose Auto, RARP, BOOTP or DHCP, you will be asked to enter how many times the machine tries to obtain the IP address.)
				2. IP Address	[000-255]. [000-255]. [000-255]. [000-255] [000]. [000]. [000]. [000]* <sup>1</sup>
	3. Subnet Mask			[000-255]. [000-255]. [000-255]. [000-255] [000]. [000]. [000]. [000]* <sup>1</sup>	

Main Menu	Submenu	Menu Selections	Options	
7. Network (continued)	2. WLAN (continued)	1. TCP/IP (continued)	4. Gateway	[000-255]. [000-255]. [000-255]. [000-255] [000]. [000]. [000]. [000]*
			5. Node Name	BRWxxxxxxxxxxxxxx (up to 32 characters)
			6. WINS Config	Auto* Static
			7. WINS Server	(Primary) [000-255]. [000-255]. [000-255]. [000-255] [000]. [000]. [000]. [000]* (Secondary) [000-255]. [000-255]. [000-255]. [000-255] [000]. [000]. [000]. [000]*
			8. DNS Server	(Primary) [000-255]. [000-255]. [000-255]. [000-255] [000]. [000]. [000]. [000]* (Secondary) [000-255]. [000-255]. [000-255]. [000-255] [000]. [000]. [000]. [000]*
			9. APIPA	On* Off
			0. IPv6	On Off*
		2. Setup Wizard	—	—
		3. SES/WPS/AOSS	—	—
		4. WPS w/PIN Code	—	—
		5. WLAN Status	1. Status	Active(11b) Active(11g) Wired LAN Active WLAN OFF AOSS Active Connection Fail



Main Menu	Submenu	Menu Selections	Options	
7.Network (continued)	2.WLAN (continued)	5.WLAN Status (continued)	2.Signal	Strong Medium Weak None
			3.SSID	—
			4.Comm. Mode	Ad-hoc Infrastructure
		6.Set to Default	1.Reset	—
			2.Exit	—
		7.WLAN Enable	—	On Off*
		3.E-mail/IFAX	1.Mail Address 2.Setup Server	Name (Up to 60 characters)
	1.SMTP Server			Name? (Up to 64 characters) IP Address? [000-255].[000-255].[000-255].[000-255]
	2.SMTP Port			00025* [00001-65535]
	3.Auth. for SMTP			None* SMTP-AUTH POP bef.SMTP
	4.POP3 Server			Name? (Up to 64 characters) IP Address? [000-255].[000-255].[000-255].[000-255]
	5.POP3 Port			00110* [00001-65535]
	6.Mailbox Name			(Up to 60 characters)
	7.Mailbox Pwd			(Up to 32 characters)
	8.APOP			On Off*
	3.Setup Mail RX			1.Auto Polling

Main Menu	Submenu	Menu Selections	Options	
7.Network (continued)	3.E-mail/IFAX (continued)	3.Setup Mail RX (continued)	2.Poll Frequency	10Min* (01Min to 60Min)
			3.Header	All Subject+From+To None*
			4.Del Error Mail	On* Off
			5.Notification	On MDN Off*
		4.Setup Mail TX	1.Sender Subject	(Up to 40 characters)
			2.Size Limit	On Off*
			3.Notification	On Off*
		5.Setup Relay	1.Rly Broadcast	On Off*
			2.Relay Domain	RelayXX: Relay(01 - 10)
			3.Relay Report	On Off*
	4.Scan to E-mail	—	Color 100 dpi* Color 200 dpi Color 300 dpi Color 600 dpi Gray 100 dpi Gray 200 dpi Gray 300 dpi B&W 200 dpi B&W 200x100 dpi	(If you choose Color option) PDF* Secure PDF JPEG XPS (If you choose Gray option) PDF* Secure PDF JPEG XPS (If you choose B&W option) PDF* Secure PDF TIFF

Main Menu	Submenu	Menu Selections		Options
7.Network (continued)	5.Scan to FTP	—	<b>Color 100 dpi*</b> Color 200 dpi Color 300 dpi Color 600 dpi Gray 100 dpi Gray 200 dpi Gray 300 dpi B&W 200 dpi B&W 200x100 dpi	(If you choose Color option) <b>PDF*</b> Secure PDF JPEG XPS (If you choose Gray option) <b>PDF*</b> Secure PDF JPEG XPS (If you choose B&W option) <b>PDF*</b> Secure PDF TIFF
	6.ScanTo Network	—	<b>Color 100 dpi*</b> Color 200 dpi Color 300 dpi Color 600 dpi Gray 100 dpi Gray 200 dpi Gray 300 dpi B&W 200 dpi B&W 200x100 dpi	(If you choose Color option) <b>PDF*</b> Secure PDF JPEG XPS (If you choose Gray option) <b>PDF*</b> Secure PDF JPEG XPS (If you choose B&W option) <b>PDF*</b> Secure PDF TIFF
	7.Fax to Server	—	—	On <b>Off*</b>
	8.Time Zone	—	—	UTC+XX:XX UTC-XX:XX
	0.Network Reset	1.Reset	—	1.Yes 2.No
	2.Exit	—	—	—

<sup>1</sup> On connection to the network, the machine will automatically set the IP address and Subnet Mask to values appropriate for your network.

## Entering Text

When setting certain menu selections, such as the E-mail address, you will need to type text characters. The dial pad keys have letters printed on them. The keys: **0**, **#** and **\*** do not have printed letters because they are used for special characters.

Press the appropriate dial pad key the required number of times to access the characters below:

- For setting an E-mail address, Scan to FTP menu options and E-mail/IFAX menu options

Press Key	one time	two times	three times	four times	five times	six times	seven times	eight times	nine times
1	@	.	/	1	@	.	/	1	@
2	a	b	c	A	B	C	2	a	b
3	d	e	f	D	E	F	3	d	e
4	g	h	i	G	H	I	4	g	h
5	j	k	l	J	K	L	5	j	k
6	m	n	o	M	N	O	6	m	n
7	p	q	r	s	P	Q	R	S	7
8	t	u	v	T	U	V	8	t	u
9	w	x	y	z	W	X	Y	Z	9

- For setting other menu selections

Press Key	one time	two times	three times	four times	five times
2	A	B	C	2	A
3	D	E	F	3	D
4	G	H	I	4	G
5	J	K	L	5	J
6	M	N	O	6	M
7	P	Q	R	7	P
8	T	U	V	8	T
9	W	X	Y	9	W

### Inserting spaces

To enter a space in a fax number, press **▶** once between numbers. To enter a space in a name, press **▶** twice between characters.

### Making corrections

If you entered a letter incorrectly and want to change it, press **◀** to move the cursor to the incorrect character, and then press **Clear/Back**.

## Repeating letters

To enter a character on the same key as the previous character, press ► to move the cursor right before pressing the key again.

## Special characters and symbols

Press \*, # or 0, and then press ◀ or ▶ to move the cursor to the symbol or character you want.

Press **OK** to choose it. The symbols and characters below will appear depending on your menu selection.

Press \* for (space) ! " # \$ % & ' ( ) \* + , - . /

Press # for ; < = > ? @ [ ] ^ \_ \ ~ ` | { }

Press 0 for 0 \ { | } ~

## Open Source Licensing Remarks

### **Part of the software embedded in this product is gSOAP software.**

---

Portions created by gSOAP are Copyright (C) 2001 2004 Robert A. van Engelen, Genivia inc. All Rights Reserved.

THE SOFTWARE IN THIS PRODUCT WAS IN PART PROVIDED BY GENIVIA INC AND ANY EXPRESS OR IMPLIED WARRANTIES, INCLUDING, BUT NOT LIMITED TO, THE IMPLIED WARRANTIES OF MERCHANTABILITY AND FITNESS FOR A PARTICULAR PURPOSE ARE DISCLAIMED. IN NO EVENT SHALL THE AUTHOR BE LIABLE FOR ANY DIRECT, INDIRECT, INCIDENTAL, SPECIAL, EXEMPLARY, OR CONSEQUENTIAL DAMAGES (INCLUDING, BUT NOT LIMITED TO, PROCUREMENT OF SUBSTITUTE GOODS OR SERVICES; LOSS OF USE, DATA, OR PROFITS; OR BUSINESS INTERRUPTION) HOWEVER CAUSED AND ON ANY THEORY OF LIABILITY, WHETHER IN CONTRACT, STRICT LIABILITY, OR TORT (INCLUDING NEGLIGENCE OR OTHERWISE) ARISING IN ANYWAY OUT OF THE USE OF THIS SOFTWARE, EVEN IF ADVISED OF THE POSSIBILITY OF SUCH DAMAGE.

Permission to use, copy, modify, and distribute this software for any purpose and without fee is hereby granted, provided that the above copyright notices appear in all copies and that both the copyright notice and this permission notice appear in supporting documentation. This software is provided "as is" without express or implied warranty.

### **This product includes SNMP software from WestHawk Ltd.**

---

Copyright (C) 2000, 2001, 2002 by Westhawk Ltd

Permission to use, copy, modify, and distribute this software for any purpose and without fee is hereby granted, provided that the above copyright notices appear in all copies and that both the copyright notice and this permission notice appear in supporting documentation. This software is provided "as is" without express or implied warranty.

## MIT Kerberos statements

---

### MIT Kerberos license copyright Version 1.6.3

Copyright (C) 1985-2007 by the Massachusetts Institute of Technology. All rights reserved.

Export of this software from the United States of America may require a specific license from the United States Government. It is the responsibility of any person or organization contemplating export to obtain such a license before exporting.

WITHIN THAT CONSTRAINT, permission to use, copy, modify, and distribute this software and its documentation for any purpose and without fee is hereby granted, provided that the above copyright notice appear in all copies and that both that copyright notice and this permission notice appear in supporting documentation, and that the name of M.I.T. not be used in advertising or publicity pertaining to distribution of the software without specific, written prior permission. Furthermore if you modify this software you must label your software as modified software and not distribute it in such a fashion that it might be confused with the original MIT software. M.I.T. makes no representations about the suitability of this software for any purpose. It is provided "as is" without express or implied warranty.

THIS SOFTWARE IS PROVIDED "AS IS" AND WITHOUT ANY EXPRESS OR IMPLIED WARRANTIES, INCLUDING, WITHOUT LIMITATION, THE IMPLIED WARRANTIES OF MERCHANTABILITY AND FITNESS FOR A PARTICULAR PURPOSE.

Copyright (C) 1998 by the FundsXpress, INC. All rights reserved.

Export of this software from the United States of America may require a specific license from the United States Government. It is the responsibility of any person or organization contemplating export to obtain such a license before exporting.

WITHIN THAT CONSTRAINT, permission to use, copy, modify, and distribute this software and its documentation for any purpose and without fee is hereby granted, provided that the above copyright notice appear in all copies and that both that copyright notice and this permission notice appear in supporting documentation, and that the name of FundsXpress. not be used in advertising or publicity pertaining to distribution of the software without specific, written prior permission. FundsXpress makes no representations about the suitability of this software for any purpose. It is provided "as is" without express or implied warranty.

THIS SOFTWARE IS PROVIDED "AS IS" AND WITHOUT ANY EXPRESS OR IMPLIED WARRANTIES, INCLUDING, WITHOUT LIMITATION, THE IMPLIED WARRANTIES OF MERCHANTABILITY AND FITNESS FOR A PARTICULAR PURPOSE.

Copyright 1993, 1995 by OpenVision Technologies, Inc.

Permission to use, copy, modify, distribute, and sell this software and its documentation for any purpose is hereby granted without fee, provided that the above copyright notice appears in all copies and that both that copyright notice and this permission notice appear in supporting documentation, and that the name of OpenVision not be used in advertising or publicity pertaining to distribution of the software without specific, written prior permission. OpenVision makes no representations about the suitability of this software for any purpose. It is provided "as is" without express or implied warranty.

OPENVISION DISCLAIMS ALL WARRANTIES WITH REGARD TO THIS SOFTWARE, INCLUDING ALL IMPLIED WARRANTIES OF MERCHANTABILITY AND FITNESS, IN NO EVENT SHALL OPENVISION BE LIABLE FOR ANY SPECIAL, INDIRECT OR CONSEQUENTIAL DAMAGES OR ANY DAMAGES WHATSOEVER RESULTING FROM LOSS OF USE, DATA OR PROFITS, WHETHER IN AN ACTION OF CONTRACT, NEGLIGENCE OR OTHER TORTIOUS ACTION, ARISING OUT OF OR IN CONNECTION WITH THE USE OR PERFORMANCE OF THIS SOFTWARE.

Copyright 2000 by Zero-Knowledge Systems, Inc.

Permission to use, copy, modify, distribute, and sell this software and its documentation for any purpose is hereby granted without fee, provided that the above copyright notice appear in all copies and that both that copyright notice and this permission notice appear in supporting documentation, and that the name of Zero-Knowledge Systems, Inc. not be used in advertising or publicity pertaining to distribution of the software without specific, written prior permission. Zero-Knowledge Systems, Inc. makes no representations about the suitability of this software for any purpose. It is provided "as is" without express or implied warranty.

ZERO-KNOWLEDGE SYSTEMS, INC. DISCLAIMS ALL WARRANTIES WITH REGARD TO THIS SOFTWARE, INCLUDING ALL IMPLIED WARRANTIES OF MERCHANTABILITY AND FITNESS, IN NO EVENT SHALL ZERO-KNOWLEDGE SYSTEMS, INC. BE LIABLE FOR ANY SPECIAL, INDIRECT OR CONSEQUENTIAL DAMAGES OR ANY DAMAGES WHATSOEVER RESULTING FROM LOSS OF USE, DATA OR PROFITS, WHETHER IN AN ACTION OF CONTRACT, NEGLIGENCE OR OTHER TORTUOUS ACTION, ARISING OUT OF OR IN CONNECTION WITH THE USE OR PERFORMANCE OF THIS SOFTWARE.

Copyright (c) 2006 Red Hat, Inc.

Portions copyright (c) 2006 Massachusetts Institute of Technology All Rights Reserved.

Redistribution and use in source and binary forms, with or without modification, are permitted provided that the following conditions are met:

- \* Redistributions of source code must retain the above copyright notice, this list of conditions and the following disclaimer.
- \* Redistributions in binary form must reproduce the above copyright notice, this list of conditions and the following disclaimer in the documentation and/or other materials provided with the distribution.
- \* Neither the name of Red Hat, Inc., nor the names of its contributors may be used to endorse or promote products derived from this software without specific prior written permission.

THIS SOFTWARE IS PROVIDED BY THE COPYRIGHT HOLDERS AND CONTRIBUTORS "AS IS" AND ANY EXPRESS OR IMPLIED WARRANTIES, INCLUDING, BUT NOT LIMITED TO, THE IMPLIED WARRANTIES OF MERCHANTABILITY AND FITNESS FOR A PARTICULAR PURPOSE ARE DISCLAIMED. IN NO EVENT SHALL THE COPYRIGHT OWNER OR CONTRIBUTORS BE LIABLE FOR ANY DIRECT, INDIRECT, INCIDENTAL, SPECIAL, EXEMPLARY, OR CONSEQUENTIAL DAMAGES (INCLUDING, BUT NOT LIMITED TO, PROCUREMENT OF SUBSTITUTE GOODS OR SERVICES; LOSS OF USE, DATA, OR PROFITS; OR BUSINESS INTERRUPTION) HOWEVER CAUSED AND ON ANY THEORY OF LIABILITY, WHETHER IN CONTRACT, STRICT LIABILITY, OR TORT (INCLUDING NEGLIGENCE OR OTHERWISE) ARISING IN ANY WAY OUT OF THE USE OF THIS SOFTWARE, EVEN IF ADVISED OF THE POSSIBILITY OF SUCH DAMAGE.

Copyright 1995,1996,2003,2004 by Sun Microsystems, Inc.

Permission to use, copy, modify, distribute, and sell this software and its documentation for any purpose is hereby granted without fee, provided that the above copyright notice appears in all copies and that both that copyright notice and this permission notice appear in supporting documentation, and that the name of Sun Microsystems not be used in advertising or publicity pertaining to distribution of the software without specific, written prior permission. Sun Microsystems makes no representations about the suitability of this software for any purpose. It is provided "as is" without express or implied warranty.

SUN MICROSYSTEMS DISCLAIMS ALL WARRANTIES WITH REGARD TO THIS SOFTWARE, INCLUDING ALL IMPLIED WARRANTIES OF MERCHANTABILITY AND FITNESS, IN NO EVENT SHALL SUN MICROSYSTEMS BE LIABLE FOR ANY SPECIAL, INDIRECT OR CONSEQUENTIAL DAMAGES OR



ANY DAMAGES WHATSOEVER RESULTING FROM LOSS OF USE, DATA OR PROFITS, WHETHER IN AN ACTION OF CONTRACT, NEGLIGENCE OR OTHER TORTIOUS ACTION, ARISING OUT OF OR IN CONNECTION WITH THE USE OR PERFORMANCE OF THIS SOFTWARE.

COPYRIGHT (C) 2006-2007

THE REGENTS OF THE UNIVERSITY OF MICHIGAN ALL RIGHTS RESERVED.

Permission is granted to use, copy, create derivative works and redistribute this software and such derivative works for any purpose, so long as the name of The University of Michigan is not used in any advertising or publicity pertaining to the use of distribution of this software without specific, written prior authorization. If the above copyright notice or any other identification of the University of Michigan is included in any copy of any portion of this software, then the disclaimer below must also be included.

THIS SOFTWARE IS PROVIDED AS IS, WITHOUT REPRESENTATION FROM THE UNIVERSITY OF MICHIGAN AS TO ITS FITNESS FOR ANY PURPOSE, AND WITHOUT WARRANTY BY THE UNIVERSITY OF MICHIGAN OF ANY KIND, EITHER EXPRESS OR IMPLIED, INCLUDING WITHOUT LIMITATION THE IMPLIED WARRANTIES OF MERCHANTABILITY AND FITNESS FOR A PARTICULAR PURPOSE. THE REGENTS OF THE UNIVERSITY OF MICHIGAN SHALL NOT BE LIABLE FOR ANY DAMAGES, INCLUDING SPECIAL, INDIRECT, INCIDENTAL, OR CONSEQUENTIAL DAMAGES, WITH RESPECT TO ANY CLAIM ARISING OUT OF OR IN CONNECTION WITH THE USE OF THE SOFTWARE, EVEN IF IT HAS BEEN OR IS HEREAFTER ADVISED OF THE POSSIBILITY OF SUCH DAMAGES.

Copyright (c) 2002 Naval Research Laboratory (NRL/CCS)

Permission to use, copy, modify and distribute this software and its documentation is hereby granted, provided that both the copyright notice and this permission notice appear in all copies of the software, derivative works or modified versions, and any portions thereof.

NRL ALLOWS FREE USE OF THIS SOFTWARE IN ITS "AS IS" CONDITION AND DISCLAIMS ANY LIABILITY OF ANY KIND FOR ANY DAMAGES WHATSOEVER RESULTING FROM THE USE OF THIS SOFTWARE.

Copyright (C) 1986 Gary S. Brown. You may use this program, or code or tables extracted from it, as desired without restriction.

Copyright (c) 1994 CyberSAFE Corporation

Copyright (c) 1993 Open Computing Security Group

## Cyrus SASL statements

---

### The Cyrus SASL License

Copyright (c) 1998-2003 Carnegie Mellon University. All rights reserved.

Redistribution and use in source and binary forms, with or without modification, are permitted provided that the following conditions are met:

1. Redistributions of source code must retain the above copyright notice, this list of conditions and the following disclaimer.
2. Redistributions in binary form must reproduce the above copyright notice, this list of conditions and the following disclaimer in the documentation and/or other materials provided with the distribution.
3. The name "Carnegie Mellon University" must not be used to endorse or promote products derived from this software without prior written permission. For permission or any other legal details, please contact.

Office of Technology Transfer

Carnegie Mellon University

5000 Forbes Avenue

Pittsburgh, PA 15213-3890

(412) 268-4387, fax: (412) 268-7395

tech-transfer@andrew.cmu.edu

4. Redistributions of any form whatsoever must retain the following acknowledgment:

"This product includes software developed by Computing Services at Carnegie Mellon University (<http://www.cmu.edu/computing/>)."

CARNEGIE MELLON UNIVERSITY DISCLAIMS ALL WARRANTIES WITH REGARD TO HIS SOFTWARE, INCLUDING ALL IMPLIED WARRANTIES OF MERCHANTABILITY AND FITNESS, IN NO EVENT SHALL CARNEGIE MELLON UNIVERSITY BE LIABLE FOR ANY SPECIAL, INDIRECT OR CONSEQUENTIAL DAMAGES OR ANY DAMAGES WHATSOEVER RESULTING FROM LOSS OF USE, DATA OR PROFITS, WHETHER IN AN ACTION OF CONTRACT, NEGLIGENCE OR OTHER TORTIOUS ACTION, ARISING OUT OF OR IN CONNECTION WITH THE USE OR PERFORMANCE OF THIS SOFTWARE.

## OpenSSL statements

---

### OpenSSL License

Copyright © 1998-2005 The OpenSSL Project. All rights reserved.

Redistribution and use in source and binary forms, with or without modification, are permitted provided that the following conditions are met:

1. Redistributions of source code must retain the above copyright notice, this list of conditions and the following disclaimer.
2. Redistributions in binary form must reproduce the above copyright notice, this list of conditions and the following disclaimer in the documentation and/or other materials provided with the distribution.
3. All advertising materials mentioning features or use of this software must display the following acknowledgment: "This product includes software developed by the OpenSSL Project for use in the OpenSSL Toolkit. (<http://www.openssl.org/>)"
4. The names "OpenSSL Toolkit" and "OpenSSL Project" must not be used to endorse or promote products derived from this software without prior written permission. For written permission, please contact [openssl-core@openssl.org](mailto:openssl-core@openssl.org).
5. Products derived from this software may not be called "OpenSSL" nor may "OpenSSL" appear in their names without prior written permission of the OpenSSL Project.
6. Redistributions of any form whatsoever must retain the following acknowledgment: "This product includes software developed by the OpenSSL Project for use in the OpenSSL Toolkit (<http://www.openssl.org/>)"

THIS SOFTWARE IS PROVIDED BY THE OpenSSL PROJECT "AS IS" AND ANY EXPRESSED OR IMPLIED WARRANTIES, INCLUDING, BUT NOT LIMITED TO, THE IMPLIED WARRANTIES OF MERCHANTABILITY AND FITNESS FOR A PARTICULAR PURPOSE ARE DISCLAIMED. IN NO EVENT SHALL THE OpenSSL PROJECT OR ITS CONTRIBUTORS BE LIABLE FOR ANY DIRECT, INDIRECT, INCIDENTAL, SPECIAL, EXEMPLARY, OR CONSEQUENTIAL DAMAGES (INCLUDING, BUT NOT LIMITED TO, PROCUREMENT OF SUBSTITUTE GOODS OR SERVICES; LOSS OF USE, DATA, OR PROFITS; OR BUSINESS INTERRUPTION) HOWEVER CAUSED AND ON ANY THEORY OF LIABILITY, WHETHER IN CONTRACT, STRICT LIABILITY, OR TORT (INCLUDING NEGLIGENCE OR OTHERWISE) ARISING IN ANY WAY OUT OF THE USE OF THIS SOFTWARE, EVEN IF ADVISED OF THE POSSIBILITY OF SUCH DAMAGE.

This product includes cryptographic software written by Eric Young ([eay@cryptsoft.com](mailto:eay@cryptsoft.com)). This product includes software written by Tim Hudson ([tjh@cryptsoft.com](mailto:tjh@cryptsoft.com)).

### Original SSLeay License

Copyright © 1995-1998 Eric Young ([eay@cryptsoft.com](mailto:eay@cryptsoft.com)) All rights reserved.

This package is an SSL implementation written by Eric Young ([eay@cryptsoft.com](mailto:eay@cryptsoft.com)). The implementation was written so as to conform with Netscapes SSL.

This library is free for commercial and non-commercial use as long as the following conditions are adhered to. The following conditions apply to all code found in this distribution, be it the RC4, RSA, lhash, DES, etc., code; not just the SSL code. The SSL documentation included with this distribution is covered by the same copyright terms except that the holder is Tim Hudson ([tjh@cryptsoft.com](mailto:tjh@cryptsoft.com)).

Copyright remains Eric Young's, and as such any Copyright notices in the code are not to be removed. If this package is used in a product, Eric Young should be given attribution as the author of the parts of the library used. This can be in the form of a textual message at program startup or in documentation (online or textual) provided with the package.

Redistribution and use in source and binary forms, with or without modification, are permitted provided that the following conditions are met:

1. Redistributions of source code must retain the copyright notice, this list of conditions and the following disclaimer.
2. Redistributions in binary form must reproduce the above copyright notice, this list of conditions and the following disclaimer in the documentation and/or other materials provided with the distribution.
3. All advertising materials mentioning features or use of this software must display the following acknowledgement: "This product includes cryptographic software written by Eric Young (eay@cryptsoft.com)" The word 'cryptographic' can be left out if the routines from the library being used are not cryptographic related :-).
4. If you include any Windows specific code (or a derivative thereof) from the apps directory (application code) you must include an acknowledgement: "This product includes software written by Tim Hudson (tjh@cryptsoft.com)"

THIS SOFTWARE IS PROVIDED BY ERIC YOUNG "AS IS" AND ANY EXPRESS OR IMPLIED WARRANTIES, INCLUDING, BUT NOT LIMITED TO, THE IMPLIED WARRANTIES OF MERCHANTABILITY AND FITNESS FOR A PARTICULAR PURPOSE ARE DISCLAIMED. IN NO EVENT SHALL THE AUTHOR OR CONTRIBUTORS BE LIABLE FOR ANY DIRECT, INDIRECT, INCIDENTAL, SPECIAL, EXEMPLARY, OR CONSEQUENTIAL DAMAGES (INCLUDING, BUT NOT LIMITED TO, PROCUREMENT OF SUBSTITUTE GOODS OR SERVICES; LOSS OF USE, DATA, OR PROFITS; OR BUSINESS INTERRUPTION) HOWEVER CAUSED AND ON ANY THEORY OF LIABILITY, WHETHER IN CONTRACT, STRICT LIABILITY, OR TORT (INCLUDING NEGLIGENCE OR OTHERWISE) ARISING IN ANY WAY OUT OF THE USE OF THIS SOFTWARE, EVEN IF ADVISED OF THE POSSIBILITY OF SUCH DAMAGE.

The licence and distribution terms for any publically available version or derivative of this code cannot be changed. i.e. this code cannot simply be copied and put under another distribution licence [including the GNU Public Licence.]

## OpenLDAP Statements

---

### **This product includes software developed by the OpenLDAP Project.**

Unless otherwise expressly stated herein, The OpenLDAP Public License Version 2.8 shall be applied to individual files.

Copyright 1998-2007 The OpenLDAP Foundation All rights reserved.

Redistribution and use in source and binary forms, with or without modification, are permitted only as authorized by the OpenLDAP Public License.

A copy of this license is available in the file LICENSE in the top-level directory of the distribution or, alternatively, at <http://www.OpenLDAP.org/license.html>.

Portions Copyright 1999 Lars Uffmann.

All rights reserved.

Redistribution and use in source and binary forms, with or without modification, are permitted only as authorized by the OpenLDAP Public License.

Portions Copyright ©1990, 1993-1996 Regents of the University of Michigan. All rights reserved.

Redistribution and use in source and binary forms are permitted provided that this notice is preserved and that due credit is given to the University of Michigan at Ann Arbor. The name of the University may not be used to endorse or promote products derived from this software without specific prior written permission. This software is provided “as is” without express or implied warranty.

Portions Copyright ©1999, 2000 Novell, Inc. All Rights Reserved.

THIS WORK IS SUBJECT TO U.S. AND INTERNATIONAL COPYRIGHT LAWS AND TREATIES. USE, MODIFICATION, AND REDISTRIBUTION OF THIS WORK IS SUBJECT TO VERSION 2.0.1 OF THE OPENLDAP PUBLIC LICENSE, A COPY OF WHICH IS AVAILABLE AT [HTTP://WWW.OPENLDAP.ORG/LICENSE.HTML](http://www.openldap.org/license.html) OR IN THE FILE "LICENSE" IN THE TOP-LEVEL DIRECTORY OF THE DISTRIBUTION. ANY USE OR EXPLOITATION OF THIS WORK OTHER THAN AS AUTHORIZED IN VERSION 2.0.1 OF THE OPENLDAP PUBLIC LICENSE, OR OTHER PRIOR WRITTEN CONSENT FROM NOVELL, COULD SUBJECT THE PERPETRATOR TO CRIMINAL AND CIVIL LIABILITY.

Portions Copyright ©The Internet Society (1997).

See RFC 2251 for full legal notices.

### **The OpenLDAP Public License Version 2.8, 17 August 2003**

Redistribution and use of this software and associated documentation ("Software"), with or without modification, are permitted provided that the following conditions are met:

1. Redistributions in source form must retain copyright statements and notices,
2. Redistributions in binary form must reproduce applicable copyright statements and notices, this list of conditions, and the following disclaimer in the documentation and/or other materials provided with the distribution, and
3. Redistributions must contain a verbatim copy of this document.

The OpenLDAP Foundation may revise this license from time to time. Each revision is distinguished by a version number. You may use this Software under terms of this license revision or under the terms of any subsequent revision of the license.

THIS SOFTWARE IS PROVIDED BY THE OPENLDAP FOUNDATION AND ITS CONTRIBUTORS "AS IS" AND ANY EXPRESSED OR IMPLIED WARRANTIES, INCLUDING, BUT NOT LIMITED TO, THE IMPLIED WARRANTIES OF MERCHANTABILITY AND FITNESS FOR A PARTICULAR PURPOSE ARE DISCLAIMED. IN NO EVENT SHALL THE OPENLDAP FOUNDATION, ITS CONTRIBUTORS, OR THE AUTHOR(S) OR OWNER(S) OF THE SOFTWARE BE LIABLE FOR ANY DIRECT, INDIRECT, INCIDENTAL, SPECIAL, EXEMPLARY, OR CONSEQUENTIAL DAMAGES (INCLUDING, BUT NOT LIMITED TO, PROCUREMENT OF SUBSTITUTE GOODS OR SERVICES; LOSS OF USE, DATA, OR PROFITS; OR BUSINESS INTERRUPTION) HOWEVER CAUSED AND ON ANY THEORY OF LIABILITY, WHETHER IN CONTRACT, STRICT LIABILITY, OR TORT (INCLUDING NEGLIGENCE OR OTHERWISE) ARISING IN ANY WAY OUT OF THE USE OF THIS SOFTWARE, EVEN IF ADVISED OF THE POSSIBILITY OF SUCH DAMAGE.

The names of the authors and copyright holders must not be used in advertising or otherwise to promote the sale, use or other dealing in this Software without specific, written prior permission. Title to copyright in this Software shall at all times remain with copyright holders.

OpenLDAP is a registered trademark of the OpenLDAP Foundation. Copyright 1999-2003 The OpenLDAP Foundation, Redwood City, California, USA. All Rights Reserved.

Permission to copy and distribute verbatim copies of this document is granted.

A number of files contained in OpenLDAP Software contain a statement:

USE, MODIFICATION, AND REDISTRIBUTION OF THIS WORK IS SUBJECT TO VERSION 2.0.1 OF THE OPENLDAP PUBLIC LICENSE, A COPY OF WHICH IS AVAILABLE AT [HTTP://WWW.OPENLDAP.ORG/LICENSE.HTML](http://www.openldap.org/license.html) OR IN THE FILE "LICENSE" IN THE TOP-LEVEL DIRECTORY OF THE DISTRIBUTION.

The following is a verbatim copy of version 2.0.1 of the OpenLDAP Public License referenced in the above statement.

## **The OpenLDAP Public License**

Version 2.0.1, 21 December 1999

Copyright 1999, The OpenLDAP Foundation, Redwood City, California, USA. All Rights Reserved.

Redistribution and use of this software and associated documentation ("Software"), with or without modification, are permitted provided that the following conditions are met:

1. Redistributions of source code must retain copyright statements and notices. Redistributions must also contain a copy of this document.
2. Redistributions in binary form must reproduce the above copyright notice, this list of conditions and the following disclaimer in the documentation and/or other materials provided with the distribution.

3. The name "OpenLDAP" must not be used to endorse or promote products derived from this Software without prior written permission of the OpenLDAP Foundation. For written permission, please contact [foundation@openldap.org](mailto:foundation@openldap.org).
4. Products derived from this Software may not be called "OpenLDAP" nor may "OpenLDAP" appear in their names without prior written permission of the OpenLDAP Foundation. OpenLDAP is a trademark of the OpenLDAP Foundation.
5. Due credit should be given to the OpenLDAP Project (<http://www.openldap.org/>).

THIS SOFTWARE IS PROVIDED BY THE OPENLDAP FOUNDATION AND CONTRIBUTORS "AS IS" AND ANY EXPRESSED OR IMPLIED WARRANTIES, INCLUDING, BUT NOT LIMITED TO, THE IMPLIED WARRANTIES OF MERCHANTABILITY AND FITNESS FOR A PARTICULAR PURPOSE ARE DISCLAIMED. IN NO EVENT SHALL THE OPENLDAP FOUNDATION OR ITS CONTRIBUTORS BE LIABLE FOR ANY DIRECT, INDIRECT, INCIDENTAL, SPECIAL, EXEMPLARY, OR CONSEQUENTIAL DAMAGES (INCLUDING, BUT NOT LIMITED TO, PROCUREMENT OF SUBSTITUTE GOODS OR SERVICES; LOSS OF USE, DATA, OR PROFITS; OR BUSINESS INTERRUPTION) HOWEVER CAUSED AND ON ANY THEORY OF LIABILITY, WHETHER IN CONTRACT, STRICT LIABILITY, OR TORT (INCLUDING NEGLIGENCE OR OTHERWISE) ARISING IN ANY WAY OUT OF THE USE OF THIS SOFTWARE, EVEN IF ADVISED OF THE POSSIBILITY OF SUCH DAMAGE.

### **RFC 2251 Full Copyright Statement**

Copyright ©The Internet Society (1997). All Rights Reserved.

This document and translations of it may be copied and furnished to others, and derivative works that comment on or otherwise explain it or assist in its implementation may be prepared, copied, published and distributed, in whole or in part, without restriction of any kind, provided that the above copyright notice and this paragraph are included on all such copies and derivative works. However, this document itself may not be modified in any way, such as by removing the copyright notice or references to the Internet Society or other Internet organizations, except as needed for the purpose of developing Internet standards in which case the procedures for copyrights defined in the Internet Standards process must be followed, or as required to translate it into languages other than English.

The limited permissions granted above are perpetual and will not be revoked by the Internet Society or its successors or assigns.

This document and the information contained herein is provided on an "AS IS" basis and THE INTERNET SOCIETY AND THE INTERNET ENGINEERING TASK FORCE DISCLAIMS ALL WARRANTIES, EXPRESS OR IMPLIED, INCLUDING BUT NOT LIMITED TO ANY WARRANTY THAT THE USE OF THE INFORMATION HEREIN WILL NOT INFRINGE ANY RIGHTS OR ANY IMPLIED WARRANTIES OF MERCHANTABILITY OR FITNESS FOR A PARTICULAR PURPOSE.

# D

## Index

### A

Accessories and supplies .....iv  
Ad-hoc mode .....56, 83  
AES .....23  
AOSS™ .....28, 36, 51, 78, 102  
APIPA .....8, 100, 203  
APOP .....165  
ARP .....8, 204  
Authentication .....22

### B

BINARY\_P1 .....201  
BOOTP .....8, 94, 202  
BRAdmin Light .....1, 2  
BRAdmin Professional .....1, 3, 15, 18  
BRNxxxxx .....201  
BRNxxxxx\_AT .....201  
Brother  
    accessories and supplies .....iv  
Brother installer application .....28, 30  
Brother Solutions Center .....15, 18

### C

CA .....164, 173  
Certificate .....164, 173  
Channels .....22  
CIFS .....10  
CKIP .....23  
Control panel .....19  
CSR .....164  
Custom Raw Port .....9

### D

DHCP .....8, 94, 201  
Digital signature .....164  
DNS client .....8  
DNS server .....99  
Domain .....133, 134  
Driver Deployment Wizard .....1, 124

### E

EAP-FAST .....23  
Encryption .....23

### F

Factory default .....123  
Firewall .....191, 194, 196

### G

Gateway .....96

### H

HTTPS .....165, 167  
Hyper Text Transfer Protocol .....20

### I

Infrastructure mode .....41, 68  
Internet printing .....1, 132  
IP address .....12, 95  
IPP .....9, 132  
IPPS .....165, 170  
IPv6 .....10, 100

### L

LDAP .....10, 153  
LEAP .....23  
LLMNR .....9  
LLTD .....11  
LPR/LPD .....9

### M

MAC Address .....15, 16, 18, 19, 45, 62, 72, 87,  
.....97, 123, 133, 134, 138, 139,  
.....142, 201, 202, 203, 204, 207  
Macintosh printing .....137  
mDNS .....9

### N

NetBIOS name resolution .....8  
Network Configuration List .....123  
Network Key .....24  
Network printing .....129  
Network shared printing .....6  
Node name .....97



## O

Open Source Licensing Remarks .....	227
Open system .....	22
Operating systems .....	1

## P

Password .....	132
PBC .....	28, 36, 102
PCL_P1 .....	201
Peer-to-Peer .....	5
PIN Method .....	29, 39, 102
Ping .....	194, 195
POP before SMTP .....	165, 171
POSTSCRIPT_P1 .....	201
Print server setting .....	18
private key .....	173
Protocol .....	8
Public key cryptosystem .....	164

## R

RARP .....	8, 94, 203
Remote Setup .....	1, 20
Restoring the network settings .....	123
RFC 1001 .....	201

## S

SecureEasySetup™ .....	28, 36, 51, 78, 102
Security terms .....	164
Service .....	201
Shared key .....	22
Shared key cryptosystem .....	164
Simple Network Configuration for Mac OS X .....	192
SMTP client .....	9
SMTP-AUTH .....	165, 171
SNMP .....	9
SNMPv3 .....	165, 167
Specifications .....	209
SSID .....	22
SSL/TLS .....	165, 173
Status Monitor .....	1
Subnet mask .....	13, 95

## T

TCP/IP .....	8, 93
TCP/IP printing .....	129
TELNET .....	9, 205
Text	
entering .....	225
special characters .....	226
TEXT_P1 .....	201
TKIP .....	23
Trademarks .....	i

## W

Web Based Management (web browser)	
.....	20, 166, 167
Web BRAdmin .....	3
Web server (HTTP) .....	10
Web server (HTTPS) .....	165
Web services .....	10, 207
WEP .....	23
Wi-Fi Protected Setup .....	28, 29, 36, 39, 51, 78, 102
WINS .....	9
WINS Config .....	97
WINS Server .....	98
Wireless network .....	21
WPA-PSK/WPA2-PSK .....	22